

Birla Central Library

PILANI (Rajasthan)

Class No. 671

Book No. C75M

Accession No. 37545

METAL CASTINGS

BOOKS BY H. L. CAMPBELL

METAL CASTINGS

318 pages. 6 by 9. 174 figures.

**THE WORKING, HEAT TREATING, AND
WELDING OF STEEL**

Second Edition. Supplemented with a series of
laboratory assignments. 230 pages. 6 by 9. 133
figures.

PUBLISHED BY

JOHN WILEY & SONS, Inc.

METAL CASTING

BY

HARRY L. CAMPBELL, M.S.

NEW YORK

JOHN WILEY & SONS, Inc.

LONDON: CHAPMAN & HALL, LIMITED

COPYRIGHT, 1936
By HARRY L. CAMPBELL

All Rights Reserved

*This book or any part thereof must not
produced in any form without
ritten permission of the publisher.*

ELFTH PRINTING, APRIL, 1950

PRINTED IN U. S. A.

“ TO THOSE PIONEERS
OF THE PAST AND PRESENT
WHO BY WRITTEN RECORDS
HAVE CONTRIBUTED TO THE
ADVANCEMENT OF THE
VARIOUS DIVISIONS OF THE
METAL-CASTING INDUSTRY
THIS BOOK IS RESPECTFULLY
. DEDICATED ”



"PREFACE"

This textbook has been prepared to assist in the organized study of the materials and processes employed in the production of metal castings. The reasons for the selection of materials and the procedure used in the manufacturing processes are explained. Special consideration is given to the constitution, properties, and classification of the cast ferrous and non-ferrous alloys. The relationship of design to the production of metal castings is an important division of this study. A bibliography is appended to each chapter to aid those who desire further information on the subjects presented. The review questions offer to the reader an opportunity for testing his knowledge of the content of each chapter. Attention is directed to the Appendix for tabulated data, standard specifications for the cast metals, and foundry control methods.

In the preparation of this textbook, the author has supplemented the results of his research with the developments of many other investigators. Proper acknowledgment is made in the text to these sources of instruction. It is appropriate, however, to refer to the admirable works of Thomas D. West, Thomas Turner, W. J. Keep, H. M. Howe, Richard Moldenke, J. H. Hall, W. H. Hatfield, H. A. Schwartz, J. W. Bolton, R. H. MacPherran, and R. A. Bull, who have contributed extensively to the advancement of the casting industry. The author is indebted to J. W. Bolton, R. A. Bull, D. P. Forbes, John Grennan, D. J. Reese, Enrique Touceda, and F. L. Wolf for reviewing portions of the text, and to Professor C. Uptegrove for the photomicrographs.

H. L. CAMPBELL

ANN ARBOR, MICHIGAN,
MAY, 1936.

CONTENTS

CHAPTER	PAGE
I. THE METAL-CASTING INDUSTRY.....	1
II. MATERIALS FOR THE FOUNDRY.....	10
✓ III. MOLDING PRACTICE.....	30
✓ IV. CORE PRACTICE.....	68
V. MELTING PROCESSES FOR CAST IRON.....	86
VI. METHODS AND EQUIPMENT FOR CLEANING AND RECLAIMING CASTINGS..	118
VII. THE CONSTITUTION OF CAST IRON.....	135
VIII. THE PROPERTIES OF CAST IRON.....	152
IX. THE CLASSIFICATION OF IRON CASTINGS.....	163
X. CALCULATION OF THE METAL CHARGES FOR THE CUPOLA.....	174
✓ XI. MALLEABLE IRON CASTINGS.....	192
✓ XII. STEEL CASTINGS.....	202
XIII. NON-FERROUS METAL CASTINGS.....	222
XIV. THE DESIGN OF METAL CASTINGS.....	253
XV. COMPARATIVE PROPERTIES OF THE CAST METALS.....	264
APPENDIX	
I. TABULATED DATA.....	279
II. SPECIFICATIONS FOR THE CAST METALS.....	285
III. METHODS FOR SAND TESTING.....	305
IV. METHODS FOR CORE TESTING.....	312
INDEX.....	315



METAL CASTINGS

CHAPTER I

THE METAL-CASTING INDUSTRY

EXTENT OF THE CASTING INDUSTRY—DIVISIONS OF THE CASTING INDUSTRY—DEVELOPMENTS IN THE CASTING INDUSTRY—NATIONAL ASSOCIATIONS OF FOUNDRYMEN

Metal castings are produced by pouring molten metal into molds having the desired shapes and approximate sizes of the castings, and allowing the metal to solidify. The origin of the casting method for obtaining metal products is obscured in prehistoric times; it is probable that the earliest castings were made of gold or copper because these metals were found in a free state, and were formed to the desired shapes in molds of stone or clay. The art and the science of this method of shaping metals in the liquid state have been in process of development through many centuries, and the applications of the product have become so extensive that an industry of tremendous magnitude has grown up to meet the requirements for metal castings.

In "The History of Iron and Steel," G. E. Thackray states: "As far as we can learn, the first real operating iron works in this country was established in Lynn, Massachusetts, in 1643 to 1645. As the country developed and became more settled, other iron works were started and operated in New York State, Connecticut, and New Jersey, there being 76 iron works in Massachusetts in 1774."¹ The early blast furnaces used ores from nearby sources and charcoal for fuel. The metal from these furnaces was poured directly into molds for stove plate, kettles, andirons, baking pans, and other household articles. It was not until 1820 that the cupola furnace came into use in the United States.² This method of melting gradually replaced the small blast furnaces, and for many years the cupola furnace has been the most extensively used melting unit for gray iron castings.

¹ Reference numbers in the text correspond with similar numbers in the Bibliography at the end of the chapter.

Another division of the casting industry is the manufacture of malleable iron castings, a process which, as used in America, was originally devised by Seth Boyden at Newark, New Jersey, in 1826. The entire practice for making malleable iron castings has been developed gradually through the control of the melting, molding, and annealing operations.

The production of steel castings necessarily followed the developments in the steel-making processes. The first company to make steel by the Bessemer process was organized in 1866. Later, a number of works for the making of converter steel were built in the United States. The Siemens furnace for open-hearth steel was used in England about 1868; two years later the first successful open-hearth furnace in America was built at Boston, Massachusetts.

EXTENT OF THE CASTING INDUSTRY

The Foundry magazine³ has reported that the number of foundries in the United States in 1935 was 5,080; of this total, 3,215 foundries

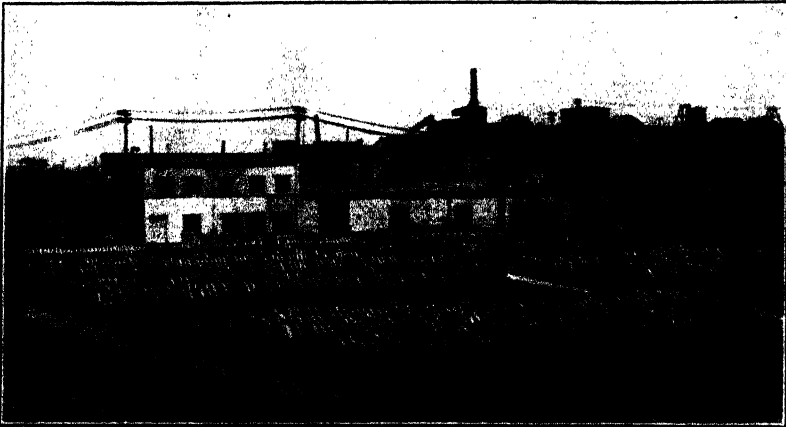

Courtesy of Griffin Wheel Company

FIG. 1.—CAR WHEELS ON LOADING PLATFORM

produced gray iron castings, 147 produced malleable iron castings, 319 produced steel castings, and 2,574 produced castings of brass, bronze, and aluminum alloys. Some foundries make castings of several types of metals. The leading foundry centers in the United States are Chicago, Cleveland, New York, Los Angeles, and Detroit.

The total tonnage of gray iron castings produced annually in the United States is indefinite; it has been estimated, however, that over

15,000,000 tons of iron castings are made each year. Some foundries make as much as 2,000 tons of iron castings in one day. Approximately twenty million chilled-iron wheels for freight cars are in service in the United States, requiring an annual replacement of about three million. *The American Iron and Steel Institute* has reported a total production of 537,673 tons of cast-iron pipe for 1934. The total production of malleable iron castings as reported by the *U. S. Department*



Courtesy of The Cast-Iron Pipe Research Association

FIG. 2.—CAST-IRON PIPE LINE

Diameter of pipe, 36 inches. Length of line, 25 miles.

of Commerce for 1934 was 369,458 tons, this amount being about 36 per cent of the possible capacity of malleable iron plants in the United States. The yearly capacity for the production of steel castings in the United States has been estimated by the *Steel Founders' Society of America* as 2,298,506 net tons. In 1933, the quantity of brass and bronze castings produced in the United States was 73,086,627 pounds as reported by the *U. S. Department of Commerce*.

The following examples show the importance of metal castings in the construction of modern machines. The crawler shovel illustrated in Fig. 3 weighs approximately 115,000 pounds, 45 per cent of the total weight of which is made of carbon steel castings, 22 per cent of alloy steel castings, 10.3 per cent of iron castings, and 1.4 per cent of bronze castings. At least 78 per cent of the weight of the materials used in building this shovel was produced in the foundry. The tractor shown



Courtesy of Link-Belt Company

FIG. 3.—CRAWLER SHOVEL

Metal castings, 78 per cent of total weight.

in Fig. 4 contains 6,375 pounds (188 pieces) of gray iron castings, 1,865 pounds (105 pieces) of malleable iron castings, 1,775 pounds (23 pieces) of steel castings, and 100 pounds (64 pieces) of brass, bronze, and aluminum castings. In the construction of this machine, 53 per cent of its total weight was made of metal castings. The overhead traveling crane illustrated in Fig. 5 weighs 320,000 pounds and has a lifting capacity of 400,000 pounds. The construction of this crane required 52,550 pounds of steel castings used in the bridge trucks, side frames of trolleys, and

for gears; and 19,900 pounds of gray iron castings used in the gear covers, hoisting drums, and other parts. About one-fourth of the entire weight of the structure is made of metal castings.

DIVISIONS OF THE CASTING INDUSTRY

Castings of gray iron, malleable iron, steel, and the non-ferrous alloys are usually made in independent manufacturing units. This separation of the casting industry into divisions based on the types of castings pro-

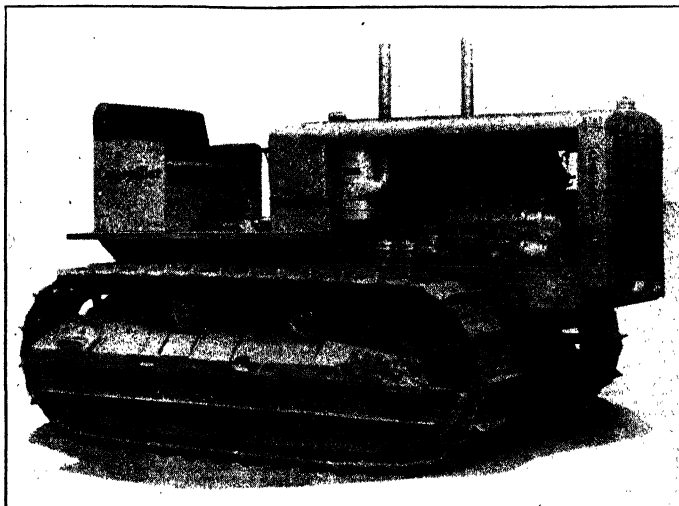

Courtesy of Caterpillar Tractor Company

FIG. 4.—TRACTOR

Metal castings, 53 per cent of total weight.

duced is caused by the differences in melting equipment as well as molding materials required in the different processes. Specialization in the manufacture of castings of one type of metal is the rule; however, some foundries produce castings from both the ferrous and the non-ferrous metals.

Foundries in general may be classified into two main groups, production foundries and jobbing foundries. The difference lies in the number of castings made of similar designs. In the **production foundry**, large numbers of castings are made from relatively few patterns, special equipment being provided to facilitate the rapid manufacture of a standardized product. The employment of labor-saving machinery and the accurate control of all operations result in low unit costs of the

product. Cast-iron pipe, parts for stoves, car wheels, piston rings, and automobile cylinder blocks are examples of castings made in production foundries.

In the **jobbing foundry**, a small number of castings are made of each design; therefore, a large variety of patterns must be handled. This practice limits to some extent the possibility of standardization in equipment and methods so that the manufacturing cost of castings made in the jobbing foundry is necessarily greater than in the production foundry.

The operations which are necessary for the production of metal castings are grouped in departments for purposes of administration. These divisions of the foundry generally include the core department, the molding department, the melting department, and the cleaning depart-

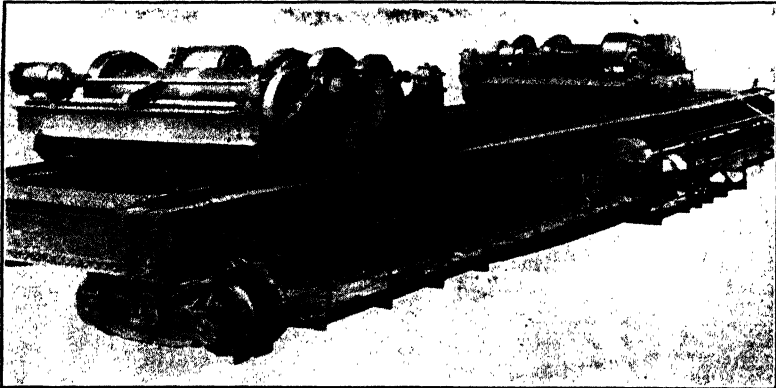

Courtesy of Harnischfeger Corporation

FIG. 5.—TRAVELING CRANE

Metal castings, over 23 per cent of total weight.

ment. An additional department is sometimes required for the heat treatment of castings. Each of these departments contributes in a vital way to the production of good castings.

DEVELOPMENTS IN THE CASTING INDUSTRY

Improved physical properties and greater reliability of the metal in castings are the result of close attention to materials and plant processes.⁴ It is generally recognized that chemical control is essential to the operation of all metallurgical processes. The properties of the cast metals are dependent upon their compositions, and with accurate control of the composition, as well as of the melting and molding operations, uniform machining qualities and reliability of the castings are assured.

A better understanding of furnace practice is also causing an improvement of the qualities of the foundry product. Furthermore, the control of molding materials and cores aids in the economical production of metal castings.

The general use of mechanical equipment in the foundry is making possible a remarkable increase in production with a corresponding decrease in unit costs. A superior product is being obtained by better pattern and molding equipment, by more efficient sand-handling and mixing machinery, and by conveying systems for metal and molds.



FIG. 6.—PRODUCTION FOUNDRY

The cost of cleaning and reclaiming castings has been greatly reduced by the adoption of improved methods and equipment.

One of the most marked advances in the ferrous division of the casting industry is the use of special alloys in steel and cast iron. The valuable properties obtained by special alloy combinations have extended the use of these new products. Some machine parts which have been made regularly of forged steel are being replaced successfully by alloy cast iron. In the field of corrosion- and heat-resisting castings, alloys containing chromium and nickel are finding extensive outlets for industrial equipment.

In the non-ferrous division, improvements have been brought about as the result of the availability of purer metals, the use of new alloy combinations, and better melting practice. The present tendency at many foundries is to decrease the number of alloys produced and to standardize on a few specific types. Die-casting applications are growing in volume and importance as a result of the use of superior alloys and improved casting equipment.

Special attention is being given to the design of castings so as to obtain the full benefit of the properties of the cast metals and to facili-



FIG. 7.—JOBGING FOUNDRY

tate the casting of these materials. In some cases, castings are being redesigned to obtain lower cost of production and better service conditions.

NATIONAL ASSOCIATIONS OF FOUNDRYMEN

The *American Foundrymen's Association* was organized in 1896 to promote and improve the production and application of the cast metals and alloys, and to distribute information relating to all phases of foundry practice. This association holds annual meetings for the presentation of reports and papers on foundry topics; sponsors periodic local and district meetings of foundrymen; encourages research to improve materials, processes, and methods; cooperates with other technical

societies in the development of specifications and standards; and, at frequent intervals, publishes data on the cast products for the benefit of users and producers of metal castings.

Other organizations which have an active part in promoting the interests of the casting industry are the *Malleable Iron Research Institute*, the *Steel Founders' Society of America*, the *National Founders' Association*, the *Gray Iron Founders' Society*, the *Non-Ferrous Foundry Association*, the *American Society for Testing Materials*, and the *U. S. Bureau of Standards*.

BIBLIOGRAPHY

1. G. E. THACKRAY, "Notes on the History of Iron and Steel." *Trans. A.S.S.T.*, v. VI (1924), p. 443-490.
2. RICHARD MOLDENKE, "The Principles of Iron Founding." 1930. McGraw-Hill Book Company, New York, N. Y.
3. DAN AVEY, "Foundries in the United States." *The Foundry*, v. 63 (1935), n. 6, p. 48.
4. H. R. SIMONDS, "Notable Advance Made in Foundry Practice in the Last Ten Years." *The Iron Age*, v. 132 (1932), p. 1097-1099.

REVIEW QUESTIONS

I

What process was used for obtaining the metal for the first gray iron castings?

II

What was the order of development of the iron alloys for castings?

III

What are the leading foundry centers in the United States?

IV

Define the two main groups into which all foundries may be classified.

V

Name the production departments of a foundry.

VI

What methods of control are used in modern foundry practice?

VII

What improvements in foundry practice have resulted in increased production and decreased costs?

VIII

What national associations have aided in the progress of the casting industry?

CHAPTER II

MATERIALS FOR THE FOUNDRY

METALS—Manufacture of Pig Iron—Classification of Pig Iron—Ferro-Alloys—Ferrosilicon—Ferromanganese—Ferrochromium—Ferromolybdenum—Ferrovanadium—Scrap Metals—FUELS—By-Product Coke—Beehive Coke—Fuel Oil—Gas—FLUXES—Limestone—Fluorspar—Soda Ash—REFRACTORIES—Foundry Sands—Requirements of Molding Sands—Test Methods for Molding Sands—Sources of Supply of Molding Sands—Core Sands—Fire Clay—Bentonite—Ganister—Fire Brick—Graphite Crucibles

The materials which are purchased in large quantities for foundry use may be placed in four general groups: metals, fuels, fluxes, and refractories. The metals include pig iron; ferro-alloys; ingot copper, tin, lead, zinc, and aluminum; and scrap metals. Practically all the industrial fuels are used to some extent in foundry practice. The materials which serve as fluxes during melting operations are limestone, fluorspar, and soda ash. Under refractories are included sand, clay, and ganister, as well as manufactured shapes such as fire brick and crucibles. The qualities and characteristics of the important materials used in the foundry are discussed in this chapter, and the prices of these materials are given in Table I. Those supplies which are needed in smaller amounts in the foundry include sand binders, blackings, chaplets, and grinding wheels, reference to which will be made in later discussions. All materials and supplies for the foundry should be purchased under specifications which define the requirements for their particular uses.

METALS

This group of materials which are purchased for foundry use includes pig iron, ingot metals, ferro-alloys, and scrap metals. Special attention is given to the classification and selection of these important foundry materials. The compositions and other requirements of the non-ferrous metals and alloys are given in Chapter XIII.

Manufacture of Pig Iron

Pig iron is produced by smelting iron ores in blast furnaces, and casting the molten iron into pieces of convenient size for handling. The

TABLE I
 PRICES OF MATERIALS FOR THE FOUNDRY
 At Chicago, Ill., February, 1936

Material	Class or Grade	Price
Pig Iron.....	Bessemer.....	\$20.00 Gross Ton
Pig Iron.....	Basic.....	19.00 Gross Ton
Pig Iron.....	Forge.....	19.00 Gross Ton
Pig Iron.....	No. 2 Foundry.....	19.50 Gross Ton
Pig Iron.....	Malleable.....	19.50 Gross Ton
Pig Iron.....	Low-Phosphorus.....	24.00 Gross Ton
Pig Iron.....	Charcoal.....	25.25 Gross Ton
Ferromanganese.....	80% Mn.....	85.00 Gross Ton
Spiegeleisen.....	19-21% Mn.....	26.00 Gross Ton
Ferrosilicon.....	50% Si.....	77.50 Gross Ton
Ferrosilicon.....	Electric 15% Si.....	35.00 Gross Ton
Ferrosilicon.....	Bessemer 15% Si.....	34.50 Gross Ton
Silvery Iron.....	8% Si.....	26.00 Gross Ton
Copper.....	Lake.....	.09 Pound
Tin.....	Straits.....	.48 Pound
Lead.....		.05 Pound
Zinc.....		.05 Pound
Antimony.....		.13 Pound
Aluminum.....		.21 Pound
Magnesium.....		.30 Pound
Nickel.....	92% Ni, 6% Si.....	.34 Pound
Phosphor Copper.....	15% P, 85% Cu.....	.20 Pound
Aluminum-Copper.....	50% Al, 50% Cu.....	.28 Pound
Aluminum-Silicon.....	50% Al, 50% Si.....	.31 Pound
Ferrochromium.....	66-70% Cr, 4-6% C.....	.10 Pound of Cr
Ferromolybdenum.....	55-65% Mo.....	.95 Pound of Mo
Ferrovandium.....	30-45% Va.....	2.80 Pound of Va
Scrap Iron.....	No. 1 Machinery.....	12.00 Net Ton
Scrap Steel.....	Rails.....	15.50 Net Ton
Foundry Coke.....	Beehive.....	9.50 Net Ton
Foundry Coke.....	By-Product.....	9.75 Net Ton
Limestone.....	Cupola.....	3.20 Net Ton
Fluorspar.....	85% CaF ₂	17.50 Net Ton
Soda Ash.....	Fused.....	25.00 Net Ton
Iron Molding Sand.....	Average.....	3.50 Net Ton
Core Sand.....	Lake.....	1.00 Net Ton
Steel Molding Sand.....	Silica.....	1.50 Net Ton
Fire Clay.....	Plastic.....	2.50 Net Ton
Sea Coal.....	Best.....	14.00 Net Ton
Bentonite.....	Best.....	18.00 Net Ton
Fire Clay Brick.....	Best.....	45.00 1,000
Silica Brick.....	Best.....	54.00 1,000
Magnesite Brick.....	Best.....	72.50 1,000
Graphite Crucibles.....	Best.....	.11 Number

modern blast furnace is constructed of a steel shell about 90 feet in height, lined with refractories, and having necessary means for introducing iron ore, fuel, and flux at the top, and air near the bottom; and for removing molten metal and slag near the bottom and gases near the top. The furnace is circular at all levels and has a maximum diameter of about 25 feet. In order to permit continuous operation of the blast furnace, the temperature of the lining is controlled by the use of water-cooled plates at certain locations in the furnace wall.

The modern blast furnace requires about 1,200 tons of ore, 600 tons of coke, and 250 tons of limestone every 24 hours. During the same

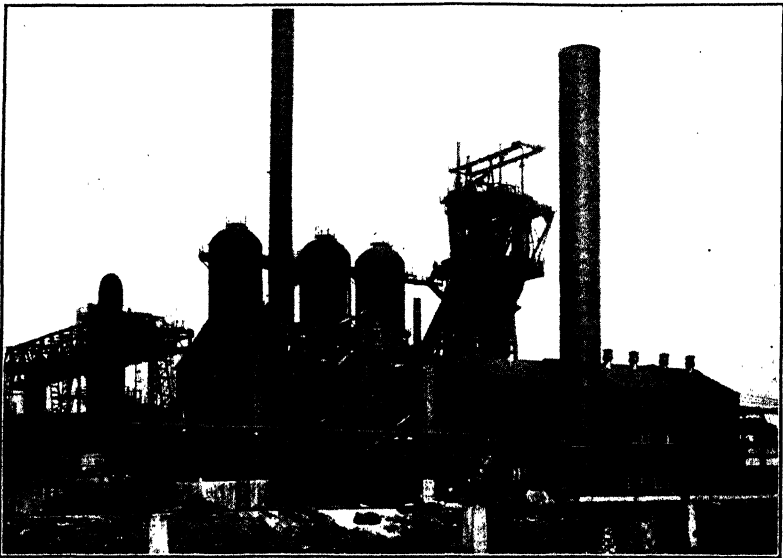

FIG. 8.—BLAST FURNACE PLANT

period, 2,400 tons of air at a temperature of 900 to 1400 degrees F., and at a pressure of 8 to 16 lb. per sq. in. are supplied to the furnace. The average production from this furnace is 600 tons of pig iron in 24 hours. A blast-furnace plant is shown in Fig. 8.

During the operation of the blast furnace, the combustion of the fuel produces heat as well as reducing gases which cause the formation of metallic iron from the oxides of iron in the ore. At the same time, some silicon and manganese are reduced from the compounds of these elements which are present in the furnace charges. Most of the phosphorus and sulphur in the ore and fuel are taken up by the iron. On exposure to the heat within the furnace, the limestone is converted into

lime which combines with the earthy constituents from the ore and the ash from the fuel to form a liquid slag. The molten iron is drawn off from the bottom of the furnace, and the slag which collects above the metal is tapped off at a higher level.

Pig iron is essentially a combination of chemical elements, the proportions of which are controlled to a large extent by the composition of the ore from which the iron was produced. The principal ore-producing sections of the United States are the Lake Superior district which includes portions of Minnesota, Michigan, and Wisconsin; the southern district in Alabama, Georgia, and Tennessee; and the eastern district with iron ore deposits in New York, New Jersey, and Pennsylvania. From the Lake Superior ores which are comparatively pure, pig iron is produced containing low sulphur (less than 0.05 per cent), low phosphorus (0.10 to 0.40 per cent), and medium manganese (0.40 to 2.00 per cent). With few exceptions, all ores found in the southern district are high in phosphorus, and as a result of this condition, only high-phosphorus (0.50 to 1.00 per cent) irons are marketed from this section. Certain ores from the eastern district are used in making a superior grade of pig iron with a low sulphur and phosphorus content (each less than 0.035 per cent).

The silicon content of pig iron can be controlled to some extent by changes in the blast-furnace practice. The higher the temperature within the furnace, the greater will be the proportion of silicon reduced from the furnace charges. This practice requires a larger ratio of fuel, which increases the cost and also decreases the output from the furnace.

Classification of Pig Iron

On account of the differences in the materials used and in the operation of blast furnaces, a definite plan is necessary for classifying pig iron. This classification is based upon: first, the kind of fuel used in the blast furnace; second, the method of casting the metal; and third, the purpose for which the metal is produced, or its industrial use. The fuel used in smelting iron ore is either coke or charcoal. Of the total number of active blast furnaces in the United States in 1933, 270 were operated with coke and only 5 with charcoal. As a rule, charcoal iron is produced in relatively small furnaces under conditions which permit a higher total carbon and a lower sulphur content than are obtained in coke iron. On account of the higher cost of the fuel used, the market price of charcoal iron is considerably higher than that of coke iron. Refer to Table I.

Pig iron is classified into two groups according to the method of casting the metal from the blast furnace. When the iron is allowed to run directly from the furnace into sand molds, the product is known as **sand-cast pig iron**. When the iron is cast into a series of metal molds mounted on a conveyor, the metal in this form is designated as **machine-cast pig iron**. The distinction between these two forms of pig iron has little importance, except that the machine-casting method produces a cleaner product than is possible with the sand-casting method.

The third method of classifying pig iron provides for ranges of composition which are suited to different metallurgical processes as stated in Table II. The acid **Bessemer** process for steel making requires an iron with relatively low silicon, low sulphur, and low phosphorus con-

TABLE II
RANGES OF COMPOSITION OF PIG IRON

Class or Grade of Pig Iron	Silicon, %	Sulphur, %	Phosphorus, %
Bessemer.....	1.00 to 2.00	less than 0.05	less than 0.10
Basic.....	less than 1.00	less than 0.05	less than 1.00
Forge.....	less than 1.50	less than 0.10	less than 1.00
Foundry.....	0.50 to 3.75	0.02 to 0.05	0.10 to 1.00
Malleable.....	0.75 to 2.00	less than 0.05	less than 0.20
Low-Phosphorus.....	1.50 to 3.50	less than 0.035	less than 0.035

tent. The grade known as **basic pig iron** is used in the production of basic open-hearth steel. As this process provides for the purification of the metal, an iron with a high phosphorus content can be used. **Forge pig iron** with a relatively high sulphur and phosphorus content is used in the puddling process for the manufacture of wrought iron. In the **foundry** group of irons for gray iron castings, a wide range of composition is provided. The limits on the composition of the **malleable** class of pig iron are suited to the manufacture of malleable iron castings. The **low-phosphorus** grade of iron is required at foundries making steel castings by the acid open-hearth and converter processes.

The grading of pig iron, other than the general classification which has been described, has not been standardized by the producers and merchants of this material throughout the United States. Therefore, it is necessary when ordering pig iron to specify ranges of composition

sued to the specific foundry practice. The silicon content of pig iron is usually specified in ranges of 0.25 per cent. Thus, if an iron with about 2.00 per cent silicon is desired, any iron within a range of 2.00 to 2.25 per cent would be satisfactory to the purchaser. The sulphur content is ordinarily stated as the maximum amount allowed. Phosphorus and manganese are specified as limiting ranges usually with variations of 0.20 per cent.

The prices of pig iron are dependent on the chemical composition of this material; as the silicon and manganese increase, the price advances. All pig iron is sold on the basis of a gross ton of 2,240 pounds. At the blast-furnace plant each lot of pig iron is sampled and analyzed, and the chemical analysis of the metal is sent to the purchaser. When the cars of pig iron are received at the foundry, they are piled separately and each pile is properly marked. In order to avoid any discrepancy in records, many foundries check the furnace analysis of each car of iron before it is used.

Ferro-Alloys

Certain alloys of iron are purchased by foundries to be used as deoxidizers and cleansers of the molten metal, or to increase the proportion of one or more elements in the metal. These alloys are supplied in the form of pigs, lumps, briquets, or in a finely pulverized state. The prices of the ferro-alloys are dependent upon the amounts of the special elements in the alloys. Refer to Table I.

Ferrosilicon.—Several grades of ferrosilicon are available with the silicon ranging from 47 to 95 per cent. These high-silicon alloys are produced in electric furnaces from iron ore (or steel scrap), silica sand, and carbon. The 50 per cent alloy has a melting temperature of about 2170 degrees F. Other ferrosilicon alloys containing 5 to 17 per cent silicon and 0.25 to 3.00 per cent manganese are produced in blast furnaces by smelting siliceous iron ores at very high temperatures. This product is known as **silvery iron** and is classified into a standard grade with phosphorus over 0.10 per cent and Bessemer ferrosilicon with a phosphorus content of 0.10 per cent or less. These alloys are supplied within limits of plus or minus 0.25 per cent of the specified silicon and manganese contents. The melting temperatures of these alloys are about 2100 degrees F.

Ferromanganese.—The standard grade of ferromanganese, which is an electric furnace product, has the following analysis: manganese, 78 to 82 per cent; iron, 15 to 19 per cent; carbon, 6 to 8 per cent; silicon, maximum 1.00 per cent; and phosphorus, maximum 0.25 per cent.

This alloy melts between 2280 and 2325 degrees F. **Spiegeleisen** contains 15 to 30 per cent manganese, and is produced by smelting ores rich in manganese in a blast furnace. This material in the form of pigs is used to supply manganese to the metal in the Bessemer and open-hearth steel processes. The melting point of spiegeleisen is between 1950 and 2265 degrees F.

Ferrochromium.—Chromium is added to cast iron and steel in alloys which contain 60 to 75 per cent of this element. Ferrochromium is produced in the electric furnace from charges of anthracite coal and ores containing chromium. The melting temperatures of the chromium alloys range from 2200 degrees F. for alloys with a high carbon content (4 to 8 per cent), to 2800 degrees F. for alloys with a low carbon content (0.10 to 2.00 per cent).

Ferromolybdenum.—The commercial alloy of molybdenum contains 55 to 65 per cent molybdenum. It is generally supplied in crushed form and has a melting temperature of approximately 2965 degrees F. Ferromolybdenum dissolves readily in molten cast iron or steel.

Ferrovandium.—The beneficial effects of vanadium are obtained by additions of ferrovandium to the molten metals. The approximate analysis of this alloy is as follows: vanadium, 30 to 45 per cent; silicon, 1.25 to 12.00 per cent; carbon, 0.35 to 3.50 per cent. Its melting temperature is between 2280 and 2550 degrees F.

SCRAP METALS

All metals which have no particular use in their existing forms may be considered as scrap metals. This material is remelted with or without the addition of new metals and cast into the desired shapes. At all foundries, scrap metals are divided into two classes which are designated as foundry scrap and purchased scrap. **Foundry scrap** consists of gates, risers, defective castings, and metal which has been melted in excess of immediate requirements for castings. **Purchased scrap** includes all scrap metals which are brought to the foundry from outside sources. In modern foundry practice, the compositions of all metal mixtures are accurately controlled. As these mixtures often contain large proportions of scrap metals, it is important that only definite grades of scrap be purchased.

Scrap metals are classified into the various kinds of metals such as steel, cast iron, copper, and yellow brass. Furthermore, dealers in scrap metals sort these materials in piles according to the previous uses of the metal parts, such as stove-plate, machinery, car wheels, structural

steel, steel rails, and sheet copper. This method of classification is not based directly on the chemical composition of the material; nevertheless, the average composition of every carefully selected group of metal scrap is within a limited range. This composition can be estimated, or an analysis can be made at the foundry of each lot of scrap metal for use in preparing metal mixtures.

The extensive use of special alloying elements in steel and cast iron makes the sorting of scrap metals considerably involved. Additions of nickel, chromium, vanadium, or molybdenum produce favorable qualities when used under properly controlled conditions. On the other hand, a small proportion of an unexpected alloy in some metal mixtures may interfere seriously with the development of the desired properties. As it is somewhat difficult to ascertain the alloy content of cast-iron and steel scrap, it is desirable to separate the scrap metals into lots from definite sources and to determine the compositions of the metals used at those plants from which the scrap was obtained. Under these conditions, the alloy content of the scrap metals can be utilized to best advantage.

Specifications for scrap metals vary to a large extent, although there is a tendency to adopt the classification proposed by the *American Foundrymen's Association* or the *Railway Storekeepers' Association*.³ Every foundry should have its own specifications for scrap metals to suit local conditions or for special requirements. The kind of metal as well as the limiting dimensions, weight, and cleanliness of the pieces are generally given in the specifications.

Two typical specifications for scrap metals are given here to illustrate the limitations which may be prescribed for these foundry materials.

Specification for Steel Scrap for Foundry "A"

Scrap such as steel plate from boiler shops, or drop-forge flashings, or structural steel, or steel rails is required.

Pieces shall be not over 18 inches in length or width, and not less than $\frac{1}{8}$ inch in thickness.

Pieces shall range in weight from 2 to 40 pounds.

Only steel with the sulphur and phosphorus each below 0.06 per cent shall be accepted.

All steel scrap shall be purchased on the basis of a net ton of 2,000 pounds.

On rejection, if the material is not according to specification, the seller shall pay demurrage and return freight.

Specification for Cast-Iron Scrap for Foundry "B"

This material shall consist of broken pieces of machinery in sizes which can be charged into the door of the cupola by one man.

The iron scrap shall not be over 18 inches long or wide, and shall be from $\frac{1}{2}$ to 6 inches in thickness.

Pieces shall weigh from 10 to 50 pounds.

Pieces shall possess evidence of having been machined, such as planed or turned surfaces, drilled holes, etc.

Under no circumstances shall agricultural machinery scrap, stove-plate, malleable iron, grate bars, car wheels, or ornamental castings be accepted.

Pieces shall be reasonably free from rust and foreign matter.

All iron scrap shall be purchased on the basis of a net ton of 2,000 pounds.

On rejection, if the material is not according to specification, the seller shall pay demurrage and return freight.

FUELS

As heat is required in many divisions of foundry practice, fuels are an important item of expense in this industry. The foundry fuels

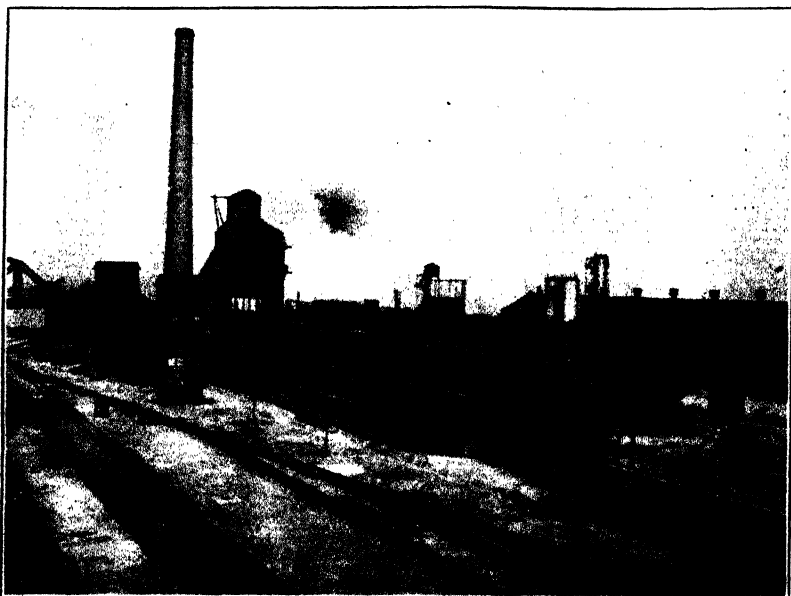

Courtesy of The Koppers Construction Company

FIG. 9.—BY-PRODUCT COKE PLANT

include wood, charcoal, coal, coke, oil, and gas. The heating values of these fuels are listed in Table XVII in the Appendix.

Wood has a limited but important use in lighting cupolas. Because of its low kindling temperature and long flame, wood is an excellent fuel for starting the fire and drying the lining of a cupola. Charcoal is used to furnish heat for drying molds, and also as a cover for molten metal in ladles. Bituminous coal in lump form or in a powdered state

is generally used in air furnaces, the requirements for this purpose being low moisture, low ash, low sulphur, and high volatile content.

The important use of coke in the foundry is in cupola melting. Coke is charged into the cupola in layers and furnishes the heat for melting and superheating the cast iron. Coke for the cupola should have a porous structure so that combustion will take place rapidly, and it should be sufficiently strong to resist the weight of the metal charges above the coke layers. Furthermore, the pieces of coke for this purpose should be relatively large, over 4 inches across. The standard specifications for **foundry coke** as established by the *American Society for Testing Materials* places the following limits on the composition of this fuel:

Moisture	maximum	3 per cent
Volatile matter	maximum	2 per cent
Fixed carbon	minimum	86 per cent
Ash	maximum	12 per cent
Sulphur	maximum	1 per cent

The two types of coke which are employed extensively for cupola melting are by-product coke and beehive coke. The processes used in producing foundry coke will now be described.

By-Product Coke

The by-product coking process is accomplished in closed retorts which are heated externally. Each oven contains a group of about 30 retorts as is illustrated in Fig. 9. The retorts are constructed of a refractory material, and are about 10 feet high, 17 inches wide at one end, 20 inches wide at the discharge end, and 40 feet long. A cross section of a retort and of the heating chambers is shown in Fig. 10. The coal which is charged into the top of each retort is heated by gas burning in the adjoining flues. With this arrangement, the total coking

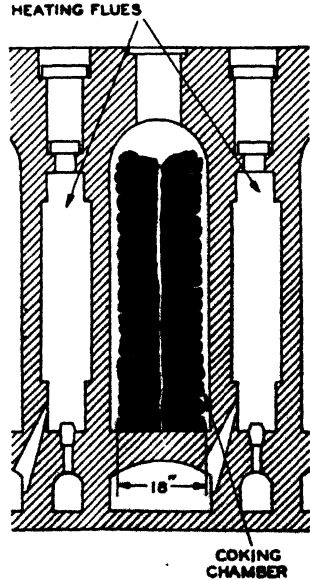

FIG. 10.—BY-PRODUCT COKE RETORT

period for foundry coke is about 36 hours. When the coking process is completed in any retort, the end doors are removed, and a mechanical

pusher forces the contents of the retort out at one end of the oven. The hot coke is then quenched with water. In the by-product coking process, the mass of coke is separated by a cleavage plane which extends for the full length of the retort and is midway between the two walls. Consequently, the pieces of by-product coke have a maximum length equal to one-half of the width of the retort.

Beehive Coke

A beehive oven is constructed of fire brick and has a hemispherical shape with a flat bottom as shown in Fig. 11. An opening is provided in the top of the oven for introducing the coal and for discharging the

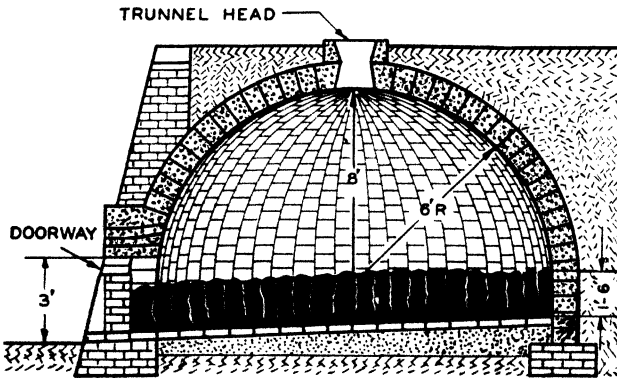

FIG. 11.—BEEHIVE COKE OVEN

waste gases. An arched doorway at the bottom is used for admitting air and removing the coke. About 8 tons of coal are charged into the oven from a car on a track above the oven. The coal is leveled by means of a scraper which is operated through the doorway; then the doorway is bricked up within a few inches from the top. The reserve heat in the lining raises the temperature of the coal to that at which the volatile matter is evolved. The coking proceeds from the top downwards, and the burning of the gas is regulated by closing the opening for the air supply. At the end of the coking period, which requires 72 hours, the door is torn down, and the coke is sprayed with water before being withdrawn from the oven. This method of coking causes the formation of vertical shrinkage cracks through the coke bed, and for this reason the length of pieces of beehive coke may be equal to the depth of the coke bed. Beehive coke has a silvery appearance due

to the precipitation of finely divided carbon in the cells of the coke as a result of quenching within the oven.

Fuel Oil

Fuel oil is the term applied to any of the products from petroleum which are used for heating purposes. As a rule, fuel oil is purchased on specifications to suit individual requirements. The higher the specific gravity, the greater is the heating value per gallon.

Gas

On account of the ease of regulation and the cleanliness of gas, this fuel is often used in core ovens and for other heating purposes in the foundry.

FLUXES

The sand and clay which are charged with the metals, the ash from the fuel, and the oxides formed during melting produce a viscous slag within the melting furnace, which may collect in sufficient quantity to interfere with subsequent melting. In order to obtain a free-flowing slag which can be tapped from the furnace, it is necessary to include with the furnace charges a material known as a flux which will combine with the slag and lower its viscosity.

Limestone

The principal fluxing agent used in the foundry is a natural rock containing calcium carbonate and magnesium carbonate. A high-calcium limestone is usually preferred in cupola practice. The undesirable constituents in limestone for fluxing purposes are silicon oxide, iron oxide, and aluminum oxide. These compounds decrease the proportion of available lime in the flux, and should not exceed 3.00 per cent of the weight of the stone. Sulphates and phosphates are objectionable in a fluxing stone, and should not be present in amounts greater than 0.02 per cent in either case. The limestone which is to be used as a cupola flux should be a screened product between $1\frac{1}{2}$ and $2\frac{1}{2}$ inches in size.

Fluorspar

Calcium fluoride is an important fluxing agent which is present in fluorspar. This mineral is found chiefly in Illinois and Kentucky. Fluorspar is very effective in lowering the viscosity of slags in melting

furnaces and is often used in combination with limestone. A satisfactory grade of fluorspar for fluxing purposes contains more than 85 per cent of calcium fluoride, less than 3 per cent of silica, and the remainder of calcium carbonate. The pieces of fluorspar for use in the cupola furnace should be from $\frac{1}{2}$ to $1\frac{1}{2}$ inches in size.

Soda Ash

Soda ash (fused sodium carbonate) is an active flux which may be used in conjunction with limestone to increase the fluidity of furnace slags. This material is usually supplied in the form of cakes weighing about 2 pounds each.

REFRACTORIES

The refractory materials which are required in foundry practice include sands, fire clay, ganister, and some manufactured products such as fire brick and crucibles. These materials are used in the preparation of molds, and for the linings of furnaces and ladles. Although resistance to high temperatures is the chief characteristic demanded of refractories, other requirements such as resistance to abrasion as well as resistance to chemical reactions with furnace gases and slags are also important.

Refractory materials are of three types, designated as acid, basic, and neutral. These divisions are dependent on the chemical properties of the materials. The acid refractories have in common a high silicon content, and include silica sand, ganister, and siliceous fire clays. The basic materials are lime, magnesia, and iron oxide. Neutral refractories are usually made from ores which contain chromium oxide.

In the selection of refractories for furnace linings, it is important to take into account the nature of the slag to which the refractories will be exposed. Acid slags at furnace temperatures attack basic linings; likewise, basic slags destroy acid linings. It is therefore necessary to provide refractories which will not be unfavorably affected by the established furnace practice.

Foundry Sands

This group of refractories may be divided into molding sands, core sands, furnace sands, and blasting sands.

Requirements of Molding Sands.—The composition of molding sand must be such that it will resist the heat to which it is subjected, without fusing. The severity of this requirement will depend upon the metal for which the molds are prepared. Steel is poured at a higher tempera-

ture than cast iron. Therefore, the molds for steel castings must have a greater resistance to heat than is necessary for iron castings, and these molds are usually made of silica sand bonded with a small proportion of fire clay. Iron oxide or the compounds of calcium, sodium, and potassium lower the fusing temperature of the sand.

Molding sands must be sufficiently permeable to allow the gases which are generated within the molds to be removed freely when the molds are poured. This property is affected to a large extent by the distribution of the grain sizes of the sand. Rounded grains of uniform size are most favorable for obtaining high permeability. The presence of large proportions of clay or other finely divided material will cause low permeability. Therefore, the smallest amount of clay which will produce the necessary bond in the sand should be used.

The strength of molding sand must be sufficient to permit the mold to be formed to the desired shape and to retain this shape until the metal in the casting has solidified; this condition is obtained by the presence of clay or other adhesive material in the sand. The sands used in molds for brass and aluminum have a smaller grain size than the sands used in molds for iron castings, a condition necessary on account of the tendency of the non-ferrous metal alloys to seep into the mold surfaces.

Test Methods for Molding Sands.—The investigation of molding sands includes the determinations of the proportions of the components in the sand, as well as the measurement of the properties conferred by these components to the sand. Molding sands contain, in addition to silica grains, some clay or bonding substance and moisture. Tests on molding sands include the determinations of moisture and clay, as well as the distribution of the sizes of the silica grains. The apparatus which is used in washing the clay from the sand grains in the determination of clay substance is shown in Fig. 12. Except for detecting certain undesirable elements such as sodium, potassium, calcium, and magnesium, the ultimate chemical analysis offers little assistance in establishing the quality of molding sands.

The important physical properties of molding sands are the strength of the sand in the moist state, known as green strength; the strength of the sand after it has been dried in a test specimen, known as dry strength; and the permeability or venting property of the sand. The most satisfactory method for determining the green and dry strengths of a molding sand is to measure the maximum compressive loads sustained by specimens which have been prepared in a standard way. In the determination of the permeability of molding sands, the rate at which a definite

volume of air passes through a sand specimen of standard dimensions is measured by means of the permeability apparatus. The established test methods for the investigation of molding sands are given in the Appendix. Most producers of molding sand for iron foundries grade their product according to the classification established by the *American Foundrymen's Association*. This method of grading sand is based upon

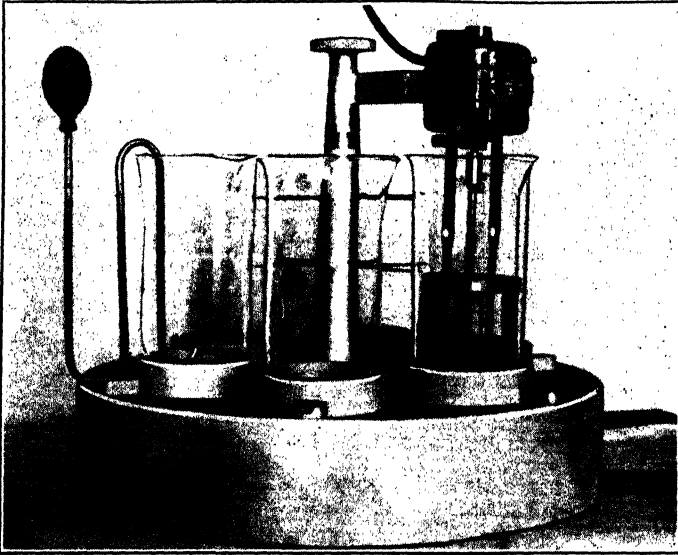

FIG. 12.—SAND-WASHING APPARATUS

the clay content, as well as upon the predominating grain size of each sand.

Sources of Supply of Molding Sands.—The chief sources of supply of natural molding sand for iron, brass, and aluminum practice are in the Albany district of eastern New York, in the northern and central parts of Ohio, and in the southern part of Indiana. Most of the naturally bonded steel sand is produced in Pennsylvania and New Jersey. The tendency at the present time is to prepare synthetic molding sands from mixtures of clean silica sand and mineral binders such as fire clay and bentonite.

Core Sands.—The sands used for making cores generally contain clean silica grains with little or no clay. These sands may be classified into two ranges of grain size. The sands which are found most abundantly along the eastern shore of Lake Michigan and are known as *lake sand* or *dune sand* will in large part pass a 40-mesh sieve and be

retained on a 70-mesh sieve. Sands of this grain size are also found along the Atlantic and Pacific coasts. Another type of core sand which is sometimes designated as **bank sand** will pass a 50-mesh sieve and be retained on a 200-mesh sieve.

Core sands should contain the minimum amount of clay or other finely pulverized material which would interfere with the permeability of cores made with them. Also, they should be as free as possible from shells or other fluxing constituents which would decrease the refractoriness of the sand. Vegetable matter such as roots and leaves cause the formation of gas in cores, and should not be present in core sands.

Furnace Sand and Blasting Sand.—The sand which is used in mixtures for furnace bottoms or for ladle linings is high in silica content and low in fluxing constituents. Blasting sand is a carefully graded silica sand of large grain size. A large amount of silica sand for foundry use is produced in the Ottawa district of Illinois. The St. Peter's sandstone found in this section is disintegrated by hydraulic means, washed with water, dried, and screened into definite sizes. This product contains rounded grains of practically pure silica.

Fire Clay

Fire clay is a mineral product consisting essentially of hydrated aluminum silicate. Good fire clays should contain the minimum amount (less than 3 per cent) of fluxing constituents such as iron, calcium, magnesium, sodium, and potassium compounds. Pure clay or kaolin has the formula $\text{Al}_2\text{O}_3 \cdot 2 \text{SiO}_2 \cdot 2\text{H}_2\text{O}$ and contains 39.5 per cent alumina (Al_2O_3), 46.6 per cent silica (SiO_2), and 13.9 per cent water. If the proportion of silica in a fire clay is higher than this amount, it is termed an acid or siliceous clay. When the silica content is lower, the fire clay is termed basic or aluminous.

The **flint fire clays** approach the composition of kaolin, and have low plasticity when mixed with water. The melting temperature of these clays is about 3200 degrees F. The **plastic fire clays**, on the other hand, are high in alumina, and their softening temperatures are lower than those of the flint clays.

Fire clay is mixed with silica sand or ganister for use in patching furnace walls and ladles. Another important use of fire clay in the foundry is for bonding molding sand, either in the preparation of new molding sand mixtures, or for re-bonding used sands. These applications require fire clays which are fairly plastic and also resistant to high temperatures.

Bentonite.—A material which is being employed successfully as a bonding agent in the preparation of synthetic molding sands, as well as in the reclamation of used molding sands, is a clay-like mineral known as bentonite, deposits of which are located in Wyoming and South Dakota. The outstanding characteristic of bentonite is its exceedingly sticky nature when it is wet with water. The weight of bentonite required to produce a given strength in a synthetic molding sand is much less than the weight of fire clay necessary for this purpose.

Ganister

This is a dense high-silica rock having favorable heat-resisting qualities. The ganister is often crushed to small sizes and mixed with fire clay and water for rammed-up linings of furnaces and ladles. Blocks of ganister are sometimes used in the construction of furnace walls.

Fire Brick

As the cost of maintenance of furnaces depends to a large extent on the refractory materials from which the linings of the furnaces are constructed, the selection of fire brick should receive attention. The materials used in the manufacture of fire brick and the important characteristics of the various types of fire brick will now be described.

A **standard fire brick** has dimensions of 9 by $4\frac{1}{2}$ by $2\frac{1}{2}$ inches and weighs from 7 to 8 pounds. Another size which is designated as **split brick** is 9 by $4\frac{1}{2}$ by $1\frac{1}{4}$ inches and is commonly used for ladle linings and for repairs to cupola linings. High-grade fire clay bricks are produced from mixtures of crushed flint clay and plastic fire clay. These bricks are usually burned at temperatures of 2100 to 2400 degrees F. Fire clay bricks are low in heat conductivity, and are therefore satisfactory for heat-insulation. They are almost neutral in character, and are well suited to many furnace conditions. Another advantage of fire clay refractories is the low cost of these products.

Certain minerals which contain a large proportion of alumina such as the bauxite clays and sillimanite are used in the making of high-alumina refractories. The valuable property of these refractories is that they will withstand large loads at relatively high temperatures.⁴

Silica bricks are prepared from finely ground ganister and about 2 per cent of lime. After being formed to the desired dimensions, they are burned at high temperatures for a long time. Because silica bricks are extremely sensitive to temperature changes, they are used only in walls and roofs of furnaces which are operated almost continuously.

Magnesite bricks are made of calcined magnesite ore, and are molded to shape without additional bonding material. These bricks expand considerably when heated and are relatively weak at high temperatures. They are used mainly in the linings of basic open-hearth furnaces.

A chromite ore which contains largely iron oxide and chromium oxide is used in the making of chrome bricks. These bricks are neutral to reactions at high temperatures and are therefore often placed in furnaces between courses of acid and basic refractories. An advantage of chrome bricks is that they are not attacked by iron oxide slags.

Cupola Blocks

The linings of cupola furnaces are usually constructed of standard fire bricks and larger blocks which form segments of circles when they are assembled. Several sizes of cupola blocks can be obtained from manufacturers of refractories. A size which is often used is $4\frac{1}{2}$ inches in thickness with a face 9 by 6 inches.

Graphite Crucibles

In making graphite crucibles, high-grade fire clay and water are added to flake graphite to produce a plastic mixture. Silica sand is also used in the mixture to decrease the changes in volume resulting from changes in temperature. The crucibles are formed to the desired shape in a way which permits the flakes of graphite to overlap so as to obtain maximum strength in the crucibles. The dimensions and capacities of standard sizes of crucibles are given in Table XVIII in the Appendix.

BIBLIOGRAPHY

1. RICHARD MOLDENKE, "The Principles of Iron Founding." 1930. McGraw-Hill Book Company, New York, N. Y.
2. W. J. PRIESTLEY, "Metals and Ferro-Alloys Used in the Manufacture of Steel." National Metals Handbook, 1933. *American Society for Steel Treating*, Cleveland, Ohio.
3. G. H. MANLOVE and CHARLES VICKERS, "Scrap Metals." 1918. The Penton Publishing Company, Cleveland, Ohio.
4. F. H. NORTON, "Refractories." 1931. McGraw-Hill Book Company, New York, N. Y.
5. *American Foundrymen's Association*, Chicago, Ill., "Testing and Grading Foundry Sands." March, 1931.
6. *American Society for Testing Materials*, Philadelphia, Pa., "A.S.T.M. Standards, Part I, Metals." 1933.

REVIEW QUESTIONS

I

What conditions control the chemical composition of pig iron produced at any blast furnace?

II

What methods are used in classifying pig iron?

III

What requirements should be stated in specifications for pig iron?

IV

What alloy of chromium is used in adding this element to cast iron?

V

Explain the importance of using only carefully selected grades of scrap metals.

VI

What should be included in specifications for a cupola flux?

VII

Outline the specific uses of the different foundry fuels.

VIII

Account for the difference in size of cupola coke produced by two processes.

IX

What requirements should be given in a specification for cupola coke?

X

Outline the uses of the refractory materials required in foundry practice.

XI

What are the important physical properties of molding sands?

XII

Explain the meaning of No. 4 E molding sand for the iron foundry.

XIII

What are the requirements for foundry core sand?

XIV

What kind of sand is satisfactory for refractory mixtures to be used in patching melting furnaces?

XV

What are the differences in composition and qualities of flint clays and plastic clays?

XVI

What are the advantages of fire clay refractories?

XVII

Define acid, basic, and neutral refractories, and give an example of a material in each of these groups.

XVIII

What materials are used in making graphite crucibles?

XIX

Find the price of a graphite crucible having a capacity of 200 pounds of a copper-base alloy.

XX

What are the characteristic properties of bentonite?

XXI

Describe the equipment and procedure for testing molding sands.

XXII

What references may be used for specifications for foundry materials?

CHAPTER III

MOLDING PRACTICE

CONSTRUCTION OF SAND MOLDS—MOLDING PROCEDURE—PRESSURES IN MOLDS—PATTERN EQUIPMENT—Pattern Materials—Pattern Identification Markings—Loose Patterns—Mounted Patterns—Patterns Mounted in Vibrator Frame—Cope and Drag Mounts—Match Plates—Patterns Built on Special Machines—TYPES OF MOLDS—Green-Sand Molds—Skin-Dried Molds—Mold Coatings—Dry-Sand Molds—Loam Molds—Metal Molds—Die-Casting Process—Permanent-Mold Process—Centrifugal Process—MOLDING METHODS—MOLDING OPERATIONS—MOLDING MACHINES—Squeezer Machines—Jolt Machines—Sandstingers—Combination Molding Machines.

Metal castings are obtained by pouring molten metal into cavities formed in sand or metal molds and allowing the metal to solidify. In the making of sand molds, suitable mixtures of molding sand are rammed around patterns which are removed after the impression has been produced. In order to compensate for the contraction of the metal when it solidifies and cools, the patterns are usually made somewhat larger than the dimensions required on the finished castings. Also, it is desirable to have the patterns slightly tapered so that they can be removed from the molds without tearing the sand.

CONSTRUCTION OF SAND MOLDS

A sand mold is made within a frame of wood or metal known as a **flask** which may be of any size or shape to accommodate the pattern to be used in it. Each flask has two or more sections, depending upon the design and size of the castings to be produced. The top section of the flask is the **cope**, the bottom section is the **drag**, and any intermediate sections are the **cheeks**. **Pins** and **lugs** are attached to the flask as shown in Fig. 13 to insure positive alignment of all sections when the mold is closed. A **bottom board** supports the sand in the drag. In order to carry the sand in the cope of a large mold, **bars** are fastened securely across this section of the flask. **Gaggers** are the L-shaped pieces of steel or cast iron which are used to hold up pockets of sand in the cope as illustrated in Fig. 13.

The mold cavity contains, in addition to the impression for the cast-

of the pattern and the cope section of the flask are then assembled as shown in Fig. 18. Some parting sand is sprinkled on the surface of the sand in the drag to enable the two parts of the mold to be separated later. The opening for the gate is formed around a pin which is set on the sand in the drag. A layer of molding sand is now riddled over the pattern in the cope, and the sand is rammed well around the pattern and the gate pin. More sand is added, and the cope is rammed in the same way as in preparing the drag. Before removing the gate pin, the opening at the top of the cope is enlarged to form a pouring basin. The cope is then lifted off and is turned over on the mold board. The two parts of the pattern are rapped and drawn carefully from the sand. If any portion of the mold is broken in this process, it is patched and all loose sand is removed from the mold cavity. It is necessary to cut a runner in the top of the drag from the impression left by the gate pin to the cavity for the casting. Also, the core must be set in the print left by the pattern in the drag. When the mold is closed as shown in

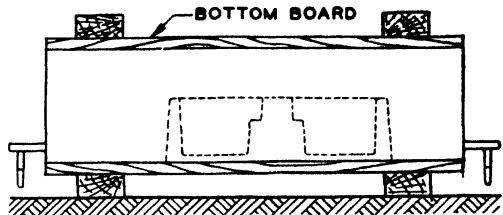

FIG. 17.—DRAG RAMMED AND BOTTOM BOARD
IN POSITION
Drag ready to roll over.

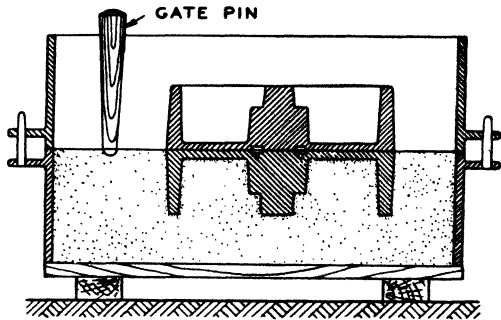

FIG. 18.—DRAG ROLLED OVER
Cope ready to ram.

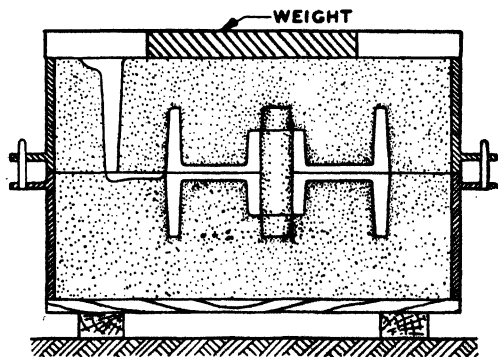

FIG. 19.—PATTERN REMOVED, RUNNER CUT,
CORE SET, AND MOLD CLOSED
Mold ready to pour.

Fig. 19, the alignment of the cope and drag is assured by the fitting of the pins and lugs on the flask. Before the mold is poured, the two parts of the flask are clamped together or weighted to prevent the cope being raised by the pressure of the metal as it fills the mold.

Different methods can be used in making molds for a given design

of casting. The drawings in Fig. 20 show four ways for molding a sheave wheel. Beginning at the top, the first method utilizes a two-part flask with a dry-sand core placed in the mold to form the groove of the sheave. The pattern is made solid and is provided with a projection to form a seat for the core. The molding procedure is about the same as that described for making the pulley.

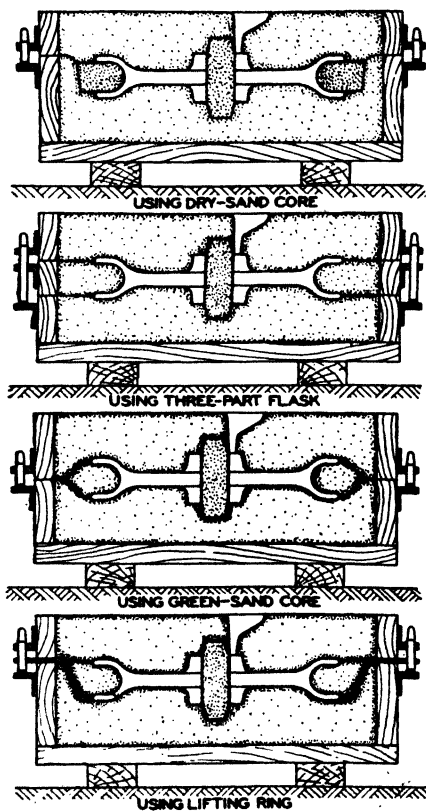

FIG. 20.—METHODS FOR MOLDING SHEAVE WHEEL

In the second method, a three-part flask is employed and the groove of the sheave is formed by the cheek of the mold. In this method, as well as for each of the following molding methods, the pattern is split horizontally through the center. The assembled pattern is placed on a mold board which has been cut away to embed the pattern to the parting surface, and the cheek section of the flask is put around it. Molding sand is rammed in the cheek, and parting sand is sprinkled on the parting surface.

The drag section of the flask is then placed on the cheek, and the drag is rammed. After a bottom board is placed on the drag, the assembly is rolled over. Parting sand is sprinkled on the upper parting surface, and the cope is rammed with the gate pin in place. The cope is then lifted off, and the top half of the pattern is removed from the mold. After the cheek is lifted off, the other half of the pattern is removed from the mold. The cheek is then replaced, the center

core is set, and the cope is put on the cheek. The mold is now ready to pour.

In the third molding method, one-half of the pattern with the split side down is placed on a mold board, the cope section of the flask is placed around it, and sand is rammed into the cope with the gate pin in place. After the cope is rolled over, the first parting is made to the maximum diameter of the rim on the pattern. Parting sand is sprinkled on this surface, the other half of the pattern is put in place, and sand is rammed into the groove. A second parting is then made sloping down to the first one as shown on the drawing. Parting sand is sprinkled on this surface, the drag section of the flask is placed over the cope, and the drag is rammed. The drag is then lifted off and the bottom half of the pattern is removed from the sand. After the drag is replaced, the mold is rolled over, the cope is lifted off, and the upper half of the pattern is removed from the sand. When the center core is set and the cope placed back on the drag, the mold is ready to pour.

In the fourth method for molding the sheave, a metal plate is provided in the mold to carry the sand which forms the groove of the sheave. The assembled pattern is placed on a mold board, and the lifting ring is put upside down around the pattern. The drag section of the flask is set in place and the sand is rammed in the drag. After this part of the mold is rolled over on a bottom board, sand is rammed into the groove of the sheave pattern. The parting is then cut to the center of the upper flange, and parting sand is sprinkled on this surface. The cope section of the flask is put on the drag, and the cope is rammed with the gate pin in place. The cope is then lifted off and the top half of the pattern is removed from the sand. After the lifting ring, which carries the green-sand core, is taken out of the mold, the lower half of the pattern is removed from the sand. The plate is then returned to the mold, the center core is set, the cope is replaced on the drag, and the mold is ready to pour.

Smooth surfaces can be obtained on molds for castings which are to be electroplated or enameled, by an operation known as **printing back**. This procedure consists of dusting a coating of powdered talc, plumbago, or charcoal on the surface of one part of the mold and replacing the pattern carefully. The pattern is tapped lightly to make sure that the entire mold face is in contact with the smooth surface of the pattern, and the pattern is then removed. On account of the extra labor and expense required for this operation, it is used only to a limited extent in molding.

Metal surfaces known as **chills** are provided in some molds to accel-

erate the cooling of the metal at definite locations, as in the chilled-iron car wheel shown in Fig. 21. Chills are also used to hasten the solidifica-

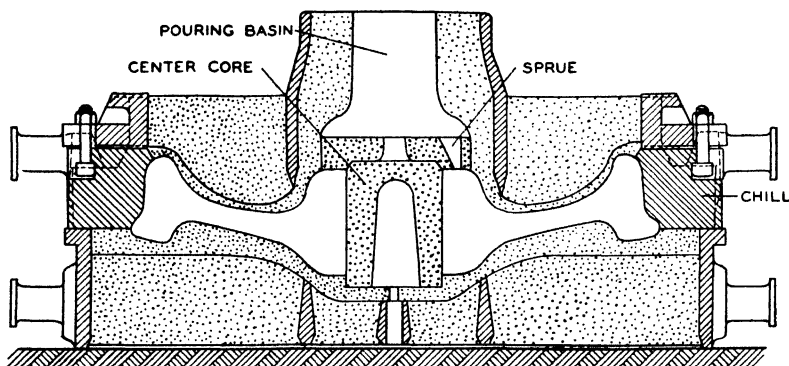

FIG. 21.—MOLD FOR CHILLED CAST-IRON CAR WHEEL

tion of the metal at certain sections of castings and thereby tend to eliminate the presence of shrinkage cavities in these sections.

PRESSURES IN MOLDS

When metal is poured into a mold, certain pressures are produced on all surfaces within the mold cavity. The magnitude of the static pressure on any area of the mold is directly proportional to the head of liquid metal above that area. As the weight of 1 cubic inch of cast iron is 0.26 pound, the pressure in pounds per square inch at any point is equivalent to the head of metal in inches at that point multiplied by 0.26. The total pressure exerted on the inside surface of the cope of a mold is determined by multiplying the average pressure on this surface by the area of the vertical projection of the cope in contact with the metal. If the total lifting force on the cope is not entirely resisted, the cope will be raised and metal will flow from the mold at the joint. The static pressure exerted on the cope of the mold shown in Fig. 22 is equivalent to the height in inches of the metal in the sprue multiplied by the area in square inches of the cope which is exposed to the metal, and again multiplied by the factor 0.26. If the casting is poured with a copper-base alloy, the factor will be 0.31. It is also necessary to take into account the additional pressure on the cope caused by the momentum of the metal as it fills the mold cavity. To meet this condition, the maximum pressure on the cope may be considered as equivalent to two

times the static pressure. Whereas the weight of the cope alone may be sufficient to resist the pressure developed within a mold, it is usually necessary to place an additional weight on the finished mold, or to clamp the mold together before it is poured. The flask equipment is made sufficiently rigid to overcome the lateral pressures developed within a mold.

The pressures produced by liquid metal in a mold are transmitted in all directions and act perpendicularly to the mold surfaces. If the molding sand has not been rammed sufficiently hard so as to resist the pressures caused by the liquid metal, the mold cavity will be enlarged

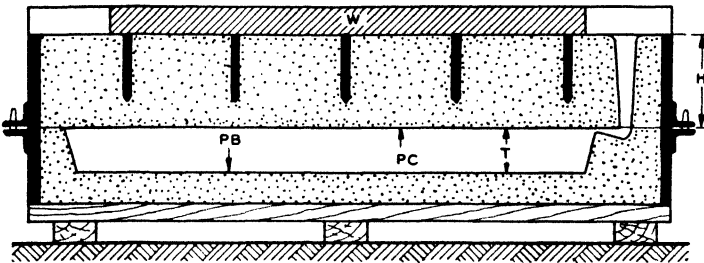

FIG. 22.—MOLD FOR IRON CASTING

- W = Weight in pounds to resist ferrostatic pressure.
 H = Height of sprue in inches.
 T = Thickness of casting in inches.
 A = Area in square inches of sand in cope in contact with metal (not on drawing).
 PC = Pressure on the cope in pounds per square inch.
 PB = Pressure on the bottom of the mold in pounds per square inch.
 $PC = H \times 0.26$
 $W = A \times PC$ minus weight of cope
 $PB = (H + T) \times 0.26$

at those locations where the mold is too soft. Therefore, it is important to adjust the ramming of every sand mold according to the pressures developed at various parts of the mold. The sand at the bottom of the mold shown in Fig. 22 is subjected to a pressure which is dependent upon the combined height of the cope and the casting.

As the density of sand cores is less than the density of cast iron or other metals, cores will tend to rise when they are surrounded by molten metal. The force required to hold a core in place is equivalent to the weight of the metal displaced by the core, in excess of the weight of the core. Whenever the conditions are such that cores can not be made with enough strength to hold to the desired positions in molds without other supports, they are secured in place by pieces

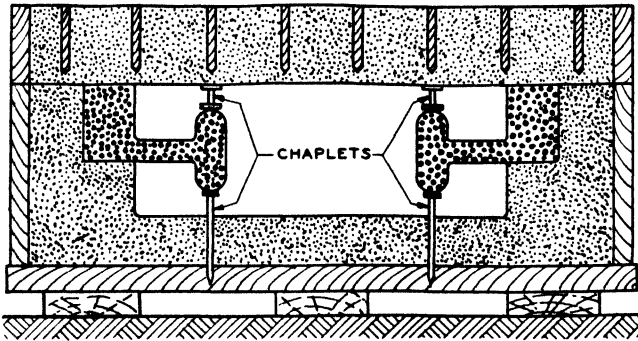

FIG. 23.—MOLD WITH CORES
Metal chaplets hold cores in place.

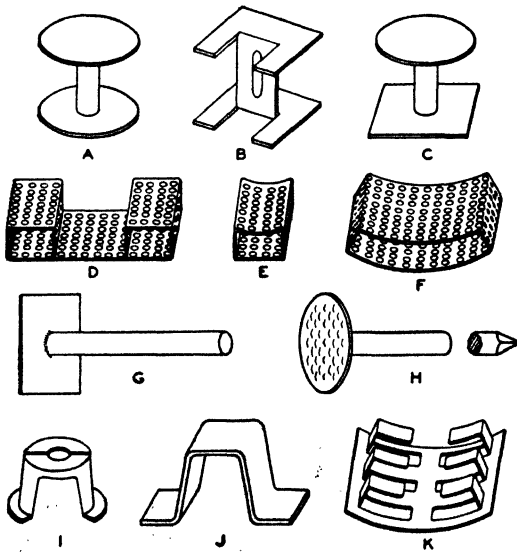

FIG. 24.—CHAPLETS

- A—Double, round head chaplet made in many sizes for light or heavy loads.
- B—One-piece chaplet with double, rectangular head.
- C—Round and square head chaplet.
- D—E—F—Perforated chaplets made in many sizes and shapes for supporting round or flat cores.
- G—Single, rectangular head chaplet with straight stem.
- H—Single, round head chaplet for supporting heavy loads.
- I—Shell chaplet.
- J—Bridge or saddle-back chaplet.
- K—Ventilated chaplet for castings requiring small cores.

of metal known as chaplets. As a rule, chaplets have relatively thin sections which fuse readily in the metal of the castings. In the mold shown in Fig. 23, both the weight of the core and the floating action of the core in the metal are resisted by chaplets. The lifting force on a core which is surrounded by molten cast iron is approximately three and one-half times the weight of that portion of the core which is submerged in the metal. When long cores are used in a mold to form the internal surfaces of castings, these cores are often supported at two or more points by chaplets as illustrated in Fig. 55 in Chapter IV. Chap-

lets are supplied in many shapes and sizes for a variety of applications in molding. Some of the more generally used forms are shown in Fig. 24. Those used in molds for iron and steel castings are made of steel and coated with tin to resist corrosion.

PATTERN EQUIPMENT

The rate of production as well as the uniformity of sand molds are dependent to a large extent on the pattern equipment with which any foundry is supplied. In recent years the demands from many lines of industry for large numbers of castings of standard designs have led to the extensive use of mounted patterns and power-operated molding machines.

Pattern Materials

Patterns may be constructed of any material which will retain the exact outline of the design for the required number of molds. Wooden patterns are generally used when a small number of castings are to be produced. White pine, yellow pine, and mahogany are commonly selected for this purpose. The disadvantages of wood are that the dimensions of these patterns are subject to change in storage, and that wood is less resistant to hard use than some other materials. In order to withstand continual service on molding machines, metal patterns made of copper, brass, aluminum, or cast iron are preferred. Most working patterns are prepared from metal castings, which in turn are made from wooden patterns. The weight of a casting can be estimated from the weight of the pattern by the use of the factors listed in Table XIX in the Appendix.

Pattern Identification Markings

To provide correct information for the molder, so as to eliminate errors in molding, a standard method of marking patterns has been adopted by the *American Foundrymen's Association*. The following colors are specified to designate certain parts of patterns: black for surfaces which are to remain unmachined or unfinished, red for machined or finished surfaces, yellow for core prints, red stripes on yellow background for seats for loose pieces, and black stripes on yellow background for stop-off pieces.

Loose Patterns

Pattern equipment may be classified into three groups which are designated as loose patterns, mounted patterns, and patterns built on special machines. Patterns which are molded by hand and are not

attached to a frame or a plate are known as loose patterns. The simplest type of loose pattern is a piece having the shape and approximate dimensions of the desired casting. A loose pattern may be in one piece or consist of two or more parts which join on surfaces corresponding with the partings in a mold. Furthermore, the gates may be attached to loose patterns in order to save time in molding.

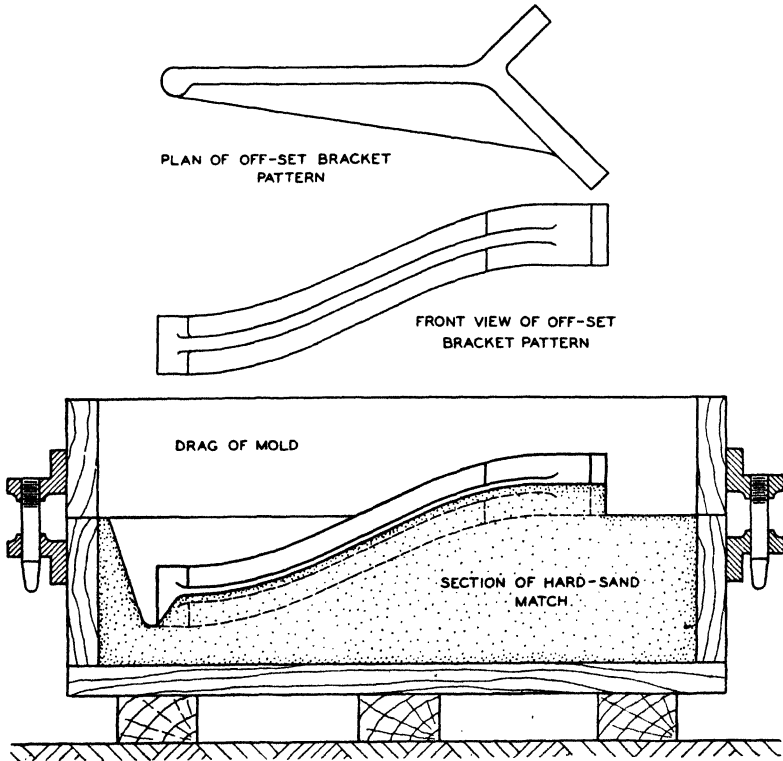

FIG. 25.—LOOSE PATTERN AND HARD-SAND MATCH

For some designs of patterns, a flat mold board is used to support the pattern while the drag is being rammed. (See Fig. 16.) The preparation of molds from other patterns requires considerable labor in forming the parting surfaces. To facilitate the making of molds from a loose pattern which has an irregular parting, the pattern can be supported in a form corresponding to a cope while the drag is being rammed. This device for establishing the parting surface is known as a follow board, green-sand match, hard-sand match, or plaster-of-Paris match,

depending on the material used in making this temporary support for the pattern.

A **follow board** is often used to assist in making molds from a loose pattern of large or small size. For this purpose, a wooden board is carved out to conform to the irregularities in the pattern so that the pattern can be embedded in the board up to the parting line. When making a mold, the pattern is placed on the follow board, the drag section of the flask is put over the pattern, and sand is rammed in the drag. After the bottom board has been placed on the drag, the assembly is rolled over, and the follow board is lifted from the drag. Sand is then rammed around the pattern in the cope, and the mold is completed in the usual way.

When a **green-sand match** is to be made, molding sand is first rammed in the drag and the parting is cut by hand. Then a wooden frame is placed over the drag, and the cope which is to serve as the match is made by ramming new molding sand within this frame. The molding material used in making a **hard-sand match** is prepared by mixing 1 quart of linseed oil and 4 ounces of litharge with 15 pounds of dry molding sand. This mixture is rammed into the frame above the drag and becomes very hard after standing for a short time. The use of a hard-sand match in molding a loose pattern of irregular shape is illustrated in Fig. 25. The pattern is supported in the match while the drag is being rammed. A match can also be made of plaster-of-Paris by pouring a mixture of this material and water into the frame which is placed over the green-sand drag.

Mounted Patterns

When a large number of castings of a given design are required, the molding operations will be facilitated by mounting the pattern in a frame or on a plate. More accurate molds can be produced with mounted patterns than is possible with loose patterns.

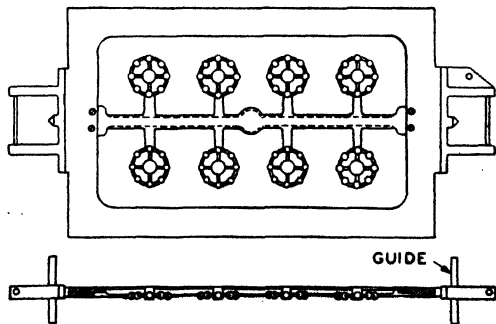

FIG. 26.—PATTERNS ON VIBRATOR FRAME

Patterns Mounted on Vibrator Frame.—To assist in the removal of patterns from sand molds, the patterns may be attached to a frame which extends beyond the outside dimensions of the flask. With this arrangement, it is possible to vibrate the patterns while they are being

drawn from the molding sand. Furthermore, the guides on the vibrator frame aid in effecting a satisfactory draw. A hard-sand match is generally used to support the patterns and to provide the correct parting while the sand is being rammed into the drag. One or more loose patterns may be mounted on a metal frame as shown in Fig. 26.

Cope and Drag Mounts.—The patterns for large castings are often mounted with the necessary gating on separate boards to form the cope and the drag portions of the molds. In some cases, two molding machines with cope and drag mounts are operated alongside one another for the preparation of the complete molds. Less time is required in preparing a mold with a mounted pattern than in molding a loose pattern of the same design. Furthermore, the life of a mounted pattern is much longer than that of a loose pattern.

Match Plates.—A convenient method for molding a number of small patterns is to mount them so that parts of the patterns are on each side of a wooden board or metal plate. The patterns and plate can

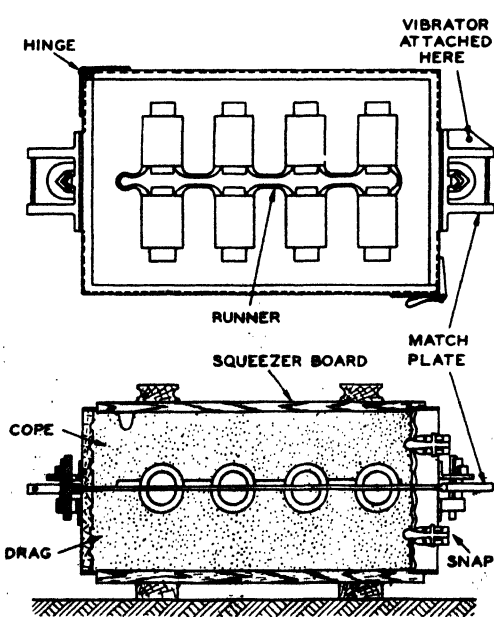
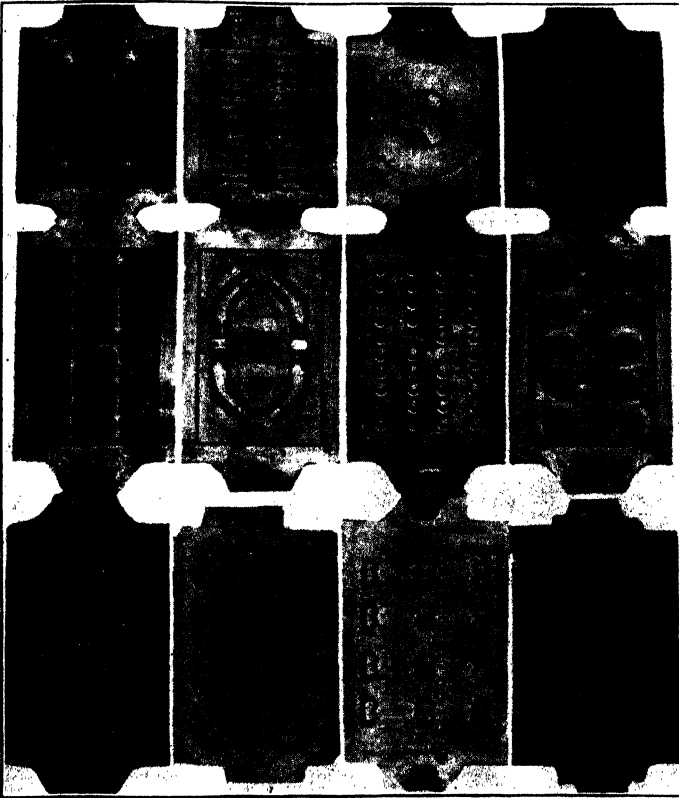

FIG. 27.—SNAP FLASK AND MATCH PLATE

also be cast in one piece with aluminum or a cement mixture. This pattern equipment, which is known as a match plate, is ordinarily used between the cope and drag sections of a snap flask as indicated in Fig. 27. The two sections of the snap flask have hinges and latches at opposite corners so that the flask can be opened and removed from the completed molds. When making a mold with this equipment, the drag side is first filled with sand after some parting material is sprinkled upon the plate. The sand is

rammed in the drag and then struck off level with the top of the flask. After the bottom board is placed on the sand, the flask is turned over. Parting material is now shaken on the cope side of the plate, and sand is rammed well around the edges of the cope. If the mold is to be

squeezed in a machine, a board is placed on the sand in the cope. Pressure is then applied between the squeezer board and the bottom board, both of which are smaller than the inside dimensions of the flask. After the mold has been squeezed, the squeezer board is removed, the sprue opening is cut in the cope sand, the vibrator is started, and the cope is lifted from the plate. Then the match plate is removed from the



Courtesy of City Pattern Works of Detroit

FIG. 28.—MATCH PLATES

drag portion of the mold. The cope and drag are assembled with the aid of the pins and lugs on the flask to obtain accurate alignment. After removing the snap flask, the completed mold is transferred on the bottom board to the foundry floor. In order to hold the mold together and to prevent the metal from running out at the joint, a jacket made of wood or metal is slipped over each mold, and a metal weight is placed

on top of the cope. The jacket and weight are shifted from one mold to another when the molds are poured.

The advantages of match plates in molding are that the entire mold can be squeezed in one operation, the correct parting is automatically produced, and the two parts of the mold are definitely aligned when the mold is assembled. This method of mounting patterns is illustrated in Fig. 28. A great variety of designs of castings are molded with this kind of pattern equipment.

Patterns Built on Special Machines

Pattern equipment which is employed regularly for the rapid production of large numbers of molds is often built on special molding

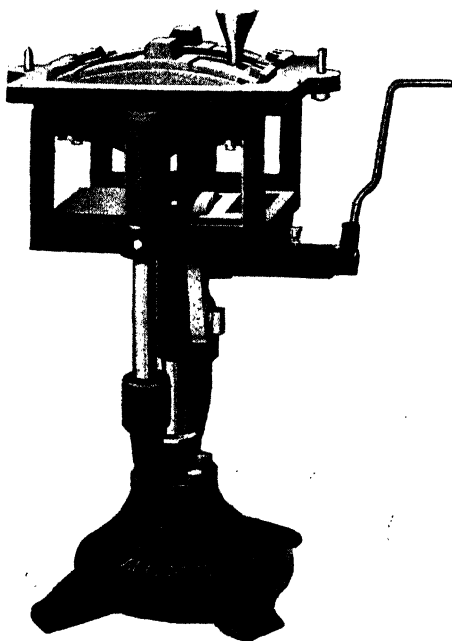

Courtesy of Arcade Manufacturing Company

FIG. 29.—MOLDING MACHINE WITH MOUNTED PATTERNS AND STRIPPING PLATE

The cope section of a flask is placed on the machine and molding sand is rammed by hand around the patterns; then the patterns are lowered through a plate on the machine.

machines. This equipment is designed to facilitate the separation of the pattern and the sand after one part of the mold has been rammed. Two types of pattern equipment are used for this purpose. With the **plain stripper**, the entire pattern is drawn away from the sand, or the sand mold is drawn away from the pattern, leaving the mold on supports above the pattern. The **stripping-plate** equipment provides for drawing the pattern through a plate which fits the outline of the pattern at the parting surface. A molding machine with two patterns and a stripping plate is shown in Fig. 29. The patterns are lowered through the plate by moving the hand lever after the sand has been rammed around the patterns. Molds which have considerable detail at the parting surface and relatively little draft can be

readily produced with stripping-plate equipment. The cost of mounting patterns with a stripping plate is much greater than the cost

of mounting patterns which are drawn by a plain stripping operation. The construction and operation of these two types of pattern equipment are indicated in Fig. 30 and 31. Several different molding machines which are arranged for plain stripping or stripping-plate operations will be described later in this chapter.

TYPES OF MOLDS

The following types of molds are employed in the casting industry: (1) green-sand molds, (2) dry-sand molds, (3) loam molds, and (4) metal molds. This classification is based on the materials from which

the molds are prepared. The advantages and special applications of each of these types of molds will now be described.

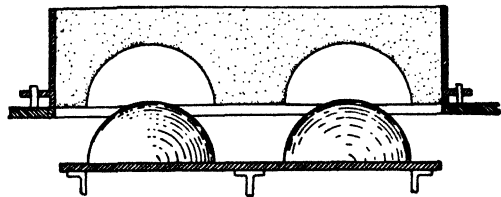
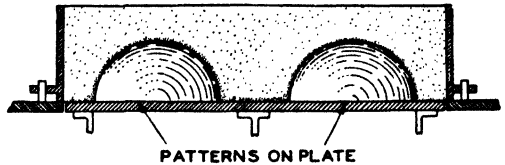

FIG. 30.—PRINCIPLE OF DRAWING PATTERN ON PLAIN STRIPPER MACHINE

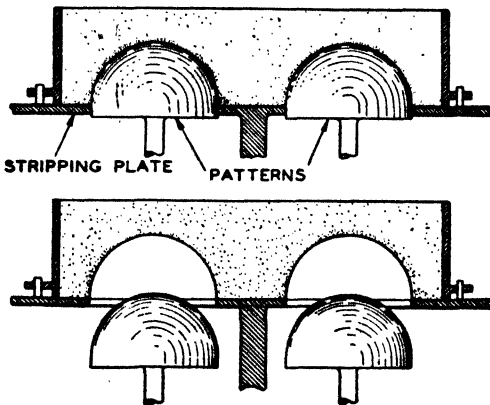

FIG. 31.—PRINCIPLE OF DRAWING PATTERN ON STRIPPING-PLATE MACHINE

Green-Sand Molds

Green-sand molds are prepared with natural molding sands or with mixtures of silica sand, bonding clay, and water. These materials are thoroughly mixed in proportions which will give the desired properties for the class of work being done. The surfaces of the molds which come in contact with the molten metal must be refractory as well as permeable to the

gases formed when the molds are poured. To meet these requirements, the practice at some foundries is to use a layer of **facing sand** next to the pattern with ordinary molding sand for filling up the flask.

Facing-sand mixtures for iron castings generally contain some finely ground bituminous coal known as **seacoal**, and new sand in addition to used molding sand. One part by volume of seacoal to ten parts of molding sand is a common ratio in mixtures for molds for iron castings. The seacoal aids in preventing the sand from fusing to the surfaces of the castings, whereas the new sand increases the bond in the facing mixture, and thereby prevents cutting of the sand surfaces by the liquid metal.

Green-sand molds cost less and are used more extensively than any of the other types because these molds can be poured as soon as they are completed, and the sand can be used repeatedly. Furthermore, green-sand molds are softer than dry-sand molds; a condition which allows greater freedom in contraction when the castings solidify and cool in these molds.

Skin-Dried Molds.—When hard surfaces are required on green-sand molds, a bonding material such as molasses or gelatinized starch is added to the facing-sand mixture or is sprayed upon the surfaces of the finished molds. A kerosene torch or charcoal fire is then used to remove the moisture, thereby hardening the sand. Skin drying is particularly adapted to very large molds, or to work which requires accurate detail. Molds which have been skin dried must be poured soon after heating; otherwise, the hardened surfaces will absorb moisture from the interior of the molds and again become soft.

Mold Coatings.—Castings with smooth surfaces are obtained by providing smooth and highly refractory surfaces on the molds. It is common practice to coat the surfaces of sand molds with refractory materials to prevent the fusing of the sand to the castings and to resist the cutting action of the molten metal. The materials ordinarily used for this purpose are graphite, coke, charcoal, silica, mica, and talc. These materials may be placed in two groups: the carbonaceous materials are known as **blackings**, and the other materials are designated as **mineral coatings**.

Refractory coatings may be applied to molds in several ways. The finely ground material is often dusted on the mold surfaces from a cotton bag; this operation is usually followed by smoothing the surfaces with finishing tools. A soft brush is also used for distributing the powdered material on the molds. Another procedure is to suspend the refractory materials in water to which some bonding material such as dextrin, molasses, or bentonite is added. After these mixtures are sprayed upon the surfaces of the molds, the coatings are dried with a torch or by placing the molds in ovens. Cores are often

blackened in the same way as molds or are dipped in a coating mixture and then dried to remove the moisture.

The blackings are generally used for coatings on molds for gray iron castings. A large number of commercial mixtures are available for this purpose. However, the blackings are not suited for coatings on molds for steel castings, because the carbonaceous material would combine with the steel. In the steel foundry, a mixture of powdered silica, molasses, and water often serves as a coating for molds. The surfaces of these molds are always dried after applying the coating mixture.

Dry-Sand Molds

Castings of intricate design and those requiring special smoothness,

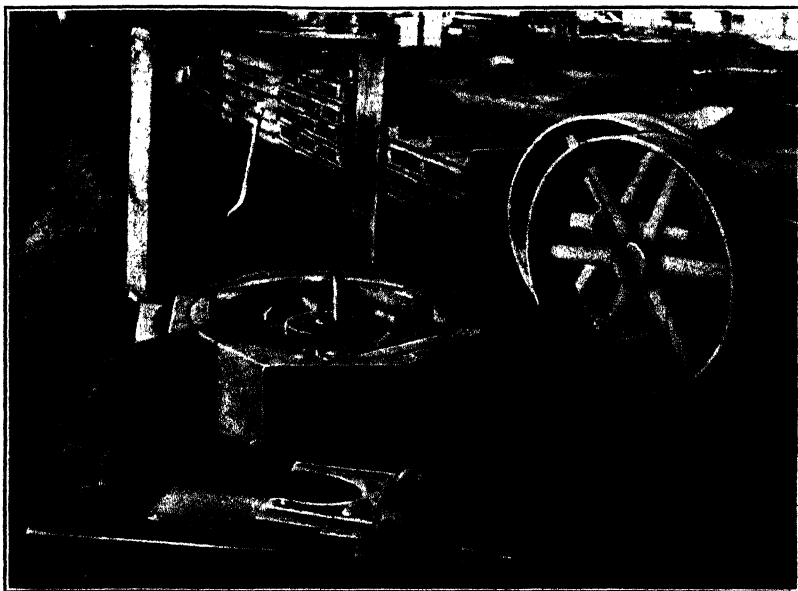

FIG. 32.—MOLD FOR PULLEY

soundness, and accuracy are often made in dry-sand molds. In the preparation of these molds, the facing mixture contains a relatively coarse molding sand with some binder such as dextrin, molasses, or gelatinized starch. After the molds are finished, they are placed in ovens where they are heated until all moisture has been removed and the bonding material has hardened. A large mold-drying oven is shown in Fig. 122 in Chapter XII. Metal flasks must be used for dry-sand molds to

withstand the heat in the ovens. These molds can be held for any length of time before pouring, provided they are kept dry.

Molds prepared from assemblies of dry-sand cores are sometimes used for cast iron, steel, and other metals. This practice insures freedom from gases due to moisture, and makes possible the production of castings having intricate detail. The cast-iron pulleys shown in Fig. 32

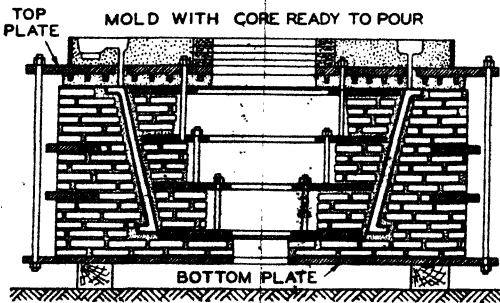
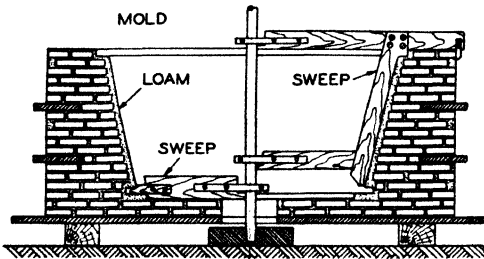
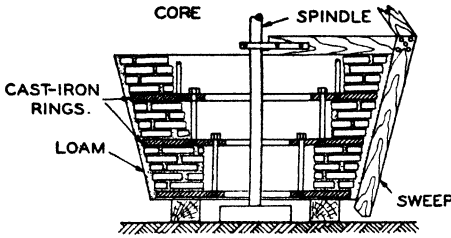

FIG. 33.—CONSTRUCTION OF LOAM MOLD

were made in molds constructed of dry-sand cores. Several different core boxes were needed for this job, but the equipment required was rather simple.

Loam Molds

Loam molds are employed chiefly in the making of large castings for which it would be too expensive to use full patterns and ordinary flask equipment. The molding material is a plastic mixture of molding sand and water. Loam molds are usually formed by the use of skeleton patterns or by rotating sweeps around a central spindle. Cast-iron plates and bars serve to reinforce the brickwork which retains the molding material. Objects such as large cylinders, round-bottomed kettles, large gears, and other machine parts are produced in loam molds.

The loam mold shown in Fig. 33 is assembled from three separate parts. In addition to the main body of the mold, the core forms the internal surface of the casting, and the upper portion of the mold con-

tains the pouring basin for distributing the metal to the casting. All surfaces which come in contact with the molten metal are prepared with a mixture of loam which is plastered on the brickwork foundation and molded to the desired dimensions with the aid of wooden sweeps. The

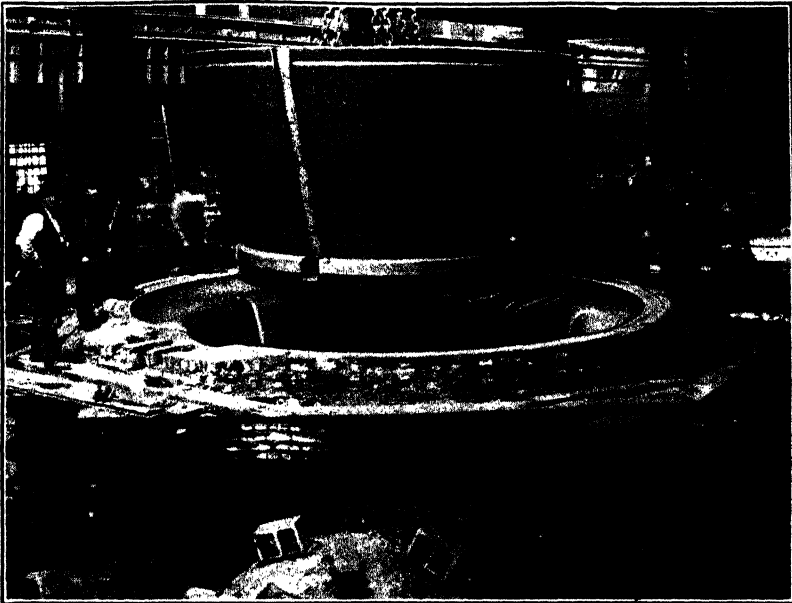

Courtesy of Allis-Chalmers Manufacturing Company

FIG. 34.—CORE BEING ASSEMBLED IN LOAM MOLD

surfaces of loam molds are blackened and are dried before being assembled. A loam mold in preparation is shown in Fig. 34.

Metal Molds

Three commercial processes employ metal molds for the production of large numbers of castings. The die-casting process is particularly adapted to the making of castings from the low-melting alloys of lead, tin, zinc, and aluminum. Iron castings are produced in large quantities by the permanent mold process (Holley patents). In another process the metal is deposited in metal molds by centrifugal force (de Lavaud patents). The industrial importance of these casting processes warrants some attention to the equipment used and to the results obtained.

Die-Casting Process.—Die castings are made by forcing molten metal under high pressure into a metal mold or die, and maintaining the pressure until the metal has solidified. The advantages of die-casting practice lie in the possibility of obtaining castings of sufficient

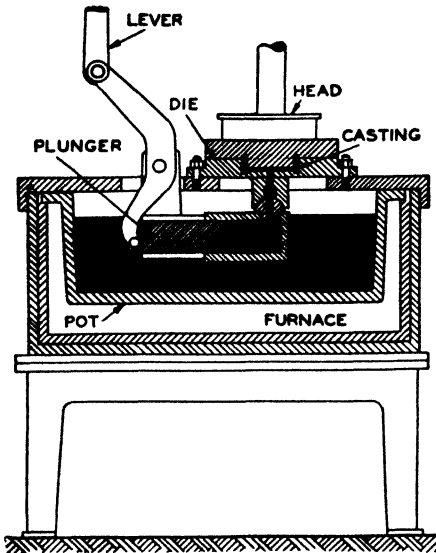

FIG. 35.—PLUNGER-TYPE DIE-CASTING MACHINE

exactness to dispense with many machining operations and in the facility for casting thinner sections than can be produced by any other casting method. A limit of accuracy within 0.002 inch of specified dimensions is obtained without great difficulty by this process. The weights of die castings are most commonly from a fraction of an ounce to 10 pounds, although castings weighing over 20 pounds are being produced regularly.

The machines used in making die castings are of two types. In the **plunger-type machine**, the metal is forced into the die by means of a cylinder and piston which are submerged in the

molten metal. The construction of this machine is shown in Fig. 35. In the **air-operated machine**, the metal is forced into the die by air at high pressure on the surface of molten metal in the goose-neck as illustrated in Fig. 36.

The metal dies used in this process are complicated and expensive, and unless a sufficient number of castings of a given design can be made in one set of dies, this method of casting is not feasible. A set of dies for the production of aluminum castings is shown in Fig. 37. During the operation of the die-casting

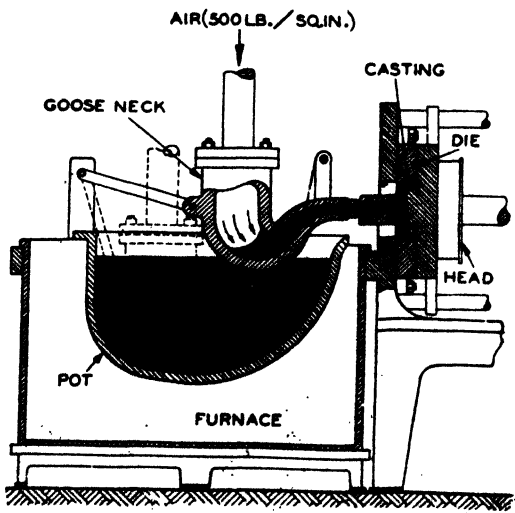
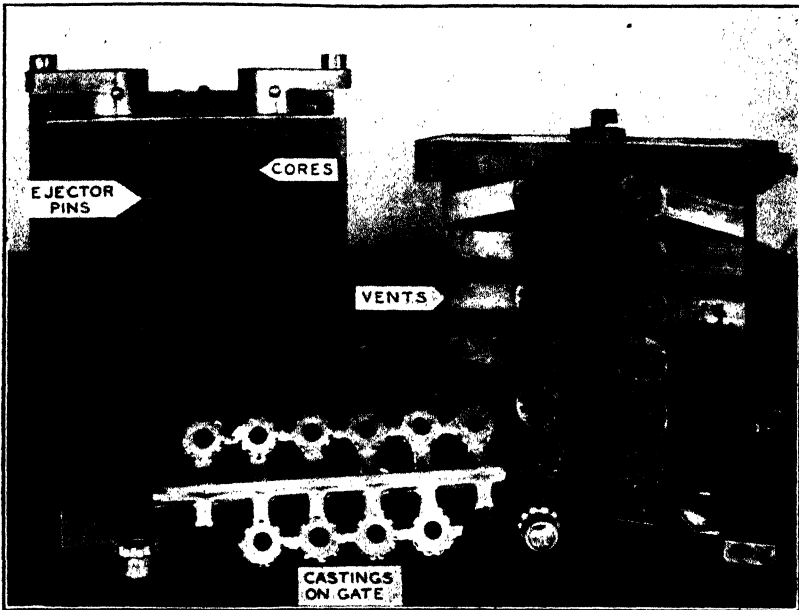

FIG. 36.—AIR-OPERATED DIE-CASTING MACHINE

machine, the die is exposed alternately to the casting temperature of the metal and to room temperature. The die must receive and transmit

the heat from each casting as it solidifies. These reversals of temperature produce a state of fatigue in the metal which causes cracks in the die after a certain number of cycles. The life of a set of dies depends to a large extent upon the alloy used in the castings produced by this process. For lead and tin alloys, dies made of carbon steel last almost indefinitely. By using dies made of alloy steel, it is possible to produce over 100,000 castings of a zinc-base alloy in one set of dies. For aluminum-base alloys, the life of a die made of the best alloy steel and correctly heat treated will permit the making of 100,000 castings.



Courtesy of Madison-Kipp Corporation

FIG. 37.—SET OF DIES FOR THE PRODUCTION OF DIE CASTINGS

The compositions of the non-ferrous alloys used in making die castings are given in Chapter XIII. The metals which are employed most extensively for this purpose are the zinc-base and aluminum-base alloys. Other types of alloys have as predominant elements tin, lead, magnesium, or copper. As a rule, the lower the melting point of the alloy, the less the cost of making castings by this method.

Another process for producing castings from the non-ferrous alloys, including some copper alloys, has been described by Pack² as **press casting**. In this process, a roughly measured quantity of molten metal

is poured into a cylinder and is immediately forced into a die by a plunger mounted on a power press. A pressure of about 4,000 lb. per sq. in. causes the molten metal to fill all parts of the metal die.

Permanent-Mold Process.—Large numbers of iron castings of many designs are made on permanent-mold machines. This equipment consists of thin cast-iron molds which are split vertically and mounted so that they can be opened and closed conveniently. The interior surfaces of the molds are coated with a thin layer of refractory material, and a deposit of carbon is placed on this coating to protect the molds against

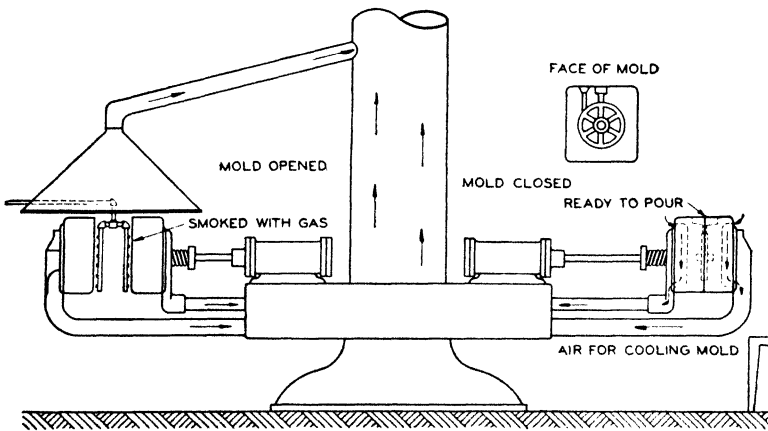

FIG. 38.—METAL-MOLD CASTING MACHINE
Twelve molds rotate through the cycle of operations.

the abrasive action of the molten metal. A machine on which metal molds are mounted is shown diagrammatically in Fig. 38.

Pouring is done through short gates, and relatively little pressure is produced within the mold. As soon as the metal has set, the mold is opened and the casting is ejected. A stream of air is supplied to clean the surfaces of the mold. Then another deposit of carbon is made with an acetylene flame, and the two parts of the mold are air cooled for a short time before being closed and poured again. At the beginning of each working period, the molds are heated to a temperature of about 500 degrees F. before the first castings are poured. The molds are used repeatedly for an average production of 15,000 iron castings. Practically all iron castings made in metal molds are annealed to improve the machinability of the metal.

Large numbers of aluminum castings are made by pouring the molten metal at atmospheric pressure into metal molds. These molds are

poured so that the portion of the casting farthest from the gate solidifies first; this allows the casting to be fed as the metal sets and thus prevents the formation of shrinkage cavities.

Slush castings are produced by pouring the low-melting alloys of lead, antimony, and zinc into metal molds and, after a short interval, slushing out the metal which remains in a liquid state. By this means, a hollow skin of metal is left in contact with the mold surface; then the mold is opened and the casting is removed. This casting process is used in making toys, hardware, and a variety of small ornamental objects.

Centrifugal Process.—Cast-iron pipe is produced in large quantities by the centrifugal process. The de Lavaud machine shown in Fig. 39 contains a cylindrical metal mold with a water jacket around the outside. Molten iron is delivered from a ladle to a long trough having a curved spout at its discharge end. At the beginning of operations, the trough is extended for its full length within the hollow mold which is rotated at a high speed. The iron is deposited uniformly on the surface

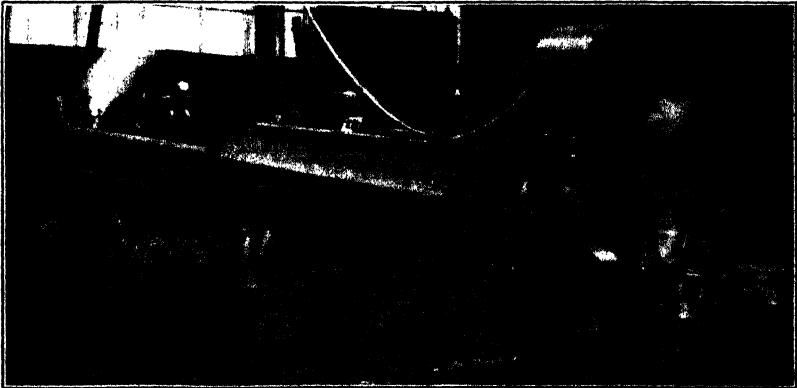

Courtesy of United States Pipe and Foundry Company

FIG. 39.—CENTRIFUGAL CASTING MACHINE

of the mold by moving the mold gradually away from the end of the spout as the metal is poured.

The drawings in Fig. 40 show the different positions of the mold and trough during one complete casting cycle. As soon as the metal in the mold has solidified, suitable pullers are attached to the bell end of the pipe, and the pipe is withdrawn from the mold. After the mold has been returned to the opposite end of the bed and a new head core has been placed in the bell, the casting cycle is repeated. Each length of

pipe is transferred to an annealing furnace immediately after removal from the casting machine. Centrifugally cast pipe is made in sizes from 3 to 24 inches in diameter and up to 18 feet in length.

Another method for making cast-iron pipe consists of casting the metal centrifugally in molds lined with molding sand. The sand is rammed around metal patterns within cylindrical flasks which are supported in a vertical position on jolt machines. After the patterns are withdrawn, the molds are returned to a horizontal position and are skinned before being placed in position for casting. A definite amount of

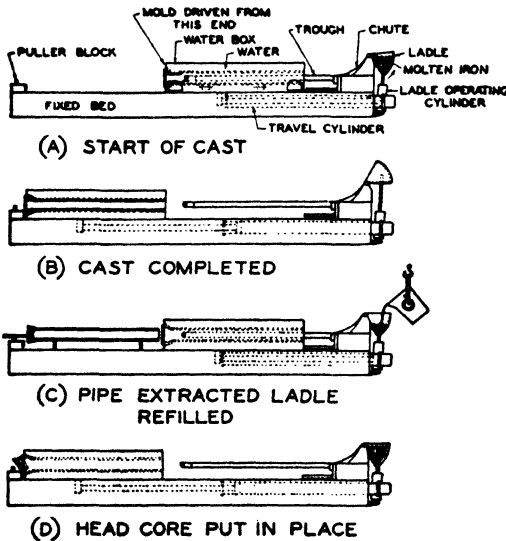

metal is supplied to the pouring basin; then the pouring end of the mold is raised slightly, and the metal is delivered from the basin to the long trough on the casting machine. This takes place while the mold is being rotated at a high speed. As the pouring continues, the mold is gradually moved to a horizontal position. Following the pouring operation, the mold and casting are transferred to the cleaning department where the sand is shaken out and the casting is removed from the flask. It is not necessary to anneal cast-iron pipe which is

FIG. 40.—OPERATIONS IN MAKING CENTRIFUGALLY CAST PIPE

produced in sand-lined molds by the centrifugal process.

MOLDING METHODS

Molding practice for the production of metal castings varies greatly. Two factors which affect the equipment and methods for molding are the size of the castings and the number required from each pattern. Molding methods are designated as **bench molding**, **floor molding**, and **pit molding**, depending upon the position of the equipment during the preparation of the molds. Molds for small castings are usually prepared on a bench at a convenient working height. These molds are placed on the floor or on conveyors for pouring. When large patterns are used,

the molds are made on the foundry floor, and an overhead crane is generally provided to handle the molding equipment. Molds which are too large to be constructed handily above the floor are prepared in pits below the floor level.

Molds can be prepared in several different ways. The simplest is to make a cavity in the sand on the foundry floor. **Open molds** have a

limited use, being suited only to the making of weights and other rough castings. The practice generally followed in molding is to prepare copes and drags with the addition of cheeks when necessary. A three-part mold is shown in Fig. 13. Another method of arranging molds for pouring is to place a number of sections upon one another so that all castings can be poured through one sprue. This practice is used in making piston rings and a variety of other small castings. The drawing in Fig. 41 illustrates the method of stacking molds. When thin castings are poured in **stacked molds**, the metal in the castings solidifies so rapidly that the pressures developed

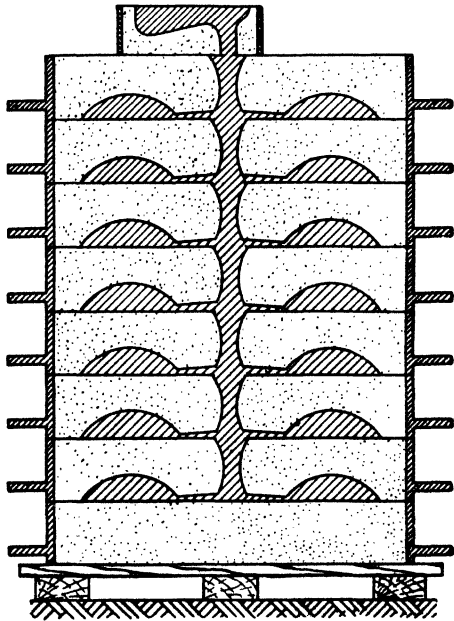

FIG. 41.—STACKED MOLD

by the head of metal within the molds are relatively small.

When only a few castings are required from a given pattern, the molds are usually made by hand. However, it is more economical to use molding machines when a sufficient number of castings are to be made from one pattern. By substituting mechanical means for the slow, laborious hand operations of molding, it is possible to increase production to a large extent.

MOLDING OPERATIONS

The procedure required in the preparation of a sand mold may be divided into major operations and minor operations. Ramming the sand against the pattern, rolling the flask over, and drawing the pattern

from the sand are essential steps in practically all molding procedure. Therefore, these are designated as **major operations**. The completion of the mold requires a number of **minor operations** such as cutting gates, providing vent openings, finishing the mold surfaces, placing cores, assembling the cope and drag, and finally clamping these parts of the mold. One or more of the major operations can be performed on molding machines, but the minor operations are usually done by hand.

MOLDING MACHINES

Mechanical equipment is used extensively for performing one or more of the operations necessary in molding. In molding-machine practice, the sand is rammed against the pattern by squeezing, jolting, or throwing the sand into the flask. Some molding machines also reverse the position of the flask and draw the pattern from the sand.

Squeezer Machines

The squeezer machine is constructed on the principle of a press. The mold is rammed by forcing a squeezer board against the sand which covers the pattern within the flask. This squeezing action compresses the sand most effectively near the squeezer board and is therefore particularly suited to the molding of relatively shallow patterns. Squeezer machines are used extensively in the preparation of molds from match plates. The hand squeezer is provided with a leverage mechanism for obtaining the desired pressure by hand operation. This type is being superseded largely by machines using compressed air within cylinders to obtain the desired pressure on the molds. The air is supplied to power squeezers at a pressure of about 80 lb. per sq. in.

Jolt Machines

Sand can be rammed into a mold by a jolting action obtained by raising the pattern mount, flask, and sand, and allowing them to fall upon a solid foundation. An air-operated piston within a cylinder with the proper valves produces the jolting motion. The density of the sand produced by each jolt is dependent upon the head of sand above the pattern and the distance through which it falls. The desired amount of ramming is obtained by repeated blows on the jolt machine. Plain jolt machines are built in many sizes to accommodate large and small molds. They operate with a stroke of 1 to 2 inches in length, and at a rate of 150 to 250 blows per minute. As the sand is not compressed at

The **motive-type sandslinger** is best adapted to the making of molds of large or medium size. This machine travels on a narrow-gage track under its own power, and the supply of molding sand is carried in a tank mounted on the machine. The tank is filled by a grab bucket or at a loading station in the foundry. With the aid of this flexible mold-

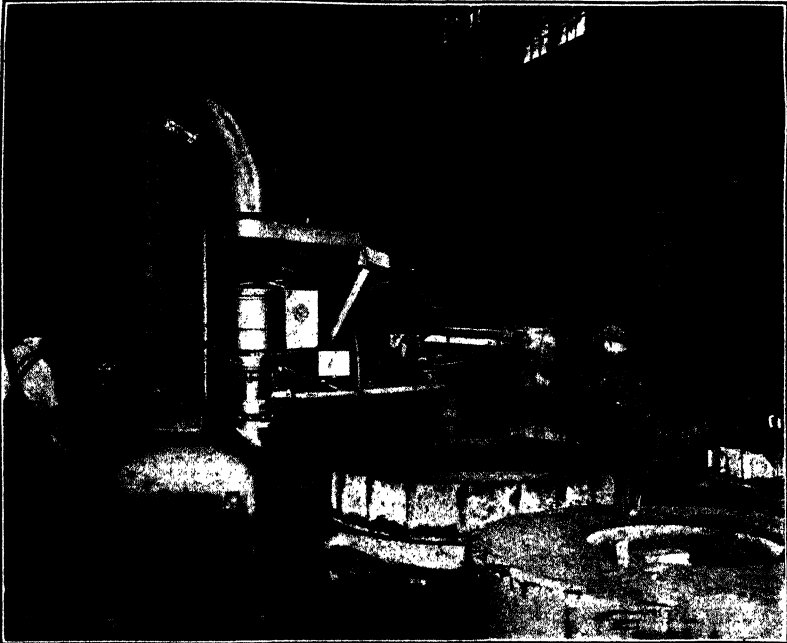

Courtesy of The Beardsley and Piper Company

FIG. 44.—PORTABLE-TYPE SANDSLINGER.

ing equipment, molds can be rammed in pits as well as on the foundry floor.

Combination Molding Machines

In addition to ramming the sand, other molding operations which can be accomplished by mechanical means are rolling the flask over and drawing the pattern from the sand. Molding machines on which a combination of operations are performed are usually employed on quantity-production work. Machines are available on which the sand is jolted, the mold is rolled over, and the pattern is drawn by power, thus eliminating a large part of the hand work in connection with the making of a mold. These steps in the molding practice for the prepara-

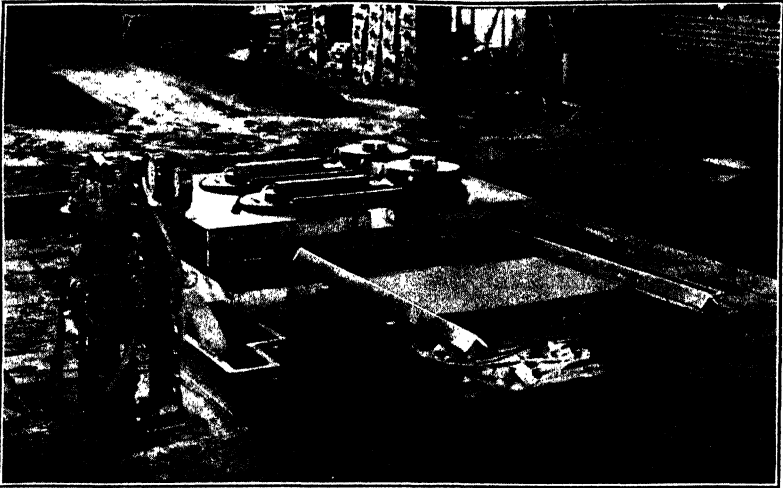

Courtesy of Herman Pneumatic Machine Company

FIG. 45.—JOLT-ROLLOVER-PATTERN DRAW MOLDING MACHINE
The mounted drag pattern is attached to the machine and rests on the jolting table.



Courtesy of Herman Pneumatic Machine Company

FIG. 46.—JOLT-ROLLOVER-PATTERN DRAW MOLDING MACHINE
The flask is set around the pattern and is clamped to the machine. Molding sand is placed in the flask and is rammed by jolting.

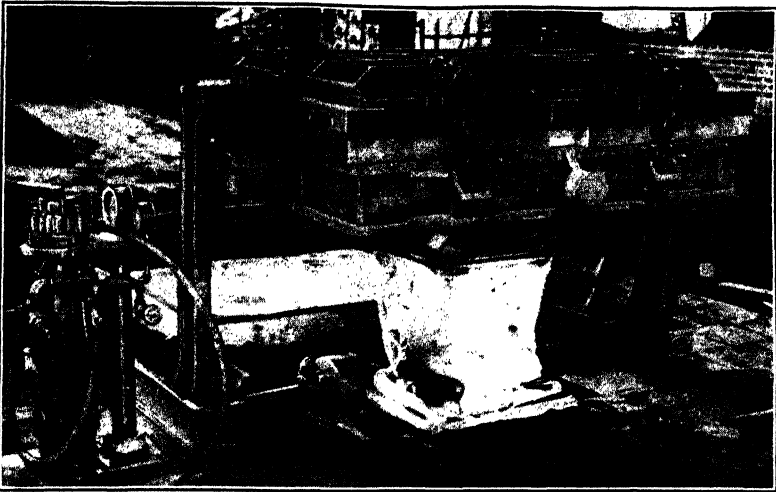

Courtesy of Herman Pneumatic Machine Company

FIG. 47.—JOLT-ROLLOVER-PATTERN DRAW MOLDING MACHINE

The drag is rolled over. The leveling table is in the raised position. The clamps are released and the drag rests on the table.

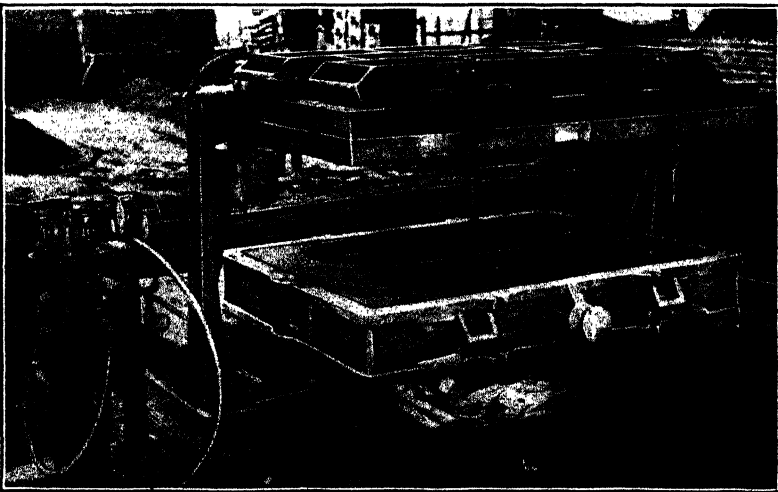

Courtesy of Herman Pneumatic Machine Company

FIG. 48.—JOLT-ROLLOVER-PATTERN DRAW MOLDING MACHINE

The drag is stripped from the pattern by lowering the table. After the pattern mount has been returned to the jolting table, the cores are set in the drag, and the finished drag is then transferred to the floor.

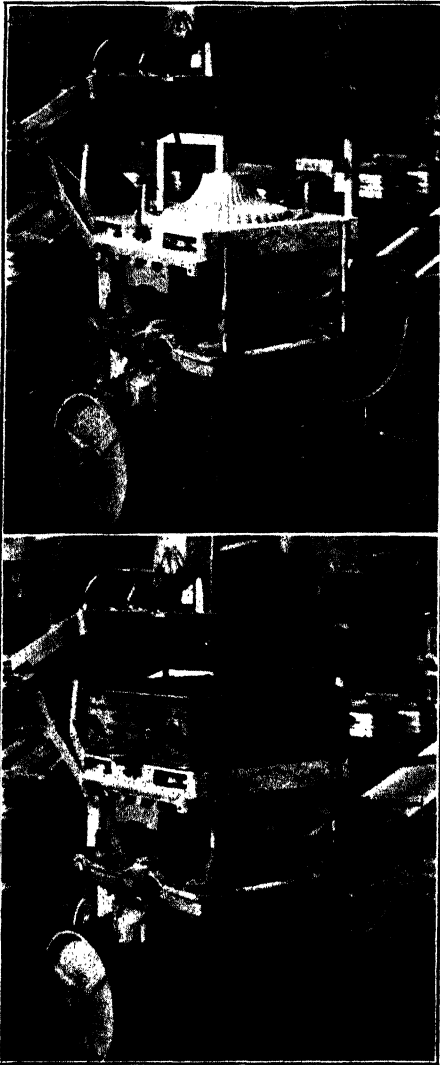

Courtesy of The Osborn Manufacturing Company

FIG. 49.—JOLT-SQUEEZE-STRIPPER
MOLDING MACHINE

The cope pattern is mounted on the machine ready to receive the flask as shown in the upper view. Molding sand has been placed in the flask as shown in the lower view, and the mold has been rammed by jolting.

tion of large molds may be observed in the illustrations from Fig. 45 to Fig. 48. The operation of the machine is controlled by air valves shown at the left in each view. Some parts of the machine are below the level of the molding floor. A cloth bag is used to keep the molding sand from the surface of the piston to which the leveling table is attached.

The rolling over of a mold is greatly facilitated by clamping the mold to a table which is revolved on trunnions or arms. On rollover machines, the pattern is fastened securely to the rollover table, and the mold in its reversed position rests on a leveling table which is provided with some means for equalizing the variations in height of the flask. In drawing the pattern, either the rollover table with the pattern attached is raised from the mold, or the mold on the leveling table is lowered from the pattern. The relative motion of parts of the machine is obtained by means of sliding surfaces. The advantages of drawing the pattern by mechanical means lie in the speed and accuracy with which this operation can be performed. Jolt-rollover-pattern draw machines are particularly advantageous for the making of drags because, on the comple-

tion of the molding, this part of the mold is left in the position in which it will be poured.

The density of the sand in a mold which has been jolted is greatest at the surface of the pattern and decreases towards the top of the flask so that additional ramming is necessary at the upper surface of the mold, which is readily obtained by a squeezing operation. Therefore, molding machines are often designed for a combination of jolting and squeezing. Furthermore, these machines often provide for stripping the mold from the pattern. This series of molding operations is illustrated in Fig. 49 and 50. Molding sand is shoveled into the flask by hand or is supplied through a gate on an overhead bin. This machine occupies little floor space and can be moved to any location on the molding floor. Only a short time is required to change patterns on a molding machine of this type. The jolt-squeeze-stripper machines perform all the major operations for the making of copes, and a high rate of production is possible with this molding equipment. A machine with mounted pattern is also shown in Fig. 51. The squeeze head is attached to a vertical support and can be moved to one side when not in use. On

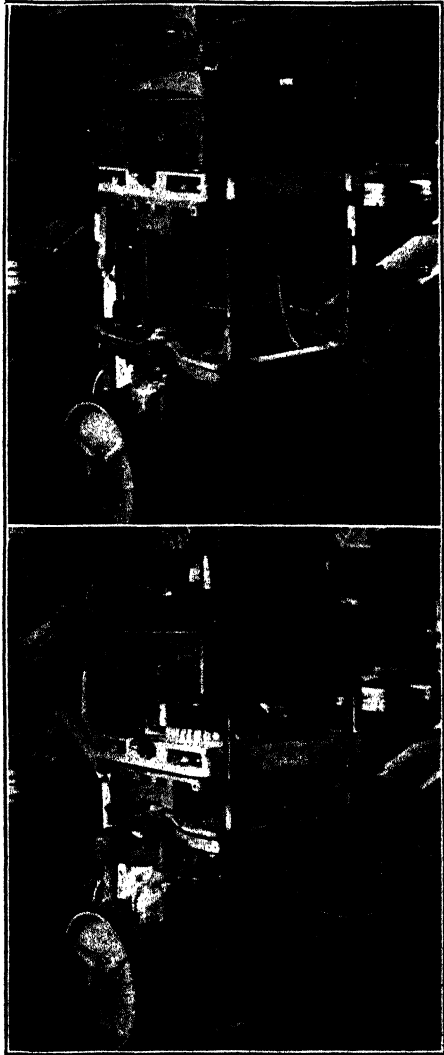

Courtesy of The Osborn Manufacturing Company

FIG. 50.—JOLT-SQUEEZE-STRIPPER
MOLDING MACHINE

The squeeze head has been pulled forward as shown in the upper view and the sand has been rammed by squeezing. In the lower view, the head has been pushed back and the mold has been drawn from the pattern by raising the lifting pins. The mold is then taken from the machine and the pins are lowered.

machines of this type, the jolting and squeezing operations, as well as the stripping of the patterns, are accomplished by air at a pressure of about 80 lb. per sq. in.

Conveying systems are often provided in conjunction with molding machines for supplying sand, flasks, bottom boards, and cores to the machines, and for transporting the finished molds to the pouring stations. Some designs of molding machines are arranged to place the completed half-molds directly

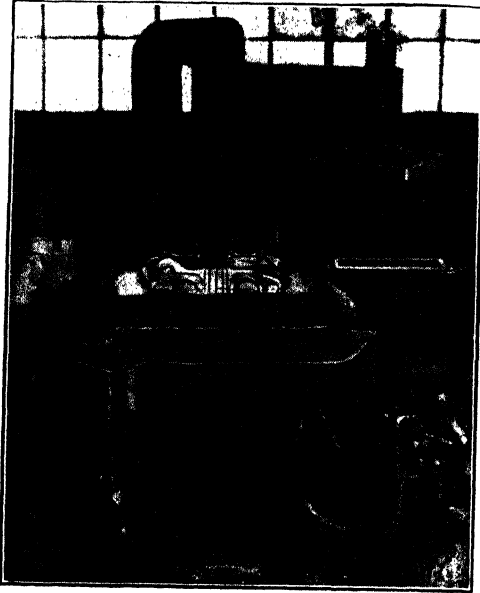

Courtesy of Milwaukee Foundry Equipment Company

**FIG. 51.—JOLT-SQUEEZE-STRIPPER
MOLDING MACHINE**

The pattern equipment is mounted on the machine. The operator stands in one position, places a flask around the pattern, and fills the flask with sand from an overhead bin. The movements of the control valve at the right cause the machine to jolt and squeeze the sand in the cope, as well as to draw the pattern from the sand after ramming.

machine equipped for making cores is shown in Fig. 58 in Chapter IV. After the sand mixture is rammed into the box and a core plate is clamped on top, the box is rolled over and the cores are removed by lowering the table on which the plate rests. In the making of large cores, the core-sand mixture is often rammed into the boxes by jolting. The core boxes are then rolled over on the machine and the cores are stripped from the boxes.

on a roller conveyor. This method for handling drags from a molding machine is illustrated in Fig. 52.

A jolt-rollover-pattern draw machine is shown with the drag lowered from the pattern and with the pattern mount being reversed to the jolting position. The procedure in many production foundries is to prepare the copes on jolt-squeeze-stripper machines and to transfer these directly from the machines to the drags on a conveyor. The complete molds are then carried along to the pouring stations.

Combination molding machines are often employed for making cores. The core boxes are mounted on the roll-over tables and the cores are turned out on plates for baking. A

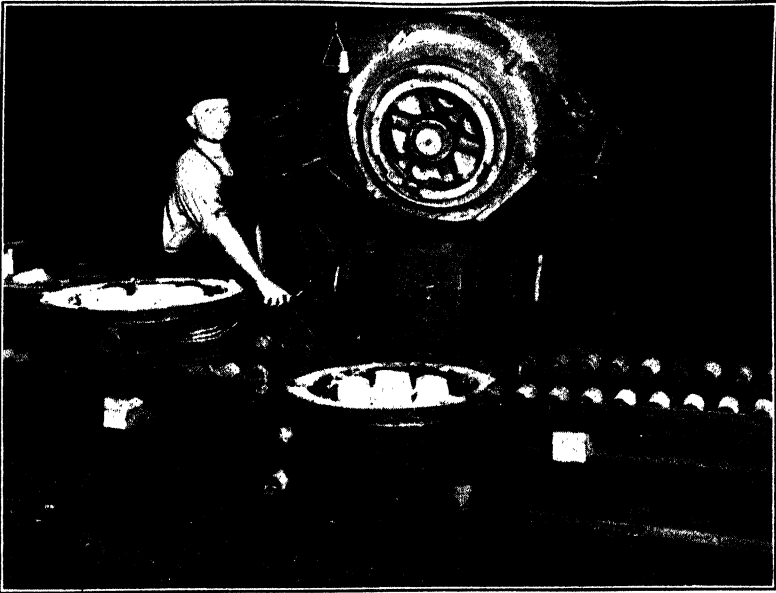

Courtesy of International Molding Machine Company

FIG. 52.—JOLT-ROLLOVER-PATTERN DRAW MOLDING MACHINE

The drag is shown after being stripped from the pattern. The jolting table is on the opposite side of the machine. The pattern mount is being reversed to the jolting table. The machine will raise the drag to the level of the roller conveyor so that the drag can be transferred to other locations.

BIBLIOGRAPHY

1. EDWIN S. CARMAN, "Foundry Moulding Machines and Pattern Equipment." 1920. The Penton Publishing Company, Cleveland, Ohio.
2. CHARLES PACK, "Press Casting." *Metals and Alloys*, v. III (1932), p. 29-37.
3. MARC STERN, "Die-Casting Practice." 1930. McGraw-Hill Book Company, New York, N. Y.
4. RICHARD MOLDENKE, "Permanent and Long Life Molds." *Trans. A.F.A.*, v. XXXIV (1926), p. 204-213.
5. S. B. CLARK, "Late Developments in the de Lavaud Process." *The Iron Age*, v. 131 (1931), p. 1426-1429.
6. PAT DWYER, "Gates and Risers for Castings." 1935. The Penton Publishing Company, Cleveland, Ohio.
7. HERBERT L. CHASE, "Die Castings." 1935. John Wiley and Sons, New York, N. Y.

REVIEW QUESTIONS

I

What is the purpose of each of the following parts of a sand mold: (a) sprue, (b) runner, (c) riser, (d) gagers, (e) bottom board?

II

What conditions control the size and location of gates?

III

Explain the purpose and method of preparing a hard-sand match.

IV

What are the advantages of mounted patterns?

V

Discuss three types of mounted patterns.

VI

Explain the difference in the principle of operation of the two types of stripping machines.

VII

What are the advantages of green-sand molding practice?

VIII

Account for the difference in the materials used in preparing green-sand molds and dry-sand molds.

IX

Describe the practice used in making loam molds.

X

What are the advantages of the die-casting process?

XI

Account for the limited life of dies used in making die castings from different alloys.

XII

What defects may be found in die castings?

XIII

Describe the centrifugal process for making cast-iron pipe.

XIV

What difficulties would be encountered in using cast-iron molds without coatings on the surfaces of the molds?

XV

Explain the difference in the die-casting process and the permanent-mold process for producing aluminum castings.

XVI

Outline the major and minor operations required in molding practice.

XVII

What advantages are obtained by the use of molding machines?

XVIII

Discuss the uses and advantages of each of three types of sand-ramming machines.

XIX

What type of molding equipment is particularly suited to the making of copes?

XX

Explain the purpose of employing both the jolt and squeeze operations of ramming sand in the same machine.

CHAPTER IV

CORE PRACTICE

REQUIREMENTS OF SAND MIXTURES FOR CORES—Green Strength—Dry Strength—Permeability—Resistance to Heat—Smoothness of Surface—CORE SANDS—CORE BINDERS—Oil Binders—Water-Soluble Binders—Pitch and Rosin Binders—Combinations of Binders—PREPARATION OF CORE MIXTURES—CORE MAKING—CORE BAKING—Core Ovens—FINISHING AND PLACING CORES—DEFECTIVE CASTINGS CAUSED BY IMPERFECT CORES

A core is a body of sand or other refractory material which is prepared separately and is introduced into a mold either during its construction or after the mold proper has been completed. The internal surfaces of most castings are formed by cores. Other applications of cores are illustrated in Fig. 53; the strainer core separates solid masses of slag from the metal; the ram-up core at the bottom of the gate prevents cutting of the molding sand by the molten metal; and the cover core forms

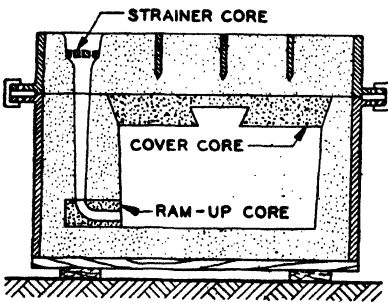
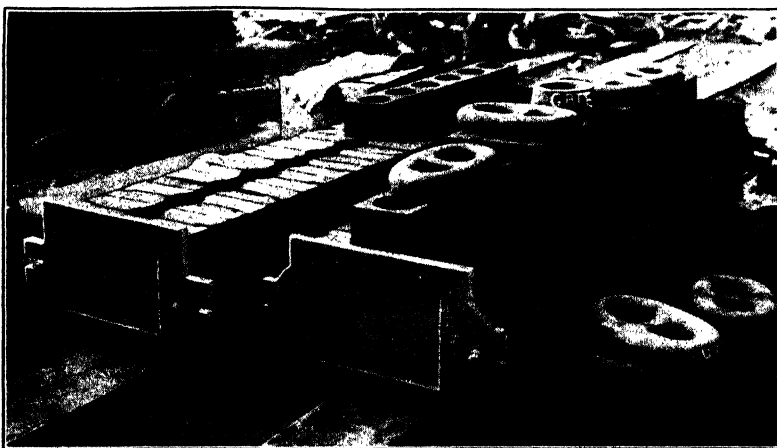

FIG. 53.—CORES IN MOLD

a detail in the mold which would be difficult to produce in molding sand. Many castings are made in molds prepared entirely from baked cores which are assembled and clamped together as shown in Fig. 54. Cores made of molding sand in the damp state are known as **green-sand cores**. The sand is rammed into boxes or is swept to the desired shapes in about the same way that green-sand molds are made. Because of the low strength of cores made of molding sand, their use is limited to simple shapes which can be readily supported in the molds. **Dry-sand cores** are prepared with mixtures of sands and other materials which cement the sand grains together after the cores have been baked.

REQUIREMENTS OF SAND MIXTURES FOR CORES

The selection of materials and the proportioning of these materials in mixtures for cores depend upon the specific requirements of the cores to be made from these mixtures. In general, the properties which are most significant in core-sand mixtures are: (1) green strength, (2) dry



Courtesy of Norfolk Navy Yard

FIG. 54.—MOLDS PREPARED WITH DRY-SAND CORES

strength, (3) permeability, (4) resistance to heat, and (5) smoothness of surface.

Green Strength

Sand mixtures for cores must have sufficient strength in the damp state to permit them to be molded into the desired shapes and to retain these shapes until the cores become hardened in the baking process. Materials such as gelatinized starch, dextrin, molasses, and plastic clays, because of their adhesive properties, are used to develop green strength in sand mixtures. Any finely pulverized insoluble material such as powdered silica will increase the green strength of a core mixture by exerting a frictional resistance between the sand grains. The green strengths of most core-sand mixtures can be measured by tests in compression in the same way in which molding sands are tested.

Dry Strength

Cores must have sufficient strength after baking to retain the exact shapes into which they were formed until the metal has solidified around

them. This property is determined to a large extent by the kind and proportion of the binder used in the core-sand mixtures. The strength required of a specific core depends upon its application or its position in the mold. A core must be strong enough to support its own weight as well as to resist the buoyant effect of the liquid metal in which it is submerged. Some cores are reinforced with steel wires or metal frames known as **core arbors** to overcome the forces to which they are subjected. The resistance offered to abrasion resulting from handling the baked cores and from the flowing of the metal over the cores depends upon the bond between the sand grains.

The strengths of test specimens prepared from different core-sand mixtures are determined most satisfactorily by transverse tests. A washed and dried silica sand which passes a 50-mesh sieve and is retained on a 70-mesh sieve is generally used in mixtures for test specimens. To obtain comparative data, it is necessary that the cores be made in a uniform way. Specimens 1 inch by 1 inch by 8 inches are prepared on the core-making apparatus (see Fig. 172 in the Appendix) and after they are baked are tested on the transverse testing machine (see Fig. 173 in the Appendix). A transverse strength of about 20 pounds may be sufficient for the mixtures used in some cores, but as a rule, over 40 pounds is required for most applications of dry-sand cores.

Permeability

All cores must be sufficiently permeable to allow the gases generated by contact of the molten metal with the cores to escape freely. The permeability is controlled largely by the grain size of the sand in the

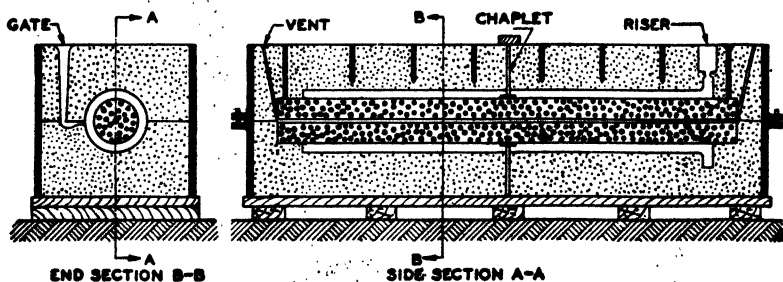

FIG. 55.—MOLD WITH CORE

core mixtures. If the gases are not removed through the cores within the time during which the metal remains liquid, they will be forced into the metal, causing defects in the castings. The areas for the removal

of gases from molds are relatively large compared to the areas of cores through which the gases can escape. This condition is illustrated in Fig. 55. Additional openings or vents are commonly made in cores to assist in the removal of gases from the interior of the cores to the outside of the molds. The relative permeability of dry-sand cores is determined by measuring the rate of flow of air through specimens of uniform size prepared on the core-making apparatus. The procedure for this test is given in the Appendix.

Resistance to Heat

All cores must be sufficiently refractory so that they will not be destroyed before the metal has solidified around them. The strainer core and the ram-up core shown in Fig. 53 must resist the heat from the metal for a short time. The larger the mass of metal which comes in contact with a core, the more severe will be the effect of the heat in altering the shape of the core. The resistance offered to the deterioration of the cores caused by the heat of the molten metal depends upon the refractory properties of the ingredients in the core mixtures, or upon the coatings which are applied to cores. A thin coating of graphite or silica flour aids in protecting cores which are subjected to the destructive action of molten metal. Core sands are usually very refractory, and a binder can be selected which will have the desired resistance to heat.

In many applications of cores, the bonding material must be destroyed by the heat from the metal to allow the normal contraction of the metal during cooling. A hard core which remains rigid after the metal has solidified around it will cause cracks or a stressed condition in the casting. For this reason, organic materials which are decomposed at the temperatures encountered in the molds are generally used as core binders. Some cores are almost completely surrounded by metal, and it is necessary for the bonding material to be destroyed by the heat from the metal so that the remaining core sand can be removed through small openings in the castings.

Smoothness of Surface

Those surfaces of castings made in contact with cores have practically the same smoothness as the surfaces of the cores, provided the metal is sufficiently fluid to fill the minute cavities on the cores. The predominating sizes of the grains of sand determine to a large extent the surface condition of the cores. Smoother surfaces are produced by

using sand containing grains of 50- to 70-mesh size than are obtained with a sand having a predominating grain size of 40- to 50-mesh. Core sand having a variety of grain sizes ranging from fine to coarse can not be used to advantage in making cores which must have smooth surfaces because the spaces between the larger grains are not completely filled by smaller grains. If it were possible to produce a dense, compact mass of sand in a core by using grains of different sizes, the core would usually not be satisfactory because of its low permeability. Small additions (less than 20 per cent) of finely divided materials such as silica flour to core-sand mixtures do not improve appreciably the smoothness of the surfaces of cores. The most desirable properties are obtained when the core sand consists of grains of uniform size and of a sufficient fineness to produce the desired smoothness of surface.

CORE SANDS

The sands used for making cores may be classified into two ranges of grain size; those which in large part pass a 40-mesh sieve and are retained on a 70-mesh sieve are known as **lake sand** or **dune sand**; and those which pass a 50-mesh sieve and are retained on a 200-mesh sieve are sometimes known as **bank sand**. Small cores are usually made with sand free from clay, whereas the mixtures for large cores may contain some molding sand or bentonite for the purpose of strengthening the cores in the green state. The smaller the grain size of the sand used in cores, the smoother will be the surfaces of the castings made in contact with these cores. Furthermore, sand with rounded grains is more satisfactory for cores than sand with angular grains.

CORE BINDERS

The mixtures from which cores are made contain materials known as core binders which cement the sand particles together before or after the cores are baked. The commercial core binders may be classified as oil binders, water-soluble binders, and pitch and rosin binders. The characteristics of these materials will now be considered.

Oil Binders

Linseed oil, china wood oil, soya bean oil, and other drying oils which form hard films when they are oxidized are used extensively as core binders. The oxidation of the drying oils proceeds at a slow rate at temperatures below 350 degrees F., but when the baking temperature is raised to 425 degrees F., the rate of hardening is greatly accelerated.

Temperatures above 500 degrees F. destroy the oil films and thereby lower the strength of the cores.

The oil binders are used in sufficient proportion to coat each grain of sand with a thin film of oil. If the sand contains clay or fine silt, more oil is required to cover the increased area of the material. The effect of increasing the proportion of raw linseed oil in mixtures prepared with clean silica sand is indicated on the diagram in Fig. 56. Small intricate cores which must be very strong and also very permeable are often made from mixtures containing 50 parts by volume of core sand

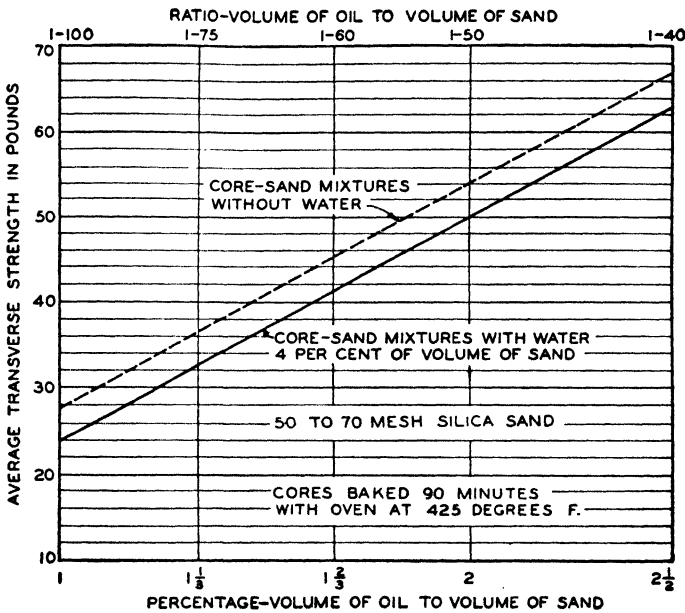

FIG. 56.—DRY STRENGTHS OF OIL-SAND CORES

and 1 part by volume of linseed or other drying oil. Oil binders are seldom used in proportions greater than 2½ per cent or less than 1 per cent of the volume of sand.

Some water is usually added to oil-sand mixtures to improve their green strength and thus cause the sand to be more easily formed into the desired shapes. The presence of water lowers the strengths of oil-sand cores as a result of losing some of the binder when the water is evaporated during the baking of the cores. The decrease in strength of specimens prepared from oil-sand mixtures containing water in the ratio of 4 per cent of the volume of the sand is shown in Fig. 56. Larger

proportions of water cause a greater decrease in the strength of oil-sand cores.

Water-Soluble Binders

Gelatinized starch, dextrin, molasses, and lignone are used extensively as sand binders. These materials are sticky when mixed with water, and concentrate to form a bond between the sand grains when the water is evaporated. A baking temperature of 350 degrees F. is satisfactory for all cores prepared with the water-soluble binders. Gelatinized starch and dextrin are products obtained by heating starch alone or in combination with chemical agents. Dextrin is readily soluble in water, whereas gelatinized starch forms a jelly-like suspension in water. Cores prepared with dextrin usually have hard surfaces and soft centers after

TABLE III
TRANSVERSE STRENGTHS OF DRY-SAND CORES

Sand used, 50- to 70-mesh silica sand.

Total baking time, 90 minutes.

Binder	Binder Ratio		Water Ratio, % of Vol. of Sand	Baking Temperature, Degrees F.	Average Strength, Pounds
	% of Vol. of Sand	% of Wt. of Sand			
Linseed Oil	2	..	4	425	50
Gelatinized Starch	2	18	350	50
Dextrin	2	6	350	20
Lignone *	2	8	350	27
Molasses	2	..	4	350	32
Pitch	5	8	350	23
Rosin	4	4	350	24
Linseed Oil †	1	..	8	400	51
Linseed Oil ‡	1	..	12	400	63
Linseed Oil §	2	..	8	425	23
Linseed Oil ¶	2	..	10	425	23

* Mixture contained fire clay in proportion of 2% of weight of sand.

† Mixture contained gelatinized starch in proportion of 1% of weight of sand.

‡ Mixture contained dextrin in proportion of 2% of weight of sand.

§ Mixture contained bentonite in proportion of 1% of weight of sand.

¶ Mixture contained silica flour in proportion of 20% of weight of sand.

baking, a condition caused by the transfer of the binder to the surfaces of the cores by the water vapor. Gelatinized starch, on the other hand, remains in place when the water evaporates and produces cores of uniform hardness. The results of tests of cores containing each of the water-soluble binders are given in Table III.

Molasses is a by-product of the sugar industry. It is often used in combination with other binders and increases both the green strength and dry strength of sand mixtures.

Lignone is a product from the sulphite process of paper making. It is composed of the soluble resins from pulp-wood. After the sulphite liquors are separated from the pulp, they are concentrated or evaporated to dryness to obtain the material which is used as a sand binder. Because of the high solubility of lignone, this binder is transferred to the surfaces of cores by the water vapor during the baking period. The presence of clay or other finely divided material in the core-sand mixture retards the migration of the binder and results in greater strengths than can be obtained with very permeable core-sand mixtures. The transverse strength of test specimens containing lignone is given in Table III.

Cores prepared with the water-soluble binders become hardened on all exposed surfaces when they are permitted to remain for even a short time in a warm room. This preliminary strengthening aids in preventing injury to the cores during the transfer to the ovens.

Pitch and Rosin Binders

Pitch is the hard black residue from the distillation of coal tar. The melting point of the pitch which is used as a core binder is between 270 and 300 degrees F. Rosin is a by-product from the turpentine industry. It melts at temperatures between 140 and 200 degrees F. These materials are pulverized finely before being mixed with core sand. To develop green strength, water is usually added to the mixtures in a proportion of about 4 per cent of the volume of the sand. During the baking of cores containing pitch or rosin, the binder melts and flows between the grains of sand, and when the cores are cooled to ordinary temperatures, the binder hardens and thereby strengthens the cores. A temperature of 350 degrees F. is satisfactory for baking cores containing pitch or rosin. These binders must be used in relatively large proportions (not less than 4 per cent of the weight of the core sand) to develop useful strengths in the cores after baking. The properties of test specimens prepared from core-sand mixtures containing pitch and rosin are given in Table III.

Pitch-bonded cores are softened when they are exposed in molds to temperatures sufficiently high to melt the pitch, but on further heating and cooling, these cores become very hard and are difficult to remove from the interior of castings. Because of the low temperatures at which rosin melts and decomposes, this binder is particularly advantageous in cores which must collapse promptly to permit the free contraction of the metal around the cores. In some applications where the rapid softening of the rosin would cause the core to change its shape, this binder is not satisfactory.

Combinations of Binders

Combinations of binders are often used in core-sand mixtures to obtain the desired properties. Because the drying oils produce little strength in the sand mixtures before the cores are baked, water-soluble binders are often added to these mixtures to increase their green strength. The average transverse strengths of test cores prepared with combinations of linseed oil and other binders are given in Table III.

PREPARATION OF CORE MIXTURES

Several types of mixers are employed in foundries for the preparation of sand mixtures for cores. In the paddle-type mixer, the sand is agitated within a trough by a number of revolving blades on a horizontal shaft. Some designs have spiral blades which rotate within a metal trough. In machines of the muller type (see Fig. 121 in Chapter XII), the sand is turned over by plows and is then compressed by one or two rollers which revolve inside a pan.

The powdered core binders are usually mixed first with dry sand; then the liquid binders and water are added as the mixing is continued. All materials are measured accurately to insure uniform qualities in the core-sand mixtures. Liquid materials are usually prescribed and measured in proportions by volume. On the other hand, solid core binders are purchased on the basis of weight; so these materials should be added to core-sand mixtures in proportions by weight. The volume occupied by a unit weight of a powdered material depends upon the fineness of grinding and other conditions. However, it is often more convenient to measure powdered materials in units of volume when equivalent weights are known.

CORE MAKING

Cores are made by ramming the sand mixtures into boxes, the interiors of which have the desired shapes and dimensions. Some core

boxes have two or more parts which are held together by dowels and clamps when the cores are being formed. The cores are transferred from the boxes to metal plates on which the cores remain until after they are baked. If the cores have irregular shapes which can not be supported on flat plates, they are baked in metal forms known as **driers**, or are bedded in coarse sand. The core plates and driers are usually perforated to permit the circulation of gases and to lessen the sticking of the cores to the supports. Cores are often reinforced with steel wires

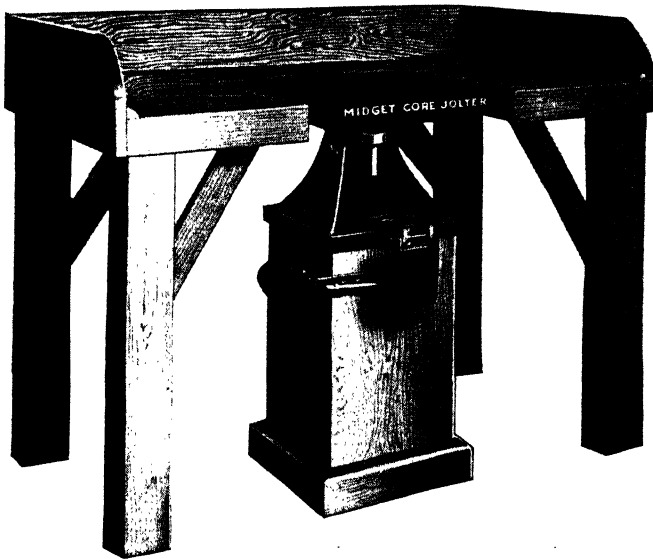

Courtesy of Arcade Manufacturing Company

FIG. 57.—JOLT MACHINE FOR CORE MAKING

and rods so that they will have sufficient strength to resist the forces to which they are subjected within the molds.

As a rule, one or more vents are provided in cores to assist in the discharge of gases from the interior to the core prints. These openings are made by ramming the sand around a steel rod when the core is being made or by pushing a vent wire through the core after it has been rammed. When a core is made in two parts, a notch is usually cut along the center of each part before the core is assembled. Cores of intricate shapes are often vented by placing strips of wax in the sand during their preparation. This wax is melted or destroyed when the cores are baked, thus leaving the openings through the cores.

When a small number of cores are required, they are made by hand operations with the materials placed at a convenient working height on a bench. The ramming of the sand into core boxes is sometimes assisted by a small jolt machine such as that shown in Fig. 57. Molding

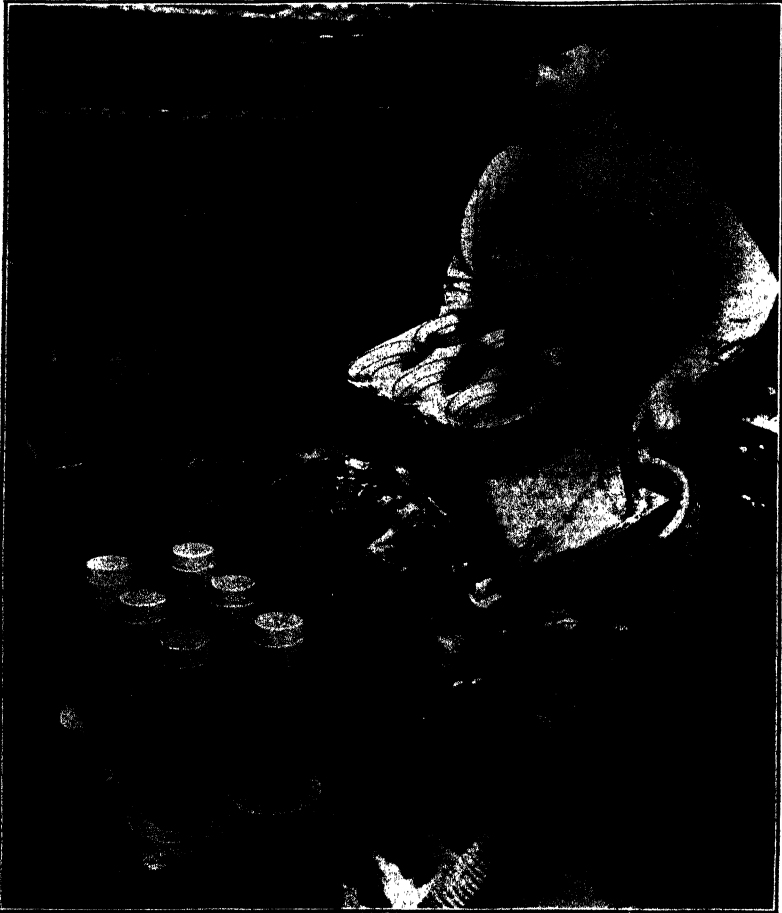

Courtesy of International Molding Machine Company

FIG. 58.—CORES MADE ON MACHINE

machines on which the core boxes are mounted are generally employed for the rapid production of cores of small and medium size. (See Fig. 58.) Large cores are swept up with templates or are made in boxes on molding machines. A high rate of production of cores is obtained on core-blowing machines which deliver the sand mixture by air at high pressure

into core boxes. A machine for this purpose is illustrated in Fig. 59. The core box is clamped in position on the machine while it is being filled with sand. Openings at the bottom of the sand reservoir connect with openings at the top of the core box. In another type of core-making machine shown in Fig. 60, cores of uniform section are produced by forcing the core-sand mixture through a die by means of a conveyor screw. Cores of any desired length in sizes from $\frac{3}{8}$ to 3 inches in diameter



Courtesy of The Osborn Manufacturing Company

FIG. 59.—CORE MAKER

are made in this way and are baked on trays. Each machine is equipped with an assortment of die tubes, conveyor screws, and trays for different sizes and shapes of cores. During the forming of these cores, a vent is made throughout the entire length of every core.

CORE BAKING

After the cores are formed to the desired shapes from core-sand mixtures, they are heated in ovens to assist in finally obtaining hard

cores. The conditions under which cores are baked depend upon the kind of binder used in the cores. The drying oils, such as linseed oil, harden by combining with oxygen, a reaction which takes place slowly at ordinary temperatures but more rapidly when the temperature of the oil exceeds 350 degrees F. Oil-sand cores are therefore heated in ovens to hasten the oxidation of the oil binder. The total time that the cores are in the baking oven may be divided

into three periods: first, the "heating-up" period; second, the "evaporation" period; and third, the "oxidation" period. During the heating-up period, the cores and core plates are heated to the temperature at which moisture or other volatile constituents are driven from the cores. The length of this period depends upon the initial temperature of the oven, as well as upon the rate at which heat is supplied to the oven. Because of the low thermal conductivity of core sand and the porous structure of cores, they are heated most effectively by hot air circulated through the oven. The evaporation period is the interval during which moisture and other volatile material is removed from the cores. If the core-sand mixture contains a light mineral oil in

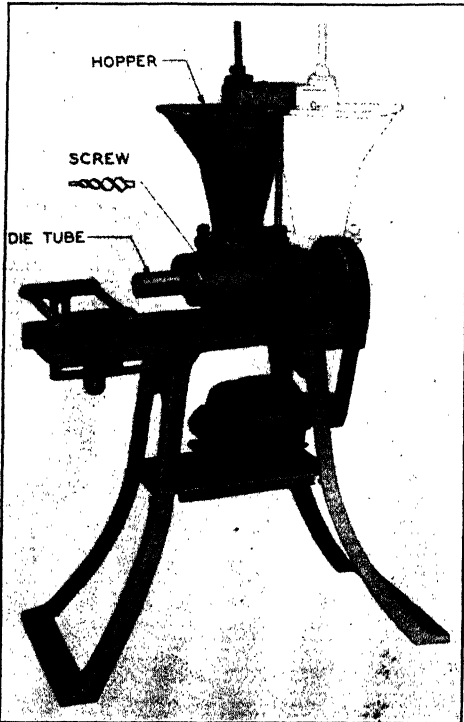

Courtesy of The American Foundry Equipment Company

FIG. 60.—CORE MACHINE

addition to moisture, the range of temperature and the length of time for the evaporation period will be extended until the mineral oil has been distilled off. The removal of the volatile products from the cores is hastened by providing an adequate supply of hot dry air to the oven during this period. The oxidation period is that part of the total baking time during which the drying oil becomes hardened by combining with oxygen. For the best baking conditions, a minimum volume of 1,000 cubic inches of air must be supplied to the oven for

every pound of oil-sand cores. The maximum strength of cores 1 inch in thickness and containing linseed oil in the proportion of 2 per cent of the volume of the sand, and water equal to 4 per cent of the volume of the sand, is obtained in 90 minutes with the temperature of the oven at 425 degrees F. Oil-sand cores 3 inches in thickness require 3 hours to bake to the center.

Cores prepared from sand mixtures containing the water-soluble binders become hardened when the moisture is removed. A maximum baking temperature of 350 degrees F. is most satisfactory for these cores. In a circulating atmosphere of dry air, cores 1 inch in thickness can be baked in 90 minutes.

Some water is usually added to core mixtures containing pitch or rosin to improve their green strength. In baking cores made from these mixtures, it is first necessary to evaporate the moisture and then to heat the cores until the binder melts and flows between the grains of sand. A temperature of 350 degrees F. is satisfactory for baking cores containing pitch or rosin.

Any of the industrial fuels which permit accurate control of the baking conditions may be used for heating core ovens. The relatively low temperatures which are most favorable for baking cores can be obtained conveniently from the combustion of gas. Fuel oil is sometimes burned in air heaters equipped with fans to circulate the hot air through the ovens.

Core Ovens

Core ovens may be classified on the basis of their construction and the methods of handling the cores.⁵ The **shelf-type oven** has a number of fixed shelves which are accessible through one or more doors on the oven. The cores on plates or driers are placed on the shelves and are removed after the cores are baked.

The **drawer-type oven** contains a tier of drawers arranged so that one or more can be withdrawn for loading or unloading while the cores on the remaining drawers are baking. In all designs of drawer ovens, the opening to the interior of the oven is closed when each drawer is fully extended. The drawer-type oven is commonly employed for baking small numbers of cores of many different sizes. An oven of this type is shown at the left in Fig. 61.

When the production of cores is very large, the coremakers' benches and machines are necessarily distributed over a large area. This condition requires that equipment be provided for transporting the cores to

the ovens and from the ovens to the storage space. Portable steel racks are sometimes used for holding cores and are placed at convenient locations in the core room. As soon as each rack is filled, it is moved by an elevating platform truck to a core oven. After the cores are baked, the rack is transferred to the molding floor or storage space. When the cores are removed from the racks, the plates and driers on which they were baked are left on the racks to be returned to the coremakers. The



FIG. 61.—CORE OVENS

ovens used for baking cores on portable racks have plain rectangular interiors which accommodate one or two racks at a time. A **box-type oven** within which cores are baked on racks is shown in Fig. 61.

The **car-type oven** is most satisfactory for baking large cores. (See Fig. 122 in Chapter XII.) The cars are loaded and unloaded with the aid of an overhead traveling crane. At the end of the baking period, the car is pulled from the oven and the cores are delivered directly to the molds or to the storage space.

The **continuous conveyor oven** was developed to meet the need for baking large numbers of cores and for decreasing handling costs. In

this type of oven, metal racks are carried on one or more endless chains which convey the cores through the oven. Conveyor ovens have been built of several different designs in which the cores are transported vertically, horizontally, and in combinations of these directions. With the vertical oven shown in Fig. 62, the cores are loaded on the left side, travel up through the heated space, descend through a cooling chamber, and are removed at the right side.

FINISHING AND PLACING CORES

Some cores are made in two or more parts which are cemented together with a paste prepared from dextrin or other water-soluble binder. A mixture of graphite or silica flour with dextrin and water is used to fill the joints and to repair cores which are slightly damaged. The assembled cores are heated in ovens to dry the paste and patching mixture.

Refractory coatings are applied to some dry-sand cores to resist the destructive action of the metal for a longer time. In the steel foundry, a mixture of powdered silica, molasses, and water is commonly used on cores. The surfaces of cores for iron castings are often coated with graphite or other refractory material held in suspension in a water solution of dextrin or molasses. The cores are dried after being sprayed or dipped in the coating mixtures.

The strengths of all dry-sand cores prepared with the ordinary binders are decreased when the cores are exposed to a moist atmosphere. The extent of this deterioration in strength is dependent on the kind of

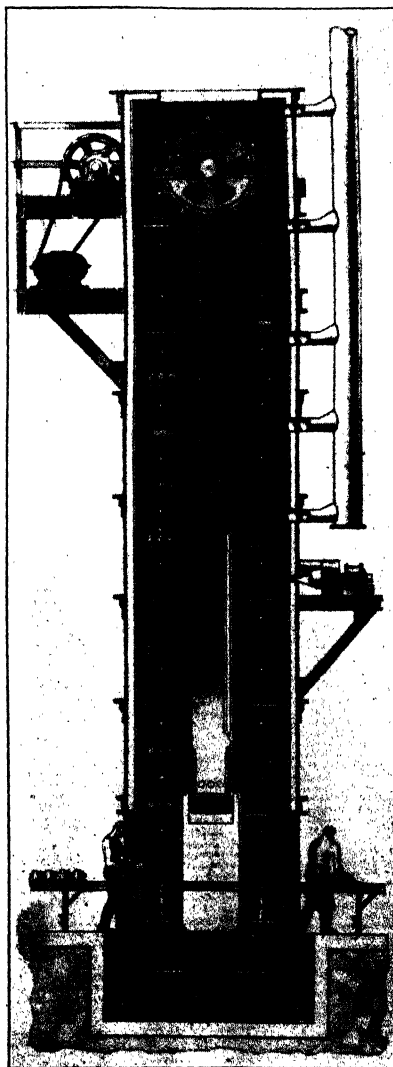

Courtesy of Jeffery Manufacturing Company

FIG. 62.—VERTICAL CORE OVEN

binder used in making the cores and the length of time during which the cores remain in the moist air. The losses in transverse strength of baked cores prepared with each of the binders after standing in green-sand molds for 4 hours is about as follows:

Linseed oil	36%	Lignone	60%
Gelatinized starch	65%	Molasses	100%
Dextrin	50%	Pitch	58%

All dry-sand cores should be stored in dry places and should not remain in green-sand molds any longer than is necessary before the molds are poured.

DEFECTIVE CASTINGS CAUSED BY IMPERFECT CORES

Large volumes of gas are produced when metal is poured around cores which are not completely baked. This gas may be evolved at a sufficient rate to stop off parts of the mold cavity or to be forced into the surrounding metal. With some designs of cores, the openings for venting through the core prints are so small that the rapid formation of gas within the core is certain to cause defective castings. Cores which are not completely baked in the ovens may become hard when they are exposed to additional heat in the molds. If the normal contraction of the metal is resisted by the hard cores, stresses or cracks will be produced in the castings. Furthermore, the hard cores will be difficult to remove from the castings.

The low strengths of cores which have been baked too long or at too high temperatures may cause losses in handling or defects in castings because of failures of the cores in the molds. Defective castings are sometimes caused by changes in the shapes of dry-sand cores when they are allowed to remain in green-sand molds for long periods. The drying oils are more resistant to deterioration caused by moisture absorption than the water-soluble binders.

BIBLIOGRAPHY

1. H. L. CAMPBELL, "The Qualities of Commercial Core Oils." *Trans. A.F.A.*, v. XXXIII (1925), p. 72-84.
2. H. L. CAMPBELL, "Methods for Determining the Properties of Cores Made with Cereal Binders." *Trans. A.F.A.*, v. XXXIV (1926), p. 558-566.
3. C. A. HANSEN, "Some Properties of Core Oils." *Trans. A.F.A.*, v. XXXIV (1926), p. 577-610.
4. H. L. CAMPBELL, "Baking Practice for Oil-Sand Cores." *Trans. A.F.A.*, v. XXXVII (1929), p. 289-294.
5. H. L. CAMPBELL, "The Application of Heat to Core Baking." *Bulletin*, 1930. *American Gas Association*, New York, N. Y.

6. A. A. GRUBB, "Selection and Blending of Core Sands." *Trans. A.F.A.*, v. XXXIII (1925), p. 808-816.
7. H. L. CAMPBELL, "The Use of Convected and Radiated Heat in Core Ovens." *Bulletin*, 1930. *American Gas Association*, New York, N. Y.
8. H. L. CAMPBELL, "The Surface Conditions of Castings as Affected by Core-Sand Mixtures." *Trans. A.F.A.*, v. XXXVI (1928), p. 461-468.
9. H. L. CAMPBELL, "The Effects of Moisture Absorption on the Properties of Dry-Sand Cores." *Trans. A.F.A.*, v. XXXV (1927), p. 158-169.

REVIEW QUESTIONS

I

What are the uses of cores?

II

Explain the requirements of sand mixtures for cores.

III

How are the properties for cores measured?

IV

Classify core binders, and give one example in each class.

V

Explain the principle of hardening of cores containing each of the different types of core binders.

VI

In the preparation of core mixtures, what is the order of adding the materials, and how are the materials measured?

VII

How are cores of irregular shape supported during baking?

VIII

Describe three types of machines used in making cores.

IX

What conditions are most favorable to the baking of cores containing the different binders?

X

State the method of handling cores in each of five types of core ovens.

XI

Discuss the effect of moisture absorption upon the strengths of dry-sand cores.

XII

Explain the defects in castings which may result from the use of under-baked cores.

CHAPTER V

MELTING PROCESSES FOR CAST IRON

THE CUPOLA FURNACE—Construction of the Cupola—Shell—Bottom Construction—Wind Belt—Tuyeres—Crucible—Height of Cupola—Tap and Slag Holes—Charging Doors—Lining—Operation of the Cupola—Preparation of the Cupola—Making and Lighting the Coke Bed—Charging Metal, Fuel, and Flux—Mechanical Charging Equipment—Melting and Tapping—Dropping the Bottom—Principles Relating to Cupola Operation—Combustion in the Cupola—Air Required for Combustion—Height of Coke Bed—Coke Charges—Metal Charges—Rate of Air Supply—Cupola Fluxes—Zones in the Cupola—Cupola Blowers—THE AIR FURNACE—Construction of the Air Furnace—Operation of the Air Furnace—Rotary Pulverized-Fuel-Fired Furnace—THE ELECTRIC FURNACE—Direct-Arc Furnace—Indirect-Arc Furnace—Methods of Operation

The metal for iron castings may be melted in any type of furnace in which a sufficiently high temperature can be produced; the cupola, air furnace, and electric furnace are ordinarily employed for this purpose. The heat efficiency of the cupola furnace is relatively high because the products from the combustion of the fuel come in direct contact with the materials being melted. Also, the counterflow of gases and melting stock permit the recovery of much of the heat produced within the cupola. The chief advantage of the air furnace lies in the possibility of accurate control of the composition as well as the temperature of the molten metal. Electric furnaces, although high in installation and operating cost, are being used for the preparation of cast iron which is required to have special properties. In some cases, molten iron is transferred from the cupola to an electric furnace to obtain additional superheat and to improve the composition of the metal.

THE CUPOLA FURNACE

✓ The cupola is a shaft furnace into which the metals and the fuel are supplied in alternate layers or charges. The air for combustion passes into a preheated bed of coke at the bottom of the cupola. The height of the coke bed and the rate at which air is supplied to the cupola have an important influence on the melting conditions within this furnace. ✓ The following discussion of the cupola includes a description of the

construction and operation of the furnace and an explanation of the principles relating to cupola operation.

Construction of the Cupola

The cupola furnace has a steel shell of plain cylindrical form which is supported in a vertical position and is lined with refractory materials.

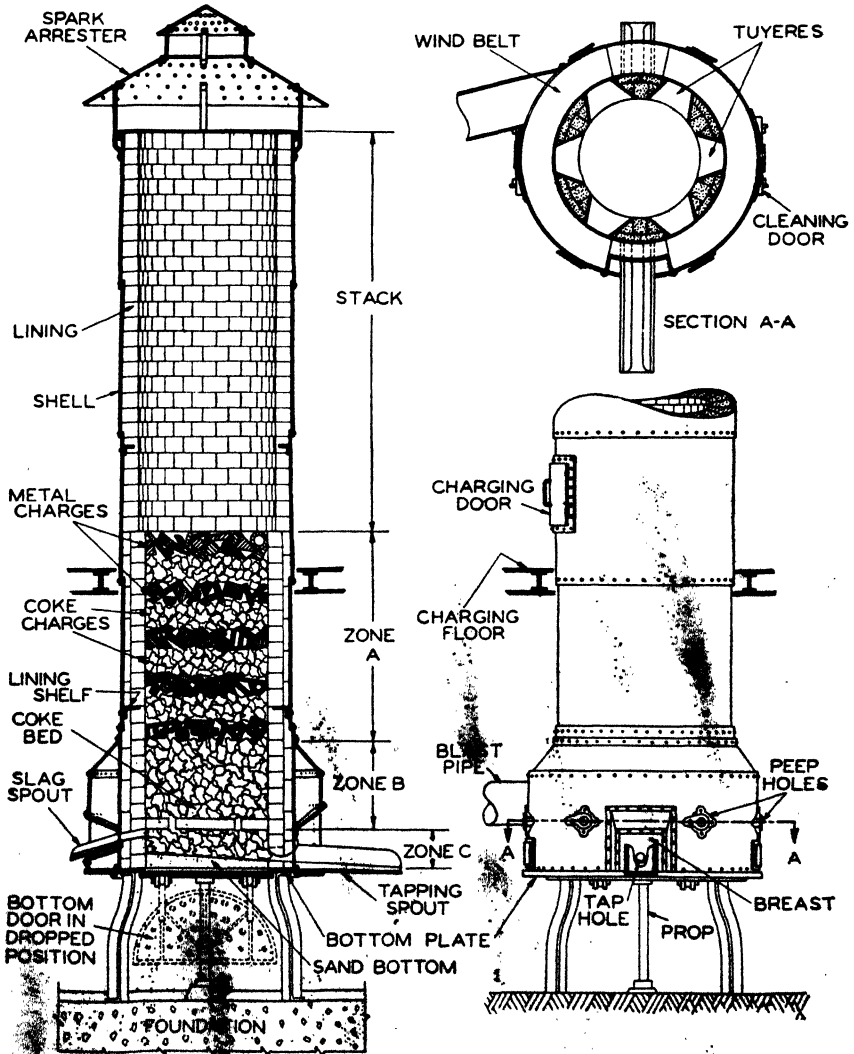

FIG. 63.—CUPOLA FURNACE

Openings are provided for introducing air, fuel, flux, and metals, and for removing molten metal, slag, and waste gases. Each of the parts of the cupola, the construction of which is shown in Fig. 63, will now be described.

Shell.—The shell of the cupola is made of steel plates which are rolled into cylindrical sections and riveted or welded together. The thickness of the steel plates varies with the diameter of the shell and the position of the sections. As the lower portion of the shell supports the weight of steel and refractories above, the sections near the bottom are usually built of thicker plates than the upper sections. For cupolas of small size, the maximum thickness of plate is $\frac{3}{8}$ inch, whereas for cupolas of large size, the thickness is often $\frac{1}{2}$ inch. The shells of cupolas which are over 60 inches in diameter are often decreased in size above the charging door, and the stack is usually extended about 10 feet above the roof of the foundry to avoid damage from heat and sparks. In order to support the lining and to prevent the collapse of the entire lining when a portion becomes worn away, brackets made of cast iron or steel are riveted to the inside of the shell at a number of places throughout the height of the cupola.

Bottom Construction.—The bottom plate is the ring-shaped casting on which the shell rests and to which the bottom doors are hinged. Two semicircular castings are used for the bottom doors. The cupola is supported on columns of sufficient height and distance apart to allow the bottom doors to swing clear. When the cupola is in operation, the bottom doors are held in the raised position by metal props or by a locking device.

Wind Belt.—The wind belt is the annular chamber encircling the lower part of the cupola. With the construction shown in Fig. 63, the shell of the cupola and the bottom plate form two walls of the wind belt. In other designs (see Fig. 64), the wind belt is entirely above the tuyeres; with this arrangement, it is not necessary to cut through the wind belt to get to the tap hole and slag hole.

The air for combustion enters the wind belt and passes into the cupola through openings known as tuyeres. Opposite each tuyere, a hole about 3 inches in diameter called a peep hole is cut through the outer shell of the wind belt to permit the inspection of conditions within the cupola and to allow a bar to be inserted to open up the tuyere if this becomes necessary. Covers with small mica windows are arranged so that they can be fastened tightly over these openings. Two or more doors are provided for cleaning out the inside of the wind belt. In some installations, the blast pipe is connected to the top of the wind

belt on two sides of the cupola; in others, it enters tangentially on one side of the wind belt.

Tuyeres.—Tuyeres have been designed in many shapes and sizes, and have been used in cupolas in various positions with more or less satisfactory results. The practice generally adopted is to use one row of tuyeres having a rectangular shape with a height of 4 to 6 inches on the inside of the cupola. To obtain uniform distribution of the air, the tuyeres are placed regularly around the circumference of the cupola, forming a nearly continuous inlet for the air supply as shown in Fig. 63. As a rule, the tuyeres are decreased in width at the shell, so that it will not be necessary to cut away a large portion of the circumference of the cupola shell. The tuyeres are made of cast iron, and are placed in the cupola during the construction of the lining. The area of the tuyere openings is sufficiently large to prevent excessive friction of the air as it enters the cupola. A total tuyere area on the inside of the cupola equal to one-fourth the area of the cross section of the cupola is satisfactory.

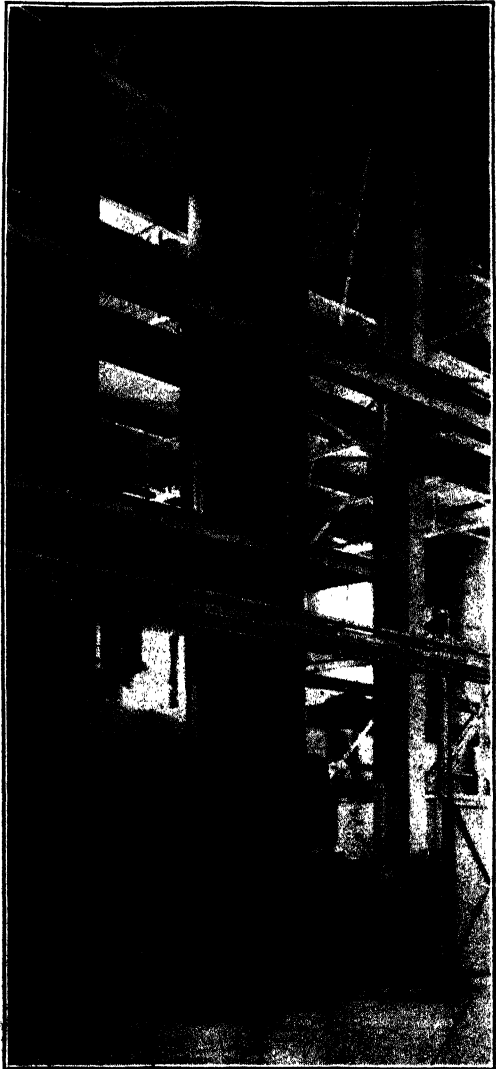

Courtesy of Whiting Corporation

FIG. 64.—TWO 54-INCH CUPOLAS

Crucible.—The tuyeres are placed at a distance above the bottom of the cupola which will allow the desired amount of metal to collect

within the cupola before tapping. The interior of the cupola below the tuyeres is known as the crucible. If it is desired to retain a large quantity of molten iron before tapping, a deep crucible is provided. On the other hand, when the metal is taken from the cupola continuously, a shallow crucible is most satisfactory. The greater the height of the crucible, the more coke is required in the bed; hence it is desirable to have the crucible of a minimum height. For average conditions, a crucible 20 inches in height is usually preferred.

Height of Cupola.—The **effective height** of the cupola is the distance from the top of the tuyeres to the sill of the charging door. This is an important dimension, as it affects the amount of heat which is recovered from the gases by the descending charges. In general, the greater the effective height, the more heat will be absorbed, and the lower will be the temperature of the gases in the stack. However, the carrying capacity of the coke in the bed places a limit on the weight of materials which may be charged into a cupola. Furthermore, the advantage of more complete recovery of sensible heat would be offset by the additional power required to force the gases through a large number of charges. For cupolas lined to 36 inches, the effective height may be placed at 12 feet, and for larger cupolas which are operated for long periods this height may be 18 feet.

Tap and Slag Holes.—At the front of the cupola, the shell and the lining are cut away to provide a means for tapping the molten metal from the cupola. The wall of refractory material which is placed in this opening is the breast, and the small hole in the breast through which the metal is tapped is the tap hole. A cast-iron or steel spout with a refractory lining guides the molten metal to the ladles. On the side opposite to the tap hole, another opening is provided for drawing off the liquid slag which accumulates within the cupola during long heats. In order to prevent the freezing of the slag by the air blast, this opening is located about 4 inches below the bottom of the tuyeres and between two tuyeres. The molten metal and slag collect in the spaces between the pieces of coke in the crucible. As the slag is lighter than the metal, it remains above the metal and is drawn off through the slag hole.

Charging Doors.—One or more openings are provided in the upper part of the cupola for introducing the fuel and metal charges. When drop-bottom buckets are used for charging the materials, one large opening is required. It is sometimes convenient with hand charging to have two openings through which the fuel and metals can be supplied. The charging doors are made of cast iron with a lining of fire brick.

Heavy cast-iron frames are fastened to the cupola shell to protect the lining around the doors.

Lining.—The steel shell of the cupola is lined with refractory material to insulate the shell and to resist the abrasion of the materials charged into the cupola. The lining is usually constructed of fire clay bricks and cupola blocks, which form segments of circles inside the shell. Either single or double courses of refractories may be used. A single course of cupola blocks $4\frac{1}{2}$ inches in thickness is satisfactory for small cupolas, whereas the lining in large cupolas is from 7 to $10\frac{1}{2}$ inches in thickness.

When the lining is placed in a cupola, a space about $\frac{3}{4}$ inch between the lining and the shell is filled with loose sand to take up the expansion when the lining is heated. Cupola blocks 9 inches by 9 inches by $4\frac{1}{2}$ inches in thickness, or 9 inches by 4 inches by 6 inches in thickness, of the correct curvature to form the desired inside diameter of the cupola, are ordinarily used for the lining. These blocks are backed up with standard fire bricks having dimensions of 9 inches by $4\frac{1}{2}$ inches by $2\frac{1}{2}$ inches. A cementing mixture of fire clay and water is used in the joints between the blocks or bricks, which are placed together as closely as possible. The shell of the cupola above the charging door is usually lined with one course of blocks.

Operation of the Cupola

The cupola furnace is adapted to the melting of intermittent heats of cast iron. At many foundries the melting period does not exceed 4 hours, but cupolas may be operated continuously for 10 hours or more. A schedule which is often followed is to melt iron in the cupola only for a sufficient length of time in the afternoon so that all molds made on that day will be poured before the end of the working period. A night crew then shakes out the castings and prepares the sand for use by the molders on the following morning. When continuous molding methods are used, molten metal is required during the entire molding time, and additional cupolas are provided so that some are being repaired while others are in service.

The satisfactory operation of the cupola requires strict attention to many details. As it is difficult to make adjustments in furnace operation after the materials have been charged, it is necessary to follow closely an established procedure to obtain the best results.

Preparation of the Cupola.—After every heat, the lining in the lower part of the cupola is burned out to some extent and is coated with slag.

It is necessary to remove the collection of slag and to replace any portion of the lining which has been destroyed during the previous heat. If the lining were not maintained to the required thickness, the heat developed inside the cupola would eventually penetrate to the shell and cause considerable damage.

Before the cupola lining is repaired, a heavy wire screen is placed across the cupola shaft at the charging door to serve as a protection from falling objects while work is in progress within the cupola. In order to make a satisfactory replacement of any portion of the cupola lining, all slag must be removed back of the patch; otherwise, this slag will melt later and cause the daubing material to separate from the lining. The slag coating is removed by means of a sharp-pointed short-handled pick. Special care is taken not to cut away the original lining any more than is necessary when the repairs are being made. After the slag has been removed from all surfaces which are to be patched, these areas are wet down with a thin mixture of fire clay and water. Large cavities in the lining are filled with pieces of fire brick. A mixture consisting of one part of high-grade fire clay and two parts by weight of clean silica sand with just enough water to form a plastic mass is used to fill the cracks and to restore the lining to its original dimensions.

The preparation of the sand bottom in the cupola is begun as soon as the patching of the lining has been completed. The bottom doors are raised and held in this position by metal props which rest on an iron block below the cupola. A molding sand which has been burned to some extent, and which has good permeability and strength, is used for making the bottom. The bottom sand is introduced through the charging door and is rammed well around the lining and across the intersection of the bottom doors. This layer of sand is built up to a height of 4 to 8 inches above the cast-iron doors. The surface of the sand bottom is sloped from all directions towards the tap hole so that the molten metal can be drained completely from the cupola at any time.

The slag hole is cleaned out and patched when the lining is being repaired. An opening about $1\frac{1}{2}$ inches in diameter is provided for the removal of the slag. The procedure used in making the breast varies considerably at different foundries. Some operators prefer to build the breast from the inside of the cupola after the sand bottom has been finished. In other practice, the breast is filled in after the entire bed coke has been charged. When a wood-fire is used for lighting the cupola, the breast opening allows the entrance of air for the combustion of the fuel. Also, the breast opening permits the introduction of an oil burner

when the coke bed is lighted by this means. The same refractory mixture that is applied in repairing the lining is used in replacing the breast of the cupola. The tap hole is formed around a wooden pattern about $\frac{3}{4}$ inch in diameter.

⑨ **Making and Lighting the Coke Bed.**—The melting conditions within a cupola at the beginning of a heat will depend to a large extent on the care taken in preparing and lighting the coke bed. The coke in the bed is ignited by a wood fire or by an oil-burning torch. When the

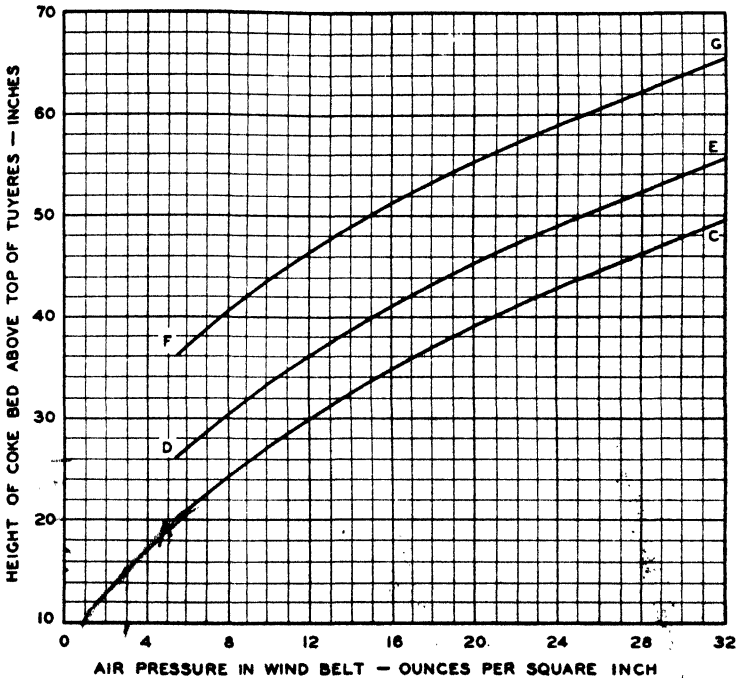

FIG. 65.—HEIGHTS OF COKE BED FOR DIFFERENT AIR PRESSURES

former method is used, shavings and small pieces of wood are first placed in the cupola without destroying the sand bottom. Then larger pieces of dry wood are added until the wood is piled up above the tuyeres. Approximately one-half of the total amount of coke for the bed is charged on the wood. In order to provide better conditions for the separation of slag and metal, only large pieces of coke, about 6 inches across, are used in the coke bed below the tuyeres. The fire is started by lighting the kindling at the breast or by dropping ignited oily waste into the cupola. With the introduction of air through the breast, as well

as through the peep holes, sufficient heat is produced from the wood fire to dry the daubing on the cupola lining and to ignite the coke.

(*) When the coke which was first charged is well ignited, more coke is supplied, and combustion is maintained. As soon as red spots begin to show over the top of the fuel bed, additional coke is introduced to obtain the correct height of the coke bed. This is determined by using a measuring rod which has been prepared to indicate the distance from the sill of the charging door to the top of the coke bed. The amount of coke in the bed is dependent upon the pressure of the air supplied to the cupola. The height of the coke bed above the top of the tuyeres is determined by the pressure of the air supplied to the cupola and can be found on the chart in Fig. 65.

When an oil burner is used to light the cupola, the coke at the bottom of the bed is arranged so that the flame from the burner will penetrate and ignite the bed uniformly. The oil burner is usually applied at the breast opening. About one-half of the total amount of the coke required for the bed is placed in the cupola before the burner is started. As soon as red spots appear on the top of the first coke, the remainder of the bed coke is charged. At this time the burner is stopped, and the natural draft through the breast opening will produce sufficient heat to ignite the upper portion of the coke bed.

After the coke bed has been built up to the correct height and has been ignited uniformly throughout, the breast is filled in and all peep-hole openings except one or two are closed. Care is taken not to burn the bed coke to a mushy state. If burned excessively, the bed will be lowered considerably by the weight of the materials placed on the bed. The cupola is now ready for the metal and coke charges.

Charging Metal, Fuel, and Flux.—The first metal charge is placed on the coke bed as shown in Fig. 66. This is followed by a layer of coke, and then additional layers of metal and coke until the level of the charging door is reached or until sufficient metal has been charged for all requirements. Additional charges are supplied as rapidly as the stock lowers within the cupola. The materials in each metal charge are placed so that the melting of the entire charge will be as uniform as possible. Scrap metals having relatively thin sections absorb heat more rapidly than heavy pieces of pig iron or scrap; therefore, this material is placed at the top of the metal charge. The order of charging is to put the steel scrap on the coke, the pig iron around the lining, and the iron scrap over the entire area to level off the metal charge. All materials for the metal charges are weighed accurately and are combined in the correct proportions to produce the desired average chemical composition in the charges. The total weight of each metal charge varies

with a number of factors which will be discussed later. The average practice is to have the metal charges eight times the weight of the coke charges.

The amount of coke in each coke charge is established as the weight which will occupy a height of 6 inches within the cupola. This is designated as **fusion coke** to distinguish it from that portion of the coke in the bed which is not consumed during the melting period. The coke

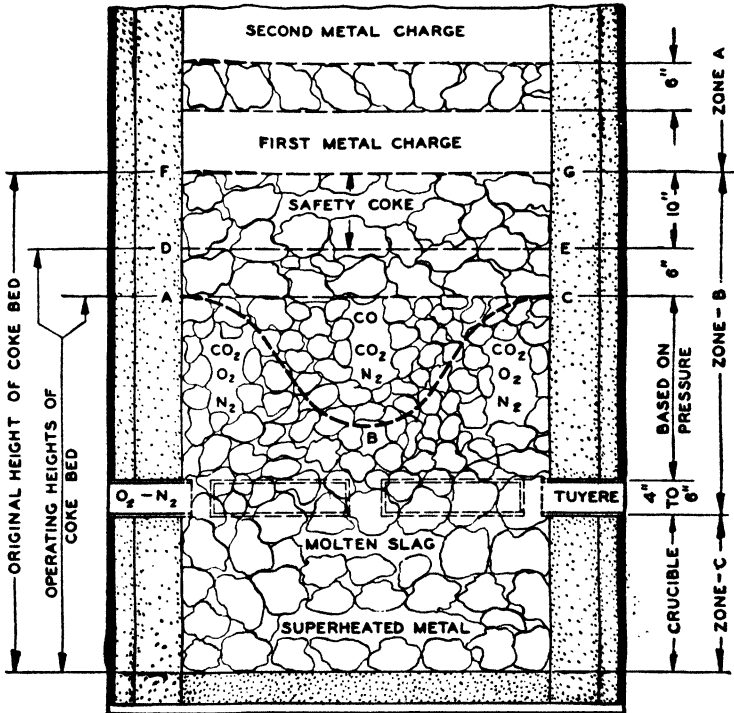

FIG. 66.—CROSS SECTION OF CUPOLA

charges are placed as evenly as possible over the entire area of the cupola.

The limestone which is added to decrease the viscosity of the cupola slag is distributed over each coke charge, and is kept away from the cupola lining. Since it is ordinarily possible to make the coke charges more even across the cupola than the metal charges, the limestone can be distributed to better advantage on the layers of coke. The amount of limestone required for good operation is dependent upon the ash content of the coke as well as upon the cleanliness of the metals used in

the cupola charges. As a rule, 20 per cent of the weight of the fusion coke is a satisfactory proportion for the limestone additions.

✕ **Mechanical Charging Equipment.**—Much attention has been given to the development of mechanical equipment for transporting materials from stock piles to melting furnaces. At those foundries where large quantities of metal are melted in cupolas, charging equipment is often used for placing the metal, fuel, and flux in definite positions within the cupolas. The necessity of regular and uniform distribution of the

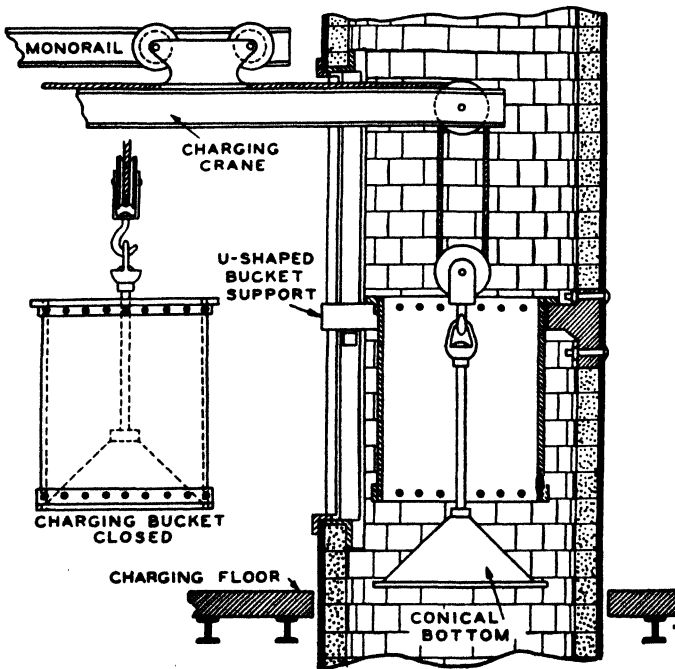

FIG. 67.—CHARGING BUCKET (WHITING DESIGN)

cupola charges will be discussed later. Many of the charging devices in regular use have drop-bottom buckets which are handled by electric cranes. The buckets may be loaded at any location and transported directly to the cupola, or to the charging floor where they are picked up by a special crane and placed in the cupola. A charging bucket having a cone-shaped bottom is shown in Fig. 67. With equipment of this design, the loaded bucket is placed on a U-shaped support within the cupola, and the contents of the bucket are allowed to drop into the cupola when the bottom is lowered.

Melting and Tapping.—The melting is started soon after the coke and metal charges have been placed in the cupola. Melting conditions are not improved by allowing the cupola to stand for a long time before starting the blower.⁷ It is possible, however, to defer melting for several hours after the cupola has been charged, if foundry conditions necessitate this delay.

Within ten minutes after the blower is started, some molten metal will appear at the hole in the breast. As soon as a small stream of metal begins to flow out of the tap hole, this is closed by a cone-shaped lump of clay known as a **bott** which is applied by means of a metal bar. The stopping bott is pushed into the tap hole at an oblique angle, cutting the stream of metal from top to bottom. The tools used during the operation of the cupola are shown in Fig. 68. The stopping bar aids in applying the clay bott for plugging the tap hole and the slag hole. The tap-

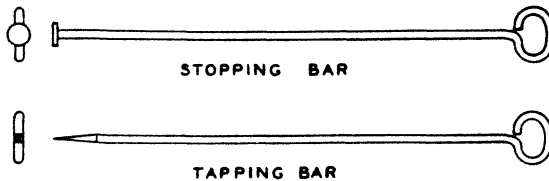

FIG. 68.—TOOLS FOR CUPOLA OPERATION

ping bar has a tapered point and is used in chipping out the clay stopper for the removal of the iron or slag.

During the melting period, the drops of metal travel down through the coke bed and collect between the pieces of coke in the crucible. Likewise, the molten slag accumulates within the coke bed below the tuyeres. The slag hole usually remains botted up until sufficient slag has accumulated within the cupola to permit its removal through the slag opening. Then the clay stopper in the slag hole is dug out with the tapping bar. When the slag layer approaches the top of the crucible, the molten slag runs out of the cupola into the slag spout. As soon as a stream of bright sparks appears at the slag hole, the metal is tapped from the cupola. Some attention is usually required to keep the slag hole open during the remainder of the heat. With intermittent tapping practice, sufficient time is allowed between plugging and tapping for the slag to rise and flow out of the slag hole. This period is dependent on the height of the crucible as well as on the speed of melting.

The air pressure in the wind belt is usually from 8 to 16 ounces per square inch, depending upon the effective height of the cupola, the con-

dition of the charges, and the rate at which the air is supplied to the cupola. Under some conditions of operation, the pressure in the wind belt will at times be greater than 16 ounces per square inch. At the beginning of a heat, the openings between the materials in a cupola allow comparatively free passages for the air, but after the cupola has operated for some time, the air passages become more obstructed with slag, and the pressure rises. Towards the end of the heat when the last charges are lowering in the cupola, the resistance offered to the flow of the air is decreased, and the pressure is lowered. The air pressure in the wind belt is a valuable index of conditions within the cupola.

The procedure in removing molten metal and slag from the cupola varies with the construction of this furnace. When a deep crucible is

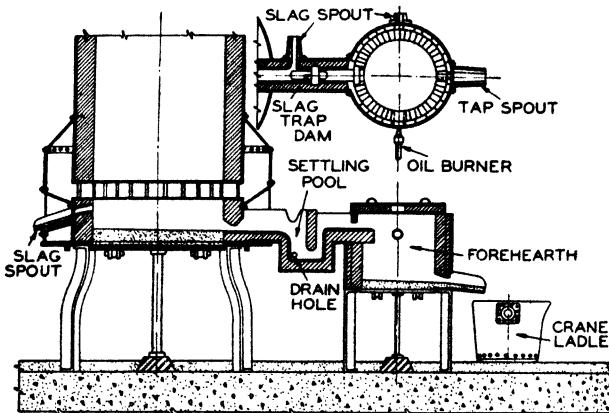

FIG. 69.—CUPOLA AND FOREHEARTH

provided, the metal and slag are usually allowed to collect within the cupola until the slag is removed through the slag opening; then the tap hole is opened for the removal of the metal. When the distance from the sand bottom to the tuyeres is small, the molten iron and slag are allowed to discharge continuously through the tap hole. By the proper adjustment of the size of the tap hole during long heats, it is possible to remove the slag through the upper opening and to maintain a continuous stream of metal through the lower opening.

Several types of receivers are employed for holding the metal as it flows from the cupola. A large ladle mounted on trunnions in front of the spout commonly serves as a reservoir for molten metal. The teapot-spout ladle shown in Fig. 123 in Chapter XII is well suited to this purpose. As a rule, the metal is poured from the receiver into ladles for

distribution to the molds; however, it may be desirable in some foundries to transport the receiving ladle by an overhead crane for the pouring of large molds.

Another means for holding a supply of molten metal is the **forehearth**, which is a stationary reservoir connected to the cupola by a short spout. The forehearth is usually heated by an oil burner and has a tap hole at the bottom and a slag hole near the top. With the arrangement shown in Fig. 69, most of the slag can be separated from the metal at the spout. Alloys and cleansing reagents can be added to the metal in the forehearth.

The different types of receivers as well as pouring ladles are constructed of steel plate and are lined with refractories. Large ladles and forehearths have one or more courses of fire brick on the inside, whereas small ladles are lined with mixtures of silica sand and fire clay. All ladles are thoroughly dried and preheated before being used for holding molten metal.

Dropping the Bottom.—When the requirements for molten metal have been met, or the metal in the cupola has been completely melted, the operation of the cupola is immediately discontinued by stopping the blower. The next step is to remove the entire contents of the cupola. The molten metal is first drained from the crucible through the tap hole; then the remaining materials are allowed to drop out when the props which support the bottom doors are pulled away. A stream of water is directed on to the pile of burning coke, slag, and unmelted metal. The coke recovered from this pile can be used as a cover for the last metal charge in following heats.

Principles Relating to Cupola Operation

In the previous discussion on the cupola furnace, attention has been directed to the construction and operation of the cupola. It is well to understand the principles which relate to the operation of this important melting unit. As the combustion of the fuel and the melting of the metal are confined within a refractory-lined furnace, the proportions of all materials used in the charges can be controlled so that economical melting will be achieved. A definite amount of air may be supplied to the cupola, containing sufficient oxygen to burn a definite weight of coke, which in turn will produce sufficient heat to melt and superheat a definite weight of metal. Furthermore, a definite weight of flux is necessary to obtain satisfactory slagging conditions. When the proportions of air, fuel, flux, and metal are correct, reliable and uniform melting conditions are obtained in the cupola.

Combustion in the Cupola.—The principles of combustion within the cupola are based upon the chemical reactions which take place when carbon and oxygen are brought together at relatively high temperatures. Some heat is also derived from the oxidation of the metallic elements in the cupola charges.

When the cupola is in operation, air is delivered at a relatively low pressure into a bed of hot coke in the lower part of the cupola. Additional fuel is supplied in the coke charges to preheat, melt, and superheat the succeeding metal charges. The conditions for supporting combustion are not ideal because the materials used for this purpose are not in the pure, elementary form. Foundry coke usually contains over 5 per cent by weight of ash, which must be removed after the coke has burned, and the nitrogen content of the air is about 76.9 per cent by weight. The intensity of the heat developed by the oxidation of the carbon in the coke is decreased by the nitrogen in the air supply. However, the heat efficiency of the cupola is high compared with other melting furnaces because the products from the combustion of the fuel come in direct contact with the materials being melted, and the counter flow of gases and melting stock permit the recovery of much of the heat produced within the cupola.

At the high temperatures encountered in the bed of a cupola furnace, the oxygen in the air supply combines with the carbon in the coke to form carbon dioxide. The chemical reaction for the complete combustion of carbon is as follows:

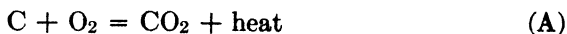

This equation implies that 12 pounds of carbon will combine with 32 pounds of oxygen to produce only carbon dioxide with an evolution of heat. The complete combustion of 1 pound of carbon requires 2.66 pounds of oxygen, and develops 14,550 B.t.u. of heat.

Another chemical reaction which occurs to some extent in normal cupola operation is indicated by the following equation:



This secondary reaction takes place when the carbon dioxide which was formed by complete combustion comes in contact with more carbon at high temperatures. For every pound of carbon consumed in this way, 5,850 B.t.u. of heat are absorbed from the reacting materials. Hence, the conditions which favor this reaction are avoided as much as possible in cupola practice.

x
 When the cupola blower is operating, the air which enters the tuyeres encounters the hot coke in the bed and soon becomes heated. Combustion of the coke proceeds more rapidly as the air passes up through the coke in the bed. If the bed is of sufficient height, a location is reached at which the oxygen in the air is completely consumed by combustion to carbon dioxide according to reaction A. As the carbon dioxide thus formed continues to travel past more hot coke, some carbon monoxide is produced according to reaction B. If the height of the coke bed and the rate of the air supply are properly adjusted, this heat-consuming reaction proceeds only to a minimum extent. \checkmark

An extensive investigation of the conditions of combustion within a cupola furnace was made in 1913 by A. W. Belden of the U. S. Bureau of Mines.³ The compositions and temperatures of the gases were found at many points within the coke bed of a cupola. From the results of these determinations, the area of highest temperatures in the fuel bed was found to have the shape of an inverted cone with the base intersecting the cupola lining 20 inches above the top of the tuyeres, when the air was supplied at a pressure of 5.3 ounces per square inch. The line *A-B-C* in Fig. 66 locates the cross section of the area of highest temperature in the coke bed. The heat produced within the coke bed (below the line *A-B-C*) is transferred to the metal charges by the gases. Below this area free oxygen is present in the gases. In order to melt the metal charges without excessive oxidation, all melting must be completed above the level in which oxygen is present in the fuel bed of the cupola. The exact location of this area which is represented by the straight line *A-C* in Fig. 66 is dependent upon the velocity of the gases or indirectly on the volume of the air supplied to the cupola.

Air Required for Combustion.—The amount of air required, and also the quantity of heat produced in burning 1 pound of carbon, depend upon the conditions of combustion. When the carbon is burned completely to carbon dioxide, the maximum heat will be obtained. This condition requires 2.66 pounds of oxygen for each pound of carbon.

The combustion condition within any cupola can be established by the analysis of the cupola gases. \checkmark With good melting practice, the proportions by volume of carbon dioxide and carbon monoxide in the gases just below the charging door will be about equal. The gas samples from cupolas operating under favorable conditions will show about 14 per cent carbon dioxide, 12 per cent carbon monoxide, and 74 per cent nitrogen.

When one-half of the carbon is finally burned to carbon dioxide, and the other half to carbon monoxide, 1 pound of carbon will require 2.00 pounds of oxygen $[(2.66 \times 0.5) + (1.33 \times 0.5)]$. To convert oxygen

to air, the weight of oxygen in pounds is divided by 0.231, which is the proportion of oxygen in air. It is found that 8.66 pounds of air are necessary to burn 1 pound of carbon under favorable conditions. As 1 cubic foot of air at a pressure of 14.7 lb. per sq. in. and at 60 degrees F. weighs 0.0765 pound, 113 cubic feet of air are required for each pound of carbon. A correction must be made on this volume of air whenever the conditions of operation are other than those specified. The correction factors for different combinations of atmospheric pressures and temperatures can be found on the chart in Fig. 70. To correct the volume of air

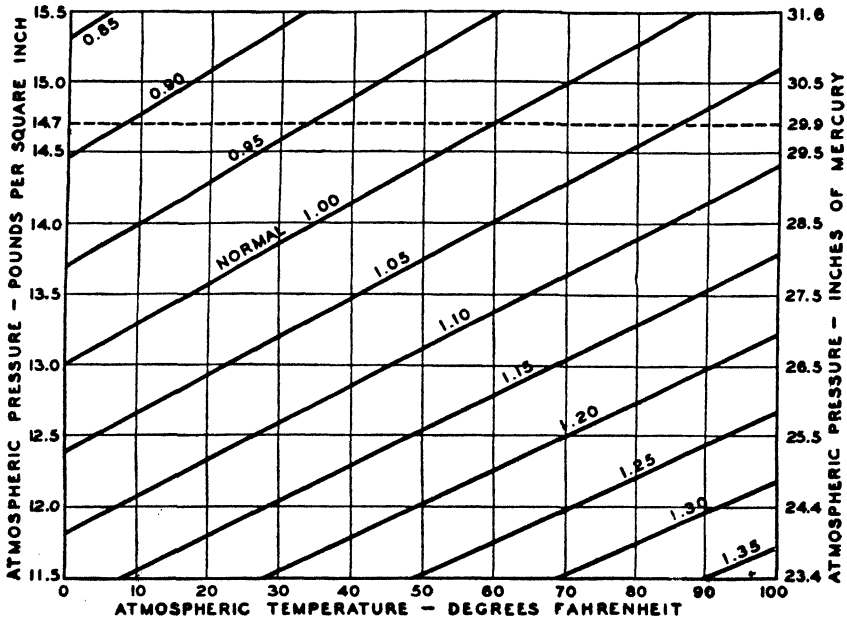

FIG. 70.—FACTORS FOR CORRECTING VOLUME OF AIR TO NORMAL CONDITIONS

at 14.7 lb. per sq. in. and 60 degrees F. to other conditions of pressure and temperature, the volume in cubic feet at normal conditions is multiplied by the factors given on the chart.

The chief heat-producing constituent of foundry coke is the fixed carbon, which is usually about 90 per cent of the weight of the coke. The air required for the combustion of 1 pound of this fuel under the conditions as stated previously amounts to 102 cubic feet (113×0.90); this value will be used later in the computation for the size of blower for a given cupola.

Many types of equipment have been proposed for recovering the

heat from the gases in the upper part of the cupola. In all these designs, a heat exchanger is used to preheat the air blast. The equipment developed by the American Cast-Iron Pipe Company⁵ makes use of hollow castings suspended vertically along the inside wall of the cupola. The air from the blower passes through these heating pipes on its way to the tuyeres. The equipment offered by The Air Preheater Corporation has a combustion chamber in which the gases from the cupola are burned, and a heat exchanger for preheating the air blast. A drawing of this equipment is shown in Fig. 71. It is generally agreed that the utilization

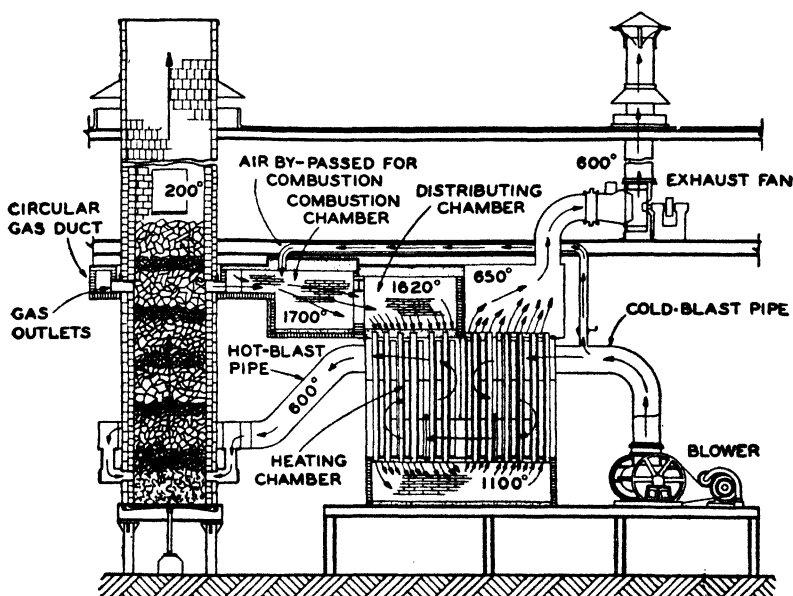

FIG. 71.—GRIFFIN HOT-BLAST EQUIPMENT

Gases are drawn from the cupola below the charging door and pass into a combustion chamber where additional air is supplied to burn the combustible constituents in the gases. Then the hot gases pass through two banks of tubes in the preheater, and are finally discharged through an exhaust fan into the atmosphere. Air for the cupola is delivered by a blower through the heating chambers and hot-blast pipe to the tuyeres.

of waste heat from the cupola furnace is feasible only when the foundry conditions require long heats.

Height of Coke Bed.—The coke bed is made sufficiently high so that all melting of the metal charges will take place in that section of the cupola in which there is no free oxygen. The production of iron of good quality by this method of melting depends to a large extent upon maintaining the correct height of the coke bed throughout the entire heat.

When the bed is too low, the oxygen in the air supply will not be completely consumed by the coke in the bed, and will pass up through the metal charges causing the rapid oxidation of the metal. If the coke bed is higher than is necessary for the complete consumption of the oxygen, the carbon dioxide formed initially will combine with more carbon in the upper part of the bed to produce carbon monoxide. This reaction will prevent the development of the maximum amount of heat from the coke in the top portion of the bed and will retard the melting.

The investigations which have been made of the conditions of combustion within the fuel bed of the cupola furnace have shown that the oxygen in the air supply is gradually consumed as it passes through the hot coke bed. A certain amount of time is required for the oxygen to combine with the carbon, and the distance that the oxygen travels before it is completely burned to carbon dioxide depends upon the velocity of the gases. This in turn is controlled by the volume of air delivered to the cupola. An increase in the volume of the air supply causes an increase in the pressure in the wind belt, other conditions being constant. As the air pressure can be readily measured, the location of the region of minimum oxygen in the coke bed can be established most conveniently on this basis. The line *A-C* in Fig. 65 indicates the minimum operating heights of the coke bed for all pressures in a cupola of any size. The points on the line *A-C* were computed on the basis of the increase in the velocity of the gases over that used by Belden to obtain a height of 20 inches above the top of the tuyeres for the location of minimum oxygen. It is important that all melting of the metal charges be confined above the line *A-C* where practically no oxygen is present in the gases. The line *D-E* locates the top of the 6-inch layer of coke which will replace the coke consumed in the development of heat for melting and superheating the first metal charge. To compensate for the settling of the bed, as well as for the consumption of fuel from the time the coke bed is measured until the blower is started, the bed is increased by an additional height of 10 inches; this is known as safety coke. Under normal operating conditions, the height of the coke bed varies between points on the line *D-E* and points on the line *A-C* corresponding with the operating air pressure in the wind belt. The coke between these limits is replaced intermittently by the succeeding coke charges.

Coke Charges.—The coke in the bed which is consumed to furnish the heat for melting the metal charges is replenished by the intermediate coke charges. In this way, the coke bed is maintained at the correct level to insure favorable melting conditions. To decrease the formation of carbon monoxide, which lowers the temperature of the gases, the

coke charges are kept as small as practicable. With the ordinary sizes of foundry coke, layers less than 6 inches in thickness are not readily obtained. Therefore, each coke charge will contain a definite weight of dry coke which can be placed to a height of 6 inches within the cupola. This amount of coke can be determined experimentally by weighing the coke which will fill a cylinder having the same diameter as the cupola and a height of 18 inches, and dividing by 3. The volume occupied by 1 pound of foundry coke varies with the method of manufacture, as well as with the care taken in handling this fuel. If the relation of weight to volume for a specific coke can not be found by trial, it may be assumed that, as an average, 1 pound of foundry coke occupies 65 cubic inches. The coke charges are placed as level as possible over the entire area of the cupola so that the top of the coke bed will remain level during the entire melting period.

When large pieces of iron scrap or large bundles of steel scrap are included in the metal charges, it is desirable to have the coke charges of sufficient thickness so that combustion will be maintained for the length of time required for all the metal in each charge to be melted before it reaches the region containing free oxygen.

Metal Charges.—The heat from the combustion of the coke preheats, melts, and superheats the pig iron and scrap metals in the charges. The ratio of the weight of metal melted for each pound of coke is dependent upon a number of conditions, among which are: (1) the quality of the coke, (2) the relative proportion of the surfaces of the pieces of metal which are exposed to the hot gases, and (3) the amount of superheat required in the metal. The greater the fixed carbon content of the coke, the more heat will be produced from a given weight of this fuel. Scrap metals having relatively thin sections absorb heat more rapidly than heavy pieces of pig iron or scrap. Furthermore, the metal which is poured into castings with light sections is usually heated to higher temperatures than the metal which is used in castings with heavy sections. When steel scrap is used in the charges for the cupola, some carbon is necessarily consumed in carburizing this material. Therefore, the ratio of the weights of metal to coke must be established on the basis of all the operating conditions. The average practice is to melt 8 pounds of metal with 1 pound of fusion coke. After the weight of one coke charge is found for a specific cupola practice, this weight is multiplied by 8 to obtain the weight of one metal charge.

Rate of Air Supply.—Because the operation of the cupola furnace requires a continuous supply of fuel and air, the control of this melting process is based on the rate at which combustion takes place. The

volume of air required for the combustion of 1 pound of coke has been derived. Also, the method for computing the weight of one coke charge has been established. From these values, the volume of air required for the combustion of one coke charge can be readily found. This amount of air, when supplied to the cupola at a favorable rate, will melt and superheat one metal charge. The most satisfactory melting conditions are obtained when the air is supplied to a cupola at a rate which will burn one coke charge (6 inches in height) and melt one metal charge in 5 minutes. The loss of air in the piping from the blower to the cupola and at the wind belt is sometimes assumed to be 5 per cent of the total air delivered by the blower.

The following calculations are used in finding the air required as well as the melting rate of a cupola lined to 54 inches in diameter.

$$\frac{3.14 \times 27 \times 27 \times 6}{65} = 211 \text{ lb. of coke in one charge.}$$

$211 \times 102 = 21,522$ cu. ft. of air required to burn one coke charge.

$21,522 \div 5 = 4,304$ cu. ft. net volume of air required in one minute.

$4,304 \div 0.95 = 4,530$ cu. ft. total volume of air required in one minute.

$211 \times 8 = 1,688$ lb. of metal in one charge.

$1,688 \times 12 = 20,256$ lb. of metal melted in one hour.

Cupola Fluxes.—The non-metallic, non-combustible materials which accompany the cupola charges or are produced during melting form a viscous slag within the cupola. If this slag accumulates in sufficient quantity, it will interfere with good melting practice. The combustion of the fuel is retarded by the presence of a gummy slag which adheres to the surfaces of the pieces of coke. Furthermore, slags which fuse at high temperatures obstruct some of the gas passages through the charges and consequently make uniform melting impossible. The viscosity of cupola slags is lowered by the addition of fluxes to the charges. Limestone (CaCO_3) is the most important cupola flux, although fluorspar (CaF_2) and soda ash (Na_2CO_3) are also used for this purpose. Specifications for cupola fluxes are given in Chapter II.

The most satisfactory fluxing material is calcium oxide (CaO), which is produced by the decomposition of limestone within the cupola. The calcium oxide combines with silicon oxide (SiO_2) to form a calcium silicate slag.

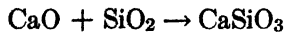

This reaction requires 1.66 pounds of pure limestone, or 1.71 pounds of limestone containing 3 per cent of impurities, to unite with each pound of silicon oxide.

The silicon oxide content of the cupola charges is derived mainly from the ash of the coke, from the products of oxidation of the metal, and from the sand on the iron scrap. If it is assumed that the coke contains 10 per cent ash, and that 250 pounds of coke are required to melt 2,000 pounds of metal, 25 pounds of ash will be produced in the cupola during the melting of each ton of metal. As the ash contains approximately 50 per cent of its weight of silicon oxide, the combustion of 250 pounds of coke will produce 12.5 pounds of silicon oxide.

During the melting of the metal mixtures in the cupola, silicon is oxidized to the extent of about 10 per cent of the total silicon in the metal charges. The silicon oxide from this source collects in the cupola slag. If it is assumed that the total metal mixture contains 2.20 per cent silicon, the normal oxidation of 2,000 pounds of metal will result in the formation of 9.4 pounds of silicon oxide. When this amount is added to the weight of silicon oxide from the coke used in melting the metal, a total of 21.9 pounds will be obtained. The weight of limestone which will be required to produce a liquid slag by combining with the silicon oxide from these two sources alone amounts to 37.4 pounds, or the equivalent of about 15 per cent of the weight of the coke used. Other sources of slag in the cupola are the patching material and the sand on the metals which are charged into the furnace. The limestone is apportioned according to the conditions of operation for every cupola; as a rule, 20 per cent of the weight of the coke consumed in melting is a satisfactory proportion for the limestone additions. This flux is distributed over each coke charge and is kept away from the lining. As the coke can usually be placed more level in the cupola than the metal charges, the limestone can be distributed more uniformly over the coke layers.

Fluorspar is a very active fluxing agent for cupola slags and is often supplied with the limestone in the cupola charges; as little as 5 per cent of the weight of the limestone is sufficient to increase noticeably the fluidity of the cupola slag.

Soda ash is also used to increase the fluidity and the dissolving action of cupola slags. Under favorable conditions, soda ash is a valuable desulphurizer of the metal. A combination of one part of soda ash and ten parts by weight of limestone is sometimes used as a cupola flux.

Zones in the Cupola

The entire shaft of the cupola may be divided into four sections for convenience in examining the operation of this furnace. The interior of a cupola with the charges in place ready to begin melting is shown in

Fig. 63. The stack extends from the sill of the charging door to the top of the shell. This section serves only for the removal of waste heat and gases from the cupola.

Zone *A* extends from the charging door to the top of the coke bed. Within this volume, the coke and metal charges are preheated by the ascending gases. On account of the deficiency of oxygen in the gases in zone *A*, practically no combustion of the coke takes place in this section. The heat in this region is sufficient to dissociate the limestone flux into lime and carbon dioxide and to melt some thin pieces of metal. Near the bottom of zone *A*, the temperature of the gases is about 3000 degrees F., and the temperature decreases as the gases travel up through the charges. At the level just below the charging door, temperatures of 800 to 1500 degrees F. have been obtained.

The bottom of the tuyeres locates the lower level of zone *B* as shown in Fig. 66. Maximum combustion of the fuel takes place within this section. Furthermore, the charges are so arranged that maximum melting and superheating of the metal occurs in the upper part of zone *B*. The lower portion of the interior of the cupola from the bottom of the tuyeres to the sand bottom is the crucible. Molten metal and slag collect between the pieces of coke within this volume. As practically no combustion takes place below the tuyeres, it is impossible to add heat to the metal which is retained in the crucible.

Cupola Blowers

The two types of blowers which are used for supplying air at the low pressures required for cupola operation are the positive-displacement

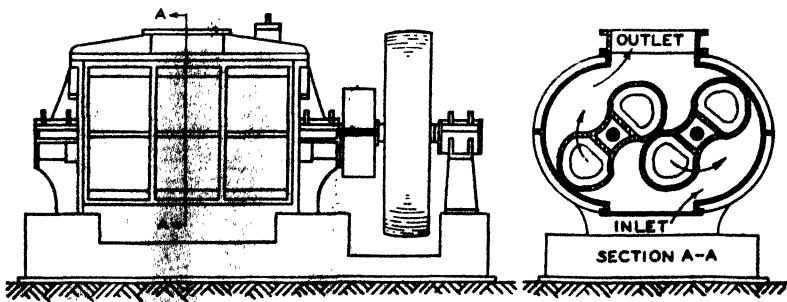

FIG. 72.—POSITIVE-DISPLACEMENT BLOWER

blower and the centrifugal blower. The construction of the positive-displacement blower is illustrated in Fig. 72. Two impellers mounted

on parallel shafts rotate in opposite directions within a casing which has an air inlet at one side and an outlet at the opposite side. These impellers run close together, but without touching each other or the surrounding casing. The necessary relative motion of the two impellers is obtained by gears mounted on the shafts. With each revolution of each impeller, twice the volume of air between the impeller and casing is pushed around to the discharge opening. A small allowance is made for the slippage of air past the ends of the impellers. The advantage of this type of blower is that a constant volume of air is delivered to the cupola irrespective of changing conditions within the furnace. The output from a positive-displacement blower can be varied to suit requirements by using a variable-speed motor or a variable-speed transmission connected to a constant-speed motor.

The centrifugal blower has a scroll-shaped casing within which an impeller with curved blades is rotated at a high speed; with most designs the impeller is mounted directly on the shaft of an electric motor. Air enters the impeller and is discharged into the casing where the velocity energy is changed to pressure energy. When a centrifugal blower is operated at a constant speed, the output is dependent on the pressure against which the air is delivered. On account of the changing resistance offered to the flow of gases within the cupola furnace, the centrifugal blower without auxiliary equipment is not well adapted to supplying air for cupola melting.

Equipment has been developed for the control of the air supplied to cupolas, which requires the use of a centrifugal blower and an electric motor having characteristics such that the weight of air delivered by the blower is proportional to the power input to the motor. This equipment includes a blast gate which serves as a variable restriction in the air line. When the blower is running at constant speed, the adjustment of the blast gate will affect the amount of power used by the motor and therefore the weight of air delivered by the centrifugal blower. With the aid of suitable electrical controls, the equipment for a cupola installation can be set to deliver a constant amount of air regardless of atmospheric conditions or the resistance to the flow of gases within the cupola.

Another system of air control for foundry cupolas is based on the measurement of the air flow by means of an orifice plate in the air line. The differential pressure created across the orifice plate actuates the air-control mechanism. This instrument compensates for changes in atmospheric temperature, barometric pressure, and pressure in the wind belt. The air supply is controlled by throttling either the intake or discharge side of a centrifugal blower. When a positive-displacement blower is

used with this equipment, the control of the air is secured by changing the speed of the blower or by wasting the air in excess of the volume required.

THE AIR FURNACE

The air furnace is used chiefly at foundries producing malleable iron castings, although some installations are used for the production of gray iron castings of superior quality. The principal advantage of this melting equipment over the cupola furnace lies in the possibility of obtaining a low total carbon in the molten iron. It is also possible to obtain any desired temperature of the metal before pouring. The average capacity of the air furnace is 20 tons of metal in each heat.⁸ With powdered coal as fuel, this amount of metal can be melted and superheated in about 5 hours.

Construction of the Air Furnace

The construction of an air furnace for burning powdered coal or fuel oil is shown in Fig. 73. This furnace has a long, shallow hearth above

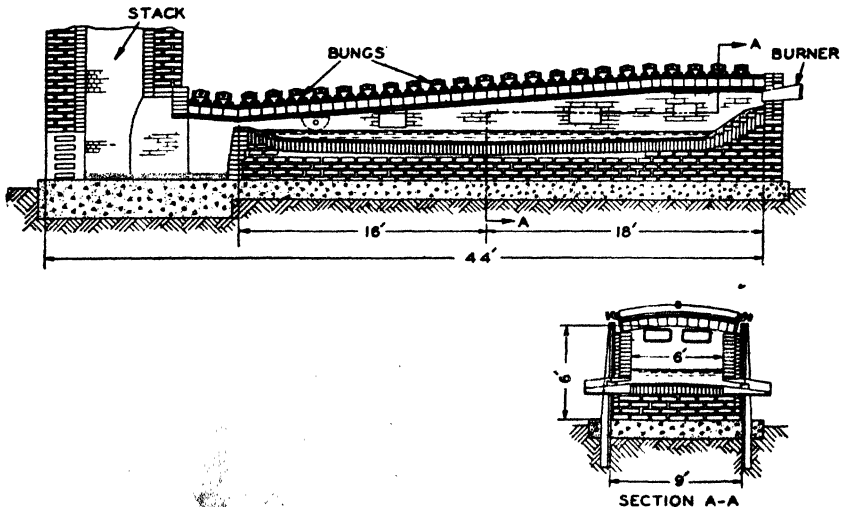

FIG. 73.—CROSS SECTION OF AIR FURNACE

which are a sloping roof and a stack through which the products of combustion escape. When lump bituminous coal is used for fuel, it is burned on grates at one end of the furnace. With this arrangement, the hot gases pass over a bridge wall, through the furnace, and up the stack.

The hearth is prepared with silica sand which is rammed upon a base of fire brick and fuses in place to form a hard, smooth surface. The bottom of the hearth slopes from both ends towards the center where a tap hole is provided on each side of the furnace for removing the molten metal.

The roof is made of arched sections or bungs of fire brick which are held in adjustable metal frames so that these sections can be removed for repairing or charging the furnace. The joints between the bungs are packed with fire clay. A relatively flat arch is required to distribute the hot gases and to reflect the heat upon the metal on the hearth.

The side walls are constructed of two rows of fire brick laid against heavy cast-iron plates which are held in place by vertical supports carried into the foundation. On one side of the furnace two or more openings are provided for stirring, skimming, or sampling the metal in the bath. Additional air is introduced through a door or open brickwork at the bottom of the stack to lower the temperature of the gases.

Operation of the Air Furnace

When the furnace is ready to be charged, the sand bottom is covered with wooden boards so that it will not be damaged by the materials placed in the furnace. The metal charge consisting of malleable iron scrap, steel scrap, and pig iron is distributed over the full length of the hearth and is piled up nearly to the roof. On completion of the charging, the bungs are replaced, and fuel is supplied through burners located at one end of the furnace.

When the metal is partially melted, it is necessary to stir the bath to obtain a uniform temperature throughout. During the melting period, some of the elements in the charge are oxidized, forming a layer of slag which collects on the surface of the metal bath and protects the metal from further oxidation. The length of time required for superheating the metal can be decreased by removing the slag cover which insulates the bath from the hot fuel gases. The bath is usually skimmed two or three times during each heat by means of skimmers on metal rods inserted through the doors on the sides of the furnace.

The melting conditions within the furnace are affected by the air supplied in excess of that required for the combustion of the fuel; the usual practice is to introduce from 25 to 50 per cent excess air. This atmosphere above the hearth causes the oxidation of some of the elementary constituents in the metal charge. The oxide of carbon separates as a gas, whereas the oxides of silicon and manganese collect in the slag.

The loss of silicon amounts to about 30 per cent of the total silicon, and the loss of manganese is about 40 per cent of the manganese in the charge. Carbon is also reduced to the proportion desired in the castings. These changes in composition, as well as the changes in the temperature of the metal, are established by the inspection of the fractured surfaces of test specimens which are cast at intervals with metal from the hearth.

Fuel economy is usually expressed as the ratio of pounds of iron melted for each pound of coal consumed; this ratio depends upon the size of the air furnace, the melting stock, the quality of fuel used, and the method of operating the furnace. It has been reported⁹ that 3

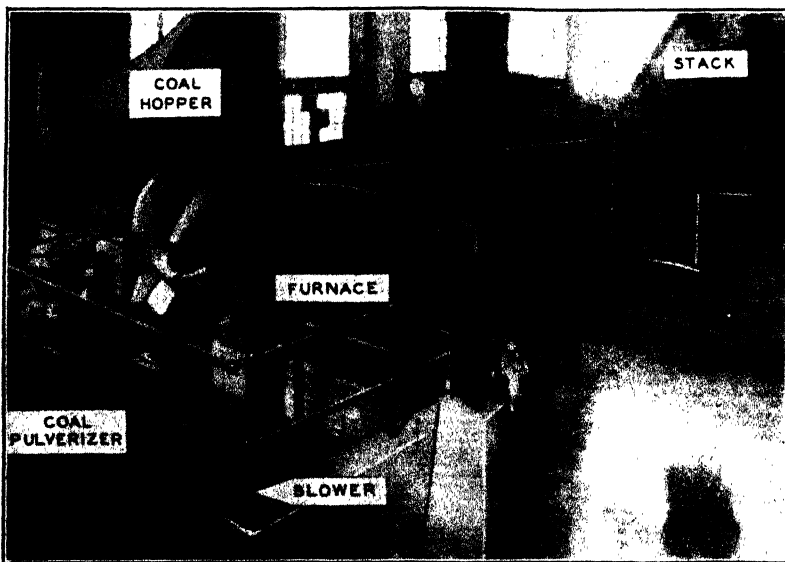

Courtesy of Whiting Corporation

FIG. 74.—AIR FURNACE WITH POWDERED COAL EQUIPMENT

pounds of metal melted per pound of pulverized coal is a satisfactory fuel ratio in malleable iron practice.

Most of the plants operating air furnaces use powdered coal for fuel. The two systems for preparing powdered coal are the central system employing a pulverizer with pipes leading to the separate furnaces, and the unit system with a pulverizer and blower for each furnace. An installation of a powdered coal unit in connection with an air furnace is illustrated in Fig. 74.

Rotary air furnaces fired with pulverized coal are being used to some

extent for melting and superheating special grades of iron. This type of furnace has a cylindrical steel shell with tapered ends. On the outside of the shell two steel tires rest on wheels in the frame and allow the shell to be rotated. A monolithic lining of ganister or a lining of refractory blocks is provided on the inside of the shell. Pulverized coal is supplied to a burner at one end of the furnace, and the products of combustion are discharged at the opposite end. After the metal charge has partially melted, the shell is rotated slowly, and the heat in the lining is conducted to the metal. Rotary air furnaces are built with capacities of $2\frac{1}{2}$, 5, and 10 tons of metal.

The initial cost of an air furnace is much more than that of a cupola. Furthermore, the expense of operating and maintaining the equipment is greater for the air furnace than for the cupola. The use of an air furnace is therefore warranted only when the control of the entire composition as well as of the temperature of the metal is necessary in the production of castings requiring special properties.

THE ELECTRIC FURNACE

Electric furnaces have been used for many years in steel foundries, but their introduction to iron foundries is comparatively recent. This extension of electric-furnace practice has been brought about by the large demand for iron castings having superior properties. On a heating-value basis, electrical energy usually costs more than liquid or solid fuels. This handicap of the electrically heated furnace for cast iron is overcome to some extent by the possibility of using low-priced materials in the furnace charges. Cast iron of good quality can be obtained by melting cast-iron borings of known composition and other kinds of scrap metals in the electric furnace. This method of melting is of special importance in districts where the prices of pig iron and coke are relatively high.

The two types of electric furnaces used in gray iron foundries are the direct-arc furnace and the indirect-arc furnace, each of which will be described later. In addition to the cost of labor, the main items in the cost of melting cast iron in electric-arc furnaces are power, electrodes, and refractories. The average power consumption for intermittent operation of arc furnaces is from 500 to 600 kw.-hr. per ton of iron melted. Under favorable conditions, it is necessary to use from 4 to 9 pounds of graphite electrodes or 12 to 15 pounds of carbon electrodes during the melting and superheating of each ton of metal. The cost of refractories will average 40 cents per ton of electric-furnace iron.

Direct-Arc Furnace

The "Lectromelt" furnace shown in Fig. 117 in Chapter XII has three electrodes arranged in a vertical position above the hearth. In this type of furnace, the current passes from one electrode to another through the metal on the hearth. When the furnace is in operation, the electrodes are raised and lowered by automatic controls to maintain the arcing of the current. The transformers and electrical control equipment are located in a separate room adjacent to the furnace. A charging door is provided at one side with the pouring spout on the opposite side, and the furnace is tilted for charging, slagging, or pouring.

Direct-arc furnaces are rated on the basis of the hourly output, using cold charges and an acid lining. The maximum holding capacity of a furnace is from three to four times the rated output. Most of the direct-arc furnaces which are used in gray iron practice have ratings of $1\frac{1}{2}$ to 5 tons per hour.

Indirect-Arc Furnace

With the indirect-arc furnace, the arc is formed between two electrodes which are placed horizontally above the hearth. The Detroit

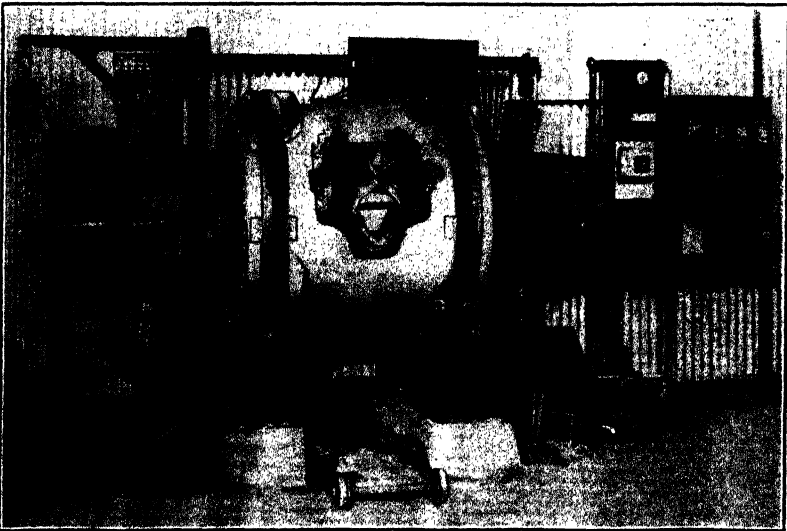

Courtesy of Detroit Electric Furnace Company

FIG. 75.—INDIRECT-ARC FURNACE

rocking furnace shown in Fig. 75 uses the indirect-arc method of heating, and has a mechanism for automatically rocking the furnace through any

desired angle. Heat from the arc is radiated to the metal within the furnace as well as to the lining of the furnace, and the rocking action permits the conduction of heat from the lining to the metal. Furthermore, the movement of the shell of the furnace produces a thorough mixing of its contents. The operation of this furnace requires the use of a transformer to reduce the voltage of the power line to about 120 volts at the electrodes.

Methods of Operation

Several methods are employed in operating electric furnaces. One consists of melting cold charges, adjusting the composition of the metal in the furnace, superheating, and finally pouring the entire melt. In another, molten metal is transferred from a cupola to the electric furnace where the required analysis is obtained, and the metal is heated to the desired temperature. Additions of steel scrap and ferro-alloys can be made directly to the furnace. Another method of operating the electric furnace is to retain a bath of molten metal in the furnace during the entire operating period. At short intervals, in some cases every fifteen minutes, a portion of the molten metal is poured out, and an equal weight of cold metal is charged into the furnace. This practice of drawing off and charging the metal in small amounts is continued until the required amount is melted.

BIBLIOGRAPHY

1. RICHARD MOLDENKE, "The Principles of Iron Founding." 1930. McGraw-Hill Book Company, New York, N. Y.
2. J. E. HURST, "Melting Iron in the Cupola." 1929. Penton Publishing Company, Cleveland, Ohio.
3. A. W. BELDEN, "Foundry-Cupola Gases and Temperatures." *U. S. Bureau of Mines Bulletin* 54, 1913.
4. JOHN GRENNAN, "Visual Observation of Melting in a Cupola." *Trans. A.F.A.*, v. XXXI (1924), p. 101-110.
5. J. T. MACKENZIE, "The Moore Hot-Blast Cupola." *Trans. A.F.A.*, v. XXXIX (1931), p. 197-204.
6. P. H. WILSON, "The Importance of Air Control in Efficient Cupola Practice." *The Foundry Trade Journal*, v. XXXVII (1927), p. 83-88.
7. W. H. SPENCER and M. M. WALDING, "Effect of Soaking Time on Initial Temperature and Analysis of Cupola-Melted Iron." *Trans. A.F.A.*, v. XL (1932), p. 913-922.
8. E. F. WILSON, "Some Features of the Pulverized Coal-Fired Air Furnace." *Trans. A.F.A.*, v. XXXVIII (1930), p. 1-40.
9. F. L. WOLF and W. ROMANOFF, "Powdered Coal in a Malleable Casting Plant." *Trans. A.F.A.*, v. XXXII (1924), p. 658-667.
10. H. E. BROMER, "Electric Process Iron for Cylinder and Cylinder-Head Castings." *Trans. A.F.A.*, v. XXXIX (1931), p. 585-601.

REVIEW QUESTIONS

I

What conditions should be taken into account when establishing the height of crucible for a cupola?

II

What is meant by the effective height of a cupola, and what should this distance be for large cupolas?

III

What precautions should be observed in repairing a cupola lining?

IV

When is the breast placed in the cupola?

V

Find the volume of air at normal conditions to burn 1 pound of coke. Assume that the ratio of carbon dioxide to carbon monoxide is 2 to 1, and that the air is supplied at 30 degrees F. with the barometer at 30.5 inches of mercury.

VI

Define the three zones in a cupola through which the metal passes, and state what takes place in each of these zones.

VII

Define fusion coke. Determine the weight of fusion coke in each charge for a 60-inch cupola.

VIII

Determine the diameter of cupola, the size of tuyeres, and the capacity of blower for a foundry requiring 30 tons of molten metal per hour.

IX

A metal mixture containing 20 per cent of steel scrap, 30 per cent of iron scrap, and 50 per cent of pig iron is used in a cupola having an inside diameter of 48 inches and a crucible 20 inches in height. Find the weight of coke in the bed and in each coke layer. What is the capacity of the cupola in tons per hour?

X

Six cast-iron tuyeres are to be used in a 60-inch cupola having a shell 78 inches in diameter. Prepare a drawing with complete dimensions for these tuyeres. Also indicate the method of molding for these castings.

XI

A foundry producing automobile castings requires 18 tons of molten metal per hour. Determine the size of cupola, and the weight of metal in each charge.

XII

Determine the weight of cupola flux required at a foundry melting 40 tons of iron in each heat.

XIII

What are the advantages of melting cast iron in air furnaces?

XIV

Account for the difference in the total cost of melting cast iron in the air furnace and in the cupola furnace.

XV

Describe two methods for lighting the coke bed in a cupola furnace.

XVI

Explain the order of adding the materials in each metal charge for the cupola furnace.

XVII

What determines the length of time between plugging and tapping a cupola?

XVIII

Describe two types of receivers for molten metal.

XIX

Indicate on a drawing of the transverse section of a cupola the location of maximum temperature.

XX

Explain the purpose of a cupola flux.

XXI

What size of cupola is required to obtain the same melting rate as that of a 20-ton air furnace?

XXII

What are the advantages of the electric furnace as a melting unit for iron castings?

XXIII

Explain three methods for the operation of electric furnaces for producing iron castings.

CHAPTER VI

METHODS AND EQUIPMENT FOR CLEANING AND RECLAIMING CASTINGS

CLEANING METHODS—Tumbling Mills—Blasting Equipment—Pickling—Hydraulic Cleaning Equipment—Brushes—Grinding Wheels—Sprue Cutters—Power-Operated Saws—Gas Cutting Torches—Chipping Hammers—Combinations of Cleaning Methods—WELDING METHODS—Gas Welding—Electric Arc Welding—“Thermit” Welding—Welding with Metal from Furnace—Welding Cast Iron—Welding Steel—Welding Non-Ferrous Alloys—GENERAL REQUIREMENTS

All castings produced in sand molds are covered with a more or less tenacious layer of sand and have the gates attached when taken from the molding floor. To prepare the castings for commercial use, they must be cleaned by removing the sand, scale, and all extraneous metal. Furthermore, some minor defects are corrected by welding before the castings leave the foundry. Castings of the more ductile metals which have become deformed during the manufacturing process are often worked in presses to the desired shapes and dimensions. The cleaning operations begin as soon as the castings are shaken from the sand and continue until the castings are shipped from the foundry. Even castings which are made in metal molds require some cleaning operations. Since the cleaning and finishing costs are often a large proportion of the total manufacturing expense, special attention is usually given to methods and equipment for this division of foundry practice.

CLEANING METHODS

The equipment used in cleaning castings may be divided into two groups as follows:

For Removing Sand and Scale

Tumbling mills
Blasting equipment
Pickling tanks
Hydraulic equipment
Brushes

For Removing Metal

Grinding wheels
Sprue cutters
Power-operated saws
Gas cutting torches
Chipping hammers

Tumbling Mills

A method which is in general use for cleaning a variety of work consists of tumbling the castings inside rotating barrels. The tumbling barrel or mill illustrated in Fig. 76 has a steel shell either round or square in shape with a hollow trunnion attached to each head. The frame of the machine carries the bearings and the driving mechanism. Tumbling mills are usually connected to an exhaust system for removing the dust from the machines. The air enters through one of the hollow trunnions and is drawn out at the other end of the mill. The speed of rotation of the barrel is about 30 revolutions per minute. Most of the space within the barrel, after the castings have been loaded, is filled with small pieces

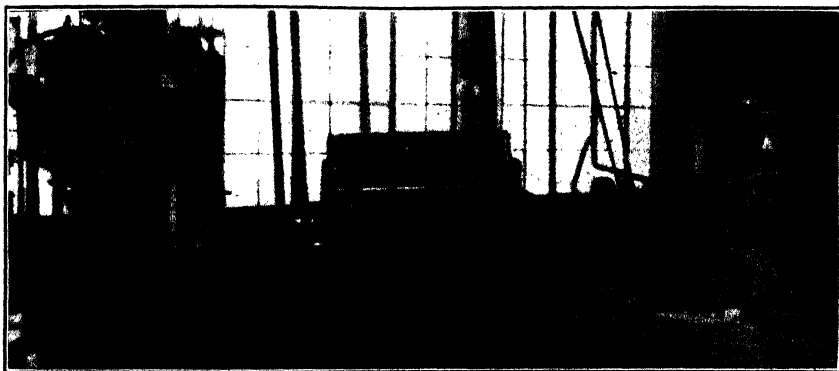

FIG. 76.—CLEANING EQUIPMENT FOR METAL CASTINGS
Showing blasting cabinet, tumbling mill, and stand grinders.

of metal called stars. The abrasive action produced within the mill cleans the surfaces of the castings rapidly and economically.

Blasting Equipment

A very effective method for cleaning the surfaces of metal castings is by the use of a stream of high-pressure air into which quartz sand or metal abrasive is introduced. The different types of equipment for blasting purposes include blasting rooms, blasting cabinets, blasting barrels, and rotary blasting tables. The essential parts of this equipment are a mixing chamber for the sand and air, a hose and nozzle for directing the stream of abrasive on the work, some means for recovering and returning the abrasive to the mixing chamber, and a dust-collecting system. The operations within blasting rooms of modern design are controlled from outside by an operator who makes observations through

windows. An opening at one side allows the operator to direct the stream of abrasive material on the castings.

Blasting cabinets are particularly suited to the cleaning of small castings. The cabinet shown in Fig. 76 is built of sheet steel and has openings at the front through which the operator's hands are inserted. The operator watches the progress of the blasting through a glass window. Doors are provided at one side for placing the castings in the cabinet.

In some designs of blasting equipment, rotating barrels are used in combination with streams of abrasive material. It is possible to clean



Courtesy of The American Foundry Equipment Company

FIG. 77.—BLASTING BARRELS

large quantities of small castings thoroughly and quickly by this method. An installation of two blasting barrels is shown in Fig. 77.

A rotary table blasting machine is illustrated in Fig. 78. By this means, castings are carried from the loading position at the front of the machine, through the blasting chamber, and around to the original position. Nozzles are located in the blasting chamber to direct the streams of abrasive on all the exposed surfaces of the castings.

A mechanical method of abrasive cleaning which eliminates the use of compressed air is employed at many foundries. In this method, sand or other abrasive is fed by gravity into a rapidly revolving wheel which



Courtesy of Pangborn Corporation

FIG. 78.—ROTARY TABLE BLASTING MACHINE

throws the abrasive against the castings being cleaned. During the cleaning process, the castings are tumbled so that all surfaces will be exposed to the stream of abrasive.

Pickling

Pickling is the term applied to the cleaning of metals by immersion in weak acid solutions. These solutions are held in tanks having acid-resisting linings of wood, lead, or hard rubber. When sulphuric acid is used in the pickling solution, the scale is dissolved, or is loosened by the hydrogen gas which is evolved when the acid attacks the metal beneath the scale. A bath of hydrofluoric acid will attack and remove the scale without affecting the metal. The concentrations of pickling solutions vary from 2 to 15 per cent of acid. In order to decrease the time of

122 EQUIPMENT FOR CLEANING AND RECLAIMING CASTINGS

pickling, the solutions are often heated to temperatures between 140 and 180 degrees F. This method of cleaning is used chiefly for preparing the surfaces of castings for galvanizing and electroplating.

Hydraulic Cleaning Equipment

Equipment has been installed at a number of foundries for cleaning large castings by the hydraulic method. An installation of this kind is shown in Fig. 79. The castings are placed on a revolving table within an enclosed room. Streams of water at high pressure (up to 450 lb. per sq. in.) are directed on the castings by an operator who views the work



FIG. 79.—ROOM FOR HYDRAULIC CLEANING

Casting being fastened to revolving table. Water used at a pressure of 400 lb. per sq. in.

through windows in the walls of the room. Molding sand and cores are removed without difficulty from large castings by this method of cleaning. With some installations of hydraulic cleaning equipment, the sand which is washed from the castings is recovered and used again in the foundry.

Brushes

Wire brushes which are employed extensively in the cleaning of metal castings are constructed of hardened steel wires held securely in wooden

blocks or in metal forms. Some brushes are made with wires of small diameter; others have thick flat wires. A rectangular brush with a wooden back is commonly used for cleaning flat surfaces by hand. Plain circular and cup-shaped brushes are used on power-driven machines. A wire-wheel brush having small flexible wires is well adapted to cleaning irregular surfaces.

Grinding Wheels

The use of grinding wheels for removing metal from rough castings

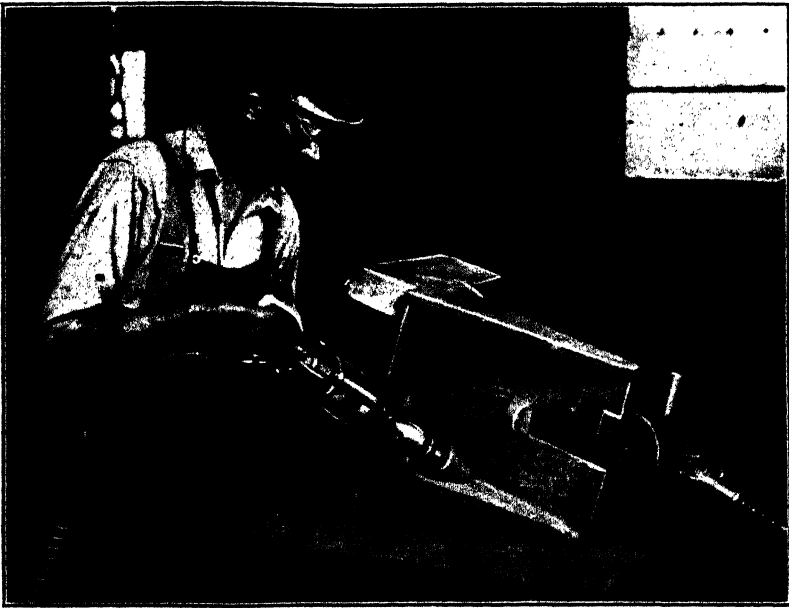

Courtesy of Norton Company

FIG. 80.—PORTABLE GRINDERS

is common practice at nearly all foundries. This operation, known as **snagging**, is an economical method for removing excess metal from both ferrous and non-ferrous castings. The grinders used in the cleaning rooms of foundries are of several types. The stationary type has wheels mounted on a heavy stand which is attached to the floor or bench. Portable grinders are operated by compressed air or electric power, and are built in units which can be handled and controlled easily by the operator. Two portable grinders for cleaning flat surfaces and corners of castings are illustrated in Fig. 80. The swing-frame grinder shown in

Fig. 81 is particularly suited to the snagging of large castings. It has a horizontal frame with a grinding wheel at one end and an electric motor at the other end. The frame is suspended on a chain from an overhead crane, and the grinding wheel is guided over the castings by the operator.

The results obtained in grinding castings are dependent largely upon the grinding wheel and the speed at which it is operated. Grinding wheels are classified according to the kind of abrasive, the size of the particles of abrasive, the amount of the abrasive, the bonding material, and the grade or hardness of the wheel. The abrasive materials, which



Courtesy of Norton Company

FIG. 81.—SWING-FRAME GRINDER
Cleaning large steel casting.

are known by various trade names, may be placed in two general groups, namely aluminum oxide and silicon carbide. Aluminum oxide is used in wheels for grinding steel; silicon carbide is usually recommended for grinding cast iron and the non-ferrous alloys.

Grinding wheels are prepared from many different grain sizes of the abrasives. These sizes are designated by numerals which indicate approximately the number of meshes per linear inch of a screen through which the grains will pass. The amount of abrasive used in the composition of the wheels determines the structure, which is also indicated by numbers.

The types of bonds used in making grinding wheels include clay, silicates, shellac, rubber, and "bakelite." Wheels made with clay bond are heated in kilns to the temperature of vitrification of the clay. Many grades of hardness are produced in grinding wheels containing the different bonding materials. Each manufacturer of grinding wheels has special designations for classifying its product and provides tables from which a selection can be made for specific requirements.

Sprue Cutters

The most convenient means for removing the gates from small castings made of relatively soft metals is the sprue cutter illustrated in Fig. 82. This machine has two chisel-shaped cutters which shear the extra metal from the castings.

Power-Operated Saws

Power-operated saws may be used for cutting the risers from steel castings. This method necessitates the mounting of the rough castings on the machines. Band saws are frequently used for trimming castings of the non-ferrous metals.

Gas Cutting Torches

Large sections of steel can be cut rapidly and economically by special torches burning fuel gases and oxygen. A cutting torch in which acetylene gas is used with oxygen is shown in Fig. 83. One advantage of this method lies in the ease of moving from one position to another when trimming steel castings. The operation of cutting a riser from a

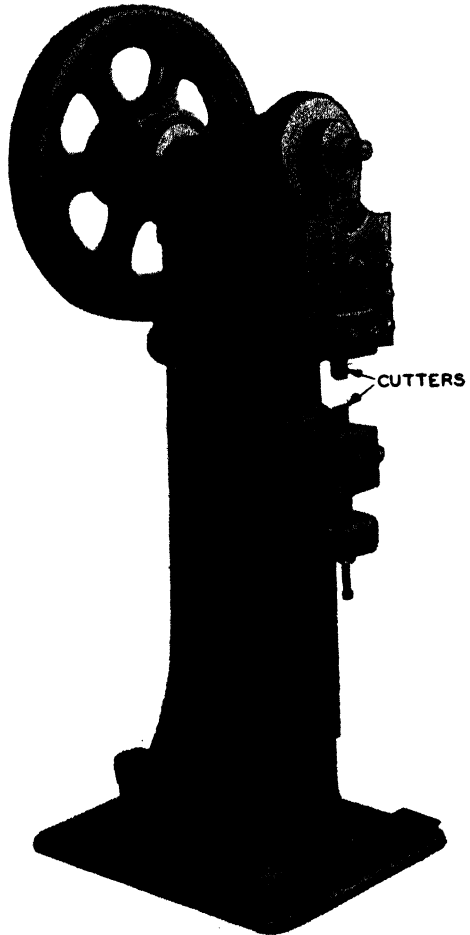

Courtesy of The Toledo Machine and Tool Company

FIG. 82.—SPRUE CUTTER

large steel casting is illustrated in Fig. 84. After the metal has been preheated at the section where the cut is to be made, a large supply of

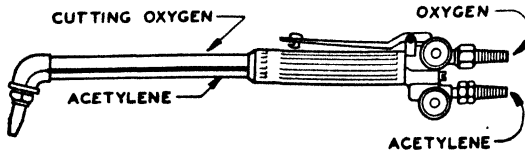
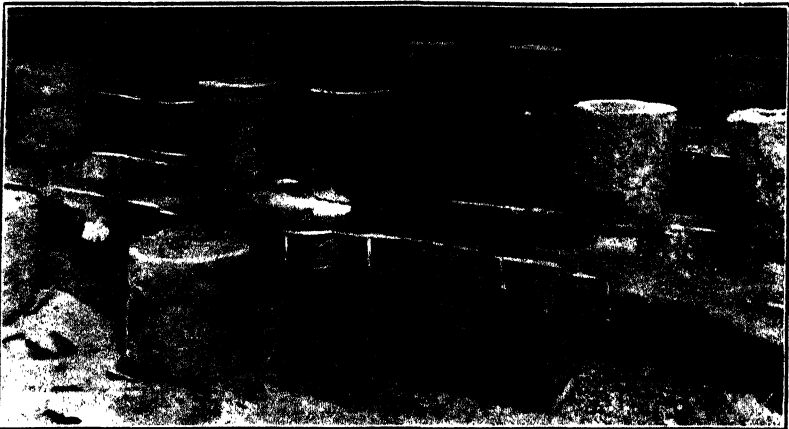

FIG. 83.—CUTTING TORCH

oxygen at a high pressure (65 lb. per sq. in. for a 4-inch thickness) is introduced through the tip of the torch. This causes the metal to burn vigorously, and the heat generated is sufficient to melt the iron oxide



Courtesy of Air Reduction Sales Company

FIG. 84.—CUTTING RISERS FROM STEEL CASTINGS WITH OXY-ACETYLENE FLAME

so that it runs off as a molten slag, exposing more metal to combine with the oxygen.

Chipping Hammers

Air-operated tools known as chipping hammers are commonly used for removing fins and other projections from castings. With this equipment, repeated blows are delivered to a cold chisel which is mounted on the hammer. Cores are often removed from large castings with the aid of these tools.

Combinations of Cleaning Methods

The selection of the most favorable methods for cleaning a definite group of castings depends upon the properties of the metal, the size

of the pieces, and the requirements as to the finish of the castings. Cast steel can be readily cut with the aid of a gas torch, whereas cast iron cannot be cut economically by this method. Small castings are brought to the metal-cutting machines, and large castings are usually cleaned by the use of portable tools. Some uses of castings require that the surfaces be very smooth and free from imperfections. In others, the condition of the surfaces of the castings is of minor importance.

At foundries where gray iron and malleable iron castings are produced, the cleaning practice usually includes the removal of sand and scale by brushing, tumbling, blasting, or pickling, and the removal of surplus metal by grinding or chipping. The gate connections and fins on iron castings are broken off with hand hammers.

In the steel foundry, the sand and scale are removed from the castings by brushing, tumbling, or blasting; the gates and risers are cut off with gas torches, sprue cutters, or saws; and the fins are ground or chipped from the surfaces.

Brass and aluminum castings can be cleaned more readily than the ferrous metals. Sprue cutters and band saws are commonly used for removing gates and risers. Revolving brushes, grinding wheels, and blasting equipment are also required for preparing these castings for the market.

WELDING METHODS

The extensive use of welding in the reclamation and repair of metal castings warrants some attention to this subject. The principal welding methods include gas welding, electric arc welding, and "thermit" welding. When the gas flame or the electric arc is used as a source of heat, the material being welded is heated over a small area at one time, and the metal is deposited gradually. In the "thermit" process, the liquid metal is produced in bulk at a sufficiently high temperature to melt and unite the surfaces of the parts being joined. Thin sections or small defects can be welded advantageously by the use of the gas torch or the electric arc, whereas the "thermit" process is particularly adapted to the welding of large sections of metal.

Gas Welding

Various gas combinations can be used in producing a hot flame for welding metals. Acetylene (C_2H_2) and oxygen (O_2) are in general use, although hydrogen and oxygen are satisfactory for some purposes. These gases are thoroughly mixed in correct proportions in a hand torch and are ignited at the nozzle or tip.

The equipment required for oxy-acetylene welding includes tanks of oxygen and acetylene, a suitable torch, and rubber hose to connect the torch to the gas supply. This equipment is shown in Fig. 85 and 86.

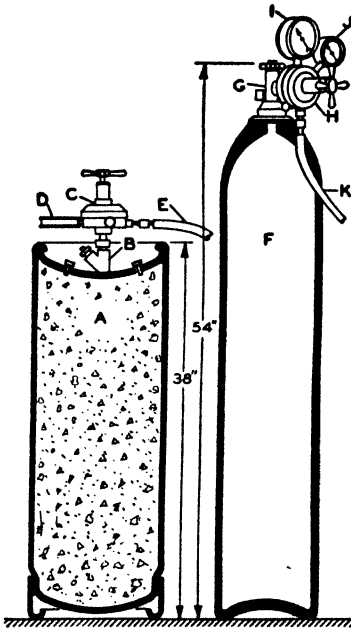

Automatic regulators are used to reduce the pressures of the gases from those in the usual trade cylinders to the pressures suitable for welding. By adjusting the proportion of oxygen to acetylene at the torch, different types of flames can be produced. When these gases are supplied in nearly equal volumes, a neutral flame which is used in most welding operations is obtained. One advantage of the oxy-acetylene flame over the electric arc for general welding purposes is that the temperature of the flame and the amount of heat can be controlled in the former method, whereas only a very high temperature can be produced by the electric arc.

Electric Arc Welding

FIG. 85.—CYLINDERS AND REGULATORS FOR OXY-ACETYLENE WELDING

- A—Acetylene cylinder contains porous filler and acetone in which 300 cu. ft. of acetylene gas is dissolved.
- B—Acetylene valve.
- C—Acetylene regulator.
- D—Cylinder pressure gage, maximum 250 lb. per sq. in.
- E—Hose to torch, pressure 4 to 6 lb. per sq. in.
- F—Oxygen cylinder contains 220 cu. ft. of oxygen gas.
- G—Oxygen valve.
- H—Oxygen regulator.
- I—Cylinder pressure gage, maximum 2000 lb. per sq. in.
- J—Outlet pressure gage 2 to 20 lb. per sq. in.
- K—Hose to torch.

impinges. The remainder of the heat is produced between the electrodes or at the negative electrode.

An arc is produced when two conductors of an electric current are brought together to form a circuit, and then separated for a distance such that the current continues to flow through the gaseous medium between the solid conductors. Electrical energy is transformed at the arc into heat which is concentrated within a small space. The conductor from which the current passes into the arc is designated as the positive electrode, the other conductor as the negative electrode. It is estimated that from two-thirds to three-fourths of the total electric power which is converted into heat is expended at the positive electrode where the arc

There are two methods for utilizing the heat of the electric arc for welding purposes. In one, a rod of carbon is the negative electrode, and the metal object is the positive electrode. The arc produced between these electrical conductors heats the metal rapidly to the liquid state. For welding or building-up operations, additional metal is intro-

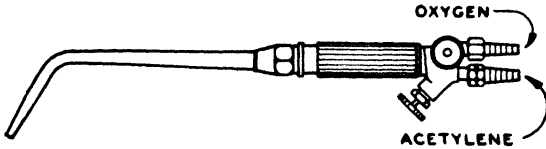

FIG. 86.—WELDING TORCH

duced within the heated area. A holder for carbon electrodes is shown in Fig. 87. The second method makes use of a low-carbon steel wire or rod of small diameter as the negative electrode. During the welding operations, this metal electrode is fused by the heat of the arc, and is gradually deposited on the work. Metal electrodes are often coated

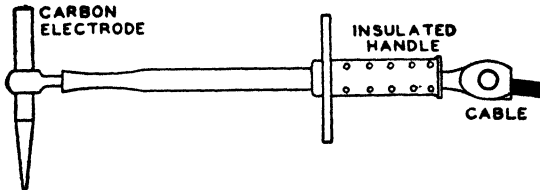

FIG. 87.—CARBON-ELECTRODE HOLDER

with materials which tend to decrease the oxidation of the weld metal by forming a non-oxidizing atmosphere in the vicinity of the weld. The holder shown in Fig. 88 has a metal clamp for gripping the electrodes during arc welding.

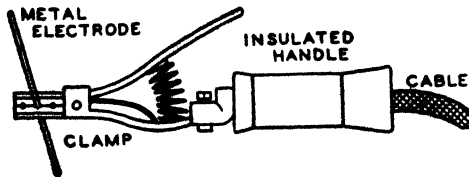

FIG. 88.—METAL-ELECTRODE HOLDER

The current supplied to carbon electrodes is sometimes as high as 600 amperes, whereas the current used for welding with metal electrodes rarely exceeds 400 amperes. The voltage which has been found to

give the most satisfactory results for arc welding varies from 15 to 45 volts. A motor-driven, direct-current generator is usually employed for supplying the current for electric arc welding.

“Thermit” Welding

The “thermit” process for welding iron or steel castings utilizes the chemical reaction between finely divided aluminum and iron oxide. In this heat-forming reaction, the aluminum combines with the oxygen of the iron oxide to form aluminum oxide or slag, and iron is set free in a highly superheated state. A temperature of about 4800 degrees F. is obtained by the “thermit” reaction.

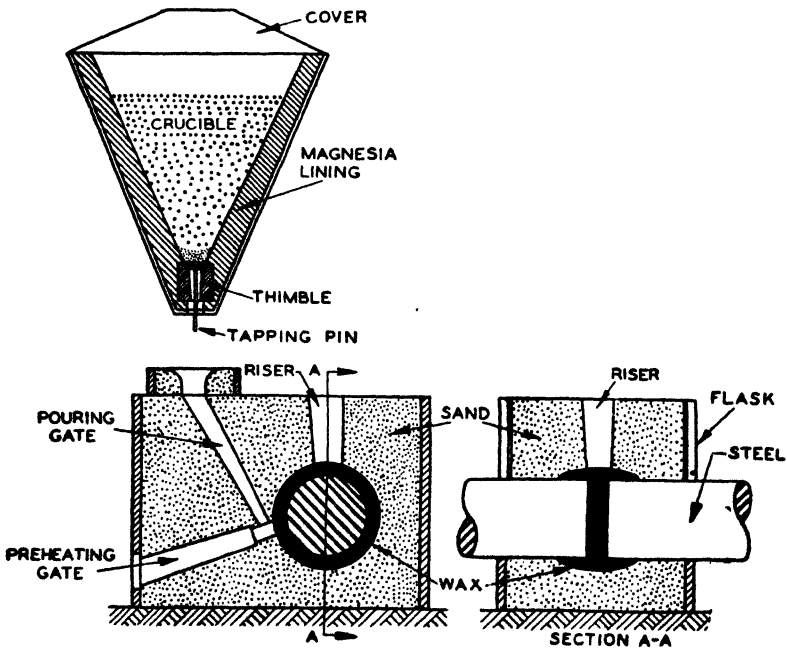

FIG. 89.—EQUIPMENT AND MOLD FOR “THERMIT” WELD

Commercial “thermit” is a mixture of granulated aluminum and iron oxide, the ratio by weight being approximately three parts of iron oxide to one part of aluminum. Other elements are added to the mixture to obtain the desired composition of the weld metal. The “thermit” mixture is not explosive, and there is no danger in handling, or storing this material.

In the preparation of the parts to be welded, the surfaces are thoroughly cleaned, and provision is made for the contraction of the metal when it cools after welding. A pattern of yellow wax is shaped around and between the parts as shown in Fig. 89. It is necessary to place a flask around the sections to be welded so that a mixture of quartz sand and fire clay can be rammed around the wax pattern. Openings are provided in the mold for the pouring gate, riser, and preheating gate. When the mold is completed, a gas torch is used at the lower opening to burn out the wax and to preheat the exposed metal parts within the mold. This opening is plugged with sand as soon as the torch is removed.

While the preheating is in progress, a charge of "thermit" is placed in the conical-shaped crucible which is supported above the pouring gate of the mold. The amount of "thermit" required is dependent upon the volume of metal in the weld. This can be established by using "thermit" in the ratio of twenty-five times the weight of the wax used in making the pattern. A small quantity of magnesium powder is placed on the "thermit" mixture in the crucible, and this is ignited by a match or a hot iron. Within one minute, the "thermit" reaction is complete and the slag (Al_2O_3) has risen above the metal in the crucible; then the metal is tapped into the mold by striking the pin at the bottom of the crucible. The metal in its highly superheated state melts the ends of the parts within the mold and finally joins them in one mass. After the welded section has cooled slowly in the mold, the gates, risers, and all extraneous metal are removed from the joint.

The "thermit" process of welding is adapted to the repair of heavy sections of cast iron or steel where large quantities of weld metal are required. These applications include the repair of large machine parts, railroad equipment, parts of ships, and steel-mill equipment.

Welding with Metal from Furnace

Defective or broken castings can be repaired in the foundry by using molten metal directly from the melting furnace. The pieces to be joined or built up are secured within a mold of refractory sand with inlet and outlet openings. Metal which has been highly superheated is run through the mold until the surfaces of the casting are heated to a temperature at which they will fuse with the molten metal; then the outlet is stopped off and pouring is continued until the mold is filled. This welding method is particularly adapted to the reclamation of large castings at the foundry.

Welding Cast Iron

Gray iron castings can be welded satisfactorily with the oxy-acetylene torch and cast-iron welding rods. In order to produce welds which are machinable, it is necessary to use filling rods with a relatively high silicon or nickel content. Fluxes consisting of alkali carbonates assist in the removal of slag from the welds. It is often desirable to preheat the castings before welding and to cool the castings slowly after welding. This procedure prevents the development of cracks caused by the unequal expansion and contraction of the metal in different sections of the castings.

The most satisfactory method for reclaiming malleable iron castings is to use a bronze welding rod which is melted with the gas torch at relatively low temperatures, rather than to weld this material at high temperatures with cast-iron or steel welding rods. The reason for this practice is that the valuable properties of malleable cast iron are not regained after the metal has been heated to high temperatures.

Welding Cast Steel

Steel castings can be welded by any one of the methods which have been described. Electric arc welding equipment is often used in foundries for correcting minor defects on the surfaces of steel castings. For very large sections of metal, the "thermit" process will undoubtedly be most economical. It should be understood that the high temperatures required for welding will destroy the results of previous heat treatments to which the castings have been subjected.

Welding Non-Ferrous Alloys

Brass and bronze castings can be welded by using the oxy-acetylene torch and welding rods of approximately the same composition as the castings. A flux aids in producing sound welds. Aluminum castings which are to be welded are first preheated slowly and uniformly in a suitable furnace. Then the parent metal at the location of the weld is heated to a melting temperature with a gas torch. A filling rod composed of 95 per cent aluminum and 5 per cent silicon is well adapted for supplying additional metal at the weld. The oxides are removed from the weld metal with a suitable flux and by means of a scraper.

GENERAL REQUIREMENTS

The amount of attention required in the cleaning and reclaiming of metal castings is determined largely by the subsequent uses of the

foundry product. Castings which are to be enameled or electroplated must be free from surface defects in order that satisfactory coatings may be obtained. A good appearance is essential to the sale of castings for hardware, plumbing goods, and household appliances, as well as for ornamental purposes. To improve the appearance of castings, minor defects on the surfaces are often corrected by welding.

A number of methods have been described for cleaning and welding metal castings. It is necessary to select that combination of methods which will produce the most satisfactory results for any group of castings. The costs of cleaning and finishing castings are necessarily dependent upon other divisions of the foundry practice. The care taken in melting, core making, and molding will influence to a large extent the expense required in the cleaning department.

BIBLIOGRAPHY

1. E. C. BARRINGER, "Cleans Castings Hydraulically." *The Foundry*, v. LIII (1925), p. 951.
2. J. H. HOPP, "Reducing the Cost of Cleaning Ferrous Castings." *Trans. A.F.A.*, v. XXXIII (1925), p. 48-59.
3. F. G. STEINEBACH, "Cleaning Room Progress Aids Production of Quality Castings." *The Foundry*, v. LVI, Feb. 15, March 1, March 15, April 1, April 15, May 15, June 15, July 1, July 15, Aug. 1, Aug. 15, Sept. 1, Sept. 15, Nov. 1, Nov. 15, Dec. 1, 1928.
4. JAMES W. OWENS, "Fundamentals of Welding." 1923. The Penton Publishing Company, Cleveland, Ohio.
5. L. B. MACKENZIE, "The Welding Encyclopedia." 1930. The Welding Engineer Publishing Company, Chicago, Ill.
6. NORTON COMPANY, Worcester, Mass. *Grits and Grinds*, v. XXIV (1932), n. 9.

REVIEW QUESTIONS

I

What operations are necessary in the cleaning of metal castings?

II

Describe three types of grinders used in the cleaning departments of foundries

III

Classify the equipment used in sandblasting.

IV

What methods are used in cleaning steel castings?

134 EQUIPMENT FOR CLEANING AND RECLAIMING CASTINGS

V

What equipment and materials are required for welding iron castings?

VI

Why is it difficult to cut cast iron with the gas cutting torch?

VII

Describe the two methods used in electric arc welding.

VIII

Explain the heat-forming reaction utilized in the "thermit" process.

IX

What precautions should be taken in the foundry to decrease the amount of cleaning required for iron castings?

X

What methods are used in welding steel castings?

XI

Discuss the procedure for welding aluminum castings.

XII

What precautions must be observed when welding iron castings?

XIII

What procedure is used in welding with metal from the melting furnace?

XIV

What are the applications of "thermit" welding?

XV

Describe the procedure for welding with metal from the melting furnace.

CHAPTER VII

THE CONSTITUTION OF CAST IRON

MICRO-CONSTITUENTS OF CAST IRON—Ferrite—Graphite—Cementite—Pearlite—Austenite—Steadite—Grain Size—CHEMICAL COMPOSITION OF CAST IRON—Carbon—Silicon—Manganese—Sulphur—Phosphorus—Nickel—Chromium—Molybdenum—SOLIDIFICATION AND COOLING OF CAST IRON—TYPES OF CAST IRON—White Cast Iron—Malleable Cast Iron—Gray Cast Iron—HEAT TREATMENT OF CAST IRON

The alloys known as cast iron contain, in addition to iron, carbon, and silicon, appreciable percentages of manganese, sulphur, and phosphorus, which are intentionally added to improve the qualities of the resulting metal or are unavoidably present as a result of the manufacturing processes. Nickel, chromium, and molybdenum may also be present in cast iron as special alloying elements. With the possible exception of carbon, the chemical elements are not present in the pure state in cast iron, but are contained in combinations in the physical constituents of the metal.

MICRO-CONSTITUENTS OF CAST IRON

The properties of cast iron are dependent directly upon the proportion and condition of its structural constituents. The amounts of these constituents can be computed approximately from the chemical analysis and their size and distribution can be established by microscopic examination.

The procedure used in the metallographic examination of cast iron is first to grind and polish small specimens of the metal and then to observe the structures under a microscope. To develop the features of the constituents in the matrix of cast iron, the surfaces are etched with dilute acids or other corrosive solutions which attack in varying degree the different constituents in the metal. This method of inspection discloses the size of the grains and the shape of the graphite particles, as well as flaws in the cast iron. The characteristics of the micro-constituents ordinarily found in cast iron will now be discussed.

Ferrite

Ferrite is composed largely of iron with small proportions of iron silicide (FeSi) and iron phosphide (Fe_3P) in solution with the iron in the solid state. This constituent is soft and ductile, strongly magnetic, and has a tensile strength of 40,000 to 50,000 lb. per sq. in. and an elongation between 40 and 50 per cent. It has a Brinell hardness of



FIG. 90.—GRAY CAST IRON (A.S.T.M. CLASS 20B), UNETCHED, $\times 100$
Black areas are graphite.

about 80. Under the microscope, ferrite appears as light-colored grains having irregular shapes. (See Fig. 112 in Chapter XI.)

Graphite

Graphite is relatively pure carbon occurring in the form of flakes or small particles in gray cast iron. This constituent is soft and improves the machinability of cast iron. The proportion of graphite in cast iron is dependent upon the chemical composition, as well as upon the rate of cooling of the metal. The mechanical properties of gray cast iron are influenced largely by the amount, size, and distribution of the graphite particles. The larger and more continuous the graphite flakes, the lower

will be the tensile strength. When subjected to loads in tension, the graphite constituent is equivalent to voids in gray cast iron. If a small amount of graphite is evenly distributed in small particles, the continuity of the matrix is interrupted less and the tensile strength is higher than in an iron containing a large proportion of graphite in large flakes. Compare the structure and properties of the cast iron shown in Fig. 90

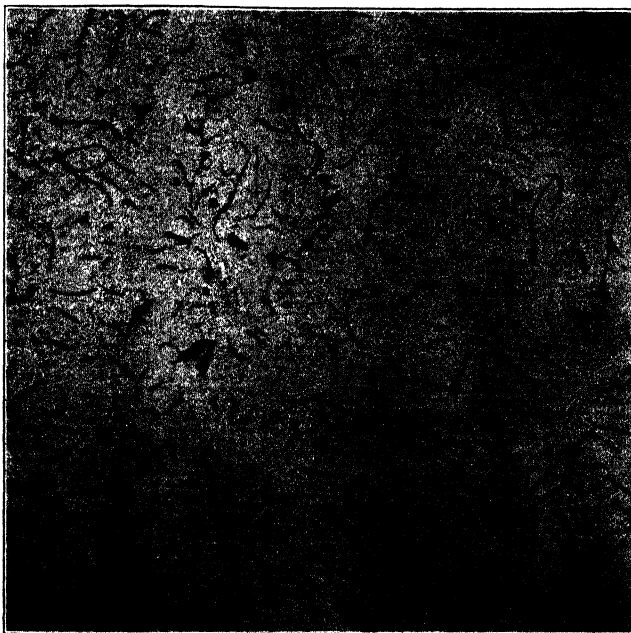

FIG. 91.—GRAY CAST IRON (A.S.T.M. CLASS 50B), UNETCHED, $\times 100$
Black lines are graphite.

with that shown in Fig. 91. The micro-constituents in these specimens of gray cast iron as developed by etching are shown in Figs. 92 and 93.

Cementite

Cementite is a chemical compound of iron and carbon, having the formula Fe_3C , and containing 93.33 per cent iron and 6.67 per cent carbon by weight. Other elements such as manganese and chromium also combine with carbon to form cementite. This constituent is extremely hard and brittle. Cementite appears as uniform, light-colored grains at high magnification as shown in Fig. 111 in Chapter XI. The Brinell hardness of cementite is about 550.

Pearlite

Pearlite is a mixture of ferrite and cementite in alternate layers as is plainly indicated in Fig. 94. The larger portion of the matrix of many commercial irons is composed of pearlite. Normal pearlite has a tensile strength of approximately 125,000 lb. per sq. in. and an elongation of about 10 per cent. It has a Brinell hardness of about 200.



FIG. 92.—GRAY CAST IRON (A.S.T.M. CLASS 20B), ETCHED WITH
3 PER CENT NITAL, $\times 100$

Black areas are graphite. White areas are ferrite. Gray areas are pearlite and steadite.

Austenite

Austenite is a solid solution of iron and cementite with a variable carbon content between 0 and 1.7 per cent by weight. The amount of carbon in saturated austenite depends upon the proportions of other elements in the alloy. In cast iron containing 2 per cent silicon, saturated austenite has a carbon content of about 1.5 per cent. This constituent is present in plain cast iron at temperatures above 1382 degrees F. Alloy cast irons containing more than 20 per cent nickel retain austenite at ordinary temperatures. Austenite can be detected because it is non-magnetic.

Steadite

Steadite is a mixture of iron phosphide (Fe_3P) and iron. This constituent contains about 10 per cent phosphorus and 90 per cent iron. It solidifies at a temperature about 1800 degrees F. and, as it is the last constituent to solidify, is often found at the grain boundaries of the other constituents in cast iron. (See Fig. 95.) Steadite is hard and

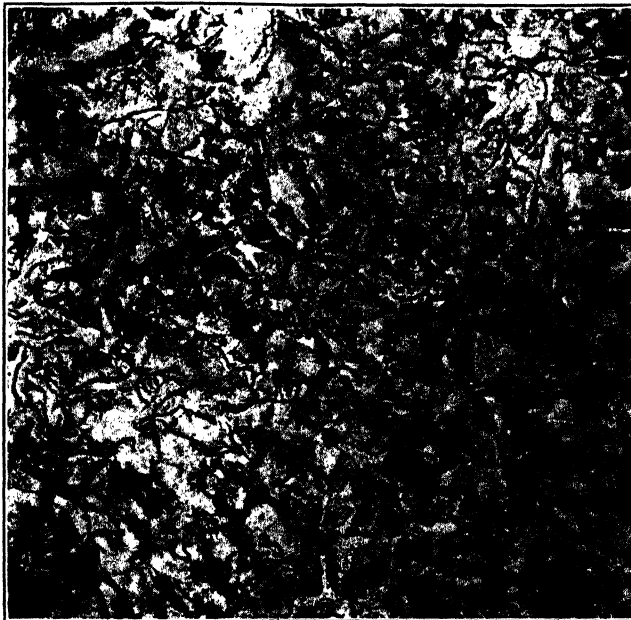

FIG. 93.—GRAY CAST IRON (A.S.T.M. CLASS 50B), ETCHED WITH
3 PER CENT NITAL, $\times 100$

Black lines are graphite. Gray areas are largely pearlite.

brittle and, if it is present in sufficient quantity, will confer these properties to the metal.

Grain Size

The size of the crystalline grains in cast iron is determined largely by the rate of cooling of the metal in the molds. Thin sections of castings cool rapidly and have small grains. The grain size of large castings usually increases towards the center of the heavier sections; this tendency is counteracted to some extent by the addition of alloys to the cast iron. Large graphite flakes and a coarse grain structure are produced by a high silicon content. When a dense, close-grained iron is

required in castings which are subjected to high fluid pressures, as well as for castings which must have smooth surfaces after machining, a relatively low silicon content is specified.

CHEMICAL COMPOSITION OF CAST IRON

The physical constitution of cast iron is dependent to a large extent upon the chemical composition of the metal. Commercial cast iron



Courtesy of R. Schneidewind

FIG. 94.—GRAY CAST IRON, ETCHED WITH 3 PER CENT NITAL, $\times 1000$
Laminated area is pearlite. Black area is part of a graphite flake. Gray hexagonal inclusion is manganese sulphide.

always contains iron, carbon, silicon, manganese, sulphur, and phosphorus. Furthermore, alloy cast iron may be prepared with one or more special elements such as nickel, chromium, and molybdenum. The influence of the chemical elements on the structural constituents, and consequently on the physical properties of cast iron, will now be considered.

Carbon

Pure iron will dissolve about 5 per cent of carbon at a temperature slightly above its melting point. However, the solubility of carbon in

cast iron is influenced by the presence of other elements in the metal. Silicon in particular decreases the amount of carbon which can be held in solution at any definite temperature. The total carbon in cast iron which has been melted in a cupola furnace is usually between 3 and 4 per cent of the weight of the metal.

When cast iron is in the molten state, most of the carbon is in solution as iron carbide (Fe_3C). On solidification, this compound separates, the presence of free carbon (graphite) being due to the decomposition

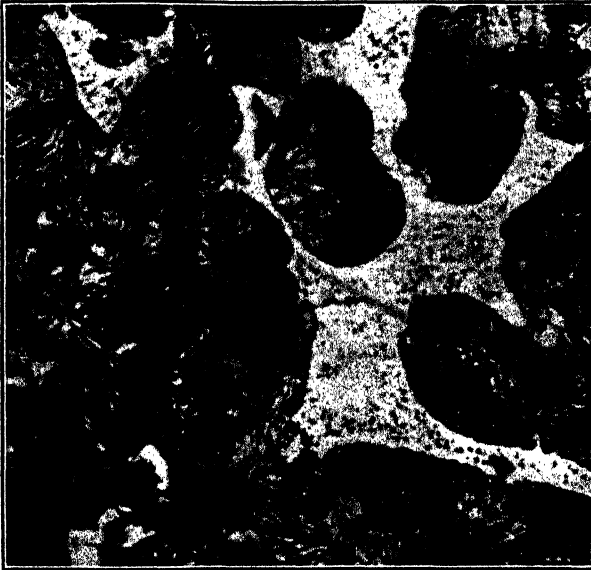

FIG. 95.—GRAY CAST IRON, ETCHED WITH 3 PER CENT NITAL, $\times 1000$
Dark areas are pearlite. Light spotted areas are steadite.

of the cementite according to the reaction: $\text{Fe}_3\text{C} \rightarrow 3\text{Fe} + \text{C}$. The extent of the dissociation of the cementite is controlled by the composition and the rate of cooling of the metal. Silicon has a pronounced influence in causing the formation of graphite, whereas sulphur tends to retain carbon in the combined state. Slow cooling of the metal favors the development of graphite; rapid cooling allows the carbon to remain combined with the iron in the form of cementite. The balance between the proportions of free carbon and combined carbon determines to a large extent the properties of cast iron.

Silicon

The silicon content of pig iron is derived from the reduction of silicates in the ore and fuel used in the blast furnace. High-silicon pig iron is produced by operating the blast furnace at high temperatures with a large fuel ratio. The amount of silicon in iron castings ranges from 0.50 to 3.00 per cent, depending upon the physical requirements of each application. The proportion of silicon in cast iron can not be determined directly by microscopic observations because this element is combined with iron and is dissolved in the ferrite.

The important influence of silicon on the properties of cast iron is to cause the formation of graphite from the dissociation of cementite. Different types of cast iron, from extremely hard white iron to soft gray iron, can be obtained by controlling the silicon content. The tensile strength of gray cast iron decreases as the amount of graphite and the size of the graphite particles increase. The change in the condition of the carbon from the combined to the free state is accompanied with an increase in volume. Therefore, as the silicon content of cast iron increases, the net contraction of the metal decreases.

Manganese

The pig iron, scrap metals, and ferro-alloys introduce manganese to the mixtures for iron castings. The manganese content usually ranges from 0.50 to 1.00 per cent in the castings. Manganese may be present in two forms in the structure of cast iron, either as the sulphide, MnS , or as the carbide, $(\text{FeMn})_3\text{C}$. The former constituent can be seen under the microscope as small angular crystals (see Fig. 94); the latter is present as cementite. Manganese sulphide has a low specific gravity (about 4.00) in comparison with that of gray cast iron (about 7.00); consequently it will tend to rise in the metal. The effect of increasing the proportions of manganese above the amount which combines with the sulphur is to raise the tensile strength and hardness of cast iron. Manganese also acts as a cleanser in the molten metal by forming oxides and sulphides, which separate to some extent into the slag.

Sulphur

The sulphur in cast iron is derived largely from the fuel used in the blast furnace and in the cupola. Charcoal pig iron is low in sulphur because of the purity of the fuel used during its production. The effect of sulphur on the properties of cast iron is dependent upon the proportions of the other elements which are present in the metal. In combina-

tion with a low silicon content, sulphur has a decided hardening effect. Hatfield states that the presence of iron sulphide increases the stability of cementite (Fe_3C) and in this way produces a hard structure.¹ When manganese is present in sufficient quantity, it combines with the sulphur to form manganese sulphide (MnS), which occurs as a separate constituent in the metal. (See Fig. 94.) As a rule, the sulphur content of iron castings does not exceed 0.12 per cent. The metal for castings which have chilled surfaces often contains as much as 0.15 per cent sulphur.

Phosphorus

The original sources of phosphorus in iron castings are the compounds of phosphorus in the ore and fuel used in the blast furnace. Pig iron is produced with a wide range of phosphorus content; consequently it is necessary to select the iron which will give the desired limits of phosphorus in the metal mixtures for each type of castings.

In cast iron containing a small percentage of phosphorus, this element is combined with iron as iron phosphide (Fe_3P), which is dissolved in the ferrite. When the phosphorus content exceeds the amount which is soluble in the ferrite, it occurs as a separate constituent known as steadite. This is a eutectic mixture of iron phosphide and iron, which can be observed under the microscope in more or less continuous patches, depending upon the amount present. (See Fig. 95.) The low temperature at which this constituent solidifies (about 1800 degrees F.) accounts for the greater flowability of cast iron having a high phosphorus content. Ornamental castings of intricate designs are often made from an iron containing about 1.00 per cent phosphorus. The strength of cast iron is slightly improved by an increase of phosphorus up to 0.30 per cent. When the phosphorus content is sufficiently high and the cooling conditions are such that steadite forms in large areas, the tensile strength of the iron is decreased.

Phosphorus has no influence on the condition of the carbon in cast iron, and therefore does not affect the hardness caused by iron carbide. However, steadite is a hard constituent, the presence of which causes a decided wear on cutting tools. The phosphorus content of cast iron for high-speed machining operations is limited to a maximum of 0.30 per cent.

Nickel

Large differences in the thickness of iron castings usually cause a variation in the structure of the metal in the light and heavy portions.

When a low-silicon alloy is used, the thin sections become chilled, and the thick sections are gray. If the silicon content of the iron is increased sufficiently to overcome the chilling of the thin sections, the heavier portions will have a coarse, open structure. The addition of nickel to cast iron aids in producing a uniform structure throughout castings having sections of unequal thickness. Nickel has a graphitizing action, and consequently reduces the tendency of thin sections of iron castings to chill. At the same time, the presence of this element tends to harden the matrix of cast iron and thereby produces a dense structure in the heavy sections of castings.

The commercial alloy used in supplying nickel to cast iron contains an average of 92 per cent nickel, 6 per cent silicon, and 2 per cent iron. This material is added in the form of shot to the stream of iron as it leaves the melting furnace. The melting range of the nickel shot is 2275 to 2350 degrees F., and it is readily dissolved in the molten iron. The proportion of nickel which is supplied to improve the strength and uniformity of the metal in iron castings is ordinarily from 0.5 to 2.0 per cent. When the nickel content exceeds 2 per cent, the irons gradually become harder, and those alloys containing 4 to 6 per cent nickel are used in castings to resist abrasive wear. The austenitic irons with 12 per cent or more nickel in combination with other alloying elements have greater resistance to heat and corrosion than plain irons. When large proportions of nickel are required in cast iron, the low-melting nickel alloy is available in the form of 5-pound pigs for charging in the cupola or air furnace.

Chromium

The pronounced effect of chromium in cast iron is to retard the dissociation of combined carbon. Therefore, the hardness of cast iron is increased by chromium, and castings which are subjected to severe wearing conditions often contain this element. Chromium is also a valuable addition to metal mixtures for heat-resisting castings. As a rule, the chromium content of alloy cast iron which is to be machined is within the range of 0.20 to 0.60 per cent.

Chromium is supplied to cast iron either by ladle additions of ferrochromium or in the furnace charges by means of chrome-bearing pig and briquets containing ferrochromium. "Mayari" pig iron, which has an average analysis of 2.40 per cent chromium and 1.20 per cent nickel, is often used to introduce chromium and nickel in furnace charges. The alloy of chromium which is generally used for ladle addi-

tions contains 60 to 75 per cent chromium, 4 to 6 per cent carbon, 2 to 3 per cent silicon, and the remainder iron.

Molybdenum

When molybdenum is alloyed with cast iron, it not only forms a solid solution with the ferrite but also enters into combination with the carbides. The influence of molybdenum is to prevent the agglomeration of free carbon, and thereby to cause the formation of finely divided graphite. It also tends to strengthen the constituents in the matrix. The molybdenum content of alloy cast iron is usually from 0.25 to 1.50 per cent. This alloying element is supplied to the iron by ladle additions of ferromolybdenum which contains 55 to 65 per cent molybdenum.

SOLIDIFICATION AND COOLING OF CAST IRON

The presence of the different structures found in iron castings can be explained on the basis of the changes which take place in the constitution of cast iron when it solidifies and cools to ordinary temperatures. The diagram in Fig. 96 shows the temperatures at which transformations occur in the constitution of cast iron containing 2 per cent silicon and 2 to 4 per cent carbon.⁴ Above the line $A-B-C$ the alloys are entirely in the liquid state, and below the line $D-B-F$ they are solid. The alloy corresponding to point B is the composition of lowest melting point; it is known as the eutectic alloy and is composed of a mixture of 56.5 per cent of saturated austenite (containing 1.5 per cent carbon) and 43.5 per cent of cementite. The constituents which are present within the different temperature areas are indicated on the diagram.

Attention will be directed to the transformations which occur in a cast iron of definite composition as the metal solidifies and cools to atmospheric temperature. It is assumed that an alloy containing 2 per cent silicon and 3.40 per cent carbon is poured at 2800 degrees F. into a mold. The decrease in the temperature of this metal is indicated at the points J , K , L , and M on the diagram in Fig. 96. The metal within the mold remains liquid until the temperature corresponding to point K is reached. At this temperature austenite begins to separate from the liquid metal, and austenite continues to solidify down to the temperature indicated by point L . During the drop in temperature from K to L , the carbon content of the remaining liquid increases until, at the temperature of 2020 degrees F., the last portion of liquid metal to solidify is the eutectic mixture, which has a carbon content of 3.75 per cent and contains austenite with cementite.

As the metal in the mold continues to cool below 2020 degrees F., cementite (containing 6.67 per cent carbon) gradually separates from the saturated austenite (containing 1.5 per cent carbon) until the temperature corresponding to point *M* is reached. This causes a continuous decrease in the carbon content of the austenite until, just below 1382 degrees F., all remaining austenite, which now contains 0.55 per cent carbon, is changed into pearlite.

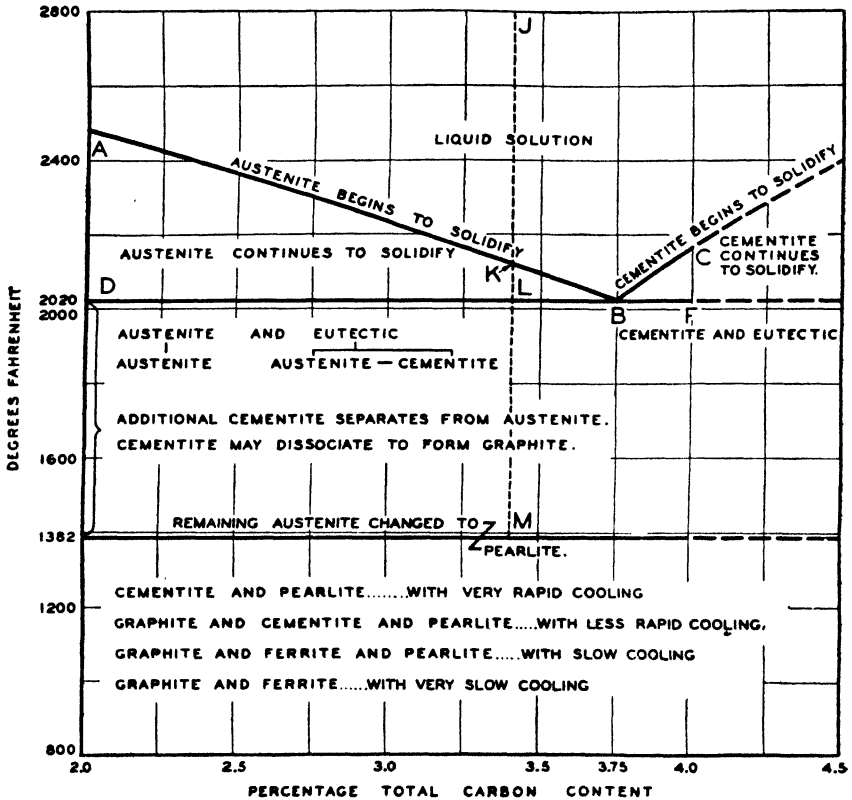

FIG. 96.—CONSTITUTIONAL DIAGRAM FOR CAST IRON CONTAINING 2 PER CENT SILICON

Within the range of temperature from *L* to *M*, the cementite in the eutectic mixture, as well as the cementite which separates from the austenite, may be dissociated partially or entirely to produce graphite. The extent to which cementite is separated into its elements is dependent upon the composition of the alloy, as explained previously, and the rate at which the alloy was cooled. With very rapid cooling, no graphite is liberated, and the final constituents are cementite and pearlite, which

occur in white cast iron. On the other hand, if the cooling is very slow, only graphite and ferrite will be present below 1382 degrees F. In most cases, an intermediate rate of cooling is obtained, which results in large proportions of pearlite in the cast iron. It has been explained that free carbon is produced from solid cementite at relatively high temperatures. The lack of mobility of the metal when graphite is formed accounts for the distribution of this light constituent throughout gray cast iron.

TYPES OF CAST IRON

In the previous discussion on the constitution of cast iron, the effects of the chemical elements and the rate of cooling on the development of the micro-constituents were explained. Several different types of cast iron can be produced by the control of the chemical composition and the thermal treatment of these alloys.

White Cast Iron

Cast iron in which practically all the carbon is in the combined state is known as white cast iron because of the white, metallic appearance of its fractured surfaces. The principal constituents of white cast iron are pearlite and cementite as illustrated in Fig. 111 in Chapter XI. This structure is readily produced by the rapid cooling of cast iron having a low silicon content (usually less than 1 per cent). A low total carbon aids in retaining all carbon in the combined state. White cast iron is very hard and brittle, and is suited only to those uses for which a hard, unmachinable metal is satisfactory.

Malleable Cast Iron

When white cast iron of special composition is heat treated so as to obtain only ferrite and graphite (see Fig. 112 in Chapter XI), the product is known as malleable cast iron. The manufacture, constitution, and properties of malleable cast iron are discussed in Chapter XI.

Gray Cast Iron

Cast iron containing a considerable proportion of graphite is known as gray cast iron because of the color of its fractured surfaces. This product is composed of a steel-like matrix, the continuity of which is interrupted by numerous particles of graphite. The amount, size, and shape of the graphite particles vary greatly in different specimens. The percentage of graphite in gray cast iron is dependent upon the chemical

composition, as well as upon the rate of cooling of the metal. A high silicon content and slow cooling promote the formation of graphite. In some specimens the graphite is in long, thin strips, and in others as short irregular particles. (Compare the micrographs in Fig. 90 and Fig. 91.) The strength of cast iron is affected to a large extent by the amount and condition of the graphite constituent.

The matrix of gray cast iron is composed of varying proportions of ferrite, pearlite, and steadite. The amounts of these constituents are

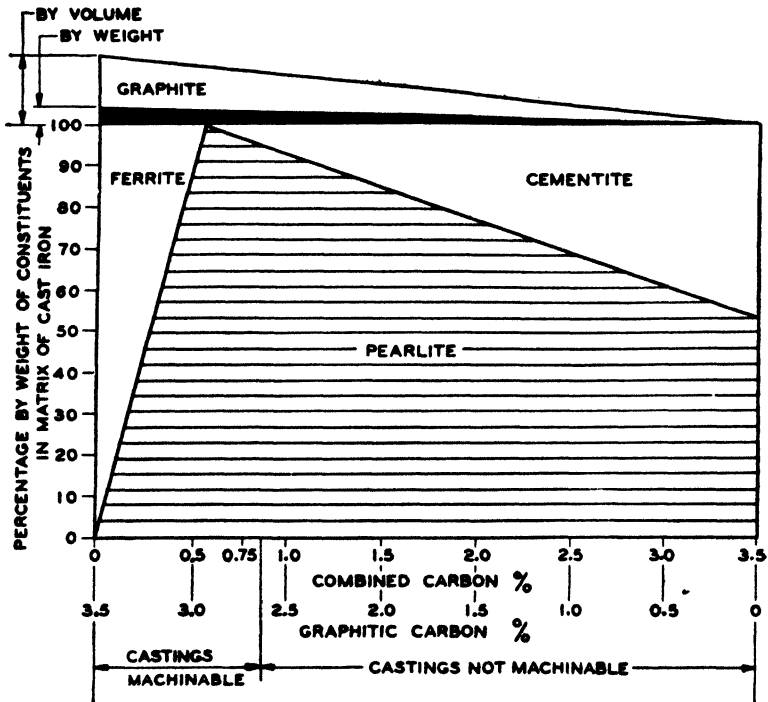

FIG. 97.—STRUCTURAL COMPOSITION DIAGRAM FOR CAST IRON

dependent upon the chemical composition and the rate of cooling of the alloys. With a high silicon content and very slow cooling, gray cast iron is obtained having a structure of only ferrite and graphite; a condition which is usually undesirable, except when a soft, easily machined iron is needed, because a large proportion of coarse graphite causes the metal to have low strength. The lower the silicon content and the more rapid the cooling, the more carbon will be retained in the combined state. When the percentage of combined carbon in any specimen of cast iron containing 3.5 per cent total carbon is known, the pro-

portions of the constituents in the matrix can be found on the structural composition diagram in Fig. 97. In most gray iron castings, the combined carbon is less than 0.55 per cent, and the matrix is composed of ferrite and pearlite. When the combined carbon exceeds 0.80 per cent, the castings become too hard to be machined economically.

Iron castings are sometimes required to be very hard on certain surfaces and machinable on all other parts. This combination of properties in one casting can be obtained by adjusting the composition of the metal, as well as the rates of cooling, in different parts of the casting. The lower the silicon or total carbon content, the greater the tendency to form white cast iron and the greater the thickness of the white or chilled portion. Iron plates known as **chills** are placed in the molds at locations where the surfaces of the casting are to remain hard. The rapid solidification and cooling of the casting in contact with the chills cause the formation of white cast iron, whereas the slower cooling of the remainder of the casting results in the development of a gray iron structure. Metal chills are used in the molding of chilled-iron car wheels as illustrated in Fig. 21 in Chapter III. The silicon content of the cast iron used in car wheels is about 0.55 per cent and the total carbon is about 3.50 per cent.

HEAT TREATMENT OF CAST IRON

Iron castings may be heat treated for any one of three purposes: (1) to relieve internal stresses in the metal resulting from uneven cooling of different sections of the castings; (2) to decrease the hardness and improve the machinability; and (3) to increase the hardness. Methods for the heat treatment of iron castings to obtain these results are given in the following paragraphs.

The dimensions of the finished surfaces on some iron castings such as straightedges, surface plates, and planer beds must remain permanently accurate, and to meet this requirement, all stresses in the castings caused by uneven cooling in the molds or by severe machining operations must be removed. If the rough castings are exposed to atmospheric temperatures for very long periods, the stresses in the castings will gradually be relieved; this method is known as **air seasoning** or **aging**. It is possible, however, to overcome the cause of warping in a shorter time by heating the castings throughout to 950 degrees F. and cooling slowly in the furnace.⁶ In the manufacture of machine parts which must have accurate dimensions, the usual procedure is to rough machine first, then heat treat, and finally perform the finishing operations.

The hardness of gray cast iron is dependent upon the proportions of the micro-constituents in the matrix. As the combined carbon increases, more of the hard constituents are present. This is shown on the structural composition diagram in Fig. 97. The hardness of iron castings can be lowered and the machinability improved by decreasing the proportion of combined carbon in the metal. This can be accomplished by heating the castings uniformly throughout to a temperature of 1550 degrees F. and cooling slowly. The hard constituents in the matrix are partially converted into ferrite and graphite by this treatment.

An increase in hardness can be obtained in cast iron having a pearlitic structure by quenching the castings in water or oil after heating to temperatures above the critical range of the metal. A temperature of 1550 degrees F. is usually satisfactory for most iron alloys. This treatment can be used only for castings of plain designs because those with complicated and non-uniform sections will crack during the quench.

BIBLIOGRAPHY

1. W. H. HATFIELD, "Cast Iron in the Light of Recent Research." 1918. Charles Griffin and Company, London, England.
2. ALBERT SAUVEUR, "The Metallography and Heat Treatment of Iron and Steel." 1926. The University Press, Cambridge, Mass.
3. J. KENTSMITH and C. M. LOEB, "The Position of Molybdenum in the Gray Iron Foundry." Climax Molybdenum Company, New York, N. Y.
4. A. L. NORBURY, "Constitutional Diagrams for Cast Iron and Quenched Steels." *Foundry Trade Journal*, May 23, 1929, p. 375-378.
5. MATSUJIRO HAMASUMI, "The Influence of Various Elements on Cast Iron." *Science Reports*, Tohoku Imperial University, Sendai, Japan.
6. F. J. WALLS and A. HARTWELL, "Heat Treatment of Cylinder and Alloy Iron." *Trans. A.F.A.*, v. XXXVIII (1930), p. 865-896.
7. J. F. HARPER and R. S. MACPHERRAN, "Annealing Gray Cast Iron." *Trans. A.F.A.*, v. XXX (1923), p. 167-180.

REVIEW QUESTIONS

I

What are the characteristic properties of each of five micro-constituents found in cast iron at ordinary temperatures?

II

Explain the factors which control the condition of the total carbon in cast iron.

III

In what form is silicon present in gray cast iron, and how does this element influence the properties of the metal?

IV

What are the effects of manganese on the properties of cast iron?

V

In what conditions does phosphorus occur in gray iron ornamental castings?

VI

What advantages are obtained in using special alloying elements in cast iron?

VII

What changes take place in the constitution of cast iron containing 2 per cent silicon and 3.80 per cent carbon as it solidifies and cools to ordinary temperatures?

VIII

Account for the presence of large graphite flakes in cast iron.

IX

What conditions are most favorable to the formation of white cast iron?

X

Explain three purposes for heat treating cast iron, and outline the methods used in improving the properties of the metal.

XI

Discuss the factors which influence the condition and the amount of graphite in gray cast iron.

XII

What is the effect of chromium on the properties of cast iron?

XIII

In what form does sulphur occur in special chilled iron castings?

XIV

Explain the beneficial effect of nickel in iron castings with light and heavy sections.

XV

What influence does molybdenum have on the structure of gray cast iron?

CHAPTER VIII

THE PROPERTIES OF CAST IRON

TENSILE STRENGTH—COMPRESSIVE STRENGTH—TRANSVERSE STRENGTH—HARDNESS—RESISTANCE TO WEAR—GROWTH—SHRINKAGE—FLOWABILITY—DAMPING CAPACITY

Cast iron is used more extensively than any other cast metal because of the ease with which it can be cast into intricate shapes and thin sections, its wide range of mechanical properties, its favorable machining quality, and its low cost. Some of the well-established fields of application of iron castings include automobile engine parts, stoves and furnaces, radiators, freight car wheels, pipe, machine-tool bases, and sanitary ware. It was explained in Chapter VII that gray cast iron is not a single alloy, but is produced in many different compositions to obtain the desired physical and chemical characteristics.

The standardization of methods for determining the quality of the metal in gray iron castings has been the subject of much discussion by manufacturers and users of castings, and by scientific investigators. In all methods for testing cast iron, the source of the sample, as well as the type of test to be used, should be specified. Some authorities favor the use of specimens cut directly from the castings; others require that test specimens be attached to the castings; and still others prefer to use separately cast test specimens. Tensile tests, transverse tests, and shear tests have been proposed for the investigation of this material.

An attempt is being made to establish international standards for the testing of cast iron. A summary of the conclusions reached by the *International Association for Testing Materials* at the Zurich Congress in 1931 is quoted from the president's report.¹ "The use of a separately cast test bar to be tested in tension and bending is regarded as satisfactory and sufficient for the majority of industrial purposes, but that for the exploration of the properties of various parts of castings, and for the study of variations from one casting to another of the same type, and also for the investigation of castings which have failed in service, the small test piece, cut from the casting itself, should be adopted."

The specifications of the *American Society for Testing Materials* for gray iron castings (Designation A48-36) provide for seven grades of

cast iron known as classes No. 20, 25, 30, 35, 40, 50, 60; these numbers correspond to minimum tensile strengths; thus, class No. 20 refers to an iron which has a minimum tensile strength of 20,000 lb. per sq. in. Three sizes of separately cast test bars are recommended, each of which

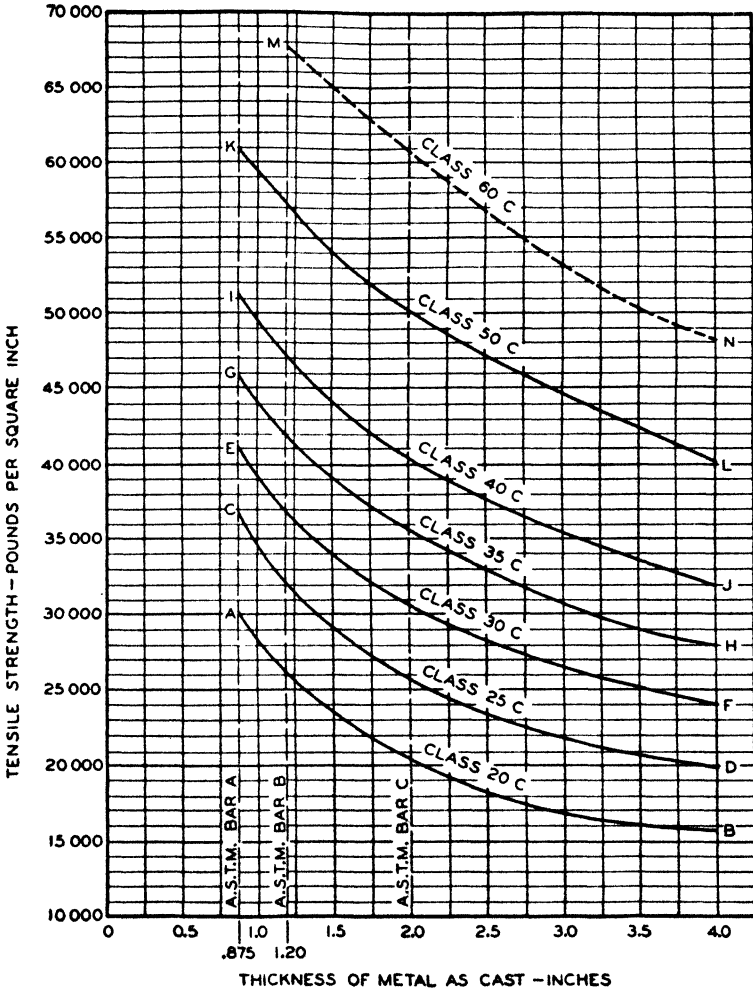

FIG. 98.—EFFECT OF SIZE OF SECTIONS ON PROPERTIES OF CAST IRON

corresponds to the controlling dimensions of the castings which it represents. The complete specifications are given in the Appendix.

TENSILE STRENGTH

The quality of cast iron can be established most satisfactorily by tensile tests. In the standard specifications for gray iron castings

(A.S.T.M. Designation A48-36), seven classes of cast iron are listed on the basis of the tensile strength of the material. The strength of cast iron is influenced by the chemical composition of the metal, as has

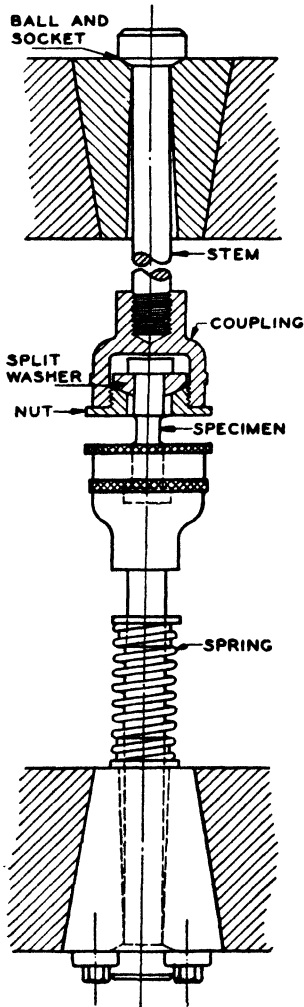

FIG. 99.—HOLDERS FOR TENSILE TEST SPECIMENS

been explained previously. Furthermore, the rate of cooling of iron castings in the molds affects to a large extent the physical properties of the metal; this applies not only to separate castings, but also to different sections in the same casting. The larger the section poured with an iron of given composition, the lower will be the tensile strength of the metal. Because of the influence of the rate of cooling on the properties of cast iron, the standard specifications provide three sizes of test specimens corresponding to the controlling sections of the castings. The relation of the tensile strength to the thickness of cast iron in the different classes is shown in Fig. 98. Each class has a range of properties depending on the thickness of the metal as cast. Iron which has a tensile strength of 20,000 to 25,000 lb. per sq. in. in a section 2 inches in diameter is classified as 20-C iron. When this iron is cast in sections 1 inch in diameter, a tensile strength within the range of 28,000 to 34,000 lb. per sq. in. will be obtained. Also, when the same iron is cast in sections 3 inches in diameter, a tensile strength within the range of 17,000 to 22,000 lb. per sq. in. will be obtained.

The tensile strength, which is the maximum load in pounds divided by the original area of the test specimen in square inches, is of primary importance to the designer of gray iron castings. During the testing of cast iron, the ratio of load (stress) to deformation (strain) is not constant and no definite elastic limit is indicated. On account of the discontinuity of the structure of cast iron, caused by the graphite particles, tensile test specimens of gray cast iron do not stretch out or change in area appreciably during this test.

When tensile tests of cast iron are made, it is very important that the loads on the specimens be applied only in tension, as any forces in transverse directions will lower the results of the tests. This requirement is met by using self-aligning specimen holders; one type of holder for tensile test specimens is shown in Fig. 99.³ The time required for the machining of specimens from the cast bars can be decreased by turning plain shoulders on the specimens rather than by using threaded ends.

COMPRESSIVE STRENGTH

The strength of cast iron in compression is about three and one-half times its strength in tension. This property, together with ease of machining and low cost of production, is the outstanding characteristic of cast iron. Because of the high compressive strength of cast iron, frames and bases of machine tools and equipment of many kinds are commonly made of this metal. The dimensions of test specimens for determining the crushing strength of cast iron are shown in Fig. 100. The specimens are tested between hardened steel surfaces in a manner which insures axial loading.

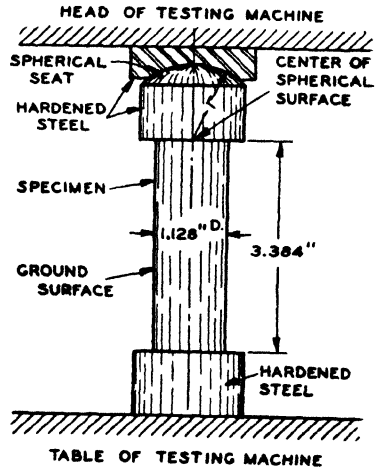

FIG. 100.—COMPRESSION SPECIMEN AND BEARING BLOCKS

TRANSVERSE STRENGTH

The transverse test is most commonly used for testing cast iron. As a rule, the test bars are not machined; hence little expense is necessary in making transverse tests. Furthermore, the maximum deflection of the specimen is obtained in the transverse test, which is an indication of the toughness of the cast iron.

The specifications for gray iron castings (*A.S.T.M.* Designation A48-36) lists three sizes of transverse test bars as follows:

Diameter of Test Bar, Inches	Length of Test Bar, Inches	Distance Between Supports, Inches	Controlling Section of Castings, Inches
0.875	15	12	0.50 max.
1.20	21	18	0.51 to 1.00
2.00	27	24	1.01 to 2.00

These bars are cast as nearly as possible to the dimensions specified. A table of correction factors is included in the specifications to correct the value for transverse strength when the diameter of the test bar varies from the standard. The minimum transverse breaking loads for three sizes of transverse test bars and seven classes of gray iron are included in the specifications given in the Appendix.

HARDNESS

The hardness of cast iron is ordinarily determined by its resistance to indentation. This property is somewhat related to wear resistance and to the machinability of the metal. The methods used for measuring hardness are described in Chapter XV.

The degree of hardness of any specimen of cast iron is dependent upon the condition of its total carbon content. Rapid cooling and low silicon favor the retention of carbon in the combined state and thereby cause an increase in the hardness of cast iron. On the other hand, slow

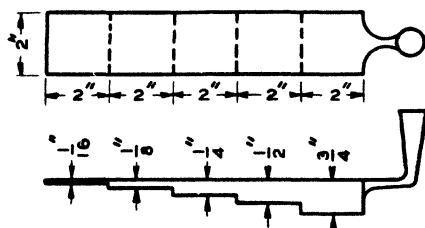

FIG. 101.—STEP-BAR CASTING

cooling and high silicon promote the formation of free carbon and ferrite which are found in a relatively soft iron. Sulphur, manganese, and chromium, if present in sufficient proportions, increase the hardness of cast iron by retaining carbon in the combined state. Nickel in amounts from 2 to 5 per cent tends to harden cast iron.

A high phosphorus content (over 0.30 per cent) causes the formation of an additional constituent, steadite, which is hard and brittle.

The surface of a gray iron casting is usually harder than the interior because of the more rapid cooling of the metal in contact with the material of which the mold is made. The variation in hardness from the surface to the interior of a casting is more pronounced in a cast iron with high silicon and high total carbon than in a stronger gray iron with low silicon and low total carbon. The hardness and chilling effect of cast iron in different sections are often determined on a step-bar casting such as is shown in Fig. 101. An examination of the fractured sections will indicate the extent of the formation of white cast iron.

RESISTANCE TO WEAR

For many uses of iron castings, resistance to wear is an important requirement. Cast iron for resisting wear may be either of two types:

(1) white iron or (2) gray iron. For service conditions requiring great hardness and resistance to abrasive wear, white iron is more durable than gray iron. Examples of such applications are wire-drawing dies, chilled-iron rolls, dies for shaping sheet metals, car wheels, and plow points.

Gray cast iron is satisfactory for resisting wear when the contact pressures are low and abrasion is not excessive. The self-lubricating effect of the graphite particles distributed throughout the metal prevents galling or seizing of a mating part. This characteristic is of particular advantage in brake drums. The most favorable wearing condition of a machinable iron is obtained by having the graphite uniformly distributed in small particles within a matrix of pearlite.

GROWTH

When cast iron is subjected to alternate cycles of heating and cooling, a permanent expansion of the metal takes place; this change in volume is due principally to the graphitizing of the combined carbon in the metal. Also, the penetration of oxidizing gases along particles of graphite results in the oxidation of some ferrite, which causes a continuous growth as well as a gradual deterioration of the cast iron. At temperatures below 800 degrees F. comparatively little trouble is experienced from the growth of cast iron,⁵ but as the temperature is increased from 800 to 1800 degrees F., the change in volume is greater and more rapid.

All factors which influence the state of the total carbon and the size of the graphite flakes will affect the change in the dimensions of iron castings which are exposed to high temperatures. The lower the silicon content of the metal, the smaller will be the amount of permanent expansion. Gray cast iron having finely divided graphite distributed uniformly throughout a structure of pearlite is well suited to heat-resisting applications. Chromium is a desirable alloying element for heat-resisting irons because of its influence in retaining carbon in the combined form.

SHRINKAGE

Shrinkage is the reduction in length or volume of the metal in a casting as it solidifies and cools to room temperature. The reduction in volume of the total mass of metal results in the formation of cavities within the casting if it is not properly designed and cast. To compensate for the difference in size of pattern and casting, a shrinkage allowance is usually made on all dimensions of the pattern. The shrinkage rules used in the pattern shop are graduated with a constant increment

in length for different contraction allowances. An increase in length of $\frac{1}{8}$ in. per ft. is commonly used for gray iron, and $\frac{1}{4}$ in. per ft. for white iron castings. These allowances are not always satisfactory because the size and shape of the casting, as well as the composition of the metal used in the casting, may alter the total contraction.

When metal is poured into a mold, the portions of the casting which are in contact with the mold surfaces solidify first. This outer shell conforms to the shape and size of the mold cavity;⁶ then the metal freezes towards the interior of the casting. During the solidification period, the metal contracts and draws away from the liquid metal in the heavier sections. This contraction of the metal causes a shrinkage cavity or a spongy condition in that portion of the casting which is the last to solidify.

The net amount of shrinkage in any casting is dependent upon the pouring temperature of the metal; the higher the casting temperature, the greater will be the total contraction. Therefore, a general rule in the foundry is to pour the metal at as low a temperature as will allow complete filling of the mold. Furthermore, the total contraction is dependent on the constitution of the cast metal. When gray cast iron solidifies and cools to ordinary temperatures, the separation of graphite is accompanied by an increase in volume which offsets to some extent the normal contraction of the metal. Any influence which affects the condition of the carbon in cast iron will control the shrinkage of the metal. Slow cooling and high silicon favor the separation of graphite and result in low total contraction. On the other hand, rapid cooling, high manganese, and high sulphur tend to increase the total contraction by retaining carbon in the combined state.

The presence of shrinkage cavities in castings can be overcome by providing a sufficient supply of liquid metal to the heavier sections of the castings during the period of solidification. Feeding heads or risers are used for this purpose. When the gate is connected to the bottom of a casting as shown in Fig. 13, in Chapter III, the metal is supplied only up to the riser, and additional hot metal is then poured into the riser; this procedure aids in having the metal in the riser solidify last and causes the shrinkage cavity to be located in the riser, which is subsequently removed from the casting.

Test specimens for finding the amount of shrinkage in iron alloys may be prepared in many shapes, including spheres, cones, cylinders, and intersecting bars. When these specimens are fractured or cut apart, the size of the cavity or pourous area caused by the shrinkage of the metal can be observed. The total linear contraction of cast iron can

be found by measuring the difference in length of a casting and the mold in which it was made. The equipment for preparing specimens for this determination is shown in Fig. 102. The specimens are cast in a sand mold between two metal surfaces. After the casting has cooled to room temperature, the clearance between the specimen and the chill

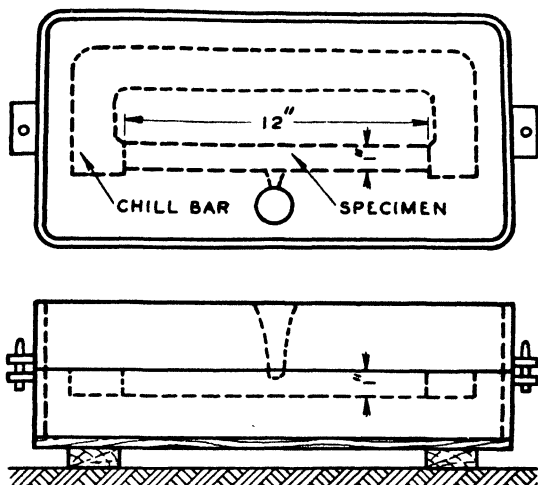

FIG. 102.—CONTRACTION TEST SPECIMEN

bar is measured; this value represents the total contraction of the cast iron for the given length of casting.

FLOWABILITY

All casting alloys should remain in the liquid state for a sufficient time to permit the complete filling of the molds; this property has been commonly described as fluidity; however, fluidity is usually measured at a constant temperature, a condition which does not obtain during the casting of metals in molds. The ability of a molten metal to flow into a mold may be designated as flowability.

A number of factors affect the flowability of cast iron. The higher the temperature of the metal above its freezing range, the longer it will remain in a liquid state. Also, the chemical composition of the cast iron will influence its flowing quality. An increase in the proportion of phosphorus above 0.30 per cent will cause the metal to remain in a liquid state longer because of the presence of a low-melting constituent of iron and iron phosphide. Metal mixtures for ornamental castings in which accurate detail is necessary usually contain about 1 per cent phosphorus.

Considerable difficulty is experienced in pouring cast iron when the total carbon is less than 2.20 per cent. The presence of dissolved oxides in molten cast iron affects seriously the flowing property of the metal. This condition can often be traced to a low coke bed in the cupola, which results in excessive oxidation of the metal in the charges. The flowing quality of cast iron is also dependent upon the condition of the mold into which it is poured. A dry-sand mold will permit a greater distribution of the metal than a green-sand mold. The flow of metal is retarded

by intricate mold cavities and by the pressure of gas within restricted portions of molds.

A method for determining the flowability of metals has been developed at the *U. S. Bureau of Standards*.⁷ The design of the casting proposed for this test is shown in Fig. 103. The specimen has a spiral shape, and the gate is attached at the outer end of the spiral. A large vent is provided at the inside end of the spiral to relieve the pressure of the gases within the mold cavity. Reference marks are cast every 2 inches along the upper surface of the specimen to aid in measuring

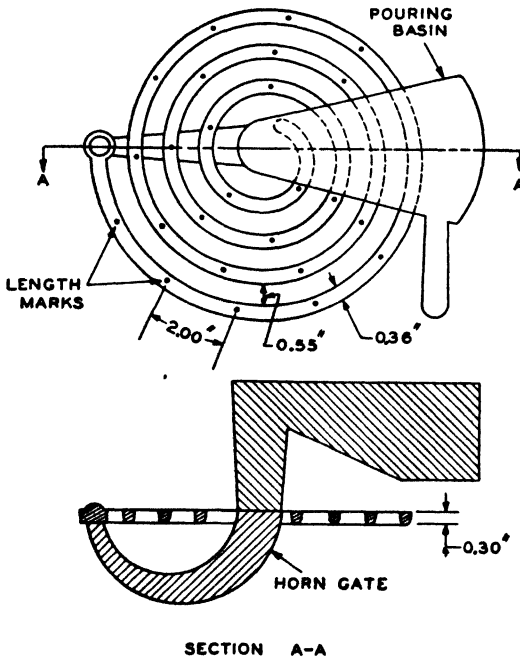

FIG. 103.—FLOWABILITY TEST SPECIMEN

the distance traveled by the metal in the mold. The total length of the spiral pattern is 60 inches. For heavy machinery castings, a length of 20 inches may be adequate; but for thin castings, a spiral over 30 inches in length should be obtained.

DAMPING CAPACITY

The ability which gray iron possesses to absorb and dampen vibrations adds greatly to its value as an engineering material. The relative damping capacities of materials can be estimated by the duration of

sound issuing from the materials when they are struck with a hammer. A suspended piece of steel will ring for a long time, whereas a piece of gray cast iron will produce only a dull sound. The damping out of vibrations is dependent on the internal friction and plasticity of the materials. The effective strength of a vibrating part will be much greater if a material such as cast iron is used which has a high damping capacity, because stresses caused by vibrations will ordinarily not be raised to a serious intensity. As the tensile strength of cast iron increases, its damping capacity decreases. A low-strength iron is therefore more satisfactory than a high-strength iron for machine-tool bases and other parts subjected to vibrations.

BIBLIOGRAPHY

1. WALTER ROSENHAIN, "The Testing of Castings." *Foundry Trade Journal*, March 10, 1932, p. 154-156.
2. J. G. PEARCE, "Design of Engineering Castings in Relation to Tests." *Foundry Trade Journal*, Jan. 24, 1929, p. 67-71.
3. H. L. CAMPBELL, "Tensile Tests of Cast Iron and Semi-Steel." *Machinery*, v. XXV (1919), p. 605.
4. A. L. BOEGEHOLD, "Wear Tests and Value of Hardness Testing for Control of Product." *Trans. A.F.A.*, v. XLI (1933), p. 575-586.
5. J. W. BOLTON, "Growth of Cast Iron." *The Foundry*, v LIX (1931), p 92-95.
6. C. M. SAEGER, JR., and E. J. ASH, "Volume Changes of Cast Irons During Casting." *Trans. A.F.A.*, v. XL (1932), p. 172-187.
7. C. M. SAEGER, JR., and A. I. KRYNITSKY, "A Practical Method for Studying the Running Quality of a Metal Cast in Foundry Molds." *Trans. A.F.A.*, v. XXXIX (1931), p. 513-540.
8. W. H. ROTHER and V. MAZURIE, "The Strength of Cast Iron in Relation to Its Thickness." *Trans. A.F.A.*, v. XXXIV (1926), p. 746-765.
9. Committee Report, "Impact Testing." *Proc. A.S.T.M.*, v. 33 (1933), p. 87-137.
10. *American Foundrymen's Association*, Chicago, Ill. "Cast Metals Handbook." 1935.

REVIEW QUESTIONS

I

What two factors control the properties of cast iron?

II

How is the quality of cast iron determined?

III

What precaution must be observed in testing cast iron in tension?

IV

Describe two methods for measuring the hardness of cast iron.

V

Account for variations in hardness in different parts of the same iron casting.

VI

What structure in gray cast iron is most favorable for resisting wear?

VII

Explain two causes for the permanent growth of cast iron when it is exposed to high temperatures.

VIII

What conditions control the total amount of shrinkage in cast iron?

IX

Explain the factors which affect the flowability of cast iron.

X

Describe a method for measuring the flowability of molten metal.

XI

Discuss the property of cast iron which is advantageous for machine parts subjected to vibrations.

XII

Explain the method of classifying the cast iron alloys as established by the *A.S.T.M.*

XIII

Account for the variations in strength of cast iron when cast in sections of different size.

XIV

What is the ratio of length to diameter of compression test specimens?

XV

What method is used for determining the total contraction of cast iron?

CHAPTER IX

THE CLASSIFICATION OF IRON CASTINGS

PERCENTAGES OF CHEMICAL ELEMENTS IN IRON CASTINGS—Carbon—Silicon—Manganese—Sulphur—Phosphorus—Nickel—Chromium—Molybdenum—CLASSES OF IRON CASTINGS—Easily Machined Cast Iron—High-Strength Cast Iron—Heat-Resisting Cast Iron—Pearlitic Iron—Ferritic Iron—Austenitic Iron—Corrosion-Resisting Cast Iron—Wear-Resisting Cast Iron

Iron castings are produced of many different compositions for a great variety of uses. The mechanical properties of cast iron are dependent upon the rate of cooling, as well as upon the composition of the metal. As the cooling conditions are fixed largely by the design and the molding practice for a given casting, the properties of the metal in the casting must be controlled by adjusting its chemical composition. But it is unreasonable to prescribe definite compositions for general classes of iron castings in which the dimensions may change considerably. To illustrate, piston rings are made in many sizes from $\frac{1}{8}$ inch to more than 1 inch in thickness, and the composition of iron which is satisfactory for one size of rings may be unsuited for other sizes. The task of classifying iron castings therefore becomes considerably involved, and ends in specifying an analysis for every design of iron casting. Practically, this ideal can not be attained, except when a sufficiently large number of castings are required of a given design. Foundries producing castings from many different sizes and designs of patterns must select a few compositions which are satisfactory for their entire production.

Failures of iron castings are often the result of selecting the wrong type of iron for the particular requirements. Commercial grades of cast iron are available having tensile strengths up to 60,000 lb. per sq. in. and Brinell hardness values from 149 to 600. Furthermore, some compositions are more serviceable than others for heat-, corrosion-, and wear-resisting purposes.

PERCENTAGES OF CHEMICAL ELEMENTS IN IRON CASTINGS

The effects of the chemical elements on the properties of cast iron have been explained in Chapter VII. This knowledge is necessary when prescribing the compositions of castings for specific uses. A review of the percentages of the chemical elements in iron castings will now be given.

Carbon

The total carbon in cast iron obtained by melting pig iron and iron scrap in the cupola is usually from 3.40 to 3.80 per cent. When the metal charges contain steel scrap, the carbon may be from 2.80 to 3.40 per cent. A low total carbon can also be obtained in cast iron produced in an air furnace or electric furnace by adding steel scrap or by burning out the carbon.

The combined carbon in cast iron may include all or part of the total carbon, and for castings which are to be machined is usually less than 0.80 per cent. In most gray iron castings the combined carbon is less than 0.55 per cent.

Silicon

The properties of cast iron are controlled most effectively by adjusting the silicon content. When white cast iron is desired, the silicon in the metal is usually between 0.50 and 1.10 per cent. The heavier the sections in the white iron castings, the lower the silicon must be to counteract the effect of the slower cooling of the castings.

In the metal for gray iron castings, the silicon content is also dependent on the thickness of the castings and is adjusted so as to obtain the desired properties in combination with the remaining chemical elements. For light castings in which all sections are from $\frac{1}{4}$ to $\frac{1}{2}$ inch in thickness, a silicon content from 2.60 to 2.20 per cent is usually satisfactory; and for castings from $\frac{1}{2}$ to 1 inch in thickness, the silicon is from 2.20 to 1.80 per cent. Castings of medium size with sections between 1 and 2 inches contain 1.80 to 1.40 per cent silicon. Large castings in which the sections are from 2 to 4 inches in thickness are produced with metal containing from 1.40 to 1.20 per cent silicon. The ranges of silicon specified here are for irons in which the total carbon is from 3.40 to 3.80 per cent. When the total carbon is less than 3.40 per cent, a higher content of silicon may be used.

Manganese

The manganese content of iron castings is usually from 0.50 to 1.00 per cent. A minimum amount of manganese equivalent to six times the sulphur is generally provided in gray iron castings.

Sulphur

The sulphur content of cast iron is from 0.09 to 0.12 per cent, except for chilled castings in which this element may be raised to 0.15 per cent.

Phosphorus

Iron castings in which high strength is required and castings which are machined at high speeds usually contain less than 0.30 per cent phosphorus. For castings having intricate designs, such as are used for ornamental purposes, a phosphorus content of 0.80 to 1.00 per cent is commonly specified. Heavy machinery castings are produced from irons containing up to 0.50 per cent phosphorus.

Nickel

The proportion of nickel which is added to cast iron to improve its properties is ordinarily from 0.5 to 2.0 per cent of the weight of the metal. Some special irons, however, contain as much as 18 per cent nickel.

Chromium

The chromium content of alloy cast iron which is machinable is usually within the range of 0.20 to 0.60 per cent. Castings which are subjected to severe wearing or to high temperatures may contain up to 3 per cent or even larger proportions of chromium.

Molybdenum

Molybdenum is used in cast iron in quantities from 0.25 to 1.50 per cent of the weight of the metal. When used in combination with other alloying elements, the molybdenum content is usually from 0.30 to 0.50 per cent.

CLASSES OF IRON CASTINGS

The two main classes of cast iron are designated as plain iron and alloy iron. The plain irons contain those elements which are ordinarily found in pig iron, and the alloy irons contain additional elements such

as nickel, chromium, and molybdenum in sufficient proportions to affect the properties. The advantages of the special alloying elements are obtained only when they are added to a base iron of suitable composition.

Some assistance in the classification of iron castings can be obtained from a consideration of the important requirements of castings in commercial applications. For some purposes, the cost of machining is the controlling factor; for others, high mechanical properties are most important; and for still others, the cast iron must be resistant to heat, corrosion, or wear.

Easily Machined Cast Iron

Ease of machining is the most important requirement of many cast-metal products. The desired structure for cast iron which can be machined easily is a matrix composed largely of ferrite with most of the carbon in the free state. Plain irons with high total carbon and high silicon have good machining qualities. For castings $\frac{3}{4}$ to $1\frac{1}{2}$ inches in thickness, an iron containing 3.50 per cent total carbon, 2.00 to 2.50 per cent silicon, and less than 0.50 per cent phosphorus is satisfactory.

High-Strength Cast Iron

The commercial production of cast iron having superior mechanical properties has resulted in extending the application of this metal to many new products. (See Fig. 104.) High-strength cast iron is

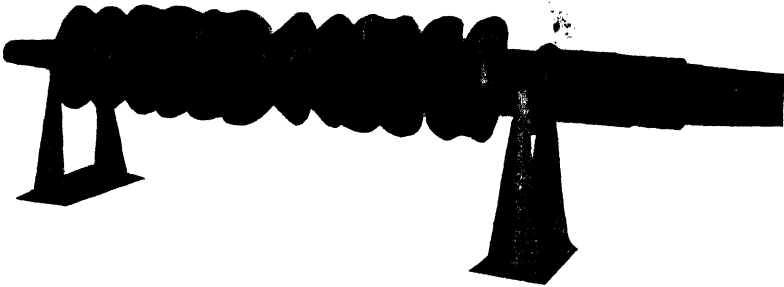

Courtesy of Campbell, Wyant, and Cannon Foundry Company

FIG. 104.—ALLOY CAST-IRON CRANKSHAFT

Length: 85 in. Weight: 472 lb. Composition: TC—2.40 to 2.75%, Si—2.20 to 2.75%, Cr—0.10%, Ni—0.80 to 1.25%, Mo—0.75 to 1.35%.

obtained by a special procedure during its preparation and by the adjustment of the chemical composition of the metal from the cupola, air furnace, or electric furnace.

The properties of gray cast iron depend upon the amount, size, and

distribution of the graphite constituent within the steel-like matrix. A relatively small proportion of free carbon is desired in irons which must have high tensile strength because the spaces occupied by the graphite are equivalent to voids when the metal is under tension. As graphite is formed from the dissociation of the combined carbon during the cooling of the metal from the molten state, the lower the total carbon and the less the graphitizing effect of the other elements in the metal, the lower will be the amount of free carbon in cast iron. When mixtures of pig iron and scrap iron are melted in the cupola, the resulting metal will ordinarily contain about 3.50 per cent carbon. A lower total carbon can be obtained by using steel scrap in the cupola charges. Metal mix-

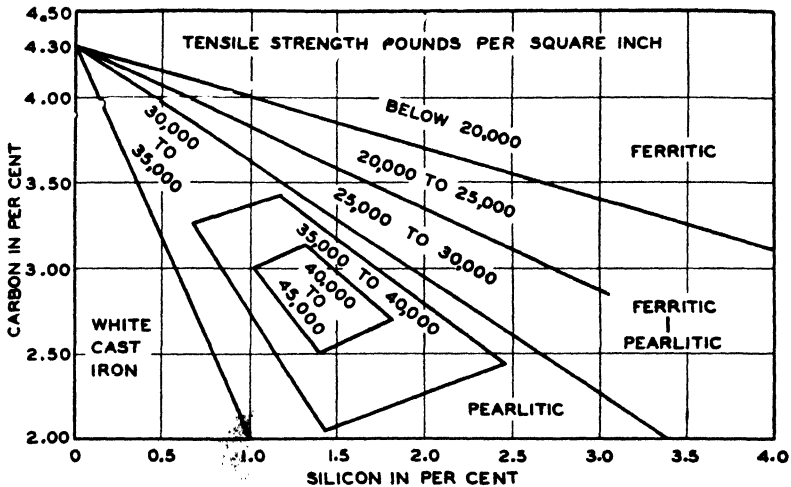

FIG. 105.—CONSTITUTIONAL DIAGRAM OF PLAIN CAST IRON (COYLE)

tures containing 20 per cent steel will have a total carbon of about 3.20 per cent, and mixtures with 50 per cent steel will have about 3.00 per cent carbon after melting in a cupola. When the metal charges contain 95 per cent steel scrap, the resulting total carbon will be about 2.80 per cent. The total carbon in cast iron produced from metal charges containing low carbon is influenced by the length of time the molten metal remains in contact with the coke in the bed. By providing a shallow crucible and allowing the metal to run from the cupola continuously, a low total carbon can be obtained. Furthermore, the quality of the coke used in the cupola has some effect on the amount of carbon absorbed by the metal. A hard, dense coke of large size is preferred when cast iron with low total carbon is desired. In the air furnace and electric furnace, the total carbon can be lowered by using steel scrap or by

oxidizing the carbon to the extent necessary to obtain the desired total carbon content.

The desired structure for a high-strength machinable iron consists of a matrix of small pearlite grains with the graphite finely divided and uniformly distributed throughout the pearlite. (See Fig. 93 in Chapter VII.) This condition is obtained by having the silicon correctly balanced for the size of section and for the total carbon content. The diagram in Fig. 105 shows the relationship of silicon to total carbon for

different strengths of plain cast iron in sections $1\frac{1}{4}$ inches in thickness.

The addition of special alloying elements to cast iron of suitable composition causes an improvement in the mechanical properties of the metal. Nickel, chromium, and molybdenum, either singly or in combinations, are employed most extensively for this purpose. Other elements such as vanadium, copper, titanium, aluminum, and zirconium may also be used to improve the properties of cast iron. In general, the beneficial effects of the alloying elements are to control the dissociation of the combined carbon, to cause the formation of finely divided graphite, and to strengthen the pearlitic matrix.

When nickel and chromium are

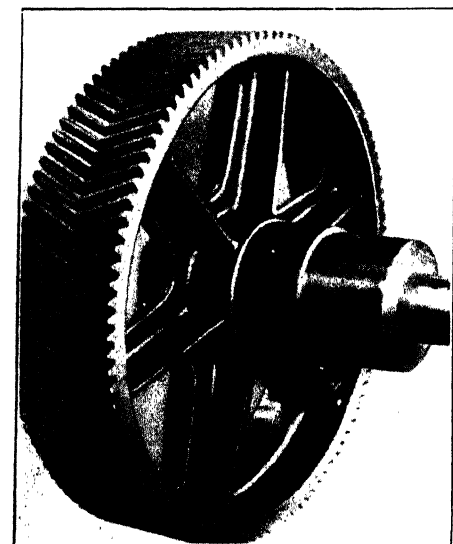

FIG. 106.—ALLOY CAST-IRON GEAR

Diameter: 44 in.
 Weight: 1,450 lb.
 Composition: TC—3.25%,
 Si—2.39%, Mn—1.08%,
 Ni—1.00%, Mo—0.50%.
 Tensile strength: 65,000 lb. per
 sq. in. (A.S.T.M. Bar B).

added to the same iron, the proportion of nickel is usually two and one-half times the amount of chromium. Molybdenum is sometimes used in equal proportions with chromium. Several typical compositions of alloy cast iron, each of which will have a tensile strength of over 50,000 lb. per sq. in. with A.S.T.M. bar B, are given in Table IV.

High-strength iron is produced from low-carbon (less than 3.0 per cent), low-silicon mixtures by adding silicon or other graphitizing elements in suitable proportions to the stream of metal as it flows from the

melting furnace. The base iron, if cast directly into molds, would solidify with a white fracture, but the ladle additions bring about the transformation to a gray machinable iron. Cast iron prepared in this way has high strength because the graphite separates in small particles

TABLE IV
COMPOSITIONS OF HIGH-STRENGTH ALLOY CAST IRON

	Total Carbon, %	Silicon, %	Manga- nese, %	Nickel, %	Chromium, %	Molyb- denum, %
Usual Limits	2.70 to 3.15	1.50 to 2.50	0.50 to 1.00	0.50 to 2.00	0.20 to 0.60	0.25 to 0.50
A	3.10	2.00	0.60	1.50	0.60
B	3.00	2.30	0.55	1.00	0.50
C	3.15	2.35	0.60	0.50	0.50	0.50
D	3.00	1.60	0.85	1.50	0.60	0.35

uniformly distributed throughout a matrix of pearlite. Nickel, chromium, or molybdenum may be included with the ladle additions to aid in producing uniformity of structure and higher strengths.

Heat-Resisting Cast Iron

The gradual deterioration in strength and soundness of iron castings when exposed to high temperatures (above 800 degrees F.) is brought about by the growth and oxidation of the metal.⁴ The separation of free carbon from the combined carbon under the influence of heat causes a permanent expansion of the metal. Furthermore, the penetration of oxidizing gases along particles of graphite results in the oxidation of the constituents in gray cast iron. If the composition of the cast iron is such that oxidation is prevented, or if the structure is such that gases cannot readily penetrate to the interior of the metal, the service life of the castings at high temperatures will be extended. The heat resistance of cast iron is also improved by retarding the dissociation of combined carbon or by producing a structure without combined carbon. Three types of machinable cast iron for heat-resisting applications will now be described.

Pearlitic Iron.—Cast iron having a pearlitic matrix with a small proportion of finely divided and well-distributed graphite is satisfactory for resisting temperatures up to 1200 degrees F. As the silicon and total carbon are lowered in plain gray iron, the castings produced are more durable at high temperatures. The addition of alloying elements, even in small percentages, causes an improvement in the heat-resisting quality of pearlitic irons. A typical composition for this group in cast sections of $\frac{3}{4}$ to $1\frac{1}{2}$ inches is 3.00 to 3.30 per cent total carbon, 1.50 per cent silicon, 0.80 per cent manganese, 1.50 per cent nickel, and 0.60 per cent chromium.

Ferritic Iron.—When the silicon content is increased to 5 per cent with the total carbon at 2.50 per cent, the resulting iron is highly resistant to oxidation and is satisfactory for castings exposed to temperatures up to 1550 degrees F. This iron is composed of ferrite with finely divided graphite, hence is easily machinable. It can be produced in the cupola from mixtures of steel scrap and ferrosilicon. Each 1 per cent of silicon causes the total carbon to decrease about 0.25 per cent.

Austenitic Iron.—A special heat- and corrosion-resisting cast iron designated as “nicrosilal” has been developed by the British Cast Iron Research Association.⁵ The composition of this alloy iron is as follows: 2 per cent total carbon, 3 per cent silicon, 1 per cent manganese, 18 per cent nickel, and 2 to 5 per cent chromium. The structural constituents in this iron as cast are austenite and graphite. At temperatures up to 1750 degrees F., scaling proceeds very slowly, and the castings show practically no growth.

Another alloy cast iron known as “ni-resist” which has favorable heat-resisting characteristics at temperatures up to 1500 degrees F., as well as resistance to attack by many chemicals, has been developed by The International Nickel Company. The chemical composition of this cast iron is as follows: 2.75 to 3.10 per cent total carbon, 1.25 to 2.00 per cent silicon, 1.00 to 1.50 per cent manganese, 12 to 15 per cent nickel, 5 to 7 per cent copper, and 1.5 to 4.0 per cent chromium. This alloy cast iron has a tensile strength of about 30,000 lb. per sq. in. Castings of the heat-resisting alloy irons are used for furnace parts, oil burners, glass molds (see Fig. 107), enameling racks, and similar applications.

Corrosion-Resisting Cast Iron

Cast iron containing 14 to 16 per cent silicon and 1 per cent or less carbon is used extensively in the chemical industries because of its resistance to corrosion. This alloy is prepared in an air furnace or electric furnace and is usually cast in green-sand molds. The high-silicon

iron is exceedingly hard and can be finished only by grinding. Holes for bolts, for outlets, or for other purposes are made by cores in the molds. This metal is practically unaffected by sulphuric, nitric, acetic, and many other commercial acids at any concentration. It is not satis-



Courtesy of The International Nickel Company

FIG. 107.—CASTINGS OF HEAT-RESISTING CAST IRON FOR SHAPING GLASS

factory for equipment subjected to rapid fluctuations in temperature or to high temperatures. The chief products made of high-silicon iron are acid pans, kettles, condensers, pumps, valves, pipes, and fittings.

Wear-Resisting Cast Iron

Resistance to wear is often an important requirement in combination with high strength for many uses of iron castings. The high-strength gray irons which have been discussed are satisfactory for resisting wear when the contact pressures are low and abrasion is not excessive. One of the valuable characteristics of gray cast iron is its freedom from any tendency to seize or gall when used in sliding contact with other metals.

Parts of machines or equipment which must withstand severe abrasion are often made of white cast iron throughout or with chilled surfaces. This hard, wear-resisting iron is obtained by lowering the silicon content (usually less than 1 per cent) and increasing the cooling rate so that all carbon will remain in the combined state. The hardness of

white cast iron can be increased by additions of alloying elements. Nickel in amounts from 2 to 5 per cent and chromium up to 3 per cent progressively increase the hardness of chilled or white iron castings. When 4.5 per cent nickel and 1.5 per cent chromium are added to a base composition which would normally produce a white structure, an iron is obtained with a Brinell hardness of about 600.

BIBLIOGRAPHY

1. J. W. BOLTON, "Classification of Gray Iron Alloys." *Proc. A.S.T.M.*, v. XXIX (1929), p. 67-75.
2. F. B. COYLE, "Static Strength of Plain and Alloy Cast Iron." *Proc. A.S.T.M.*, v. XXIX (1929), p. 87-93.
3. E. PIWOWARSKY, "Progress in the Production of High-Test Cast Iron." *Trans. A.F.A.*, v. XXXIV (1926), p. 914-985.
4. J. W. DONALDSON, "Heat-Resisting and Corrosion-Resisting Cast Irons." *Foundry Trade Journal*, Dec. 1, 1932, p. 338-339.
5. A. L. NORBURY and E. MORGAN, "Silal and Nicrosilal Heat-Resisting Cast Irons." *Trans. A.F.A.*, v. XLI (1933), p. 267-277.
6. J. E. HURST, "Alloy Cast Irons." *Metallurgia*, v. 12 (1935), p. 15-18.
7. H. BORNSTEIN, "High Strength Iron." *Metal Progress*, v. XXIII (1933), p. 37-41.
8. *American Foundrymen's Association*, Chicago, Ill., "Cast Metals Handbook." 1935.

REVIEW QUESTIONS

I

What basis is used for the classification of iron castings?

II

What structure is desired in easily machined gray cast iron?

III

Explain why a low total carbon aids in obtaining high strength in cast iron.

IV

What structure is desired in high-strength machinable iron?

V

Give definite instructions for producing plain gray cast iron to meet A.S.T.M. class 40-B specifications.

VI

State two typical compositions of high-strength alloy cast iron, and explain the effects of each of the alloying elements.

VII

Explain the effect of ladle additions of graphitizing elements to low-silicon mixtures for gray iron castings.

VIII

Discuss three types of machinable cast iron for heat-resisting applications.

IX

Discuss the advantages and uses of cast iron containing 15 per cent silicon.

X

Specify the composition of iron castings for machine parts which are subjected to severe abrasive wear.

XI

What range of silicon must be used in plain iron with 3.00 per cent carbon to obtain class 40-B iron?

XII

Specify the composition of iron castings which must be non-magnetic.

XIII

What structure of cast iron is favorable for resisting deterioration at high temperatures?

XIV

What alloy cast iron is satisfactory for resisting attack by acids?

XV

Discuss the beneficial effects of alloying elements on the properties of cast iron.

CHAPTER X

CALCULATION OF THE METAL CHARGES FOR THE CUPOLA

ESTABLISHING THE COMPOSITION OF CASTINGS—THE USE OF SCRAP METALS—CHANGES IN COMPOSITION OF METAL MIXTURES IN THE CUPOLA—CONSTITUENTS OF METAL MIXTURES—PROBLEMS ON METAL MIXTURES—ADDITIONS OF SPECIAL ELEMENTS—Manganese—Nickel—Chromium—Molybdenum—Availability of Alloying Elements—THE USE OF FORMULAS IN PROPORTIONING METAL MIXTURES—A GRAPHICAL METHOD FOR PROPORTIONING METAL MIXTURES—THE USE OF CHARTS FOR ESTABLISHING METAL MIXTURES—METAL CHARGES FOR OTHER MELTING FURNACES—FORM FOR RECORDING DATA ON METAL CHARGES

The exact proportioning of the metals used in the cupola charges is one of the important factors which contribute to the economical production of iron castings. The prices of pig iron are dependent upon the amounts of the elementary constituents in the metal. As the percentage of silicon or manganese increases, and that of sulphur or phosphorus decreases, the price advances. Furthermore, scrap metals are sorted into groups according to the previous uses of the metal parts, a classification which is based indirectly on the compositions of these metals. The prices of the ferro-alloys are also dependent on the amounts of their important elementary constituents. As all the metals used in the cupola charges are purchased directly or indirectly on the basis of their chemical compositions, the maximum value of these materials can be obtained only when they are proportioned so as to produce the most favorable composition in the castings.

It is recorded by Thomas D. West that previous to 1890 practically all foundries in the United States had purchased pig iron on the basis of the appearance of the fractured surfaces of the metal. The iron with the coarsest grains was used for the softest castings, and the iron with fine grains was melted for hard castings. The use of the fracture-grading method in preparing cupola charges resulted in unreliable properties in the castings. The foundry industry has gradually adopted the more certain method of preparing metal mixtures on the basis of the chemical constituents of the materials used in the metal charges.

ESTABLISHING THE COMPOSITION OF CASTINGS

The first requirement in the calculation of metal charges for the cupola is to establish the limits or range of composition of the castings to be produced. The effects of the chemical elements on the properties of cast iron have been discussed in previous chapters. Many combinations of properties can be obtained by adjusting the chemical composition of cast iron.

One of the important demands on iron castings is uniformity in machining qualities. This requirement has resulted from the modern practice of rapid production on repetition jobs in the machine shop. Machine tools are equipped for multiple operations, and if castings of non-uniform hardness are machined, the adjustments of the tools will not remain fixed, and a delay in production and inaccuracies will result. It is not uncommon for a manufacturing plant to pay a premium for castings having uniform machinability. This condition can be attained by controlling definitely the metal mixtures for the cupola so as to obtain molten metal of uniform composition.

THE USE OF SCRAP METALS

The metal charges for the cupola generally contain pig iron and scrap metals. At every foundry a certain proportion of the metal poured is returned to the furnace to be remelted in later charges. This material known as returned foundry scrap and machine-shop scrap consists of gates and risers from previous heats, as well as castings which have been found to be defective in the cleaning department of the foundry or in the machine shop. The proportion of this scrap is ordinarily from 25 to 50 per cent of the total weight of the metal poured. In addition to the returned foundry scrap, a supply of iron scrap is often purchased from outside sources. The composition of the returned foundry scrap is approximately the same as that of the castings produced. However, it is necessary to estimate or determine the average analysis of different lots of purchased iron and steel scrap. This information is required when calculating the metal charges for the cupola furnace.

The proportion of scrap metals which can be used in metal mixtures for the cupola depends upon the chemical compositions of these materials, as well as upon the changes in composition which take place during melting. As the sulphur content increases with each melting, the proportion of scrap metal in cupola charges is limited by the amount of this element which is permitted in the castings. The silicon

and manganese which are lost during the melting process must be replaced in subsequent charges. The amounts of pig iron, ferro-alloys, and scrap metals which can be used successfully in cupola charges depend primarily upon the chemical compositions of these ingredients.

The selection of the metals for cupola charges will also depend to some extent on the market prices of these raw materials at the foundry where they are to be used. The relative prices of pig iron and scrap iron may influence the proportions of these metals in the furnace charges.

It is possible to produce iron castings from metal mixtures which contain only pig iron. On the other hand, the metal charges may consist largely of scrap metals with sufficient additions of the ferro-alloys to produce the correct average analysis. As it is difficult to maintain a uniform composition from metal mixtures which contain some of the elements in concentrated form, this practice is not generally preferred. The average practice is to use from 40 to 60 per cent of selected iron scrap in the cupola charges.

The addition of steel scrap produces favorable properties in the resulting metal for some purposes. At many foundries, definite grades of steel scrap such as steel rails, or steel flashings from drop-forge plants, are used regularly in the metal mixtures for iron castings. The proportion of steel scrap used in this way may be from 10 to 90 per cent of the weights of the metal charges.

CHANGES IN COMPOSITION OF METAL MIXTURES IN THE CUPOLA

To obtain castings within a definite range of composition, the metal charges for the cupola must be prepared to compensate for the changes in composition which take place during the melting period. These changes in the amounts of the chemical elements before and after melting depend to a large extent upon the melting practice. For a given installation and a definite cupola practice, the loss or gain in each of the chemical elements will remain practically constant for all heats.

Cast iron which has been melted in a cupola furnace from mixtures of pig iron and iron scrap ordinarily contains from 3.40 to 3.50 per cent carbon. The use of steel scrap in the metal charges lowers the total carbon content of the resulting metal. Although the steel scrap is carburized to some extent during its descent through the cupola, this constituent dilutes the total carbon content of the entire metal mixture. This effect is due to the low carbon content (0.20 to 0.80 per cent) of the steel scrap. When a metal mixture contains 20 per cent steel, a total

carbon content of about 3.20 per cent is ordinarily obtained. As the proportion of steel scrap in the metal charges is increased, the carbon content of the resulting metal is lowered. When the cupola charges contain mostly steel scrap, the total carbon may be reduced to 2.80 per cent. The final carbon content of cupola metal is influenced to some extent by the height of the crucible, the quality of the coke used, and the rate of the air supply.

Some of the silicon in the metal charges is lost by oxidation during the melting of the metal mixtures in the cupola furnace. If this loss, expressed as a percentage of the total silicon, is equivalent to the percentage of the total loss of metal during melting, the silicon content of the resulting metal will be the same as the average silicon content of the original metal mixture. As a rule, the percentage of the total weight of metal which is not recovered after melting is less than the percentage loss of silicon alone. Therefore, it is usually necessary to supply an excess of silicon in the metal charges over the amount required in the castings. As it is difficult to determine the exact loss in silicon alone, it is more convenient to establish the **loss factor** for silicon and to use this value in finding the average silicon content of the metal mixtures for the cupola furnace. This factor is obtained experimentally by subtracting the silicon content in percentage of the resulting metal from the average silicon content of the metal charges, and dividing this difference by the silicon content of the charges from which the metal was produced. The average loss factor for silicon under favorable operating conditions is 10 per cent of the total silicon charged into the cupola. To find the silicon content of a metal mixture, it is only necessary to divide the desired silicon content of the castings by 100 minus the loss factor in percentage.

The amount of manganese in the metal mixtures is also decreased during melting in the cupola. The loss factor for manganese caused by oxidation is normally about 15 per cent of the original manganese content. The oxides of silicon and manganese collect in the cupola slag.

The sulphur content of the metal charges is increased, because of the absorption of sulphur from the fuel used in the cupola. Pig iron usually contains less than 0.05 per cent sulphur, and scrap iron generally has less than 0.12 per cent. When the coke contains less than 0.75 per cent sulphur, the metal gains about 0.02 per cent of this element during each melting.

The action of the remelting process as related to phosphorus is mainly that of concentration. The phosphorus and sulphur which are present in the cupola charges are not oxidized during the melting process.

but may be removed from the metal to some extent in the cupola slag. An increase of 0.02 per cent phosphorus in the metal may be assumed in the calculations for cupola charges.

Certain general assumptions may be made as to the changes in the proportions of the elementary constituents in the metal charges during melting. However, these factors can be established experimentally for a given cupola practice. It is only necessary to determine the average chemical composition of the metal mixture before charging, and of the castings produced from this mixture. The loss factor for either silicon or manganese is obtained by dividing the difference between the percentages of the element before and after melting by the percentage of the element in the original metal mixture.

CONSTITUENTS OF METAL MIXTURES

The metals are usually procured within the limits of the sulphur and phosphorus requirements of the castings to be produced. When castings with a phosphorus content of less than 0.20 per cent are to be made, the pig iron and scrap metals are selected with an average phosphorus content within the required limits. The same consideration is given to the sulphur content of the materials used. The desired manganese content can be obtained by proportioning the metals used in the charges, or by the addition of manganese in the form of ferro-alloys to the molten metal. In most cases, only the minimum content of manganese is specified for the castings. The pronounced influence of silicon on the properties of cast iron warrants the practice of using this element as the main factor in calculating the amounts of the different metals to be used in the cupola charges.

After establishing the desired analysis of the castings, the proportion of scrap metals to be used, and the changes in composition during melting, the materials are selected and apportioned to obtain the composition required in the castings. The computations for metal mixtures can be made on the basis of the percentages of the elements or on the basis of the weights of the chemical elements. The method of combining the elementary constituents on the basis of weight is more direct and will be used in the problems which follow.

PROBLEMS ON METAL MIXTURES

The solutions of definite problems will illustrate the procedure used in calculating the metal charges for the cupola.

Problem 1:

Find the weights of the materials used in one metal charge for machinery castings having the following composition: silicon, 1.80 per cent; manganese minimum, 0.65 per cent; sulphur maximum, 0.10 per cent; and phosphorus maximum, 0.50 per cent. Each metal charge will contain 1,000 pounds of pig iron and 1,000 pounds of iron scrap. The average changes in composition of the metal mixture during melting will be assumed. The analyses of the pig iron and scrap iron which are available for the cupola charges are as follows:

	Silicon %	Manganese %	Sulphur %	Phosphorus %
Pig iron—pile A	2.46	0.90	0.045	0.40
Pig iron—pile B	1.35	0.98	0.050	0.34
Iron scrap (automobile cylinders) . .	2.25	0.70	0.080	0.23

As the manganese, sulphur, and phosphorus in the materials to be used are within the limits of the requirements of the castings, these elements will be disregarded, and the metal mixture will be calculated on the basis of the silicon content of the metals which are available.

If X represents the pounds of pig iron from pile A, then $1,000 - X$ will represent the pounds of pig iron from pile B for each metal charge. As the metal in pile A contains 2.46 per cent silicon, the weight in pounds of silicon from this source is equal to X multiplied by 0.0246. As the metal in pile B contains 1.35 per cent silicon, the weight in pounds of silicon from this source is equal to $1,000 - X$ multiplied by 0.0135. As the iron scrap contains an average of 2.25 per cent silicon, the weight in pounds of silicon from this source is equal to 1,000 multiplied by 0.0225. Therefore, the total weight in pounds of silicon in one metal charge equals

$$(X \times 0.0246) + [(1,000 - X) \times 0.0135] + (1,000 \times 0.0225)$$

It is assumed in this problem that the loss factor for silicon is 10 per cent of the total silicon in each metal charge. This factor was determined experimentally by subtracting the silicon content of the resulting metal from the silicon content of the metal mixture, and dividing by the average silicon content of the metals charged into the cupola. Therefore, the silicon content of the resulting metal will represent 90 per cent of the silicon in each original metal charge. The total weight in pounds of silicon in one metal charge can be found by dividing 0.0180, which is the silicon content of the castings, by 0.90 and multiplying by 2,000, the weight of one metal charge.

180 CALCULATION OF THE METAL CHARGES FOR THE CUPOLA

Two expressions have now been obtained for the total silicon content of one metal charge. These values can be set forth in an equation; and by solving for X , the weight of pig iron from pile A can be readily found.

$$(X \times 0.0246) + [(1,000 - X) \times 0.0135] + (1,000 \times 0.0225) = (0.0180 \div 0.90) \times 2,000$$

$$\text{or} \quad 0.0246X + 13.5 - 0.0135X + 22.5 = \frac{0.0180}{0.90} \times 2,000$$

$$\text{or} \quad 0.0111X = 4$$

Therefore, $X = 360$ pounds of pig iron from pile A in each metal charge.

$1,000 - X = 640$ pounds of pig iron from pile B in each metal charge.

Also, 1,000 pounds of iron scrap are used in each metal charge.

Problem 2:

As soon as the returned foundry scrap collects in sufficient quantity, it will be desirable to include some of this material in the charges. If the metal mixture is changed to include 50 per cent pig iron, 30 per cent returned foundry scrap, and 20 per cent purchased scrap (automobile cylinders), determine the weights of pig iron from pile A and pile B in each metal charge.

Another equation based on the silicon content of the new mixture must be used. The returned foundry scrap will have a silicon content of 1.80 per cent.

The calculations are as follows:

$$(X \times 0.0246) + [(1,000 - X) \times 0.0135] + (600 \times 0.018) + (400 \times 0.0225) = (0.018 \div 0.90) \times 2,000$$

$$\text{or} \quad 0.0246X + 13.5 - 0.0135X + 10.8 + 9 = 40$$

Therefore, $X = 604$ pounds of pig iron from pile A in each metal charge.

$1,000 - X = 396$ pounds of pig iron from pile B in each metal charge.

Also, 600 pounds of returned foundry scrap and 400 pounds of iron scrap (automobile cylinders) are used in each metal charge.

In the previous problems, the amount of pig iron from each of two piles was found which would give a definite content of one element, sili-

con, in the castings. It is possible to derive mixtures which will give definitely two elements, such as silicon and manganese, in the resulting product, provided three lots of pig iron with analyses within a limiting range are available. However, it is seldom necessary to calculate metal mixtures on the basis of more than one element. The metal charges for the cupola are usually apportioned so as to contain a definite amount of silicon because this element has a pronounced effect on the properties of cast iron.

ADDITIONS OF SPECIAL ELEMENTS

Special alloying elements can be introduced to cast iron by including them in the charges for the melting furnace or by adding them to the metal while it is being poured from the furnace. The alloying materials are supplied to the furnace charges in the form of pigs, lumps, or briquets. High-silicon pig iron known as **silvery iron** containing 5 to 17 per cent silicon, and high-manganese pig iron known as **spiegeleisen** containing 15 to 30 per cent manganese, can be obtained for cupola charges. Furthermore, a special pig iron known as "Mayari" iron is available for introducing chromium and nickel to the metal for iron castings. This alloy pig iron is produced with 2.40 per cent chromium, 1.20 per cent nickel, and a wide range in the percentage of silicon.

The use of the ferro-alloys in briquetted form offers a convenient method for adding special elements to cupola charges. Briquets are available containing definite weights of manganese, silicon, or chromium. They are prepared from the crushed ferro-alloys with a cement binder and are formed into definite shapes which identify the specific alloys.

Ladle additions of the alloying elements or the ferro-alloys can be made with the materials in the form of shot, in a finely pulverized condition, or in the molten state. Because the alloys which are ordinarily added to cast iron have melting temperatures near to those of the metal to which they are supplied, it is important that the cast iron be superheated to a degree which will permit the maximum solution of the alloys. The most satisfactory way to introduce the solid alloys is to add them gradually to the stream of metal while the ladle is being filled.

Manganese

If the pig iron and scrap metals on hand are too low in manganese to obtain the desired amount of this element in the castings, the manganese content of the metal can be increased by the addition of ferro-manganese to each ladle of molten metal. The standard alloy for this

purpose contains about 80 per cent manganese, 7 per cent carbon, and the remainder iron. As the melting point of this alloy is relatively high (about 2210 degrees F.), the ferromanganese should be crushed, preheated, and stirred well into the liquid metal. Under average conditions, about 50 per cent of the alloy added to each ladle of metal is lost through oxidation or directly in the slag.

Nickel

A special alloy of nickel known as "F" nickel has been developed by the International Nickel Company for ladle additions to cast iron. This alloy contains an average of 92 per cent nickel, 6 per cent silicon, and 2 per cent iron. The particular advantage of this alloy is that it melts at approximately 2300 degrees F., whereas pure nickel melts at 2646 degrees F. For this reason, it is possible to dissolve the nickel alloy in cast iron which has been heated above 2400 degrees F. The "F" nickel in the form of shot is usually added to the stream of metal soon after it leaves the cupola furnace. If reasonable care is taken to superheat the cast iron and to distribute the alloy in the metal, the loss of nickel is relatively small.

Chromium

This element is introduced to cast iron either in the metal charges for the melting furnace or as ladle additions of ferrochromium. A special chromium-bearing pig iron and the chromium alloys prepared in briquet form are available for furnace charges. The alloy which is ordinarily used in adding chromium to molten cast iron contains 60 to 75 per cent chromium, 2 to 3 per cent silicon, 4 to 6 per cent carbon, and the remainder iron. This alloy has a melting temperature of about 2300 degrees F. It is therefore necessary to have the cast iron at a relatively high temperature in order to obtain complete solution of the ferrochromium. The finely pulverized alloy is usually added to the stream of metal as it enters the ladle.

When large proportions of chromium are required in cast iron, furnace additions are more satisfactory than ladle additions. The loss of chromium caused by the oxidation of this element depends upon the conditions under which it is used. In the cupola furnace, the loss may be from 10 to 30 per cent of the weight of chromium in the charges. With reasonable care, not more than 10 per cent loss is incurred when chromium is added in the ladle.

Molybdenum

Molybdenum is usually supplied to cast iron by ladle additions of ferro-alloys which are readily soluble in cast iron at ordinary pouring temperatures. The molybdenum alloys are crushed finely and are added to the stream of metal while the ladle is being filled. The loss of molybdenum when added in this way is relatively small.

Availability of Alloying Elements

When any element is introduced to a bath of metal by means of an alloy addition, the weight of metal in the bath is increased by the amount of the alloy which is added. This condition requires that more of the special element be supplied to compensate for the dilution of the bath of metal. Therefore, the full amount of the special element in the alloy will not be available for increasing the proportion of this element in the original weight of metal in the bath. The law of availability states that the available content of the special element in any alloy is equal to the percentage of this element in the alloy minus the percentage of the special element in the final mixture. This law will now be applied in the solution of several problems.

Problem 3:

An alloy cast iron having a nickel content of 2.0 per cent is to be prepared by a ladle addition of an alloy containing 92.0 per cent nickel. Determine the weight in pounds of the nickel alloy to be added to 1,800 pounds of molten cast iron.

The calculations follow:

$$1,800 \times 0.02 = 36 \text{ net pounds of nickel required.}$$

$$0.92 \times 0.02 = 0.90 \text{ pound of nickel available in each pound of the alloy.}$$

$$36 \div 0.90 = 40 \text{ pounds of the alloy required.}$$

Problem 4:

A chromium content of 0.80 per cent is required in the metal for certain iron castings. The ferrochromium which is on hand contains 70.3 per cent chromium. Determine the weight in pounds of the chromium alloy which must be added to a ladle holding 1,200 pounds of cast iron. Assume that 8 per cent of the chromium which is added to the ladle is lost by oxidation.

184 CALCULATION OF THE METAL CHARGES FOR THE CUPOLA

Following are the calculations:

$$1,200 \times 0.008 = 9.6 \text{ net pounds of chromium required.}$$

$$0.703 - 0.008 = 0.695 \text{ pound of chromium available in each pound of the alloy.}$$

$$9.6 \div 0.695 = 13.8 \text{ net pounds of the alloy required.}$$

$$100 - 8 = 92 \text{ per cent of the alloy recovered.}$$

$$13.8 \div 0.92 = 15 \text{ total pounds of alloy required.}$$

THE USE OF FORMULAS IN PROPORTIONING METAL MIXTURES

The proportions of two lots of metal which will give a desired content of an element can be found by the use of formulas. Let D equal the desired content of the element. Let L equal the content of the element in the lot which has a lower content of the element than desired. Let H equal the content of the element in the lot which has a higher content of the element than desired. Then $\frac{D - L}{H - L}$ = the proportion of the metal from the lot which has a higher content of the element than desired. And $\frac{H - D}{H - L}$ = the proportion of the metal from the lot which has a lower content of the element than desired.

This method for establishing the proportions of two or more lots of metal to obtain a desired mixture will be shown in the solution of the following problems.

Problem 5:

Find the proportions of low-silicon iron containing 1.80 per cent silicon and high-silicon iron containing 2.55 per cent silicon to obtain an average of 2.40 per cent silicon in the metal mixture.

By the use of the formulas, the following equations are derived:

$$\frac{2.40 - 1.80}{2.55 - 1.80} = \frac{0.60}{0.75} = 80 \text{ per cent of high-silicon iron required.}$$

$$\frac{2.55 - 2.40}{2.55 - 1.80} = \frac{0.15}{0.75} = 20 \text{ per cent of low-silicon iron required.}$$

If it is desired to use three or more lots of metal in one charge, mixtures are found for any combinations of two lots, and then any proportions of the different mixtures can be added to give the full charge.

Problem 6:

Three piles of pig iron are on hand. Pile A contains 2.82 per cent, pile B 2.22 per cent, and pile C 2.12 per cent silicon. Determine the weight

in pounds of iron from each of these piles for one cupola charge of 2,000 pounds of metal having an average silicon content of 2.40 per cent.

With the three different compositions of pig iron on hand, it is possible to combine pile A and pile B, as well as pile A and pile C, to obtain the desired silicon content in the metal mixtures.

Using the formulas, the weights of metal from the different piles in the two combinations are as follows:

$$\frac{2.40 - 2.22}{2.82 - 2.22} = \frac{0.18}{0.60} = 30\% \text{ or } 600 \text{ pounds from pile A (2.82\% Si)}$$

$$\frac{2.82 - 2.40}{2.82 - 2.22} = \frac{0.42}{0.60} = 70\% \text{ or } 1,400 \text{ pounds from pile B (2.22\% Si)}$$

$$\frac{2.40 - 2.12}{2.82 - 2.12} = \frac{0.28}{0.70} = 40\% \text{ or } 800 \text{ pounds from pile A (2.82\% Si)}$$

$$\frac{2.82 - 2.40}{2.82 - 2.12} = \frac{0.42}{0.70} = 60\% \text{ or } 1,200 \text{ pounds from pile C (2.12\% Si)}$$

These mixtures can be combined in any ratios to obtain one metal charge. If one-half of the first mixture is used with one-half of the second mixture, the total charge will contain 700 pounds from pile A, 700 pounds from pile B, and 600 pounds from pile C. If a larger amount of iron from pile C is to be used, one-fourth of the first mixture can be combined with three-fourths of the second mixture. The total metal charge will then contain 750 pounds from pile A, 350 pounds from pile B, and 900 pounds from pile C.

A GRAPHICAL METHOD FOR PROPORTIONING METAL MIXTURES

A graphical method can be used for finding the amounts of different lots of metal to obtain a desired composition in the mixture. A diagram is constructed as shown in Fig. 108. The base line *A-B* represents the total amount of metal in one charge. Units corresponding to percentages or pounds of metal are indicated on the base line. From points *A* and *B*, lines are drawn in opposite directions and at right angles to the base line. Equally spaced intervals are then laid off on these two lines as indicated in Fig. 108. The values given on line *A-C* designate the differences in percentage of the high silicon and the desired silicon in the mixture. Also, the values given on line *B-E* designate the differences in percentage of the desired and the low amounts of the controlling element in the mixture. Any straight line joining a point on *A-C* with

a point on $B-E$ will divide the base line in proportion to the distances laid off on $A-C$ and $B-E$. The application of this graphical method will be shown in the solution of the following problem.

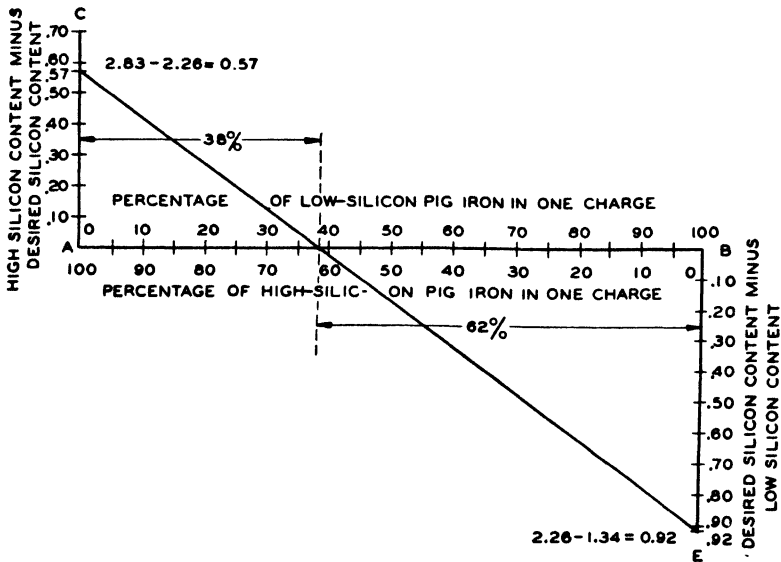

FIG. 108.—DIAGRAM FOR METAL MIXTURES

Problem 7:

Find the proportion of each of two lots of pig iron containing 2.83 and 1.34 per cent silicon to obtain 2.26 per cent silicon in the mixture.

First subtract the desired silicon content of the mixture from the silicon content of the higher-silicon pig iron; locate this value on the line $A-C$. Then subtract the silicon content of the lower-silicon pig iron from the desired silicon content of the mixture; locate this value on the line $B-E$. Now join the point on the line $A-C$ with the point on the line $B-E$. The intersection of this diagonal line with the base line will proportion the total amount of pig iron in one charge into two divisions corresponding to the proportions of high- and low-silicon pig iron in the mixture.

THE USE OF CHARTS FOR ESTABLISHING METAL MIXTURES

To facilitate the rapid and accurate determination of the metal charges for the cupola, charts can be used from which the quantities of the different metals making up the charges can be read directly. In

order to illustrate this method for establishing the weights of metals in the charges for the melting furnace, the following conditions are assumed.

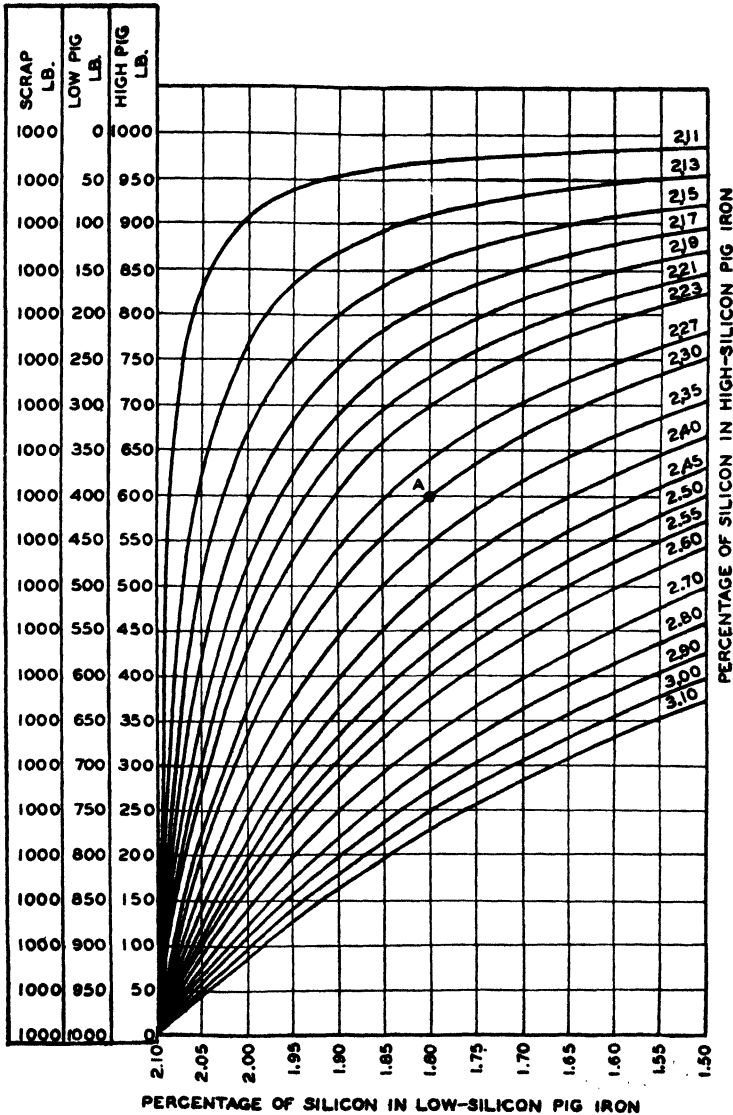

FIG. 109.—CHART FOR METAL MIXTURES

Iron castings having a silicon content of 1.65 per cent are required. Each metal charge contains 1,000 pounds of scrap iron and 1,000 pounds of pig iron. The average silicon content of the scrap iron is 1.56 per cent

As the total metal mixture must have an average silicon content of 1.83 per cent, the pig-iron mixture which makes up one-half of each metal charge will contain an average of 2.10 per cent silicon. The curves on the chart in Fig. 109 have been plotted to obtain all possible combinations of any lots of pig iron which will have an average silicon content of 2.10 per cent. Using this figure as the origin, decreasing percentages of silicon are laid off on the base line toward the right. Each lot of high-silicon pig iron is represented by a curve. On the left side of the chart, the weights of scrap iron and pig iron for every possible mixture are arranged in columns.

The correct mixture for two lots of pig iron is found by starting with the point on the base line which corresponds to the silicon percentage in the low-silicon pig, and following the vertical line to the intersection of the curve which represents the percentage of silicon in the high-silicon pig; and from this point of intersection, the horizontal line is followed to the columns at the left where the exact weights of scrap iron, low-silicon pig iron, and high-silicon pig iron are indicated.

As an example: Two lots of pig iron are on hand containing 1.80 per cent and 2.30 per cent silicon. Point *A* on the chart in Fig. 109 is the intersection of the line for the low-silicon pig and the curve for the high-silicon pig. The horizontal line through this point indicates that a full charge will contain 1,000 pounds of scrap iron, 400 pounds of low-silicon (1.80 per cent) pig iron, and 600 pounds of high-silicon (2.30 per cent) pig iron. If three or more lots of pig iron are to be used in a charge, the mixtures are derived for two lots at a time, and then any proportions of the separate mixtures can be combined to give the full charge.

In the preparation of metal-mixing charts, it is first necessary to determine the silicon content required in the pig-iron mixtures. This is derived from the desired analysis of the castings, the proportion of scrap to be used, and the average analysis of the scrap. The weights of all possible combinations of the metals are placed in columns at the left, and the silicon contents of the low-silicon irons are arranged along the lower edge of the chart. It will then be necessary to plot separately a curve for each of the high-silicon irons. The use of metal-mixing charts simplifies the practice and saves time in calculating the metal charges for the cupola.

METAL CHARGES FOR OTHER MELTING FURNACES

The procedure used in calculating the metal charges for the air furnace and the electric furnace is about the same as that for the cupola furnace. However, the changes in the composition of the metal between

charging and pouring vary with the different melting processes. The air furnace is operated with a strongly oxidizing atmosphere, and this condition causes a loss factor for silicon of about 30 per cent and a loss factor for manganese of about 40 per cent of the total amounts of these elements charged. When metal mixtures for iron castings are melted in an electric furnace, an increase in silicon is sometimes obtained, a condition brought about by the reduction of silicates from the lining of the furnace.

FORM FOR RECORDING DATA ON METAL CHARGES

The complete information on the materials used in each metal charge for the melting furnace should be recorded for the use of the furnace operator; a form for this purpose is given in Table V. An analysis of

TABLE V
RECORD OF METAL MIXTURES

Heat No. Date
Number of Charges Class of Castings

Material	Weight, Lb. per Charge	Silicon		Manganese		Sulphur		Phosphorus		
		%	Lb.	%	Lb.	%	Lb.	%	Lb.	%	Lb.
Foundry Iron Scrap....											
Purchased Iron Scrap..											
Purchased Steel Scrap..											
Ferro-Alloy.....											
Pig Iron, Pile.....											
Pig Iron, Pile.....											
Pig Iron, Pile.....											
Total Charge.....											
Average Composition..											
Changes in Composition											
Computed Analysis....											
Check Analysis.....											

the metal from each heat should be made to detect errors in the computations or irregularities in the melting practice.

BIBLIOGRAPHY

1. H. L. CAMPBELL, "Modern Methods for Making Cupola Mixtures." *Chemical and Metallurgical Engineering*, v. XXVIII (1923), p. 492-495.
2. H. L. CAMPBELL, "Calculating Ferro-Alloy Additions." *The Foundry*, v. LIII (1925), p. 391-392.
3. *American Foundrymen's Association*, "Recommended Methods for Calculation of Cupola Mixtures." *Trans. A.F.A.*, v. XXXIX (1931), p. 53-58.

REVIEW QUESTIONS

I

What determines the proportion of scrap metals which may be used in cupola charges?

II

What changes take place in the composition of metal mixtures which are melted in the cupola furnace?

III

How is the loss factor for silicon obtained?

IV

What alloys are used in introducing nickel to cast iron?

V

Describe three forms in which chromium may be added to cast iron.

VI

Calculate the weight in pounds of each of the materials used in one metal charge having a total weight of 3,200 pounds. The metal mixture will contain 25 per cent of steel scrap, 25 per cent of returned foundry scrap, and the remainder of pig iron. Heavy machinery castings will be produced. The following analyses will be assumed:

	Silicon %	Manganese %	Sulphur %	Phosphorus %
Desired analysis of castings	1.40	min. 0.50	max. 0.09	max. 0.50
Pig iron, pile A.....	2.90	0.84	0.04	0.50
Pig iron, pile B.....	2.06	0.62	0.05	0.53
Steel scrap.....	0.30	0.50	0.05	0.05

VII

If a manganese content of 0.90 per cent is required in the castings, with other conditions as in the problem above, how much ferromanganese containing 80 per cent manganese must be added to each ladle holding 2,000 pounds of metal?

VIII

Determine the weights of materials to be used in a metal mixture of 2,000 pounds for steam-cylinder castings. Each metal charge will contain 20 per cent of steel scrap and 30 per cent of returned foundry scrap. Ferromanganese will be added in the form of briquets to the cupola charges. Assume that the briquets contain 60 per cent of manganese, and that 25 per cent of the manganese from this source is lost by oxidation.

Material	Silicon %	Manganese %	Sulphur %	Phosphorus %
Castings required....	1.70	0.90	max. 0.09	max. 0.40
Steel scrap.....	0.30	0.60	0.05	0.04
Pig iron, pile A.....	2.75	0.60	0.04	0.35
Pig iron, pile B.....	1.50	0.50	0.04	0.40

IX

How much ferromanganese containing 80.0 per cent manganese must be added to a ladle holding 1,000 pounds of metal to raise the manganese content from 0.40 to 1.00 per cent?

X

How much "F" nickel shot containing 92.5 per cent nickel must be added to 500 pounds of cast iron to obtain 1.50 per cent nickel in the total metal mixture?

XI

On a graph which is designed for metal charges of 800 pounds, determine the weights of metal from two lots of pig iron containing 2.74 per cent and 1.98 per cent silicon for a mixture having an average content of 2.26 per cent silicon.

XII

Prepare a chart for metal mixtures to contain 10 per cent of steel scrap, 30 per cent of returned foundry scrap, and the remainder of pig iron. The castings must have a silicon content of 1.80 per cent. The range of silicon in the pig iron is from 1.00 to 3.50 per cent.

CHAPTER XI

MALLEABLE IRON CASTINGS

COMPOSITION OF THE METAL—MELTING PRACTICE—MOLDING PRACTICE—ANNEALING PRACTICE—Preparation for Annealing—Annealing Period—FINISHING PRACTICE—PRINCIPLES OF THE ANNEALING TREATMENT—PROPERTIES OF MALLEABLE CAST IRON—USES OF MALLEABLE IRON CASTINGS

Malleable iron castings are produced from special metal mixtures which are melted in furnaces, cast to desired shapes in sand molds, and later heat treated to obtain high strength and ductility. The chemical composition must be such that the metal in the castings will solidify as white cast iron. If any graphite flakes (**primary graphite**) form during the cooling of the metal from the molten state, these particles will not be affected by the subsequent annealing treatment, and they will remain as a source of weakness in the finished castings. The annealing treatment consists of heating the white iron castings for a definite length of time at the desired temperature, and cooling at a limited rate so as to obtain as final constituents only iron, known as **ferrite**, and free carbon designated as **temper carbon**.

COMPOSITION OF THE METAL

The chemical composition of the metal influences to a large degree the mechanical properties of malleable cast iron. The manufacturing process for malleable iron requires that the castings be produced with all of the carbon in the combined state, and that finally the carbon be converted entirely to the free state. The two factors which control the condition of the carbon in iron castings are the rate of cooling and the composition, chiefly silicon content, although the ratio of the silicon to the total carbon is an important consideration. Castings with thick sections cool more slowly than castings with thin sections, and slow cooling favors the separation of graphite. Therefore, graphite will be produced more readily in castings with heavy sections than in castings having light sections.

A high silicon content promotes the separation of free carbon in the metal as cast, and a low silicon favors the retention of carbon in the combined state. Furthermore, a low total carbon content causes the carbon to be retained in the combined state. It is now apparent that silicon and carbon must be chosen which will permit the presence of combined carbon in the castings as cast, and also assist in the development of free carbon when the castings are annealed. As a rule, the silicon content of the metal for large castings is somewhat lower than that required for castings with relatively thin sections. The average practice is to use a silicon content of 0.80 to 0.95 per cent for large castings and 0.95 to 1.10 per cent for castings with light sections.

All the carbon in the castings is finally converted into particles of temper carbon, which decrease the strength and ductility of the metal; therefore, it is desirable to have the carbon content as low as possible. With the carbon below 2.20 per cent, casting difficulties arise due to the high freezing temperature of the metal. A carbon content within the range of 2.20 to 2.50 per cent is generally obtained in air-furnace metal for malleable iron castings.

Sulphur tends to retard the graphitizing of the carbon in cast iron during annealing. Hence a low percentage of sulphur is preferred in the metal for malleable iron castings. As a rule, the sulphur content is not greater than 0.10 per cent.

Manganese should be present in sufficient amount to combine with all the sulphur. A high manganese content prevents the complete graphitizing of the carbon during the annealing treatment. This element usually does not exceed 0.40 per cent.

Phosphorus has little effect on the properties of malleable cast iron until it is present in excess of 0.20 per cent. A greater proportion of phosphorus will decrease the shock-resisting property of the metal.

The average composition of air-furnace iron for malleable iron castings is as follows: total carbon 2.20 to 2.50 per cent, silicon 0.80 to 1.10 per cent, manganese less than 0.40 per cent, sulphur less than 0.10 per cent, and phosphorus 0.10 to 0.20 per cent.

MELTING PRACTICE

Air furnaces are used in most of the foundries where malleable iron castings are produced. The construction and operation of air furnaces are described in Chapter V. (See Fig. 73 in Chapter V.) With this type of furnace, accurate control of the carbon as well as of the other elements in the metal can be obtained before pouring. The furnace

charges usually contain from 30 to 40 per cent of pig iron, 45 to 50 per cent of returned foundry scrap, and the remainder of purchased malleable iron or steel scrap. The average capacity of air furnaces used for malleable iron is 20 tons of metal in each heat; this amount of metal is melted and superheated in about 5 hours with powdered coal as fuel.

The cupola furnace is also used for melting the metal for malleable iron castings. At some plants the molten metal from the cupola is superheated to higher temperatures either in an air furnace or in an electric furnace before being poured into the molds. A typical metal mixture for the cupola consists of 15 per cent of low-phosphorus pig iron, 35 per cent of steel scrap, and 50 per cent of returned foundry scrap. Cupola furnaces are used chiefly at those plants where the main product is malleable iron pipe fittings.

MOLDING PRACTICE

The preparation of the molds for malleable iron castings requires more attention than is necessary for gray iron castings. This is caused by the high freezing temperature, and the high contraction of the metal from which malleable iron castings are produced. Because the initial freezing temperatures of the iron-carbon alloys are higher as the carbon content decreases, white cast iron with a total carbon of 2.50 per cent will solidify more rapidly than gray cast iron with 3.50 per cent of carbon. In order to have an adequate range of temperature for pouring, the metal is superheated in the air furnace to about 2900 degrees F. Consequently the materials used in the preparation of the molds must be very refractory. The molds for malleable iron castings are usually made of green sand because these molds allow the greatest freedom for the metal to contract. A permeability of about 30 and a minimum green strength of 4.5 lb. per sq. in. in compression are desired for the molding sand used in this practice.⁵ All cores are made with sand binders which permit the metal to contract freely when cooling. Special care is taken to remove the slag from the metal by means of strainers and traps in the gates.

The difference between the linear dimensions of white iron castings and the patterns from which the molds were prepared is about $\frac{1}{4}$ in. per ft. In the malleablizing treatment for these castings, the metal expands because of the separation of free carbon. The net contraction usually allowed on patterns for malleable iron castings is $\frac{1}{8}$ in. per ft. To prevent defects caused by contraction or shrinkage in white iron castings, "blind risers" or "shrink bobs" are provided in the molds

adjacent to heavy sections. The location of shrinkage cavities is also controlled to some extent by the use of cast-iron chills in the molds.

ANNEALING PRACTICE

The metal for malleable iron castings in the condition as cast is very hard and brittle. To obtain the desired ductility, the constitution of the metal is changed by a heat treatment which consists of heating the castings for a sufficient length of time at the proper temperature and cooling at the desired rate.

Preparation for Annealing

As soon as the castings are removed from the molding floor, the gates are broken off, and the surfaces of the castings are cleaned in tumbling mills or by blasting. After these operations, the castings are placed in cast-iron boxes, either with or without a packing material of sand, crushed fire brick, and slag. The main purpose of the packing



Courtesy of Whiting Corporation

FIG. 110.—ANNEALING OVENS

is to support the castings so as to prevent warping during the annealing period. The boxes are formed from a series of rings with a base and cover, and all joints are plastered with fire clay to prevent excessive oxidation of the contents. After the boxes are filled, they are placed in ovens of the intermittent or continuous type which are thoroughly insulated to prevent too rapid cooling when the fuel supply is shut off. The capacity of one oven as illustrated in Fig. 110 is 12 tons of castings.

Pyrometer couples are located at several points within the ovens to assist in the control of temperatures during the malleablizing treatment.

Annealing Period

After the boxes are placed in the oven and the door is sealed, heat is supplied as rapidly as possible until a temperature of 1600 degrees F. is

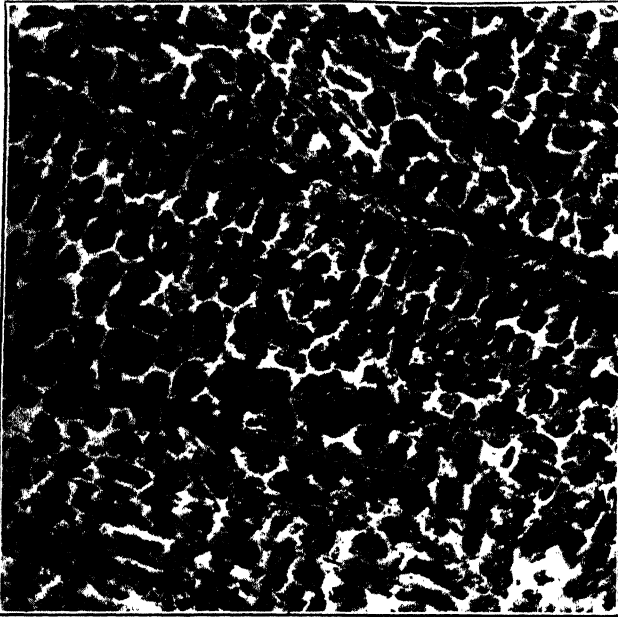

FIG. 111.—WHITE CAST IRON, $\times 100$

The white constituent is free cementite, and the dark constituent is pearlite.

reached. When powdered coal is used as the fuel, the initial heating requires from 20 to 40 hours. The temperature of the oven is held at 1600 degrees F. for an additional period of 40 to 50 hours; then the oven is allowed to cool at the rate of 5 to 10 degrees per hour. When the temperature drops below 1275 degrees F., the door is opened and the boxes are removed as soon as they can be handled. Allowing 48 hours for cooling and 24 hours for packing and shaking out the castings, the total time for annealing will require from 6 to 7 days. The annealing time may be decreased by employing special furnaces which allow the castings to be heated rapidly without packing material and to be cooled at the most favorable rates throughout the entire cooling range.

FINISHING PRACTICE

After the boxes have been removed from the annealing oven, the castings are separated from the packing material and are transferred to the cleaning room. Any excess metal on the surfaces where gates have been attached to the castings is removed by grinding. The cleaning process also includes tumbling and blasting. Castings which are

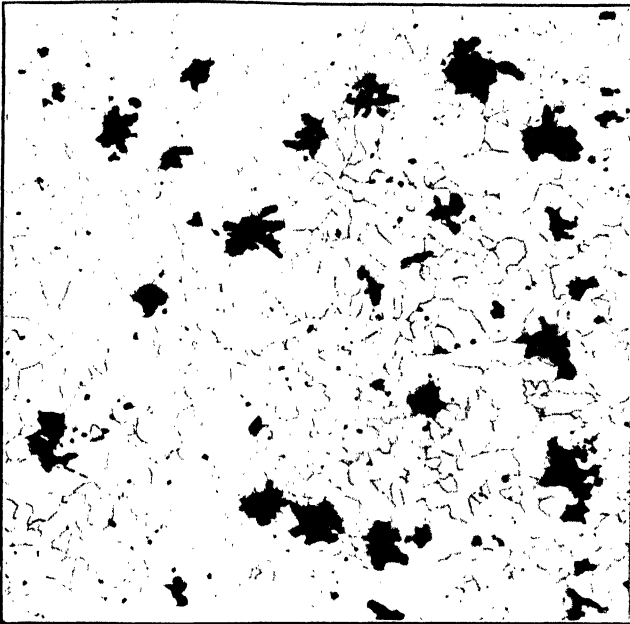

FIG. 112.—MALLEABLE CAST IRON, $\times 100$

The white grains are ferrite, and the black particles are temper carbon.

slightly warped are straightened at this stage in dies under a drop hammer or in a press.

PRINCIPLES OF THE ANNEALING TREATMENT

The complete annealing or malleablizing process requires heating the white iron castings to a definite temperature, holding at this temperature for the correct length of time, and cooling at a sufficiently slow rate to produce the desired constituents in the castings. The metal as cast contains approximately 73 per cent of pearlite and 27 per cent of free cementite. These constituents are shown on the micrograph in

Fig. 111; the light-colored constituent is cementite and the dark constituent is pearlite. It is important to adjust the composition of the metal for malleable iron castings so that no graphite separates during the solidification or initial cooling of the castings. The changes in the constitution of the metal during the heating and cooling periods of the annealing treatment will now be considered.

When the temperature of the castings reaches 1400 degrees F., the pearlite is changed completely to austenite, and the free cementite is gradually dissolved in the austenite as the temperature increases. Because the solubility of cementite in austenite is greater than the solubility of free carbon in austenite, some free carbon will gradually separate in the form of temper carbon. This process of dissolving cementite and precipitating carbon continues until a state of equilibrium is reached for any temperature. All free cementite must be dissolved at this stage of the annealing treatment. A total time of 48 hours at 1600 degrees F. is satisfactory in commercial practice.

When the castings are cooled slowly in the furnace, additional carbon separates, a condition caused by the decreased solubility of carbon in austenite as the temperature lowers. Finally, the remaining carbon is precipitated at temperatures near to, but below, the critical range, because of the low solubility of carbon in the ferrite. If the cooling is too rapid, cementite and pearlite will be formed in the metal, the presence of which will defeat the purpose of the annealing treatment. The cooling rate as used in commercial practice is from 5 to 10 degrees per hour until the temperature drops below 1275 degrees F. The characteristic structure of malleable cast iron is shown in Fig. 112; the white grains of irregular shape are ferrite and the black particles are temper carbon.

PROPERTIES OF MALLEABLE CAST IRON

One of the distinguishing properties of this type of cast iron is its ductility, which is expressed as the percentage elongation of standard tensile test specimens. This property is due to a structure of soft and ductile ferrite, which is interrupted to some extent by particles of temper carbon. The amount of deformation to which a malleable iron casting can be subjected without failure is shown in Fig. 113.

The minimum values for the tensile properties of malleable cast iron as given in the specifications of the *American Society for Testing Materials* (refer to the Appendix) are as follows:

	Grade 32510	Grade 35018
Tensile strength, lb. per sq. in.	50,000	53,000
Yield point, lb. per sq. in.	32,500	35,000
Elongation in 2 in., per cent.	10.0	18.0

The tensile properties are obtained from specimens cast to the dimensions given in the standard specifications. The average modulus of elasticity of malleable cast iron in tension is 25,000,000 lb. per sq. in. The reduction of area is usually not determined on the cast-to-size specimens. With material of standard quality, this property will be about 20 per cent of the original area of the test specimens. When subjected to loads in compression, malleable cast iron acts as other plastic materials; no definite point of failure is indicated, but the metal continues to deform as the load is increased.

When it is necessary to heat a malleable iron casting for the purpose of changing its shape, or for other reasons, the effects of high temperatures on the properties of this metal should be considered. If the maximum temperature to which the casting is subjected does not exceed 1350 degrees F., the micro-constituents will not be changed, and the

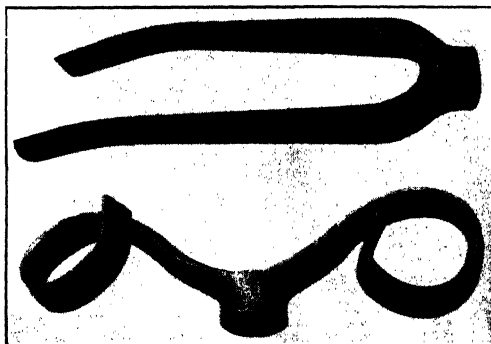

Courtesy of Malleable Iron Research Institute

FIG. 113.—MALLEABLE IRON CASTING BEFORE AND AFTER COLD BENDING

physical properties will be the same before and after heating. On the other hand, when a malleable iron casting is heated above 1350 degrees F. and cooled relatively rapidly, the ductility of the metal will not be regained. The hardness and brittleness of the metal will increase with the length of time and the temperature of heating. The normal tensile strength of malleable iron is retained at temperatures up to 800 degrees F., but above this temperature the strength decreases rapidly. The elongation of the metal is also practically constant up to 800 degrees F., and then rises sharply.²

USES OF MALLEABLE IRON CASTINGS

Because of their favorable strength, ductility, and machinability, malleable iron castings are used for parts of automobiles, fittings for railroad cars, parts for agricultural implements, pipe fittings, industrial

machinery, and building hardware. A group of malleable iron castings is shown in Fig. 114. This material is particularly adapted to parts having shapes too complicated for economical production by forging

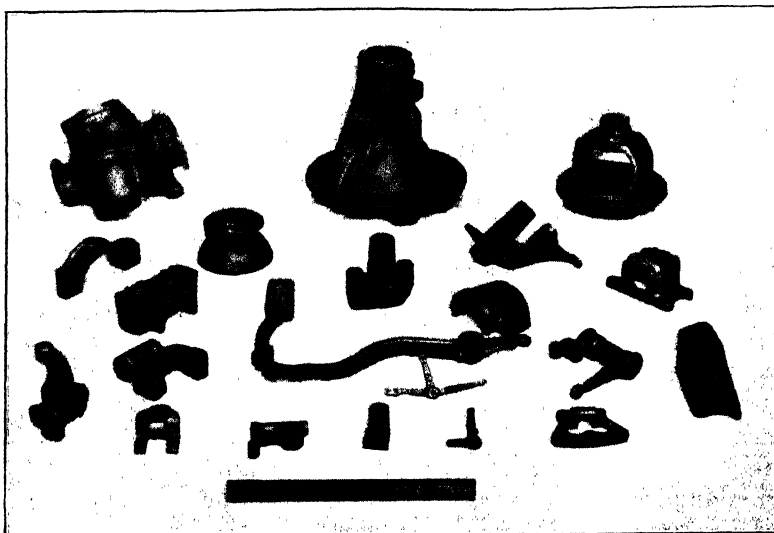

Courtesy of Saginaw Malleable Iron Company

FIG. 114.—MALLEABLE IRON CASTINGS

processes, but which must possess a combination of strength and ductility which is not attainable in gray iron castings.

BIBLIOGRAPHY

1. ANSON HAYES and W. J. DIEDERICH, "The Mechanism for the Graphitization of White Cast Iron and its Application to the Malleablization Process." *Bulletin* 71, 1924. Engineering Experiment Station, Iowa State College, Ames, Iowa.
2. *American Society for Testing Materials*, "Symposium on Malleable Iron Castings." *Proc. A.S.T.M.*, v. 31 (1931), part II.
3. H. A. SCHWARTZ, "American Malleable Cast Iron." 1922. Penton Publishing Company, Cleveland, Ohio.
4. A. E. WHITE and R. SCHNEIDWIND, "The Metallurgy of Malleablization." *Trans. A.F.A.*, v. XL (1932), p. 88-124.
5. CHARLES MORRISON, "Sand Control on a Continuous Molding Unit in a Malleable Foundry." *Trans. A.F.A.*, v. XLI (1933), p. 127-143.
6. H. W. DIETERT and FRANK VALTIER, "Molding Sand in the Malleable Iron Foundry." *Trans. A.F.A.*, v. XLIV (1936).

REVIEW QUESTIONS

I

What materials are used in the metal mixtures for malleable iron castings?

II

What are the main divisions of the process for the manufacture of malleable iron castings?

III

State the limits in the composition of the metal for malleable iron castings and the reasons for these limits.

IV

Account for the differences in the molding practice for gray iron and malleable iron castings.

V

Outline the changes in the constitution of the metal during the annealing period.

VI

On the basis of their micro-constituents, account for the differences in the physical properties of white cast iron and completely malleablized iron.

VII

What determines the size of castings which can be made of malleable cast iron?

VIII

Account for the difference in the cost of producing malleable iron castings and gray iron castings.

IX

Describe the procedure for measuring the properties of malleable cast iron.

X

Explain the advantages of malleable cast iron over other materials for machine parts.

XI

What effects are produced when malleable iron castings are heated to 500 degrees F., and 1500 degrees F., followed by rapid cooling?

CHAPTER XII

STEEL CASTINGS

PRINCIPLES OF STEEL MAKING—OPEN-HEARTH STEEL—Acid Open-Hearth Practice—Basic Open-Hearth Practice—ELECTRIC FURNACE STEEL—Direct-Arc Furnace—High-Frequency Induction Furnace—CONVERTER STEEL—CRUCIBLE STEEL—MOLDING AND POURING PRACTICE—CLASSIFICATION AND PROPERTIES OF CAST STEEL—Carbon Steel—Alloy Steel—Nickel Steels—Chromium Steels—Manganese-Molybdenum Steels—Vanadium Steels—Austenitic Manganese Steel—Corrosion- and Heat-Resisting Alloys

In all modern industrial developments the trend is towards larger loads, increased power, higher speed, greater reliability, and longer service. These demands can be met only by the use of superior materials for the construction of industrial equipment. Because of its high strength and ductility, as well as the possibility of unlimited variations in size and shape, cast steel is well adapted to many engineering uses. Furthermore, different combinations of mechanical properties can be obtained by changes in the composition of steel, or by the use of heat treatments.

Steel is an alloy of iron and carbon produced completely in the liquid state by refining pig iron. When the metal is cast directly from the steel-making furnaces into the shapes in which it is finally to be used, the product is known as cast steel. The production of steel castings in the United States in 1931 classified as to processes of manufacture was as follows: open-hearth 387,415 net tons, electric 190,437 net tons, converter 10,972 net tons, and crucible 493 net tons. Each of these steel-making processes will be considered in the following discussion, but before describing the commercial processes, some attention will be given to the principles involved in the production of steel.

PRINCIPLES OF STEEL MAKING

Pig iron is the raw material from which all the commercial forms of iron are originally produced. The chemical composition of pig iron includes considerable proportions of carbon, silicon, and manganese. In the remelting processes for iron castings, the amounts of the chemical elements in the cast metal remain about the same as in the pig iron.

However, as steel contains relatively small percentages of carbon and silicon, the amounts of these elements must be decreased in the refining processes used in making steel. This change in composition is brought about by oxidizing reactions which cause the carbon to separate as a gas and the silicon and manganese to form oxides which collect in the slag. The presence of dissolved gases and iron oxide in the metal after the refining period produces an unfavorable condition which is corrected to a large extent by additions of ferromanganese and ferrosilicon to the molten steel.

To understand the reactions involved in the production of steel, it is necessary to distinguish between acid practice and basic practice. These terms relate to the refractory materials used in the furnace linings, or to the compositions of the slags produced during the refining processes. At steel-making temperatures, certain otherwise inert substances have either an acid or basic character, and combine chemically with one another. An acid furnace lining is prepared with materials rich in silica (SiO_2), whereas basic refractories contain magnesia (MgO). When limestone is used in the furnace charges, a basic slag is produced on the bath of metal within the furnace. During the refining period, the phosphorus in the metal is oxidized and the compounds of phosphorus combine with the basic slag. The sulphur content of the metal is also lowered to some extent. Basic slags are produced only in furnaces lined with basic refractories. Likewise, slags containing an excess of silica are produced only in furnaces lined with acid refractories.

OPEN-HEARTH STEEL

Open-hearth steel is used in about 65 per cent of the total production of steel castings in the United States. This process is generally used in the making of steel castings of large and medium size. The average capacity of open-hearth furnaces in steel foundries is 25 tons of metal. The open-hearth furnace has a bricked-in chamber surrounding a shallow hearth which is supported on a concrete foundation as shown in Fig. 115. At one side of the furnace, doors are provided for charging the materials on to the hearth. The opposite side has the tap hole, which is closed with refractory material until the steel is ready to be poured. The walls and roof of the furnace are held in place by steel plates and tie rods.

The gaseous or liquid fuel and the air for combustion are supplied through ports at each end of the furnace. The hot gases pass over the entire length of the hearth and finally heat the brickwork in the regenera-

tive chambers before passing to the stack. The direction of flow of the gases is reversed at regular intervals of about 20 minutes. The air for combustion is preheated by passing through the chambers which were previously heated by the outgoing gases. The regenerative chambers and the flues leading to the hearth are shown in Fig. 115. The hearth of the furnace is constructed of a number of courses of refractory bricks. When an acid lining is prepared, these bricks are of fire clay or silica and underlie a working bottom of silica sand which is originally about 18 inches in thickness. In the preparation of a basic lining, a thick layer

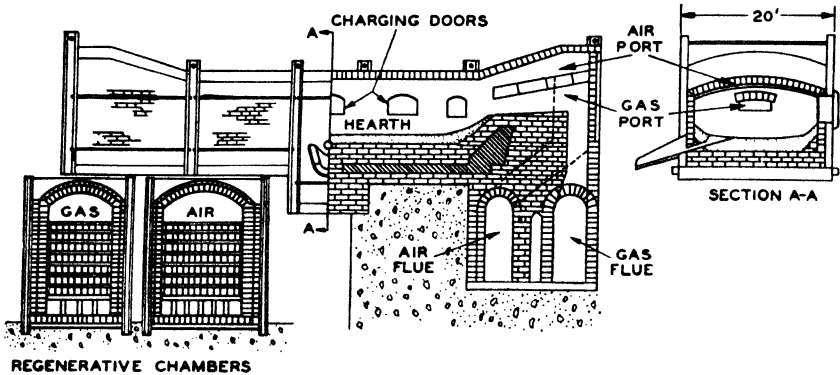

FIG. 115.—OPEN-HEARTH FURNACE

of ground magnesite is fused on to magnesite bricks. The upper part of the walls and the roof are built of silica bricks with intermediate courses of chrome bricks.

Acid Open-Hearth Practice

The pig iron and steel scrap used in the acid open-hearth furnace are always low in phosphorus and sulphur because these elements can not be removed in this refining process. Soon after the metal is melted, a slag forms on the surface of the bath. The silicon, manganese, and carbon in the metal are removed by the action of the oxidizing gases in the furnace or by the slag which is made oxidizing with additions of iron ore. The oxides of silicon and manganese collect in the slag, and the oxide of carbon passes off as a gas. Before the metal is tapped from the furnace, ferromanganese and ferrosilicon are added to deoxidize the metal and to produce the desired composition in the steel. The melting and refining of each heat of acid open-hearth steel require from 5 to 6 hours.

Basic Open-Hearth Practice

In the basic process, limestone is charged with the pig iron and steel scrap into the open-hearth furnace. At the end of the melting period, the limestone is completely changed to lime which combines with the oxides of silicon and manganese to form a basic slag on the bath of metal. Most of the phosphorus and some sulphur are taken up by this basic slag. Iron ore is then added to the bath to react with the carbon and to cause its removal to the extent desired. In order to deoxidize the metal, and also to obtain the correct amounts of manganese and silicon in the steel, ferromanganese and ferrosilicon are added to the furnace just before tapping, or are supplied to the metal as it is poured from the furnace. From 6 to 8 hours are required to make one heat of basic open-hearth steel.

ELECTRIC FURNACE STEEL

In 1931 about 32 per cent of the steel castings produced in the United States were made of electric furnace steel. Within recent years the electric furnace has been replacing other types of furnaces in steel foundries. On account of the low cost and availability of large quantities

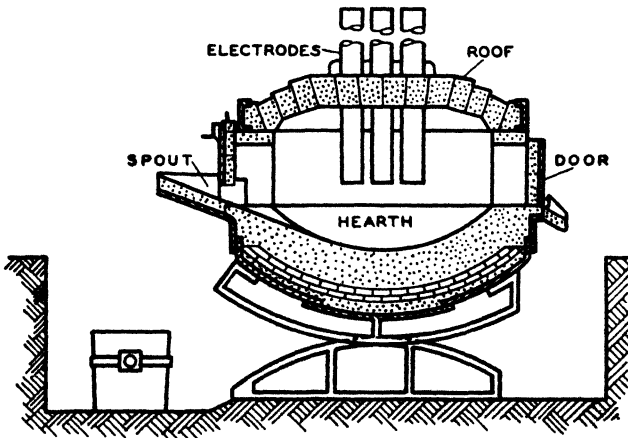

FIG. 116.—CROSS SECTION OF DIRECT-ARC FURNACE

of steel scrap of excellent quality, the electric furnace is operated chiefly as a melting unit for charges of steel scrap. The metal is deoxidized and special alloys are added to obtain the desired analysis in the castings. An acid lining is usually provided in the furnace because the

removal of phosphorus and sulphur from the metal is not necessary, and acid refractories cost less than basic refractories.

Electric furnace steel is particularly satisfactory for the manufacture of small steel castings because the highly superheated condition of the metal permits it to flow readily into thin sections. The advantage of electric furnace practice lies in the possibility of obtaining high temperatures without introducing impurities from the fuel. Also, the operating conditions can be more readily controlled in this practice than in any of the other steel-making processes.

Direct-Arc Furnace

The two types of furnaces which are employed in the steel foundry are the direct-arc furnace and the high-frequency induction furnace.

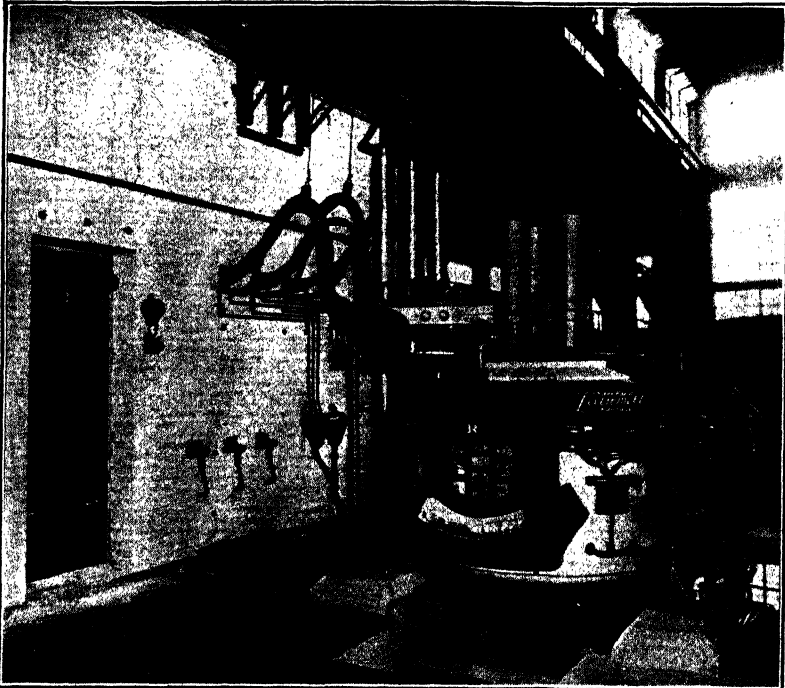

Courtesy of Pittsburgh Lectromelt Furnace Corporation

FIG. 117.—DIRECT-ARC FURNACE

The construction of a direct-arc furnace is shown in Fig. 116. This furnace has a heavy steel shell lined with refractories and a roof which

is prepared separately and replaced when necessary. Three electrodes connected to a three-phase alternating-current supply are supported externally and extend through the roof into the furnace. The arcing of the current is maintained automatically by lowering and raising the electrodes. An installation of a direct-arc furnace is illustrated in Fig. 117. A charging door is provided at one side of the furnace, and a pouring spout is on the opposite side. This furnace is mounted so that it can be tilted for charging, slagging, or pouring. The capacities of electric arc furnaces used in steel foundries range from $1\frac{1}{2}$ to 6 tons of metal in each heat.

High-Frequency Induction Furnace

The latest development in the adaptation of electric heat to steel melting is in the use of the high-frequency induction furnace. The construction of this furnace is shown in Fig. 118. A high-frequency alternating current is supplied to the water-cooled copper coil which surrounds the crucible. The secondary current which is induced in the metal charge within the crucible produces the heat for melting and superheating the charge. A cold charge of metal can be melted rapidly without contamination from outside sources. After the metal is melted, the induced current causes

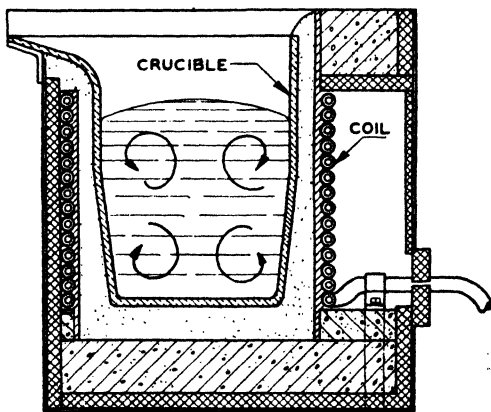
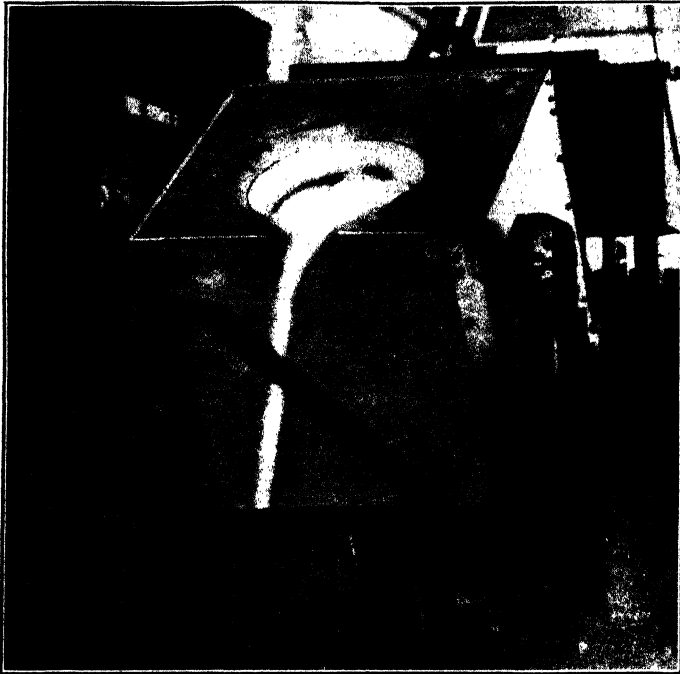

FIG. 118.—CROSS SECTION OF HIGH-FREQUENCY INDUCTION FURNACE

a thorough stirring of the contents of the crucible. The capacities of industrial furnaces now in use range from 100 to 8,000 pounds of steel in each melt. These furnaces are operated with 960- or 1,000-cycle, single-phase generators in units of 150- to 1,200-kilowatt output. A modern installation of a high-frequency induction furnace used in the manufacture of alloy steel castings is shown in Fig. 119. The operation of this furnace is particularly advantageous because of the small metal losses during melting and the possibility of accurate control of the composition as well as of the temperature of the metal.



Courtesy of Ajax Electrothermic Corporation

FIG. 119.—HIGH-FREQUENCY INDUCTION FURNACE

CONVERTER STEEL

The converter process which is used in steel foundries consists of melting mixtures of steel scrap and pig iron in a cupola and refining the molten metal in a converter. The construction of a side-blown converter is shown in Fig. 120. The shell is made of heavy steel plate and is supported on two standards so that it can be rotated to any position desired for charging and pouring the metal. A mixture of ganister, silica sand, and fire clay is rammed into place to form the lining. When the converter is in operation, air is supplied from a blower through the hollow trunnion into the tuyere box.

The charges for the cupola usually contain from 30 to 60 per cent of steel scrap and the remainder of pig iron. The metal from the cupola contains about 1.60 per cent silicon and not over 0.60 per cent manganese. The oxidation of silicon, manganese, and carbon furnishes the heat for the refining process. The cupola which is used for melting the metal for the converter is operated in the same way as in gray iron

practice. At the beginning of operations, it is necessary to preheat the lining of the converter. The molten metal is transferred from the cupola in a large ladle and is poured directly into the converter. After the converter is tipped to the correct angle, air is supplied from a blower at a pressure of less than 6 lb. per sq. in. The length of time for blowing is from 15 to 30 minutes, the end of the blowing period being judged by inspecting the flame issuing from the mouth of the converter. The amount of steel produced in each heat is about 2 tons.

The molten metal as it leaves the converter contains no silicon or

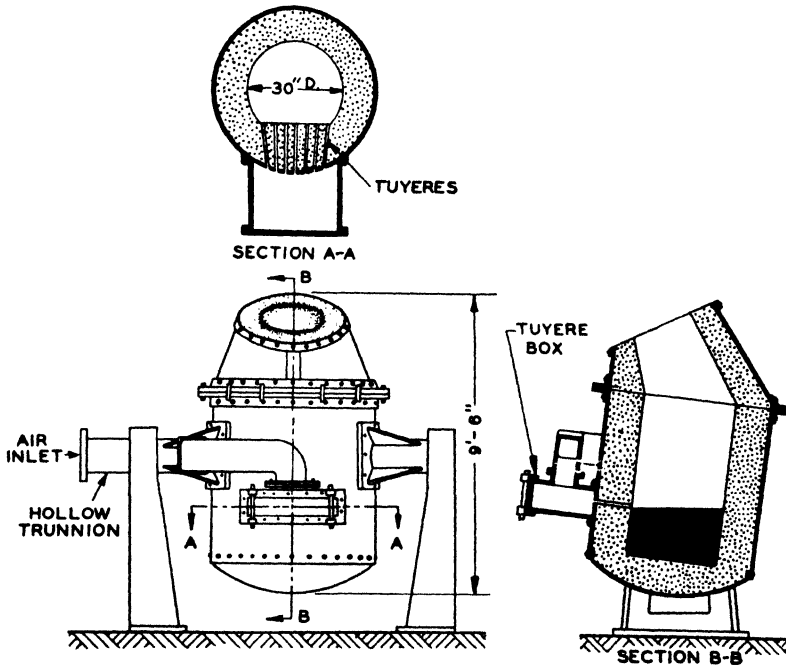

FIG. 120.—SIDE-BLOWN CONVERTER

manganese, and only a small percentage of carbon. It is necessary to deoxidize the metal by ferromanganese and ferrosilicon, which are added in the converter or are preheated in the ladle into which the metal is poured from the converter. These alloys are supplied in sufficient amounts to provide the desired content of manganese and silicon in the metal. Carbon is increased by the carbon content of the ferro-alloys or by adding powdered coke to the metal in the ladle.

Converter steel is produced at very high temperatures, and is therefore well adapted to the pouring of thin and intricate castings. As the large losses of metal by oxidation both in the cupola (about 5 per cent)

and in the converter (about 10 per cent) have handicapped this process, converters have been replaced by electric furnaces in many steel foundries.

CRUCIBLE STEEL

The crucible process is the oldest and simplest of the methods for producing steel. In this process, steel is made by melting accurately proportioned mixtures of wrought iron and/or steel scrap, charcoal, and ferro-alloys. The crucibles, which are heated in a regenerative gas-fired furnace, hold from 50 to 100 pounds of metal. The charges remain in the covered crucibles until all the deoxidizing reactions are completed, and the metal becomes quiet; then the crucibles are taken from the furnace and the steel is poured.

The high quality which can be obtained in crucible steel is due to the control of the composition and the temperature of the metal in the process, as well as to the freedom from the influence of oxidizing gases. This steel is particularly suited to the production of small castings requiring special physical properties. Less than one-tenth of one per cent of the total tonnage of steel castings produced in the United States is made in crucibles.

MOLDING AND POURING PRACTICE

As steel is poured at high temperatures (about 2,900 degrees F.) very refractory sand mixtures must be used in the molds for steel

castings. Furthermore, the permeability of the molding sand must be high to permit the rapid removal of the gases which are formed at the high temperatures within the molds. A quartz sand of relatively large grain size (retained on 100-mesh sieve) is mixed with a small proportion of fire clay or bentonite and usually some additional binder such as molasses or gelatinized starch. These mixtures are prepared in mechanical mixers of the muller type as shown in Fig. 121. Water is added during the mixing operation to obtain the desired plasticity.

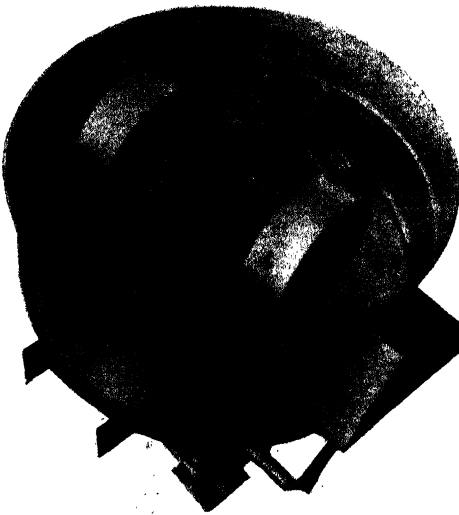

Courtesy of National Engineering Company

FIG. 121.—MULLER-TYPE SAND MIXER

Green-sand molds are generally used for steel castings having light sections and intricate designs because these molds offer less resistance than dry-sand molds to the normal contraction of the metal. Two types of sand mixtures are commonly used in making green-sand molds, namely facing sand and backing or heap sand. A layer of finely sifted facing mixture prepared from old sand, new sand, and additional bonding material is placed next to the pattern when the molds are made. The backing sand is usually taken from the heaps of old sand and is

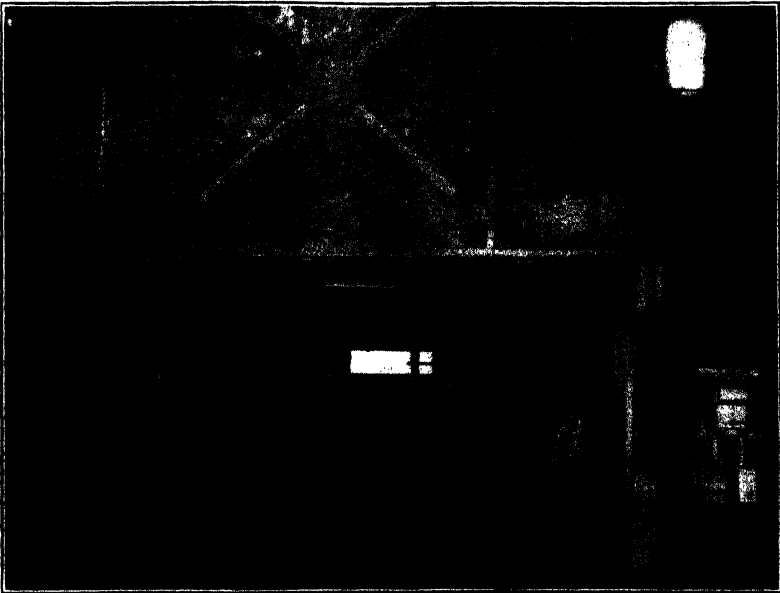

Courtesy of Drying Systems, Inc.

FIG. 122.—MOLD DRYING OVEN

used to fill the flasks back of the facing sand. The following properties are desired in the synthetic sand mixtures used in the steel foundry:

	Facing Sand	Backing Sand
Strength in compression, lb. per sq. in.	8 to 10	4 to 6
Permeability	140 to 180	180 to 220

To maintain the desired permeability of the molding sand, the fine material which gradually accumulates in the sand is removed by screen-

ing or air separation. As a rule, the fine inert material and bond are kept below 10 per cent of the weight of the sand.

Because of their greater rigidity and resistance to the cutting action of the metal, **dry-sand molds** are often used for steel castings with heavy sections and plain designs. These molds are made from mixtures of silica sand and fire clay or bentonite, together with small proportions of sand binders such as molasses, drying oils, or gelatinized starch. A

refractory coating usually of powdered silica held in suspension in a solution of molasses and water is often applied to the mold surfaces. After the molds are finished, they are placed in ovens where they are heated until all moisture is removed and the bonding material has hardened. A large mold drying oven is shown in Fig. 122.

On account of the high shrinkage of steel, many risers are provided in the molds to supply extra metal to the heavy parts of the castings. (See Fig. 84 in Chapter VI.) Furthermore, large gates are used on steel castings because the metal solidifies at high temperatures, and small openings would freeze too quickly. In order to strengthen intersecting mem-

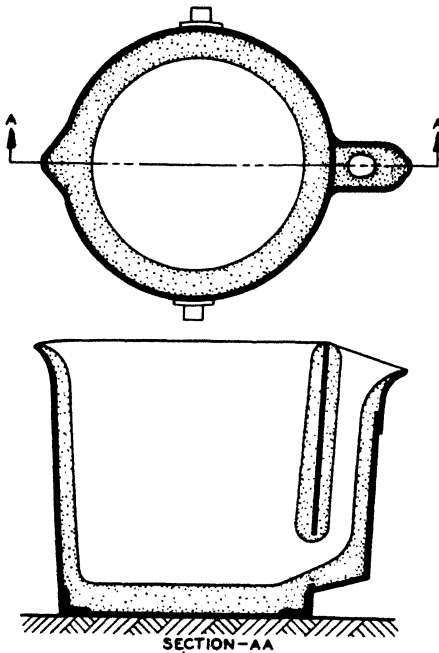

FIG. 123.—TEAPOT-SPOUT LADLE

bers of castings, it is common practice in steel molding to cut away the sand in certain parts of the mold to form brackets on the castings. The brackets solidify earlier than the sections which they join and thereby serve as strengthening ribs during the cooling of the metal.

Molten steel is transferred in large ladles from the furnace directly to large molds or to other parts of the foundry where it is poured into hand ladles for distribution to small molds. The bottom-pouring ladle used for steel has a nozzle made of fire clay and graphite through which the metal is discharged. The flow of metal is regulated by a lever and a rod to which a stopper made of fire clay and graphite is attached. The

steel rod has a covering of refractory material to insulate it from the heat of the molten metal which surrounds it. Another design of ladle which is often used in steel foundries has a teapot spout as shown in Fig. 123. The metal can be poured from this ladle without disturbing the cover of slag which collects above the metal.

CLASSIFICATION AND PROPERTIES OF CAST STEEL

The two main groups of steels used in castings are carbon steels and alloy steels. The properties of carbon steels are related directly to the percentages of carbon which they contain, whereas the properties of alloy steels are dependent upon the presence of metallic elements other than those found in carbon steels or upon a considerable increase in either silicon or manganese. The bulk of the steel castings produced in the United States is made of carbon steel, although alloy steels are being employed in increasing amounts for uses in which high strength as well as resistance to shock and wear are important.

Carbon Steels

The elements found in carbon steels are iron, carbon, manganese, silicon, sulphur, and phosphorus. The amounts of these elements and their effects on the qualities of cast steel will now be considered. The range of **carbon** in most carbon steel castings is from 0.18 to 0.45 per cent, although castings for special purposes are made with the carbon below and above these limits. As the carbon content increases, the tensile strength and yield strength are raised, but the percentage elongation and reduction of area are lowered. For most structural purposes, steel with a high ductility (above 18 per cent elongation) is preferred, a condition which limits the maximum percentage of carbon in cast steel.

The **manganese** content of carbon steel castings is within the range of 0.5 to 1.0 per cent. The beneficial effect of this element lies in deoxidizing the liquid steel, which results in improving the mechanical properties of the metal.

In all the processes for making steel, **silicon** is used as a deoxidizer or cleanser of the metal, and is added in sufficient quantity to provide a residual content of 0.20 to 0.75 per cent in the cast steel.

Specifications for steel castings generally limit the **sulphur** content to a maximum of 0.06 per cent. An excessive proportion of sulphur results in the formation of constituents which cause cracks in steel castings.

As a rule, the phosphorus in steel for castings does not exceed 0.05 per cent. When present in larger amounts, this element causes a decrease in the shock-resisting property of cast steel.

The structure of carbon steel in the condition as cast is shown on the micrograph in Fig. 124. The large grains of ferrite and pearlite are formed during the slow cooling of the steel in the sand molds. To decrease the grain size and thereby improve the mechanical properties, carbon steel castings are usually heated throughout to 1650 degrees F. and cooled in the furnace or in air at room temperature. The structure of cast steel after the annealing treatment is shown in Fig. 125. Other heat treatments such as quenching in oil or water and subsequent tem-

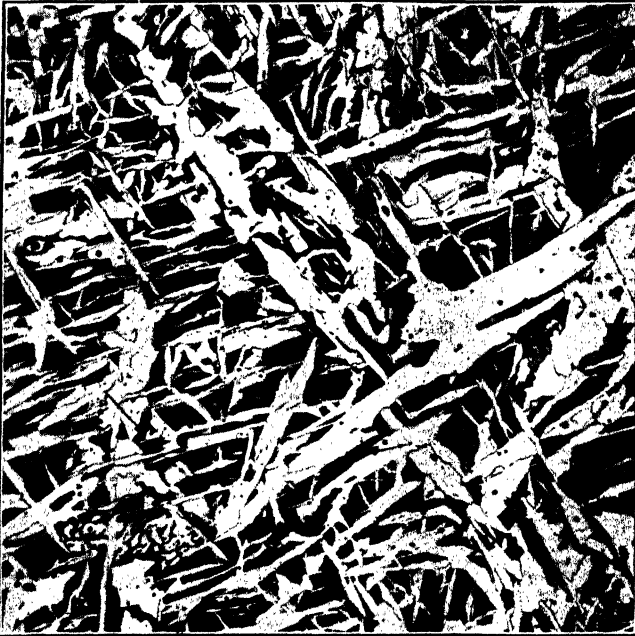

FIG. 124.—CAST CARBON STEEL, $\times 100$

With large grains as cast. White constituent is ferrite. Dark constituent is pearlite.

pering may be used when greater hardness than that obtained by annealing is required.

Many combinations of mechanical properties can be obtained by changes in carbon content or by using different heat treatments. In the standard specifications for carbon steel castings (*A.S.T.M.* Designation: A27-24) given in the Appendix, two classes based on chemical com-

position, and three grades based on tensile properties, are specified for different kinds of service. The following average properties are obtained with cast carbon steel containing 0.25 per cent carbon:

	As Cast	Annealed	Quenched and Tempered
Tensile strength, lb. per sq. in.	65,000	70,000	80,000
Yield point, lb. per sq. in.	35,000	40,000	50,000
Elongation in 2 inches, per cent.	20	30	20
Reduction of area, per cent.	30	45	30
Brinell hardness.	140	130	160

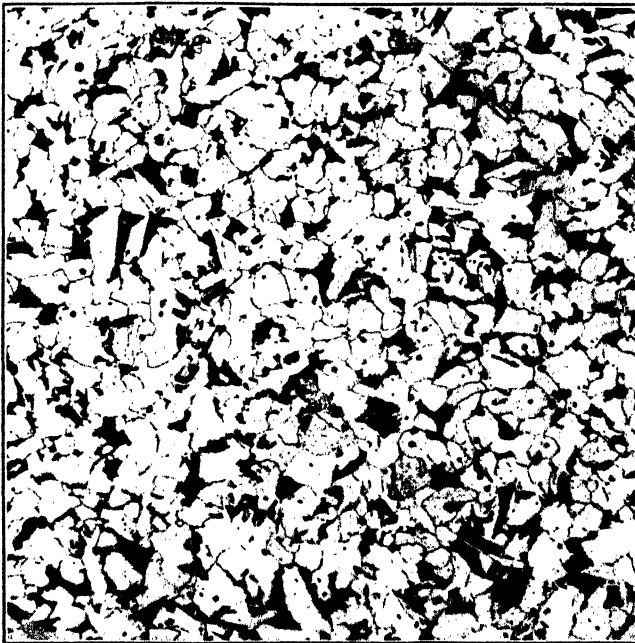

FIG. 125.—CAST CARBON STEEL, $\times 100$

With small grains after annealing. White constituent is ferrite. Dark constituent is pearlite.

Alloy Steels

For some uses of steel castings, combinations of properties superior to those obtainable in plain carbon steels are required. The addition of special elements to steel for castings has resulted in improvements in yield strength and ductility, as well as resistance to shock and wear. The

alloying elements used most generally, either singly or in combinations, are nickel, chromium, molybdenum, vanadium, and manganese. Nickel and molybdenum, as they are not readily oxidized, may be supplied in the furnace charges. Chromium and manganese are usually added to the furnace a short time before the heat is tapped. Vanadium is often placed in the stream of metal entering the ladle because it is oxidized rapidly. A few of the most widely used alloy steels for castings will be described in the following paragraphs.

Nickel Steels.—Nickel occurs chiefly in solid solution in the ferrite and causes an increase in the tensile strength of steel without decreasing its ductility. Nickel steels are used in locomotive castings, ship castings, rolling-mill machinery, bridge castings, and for other purposes. The ranges of composition for these steels are as follows: carbon, 0.20 to

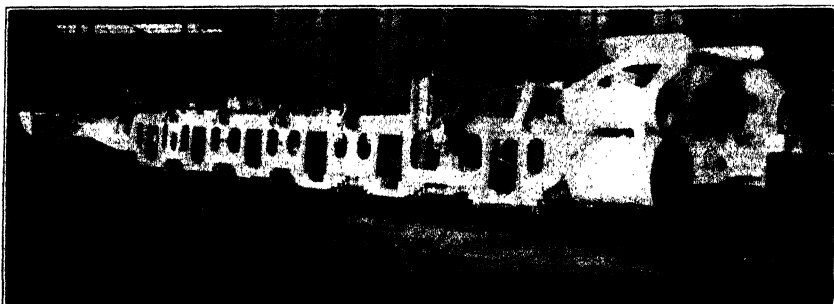

Courtesy of General Steel Castings Corporation

FIG. 126.—LOCOMOTIVE BED OF CAST ALLOY STEEL

0.30 per cent; nickel, 2.00 to 2.25 per cent; manganese, 0.80 to 1.00 per cent; silicon, 0.25 to 0.40 per cent; phosphorus and sulphur, less than 0.05 per cent. Castings made of these steels are heated to 1650 degrees F., cooled in air, and tempered at 1200 degrees F. The properties obtained after heat treating are as follows:

Tensile strength, lb. per sq. in.	90,000–105,000
Yield point, lb. per sq. in.	55,000– 65,000
Elongation in 2 inches, per cent.	28–22
Reduction of area, per cent.	55–42

Chromium Steels.—Chromium combines with carbon to form carbides which increase the hardness and strength of steel. The chromium steels are used for wear-resisting parts of machines, such as sprockets and sheaves. The carbon content of these steels is usually between 0.35 and 0.45 per cent, and the chromium between 0.50 and 0.90 per cent,

although for some uses the chromium may be as high as 3.00 per cent. The tensile properties obtained with cast steel containing 0.38 per cent carbon and 0.81 per cent chromium, after it is cooled in air from 1650 degrees F. and tempered at 1250 degrees F., are as follows:

Tensile strength, lb. per sq. in.	97,000
Yield point, lb. per sq. in.	55,000
Elongation in 2 inches, per cent.	19
Reduction of area, per cent.	30

Manganese-Molybdenum Steels.—Steels which contain both manganese and molybdenum as alloying elements have high yield strength and resistance to shock, and retain high strength at elevated temperatures. A high manganese insures good deoxidation of the steel, and the molybdenum tends to inhibit grain growth. The usual range of composition is 0.30 to 0.40 per cent carbon, 1.00 to 1.75 per cent manganese, and 0.20 to 0.40 per cent molybdenum. Large castings made with these alloy steels are heat treated by cooling in air from a temperature of 1650 degrees F. and tempering at 1250 degrees F. The tensile properties obtained after heat treating are about as follows:

Tensile strength, lb. per sq. in.	96,000
Yield point, lb. per sq. in.	68,000
Elongation in 2 inches, per cent.	26
Reduction of area, per cent.	58

Vanadium Steels.—The influence of vanadium in steel is to decrease the grain size and to produce a more uniform structure throughout large sections. Castings for the construction of locomotives and other heavy machinery, which require resistance to shock and vibration, are often made of vanadium steel. The composition of this steel is as follows: carbon, 0.30 to 0.40 per cent; vanadium, 0.16 to 0.20 per cent; manganese 0.80 to 1.00 per cent; silicon, 0.25 to 0.30 per cent; phosphorus and sulphur, less than 0.05 per cent. The castings with large and irregular sections are heated to 1800 degrees F., cooled in air, and tempered at 1250 degrees F. The following minimum properties are obtained with cast vanadium steel after heat treating:

Tensile strength, lb. per sq. in.	95,000
Yield point, lb. per sq. in.	65,000
Elongation in 2 inches, per cent.	18
Reduction of area, per cent.	30

Austenitic Manganese Steel.—A special manganese steel, which has a high tensile strength, together with extreme toughness and great resistance to wear, was invented by Robert A. Hadfield in 1882. The usual composition of this alloy steel is 1.00 to 1.40 per cent carbon, 11 to 14 per cent manganese, 0.30 to 1.00 per cent silicon, less than 0.05 per cent sulphur, and less than 0.06 per cent phosphorus. Manganese steel is produced in a basic-lined open-hearth or electric furnace, or by the addition of ferromanganese to molten metal from the converter, open-hearth, or electric furnace. When the ferromanganese is supplied to molten steel in the ladle, it is melted separately and is added in the proportion which will give the desired composition in the castings. The micro-constituents in the metal after the castings cool in the molds are austenite and free cementite. The presence of cementite causes the metal to be very hard and brittle. To bring about the complete solution of the cementite and thus obtain only austenite, the castings are heated to 1850 degrees F. and quenched in cold water. After this heat treatment, the steel is non-magnetic.

All holes which are needed in assembling manganese steel castings are made by cores in the molds because it is practically impossible to drill this material. The shrinkage of manganese steel is very high, about $\frac{5}{16}$ inch per foot. As the ductility of the metal is low before heat treating, and as the quenching treatment without tempering may cause high stresses in some parts of castings, special attention should be given to the design, as well as to the molding, for manganese steel castings.

The tensile strength of cast manganese steel after being heat treated is over 100,000 lb. per sq. in., and the elongation in a 2-inch gage length is from 15 to 35 per cent. Test specimens of this material are cast nearly to size and are finished by grinding. When manganese steel is heated to temperatures above 700 degrees F., the superior qualities of this metal are impaired and can be regained only after another heat treatment.

The surface hardness of austenitic manganese steel is increased rapidly by cold working; this characteristic is of particular advantage in castings subjected to wear by a pounding or rolling action. Some typical castings made of manganese steel are: the plates for rock crushers; frogs, crossings, and switches for railroad tracks; dipper teeth and lips for excavating machinery; and gears, racks, and sheaves for many purposes.

Corrosion- and Heat-Resisting Alloys.—Castings containing large percentages of the alloying elements are often produced in steel foundries where suitable melting equipment and other facilities are available. The most extensively used alloys for resisting corrosion and high tem-

peratures contain chromium and/or nickel. The chromium alloys are quite stable in atmospheres containing oxidizing and sulphur-rich gases at high temperatures. However, the strength and ductility of these

TABLE VI
CORROSION- AND HEAT-RESISTING ALLOYS

Alloy	Carbon, %	Chromium, %	Nickel, %	Max. Temp., Degrees F.
A	0.30 Max.	17-21	1600
B	0.25-0.50	26-30	2000
C	0.15 Max.	18-22	8-10	1800
D	0.30 Max.	26-30	8-12	2000
E	0.60 Max.	14-17	34-37	2000

alloys are decreased at high temperatures because large grains are formed in the metal. An improvement in the tensile properties of the special alloys is obtained by combining nickel with chromium. The ranges of

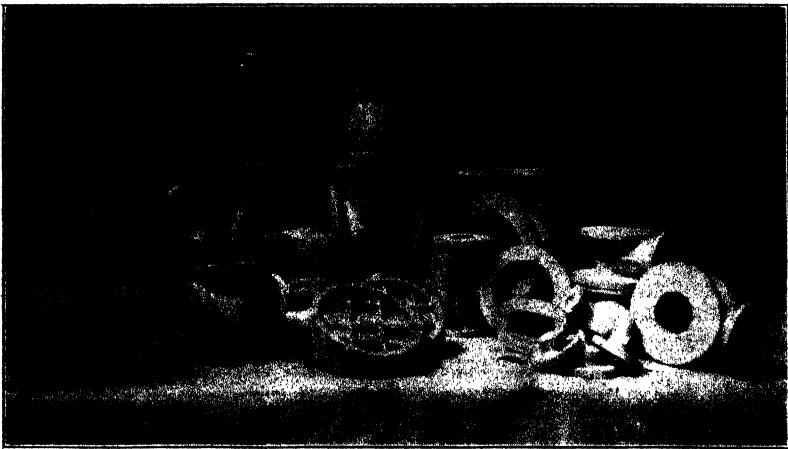

Courtesy of Lebanon Steel Foundry

FIG. 127.—ALLOY STEEL CASTINGS FOR VALVES
18% Chromium, 8% Nickel, 0.15% Carbon

the special elements in a few of the most widely used alloys for resisting corrosion and high temperatures are given in Table VI. Other elements in these alloys are: manganese from 0.25 to 0.75 per cent; silicon, up to

2 per cent; sulphur, less than 0.05 per cent; phosphorus, less than 0.05 per cent; and iron making up the remainder.

Alloys A and B in Table VI are resistant to attack by some acid solutions and are employed in equipment for chemical plants. Castings of these alloys are heat treated mainly to relieve stresses. Alloy C has good mechanical properties and resists corrosion under many conditions. All castings made of this alloy are heat treated by quenching in water after heating to temperatures above 1900 degrees F. Typical applications of alloy C include parts for pumps, valve bodies (see Fig. 127), equipment for dairies, marine fittings, and ornamental work. Alloy D is used in castings which are required to resist the corrosive action of solutions handled in the chemical industries. These castings are not heat treated. Alloy E is particularly satisfactory for resisting oxidation at high temperatures and is used in carburizing boxes and furnace parts. No specific alloy is suited for all corrosion- and heat-resisting purposes. The selection of a cast metal for a definite application must be based upon all of the operating conditions.

BIBLIOGRAPHY

1. JOHN HOWE HALL, "The Steel Foundry." 1914. McGraw-Hill Book Company, New York, N. Y.
2. DAVID ZUEGE, "Alloy Cast Steels." *Trans. A.F.A.*, v. 37 (1929), p. 361-384.
3. G. P. ROGERS, "Statistical Data on Steel Casting Production in the United States." *Proc. A.S.T.M.*, v. 32 (1932), Part II, p. 50-57.
4. C. H. LORIG and C. E. WILLIAMS, "Physical and Mechanical Properties of Some Well-Known Cast Steels." *Proc. A.S.T.M.*, v. 32 (1932), Part II, p. 114-196.
5. JOHN HOWE HALL, "Austenitic Manganese Steel Castings." *Proc. A.S.T.M.* v. 32 (1932), Part II, p. 238-250.
6. H. W. GILLETT and J. L. GREGG, "Molybdenum in Cast Steel." *Trans. A.F.A.*, v. XLI (1933), p. 193-198.
7. ALBERT G. ZIMA, "Properties and Uses of Some Cast Nickel Alloy Steels." *Trans. A.F.A.*, v. XLI (1933), p. 199-224.
8. JEROME STRAUSS, "Vanadium in Steel Castings." *Trans. A.F.A.*, v. XLI (1933), p. 225-244.
9. J. H. CRITCHETT, "Chromium in Steel Castings." *Trans. A.F.A.*, v. XLI (1933), p. 245-255.
10. JEROME STRAUSS, "Castings of Corrosion-Resistant Steels." *Proc. A.S.T.M.* v. 32 (1932), p. 213-230.
11. *American Foundrymen's Association*, Chicago, Ill. "Cast Metals Handbook." 1935.
12. R. A. BULL, "Special Steels for Castings." *A.S.M.E. Paper* Dec. 1932.

REVIEW QUESTIONS

I

What changes in the composition of the metal take place during the refining of pig iron in the steel-making processes?

II

Explain the meaning of acid practice and basic practice as related to steel making.

III

Describe the construction of the furnace and outline the practice for producing basic open-hearth steel.

IV

Discuss the operation of two types of electric furnaces used in the steel foundry.

V

State the average capacities of the different steel-making furnaces.

VI

Explain the differences in molding practice for steel castings and iron castings.

VII

State the range of composition of cast carbon steel.

VIII

On the basis of its micro-constituents, account for the properties of carbon steel as cast.

IX

Compare the tensile properties of carbon steel and one alloy steel after heat treating.

X

State the important physical properties of austenitic manganese steel.

XI

Specify the composition of a heat-resisting alloy.

XII

State the composition of an alloy cast steel for resisting corrosion.

CHAPTER XIII

NON-FERROUS METAL CASTINGS

CONSTITUTION OF ALLOYS—PREPARATION OF ALLOYS—MELTING EQUIPMENT—Crucible Furnaces—Metal-Pot Furnaces—Direct-Fired Furnaces—Electric Furnaces—Detroit Rocking Furnace—Ajax-Wyatt Induction Furnace—Ajax-Northrup Induction Furnace—EQUIPMENT FOR MEASURING TEMPERATURES—MELTING LOSSES—MOLDING PRACTICE—COPPER CASTINGS—Melting Practice—BRASS CASTINGS—Yellow Brass—Red Brass—Manganese (Bronze)—BRONZE CASTINGS—Gun-Metal—Phosphor Bronze—Aluminum Bronze—ANTI-FRICTION ALLOYS—Copper-Base Bearing Metals—Tin-Base Bearing Metals—Lead-Base Bearing Metals—Cadmium-Base Bearing Metals—ALUMINUM ALLOY CASTINGS—Aluminum Casting Alloys—Aluminum-Copper Alloy—Aluminum-Silicon Alloy—Foundry Practice—MAGNESIUM ALLOY CASTINGS—Magnesium Casting Alloy—Foundry Practice—DIE-CASTING ALLOYS—“MONEL METAL”—SUMMARY OF THE NON-FERROUS ALLOYS

The physical and chemical requirements of metal castings are seldom obtainable with the separate metals; hence it is generally necessary to combine two or more elements to procure the desired properties. Combinations of metallic elements or of metallic with non-metallic elements are known as **alloys** when the constituents are completely dissolved in the liquid state and do not separate into distinct layers when solid. The properties of alloys are often quite different from those of the metals from which they were prepared and therefore cannot be predicted from the properties of the separate metals.

The non-ferrous casting alloys of greatest industrial importance contain copper, aluminum, zinc, lead, tin, nickel, antimony, and magnesium. These metals are purchased for foundry use in a relatively pure form known as **primary metals**, or in combinations of the metallic elements known as **ingot metal**. The latter product is usually obtained by melting and purifying scrap metals (**secondary metals**), and adjusting the composition to conform to definite chemical specifications. Some producers of ingots for foundry use prepare the desired alloys from primary metals and market the product as **special composition ingots**.

Specifications for many of the non-ferrous metals and their alloys have been established by the *American Society for Testing Materials* and

are available in the publications of that society. An extensive list of non-ferrous alloys may be found in Vol. 30 (1930), Part I, of the *Proceedings of the American Society for Testing Materials*. Only a few compositions in each class of these important alloys will be described in this chapter, and attention will be given to the characteristic effects of the chemical constituents on the properties of the alloys.

CONSTITUTION OF ALLOYS

The physical properties of alloys are dependent directly upon the proportions and form of their micro-constituents. Furthermore, the constituents of the alloys are controlled by the chemical composition, as well as the heating and cooling conditions to which the alloys have been subjected. The types of constituents which may be present in alloys are: (1) pure metals; (2) chemical compounds; and (3) solid solutions of one metal in another, or of a compound in a metal. Eutectics, which are formed of combinations of pure metals, compounds, or solid solutions, are also found in the non-ferrous alloys. The different types of constituents have characteristic qualities which determine the various properties of the commercial alloys. As a rule, the pure metals are relatively soft and are of value chiefly in combination with other types of constituents. Chemical compounds are usually hard, and the hard constituents have an important function in the structure of anti-friction alloys. Solid solutions possess favorable mechanical properties. Many of the non-ferrous alloys which have high strengths are composed of solid solutions. Eutectics have low melting points and because of this property serve some useful purposes.

PREPARATION OF ALLOYS

The general procedure for preparing alloys is to melt the metal which forms the greater part of the alloy, and then to add the other metals in the order of their decreasing melting points. This procedure is used in producing the copper-base alloys. When an alloy is required with a large proportion of one metal and a small proportion of another, it is most satisfactory to combine equal weights of the two metals and to add this alloy in the correct ratio to the predominant metal. This practice is usually employed in preparing the aluminum casting alloys. As a rule, the furnace charges contain scrap metals, including gates and risers from previous heats, some ingot metal, and sufficient primary metals to obtain the desired composition for the castings.

MELTING EQUIPMENT

The temperatures at which most of the non-ferrous metals and alloys melt are lower than the melting temperatures of those alloys in which iron is the chief constituent. The data presented in Table XV in the Appendix give the melting points of the metallic elements and some alloys. It is apparent that widely varying temperatures are required in melting the different metals and alloys for castings. This has resulted in the utilization of many types of melting furnaces for the non-ferrous metals and their alloys. The following outline classifies these industrial furnaces into three groups based on their construction or operation.

I. Stationary type

Crucible furnace.
Metal-pot furnace.
Reverberatory furnace.
Cupola furnace.

II. Tilting type.

Crucible furnace.
Metal-pot furnace.
Reverberatory furnace.
Barrel furnace.

III. Rocking type

Barrel furnace.

The metal is removed from a stationary furnace by lifting the crucible from the furnace, by dipping the molten metal from a pot in the furnace, or by tapping the metal from a hearth within the furnace. With those designs which provide some means for tilting the furnace, the metal is

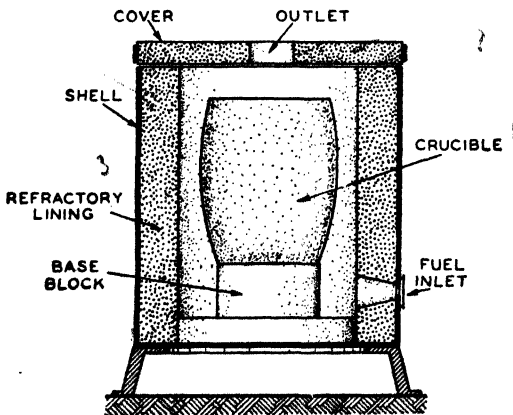

FIG. 128.—CROSS SECTION OF STATIONARY CRUCIBLE FURNACE

usually poured into ladles for distribution to the molds. The rocking type of furnace has been developed to promote thorough mixing of the metals within the furnace, as well as to obtain the transfer of heat from the walls of the furnace to the metal.

In the following discussion on melting equipment for the non-ferrous metals and alloys, indirect-fired furnaces are described as

crucible furnaces and metal-pot furnaces. The direct-fired furnaces include the reverberatory furnace, the barrel furnace, and the cupola furnace. Three types of electric furnaces are described for melting the copper-base and nickel-base alloys.

Crucible Furnaces

All the non-ferrous metals and their alloys can be melted within graphite crucibles which are heated in furnaces of the stationary or tilt-

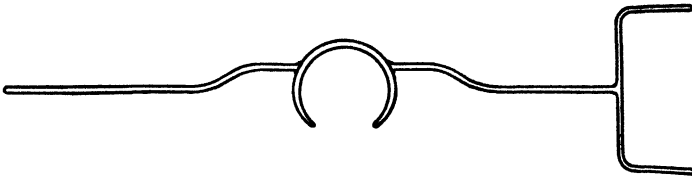

FIG. 129.—CRUCIBLE SHANK WITH SIDE OPENING

ing types. With the design of furnace shown in Fig. 128, the crucible is lifted out by tongs and is transferred to the molds for pouring. The tongs are inserted through the top of the furnace after removing the cover. Crucible furnaces of the stationary type are often arranged in pits below the level of the foundry floor. Other designs of stationary furnaces provide for raising the shell and lining so that the crucible can be picked up with the aid of a shank which has an opening in the side as illustrated in Fig. 129.

In another type of crucible furnace shown in Fig. 130, the crucible is

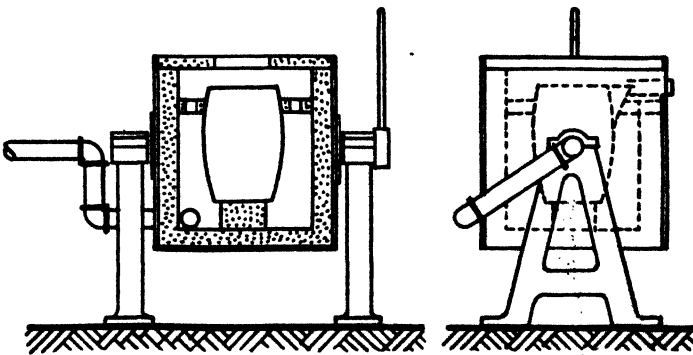

FIG. 130.—TILTING CRUCIBLE FURNACE

held in position while its contents are removed by tilting the furnace. The molten metal is transferred from the tilting crucible furnace to the molds in carrying ladles. The crucible furnace is well adapted to the

melting of a variety of alloys in relatively small batches. By using separate crucibles for different compositions of alloys, the possibility of contamination is eliminated.

The fuels used for crucible melting are anthracite coal, coke, oil, and gas. With this indirect method of heating, it is possible to prevent the products of combustion from coming in contact with the metal. In



FIG. 131.—CRUCIBLE FURNACE

those furnaces using coal or coke, the crucible rests on the fuel bed, and in the gas-fired and oil-fired furnaces the crucible is supported on a block of refractory material. The construction of a gas-fired furnace which has a movable shell is illustrated in Fig. 131. The burners for gaseous or liquid fuels are placed so that the flames enter at a tangent and encircle the entire crucible on their way to the outlet.

The standard sizes and capacities of graphite crucibles are listed in Table XVIII in the Appendix. It is important that the crucibles be kept in dry storage and be preheated slowly to temperatures above 250 degrees F. before being exposed to the high temperatures used in melting. The number of heats which can be

obtained with one crucible depends upon the alloys which are melted as well as upon the care given to the handling of the crucible. Under favorable conditions it is possible to melt in a single crucible three heats of nickel, or twenty-five heats of copper, or forty heats of bronze, or sixty heats of the white-metal alloys.

Metal-Pot Furnaces

The alloys of aluminum, magnesium, antimony, zinc, lead, cadmium, and tin can be melted in a metal pot. Because the metal pot conducts heat more readily than a graphite crucible, the metal container is preferred for melting those alloys which have relatively low melting points. The metal pot is supported by its rim in a stationary furnace as shown in Fig. 132. Combustion of the gas or oil fuel takes place in the space between the pot and the furnace wall. The products of combustion are discharged through a flue, and do not come in contact with the metal which is being melted in the pot.

The method of transferring the metal from the pot in a stationary furnace is to dip a hand ladle into the molten metal and to deliver this to the molds. When a furnace of the tilting

type is used, the metal is easily poured from the melting pot into carrying ladles. The pot is usually made of cast iron or steel and has an average capacity of 400 pounds of metal. A cast-iron pot will last for about sixty heats of the aluminum alloys.

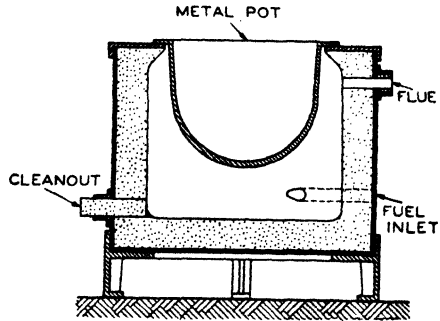

FIG. 132.—CROSS SECTION OF STATIONARY METAL-POT FURNACE

Direct-Fired Furnaces

The furnaces in which the non-ferrous metals are melted and superheated in direct contact with the products of combustion from the fuel include the reverberatory furnace, the barrel furnace, and the cupola furnace. These open-flame furnaces are economical as to fuel consumption; however, they are not favorably adapted to the melting of alloys containing a large proportion of zinc. The reason for this is that the loss of zinc by volatilization at high temperatures is increased with a greater flow of gas through the furnace.

Reverberatory furnaces are used in foundries where large quantities of metal are required in each melt. These furnaces may be of either the stationary or tilting types. A reverberatory furnace has a hearth lined with fire bricks and an arched roof from which the heat is reflected to the metal on the hearth. Oil, gas, or powdered coal supplied through burn-

ers located on one or more sides of the furnace furnishes the heat for melting.

The barrel furnace has a cylindrical steel shell which is mounted horizontally on trunnions and is lined with refractories around the circumference and over a portion of the ends. The tilting- or rocking-type furnace is provided with a central door for charging and pouring the metal. In the double-chamber furnace shown in Fig. 133, the metal in

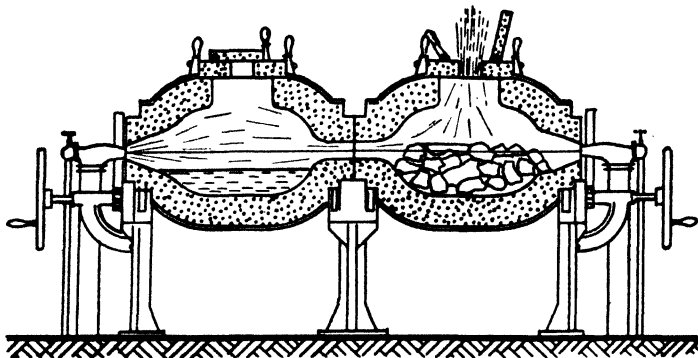

FIG. 133.—CROSS SECTION OF DOUBLE-CHAMBER BARREL FURNACE
(MONARCH DESIGN)

one half of the furnace is preheated while the metal in the other half is being melted and superheated.

At some foundries where castings of the non-ferrous metals are produced in large quantities, the cupola furnace has been found to be advantageous for melting copper alloys having a low zinc content. This method of melting requires a good quality of coke and a low blast pressure for combustion. A lining of silicon carbide refractories is usually provided in these furnaces. The metal is tapped from the cupola and is delivered to the molds in hand ladles.

Electric Furnaces

On account of the possibility of accurate control of all melting conditions, electric furnaces are employed at many foundries where non-ferrous metal castings are produced. The low melting losses and the superior quality of the molten metal compensate to some extent for the higher cost of electric heat over the cost of solid, liquid, or gaseous fuels. Electric furnaces of the indirect-arc type as well as of the induction type are suited to the melting of alloys high in copper or nickel, whereas the

induction type is particularly adapted to the melting of alloys containing large proportions of zinc.

Detroit Rocking Furnace.—This furnace has a cylindrical steel shell lined with refractories. (See Fig. 75 in Chapter V.) The shell is mounted in a horizontal position on rollers, and can be rocked through any desired angle by automatic control equipment. The heat for melting is produced by an electric current arcing between two carbon electrodes which pass through the ends of the furnace. After the metal charge becomes melted, the shell is rocked until the desired amount of superheat is obtained. This movement of the shell makes possible the conduction of heat from the furnace lining to the metal. The opening for the charging door and pouring spout is cut through the shell on the side of the furnace.

Ajax-Wyatt Induction Furnace.—In the Ajax-Wyatt electric furnace, heat is derived by the resistance offered to an induced current in the liquid metal within the furnace. The drawing in Fig. 134 shows the interior construction of this furnace. An alternating current at regular power-line voltage is supplied to the primary coil *A* of the transformer *B* which is built into the furnace. This causes an induced current to flow through the liquid metal *C* which serves as the secondary coil of the transformer. The amount of heat developed within the metal of the bath is dependent upon the voltage impressed on the furnace transformer. Thus the temperature of the metal can be controlled as desired.

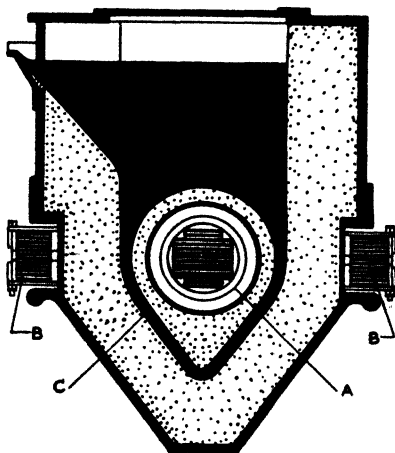
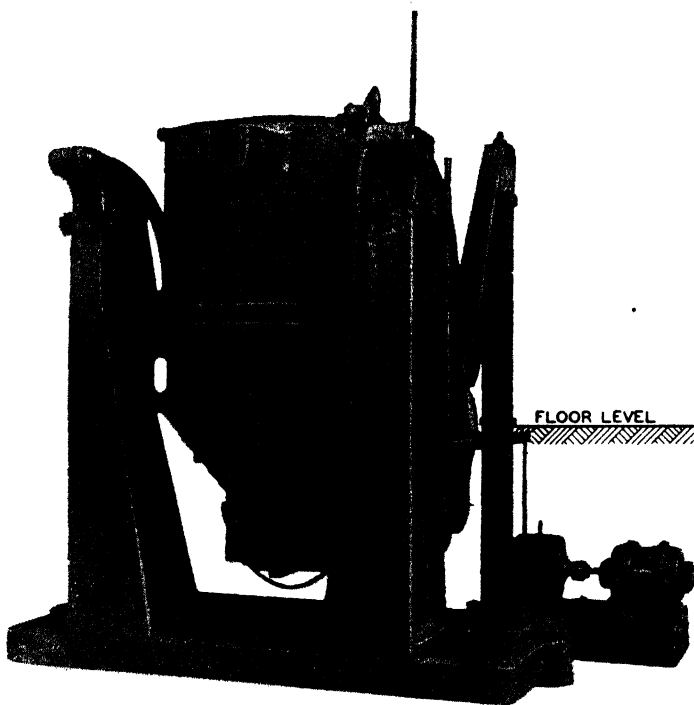

FIG. 134.—CROSS SECTION OF AJAX-WYATT INDUCTION FURNACE

The operation of the Ajax-Wyatt furnace requires some liquid metal in the melting channel at all times. During short, inactive periods, a residual charge of metal is kept in the liquid state, or a priming charge of molten metal is supplied when the furnace is put into service after being idle for a long time. The electromagnetic forces set up by the large currents in the secondary circuit cause a circulation of liquid metal within the furnace. Metals in the form of chips, turnings, clippings of thin sheets, and wire can be melted readily with low oxidation losses in this furnace.

The pouring capacities of Ajax-Wyatt furnaces range from 400 to 2,200 pounds of metal per heat. A typical installation is shown in Fig. 135. With normal operation, the power required for melting 1 ton of red brass is approximately 250 kw.-hr. As the refractory lining of this furnace is not subjected to extremely high temperatures, the life of a lining is well over 1,000 heats. Furthermore, the time required in melt-



Courtesy of Ajax Electric Furnace Corporation

FIG. 135.—ELECTRIC INDUCTION FURNACE

ing is relatively short because the heat is generated directly within the bath of metal.

Ajax-Northrup Induction Furnace.—The Ajax-Northrup high-frequency or coreless induction furnace is a recent development in crucible melting. With this equipment, the metal charge within the crucible is heated by its resistance to an electric current induced from a winding around the outside of the crucible. (See Fig. 118 in Chapter XII.) The effect of the induced current is to cause an agitation of the molten metal, which assures thorough alloying of the metallic elements. The various

compositions for brass and bronze castings can be melted satisfactorily in a furnace of this type. Ajax-Northrup melting furnaces are being used with capacities from a few pounds up to 4 tons of metal.

EQUIPMENT FOR MEASURING TEMPERATURES

It is generally recognized that the close control of the melting and pouring temperatures is necessary to obtain the most favorable properties in the non-ferrous alloys. The avoidance of overheating and strict adherence to the correct pouring temperatures for these metals will aid in obtaining castings of good quality. A thermoelectric pyrometer is the most satisfactory means for determining the temperatures of molten copper alloys and aluminum alloys. This equipment consists of two wires which form the thermocouple and an instrument which measures the electromotive force generated within the thermocouple circuit. As a rule, the thermocouple is made of nickel-aluminum wire (2 or 4 gage) and nickel-chromium wire (6 or 8 gage). One end of each of the wires is connected to the instrument, and the other two ends are immersed in the molten metal. The couple wires are insulated to within $\frac{1}{4}$ inch from the ends so that the hot junction of the couple will be below the surface of the metal. Only a few seconds are required to determine the temperature of the metal in a crucible or ladle.

MELTING LOSSES

One of the factors which contribute to the cost of melting the non-ferrous alloys is the loss of metal caused by oxidation and volatilization of the elementary constituents of the alloys. The extent of this loss is dependent upon the composition of the alloy, as well as upon the construction and operation of the furnace. Alloys which contain large proportions of zinc, tin, or lead are particularly subject to high melting losses. As a rule, these losses are greater in furnaces of the open-flame type than in furnaces in which the products of combustion of the fuel do not come in direct contact with the metal being melted. Furthermore, the loss of metal will be increased by extending the time during which the metal is held in the molten condition and by heating the alloys to excessive temperatures. The total loss encountered in melting the alloy containing 85 per cent copper and 5 per cent each of lead, tin, and zinc in an open-flame furnace will often amount to 4 per cent of the weight of the metal charged. When this alloy is melted in a crucible furnace, the melting loss may be less than 1 per cent of its original weight.

MOLDING PRACTICE

In general, the molding practice for the production of castings of the non-ferrous metals is about the same as that used for iron castings. However, the non-ferrous alloys have in common some characteristics which are ordinarily taken into account in the preparation of molds for these metals.

The sands used for making molds for castings of the non-ferrous metals have relatively small grains because these metals are very fluid at their pouring temperatures and tend to seep into the pores of the sand; this property is especially characteristic of phosphor bronze and alloys having a high lead content. In most cases, smooth surfaces are required on the castings, a condition made possible by the use of molding sand of small grain size.

Special care in molding is necessary to avoid shrinkage cavities and cracks in castings of the non-ferrous metals because most of these metals contract to a large extent when cooling from the molten state. To prevent defects, many risers are provided in the molds. Furthermore, the cores used in these molds are prepared from materials which allow free contraction of the metal when it solidifies and cools around the cores. Relatively little pressure is produced in molds for the light casting alloys because of their low specific gravity. Therefore, these molds must be well vented to permit rapid and complete filling of all parts.

COPPER CASTINGS

Copper castings are used chiefly for equipment in which high electrical conductivity is an essential property. The presence of small amounts of phosphorus, aluminum, iron, tin, antimony, or zinc lowers the electrical conductivity of the metal. Therefore, it is usually desired to have the copper as pure as possible in castings for electrical purposes.

The difficulties encountered in producing sound copper castings are due to the tendencies of this metal to oxidize while in the molten state and to absorb gases which are evolved when the metal solidifies. These undesirable conditions can be minimized by holding the molten metal for the shortest possible time, and by pouring the metal at the lowest temperature which will permit filling of the molds. The addition of an active deoxidizer such as silicon copper assists in producing clean castings. Pure cast copper contracts considerably on cooling, and for this reason special care is required in molding to avoid cracked castings and shrinkage cavities within the castings.

Melting Practice

Pure copper is melted in a graphite crucible as rapidly as possible under a thick layer of charcoal. Soon after the copper has melted, an alloy containing 15 per cent silicon and 85 per cent copper is added to the metal in the proportion of 2 ounces of silicon-copper to 100 pounds of ingot copper. As silicon-copper is lighter than the molten copper in the crucible, it is necessary to stir the metal well after adding this deoxidizer. A clean graphite stirring rod is used for this purpose. The charcoal and dross are skimmed from the top of the metal before pouring.

The physical properties of pure cast copper are as follows: yield strength about 8,000 lb. per sq. in.; tensile strength from 20,000 to 30,000 lb. per sq. in.; elongation in 2 inches about 30 per cent; reduction of area about 40 per cent; and Brinell hardness 48 (with 500-kg. load).

BRASS CASTINGS

Brass is essentially an alloy of copper and zinc. Additions of zinc up to 40 per cent result in a continuous increase in the tensile strength and hardness of the copper-zinc alloys. On account of the difficulties in obtaining sound castings, and the tendency of zinc to volatilize, brass alloys containing over 40 per cent of zinc are not in general use in the foundry. Small proportions of other metals are usually added to the copper-zinc alloys to obtain desirable properties. The addition of lead up to 5 per cent of the weight of the alloy results in an improvement in the machinability of the metal in the castings. Tin increases the strength and hardness of brass and is used in amounts up to 5 per cent of the weight of the alloy.

The chemical compositions of twenty copper-base alloys which have been established by the *American Society for Testing Materials* (Designation: B30-36) are listed in Table XXV in the Appendix. The properties of these alloys are also recorded in Table XXVI, but the properties are not a part of the standard specifications.

Yellow Brass

An alloy which is typical of the compositions used in making yellow brass castings is as follows: copper, 70.0 per cent; zinc, 25.0 per cent; lead, 3.0 per cent; and tin, 2.0 per cent. A yield strength of 12,500 lb. per sq. in., a tensile strength of 31,000 lb. per sq. in., and an elongation of 27 per cent can be obtained with this alloy. Induction furnaces are most satisfactory for melting the yellow brass alloys used in castings for machine parts, ornamental fixtures, plumbing goods, and hardware.

Red Brass

Alloys which contain a high percentage of copper together with approximately equal amounts of tin, lead, and zinc are known as red brasses. A typical analysis for red brass is 85 per cent copper, 5 per cent tin, 5 per cent lead, and 5 per cent zinc. This alloy is used extensively in sand castings which must have considerable strength and resistance to corrosion. The tin content contributes to the strength and hardness of the alloy. The presence of lead causes an improvement in the machinability of the metal. Zinc serves as a deoxidizer and facilitates the casting of the alloy. The most favorable pouring temperature for red brass has been found to be 2100 degrees F.¹² The following properties can be expected in castings of this alloy: yield strength 18,000 lb. per sq. in., tensile strength 30,000 lb. per sq. in., and percentage elongation about 18 per cent.

Manganese (Bronze)

The chemical composition of manganese bronze as specified by the *American Society for Testing Materials* (Designation: B54-27) is as follows: copper, 60.0 to 55.0 per cent; zinc, 42.0 to 38.0 per cent; tin, maximum 1.5 per cent; manganese, maximum 3.5 per cent; aluminum, maximum 1.5 per cent; iron, maximum 2.0 per cent; lead, maximum 0.4 per cent. As this composition is typical of brass alloys, the term bronze is incorrectly used in designating this material. The copper-zinc-manganese alloy possesses the very desirable combination of high strength and ductility as well as resistance to corrosion. It is used in machine parts such as lever arms, gears, and shafts. The standard specification for cast manganese bronze requires a minimum tensile strength of 65,000 lb. per sq. in. and an elongation of 25 per cent in a 2-inch gage length.

In the preparation of manganese bronze for casting purposes, a **hardener** which contains the manganese, iron, and aluminum is melted with the copper, and the zinc is added in solid form to the molten alloy. In some cases, manganese bronze is purchased in the form of ingots for foundry use. Because this metal shrinks to a large extent when it solidifies, a sufficient number of risers must be provided to prevent cavities from forming within the castings. Manganese bronze is poured with minimum agitation, and at the lowest possible temperature (about 1950 degrees F.) which will allow complete filling of the molds.

BRONZE CASTINGS

Bronze is an alloy of copper and tin having properties which are dependent upon the proportions of these elements. The tensile strength and hardness of the bronze alloys are increased as the tin content is raised, but the ductility of the alloys decreases rapidly when the proportion of tin exceeds 12 per cent. The hard bronzes used in casting bells usually contain from 20 to 25 per cent tin. The presence of tin in amounts above 2 per cent of the weight of the alloy increases its resistance to corrosion.

Gun-Metal

The bronze alloy containing 88 per cent copper, 10 per cent tin, and 2 per cent zinc is known commercially as government bronze or gun-metal. This is an excellent casting alloy and is used in pipe fittings, pump pistons, gears, and other machine parts. The standard specification of the *American Society for Testing Materials* (Designation: B10-18) for this alloy requires a minimum tensile strength of 30,000 lb. per sq. in. and a minimum elongation in 2 inches of 14 per cent. The zinc is added to deoxidize the copper-tin alloy and, because of this effect, makes possible the production of sound castings. This metal is poured at temperatures within the range of 2050 to 2200 degrees F., depending upon the sections of the castings; the heavier the section, the lower should be the pouring temperature.

Phosphor Bronze

The copper alloys which contain from 8 to 12 per cent tin and 0.1 to 1.0 per cent phosphorus are known as phosphor bronze. Phosphorus is usually added to the bronze in a commercial alloy containing 10 to 15 per cent phosphorus and the remainder copper. The phosphor bronze alloys are particularly serviceable for highly stressed machine parts which must have the property of a bearing metal as well as great resistance to wear. The phosphorus acts as a deoxidizer and assists in producing castings free from porosity. A structure composed of hard constituents of copper tin and copper phosphide within a softer matrix of copper-tin solid solution gives to this metal its anti-friction characteristic. The desired degree of hardness may be obtained by adjusting the proportions of tin and phosphorus in the alloys. A phosphor bronze containing 10 per cent tin and 0.3 per cent phosphorus has a yield strength of about 25,000 lb. per sq. in., a tensile strength of about 35,000 lb. per sq. in., and an elongation of about 8 per cent. Castings of phos-

phor bronze are used for boiler fittings, equipment for marine service, parts for pumps, and bearings subjected to heavy loads.

Aluminum Bronze

The properties which are responsible for the extensive use of aluminum bronze are its high strength, favorable ductility, and good resistance to corrosion. The specifications of the *American Society for Testing Materials* (Designation: B59-28) give the following requirements as to the chemical composition for aluminum bronze: copper, 87 to 89 per cent; aluminum, 7 to 9 per cent; iron, 2.5 to 4 per cent; tin, maximum 0.5 per cent; and other impurities maximum, 1.0 per cent. These specifications also include the following requirements as to physical properties of the alloys as cast: yield strength, minimum 25,000 lb. per sq. in.; tensile strength, minimum 65,000 lb. per sq. in.; and elongation in 2 inches, minimum 20 per cent.

Some difficulties are encountered in casting the alloys known as aluminum bronze. The high solidification shrinkage of these alloys makes it necessary to provide adequate risers to feed the castings. Under some conditions, the molten metal will absorb gases which are evolved when the metal solidifies. A neutral or slightly oxidizing atmosphere has been found to be most suitable for melting these alloys. The presence of aluminum oxide in the metal can be kept to a minimum by preventing unnecessary agitation of the metal during melting and pouring.

The procedure recommended by Strauss⁸ for preparing aluminum bronze is first to melt the copper under a layer of charcoal, and then to deoxidize the copper by the addition of 0.1 to 0.2 per cent of manganese. Following this, one-half of the aluminum is added, then the iron, and finally the remainder of the aluminum.

Because of its high strength and resistance to corrosion, aluminum bronze is used in castings for marine service, for pickling tanks, and for equipment in the chemical industries. This high-property metal is also used in gears, worm-wheel rims, and other parts of machines.

ANTI-FRICTION ALLOYS

The following extract from the "Report of the Sub-Committee on Bearing Metals" of the *American Society of Mechanical Engineers*⁹ explains the requirements of bearing metals.

"The essential characteristic of all bearing alloys is a structure made up of alternately hard, and relatively soft microscopic particles intimately mixed. The function of the hard particles or bearing

crystals is to support the load and resist the wear. These bearing crystals should not be hard enough to prove distinctly abrasive to the journal surface. General experience shows that an extreme hardness of the bearing crystals is characterized by an excessive wear of the journal. The function of the softer or more readily abraded crystals is that of being plastic and permitting the bearing crystals to adjust themselves to surface requirements of the journal. These softer crystals are also more readily abraded, and therefore wear slightly below the surface of the bearing crystals and thus form slight depressions upon the bearing surfaces which serve for the retention of the lubricant. However infinitesimal in amount this may seem, nevertheless it is this lubricant that prevents scoring or seizing when the journal is starting up from rest at a time when actual metallic contact between the bearing surfaces exists. The same is equally true under an excessive load. This function of retaining a slight quantity of the lubricant upon the bearing surfaces when metallic contact exists, characterizes a bearing alloy in its truest sense. Therefore a bearing metal may be defined as an alloy that is capable of retaining a lubricant on a bearing surface."

From the definition of the requirements of bearing metals, it is evident that pure metals or combinations of metals which form solid solutions only are not suited for anti-friction service. On the other hand, it is essential that bearing alloys be composed of constituents having marked differences in their physical hardness and wearing qualities.

The non-ferrous, anti-friction alloys may be classified into the following groups: alloys containing over 50 per cent of copper, known as copper-base bearing metals; alloys containing over 50 per cent of tin, known as tin-base bearing metals; alloys containing over 50 per cent of lead, known as lead-base bearing metals; and alloys containing over 50 per cent of cadmium, known as cadmium-base bearing metals. Those alloys in which tin, lead, and cadmium are the predominating elements are designated as **white-metal bearing alloys**. They have the properties of high plasticity combined with low hardness and comparatively low melting point. Bearings of the white-metal alloys are produced by casting the metal against harder metal surfaces, whereas bearings of the copper-base alloys are first cast to shape, and then machined to the desired dimensions. The copper-base alloys are harder and stronger than the white-metals and are used for bearings which are required to resist heavier pressures.

Specifications for twelve grades of white-metal bearing alloys have been established by the *American Society for Testing Materials*. The chemical compositions of these standard alloys and also the physical properties obtained from them are presented in Table XXVII in the Appendix.

Copper-Base Bearing Metals

The chief constituents of the copper-base bearing metals are copper, tin, and lead. Tin combines with copper to produce hard alloys. The

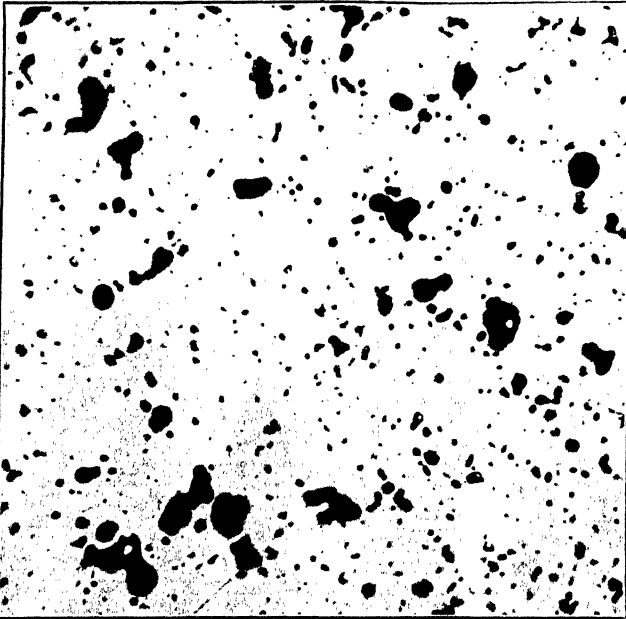

FIG. 136.—COPPER-BASE BEARING METAL. UNETCHED, $\times 100$
White background is copper-tin solid solution. Black spots are locations of lead particles.

hardness and compressive strength of the copper-tin alloys increase with additions of tin as high as 30 per cent, although the ductility decreases rapidly when the tin content exceeds 12 per cent. Lead does not remain dissolved in the metal when it solidifies, but separates as minute globules throughout the metal. These small particles of lead are worn away on a bearing surface, and form pockets for the retention of oil. The lead content is usually within the range of 5 to 25 per cent of the weight of the metal. A typical composition of a bearing bronze which is used extensively for railroad car-journal bearings is 80 per cent copper, 10 per cent

tin, and 10 per cent lead. The micro-structure of this alloy is shown in Fig. 136.

Tin-Base Bearing Metals

The tin-base bearing metals are prepared from tin, antimony, and copper. In these alloys the tin serves as a plastic matrix in which the harder crystals of tin-antimony and copper-tin are embedded. (See Fig. 137.) Antimony causes an increase in the hardness of the alloys and is usually limited to a maximum of 18 per cent. The tin-base

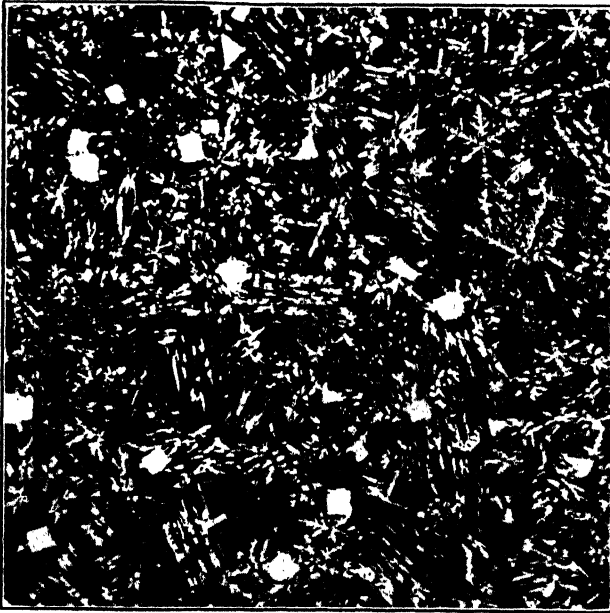

FIG. 137.—TIN-BASE BEARING METAL. ETCHED, $\times 100$

Dark background is eutectic, principally of tin. Star-shaped, white crystals are copper-tin compound. Angular, white crystals are antimony-tin compound.

alloys which contain a high percentage of antimony are suitable for use in bearings of heavy-duty machinery, whereas alloys with a low percentage of antimony are well adapted for bearings for high-speed journals. The chief advantage of a tin-base bearing metal over a high-lead composition is its greater resistance to repeated impacts or shock. The composition of the alloy designated as *S.A.E.* No. 11 which is used for crankshaft bearings and connecting-rod bearings in internal-combustion motors is 86 per cent tin, $7\frac{1}{2}$ per cent antimony, and $6\frac{1}{2}$ per cent copper. The pouring temperature for this alloy is about 800 degrees F.

Lead-Base Bearing Metals

The principal elements in the lead-base bearing metals are lead, tin, and antimony. In these alloys the bearing crystals of antimony-tin compound are supported in a soft, plastic matrix of lead as is shown in Fig. 138. The tin content of the lead-base bearing metals is usually within the range of 5 to 10 per cent, and the antimony is from 10 to 15 per cent of the weight of the metal. A composition which is used for

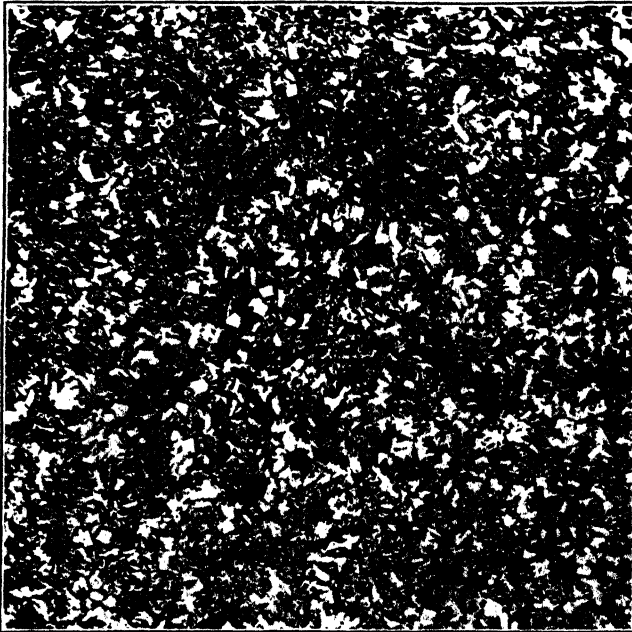

FIG. 138.—LEAD-BASE BEARING METAL. ETCHED, $\times 100$

Dark background is eutectic, principally of lead. Angular, white crystals are antimony-tin compound.

line-shaft bearings in manufacturing plants is 80 per cent lead, 5 per cent tin, and 15 per cent antimony. This alloy is poured in place at a temperature of 645 degrees F.

Cadmium-Base Bearing Metals

The cadmium-base bearing metals contain from 1.35 to 3.00 per cent nickel. It has been reported by Swartz and Phillips¹⁰ that the cadmium-nickel bearing alloys have more favorable properties, especially at elevated temperatures, than the tin-base alloys. The compressive

strengths of the cadmium-base bearing alloys are greater than those of the tin-base alloys. Furthermore, the cadmium-base alloys are not brittle and will not injure a soft steel shaft. The constituents in cadmium-base bearing metals are particles of the compound, NiCd_7 , in a matrix of a eutectic of cadmium and nickel-cadmium compound.

ALUMINUM-ALLOY CASTINGS

The mechanical properties and casting characteristics of commercially pure aluminum are not such as to recommend it for general casting

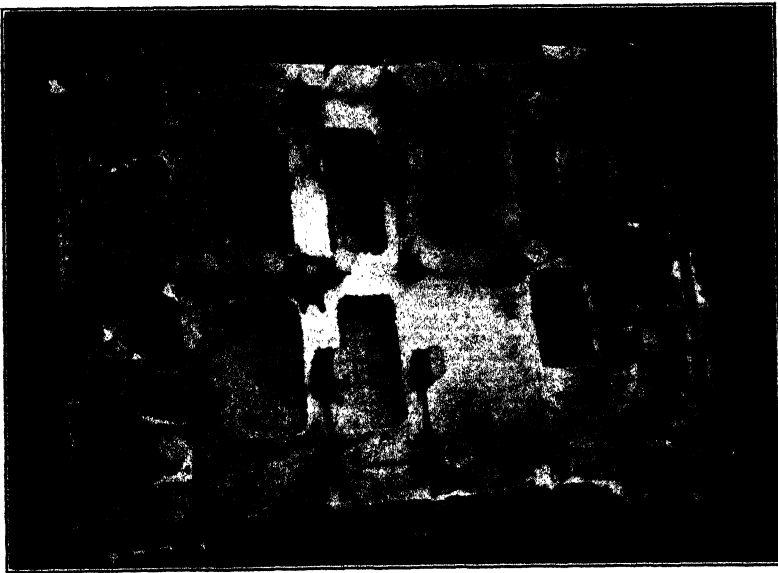

Courtesy of Aluminum Company of America

FIG. 139.—ALUMINUM CASTING BEFORE REMOVING RISERS AND GATES

purposes. However, certain alloys of aluminum possess valuable qualities when they are used in castings. The most important properties of the cast aluminum alloys are low specific gravity, resistance to corrosion, high thermal conductivity, and ease of machining.

The choice of methods for casting the aluminum alloys depends upon the size and weight of the castings, the intricacy of the designs, and the number of castings required of each design. The sand-casting method is applicable to a wide range in size and weight of castings, as well as to designs which have complicated cores. A large aluminum casting with risers and gates attached is illustrated in Fig. 139. The

same casting after cleaning appears in Fig. 140. Large numbers of aluminum-alloy castings are produced by pouring the molten alloys at

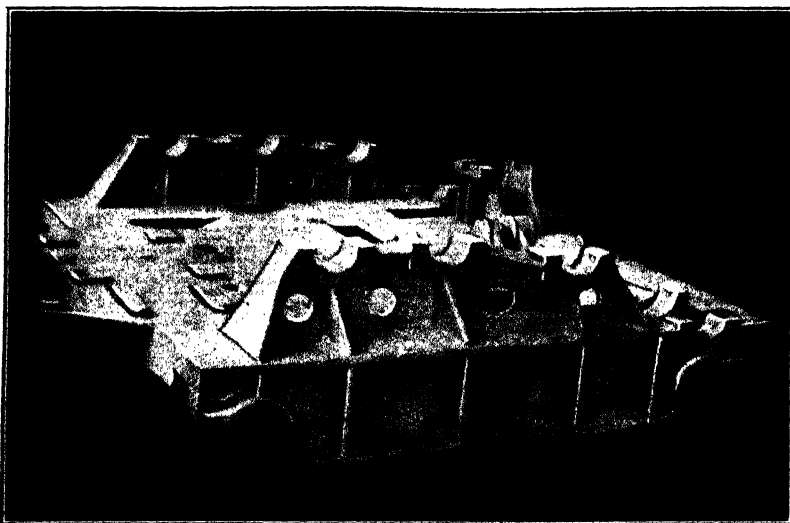

Courtesy of Aluminum Company of America

FIG. 140.—CAST-ALUMINUM CRANE TROLLEY
Weight, 2,540 pounds.

atmospheric pressure into metal molds. The die-casting method is best suited for the quantity production of aluminum-alloy castings in which extreme accuracy and superior finish are required.

Aluminum Casting Alloys

Although a large number of aluminum casting alloys have been developed, the majority of castings are produced from only a few standard compositions. In the following discussion, two of the aluminum-base alloys which are used most widely will be described. However, other alloys of aluminum are available having higher mechanical properties than can be obtained with the casting alloys which are in more general use. As a rule, the special alloys of aluminum depend upon heat treatment or a fluxing treatment to develop their superior properties. These special alloys and modification processes are covered by patents.

The standard specifications of the *American Society for Testing Materials* for aluminum-base alloy sand castings (Designation: B26-33T)

are given in the Appendix. These specifications include the chemical compositions and properties of nine aluminum-base alloys.

Aluminum-Copper Alloy.—The addition of copper to aluminum causes an increase in the strength and hardness of the alloys. When the copper exceeds 8.5 per cent, the metal becomes too brittle for many uses. The aluminum alloy containing 7.0 to 8.5 per cent copper, 0.8 to 1.2 per cent iron, and 1.0 to 1.5 per cent silicon is in general use for castings. The iron content strengthens the metal immediately after it solidifies, thereby preventing to a considerable extent the occurrence of cracks. Silicon promotes fluidity of the alloy, thus making it easier to cast. The tensile strength of this alloy, designated as alloy B in the *A.S.T.M.* specifications, is from 19,000 to 25,000 lb. per sq. in. and the elongation in a 2-inch gage length is from 1 to 2 per cent.

Aluminum-Silicon Alloy.—The aluminum-silicon alloys remain fluid at relatively low temperatures and have low shrinkage on solidifying, which combination of properties favors the use of the aluminum-silicon alloys for casting purposes. These are among the most resistant to corrosion of all the aluminum alloys. The alloy which contains from 4.5 to 6.0 per cent silicon, with copper a maximum of 0.4 per cent and iron a maximum of 0.8 per cent, is used extensively in sand castings. The physical properties obtained from test specimens of this alloy, designated as alloy J in the *A.S.T.M.* specifications, are as follows: tensile strength from 17,000 to 22,000 lb. per sq. in., and elongation in 2 inches of 3 to 8 per cent.

Foundry Practice

The aluminum casting alloys have low strength at temperatures just after solidifying, and if free contraction of the metal is not permitted, cracks may be produced in the castings. Therefore, the sand molds must be relatively soft, and the cores must soften at low temperatures in order to obtain sound castings.

The low specific gravity of the aluminum alloys makes extra venting necessary so that all gases can be removed rapidly from the molds. A molding sand having a small grain size is required for producing smooth surfaces on these castings. The properties of the molding sands for aluminum alloys depend upon the type of castings to be made; for small castings a compressive strength of 3 to 6 lb. per sq. in. and a permeability of 4 to 10 are ordinarily satisfactory; for large castings a compressive strength of 4 to 8 lb. per sq. in. and a permeability of 10 to 20 are usually necessary. The refractory property of sands for aluminum alloy cast-

ings is not as important as for metals which are poured at higher temperatures.

The total contraction of the aluminum casting alloys is about 0.156 inch per foot; this allowance is made on the patterns for aluminum alloy castings. A large number of risers are required to prevent the formation of shrinkage cavities within the castings. As a rule, aluminum castings are gated in a way such that the parts farthest from the gates will solidify first. Also, the gates are placed so that the metal will enter the mold with a minimum of agitation.

The aluminum alloys are prepared for casting by melting the metals in graphite crucibles or in cast-iron pots. As the fuel economy is relatively high with the iron pots, this equipment is ordinarily used for melting the aluminum alloys. It is necessary to have the inside surfaces of the iron pots well coated with lime to prevent contamination of the aluminum by the iron.

Copper and silicon are usually added to aluminum in the form of commercial alloys known as **hardeners** which contain 50 per cent of aluminum and 50 per cent of either copper or silicon. These alloys are readily soluble in molten aluminum. In the preparation of the casting alloys, pure ingot aluminum is first melted; then the correct weight of hardener is added to obtain the desired percentage of copper or silicon in the alloy. The aluminum casting alloys are also available in ingot form. Temperature measurements are made to insure proper control of melting and pouring conditions. The temperature of the metal is kept as low as possible (usually below 1400 degrees F.) and should not be raised above that required to pour the castings. A small amount of zinc chloride or ammonium chloride is often added to the molten metal to serve as a cleanser. The metal is stirred thoroughly, and is skimmed before pouring. The lowest temperature at which the molds will be completely filled is used in pouring; this is about 1320 degrees F.⁶ A high pouring temperature causes an increase in the absorption of gases which may result in holes in the castings. Furthermore, a coarse grain structure is produced in the metal when it is poured at a high temperature, or when it has been heated to a high temperature previous to pouring.

MAGNESIUM ALLOY CASTINGS

Alloys of magnesium have been developed with physical and mechanical properties which make these alloys suited to many engineering uses. In all cases where strength in relation to weight is an important consideration, the magnesium alloys are particularly advantageous. Some of

the applications for which castings of the magnesium alloys are of special value are portable tools, the moving parts of machines, and transportation equipment. These alloys are resistant to ordinary atmospheric corrosion and are easily machined.

Magnesium Casting Alloy

The commercial alloys of magnesium have been developed by The Dow Chemical Company and are known as "downmetal." Certain standard compositions have been established for specific uses. "Downmetal" "H" which contains approximately 90.8 per cent magnesium,

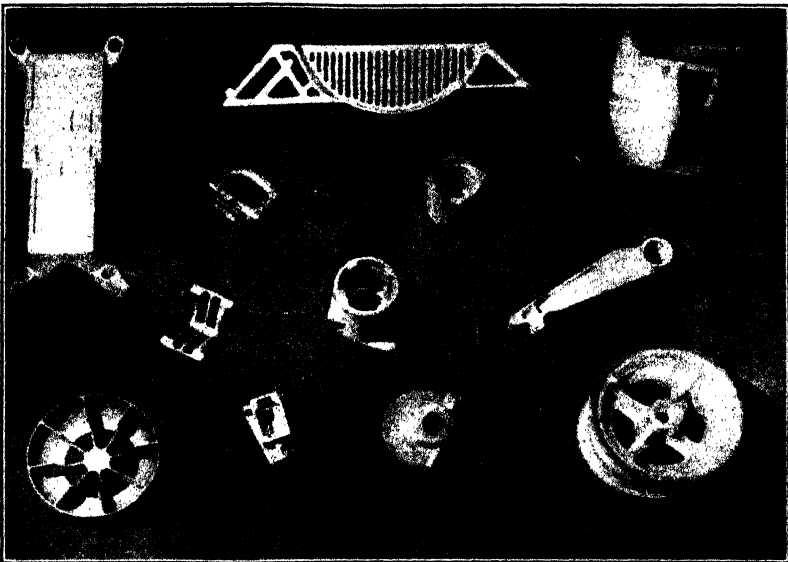

Courtesy of The Dow Chemical Company

FIG. 141.—MAGNESIUM ALLOY CASTINGS

6 per cent aluminum, 0.2 per cent manganese, and 3 per cent zinc, is a casting alloy. This alloy in the condition as cast has a yield strength of 12,000 lb. per sq. in., a tensile strength of 27,000 lb. per sq. in., and an elongation of 6 per cent in 2 inches.¹¹ A group of magnesium alloy castings is shown in Fig. 141.

Foundry Practice

The magnesium alloys are purchased in ingot form and are melted in cast-steel pots at the foundry. A flux composed of magnesium chloride and sodium chloride is melted in the pot with the metal. This molten flux surrounds the metal and aids in protecting it from surface oxidation

and contamination. The molten alloy is transferred to the molds by hand ladles which have bottom-pouring spouts. Either green-sand or dry-sand molds are used, and many risers are provided to insure sound castings. A small amount of sulphur, boric acid, or ammonium fluoride is mixed with the molding sand to prevent surface oxidation of the castings in the molds. Gates having a large total area are necessary to permit rapid filling of each mold. Many small gates are preferred to a few large ones.

DIE-CASTING ALLOYS ✓

Die castings are produced by forcing molten metal under high pressure into steel dies. After the metal has solidified, the castings are ejected from the dies. The equipment and methods used in making die castings have been described in Chapter III. Much attention has been given by manufacturers to the selection of alloys for modern die-casting practice. These materials may be classified into the following groups:

- I. **Tin-Base Alloys**, in which tin is combined with copper and antimony. These alloys have been described as tin-base bearing metals. Their principal uses are for high-grade bearings and in parts for food containers.
- II. **Lead-Base Alloys**, in which lead is combined with antimony, or with antimony and tin. The lead-base alloys are commonly used in low-priced die castings for applications where strength and other mechanical properties are unimportant. These alloys are also die-cast for bearing purposes.
- III. **Zinc-Base Alloys**, in which zinc is combined with copper, aluminum, and magnesium. One of the alloys in this group contains 92.9 per cent high-grade zinc, 3 per cent copper, 4 per cent aluminum, and 0.1 per cent magnesium. The following properties are obtained on die-cast specimens of this alloy; a tensile strength of 45,000 lb. per sq. in., and an elongation in a 2-inch gage length of 5 per cent.

Another alloy in this group which has favorable qualities contains 95.95 per cent high-grade zinc, 4.00 per cent aluminum, and 0.05 per cent magnesium. The zinc-base alloys are cast at temperatures from 750 to 850 degrees F. These alloys are used in die castings for hardware, instrument cases, decorative objects, motors, and fans.

- IV. **Aluminum-Base Alloys**, in which aluminum is combined with copper or silicon. These are the aluminum casting alloys described earlier in this chapter. Because of their lightness, strength, and resistance to corrosion, aluminum die castings are used for cooking utensils, parts for household appliances, instrument housings, typewriter frames, and other articles.
- V. **Magnesium-Base Alloys**, in which magnesium is combined with aluminum and manganese. These are the "dowmetal" alloys which have been described previously. Most die castings made of the magnesium-base alloys are produced by the press-

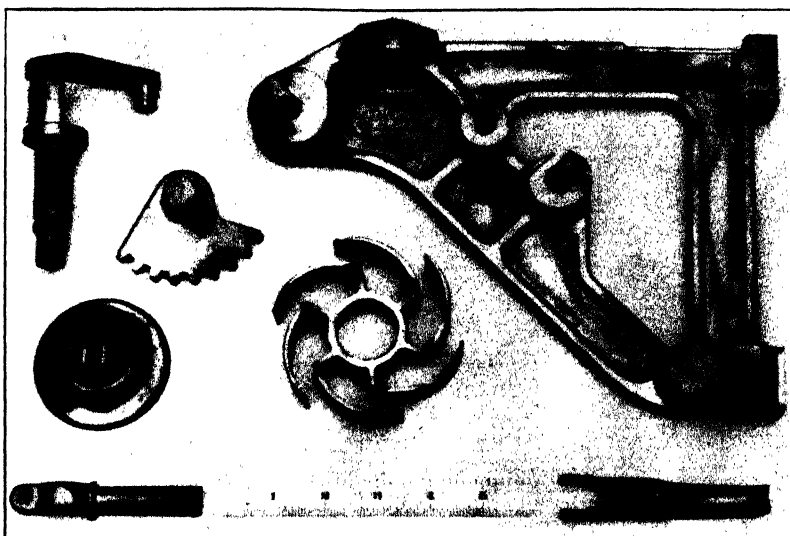

Courtesy of Aurora Metal Company

FIG. 142.—DIE CASTINGS OF ALUMINUM BRONZE

cast method. A roughly measured quantity of the metal is poured into a cylinder and is forced by a ram into the dies at a pressure of about 5,000 lb. per sq. in. Parts for typewriters and small portable tools are made in this way.

- VI. **Copper-Base Alloys**, in which copper is combined with zinc, tin, lead, aluminum, iron, or other metals. These alloys have also been described earlier in this chapter. The die casting of brass and bronze alloys requires that the dies be subjected to high temperatures and high pressures, which conditions limit the life of the alloy-steel dies. Some die castings made of aluminum bronze are shown in Fig. 142.

“MONEL METAL”

“Monel metal” is the trade name of an alloy produced and marketed by The International Nickel Company. This alloy contains approximately 68 per cent nickel, 29 per cent copper, and 3 per cent of other

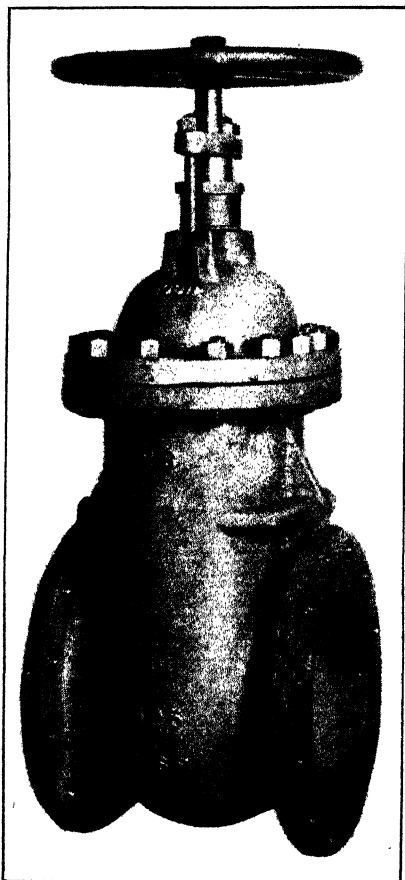

Courtesy of The William Powell Company

FIG. 143.—GATE VALVE OF
“MONEL METAL”
Weight, 550 pounds.

elements including iron, manganese, and silicon. The constitution of “monel metal” is a homogeneous solid solution. Because of its high melting range, a large amount of heat is required to melt “monel metal.” A cover of charcoal or fluorspar is used to protect the metal in the crucible while it is being heated. The metal is deoxidized by adding $1\frac{1}{2}$ ounces of pure magnesium to 100 pounds of “monel metal” just before pouring. A pouring temperature of 2800 degrees F. is required for this metal.

The properties which make “monel metal” of special value in commercial castings are its resistance to corrosion by sea water and many chemicals, its strength and hardness even at high temperatures, and its resistance to erosion by water and steam. The mechanical properties which are specified by The International Nickel Company for “monel metal” are as follows: yield point, 30,000 to 60,000 lb. per sq. in.; tensile strength, 65,000 to 100,000 lb. per sq. in.; elongation in 2 inches, 5 to 35 per cent; reduction of area, 5 to 35 per cent; and Brinell hardness, 120 to 300. The uses of “monel metal” include

castings for pumps, mining machinery, steam turbines, laundry machinery, fittings for ships, textile machinery, and food-handling equipment. The gate valve illustrated in Fig. 143 was made entirely of “monel metal.”

SUMMARY OF THE NON-FERROUS ALLOYS

Many combinations of chemical and physical properties can be obtained with the non-ferrous casting alloys. In applications where resistance to atmospheric corrosion and to other forms of chemical attack is important, the copper-, tin-, and nickel-base alloys are particularly advantageous. Castings for marine service, as well as for machine parts which are subjected to corroding influences, are generally made of bronze or of copper-nickel alloys. Die castings for food-handling equipment are often produced from alloys having a high tin content.

Some uses of metal castings require alloys which have a high tensile strength. This characteristic together with other favorable qualities can be secured by using manganese bronze, aluminum bronze, or "monel metal." The properties of these valuable alloys have been stated earlier in this chapter.

The light alloys of aluminum and magnesium have made possible an extension of the field of metal castings. These alloys have the advantage of low specific gravity in addition to being readily cast and easily machined. Furthermore, the commercial alloys of aluminum and magnesium possess mechanical properties which recommend them for many uses.

A number of standard compositions of bearing metals have been proposed for different types of service. The white-metal alloys consisting of tin-, lead-, and cadmium-base alloys are usually poured in place, whereas the copper-base bearing metals are cast to shape and are finally machined to the desired dimensions.

In this chapter on non-ferrous metal castings, the discussion has necessarily been confined to a small number of the most extensively used compositions in the different classes of these important alloys. There are, however, many other combinations of the metals which have valuable properties. Supplementary data on the compositions and properties of the non-ferrous metals and their alloys can be acquired from the references given at the end of this chapter.

BIBLIOGRAPHY

1. L. AITCHISON and W. R. BARCLAY, "Engineering Non-Ferrous Metals and Alloys." 1923. Henry Frowde, 1 Bedford St., Strand, W.C. 2, London, England.
2. J. D. EDWARDS, F. C. FRARY, and Z. JEFFRIES, "The Aluminum Industry." 1930. McGraw-Hill Book Company, New York, N. Y.
3. CHARLES VICKERS, "Metals and Their Alloys." 1923. The Penton Publishing Company, Cleveland, Ohio.

4. W. E. PAULSON, "Overcoming Alloy Ingot Troubles in the Brass Foundry." *Trans. A.F.A.*, v. XXXVIII (1930), p. 193-195.
5. W. ROMANOFF and C. O. THIEME, "Application of Brass Ingot Metal in Industry." *Trans. A.F.A.*, v. XXXVIII (1930), p. 196-209.
6. T. W. BOSSERT, "Effect of Melting and Pouring Conditions upon the Quality of No. 12 Aluminum Alloy Sand Castings." *Trans. A.F.A.*, v. XXXVI (1928), p. 427-438.
7. T. MAULAND, "Cupola Melting of Brass." *Trans. A.F.A.*, v. XXXIX (1931), p. 602-608.
8. JEROME STRAUSS, "Aluminum Bronze." *Trans. A.S.S.T.*, v. 12 (1927), p. 69-105, p. 239-273.
9. *American Society of Mechanical Engineers*, "Report of Sub-Committee on Bearing Metals." *Mechanical Engineering*, v. 41 (1919), p. 537.
10. C. E. SWARTZ and A. J. PHILLIPS, "A Comparison of Certain White-Metal Bearing Alloys, Particularly at Elevated Temperatures." *Proc. A.S.T.M.*, v. 33 (1933), Part II Technical Papers, p. 416-425.
11. J. A. GANN, "Founding Magnesium Alloys." *Trans. A.F.A.*, v. XLIII (1935), p. 591-614.
12. H. B. GARDNER and C. M. SAEGER, "Factors Affecting the Properties of Cast Red Brass," *Proc. A.S.T.M.*, v. 32 (1932), Part II, p. 517-535.
13. *American Foundrymen's Association*, "Recommended Practice for the Common Aluminum Alloys." *A.F.A. Trans.*, v. XLIII (1935).

REVIEW QUESTIONS

I

What are the characteristics of the different types of constituents which are present in the non-ferrous alloys?

II

What procedure is used in the order of melting the metals for the non-ferrous alloys?

III

What conditions influence the melting losses of the non-ferrous alloys?

IV

Describe the types of construction of melting furnaces.

V

What are the advantages of the crucible furnace?

VI

Under what conditions can the cupola furnace be used advantageously for melting the non-ferrous alloys?

VII

State the advantages of each of two types of electric furnaces.

VIII

What are the requirements of copper castings for electrical purposes?

IX

Outline the melting practice for the production of copper castings.

X

Define brass, and give a typical composition of a brass alloy.

XI

What are the important qualities of red brass?

XII

State the characteristic properties of manganese bronze.

XIII

What is the effect of increasing the tin content in a bronze?

XIV

What difficulties are encountered in making castings of aluminum bronze?

XV

Explain the essential characteristics of anti-friction alloys.

XVI

State the limiting compositions of each of the four groups of non-ferrous bearing metals.

XVII

What are the characteristic uses of the white-metal bearing alloys?

XVIII

Prepare specifications for a tin-base bearing metal for heavy-duty service.

XIX

State the chemical composition and micro-structure of phosphor bronze for bearing purposes.

XX

What physical properties can be obtained with the aluminum casting alloys?

XXI

Outline the equipment, materials, and practice necessary to produce sound castings of an aluminum-silicon alloy.

XXII

Give the composition and properties of a magnesium casting alloy.

XXIII

What are the differences in the melting practice for magnesium alloys and aluminum alloys?

XXIV

Classify the alloys used for die-casting purposes, and give a typical example in each class.

XXV

What are the characteristic properties of "monel metal"?

CHAPTER XIV

THE DESIGN OF METAL CASTINGS

METALLURGICAL FACTORS—Crystallization of the Metal—Shrinkage of the Metal—MECHANICAL FACTORS—Molding Costs—Cleaning Costs—Machining and Assembling Costs—APPEARANCE

Castings are produced by the solidification of metal within connected mold cavities. This method of assembling metal in the liquid state offers the possibility of great variations in sizes and shapes of metal products. The intricacy of castings is limited only by the necessity of obtaining the desired detail in the molds. The general shape and distribution of the metal in a casting are determined by the specific requirements of its application. Some castings are made primarily for decorative purposes; hence appearance is the controlling feature of these designs. Other castings are used for parts of machines to transmit power, and for this purpose the mechanical properties are of greatest importance. Other castings are used as covers, containers, and foundations for machines and equipment of many kinds. The development of designs for all metal castings should be based on a knowledge of the metallurgical factors which influence the quality of the metal in the castings and the mechanical factors which affect the cost of producing the finished parts.

METALLURGICAL FACTORS

Those characteristics of the metals on which the soundness and strength of castings depend will now be discussed.

Crystallization of the Metal

After the metal has been poured into a mold, it begins to solidify at those surfaces where heat is extracted and continues to solidify towards the centers of the heavier sections. The progressive cooling of the metal establishes a definite direction for the growth of the crystalline grains. In a rectangular section shown at A_1 in Fig. 144, the grains are perpendicular to the surfaces and intersect on diagonal lines joining the corners. Those locations where an interference in the crystal growth of the metal

occurs are sources of weakness in the casting. The section of a flat casting shown at B_1 has an additional line of weakness joining the diagonals.

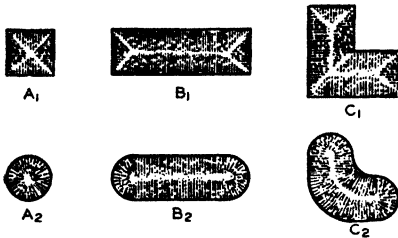

FIG. 144.—CRYSTALLIZATION OF CAST METALS

directional crystallization of the metal in gray iron castings is not as pronounced as in other cast metals because the separation of graphite occurs after the metal has solidified. An improvement in each of the previous designs of cast sections is indicated at A_2 , B_2 , and C_2 in Fig. 144.

In many designs of castings, holes are provided in flat surfaces to reduce weight or for other purposes. When these openings are circular in shape, as shown at the right in Fig. 145, uniform crystallization of the metal around the opening will be permitted. Furthermore, the stresses resulting from the contraction of the metal as it cools will be distributed more uniformly around circular openings.



FIG. 145.—CRYSTALLIZATION OF CAST METALS AROUND OPENINGS

Shrinkage of the Metal

During an investigation conducted by Thomas Turner on the shrinkage or contraction of the cast metals, it was discovered that the different metals had characteristic volume changes when cooled from the molten state. Some contraction curves which Turner obtained are shown in Fig. 146. Pure copper contracts uniformly when cooled from the liquid condition; this is characteristic of most pure metals. The curve for white cast iron indicates one retardation in the rate of contraction during cooling. In the case of low-phosphorus gray iron, two expansions take place as the metal cools; the first expansion is probably due to the separation of graphite, and the second expansion is caused by a change

in the form of the iron at its lower critical temperature. Three expansions take place during the cooling of high-phosphorus irons. It has been shown that the rate of contraction of the ferrous alloys is not constant at all temperatures. In a casting having light and heavy sections, the light sections normally cool faster than the heavy sections, and at one instant the light portion of the casting is contracting while the heavy portion is expanding, and at another instant just the opposite condition occurs. These changes cause stresses in unequal sections of castings, which frequently result in failures either while in the sand or after the castings have been removed from the molding floor.

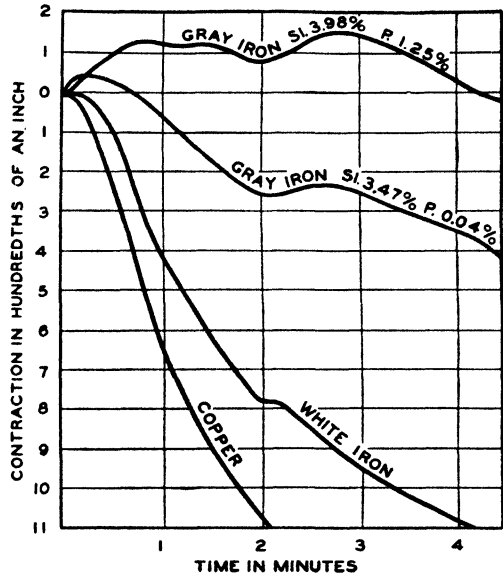

FIG. 146.—CONTRACTION CURVES

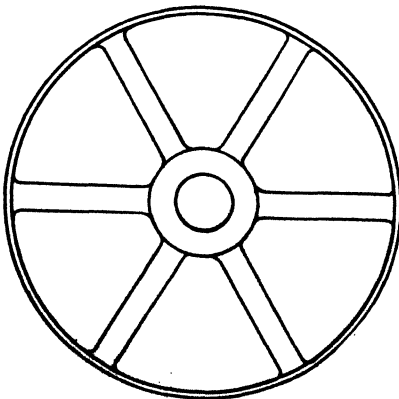

FIG. 147.—PULLEY WITH SOLID HUB

A typical example of a design with light and heavy sections is shown in Fig. 147. The thin rim of the cast-iron pulley will ordinarily cool more rapidly than the heavy arms; therefore, the metal in the rim will go through the cycle of expansion and contraction before the heavier parts, with the result that the arms will tend to pull away from the rim.

Castings should be designed so as to avoid as much as possible the detrimental effects of contraction stresses caused by uneven rates of cooling. The difficulty encountered in the pulley casting shown in Fig. 147 can be overcome by allowing each arm to contract

or expand independently. The corrected design is shown in Fig. 148. When these castings are used in machines, a band is placed around the segments of the hub, and the spaces between the arms at the hub are filled

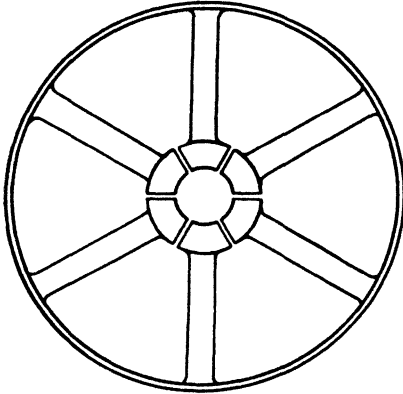

FIG. 148.—PULLEY WITH HUB IN SEGMENTS

with lead. Hand wheels such as are used on the brake equipment for railroad cars (see Fig. 149) are often made with curved spokes so as to permit some deformation without failure when the casting cools. To eliminate severe stresses in castings, all adjoining members should be designed so that as much freedom as possible will be allowed for the normal contraction of the metal during cooling.

Contraction difficulties caused by unequal sections in castings can be overcome to some extent by special care in the foundry. Metal

chills can be used in molds to increase the rate of cooling of heavy sections and thus control the contraction at critical parts of castings. The heavy portions of castings can be uncovered and exposed to the air soon after pouring to equalize rates of cooling in light and heavy sections. In some cases it may be necessary to remove the entire casting from the sand while it is still at a high temperature, and to place it in a preheated furnace where it can be cooled uniformly. In malleable-iron practice, the internal stresses produced during the initial cooling of the castings are entirely removed in the annealing process. Many steel castings are annealed to relieve the stresses in the metal caused by uneven cooling rates and at the same time to produce an improved structure.

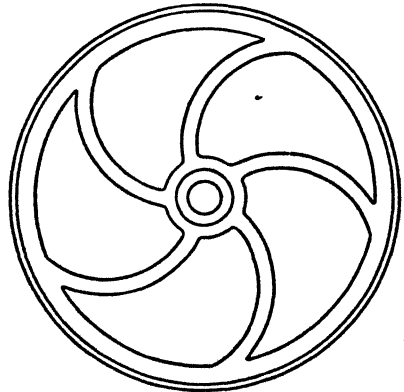

FIG. 149.—HAND WHEEL

In the construction of patterns for metal castings, allowances are made for the shrinkage of the metal during solidification and cooling. The usual allowances by which the dimensions given on drawings are

increased by the patternmaker to obtain the desired sizes of castings are given in Table VII. Other factors which influence the dimensional changes from patterns to castings are: the materials and methods used

TABLE VII
SHRINKAGE ALLOWANCES FOR THE CAST METALS

Material	Inch per Foot
Gray Cast Iron.....	$\frac{1}{10}$ to $\frac{5}{32}$
White Cast Iron.....	$\frac{1}{4}$
Carbon Steel.....	$\frac{3}{16}$ to $\frac{1}{4}$
Manganese Steel.....	$\frac{5}{16}$
Yellow Brass.....	$\frac{5}{32}$ to $\frac{3}{16}$
Gunmetal Bronze.....	$\frac{1}{8}$ to $\frac{3}{16}$
Phosphor Bronze.....	$\frac{1}{8}$ to $\frac{3}{16}$
Aluminum Bronze.....	$\frac{1}{4}$
Manganese Bronze.....	$\frac{1}{4}$
Aluminum Alloys.....	$\frac{5}{32}$
"Downmetal" Alloys.....	$\frac{5}{32}$ to $\frac{3}{16}$

in molding, the pressure of the liquid metal, and the rate of cooling. Hard molds and cores which do not soften readily resist the normal contraction of the metal.

When the metal in a casting solidifies, the reduction in volume from the liquid to the solid state causes shrinkage cavities or porous areas to be formed in those portions which are last to solidify. Sound castings are obtained by controlling the solidification of the metal so that adequate liquid metal will be supplied to all sections as the castings solidify. The ideal arrangement for all designs of castings to be made of metal in which the shrinkage is high is to have the sections gradually increase in size towards the risers. With this provision, the light sections are fed by metal from the heavier sections, so that the shrinkage

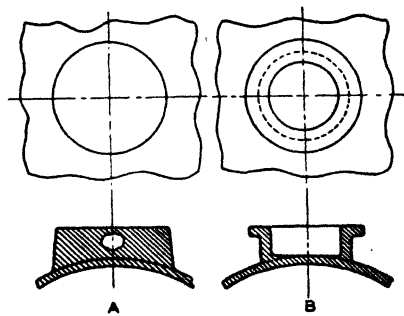

FIG. 150.—PROJECTION ON CASTING

cavities are confined to the risers, which are later removed from the casting. When the requirements of the design are such that directional solidification can not be obtained, chills can be used to hasten the solid-

ification of certain portions in advance of the lighter sections. It is also possible in the case of complex designs to provide feeders on isolated heavy sections; this precaution is used frequently in making malleable iron castings.

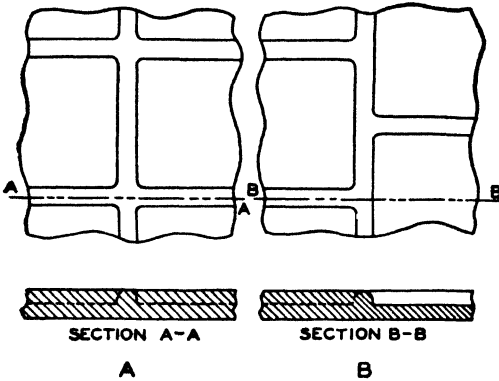

FIG. 151.—RIBS ON CASTING

Defects caused by shrinkage cavities in heavy sections of castings can often be eliminated by corrections in design. The flange construction shown at *B* in Fig. 150 is lighter and stronger than the lug shown at *A*. The design for strengthening ribs on castings

shown at *B* in Fig. 151 is preferred to the arrangement shown at *A*.

MECHANICAL FACTORS

During the preparation of all designs for metal castings, those factors which influence the cost of producing the finished cast parts should be kept constantly in mind. The mechanical factors are discussed under molding costs, cleaning costs, and machining and assembling costs.

Molding Costs

The simpler the designs, the lower the cost of pattern equipment and the more easily the patterns can be mounted for machine molding. Complicated designs often require loose pieces on patterns which necessitate extra labor in molding and also become inaccurate with use. If the parting surfaces are in planes, the mounting of patterns is readily accomplished and the difficulties encountered in molding with patterns requir-

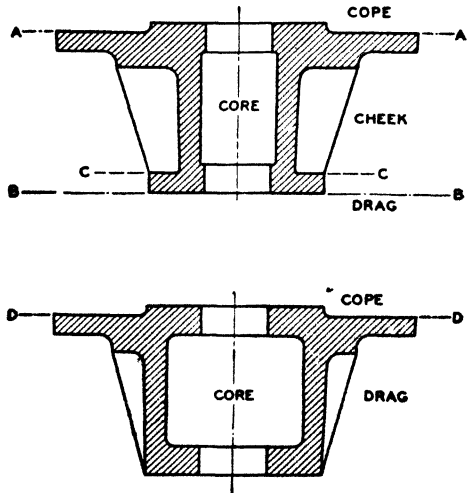

FIG. 152.—CROSS SECTIONS OF TWO DESIGNS OF WHEEL HUBS

ing irregular partings will be eliminated. The smaller the number of partings required in a mold, the less the possibility of errors in molding. The change in the design of the wheel hub shown in Fig. 152 makes the cheek unnecessary in molds for this casting. With the improved design, only one parting at $D-D$ is required, whereas with the original design, two partings at $A-A$ and $B-B$ were necessary. The pattern for the new design of wheel hub can be made in one piece, but the pattern for the original design had to be split at $C-C$.

Draft is the taper provided on all vertical faces of a pattern to permit its removal from the sand without damaging the walls of the mold. The amount of draft depends upon the shape and size of the casting as well as upon the method of molding. More draft is required on patterns which are molded by hand than on patterns which are mounted on machines. As a rule, the taper on patterns to be drawn by hand is not less than $\frac{1}{8}$ inch per foot (1 degree slope) and on those to be drawn mechanically not less than $\frac{1}{16}$ inch per foot. An ample allowance for the draft on patterns will aid in producing good molds without excessive rapping of the patterns.

The term, **flat back**, designates a design having all draft in one direction, so that the pattern can be placed flat on the mold board, allowing the casting to be made all in the drag. It is unnecessary to match accurately the cope and drag parts of a mold when the cope is just a flat surface. Furthermore, the molding operations are usually simplified when patterns have all draft in one direction.

In the development of designs for metal castings, an attempt should be made to avoid the use of dry-sand cores. The chief reason for their elimination is the high cost of baked cores. Also, cores may become shifted during the pouring of the metal, or cracks may develop because the cores do not yield sufficiently when the cooling metal contracts. A U-shaped section consisting of three intersecting members can often be used in designs for metal castings in preference to an inclosed section having four intersecting members, thus avoiding the necessity of a separate body of sand which requires more care in preparation.

When dry-sand cores are required in the making of castings, they should be designed if possible so that they can be baked on flat plates. The use of metal core driers for supporting cores until after they are baked involves an additional item of expense which should be avoided when possible.

Bosses and brackets should be omitted when possible from all designs because these projections frequently lead to difficulties in molding and also interfere with the free contraction of the metal. The one-

piece pattern shown at the left in Fig. 153 cannot be drawn from the sand without tearing the mold. If the boss *B* is a loose piece on the

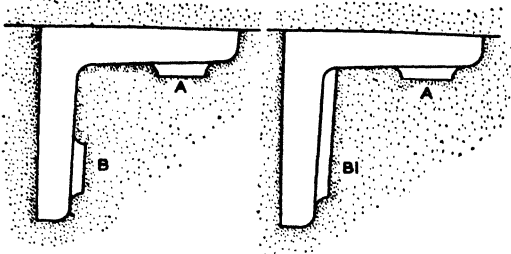

FIG. 153.—BOSSSES ON CASTING

pattern, it can be removed after the main pattern is drawn; however, this operation requires considerable care. When the design is changed so that the boss extends to the corner of the angle, as shown at the right in Fig. 153, the entire pattern can be drawn without tearing the mold.

pattern can be drawn without tearing the mold.

Cleaning Costs

The expense of trimming and cleaning castings is often a large part of the total manufacturing cost. All designs should, therefore, be prepared to facilitate the cleaning operations. The designs should allow for the placing of risers on heavy sections where they can be removed with the minimum expense. Attention should be given to the directional solidification of the metal so that the smallest number of risers will be needed to produce sound castings. Deep pockets and recesses should be avoided as much as possible because of the difficulty of cleaning the interior surfaces. The removal of fins which are caused by the metal filling the openings at the joints of molds and cores necessitates additional expense. The smaller the number of partings in a mold and the smaller the number of parts to the cores, the less the possibility of fins being formed on the casting.

Machining and Assembling Costs

Extra metal is provided on those surfaces of castings which are to be machined. The added thickness of metal, known as finish, depends upon the method of machining and the design of the casting. Some castings which are ground to the desired dimensions are made with only $\frac{1}{32}$ inch of extra metal. Other castings of large size which are subject to warping have an additional thickness of $\frac{1}{2}$ inch on parts which are to be machined. Those surfaces of a casting which require machining are usually made in the lower part of a sand mold because slag and gas tend to rise in the liquid metal, and thus cause defects in the upper parts of the casting.

Designs which permit the consolidation of a number of structural members in one casting save the expense of machining and assembling operations. The cast-steel underframe for a hopper car shown in Fig. 154 includes the center, end, and side sills, body bolsters, and hopper bottoms in one casting which replaces over 170 separate parts found in

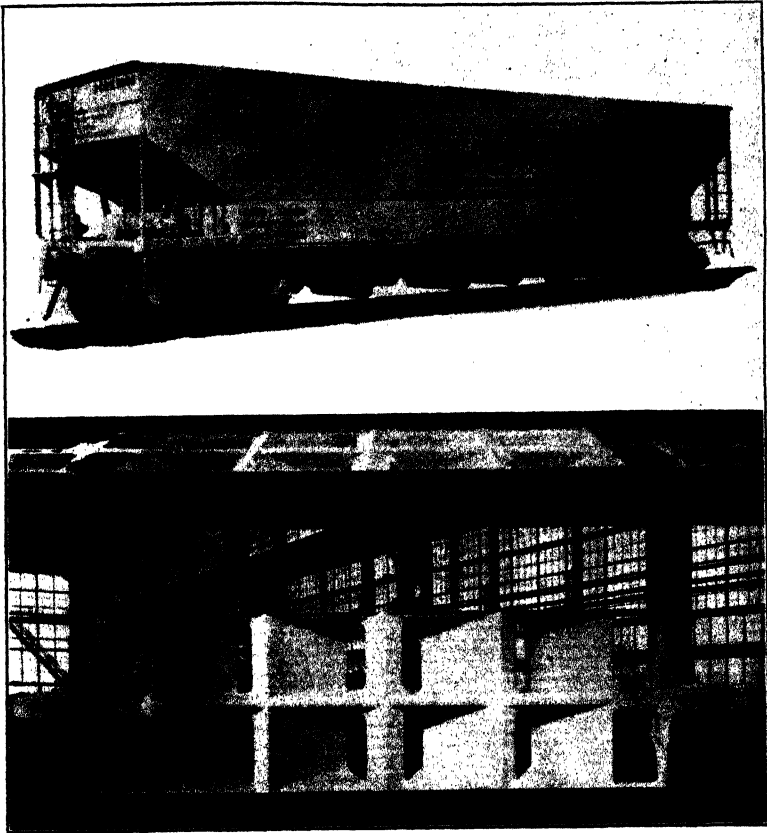

Courtesy of General Steel Castings Corporation

FIG. 154.—CAST-STEEL UNDERFRAME FOR HOPPER CAR
Weight about 13,000 pounds.

a hopper car of ordinary design. The advantages of the cast-steel underframe are great rigidity, low maintenance cost, a long period between repairs, and a long life for the car. The cast-steel locomotive bed in which the cylinders are cast integral with the main frames and cross-ties, as illustrated in Fig. 126 in Chapter XII, is another

example of a consolidated design in which all parts were united in the liquid state, with the saving of machining and assembling expense.

The die-casting method can be used to advantage in producing a number of parts in one casting and in eliminating many machining operations. Die castings are made with a limit of accuracy within 0.002 inch of specified dimensions, thus making machining unnecessary for



Courtesy of The New Jersey Zinc Company

FIG. 155.—ZINC ALLOY DIE CASTING
Size, $6\frac{1}{2}$ by $6\frac{1}{2}$ by 5 inches. Weight, $9\frac{1}{2}$ pounds.

many purposes. The casting shown in Fig. 155 has a large number of cored holes formed during the casting of the metal.

APPEARANCE

The appearance of metal castings has much to do with their adoption for many uses; this applies not only to castings which are designed primarily for decorative effects, but also to parts of machines which have utilitarian purposes. Within recent years, many cast products have been redesigned to secure a more attractive appearance. This consid-

eration is of special importance in the development of metal castings for machine tools, electrical appliances, household equipment, hardware, and plumbing goods.

BIBLIOGRAPHY

1. F. A. LORENZ, JR., "Notes on the Design of Steel Castings." *Proc. A.S.T.M.*, v. 32 (1932), p. 58-72.
2. LEWIS H. FAWCETT, "The Influence of Design on Brass and Bronze Castings." *Trans. A.F.A.*, v. XI (1932), p. 360-374.
3. ALEX TAUB, "Correlation of Casting Design and Foundry Practice." *Trans. A.S.M.E.*, v. 54 (1932).
4. K. V. WHEELER, "Foundry Factors Affecting Steel Casting Design." *Trans. A.F.A.*, v. XI (1932), p. 125-152.
5. CHARLES W. BRIGGS and ROY A. GEZELIUS, "Studies on Solidification and Contraction and Their Relation to the Formation of Hot Tears in Steel Castings." *Trans. A.F.A.*, v. XLI (1933), p. 385-424.

REVIEW QUESTIONS

I

What factors should be taken into account in the design of metal castings?

II

What difficulty would be encountered in the use of triangular openings in flat castings?

III

What conditions affect the contraction in iron castings?

IV

What principle should be observed by the designer to avoid serious stresses in metal castings?

V

Explain how defects caused by shrinkage cavities may be eliminated.

VI

What precautions may be taken in the foundry to overcome difficulties due to faulty design?

VII

Explain the advantage of a pattern having all draft in one direction.

VIII

What conditions assist in decreasing the cleaning costs?

IX

What provision is made to obtain clean metal on surfaces of castings which are to be machined?

CHAPTER XV

COMPARATIVE PROPERTIES OF THE CAST METALS

TENSILE PROPERTIES—STRENGTH IN COMPRESSION—HARDNESS—WEIGHT—MACHINABILITY—RESISTANCE TO CORROSION—RESISTANCE TO HIGH TEMPERATURES—THERMAL CONDUCTIVITY—THERMAL EXPANSION—MODULUS OF ELASTICITY—ANTI-FRICTION PROPERTY—TEST PROCEDURE

The selection of materials for new designs of metal castings should be based on complete knowledge of the qualities of all the cast metals. The properties of some of the most extensively used casting alloys have been stated in discussions in previous chapters. With the purpose of summarizing this information, two tables of data, one on the ferrous alloys (Table IX) and one on the non-ferrous alloys (Table X), have been prepared to assist in comparing the properties of these materials. The values given in the tables were collected from the sources indicated and are representative for these alloys. With some individual specimens of the cast metals, properties above or below the values specified in the tables may be obtained.

It is not possible to classify the cast metals in a series based on the general desirability of these materials. In practically all cases the selection of a material for a metal casting must be made on the basis of a combination of qualities which may involve both physical and chemical characteristics. For some purposes, the mechanical properties are of chief importance, whereas for other uses, resistance to heat or chemical attack is most significant. Furthermore, the ease of machining may influence the choice of a material for a casting.

The factor of cost should always be taken into account when specifying materials for definite purposes. As the market prices of the materials used in the foundry change continuously, the prices of the different cast metals can not be established far in advance. Furthermore, the selling price of castings includes much more than the cost of the metals used in their preparation. The cost of patterns must be distributed over a certain number of castings. Other expenses, which include the cost of cores, molding, and cleaning, are dependent on the designs and the requirements of the castings. In spite of the many factors which right-

fully determine the final selling price, every designer should have some information at hand on the current prices of castings made of the different metals. The data presented in Table VIII were obtained from bids

TABLE VIII
COMMERCIAL PRICES OF METAL CASTINGS

Based on 200 castings of plain design without cores. Pattern costs not included.
May, 1935

Material in Casting	Weight of Casting, Pounds	Price of One Casting	Price per Pound
Plain Cast Iron	7	\$0.28	\$0.04
Alloy Cast Iron	7	0.35	.05
Malleable Cast Iron	7	0.42	.06
Carbon Steel	7½	1.13	.15
Alloy Steel (Low Alloy Content)	7½	1.28	.17
Manganese Steel (13 Mn)	7½	1.50	.20
"Stainless" Steel (18 Cr-8 Ni)	7½	4.50	.60
Special Steel (29 Cr-9 Ni)	7½	5.03	.67
Yellow Brass (70-25-2-3)	8⅜	1.09	.13
Red Brass (85-5-5-5)	8⅜	1.34	.16
Gun-Metal (88-10-2)	8⅜	1.51	.18
Manganese Bronze	8⅜	1.51	.18
Aluminum Bronze	8⅜	1.59	.19
"Monel Metal"	8⅜	5.86	.70
Aluminum (92 Al-8 Cu)	2¾	0.83	.30
Aluminum (95 Al-5 Si)	2¾	0.91	.33
"Dowmetal" "H"	1¾	1.65	.94

submitted by foundries for the production of 200 castings of a plain design without cores. These prices will not necessarily apply to requirements other than those stated. However, the ratios of the prices per pound for the different metals will remain fairly constant.

TENSILE PROPERTIES

The tensile strength is the maximum stress which can be sustained by a specimen representing the material when the load is gradually

TABLE IX
PROPERTIES OF FERROUS ALLOYS

Cast Metal	Tensile Strength, Lb. per Sq. In.	Yield Point, Lb. per Sq. In.	Elongation, % 2 In.	Reduction of Area, %	Compressive Strength, Lb. per Sq. In.	Hardness Numbers		Weight, Lb. per Cu. Ft.
						Br.	Scl.	
Gray Iron	*20,000 to 60,000	Indeterminate	Negligible	Negligible	90,000 to 145,000	150 to 300	25 to 40	449
White Iron	50,000	Indeterminate	Negligible	Negligible	250,000	400	90	480
Malleable Iron	*50,000 *53,000	*32,500 *35,000	*10 *18	15 20	120 130	15 17	474 474
Carbon Steel C-0.25%								
As Cast	65,000	35,000	20	30	35,000	140	20	480
Annealed	70,000	40,000	30	45	40,000	130	18	480
Quenched and Tempered	80,000	50,000	20	30	50,000	160	22	480
Manganese-Molybdenum Steel Mn-1.40%, Mo-0.35% Heat Treated	96,000	68,000	26	58	68,000	180	28	480
Vanadium Steel Va-0.16 to 0.20% Heat Treated	95,000	65,000	18	30	65,000	180	32	480
Manganese Steel Mn-11.0 to 14.0% Heat Treated	100,000	50,000	33	35	50,000	200	45	480

* A.S.T.M. Standards, Minimum Properties.

applied so as to stretch the specimen in the direction of its length. The results are expressed in pounds per square inch of the original cross-

sectional area of the test specimen. A wide range in the tensile properties of the different cast metals is indicated in Tables IX and X.

TABLE X
PROPERTIES OF NON-FERROUS METALS AND ALLOYS

Cast Metal	Tensile Strength, Lb. per Sq. In.	Yield Point, Lb. per Sq. In.	Elongation, % 2 In.	Reduction of Area, %	Compressive Strength, Lb. per Sq. In.	Hardness Numbers		Weight, Lb. per Cu. Ft.
						Br.	Scl.	
Copper *	30,000	8,000	30	40	48	11	552
Yellow Brass † Cu Zn Sn Pb 70 25 2 3	31,000	12,500	27	26	6,000	46	10	535
Red Brass * Cu Zn Sn Pb 85 5 5 5	30,000	20,000	18	18	10,000	55	14	535
Manganese Bronze..	†65,000	30,000	†25	25	28,000	104	21	518
Phosphor Bronze *.. Cu Sn P 89.7 10 0.3	35,000	25,000	8	10	16,000	70	19	536
Aluminum Bronze..	†65,000	25,000	†20	30	20,000	80	18	481
Bearing Bronze *.. Cu Sn Pb 80 10 10	31,000	24,000	8	10	15,000	60	15	553
Aluminum * Al Cu 92 8	20,000	15,000	1.5	10,000	59	11	180
Aluminum * Al Si 95 5	20,000	12,000	4.5	43	4	168
"Downmetal" "H" ..	27,000	12,000	6	47,000	50	22	113
"Monel Metal"	72,300	37,100	34	32	60,000	100	25	551

* Average U. of M. Laboratory Tests.
† A.S.T.M. Standards, Minimum Properties.

Alloy cast steel having a tensile strength of over 100,000 lb. per sq. in. after heat treatment is used for machine parts which require high

strength and toughness. Alloy cast iron is employed extensively in applications where high strength and resistance to wear are important.

The yield point is the load per unit of original cross section of the test specimen, which causes a marked increase in the deformation of the specimen as the load is gradually applied. During the tensile test, the yield point is determined by the drop of the beam of the testing machine, or by the use of dividers in the gage points of the test specimen.

The elongation in percentage is obtained by dividing the difference in the gage length of the specimen before testing and after breaking by the original gage length, and multiplying by 100. As a rule, the gage length of standard tensile test specimens is 2 inches.

The difference between the original cross-sectional area and the smallest cross-sectional area of the tensile test specimen after failure is the reduction of area which is expressed as the percentage of the original cross-sectional area. When determining the cross-sectional area of test specimens, the actual measured dimensions should be used rather than the nominal dimensions.

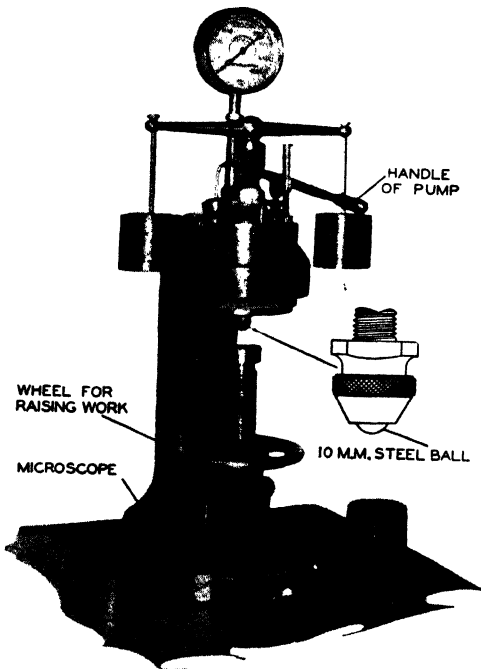

Courtesy of Steel City Testing Laboratory

FIG. 156.—BRINELL HARDNESS TESTING MACHINE

STRENGTH IN COMPRESSION

The compressive strength is the maximum load which can be sustained by a material before complete failure occurs. In the case of highly plastic materials, it is usually expressed as the stress per unit of deformation. This property is stated in pounds per square inch of the original cross section of the specimen. The strength in compression of

many of the cast metals is about the same as the yield strength in tension. Cast iron has a high strength in compression and is therefore commonly employed for parts which are subjected to high compressional stresses.

HARDNESS

Hardness is a property which may be interpreted as resistance to indentation and resistance to abrasion. These two kinds of hardness

are somewhat related, although a material may be hard in one sense and less hard in the other. Hardness measurements based on the resistance of the material to indentation are obtained by the Brinell test in which the diameter of the impression left by a steel ball is measured after a definite load has been applied to the ball. The diameter of the ball is 10 millimeters, and the pressure is 3,000 kilograms for iron or steel and 500 kilograms for the softer metals. These loads are applied for 30 seconds. The Brinell hardness number is the quotient obtained by dividing the pressure in kilograms by the area of the spherical indentation in square millimeters. A microscope containing a calibrated scale is used to measure the diameter of the impression left in the specimen. The Brinell numbers corresponding to the diameters of the impressions are readily found in tables prepared for this purpose. In the Brinell

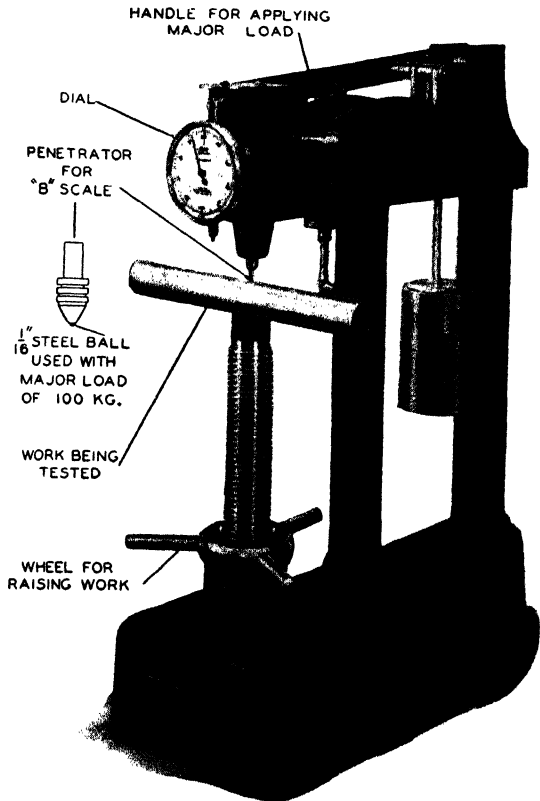

Courtesy of Wilson Mechanical Instrument Company

FIG. 157.—ROCKWELL HARDNESS TESTER

test, a microscope containing a calibrated scale is used to measure the diameter of the impression left in the specimen. The Brinell numbers corresponding to the diameters of the impressions are readily found in tables prepared for this purpose. In the Brinell

machine shown in Fig. 156, the pressure obtained by a hand pump is applied against a piston to which the steel ball is attached.

The Rockwell tester shown in Fig. 157 is used to measure hardness by determining, under an increment of load, the increment of depth of penetration of a steel ball or diamond cone into the material being tested. A preliminary load of 10 kilograms is first applied to a hardened steel ball $\frac{1}{16}$ inch in diameter, and then a major load of 100 kilograms is used. The Rockwell hardness readings are based on the depth to

which the major load forces the steel ball below the depth to which it was impressed by the preliminary load. In the testing of very hard metals, a 120-degree diamond cone is used with a major load of 150 kilograms. The Rockwell hardness values are noted on a direct-reading dial. This method is commonly used in determining the hardness of piston rings and other castings possessing a fine grain structure.

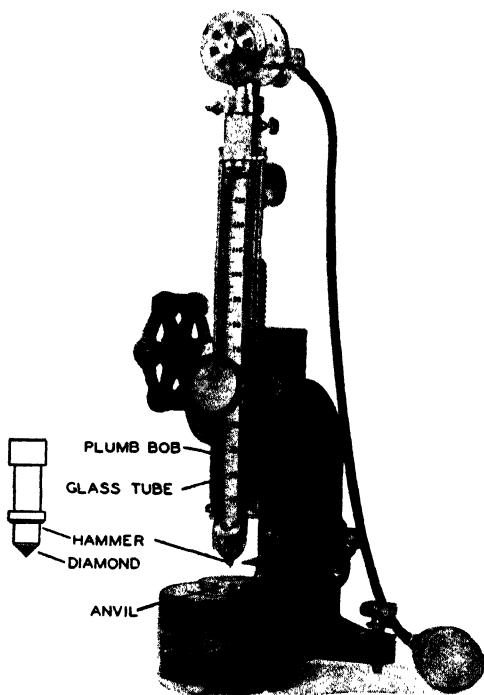

*Courtesy of
The Shore Instrument and Manufacturing Company*

FIG. 158.—SHORE SCLEROSCOPE

Hardness values are also obtained with the Shore scleroscope by observing the height of rebound of a diamond-tipped hammer which is allowed to fall through a fixed distance upon the polished surface of the material being tested. This instrument is shown in Fig. 158. The hammer travels

within a glass tube which is supported in a vertical position when hardness measurements are being made. The raising and releasing of the hammer are controlled by pressure on a rubber bulb. After each reading is taken, the specimen is moved so as to avoid having the hammer strike twice in the same spot. The hardness values are indicated on a scale graduated in units from 0 to 140. The average hardness of martensitic high-carbon steel is 100 on the scleroscope scale.

The ability of metals to resist abrasion involves toughness as well as hardness, and this property can not be established conclusively by indentation measurements. The difference in the resistance offered to wear by an extremely hard metal and by one which has some ductility is apparent when the effects of wearing are observed under a microscope. The action of rubbing of one metal on another will either break off particles of metal if the material is brittle, or bend over the projecting particles of metal if the material is ductile and tough. In the case of the hard metal, the surface will continue to be rough and the metal will



Courtesy of The Dow Chemical Company

FIG. 159.—MAGNESIUM ALLOY CASTINGS

Light weight and easily machined.

be gradually worn away. The rubbing action on the tough metal tends to make the surface smooth and increases the resistance to wear. Manganese steel has a high resistance to wear, but its initial Brinell hardness is relatively low.

WEIGHT

The weight per unit of volume is an important consideration in the selection of the materials for metal castings. A wide range is found in the specific weights of the cast metals. Lead weighs 710 lb. per cu. ft., whereas "dowmetal" weighs only 113 pounds to the same volume. The

light casting alloys described in Chapter XIII are particularly advantageous for uses where the low weight of moving parts results in a saving in power. Much attention is being given to the reduction in weight of manufactured products not only to parts for aircraft, but also to parts for buses, trucks, railway cars, packaging machinery, textile machinery, household appliances, and laboratory instruments.

MACHINABILITY

The machinability of metals refers to the characteristics of the materials when being cut by tools in operations such as drilling, turning, and milling; it may be evaluated in various ways, depending upon the objective sought in the cutting operation. The relative machinability of metals is determined on the basis of tool life before regrinding, on the speed at which metals are cut under given conditions for a definite tool

TABLE XI
MACHINABILITY OF THE CAST METALS

Material	Horsepower per Cu. In. per Minute
"Downmetal".....	0.180
Leaded Brass.....	0.288
No. 12 Aluminum Alloy.....	0.305
Malleable Cast Iron.....	0.610
Gray Cast Iron.....	0.614
Gunmetal Bronze.....	0.685
Manganese Bronze.....	0.832
"Monel Metal".....	1.475

life, or on the basis of the force or energy required in cutting. Values for machinability have been obtained by the measurement of the horsepower required to remove 1 cubic inch of metal per minute; with this basis of comparison, the values given in Table XI have been found by Boston³ to represent the machinability of the cast metals, when a twist drill of $\frac{3}{4}$ -inch diameter was operated with a feed of 0.012 inch per revolution.

RESISTANCE TO CORROSION

A property which is of importance in many applications of the cast metals is resistance to corrosion. This requirement can often be satis-

fied by the brass and bronze alloys. Manganese bronze and "monel metal" are particularly suited to uses where resistance to corrosion is of primary importance. Several types of alloy cast iron for resisting corrosion have been described in Chapter IX. Parts which must be resistant to atmospheric corrosion, as well as to attack by various chemicals, are also cast of special alloy steels.

RESISTANCE TO HIGH TEMPERATURES

A number of heat-resisting alloys are available in castings for furnace equipment. The most important of these are the nickel-chromium alloys which are used extensively in carburizing boxes, cyanide pots,

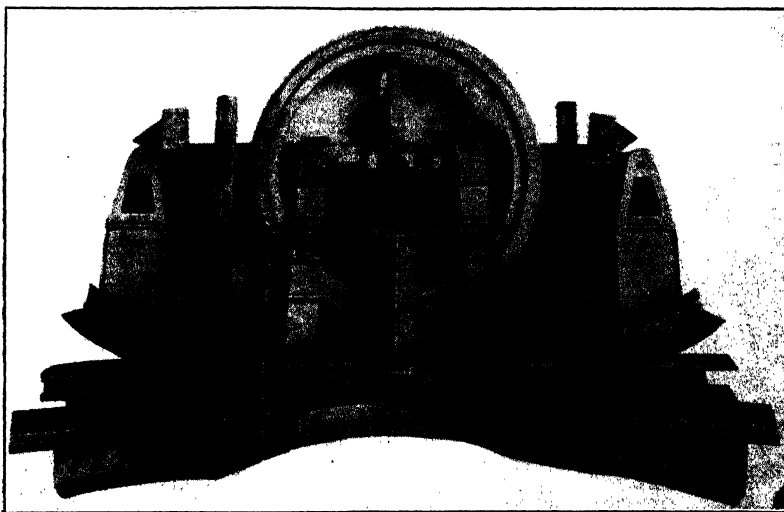

Courtesy of Driver-Harris Company

FIG. 160.—NICKEL-CHROMIUM ALLOY CASTINGS
Furnace parts, resistant to heat.

and other castings which are exposed in service at high temperatures. The compositions and maximum operating temperatures of five heat-resisting alloys are listed in Table VI in Chapter XII. Three types of cast iron which are serviceable at high temperatures are described in Chapter IX.

THERMAL CONDUCTIVITY

Special significance is attached to the thermal conductivity of the metals used in the construction of parts for internal-combustion engines. Copper inserts are sometimes cast in place to improve the thermal con-

ductivity. The values given in Table XII for the thermal conductivities of the cast metals are the amounts of heat in gram-calories transmitted per second through a plate 1 centimeter thick per square centimeter of

TABLE XII

THERMAL CONDUCTIVITIES OF THE CAST METALS

Copper.....	0.90 to 0.94
Aluminum Alloys.....	0.30 to 0.45
Magnesium Alloys.....	0.16 to 0.30
Zinc.....	0.24 to 0.27
Brass Alloys.....	0.13 to 0.24
Bronze Alloys.....	0.11 to 0.23
Carbon Steel.....	0.12 to 0.14
Gray Iron.....	0.11 to 0.14
Malleable Cast Iron.....	0.09 to 0.13
Tin.....	0.08 to 0.14
Tin-Base Bearing Metal.....	0.06 to 0.09
"Monel Metal".....	0.06 to 0.09
Lead.....	0.04 to 0.08

its surface when the difference in temperature between the two faces of the plate is 1 degree C. The thermal conductivity of a metal varies with the temperature and usually decreases as the temperature is raised.

THERMAL EXPANSION

For some uses of metal castings, it is necessary to give attention to the changes in dimensions which occur when the metal is heated. The values given in Table XIII indicate that the coefficients of linear expansion of the cast metals vary considerably. Furthermore, the rate of expansion changes within different temperature ranges. When the allowable clearance between cooperating parts of a machine is relatively small, special care is required in selecting materials which will be satisfactory at all operating temperatures.

MODULUS OF ELASTICITY

The modulus or coefficient of elasticity is the relation between the amount of deformation of a material and the load which causes the deformation. It is defined as the load in pounds per square inch of area divided by the change in length in inches for all loads below the elastic

TABLE XIII
THERMAL EXPANSION OF THE CAST METALS

Material	Linear Coefficient of Expansion per Degree F. $\times 10^{-6}$			
	Between 70 and 210° F.	Between 32 and 212° F.	Between 70 and 570° F.	Between 32 and 570° F.
“Dowmetal” “H”	16.0			
Zinc-Aluminum (96-4)	15.2		
Aluminum-Silicon (95-5)	12.2	13.3	
Aluminum-Copper (92-8)	12.2			
Phosphor Bronze	10.0	10.4	
Aluminum Bronze	9.2	10.3	
“Monel Metal”	9.2	9.3
Cast Carbon Steel	6.6	7.4
Malleable Cast Iron	6.6
Gray Cast Iron	5.9	6.6

TABLE XIV
MODULUS OF ELASTICITY IN TENSION

Cast Metal	Lb. per Sq. In.
Steel	27,000,000 to 30,000,000
Malleable Cast Iron	25,000,000
“Monel Metal”	22,000,000 to 23,000,000
Gray Cast Iron	12,000,000 to 20,000,000
Copper	15,000,000
Brass	14,000,000
Bronze (85-5-5-5)	13,000,000
Zinc	12,500,000
Aluminum Alloys	10,000,000
“Dowmetal”	6,500,000
Lead	2,560,000

limit. The coefficients of elasticity for some of the cast metals are given in Table XIV. These values are used in calculations for determining the deformation of structures under definite loads.

ANTI-FRICTION PROPERTY

The alloys which are satisfactory for anti-friction bearings contain two or more physical constituents having different degrees of hardness. The softer constituents wear away, forming oil pockets for the retention of lubricants. The non-ferrous bearing alloys may be classified into two groups known as the white-metal alloys which have low melting points and are poured in place, and the bronze alloys which are cast to shape and are machined to the desired dimensions. Several compositions of alloys in each of these groups are described in Chapter XIII. Gray cast iron is also employed where its anti-friction property is advantageous.

TEST PROCEDURE

When making comparisons of the results of tests on the cast metals, it is important that the exact procedure for obtaining the properties of these materials be duplicated. The effects of changes in the size of test specimens on the mechanical properties of cast iron have been discussed in Chapter VIII. It has been pointed out that small differences in the dimensions of cast specimens cause disagreement in the results obtained by testing. The standard methods for casting and testing specimens of the ferrous and non-ferrous alloys are given in the Appendix. Also, the dimensions of the finished test specimens are shown on the drawings accompanying the standard test methods. The preparation of test specimens when not properly carried out may introduce factors which will materially affect the results of the tests.

BIBLIOGRAPHY

1. L. AITCHISON and W. R. BARCLAY, "Engineering Non-Ferrous Metals and Alloys." 1923. Henry Frowde and Hodder, 1 Bedford Street, Strand, W. C. 2, London, England.
2. CHARLES VICKERS, "Metals and Their Alloys." 1923. The Penton Publishing Company, Cleveland, Ohio.
3. O. W. BOSTON, "An Investigation of Methods to Determine the Machinability of Malleable Iron Castings." *Proc. A.S.T.M.*, v. 31 (1931), Part 2, p. 388-421.
4. J. W. DONALDSON, "Thermal Conductivity of Metals and Alloys." *Metal-lurgia*, v. 1 (1930), p. 119-120.

REVIEW QUESTIONS

I

What factors should be taken into account in the selection of materials for metal castings?

II

Define tensile strength and yield point.

III

Describe two methods for measuring the hardness of the cast metals.

IV

What methods may be used in evaluating the machinability of the cast metals?

V

What cast metals are particularly suited to resisting corrosion?

VI

Specify the cast metal to be used in propellers for ships.

VII

Specify a cast metal for each of the following combinations of properties:

- (a) light weight, easily machined.
- (b) anti-friction, for heavy loads, and resistance to shock.
- (c) non-magnetic, non-corrosive, with tensile strength over 50,000 lb. per sq. in.
- (d) elongation over 15 per cent, tensile strength over 75,000 lb. per sq. in.

VIII

State the composition of a cast metal to be used in equipment for handling commercial acids.

IX

What metals may be used in castings which are to be exposed to temperatures above 1500 degrees F.?

X

What precautions should be observed when obtaining the properties of the cast metals?



APPENDIX

TABLE XV
INDUSTRIAL TEMPERATURES *

Degrees Fahrenheit

<p>6300 Oxy-acetylene flame</p> <p>6152 Tungsten melts</p> <p>5072 Magnesia (MgO) fuses</p> <p>4757 Molybdenum melts</p> <p>4658 Lime (CaO) fuses</p> <p>4800 "Thermit" reaction</p> <p>3722 Aluminum oxide (Al₂O₃) fuses</p> <p>3600 Oxy-hydrogen flame</p> <p>3550 Silica brick softens</p> <p>3272 Titanium melts</p> <p>3191 Platinum melts</p> <p>3128 Vanadium melts</p> <p>3115 Silicon oxide (SiO₂) fuses</p> <p>3100± Open-hearth tapped</p> <p>3055 Fire clay brick softens</p> <p>2939 Chromium melts</p> <p>2900± Blast furnace tapped</p> <p>2894 Iron oxide (Fe₃O₄) melts</p> <p>2808 Iron oxide (Fe₂O₃) melts</p> <p>2788 Pure iron melts</p> <p>2750± Cupola tapped</p> <p>2696 Cobalt melts</p> <p>2650± Steel melts</p> <p>2646 Nickel melts</p> <p>2588 Silicon melts</p> <p>2500± Ferrochromium (60-70% Cr) melts</p>	<p>2480 Ferrosilicon (50% Si) melts</p> <p>2480 Iron oxide (FeO) melts</p> <p>2453 Manganese steel (13% Mn) melts</p> <p>2336 Beryllium melts</p> <p>2335 Ferrosilicon (15% Si) melts</p> <p>2280± Ferromanganese (80% Mn) melts</p> <p>2280± Open-hearth slag fuses</p> <p>2250± Cast iron melts</p> <p>1981 Copper melts</p> <p>1946 Gold melts</p> <p>1800 Red brass (85-5-5-5) melts</p> <p>1761 Silver melts</p> <p>1600 Manganese bronze melts</p> <p>1560 Sodium carbonate melts</p> <p>1220 Aluminum melts</p> <p>1204 Magnesium melts</p> <p>1166 Antimony melts</p> <p>1000 Red heat</p> <p>787 Zinc melts</p> <p>621 Lead melts</p> <p>610 Cadmium melts</p> <p>518 Bismuth melts</p> <p>449 Tin melts</p>
--	---

* Data from *U. S. Bureau of Standards* and other reliable sources.

TABLE XVI
COMPOSITIONS OF SOLID FUELS

	Moisture, %	Volatile Matter, %	Fixed Carbon, %	Ash, %	Sulphur, %
Wood.....	20	..	40	1.6
Charcoal.....	10	4.0	84	2.0	0.05
Bituminous Coal..	7	20-30	60-75	10.0	7.00
Anthracite Coal...	4	3-7	85-90	3-7	1.50
By-Product Coke..	2	1.0	87	10.0	0.60
Beehive Coke.....	..	1.5	88	10.5	0.90
Petroleum Coke...	1	10.0	88	1.0	0.50

TABLE XVII
HEATING VALUES OF FOUNDRY FUELS

	B. T. U. per Lb.	B. T. U. per U. S. Gal.
Wood (Dry Pine).....	9,000	
Charcoal (Hardwood).....	12,850	
Bituminous Coal (dry).....	14,000	
Anthracite Coal (dry).....	12,000	
By-Product Coke.....	12,500	
Petroleum Coke.....	15,500	
Fuel Oil.....	19,300	144,000
Kerosene.....	20,000	B. T. U. per Cu. Ft.
City Gas.....		625
Producer Gas.....		145
Coke-Oven Gas.....		600
Natural Gas.....		1,000
Electric Current.....		3,412 B. T. U. per Kw.-Hr.

TABLE XVIII
STANDARD SIZES OF CRUCIBLES
Outside Dimensions in Inches

No.	Height	Top	Bilge	Bottom	Approximate Capacities in Pounds	
					Copper Alloy	Aluminum Alloy
10	$8\frac{1}{16}$	$6\frac{1}{16}$	$6\frac{9}{16}$	$4\frac{3}{16}$	41	14
12	$8\frac{1}{2}$	$6\frac{3}{8}$	$6\frac{7}{8}$	$5\frac{1}{16}$	48	16
14	$8\frac{7}{8}$	$6\frac{1}{16}$	$7\frac{3}{16}$	$5\frac{1}{4}$	55	19
16	$9\frac{1}{4}$	$6\frac{15}{16}$	$7\frac{1}{2}$	$5\frac{1}{2}$	62	21
18	$9\frac{3}{16}$	$7\frac{5}{16}$	$7\frac{15}{16}$	$5\frac{3}{16}$	74	25
20	$10\frac{5}{16}$	$7\frac{11}{16}$	$8\frac{3}{8}$	$6\frac{1}{8}$	86	29
25	$10\frac{15}{16}$	$8\frac{3}{8}$	$8\frac{7}{8}$	$6\frac{1}{2}$	103	35
30	$11\frac{1}{2}$	$8\frac{5}{8}$	$9\frac{5}{16}$	$6\frac{3}{8}$	120	41
35	12	9	$9\frac{3}{4}$	$7\frac{1}{8}$	138	46
40	$12\frac{1}{2}$	$9\frac{3}{8}$	$10\frac{1}{8}$	$7\frac{7}{16}$	155	52
45	$13\frac{3}{16}$	$9\frac{7}{8}$	$10\frac{11}{16}$	$7\frac{13}{16}$	181	61
50	$13\frac{3}{4}$	$10\frac{1}{4}$	$11\frac{1}{8}$	$8\frac{1}{8}$	206	70
60	$14\frac{7}{16}$	$10\frac{13}{16}$	$11\frac{11}{16}$	$8\frac{9}{16}$	241	81
70	$15\frac{1}{16}$	$11\frac{1}{4}$	$12\frac{3}{16}$	$8\frac{15}{16}$	275	93
80	$15\frac{5}{8}$	$11\frac{1}{16}$	$12\frac{1}{16}$	$9\frac{1}{4}$	310	104
90	$16\frac{3}{16}$	$12\frac{1}{8}$	$13\frac{1}{8}$	$9\frac{9}{16}$	344	116
100	$16\frac{11}{16}$	$12\frac{1}{2}$	$13\frac{1}{2}$	$9\frac{7}{8}$	378	128
125	$17\frac{3}{8}$	13	$14\frac{1}{16}$	$10\frac{5}{16}$	430	145
150	$18\frac{3}{8}$	$13\frac{3}{4}$	$14\frac{7}{8}$	$10\frac{7}{8}$	516	174
175	$19\frac{1}{4}$	$14\frac{3}{8}$	$15\frac{9}{16}$	$11\frac{3}{8}$	602	203
200	20	15	$16\frac{1}{4}$	$11\frac{7}{8}$	688	232
225	$20\frac{3}{4}$	$15\frac{1}{2}$	$16\frac{13}{16}$	$12\frac{5}{16}$	774	261
250	$21\frac{3}{8}$	16	$17\frac{5}{16}$	$12\frac{1}{16}$	860	290
275	22	$16\frac{7}{16}$	$17\frac{13}{16}$	13	946	319
300	$22\frac{1}{2}$	$16\frac{7}{8}$	$18\frac{1}{4}$	$13\frac{3}{8}$	1,032	348
400	$24\frac{5}{16}$	$18\frac{3}{16}$	$19\frac{11}{16}$	$14\frac{7}{16}$	1,376	464

TABLE XIX
WEIGHTS OF CASTINGS FROM WEIGHTS OF PATTERNS

Multiply weights of patterns by factors below.

Pattern Materials	Cast Metals					
	Gray Iron (449 lb./ cu. ft.)	Malle- able Iron (474 lb./ cu. ft.)	Steel (480 lb./ cu. ft.)	Copper Alloy (535 lb./ cu. ft.)	Alumi- num Alloy (180 lb./ cu. ft.)	Mag- nesium Alloy (113 lb./ cu. ft.)
White Pine (26 lb./cu. ft.)	17.3	18.2	18.4	20.6	6.9	4.3
Yellow Pine (34 lb./cu. ft.)	13.2	13.9	14.1	15.7	5.3	3.3
Mahogany (34 lb./cu. ft.)	13.2	13.9	14.1	15.7	5.3	3.3
Aluminum Alloy (180 lb./cu. ft.)	2.5	2.6	2.7	3.0	1.0	0.6
Copper Alloy (535 lb./cu. ft.)	0.8	0.9	0.9	1.0	0.3	0.2
Magnesium Alloy (113 lb./cu. ft.)	4.0	4.3	4.3	4.8	1.6	1.0

TABLE XX
CUPOLA DATA

Dia. Inside Lining, In.	Area Inside Lining, Sq. In.	Total Tuyere Area, Sq. In.	Volume 6 In. High, Cu. In.	Coke per Charge, Lb.*	Cu. Ft. Air per Min. †	Limestone per Charge, Lb. ‡	Weight of One Metal Charge		
							Ratio 8 to 1 Lb.	Ratio 9 to 1 Lb.	Ratio 10 to 1 Lb.
32	804	201	4,824	74	1,509	15	592	666	740
36	1,018	254	6,108	94	1,917	19	752	846	940
42	1,385	346	8,310	128	2,611	26	1,024	1,152	1,280
48	1,810	453	10,860	167	3,407	33	1,336	1,503	1,670
54	2,290	573	13,740	211	4,304	42	1,688	1,899	2,110
60	2,827	707	16,962	261	5,324	52	2,088	2,349	2,610
66	3,421	855	20,526	316	6,446	63	2,528	2,844	3,160
72	4,072	1,018	24,432	376	7,670	75	3,008	3,384	3,760
78	4,778	1,195	28,668	441	8,996	88	3,528	3,969	4,410
84	5,542	1,386	33,252	512	10,445	102	4,096	4,608	5,120
90	6,362	1,591	38,172	587	11,975	117	4,696	5,283	5,870

* Assumes 1 pound of coke occupies 65 cubic inches.

† Assumes 1 pound of coke requires 102 cubic feet of air, and coke charge is burned in 5 minutes.

‡ Assumes limestone required is 20 per cent of weight of coke.

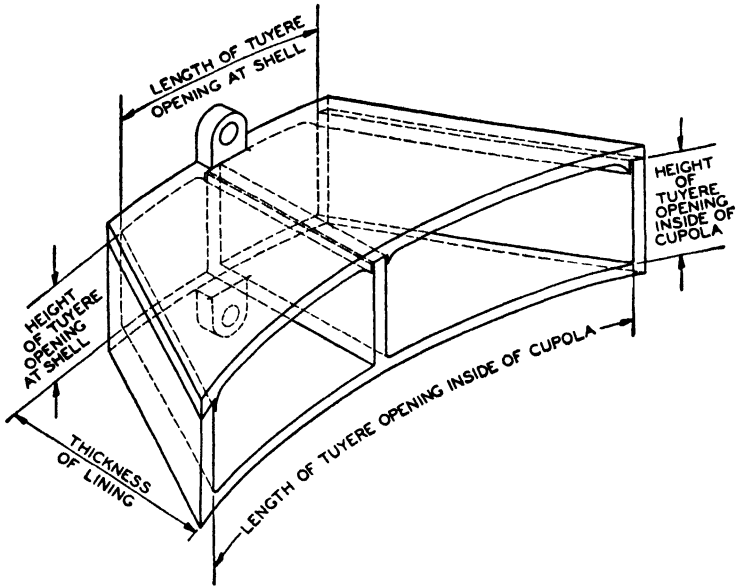

FIG. 161.—CUPOLA TUYERES

TABLE XXI
CUPOLA TUYERES

Diameter of Cupola Inside of Lining, Inches	Number of Tuyeres	Area of Each Tuyere Inside of Lining, Square Inches	Size of Tuyere Opening Inside of Lining, Inches		Size of Tuyere Opening at Shell, Inches	
			Height	Length	Height	Length
32	4	50	4	12	4	9
36	4	64	4	16	4	11
42	6	58	4	15	4	10
48	6	75	4	19	4	13
54	6	95	4	24	4	16
60	6	118	5	23	5	16
66	6	143	5	29	5	20
72	6	170	5	34	5	23
78	8	149	6	25	6	17
84	8	173	6	29	6	20
90	8	200	6	33	6	23

TENTATIVE SPECIFICATIONS FOR GRAY-IRON CASTINGS

A.S.T.M. Designation: A48-36

1. These specifications cover general gray-iron castings not covered by other existing specifications of the American Society for Testing Materials. These specifications apply to gray-iron castings where strength is a consideration. It is a purpose of these specifications to classify cast irons in respect to tensile strength.

PHYSICAL PROPERTIES AND TESTS

2. Gray-iron castings conforming to these specifications shall be known and listed by classes, according to minimum tensile strengths of test bars as follows:

Class	Tensile Strength, Minimum Lb. per Sq. In.
No. 20.....	20,000
No. 25.....	25,000
No. 30.....	30,000
No. 35.....	35,000
No. 40.....	40,000
No. 50.....	50,000
No. 60.....	60,000

3. (a) Transverse tests shall be optional and the following minimum breaking loads are specified:

Transverse Test	0.875 in. in Diameter	1.2 in. in Diameter	2.0 in. in Diameter
Bar.....	12-in. Supports	18-in. Supports	24-in. Supports

Class	Load at Center, Lb.	Load at Center, Lb.	Load at Center, Lb.
No. 20.....	900	1,800	6,000
No. 25.....	1,025	2,000	6,800
No. 30.....	1,150	2,200	7,600
No. 35.....	1,275	2,400	8,300
No. 40.....	1,400	2,600	9,100
No. 50.....	1,675	3,000	10,300
No. 60.....	1,925	3,400

(b) By mutual agreement between the manufacturer and purchaser, deflection values in the transverse test may be specified.

(c) The transverse breaking loads specified in Paragraph (a) are based on actual averages of transverse test loads for each class of casting. It is not implied by these specifications that the ratio of tensile strength to transverse load is constant. By agreement between the manufacturer and purchaser, tensile strength and transverse tests may be made and a range of transverse values determined. These values will then supersede the values specified in Paragraph (a).

(d) When an iron is specified by class (No. 20, No. 25, etc.) and the transverse test bar fails to meet the load requirements specified in Paragraph (a), then the manufacturer shall have the right to have tested a tension test specimen machined from a broken end of the transverse bar. In the event that this tension specimen meets the requirements of the specified class, as given in Section 2, the class requirement shall be considered as having been met, irrespective of the transverse breaking load.

4. Test bars shall be cast separately from the casting. Three standard sizes of transverse test bars are available under these specifications as shown in Fig. 162. Tension test specimens shall be machined from the transverse test bars to the dimensions shown in Fig. 163.

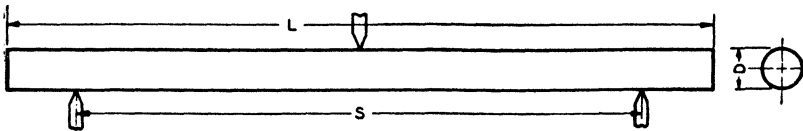

FIG. 162.—TRANSVERSE TEST BARS

Test Bar	Dimensions		Distance between Supports S
	Diameter D	Length L	
A.....	0.875 in.	15 in.	12 in.
B.....	1.20 in.	21 in.	18 in.
C.....	2.00 in.	27 in.	24 in.

5. (a) The manufacturer and purchaser shall agree upon the controlling section of the casting. Then the corresponding test bar shall be used as follows:

Controlling Section of Casting	Test Bar	Nominal Diameter of Test Bar as Cast
0.50 inch and under.....	A	0.875 inch
0.51 to 1.00 inch.....	B	1.20 inch
1.01 to 2.00 inch.....	C	2.00 inch
Over 2.00 inch	{ Test bar C may be used or a larger test bar may be used by mutual agreement between the manufacturer and purchaser.	

(b) The correlation in Paragraph (a) is only approximate and may need modification for complicated castings. The test bar size for a given casting may then be determined by mutual agreement between the manufacturer and purchaser.

6. Unless otherwise agreed upon by the manufacturer and purchaser, test bars shall be made under the same sand conditions as the castings. The bars shall be poured from a ladle or ladles of iron used to pour the castings. The test bars shall receive the same mechanical and thermal treatment as the castings. In the case of heat treatment, the test bars are to be treated adjacent to the castings they represent.

7. Tensile test specimens shall fit the holders of the testing machine in such a way that the load shall be axial. The use of self-aligning shackles is recommended.

8. The transverse test shall be made on the bar as cast with central loading between supports. Corrections shall be made for sizes of bars as shown in Table XXII. Controlling dimensions shall be the diameter of the bar at the fracture. The rate of application of the load shall be such that fracture is

produced in not less than 15 seconds for the 0.875-inch diameter bar; 20 seconds for the 1.2-inch diameter bar; and 40 seconds for the 2.0-inch diameter bar.

9. The manufacturer shall prepare and furnish all test bars as agreed upon. Two or more test bars shall be cast.

TABLE XXII

CORRECTION FACTORS FOR TRANSVERSE TEST BARS

In order to correct to the standard diameter, the breaking load obtained in testing the bar shall be divided by the correction factor.

0.875 In. Diameter Bar		1.20 In. Diameter Bar		2.00 In. Diameter Bar	
Diameter of Test Bars, Inches	Correction Factor	Diameter of Test Bars, Inches	Correction Factor	Diameter of Test Bars, Inches	Correction Factor
0.825	0.838	1.10	0.770	1.90	0.857
0.830	0.853	1.11	0.791	1.91	0.871
0.835	0.869	1.12	0.813	1.92	0.885
0.840	0.885	1.13	0.835	1.93	0.899
0.845	0.900	1.14	0.857	1.94	0.913
0.850	0.916	1.15	0.880	1.95	0.927
0.855	0.933	1.16	0.903	1.96	0.941
0.860	0.949	1.17	0.927	1.97	0.955
0.865	0.966	1.18	0.951	1.98	0.970
0.870	0.983	1.19	0.975	1.99	0.985
0.875	1.000	1.20	1.000	2.00	1.000
0.880	1.017	1.21	1.025	2.01	1.015
0.885	1.034	1.22	1.051	2.02	1.030
0.890	1.051	1.23	1.077	2.03	1.046
0.895	1.069	1.24	1.103	2.04	1.061
0.900	1.087	1.25	1.130	2.05	1.076
0.905	1.106	1.26	1.158	2.06	1.092
0.910	1.125	1.27	1.185	2.07	1.109
0.915	1.143	1.28	1.214	2.08	1.125
0.920	1.162	1.29	1.242	2.09	1.141
0.925	1.181	1.30	1.271	2.10	1.158

10. (a) If a faulty or unsound test bar gives a result not in accord with the specifications, the result shall be disregarded and another test made.

(b) In case of failure of a test bar to meet the specifications, a retest may be made. If the retest fails, the castings shall be rejected, except as provided for in Paragraph (c).

(c) As provided for in Section 3 (d), when the transverse test bars fail to meet the specification requirements, tension test specimens may be machined from the broken ends of the transverse test bar. If the tension specimen meets the requirements of the specified class, the castings shall be accepted.

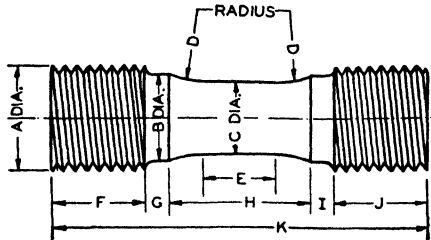

FIG. 163.—TENSION TEST SPECIMENS

	Dimensions of Test Bars		
	Test Bar A	Test Bar B	Test Bar C
A.....	3/4 in.	1 1/8 in.	1 7/8 in.
B.....	5/8 in.	15/16 in.	1 7/16 in.
C.....	0.505 in.	0.800 in.	1.25 in.
D.....	1.00 in.	1.00 in.	2.00 in.
E.....	Shall be equal to or greater than C		
F.....	1.00 in.	1.00 in.	1 3/4 in.
G.....	0.25 in.	0.25 in.	5/16 in.
H.....	1.25 in.	1.50 in.	2 1/4 in.
I.....	0.25 in.	0.25 in.	5/16 in.
J.....	1.00 in.	1.00 in.	1 3/4 in.
K.....	3.75 in.	4.00 in.	6 3/8 in.

CHEMICAL COMPOSITION

11. It is the intent of these specifications to subordinate chemical composition to physical properties. By agreement between the manufacturer and purchaser, the quantities of any chemical element in the cast iron may be specified.

WORKMANSHIP AND FINISH

12. The castings shall be true to pattern and free from cracks, gas holes, flaws, and excessive shrinkage. Surfaces of the castings shall be free from burnt-on sand and shall be reasonably smooth. Runners, risers, fins, and other cast-on pieces shall be removed. In other respects the castings shall conform to whatever points may be specially agreed upon between the manufacturer and purchaser.

INSPECTION

13. The inspector representing the purchaser shall have free entry at all times while work on the contract of the purchaser is being performed, to all parts of the manufacturer's works which concern the manufacture of the castings ordered. The manufacturer shall afford the inspector all reasonable facilities to satisfy him that the castings are being furnished in accordance with these specifications. All tests and inspection shall be made at the place

of manufacture prior to shipment, unless otherwise specified, and shall be so conducted as not to interfere unnecessarily with the operation of the works.

CERTIFICATION

14. Upon request of the buyer, the manufacturer shall be prepared to certify that his product conforms to the requirements of these specifications.

STANDARD SPECIFICATIONS FOR MALLEABLE IRON CASTINGS

A.S.T.M. Designation: A47-33

1. These specifications cover malleable iron castings for railroad, motor vehicle, agricultural implement, and general machinery purposes.

MANUFACTURE

2. The castings shall be produced by either the air-furnace, open-hearth, or electric-furnace process.

3. Castings shall be free from primary graphite.

PHYSICAL PROPERTIES AND TESTS

4. (a) The tension test specimen specified in Section 6 shall conform to the following minimum requirements as to tensile properties:

	Grade No. 32510	Grade No. 35018
Tensile strength, lb. per sq. in.	50,000	53,000
Yield point, lb. per sq. in.	32,500	35,000
Elongation in 2 in., per cent.	10.0	18.0

(b) The yield point, defined as that load under which the specimen has an elongation in 2 in. of 0.01 in., may be determined by the drop of the beam of the testing machine or by the divider method.

5. (a) All castings, if of sufficient size, shall have cast thereon test lugs of a size proportional to the thickness of the casting, but not exceeding $\frac{5}{8}$ by $\frac{3}{4}$ in. in cross section. On castings which are 24 in. or over in length, a test lug shall be cast near each end. These test lugs shall be attached to the casting at such a point that they will not interfere with the assembling of the castings, and may be broken off by the inspector.

(b) If the purchaser or his representative so desires, a casting may be tested to destruction. Such a casting shall show good, tough malleable iron.

6. (a) Tension test specimens shall be of the form and dimensions shown in Fig. 164. Specimens whose mean diameter at the smallest section is less than $\frac{1}{2}$ in. will not be accepted for test.

(b) A set of three tension test specimens shall be cast from each melt, without chills, using heavy risers of sufficient height to secure sound bars. The specimens shall be suitably marked for identification with the melt. Each set of specimens so cast shall be placed in some one oven containing castings to be annealed.

7. (a) After annealing three tension test specimens shall be selected by the inspector as representing the castings in the oven from which these specimens are taken.

(b) If the first specimen conforms to the specified requirements, or if in the event of failure of the first specimen the second and third specimens conform to the requirements, the castings in that oven shall be accepted, except that any casting may be rejected if its test lug shows that it has not been properly annealed. If either the second or third specimen fails to conform to the requirements, the entire contents of that oven shall be rejected.

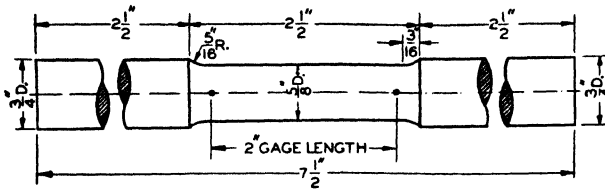

FIG. 164.—TENSION TEST SPECIMEN

(c) *Retests.* In case one of the retest specimens contains a flaw which results in the failure of the specimen to meet the specifications, at the discretion of the inspector additional test specimens from the same oven may be tested, or test specimens cut from castings may be tested.

8. Any castings rejected for insufficient annealing may be re-annealed once. The re-annealed castings shall be inspected and if the remaining test lugs, or castings broken as specimens, show the castings to be thoroughly annealed, they shall be accepted; if not, they shall be finally rejected.

WORKMANSHIP AND FINISH

9. The castings shall conform substantially to the patterns or drawings furnished by the purchaser, and also to gages which may be specified in individual cases. The castings shall be made in a workmanlike manner. A variation of $\frac{1}{8}$ in. per ft. will be permitted.

10. The castings shall be free from injurious defects.

MARKING

11. The manufacturer's identification mark and the pattern numbers assigned by the purchaser shall be cast on all castings of sufficient size, in such positions that they will not interfere with the service of the castings.

INSPECTION AND REJECTION

12. (a) The inspector representing the purchaser shall have free entry, at all times while work on the contract of the purchaser is being performed, to all parts of the manufacturer's works which concern the manufacture of the castings ordered. The manufacturer shall afford the inspector, without charge, all reasonable facilities to satisfy him that the castings are being furnished in accordance with these specifications. All tests and inspection shall be made at the place of manufacture prior to shipment, unless otherwise specified, and

shall be so conducted as not to interfere unnecessarily with the operation of the works.

(b) The manufacturer shall be required to keep a record of each melt from which castings are produced, showing tensile strength and elongation of test specimens cast from such melts. These records shall be available and shown to the inspector whenever required.

13. Castings which show injurious defects subsequent to their acceptance at the manufacturer's works may be rejected, and if rejected, shall be replaced by the manufacturer without charge to the purchaser.

STANDARD SPECIFICATIONS FOR CARBON STEEL CASTINGS

A.S.T.M. Designation: A27-24

1. These specifications cover steel castings for general service and for ships. Two classes of castings are covered, namely:

CLASS A, castings for which no physical requirements are specified.

CLASS B, castings for which physical requirements are specified. These are of three grades: hard, medium, and soft.

MANUFACTURE

2. The steel shall be made by one or more of the following processes: open-hearth, electric-furnace, converter, or crucible.

3. (a) Class A castings need not receive any heat treatment unless so specified, or unless the carbon content exceeds 0.30 per cent.

(b) Class A castings in which the carbon content is over 0.30 per cent and all class B castings shall receive a heat treatment proper to the design and chemical composition of the castings.

(c) Heat treatment, unless otherwise specified by the purchaser, may consist of annealing, or of normalizing, or of normalizing followed by annealing, or of normalizing followed by a draw-back to a temperature below the critical range. No castings which have been quenched in any liquid medium shall be offered under these specifications.

(d) *Annealing.* The procedure for annealing shall consist in allowing the castings to cool after pouring, to a temperature below the critical range. They shall then be uniformly reheated to the proper temperature to refine the grain, and allowed to cool uniformly in the furnace.

(e) *Normalizing.* The procedure for normalizing shall consist in allowing the castings to cool after pouring, to a temperature below the critical range. They shall then be reheated to the proper temperature to refine the grain and allowed to cool in still air.

CHEMICAL PROPERTIES AND TESTS

4. The steel shall conform to the following requirements as to chemical composition:

	Class A	Class B
Carbon	not over 0.45 per cent	not over 0.06 per cent
Phosphorus (Acid)	not over 0.07 per cent	not over 0.05 per cent
(Basic)	not over 0.06 per cent	not over 0.06 per cent
Sulphur	not over 0.06 per cent	not over 0.06 per cent

5. An analysis of each melt of steel shall be made by the manufacturer to determine the percentages of the elements specified in Section 4. This analysis shall be made from drillings taken at least $\frac{1}{4}$ inch beneath the surface of a test ingot obtained during the pouring of the melt. The chemical composition thus determined shall be reported to the purchaser or his representative, and shall conform to the requirements specified in Section 4.

6. (a) Analyses of Class A castings may be made by the purchaser. The phosphorus content thus determined shall not exceed that specified in Section 4 by more than 20 per cent. Samples for analysis shall be taken not less than $\frac{1}{4}$ inch beneath the surface, and in such a way as not to destroy the castings.

(b) Analyses of Class B castings may be made by the purchaser from a broken tension test specimen. The phosphorus and sulphur content thus determined shall not exceed that specified in Section 4 by more than 20 per cent.

PHYSICAL PROPERTIES AND TESTS

(For Class B Castings Only)

7. (a) The castings shall conform to the following minimum requirements as to tensile properties:

	Hard	Medium	Soft
Tensile strength, lb. per sq. in.	80,000	70,000	60,000
Yield point, lb. per sq. in.	0.45 tens. str.	0.45 tens. str.	0.45 tens. str.
Elongation in 2 in., per cent.	17	20	24
Reduction of area, per cent.	25	30	35

(b) The yield point shall be determined by the drop of the beam of the testing machine.

8. (a) Bend tests shall not be required for castings of the hard grade, and shall be required for castings of the medium and soft grades only when so specified in the order.

(b) When a bend test is specified, the test specimen shall stand being bent cold without cracking on the outside of the bent portion, around a pin 1 inch in diameter through the following angles:

	Hard	Medium	Soft
Angle of bend	No bend test	90 deg.	120 deg.

9. The tensile properties of the castings shall be determined from test bars unless in the case of castings weighing not over 150 pounds the manufacturer desires to offer, as an alternative, tests to destruction. Upon agreement with the inspector, the castings shall be grouped in lots, each lot containing castings from the same melt and from the same heat-treatment charge, and the inspector shall select from each lot one casting to represent the lot. The representative casting shall be tested to destruction as a substitute for the tension test. This test shall show the material to be ductile and free from injurious defects.

10. (a) Tension and bend test specimens shall be taken from test bars cast attached to the castings where practicable. If the design of the castings is such that test bars should not be attached to the castings, the test bars shall be cast attached to special blocks, of which a sufficient number shall be provided for each lot of castings. Test bars from which tension and bend test specimens are to be taken shall remain attached to the castings or blocks they represent through heat treatment and until presented for inspection. Test bars shall be provided in sufficient numbers to furnish the tests required in Section 11.

(b) If satisfactory to the manufacturer and inspector, tension test specimens may be cut from heat-treated castings instead of from test bars.

(c) Tension test specimens shall conform to the dimensions shown in Fig. 165. The ends shall be of a form to fit the holders of the testing machine in such a way that the load shall be axial.

(d) Bend test specimens shall be machined to 1 by $\frac{1}{2}$ inch in section with the corners rounded to a radius of not over $\frac{1}{16}$ inch.

11. (a) One tension test and, when specified, one bend test shall be made from each melt in each heat-treatment charge, and when specified, from each casting weighing 500 pounds or over.

(b) If any test specimen shows defective machining or develops flaws, it

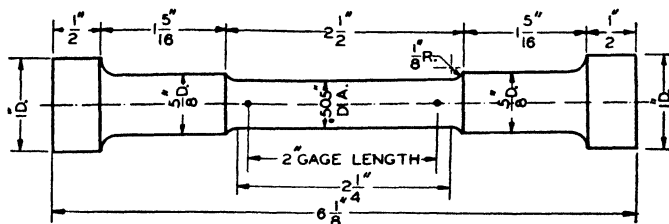

FIG. 165.—TENSION TEST SPECIMEN

may be discarded; in which case another specimen from the same lot shall be substituted.

(c) If the percentage of elongation of any tension test specimen is less than that specified in Section 7 (a) and any part of the fracture is more than $\frac{3}{4}$ inch from the center of the gage length, as indicated by scribe scratches marked on the specimen before testing, a retest shall be allowed.

12. If the results of the physical test for any lot do not conform to the requirements specified, such lot may be re-treated, but not more than twice. Retests shall be made as specified in Sections 7 and 8.

WORKMANSHIP AND FINISH

13. The castings shall conform substantially to the shapes and sizes indicated by the patterns and drawings submitted by the purchaser.

14. (a) The castings shall be free from injurious defects.

(b) Defects which do not impair the strength of the castings may be welded by an approved process. The defects shall be cleaned out to solid metal, before welding, and when so required by the inspector, shall be submitted to him in this condition for his approval. When required by the inspector, important castings shall be heat treated after welding.

INSPECTION AND REJECTION

15. (a) The inspector representing the purchaser shall have free entry, at all times while work on the contract of the purchaser is being performed, to all parts of the manufacturer's works which concern the manufacture of the castings ordered. The manufacturer shall afford the inspector, without charge, all reasonable facilities to satisfy him that the castings are being furnished in accordance with these specifications.

(b) If, in the case of important castings for special purposes, surface inspection in the green state is required, this shall be so specified in the order.

(c) All tests (except check analyses) and inspection shall be made at the place of manufacture prior to shipment unless otherwise specified, and shall be so conducted as not to interfere unnecessarily with the operation of the works.

16. (a) Unless otherwise specified, any rejection based on tests made in accordance with Section 6 shall be reported within five working days from the receipt of samples.

(b) Castings which show injurious defects subsequent to their acceptance at the manufacturer's works will be rejected and the manufacturer shall be notified.

17. Samples tested in accordance with Section 6, which represent rejected castings, shall be preserved for two weeks from the date of the test report. In case of dissatisfaction with the results of the tests, the manufacturer may make claim for a rehearing within that time.

SPECIAL REQUIREMENTS FOR CASTINGS FOR SHIPS

18. In addition to the preceding requirements, castings for ships, when so specified shall conform to the following requirements:

19. All castings shall be of Class B, medium or soft grade, and shall receive a proper heat treatment.

20. (a) One tension and one bend test shall be made from each of the following castings: stern frames, stern posts, twin screw spectacle frames, propeller shaft brackets, rudders, steering quadrants, tillers, stems, anchors, and other castings when specified.

(b) When a casting is made from more than one melt, four tension and four bend tests shall be made from each casting.

21. (a) A percussion test shall be made on each of the following castings: stern frames, stern posts, twin screw spectacle frames, propeller shaft brackets, rudders, steering quadrants, tillers, stems, anchors, and other castings when specified.

(b) For this test, the casting shall be suspended by chains and hammered all over with a hammer of a weight approved by the purchaser or his representative. If cracks, flaws, defects, or weakness appear after such test, the casting may be rejected.

STANDARD SPECIFICATIONS FOR COMPOSITION BRASS OR OUNCE METAL SAND CASTINGS

A.S.T.M. Designation: B62-28

1. These specifications cover alloy castings, the alloy being a composition of copper, tin, lead, and zinc, known commercially as composition metal, 85-5-5-5 or ounce metal. Castings of this alloy are commonly used in hydrostatic pressures up to 350 lb. per sq. in.

MANUFACTURE

2. (a) The alloy may be made by any approved method.

(b) The castings shall be of uniform quality.

CHEMICAL PROPERTIES AND TESTS

3. (a) The alloy shall conform to the following requirements as to chemical composition:

	Desired	Minimum	Maximum
Copper, per cent.	85.00	84.00	86.00
Tin, per cent.	5.00	4.00	6.00
Lead, per cent.	5.00	4.00	6.00
Zinc, per cent.	5.00	4.00	6.00
Iron, per cent.	none	0.25
Nickel, per cent.	0.75
Phosphorus, per cent.	none	0.05
Aluminum, per cent.	none	none
Sulphur, per cent.	0.05
Antimony, per cent.	0.25
Total other impurities, per cent.	0.15

(b) Where "none" is specified, it shall be construed to refer to none as determined on a 10-g. sample.

4. (a) An analysis of each melt may be made at the option of the purchaser and at his own expense.

(b) The sample for chemical analysis shall be taken from cuttings from the test bars.

PHYSICAL PROPERTIES AND TESTS

5. (a) Where desired by the purchaser and so specified in the contract or purchase order, the alloy shall conform to the following minimum requirements as to tensile properties:

Tensile strength, lb. per sq. in.	26,000
Yield point, lb. per sq. in.	12,000
Elongation in 2 in., per cent.	15

(b) Where physical requirements are not specified in the contract or purchase order, a fracture of the test specimens shall be made and the fractured surface shall indicate the soundness and uniformity of the metal upon examination with the naked eye. If the test bars do not indicate a uniform soundness and quality of metal, the castings may be rejected.

(c) The yield point shall be determined as the stress producing an elongation under load of 0.5 per cent, that is, 0.01 inch in a gage length of 2 inches.

(d) Castings made from this alloy shall conform to such requirements as to pressure tests as may be mutually agreed upon between the purchaser and the manufacturer and as specified in the contract or purchase order.

6. (a) The tension test specimen shall be machined from coupons to the dimensions shown in Fig. 166. The ends shall be of a form to fit the holders of the testing machine in such a way that the load shall be axial.

(b) The coupon attached to the casting shall be in accordance with the dimensions shown in Fig. 167. The fin gate along the side shall be not less than $\frac{5}{16}$ inch in thickness at any point along its length.

7. (a) Each casting weighing 250 pounds or more shall have, if practicable, at least one test coupon attached. The responsibility of furnishing sufficient test specimens shall rest with the manufacturer.

(b) In the case of castings weighing less than 250 pounds each, at least one test coupon shall, if practicable, be attached to one or more castings from

each melt or heat or from such groups of melts or heats as the purchaser may specify, but in no case shall a lot consist of more than 1,000 pounds of castings.

(c) In the case of castings where, in the opinion of the inspector, it is impracticable to attach a test coupon to the casting, bars shall be cast separately in sand. At least one test bar shall be poured from each melt or heat of metal, or such groups of melts or heats as the purchaser may specify, but in no case

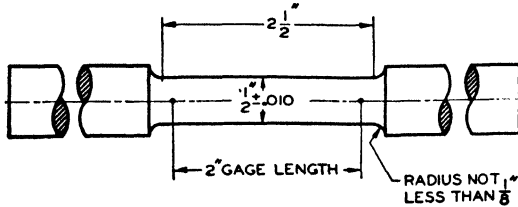

FIG. 166.—TENSION TEST SPECIMEN

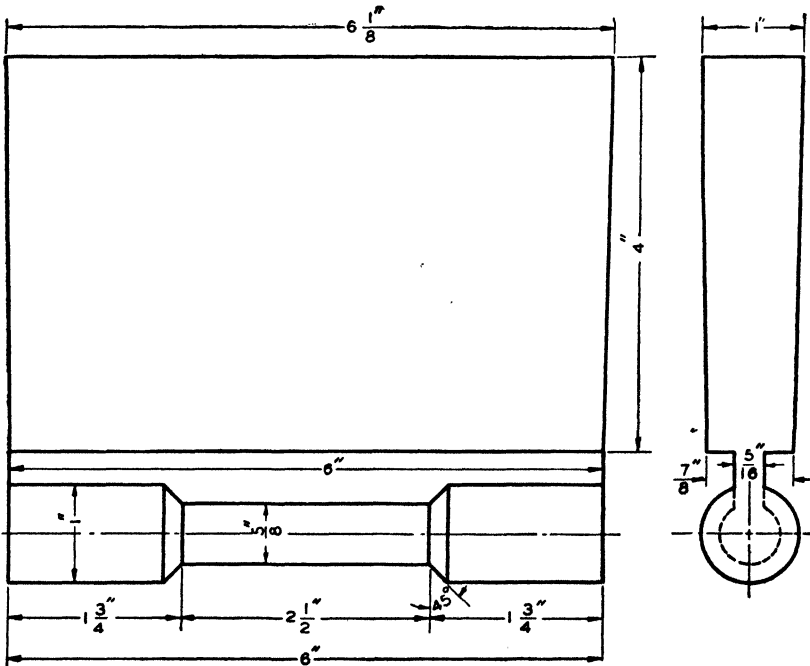

FIG. 167.—TENSION TEST SPECIMEN

shall a lot consist of more than 1,000 pounds of castings. The bars shall be cast from the first metal poured from the heat, and the inspector shall witness the pouring of the test mold.

(d) If any test specimen shows defective machining or reveals casting defects, it may be discarded and replaced by another specimen selected by the

inspector. If additional test coupons are not available, the replacement specimen may be taken from the body of a casting selected by the inspector to represent the lot.

WORKMANSHIP AND FINISH

8. (a) The castings shall be free from blow holes, porosity, hard spots, shrinkage defects or cracks, or other injurious defects and shall be smooth and well cleaned, before inspection, by sand blasting, tumbling, chipping, or other process approved by the inspector.

(b) The castings shall not be repaired, plugged, welded, or "burned in," unless permission from the inspector has been secured previously. This permission will be given only when the defects are such that after the approved repair the usefulness and strength of the casting has not been impaired. Each such repair shall be encircled by a ring of white paint at the time of shipment.

(c) All castings shall be true to pattern, free from swells, etc. Wall thickness shall be uniform throughout the lot of castings and all cores shall be set accurately.

(d) Where thick and thin sections join, the manufacturer shall be permitted to add (where not previously provided) fillets of proper size to avoid cracking upon cooling, subject to the approval of the inspector.

MARKING

9. The castings shall be marked with pattern or mark number, and when practicable with the melt or lot number, at a position on the castings where they will not be machined off in manufacture to finished dimensions.

INSPECTION AND REJECTION

10. (a) Inspection may be made at the manufacturer's works or at the point of delivery. Inspection shall be made at the option of the purchaser.

(b) If the purchaser elects to have the inspection made at the manufacturer's works, the inspector representing the purchaser shall have free entry, at all times while work on the contract of the purchaser is being performed, to all parts of the manufacturer's works which concern the manufacture of the material ordered. The manufacturer shall afford the inspector, without charge, all reasonable facilities to satisfy him that the material is being furnished in accordance with these specifications. All tests and inspection shall be so conducted as not to interfere unnecessarily with the operation of the works.

11. Castings which show injurious defects revealed by machining operations subsequent to acceptance may be rejected, and if rejected, shall be replaced by the manufacturer without charge to the purchaser. The full weight of the original material rejected shall be returned to the manufacturer.

STANDARD SPECIFICATIONS FOR ALUMINUM-BASE ALLOY SAND CASTINGS

A.S.T.M. Designation: B26-33T

1. These specifications cover commercial aluminum-base alloy sand castings having a specific gravity of 3 and less. Nine alloys are specified and are designated Alloys B, C, E, F, G, GG, H, J, and K.

MANUFACTURE

2. The alloy may be made by any approved method.

CHEMICAL COMPOSITION AND TESTS

3. The alloys shall conform to the requirements as to chemical composition specified in Table XXIII (see Explanatory Notes).

4. (a) The sample for chemical analysis may be taken either by sawing,

TABLE XXIII

CHEMICAL COMPOSITIONS OF ALUMINUM-BASE ALLOY SAND CASTINGS *

Alloy	Aluminum, %	Copper, %	Iron, %	Silicon, %	Magnesium, %	Manga- nese Max., %	Zinc Max., %	Other Impu- rities Max., %
B	Remainder	7 to 8.5	0.8 to 1.4	1 to 1.5	0.05 max.	0.3	0.2	0.3
C	86.5 min.	6 to 8	1.5 max.	1 to 3	0.05 max.	0.3	2.2	1.0
E	Remainder	11 to 13	1.2 max.	1 max.	0.05 max.	0.3	0.2	0.3
F	Remainder	9.25 to 10.75	1.5 max.	0.15 to 0.35	0.3	0.2	0.3
G	Remainder	4 to 5	1.2 max.	1.2 max.	0.02 max.	0.3	0.2	0.2
GG	Remainder	4.5	1.2 max.	1.2 max.	0.3 max.	0.3	0.2	0.2
H	Remainder	3.5 to 4.5	1 max.	0.7 max.	1.2 to 1.7	0.3	0.1	0.3
J	Remainder	0.4 max.	0.8 max.	4.5 to 6	0.05 max.	0.3	0.2	0.3
K	Remainder	0.3 max.	0.8 max.	12 to 13	0.05 max.	0.5	0.2	0.3

* Data from A.S.T.M. Specifications, Designation: B26-33T.

drilling, or milling the casting or tension test specimen and shall represent the average cross section of the piece.

(b) The saw, drill, cutter, or other tool used shall be thoroughly cleaned. No lubricant shall be used in the operation, and the sawings or metal chips shall be carefully treated with a magnet to remove any particles of iron introduced in taking the sample.

PHYSICAL PROPERTIES AND TESTS

5. The alloys shall conform to the minimum requirements as to tensile properties specified in Table XXIV.

6. The test bars shall be separately cast in green sand and shall be "cast to size" according to the dimensions shown in Fig. 168. If the castings are heat treated, the test bars representing such castings shall be similarly heat treated. They shall not be machined prior to test except to adapt the grips to the holders of the testing machine in such a manner as to insure an axial load.

7. (a) The tests shall, so far as possible, be made by heats or melts but, unless otherwise agreed upon, two tension tests shall be made for each unit of 500 lb. or fraction thereof.

TABLE XXIV

PHYSICAL PROPERTIES OF ALUMINUM-BASE ALLOY SAND CASTINGS *

Alloy	Tensile Strength, Minimum, Lb. per Sq. In.	Elongation in 2 In., Minimum, %	
B.....	19,000	..	
C.....	19,000	..	
E.....	19,000	..	
F.....	19,000	..	
G {	Heat Treatment No. 1.....	28,000	6
	Heat Treatment No. 2.....	30,000	3
	Heat Treatment No. 3.....	36,000	..
GG Heat Treated.....	36,000	..	
H Heat Treated.....	32,000	..	
J.....	17,000	3	
K.....	24,000	5	

* Data from A.S.T.M. Specifications, Designation: B26-33T.

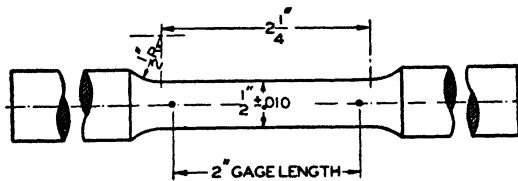

FIG. 168.—TEST SPECIMEN COUPON

(b) If any test specimen shows defective machining or develops flaws, it may be discarded; in which case the manufacturer and the purchaser or his representative shall agree upon the selection of another specimen in its stead.

INSPECTION AND REJECTION

8. (a) Inspection may be made at the manufacturer's works where the castings are made, or at the point at which they are received, at the option of the purchaser.

(b) If the purchaser elects to have inspection made at the manufacturer's works, the inspector representing the purchaser shall have free entry, at all times while work on the contract of the purchaser is being performed, to all parts of the manufacturer's works which concern the manufacture of the material ordered. The manufacturer shall afford the inspector, without charge, all reasonable facilities to satisfy him that the material is being furnished in accordance with these specifications. All tests and inspection shall be so conducted as not to interfere unnecessarily with the operation of the works.

9. Castings which show injurious defects revealed by machining operations subsequent to acceptance may be rejected, and if rejected shall be replaced by the manufacturer without charge to the purchaser. The full weight of the original material rejected shall be returned to the manufacturer.

EXPLANATORY NOTES

Alloy B.—This alloy has a specific gravity of about 2.83. The pattern shrinkage is about $0.156 \left(\frac{5}{32}\right)$ in. per ft. It is superseding Alloy A as it possesses better casting characteristics, especially in the more difficult work where higher pouring temperatures than those usually employed are found necessary. The tendency towards cracks and shrinks is considerably overcome by the careful control of the iron and silicon contents. This alloy is used for general casting purposes.

Alloy C.—The specific gravity of this alloy is about 2.83 to 2.86. The pattern shrinkage is about $0.156 \left(\frac{5}{32}\right)$ in. per ft. It has somewhat better machining qualities than Alloy B. It is used for about the same purposes as Alloy B, particularly for automotive work, such as crank and transmission cases and similar parts.

Alloy E.—This alloy has a specific gravity of about 2.95 and the pattern shrinkage is $0.156 \left(\frac{5}{32}\right)$ in. per ft. It is used for pumps, manifolds, and general castings which should be leak proof. The high copper content makes the alloy more brittle and lowers its shock resistance.

Alloy F.—The specific gravity of this alloy is about 2.90 and the pattern shrinkage about $0.156 \left(\frac{5}{32}\right)$ in. per ft. The alloy is used for pistons, cylinder heads, valve guides, and bearings or other parts where hardness and good bearing qualities are essential. Together with Alloy H it possesses the property of retaining at higher temperatures a greater percentage of its room temperature strength than any other alloy in this group. This alloy may be heat treated, in which case substantially higher strength and hardness or other desirable characteristics are obtained.

Alloy G.—This alloy has a specific gravity of about 2.78. It is for general casting purposes where a combination of lightness, higher strength, and ductility is desired. The various strengths are obtained through different heat treatments. Heat Treatment No. 1 gives maximum elongation and resistance to shock. It is a solution heat treatment and may be specified where the most rugged service is required. An aging effect takes place on standing which increases the strength and slightly decreases the elongation. Heat Treatment No. 2 is a solution and precipitation heat treatment, and should be specified where a higher initial strength, yield point, and hardness are desired. Heat Treatment No. 3 should be specified where the highest strength and hardness are desired and lower ductility is not objectionable. This alloy with the various heat treatments is used in general for high strength parts in street cars and busses, parts for internal combustion engines, outboard motor parts, and other marine castings.

Alloy GG.—This alloy is used in the heat-treated condition where high strength and maximum hardness are desired, such as bearing caps.

Alloy H.—The specific gravity of this alloy is about 2.80. It is usually employed in the heat-treated condition. The alloy is used for pistons, cylinder heads, valve guides, and bearings, or other parts where hardness or good bearing qualities are essential. Together with Alloy F it possesses the property of retaining at higher temperatures a greater percentage of its room-temperature strength than any other alloy in this group.

Alloy J.—This alloy is somewhat lighter than aluminum, having a specific gravity of about 2.69. It withstands corrosion better than the copper alloys. The free flowing property of the alloy when molten makes it easier to pour castings of thin section or intricate design. Its leak-proof properties are valuable where pressure tightness is essential. It has a lower strength and yield point than the copper alloys and poorer machining qualities. It is especially suitable for automobile body parts, cooking utensils, architectural and marine castings.

Alloy K.—The specific gravity of this alloy is about 2.68. Immediately before pouring, the alloy is treated by a process called "modification." Its corrosion resistance is good, especially to salt water. It has good foundry characteristics and can be used for castings having both thin and heavy sections. It is not as readily machined and has a lower yield point in proportion to tensile strength than most of the copper alloys. It is used for marine castings, bus, street car, and engine parts, and for thin castings such as radiators, small motor housings, and meter cases.

TABLE XXV
CHEMICAL COMPOSITIONS OF COPPER-BASE ALLOYS *

Alloy No.	Copper, %	Tin, %	Lead, %	Zinc, %
Bronze Alloys				
1	89	6	2	3
2	86	10	2	2
3	86	8	2	4
Red Brass Alloys				
4	85	5	5	5
5	85	5	5	5
6	83	7	7	3
Semi-Red Brass Alloys				
7	84	3	3	10
8	83	4	6	7
9	80.5	3	7	9.5
10	78.5	3	5	13.5
Yellow Brass Alloys				
11	71.5	1.5	3	24
12	70	0	3	27
13	67	0	2	31
14	63	0	2	35
High-Lead Alloys				
15	85	5	9	1
16	80	10	10	0
17	79	10	10	1
18	75.5	8	15	1.5
19	74.5	4.5	17	4
20	73	6	20	1

* Data from A.S.T.M. Specifications, Designation: B30-86.

TABLE XXVI
 PROPERTIES OF COPPER-BASE ALLOYS *

Alloy No.	Tensile Strength, Lb. per Sq. In.	Elongation in 2 Inches, Per Cent	Reduction of Area, Per Cent	Brinell Hardness Number 500 Kg.	Weight Lb. per Cubic Foot
1	30,000 to 40,000	15 to 30	15 to 30	44 to 48	535
2	32,000 to 38,000	15 to 20	15 to 20	55 to 65	535
3	30,000 to 36,000	25 to 30	25 to 30	55 to 65	535
4	27,000 to 33,000	15 to 20	15 to 20	50 to 60	535
5	27,000 to 33,000	15 to 20	15 to 20	50 to 60	535
6	26,000 to 32,000	13 to 19	14 to 21	50 to 60	540
7	31,000 to 37,000	25 to 35	20 to 30	50 to 60	535
8	29,000 to 35,000	25 to 35	20 to 30	40 to 50	535
9	22,000 to 28,000	10 to 15	10 to 15	50 to 55	540
10	25,000 to 30,000	15 to 25	20 to 25	45 to 55	540
11	30,000 to 35,000	35 to 45	25 to 35	40 to 50	535
12	30,000 to 35,000	25 to 35	20 to 30	40 to 50	535
13	30,000 to 35,000	25 to 35	20 to 30	40 to 50	533
14	30,000 to 45,000	15 to 25	20 to 30	40 to 50	500
15	25,000 to 31,000	8 to 13	7 to 13	45 to 55	540
16	27,000 to 33,000	7 to 12	8 to 13	47 to 52	553
17	27,000 to 33,000	7 to 10	7 to 12	47 to 52	553
18	25,000 to 30,000	10 to 17	10 to 16	45 to 50	570
19	25,000 to 30,000	10 to 15	7 to 13	47 to 52	570
20	22,000 to 27,000	10 to 16	7 to 13	42 to 47	570

* Data from Appendix to A.S.T.M. Specifications, Designation: B30-36.

NOTE: The chemical compositions of these alloys are given in Table XXV.

TABLE XXVII

COMPOSITIONS AND PHYSICAL PROPERTIES OF WHITE-METAL BEARING ALLOYS *

(From Appendix to Standard Specifications A.S.T.M. Designation: B23-26)

Alloy Number	Copper, %	Tin, %	Antimony, %	Lead, %	Specific Gravity	Yield Point, Lb. per Sq. In.		Brinell Hardness		Melting Range, °F.	Pouring Temp., °F.
						68°F.	212°F.	68°F.	212°F.		
1 Specified	4.5	91.0	4.5	7.34	4,400	2,650	17.0	8.0	433	825
1 Tested	4.56	90.9	4.52	0							
2 Specified	3.5	89.0	7.5	7.39	6,100	3,000	24.5	12.0	466-669	795
2 Tested	3.1	89.2	7.4	0.03							
3 Specified	8.3	83.4	8.3	7.46	6,600	3,150	27.0	14.5	464-792	915
3 Tested	8.3	83.4	8.2	0.03							
4 Specified	3.0	75.0	12.0	10.0	7.52	5,550	2,150	24.5	12.0	363-583	710
4 Tested	3.0	75.0	11.6	10.2							
5 Specified	2.0	65.0	15.0	18.0	7.75	5,050	2,150	22.5	10.0	358-565	690
5 Tested	2.0	65.5	14.1	18.2							
6 Specified	1.5	20.0	15.0	63.5	9.33	3,800	2,050	21.0	10.5	358-531	655
6 Tested	1.5	19.8	14.6	63.7							
7 Specified	10.0	15.0	75.0	9.73	3,550	1,600	22.5	10.5	464-514	640
7 Tested	0.11	10.0	14.5	75.0							
8 Specified	5.0	15.0	80.0	10.04	3,400	1,750	20.0	9.5	459-522	645
8 Tested	0.14	5.2	14.9	79.4							
9 Specified	5.0	10.0	85.0	10.24	3,400	1,550	19.0	8.5	450-493	620
9 Tested	0.06	5.0	9.9	84.6							
10 Specified	2.0	15.0	83.0	10.07	3,350	1,850	17.5	9.0	468-507	630
10 Tested	0.12	2.05	15.7	82.0							
11 Specified	15.0	85.0	10.28	3,050	1,400	15.0	7.0	471-504	630
11 Tested	0.19	0.09	14.8	84.7							
12 Specified	10.0	90.0	10.67	2,800	1,250	14.5	6.5	473-498	625
12 Tested	0.12	0.11	9.9	89.4							

NOTES: The compression test specimens were cylinders $1\frac{1}{2}$ inches in length and $\frac{1}{2}$ inch in diameter, machined from chill castings 2 inches in length and $\frac{1}{2}$ inch in diameter. The Brinell tests were made on the bottom face of parallel machined specimens cast in a 2-inch diameter by $\frac{1}{2}$ -inch deep steel mold at room temperature. The values for yield point were taken from stress-strain curves at a deformation of 0.125 per cent reduction of gage length. The Brinell values are the average of three tests on each alloy using a 10-millimeter ball and a 500-kilogram load applied for 30 seconds.

* Data from tests made at the Bureau of Standards.

MOISTURE CONTENT OF MOLDING SANDS

The properties of molding sands are affected to a large extent by the moisture content of the sand. It is therefore important to control the proportion of moisture in the molding sand used in foundries. The moisture content is always expressed as a percentage of the weight of the wet sand.

Instructions for Determination of Moisture

1. Weight out 100.0 grams of a representative sample of sand on a balance which is sensitive to 0.1 gram.
2. Transfer this sand to a shallow pan and dry for 1 hour at 220 to 230 degrees F.
3. Cover the pan or place it in a desiccator until the sand is at room temperature.
4. Weigh the sand immediately and compute the moisture content as follows: 100.0 minus the net weight of dry sand in grams equals the percentage of moisture in the sample.

NOTE: This dry sand may be used in the determinations of clay content and grain fineness.

CLAY CONTENT AND GRAIN FINENESS OF MOLDING SANDS

The method for determining the clay content of molding sands consists of agitating the sand in water so as to separate the clay from the sand particles and then removing the clay which remains suspended in the water. The material which fails to settle a distance of 5 inches within a period of 5 minutes in distilled water at room temperature is designated as **clay substance**. The sand remaining from the clay determination is passed through a series of sieves to separate the grains of different sizes.

Description of Sand-Washing Apparatus

The sand-washing apparatus shown in Fig. 169 has a stand for holding six tall-form beakers of 1-liter capacity, a circular base supporting the stand, an electrically operated stirrer, and a siphon. The stand rotates on the base so as to make all beakers accessible from any position. The stirring motor is attached to a bracket which can be raised or lowered in the central post of the stand. A guide on the top of the post is used to index the position of the stirrer so that it can be lowered only in one of the six positions for the beakers. Furthermore, the motor support can be locked in any one of six positions above the beakers. These provisions assist in handling the stirring motor in a way which will prevent breaking the glass beakers. The shaft of the stirrer carries one blade for agitating the mixtures. A circular disk at the end of the shaft aids in supporting the blade. The sand particles set in motion by the blade which is operated at a speed of 7,000 revolutions per minute impinge on eight vertical baffles located around the wall of the beaker. The siphon which is used to remove the wash water from the beakers can be mounted at the end of each arm on the stand so that the inlet is 1 inch from the bottom of the beaker. The siphon action is started by first compressing the rubber bulb, then closing the outlet end of the tube with one finger and releasing the bulb. As an aid in obtaining the correct water levels in the beakers, two pointers are provided for each beaker on the stand; the lower pointers indicate the height of 500 cubic centimeters of water in the beakers; the upper pointers indicate the distance of 6 inches from the bottom of the beakers.

Instructions for Determination of Clay

1. Weigh out 50.0 grams of dried sand, and transfer this sample to one of the beakers of the sand-washing apparatus.
2. Add 25 cubic centimeters of sodium hydroxide solution to the beaker, and then distilled water until the level of the lower pointer is reached.

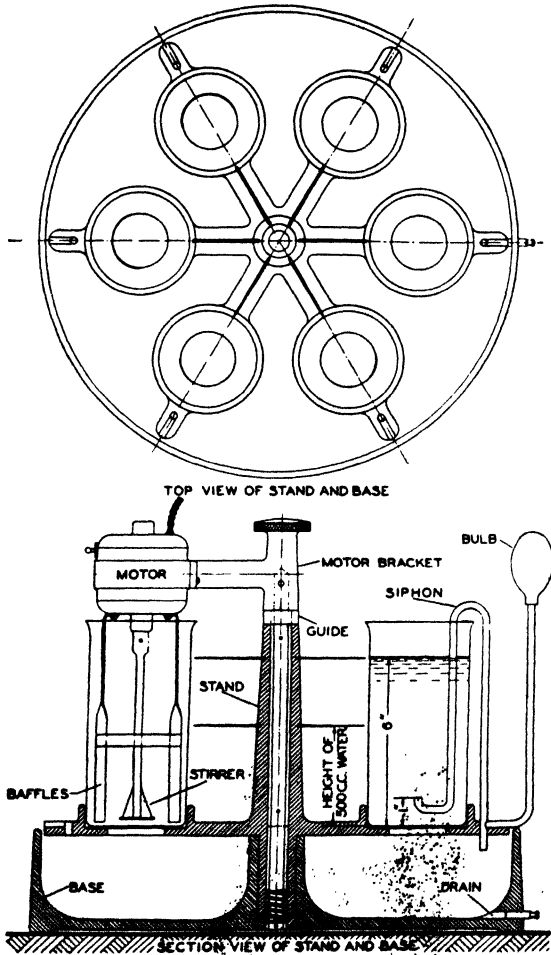

FIG. 169.—SAND-WASHING APPARATUS

(The sodium hydroxide solution contains 10 grams of sodium hydroxide in 1,000 cubic centimeters of water.)

3. Place the baffles and stirrer in the beaker and agitate the mixture for 5 minutes.
4. Remove the baffles and stirrer, washing all sand from these parts into the beaker with distilled water. Add distilled water to the level of the upper

- pointer, washing down the sides of the beaker as the water is added. Allow this mixture to stand for 10 minutes.
5. Place the siphon in the beaker, and draw off the water to within 1 inch of the bottom.
 6. Remove the siphon and add distilled water to the beaker until the level of the upper pointer is reached. Stir the mixture well with a stirring rod which has a rubber tip on the end. Allow this mixture to stand for 5 minutes, and again siphon off the water to within 1 inch of the bottom.
 7. Repeat operation 6 until the water in the beaker becomes clear for a depth of 5 inches after standing for 5 minutes.
 8. Pour off as much clear water as possible from the beaker without disturbing the sand residue. Place the beaker containing the wet sand on a hot plate or remove the sand from the beaker to a shallow dish, and allow the moisture to evaporate gradually.
 9. After the dried sand has cooled to room temperature, transfer it to a scale pan and weigh. The difference between the weight of the original sample and the remaining washed sand is the amount of clay substance.

$$\frac{[50.0 - \text{weight of washed sand}] \times 100}{50.0} = \text{percentage of clay substance}$$

Instructions for Determination of Grain Fineness

1. Place the dry washed sand from the clay determination on the upper or coarsest sieve in a set of standard sieves. A pan at the bottom of the set is used to collect the material which passes through the 270-mesh sieve.

A.F.A. SIEVE SERIES

U. S. Bureau of Standards Sizes

Sieve Number	Opening in Inch
6.....	0.1320
12.....	0.0661
20.....	0.0331
30.....	0.0232
40.....	0.0165
50.....	0.0117
70.....	0.0083
100.....	0.0059
140.....	0.0041
200.....	0.0029
270.....	0.0021

2. Shake the sieves in a mechanical shaker for 15 minutes.
3. Weigh the sand remaining on each sieve and on the pan.
4. Compute the A.F.A. fineness number as follows: (a) multiply the weight of sand remaining on each sieve and on the pan by the factors listed below, (b) add these products, (c) divide this sum by the total weight of the sample.

FACTORS FOR COMPUTING A.F.A. GRAIN FINENESS NUMBER

Multiply the weight of sand on sieve number 6 by 3, on 12 by 5, on 20 by 10, on 30 by 20, on 40 by 30, on 50 by 40, on 70 by 50, on 100 by 70, on 140 by 100, on 200 by 140, on 270 by 200, and on the pan by 300.

5. Classify the sand on the basis of the A.F.A. grain size and clay class.

**A.F.A. CLASSIFICATION
OF GRAIN FINENESS**

Grain Fineness Numbers between	Grain Size Class
300 and 200.....	No. 1
200 and 140.....	No. 2
140 and 100.....	No. 3
100 and 70.....	No. 4
70 and 50.....	No. 5
50 and 40.....	No. 6
40 and 30.....	No. 7
30 and 20.....	No. 8
20 and 15.....	No. 9
15 and 10.....	No. 10

**A.F.A. CLASSIFICATION
OF CLAY CONTENT**

Percentage of Clay Substance in Sand	Clay Class
0.0 to 0.5.....	A
0.5 to 2.0.....	B
2.0 to 5.0.....	C
5.0 to 10.0.....	D
10.0 to 15.0.....	E
15.0 to 20.0.....	F
20.0 to 30.0.....	G
30.0 to 45.0.....	H
45.0 to 60.0.....	I
60.0 to 100.0.....	J

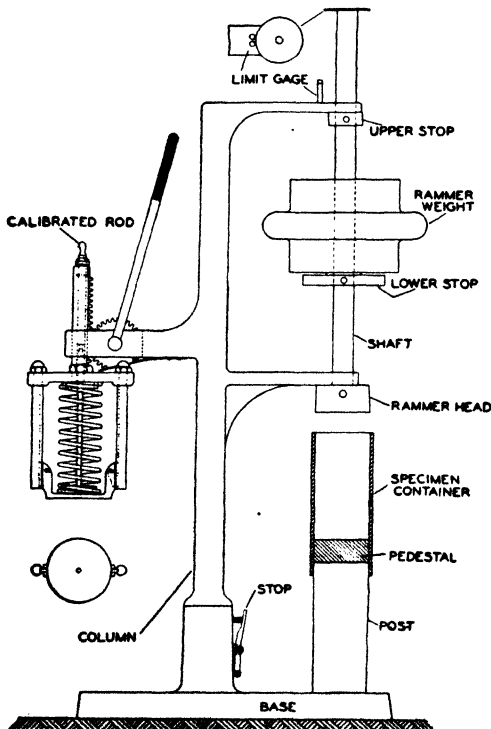

FIG. 170.—SAND RAMMER AND COMPRESSIVE-STRENGTH TESTER

**PERMEABILITY OF
MOLDING SANDS**

In testing molding sands for permeability, the rate is determined at which a definite volume of air under a given pressure passes through a standard specimen of the sand. Test specimens 2 inches in diameter and 2 inches ($\pm \frac{1}{16}$ inch) high are prepared and tested within a cylindrical tube.

Description of Sand Rammer

The sand rammer used in preparing specimens for the permeability test, as well as for the compressive-strength test, is shown in Fig. 170. This equipment consists of the specimen container within which the sand is rammed, the pedestal on which the container rests when the sand is being rammed, the rammer head which slides within the specimen container, the rammer weight which has a maximum travel on a steel shaft of 2 inches, and a limit gage on the upper bracket of the column. The A.F.A. specifications require 14 pounds for the rammer weight and a total weight of

17½ pounds for all the moving parts of the rammer. The rammer weight is designed so that it can be easily gripped and released by the hands.

Instructions for Preparation of Test Specimens

1. Place the specimen container on the pedestal, and put sufficient sand (about 150 grams) in the container, which will produce a specimen 2 inches high with a tolerance of $\pm \frac{1}{16}$ inch when rammed.
2. Place the pedestal and the container on the post.
3. Lower the rammer assembly gently with the rammer head in the container until the total weight of the moving parts is supported by the sand.
4. Raise only the rammer weight to the upper stop, and let the weight fall freely on the lower stop. Repeat this operation for a total of three impacts.
5. Observe whether the height of specimen is now within the tolerances of the limit gage. The top of the disk should be at or above the top of the short pin, or at or below the top of the long pin. If the specimen is not within the prescribed limits, discard the specimen and put other sand in the container in sufficient quantity to produce a standard specimen.
6. Lift the rammer head from the container, and remove the container from the pedestal.

Description of Permeability Apparatus

The permeability apparatus shown in Fig. 171 consists of a water tank, an air holder or bell, a mercury-seal valve, and a cup containing mercury which serves as a seal around the sand-specimen container or core specimen. A handle at the top of the bell is used in raising the bell. The required air pressure (10.0 centimeters of water) is obtained by a weight which is slipped over the lower end of the guide rod attached to the inside of the bell. The three rolls on each of the two guides make contact with the inside surface of the inner tube. The air passes from the bell, through the inner tube, then through the large opening in the base to the mercury-seal valve, and finally through the test specimen. A water seal for the air in the bell is provided between the outside of the water tank and the inner tube.

The upper cup of the mercury-seal valve shown in Fig. 171 has three cylinders of different lengths projecting from its lower side and is raised or lowered by rotating it on cams located in the rim of the lower cup. Mercury is placed to a definite level in the lower cup. When the upper cup is turned to the extreme right (clockwise), the two inside cylinders are raised clear of the mercury, and air can be drawn from around the upper cup into the bell. This is the "vent position." When the upper cup is turned to the left (counter-clockwise) until the middle cylinder is below the level of the mercury in the lower cup, air can be delivered from the bell to the central opening in the upper cup. This is the "on position" as shown in Fig. 171. When the upper cup is turned to the extreme left (counter-clockwise), the inner cylinder dips below the mercury and the air supply is completely sealed; this is the "off position."

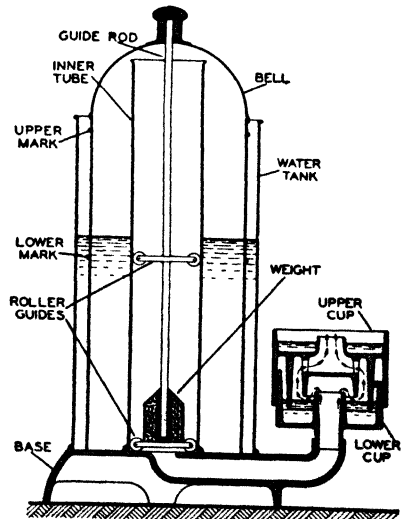

FIG. 171.—PERMEABILITY APPARATUS

Any condition required in the procedure for the permeability test can be obtained by turning the upper cup through an arc of 120 degrees. Two marks around the outside of the bell show the distance which the bell travels when delivering a total of 2,000 cubic centimeters of air from the air holder through the test specimen.

Instructions for Making a Permeability Test

1. Turn the upper cup of the mercury-seal valve to the extreme right (clockwise). This is the "vent position." Then raise the bell slowly until the lower mark on the bell is above the upper edge of the water tank. With the bell held in this position, turn the upper cup of the mercury-seal valve to the extreme left. This is the "off position."
2. Set the specimen container in the mercury in the upper cup.
3. Turn the upper cup of the mercury-seal valve to the right (clockwise) about 60 degrees. This is the "on position" which allows air to be delivered from the bell to the specimen.
4. Measure the time required for the bell to drop the distance between the lower and upper marks on the bell; this is equivalent to a displacement of 2,000 cubic centimeters of air.
5. Calculate the permeability by using the *A.F.A.* permeability formula which is as follows:

$$\text{Permeability} = \frac{\text{Volume of Air (cm.}^3\text{)} \times \text{Height of Specimen (cm.)}}{\text{Area of Specimen (cm.}^2\text{)} \times \text{Air Pressure (cm.)} \times \text{Time (min.)}}$$

$$\text{Permeability} = \frac{2,000 \text{ cm.}^3 \times 5.08 \text{ cm.}}{20.268 \text{ cm}^2 \times 10.0 \text{ cm.} \times \text{minutes}}$$

$$\text{Permeability} = \frac{3007}{\text{seconds}}$$

STRENGTH OF MOLDING SANDS

Molding sands must have sufficient strength to retain the shapes of the molds until the metal has solidified. The use of sands which are too low in strength will cause defects in the castings. The compressive-strength test is the standard method adopted by the *American Foundrymen's Association* for measuring the bonding property of molding sand.

Description of Compressive-Strength Tester

The apparatus used in measuring the compressive strength of molding sands (see Fig. 170) is a spring-dynamometer with a device for indicating the maximum load on the test specimen. A carriage attached to the lower end of the spring is guided by two gibs which slide loosely in two vertical rods. The pin fastened to the upper side of the carriage comes in contact with a rod which is located in the hollow post. A packing gland with a felt washer at the upper end of the post produces just enough friction to hold the rod in any position. When the spring is compressed, the pin shoves the rod upward. A flat-headed screw at the lower end of the calibrated rod can be adjusted for the zero reading. The spring-assembly is raised or lowered by means of a rack and pinion operated by a hand lever. The entire testing unit is attached to the same column that is used for the sand rammer. This column can be rotated in the base so that the compressive-strength tester is directly above the post.

Instructions for Making a Compressive-Strength Test

1. After making the permeability test, remove the sand specimen from the container by sliding the container over the post on the testing apparatus.
2. Bring the compressive-strength tester into position above the specimen.
3. Apply an increasing load on the specimen by pulling down the hand lever on the tester. When the specimen collapses, the spring recoils and the calibrated rod remains at its highest position. The maximum load in pounds per square inch of the area of the specimen can be read directly on the rod.

STRENGTH OF DRY-SAND CORES

The most satisfactory method for determining the dry strength of core mixtures is to prepare specimens in a uniform way and to test the specimens transversely after they are baked. A core-making apparatus, using the principle of the jolter, has been developed for making test specimens, and a transverse testing machine is used for measuring the strength of the baked cores.

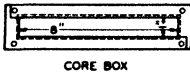
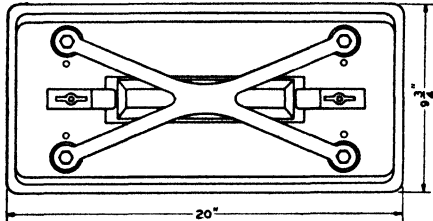

CORE BOX

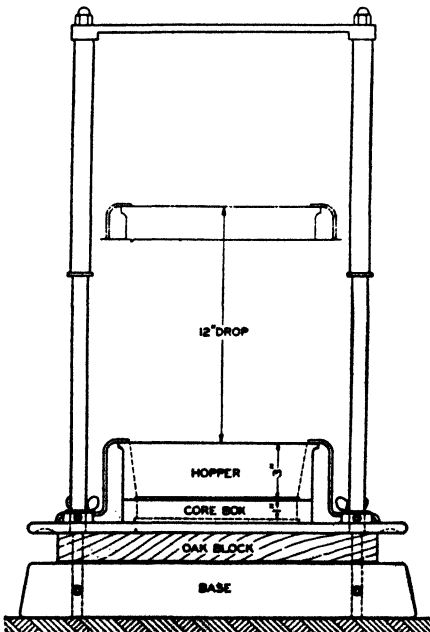

FIG. 172.—CORE-MAKING APPARATUS

Description of Core-Making Apparatus

The core-making apparatus shown in Fig. 172 has a cast-iron base to which four vertical rods are attached. The upper ends of these rods are held in position by a metal spider. Guides on the four rods control the movement of an aluminum plate which can be raised for a distance of 12 inches. An oak block is attached to the metal plate to absorb the shock. The surfaces of the rods are protected by telescoping brass sleeves.

The test specimens are made in a bronze core box having dimensions of 1 inch by 1 inch by 8 inches on the inside. A cast-aluminum hopper 3 inches in height is held in place above the core box by dowels. The core box is constructed of two parts so arranged that one half can be pulled away for the removal of the specimen. The core is rammed on a core plate so that it can be handled.

Instructions for Making Test Specimens

1. Place a steel core plate under the core box, and assemble core box and hopper.
2. Fill the core box and hopper with the core-sand mixture which is placed loosely in the cavity level with the top of the hopper.
3. Raise the aluminum plate, to which the core box and hopper are clamped, to the full height of the stroke (12 inches), and allow the assembly to drop freely. Repeat this operation for a total of ten blows.
4. Loosen the clamps and pass the cut-off sheet through the slot at the bottom of the hopper to separate the surplus sand from the core.

5. Move a straightedge across the top of the core box to make certain that the height of the specimen is 1 inch.
6. Remove the front half of the core box, and then pull the plate with the specimen away from the other half of the core box by using two wires hooked into holes near the edge of the core plate.
7. Transfer the test specimen on the core plate to the baking oven.

Description of Transverse Testing Machine

The strength of core specimens is determined on the transverse testing machine shown in Fig. 173. The test specimens are placed on two supports

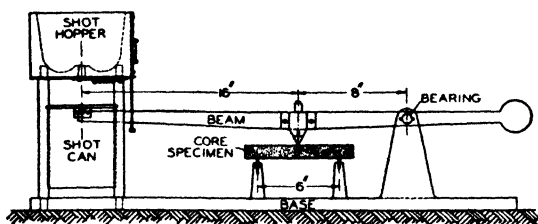

FIG. 173.—TRANSVERSE TESTING MACHINE

6 inches apart, and the load is applied on the upper surface one-half way between the two supports. One of the supports is stationary, and the other is mounted on a pin bearing. The load on the test specimen is applied by contact with a $\frac{3}{8}$ -inch steel rod on the upper fulcrum which bears on a knife edge in the beam. The use of one stationary and two self-adjusting edges in contact with the core prevents twisting of the specimen during the test.

The cast-aluminum beam is mounted on ball bearings and balances without the shot can which is carried on knife edges at one end of the beam. The load is applied at a rate of 24 pounds per minute by allowing No. 10 lead shot to drop from the hopper into the can. When the specimen fails, the stream of shot is stopped by a trip mechanism. The load on the specimen at the time of failure is found by multiplying the weight of the shot and can by three.

Instructions for Making Transverse Tests

1. Remove the specimen from the core plate and place it on the supports of the transverse testing machine in the same position as that in which it was made.
2. Start the flow of shot into the can by moving the slide at the bottom of the hopper.
3. Weigh the shot and can after the specimen fails, and multiply the weight in pounds by 3. The breaking load is recorded only to the nearest pound.

PERMEABILITY OF DRY-SAND CORES

The permeability test is made by forcing air at a constant pressure through a test specimen and measuring the time required for 2,000 cubic centimeters of air to pass through a minimum of 1 cubic inch of the core. The core box shown in Fig. 174 is used on the core-making apparatus for preparing permeability-test specimens. This test is made on the permeability apparatus which has been described.

Instructions for Making Permeability-Test Specimens

1. Place the permeability core box and hopper on the plate of the core-making apparatus, and clamp these parts in position.
2. Fill the core box and hopper with the core mixture.
3. Ram the mixture into the core box by ten blows on the apparatus.
4. Insert the cut-off sheet and remove the excess sand from above the core box.
5. Place a core plate on the box, roll the box over, and withdraw the box, leaving the core on the plate.

Instructions for Making Permeability Tests

1. Place the permeability specimen in the upper cup of the permeability apparatus. The mercury forms a seal around the specimen. As a core will float in mercury, a weight is required to hold it down while being tested.

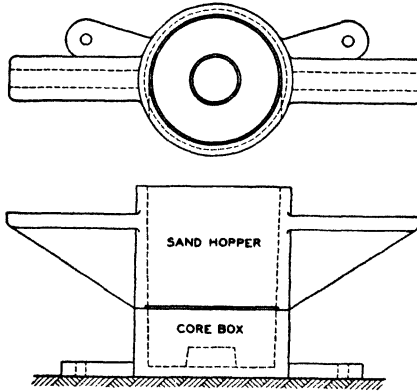

FIG. 174.—CORE BOX AND HOPPER FOR PERMEABILITY TEST SPECIMENS

2. Record the time in seconds required for 2,000 cubic centimeters of air to pass through the specimen. It is necessary to remove the weight from the bell of the permeability apparatus in order to have a low air pressure (usually between 5 and 7 centimeters on the water gage) for this test.
3. Calculate the permeability for dry-sand cores by using the following formula:

$$\text{Permeability} = \frac{\text{Volume of Air (cm.}^3\text{)} \times \text{Height of Specimen (cm.)}}{\text{Area of Specimen (cm.}^2\text{)} \times \text{Air Pressure (cm.)} \times \text{Time (min.)}}$$

$$\text{Permeability} = \frac{2,000 \text{ cm.}^3 \times 2.54 \text{ cm.}}{6.45 \text{ cm.}^2 \times \text{Pressure (cm.)} \times \text{Time (min.)}}$$

$$\text{Permeability} = \frac{47,256}{\text{Pressure (cm.)} \times \text{Time (sec.)}}$$

INDEX

A
Aging cast iron, 149
Air for combustion, 101
Air furnace, construction, 110
 operation, 111
Ajax-Northrup induction furnace, 230
Ajax-Wyatt induction furnace, 229
Aluminum-alloy castings, 241
 foundry practice, 243
 specifications, 297
Aluminum bronze, 236
Aluminum-copper alloy, 243
Aluminum-silicon alloy, 243
Associations of foundrymen, 8
Austenite, 138

B
Baking cores, 79
Bearing alloys, definition, 236
Beehive coke, 20
Bench molding, 54
Bentonite, 26
Blackings, 46
Blasting equipment, 119
Blasting sands, 25
Blowers for cupolas, 108
Bottom board, definition, 30
Brass castings, 233
 specifications, 294
Brinell hardness machine, 269
Bronze alloys, compositions, 302
 properties, 303
Bronze castings, 235
Brushes, 122
Butting off, definition, 57
By-product coke, 19

C
Cadmium-base bearing metals, 240
Calculation of cupola charges, 174
Carbon in cast iron, 140, 164

Cast iron, compressive strength, 155
 corrosion-resisting, 170
 easily machined, 166
 flowability, 159
 growth, 157
 hardness, 156
 heat-resisting, 169
 high-strength, 166
 shrinkage, 157
 tensile strength, 153
 transverse strength, 155
 wear resistance, 156
 wear-resisting, 171
Cast metals, anti-friction property, 276
 hardness, 269
 machinability, 272
 modulus of elasticity, 274
 resistance to corrosion, 272
 resistance to high temperatures, 273
 strength in compression, 268
 tensile properties, 267
 thermal conductivity, 273
 thermal expansion, 274
 weight, 271
Cementite, 137
Centrifugal process, 53
Chaplets, 38
Charging doors, 90
Cheek, definition, 30
Chills, 35
Chipping hammers, 126
Chrome bricks, 27
Chromium in cast iron, 144, 165, 182
Chromium steels, 216
Classes of iron castings, 165
Classification of pig iron, 13
Clay determination, 305
Coatings for molds, 46
Coke bed in cupola, 93
Coke charges, 104
Coke, foundry, 19

- Combustion in cupola, 100
 Compressive strength of cast iron, 155
 Constitution of cast iron, 135
 Construction of cupola, 87
 Converter steel, 208
 Cope, definition, 30
 Cope mounts, 42
 Copper-base bearing metals, 238
 Copper castings, 232
 Core baking, 79
 Core binders, 72
 Core blower, 79
 Core making, 76
 Core-making apparatus, 312
 Core mixtures, preparation, 76
 Core ovens, 81
 Core sands, 24, 72
 Cores, requirements, 69
 Corrosion-resisting cast iron, 170
 Crucible furnaces, 224
 Crucible of cupola, 89
 Crucible steel, 210
 Crucibles, graphite, 27
 sizes, 281
 Crystallization of metals, 253
 Cupola blocks, 27
 Cupola blowers, 108
 Cupola charging equipment, 96
 Cupola construction, 87
 Cupola data, 283
 Cupola fluxes, 106
 Cupola lining, 91
 Cupola operation, 91
 Cupola tuyeres, 89, 284
- D
- Damping capacity of cast iron, 160
 Defects caused by cores, 84
 Design of metal castings, 253
 Detroit rocking furnace, 229
 Die-casting alloys, 246
 Die-casting machines, 50
 Die-casting process, 49
 Direct-arc furnace, 114, 206
 "Downmetal" alloy, 245
 Draft on patterns, 259
 Drag, definition, 30
 Drag mounts, 42
- Dry-sand cores, 68
 Dry strength of cores, 69
- E
- Electric arc welding, 128
 Electric furnaces, 113, 228
 operation, 115
 Electric furnace steel, 205
- F
- Facing sand, 45
 Ferrite, 136
 Ferro-alloys, 15
 Ferrocromium, 16
 Ferromanganese, 15
 Ferromolybdenum, 16
 Ferrosilicon, 15
 Ferrovanadium, 16
 Fire brick, 26
 Fire clay, 25
 Flat back, definition, 259
 Floor molding, 54
 Flowability of cast iron, 159
 Fluorspar, 21
 Fluxes, foundry, 21, 107
 Follow board, 40
 Forehearth, 98
 Foundry coke, 19
 Foundry fluxes, 21
 Foundry sands, 22
 Foundry scrap, 16
 Fuel oil, 21
 Fuels, compositions, 280
 heating values, 280
- G
- Gagers, definition, 30
 Ganister, 26
 Gas cutting, 125
 Gas welding, 127
 Gate, definition, 31
 Grain fineness, determination, 307
 Graphite, 136
 Graphite crucibles, 27
 Gray cast iron, 147
 Gray iron castings, specifications, 285
 Green-sand cores, 68
 Green strength of cores, 69
 Grinding wheels, 123

INDEX

Growth of cast iron, 157
Gun-metal, 235

H

Hardness of cast iron, 156
Hardness testing methods, 269
Hard-sand match, 40
Heat-resisting cast iron, 169
Heat treatment of cast iron, 149
Height of coke bed, 103
Height of cupola, 90
High-strength cast iron, 166

I

Indirect-arc furnace, 114
Induction furnace, 207
In-gate, definition, 31

J

Jobbing foundry, definition, 6
Jolt machines, 56

L

Lead-base bearing metals, 240
Limestone, 21
Loam molds, 48
Loose patterns, 39
Loss factor for silicon, 177

M

Machinability of cast metals, 272
Machines, molding, 56
Magnesite bricks, 27
Magnesium alloy castings, 244
Malleable iron castings, 192
 annealing, 195
 composition, 192
 finishing, 197
 melting, 193
 molding, 194
 properties, 198
 specifications, 289
 uses, 199
Manganese bronze, 234
Manganese in cast iron, 142, 165, 181
Manganese-molybdenum steels, 217
Manganese steel, 218
Manufacture of pig iron, 10
Match plates, 42

Match, sand, 40
Melting losses, 231
Melting points of metals, 279
Metal charges, 105
Metal molds, 49
Metal-pot furnaces, 227
Mineral coatings, 46
Moisture determination, 305
Mold board, definition, 32
Mold coatings, 46
Molding machines, 56
Molding methods, 54 ✓
Molding operations, 55 ✓
Molding procedure, 32 ✓
Molding sands, requirements, 22 ✓
 test methods, 23
Molds, dry-sand, 47
 green-sand, 45
 loam, 48
 metal, 49
 skin-dried, 46
 stacked, 55
Molybdenum in cast iron, 145, 165, 1
"Monel metal," 248
Mounted patterns, 41

N

Nickel in cast iron, 143, 165, 182
Nickel steels, 216

O

Oil binders for cores, 72
Open-hearth steel, 203
Open molds, 55
Operation of cupola, 91
Ovens for baking cores, 81

P

Pattern identification markings, 39
Pattern materials, 39
Patterns, mounted, 41
Pearlite, 138
Permanent-mold process, 52
Permeability apparatus, 309
Permeability determination, 308
Permeability of cores, 70
Permeability of dry-sand cores, deter-
 mination, 314
Phosphor bronze, 235

Phosphorus in cast iron, 143, 165
 Pickling, 121
 Pig iron, classification, 13
 manufacture, 10
 Pitch binders for cores, 75
 Pit molding, 54
 Press castings, 51
 Pressures in molds, 36
 Prices of foundry materials, 11
 Prices of metal castings, 265
 Primary metals, 222
 Production foundry, definition, 5
 Properties of cast iron, 152
 ferrous alloys, 266
 malleable cast iron, 198
 non-ferrous alloys, 267
 steel castings, 213
 Pyrometers, 231

R

Record of metal mixtures, 189
 Refractories, 22
 Requirements of molding sands, 22
 Riser, definition, 32
 Rockwell hardness tester, 270
 Rosin binders for cores, 75
 Runner, definition, 31

S

Sand molds, construction, 30
 Sand rammer, description, 308
 Sands for cores, 72
 Sands, foundry, 22
 Sandslingers, 57
 Sand-washing apparatus, 24, 305
 Scrap metal, 16, 175
 Secondary metals, 222
 Shell of cupola, 88
 Shot microscope, 270
 Shrinkage of cast iron, 157
 Shrinkage of metals, 254
 Silica bricks, 26
 Silicon in cast iron, 142, 164
 Silvery iron, 15
 Slush castings, 53
 Soap flask, 42
 Soda ash, 22
 Specifications for foundry coke, 19
 Specifications for scrap metals, 17
 Spiegeleisen, 16

Sprue cutters, 125
 Sprue, definition, 31
 Squeezer machines, 56
 Stacked molds, 55
 Steadite, 139
 Steel castings, 202
 classification, 213
 corrosion-resisting, 218
 heat-resisting, 218
 molding, 210
 properties, 213
 specifications, 291
 Strength of dry-sand cores, determination, 312
 Strength of molding sands, determination, 310
 Strengths of dry-sand cores, 74
 Stripper, plain, 44
 Stripping plate, 44
 Sulphur in cast iron, 142, 165

T

Teapot-spout ladle, 212
 Tensile strength of cast iron, 153
 Test methods for molding sands, 23
 Thermal conductivity, 273
 "Thermit" welding, 130
 Tin-base bearing metals, 239
 Tools for cupola, 97
 Tools for molder, 31
 Transverse core testing machine, 313
 Transverse strength of cast iron, 155
 Tumbling mills, 119 -
 Tuyeres for cupola, 89

V

Vanadium steels, 217

W

Water-soluble binders for cores, 74
 Wear resistance of cast iron, 156
 Wear-resisting cast iron, 171
 Weights of cast metals, 271
 Welding methods, 127
 White cast iron, 147
 White-metal bearing alloys, 237, 304
 Wind belt, 88

Z

Zinc-base alloys, 246

