

Birla Central Library

PILANI (Jaipur State)

Engg College Branch

Class No :- 622.26

Book No :- R46P

Accession No :- 31768

Acc. No

ISSUE LABEL

Not later than the latest date stamped below.

~~20 Nov 81~~

PRACTICAL TUNNEL DRIVING

*The quality of the materials used in the manufacture
of this book is governed by continued postwar shortages.*

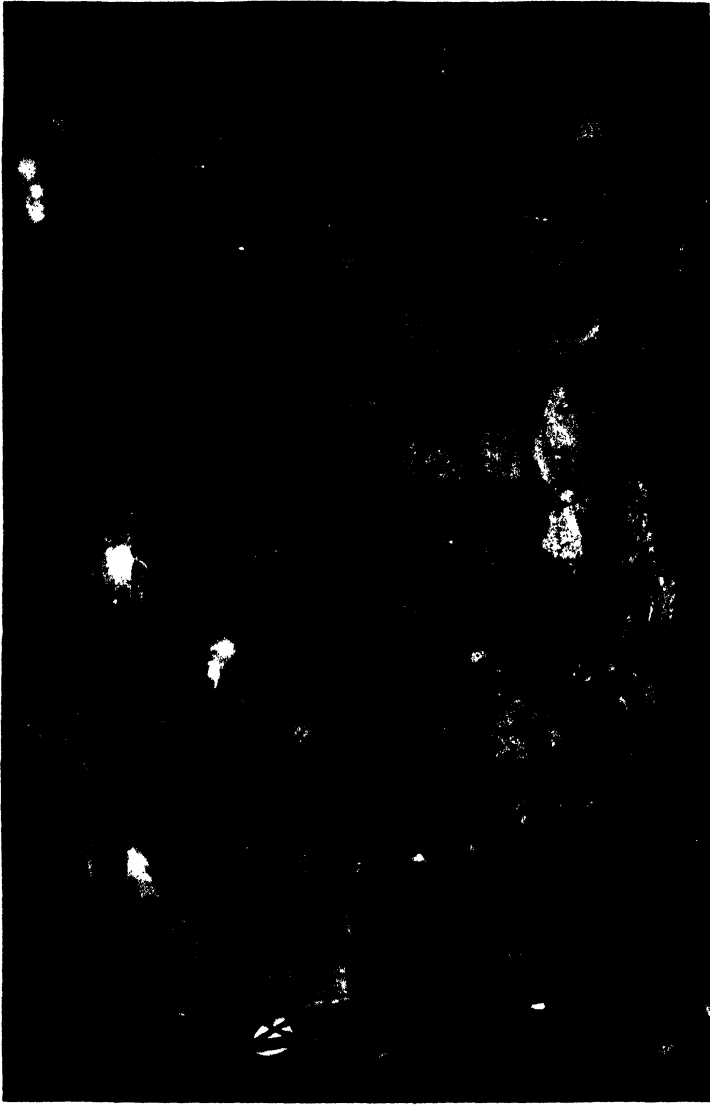

The Shove. Lincoln Tunnel, Hudson River, New York. (Part of New York Authority Photograph.)

PRACTICAL TUNNEL DRIVING

BY

HAROLD W. RICHARDSON
Associate Editor, "Engineering News-Record"

AND

ROBERT S. MAYO
Construction Engineer

FIRST EDITION
FOURTH IMPRESSION

McGRAW-HILL BOOK COMPANY, Inc.
NEW YORK AND LONDON
1941

PRACTICAL TUNNEL DRIVING

COPYRIGHT, 1941, BY THE
MCGRAW-HILL BOOK COMPANY, INC.

PRINTED IN THE UNITED STATES OF AMERICA

*All rights reserved. This book, or
parts thereof, may not be reproduced
in any form without permission of
the publishers.*

COMPOSITION BY THE MAPLE PRESS COMPANY, YORK, PA.
PRINTED AND BOUND BY COMAC PRESS, INC., BROOKLYN, N. Y.

TO THE TUNNEL MEN OF AMERICA—ENGI-
NEERS, CONTRACTORS, SUPERINTENDENTS, SHIFT
BOSSES, MINERS, SANDHOGS, AND LABORERS—
WHO CARVE OUT THE EARTH FOR THE BENEFIT
OF MANKIND, THIS BOOK IS RESPECTFULLY
DEDICATED.

PREFACE

As indicated by the title, the authors have confined this work principally to the practical side of tunnel driving. They have endeavored to explain in detail the fundamental operations that form the basis of each and every tunnel job, large or small, in soft ground or hard. No two tunnels are alike as to driving conditions; therefore the details of procedure will vary to meet each different situation. In recognition of these varying conditions, this book gives several variations of fundamental procedures, such as ground support, drilling, shooting, mucking, track installation and haulage, shaft operations, pumping and concrete lining, to mention only a few. Preliminary ground investigations, elements of design and engineering, and surveying are given proper attention.

In presenting this practical work, the authors hope they have filled in a gap in the list of books on tunneling. Most other works have been devoted to specific classes of tunnels or to reviews of the larger, more spectacular projects. This book is intended as an aid to the engineer or contractor who has a tunnel problem at hand, not as a history of what has been accomplished elsewhere. It is hoped the experienced tunnel man will find much to refresh his memory, to recall details of operations perhaps forgotten, and perhaps a new idea or a new adaptation of an old idea that might be of aid. To the less experienced and to those who drive tunnels only occasionally, it is hoped this book will be of even greater assistance.

The authors deeply appreciate the material, help and advice so kindly provided by many firms and individuals. To mention all to whom we are indebted for such assistance is impossible. To several, however, we desire to express our special thanks. These include *Engineering News-Record* and *Construction Methods*, whose files and records have been raided for information and illustrations; Ingersoll-Rand Company; Worthington Pump and Machinery Corporation; Commercial Shearing and Stamping Company; Timken Roller Bearing Company; The Institute of

Makers of Explosives; E. J. du Pont de Nemours & Company; Hercules Powder Company; John Kruse, ventilating engineer; New York Board of Water Supply; Pennsylvania Turnpike Commission; Metropolitan Water District of Southern California; New York Tunnel Authority; and the Port of New York Authority. To the scores of others—engineers, contractors and manufacturers—our heartfelt thanks.

HAROLD W. RICHARDSON.
ROBERT S. MAYO.

NEW YORK, N. Y.,
LANCASTER, PA.,
December, 1940.

CONTENTS

	PAGE
PREFACE	vii
CHAPTER	
• 1. HISTORY OF TUNNELING	1
Tunnel Development	1
Agricola	1
Modern Tunnels	3
Early American Tunnels	4
Early Soft-ground Tunnels	7
2. ENGINEERING AND DESIGN	9
Advantages of Tunneling	9
Selecting the Route	10
Approach and Access	10
Geological Investigation	11
Punch Boring	11
Auger	12
Churn Drilling	13
Wash Drilling	14
Core Drilling	16
Spacing of Core Holes	18
Subsurface Map	21
Methods of Tunneling	22
Size and Shape of Tunnels	23
Selection of the Lining	25
Concrete Lining	26
Design of Tunnel Lining	27
Lining Design in Rock	28
Lining Design for Firm Ground	28
Lining Design for Soft Ground	29
Reinforcement for Tension	31
Weepers and Water Stops	32
Curing Tunnel Concrete	33
Methods of Payment	33
Engineering Organization	35
Engineer's Office	36
3. TUNNEL SURVEYING	37
Degree of Accuracy	37
Running the Ground Line	38
Leveling and Chaining	40
Triangulation	40

CHAPTER	PAGE
Dropping the Line Down Shafts.	41
Special Conditions.	43
Tunnel Line	44
Surveying from Portals	44
Prolonging Line.	45
Light Boxes	46
Plumb Candles	46
Carrying Line Through Locks.	47
Checking Line from Surface	48
Tunnel Grade.	48
Carrying the Grade	48
Station.	49
Cross-sectioning.	49
Cross-sectioning for Record.	51
Pantographs and Sunflowers	52
Curves.	54
Offsets from Tangents.	55
Chords and Deflection Angles.	55
Final Line on Curves	56
4. SAFETY IN TUNNELING.	58
Good Housekeeping.	59
Safe Mucking and Haulage.	62
Shaft Operation.	64
Rock Falls.	65
Explosives	66
Personal Protection	66
Fire Protection	67
Compressed Air.	67
First Aid and Medical Attention	69
Public Safety.	70
Compensation	70
5. SHAFT SINKING	72
Headframes	74
Shafts in Rock	75
Drilling	75
Mucking.	76
Timbering	76
Steel Ribs	77
Lagging	78
Pumping.	78
Raising	78
Glory-holing	79
Sinking Manholes in Rock	79
Shaft Sinking in Soft Ground.	79
Design of Shaft Supports.	80
Methods of Timbering.	80

CONTENTS

xi

CHAPTER	PAGE
Timbering in Firm Ground	82
Steel Liner Plates	82
Steel-sheet Piling	84
Predraining	85
Manholes in Soft Ground	86
Chicago Wells	86
Drop Caissons	87
Pneumatic Caissons	88
6. MUCKING	90
Hand Mucking	90
Cleaning Bottom	91
Trapping	91
Belt Conveyors	92
Mechanical Loaders	93
Railroad Type Shovels	93
Full-revolving Shovels	94
Crawler Shovels	96
Mine Car Loaders	97
Conway Mucker	99
Slushers	100
Car Changers	102
Simple Car Changers	102
Passing Track	102
California Switch	103
Spur Switch	104
Cherry Picker	105
Grasshopper	107
Dixon Conveyor	108
7. TUNNEL HAULAGE	109
Track	109
Gage of Track	110
Rail	110
Ties	113
Curves	113
Switches	114
Selecting the Switch	117
Jumper Switches	117
Diamond Switch	119
Track Layout	120
Track at Foot of Shaft	120
Block System	122
Track Layout on Surface	123
Cars	125
Type of Car	126
Friction	130

CHAPTER	PAGE
Haulage Operations	130
Trammers	130
Animal Haulage.	131
Train Resistance	131
Locomotives	132
Tractive Effort	132
Battery Locomotives.	134
Trolley Locomotives.	134
Trolley-Battery Locomotives	135
Internal Combustion Locomotives.	136
Steam Locomotives	136
Truck Haulage	137
8. HOISTS AND HEADFRAMES	139
Functions of Hoisting Plant	139
General Layout.	139
Skip and Cage Arrangement	142
Design of Cage and Skip.	147
Signals and Safety Devices.	149
Bins and Hoppers.	150
9. VENTILATION AND DUST CONTROL.	153
Equipment	155
Fans.	155
Piping.	155
Selection of Equipment	156
Fan Arrangement	157
Pipe Installation	161
Dust Control.	164
Silicosis	165
Vacuum Hood Systems	166
Wet Drilling	166
Combined Systems	168
Respirators.	170
10. PUMPING AND WATER HANDLING	171
Types of Pumps Available	172
Heading Installations	174
Special Heading Conditions.	176
Pumping in Shafts.	179
11. PLANT AND UTILITIES	183
Power and Lighting	183
Compressor Plant.	188
Air Coolers and Receivers	191
Air Lines and Utility Arrangements	194
Repair Shops and Facilities.	196
Buildings.	197

CONTENTS

xiii

CHAPTER	PAGE
12. SOFT-GROUND TUNNELING WITH TIMBER	199
Definition of Soft Ground	199
Other Factors Influencing Method of Attack	200
Forepoling	200
Runs	204
Driving the Spiles.	204
Flooring the Tunnel.	205
Boiling Bottom.	205
Forepoling at St. Paul.	206
Forepoling at Erie.	206
Forepoling in Firm Ground.	207
Swinging False Set	207
Needle Beam and Timber	208
Other Timbering Methods	211
Five-piece Sets	211
Horse Cups.	212
Square Sets and Lagging.	212
Driving with Cases	212
American Method.	213
English Method.	214
Belgian Method.	215
German Method	216
Austrian Method	216
Italian Method.	216
Soft-ground Mining Methods.	216
Soft-ground Mucking	220
13. SOFT-GROUND TUNNELING WITH LINER PLATES	221
Types of Plate	221
Stiffening Ribs	222
Selecting the Plate and Rib.	223
Erecting Plates and Ribs.	224
Mining Methods with Liner Plates	228
Needle Beam.	228
Needle Beams with Inside Ribs.	229
Flying Arch	229
Poling Plates.	230
Grouting Liner Plates	230
Robbing Plates.	232
14. SHIELD-DRIVEN TUNNELS.	233
Shape of Shield-driven Tunnels.	233
Primary Lining.	235
Design.	236
Cast-iron Lining.	236
Cast-steel Lining	240
Segments for Tunnel Curves	241

CHAPTER	PAGE
Pressed-steel Liner Plates	241
Fabricated Plates	242
Concrete Block Lining	244
O'Rourke Blocks	245
T. & M. Block	248
Wood Lining	249
Other Types of Primary Lining	249
Distortion of Primary Lining	250
Grouting the Tail Void	251
Gravel Packing	252
Necessity for Secondary Lining	253
15. THE SHIELD	256
Essential Parts	256
Skin	256
Tail	256
Cutting Edge	257
Hood	258
Inner Structure	259
Pockets	259
Bulkheads	259
Weight	260
Articulated Shields	260
Over-cutter	261
Hydraulic Equipment	262
Jacks	262
Valves	263
Pumps	265
Hydraulic Pressure	265
Face Jacks	265
Erector Arms	266
Handling the Shield	267
Silt	269
Soft Clay	270
Dry Clay	270
Mixed Face	271
Sand or Gravel	272
Rock	273
Steering the Shield	273
16. THE PLENUM PROCESS	275
Air Pressure Required	275
Unbalanced Pressures	276
Plenum Process in Various Materials	277
Clay	277
Silt	277
Sand	278
Gravel	279

CONTENTS

XV

CHAPTER	PAGE
Holding the Air	280
Blows	281
Volume of Air Required	281
Fire Hazard	282
Predraining Tunnel Ground	282
Well Points	282
Wells	283
Hours of Labor	285
17. AIR LOCKS	286
General Types	286
Material Locks	286
Man Locks	287
The Lock Tender	288
Emergency Locks	288
Escape Locks	290
Medical Locks	291
Various Designs	292
Bulkhead Locks	292
Tee Locks	292
Vertical Locks	292
Concrete Locks	294
Other Compressed-air Equipment	295
Bulkhead	295
Piping	296
Low-pressure Air Line	296
Blow Line	297
Safety Screen	297
Gas Traps	298
18. TUNNELING IN ROCK	300
Full-face Attack	300
Small Tunnels	300
Large Tunnels	301
Heading and Bench	302
Top Heading	303
Bottom Heading	305
Drifts	305
Center Drift	305
Center Drift in Bad Ground	306
Side Drift	307
Drifting for Wall Plates	308
Pilot Tunnel Method	308
Enlarging Old Tunnels	309
Double-tracking an Old Tunnel	310
Enlarging a Lined Tunnel	311
Daylighting an Old Tunnel	311
Cooperation from the Owners	312

CHAPTER	PAGE
19. DRILLS AND DRILLING.	313
Drifter Drills.	313
Air Consumption	314
Other Rock Drills.	315
Drill Steel and Bits	317
Forged Bits.	317
Sharpening.	319
Removable Bits.	319
Nipper Cars	324
Drill Mounting.	325
Number of Drills	325
Bar Mounting	325
Column Mounting.	327
Drill Carriages	328
Drills Mounted on Car Switcher	329
Drilling Patterns	331
Choosing the Hole Pattern.	332
Depth of Holes.	333
Horizontal Wedge Cut.	334
Vertical Wedge Cut.	334
Bottom Cut	334
Pyramid Cut.	334
Buster Cut.	334
Cuts on the Los Angeles Aqueduct	336
Ring Drilling.	336
Bench Drilling	337
20. EXPLOSIVES.	338
Properties of Various Types	338
Straight Dynamite	338
Ammonia Dynamite.	338
Gelatin Dynamite.	339
Semigelatins	339
Blasting Gelatin.	339
Other High Explosives.	339
Comparative Strengths.	339
Handling and Care of Explosives	340
Transportation	340
Magazines	341
Priming	343
Loading and Stemming.	345
Delays and Wiring	347
Circuits	347
Electrical Resistance.	350
Inspection and Handling Misfires.	352
21. GROUND SUPPORT IN ROCK TUNNELS	354
Ground Pressures.	354
Pressures in Shallow Tunnels.	354

CONTENTS

xvii

CHAPTER	PAGE
Pressures in Deep Rock Tunnels	355
Design of Timber Supports	355
Selecting the System	357
Cap and Post	358
Three-piece Arch	358
Five-piece Arch	360
Jump Sets	360
Segments	360
Wall Plate	361
Posts	362
Foot Blocks	362
Collar Bracing	363
Lagging	363
Packing	363
Portal Bracing	364
Permanent Timbers	364
Steel Tunnel Support	365
Design of Steel Ribbs	366
Wall Plates	367
Posts	368
Collar Bracing	368
Lagging	370
Protective Coatings	372
 22. CONCRETE LINING	 373
General Lining Procedure	373
Lining Rock Tunnels	374
Concreting Sequence	374
Lining Soft-ground Tunnels	375
Forms	376
Time of Stripping	377
Separate Sidewall and Arch Forms	379
Single Unit Forms	379
Nontelelescoping Forms	380
Telelescoping Forms	383
Forms of Continuous Concreting	384
Monolithic Forms	385
Economy of Steel Forms	387
Bracing the Forms	387
Bulkheads	389
Water Stops	390
Concreting Curves	391
Mixing and Placing	392
Concrete Haulage	392
Tunnel Mixers	394
Hand Placing	394
Pneumatic Placers	396
Operation of the Placer	397

CHAPTER	PAGE
Gun Discharge Pipes	399
Charging the Placer.	401
Concrete Pump.	403
Continuous Placing	405
Vibration.	406
Concreting the Invert	406
Making the Closure.	407
Concrete Crews.	409
Precast Pipe	409
Grouting.	410
Grout Machines.	411
Grouting Procedure	412
Grout Pipes	413
 23. TUNNELS IN EXCEPTIONAL GROUND	 414
Hydraulic Mining in Sandstone.	414
Tunneling through Marl	417
 24. PIPE JACKING.	 420
Procedure	420
Pipe.	420
Jacks	420
Mining.	422
Steering	423
Friction	424
 INDEX.	 425

PRACTICAL TUNNEL DRIVING

CHAPTER 1

HISTORY OF TUNNELING

Tunnels are underground passages for transportation. They may be used for the transportation of passengers, freight, water, sewage, gas or minerals. Tunnels are, correctly defined, driven by underground means without disturbing the surface, although many structures built by "cut-and-cover" are termed tunnels.

Tunnels for the transportation of passengers and freight are comparatively recent, having first been used during the Canal Era which began around 1750. Tunneled aqueducts were built long before the Christian Era, some Roman tunnels being still used for the water supply of modern cities.

Tunnels for the winning of ore or the drainage of mines date back to the first metallurgical discoveries at the end of the Stone Age. Ancient man was an indefatigable prospector; any ore that he could refine with his crude furnace was discovered and exploited. Many of the big modern mines, particularly in Africa, owe their rediscovery to the presence of long-abandoned workings. The Indians of North America were still in the nomadic Stone Age when the white man landed; yet outcrops of native copper along the inhospitable shores of Lake Superior were dotted with the crude shafts of the aboriginal. The presence of copper ornaments in the graves of the Mound Builders of Ohio attests the wide distribution of the finished product.

TUNNEL DEVELOPMENT

Agricola.—Georg Bauer, a German who used the Latinized form of his name, Georg Agricola, wrote *De Re Metallica* published in 1556. This was first printed in Latin but quickly translated into the more popular languages. It was the standard,

and only, handbook on mining, tunneling and metallurgy for 350 years. The book was a careful compilation of the most "scientific" methods—and superstitions—of the day. Methods and machines were profusely illustrated with quaint woodcuts, remarkably clear.

Ground was broken by "fire-setting," building a fire against the face, then drenching the heated rock with a mixture of vinegar



FIG. 1.—Breaking rock by fire-setting. The miner has just lighted a fire against the face and is retreating, holding his nose. The laborer on the surface is preparing "kindling sticks." A, kindled logs; B, sticks shaved down fan-shaped; C, tunnel. (From "*De Re Metallica*," 1556.)

and water. The shattered rock was then pried out with gads and bars. Transportation to the shaft was in wheelbarrows or four-wheeled cars running on planks. Hoisting was done in skin baskets raised sometimes by water wheels but more often by laborers toiling up ladders with baskets on their backs. Timbering was exactly the same as at present. Numerous illustrations are given of pumps and blowers, all, of course, of wood. This is a remarkably interesting book. The Hoover translation is available in most engineering libraries.

Modern Tunnels.—Tunnels as we know them, not connected with mines, first came in with the Canal Era. Probably the first was the Malpas Tunnel in France, 515 ft. long, built in 1679–1681. The Tronquoy Tunnel on the St. Quentin Canal was

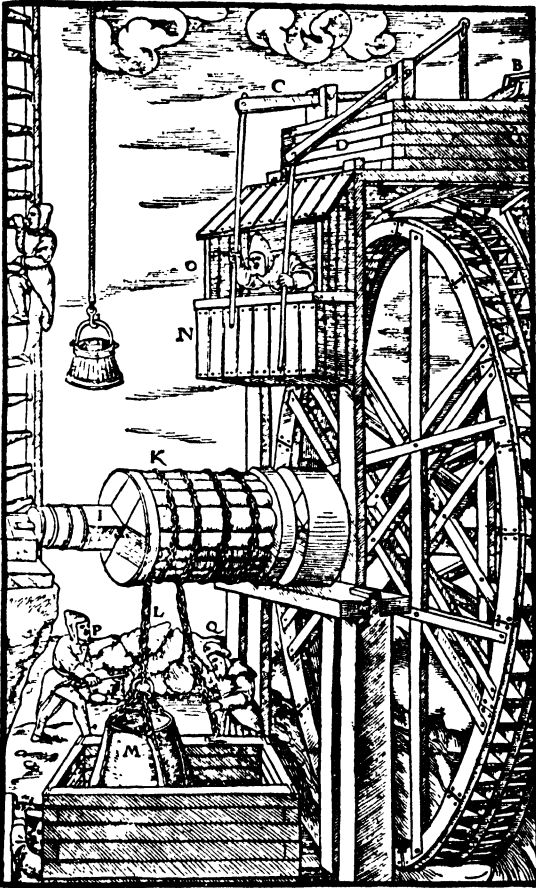

FIG. 2.—A hoisting engine of 1556. A, reservoir; B, race; C-D, levers; E-F, troughs under the water gates; G-H, double rows of buckets; I, axle; K, larger drum; L, drawing chain; M, bag; N, hanging cage; O, man directing the machine; P-Q, men emptying bags. (From "De Re Metallica," 1556.)

built in 1803. It was the first to be timbered and arched with stone throughout.

In England there were 45 tunnels on the early canals, totaling 40 miles. The Harecastle Tunnel was $1\frac{1}{2}$ miles long, 9x12 ft. in cross section. It was built in 1766–1777. The Marsden Canal

Tunnel was 3 miles long. The development of railways in England brought many long tunnels: the Box Hill Tunnel on the Great Western Railway was 2 miles long. It was driven through



FIG. 3.—The early mine surveyor. Aligning a drainage tunnel to intersect a shaft by a system of similar triangles. *A*, upright forked posts; *B*, pole over the posts; *C*, shaft; *D*, first cord; *E*, weight of first cord; *F*, second cord; *G*, same fixed to ground; *H*, head of first cord; *I*, mouth of tunnel; *K*, third cord; *L*, weight of third cord; *M*, first side of minor triangle; *N*, second side of minor triangle; *O*, third side of minor triangle; *P*, the minor triangle. (From "*De Re Metallica*," 1556.)

heavy ground and took a toll of 100 lives. The Kilsby Tunnel on the London and Birmingham Railway was $1\frac{1}{2}$ miles long.

Early American Tunnels.—The first American tunnel was on the Schuylkill Canal at Auburn, Pa. It was 820 ft. long, 20x18 ft. in cross section, built in 1820. Bad ground soon caused it to

be "daylighted" throughout. The second tunnel was on the Union Canal near Lebanon, Pa. Built in 1827, it was 720 ft. in length and cost \$30,000. It has been restored and stands today.

The first American railroad tunnel was on the Allegheny Portage Railroad which carried canal boats over the mountains from the Juniata River, a tributary to the Atlantic, to the headwaters of the Ohio-Mississippi system. It was 900 ft. long and



FIG. 4.—America's first railroad tunnel, Staples Bend, Allegheny Portage Railroad. Used for portaging canal boats over the Allegheny Mountains. Built 1831. (*Pennsylvania Railroad Photograph.*)

cost \$37,798.84 $\frac{1}{2}$, according to official records. Built in 1831, it now stands deserted in the mountains near Johnstown, Pa.

The rapid spread of railroads caused numerous tunnels to be built. Methods were standardized, and gunpowder gave way to dynamite; the hand driller slowly yielded to steam and air. The hand mucker and the mule still held on until the last decade. One of the notable tunnels of this period of transition was the Hoosac, connecting Boston and Albany. This tunnel, 4 $\frac{3}{4}$ miles long, was started by private interests in 1854 and finally completed by the state in 1876. It was here both dynamite and power drills had their first practical tryout.

The Washington St. Tunnel under the Chicago River in Chicago was America's first vehicular tunnel. This was built

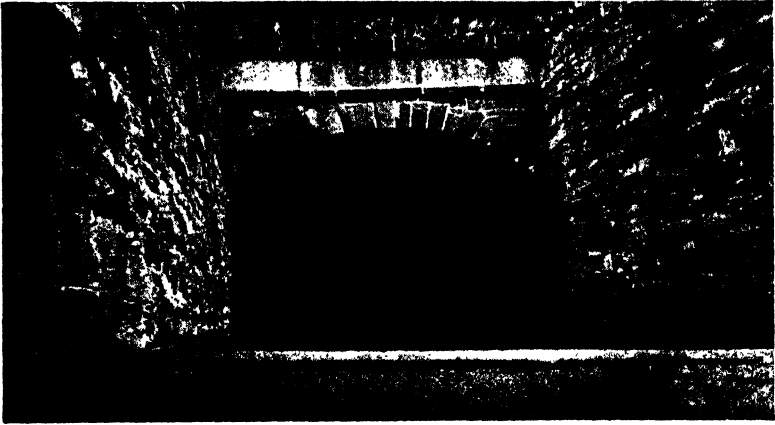

FIG. 5.—Oldest American tunnel, on the Union Canal near Lebanon, Pa. Built 1827.

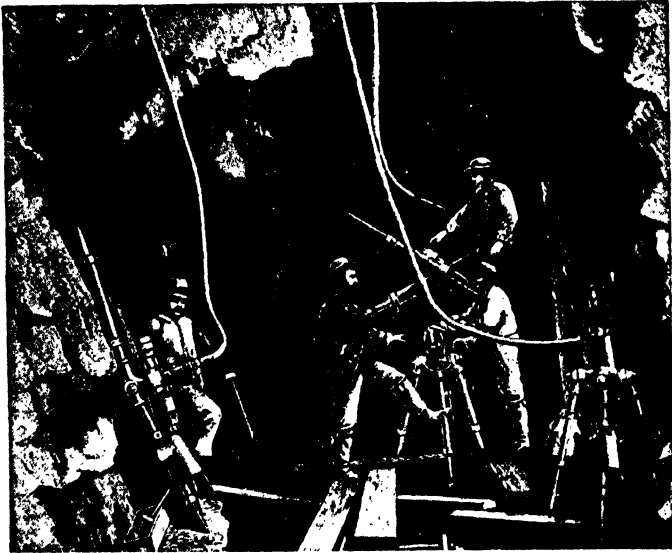

FIG. 6.—Tunneling operations in the early 1880's. Originally from Ingersoll Rock Drill Co. catalog, published about 1885. (Courtesy "Compressed Air Magazine.")

by the cut-and-cover method in cofferdam in 1866. After the great fire of 1871, the tunnel provided the only means of crossing the river for a long time.

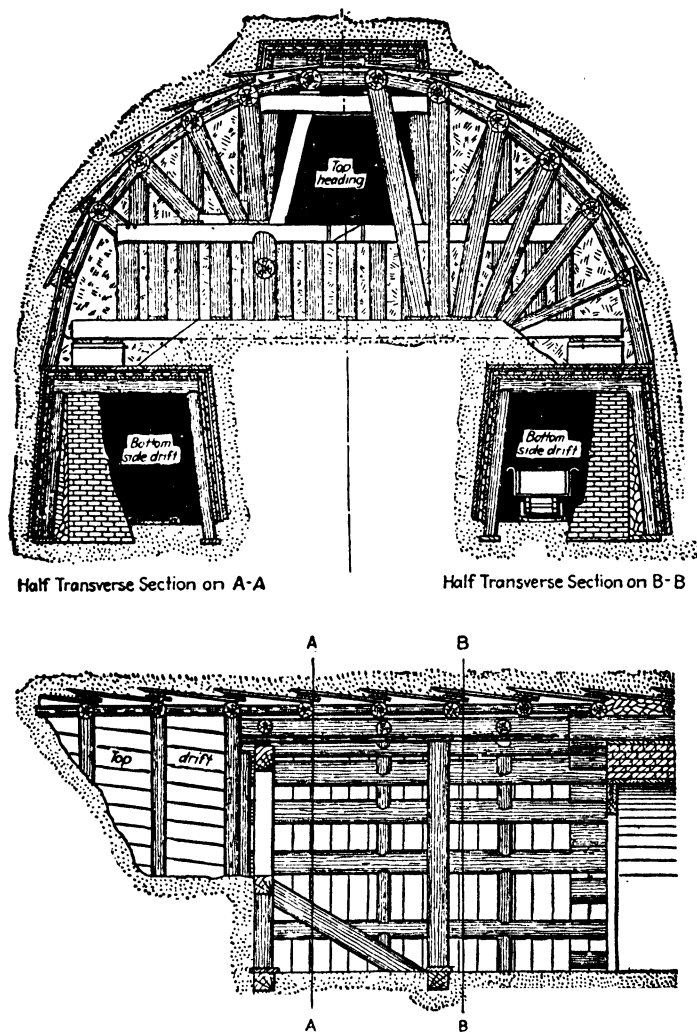

FIG. 7.—Baltimore Belt Tunnel, 1891. Note the heavy timbering. This tunnel was lined with five rings of brick. It is still in main-line use on the Baltimore & Ohio Railroad.

Early Soft-ground Tunnels.—One of the first soft-ground tunnels in this country was the intake of the Chicago waterworks.

This was 5 ft. in diameter, lined with two rings of brick and extended 2 miles under the lake. It was driven in clay without the use of air. Ventilation was by a 6-in. tin pipe whose exhaust was carried to a furnace on the surface. This tunnel was started in 1864 and opened with a grand celebration in March, 1867. Cleveland built an intake tunnel in 1871; a shield was first tried, but, after some unsuccessful attempts, it was abandoned in favor of simpler methods.

The Haskins Tunnel, started in 1879, was supposed to connect various railroad terminals on the New Jersey side with a proposed central depot near Washington Square, New York City. Haskins had watched the foundations of the Eads Bridge, St. Louis, being put in by air, and there he conceived the idea of tunneling through Hudson River silt by the use of compressed air. Though receiving no encouragement from the railroads, he raised enough capital to start the project. Shafts were sunk on both sides of the river. After many changes in the scheme of operations and after several disasters, the work was pushed ahead, until in 1882 about 1,600 ft. of tunnel, 24x26 ft., was completed. Work was then suspended for lack of money. These tunnels were finally completed by McAdoo in 1905 and form part of the "Hudson Tubes."

The Sarnia International Tunnel under the St. Clair River was pushed through clay by means of a shield in 1888. It is 20 ft. in diameter, 6,000 ft. in length. The tunnel of the Baltimore Belt Railroad was built under the principal street of Baltimore in 1891. The ground was mostly sand, and numerous buildings on each side complicated the work. This job was done by the German method and is notable for the amount of timbering that was used to hold the ground until the five-ring brick arch could be laid. It is 8,000 ft. long, 27x22 ft. for double track, Fig. 7.

CHAPTER 2

ENGINEERING AND DESIGN

There is little material in technical literature on the engineering and design of tunnels. A full and intelligent discussion of the subject would require a book in itself. Though this book is devoted to the construction of tunnels, the authors feel a brief discussion of engineering and design should be included.

ADVANTAGES OF TUNNELING

It is not within the scope of this book to discuss the economics of tunneling; for example, to compare the economic worth of the Lincoln Tunnel under the Hudson River with the George Washington Bridge over the same river a few miles upstream. There are many factors, simple and complex, tangible and intangible, that affect the economic value of tunnels. No doubt the rapid rise of aerial warfare and bombing of cities have added an intangible value to tunnels in comparison with bridges.

However, there are many instances in everyday engineering where a tunnel would be more advantageous and perhaps more economical than other types of construction. For example, where a public utility must carry a water or gas line across a stream, street or railroad, tunneling is often cheaper and is usually more desirable than an open cut or a bridge.

Great improvements in tunneling equipment and new methods of construction have, in the last decade or so, changed radically the economic ratio between deep open cuts and tunneling, both in rock and soft ground. Another factor in favor of tunnels is that they save tearing up expensive pavement, with consequent interference with traffic, and they often avoid dangerous open cuts adjacent to structures. Railroads now insist that, whenever possible, utility lines be tunneled under the right-of-way, thus eliminating temporary trestles required for trenches and annoying slow orders.

Formerly, soft-ground tunneling often resulted in settlement of the overlying ground, causing damage to pavements and other

surface structures. Modern methods, with improved primary and secondary lining, have practically eliminated this danger.

SELECTING THE ROUTE

In general, the route of the tunnel is fairly well established before it comes to the hand of the engineer. Natural features of topography or convenience of entrance and egress will locate the tunnel for the railroad or public utility. However, there are times when the difficulty of securing the right-of-way or easements under private property, will cause a new route to be located. Geologic investigation may prove that the most logical route will encounter difficult ground conditions. Then the engineers should make surveys on alternate routes with the hope of finding ground which can be tunneled more cheaply.

The municipal engineer will try to keep his tunnel route under the public streets but may obtain occasional easements under private property in order to give a larger radius on the curves or to obtain short cuts from one street to another. In laying out the route for an intercepting sewer, it is sometimes possible to pick a street where there is little development, or where the buildings are small, thereby lessening the risk of damage to adjacent property.

APPROACH AND ACCESS

A factor in locating the line for a tunnel is the economy of construction and the convenience of the contractor. Where there is to be more than one contract, the sections should be divided in such a manner that each job is as compact as possible and that the cross section and ground encountered will be the same. Thus the point where a tunnel leaves rock and enters soft ground would be a logical division point, since one contractor could set up his plant as an all-rock job, and the other contractor would use equipment for all soft ground. Another logical dividing point is where the cross section of the tunnel changes.

The locating engineer should also bear in mind that the contractor will require room for shafts, surface plant and possibly spoil banks. Where the right-of-way or street is insufficient or cannot be occupied, it would be well for the engineer to secure options on vacant property along the route to be used for this purpose. Such options can be turned over to the successful

bidder, if he elects to use them, and may result in considerable savings to the owner, as it removes one of the unknowns from the job. Bidders seldom have time to make all investigations and secure such options.

GEOLOGICAL INVESTIGATION

There is a saying in the drilling profession: "You pay for borings whether you get them or not." This is very true. The owner who presents to the bidders full and accurate information on the subsoil conditions will be assured of the lowest and best

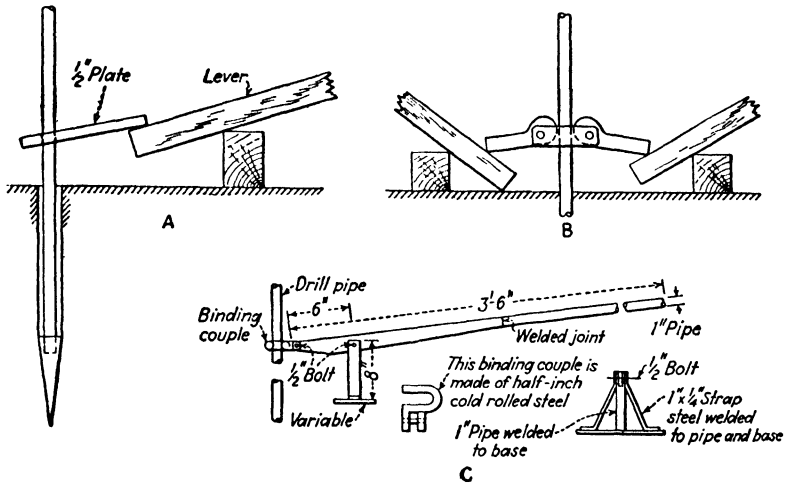

FIG. 8.—Devices for pulling a punch drill.

bids from responsible contractors. Ground conditions are the big hazard in tunnel contracting, and the more complete the information the less the risk and the lower the bids.

Following are descriptions of various methods of making soil investigations.

Punch Boring.—Where the tunnel is near the surface, or bed-rock is near, punch boring is sometimes used to secure information on the subsoil. The punch rod is of $\frac{7}{8}$ or 1-in. steel with an enlarged point to make the hole slightly oversize, Fig. 8A. A set of these rods should be 4, 8, 12 and 16 ft. long. If it is necessary to go deeper than 16 ft., the rods should be made up with threaded ends. Punch borings have been made as deep as 40 ft.

The rods are driven into the ground either with sledge hammers, or by weighting a removable crossarm clamped to the rod.

While two men rest their weight on the crossarm, two more men revolve the rod by pushing on the arms, thus twisting it into the ground. Every 4 ft., the rod is withdrawn. This can be done by slipping a $\frac{1}{2}$ -in. plate over the rod and prying under one end of the plate as shown in Fig. 8A or by making up an arrangement of two eccentrics as shown in Fig. 8B, which allows two prys to be used at one time, giving a straight lift. A soil sample is taken every 4 ft. by means of a "spoon" on the end of a $\frac{1}{2}$ -in. rod. Experienced punch borers claim they can detect, by the sound of

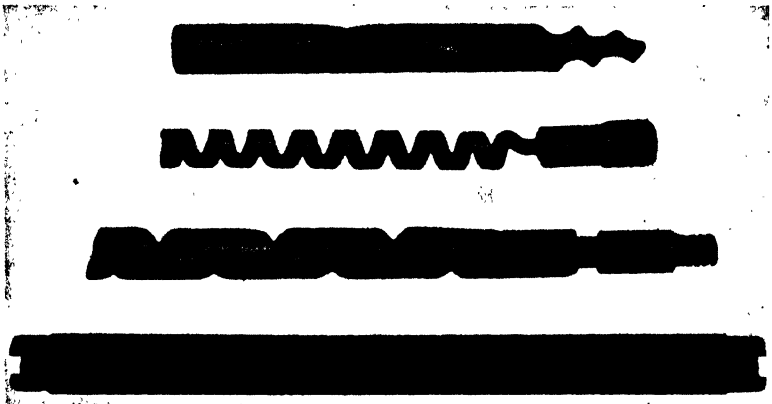

Fig. 9.—Augers and split tubes for taking undisturbed samples at bottom of test holes. (Courtesy Acker Drill Co.)

the rod, when the point is passing from one stratum to another. Similarly, there is a decided difference in sound when the rod strikes bedrock or a boulder.

Auger.—An auger may be used for sampling the ground to considerable depth. This may be a posthole auger, or a smaller auger. The latter is an ordinary carpenter's auger, generally between 2 and 3-in. diameter, from which the small lead point has been removed, welded on to a piece of $\frac{3}{4}$ -in. pipe. Additional pieces of pipe about 4 ft. long are used for extending the stem. This auger can be worked at considerable depths providing the hole will not cave, as will occur in quick or dry sand. If such sand is at the surface, the hole can be cased with a piece of pipe slightly larger than the diameter of the auger. Hard strata are penetrated by substituting a fishtail or chisel bit for the auger and using it as a "jump" drill.

However, the auger might give a false sample when working in clay in case water collects for the whole depth of the hole and runs to the bottom. Here it is churned up with the sample, giving the impression that the ground is softer than it actually is. A better sample can be obtained by substituting a piece of seamless tubing about 12 in. long for the auger. This tubing is then forced into the ground and given a twist to break off the sample, which can then be withdrawn.

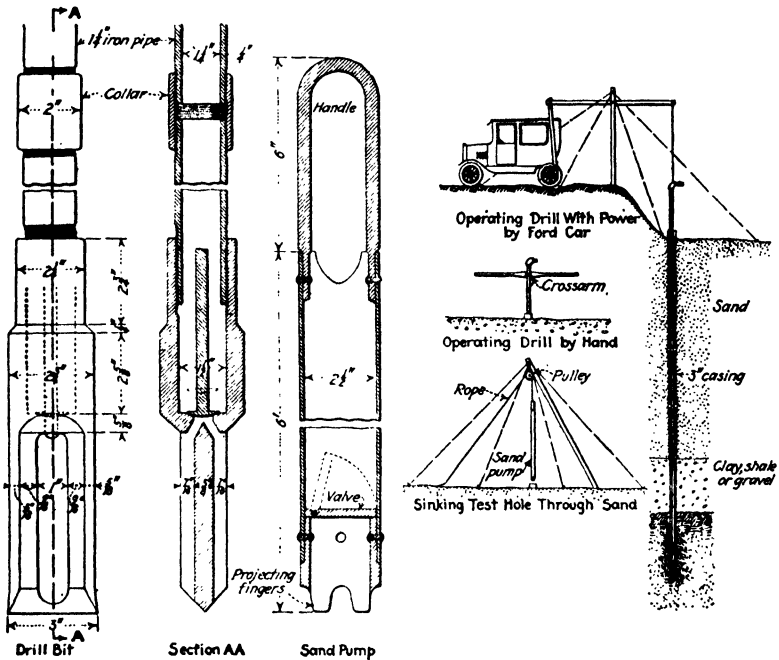

FIG. 10.—Equipment and methods used in churn drilling.

Churn Drilling.—Churn drills may also be employed for subsoil exploration, but, like the wash drill, the samples are not obtained in their original state. A simple rig is shown in Fig. 10. This consists of a fishtail bit weighing 60 lb., to which is connected a string of 1 1/4-in. pipe. If the soil caves, the hole is cased with 3-in. pipe. This drill is raised and dropped by two or three men on the crossarm. It is a simple matter to rig up the hind wheel of an automobile with a balance beam so that power can be used.

These holes are always drilled wet, the soil or rock chips being kept in suspension by churning. Occasionally it is necessary to

use a bailer or bucket to remove the sludge, and more water is then added. In sand, the bailer can be used for loosening and removing the spoil. As the drill is churned up and down in the hole, the suspended sand will enter the bailer through the bottom flap valve and can then be removed.

When rock is reached, the hole should be continued a few feet to be sure it is not a ledge or boulder. Samples of the material should be preserved for inspection by the geologist.

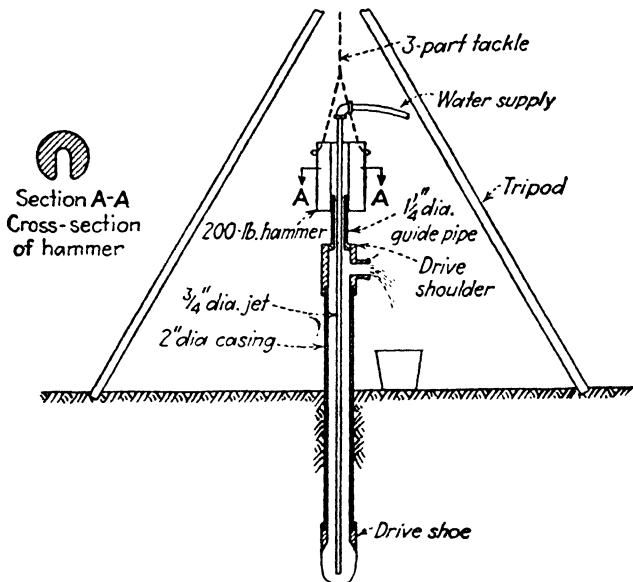

FIG. 11.—Wash boring rig.

Wash Drilling.—Wash drilling is a simple method for getting ground samples. The essential parts of this rig are the tripod, about 12 ft. high made of 1½-in. pipe, from which is suspended a block and fall for raising the hammer or pulling the casing; a flush joint casing, generally of 2-in. diameter in 5-ft. lengths, with a steel drive shoe and a T driving head; and ¾-in. jet pipe; a cast-iron hammer; and a force pump. This force pump may be hand-operated, using water from barrels which are refilled by hauling water from the nearest source.

As shown in Fig. 11, the hammer, weighing about 200 lb. is made U-shaped so that it can be removed from the piece of 1½-in. pipe which forms the guide. The tackle should be reeved in

three parts. The T-head has a side discharge and is fitted with a shoulder and a wood buffer.

The $\frac{3}{4}$ -in. jet pipe goes down through the $1\frac{1}{4}$ -in. guide pipe as shown. A hose connects it to the water main or force pump.

The outer casing is driven down a short distance; then the jet pipe is put into service, washing out the core material. Samples can be trapped in a bucket; such samples should not be allowed to overflow, as the overflow will carry away the fines. A sample pail should be about 10 gal. capacity. This sample is set aside for $\frac{1}{2}$ hr., then the inspector adds 2 cc. of hydrochloric acid to hasten precipitation. After a short time the turbid water is

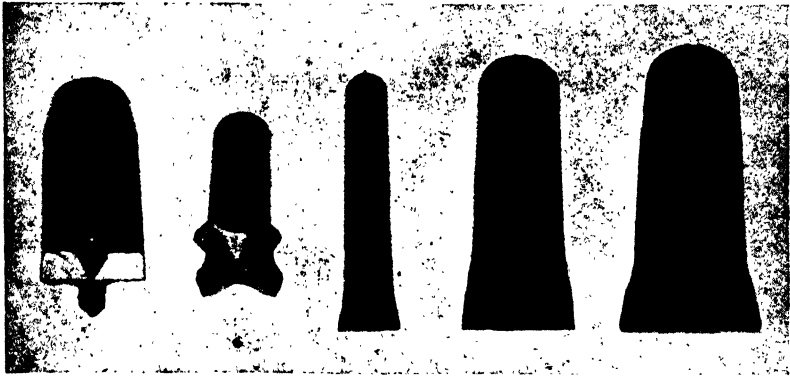

FIG. 12.—Various types of jump bits for breaking hard ground in wash boring. The bits screw on to the jet pipe; water is passed through the bit while chopping. (Courtesy Acker Drill Co.)

decanted, and a fair sample is taken of the precipitate, which is bottled and labeled for location and depth.

When rock or hardpan is struck, a fishtail jumper drill can be worked through the casing. If it is only a ledge or thin stratum, a small charge of dynamite is exploded at the bottom of the hole and the casing forced through the shattered material. Whenever bedrock is reached, it is a general practice to drill 2 or 3 ft. to make sure that it is not a boulder. Wash samples should be taken of the fines from the bedrock and bottled and saved for geological inspection. The fishtail drill is also used for shattering large gravel which the jet will not wash to the surface.

Wash drilling, of course, gives no indication of the moisture content of the original material. Nor can one always tell the height of the water table. In certain soils, a true sample may be

obtained by using an auger ahead of the casing; or a piece of seamless steel tubing may be forced into the ground ahead to obtain an undisturbed section of soil.

The casing should always be pulled. Generally this can be done by taking a strain with the block and fall, while two or three



FIG. 13.—Driving and jetting a casing to rock preparatory to taking a core boring. (Courtesy Acker Drill Co.)

men revolve the pipe by means of large chain tongs. If the falls will not move the casing, jacks are set against it, and it is forced up. If sufficient jetting pressure is available, the casing may be loosened by forcing the jet down on the outside.

Core Drilling.—The only way to get a true, undisturbed sample of the bedrock is by core drilling. These cores may be obtained by the diamond drill or the shot drill.

Both rigs consist essentially of an annular cutting head and core barrel; this is driven by a rotating head on the machine which transmits its torque through a set of jointed pipes. Water is pumped through the hollow drive shaft to lubricate the cutting head and to carry away the sludge, which travels up the hole outside the pipe. After advancing the length of the core barrel, about 6 ft., the whole string of tools is withdrawn and the core

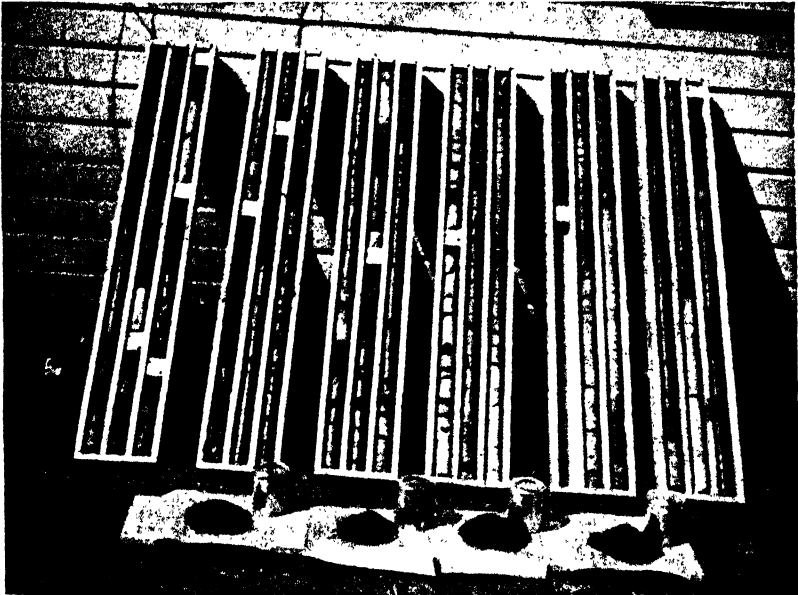

FIG. 14.—Core samples carefully boxed for inspection and preservation. The fines are kept in the sealed cans. (Courtesy Sullivan Machinery Co.)

removed from the core barrel. This core is boxed, Fig. 14, and location of hole and depth of core are carefully recorded.

The diamond drill has a number of diamonds or bort set around the edge of the cutting head. Smaller sizes of the diamond drill machines are very compact and can be set up in the heading of even the smallest tunnel for advance exploration. There are occasions when this is very important, especially when penetrating ground which may have fissures filled with water under high head. The diamond drill can work on any angle, vertically, horizontally, or even upward. The commonest size pulls a $\frac{7}{8}$ -in. diameter core.

The shot drill has a soft steel cutter head, in one side of which is a slot. The cutting is done by chilled steel shot which are fed in with the water supply. If the shot escape from under the cutting edge, they are caught by the slot and fed back under. Because of this gravity feed of the cutting element, a shot drill will not operate at a flatter angle than 45 deg., and in very soft rock the shot may become embedded in the rock, stopping the



FIG. 15.—Diamond core drill making an inclined exploratory hole. (Courtesy Sullivan Machinery Co.)

drilling action. Because of the cheapness of the shot, large cores can be cut without an expensive cutter head. Cores as large as 30 in. have been cut, providing a hole into which a man can be lowered for visual inspection.

Spacing of Core Holes.—The spacing of the holes depends entirely on the type of ground penetrated. If the ground is much folded or faulted, the holes must be much closer than when the beds are straight and uniform. Figure 16 illustrates the extensive core borings made for a recent tunnel under the East

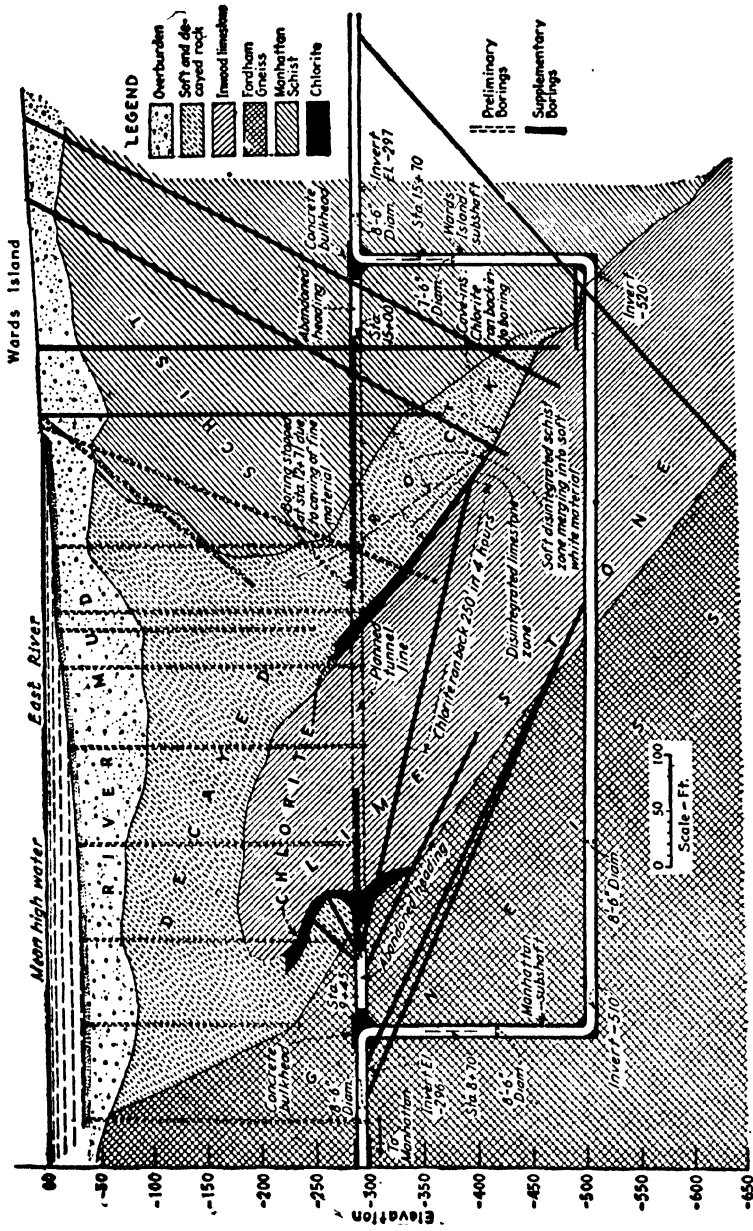

Fig. 16.—Extensive core drilling on Wards Island sewer tunnel under the East River, New York, showed the way to get under a bad fault that stopped driving on original upper level tunnel. Preliminary borings failed to reveal true conditions.

River in New York, after a less elaborate investigation had failed to reveal a seam of decomposed rock under a high head of water. It was necessary, from the explorations shown here, to by-pass part of the original tunnel route.

Drill holes will deviate from the true line, sometimes as much as 5 deg.; but, since tunnel exploration holes are rarely more than 400 ft. deep, this is not serious. It is best to drive the core holes to one side of the tunnel line; otherwise there is danger of running into a water-filled hole in the subsequent tunneling operations.

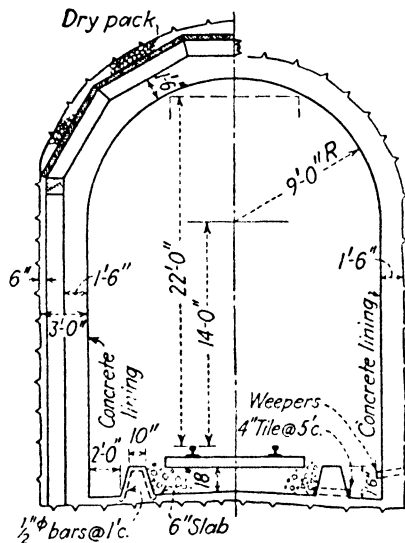

FIG. 17.—Typical single-track railroad tunnel. Note ballast walls to keep drainage ditches clear.

Core drilling is generally done under separate contract by firms who specialize in this work. It is well to specify a certain minimum core recovery to ensure that the work is carefully done. Core recovery should run about 40 per cent in shale, 75 per cent in sandstone, 60 per cent in limestone and 80 per cent in igneous rock. This percentage varies with the diameter of the core. Core-drilling machines may be of great value when approaching fissured, water-bearing ground. Holes may be drilled, either from the surface or from the heading, and grout forced down to solidify the rock and to seal off the ground water, as further described in Chap. 10.

SUBSURFACE MAP

If not already available, a subsurface map should be made for a project involving shallow tunnels under city streets. The map should show location, size and depth of all sewers, water mains, gas mains, steam mains, electric and telephone conduits. It is important to show the cutoff valves on the water mains so that

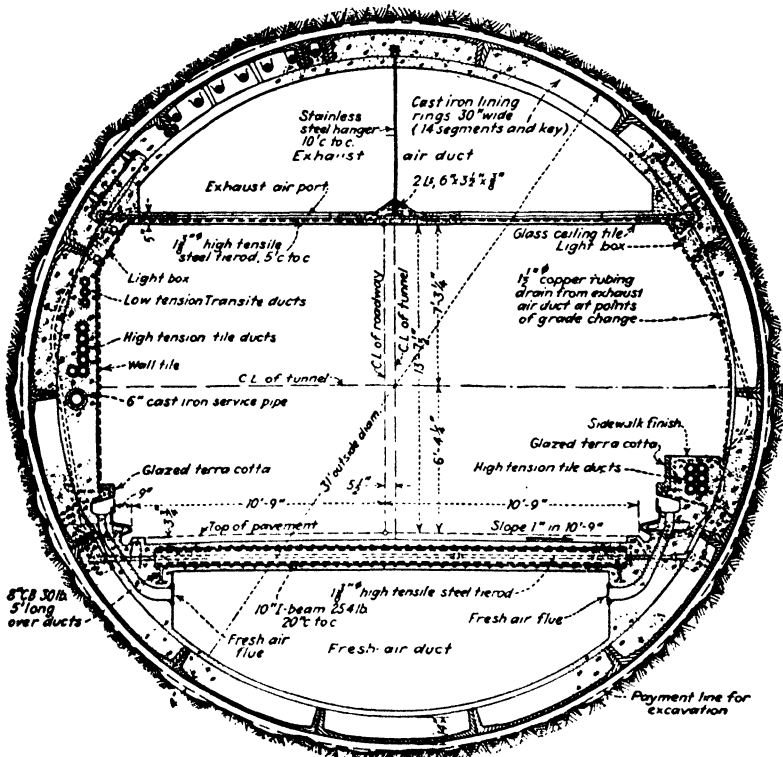

FIG. 18.—Cross section of Lincoln Tunnel under the Hudson River, New York, a typical design of a subaqueous shield-driven iron-lined vehicular tunnel.

in case of a break the water may be turned off with the least delay. This survey should also indicate the buildings and their type of foundation in order that the bidders may judge what steps must be taken to protect them against settlement.

This same map can be used for showing the results of the geological exploration. The plan shows the location and identity of the holes, an accompanying profile shows the depth of hole

and the various strata, indicated by conventional signs. The water table should be indicated on each hole, together with the date. If the holes are near a large stream, the stage of the stream on that date should be shown somewhere on the drawing. The ratio between horizontal and vertical scales is generally 10:1 for convenience in plotting the profile data.

METHODS OF TUNNELING

The contractor should be given fullest latitude as to methods of tunneling and sequence of operations. His superintendent and

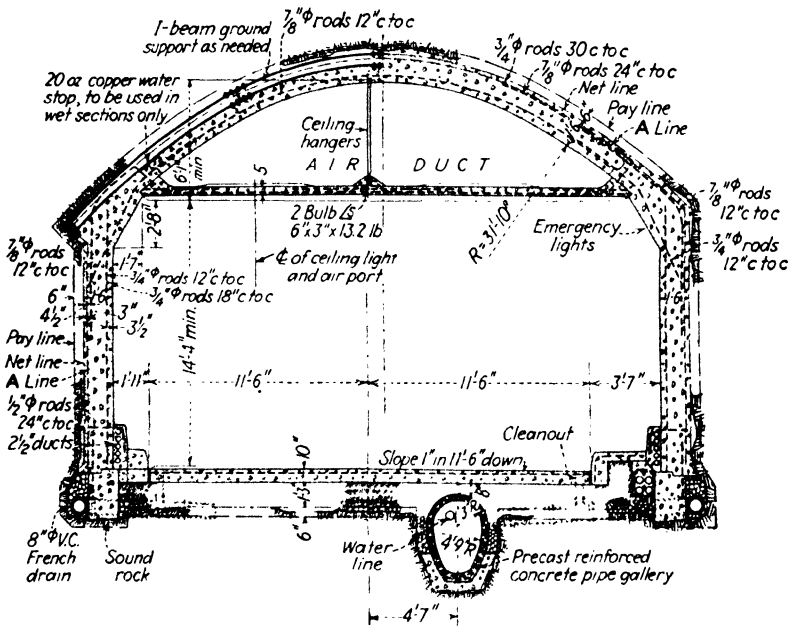

Fig. 19.—Modern two-lane vehicular tunnel. Typical design of the six mile-long tunnels on the Pennsylvania Turnpike.

the resident engineer are in a better position to decide what methods and precautions will give the fullest measure of progress and safety than is the engineer who originally wrote the specifications.

This, too, applies to the amount and type of roof support. In the specifications should be clauses whereby the contractor will be paid for the timbering or steel liner plates when installed at the direction of the engineer. This is to expedite the job, since

protection will not be erected except when needed; and the contractor will not slight this work when required, for he is being paid for it.

SIZE AND SHAPE OF TUNNELS

The size of a tunnel will, of course, be controlled by its use; whereas the shape, to a large degree, will be governed by the type of ground penetrated.

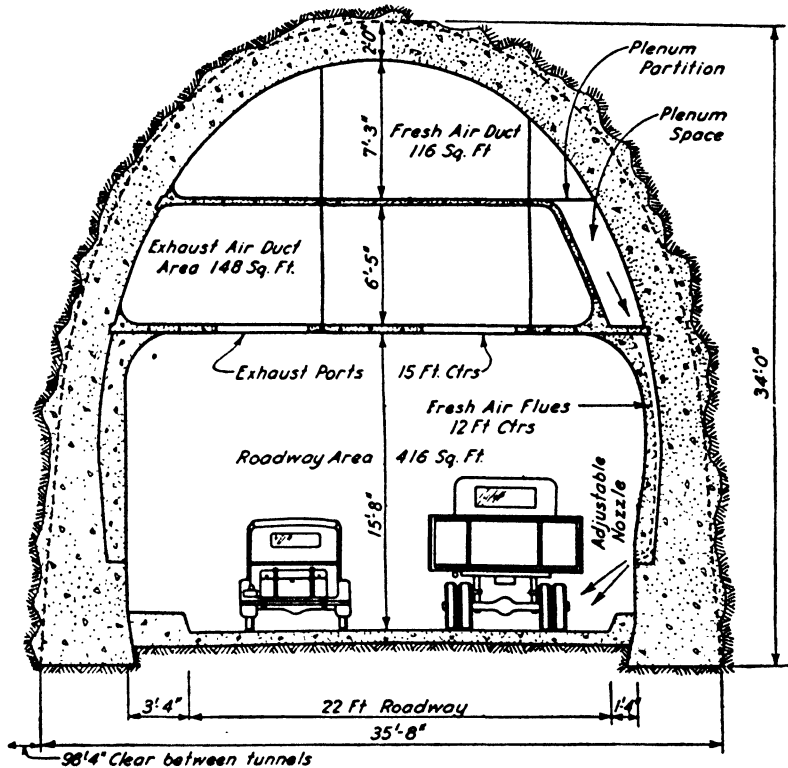

FIG. 20.—Broadway Low Level Tunnel, Oakland, Calif. Note unusual arrangement of ventilation ducts. (From "Western Construction News.")

The designer should keep in mind that the capacity and useful life of a sewer or aqueduct will be greatly increased by adding only a few inches to its size, yet the cost increase may be negligible. This is particularly true in small tunnels. The contractor needs a certain minimum width and height, about 7x7 ft., for efficient mining; tunnels smaller than this size are more costly.

Railroad tunnels are now being built with a clear width of 18 ft., instead of the conventional 16 ft. to allow for larger equipment. Double-track tunnels are now built 32 ft. wide instead of 28 ft. Clear height is still 22 ft. above rails, except in case of possibility of future electrification; then additional height should be allowed for the catenary wire. Vehicular tunnels are being built with a clear width between curbs of $21\frac{1}{2}$ ft., and a clear height of $13\frac{1}{2}$ ft.

Tunnels in rock are generally designed with a semicircular arch and vertical side walls. Tunnels in soft ground must be prepared to resist horizontal pressures; thus most of them are either circular or horseshoe shaped.

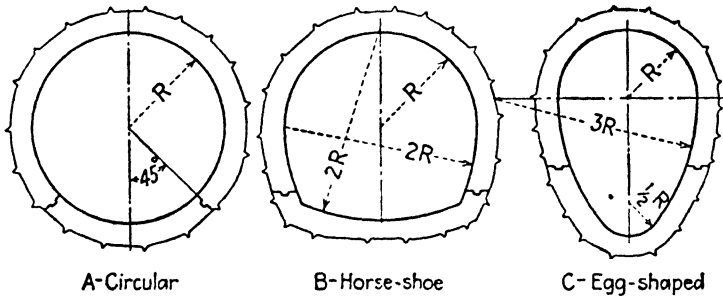

FIG. 21.—Typical cross sections for soft-ground tunnels.

The circular tunnel is theoretically the best for resisting either external or internal forces, and it provides the greatest cross-section area for the least perimeter; but it has several practical disadvantages from the construction point of view. The rounded floor makes it difficult for the contractor to carry a double track without considerable filling or cribbing, and this shape is slightly more difficult for placement of the concrete lining.

The horseshoe shape, Fig. 21b represents a compromise between the arched tunnel and the circular and has become very popular with both designers and contractors. The floor of this tunnel is flat enough to give the width a contractor needs for his operations, yet the curved sides and invert resist external pressures by arch action. The wetted perimeter is not much greater than that of a circle.

The egg shape, Fig. 21c, was once very popular for sewers carrying combined sanitary and storm flows, but it is an awkward

shape for efficient tunneling, for the floor is so narrow. Rectangular tunnels are almost never used, as they are very difficult to concrete.

SELECTION OF THE LINING

Concrete has become the standard material for lining tunnels, and it will be the only material discussed in this book. However, it will be well to briefly mention other methods.

Many railroad, mine and drainage tunnels through good rock are left unlined. But even the best of rock is liable to air slake. Railroad tunnels are inspected daily by the track walker and loose pieces scaled down and falls removed. It is doubtful economy to leave a sewer or aqueduct unlined, for the cost of unwatering the tunnel to make the inspection and laying track to remove the fallen material will be considerable. Also the rough surface so increases the turbulence of flow that a smaller tunnel with a smooth lining will transport more water than a larger unlined one.

Some unlined tunnels have been covered with a coat of Gunite or shotcrete, about $\frac{3}{4}$ in. thick. Though this thin coating adds no structural strength to the tunnel, it does protect the rock against air slaking and prevents unraveling by holding small pieces in place.

Brick, once the standard material for tunnel lining, is now seldom used except in sewers which carry high-acid industrial wastes, for brick is more acid resistant than concrete. Standard sewer bricks are $2\frac{1}{4} \times 4 \times 8\frac{1}{4}$ in. and should be well burned. They are laid longitudinally. The lining is either of two or three rings, or 9 or 13 in. thick, respectively. The mortar should be of best quality and joints, since the acid sewage will attack them, as narrow as possible. The disadvantage of brick lining is the difficulty of back packing the space between the extrados of the arch and the roof of the tunnel. This is generally specified to be filled with spalls or sand, well rammed, but it is a tedious operation and seldom well done. The resulting voids will eventually allow settlement and put uneven pressure on the lining.

Shield-driven tunnels, with a primary lining of cast-iron segments or precast concrete blocks, are sometimes built without a secondary lining of concrete. These types of primary lining are discussed in Chap. 14.

CONCRETE LINING

Concrete has become the standard material for lining tunnels in both rock and soft ground. Its plasticity allows it to be well packed between the forms and the ground; it is watertight and gives a smooth surface.

Tunnel concrete has suffered from the borrowing of specifications for concrete used in mass structures such as dams and foundations. This is particularly true in applying the water-cement ratio to the design of the mix. This ratio penalizes the contractor for using a wet concrete; yet vibration can rarely be satisfactorily employed in thin-walled tunnels (where it is most needed) to obtain a dense, smooth concrete from a dry mix. Concrete for tunnel arches should have a slump between $2\frac{1}{2}$ and $3\frac{1}{2}$ in. in fact, some engineers insist on a slump of 4 to 5 in. If the engineer is to design the mix by the water-cement ratio, it is more satisfactory to all concerned to pay for the cement under a separate item.

As invert concrete can be deposited and worked by conventional methods, it can be mixed to a lesser slump. Usual practice is to place the invert first and cast a 6- or 8-in. shoulder or curb, with it. This curb serves to align the arch forms and prevent their shifting during pouring. Any error in aligning the curbs can be corrected before the arch forms are set. In recent years, many long-rock tunnels have been concreted invert last. In such cases, there should be some kind of pedestal, precast to line and grade, to support the arch forms.

Standard practice in concreting arches is to lead a single discharge pipe directly over the crown of the form. All concrete is shot through this pipe, and care should be taken that it runs off equally to both sides. If the concrete is of proper consistency, or flowability, there will be practically no segregation. As the form fills, the concrete pipe is withdrawn, the end of the pipe being kept about 10 ft. away from the concrete. In larger tunnels the concrete of the side walls can be deposited by gravity up to the spring line before starting to fill the arch.

Here again the borrowing of specifications for placing of mass concrete, such as the phrase "concrete shall be deposited in horizontal layers not more than 3 ft. thick, and shall not be allowed to flow or fall more than 8 ft. . . ." has often caused

the contractor much needless experimentation until the clause was modified to allow methods in line with usual tunneling practice.

As temperatures within a tunnel vary little winter or summer, there is no need of transverse construction joints at regular intervals to take care of contraction or expansion. Generally the contractor requests that the joints be located to give him yardage enough for a daily pour of 6 hr. There is no necessity of having the transverse construction joints of the invert match up with those of the arch.

More complete discussion of placing the concrete lining will be found in Chap. 22.

DESIGN OF TUNNEL LINING

There are no rational methods for designing the thickness of lining for tunnels, particularly in rock. In soft ground it is possible to make certain assumptions based on hydrostatic pressures which will allow the engineer to make some kind of calculations. There is a "rule of thumb," a relic of the early days, which said: "Make the lining one inch thick for every foot of diameter," or

$$T = D$$

where T = thickness of the lining, in.

D = diameter or width of tunnel, ft.

This rule is still applicable today with the modification that the minimum thickness should not be less than 8 in. in soft ground and 6 in. in rock.

In most cities the engineer will have an opportunity of inspecting old tunnels driven through similar soil, perhaps 50 years ago, and lined with brick. Although the old lining may have deflected and cracked, it is still holding up, in spite of leached mortar and perhaps poor original workmanship. The cracking of these old brick linings is generally due to the difficulty in the old days of securing a tight packing between the extrados of the arch and the ground. These voids allowed the arch to deflect under unequal loading, with resulting cracking. After making such an inspection and knowing the quality of the material and the methods of placing the proposed lining, the engineer is in a position to judge the thickness of the lining he should use.

It is interesting to note that the Baltimore Belt R.R. tunnel, built in 1890 through extremely heavy ground, was lined for

most of the way with five rings (about 22 in.) of brick. The old Union Tunnel of the Pennsylvania Railroad, in the same city, was also lined with five rings. Both these tunnels were 26 ft. wide. After 60 years of service, they are still carrying main-line traffic, though one has been relined and reduced to single-track size.

Lining Design in Rock.—Usually there is no pressure against the lining in a rock tunnel, and the lining simply prevents air slaking of the rock or supports large slabs which have become loosened. In aqueducts or sewers the lining is essential to reduce the turbulence of the flowing water.

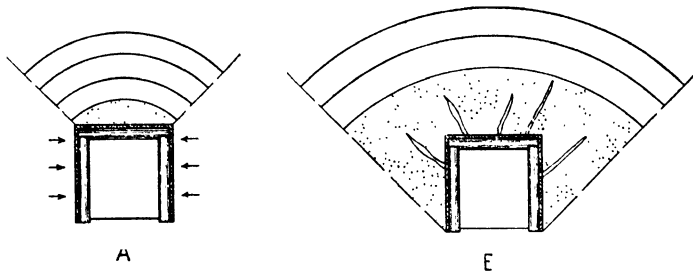

FIG. 22.—Arching of the soil relieves some of the pressure on tunnels in firm ground.

In general, the thickness of tunnel lining in rock will be based on the rule of “one inch of thickness for each foot of width.” This may be decreased safely for good rock; but the designer must remember that concrete placing in tunnels is difficult at best and that narrow walls may not be properly filled. The minimum thickness of concrete directly on the crown of a tunnel should never be less than 10 in. to allow room for the insertion of the concrete delivery pipe and the proper keying of the arch.

Occasionally a tunnel will pass through faulted zones of fractured or decomposed rock. For short distances there may be enormous pressures which will require unusually thick lining, possibly reinforced by frames of I-beams from which the lagging is blocked.

Lining Design for Firm Ground.—It is difficult indeed to make assumptions for the design of lining for tunnels through firm grounds such as shale, dry clay or dry earth. Actual soil pressure will be almost nonexistent, but such grounds, if the moisture content should increase owing to raising of the water table, are

liable to "swell" and bring tremendous pressures on the lining. This possibility must be considered.

There is a natural arch in all grounds, except quicksand, which tends to relieve the pressure on the timbering or lining of a tunnel. As shown in Fig. 22A, if a tunnel could be driven through ground without any disturbance, the side walls would act as abutments to retain the earth while the roof timbers would only have to carry the earth (shown dotted) which served as a "falsework" for the first theoretical soil arch. But there is always some disturbance of the soil, Fig. 22B. The timbering may yield some as the pressure is built up, there may have been voids carelessly left outside the sheeting, or soil may have run between the lagging, any of which cases will place the first soil arch some distance above the tunnel. Thus, the dead weight which the lining must carry is greatly increased. This theory is applicable to the design of tunnel lining in firm, cohesive soils. Note that by this method the pressure on a tunnel is independent of depth; in fact, a very shallow tunnel might have more pressure than a deeper one. For a full discussion of the soil arch see an article by J. C. Meem in *Transactions of the American Society of Civil Engineers*, vol. 60, June, 1908.

Lining Design for Soft Ground.—Running ground, whether dry or wet, and very plastic clays answer in part to the laws of hydrostatics in that the pressures, both horizontal and vertical, are increased as the depth of overburden becomes greater. If such ground followed directly the laws of hydrostatics, in that H was always equal to V , it would be a simple matter to design the lining; then the concrete would all be in compression. Actually the horizontal pressure is always less than the vertical pressure, and the vertical pressure most generally is not in direct proportion with the depth of the overburden.

With a ratio of H to V of 1:3, the unit loads on a circular lining become as shown in Fig. 23, and this unequal loading has a tend-

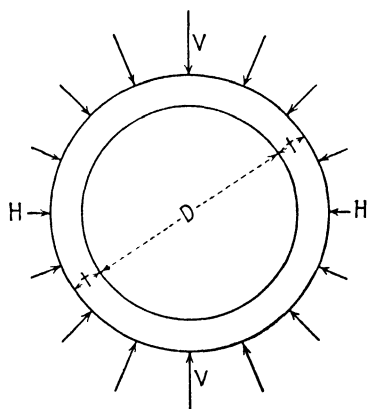

Fig. 23.—Unequal pressures on lining of soft-ground tunnel.

ency to squeeze the lining into an egg shape, with tension in the lining at certain points, Fig. 24. In the authors' opinion, failure cannot be caused by this unequal pressure. The passive resistance of the side walls is many times that of the active horizontal pressure H , and, unless voids were carelessly left between the lining and the soil, no movement, and thus no failure, can occur.

To find the actual ratio between the vertical and horizontal pressure for any particular type of soil, Robert Hennes ("Design

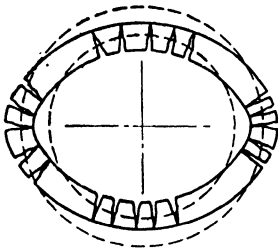

FIG. 24.—Failure of tunnel lining in soft ground. Squeezing to egg shape is resisted by passive resistance at sides.

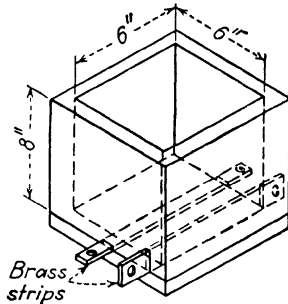

FIG. 25.—Simple device for finding the ratio between vertical and horizontal pressures in a sample of soil.

of Tunnels Sewers in Unstable Ground," *Civil Engineering*, April, 1932) used an open-top box, Fig. 25, about 6 in. square and 8 in. deep. At the bottom and side of this box were slots through which passed a 1-in. brass strip. These strips were protected by being placed in a sheath of very thin brass. The box was filled with a soil sample and set on a scale. A loose plunger was placed in the box, and a load was applied by means of a jack. After an interval to allow any water to be squeezed out of the box, the two brass strips were withdrawn from their sheaths, and the ratio of the force needed to withdraw these strips was determined as the ratio between H and V . Mr. Hennes and Dr. Terzaghi obtained the following ratios:

Pulverized quartz.....	0.42
Detroit sand.....	0.32
Detroit soft clay.....	0.67
Plastic yellow loam.....	0.70
Plastic blue clay.....	0.75

Passive pressure is the resistance which a soil offers to deformation by horizontal forces. The passive pressure is the inverse of the active pressure, or:

$$H_{\text{passive}} = \frac{1}{H_{\text{active}}}$$

or

$$H_{\text{passive}} = \frac{V}{K}$$

Thus if we assume a soil with a ratio of $k = 0.33$, the active pressure is one-third the vertical load, while the passive pressure is 3 times the vertical; so that the ratio between the active and passive pressures is, for this assumed soil, 1:9. Referring again to Fig. 23, the passive horizontal pressure is sufficient to resist any distortion of the lining.

REINFORCEMENT FOR TENSION

Concrete lining for tunnels is reinforced for tension by a single ring of bars placed as shown in Fig. 26, set close to the inner surface at the top and bottom and close to the outer surface at the spring lines. The bars must, of course, have lap splices at the invert construction joint. It may be necessary, if the arch bar is too long or too difficult to transport through the tunnel or lock, to have a lap joint at the crown of the tunnel. There must be longitudinal bars, generally $\frac{1}{2}$ -in. rods, to space and hold the arch steel.

The designer should make every effort to avoid the use of reinforcement, for it is a nuisance to the contractor and a headache to the inspector. Reinforcement is difficult to support before the form is placed, and, if it is left until after the form is set, there may not be room enough for a man to tie and space the steel properly. The concrete delivery pipe must be entered over the top of the crown steel, and the joints of the pipe will be continually hooking on the bars as it is withdrawn, displacing the steel.

Therefore, where possible, the concrete lining should be increased in thickness until the influence line falls within the

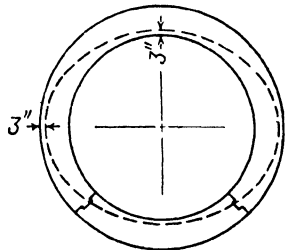

FIG. 26.—General location of reinforcing steel for tension in soft-ground tunnel lining.

middle third. A few inches more of concrete will always be cheaper than reinforcing.

WEEPERS AND WATER STOPS

In large open tunnels, such as railroad or vehicular tunnels, it is important to put weepers into the walls at frequent intervals to drain out the ground water. There have been occasions when small amounts of water, collecting behind a concrete lining, have built up enough hydrostatic pressure to rupture the concrete. The usual railroad practice is to install a pair of weepers at 30- or 40-ft. intervals along the tunnel, Fig. 27, just above the footing course.

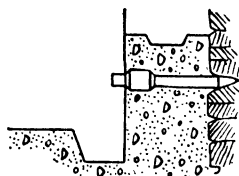

FIG. 27.—Vertical-wall tunnels require weepers at frequent intervals to relieve hydrostatic pressure against the outside of the lining.

Extra weepers are installed at any wet spots. If the water appears in the roof, corrugated iron is placed between the concrete and the rock to lead the water down to the weeper and to protect the fresh concrete. Where heavy flows of water are encountered, efforts should be made to stop or reduce the flow by grouting. Whenever possible, this grouting should be done before the lining is placed; because the grout pressure necessary to counterbalance the head may damage the lining in vertical wall tunnels.

In smaller circular or horseshoe-shaped tunnels, external pressure due to either hydrostatic or grout pressure can be resisted by the lining. Therefore, where water appears, a piece of steel pipe is set through the lining at the wet spot as a temporary weeper. This pipe has a threaded end. After the forms have been stripped and the lining has attained the necessary strength, grout is pumped through this pipe to seal the seam.

Underdrains of vitrified clay pipe are often used to relieve the tunnel permanently of external hydraulic pressure built up by ground water. These underdrains are also valuable during construction, as they simplify the problem of placing the invert concrete in the dry.

Copper water stops, Fig. 28, are rarely used between the transverse joints of the lining; dependence for watertightness is placed in the conventional tongue-and-groove keyway. As

tunnel temperature is about the same winter and summer, there is no need for contraction joints. Occasionally water stops are installed in the longitudinal joint between invert and arch. A steel plate $\frac{3}{8} \times 6$ in. is sometimes used as a water stop. A

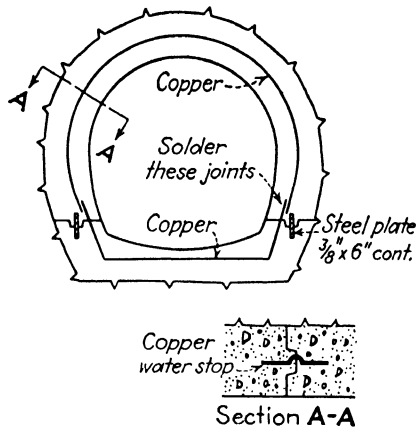

FIG. 28.—Water stops for preventing leakage into or from tunnel.

CURING TUNNEL CONCRETE

Usually the humidity in the tunnel atmosphere is high enough to provide sufficient moisture for curing the concrete lining. If more moisture is desired, it can be supplied by a water spray from a perforated pipe hung high on the arch. In arid climates tunnel concrete is often cured by spraying asphaltic or other curing compounds on the surface immediately after the forms are stripped.

METHODS OF PAYMENT

In the early days of tunneling, bids were usually taken on a unit price per lineal foot of tunnel completed. A few owners still take bids on that basis; for example, the Chicago subway tunnels are being driven on a price per lineal foot.

Present practice is to take bids on rock tunnel excavation on a unit price per cubic yard, quantity to be figured on the theoretical yardage within the *B* line, Fig. 29, regardless of whether the actual line of excavation falls within or without that line. The *A* line is the line within which no unexcavated rock, timbers or

steel supports may project. Thus the contractor has some leeway in mining and trimming and has a real incentive to control the shooting carefully. If the engineer decides to thicken the tunnel lining, the *B* line may be shifted outward to give the desired increase; and the *A* line is moved the same amount; the distance between the two is always the same. The contractor is paid the same unit price for this additional tunnel excavation; but if the tunnel was driven to the old *B* line, the trimming required to enlarge the tunnel to the new *B* line is paid for under an item of "tunnel enlargement."

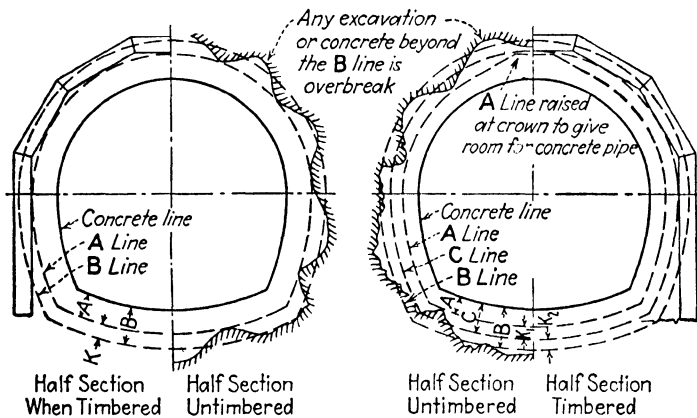

FIG. 29.—Specified trim and payment lines for tunnel excavation.

Some engineers use an additional line, the *C* line, lying between the *A* and the *B* lines. The definitions of these lines will explain their functions:

A Line: that line within which no solid rock is allowed to project.

C Line: that line within which no shattered rock or timbers may project.

B Line: payment line for excavation and concrete.

Thus the *A* line represents the minimum concrete thickness in solid untimbered rock, while the *C* line represents the minimum concrete in shattered rock or timbered sections where there is probably more need of support.

Steel or timber tunnel supports, as ordered or approved by the engineer, will be paid for on the unit per pound of steel or per thousand board feet of lumber.

Concrete lining is paid for at a price per cubic yard, the yardage being figured to the *B* line. Best practice is to pay the contractor for the cement required under a separate item.

Reinforcing steel is paid for on a unit price per pound, authorized laps being included.

Grout is paid for on the unit price per cubic foot (or cubic yard), the quantity being the total volume of cement and sand actually placed. Cement in grout will be paid for under the same item as cement in concrete. Grout pipes will be paid for under a unit bid for each pipe set. Connections to grout pipes (whether any grout is taken or not) are paid for as a separate item. Generally the contractor is allowed to dry-pack any spots of excessive overbreak with one-man stone provided he grouts around the stone at his own expense after the lining is placed.

ENGINEERING ORGANIZATION .

The organization of the engineering force for any tunnel job will be as follows:

Resident engineer, general supervision.

Chief inspector, in charge of inspection of mining, timbering, concrete mixing and placing.

Chief of party, in charge of the survey corps.

Office engineer, in charge of the office, including clerks and draftsmen, all records and the laboratory.

Just how elaborate the organization may be depends, of course, on the size of the job and the type of work. Untimbered rock tunnels need very little inspection until concreting starts. A visit twice a day from the chief of party to see that the foreman is following on line and that he has spads at convenient points may be all that is necessary. Shield-driven or timbered tunnels will generally require an inspector at all times on all shifts. When concreting starts, an inspector will be required for each placing unit as well as the mixing plant. On most jobs concreting is confined to the day shift.

An efficient survey group should not be less than four men: the recorder (chief of party), the instrument man and two intelligent rodmen. There must be a clerk for handling correspondence and reports. A draftsman will be required for plotting the records and reports as well as making occasional drawings of revised work.

ENGINEER'S OFFICE

The engineers should, by all means, have an office of their own. This should contain a room for the resident engineer's desk, a room for the clerk and draftsman and a locker for the storage of the survey equipment and office supplies. There should be a large "change" room with a ventilated steel locker for every man and a large table with benches where the men can eat their lunch. Adjoining this should be a shower bath with hot and cold water.

CHAPTER 3

TUNNEL SURVEYING

Accuracy in surveying is highly important in tunnel work. In other types of work the surveyor has a chance to check the surveys as work progresses; in tunneling there is no way to check the survey results until the bore is holed through—and then it is too late to make corrections. Therefore, in tunnel surveying it is essential that the lines and grades be checked and rechecked, not only by the original survey parties, but by others as well.

It is tradition in tunneling that the headings “meet on a dime”; actually, the discrepancy in both line and grade is often much less than the width of a dime. However, there are several cases in tunneling history where the headings failed to meet at all. In one such case, when two headings were past the supposed point of meeting, the engineers began rechecking the survey lines. Check after check failed to reveal any errors. Finally, an independent survey party was called in, and they found that the original transitman on one heading, in laying off a slight right-hand curve at the shaft, had set the angles off on the right side of the plate, thus producing a left-hand curve. This error prolonged threw the headings 50 ft. off line at point of supposed meeting. This incident shows the need for independent checking of the surveys.

DEGREE OF ACCURACY

Before starting out, the engineer should decide what degree of accuracy is required on the job. On sewer or railroad tunnels, 1 in. is considered acceptable for errors in line. Thus, knowing the distance between the shafts, the engineer can estimate what precautions he must take to keep within this limit.

The engineer should first of all appreciate that errors in chaining and grade are not generally cumulative. Such errors as do occur (unless the tape is incorrect or the level out of adjustment) are accidental and in general tend to eliminate each other. Errors in line, however, are almost always cumulative, and, as

the line is prolonged, the error is increased. This means that there need be no greater care taken when chaining or leveling in the tunnel than would be taken on similar work above ground; but precaution must be taken to eliminate all errors in the line, for any error, particularly in plumbing the shaft, will be multiplied many times.

This is illustrated in Fig. 30. Starting at the portal *A*, the line is run into a point *B*, where an angle α is turned and the line run to *C*. If there is an error in the chaining, then the point will be established at *B*₁. But the new line *B*₁*C*₁ will be parallel to the true line *BC*.

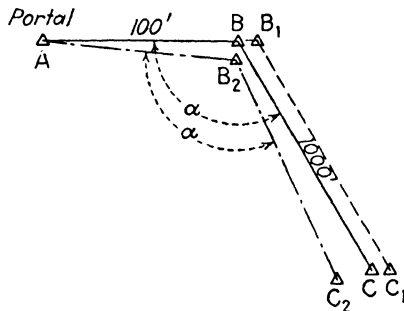

FIG. 30.—Effects of cumulative errors in surveying.

If an error is made in line when starting at the portal, it would give a point *B*₂. If the angle is then turned on this point, the new line *B*₂*C*₂ would constantly digress from the true line so much that at a distance of 1,000 ft. the error would be 11 times that at point *B*.

RUNNING THE GROUND LINE

In working in cities, the line is generally carried on an offset on the sidewalks. All intersections and turning points can be chiseled into the concrete as a permanent mark. All important points should, of course, be referenced to buildings or other permanent objects.

In laying the line in the open country, it will be necessary to drive stakes for the points. After the first line is run with ordinary methods, the engineer should return and resurvey until he is absolutely sure of his points.

The sights should not be too long. The instrument should be very carefully set up over the point and 20 to 40 points established

on the foresight. For a backsight, it will be well to hang the plumb bob from a tripod so that there will be no error due to a change in the bob support. In order to average this number of readings, a New York level rod should be clamped in a horizontal position over the foresight, Fig. 31. The target is set for each shot and the reading recorded. At the conclusion of 20 shots,

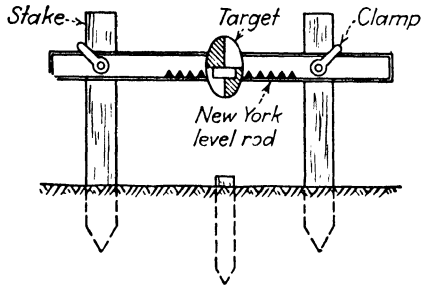

FIG. 31.—Ordinary level rod used to average a number of points for precise alignment.

10 direct and 10 with the telescope reversed, the readings are averaged; and if the engineer considers this satisfactory, the target is set on this average reading and the point plumbed down onto the stake.

After the line has been checked through, permanent monuments should be established which will not be disturbed by frost. These monuments are generally of concrete poured into a hole about 1 ft. square and 4 ft. deep. The exact point is pricked

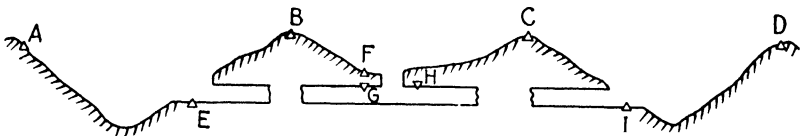

FIG. 32.—Location of permanent monuments.

into the head of a copper bolt embedded in the concrete. As a precaution, all monuments should be referenced.

Monuments should also be located for convenience of the tunnel surveyors. Figure 32 indicates the typical layouts for monuments on an assumed job. Monuments *A*, *B*, *C* and *D* are established at commanding points on the original line. Monuments *E* and *I* are established after the portals are turned. Monument *F* is established about 60 ft. from the shaft. These

monuments are the starting points for the tunnel survey corps. For their convenience, permanent targets or backsights are erected at *A*, *C* and *D* for the use of the instrument men. Such targets are generally 4x4 ft. and painted in contrasting colors. It is well to send a man around occasionally to inspect these targets to see that they have not shifted.

LEVELING AND CHAINING

Leveling is done by ordinary means, but the level should be carefully adjusted before starting the work. The sights should not be too long, and care must be taken that the distances to the foresight and the backsight are approximately equal.

Before starting a big job, the engineer should send a tape to the Bureau of Standards in Washington which will, for a small fee, check it against the master tape. This tape should then be kept in the office for checking the field tapes. The bureau will check the tape under any desired spacing of intermediate supports and with any desired tension. It is just as well to specify that the tape is to be supported only at the ends, for this will save a lot of work later in the field in spacing and leveling intermediate supports. The correct tension is applied with a spring balance.

For precise chaining on the surface or the tunnel, tripods fitted with aluminum caps may be used for the points. These bring the points high enough to keep the sag of the tape above the ground. The point is marked on the aluminum cap with a pencil.

A transit is used for lining in the tripod head; the transit can also be used for finding the grade of the heads.

Corrections must be made for: grade of tape, temperature and sag. Remember the rule: "If the tape is too long, the distance is too short."

TRIANGULATION

It is sometimes necessary to triangulate the line across streams. It is well to establish a base line on both sides of the river for checking the accuracy of the work. The angles must, of course, be very carefully read, and it is the general practice to "wind up" the angle a number of times. This total angle is then read and divided by the number of settings. The angle is then "unwound" the same number of times, and any difference at the conclusion of this operation is an error which must be distributed over the average.

DROPPING THE LINE DOWN SHAFTS

This is the most difficult problem in tunnel surveying. The method outlined is the standard one on long tunnels. On shorter tunnels, the engineer need not go to the refinements as outlined in this article.

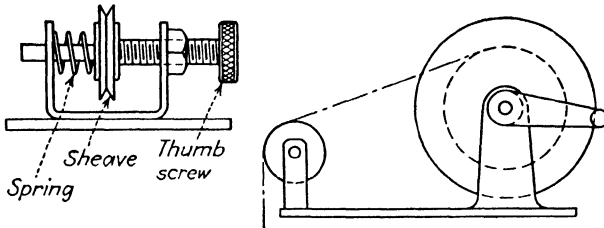

FIG. 33.—Reel for housing and handling plumb-bob wire in dropping survey line down shafts.

Plumb bobs for plumbing shafts weigh from 20 to 30 lb., and are generally made up of four angles, riveted or welded back to back. Number 8 piano wire is generally used for the plumb line. This is kept on a reel when not in use. Figure 33 shows such a reel and the adjusting screw for setting the wire to line. The reel is clamped to the collar timbers of the shaft, and the wire is lowered to the foot of the shaft by a light weight; then the heavy plumb bob is attached. There must, of course, be two of these plumb lines set as far apart as possible.

The transit is first set up on surface at the nearest monument and lined in on a permanent backsight. Then the two plumb wires are very carefully moved by means of the thumbscrew until they are on line. Several observers should do this, and they should all satisfy themselves that the instrument is centered on the monument and that wires are correct.

The party is then transferred to the foot of the shaft. The plumb bobs should be suspended in a pail of water or oil to dampen vibration. If there is much water falling down the shaft, loose-fitting covers should be laid over the pails. Just above the pail is an open box, Fig. 34, with slots top and bottom

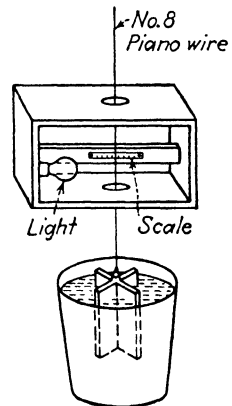

FIG. 34.—Plumb bob and light box at foot of shaft.

through which the wires pass. This box is often made out of a dynamite case from which the bottom has been removed. A scale is tacked to a cross piece in the box. This scale, of cardboard, is generally graduated in metric scale. Often a scale is placed on both sides of the cross piece, depending upon whether one or two transits are used to take the line from these bobs. Electric lights should be mounted within the box to illuminate the wire and scale. Of course, the boxes must be securely clamped to the shaft timbers to prevent any movement.

The instrument is set up about 20 ft. from the nearest wire, as shown in Fig. 35. This can be an ordinary transit which has

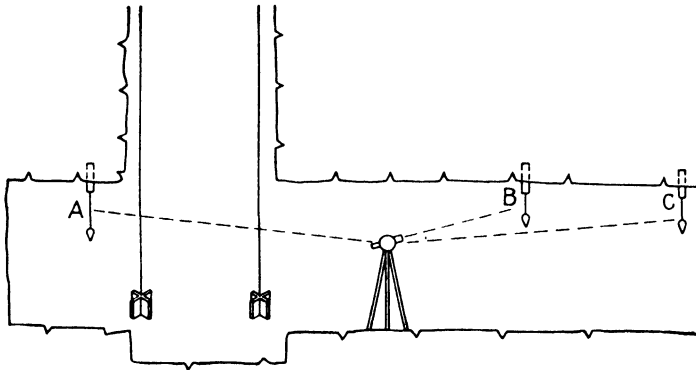

FIG. 35.—Transit set up at foot of shaft to transfer line from plumb bobs to roof spads.

been checked for adjustment, but the head must slide on the tripod. If there is a lateral adjuster, so much the better. The instrument is “joggled” into line as closely as possible by alternately setting on the near and far wire. When this is done, the plumb bobs are started swinging, one at a time. The instrument man then sights on the scale in the light box and records the reading of the extreme swing of the wire. There should be a series of about 20 readings taken, and by averaging these readings the theoretical center of the swing will be found.

After readings have been taken for both wires, the wires are pulled to one side and the instrument carefully “joggled” into line with both readings. The point A, Fig. 35, can then be set, the telescope plunged and points B and C set. The instrument is then reversed and again set to line by means of the scale readings and this point transferred to A, B and C, as before.

It is common practice to use a brass scale approximately 6 in. long, fastened to two wooden plugs in the roof by means of carriage bolts, Fig. 36. These scales are graduated to 0.01 ft. On the scale is a rider, or "skyhook," from which is suspended a plumb bob. A vernier on the rider enables readings to be taken to 0.001 ft. Readings should be transferred to the scales, with the instrument both direct and reversed, a number of times. The readings obtained are then averaged and the rider set on this average. This will give three points *A*, *B* and *C*, which are on the theoretical line.

On short tunnels the engineer may decide not to use brass scales for the roof. In this case two New York level rods should be used, set horizontally, one under points *B* and *C*. The target is set for each shot, and the average reading is used for setting a spad in the roof plugs *B* and *C*.

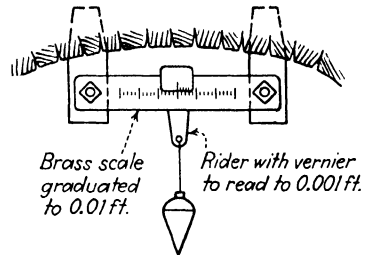

FIG. 36.—Brass scale and skyhook for averaging final line on roof of tunnel.

Great care must be taken that the plumb bobs and wires are hanging free. The wires must, of course, be as close to the shaft timbers as possible in order to secure the maximum base line, but there is always danger that they may be fouling some point along the shaft. As a partial check, it is always well to measure the distance between the wires at the top and at the bottom of the shaft. Another check on whether the wires are touching the sides of the shaft is to calculate the amplitude of vibration and check that against the observed swing.

Strong ventilating currents may affect the wires as will also vibration of machinery or the cage. Therefore, this work should be done on a Sunday when there is no interference from men or equipment.

Special Conditions.—There will be many conditions on the job which may complicate the surveying problems. Most common will be the location of locks, machinery or steel forms which may make it necessary to carry the line, the preliminary line at least, as an offset. This offset should be in a multiple of 6 in., and should be big enough so that it is obvious to all concerned that it is an offset.

The shafts through which lines must be dropped are sometimes to one side of the tunnel. This means that the plumb bobs in the shaft are set on a line at 90 deg. to the center line, and that, when the line is taken off the bobs at the foot of the shaft, an angle is turned to bring this line back on the axis of the tunnel.

TUNNEL LINE

The preliminary line is carried ahead on spads driven in plugged holes in the roof. A spad may be a screw eye, a bent nail or a horseshoe nail with a hole in it but is generally a hooked nail as shown in Fig. 37. Every 50 or 75 ft. the miners drill a hole in the roof, about 6 in. deep. A wood plug is then driven into the hole and sawed off about 1 in. from the rock. A spad is then set in this plug, to mark the primary alignment. Grade is then taken on the bottom of the plug (not the eye of the spad), Fig. 37.

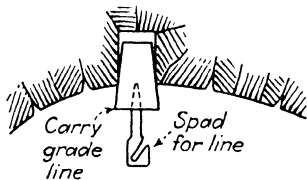

FIG. 37.—Spads and plugs for carrying line on tunnel roof.

When the final line is run, there may be some minor variations discovered between that and the primary line; but the primary line is allowed to stand "as is," and all drilling, trimming, and form-setting are done from the roof spads and their accompanying grades.

In soft-ground tunnels, the concrete is often placed each day. The concrete foreman, whenever requested, will set a small block of wood which, when the forms are stripped, can be used for carrying the spad. In timbered tunnels, of course, the spads are driven into the caps. They must be checked constantly, since timber in heavy ground may shift transversely.

Surveying from Portals.—Carrying line into the tunnel from a portal or adit requires no special equipment. As soon as the approach cut has been excavated, a permanent monument is put in the solid ground between the tracks. It is a good idea to keep the head of this monument 6 in. or more below the ground, protecting it by a wood box, as there will be much traffic over this point with consequent danger of disturbance.

A permanent target is rigged over the monument which is to be used as the backsight. As soon as the tunnel is well started, the line is thrown ahead and carried on spads in the roof.

Prolonging Line.—Lines are prolonged by setting the transit under the second point from the heading and double-centering a number of times. The backsight is checked on at least two points behind before plunging the telescope. For primary line, the points, direct and reversed, are marked on the plug with a pencil, generally four marks; these are averaged by eye and this



FIG. 38.—Transit station suspended from roof for prolonging line, Lincoln Tunnel, New York.

point used for driving the spad. Since the gun was set on the second point from the heading, the average line can be checked on the first point set on the previous prolonging.

The final line is set in similar manner, except that the telescope is plunged about 20 times and the points thrown on a brass scale or on a level rod, clamped horizontally.

The principle of accurate prolonging of line is to set the instrument in such a manner that there are at least two spads for

backsights and one for a foresight. At the conclusion of the operation the engineer will know that the last five points are all on the same line. There is always a chance that the spads may become bent.

Light Boxes.—Light boxes will be required behind the different plumb bobs to make them visible. These boxes can be made from empty dynamite cases. The inside of the box is painted white and two 100-watt lamps are fastened therein with about 75 ft. of lead wire for plugging in at the nearest light socket. The front of box is covered with tracing cloth, or in wet tunnels it may be necessary to use yellow slicker cloth. These boxes are hung behind the backsights.

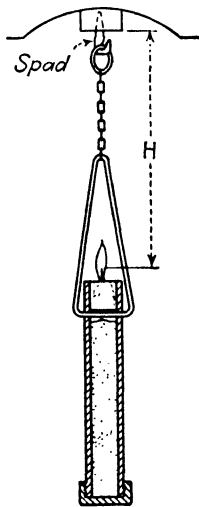

FIG. 39.—Plumb candles, hung from spads, for transferring preliminary line to the heading.

Of course, every member of the survey corps should carry a pocket flashlight. The flashlight should be of the cheaper, nonfocusing type, as these throw a duller light. The rodmen can shine the lights directly on the string, but it is more satisfactory to hold the light behind the string, with a piece of white paper tied over the lens to diffuse the light.

Precise surveying should be done at times when there is no traffic in the tunnel and when the air is clearest. This generally means Sunday, unless other arrangements can be made with the superintendent. The ventilating equipment should be run a few minutes to take out any lingering smoke from the last blast. In compressed-air jobs, it may be possible to raise the pressure a pound or two, which has a wonderful effect in clearing the air.

Plumb Candles.—Plumb candles are used by the foremen to give line and grade to the miners. The engineer will also find them useful for setting templates for checking trim and cross sections. As shown in Fig. 39, they consist of a 12-in. length of $\frac{3}{4}$ -in. pipe, capped at the bottom and filled about two-thirds full of mortar. There is a bail of heavy wire near the top to which a length of brass chain is attached. A short piece of candle is stuck in the pipe and lit. The pipe is then hung from a spad by means of the chain, which is adjusted to place the center of the

flame at the correct distance below the bottom of the plug to mark the axis of the tunnel. Special two-cell flashlights fitted with bail hooks are now available as tunnel light sights. They are more convenient and more accurate than plumb candles.

There must be, of course, two of these plumb candles. The foreman hangs them on the nearest spads. He then moves around the heading until the two flames coincide. This point is the axis of the tunnel and is marked on the heading with a daub of paint. From this point the measurements are taken for locating the drill holes.

Carrying Line through Locks.—The method of carrying line through the locks is shown in Fig. 40. In larger tunnels the emergency lock can be used, but only after making arrangements

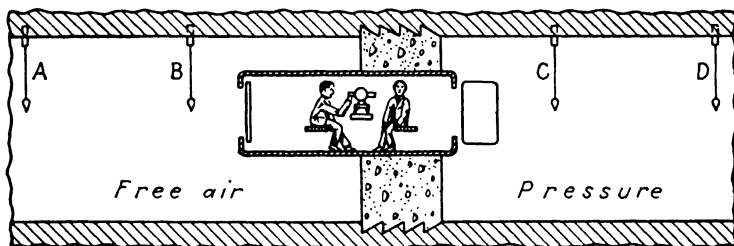

FIG. 40.—Method of carrying the survey line through an air lock, using two observers.

with the safety engineer. On smaller tunnels the muck lock must be used at a time when it will not interfere with operations.

Three boards are set across the lock, two as seats for the two instrument men and the middle one as a support for the transit. The transit is first set up under *A*, and, after sighting on point *B*, a pencil mark is thrown on the center board.

The transit is then removed from the tripod and attached to a trivet (a base about 6 in. high equipped with three leveling screws) and is set up on the board and carefully "joggled" into line with *A* and *B*. The second observer then closes the outside door and takes his seat. The first observer admits pressure and opens the inner door. The second observer then plunges the telescope and sets points *C* and *D* and perhaps a third point *E* on graduated roof scales. The gun is then reversed and reset on the external points *A* and *B*. The average readings on the scales *C*, *D* and *E* are used as the theoretical line within the tunnel.

Checking Line from Surface.—On long tunnels, every effort should be made to get an independent check from the surface. On shallow sewer tunnels, this can be done through the manholes. In deeper tunnels, it will be necessary to drive a casing and drill a hole. The casing may be 10 or 12 in., and a drilled hole should not be less than 8 in.

Great care must be taken in drilling that the hole is plumb, for of course the check is useless if the plumb wire touches the sides of the hole.

To check a line in a tunnel under compressed air requires considerable ingenuity. The casing can generally be driven ahead of the tunnel, blown out and capped. A small hole is drilled in the cap (in the center if the pipe is plumb, but to one side if there is some deviation) and the plumb bob hung in the pipe ready to be lowered when the miners uncover the lower end.

Where two tunnels are being driven parallel to each other, it is possible to get a cross check on the lines by making a crosscut or (in soft ground) by pushing a pipe across through which a tape may be pushed. If the two center lines are parallel, it will give every indication that the lines are correct.

Before "holing through" large tunnels, it is customary to break through a pilot drift while the headings are still 50 or 100 ft. apart. This will give the engineer a real check and an opportunity to compromise any minor errors.

TUNNEL GRADE

Grade is transferred from top to bottom in shallow shafts by hanging a tape vertically in the shaft with a weight equal to the specified tension attached to the bottom. Two levels are used, one at the top and one at the bottom, and simultaneous readings are taken. The tape should then be shifted vertically and another set of readings taken.

If the shaft is not too deep, two or three tapes may be clamped together, but there is always danger of slippage. In deep shafts, grade is chained down the elevator guides, the "forward" chainman riding on top of the cage and the "rear" chainman riding in a boatswain's chair tied to the cable.

Carrying the Grade.—Bench marks are established in the tunnel every 500 to 750 ft. The B.M. generally consists of a short piece of drill steel grouted in a hole drilled in the side wall.

Temporary grade is carried on the bottom of the wood plug in which the spad is driven. The distance from the plug to the axis should be painted on the wall adjacent to each spad. This should preferably be both inches and tenths so that it will be intelligible to the foreman as well as the engineer.

A word of caution: With an inverted rod, there may be some confusion as to which sights to add and which to subtract. This will be directly reversed from normal leveling. In some cities the datum, whether it be sea level or some local base, may be above the tunnel so that all grades in the tunnel are minus. To avoid this complication it is best to assume a datum an even 100 ft. below the local datum and carry all tunnel grades from this so they will be plus.

STATION

Station is dropped down the shaft on the same plumb lines which were used for line. By checking on both bob lines, top and bottom, there is a check on the accuracy of the work and also an assurance that the bob lines are not touching the shaft timbers.

Each spad is stationed as it is put in, and the station is painted on the wall. This serves to identify the spad. Precise chaining is generally not required in small tunnels unless there are curves which will require accurate location of the P.C. and P.T.

For shield-driven tunnels, stationing must be carried along both walls at the spring line. This is used for checking the "lead" of the shield and the squareness of the rings. The transit is set up under one of the forward points, and 90 deg. turned from the axis. In cast-iron lined tunnels, this is marked by a tack driven into a 2x4-in. piece wedged between the flanges of the rings. The wall station marks should be kept within 50 ft. of the shield for the convenience of the shield operators and inspectors.

CROSS-SECTIONING

Tunnels must be cross-sectioned twice; the first time for locating high points for trimming, the second time for the permanent records for calculating yardage, concrete and overbreak.

Cross-sectioning can be done by several methods. The usual procedure is to make a light framework of 1-in. lumber to a size, say, of exactly 6 in. less than the true cross section of the tunnel, carrying a cross board with a hole in it on the axis of the tunnel.

There should also be a plumb bob hanging on the frame to indicate when it is plumb after the axis has been located.

This frame is carried through the tunnel and at suspicious points is set up by holding a light behind the hole which marks the axis to give a mark for the levelman. A level can be used for both line and grade if it is fitted with a clamp so that after being set up the instrument can be sighted on a plumb bob ahead; or else a transit fitted with a level tube can be set up. The instruments should, if possible, be set up so that the H.I. corresponds

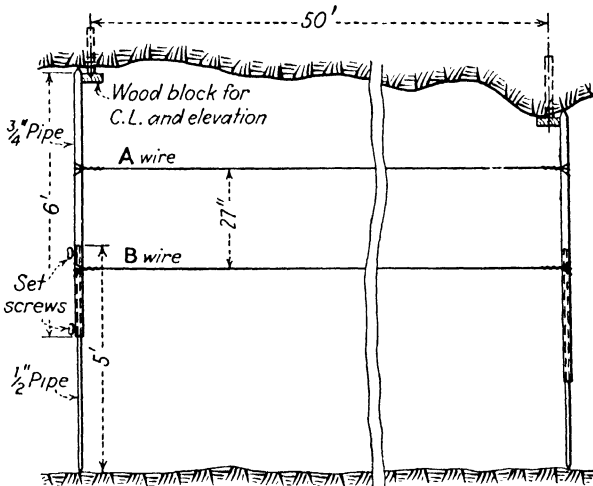

FIG. 41.—One method of checking a tunnel for trim and cross section. Checked from center line and grade blocks in roof, wires *A* and *B* are stretched on center line to predetermined grade between collapsible pipe supports. Proper clearances can be determined from wires to various points on tunnel perimeter; measurements by rule to correspond to clearance diagram will reveal tight spots.

with the axis of the tunnel. The foresight can be a plumb candle hanging from a spad with the flame on the axis of the tunnel.

A still more accurate way of checking for trim is to have two such frames made. They are then set up directly under the roof spads which were originally used to give line to the miners, approximately 50 to 100 ft. apart. Since both line and grade can be obtained from these roof spads, there is no need for an instrument. After the frames are set and plumbed, they are lightly clamped in position. Two assistants, one at each frame, then stretch a chalk line tightly from frame to frame. This is moved slowly from point to point around the circumference of

the frames while the engineers check with a rule the offset from the string to any high points of rock.

A third method is to use two telescoping rods made of $\frac{1}{2}$ -in. and $\frac{3}{4}$ -in. pipe, fitted with a setscrew. One of these is set up under one of two adjacent roof spads, Fig. 41, and clamped after being extended against the rock. A wire or chalk line is then stretched tightly between the rods, on the axis if it is a circular tunnel, or whatever other points from which measurements can be taken. Measurements are then made from these lines to

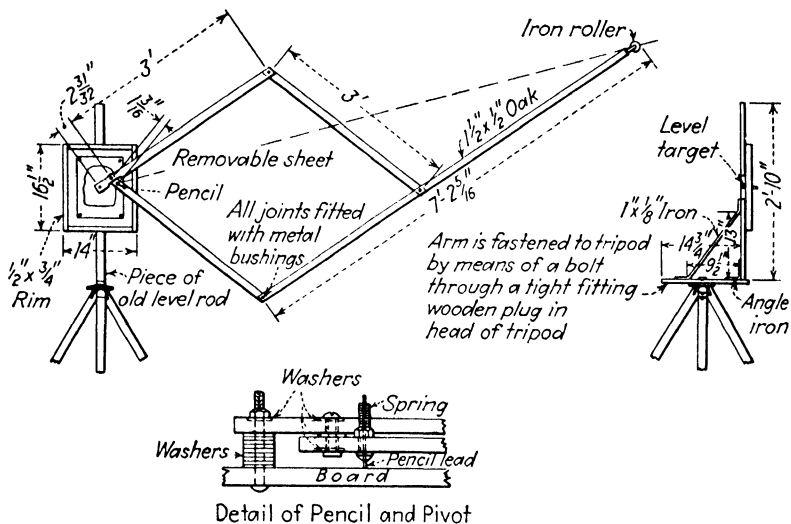

FIG. 42.—Pantograph for direct recording of cross section of a tunnel.

any high points of rock. Two men can check about 200 ft. of tunnel an hour using this system.

The high points of the rock are circled with paint for the guidance of the trimming gang.

Cross-sectioning for Record.—The tunnel must be accurately cross-sectioned at regular intervals. These intervals may be 50 or 25 ft., or even less, depending on the regularity of the breakage.

The simplest way is to take measurements from the forms just before concreting. When the forms are correctly set, it is a simple matter to get the dimensions from the form to the rock at desired intervals. There are two disadvantages to this scheme. The first is that in small tunnels there often is not

enough room for the inspector to get behind the forms to take the required measurements, and though there should be inspection doors in the forms, these doors will generally not be spaced close enough to reach all the points. The second objection is that, when the forms are set, the contractor is ready to concrete, and trouble is likely if the concrete gang must wait while an inspector takes measurements.

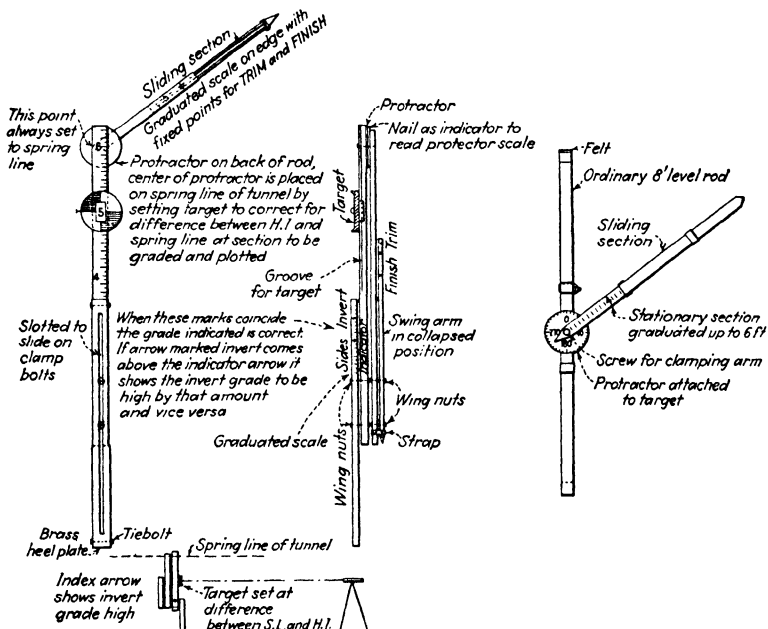

FIG. 43.—Two types of sunflowers for cross-sectioning a tunnel.

Pantographs and Sunflowers.—Pantographs can be made to record directly the cross section of the tunnel on paper. Such a one is shown on Fig. 42. The ratio is 30:1. The disadvantages of the pantograph are that, because of the large ratio, they must be made accurately and handled carefully to give good results. They become large and unwieldy for big tunnels. The paper becomes badly smeared in wet tunnels and is hardly fit to be used as a permanent record.

Sunflowers are generally used for cross-sectioning. They consist of a protractor painted on a board which is set up and plumbed on the axis of the tunnel. A measuring rod is then

swung around the circle and the angle and distance recorded for the desired points. These outfits are generally homemade, and there has been considerable ingenuity exhibited in developing sunflowers best fitted for the particular tunnel.

One such outfit is shown in Fig. 43. This consists of an ordinary telescoping level rod, with felt top and bottom to prevent

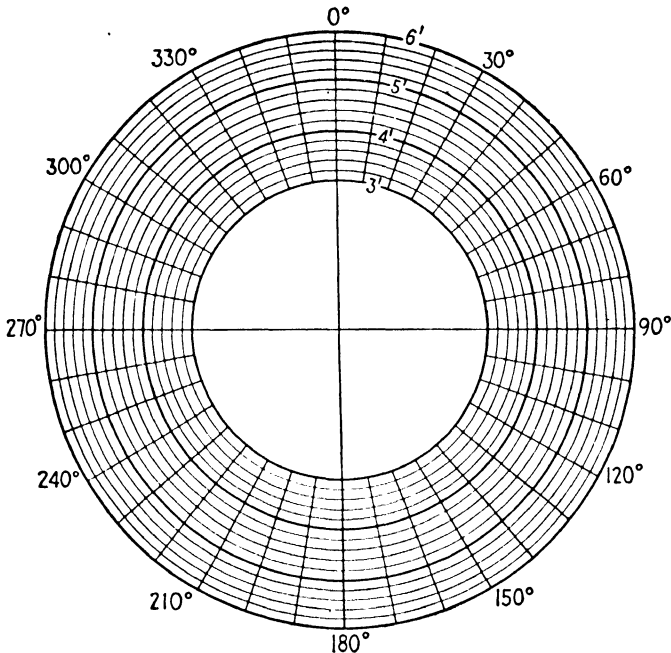

FIG. 44.—Special form for plotting sunflower readings. The area of the tunnel section can be obtained from these charts with a planimeter.

slipping, which is set up at intervals and expanded against the roof and clamped. The target has a large painted protractor attached to its face and a pivot point, to correspond with the axis of the tunnel, at its center. This target is run up or down and clamped on the axis of the tunnel. Around this pivot swings a graduated telescoping rod, from which the measurements can be read directly.

These recorded cross sections are later transferred onto special paper, Fig. 44, from which the area can be taken with a planimeter.

CURVES

Curves for tunnel work are always given as a *radius*, rather than *degree of curvature* as in railway work. The information

$$Y = R - \sqrt{R^2 - X^2}$$

$$\sin\left(\frac{1}{2}\alpha\right) = \frac{C}{2R}$$

$$X = C \cdot \cos\left(\frac{1}{2}\alpha\right)$$

$$Y = R - (R \cdot \cos \alpha)$$

$$C = 2R \cdot \sin\left(\frac{1}{2}\alpha\right)$$

$$Y = C \cdot \sin\left(\frac{1}{2}\alpha\right)$$

$$C = \sqrt{X^2 + Y^2}$$

$$\sin \alpha = \frac{X}{R}$$

$$\tan\left(\frac{1}{2}\alpha\right) = \frac{Y}{X}$$

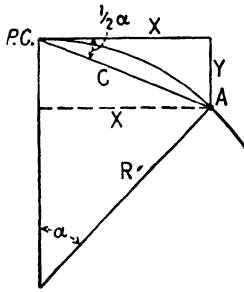

for each curve will be:

- R = radius, ft.
- Δ = central angle.
- L = true length on center line, ft.

As the laying out of curves for tunnel work is rather difficult, every effort should be made to avoid them in the original location. It will take careful engineering and intelligent supervision to keep the

FIG. 45.—Properties of a circular curve.

miners within 3 in. of true curve. Therefore it will be well, in timbered tunnels, to set the lining several inches wider than customary.

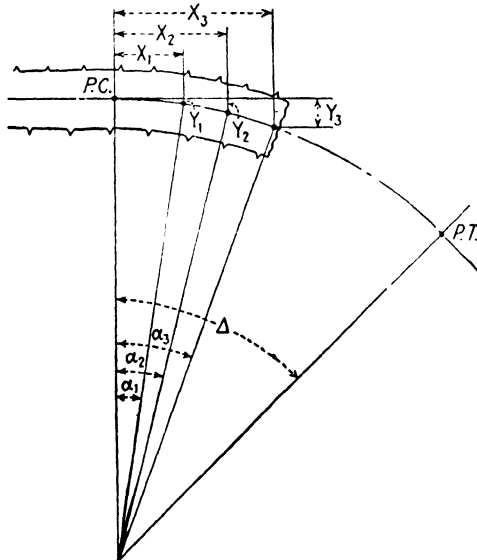

FIG. 46.—Laying out a curve by offsets from the tangent.

Before the *point of curvature* is reached, the engineer should decide what methods he will employ in giving line to the miners.

This method should be carefully explained to the foremen. The night inspectors should have tables prepared for them so that, knowing the tangent distance, they can find the offset to the curve. Meanwhile, the precise chaining should be carried up to within about 100 ft. of the heading and the preliminary line checked; thus when the P.C. is uncovered, the point can be located quickly and accurately.

Offsets from Tangents.—This is the simplest and best scheme for giving points to the miners. If the calculations have been made, an intelligent foreman can “shoot” the line ahead by means of plumb candles and locate the center point.

As shown in Fig. 46, coordinates are calculated for any point on the curve, where X is the *tangent distance* and Y is the *offset* from the tangent to the curve. These coordinates are found from these formulas:

$$\sin \alpha = \frac{X}{R}$$

$$Y = R - (R \times \cos \alpha)$$

Since there is a possibility of error in measuring the offset at truly right angles by eye, this scheme should not be used when the offset becomes too great, say, 4 ft. It is, of course, possible to figure the hypotenuse (or chord) for points, known X and Y , and thus more accurately spot in the curve; but it is general practice to use an instrument and lay off the angles.

To reduce the amount of the offset to be measured, it is sometimes desirable to establish another line, parallel to the tangent line, from which the offsets are measured, Fig. 47.

Chords and Deflection Angles.—Whenever the tunnel has progressed enough so offsets from the original tangent become too great for convenient measuring, it is necessary to establish a new point on the true center line by means of the instrument

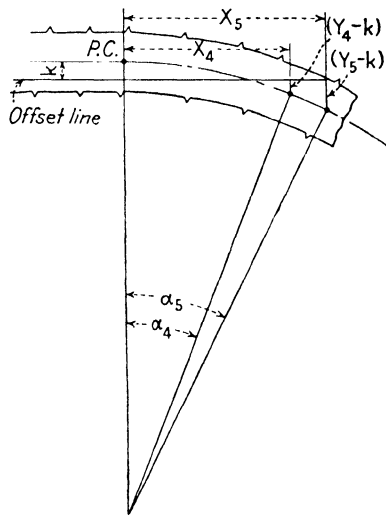

FIG. 47.—Laying out a curve by offsets from an offset line.

and to locate and mark a new tangent for that point from which the next group of offsets are measured.

As shown in Fig. 48, any chord length is taken, and the central angle subtended by the chord is calculated. The deflection angle for this point is then half the central angle.

$$\sin \frac{\alpha}{2} = \frac{C}{2R}$$

The instrument is set up at the P.C. and backsighted along the tangent. The angle $\alpha/2$, is then turned and the point *A* located

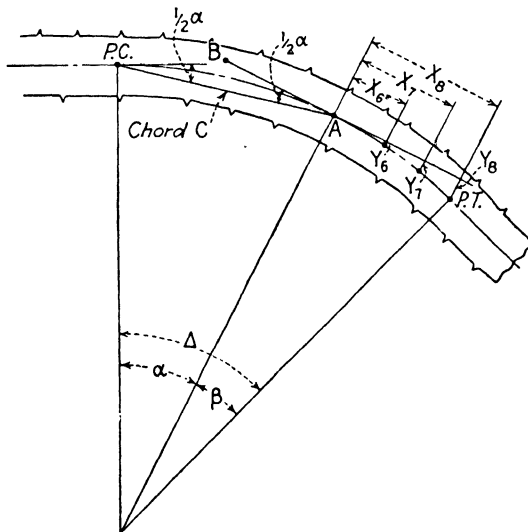

FIG. 48.—Establishing a new tangent for continuing the curve.

at a distance *C* from the P.C. The instrument is then moved to *A* and sighted on the P.C., a deflection angle of $\alpha/2$ is then turned which gives the tangent at point *A*. Another point *B* can then be set so that there are two points, *A* and *B*, on the new tangent from which the plumb candles may be hung for setting the next group of offset points.

Final Line on Curves.—After the tunnel has straightened off on the new tangent, the final line must be accurately run to establish the P.T. and check the new tangent. As in Fig. 49, we can suppose that point *A*, with an angle α , was established on the preliminary line with a spad marking the point. A brass graduated scale is now set in the roof at point *A* and the chord

distance from the P.C. to point A precisely chained. With this precise distance, the angle is again calculated and, with the transit set up on the P.C., the angle $\alpha/2$ is turned 20 or 30 times and the average used for setting the rider on the scale. The chord distance from this average setting to the P.C. should then be checked, for, if the face of the scale was not square with the chord, moving the bob might have introduced a slight error.

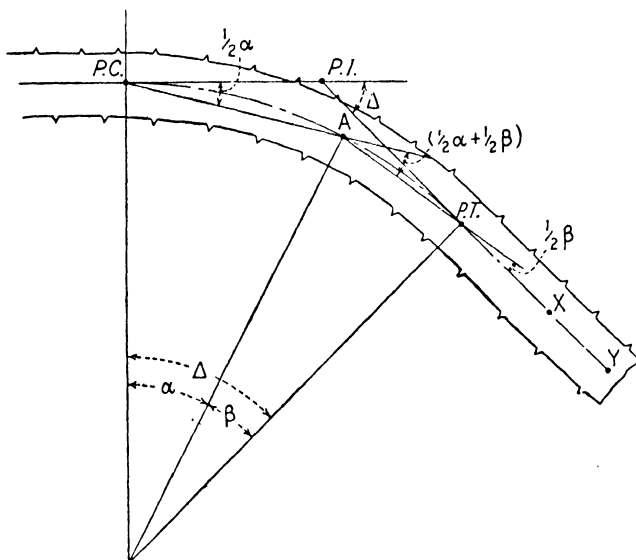

FIG. 49.—Establishing the P.T. for prolonging the new tangent.

The transit is then moved to point A. Angle β is, of course, Δ minus α . Knowing this angle, it is easy to calculate the chord distance from A to the P.T. A brass scale is then set up at the P.T., and the chord distance checked. With the instrument at A and backsighted on the P.C., the angle $(\alpha/2) + (\beta/2)$ is turned a number of times and the mean calculated to be used as the setting for the bob at the P.T. The transit is then moved to the P.T. and, with point A as the backsight, the angle $\beta/2$ is then turned a number of times and set on a brass scale along the new tangent. The average of these readings is the new tangent.

CHAPTER 4

SAFETY IN TUNNELING

Tunneling is inherently a hazardous operation. Cramped working space in the heading, wet and slippery footing, artificial lighting—all too often inadequate—unseen weaknesses in rock in the roof, handling of explosives, loading and hauling muck, coupling cars and operating trains, hoisting and muck disposal, and the bustle of activity aboveground around the shops and machinery houses are all conducive to accidents. Yet, to a great extent, the accident rate on a tunnel job is just about what the construction organization makes it. True, some accidents in tunneling are beyond all prevention, but by far the largest share are due to pure carelessness and thoughtlessness and are therefore preventable. The will and determination to operate the job safely must come from the top of the organization, and safety must be taught, preached and carried out every minute by every man on the force from top to bottom if the accident toll is to be kept at a minimum.

Set up safety rules and regulations at the start—and make them stick. Permitted violation of any safety rule—no matter how slight—nullifies the whole safety program. Regular safety meetings of the entire supervisory staff and occasional meetings of the whole working force are the best means of starting and carrying on a good safety program. In all industrial safety work, the foreman is recognized as the key to safe operation, as he is in direct contact with the men and yet carries authority from the top of the organization. Instill safety in the minds of the foremen and gang bosses, and your job is well started. However, your desire for safety must be sincere—mere passing the buck to those below you in the organization will not do.

Safety work is, of course, well worth while from a humanitarian point of view. Yet, if you want to be mercenary about it, accidents are mighty expensive. A man is the most expensive piece of equipment you have on the job. Ruin him, and you pay

dearly for it. Then, too, accidents in tunneling always cause expensive delays and tie-ups. It is far cheaper to prevent them.

Safety in tunnel work is merely the application of common sense rules of procedure. If you want a safety guide or code to help you operate safely, the National Safety Council, Inc., 20 N. Wacker Drive, Chicago, Ill., has prepared a bulletin *Safety and Health in Tunnel and Caisson Work*. Also, the Associated General Contractors of America, Munsey Building, Washington, D.C., has prepared a safety manual for general construction operations that will be of help. Through meetings, signs, posters, and announcements and individual instruction, let your men know about your safety program. Impress upon them that you want and intend to operate the job with no preventable accidents, that you regard safety as not a mere word but as a conduct of procedure.

GOOD HOUSEKEEPING

Safety on the job starts with safe working conditions. This means "good housekeeping" and safe equipment and tools. First, a word about tools and equipment. Not only for safety, but for efficiency, they must be kept in first-class shape. Failure or breakdown of equipment on a tunnel job means expensive delays and disruption of schedules and, where hoisting or haulage equipment is involved, may mean a serious accident. Moving parts of equipment should, of course, be well guarded. Keep persons having no business in shops, compressor plants and power houses, out of them. Use of worn, broken or inadequate tools should not be tolerated. They are accident breeders and a sheer waste of expensive labor.

Worn and broken sledges, wrenches and hand shovels are a prolific source of accidents. Always look to the air-hose connections, for the gaskets wear out and the metal parts become loose, resulting in accidental disconnection. An air hose thrashing around under 100-lb. pressure "packs an awful wallop." Both equipment and tools can be properly maintained by regular inspection by competent persons.

Good housekeeping means a clean job—and a clean job is the first big step toward safe and successful operation. Keep all trash, debris and refuse cleaned up, both on the surface and underground, for safety's sake and for more efficient operation.

On the surface, this applies especially to haulage areas and the immediate vicinity of the shaft or portal. It is much easier—and safer—for your men to work around the shops and yards if these areas are free of trash and if materials and supplies are kept neatly piled out of the way instead of strewn all around for the workmen to stumble over.

Although good housekeeping is sensible and desirable for outside areas, it is doubly so underground, where working space is

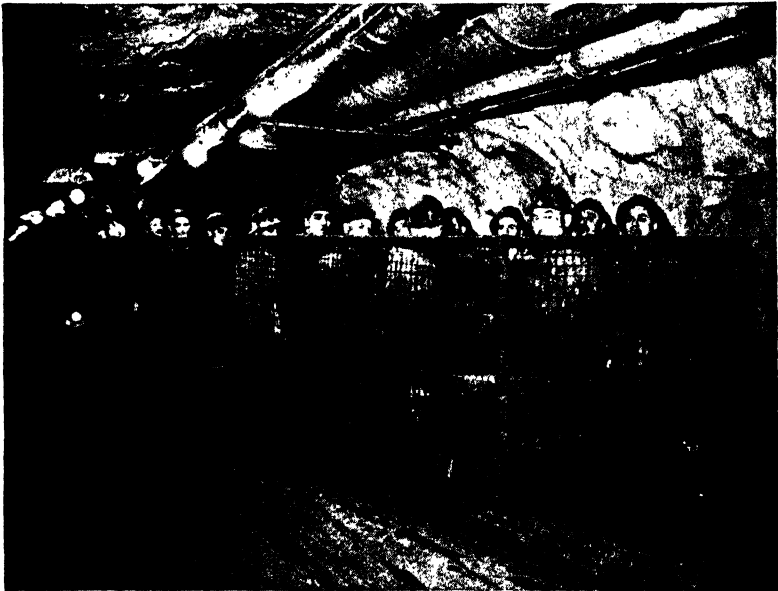

FIG. 50.—Safety car for transporting men, Colorado River Aqueduct tunnels. (Metropolitan Water District Photograph.)

cramped, lighting is apt to be poor and a great amount of activity takes place in small areas. Unless the tunnel is a large one with plenty of room well outside the haulageway, pipe, ties and rail should not be stored underground, but kept on the surface and brought in as needed. This also applies to timber and steel ground supports, although, of course, it is necessary to have a small supply near the face for emergencies. In such cases, keep the material piled up, as close to the wall as possible, and provide extra lighting at this point so the obstructing materials can readily be seen.

All useless pipe, bent rail, powder boxes, scrap lumber and timber, tools and equipment not in actual use should be removed from the tunnel. This also applies to muck spilled from cars or scaled down back of the face. It is not hard to keep a tunnel clean if these items are removed as soon as they appear—and it is the job of the shift boss to see that they are—but, if neglected even for a few days, they soon result in a messy, hazardous condition that saps the efficiency of the operations and definitely slows up progress. Furthermore, a clean tunnel has a stimulating psychological effect on both workmen and supervising force.

There is a lot of walking done in the tunnel; so the smart operator provides a safe and adequate walkway for the safety and convenience of the crew. Remember that often the workmen must carry heavy timbers, pipe and other items within the tunnel—hard physical work—and that they should not be subjected to slippery, hazardous and uncertain footing. In small tunnels, a walkway of two 8-in. planks can be spiked to the ties between the rails. Even a pathway of muck spread between the ties is better than no walkway at all. If space permits, as in large tunnels, it is far better to place the walkway to the side of the track, thus reducing the hazard of men being struck by dinkys or cars. This walkway can be either plank or muck; the main point is to have it smooth and continuous. Whatever the type of walkway may be or where it is located, it will have to be maintained. All too often in tunnels, planks in the walkway become broken or are removed and not replaced or water holes appear in the muck paths and are not filled in. Such conditions are extremely hazardous, especially if the lighting is poor—as it is apt to be on the jobs where walkways are allowed to deteriorate. Again, water is often allowed to stand in pools in the tunnel floor, obscuring walking conditions. Proper ditching and drainage (as described in Chap. 10) will remove this hazard to secure footing.

The trouble and expense of building and maintaining safe, adequate walkways will be repaid many times over the life of the job in smoother operations and in reduction of accidents. Do not expect the men to work fast or well if they have to stumble over scraps of rail, timber, slippery and submerged ties and the occasional rock that falls from the muck cars.

Keep the job well lighted, for poor lighting and accidents go hand in hand. The amount of lighting required for safe and

efficient operation depends, of course, on the size of tunnel, color of rock and other conditions. Arrangement of lighting facilities is discussed in Chap. 11 and will not be repeated here. However, remember that exceptionally good lighting is required at the face and at any other point where work is in progress, at equipment installations, such as pumps, fans and transformers, at track switches and sidings, and at underground material and supply storage points. Any obstruction in the tunnel should be well lighted. Make sure that all light and power lines are properly installed and all connections well insulated. Most tunnels are wet or damp, providing a perfect ground for short circuits. Electrocutions in tunnels are all too frequent. It is essential that steel forms and drill carriages be properly grounded.

Field telephones, located at the face, bottom of shaft and at several points in between, all connected with the various outside plants and field headquarters, are an important safety measure. The quick reporting of accidents or calling attention to hazardous conditions to the proper authority may often minimize the damage or prevent possible further trouble.

SAFE MUCKING AND HAULAGE

Mechanical loading of muck and haulage operations in tunneling are always dangerous, but with a little care their hazard can be greatly reduced. Practically all mucking today is by mechanical loaders, with either belt or bucket dumping into the cars. See that the loading zone is well lighted and keep the workmen away from the vicinity of the cars being loaded, for frequently a big rock rolls off the car. A competent man should be detailed to watch the loading of the cars, to see that they are loaded evenly and the muck not piled dangerously high above the sides. He should have authority to stop the mucking operations for a moment—a police whistle signal is effective—to adjust the position of a rock threatening to roll off the load. Inspection of the loaded cars, before they start the trip to shaft or portal, is well worth while. It takes only a moment to trim the load for safe haulage, and many an accident can be prevented if the cars are so trimmed that their contents cannot possibly jar off.

Cars carrying pipe, rail, steel and timbers must be properly loaded for safe passage through the tunnel. Tunnel tracks are usually rough; so overloading or careless loading of supply cars

is to be avoided. By all means keep the load within the side limits of the car. Loads projecting over the side are dangerous to men working in the tunnel. If wide loads must be transported, special care is necessary in the operation of the train, with ample warning to workmen along the track, to insure a safe journey.

Next to falling rock, train operation is the most prolific source of accidents in tunnel work. Generally the cars and locomotives are coupled with the crude link-and-pin system. A moment of carelessness in coupling the cars or handling the locomotive while coupling, means smashed fingers or crushed bodies. Many such accidents are caused by improper signaling. Make sure that your train crews understand their signals. Police whistle or flashlight signals are better than arm signals, especially where

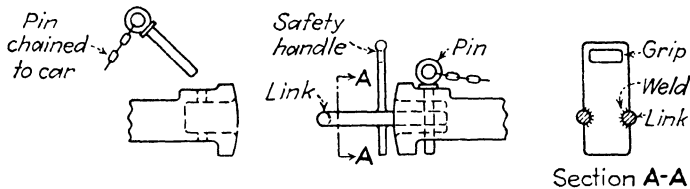

FIG. 51.—Safety car-coupling link that will prevent smashed fingers.

visibility is poor because of fog or dim lighting. Automatic couplers—patterned after those in railroad use—are being installed on some of the sections of the Delaware Aqueduct in New York. These save many a hand and speed up train operation.

Switches can be made easy-throwing, with the throw arm in easy position to reach and yet not be a stumbling block—they can be made so with a little care and thought, but all too often they are half buried in muck or stick up on a timber where they are a hazard to walking. Planking around frogs and guardrails will save many a stumble and bad fall.

Trains should be operated with care and at a speed under control of the operator at all times. The operator should remember that men are working and walking around the track all the time—men whose attention is devoted to things other than the approaching train and whose hearing may be hampered by local noises, such as pumps or drills. The locomotive should be equipped with headlights—kept clean—and a warning horn or bell. If the locomotive is pushing a string of cars, a man should

ride the front end, equipped with a whistle and flashlight for warning men along the track and for signaling the locomotive operator.

SHAFT OPERATION

The use of shafts on a tunnel job introduces another hazard. Safety precautions in shaft sinking will be discussed in Chap. 5, so only shaft operations will be considered here.

The first place to start in safe shaft operation is in the equipment itself. Hoists, sheaves, headframes and cables must be adequate not only for regular loads, but for possible overloads and shocks due to sudden stops. At the surface, the shaft opening should be fully protected to prevent both men and materials from falling accidentally into the hole. Gates wired to prevent movement of the cage when the gate is open are desirable both on top and at the shaft bottom. The cage itself should be protected by a sloping roof for the safety of the men riding it.

Safe operation demands that the hoist be equipped with limit switches and some device to indicate to the operator when the cage approaches the top or bottom limit. In case of more than one level of operation—such as the surface level and an overhead muck dumping arrangement—the indicator should show the cage position at both levels. Automatic brakes in case of power failure or overspeed are essential to safe hoist operation.

Make the signal system adequate and foolproof. The signaling system should be interlocked—that is, so the man at the surface cannot give the signal to move the cage until all is clear below, and vice versa. The signals should also indicate when men are aboard. Incidentally, safety rules demand that no men be allowed to ride the cage with materials. Equip the cage with chains or other handholds for men; the cage itself should have barriers of some kind on the open ends to prevent anyone from stepping or falling off during the cage travel.

Prominent among shaft operation accidents—and these are wholly inexcusable—are cases where the cage is moved while a car or other load is being taken off or put on. A serious accident occurred in the Baltimore water tunnel recently when the signal to hoist the cage carrying a muck car was given before the car was uncoupled from the rest of the train. The car jammed against the roof of the tunnel, and the strain on the hoisting

equipment pulled down the headframe. Where cars are hoisted, provisions should be made for blocking them on the cage.

Every shaft should be equipped with a safety ladder or stairway for emergency exit and access. For safe use of these emergency devices, sufficient lights should be installed in the shaft to enable the men to use the ladders.

ROCK FALLS

More accidents in tunneling result from rock falls than from any other cause. Except for premature explosions, rock falls

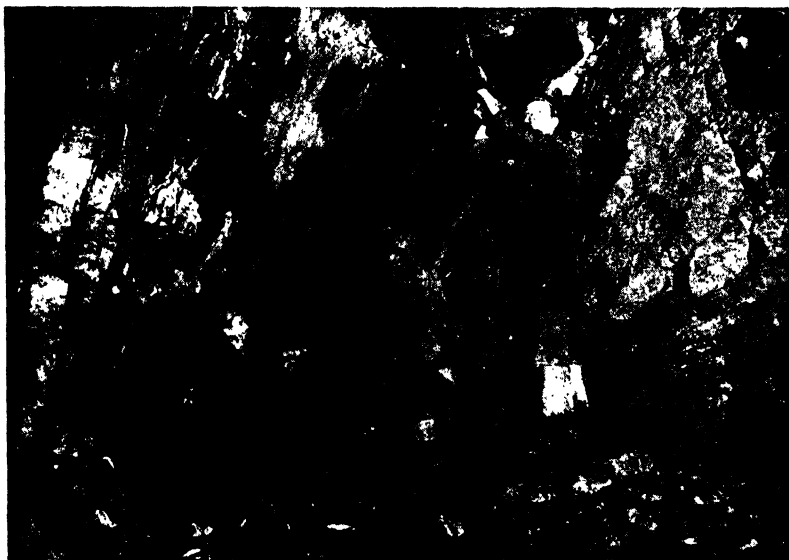

FIG. 52.—Scaling down walls and roof to remove loose rock after a blast.

are the most serious of all tunnel accidents, for they almost always involve one or more fatalities.

Careful and frequent inspection of walls and roof, thorough scaling of loose rock and timbering of all weak spots are the best preventives of rock falls. It is especially important to inspect and scale down the freshly blasted heading and face after each shot before mucking is started; the inspection should include the old heading in the vicinity of the last blast, for the near-by rock might have become shattered or loosened by the blast. Inspection should be visual, to look for seams and planes of weakness,

and by a hand hammer. Any spot that sounds hollow under the hammer warrants investigation.

Weekly inspection of untimbered sections of the tunnel from a traveling scaling platform is good practice, for weak spots might have been loosened by the succession of blasts. Isolated timbered sections should also be inspected regularly to make sure the weakness of the formation has not spread beyond the timbering. Support or remove weak or loosened rock as soon as it is discovered—do not wait until the end of the shift, for the rock may not wait that long to break loose. All timbering should be checked occasionally to make sure it is not under undue stress.

Be sure that every scaling platform—in fact, every jumbo or drill carriage—is equipped with safe ladders. Thoughtless supervisors seem to expect the men to climb up and down slippery framework without falling, but common-sense safety rules call for ladders.

EXPLOSIVES

Safety in handling and use of explosives is discussed in Chap. 20, so will not be repeated here. However, it is worth while to state that premature explosions are the most terrible of all tunnel accidents, and yet are, with rare exceptions, preventable. Too much importance cannot be placed on the need for care in use of explosives.

PERSONAL PROTECTION

Safety clothing and apparatus, developed in fairly recent times, have done much to reduce accidents. Foremost is the "hard-boiled" hat of stiff fabric or metal. Everyone—workers, engineers, supervisors and visitors in and around every tunnel and shaft job, no matter what type or size, should by all means wear one of these hats. The hats are not only invaluable in protecting the head and neck from falling rock and other objects, but also as a protection from head bumps against braces, timbers and all the other obstructions found in tunneling.

In wet tunnel work, the men are entitled to boots and slickers. Use a little thought in ordering boots of correct size, for nothing slows a workman as much as a pair of ill-fitting boots. Goggles should be provided for drill runners and their helpers—and their use insisted upon—when drilling up holes and drilling concrete from any position. Many smart tunnel contractors are reducing

toe and foot injuries substantially by furnishing safety shoes to the men. Shoes are usually sold at cost to the men, but other items of safety clothing are furnished without cost. An adequate checking system will make losses negligible.

The workmen are entitled to clean, sanitary, heated and ventilated change houses, equipped with a locker for each man, shower baths, washing and sanitary facilities. In many localities safety laws or union regulations demand such facilities.

FIRE PROTECTION

Ample fire protection must be provided for all surface plant. This includes fire hydrants and hose for general protection and



FIG. 53.—Rescue car and crew, Colorado River Aqueduct tunnels. (*Metropolitan Water District Photograph.*)

extinguishers for specific protection. Use of fireproof material, such as sheet metal, and steel framing, is recommended for plant and office buildings. Special protection is needed around the shaft, in the hoist house, compressor and power plants, where a fire would endanger the safety of men working below. It is also wise to spot a fire extinguisher within the tunnel wherever there is the slightest possibility of a fire, such as around pump housings and shaft bottom timbering.

COMPRESSED AIR

There are additional safety rules to be observed in compressed-air caissons and tunnel work. First is medical examination of

all men and periodic examination of regular workers to make sure they are physically fit for the rigors of compressed air.

Each compressed-air worker should be furnished with a metal tag, to be worn around the neck, stating that he is a compressed air worker and, if found ill, should be rushed to the nearest medical air lock (address given). Compressed-air illness, commonly known as the "bends" is likely to be mistaken for drunkenness, and the victim might be sent to the police station, with serious consequences because of the delay. Every air job must be equipped with a medical lock for treatment of the bends—recompression is the only means of relief and treatment. The medical lock is divided into two chambers, each large enough to accommodate a bunk and still permit the doors to be operated, and is equipped to manipulate the air pressure in both locks both from the inside and outside. Telephone communication should be provided between the inside and outside of each chamber.

Proper regard to length of shift under various pressures and time of decompression will do much to prevent the bends. Shift hours as stipulated by the New York compressed-air code, considered as standard throughout the world, are given in Chap. 16. In locking men into the tunnel, it is a good rule to shut off the intake valve after each 5-lb. raise in pressure to see if anyone is in distress or is "blocked."

Because the life of every man in a compressed-air tunnel depends upon the air, special attention is given to the selection and installation of equipment. Where the compressors are electrically driven, two or more independent power supplies should be brought in as a safety precaution in case of failure of one of the circuits. Most contractors also install a diesel or gasoline-driven compressor as a stand-by in case of complete failure of electric power. The care in selection and installation of equipment also applies to air receivers, locks, piping, valves, lighting, telephones and hoisting rigs.

Following a disastrous fire in a Chicago compressed-air sewer tunnel several years ago, in which seven men, including three city firemen, lost their lives, the city now prohibits the use of timber for lining compressed-air tunnels and shafts and also requires posting at the surface of a simple diagram showing the underground workings, location of tracks, locks, etc. This might be a smart thing to do on all tunnels where outside emer-

gency crews, such as police and firemen, might participate in the case of disaster. Chicago also requires a supply of gas masks for rescue crews to be kept at the surface and further requires "self-rescuing" gas masks to be kept in the tunnel, near the working zone, for the use of the tunnel crew.

Extreme care must be taken in compressed-air tunnels to prevent fire. In the excess oxygen present, fires burn much more fiercely than in free air, and even damp, heavy timbers burn readily. "No smoking" is a positive requirement, and special attention must be paid to electrical installations to prevent short circuits.



FIG. 54.—Rescue squad with special gas equipment, Hetch Hetchy Tunnel, San Francisco.

FIRST AID AND MEDICAL ATTENTION

A first-aid station, adequately equipped, should be established on every tunnel job. Larger projects will warrant a nurse or even a doctor in constant attendance. Stretchers and other equipment necessary to remove injured men from the tunnel should be placed at every shaft and portal. If the shaft cage is too small to accommodate a patient in prone position, vertical stretchers that hold the injured person in standing position should be supplied.

When the job is too small for nurse or doctor attendance, satisfactory arrangements should be made for quick medical and ambulance service. Procedure in case of accident should be posted prominently around the job, both on top and below.

Instruct all foremen, superintendents and shift bosses as to what to do and whom to call when accidents occur. Insist that every accident be reported to proper authorities and that every injury, no matter how seemingly slight or trivial, receive first aid.

PUBLIC SAFETY

Shaft sinking and tunneling operations, like all construction, fascinate the public. Yet, for their own safety and the protection of the contractor against damage suits, unauthorized persons must be kept away from the work. Authorized visitors should be equipped with safety hats and be accompanied by a guide competent to keep the visitor out of dangerous situations. Many contractors require visitors to sign a claim release before entering the work. This has a psychological effect but rarely stands up in court, for there have been too many legal decisions to the effect that a person cannot sign away certain rights.

Contractors and owners in other lines of construction are coming to realize the value of public good will created by affording observation facilities for the interested public. Some arrangement for public view of surface operations, at least, could easily be worked out on many tunnel jobs.

Public safety applies to operations off the site, too, such as trucking. Then, too, the public has some rights in the way of noise and other inconveniences. In populated areas, muffling of compressors, lining of muck bins with wood or other sound-absorbing material, use of fiber gears on hoists will reduce noise and thus prevent trouble with the neighbors. In some residential areas, blasting during the late night and early morning hours has been prohibited by local authorities.

COMPENSATION

Workmen's compensation for accidents is no different in tunneling than in any other kinds of construction. In general, the rates are high as compared with most classifications. Contractors will do well to remember, however, that they will receive a credit and thus lower premiums if they can establish a record of safe operation.

Compensation for occupational diseases is a new workmen's benefit that is being adopted in many states. In tunneling, this applies chiefly to silicosis, a lung disease caused by *long* exposure to siliceous rock dust. When occupational disease compensation

insurance has been taken out, the insurance carriers will probably demand certain precautions (some also required by law—see Chap. 9 on Ventilation and Dust Control), such as X-raying of all men before hiring to determine previous incidence of silicosis, as the compensation laws usually state that the contractor for whom a man is working, when he is found to have silicosis, is responsible.

Tunnel contractors working in states not having occupational disease compensation laws are subject to civil suit in silicosis



FIG. 55.—Safety lamp (extreme left) kept burning in heading of Chicago sewer tunnel to determine presence of harmful or explosive gas. Lamp goes out when normal oxygen content of air is disturbed.

cases. Rinchart & Dennis Co., contractor on the famous Hawk's Nest Tunnel in West Virginia several years ago, was sued by some 600 former employees after the job was finished. This case was a vicious racket, but the contractor was put to a great expense to fight the claims. What can a contractor do to guard against such suits? X-ray examination of all workmen at start of their employ and barring those who show inception of silicosis is a possible precautionary measure. However, it has the disadvantage of making all employees silicosis conscious, with possible stirring up of trouble. Equipping the job with adequate ventilation, as described in Chap. 9, and careful control of the dust to bring the concentration down to safe hygienic limits is the best precaution against silicosis.

CHAPTER 5

SHAFT SINKING

The size of shaft, when sunk for construction purposes only, will be governed by the amount of muck to be hoisted and the size of cage or skip. The smallest muck car is about 4x7 ft. and, if hoisted to the surface, will require a cage platform area of

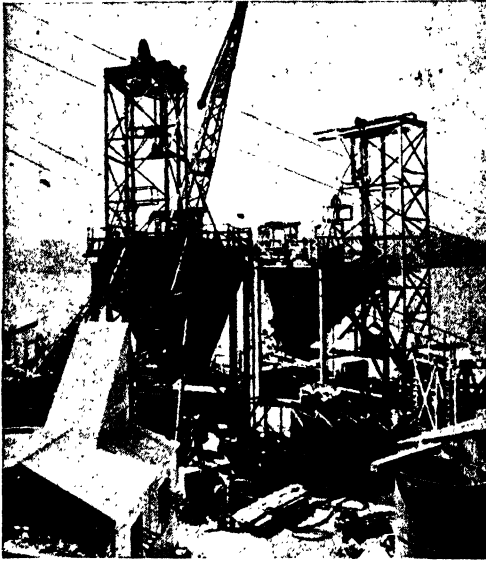

FIG. 56.—Headframes for shaft sinking at a double-shaft location, Delaware River Aqueduct. The steam derrick was used to start the shafts and was kept as a standby to remove the men from the holes in case of failure of the electric power on the hoists.

6x8 ft. Thus, the hoistway must be at least 7x9 ft. clear. As every shaft should be equipped with a ladderway, which also carries pipes and wiring, that takes an area of at least $3\frac{1}{2}$ x9 ft. The minimum excavated area required is about 11x13 ft. Larger tunnels may require shafts equipped with two cages and a ladderway for proper hoisting capacity.

If the shaft is to be lined with pressed steel liner plates or concrete, a circular section is preferred. Shafts lined with

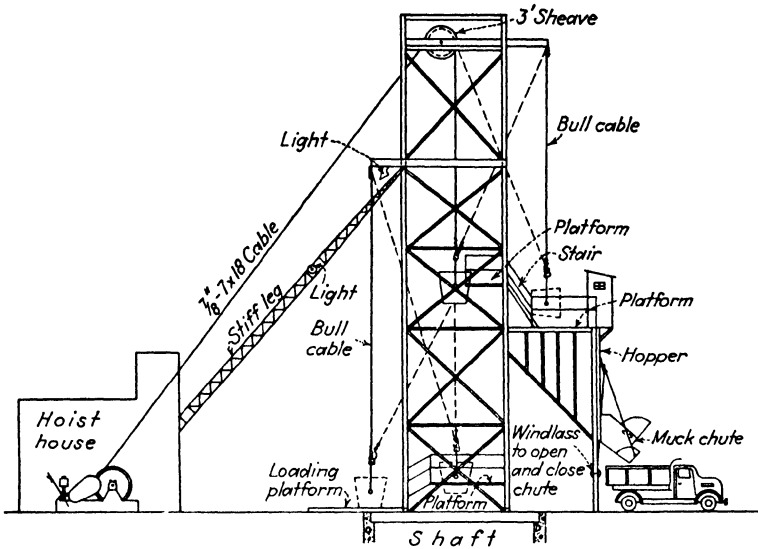

FIG. 57.—Headframe for sinking Shaft 4, Delaware River Aqueduct. Note the bull lines for swinging the bucket to side of shaft. (Courtesy Frazier-Davis Const. Co.)

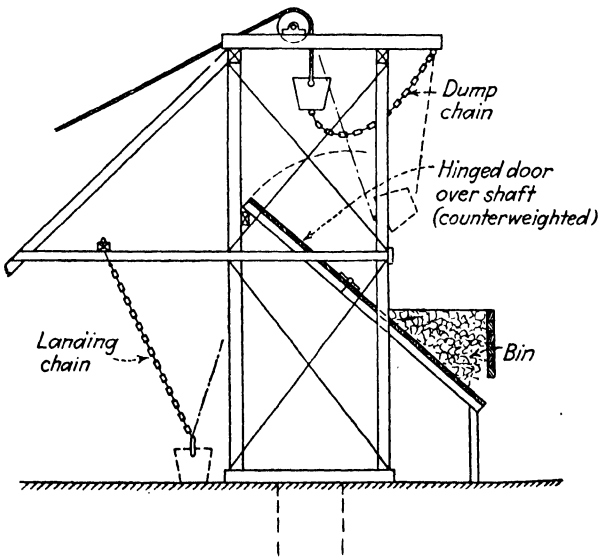

FIG. 58.—Simple headframe for small shafts.

timber or sunk within steel sheet piling are usually rectangular. Area for area, the rectangular section is more efficient than a circular shape. Construction shafts on the Delaware Aqueduct are circular, a minimum of 14 ft. in finished diameter and are all concrete lined.

HEADFRAMES

Shafts are started with a crane or derrick. When the shaft has been sunk and timbered from 60 to 100 ft., work is suspended

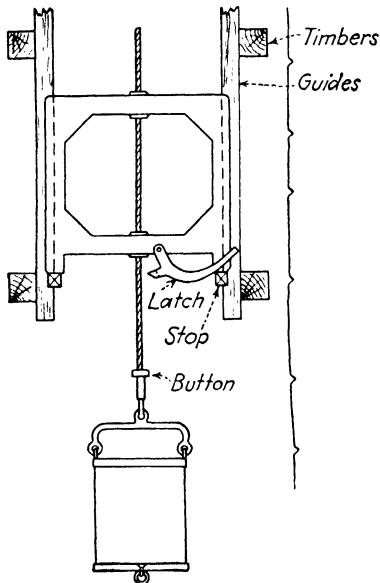

FIG. 59.—Detachable crosshead or gilly for guiding bucket through shaft timbering. The gilly stops at the bottom of the timbering.

while a headframe is erected and a hoist installed. A headframe for a deep shaft is shown in Fig. 57. This shaft is equipped with self-dumping buckets. When the buckets are not of the self-dumping type, they are tipped by hooking a chain in a ring on the bottom and slowly lowered, Fig. 58. There must be a hinged door over the shaft to prevent rock or other material from falling onto the miners.

Except in shallow shafts, there is great danger that a spinning or swinging bucket may bump the sides and spill some muck, or may dislodge a set of timbers. Laws of many states require the use of guides below a certain depth. Generally these guides will be the

ones which will later be used for the cage; but if these are not available, steel cables, weighted on the lower end, are sometimes used. The crossheads used in the guides, Fig. 59, must be of a detachable type, since the bottom of the guides will be 20 to 80 ft. above the shaft bottom. Several serious accidents have been caused by the crossheads lodging temporarily on the guides until the bucket had descended some distance further, then falling onto the bucket bail. There should be some kind of latch to lock

the crosshead to a button on the rope until the bottom of the guides has been reached. The cable should be of a "nonspinning lay," and the hook should be fastened by a ball-bearing swivel.

SHAFTS IN ROCK

Drilling.—Drilling in shafts is done almost entirely by jack-hammers or handheld drills, for they are easily hoisted and there is no loss of time setting up though some shafts have been drilled

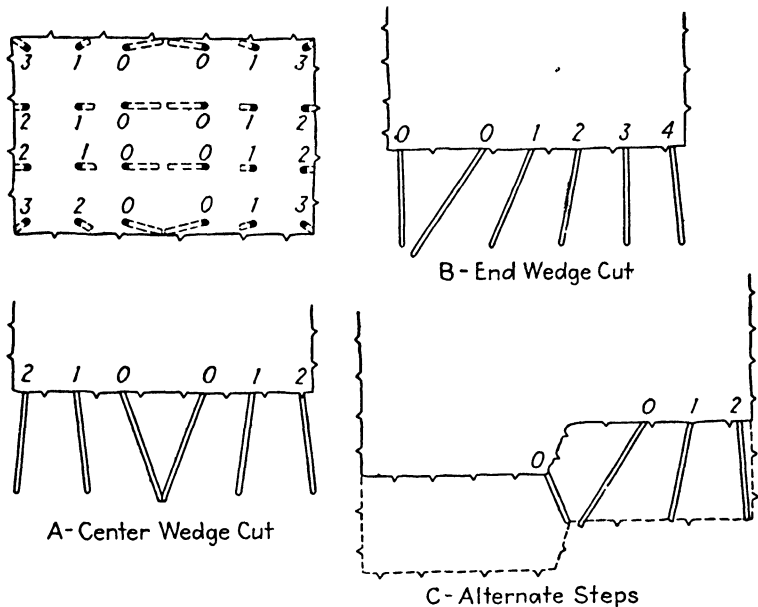

FIG. 60.—Drilling patterns for shaft sinking in rock. The numbers refer to firing delays.

with drifters working from horizontal bars. Recently a drill carriage for shaft sinking was developed but so far has not been widely used.

Most rounds are drilled with 6- or 7-ft. steel, which pulls 4 to 5 ft. Length of round will be governed by type of rock, economy of explosives and organization for progress. Sometimes greater progress can be obtained with shorter rounds.

Typical shaft drilling patterns are shown in Fig. 60. The center wedge cut (A) is the most common for rectangular shafts. For circular shafts, this will be a pyramid cut. The end wedge cut (B) is favored by some contractors; this throws much of the

muck toward one side of the shaft, enabling part of the shaft to be cleaned up quickly so drilling can be started. Large shafts have been "stepped down" (C) to permit mucking and drilling to proceed more or less together.

Mucking.—Mucking must all be done by hand. As shoveling of fine muck is very difficult on the uneven bottom, blasting should be controlled to break the ground into pieces weighing between 20 and 200 lb. A man can load about 1 cu. yd. per hr. The muck is hoisted in buckets of 1 to 2 cu. yd. capacity. Two buckets are used, one being loaded while the other is being raised, dumped and returned.

Modern practice is to employ all miners on sinking work, rather than to follow the older method of alternating drilling and mucking gangs in the shaft. Using all skilled men, work can be carried forward where the previous shift left off, be it mucking, drilling or timbering.

Timbering.—Typical timbering sets for a small shaft are shown in Fig. 61. Usually they are spaced 5 ft. c. to c. As there is generally no horizontal pressure in rock shafts, the timbering is principally to carry the cage guides and support the lagging.

A set consists of two side plates and two end plates (or wall plates and end pieces), separated into compartments by dividers. Each new set is hung from the one above by $\frac{3}{4}$ -in. hanging bolts or hook bolts with a post beside each bolt. The excavation should be about 4 in. large all around to allow for blocking the sets after alignment. Every 100 ft., a bearer set is placed, whose timbers project into hitches cut in the wall and are securely anchored. The bearer set takes the weight of the timbering below off the upper hanging bolts.

Where timbering is not required for ground support, usual practice is to sink about 60 ft., then timber; the lowest set is placed about 20 ft. above the shaft bottom. This bottom set must be protected against blasting by poles chained to hang just below it.

Generally the guides are lag-screwed directly to the divider or end plate, but on some jobs a 3-in. shim is used between them; in case a set is squeezed, the shim can be removed to realign the guides.

When passing through swelling ground, it is common to excavate the shaft several feet oversize and then block between the

set and the rock with "crushing blocks," which postpones the day when the sets are shoved out of alignment or the swelling ground has to be dressed back.

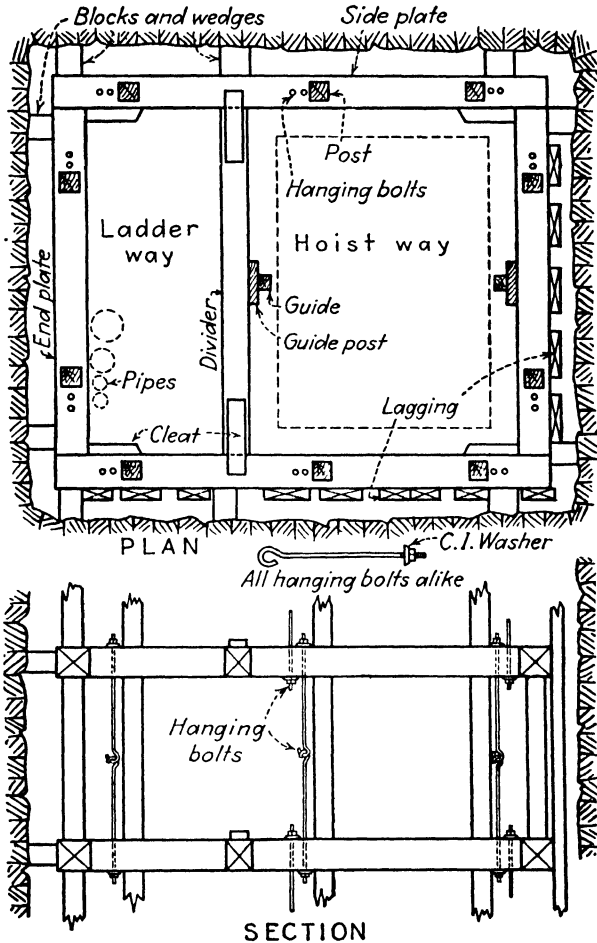

FIG. 61.—Timbering for small shafts.

Steel Ribs.—Steel ribs and sheet steel lagging have the advantage of being fireproof, which may be very important in semi-permanent shafts. Circular ribs are made up in two or three pieces; they are lowered endways into the shaft and supported on hanging bolts until they are spliced into a circle. They must

be wedged to the rock at frequent intervals. Lagging may be of wood or steel.

Rectangular shafts are often braced with steel sets, which is simply a substitution of steel for wood and introduces no new methods but may save some excavation.

Lagging.—All shafts which are not concrete lined should be lagged to prevent small pieces of rock breaking loose and falling on men below. Lagging need rarely be placed skintight. Three or four sets of timbers are placed and blocked before the lagging, 2 in. thick, is inserted from below. Sheets of corrugated iron are often used in place of lumber.

Only in rare cases will the space outside the lagging need to be dry-packed, since a displacement of a set might start a disastrous run of the packing. If packing is required to support the rock, a lean concrete, 1:3:6 mix, should be used.

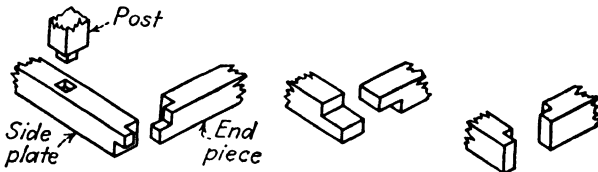

FIG. 62.—Framing details, large shaft timbering.

Pumping.—Most shafts are wet. In some cases the water can be bailed into the bucket along with the muck and hoisted out, but generally a sinking pump will be required, hanging from the lowest set of timbers. This pump must be disconnected from the riser pipe and hoisted in the clear before shooting.

Pumping from deep shafts is very expensive. Present practice is to stop at wet seams and grout them, sealing off the flow. If all the flow cannot be cut off in this manner, it is often economical in deep shafts to cut a sump and pump station just below the wet seam to collect the water and pump it to the surface from that point.

Raising.—Occasionally a shaft can be raised from a heading below instead of sinking. Raising is much cheaper as there is no mucking out or pumping required. Muck is dropped to the bottom of the raise, where it can be trapped into the tunnel cars and hauled to the portal.

Generally raises are driven to a 5-ft. diameter. If a larger shaft is required, it is "reamed" to the desired size from the top

down after the raise is completed, with the muck being dropped down the raise.

Small raises can be driven at a satisfactory rate by one experienced miner. Drilling is done with a stoping hammer resting on a stull braced across the raise. Ladders resting on stulls are used for reaching the face. Most of the miner's time will be spent in replacing these ladders after blasting and removing them before shooting.

Glory-holing.—Large shafts can be sunk economically by “glory-holing” the muck into a raise leading to the tunnel below. The bottom of the shaft is carried down funnel-shaped so that muck will roll to the raise with a minimum of labor. The contractor on the 60-ft. diameter shafts at Fort Peck lowered a small bulldozer into the shaft after each shot to shove the muck into the raise.

Muck will occasionally arch across the raise and block it. Such blockades may be cleared by turning a fire hose down the raise. If this will not clear it, the only other thing to do is to fire a stick of dynamite, tied to a long pole, at the bottom of the block.

Sinking Manholes in Rock.—Manholes in sewer tunnels are sunk through rock by conventional methods. It is difficult to control the overbreak in such small holes, so that a “burnt cut” drilling pattern, Fig. 63, may profitably be employed to limit the breakage. The cut holes, generally six in number, are drilled vertically and loaded and shot first. This gives the rim holes a better chance to break their ground clear to the bottom and will probably reduce overbreak.

Manholes are generally concreted as soon as sinking is completed and so are seldom timbered unless the rock is very treacherous.

SHAFT SINKING IN SOFT GROUND

Shafts in soft ground are rarely very deep. Sinking methods and equipment are, therefore, simpler. Mining is by pick and

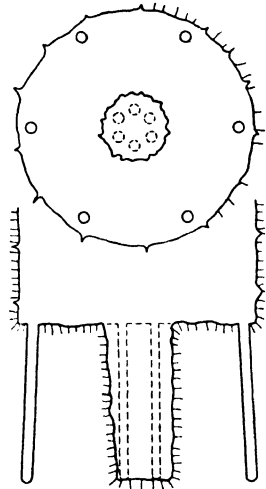

FIG. 63.—Burnt cut for sinking small shafts.

shovel, the muck being hoisted out in buckets handled by a crane. For the first 25 ft., a clamshell bucket on the crane can do much of the digging. Beyond that depth there is real danger that a clamshell will hook under the timbers.

Design of Shaft Supports.—The supports of a shaft in soft ground will probably be called on to resist an appreciable amount of earth pressure. Most engineers assume that the earth pressure increases uniformly from top to bottom, the horizontal pressure at any point being directly proportional to the depth below the surface. The formula is

$$H = KWD$$

where H = horizontal pressure, lb. per sq. ft.

W = weight of ground, lb. per cu. ft.

D = depth, ft., below the surface.

K = constant, which for average ground, is assumed as 0.33.

Values of K for certain soils as given in Peele's *Mining Engineers' Handbook* are as follows: 0.16 for damp clay and moist loam; 0.22 for moist sand, dry loam, and graded gravel; 0.27 for dry sand; 0.34 for wet sand or coarse gravel; 0.40 for dry clay; 0.50 for alluvium; and 0.60 for wet clay. Water, of course, has a K of 1.0. An increase must be made in this constant if the ground is, or is likely to become saturated.

The top bracing should in all cases be much heavier than theoretically required, as crawler cranes or surcharges of piles of material may exert a considerable local horizontal thrust. In firm soils, the ground may be assumed to arch vertically from set to set; the sheeting need not be designed to carry the full load. J. C. Meem proposed a theory of earth pressures which gave the greatest pressure at the top, (*Transactions Am. Soc. Civil Eng.*, June, 1908). Though Meem's theory has not been widely accepted, any engineer who must undertake the design of sheeting and bracing for deep trenches or shafts should read it and the discussion it provoked.

Methods of Timbering.—Timbering for small shafts in soft ground consists of side plates, end plates and dividers strutted to each other with posts and tied together with hanging bolts. Sheeting will be of 2- or 3-in. lumber set tight against the ground to prevent initial movement.

The standard method of timbering a small shaft is shown in Fig. 64. A hole about 6 ft. deep is dug at the site of the shaft, and in this hole the first two sets of timbers are assembled, plumbed and braced to each other with a few diagonals. The sheeting is then set up around these frames and held in position by backfilling.

Excavation is then started. The miner digs a few inches under the bottom of a sheeting while a laborer drives it down with a

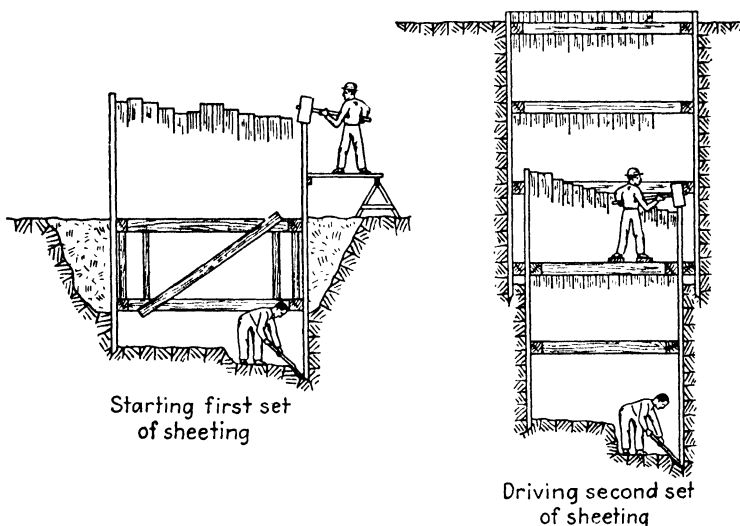

FIG. 64.—Standard method of timbering small shafts in soft ground.

maul. The miners must guide the bottom of the sheeting carefully to keep it in a vertical position.

If one length of sheeting will not reach bottom, another set must be started within the timbers of the first set. A sheet is omitted directly under the dividers of the upper timbers; this leaves a gap in the sheeting which is generally closed by nailing short boards over the opening, well packed with hay to prevent a run. Using this system, shafts have been sunk to depths of 50 ft. or more. Cleats should be nailed to the sheeting above and below each set to prevent any possible movement.

Pneumatic hammers are often used for driving the sheeting. They are particularly valuable in running ground, for the point of the sheeting can be kept a few inches below the bottom of the

excavation and thus prevent runs. This "bite" in the bottom also prevents the toe of the sheeting kicking in from outward pressure before the next set of timbers is placed.

Timbering in Firm Ground.—In firm ground, such as dry clay or earth, the banks may safely stand for a day. In such ground, the shaft may be excavated to a depth of about 10 ft. and carefully trimmed. Planks 12 ft. long are then set against the wall where they are held until three sets of timbers can be placed.



FIG. 65.—A 26-ft. shaft, steel-plate lined, being sunk through blue clay for the Chicago Subway. Excavation was easy with a clamshell bucket handled by a crane. (*Wide World Photograph.*)

Then the shaft is deepened 5 ft. more and the walls lagged with boards 5 ft. long which are held by a set placed in the middle. Wedges should be used freely between the timbers and the sheeting to ensure that every plank is tight against the ground.

Steel Liner Plates.—The standard pressed steel liner plate is often used in lining circular shafts. These plates are of $\frac{1}{8}$ -, $\frac{3}{16}$ -, or $\frac{1}{4}$ -in. metal formed into panels 16 in. wide and about 3 ft. long. The plates are bolted together to form rings of the desired diameter. For shafts up to 16-ft. diameter, no ribs are required. The plates should be selected with a thickness to take the compres-

sion from soil pressure as a flexible arch. Plates can often be removed or "robbed" when the shaft is being backfilled.

Because there are no ribs or struts in these shafts, almost all the excavation may be done with clamshell buckets. Miners trim the walls and set liner plates. Use of liner plates demands a soil that will stand unsupported for a depth of 16 in. while the

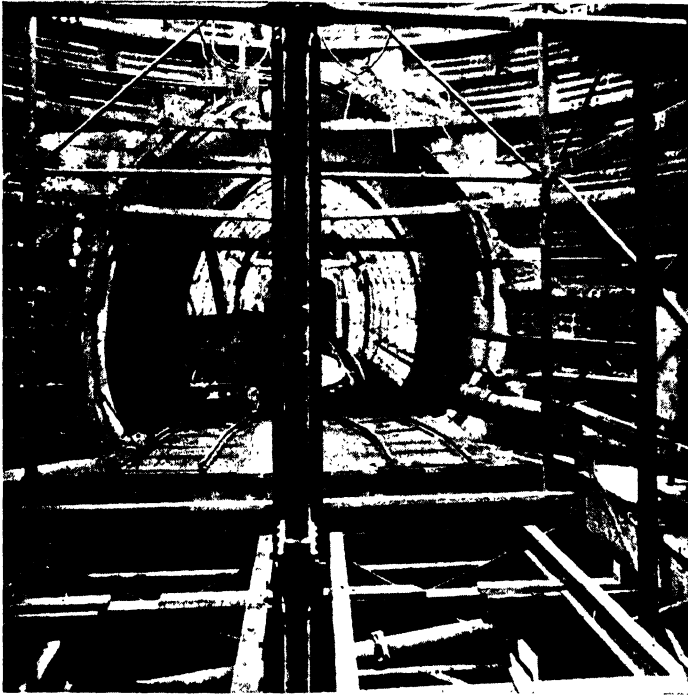

FIG. 66.—Bottom of a large shaft in soft clay, lined with steel plates and ribs. Note the tubular hoist framing. (Courtesy of Commercial Shearing & Stamping Co.)

wall is being trimmed. When the ground runs or caves, steel poling boards may be set outside the rings and jacked downward to form a shield within which the plates may be assembled.

Larger shafts must have ribs at each course of plates for strengthening. These ribs may be the type which bolt between the plates, but the type which is assembled within the ribs and then wedged is preferable. Figure 67 shows the lining for the four control shafts at Fort Peck. These shafts are 230 ft. deep and 60 ft. in excavated diameter. The plates were No. 10 gage

sheets, 8 ft. long by 2 ft. wide, with edge angles $5 \times 3 \times \frac{5}{8}$ in. The soldier beams were 8-in. H-beams, spaced 8 ft. apart; rings were spaced 8 ft. vertically. They were 18 in. deep, latticed of four angles $3 \frac{1}{2} \times 3 \frac{1}{2} \times \frac{5}{8}$ in. The space between the plates and the ground was thoroughly grouted.

On this same job in rectangular shafts, 10x30 ft., corrugated plates were used as lagging outside the H-beam sets, as shown in

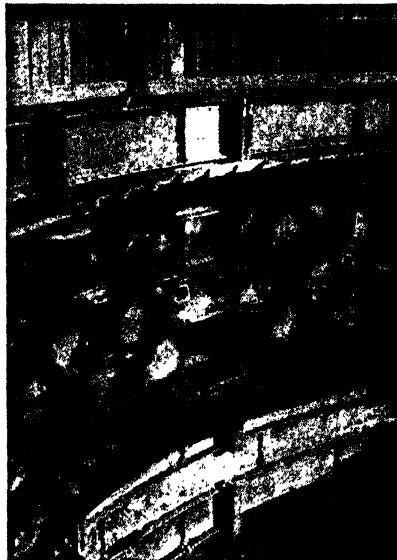

FIG. 67.—Steel supports for a 60-ft. diameter shaft at Fort Peck Dam. The steel plates are braced by H-beam soldiers and horizontal ring trusses.

Fig. 68. All plates were grouted. Overbreak was prevented on this job by ring sawing the shale with a coal undercutting machine. Although this was a shale and might not strictly be classed as soft ground, the shaft supports were designed for a hydrostatic pressure equivalent to a liquid weighing 31 lb. per cu. ft.

Steel Sheet Piling.—Steel sheet piling is frequently used for sinking rectangular or circular shafts in water-bearing or soft ground. As piles may be obtained in almost any length, most shafts can be bottomed with one set of piling. When the work is completed and the shaft backfilled, the steel piles can usually be salvaged. If the shaft is to be concreted before the piles are

pulled, they should be painted with oil and then covered with tarpaper to prevent the concrete bonding to them.

The general method of procedure is as follows: A hole about 6 ft. deep is excavated at the site of the shaft and the two upper sets assembled in it to serve as guides. The sheet piling is then placed around these frames. Whenever possible, all piling should be interlocked before driving is started, but sometimes this cannot be done because the boom on the crane is too short. In that case the piling must be driven until the next pile can be interlocked. The piles should not be driven any deeper than necessary before all piles are interlocked.

Bracing sets may be of wood or steel. They are always about 3 in. small all around, to permit assembling even if the piling has drifted out of plumb. Hardwood wedges are then driven between the set and each pile. It is important that the upper set be securely bolted to the sheeting through holes burned in the piles. Sometimes, under pressure, the top set has a tendency to slip upward. All sets should be tied and posted to each other.

Predraining.—The sites of shafts in water-bearing sand or gravel frequently can be predrained with well points or deep wells, which will permit sinking the shaft by simpler methods. This is particularly true in soils which have a tendency to “boil” upward around the bottom of the sheeting. Once the shaft has been bottomed, a concrete floor should be laid to prevent the sand running in and all openings between the sheeting packed with hay to prevent loss of fine sand. Then predraining may be stopped and the water which flows into the shaft handled by the regular pumps. If a water-tight floor is desired in a shaft of steel sheet piling, it can be laid in the dry. It must, of course, be designed against the hydrostatic uplift that will occur when pumping stops.

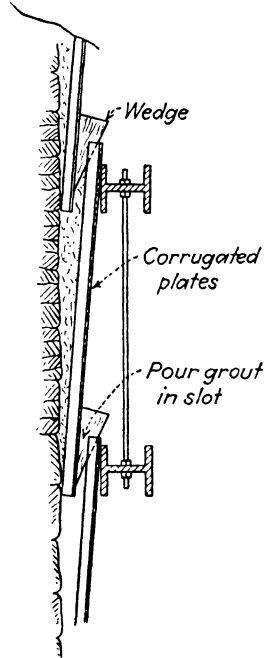

FIG. 68.—Corrugated iron plates used as shaft sheeting.

Manholes in Soft Ground.—When manholes are to be sunk through wet or caving ground, sheeting must be employed. The general scheme is to place 2x8-in. wood sheeting vertically around two square sets. As the miner excavates the shaft, a laborer drives the sheeting, one at a time, a few inches. If a 16- or 20-ft. board will not get the shaft into good ground, then the first set must be made large enough so that a second lift of sheeting may be stepped in yet still maintain the minimum size of manhole.

Cribbing, Fig. 69, is sometimes used for sinking through quicksand. All lags are alike; they are placed with the tongue down so that the last pair will brace the previous pair. The last pair

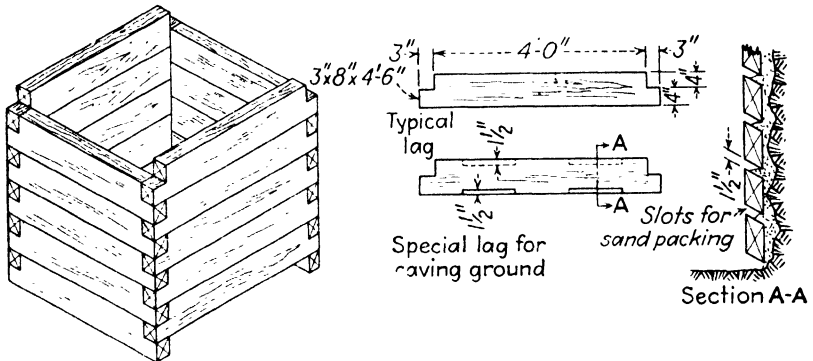

Fig. 69.—Cribbed-well method of shaft sinking in soft ground.

is held by a trench jack till the next set is placed. With very little experience, a man may sink a manhole through running ground with very little loss of ground. Vertical 2x4-in. timbers should be nailed in each corner to tie the lags together. If the ground caves badly, the tops and bottoms of all lags may be beveled as shown. This provides a slot through which sand may be rammed to make good the loss of ground.

Chicago Wells.—Chicago wells have been safely sunk through blue clay to depths of 125 ft., Fig. 70. They demand a soil that will stand unsupported for a short time. The wells are lined with vertical lags of 3x6-in. T.&G. lumber, generally 5 ft. 4 in. long. There should be a few lags of narrower widths available to make up any variation of circumference. Each set of lags is held in place by two rings of 1x3-in. steel bars, made in two half circles and bolted together. Rings for larger wells are fabricated from ship channels. The rings are spiked to the lagging to keep them

from falling out if they should become loose. Joints are staggered 90 deg.

Muck is hoisted in a 5-cu. ft. bucket, 24-in. top diameter by 24 in. deep. The tripod is fitted with a windlass for raising the bucket or the miner. The standard crew for a well is one well digger, one signal man and two windlass men. A 3½-ft. diameter well is about the smallest in which a man can work efficiently. Wells have been dug by this method up to 12-ft. diameter; such large wells could be used for tunnel shafts. Wells of 6-ft. diameter are sometimes sunk adjacent to a larger shaft, fitted with a circular staircase to serve as a separate manway.

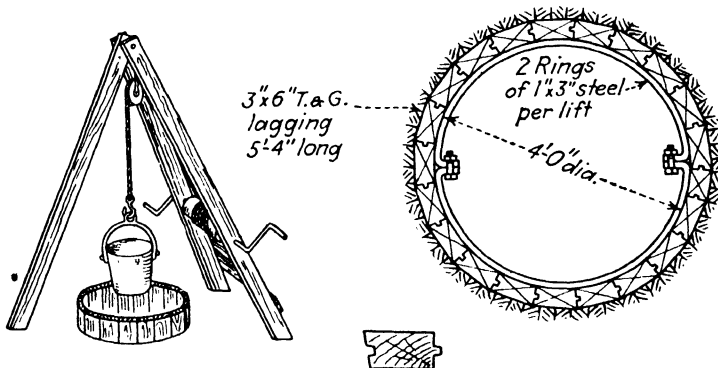

Fig. 70.—Typical Chicago-well method of sinking small shafts in soft ground.

Drop Caissons.—Drop caissons, Fig. 71, are sometimes used for sinking shafts through water-bearing sand or gravel. These caissons are generally of concrete heavily reinforced to resist unequal stresses caused by one corner “hanging up” on a boulder. These caissons may be rectangular or circular. The dredging wells are generally 8 or 10 ft. square.

The cutting edge is first assembled, then about 20 ft. of the shell concreted. Dredging is commenced within the wells; as the lower edge is undercut, the caisson will sink. Additional lifts of concrete, 10 ft. high, are added to the shell as required. Frictional resistance will be between 200 and 1,000 lb. per sq. ft., with 400 lb. the probable amount. In some cases, pig iron must be piled on the top of the caisson to increase the weight. Friction may be reduced by the use of water jets, which may be jets handled by the crane, or pipes built into the outside of the cutting edge. Sinking of the caisson should be uniform and continuous to keep friction at a minimum.

Steering of the caisson is accomplished by undercutting one edge more than another. Loosening the ground on one side with jets and piling the excavated material on the other side of the shell will aid in "pitching" (moving horizontally) the caisson. A tolerance of at least 6 in. should be allowed in sinking.

Sealing the caisson to bedrock may prove to be difficult. If the bed happens to be a soft shale, the cutting edge may embed

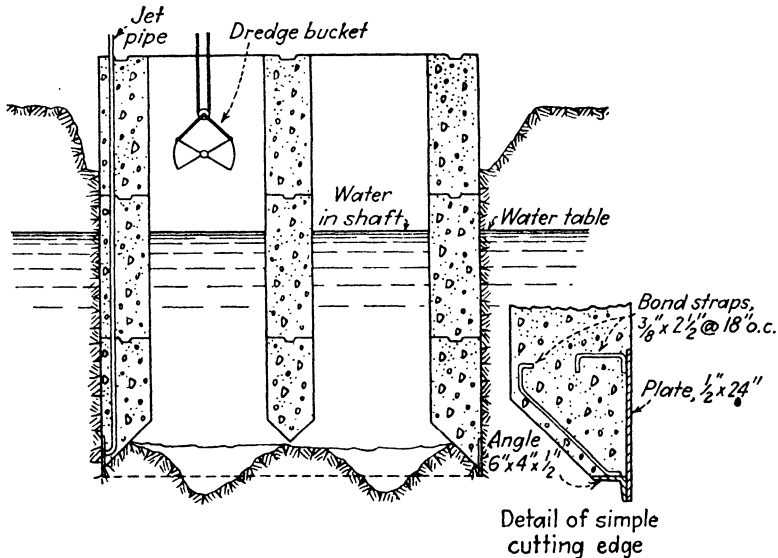

FIG. 71.—Concrete open caisson for sinking large shafts to rock through soft overburden.

itself, and the shaft may then be pumped. If the bedrock is hard and uneven, a tremie seal about 10 ft. thick may be placed; but part of this tremie concrete must be blasted out to continue the shaft, and there is likelihood of starting a bad leak. Sometimes grout may be forced down through the jet pipes connected to the cutting edge to form a seal. Often drop caissons are designed for attaching a steel bulkhead and air locks. When the cutting edge is bottomed, air is put on and the caisson sealed in the dry.

Pneumatic Caissons.—Pneumatic caissons are more expensive than drop caissons, but are surer, and there is less loss of ground flowing under the cutting edge.

A pneumatic caisson consists of a cutting edge and concrete shell. About 8 ft. above the cutting edge, Fig. 72, an airtight diaphragm forms the roof of the working chamber. Air locks of

the vertical type, located high above any danger of flooding, are connected to the working chamber by 36-in. steel shafts. Muck is raised through the shafts by small air hoists located just outside each lock.

Sometimes most of the muck within a pneumatic caisson may be ejected very readily by a "blowpipe," simply a 3- or 4-in. pipe, open to the outside. The sand or mud is heaped around the

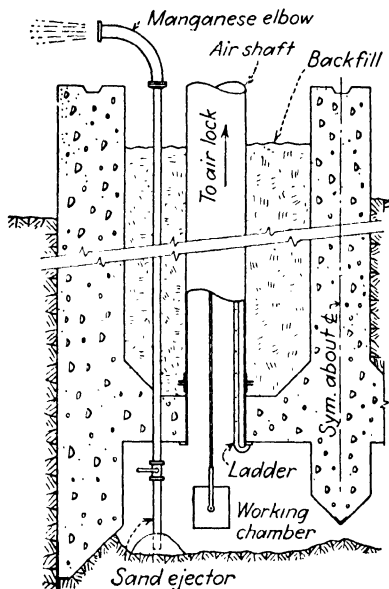

FIG. 72.—Typical pneumatic caisson for sinking shafts through wet and soft ground.

bottom of this pipe, and, when the valve is opened, the escaping air takes the muck with it. Coarse gravel, large stones, or clay must be loaded into $\frac{1}{3}$ - or $\frac{1}{2}$ -yd. buckets and hoisted through the lock.

The caisson shell is extended as sinking progresses. Muck is dumped back into the wells around the air shafts, not only to add weight but to reduce the stress on the diaphragm due to the air pressure within the working chamber. If a caisson will not sink when undercut, the sandhogs are withdrawn from the working chamber and the pressure is then reduced until the caisson drops. Safety cribs should be kept in the working chamber when first starting sinking operations to prevent the caisson from suddenly dropping and crushing the men.

CHAPTER 6

MUCKING

As rock "grows," or bulks, when broken, 1 cu. yd. of loose muck does not represent 1 cu. yd. of solid rock. Growth can be assumed as 50 per cent; in other words, 1 cu. yd. of solid rock will make $1\frac{1}{2}$ cu. yd. of muck. The growth of rock varies with the degree of breakage; the actual growth can be found by comparing the weight of a cubic yard of muck with the theoretical weight as calculated from the specific gravity of a sample. Furthermore, overbreak always increases the yardage from 15 to 30 per cent.

Performance of mucking machines is generally given in terms of loose rock. It would be better if tunnel men followed mining practice of using the term "tons loaded."

HAND MUCKING

Mucking by hand has almost entirely been displaced by the machine except in small or short tunnels; yet almost every job requires some hand mucking until there is room enough to work a mucking machine. A man needs $2\frac{1}{2}$ to 3 ft. in which to work. Therefore, a tunnel 10 ft. wide can accommodate not more than four shovelers. Hand mucking is hard work; it is desirable to alternate the men on less fatiguing work, such as picking or car-pushing.

Mining Engineers' Handbook cites an example of a small western tunnel where the mucking gang consisted of six men: two engaged in loosening the ground, two shoveling, and two switching cars. After each car was loaded, the men changed positions. A 16-cu. ft. car was filled in 3 to 4 min., a rate of about 9 cu. yd. per hr. or an average of $1\frac{1}{2}$ cu. yd. per man-hour, including lost time.

One man can load about 2 cu. yd. per hr. under best conditions; but, considering all lost time, the output is generally figured at $\frac{1}{2}$ to $\frac{2}{3}$ cu. yd. per man-hour for *every* man in the gang.

"Slick sheets" should always be used when hand loading. These are steel sheets generally of $\frac{1}{4}$ -in. or $\frac{1}{8}$ -in. plate, about 4x6 ft., with a large hole punched in each corner of the sheet for

picking up by hooks for moving. The floor of the tunnel is covered with these sheets for 20 ft. back from the face before each shot. This smooth surface materially increases the output in mucking. The cars should be as low and wide as possible to facilitate loading of large pieces.

Cleaning Bottom.—The final cleanup of the bottom before the invert is laid (whether the tunnel is concreted invert first or invert last) is usually by hand. The first operation is to distribute empty cars along the track and to clean up all the muck in the ditches and between the ties. The track is then torn out and the muck under the ties end-loaded into a muck car. This is an excellent spot for belt conveyors, one inclined conveyor filling the car and a horizontal conveyor into which the men shovel. The inclined conveyor may be wheel mounted, the wheels straddling the muck track so that the rails and ties can be removed without delaying the muckers. On one job where this system was used, an output of $1\frac{3}{4}$ cu. yd. per hr. for each shoveler was recorded, including time lost changing cars.

Sometimes it is possible to throw the track over to one side while half the floor is being cleaned, then shift the track to the other side. This method is particularly desirable when the invert is being concreted in half widths, for the muck track is available for concrete delivery.

Recently mechanical methods of cleaning up the invert have been developed on the Delaware Aqueduct. One scheme is to convert a Conway mucker to a slusher by means of a long boom attached to the mucker (Fig. 84). The mucker hoist motor operates a drag scraper, which pulls the muck onto the mucker belt. The opposite end of the boom is supported on a skid frame equipped with several hooks for varying the position of the tail sheave. Regular slusher muckers (described later) are also used for cleaning up the bottom. Several contractors on the Delaware job are using bulldozers mounted on electric-drive crawler tractors for scraping the invert muck to within reach of a mechanical loader.

Trapping.—Under certain conditions muck can be very economically trapped by hand into cars. A bottom drift of minimum cross section, about 8x8 ft., is driven, as shown in Fig. 73. Within this drift is erected about 60 ft. of jumbo consisting of square sets about 4 ft. apart, on which is laid longitudinal lagging

to form a floor for the breakup. The lags are laid to form a continuous slot about 24 in. wide, covered by short lengths of 2-in. lumber. When the top heading is shot, the muck falls onto the deck and is then loaded directly into cars in the drift below by removing the boards covering the slot. An entire train can be loaded without switching cars. The jumbo is dismantled and reerected as the work progresses.

Although this method is not often employed, it has certain advantages. The bottom drift provides good drainage and, after the drift is holed through, good ventilation. Cars can be efficiently loaded with a minimum of shoveling and without switch-

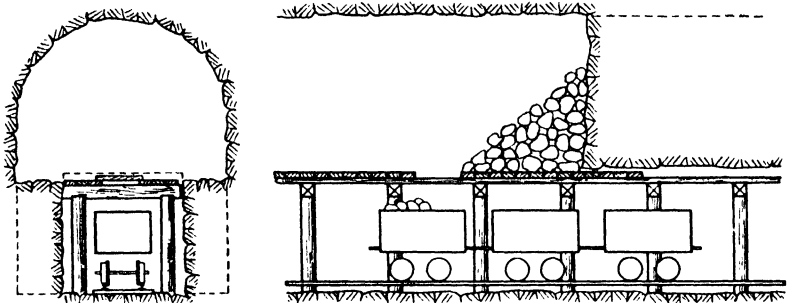

FIG. 73.—Trapping muck into cars, bottom-drift method of tunneling.

ing. This system is sometimes employed in the center-drift method for catching up bad ground ahead of the enlarging crew. (See Chap. 18.)

BELT CONVEYORS

Belt conveyors for loading cars can often be used to good advantage in hand mucking, both in rock and in soft-ground tunnels. They can also be used in connection with machine loading. The authors believe that if the possibilities of belt conveyor loading were more fully realized by tunnel men, conveyors would be used more. The conveyor may be any length desired; for hand loading any number of shovelers may be used, and the discharge end may extend as far as desired over the string of cars, in fact, over a full train.

The discharge end is carried on a jumbo or framework under which the cars are placed. A good example of the use of conveyor loaders is found on the Olmstead and Alpine-Draper Tunnels on the Provo irrigation project in Utah. A small Eimco mucking

machine loads onto an inclined belt, which extends on a traveling framework back over a full train of cars. At the start of the mucking cycle, a string of empty cars is shoved under the framework; the belt discharges into the car next to the locomotive, at the rear of the train. As each car is loaded, the train is pulled back a car length, thus placing an empty car under the discharge end of the belt.



FIG. 74.—Portable belt conveyor loading muck into a Battleship in a shield tunnel passing through a section of rock, Lincoln Tunnel, New York.

Muck conveyor belts usually made of plied rubber, running on dished rollers, though the belt can be made up of steel plates, as shown in Fig. 74. Skirts or side boards should be placed along both sides of the belt to prevent spilling of the muck. Motors for operating belt may be either electric or air.

MECHANICAL LOADERS

Railroad Type Shovels.—The first tunnel shovels were ordinary rail-mounted steam shovels converted to this new use by the simple expedient of connecting a compressed-air line to the boiler. Often these shovels were of standard gage, and the tunnel cars were of narrow gage, making it necessary to lay two tracks.

A later type is built to run on 36-in. gage track, the boom and dipper stick are proportioned to fit the particular tunnel. These machines load on an adjacent track, necessitating double track near the face; but the track on which the shovel stands is used for the delivery of the empties, these cars being transferred to the loading track one at a time by means of the "cherry

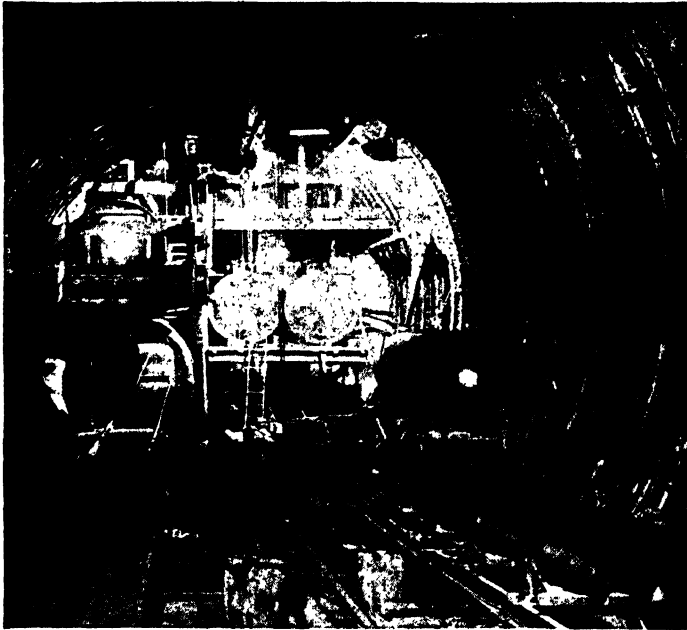

FIG. 75.—Belt conveyor for transporting muck from shield through the locks to foot of shaft, Boston Harbor Tunnel. A special conveyor arrangement was used in a pair of locks.

picker," or boom, mounted at the rear end of the machine. These machines must be moved back at least 150 ft. before shooting, as all the machinery is at the front end exposed to fly rock.

Full-revolving Shovels.—Full-revolving shovels running on narrow-gage tracks have the advantage over the railroad type shovel in being able to load to the rear on the same track, thus only requiring single track. In case of double-track operation, they can load cars alternately to the side and to the rear, thus eliminating the delay of cars changing. Figure 76 shows an air-operated shovel designed to work within a 17-ft. tunnel, equipped with a 1-cu. yd. dipper.



FIG. 76.—An Osgood 1-yd. air-powered full-revolving shovel used in mucking out a 17-ft. tunnel.

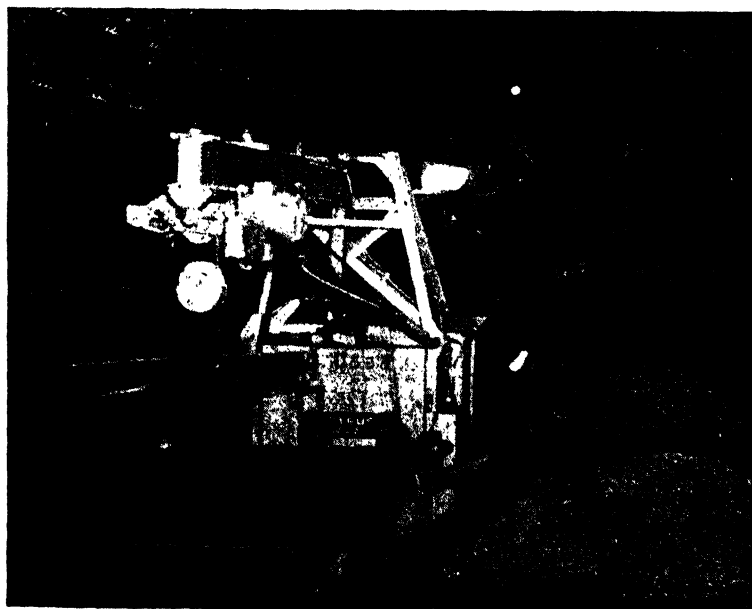

FIG. 77.—Bucyrus-Erie rail-mounted tunnel shovel, electric-powered, carrying an electric-hoist cherry picker on same running gear.

There are several models of miniature full-revolving shovels, air-operated; the smallest will work within a tunnel of 7x7 ft. cross section, and is fitted with a $4\frac{1}{2}$ -cu. ft. dipper.

Another type of full-revolving shovel is shown in Fig. 77. This machine has the cherry picker mounted on the same truck so that loading must all be done to the side. This cherry picker is equipped with an electric hoist.



FIG. 78.—Bucyrus-Erie crawler-mounted, air-powered shovel, full-revolving, on Lincoln Tunnel, New York.

Crawler Shovels.—Crawler-mounted shovels with short booms and dipper sticks are frequently used in larger tunnels. A $1\frac{1}{4}$ -cu. yd. electric shovel with extremely short tail swing can work in a tunnel whose minimum width is $20\frac{1}{2}$ ft. A special tunnel shovel can load 5-cu. yd. cars in a tunnel of 17 ft. clear width.

The crawler type of shovel, of course, needs no track and can load to either side or to the rear. As the back end of shovel may be protected by timbers, it need not be moved so far before shooting. Their disadvantage is that they are extremely hard on track as they crawl back and forth, and their width makes it

difficult to pass the drill carriage. This last objection is particularly noticeable in round-bottom tunnels.

A miniature type of crawler-mounted shovel is shown in Fig. 79. Still another type of electric tunnel shovel has a reach of 14 ft. 7 in. from center pin, yet will work in a 15-ft. tunnel. Crawler shovels, either electric or diesel powered, are being used in all the Pennsylvania Turnpike tunnels.

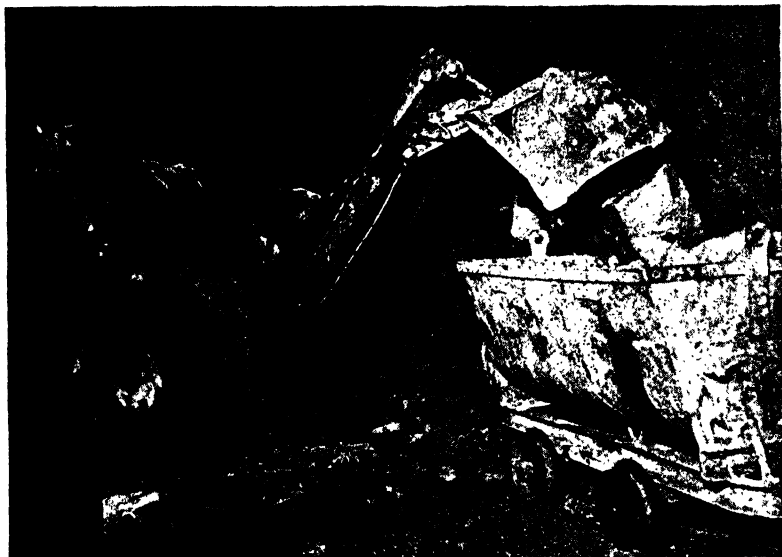

FIG. 79.—Nordberg full-revolving crawler-mounted mucking machine, air-powered, on Chicago sewer tunnels.

Mine Car Loaders.—There are several types of mine car loader designed for mucking in small tunnels or drifts, such as those made by Eimco, Gardner-Denver and Sullivan. These machines will work in tunnels as small as 4x7 ft. They are equipped with a small dipper at the front end, which is crowded into the muck pile by moving the whole machine forward. When the dipper is full, the muck is cast back over the top of the loader into a car or onto a belt. Though the dippers are small, the fast operation of the machine turns out remarkable yardages. In fact, the world's record for tunnel driving in rock to date, 1,879 ft. driven in one month (March, 1940) from a single heading in the 10x11-ft. Carlton Drainage Tunnel in Colorado, was made with this type of loader. The machines are air-operated.

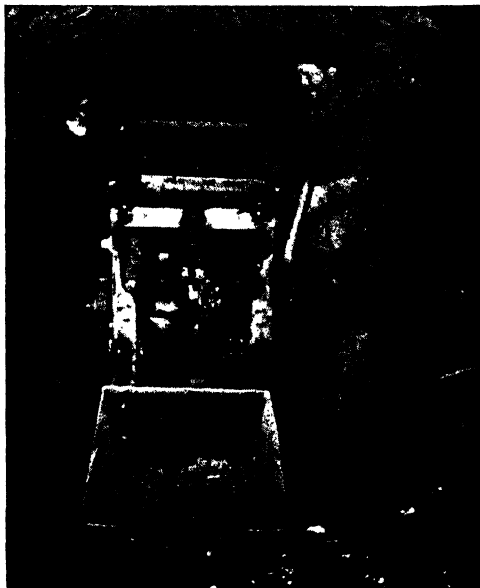

FIG. 80.—Eimco air-powered tunnel mucker, Olmstead Tunnel, Utah. It is rail-mounted and discharges overhead to the rear. Here it is discharging into a belt conveyor hopper, but it usually loads directly into the cars.

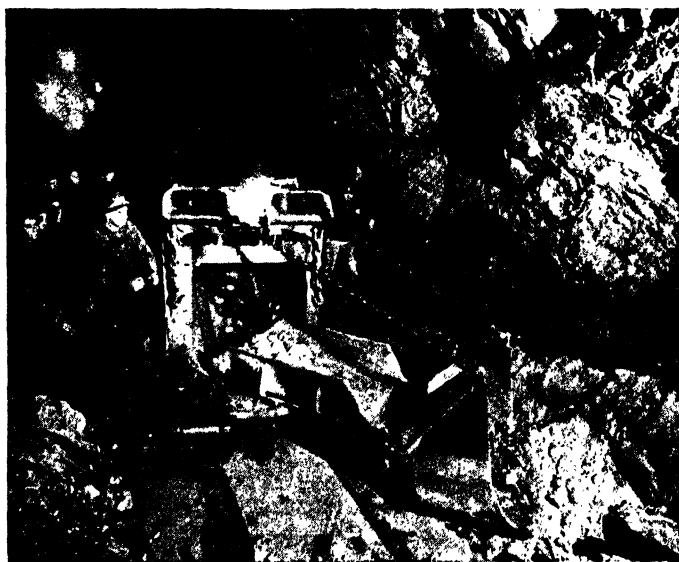

FIG. 81.—Conway mucker, rail-mounted, tip-up discharge onto belt conveyor loader that is part of the machine. This mucker is air- or electric-powered. (Courtesy of Goodman Mfg. Co.)

Conway Mucker.—By far the most popular mucker on tunnel jobs, both large and small, is the Conway. Phenomenal records have been made with this machine, such as twenty-four 6-yd. cars, or 144 cu. yd., being regularly loaded out on the Colorado River Aqueduct, with one 60-hp. machine in 2 hr.

The Conway mucker, Fig. 81, consists of a dipper hinged to the front edge of an apron. This apron is, in turn, hinged to the

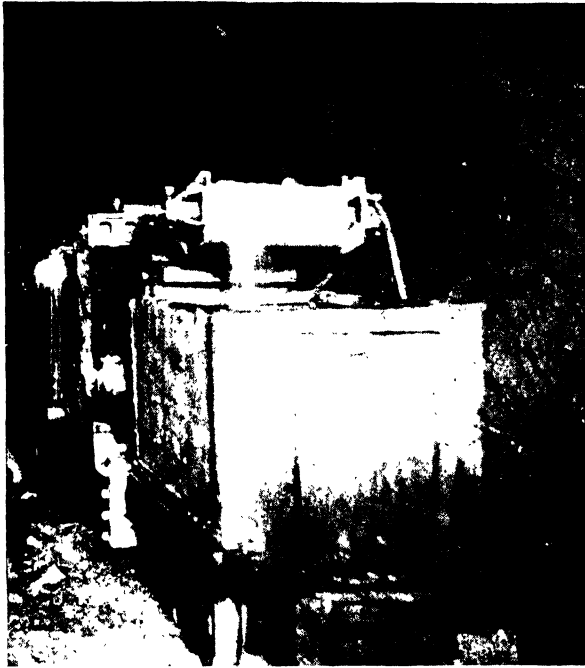

FIG. 82.—Rear view of a Conway mucker loading a car. The car is coupled to the mucking machine and travels with the mucker as it moves back and forth to crowd and load.

frame and, when raised, slides the muck lying on it onto a belt conveyor, which discharges into the car. It has only two hoists, one connected to each corner of the dipper. By tightening either drum, the dipper swings either right or left. If both drums are tightened simultaneously, the dipper is raised until its contents slide onto the apron plate. Further raising of the dipper will tilt the apron to slide the muck onto the conveyor belt.

The dipper is filled by advancing the whole machine into the muck pile. When the dipper is filled, it is raised until the muck

slides onto the apron; after several dipperfuls the apron is raised to slide the muck onto the belt. The empty car is coupled directly to the machine, Fig. 82, by means of a jack-knife draw-bar. After the back end of the car is filled, the jack-knife is tripped and the forward end of the car filled. One type of jack-

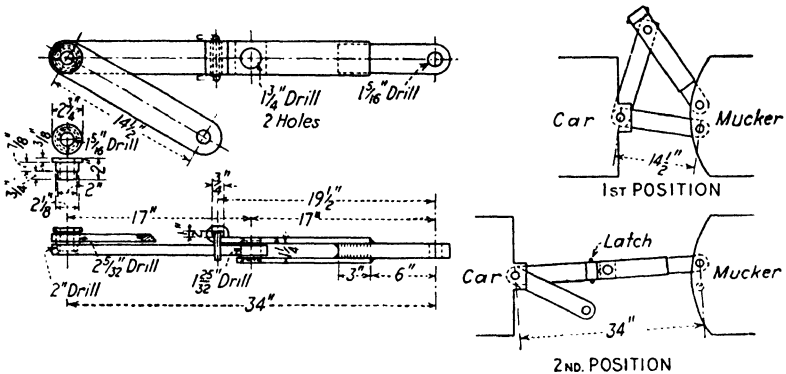

FIG. 83.—Coupler for Conway mucker. The short connection is used first for loading the rear end of the car. Then the long connection is used while loading the front end.

knife link is shown in Fig. 83. Extremely long cars may need a three-position link to trim the load properly.

This type of machine will efficiently clean up fly rock and dig out the corners of the tunnel. It is extremely hard on track, for it charges back and forth for each dipperful; therefore, the temporary track must be unusually well laid to avoid derailments.

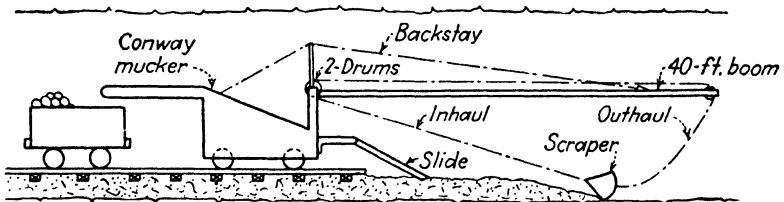

FIG. 84.—Conway mucker converted to a slusher for clean-up of the invert by adding a boom, scraper bucket and slide.

Slushers.—Slushers, or scrapers, are another loading device borrowed from the mining industry for use on several tunnels. As shown in Fig. 85, the slusher consists of a car on which is mounted a slide whose angle is about 20 deg. On this car is a two-drum hoist hauling a bottomless scraper back and forth.

The muck car is run under the upper end of the slide, and the scraper load drops into it. The tail block is anchored to the face in some manner as shown in Fig. 86; the block may be moved from one side to the other or to any position in the heading.

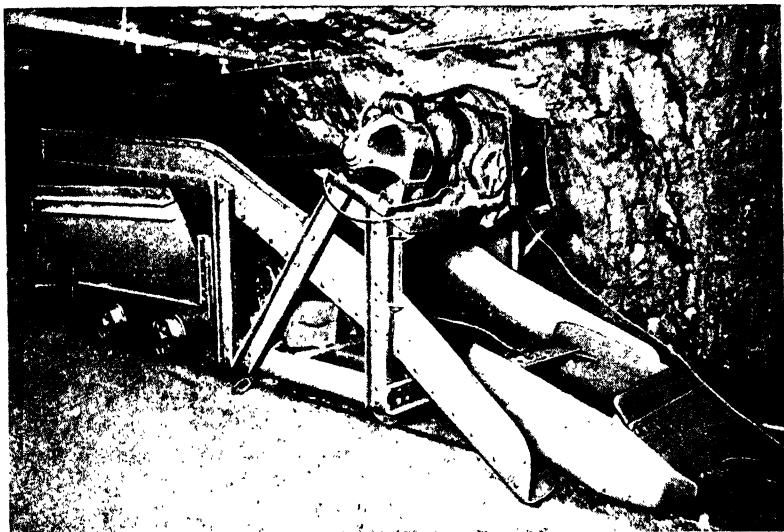

FIG. 85.—Slusher or scraper type of muck loader. (Courtesy of Sullivan Machinery Co.)

There is no reason why the tail of the slide cannot extend much farther than shown here so several cars could be loaded without switching. The city of Chicago built such a scraper with eight

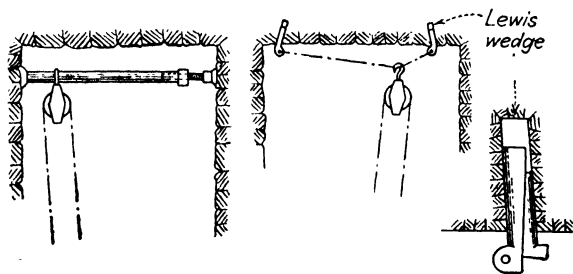

FIG. 86.—Methods of anchoring tail block in slusher mucking.

bottom-dump pockets over the track, each holding one carload. When an empty train ran under the slides, all pockets were dumped simultaneously.

The slusher requires a good deal of handwork, for the scraper will not work close to the face or walls.

CAR CHANGERS

The mechanical mucker has come into tunnel driving only within the last twenty years. Before that time, almost all small and medium-sized tunnels were hand mucked. From 4 to 10 min. were required to hand load an ordinary car; the 2 or 3 min. taken up in changing cars were considered valuable as a "breather" to the hard-working muckers. Modern mucking machines can load a 5-cu. yd. car in from 1 to 3 min.; any shortening of the car-changing time is directly reflected in the mucker output.

Simple Car Changers.—In very small tunnels the empty cars will be lifted off the track while the load is run back. In this system the string of empties is run as close to the face as possible and all except the first one turned off the track and leaned against the tunnel wall. As the cars are loaded, they are pushed

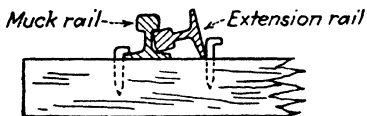

FIG. 87.—Telescoping rail.

back into the tunnel where the locomotive can get them, and the next empty is set back on the track. Cars for this service should be light enough for two men to tip them but sturdy enough to withstand the rough usage they receive.

There is, of course, only single track at the face. The rails are extended by telescoping a rail turned sideways ahead, Fig. 87, until there is room enough to lay a full rail.

When hand mucking is employed, slick sheets are laid on the floor of the tunnel for about 20 ft. from the face. If the single track ends at the edge of the slick sheets, even quite large cars can be run off the rails onto the slick sheets where they can be skidded sideways against the wall until the full car is run back onto the rails.

Passing Track.—The passing track was the standard method of switching cars in the heading until the last few years. A side track, Fig. 88, long enough to accommodate a train was laid close up to the face. The locomotive came into the heading pushing the cars. One car was shoved up to the mucker; then the rest of the empties were left on the "empty track." The locomotive

was uncoupled from the train and, when the first car was loaded, coupled onto it and retired to the "loaded track." An empty car was then pushed up to the shovel. If the cars were of 1- or 2-yd. capacity, they could be hand trammed to the mucker, but with cars of 4- or 5-yd. capacity a mule was employed. When this car was filled, the locomotive again advanced and removed it. The mule then drew the next empty to the face. When the locomotive had collected a train load, it left for the dump, and

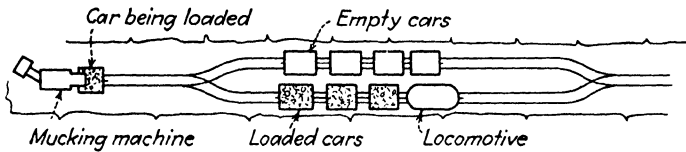

FIG. 88.—Passing track.

the next train took its place. An empty was always left at the mucker to become the first car of the next train.

The disadvantage of this system was the difficulty and delay in moving the passing track forward as the heading advanced. This moving of the switch was a time-consuming operation, generally done on Sundays. Meanwhile, as the heading advanced, the switch fell farther and farther behind the point of efficient operation.

California Switch.—The California Switch, Figs. 89 and 90, was a development from the passing track. This switch is made

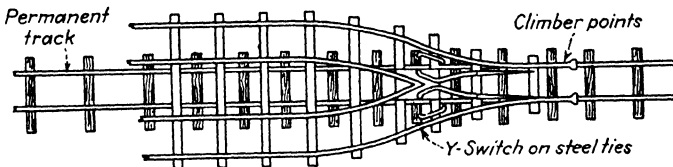

FIG. 89.—One type of California Switch.

of two jumper-type Y-switches, with rails, all welded onto steel ties of $\frac{3}{4}$ x4-in. bars. The clear length of the siding should be about 60 ft., enough to pass an entire train.

Modern practice mounts an air hoist on the rear end of the mucking machine; this hoist pulls the empty car from the siding to the mucker. The locomotive pulls the loaded car away.

When a California Switch rides on top of the permanent track, the whole assembly of switches and siding can be skidded along

to its new position by the locomotive by simply jacking up each frog on rollers running on the lower track. Moving a switch takes about 30 min. Thus it is an easy matter to keep the siding at the correct distance from the face for rapid car changing.



FIG. 90.—California Switch on Montebello water tunnel, Baltimore. The outside tracks are used for passing cars when mucking, but all heavy and wide equipment is hauled over the center track. Note the spring switches.

Spur Switch.—Occasionally in small tunnels a spur, Fig. 91, is used for holding the empties. The spur is set in a wide spot in the tunnel, or an enlargement is made especially for it. This spur should be long enough to accommodate a string of empties, and should have a decided grade, 2 per cent or more, leading toward the main line. After the locomotive has taken away a loaded car from the mucker, it retreats until it clears the spur switch. An empty car is then allowed to run down the grade on to the main line, where the locomotive pushes it ahead of the loads to the shovel for filling.

Cherry Picker.—The first cherry picker was a swinging boom attached to the rear of a railroad type shovel. The empty cars

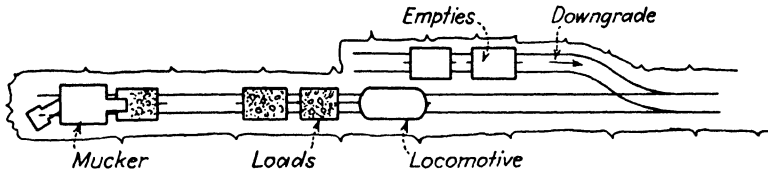

FIG. 91.—Spur track for switching cars in a tunnel.

were shoved in on the track on which the shovel stood, Fig. 92, and were then set over onto the loading track one at a time.

Another type of cherry picker developed for small tunnels and large cars is shown in Fig. 93. A pneumatic cylinder hanging

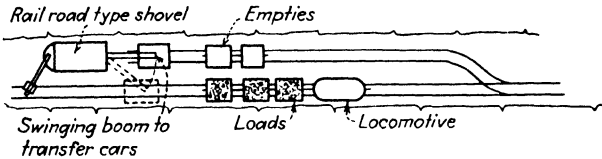

FIG. 92.—Cherry picker mounted on a shovel for transferring empty cars to loading track.

from a small trolley is used to raise an empty car about 12 in. off the rails. Car and trolley are then run sideways against the tunnel wall until they clear the main line. The trolley beam is of extra heavy pipe; a standard drill column complete with jack

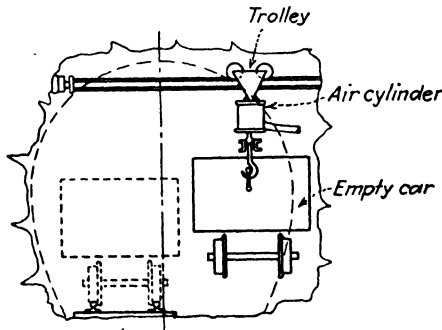

FIG. 93.—O'Rourke beam-and-hoist cherry picker for small tunnels.

makes an excellent beam, cheap and compact. When the tunnel is so small that two cars cannot be passed, this device can be located at some wide spot in the tunnel.

The cherry picker is operated as shown in Fig. 94. The locomotive comes into the heading pulling a string of empties.

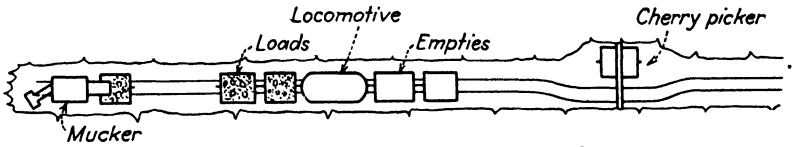

FIG. 94.—Operation of the cherry-picker car changer.

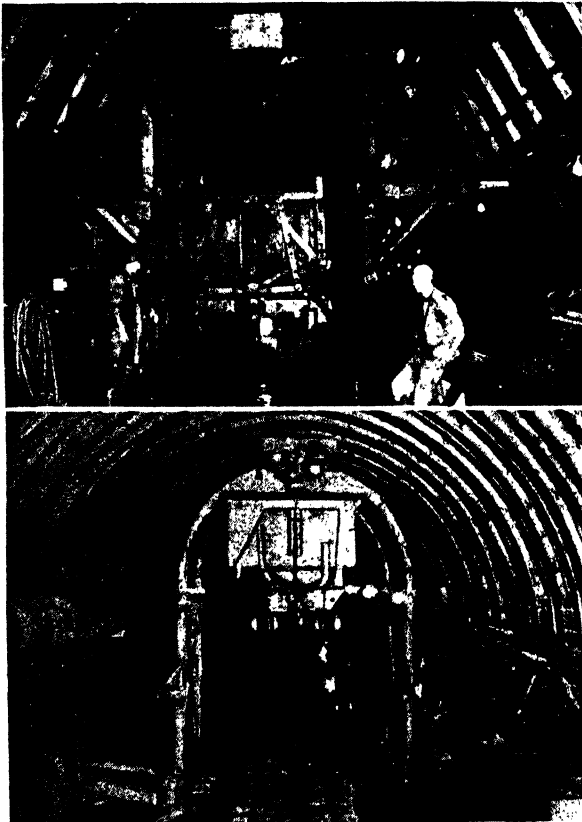

FIG. 95.—Two types of vertical cherry picker. These can be used only in tunnels high enough to permit the loaded cars to pass underneath but are suitable for single-track tunneling operations.

It stops a moment to leave the hindmost car under the cherry picker, which sets it to the side; then the locomotive advances to remove the loaded car from the mucker, this car having been left

there from the previous train. The locomotive then retreats until the cherry picker can set the empty car back on the track in a position for pushing ahead to the mucker. Meanwhile, the last empty car has been uncoupled under the cherry picker. This operation continues until all empties have been transferred from rear to front for filling. An empty car is always left at the

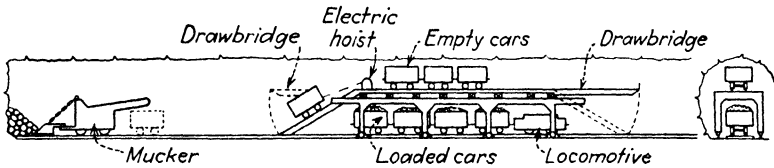

FIG. 96.—The Grasshopper car changer. Empty cars are stored on the upper level; loads are hauled back at main track level; the ramps to upper level lift up to clear passing cars below.

mucker, when the locomotive starts for the portal, to become the first car of the next trip.

Another type of cherry picker is shown in Fig. 95. This type picks the empty car up high enough to clear the train below.

Grasshopper.—The King Grasshopper, used extensively on the Colorado River Aqueduct tunnels, Fig. 96, consists of a gantry about 60 ft. long, carrying a track of sufficient length to hold a train of cars. At each end of the gantry is a hinged draw-

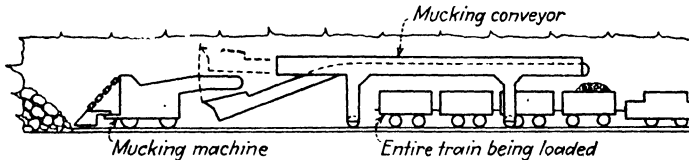

FIG. 97.—Dixon conveyor, which loads an entire train of cars without switching. A train of empties is shoved under the conveyor, then is pulled back slowly to spot each car under the discharge end of the belt for loading.

bridge, which, when lowered, connects the top track with the main line. When the locomotive arrives pushing a string of cars, the rear drawbridge is lowered and the entire string of empties is pulled onto the overhead track by means of a hoist. The locomotive stays on the main track and pulls the loaded cars away from the mucker. The empties are run down the forward drawbridge as required, and are allowed to coast to the shovel.

The Grasshopper is supported on a movable framework which straddles the muck track and operates on a wide-gage track;

the whole assembly can be rapidly run back when shooting. Many contractors have mounted the rock drills on the front end of the Grasshopper, which then serves as both drill jumbo and car changer.

Dixon Conveyor.—The Dixon conveyor consists of a belt conveyor, 36 in. wide and about 70 ft. long. The rear 50 ft. of conveyor is horizontal, carried on a gantry frame running on wide-gage rails permitting the empty muck cars to be run under-

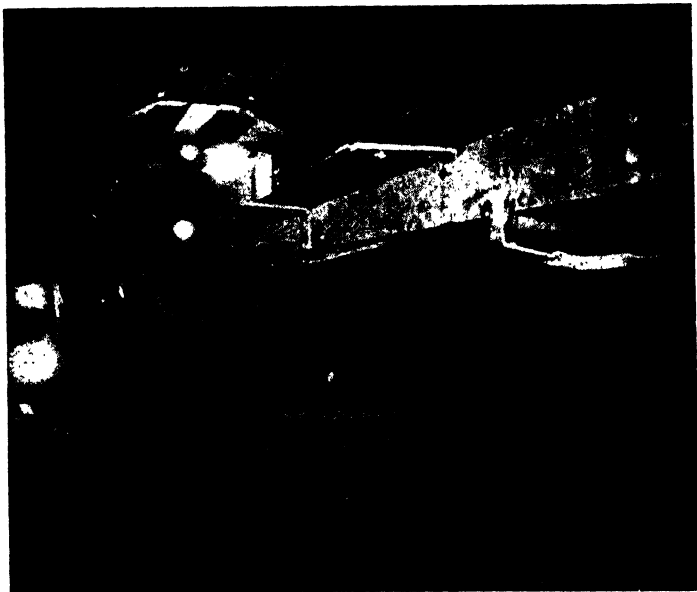

FIG. 98.—Mucking machine (right) feeding into boot of a Dixon conveyor. The inclined end of the conveyor may be raised to permit the mucking machine to pass underneath. (Courtesy of Jeffrey Mfg. Co.)

neath, Fig. 97. The front end on the conveyor is inclined, but can be raised to a horizontal position by means of pneumatic cylinders to clear the mucking machine.

The mucking machine loads directly into a boot hopper at the forward end, Fig. 98, and the muck is carried back into the empty cars. The Dixon conveyor is not actually a car changer, but instead enables an entire train to be loaded without switching. The only delays in this system will be waiting for the next empty train to arrive from the nearest passing track. The rig can also be used as a drill carriage by providing drill mountings at the front end.

CHAPTER 7

TUNNEL HAULAGE

Haulage is one of the most important links in the chain of tunneling operations. Poorly organized or inadequately equipped haulage will cripple any tunnel job and create a bottleneck that will slow up progress regardless of efficiency of other operations. Proper haulage equipment starts with good track and continues through well-planned switching and car changing layouts, selection of cars, adequate motive power and efficient train movements.

TRACK

Properly laid track is the keynote of efficient haulage operations, but, unfortunately, many contractors do not give tunnel trackage proper consideration. All too often scrap rail is used, which may be too light or too badly bent and warped to provide the satisfactory and economical haulage that successful tunneling requires. Poorly laid track will increase haulage friction as much as 10 lb. per ton. This may mean that, instead of easily hauling five cars, for example, a locomotive will have trouble in handling four cars, thus increasing the hauling costs by at least 25 per cent. Poor track also means slower travel of trains, which may require an extra locomotive to serve the mucking machine properly. Poor track inevitably results in numerous and costly derailments; every derailment will tie up the job for at least 15 min. and costs about 1 per cent of the daily payroll.

Next to improper rails, the greatest cause of poor track is haste and carelessness in laying. The muck track is extended after each round by the mucking crew. As they are always in a hurry, and track-laying is a disagreeable chore to them, they usually lay the track just well enough to last out the shift.

To overcome this neglect of proper installation of track, the well-organized tunnel job will have a separate track crew to lay and maintain all track. Once or twice a week, on a drilling shift or on a Sunday shutdown of other operations, they will tear

out the temporary track laid by the muckers and replace it with longer rails and better ties, properly ballasted. If the track is to serve the concreting operations later, this is the time to build it to proper line and grade. Well-laid track should require but little maintenance under the light trains and slow speed of tunnel traffic, but whatever maintenance is required should be done promptly before the track gets into bad shape and causes derailments or slows up haulage.

Gage of Track.—The gage of track used in tunnel construction is almost always 24 in. or 36 in. Other gages, used only occasionally, are 30 in., 42 in. and standard ($56\frac{1}{2}$ in.). For very small tunnels, gages of 12 in., 15 in. or 18 in. are used, but there seems

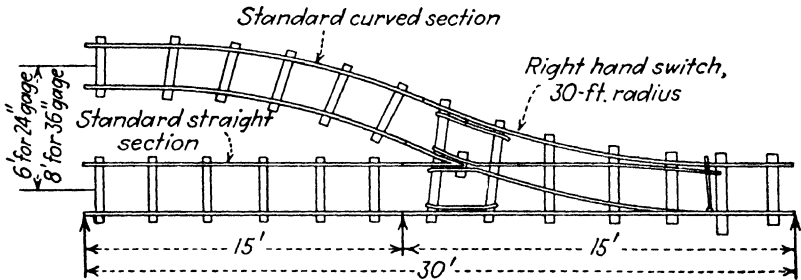

FIG. 99.—Standard narrow-gage portable track.

to be no uniformity in these smaller sizes. In countries using the metric system, the gages commonly used are 60 cm. ($23\frac{5}{8}$ in.) and meter ($39\frac{3}{8}$ in.).

As most cars and locomotives have a width twice that of the track gage and since it is necessary to pass two cars in the tunnel, the gage should be about one-fourth of the tunnel width; in other words, 24-in. gage tracks would be used in tunnels from 8 ft. to 14 ft., and 36-in. gage on larger tunnels. The most potent factor in choosing the gage of track, particularly for short tunnels, is the type of equipment the contractor has available. Another point governing the selection of the gage is the sharpness of the curves; the sharper the curve the smaller the gage should be.

Rail.—Rail is classified by weight per lineal yd. and sold by the ton. Purchaser should make sure whether the quotation is for short tons or long tons. Standard length rails are 30 ft. for weights up to 45 lb. per yd. and 33 ft. for 50 lb. or heavier, including 10 per cent of shorter rails, but none shorter than 24 ft. Rails can also be bought "fixed length" and "mill length."

Rails should not be too light, for inadequate weight rails result in frequent derailments and excessive maintenance. Various tables are given in the rail handbooks recommending weights of rail for various wheel loads and tie spacings, but track in tunnel receives unusually hard service. Unfortunately, the track is often hastily and poorly laid and is rarely given even the most rudimentary ballasting. Therefore, it will be wise to use a heavier rail than shown in Table I, which will eliminate surface bending of the rail and consequent increased friction. Heavier

TABLE I.—RECOMMENDED MAXIMUM LOAD, ONE WHEEL, IN POUNDS

Weight of rail, pounds per yard	Tie spacing, inches			
	24	30	36	42
8	800	600	500	400
12	1,800	1,300	1,100	1,000
16	2,700	2,200	1,800	1,500
20	3,800	3,100	2,500	2,100
25	4,700	3,800	3,100	2,700
30	6,700	5,400	4,500	3,900
35	8,100	6,400	5,400	4,600
40	9,700	7,700	6,400	5,500
45	11,300	9,100	7,600	6,500
50	13,300	10,600	8,900	7,600
55	15,300	12,300	10,200	8,800
60	17,700	14,100	11,600	10,000

rails reduce "pumping" of the ties. Note that stiffness of a rail varies with the square of the weight; therefore, by using a 30-lb. rail instead of a 25-lb. rail, the *stiffness* is increased 44 per cent, whereas the *strength* of the rail, which varies as the $\frac{3}{2}$ power of the weight, is increased 32 per cent. The increased weight (or cost) is 20 per cent. Referring to Table I, a 4,500-lb. wheel load requires a tie spacing of 24 in. when 25-lb. rail is used, but only a 36-in. tie spacing with 30-lb. rail. Thus a 20 per cent increase of rail weight would save 33 per cent in the number of ties.

Table II gives the pertinent dimensions and information on the A.S.C.E. rails. The newer, heavier rails are mostly rolled to the A.R.A. cross section whose height is slightly greater than its base. In buying used, or "relayers," rails, it is well to investigate

the cross section. Prior to 1891, there was no uniformity in cross section. Rails rolled during that time may still be satis-

TABLE II.—DIMENSIONS AND WEIGHTS OF LIGHT RAIL, A.S.C.E. SECTION

Weight of rail, pounds per yard	Height and width of base, inches	Width of head, inches	Section modulus	Weight of rail for 100 ft. of track, pounds	Weight of one pair of splice bars and 4 bolts, pounds	Size of bolt, inches	Size of spike, inches
8	$1\frac{9}{16}$	$\frac{3}{8}$	0.32	533	2.45	$\frac{3}{8} \times 1\frac{1}{2}$	$\frac{3}{8} \times 2\frac{1}{2}$
12	2	1	0.63	800	4.24	$\frac{1}{2} \times 1\frac{3}{4}$	$\frac{3}{8} \times 2\frac{1}{2}$
16	$2\frac{3}{8}$	$1\frac{11}{16}$	1.01	1,067	5.16	$\frac{1}{2} \times 1\frac{3}{4}$	$\frac{3}{8} \times 3$
20	$2\frac{5}{8}$	$1\frac{3}{2}$	1.43	1,333	5.69	$\frac{1}{2} \times 2$	$\frac{3}{8} \times 3\frac{1}{2}$
25	$2\frac{3}{4}$	$1\frac{1}{2}$	1.77	1,667	6.56	$\frac{1}{2} \times 2\frac{1}{4}$	$\frac{1}{2} \times 4$
30	$3\frac{1}{8}$	$1\frac{1}{8}$	2.53	2,000	8.99	$\frac{5}{8} \times 2\frac{1}{2}$	$\frac{1}{2} \times 4$
35	$3\frac{5}{16}$	$1\frac{3}{4}$	3.02	2,333	9.26	$\frac{5}{8} \times 2\frac{1}{2}$	$\frac{1}{2} \times 4\frac{1}{2}$
40	$3\frac{1}{2}$	$1\frac{7}{8}$	3.62	2,667	14.33	$\frac{3}{4} \times 3$	$\frac{1}{2} \times 5$
45	$3\frac{11}{16}$	2	4.25	3,000	16.71	$\frac{3}{4} \times 3$	$\frac{9}{16} \times 5\frac{1}{2}$
50	$3\frac{7}{8}$	$2\frac{1}{8}$	4.98	3,333	19.17	$\frac{3}{4} \times 3\frac{1}{4}$	$\frac{9}{16} \times 5\frac{1}{2}$
55	$4\frac{1}{16}$	$2\frac{1}{4}$	5.75	3,667	31.81	$\frac{3}{4} \times 3\frac{1}{2}$	$\frac{9}{16} \times 5\frac{1}{2}$
60	$4\frac{1}{4}$	$2\frac{3}{8}$	6.62	4,000	35.33	$\frac{3}{4} \times 3\frac{1}{2}$	$\frac{9}{16} \times 5\frac{1}{2}$

factory for tunnel use, but, unless the splice bars and switch material are included, these accessories will be difficult to obtain.

When trolley locomotives are used, the rails must also serve as the ground return. Because of the low conductivity of iron,

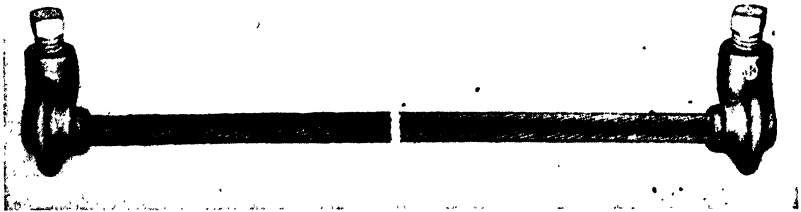

FIG. 100.—Copper rail bond, attached to base of rail by setscrews to improve conductivity of ground return past rail joints. (Courtesy of Ohio Brass Co.)

the weight of rail required may be governed by conductivity rather than by the wheel load. All joints should, of course, be bonded by copper bonds welded, or bolted, to the rail, Fig. 100. On some jobs an old piece of copper cable is laid along the tunnel,

occasionally tied to the rails, so that it is not necessary to depend on the rails alone for the ground return.

Ties.—Ties may be of wood or steel. For 24-in. gage track, common practice is to use a portable track made up of two 15-ft. lengths of 25-lb. rail, bolted or riveted to five corrugated steel ties. Two men can rapidly unload and lay track of this type; a 15-ft. length weighs about 350 lb. Curved sections and complete switches can easily be obtained (all interchangeable, Fig. 99), and these assembled units make an ideal track system for short tunnels and light loads. Portable track becomes unwieldy for wider gages or longer rails; it is seldom used for more than 24-in. gage track.

For rails of standard length, 30 or 33 ft., wood ties are used. For rails 16 lb. or under, a tie 3x4 in. is satisfactory. A 4x6-in. tie may be used on rails of 20, 25 or 30 lb.; and a 6x6-in. tie for rails of 35 lb. to 45 lb. Above 50 lb., the standard tie, 7x9-in., should be used. Ties are 4 ft. long for 24-in. gage, 5 ft. long for 36-in. gage and 8 ft. long for standard gage. The size and spacing of ties are governed by wheel load, train frequency, and sometimes by soil conditions.

For tunnel work it is good practice to use a certain number of steel ties for the temporary track at the face. The rails should be in short lengths, 5 ft. and 10 ft. being most common. After each round, the track is extended to the face and bolted to steel ties by the mucking gang. Once or twice a week the track gang tears out this temporary track and lays permanent track with 30-ft. rails spiked to wood ties. The short rails and steel ties are, of course, laid aside for the muckers to use again.

Square, chisel-pointed spikes are used for holding the rail to the tie. They should be driven so the point cuts rather than splits the wood. Each pair of spikes should be staggered, and opposite pairs of spikes in the same tie should be driven on opposite diagonals. The spike must not be too big for the tie. In Table II are given the recommended spike sizes.

Curves.—Curves in track add greatly to the power required to move a car; therefore the radius should be as large as possible. Occasionally in tunnel work there will be sharp angles to be passed, which will make it difficult to lay track within the minimum radius. If there is to be much haulage around such a curve, it will pay to widen the excavation so that, by swinging

the track over to the wall, a curve of acceptable radius can be obtained.

The permissible minimum curvature is a function of the fixed wheel base, gage of track, and diameter of wheel. Roughly, the minimum radius can be assumed, for narrow-gage cars, as six times the wheel base; therefore, if the wheel base is 3 ft. 6 in., the minimum radius of curvature is 21 ft. Portable track is made up in curved 15-ft. sections with a radius of 30 ft. or 60 ft.

Railroad curves are measured in degrees. A light freight engine can negotiate a 16-deg. curve (359-ft. radius). Standard-gage construction "dinkeys" have shorter wheel bases and can negotiate sharper curves.

TABLE III.—MIDDLE ORDINATES OF CURVED RAIL, IN INCHES

Length	Radius of curve, feet								
	20	25	30	40	50	70	100	150	200
10-ft. chord.....	$7\frac{3}{8}$	$6\frac{1}{16}$	5	$3\frac{3}{16}$	$3\frac{1}{8}$	$2\frac{1}{8}$	$1\frac{1}{2}$	1	$\frac{3}{4}$
15-ft. rail (arc).....	$16\frac{1}{4}$	$13\frac{7}{16}$	$11\frac{3}{8}$	$8\frac{3}{8}$	$6\frac{3}{4}$	$4\frac{1}{16}$	$3\frac{3}{8}$	$2\frac{1}{4}$	$1\frac{1}{8}$
30-ft. rail (arc).....	$64\frac{7}{16}$	$52\frac{7}{16}$	44	$33\frac{3}{8}$	$26\frac{1}{2}$	$19\frac{7}{8}$	$13\frac{1}{2}$	9	$6\frac{1}{4}$
33-ft. rail (arc).....	$77\frac{1}{8}$	63	$53\frac{1}{8}$	$40\frac{1}{4}$	$32\frac{3}{4}$	$23\frac{1}{4}$	$16\frac{1}{4}$	$10\frac{7}{8}$	$8\frac{1}{8}$

Rails must be bent to curvature before laying by means of a railbender, commonly called a "Jim Crow." Table III gives the middle ordinate of curves of different radiuses. The first line is for a straightedge or chord 10 ft. long. The other lines are for rails of standard lengths; these are checked by stretching a string from end to end of the rail along the arc or curved length.

The gage of track must be widened on curves to allow play for the wheel flanges, $\frac{1}{2}$ in. is generally used on curves of 30-ft. radius. Where curves are sharper than the allowable minimum (six times the wheel base), the gage should be widened out as much as the tread of the wheel will allow.

Switches.—Switches are described as right-hand, left-hand or Y. Construction track follows railway practice in using the split type switch. Occasionally on small jobs the finger switch is used, Fig. 101. This is invariably made by the local blacksmith. It works very well for small cars, particularly when animal haulage is employed.

The principal parts of the split switch are shown in Fig. 102.

The points are machined to fit snugly against the rail. There are one or more bridles to tie the points together. Slide plates are used under the rails to hold the points to proper elevation.

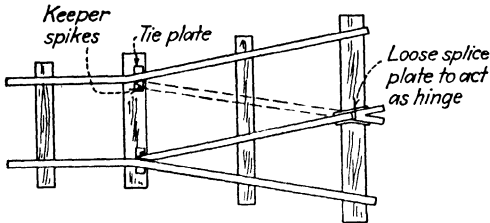

FIG. 101.—Simple finger switch. This type is not recommended for fast or heavy traffic.

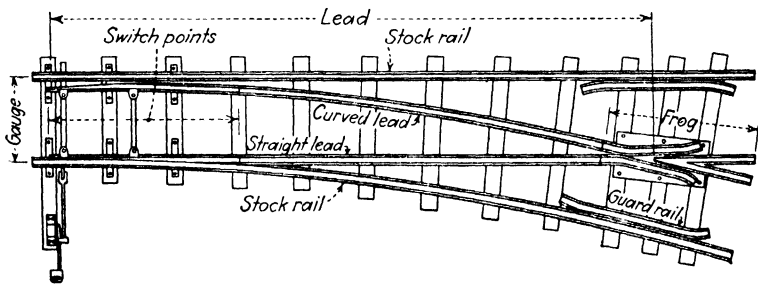

FIG. 102.—Principal parts of a standard right-hand switch.

The switch stand should be of the simplest kind, the type known as the "ground throw" and working at right angles to the rails being the commonest. It can be mounted on one long tie.

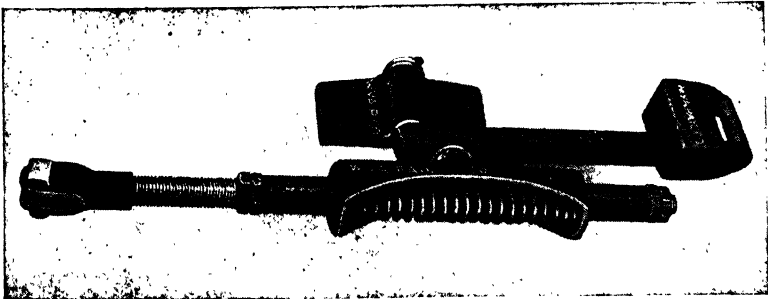

FIG. 103.—Ground throw combined with a spring to make a spring switch.

The "parallel ground throw" is a little safer for the switchman, but it requires two ties to support it. The throw is $3\frac{1}{2}$ in. for rails up to 35 lb., and 4 in. for heavier rails.

Spring switches are very desirable for construction purposes, for trains can run through them from either direction without damaging the points. Ground throws can be purchased with

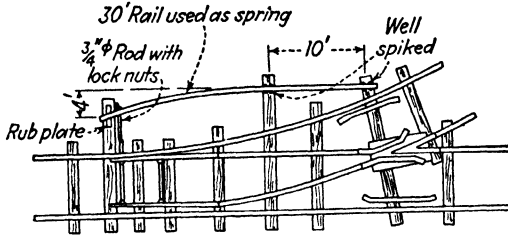

Fig. 104.—Spring switch, with a cantilevered rail acting as the spring.

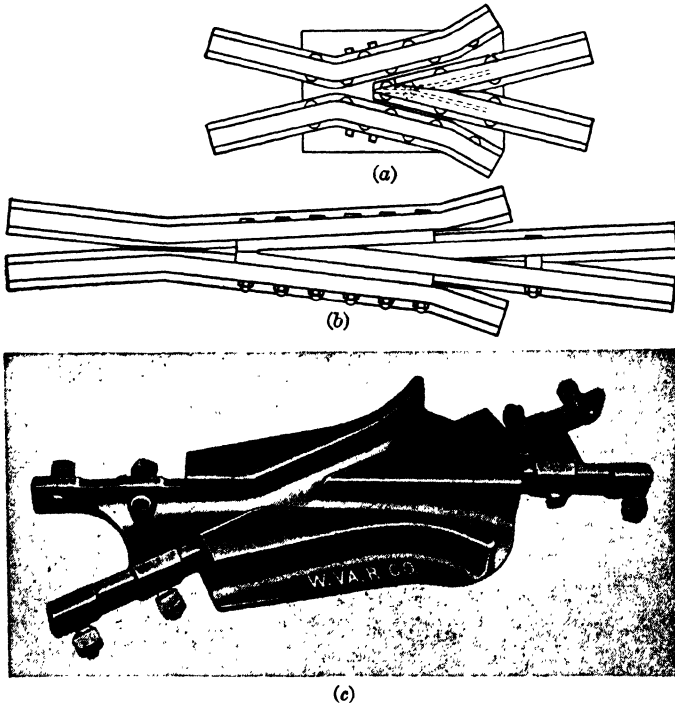

Fig. 105.—Three common types of frogs. Top, riveted-plate frog; center, rigid bolted frog; bottom, cast-steel frog, splice bars cast with the frog.

these springs, Fig. 103. Thus the switch can be thrown either way, yet the points are always protected by the springs from traffic coming out of the other track. If the spring switch need only operate in one direction, a 30-ft. length of rail can be used

for the spring as shown in Fig. 104. Spring switches are big savers of time and labor if properly used.

The frog serves to carry the flange of the wheel through the outer rail of the other track. For smaller rails, these are assembled and riveted to a rectangular base plate, Fig. 105a. For heavier rails, the frog is bolted together with the proper fillers, Fig. 105b. Cast or manganese frogs are sometimes used, Fig. 105c; these are shorter than ordinary frogs. Frogs are numbered, the number being the length divided by the spread. The number can be readily found in the field by laying a pencil across the frog at a point where the width of the frog is equal to the length of the pencil, then "stepping off" the length from that spot to the point of the frog. The number of pencil lengths in this distance is the number of the frog.

The guard rails are located on the outside rails opposite the frog. They are very important since they prevent the wheel flange from hitting the point of the frog. The flangeway should be $1\frac{3}{4}$ in. Guard rails must be well spiked.

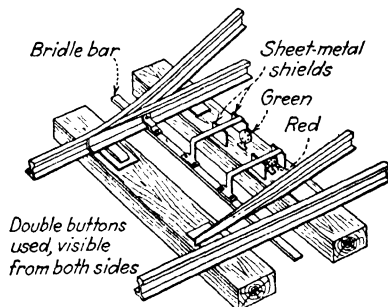

FIG. 106.—Switch indicators made from double-faced reflector buttons. The buttons, red and green, are mounted on a switch tie. A shield, attached to the switch bridle bar, hides one or the other indicator, according to position of the switch points. (From *Coal Age*, February, 1939.)

Selecting the Switch.—There are a number of satisfactory combinations of frogs and points, but the contractor should standardize on one combination as far as possible. The No. 4 frog and 6-ft. switch points are acceptable for both 24- and 36-in. gage track. There are few jobs where this combination will not fulfill all requirements. For Y switches, a frog of about half that number, say a No. 2 or No. $2\frac{1}{2}$, will give approximately the same radius. For the standard-gage switches, a No. 6 frog is about the sharpest a switch engine can negotiate. Freight locomotives can pass a No. 8 frog. Switch data are given in Table IV.

Jumper Switches.—Jumper switches, Fig. 108, are switches laid directly on top of the running track without breaking it. There must be climber points at the ends to raise the wheels from

TABLE IV.—CHARACTERISTICS OF SWITCHES
For rails weighing 12 to 35 lb. per yd.

Gage track, inches	Frog number	Frog length	Angle	Length switch points	Rad. center line of curve	Lead distance	Straight closure	Curved closure
24	3	3' 6"	18° 56'	4' 0"	23' 2 $\frac{1}{4}$ "	11' 2 $\frac{5}{16}$ "	5' 9 $\frac{1}{2}$ "	6' 0 $\frac{1}{2}$ "
24	4	4' 0"	14° 15'	6' 0"	42' 6 $\frac{3}{8}$ "	15' 3 $\frac{1}{4}$ "	7' 9 $\frac{1}{4}$ "	7' 11 $\frac{1}{4}$ "
36	3	3' 6"	18° 56'	4' 0"	42' 5"	15' 11 $\frac{7}{8}$ "	10' 7 $\frac{1}{8}$ "	10' 11 $\frac{3}{4}$ "
36	4	4' 0"	14° 15'	6' 0"	76' 2"	21' 6 $\frac{5}{8}$ "	14' 0 $\frac{5}{8}$ "	14' 3 $\frac{5}{8}$ "

For rails weighing 40 to 60 lb. per yd.

24	4	5' 0"	14° 15'	6' 0"	38' 3 $\frac{1}{4}$ "	14' 11 $\frac{3}{4}$ "	6' 11 $\frac{1}{2}$ "	7' 1 $\frac{1}{4}$ "
36	4	5' 0"	14° 15'	6' 0"	69' 10 $\frac{1}{4}$ "	21' 3 $\frac{1}{8}$ "	13' 2 $\frac{1}{2}$ "	13' 6 $\frac{1}{4}$ "
36	5	5' 6"	11° 25'	7' 6"	117' 5 $\frac{1}{4}$ "	26' 9 $\frac{11}{16}$ "	17' 1 $\frac{3}{8}$ "	17' 4"
56 $\frac{1}{2}$	6	8' 0"	9° 32'	12' 0"	286' 4 $\frac{1}{4}$ "	51' 2 $\frac{5}{8}$ "	36' 2 $\frac{5}{8}$ "	36' 5 $\frac{3}{4}$ "
56 $\frac{1}{2}$	8	10' 0"	7° 9'	15' 0"	517' 10 $\frac{3}{8}$ "	66' 10 $\frac{1}{2}$ "	48' 1 $\frac{1}{2}$ "	48' 3 $\frac{3}{8}$ "

the lower rail to the upper one. The climbers should not have too fine a point; $\frac{1}{4}$ in. is about right, or they will curl up under the

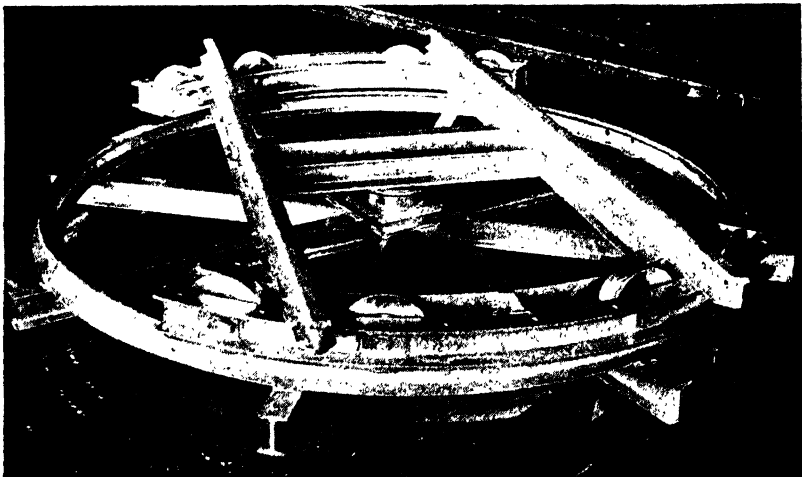

FIG. 107.—Mucking machine turntable for use in small tunnels where the mucker must serve two headings. (Designed by R. S. Mayo.)

pounding of traffic. The jumper switch is tied together with ties of bar iron, generally $\frac{3}{4}$ x 3 in., welded to the underside. Several lugs on the ties hook on each side of the running track to keep the switch from slipping off sideways. These switches are very

convenient for certain mucking schemes (they are used in the California Switch), because they can be readily skidded ahead

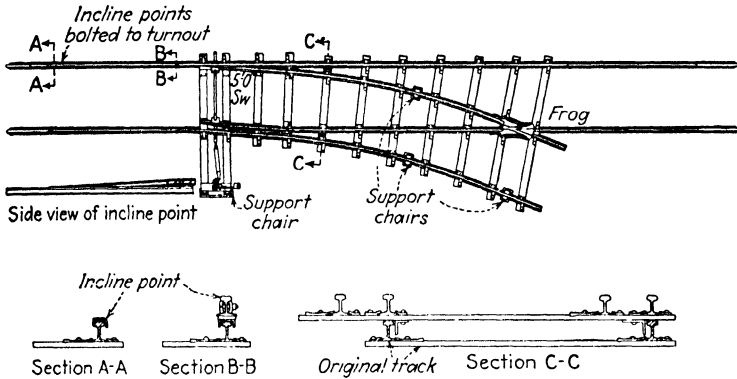

FIG. 108.—Right-hand jumper switch. This switch can be installed at any point on the main line without cutting the rails and can be skidded along as required to keep it close to the face. The overhanging rails must be blocked from the ground. (Courtesy of West Virginia Rail Co.)

without breaking joints. Often, to save height, square bars just high enough to clear the flange of the wheel are used in place of rails.

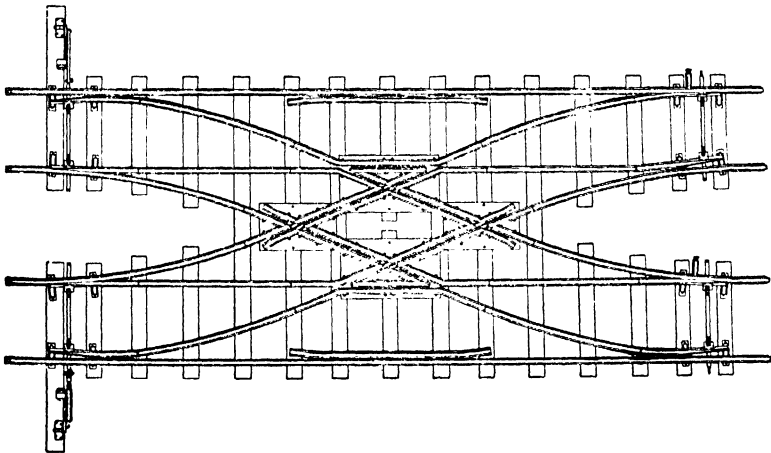

FIG. 109.—Double crossover or diamond switch. This assembly may be made up for either wood or steel ties. Note that three of the switches have spring points. (Courtesy of West Virginia Rail Co.)

Diamond Switch.—The diamond switch or double crossover, Fig. 109, is frequently used at the foot of shaft or at the surface

where cars are handled on to cages. It is a rather complicated switch, and its use should be avoided whenever possible. Its big advantage is its compactness.

TRACK LAYOUT

Considerable thought should be given the track layout for tunnels. On many jobs the switches are laid out in a haphazard fashion, resulting in confusion and lost motion. One common fault is lack of sufficient storage tracks for cars not in use; as a result, they must be taken to the surface or they are continually in the way. Such cars will be concrete, nipper and flat cars, scaling scaffold and perhaps a concrete placer. These cars are used once every day, so they might as well be left in the tunnel.

Spring switches should be employed wherever possible. These save stopping the train to throw the switch.

Since starting resistance is about twice rolling friction, every effort should be made to lay tracks to grades favorable to the loaded cars. This is especially important at the shaft when the cars are to be caged by hand. Just a slight fall in the loaded car track will be a big help in getting the cars started. Safety dogs should be placed at the head of any sharp grade to prevent cars from running away. These dogs should be hand-operated in one direction but have a spring allowing cars to pass through them in the up direction.

Where hand trammers are employed, the track layout should be as compact as possible to save steps and the switch curves, particularly for the loaded cars, as easy as practical.

Track at Foot of Shaft.—Figure 110 shows typical layouts at foot of shaft where the cars are caged by hand.

Sketch *A* shows a layout for a single cage shaft. Note that both switches for the muck track can be spring operated. Sketch *B* shows the standard layout for a two-cage shaft. A double crossover, or diamond switch is used. Note that three of the four switch points can be spring actuated. These schemes are employed where the cars are on the heading end of the locomotive, that is, the loads are pulled out, and the empties are pushed in.

Where the muck cars are switched in the heading by some type of cherry picker, the locomotive pulls the loads out and must also pull the empties in. Sketch *C* shows a "Run around track" where the locomotive, after the loads are cut off, can run around

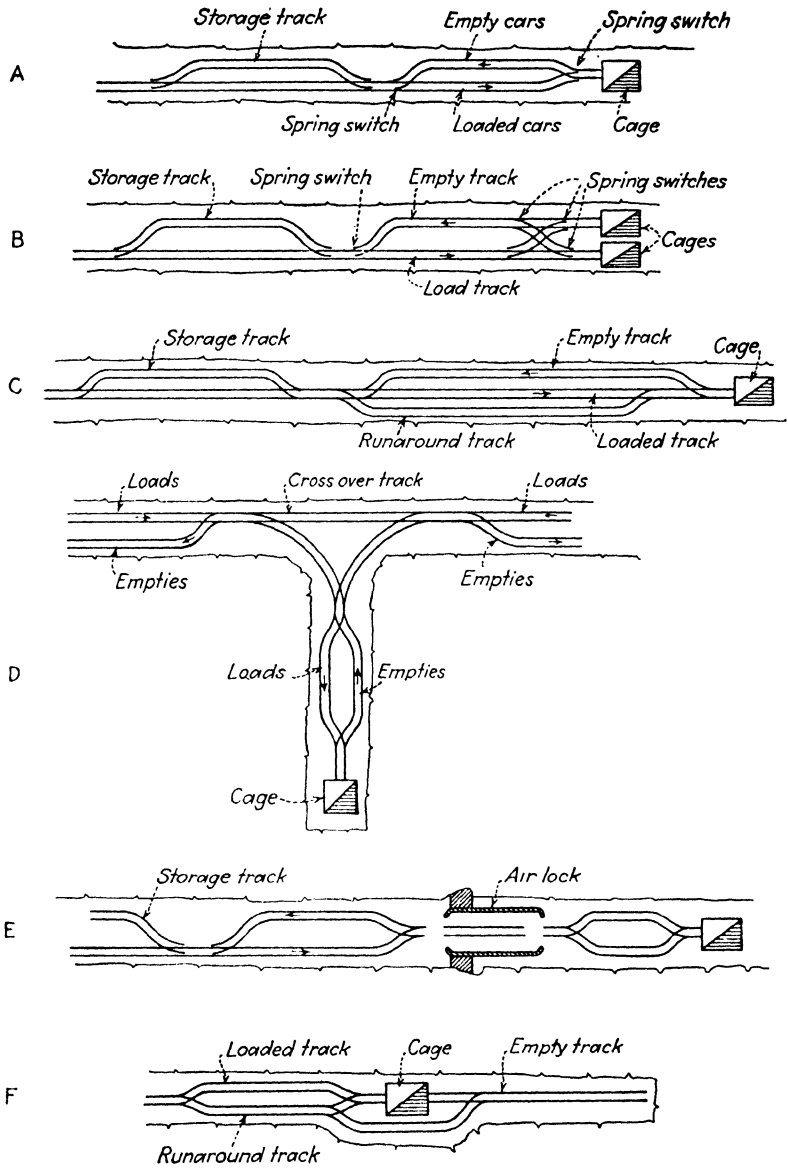

FIG. 110.—Various track layouts at foot of shaft for cage hoisting.

them and get in front of the empties. When a locomotive is employed for caging cars, the track layout need not be so compact as shown here, eliminating the need of three tracks at the one point.

Sketch *D* shows the typical layout when the shaft is located in a drift to one side. Every effort should be made to have these curves as easy as possible.

Sketch *E* shows the typical layout for track in small tunnels equipped with a single air lock. There should be a loaded and empty track on both sides of the lock. A storage track should be provided in the high-air heading to avoid locking through the

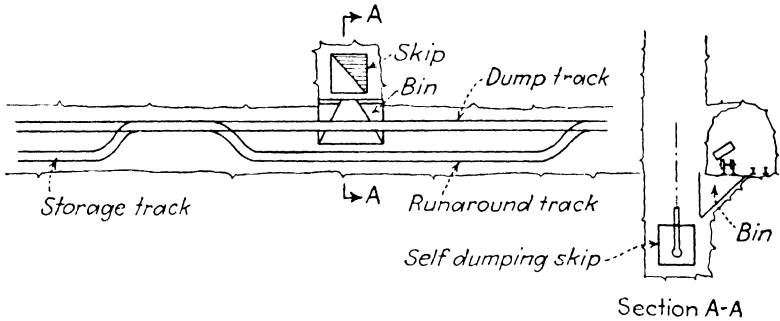

FIG. 111.—Typical double-heading track layout at foot of shaft for skip hoisting.

extra cars. Where two air locks are employed, a double crossover switch must be located on both sides of the locks.

If locomotives are used for caging the cars, the empty track should be on the opposite side of the cage, as shown in Sketch *F*; as the locomotive shoves the load on, the empty car is shoved off. The track should be on a downgrade from the shaft so the empties will run away from the cage.

Where hoisting is done with a self-dumping skip, a muck bin under the track is required, Fig. 111. Cars are dumped one at a time without uncoupling from the locomotive. A run around should be provided so the train standing at the dump will not block other traffic, also so that the locomotive can be placed at the other end of the train.

Block System.—A tunnel is rarely big enough to warrant double track throughout. If it is, generally sections of the tunnel are occupied by grouting or concrete gangs; so portions must be operated as single track anyway. For single track, passing tracks

should be not more than $\frac{1}{4}$ mile apart; the sidings should be long enough to hold an average train. If no more than two locomotives are working in one heading, no block system is required. The motormen signal "come ahead" or "wait" by blinking their headlights. A simple block system is shown in Fig. 113. A



FIG. 112.—Track layout for skip hoisting at foot of single heading shaft. Man and material cage is at extreme left. (*J. D. Jacobs Photograph.*)

double-throw single-pole knife switch is located at each end of the block, connected with two lamps in series, one lamp at each end. Thus a motorman coming from either way can light the lamps to signify that the block is occupied. He must of course break the circuit when he clears the block. These switches should be

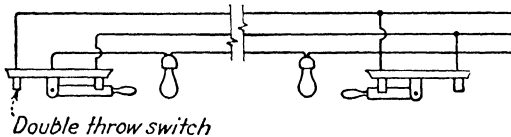

FIG. 113.—Diagram of tunnel-track signal-block system.

located where the motorman can throw them without stopping his train.

Track Layout on Surface.—A typical track layout for the surface where the cars are hoisted to ground level is shown in Fig. 114. On the left of the shaft are the dump tracks over the top of the muck bins. Note the layout with spring switches with the

empties all standing on the center track. To the right of the shaft are the tracks on the surface which are served by a landing

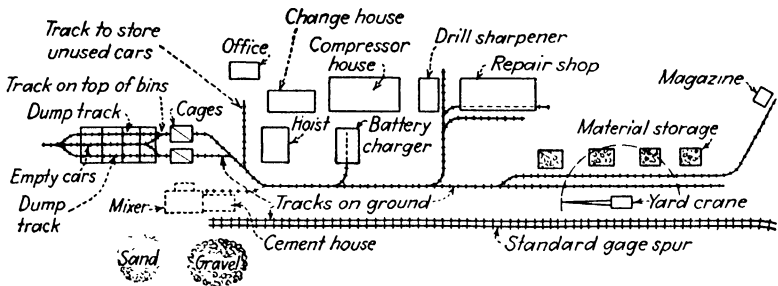

FIG. 114.—Typical surface-track layout.



FIG. 115.—Track layout at downstream portals of Fort Peck Dam diversion tunnels, an example of well-laid track. Haulage was by trolley locomotive; 36-in. track gage; 56-lb. rail. (U. S. Engineer Dept. Photograph.)

of the cage at ground elevation. Close to the shaft should be a track for the storing of unused cars. Near by should be the battery charging house with a track leading into it. Another

spur runs to the drill sharpener house where the nipper car can be loaded and unloaded. There should be two tracks at the repair shop; one inside for the repair of electric locomotives and one outside where cars can be worked on. Several tracks should lead into the material yard, where there should be ample storage room for the yard crane to load cars on the day shift, which can be left there until required at night. A spur must lead to the dynamite magazine. Another spur should lead to the cement house and to the sand pile for carrying into the tunnel the material required for grouting.

Surface track layouts will vary according to the size of the job and the topography, but the contractor should not handicap operations with insufficient track for the rapid loading and dispatch of material cars. In Fig. 115 is shown the track approaching the portals of the four Fort Peck tunnels.

CARS

Selecting the correct type and size of car for the work in hand is very important. All types of standard cars are available, and special cars can be quickly obtained. A few years ago, wood body cars were quite popular with contractors, not only because they were slightly cheaper, but because it was easier to repair them in the field. Today, as every tunnel job has a shop capable of straightening and repairing steel car bodies, the all-steel car is now standard. Some manufacturers are now offering cars made of special alloy steel, in which, for the same sturdiness there is a 20 per cent saving in dead weight.

The *width* of the car is governed by the tunnel and the gage of track. In general, width of the car should be such as to permit passing within the tunnel. Sometimes the rough width of the tunnel, and sometimes the finished width, will govern, unless there is some switching device adopted that will pass cars by setting them off sideways in wide spots. The over-all width of the car is never more than twice the gage of track.

The *capacity* of the car should be as great as possible within the limits of the tunnel, for larger cars mean fewer switching delays. If switching or caging is done by hand trammers, the size of the car is limited to what one or two men can push. Thus a 1-yd. car is all that one man can switch, and two men will have difficulty in handling 2-yd. cars.

The *height* of the car should be as great as will clear the mucking machine, except that for hand loading the car should be as low as possible.

The *length* of the car is generally about twice the wheel base (which is governed by the minimum radius of the curves) except for eight-wheeled cars, which are seldom used on tunnel jobs. Some types of mucking equipment will not fully load the back end of long cars.

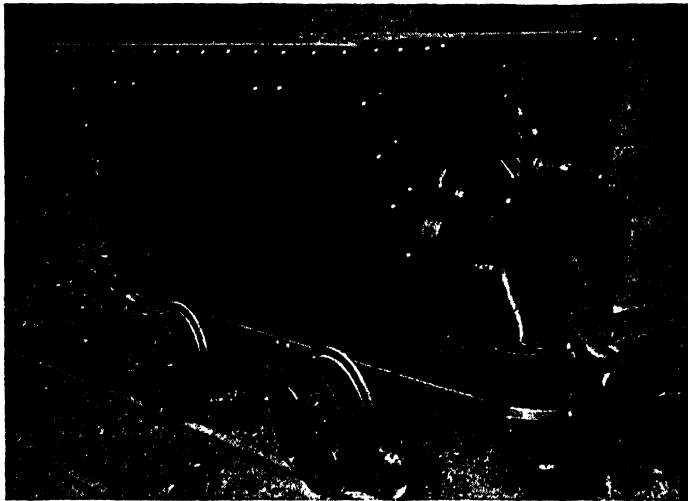

FIG. 116.—Koppel 1-yd. tipover car, 24-in. gage. This V-bottom type of car is popular for hauling sticky clay. Roller-bearing wheels are 12 in. in diameter; the wheelbase is 2 ft. 6 in.; the weight 1,400 lb. when empty.

Type of Car.—The type of car is dependent on the material to be hauled and the method of dump.

The *V-bottom*, tipover car, Fig. 116, is a favorite for small soft-ground tunnels for it is the only type of car that will dump sticky clay efficiently. It can be dumped by two men. This type makes an excellent concrete car, thus often giving it double usage.

The *side dump car*, Figs. 117, 118, is almost standard on rock tunnels. They are compact and of large capacity for their overall dimensions. Some will dump both ways, and others dump only to one side. The side doors either rise or swing outward when dumping. Almost all these cars should be chained to the track when dumping sticky muck to prevent the whole car going over the dump.



FIG. 117.—Easton 2-yd. side-dump car, 24-in. gage. Roller-bearing wheels are 14 in. in diameter. The car has a 30-in. wheelbase and weighs 2,100 lb. when empty.

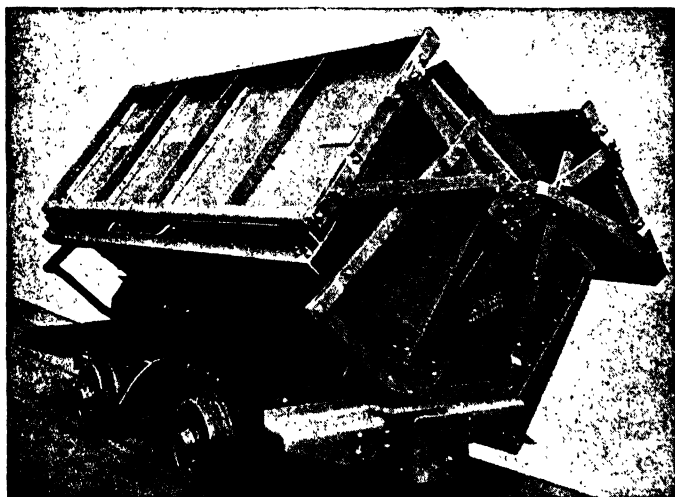

FIG. 118.—Western 6-yd. side-dump car, 36-in. gage, used at Fort Peck tunnels, later shipped to Allegheny Tunnel, Pennsylvania Turnpike. Roller-bearing wheels are 16 in. in diameter; wheelbase is 50 in.; weight, when empty, 7,600 lb. Wooden sideboards, 12 in. high, were added to increase capacity to $7\frac{1}{2}$ cu. yd.

The *Battleship* is a large steel box, Fig. 120, built on the principle of the clamshell bucket. This is carried into the tunnel on flat cars. At the shaft, a double set of spreader beams, with a total of four hooks, is hooked into the four rings on the *Battleship*; the lifting yoke to the end rings and the opening yoke to the side rings. The box is then hoisted by means of a crane and swung over the bin, where, by tightening the opening line, the load is discharged through the bottom.



FIG. 119.—Easton drop-side car fitted with bumper for dumping by pneumatic cylinder hoist.

Muck boxes are generally of hardwood, reinforced with strap iron, running into the tunnel of flat cars. There are rings on each end for lifting and a ring on the bottom for dumping. The lifting line of the crane has a yoke with hooks for engaging the end rings. At the surface, the runner line from the boom is hooked into the ring on the bottom which, when tightened, tips the box over.

The use of *Battleships* and *muck boxes* eliminates guides in the shaft, but the shaft must be large enough so that a spinning box will not strike the walls. They can be used only in shallow shafts. This method is more hazardous than caging cars.

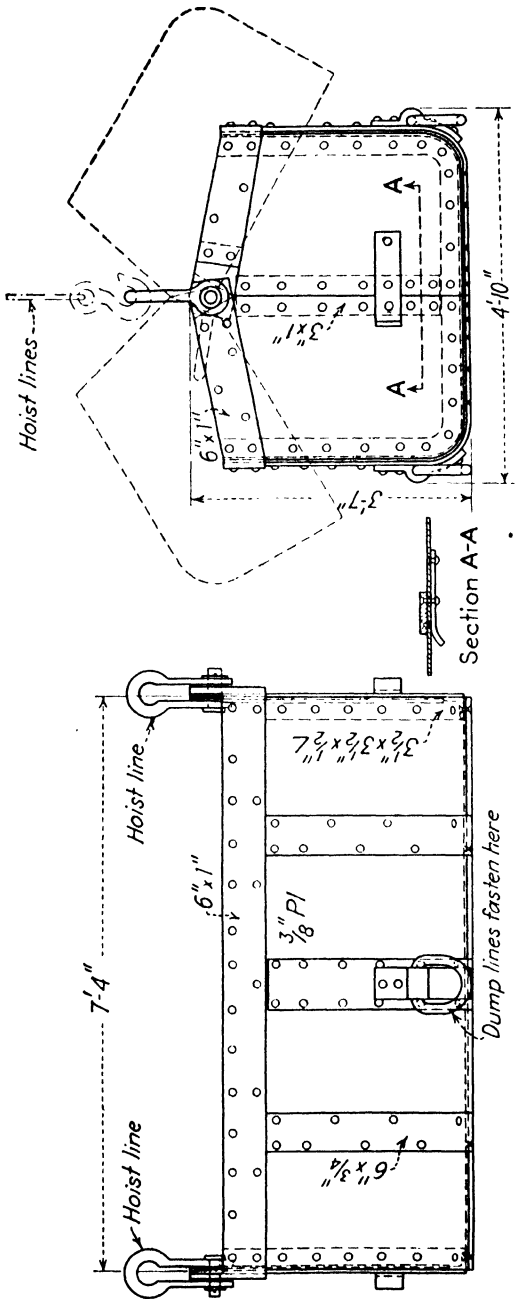

Fig. 120.—Battleship hoist box. This is a steel box hauled into the tunnel on a flat car. If used in shaft tunnels it is usually hoisted by a crane. The Battleship dumps like a clamshell bucket, requiring a two-line hoist.

Quarry cars are not often used in tunnel work but are an excellent type where the material breaks in big blocks. They are not self-dumping; therefore it is necessary to have some kind of air jack or tackle fixed alongside the track to tip the body. This means that they must be used where the dump is fixed, either into a skip hopper or into the storage bins. No doubt, some type of car will be developed on the big tunnels of the future, which, by having some external dumping device, together with high strength alloy steels and anti-friction bearings, will materially increase the haulage capacity and decrease the dead weight.

Special Cars.—Special conditions demand special cars—home-made muck cars for an extremely small tunnel, for example. The side and ends are removable, and, with these removed, the car can be tipped off the track against the wall while the full car passes. The low height of this car, 1 yd. capacity, makes it ideal for hand loading.

Couplings.—The link-and-pin coupling is standard on tunnel cars and is satisfactory for this use. The pins should be chained to the car, so they will not become lost. All locomotives should carry a few extra links and pins to eliminate delays. There is no standard height of coupler for narrow-gage cars. Therefore, in ordering new cars to work with old equipment, the type and location of couplers should be checked. Automatic couplers, similar to those in use on railroads, are now being adopted on some tunnel projects. They save both time and fingers. Safety couplers are described in Chap. 4.

Friction.—The frictional resistance of cars depends on type and condition of bearing, condition of track, curves and grade. For track in fair condition, the following are fair averages:

Plain bearings.....	30 lb. per ton.
Plain roller bearings.....	15 to 20 lb. per ton.
Tapered roller bearings.....	10 lb. per ton.

These values are for small and medium-sized cars. The frictional resistance is less in larger cars. To these figures should be added 20 lb. per ton for static friction and accelerating force. A more complete discussion of train resistance is given in the next section.

HAULAGE OPERATIONS

Trammers.—Almost every job will use trammers (men pushing) for moving cars until the heading has advanced far enough

to give a locomotive room to work. Small, short tunnels may employ men for all haulage, whereas other jobs use men for switching in the heading and caging at the shaft while a locomotive does the hauling from mucker to shaft.

One man can exert a push of 150 lb. for starting a car, 50 lb. for short distances, but only 25 lb. when walking steadily at a rate of about 2 m.p.h., which means that one man can switch cars weighing about $1\frac{1}{2}$ to 2 tons ($\frac{3}{4}$ to 1 cu. yd. loaded) but only tram for long distances cars weighing 1 ton (about $\frac{1}{2}$ cu. yd.). When it takes three men to switch a car, it will probably be more economical to employ a locomotive. Small hoists are frequently used for switching cars at the foot of shaft or through air locks.

Animal Haulage.—Horses and mules were once widely used for haulage in tunnels. Mules are healthier, surer-footed and less nervous than a horse but are lighter and cannot haul so much. Needless to say, any animal working underground should have a placid disposition. A mule can exert a pull of 500 lb. to start a train, 250 lb. for short distances but only 100 lb. for long pulls at a rate of $2\frac{1}{2}$ m.p.h. Thus on level track a mule can handle a gross load of 6 tons. Animals are frequently employed for switching cars in the heading. They become very clever at this.

Animals can be quartered underground. Their stalls should have a dry footing and protect the animal against dripping and strong drafts. They require 10 to 12 lb. of grain or bran and 15 to 20 lb. of hay daily. Regularity of watering is very important. If the work is not too heavy, animals can be worked for 12-hr. shifts.

Train Resistance.—The train resistance is made up of the following items:

Rolling Friction.—This is the journal friction of the cars, measured in pounds per ton of weight. A table for rolling friction for different types of bearings is given in the section on cars, page 130. Naturally, the journals must be kept oiled and cleaned, or journal friction will build up.

Starting resistance includes static friction of the journals and the accelerating force. Generally the slack in the couplers allows the locomotive to start the train progressively; thus static friction itself is not so serious. Static friction and accelerating force are assumed to be a uniform 20 lb. per ton for any type of journal.

Grade resistance is directly proportional to the steepness of grade. Grades on railroads and in tunnels are measured in per cent, a 1 per cent grade being a rise of 1 ft. in 100 ft. of horizontal distance. Each 1 per cent of grade adds (or subtracts) 20 lb. of resistance per ton of weight. Example: A grade of 2.4 per cent adds (or subtracts) 48 lb. per ton of weight. Cars are apt to run away on grades steeper than 1 per cent, and some type of chock or derailer should be installed to protect the men.

Curve resistance depends on sharpness of curve, widening of gage and whether one wheel is free on the axle. Curves add from 25 to 50 per cent to the rolling friction. Fortunately, as most tunnel curves are short, only a part of the train will be on them at one time.

LOCOMOTIVES

Locomotives are classified by weight. They should be mounted on sturdy steel frames to protect the machinery when

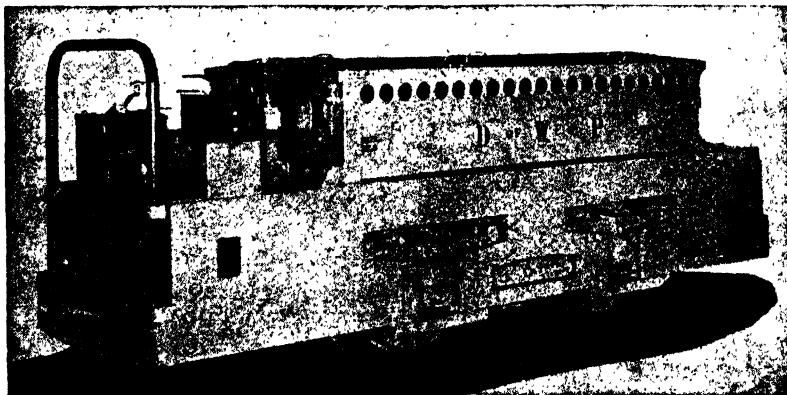

FIG. 121.—Atlas 8-ton storage battery locomotive, 24-in. gage, equipped with two 12-hp. motors and power brakes.

derailed, and be equipped with hand sanders to increase the coefficient of friction on wet rails, headlights on both ends, efficient hand brakes and a commodious tool box for carrying a rerailer and extra links and pins. The machinery must be housed against dripping water.

Tractive Effort.—Every well-designed locomotive should have sufficient power to slip the drive wheels when standing. Therefore, the tractive effort (T.E.) is the coefficient of adhesion of the

wheels on the rails times the weight of the locomotive. This can be safely assumed as 20 to 25 per cent on dry rails. Sanding may increase this to 25 or 30 per cent, but sanding is generally employed only on wet rails.

T.E. = 20 per cent of weight on drivers.

To find the maximum train a locomotive will haul, divide the tractive effort by the train resistance per ton. This gives the total tonnage, including locomotive, that the locomotive will start and move.

Example 1. How many cars will a 4-ton locomotive pull on level track? The cars weigh 1,200 lb. (0.6 ton) empty and 4,200 lb. (2.1 ton) loaded. Friction is 30 lb. per ton for rolling and 20 lb. per ton for starting.

T.E. = 20 per cent of 4 ton = 1,600 lb.

Friction = 30 (rolling) + 20 (starting) = 50 lb. per ton.

Gross load = $\frac{1,600}{50} = 32$ tons, including locomotive.

Thus the locomotive can haul itself and 46 empties or 13 loads.

Example 2. There is a 1.25 per cent grade from the face to the portal. How many empties can the same locomotive haul to the face, and how many loads from the mucker to the portal? Same cars.

T.E. = 1,600 lb.

Grade resistance = 1.25 per cent of 2,000 = 25 lb. per ton.

Upgrade: Friction = 30 (rolling) + 20 (starting) + 25 (grade) = 75 lb. per ton.

Gross load = $\frac{1,600}{75} = 21$ tons, including locomotive.

Thus the locomotive can haul 28 empties upgrade.

Downgrade: Friction = 30 (rolling) + 20 (starting) - 25 (grade) = 25 lb. per ton.

Gross load = $\frac{1,600}{25} = 64$ tons, including locomotive.

Thus the locomotive can haul 28 loaded cars downgrade.

Example 3. How many cars of concrete, loaded weight 5,200 lb. (2.6 ton) can a 4-ton locomotive push up a 10 per cent incline? The locomotive can "take a run at it."

T.E. = 20 per cent of 8,000 lb. = 1,600 lb.

Grade Resistance = 10 per cent of 2,000 = 200 lb

Gross load = $\frac{1,600}{230} = 7$ tons, including locomotive.

Thus the locomotive, by running for the grade to eliminate starting resistance, can handle only one loaded car up this grade.

Although these calculations show the maximum a locomotive can handle under certain conditions, the contractor should not

overload the locomotive. It is better to purchase the next larger size of locomotive which will provide at least 50 per cent margin for possible overloads.

Battery Locomotives.—Battery locomotives, Fig. 121, are an ideal tunnel haulage unit. They are self-contained and powerful and are used on almost all tunnel jobs. They can be safely fitted with both hand and electric brakes.

Their disadvantages are that the batteries may become sluggish toward the end of a hard shift, and that the locomotive must be run outside every shift to get a fresh battery unless an underground battery charging station is installed.

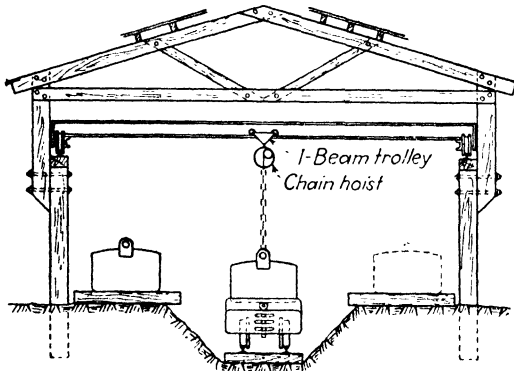

Fig. 122.—Simple battery charging station for tunnel locomotives.

The storage batteries are proportioned generally to give 8 hr. of work. It takes about 8 hr. to recharge a battery; therefore, there should be two batteries for each locomotive. Some device must be installed in the charging house, Fig. 122, for lifting the old battery off the running gear and setting in a fresh one. This changeover should not take longer than 5 min.

Trolley Locomotives.—Trolley locomotives are a compact and efficient haulage unit, receiving electric power from an overhead wire, generally of 220–250 volts, d.c. As the trolley wire must be kept at least 200 ft. away from the face to protect it from fly rock and to give the mucker room to work, these locomotives are provided with cable reels, Fig. 123. The end of the insulated wire on the reel is hooked to the end of the trolley wire so the locomotive can proceed to the face. The reel has an automatic rewinder to reel up the cable as the locomotive backs up. Trolley

locomotives should not be equipped with electrical brakes, nor should the motorman be allowed to brake his train by reversing the motor, for, if the trolley jumps the wire, all brake action is lost until the hand brake can be brought into action.

The disadvantages of trolley locomotives are that the cost of supporting the overhead wire may be quite considerable, and that the bare wire is always dangerous to men working on retimbering, concreting or grouting. In dry tunnels, the rail joints must be bonded or a return wire laid to carry the current back. On one

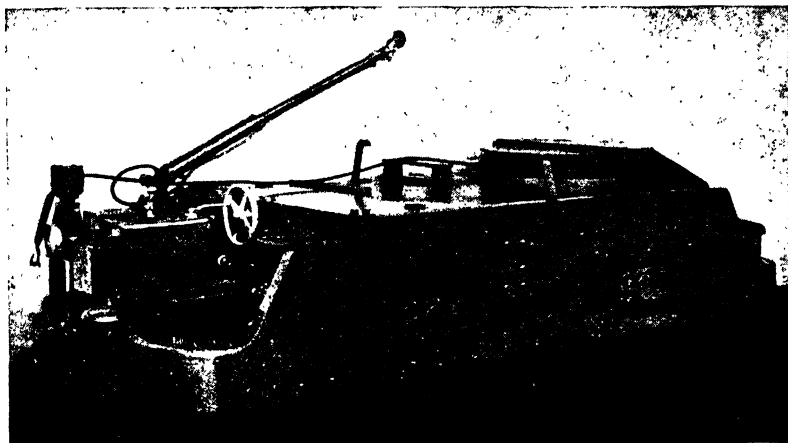

FIG. 123.—Jeffrey 8-ton trolley locomotive, 36-in. gage, equipped with two 40-hp. motors. Note the cable reel with automatic rewinder which permits the locomotive to work beyond the end of the trolley wire.

section of the Delaware Aqueduct the steel ventilating pipe was used for the ground return.

Trolley-battery Locomotive.—The trolley-battery locomotive is a combination of the trolley and battery types. Outside the tunnel, or in completed sections, the locomotive operates off the trolley wire. In the uncompleted sections, at the end of the wire, the trolley pole is lowered, and the locomotive continues on the battery. These locomotives are self-chargers, part of the current when working off the wire being diverted to recharge the batteries. If the locomotive does not work more than $\frac{1}{4}$ to $\frac{1}{3}$ of the time on batteries, the batteries will keep fully charged. Idle time of the locomotive should be used in recharging from the trolley wire.

Their disadvantage is that the batteries must work at the same voltage as the trolley, generally 250 volts, or several times that at which an ordinary battery locomotive works.

Internal Combustion Locomotives.—Dinkeys powered by internal combustion engines have been little used in the past for tunnel haulage, principally because of poor ventilation but also because mining laws of many states prohibit their use underground. However, with the improvement of tunnel ventilation, the internal combustion locomotive is becoming more popular for tunnel work. Diesel power predominates in this type of locomotive for two reasons: cheapness in operation and absence of carbon monoxide in the exhaust. While diesels generate no CO, their fumes are nauseating to breathe; therefore a tunnel must be well ventilated if diesel locomotives are to be used.

If gasoline locomotives are used, the air should be tested frequently for presence of CO. This type engine should be equipped with an electric starter, and the motorman should be instructed to kill the engine when not in actual use to keep down the pollution of the air. Gasoline locomotives can be safely used only in well-ventilated headings.

The internal combustion locomotive, either diesel or gasoline, is practical and economical for hauling trains from portal to dump and for all surface switching.

Steam Locomotives.—Steam locomotives are seldom employed in tunnel construction, but they are often used when relining an old railroad tunnel. The fireman should be instructed to do all firing outside the tunnel, and to build up a good head of steam before the engine goes underground. Some superintendents burn coke in tunnel locomotives thereby eliminating the smoke. This practice is more hazardous than burning coal, for carbon monoxide is odorless; but, if it is mixed with smoke, the men have some way of telling when the air gets bad. Carbon monoxide from a coke fire may overcome the men before they realize its presence.

In Europe, a "fireless" locomotive, equipped with an insulated tank in place of a boiler, is often used in tunnel work. The supply of steam is replenished on each trip from a high-pressure boiler outside the tunnel.

TRUCK HAULAGE

Haulage of muck by motor truck is practicable on well-ventilated, large tunnels driven from a portal. Trucks have been used on only a few tunnels in the past, notably Boulder Dam diversion tunnels, but are now becoming more popular with the application of diesel power. Recent examples of truck haulage are the diversion tunnel at Merriman Dam on the New York Delaware River water supply project; the approach headings of

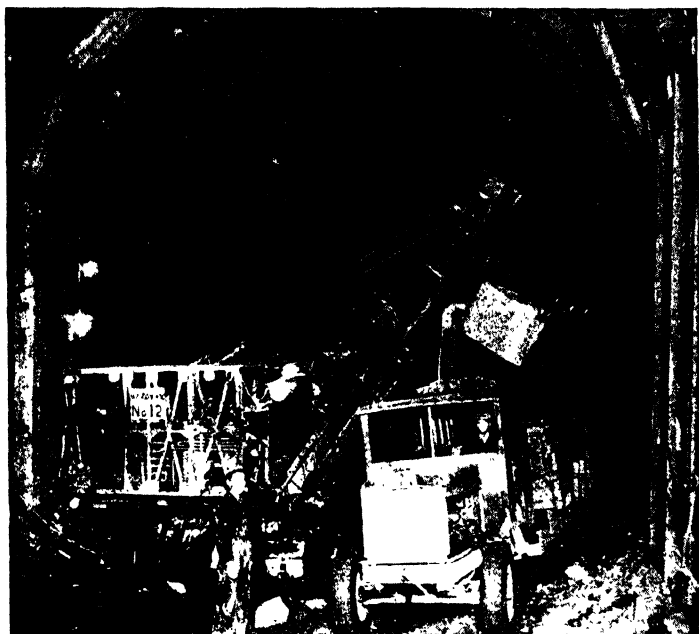

Fig. 124.—Linn tractor-truck hauling muck at Parker Dam diversion tunnel.

the Queens-Midtown Tunnel at New York; and several of the Pennsylvania Turnpike tunnels.

The chief advantage of truck haulage is the elimination of tracks. Full-size shovels, instead of the smaller mucking machines, are required for loading. However, as trucks can be used only in large tunnels, 20 ft. or more wide, shovels would undoubtedly be used anyway. Trucks may be used in connection with a belt conveyor loader but cannot be used to good advantage with any type of mucking machine that requires

the vehicle being loaded to move back and forth with the mucker.

Several types of trucks have been used successfully, such as the Linn tractor type, the Koehring Dumptor, the big Euclids and the regular dump truck. The first two have the advantage of fast and easily handled operation in reverse, permitting the units

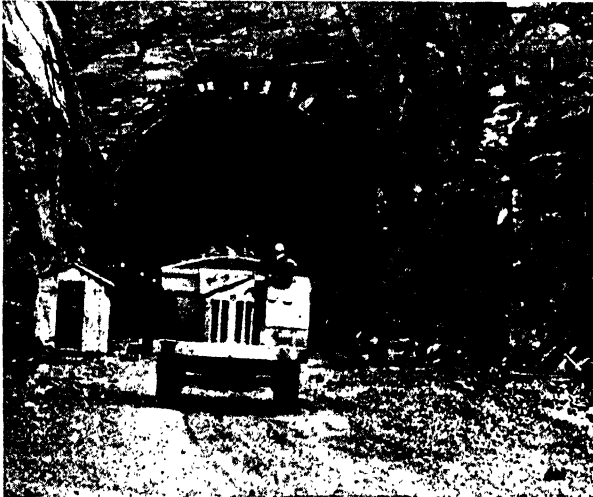

FIG. 125.—Koehring Dumptor hauling muck at Rays Hill Tunnel, Pennsylvania Turnpike. More than half of the contractors on the project used truck haulage of some kind.

to be backed into the tunnel. Regular type trucks can be backed in only for a short distance; in headings of considerable length, they must be turned around at the shovel. In tunnels of sufficient width, this is possible; otherwise much time will be lost in maneuvering. Trucks are not practicable in tunnels too narrow for them to pass, for it is important to have an empty truck ready for the shovel at all times for efficient mucking.

CHAPTER 8

HOISTS AND HEADFRAMES

Where a tunnel must be driven from one or more shafts, hoisting arrangements become an important factor in the speed, success and cost of tunneling operations. A well-designed, adequate hoisting plant is a sound investment on any tunnel job; a skimpy, inadequate hoist is a constant annoyance, hazard and expense.

In sinking the shaft, a crane or derrick is used for hoisting for the first 100 ft. or so of depth, and then a permanent hoist and headframe is installed. Although buckets or Battleship skips are the usual means of handling men, muck and materials in shaft sinking, the hoisting plant should be designed for conversion to a cage or skip hoist arrangement for driving the tunnel. (See Chap. 5.)

FUNCTIONS OF HOISTING PLANT

The hoisting plant provides the only access between tunnel and surface for men, materials, equipment and supplies, and for removal of muck, and must be designed accordingly. First, the hoisting arrangements must be safe, for men ride the cage; second, they must be strong and of adequate capacity, for the loads are heavy and the plant is subject to severe strain; and third, they must be smooth-working and fast, for the shaft is the bottleneck of the transportation system. The hoisting plant must be capable of handling the locomotives, mucking machines, drill carriages, pumps, muck cars, rail and ties, ventilation, air and water pipe, drills and drill steel, wood and steel timbering, explosives, concrete lining equipment and all other supplies, materials and equipment necessary to drive the tunnel and, of course, all the muck that comes from the tunnel.

GENERAL LAYOUT

Many factors influence the general design and layout of the hoisting plant, such as size, shape and depth of shaft, amount of room at the surface, size and length of tunnel, type of ground and

method of hoisting muck. If possible, the hoist should be electrically driven, for electric drive is safer, smoother, more dependable and in general much more satisfactory than other types of hoist power for tunnel work. A favorite type of hoist for tunnels is the electric mine hoist, with a rugged electric motor direct-connected to a large-diameter drum, and equipped with solenoid, hydraulic and foot-operated brakes, Fig. 126. Electric



FIG. 126.—Mine type of hoist at Shaft 6, Delaware Aqueduct. Dial indicates position of cage at all times. The hoist is at ground level. At this shaft a cage and muck skip are in balance; lines from each are dead-ended on the hoist drum. As one unwinds the other winds up.

motors vary from 100 to 600 hp. Several types of control are used.

Usually the hoist is placed on the ground near the headframe. In case of limited top room, such as in a congested city area, space can be saved by placing the hoist on top of the headframe, which calls for a somewhat heavier design of tower. Regardless of top space, some contractors like this arrangement of hoist and use it in open country, Fig. 127. This layout has the advantage of a direct lift and reduces the length of hoist cable.

In installations of the hoist on the ground, the cables may run direct from hoist drum to sheaves at the top of headframe, or to

the bottom of the frame and thence up to the top. The latter arrangement reduces the horizontal pull at top of tower but adds more sheaves with resulting increases in friction and cable length. The hoist must be well anchored, and the headframe designed to resist overturning. Sometimes a horizontal or

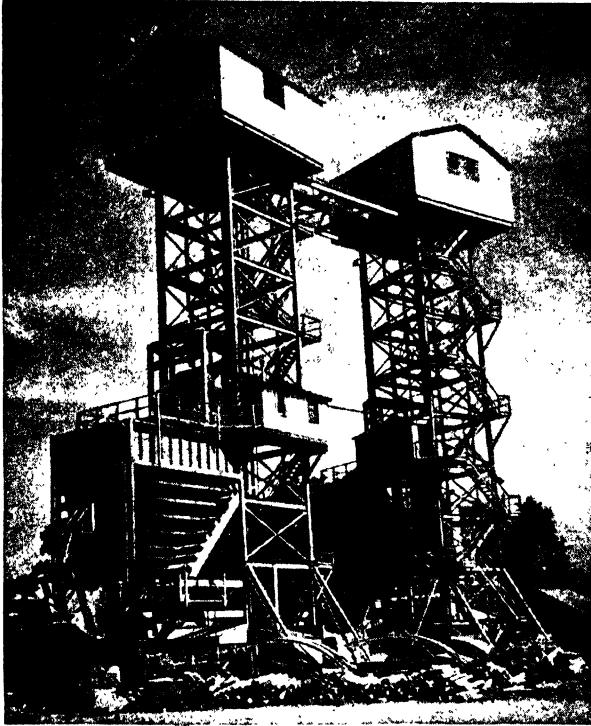

FIG. 127.—Double headframes over the uptake and downtake shafts at Shaft 19, Delaware Aqueduct. Mine hoists are located on top of the headframes; each shaft has a skip and cage in balance.

inclined strut, following the line of the cable between hoist and tower, takes the pull of the cable, Fig. 128.

Headframes may be of steel or timber construction, but steel is preferred for safety, as a wooden headframe is a constant fire hazard. As the lives of tunnel workers depend upon the hoisting facilities, a headframe or hoist house fire is a calamity that must be avoided. The usual design of steel headframe utilizes the common structural shapes, but tubular steel or pipe frames are occasionally used. Tubular steel bracing was used in the head-

frames for three shafts on the new Montebello water tunnel at Baltimore, Fig. 128.

The design of the headframe depends upon the skip and cage arrangement and upon the method of muck disposal. Muck may be hoisted in either cars or skips and dumped into a hopper for disposal by truck; or the cars may be trammed over a tippie

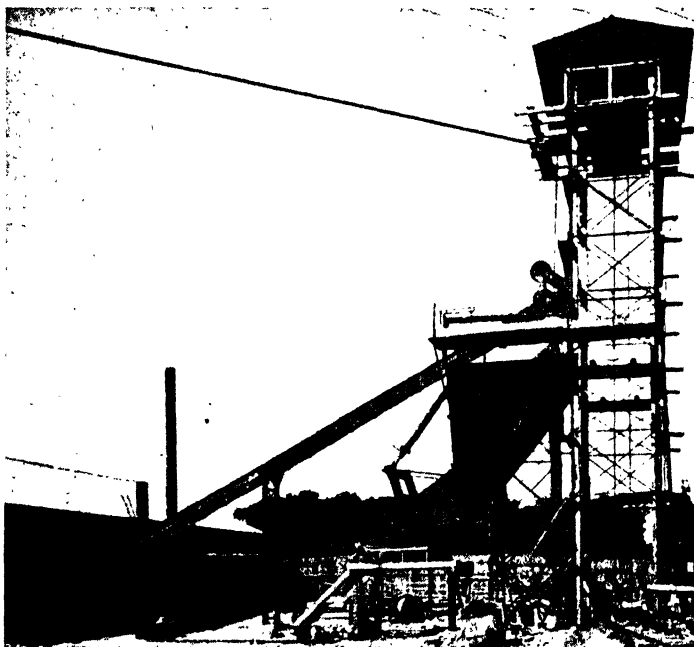

FIG. 128.—Tubular steel headframe on Montebello water tunnel, Baltimore. Hoist is in the building at extreme left. Note the inclined strut between hoist and headframe along the line of the cable, instead of the usual backstay tower bracing.

for dumping into a hopper or waiting truck, or to a near-by dump. In the former case, the hopper may be partly suspended from the headframe, in which case the towers must, of course, be designed to carry the eccentric heavy load, or the hopper may be supported independently of the headframe.

SKIP AND CAGE ARRANGEMENT

One of the basic considerations in design of the hoisting plant is the method of raising the muck. There are two general systems: (1) hoisting the loaded muck car on a cage to the surface

level, to position over a hopper or to a tipple level; (2) dumping the muck cars at bottom of shaft into a skip for hoisting to a hopper or chute at top of shaft. The first method requires less shaft equipment, is more economical on shallow shafts; on short tunnels where plant expense is to be kept at a minimum; on jobs where it is desirable to haul the muck in original cars to a dump

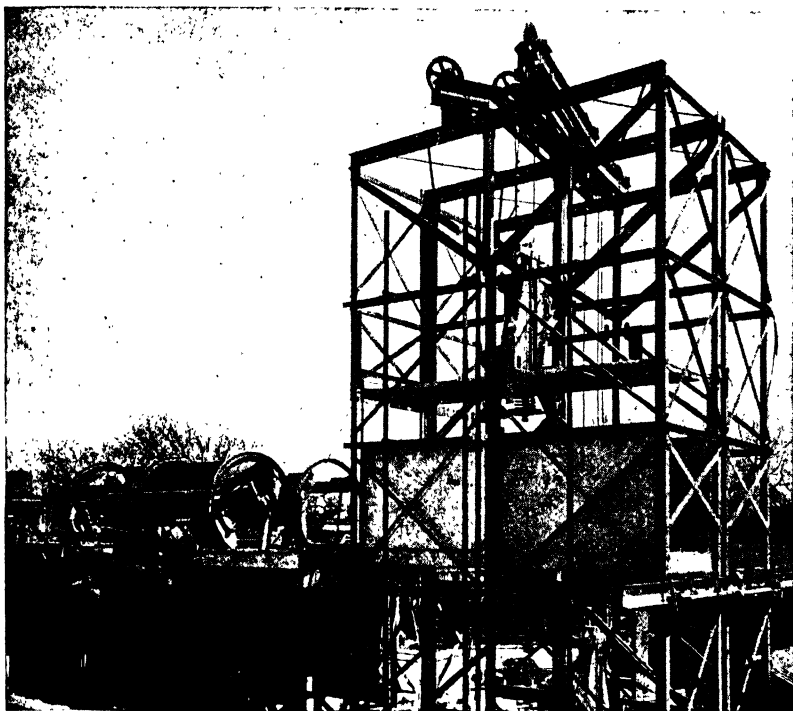

FIG. 129.—Double two-car cages and rotary car dumpers, M. J. Boyle Co. contract, Chicago subways. Dumpers turn cars nearly upside down to clean out sticky clay. Hoppers hold an even truckload, a requirement in handling sticky material.

near the shaft, thus saving the trouble and cost of rehandling; and for sticky material that is a nuisance to rehandle. The skip method is more economical on deep shafts, where cost of hoisting the dead weight of the cars is a factor. It is also faster, releases the cars quicker and does not tie up the cage when needed for other purposes.

Numerous arrangements of muck car hoisting are possible. The cars may be hoisted to ground level and then run off to a

dump; they may be taken off the cage onto a tippie for haul to a dump or to hoppers or chutes for truck disposal, or they may dump directly into a hopper. In this last method, the cage may be stopped just above hopper level and the cars dumped by hand or by an auxiliary air hoist, or the cars may be dogged to the cage and the cage automatically tipped as it reaches hopper level to dump the car.

S. A. Healy, on his Detroit sewer tunnel, and again on the Chicago subway tunnels, used a clever scheme of running the

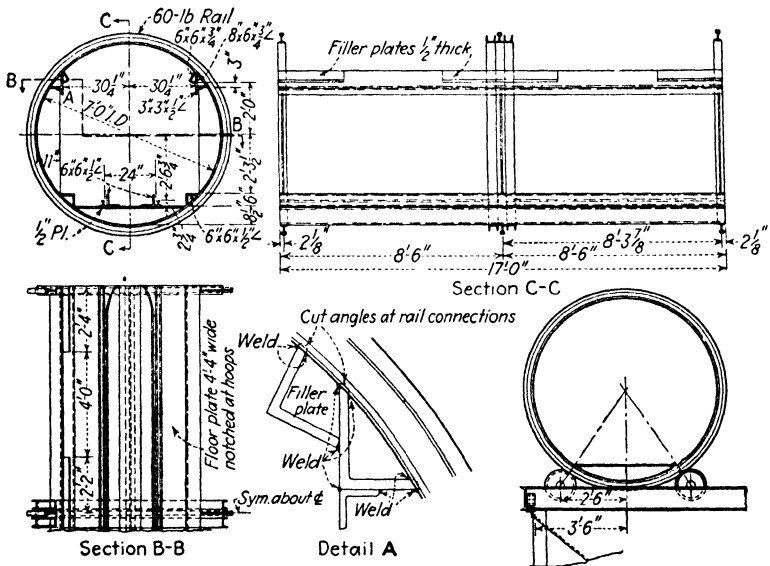

FIG. 130.—Details of rotary car dumper shown in Fig. 129, originally used by S. A. Healy Co. on Detroit sewer tunnels.

cars onto a tippie above ground level and into an automatic rollover dumper, which dumped the sticky clay into a hopper for transfer to trucks, Figs. 129, 130.

If cages alone are used, which means the muck must be hoisted in cars, two general arrangements are possible. Where the size of shaft permits installation of only one cage, the load is partly balanced by a counterweight. Where shaft conditions permit, however, frequently two cages are installed, one acting as a counterbalance for the other.

Hoisting muck in skips is becoming more and more popular, especially on the larger tunnel jobs. Several arrangements are

being used. One is a skip running in a well separate from the cage, yet hooked to the cage as a counterweight. The skip drops into a pit below the tunnel floor, and the muck cars are dumped

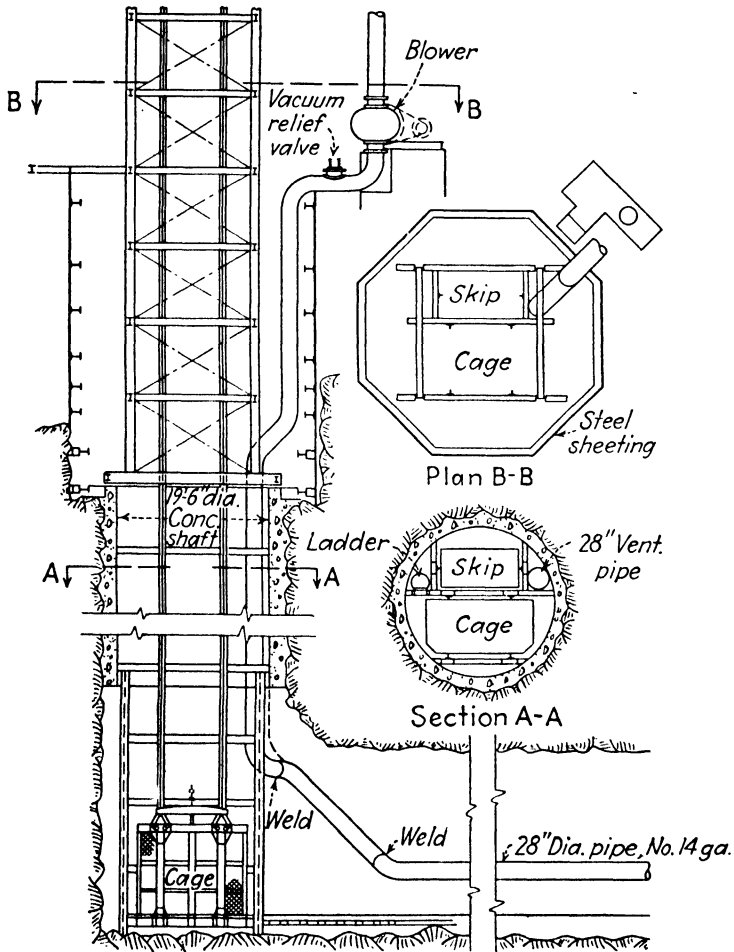

FIG. 131.—Shaft layout with balanced skip and cage, Shaft 19, Delaware Aqueduct, Associated Contractors, Inc.

into it from a run-around track at tunnel level. In this arrangement the skip and cage are on opposite ends of the same hoist line, and, as one unit rises, the other is lowered. When the skip is at the bottom, being loaded, the cage is at the top of the headframe. Operation of this system requires careful signaling, for

the surface level position of the cage is an intermediate stop. A typical layout of this type is shown in Fig. 131.

Another skip-cage combination is to place the skip below the cage, so that the two operate as a unit. In this case the skip is in a pit below tunnel floor when the cage is at floor level and is loaded from the side. This arrangement requires a heavy counterweight. In normal operation, the cage is not loaded when muck is being hoisted; but the plant must be designed so that, if



FIG. 132.—Clever trolley-hoist arrangement on a Chicago sewer tunnel to meet low headroom conditions. The muck was hoisted in skips up the shaft at right, transferred by trolley beam to truck in depressed roadway.

both cage and skip should be loaded at the same time, through an oversight, the hoist will operate with safety.

A third scheme is to have both cage and skip operate independently, with separate counterweights, requiring two hoists. Such a plan is rarely used in deep shafts because of the expense of plant installation.

A trolley-hoist arrangement is shown in Fig. 132.

For deep shafts, the hoists are geared to operate at speeds from 500 to 750 ft. per min. Regardless of arrangement of cages, skips and counterweights, the safe and customary hoist line hook-up is a cable running from the cage or skip through the headframe sheaves to the hoist drum, wrapped a minimum of four

laps around the drum, then carried back to the balancing cage, skip or counterweight. The hoists are reversible, and with this cable arrangement the operations are always under control regardless of which load is the heavier. Another favorite type of cable hook-up is to dead-end the two lines from cage and skip or counterweight to opposite ends of the hoist drum, wrapped around the drum so that, as one line unwinds, the other one winds up.

In shallow shafts, up to 50 or 60 ft. depth, a regular elevator type of hoist and cage is often satisfactory. These are slow-speed hoists, running about 90 ft. per min. They may be equipped for manual or push-button control.

Lubrication and maintenance of hoist lines and sheaves are important to obtain proper service from the cables. Large sheaves cause less rope friction and wear than do the smaller sizes, and they should be kept properly grooved to prevent excessive cutting and wear of the hoist line. A groove just slightly larger than the diameter of the cable is the correct size—too small a groove causes binding and cutting; too large grooves flatten the cable and cause excess stresses in some of the strands.

DESIGN OF CAGE AND SKIP

A typical design of cage and skip is shown in Fig. 133. Usually the size of cage is determined by the size of locomotive or car that must be handled, also by the size of timber or steel used for ground support. As a safety measure, the cage should be covered, but the cover is hinged to permit handling of long drill steel, pipe and timbers. The cage should be enclosed at the sides and fitted with safety doors or gates at the ends, which may be rigged to open automatically when the cage is at surface or tunnel level. It should also be equipped with automatic safety dogs that will grip the guides in case of failure of the hoist or cable.

Skips may be of almost any size and shape to fit the available hoistway space. Usually the most economical shape is long, narrow and deep—long and deep to provide large capacity, narrow to save hoistway space. The capacity of the skip should be such as to handle exactly one, two or three carloads without spilling. A capacity of $1\frac{1}{2}$ carloads, for example, would be uneconomical, as it is impossible to dump part of a load from any ordinary type of muck car. Skips should be self-dumping; the

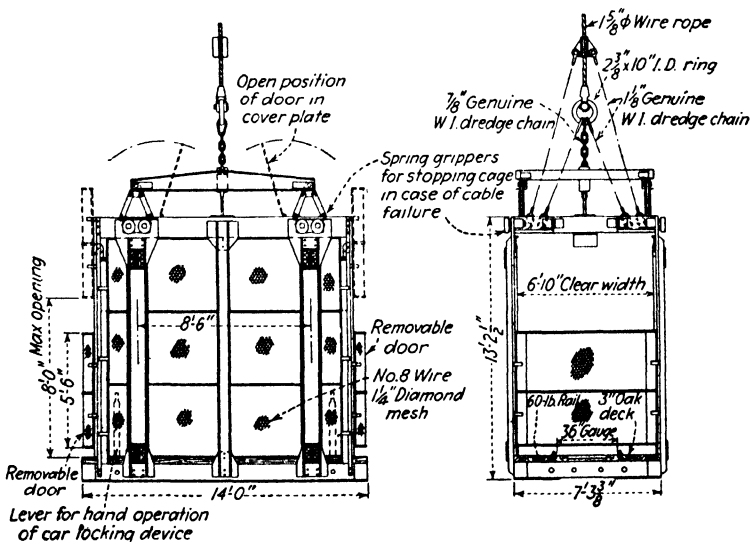
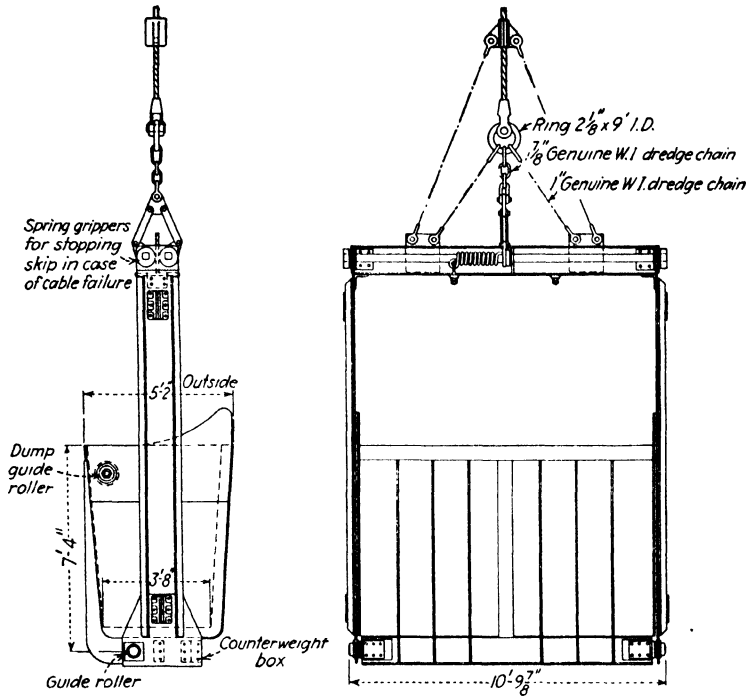

FIG. 133.—General design of muck skip (top) and cage, Shaft 19, Delaware Aqueduct. The skip and cage are in balance (Courtesy of Union Iron Works and Associated Contractors, Inc.)

common arrangement is a roller on the end of the skip body that engages a curved guide at the hopper level, tipping the skip as it is hoisted slowly at this point.

SIGNALS AND SAFETY DEVICES

A foolproof signaling system is essential for efficient and safe hoisting operations. Bells operated by pull cords are all right for shallow shafts, but electric bells are safer and are necessary on deep shafts. The signal code should be posted at the hoist and at all stations. A telephone system connecting the hoist house, surface and dumping stations and bottom of shaft is an



FIG. 134.—Dumping muck into skip at bottom of Shaft 19, Delaware Aqueduct.

additional safety measure. The signals at the various stations should be interlocked or connected through a circuit of colored lights at each station and the hoist house to prevent one station giving hoisting signals before all other stations are clear.

At the bottom of the shaft, the cage or skip should come to rest on a solid bearing, relieving the cable of strain when the load is being placed or dumped onto the lift. Similarly, when the cage is being loaded or unloaded at the surface or tipple level, it should be lowered onto landing stops operated by the cage tender; thus the sudden change in loading will not cause undue strain on the hoisting rig or cause the cage to move because of stretching of the cable. Openings to the shaft, at the bottom, surface and tipple levels, should be protected by barriers or gates. These

may be arranged to open automatically as the cage approaches the station. On surface and tippie levels, the barriers must be strong enough to keep a car or locomotive from accidentally plunging into the shaft. Derails at all stations are a sound safety precaution.

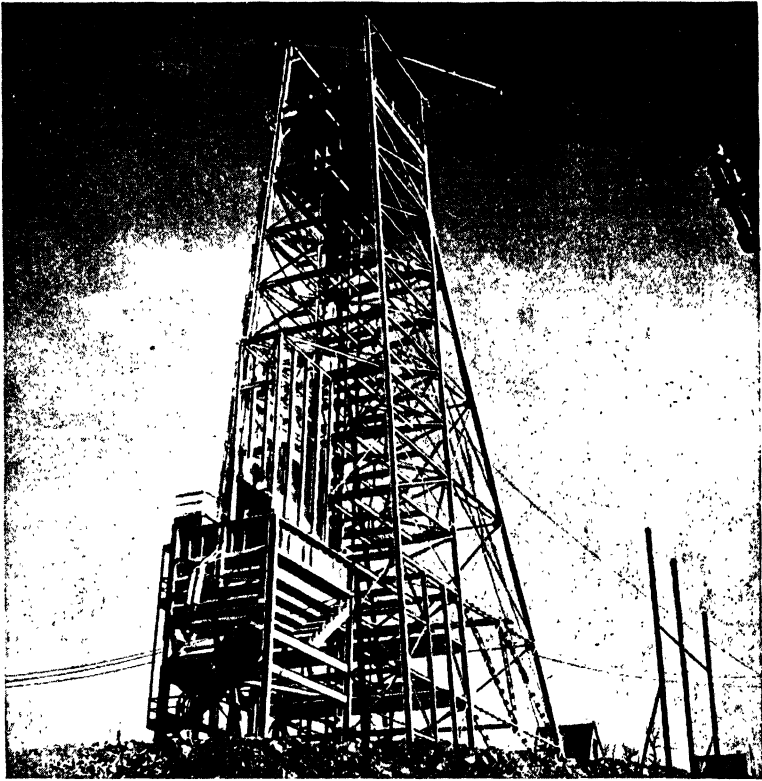

FIG. 135.—Headframe and muck storage bin, Shaft 6, Delaware Aqueduct, Pleasantville Constructors, Inc. Note the hydraulically operated bin gates. Hoist is in the house to the rear of the shaft, beyond the tower backstays.

The hoist should be equipped with automatic indicators to show the operator the position of cage and skip at all times, with the various stations plainly marked for the guidance of the hoist operator.

BINS AND HOPPERS

Care in designing and locating the muck bins or hoppers will save many a headache. They should be located, if possible,

where movement of trucks or cars used for muck disposal will cause a minimum of interference with other operations.

Bins for handling sticky clays should not have a capacity greater than that of the trucks or cars into which they dump, for there is no way to draw off part of a load of sticky material from the bins. As this material compacts into one big gob in the bin, the bin gate must be designed to pass the entire contents in a

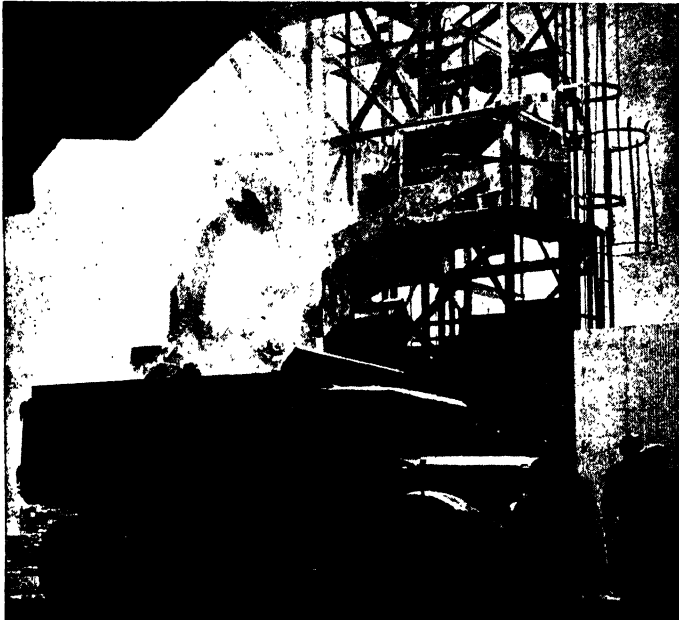

FIG. 136.—Storage bins may not be necessary if trucks are readily available. Here muck is being loaded directly from tunnel car to truck, Chicago sewer tunnels.

lump. The usual type of gate is a hinged front, fastened at the top, swinging out at the bottom. Because the contents come out in a heavy mass, the bin should be as low as possible to prevent damage to truck bodies and springs as the muck is loaded.

For handling dry materials and broken rock, the bin may be much larger. In fact, it is advisable, if possible, to have the bin hold a full round of muck. Then hoisting operations can proceed without waiting for trucks to haul the muck away.

There are several types of bin gates for handling rock. An important factor in their design is to have them big enough to

prevent clogging of the material. The gates should pass any rock that the mucking machine can load. Power-operated slide gates are popular. They may be operated by a hand crank through a rack and pinion, or by hydraulic or air rams. As it is important to be able to close as well as open the gates by power to shut off a flow of material, cable operation of slide gates is not generally satisfactory. Cylindrical gates are another popular type, which can be operated by cable, air or hydraulic rams. Hinged doors may be used if the entire contents of the bin can be dumped at once; otherwise they are difficult to close against the flow of material.

Bins may be of timber or steel construction. Renewable rubber or wood lining on the bottom and lower sides saves wear on the bin structure and also reduces the noise. The bottom and lower sides of bins are sloped toward the gate. A bottom slope of at least 30 deg. with the horizontal is necessary; 45 deg. or even steeper is more desirable, though, of course, the steeper slopes cut down the capacity. Sometimes clogging of the materials in the throat or at the gate opening, and sticking to the sides and bottom, are prevented by a vibrator fastened to the outside of the bin. A hooked rod or prong, handled by a hoist if possible, is handy in breaking up jams or pulling a blocked stone loose from the throat of the bin. Sometimes the only way to break up a really tight jam in the bin is with a light charge of powder.

CHAPTER 9

VENTILATION AND DUST CONTROL

Adequate ventilation of all tunnels is required for two main reasons: supply of fresh air to the working crew, and removal of harmful and obnoxious dust, dynamite fumes and other gases. In compressed-air tunnels, leakage of the air through the face is usually sufficient ventilation, or, if not, the heading can be blown out occasionally. In large-diameter short tunnels, natural ventilation may be adequate, and, where a small drift has been completely holed through, sufficient draft may be present for ventilation of the enlarging operations. In all other cases some form of mechanical ventilation is necessary for both the health and working efficiency of the crew.

The first problem in designing a ventilation system is to estimate the volume of air required. Several states have mining laws that require from 150 to 200 c.f.m. of fresh air for each man working underground. On tunnel work, 200 c.f.m. per man is usually considered the minimum; most contractors estimate on more, often up to 500 c.f.m. On New York City Water Tunnel No. 2, the ventilating plant was designed to supply 600 c.f.m. per man. Local conditions affect the volume of air required, such as length of heading, size of tunnel, amount of explosives used, frequency of blasting, and temperature and humidity. The volumes mentioned above are for normal fresh-air requirements. Control of dust by ventilation for prevention of silicosis is another problem to be discussed later in this chapter. Sometimes the exhaust from the drills is considered as part of the fresh-air supply, but in reality this exhaust is not fresh air—it is air polluted by moisture, oil and dust—and therefore is more harmful than beneficial as an air supply for human consumption.

There are three methods of general tunnel ventilation: blowing, exhaust and a combination of the two. In the blowing method, fresh air from an unpolluted source—usually at the portal or top of shaft—is forced by a fan through a pipe and discharged near

the working face. The foul air drifts back through the full length of the heading to the shaft or portal. This method has the advantage of a positive supply of fresh air at the face, where operations are concentrated and the majority of the men work. Its disadvantages are that the foul air and smoke filter back through the heading slowly, fogging the atmosphere and decreasing visibility.

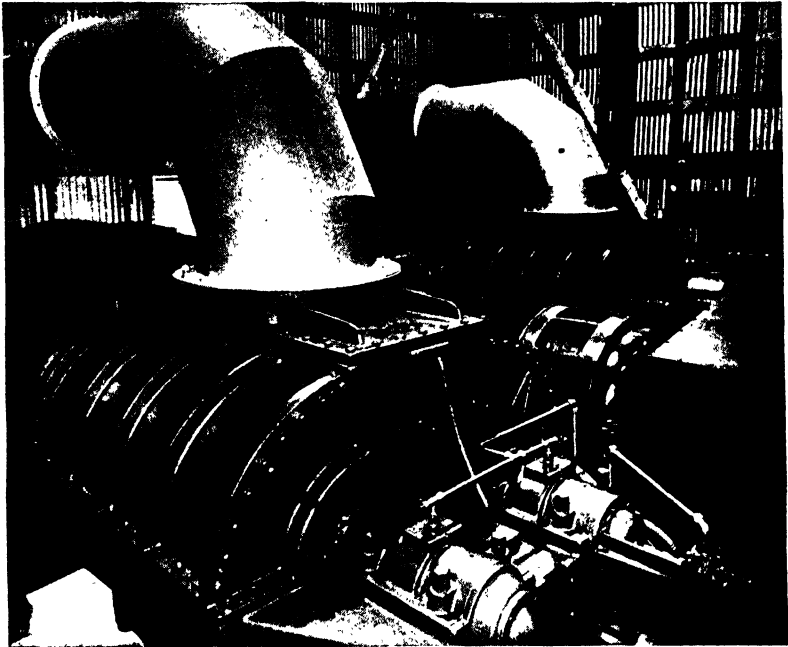

FIG. 137.—Rotary blower type of ventilating fan, Delaware Aqueduct. This type of fan can either blow or exhaust and is usually hooked up with a reversible motor. (Courtesy of Roots-Connersville Blower Co.)

In the exhaust method, foul air is pulled out through the pipe, the fresh air entering at the portal or shaft and traversing the full length of heading. The chief advantage of this method is keeping the smoke and foul air out of the general tunnel, but there is the possibility that the fresh air will absorb heat and moisture in its path down the heading, resulting in an unpleasant working condition.

The combination of blowing and exhaust is now gaining favor among tunnel men. Immediately after blasting, the exhaust

system is used for 15 to 30 min. to draw out the smoke and dust; the rest of the time the fans are reversed and are blowing. This system combines the advantages of the other two.

EQUIPMENT

Fans.—There are three general types of fans adaptable to tunnel ventilation: centrifugal, disk and turbine blower. Some models are reversible; that is, they can blow or exhaust the air. Others are nonreversing; if reversible operation is desired, it must be accomplished through the connecting piping system and dampers or gates. Figure 138 shows a simple piping arrangement

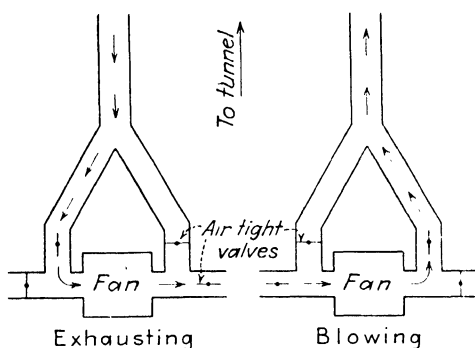

FIG. 138.—Simple valve arrangement for reversing flow of ventilating air without reversing the fan.

for reversing the air flow with a nonreversible fan. Though some types of fan are more suited than others to certain conditions, the selection of type, model and arrangement of piping is largely a matter of judgment. The required capacity of a fan, once the required volume of air to be moved is determined, can be closely calculated, as described later. Fans are always driven by an electric motor, either direct or belt connected.

Piping.—Many types and kinds of pipe are available for tunnel ventilation, such as spiral-riveted or welded steel, welded or riveted straight-joint steel, lock-bar joint steel, flexible cloth fabric, wire reinforced fabric, and spiral wire-wrapped wood stave pipe. Couplings are almost as varied. Common couplings are slip joints for metal pipe, clamped bands, or sleeves, flange couplings, and quick-connecting couplings of the Dresser type. Couplings should be easy to install and remove and should be tight to prevent wasteful leakage. Usually some type of gasket

is used with the coupling. All the above types of piping except unreinforced fabric are suitable for both blowing and exhausting. Pipe sizes, commonly used in tunnel ventilation, vary from 12 to 30 in.

Selection of Equipment.—With all the types and sizes of fans and the variety and sizes of pipe available, the selection of equipment becomes largely one of judgment as to the best and most economical combination suited to the job in question. Of course, many combinations of fan and pipe sizes will produce the required volume of ventilating air; so the problem is chiefly one of economics. G. E. Maughmer, in *Engineering News-Record*, May 10, 1934, p. 597, presents an excellent discussion of the economics of tunnel ventilation.

For a short tunnel, the economics of ventilation are not so important; but in long headings the cost is considerable, and it is worth the trouble to figure out the cheapest arrangement. However, it never pays to skimp on ventilating plant, for an inadequate plant that does not accomplish its purpose is expensive in the long run.

Ventilating costs include the following factors: power costs, motor and fan costs, pipe costs, installation and maintenance costs. Friction of air passing through the pipe must be overcome by pressure of the fan. This friction, or pressure drop, can be measured in pounds per square inch, but in ventilation, because of the low pressures involved, the measurement is usually in inches of water (5.2 in. water gage = 1 lb. per sq. in.). For a constant volume of air, the pressure drop varies as the fifth root of the pipe diameter. Thus, for a given quantity of air to be moved, the smaller the pipe the greater pressure the fan must exert to move the air and the more power is required. Power input varies almost directly with the pressure exerted by the fan.

There are several formulas for computing the friction loss of air through pipe, but they take many factors into consideration, such as temperature, barometric pressure, friction of pipe surface. The chart, Fig. 139, shows approximate pressures in inches water gage necessary to overcome friction in a 100-ft. length of pipe of various sizes carrying various volumes of air, under ordinary conditions and use of common steel pipe. Velocity of the air in feet per minute for various volumes and sizes of pipe can also be obtained from this chart.

As Maughmer points out in the article mentioned before, there is an economical combination of fans and pipe size, based on ratio of pipe size to power and fan costs. For long tunnel installations, it will pay the contractor to make a careful study of fan size and arrangement and pipe size to determine the most economical combination.

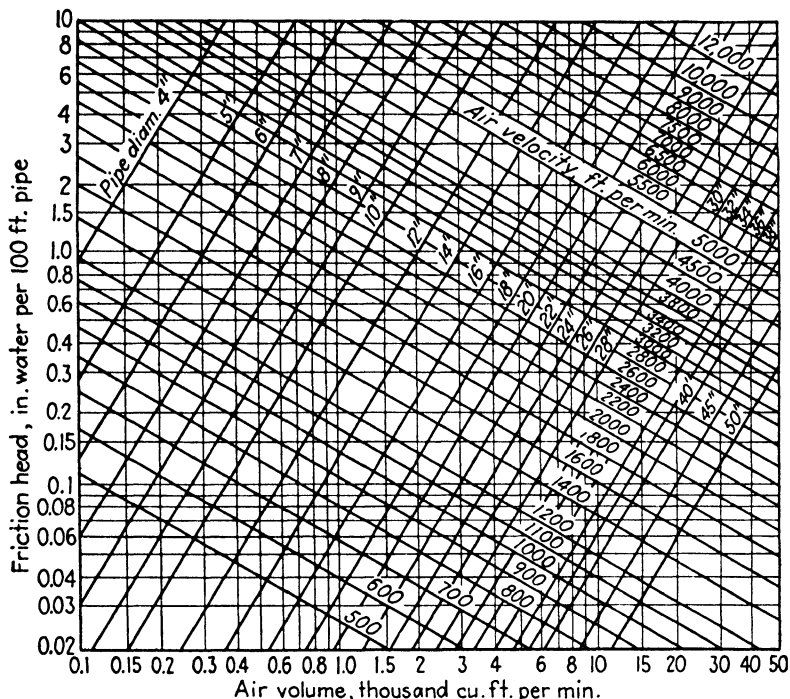

FIG. 139.—Friction losses in ventilating pipe. The chart also gives velocity in relation to volume for various sizes of pipe.

Fan Arrangement.—The ventilation plant must be designed for the worst conditions—that is, for quick removal of blasting fumes from the maximum length of heading. Yet these worst conditions prevail for only a fraction of the duration of the project, and often economies can be effected by a flexible arrangement of ventilating plant that operates at part capacity when ventilating conditions permit, with resulting saving in cost.

The simplest arrangement, of course, is either a straight blower or straight exhaust system using a constant-speed fan of one size for the entire job.

Arrangement for alternating blowing and exhausting, by means of a reversible motor and fans, or by valved piping arrangement as shown in Fig. 138, is the first step toward flexibility. Sometimes a variable-speed fan is used—top speed for clearing the heading after a blast, slower speed the rest of the time.

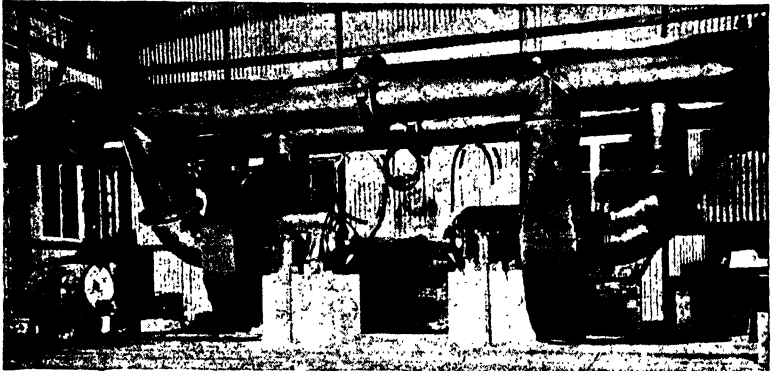

FIG. 140.—Flexible fan and piping arrangement, Colorado River Aqueduct. Fans were nonreversing, but the direction of air flow could be changed and the volume varied by manipulating the pipe valves and changing the speed and size of impellers.

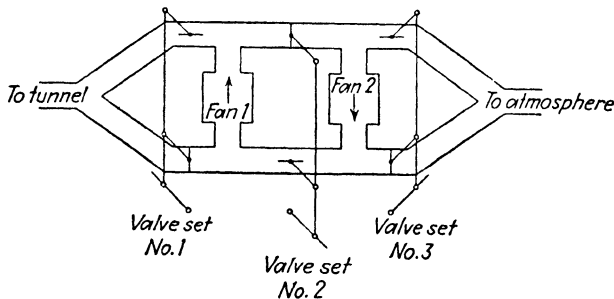

FIG. 141.—Diagram of fan and pipe layout shown in Fig. 140.

Another way to obtain variable capacity of a fan is by changes in impeller size. For example, on a long tunnel, a small impeller—with corresponding lower power requirements—will be used while the heading is fairly short, though the piping will be large from the start. As the length of heading progresses beyond the range of the first impeller, a large one is put into the fan. Only in the centrifugal type of fan can the impeller size be changed, and in most fans of this type two changes are the limit.

On some of the Colorado River Aqueduct tunnels, a combination of two fans in series, with three sets of pipe valves, as shown in Figs. 140 and 141, gave an economical and flexible ventilating arrangement. These were centrifugal fans, nonreversible. A study of the piping arrangement will show how one or both fans could be used as either blowers or exhausters. On these particular tunnels, the ventilation plan was to exhaust 6,000 c.f.m. for 20 min. or so after a blast, then blow 3,000 c.f.m. during drilling and mucking operations. As the maximum requirement in such a plan would be exhausting from the longest length of heading just before holing through, the plant was designed on that basis. However, on long headings only part of the ultimate capacity of the plant was required when the headings were short. This plant arrangement provided for partial capacity, with considerable economy as follows:

The type of fan used permitted the installation of either a full-size or small-size impeller, and the latter required far less power than the big wheel. The motors could also operate at half or full speed. At the start of the tunnel, one full-size and one small-size impeller were installed. For the first few hundred feet of heading, only the large impeller, operating at half speed, was required for both blowing and exhausting; the smaller wheel was shut off completely. Then, as the ventilating pipe increased in length with corresponding increase in pipe friction, the small wheel alone was used at full speed. The next succeeding steps were: large wheel alone at full speed; both large and small impellers at full speed; and, as the tunnel heading approached maximum length, the small wheel was replaced with a full-size impeller. The pipe valve and motor control arrangements permitted greater capacity when exhausting than when blowing for all combinations.

Another ingenious ventilating plant that provides for variable capacity for exhausting and blowing, as well as for increasing length of headings, has been installed on one of the tunnel sections of the Delaware Aqueduct at New York City. This plant is sketched in Fig. 142. As headings are being driven both ways from the bottom of a shaft, two identical units have been installed side by side, one to serve each heading. However, the piping is so arranged that either unit can operate on one heading, or, in case of emergency, both units can be turned into one heading,

thus affording great capacity, almost double that of one unit. As can be seen from the illustration, each unit consists of one 5,000-c.f.m. blower driven by a variable-speed 10-hp. motor, and one 10,000-c.f.m. blower driven by a 100-hp. constant-speed motor. These fans are nonreversible, so the change from blowing to exhausting is by means of a four-way valve in the piping. By means of ground-seat airtight butterfly valves, the two fans of each unit can be operated independently or together. The

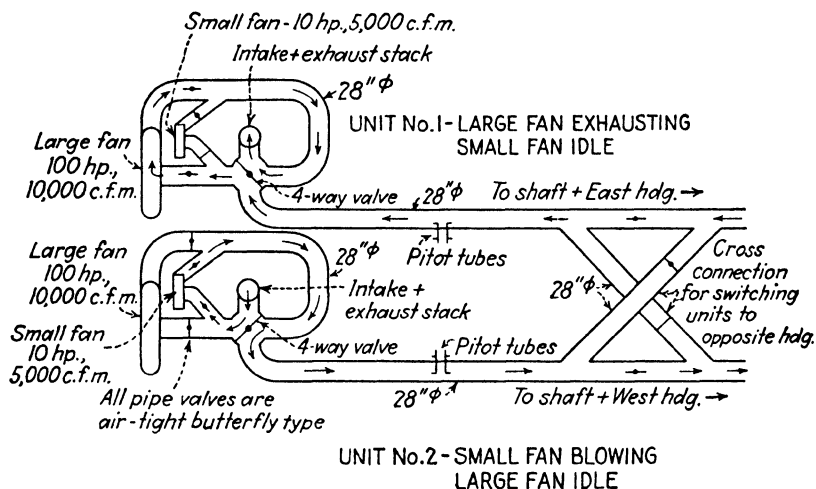

FIG. 142.—Flexible fan and piping arrangement designed for Shaft 3, Delaware Aqueduct. Large and small fans serve each of the two headings; flow is exhausting or blowing as desired; cross connections permit changeover to either heading. (Courtesy of Kruse Engineering Co., Newark, N. J.)

variable speed of the small fan provides for varying capacity in the short headings at the start. Pitot tubes, calibrated to show the volume of air passing through each set of pipes, are placed in the main lines close to the fans.

The four-way valve offers many possibilities in ventilation pipe arrangements. Ventilating engineers recommend use of the ground-seat airtight butterfly valves in place of the older dampers, for, even though their initial cost is higher, they are really economical because of greater efficiency and more satisfactory operation. Another four-way valve installation is shown in Fig. 143.

Two installations outlined above are ideal for long tunnels. On the average tunnel job, however, a single fan is usually all

that is necessary. It may be operated at constant or variable speed. The most common ventilating plant on small and short tunnels is a single reversible fan, operating at constant speed, exhausting for a while after a blast, then blowing the rest of the time. This arrangement may not be so efficient and economical as a more flexible plant, but, provided it is of proper capacity, it is entirely satisfactory.



FIG. 143.—Two ventilating fans serving the north and south headings at Shaft 6, Delaware Aqueduct. The fans are nonreversible; direction of air flow depends upon position of the four-way valves. (Courtesy of Ingersoll-Rand Co.)

PIPE INSTALLATION

The most common type of pipe used for tunnel ventilation is some form of light steel pipe with tight, yet easily installed couplings, one type of which is shown in Fig. 144. It does not pay to skim on either the size or weight of pipe—too small a size means excessive friction losses, and too light a gage of steel means risking damage by handling, installing, and from blasting, with resulting higher maintenance costs and loss of efficiency. Regardless of type or size of pipe used, it should be maintained in good condition, free of leaks, holes and dents.

The critical stress on a steel pipe is collapsing pressure. Maughmer gives the following formula for calculating the suc-

tion pressure on a pipe (difference between outside and inside pressure).

$$D = P_i \left(1 - \sqrt{1 - 16.8SQ_i^2 f \frac{L}{T_i d^5}} \right)$$

where D = friction drop or suction, lb. per sq. in.

Q_i = volume entering pipe or free air, cu. ft. per min.

P_i = pressure of air entering pipe, lb. per sq. in. abs.
(barometric pressure).

T_i = temperature of air entering pipe, deg. F. abs.

L = length pipe, ft.

d = inside diameter of pipe, in.

f = coefficient of friction (use 0.0001).

S = specific gravity of gas referred to air (use 1.0).

Safe working collapsing pressures, based on a factor of safety of $2\frac{1}{2}$, for 10-, 12- and 14-gage pipe are given in Fig. 145 for various

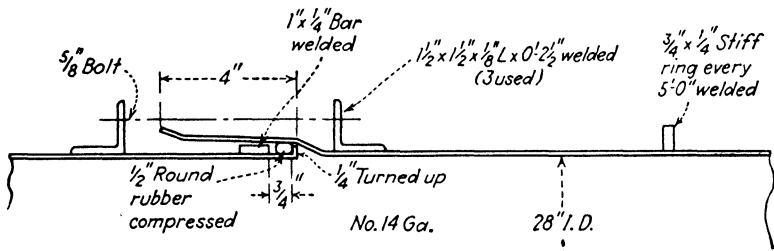

FIG. 144.—Simple vent pipe coupling used at Shaft 19, Delaware Aqueduct (Courtesy of Associated Contractors, Inc.)

sizes of pipe. Approximate weights of steel pipe in these gages are shown in Fig. 146.

Ventilating pipe is usually carried to about 100 ft. from the face; closer than this usually causes uncomfortable drafts on the heading crew; a greater distance reduces the ventilating effectiveness at the face. In preparation for a blast, the pipe must be taken down for at least 500 ft. back of the face to prevent damage from the concussion and flying rock. To increase the efficiency of exhausting or blowing after a blast to remove the powder fumes and dust, the high-pressure air line that supplies the drills is left open close to the face (shut off at the compressor during the actual blast), and the high pressure air is turned on immediately following the shot. This creates a high-pressure zone at the heading which forces the smoke back to within reach of the

vent pipe if exhausting, or back beyond the vent discharge if blowing.

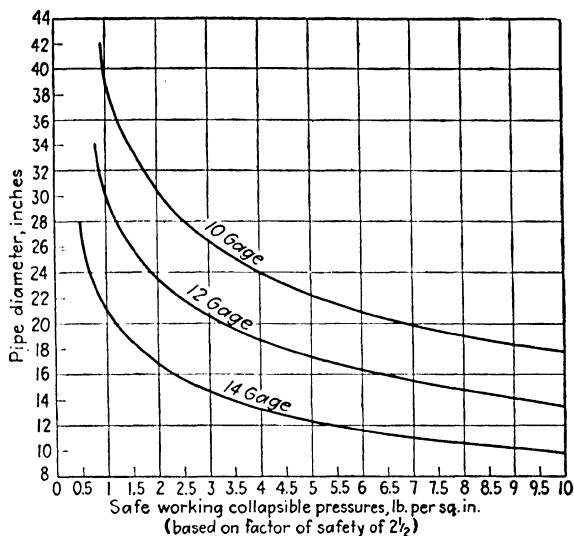

FIG. 145.—Safe working pressures for 10-, 12- and 14-gage vent pipe.

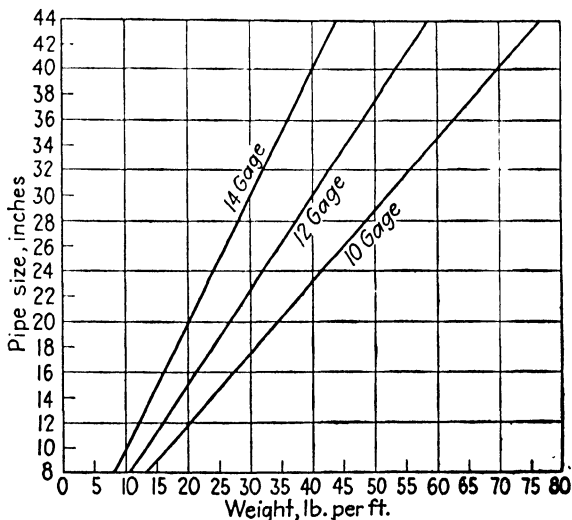

FIG. 146.—Weight of 10-, 12- and 14-gage vent pipe.

When the blowing method is used exclusively, some tunnel men prefer the fabric type of vent pipe, Fig. 147, because of its

ease in handling, especially in preparing for the blast. The fabric vent tube is also made in steel-reinforced style, which makes it suitable for exhausting, particularly on short pipe lengths. Sometimes a 500-ft. length of the reinforced fabric tube is used on the discharge end of a steel pipe because it is so easy to take down and set up for the blast.

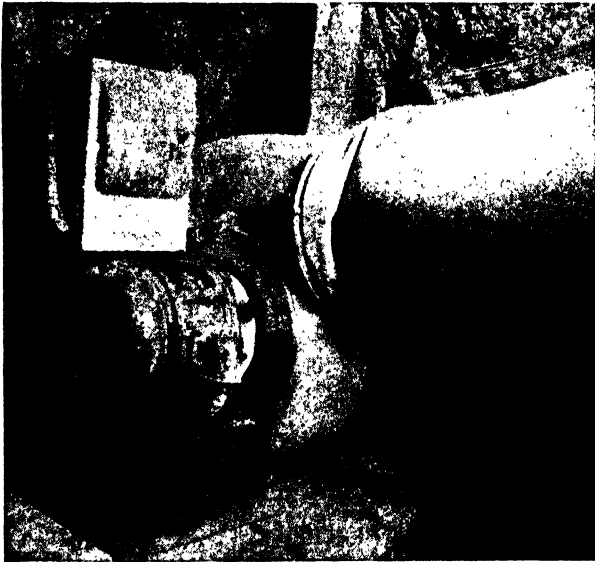

FIG. 147.—Fabric vent tube connected to nonreversing blower.

On the Stanislaus Tunnel in California, 20-in. metal pipe was carried to 40 ft. from the face and protected by the metal cage tip shown in Fig. 148 against damage from blasting.

DUST CONTROL

Control of rock dust in tunneling for the prevention of silicosis is now essential in rock containing silica. Several states have recently placed occupational diseases, including silicosis, under the coverage of workmen's compensation, and other states are considering such moves. In states where silicosis is not under compensation laws, the contractor is liable to civil suit in silicosis cases. Even though silicosis claims and suits arising from tunnel work are usually lawyers' rackets, the contractors have been put to great trouble and expense in defending them. The best

insurance against silicosis, real or imaginary, compensated or not, is proper dust control in the tunnel.

Silicosis.—Silicosis is a lung disease caused by *long-time* exposure to high concentration of rock dust containing minute particles of silica (SiO_2). Most rock formations contain silica; quartz is almost pure silica, and sandstones are largely silica. The silica dust causes a fibrosis of the lung tissue, so far incurable, and the development often continues after the victim is no longer exposed to the dust. Medical authorities differ as to the exact pathological development, but most agree that the fibrosis is caused by a chemical reaction between the silica particles and the lung fluids. However, all agree that only the dust particles 10 microns and under in size (1 micron is $1/25,000$ in.) cause silicosis. Dust particles this size are invisible to the naked eye. Thus, it is not the visible dust that causes the trouble, for the defenses in the respiratory system can throw off the large particles.

Health authorities also disagree as to the length of exposure to silica dust necessary to induce silicosis, though

most opinions range from three to five years. In Canada, where silicosis has been compensable for years under the mining laws, a claim is not even considered unless the claimant has been exposed to silica dust for at least three years. Apparently the physical condition of the individual, as well as his susceptibility to pulmonary diseases, has a lot of bearing on the length of exposure

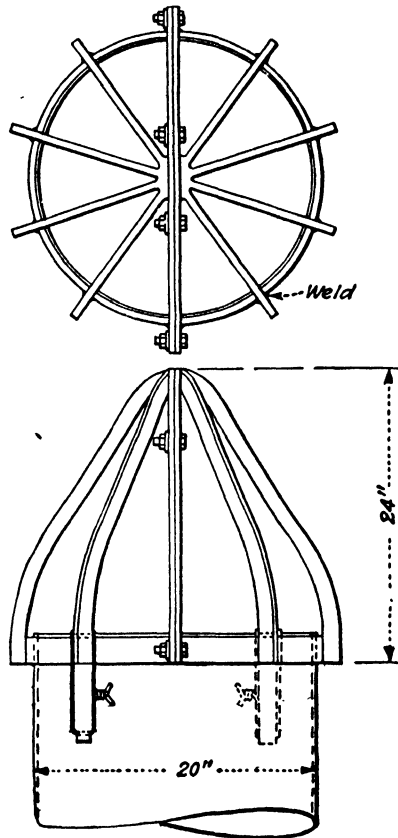

FIG. 148.—Simple tip for protecting discharge end of steel vent pipe from blasting, used on Stanislaus Tunnel, California.

necessary to contract the disease. This is why silicosis is often complicated with tuberculosis.

Although most tunnel jobs are of shorter duration than the average development period of silicosis, most occupational disease compensation laws, as well as court decisions in civil suits, hold that the employer, at the time the disease is discovered or the claim is made, is responsible. Thus, a worker already suffering from silicosis at the time of hiring out on a new project may bring claim against his new employer if he is subjected to dust-laden air.

Wet drilling, for years regarded as ample dust control in tunneling, is no longer considered sufficient for the prevention of silicosis, for the microscopic dust particles responsible for the disease escape from the water stream. Some form of ventilation in addition to wet drilling is required, or, as an alternate, the entire volume of dust created by drilling may be trapped by the vacuum hood system.

The New York State law, considered as standard, requires that on public work, rock dust from drilling be controlled to within the following limits: Class I rock, in which the free silicon dioxide is uniformly less than 10 per cent of the formation, 100 million particles per cubic foot of air; Class II rock, in which the silica amounts to 10 per cent or more of the formation, and all other formations, natural or synthetic (concrete) having a variable and unpredictable silica content, 10 million particles per cubic foot of air. Most rock formations fall in Class II.

Vacuum Hood Systems.—The vacuum hood system of drill dust control has proved satisfactory for open-cut and portal work, especially with use of dry drills, but so far has not been used to any great extent underground. This system consists of a hood that fits around the drill steel at the rock face, from which a suction hose conducts all the dust created by the drill to separators and filters, Fig. 149. Usually a primary separator collects the coarser particles while the fine dust is trapped by cloth filters. A gas or electric-powered blower provides the necessary air suction. One manufacturer has developed hoods for underground use with drifters and stopers. Tests have shown the vacuum system works satisfactorily with wet drills.

Wet Drilling.—New York State, under its industrial code, has recently approved wet drilling in combination with adequate ventilation as satisfactory for dust control. Under the code,

slight changes were necessary in the drill design, principally to prevent blowing of air alone, without water, through the drill steel, and to prevent dry collaring of the hole. Practically all models of standard rock drills have now been approved by the state as meeting the code's requirements for dust control. In Class I rock, wet drilling alone is considered sufficient for dust control, but, in Class II rock, the following combinations of air

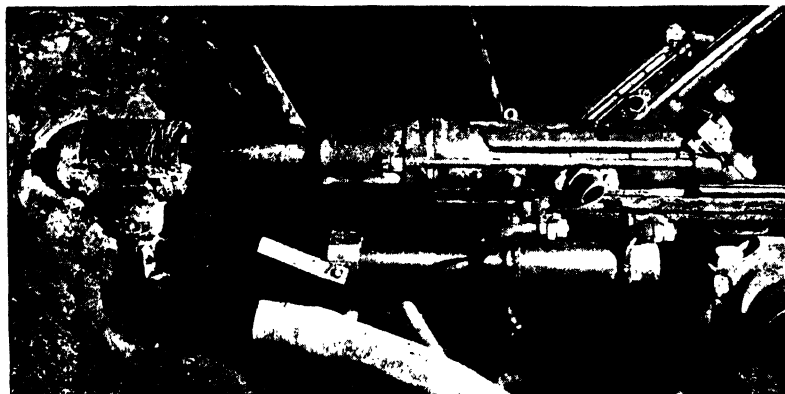

FIG. 149.—Kelley vacuum exhaust hood for drifter drills. Dust and cuttings from drill hole are conducted from hood to collector and separator through a hose. Hood is clamped to drill mounting and does not interfere with drill feed.

and water through the drill steel and certain minimum ventilation requirements per drill are demanded by the code:

Class of Drill:

- I. High air, low water flow.
- II. Medium air, medium water flow.
- III. Low air, high water flow.

	Class of Drill		
	I	II	III
Full speed operation:			
Air flow, c.f.m.....	4-6	2-4	0-2
Water flow, g.p.m.....	0.5-0.75	0.75-1.5	1.5 or over
Half speed operation:			
Air flow, c.f.m.....	5-12	2-5	0-2
Water flow, g.p.m.....	0.5-0.75	0.75-1.5	1.5 or over
Ventilation, per drill, c.f.m.....	2,500	2,000	1,200

It will be noted that the stated requirements base the general ventilation on number of drills in use, not on number of men in the tunnel. The amount of ventilation specified, from 1,200 to 2,500 c.f.m. per drill, is far in excess of that formerly regarded as adequate. However, it must be remembered these requirements are the first issued under the code for wet drilling and are just now receiving their first practical application on the Delaware Aqueduct tunnels. Obviously the chief purpose of the silicosis law is to prevent silicosis by reducing the dust concentration below safe hygienic limits. Contractors on the aqueduct are finding they can keep the dust concentration to well within the desired limits by use of less ventilating air than is specified in the above table; in fact, usually about 700 c.f.m. per drill seems to be adequate. If this experience holds true on all sections, in all probability the code requirements will be reduced some time in the near future. The entire field of dust control in tunnels is still in the experimental and development stage.

Combined Systems.—On the Delaware Aqueduct, two general systems of combination wet drilling and ventilation are in use. One is to supply the required amount of ventilation through the general ventilating system, simply to supply the volume needed from outside sources.

The second system, proving more economical and satisfactory, is to mount a secondary ventilation plant on the drill carriage, draw off the dust-laden air from the drills through vent pipes running to the front end of the jumbo, then filter and discharge this air into the tunnel. This is a recirculation method and is proving adequate in keeping the dust concentration down. Fresh air for the crew is supplied by the general ventilation system, though the quantity required is far less than without the auxiliary plant.

The first of these auxiliary plants was developed on the Park Contracting Co. section of the Sixth Ave. subway in New York City. This rig, shown in Fig. 150, carried four suction pipes on the drill carriage, but the fan was located on the ground behind the carriage, out of the way of the track, connected to the suction pipes by a reinforced fabric vent pipe. A water stream playing inside the fan precipitated the heavy dust, and the exhaust air was blown out to the surface.

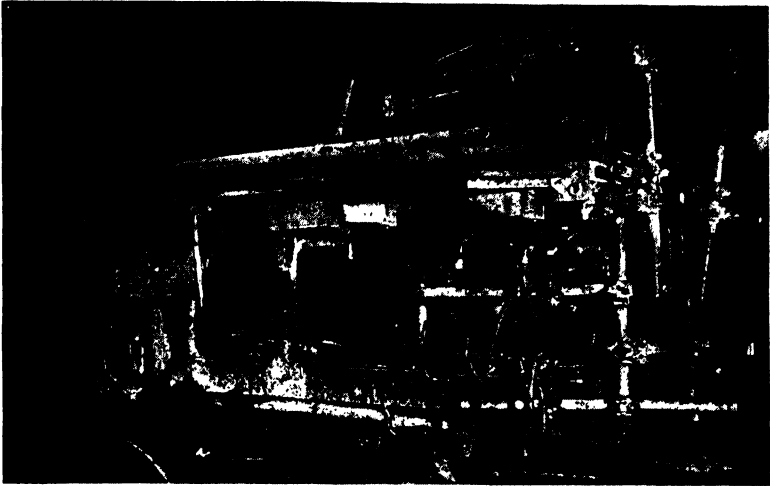

FIG. 150.—Forerunner of a new type of tunnel ventilation equipment—drill carriage equipped with suction vent pipes extending into drilling zone, developed on Park Contracting Co. section of Sixth Avenue subway in New York. The exhaust fan was located in heading some distance behind the jumbo, connected to the pipes on the jumbo with a suction type of flexible vent tube.

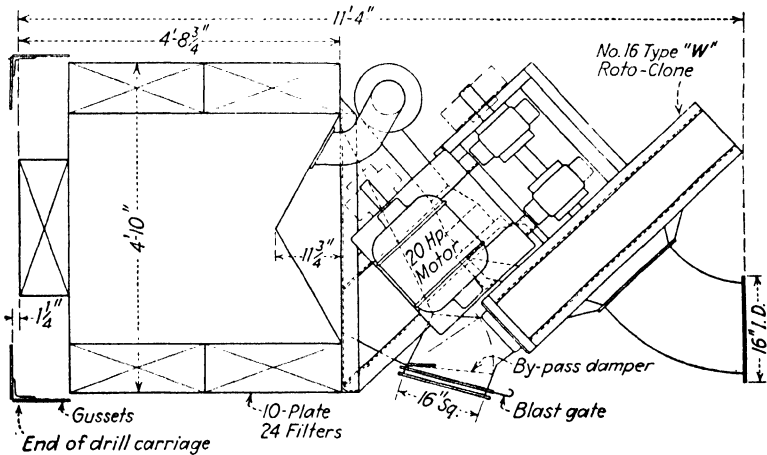

FIG. 151.—Later type of the auxiliary vent plant shown in Fig. 150. An exhaust fan and filters are mounted on the drill carriage. Dust is drawn from the drilling zone without creating drafts at the face. The dust-laden air is filtered and discharged into the heading behind the jumbo. (Courtesy of Kruse Engineering Co., Newark, N. J.)

An improvement on this plant, now in use on the Delaware Aqueduct, is shown in Fig. 151. This consists of a suction fan, mounted on the drill jumbo, driven by a 20-hp. motor. Suction pipes extend to the front of the jumbo, and the exhaust air is blown through cloth filters. A water stream in the fan precipitates the heavier particles and lessens the load on the filters. In this particular installation, six drills are in use, and the unit removes 4,200 c.f.m. from the heading without creating noticeable drafts.

Rock drills are not the only source of dust in a tunnel—blasting and mucking also create dust. Not much can be done about blasting dust except removal by general ventilation. However, wetting down the muck pile and the floor and walls in the vicinity of the mucking operations will do much to allay the dust caused by mucking.

Respirators.—The U.S. Bureau of Mines has approved certain types of respirators as effective against rock dust, but workmen “kick” about wearing them, saying they are uncomfortable and a hindrance to breathing. At any rate, respirators have not been seriously considered by tunnel contractors as a means of preventing silicosis.

CHAPTER 10

PUMPING AND WATER HANDLING

How are the pumping requirements of a tunnel figured in advance? One contractor gives the following method: "We estimate the required pumping capacity, then order pumps for twice this estimated capacity, add all the pumps we can find around the warehouse, and then usually find we have only half the capacity we actually need." This may be somewhat extreme

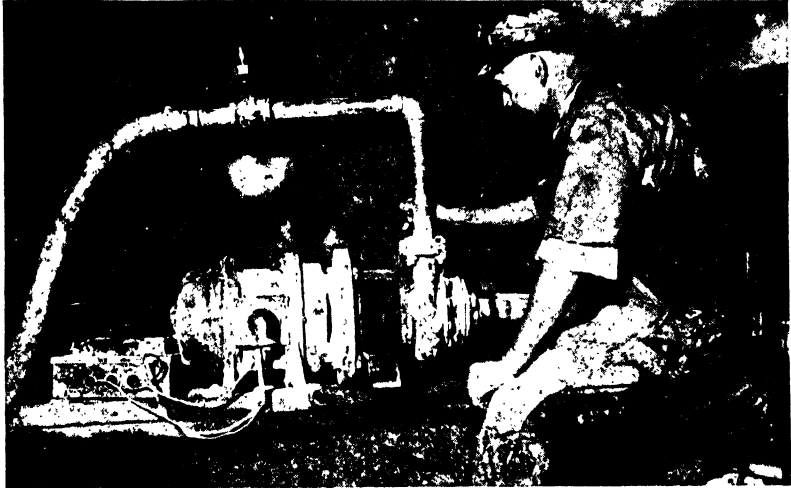

FIG. 152.—Single-stage electric-drive centrifugal pump. (Courtesy of Ingersoll-Rand Co.)

but is probably as accurate as any other method, for underground water conditions are almost impossible to predict. Advance test borings and a study of geological formations will give some indication of water to be expected, but the smart tunnel man always has a reserve of pumping capacity available for emergencies.

This reserve capacity is highly important, for when pumps are needed they are needed at once. An inflow of water, either

sudden or accumulated, greater than the capacity of pumps available means disaster to the job and to the contractor. Heavy losses have been suffered, directly and indirectly, through lack of drainage control. Headings have been flooded, causing delays while dewatering. Driving speed has been reduced with resulting increase in costs because of wet or improperly drained tunnels.

Although tunneling conditions will naturally determine the general method of water handling, the contractor has a wide



FIG. 153.—Air-driven Thor sump pump used as a gathering pump, Delaware Aqueduct.

choice in selection and detailed arrangement of his pumping plant. Various tunneling conditions that affect the methods of water handling are: headings driven on a level or downgrade, in which all water must be mechanically moved to portal or shaft; headings driven on an upgrade, in which gravity drainage may be possible; headings driven from shafts, in which all water must be pumped to the surface.

TYPES OF PUMPS AVAILABLE

In pumps the contractor has a greater variety of sizes and types available than for any other kind of tunneling equipment. The two general types are piston and centrifugal. Piston or reciprocating pumps used for tunneling are usually operated by com-

pressed air in the popular 2 and 3 in. sizes, by electric motor for the larger duplex and triplex models, and they are available in vertical or horizontal plunger models. Centrifugal pumps for tunnel work are also either electric-motor or compressed-air-driven, single or multiple stage.

The motor-driven types may be belt drive, direct drive with motor and pump mounted on the same base, or the popular



FIG. 154.—Air-driven tandem sump pump at bottom of a shaft. (Courtesy of Ingersoll-Rand Co.)

compact motor-pump units in which both motor and pump are a direct-coupled unit in a single frame and can be operated in any position. The pump manufacturers can supply electric motors for alternating or direct current of any common voltage in open, dampproof, splashproof or completely enclosed models as required. Compressed-air operated centrifugal pumps are usually the small sump pumps, which can operate completely submerged, resting on the bottom or hung by a cable. These small pumps require about 80 lb. air pressure for efficient operation.

HEADING INSTALLATIONS

The simplest method of handling water in a heading driven on a grade, either up or down, is open ditch drainage. In upgrade headings, the water may be removed to portal or shaft by gravity drainage; in downgrade slopes, it is necessary to keep a pump near the face and to pump back to a pipe line. Drainage ditches, however, are seldom satisfactory, for they must be kept free and open and usually take up valuable working space.

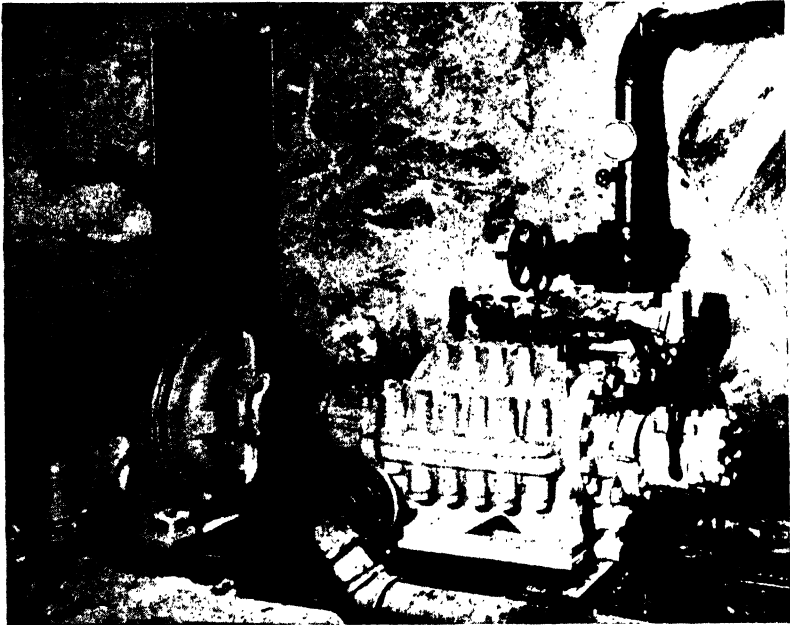

FIG. 155.—Electric-drive five-stage high-head pump at bottom of a deep shaft.
(Courtesy of Ingersoll-Rand Co.)

Unless the ditches are kept clear, which is difficult in any tunnel, large or small, objectionable pools of water will form on the floor. Most contractors prefer pump removal of all water in the headings, regardless of the direction of slope.

A popular arrangement of gathering pumps in the heading is to locate sumps at regular intervals, say 1,000 to 1,500 ft. apart, or at wet spots. A series of pumps, of any type, spotted at the sumps picks up the water at each sump and pumps it back to the next sump. An installation of this type is usually a series of

separate pumping operations in which the size of pumps can be changed as conditions warrant. The smaller sizes are moved ahead as the tunnel progresses if the total amount of water increases proportionately with the length of heading, requiring larger pumps than originally installed in the earlier stations.

Common practice in such installations is to use air-driven sump or piston pumps for the advance stations and electric-drive centrifugals for the replacements, especially if larger capacity is



FIG. 156.—Draining a tunnel with an electric-drive turbine pump on the surface, Buffalo sewer tunnel.

required. Pipe lines vary, of course, with quantity of water handled, from 2 to 10 in. The 4-in. size is popular, as it is not too hard to handle and yet will take care of all the water found in the average tunnel.

Instead of discharging the flow from sump to sump, some contractors prefer a tight pipe line from the forward pump to shaft or portal with intermediate pumps discharging into the line through check valves.

In selecting the gathering pumps to be used in the heading, capacity to pump against the friction head of the pipe is all that is required, for there is no static head to consider. Separate pumps at the shaft bottom, mentioned later in this chapter, take care of the static head.

SPECIAL HEADING CONDITIONS

Sometimes, in fairly tight ground, water inflow can be reduced or even entirely stopped by grouting off the wet seams, thus reducing the amount of pumpage. Grouting is not always successful, however, because an inflow blocked at one point may break through into the tunnel elsewhere. A wet area covering more than a single seam might be sealed off by installing a section of concrete lining.

In case of a steady flow of water from the roof or side of the tunnel, the flow should be deflected down the sides to sumps or



FIG. 157.—Diamond drilling through a concrete bulkhead for grout holes to seal a heavy water flow, Shaft 19, Delaware Aqueduct.

drainage ditch by metal shields. Otherwise the constant rain of water into the tunnel section is a nuisance and a hazard. Corrugated metal roofing, curved to the radius of the arch, is an effective shield.

A sudden inrush of water in the face of a heading indicates one of two conditions: (1) an underground pocket or lake has been tapped, which, when drained off, will cause no further trouble; (2) an underground flow connected with an inexhaustible source, such as a river or lake, has been tapped, a much more serious situation.

In the latter case, there are two possible situations: (1) water flow through stable ground, in which no ground is lost and special

tunneling methods are not required; (2) heavy water flow accompanied by a loss of ground, indicating a water-bearing unstable formation. In both situations, the usual procedure is to seal off the face with a bulkhead as quickly as possible to save the heading. Often, as an emergency measure, it is necessary to first erect a timber bulkhead, fitted with pipes for drainage and for grouting and concrete, backed up by a concrete bulkhead, though sometimes the concrete barrier is unnecessary. Explorations by drilling can then be made through the bulkhead to determine the conditions ahead. Before starting the exploration drilling, sometimes it will be possible to stop the water flow by grouting the space between bulkhead and face under high pressure. The grout may follow back into the water seam and cut off the flow. The first objective is to get the heading under control.

At Shaft 19 on the Delaware Aqueduct, some 93,000 bags of cement as grout were pumped behind the bulkhead erected after a heavy flow of water accompanied by sand and mud was encountered. Diamond drilling through the bulkhead revealed a fault about 300 ft. wide, beyond which was sound rock. The grouting reduced the water flow and partly consolidated the ground. The fault was traversed by small side drifts,

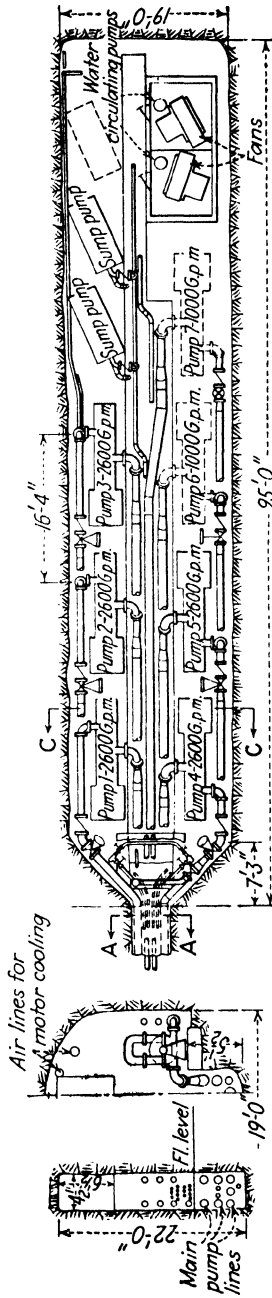

Section A-A Section C-C
 Plan
 Fig. 158.—Handling a special water problem. Scaled pump chamber at bottom of Potrero Shaft, San Jacinto Tunnel.

carefully enlarged while new water flows were checked by grouting.

On the San Jacinto tunnel in California, considerable trouble was encountered with water. One method of reducing the flow was by advance grouting. Test holes 20 to 35 ft. deep were carried ahead of the face; when a considerable inflow of water was met with these holes, they were fitted up with grout plugs and the water seams were grouted. In many cases this simple procedure was effective. When grout pumped into the holes leaked back into the heading through fissures in the face, sawdust was added

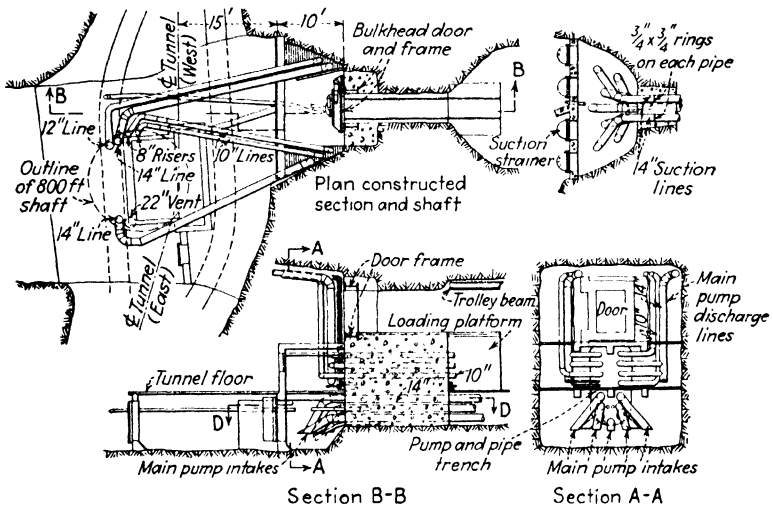

Fig. 159.—Details of pump chamber plug and connection between pump chamber and shaft, Potrero Shaft, San Jacinto Tunnel.

to the grout mix. When advance grouting was unsuccessful in stopping water flow, another expedient was tried, in which the inflow was temporarily disregarded and the tunnel was driven through the water-bearing zone, sometimes as an enlarged section so that a ring of Gunite could be shot into place in the fissured zone after operations had traversed the section. The procedure was to place a supporting cage of reinforcing bars in the section to be treated, wired and braced with timbers to hold them in place, and then apply the Gunite with two nozzles working simultaneously. Another method used on this tunnel, in extreme cases, was to build a sandbag bulkhead close to the face, through which five 6-in. drainage pipes were installed. Cement sacks

filled with sand were carefully placed to the full height of the tunnel to make a watertight bulkhead about 8 ft. thick, cement grout being poured or sprayed over the bags as the wall was laid up. As the water flow was entirely through the pipes, no pressure was exerted against the bulkhead. A timber bulkhead to support the sandbag dam was then built, after which the drain pipes were closed. A grout of four parts of quick-setting cement and one part of sawdust, with 8 gal. of water per sack of cement, was pumped behind the bulkhead. Grouting with sawdust and water and also with a mixture of cement and sawdust cut the leakage down to a small flow. Holes were then drilled around the perimeter of the tunnel to a depth of about 25 ft. beyond the bulkhead into which grout was pumped. This procedure usually was sufficient to stop the water flow and permit resumption of tunneling operations.

PUMPING IN SHAFTS

In handling water during shaft sinking, the sinker type of centrifugal pump, hung from cables, is very satisfactory. In deep shafts, booster pumps are installed in sumps cut into the side of shaft. If there is a steady flow of water down the sides of the shaft, the flow may be trapped and deflected into the booster sump to save power costs in pumping from the bottom. When the water at the bottom is not too great, the little air-driven sump pumps are used to pump into the lowest permanent sump. On the Delaware Aqueduct, one shaft contractor placed several electric-driven centrifugal pumps at various levels, connecting them in tandem without use of intermediate sumps.

The installation of the permanent pumping plant at the bottom of the shaft, to take care of all the tunnel waters, requires careful and considerate planning. First consideration is adequate capacity, for a deficiency in pumps here is likely to prove disastrous. Either the heavy-duty duplex or triplex motor-driven piston pumps or motor-driven centrifugals are satisfactory, though the trend is toward the latter.

The pumps are installed in a chamber off to one side, out of the way of haulage and hoisting operations, and they pump from a sump that collects all the water from the headings. It is wise to have at least three pumps installed, any two of which can

handle the expected flow. This provides a spare for use in case of breakdown and an excess capacity for emergencies.

The riser from pumps to surface is usually 10-in. pipe or larger. Large pipe cuts down the friction head and provides extra capacity if required. On the Delaware Aqueduct, the pump risers, as well as air and water pipes, and electric conduits were buried

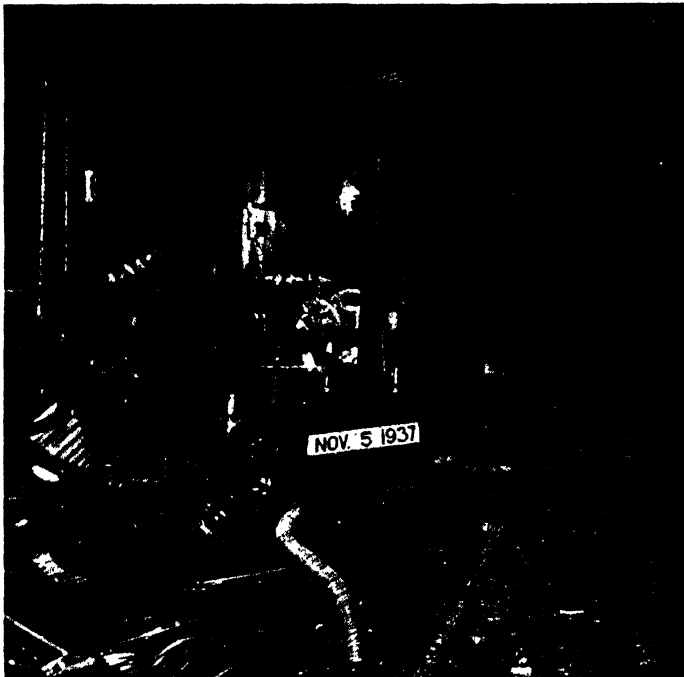

FIG. 160.—Air-driven piston pump and electric-drive centrifugal, bottom of a shaft on the Montebello water tunnel, Baltimore. (Courtesy of Bureau of Water Supply, Baltimore.)

in the shaft lining, leaving the shaft area free for hoisting and ventilating equipment.

Occasionally special equipment is necessary for shaft pumping. An example is the plant used in the Potrero shaft on the San Jacinto tunnel (*Engineering News-Record*, Aug. 22, 1935, p. 252). Twice the headings were flooded out, and water rose 600 ft. in the shaft. To guard against a third occurrence, the underground pump plant shown in Fig. 158 was installed. Five 2,600-g.p.m. and two 1,000-g.p.m. pumps were installed in a chamber 19x22x95 ft. excavated at the bottom of the shaft. The chamber was

TABLE V.—THEORETICAL HORSEPOWER REQUIRED TO RAISE WATER

Gallons per minute	Head, feet												
	10	15	20	25	30	35	40	45	50	60	75	90	100
10	0.03	0.04	0.05	0.06	0.08	0.09	0.10	0.11	0.13	0.15	0.19	0.23	0.25
15	0.04	0.06	0.08	0.09	0.11	0.13	0.15	0.17	0.19	0.23	0.28	0.34	0.38
20	0.05	0.08	0.10	0.13	0.15	0.18	0.20	0.22	0.25	0.30	0.38	0.45	0.50
25	0.06	0.10	0.13	0.16	0.19	0.22	0.25	0.28	0.32	0.38	0.47	0.57	0.68
30	0.08	0.11	0.15	0.19	0.23	0.26	0.30	0.34	0.38	0.45	0.57	0.68	0.75
35	0.09	0.13	0.18	0.22	0.26	0.31	0.35	0.40	0.44	0.53	0.66	0.80	0.88
40	0.10	0.15	0.20	0.25	0.30	0.35	0.40	0.45	0.50	0.61	0.76	0.91	1.01
45	0.11	0.17	0.23	0.28	0.34	0.40	0.45	0.51	0.57	0.68	0.85	1.02	1.14
50	0.13	0.19	0.25	0.32	0.38	0.44	0.50	0.57	0.63	0.76	0.95	1.14	1.26
60	0.15	0.23	0.30	0.38	0.46	0.53	0.61	0.68	0.76	0.91	1.14	1.36	1.52
75	0.19	0.28	0.38	0.47	0.57	0.66	0.76	0.85	0.95	1.14	1.42	1.70	1.89
90	0.23	0.34	0.45	0.57	0.68	0.80	0.91	1.02	1.14	1.36	1.70	2.04	2.27
100	0.25	0.38	0.50	0.63	0.76	0.88	1.01	1.14	1.26	1.51	1.89	2.27	2.52
125	0.32	0.47	0.63	0.79	0.97	1.10	1.26	1.42	1.58	1.89	2.37	2.84	3.16
150	0.38	0.57	0.76	0.95	1.14	1.32	1.52	1.70	1.89	2.27	2.84	3.41	3.79
175	0.44	0.66	0.88	1.10	1.32	1.54	1.78	1.99	2.21	2.65	3.31	3.98	4.42
200	0.50	0.76	1.01	1.26	1.52	1.77	2.02	2.27	2.52	3.03	3.79	4.54	5.05
250	0.63	0.95	1.26	1.58	1.90	2.20	2.52	2.84	3.16	3.79	4.73	5.68	6.31
300	0.76	1.14	1.51	1.90	2.27	2.65	3.03	3.41	3.79	4.54	5.68	5.82	7.58
350	0.88	1.33	1.77	2.21	2.65	3.09	3.54	3.98	4.42	5.30	6.62	7.95	8.84
400	1.01	1.52	2.02	2.52	3.03	3.53	4.04	4.55	5.05	6.06	7.57	9.09	10.10
500	1.26	1.90	2.52	3.16	3.78	4.42	5.05	5.69	6.31	7.58	9.47	11.36	12.63
550	1.39	2.08	2.78	3.47	4.17	4.86	5.56	6.26	6.94	8.33	10.42	12.50	13.89
600	1.52	2.28	3.03	3.79	4.55	5.30	6.06	6.82	7.58	9.09	11.36	13.64	15.15
650	1.64	2.47	3.28	4.10	4.93	5.75	6.56	7.39	8.21	9.85	12.31	14.77	16.41
700	1.77	2.66	3.54	4.42	5.30	6.19	7.07	7.96	8.84	10.60	13.26	15.91	17.68
750	1.89	2.85	3.79	4.74	5.68	6.63	7.58	8.53	9.47	11.36	14.20	17.04	18.94
800	2.02	3.04	4.04	5.05	6.06	7.07	8.08	9.10	10.10	12.12	15.15	18.18	20.20
850	2.15	3.23	4.29	5.37	6.44	7.51	8.58	9.67	10.73	12.87	16.10	19.32	21.46
900	2.27	3.42	4.54	5.68	6.82	7.95	9.09	10.24	11.36	13.63	17.04	20.45	22.73
950	2.40	3.60	4.80	6.00	7.20	8.40	9.60	10.80	11.99	14.39	17.99	21.59	23.99
1000	2.52	3.79	5.05	6.31	7.58	8.84	10.10	11.36	12.63	15.15	18.94	22.73	25.25
2000	5.05	7.57	10.10	12.63	15.15	17.67	20.20	22.72	25.25	30.30	37.87	45.45	50.50
3000	7.57	11.37	15.15	18.94	22.72	26.51	30.30	34.09	37.88	45.45	56.81	68.18	75.75
4000	10.10	15.16	20.20	25.25	30.30	35.35	40.40	45.45	50.50	60.60	75.75	90.90	101.01

$$\text{Water horsepower} = \frac{\text{Gallons per minute} \times \text{head, in feet}}{3,960}$$

$$\text{Brake horsepower} = \frac{\text{Gallons per minute} \times \text{head, in feet}}{3,960 \times \text{efficiency of pump}}$$

fitted with watertight doors capable of resisting a static head of 803 ft., the depth of shaft, and the plant was designed to operate with the headings and shafts submerged. Control of the units was from the surface, and special ventilation had to be provided for air circulation to cool the motors. Each pump had a separate



FIG. 161.—Electric-drive turbine pump, controlled by float valve, installed in a sump at bottom of shaft. (Courtesy of Ingersoll-Rand Co.)

intake from the heading, but all discharged into a manifold branching out into three risers.

Of course, such an installation is unusual and expensive, but it illustrates the problems sometimes encountered in handling water in tunnel driving.

CHAPTER 11

PLANT AND UTILITIES

Much of the plant and equipment used in tunneling is discussed in other chapters on operations to which they specifically apply. However, general utilities and certain general plant items apply to all tunnels, regardless of type or method of tunneling. These include: power and lighting, compressors, air and water lines, shops, offices and change houses.

POWER AND LIGHTING

Power is required for operation of air compressors, pumps, shop, lighting of tunnel and surface buildings, ventilating fans, mucking machines or shovels, locomotives and the aggregate and concrete plant. Usually the prime or principal power for tunneling operations is electricity. When available at reasonable rates, commercial electrical power is preferred, although modern diesel-driven generators furnish electricity at low cost and are occasionally used as the prime source of power. Where electricity is not available as prime power, internal combustion engines, gas or diesel, can be used to drive individual units, such as compressors and generators for fans, lighting and blasting. In such cases, compressed air will be used for small tools and pumps. Compressed air is essential, of course, for operating the drills—whether the compressors are to be electric, diesel or gas-driven is a matter of economics.

The most economical use of electrical power is to bring the current to the job at high voltage, then step it down with job transformers to the various voltages required. Large motors for compressors use current at 2,300, 440 or 220 volts; pumps and fan motors range through 440, 220 and 110 volts; the blasting circuit, 440, 220 or 110 volts, and the lighting circuit 110 volts. Drill steel sharpeners and furnaces use compressed air, but electrical current at 220 or 110 volts is necessary for the machine shop. Welding, indispensable for repairs and many other uses, is satisfactorily done with one or more portable machines.

The trend of electric power in the tunnel is toward higher voltages. On long headings, such as the Delaware Aqueduct, many contractors take the current into the hole at 2,300 volts for economical transmission, stepping it down to lower voltages with portable dry transformers in the tunnel.

A high-voltage distribution system in use on the Delaware Aqueduct by Walsh Construction Co. and Associated Contractors,



FIG. 162.—Transformer bank for one of the Chicago subway tunnel sections. Usually the utility furnishing the power installs the transformers, but not always.

Inc., is shown in Fig. 164, described by Charles F. Kelley in *Delaware Water Supply News* of July 1, 1939. A high-tension line of 2,300 volts is taken down the shaft and into the tunnel. Care is used in installation and protection of the high-voltage system, because of limited room and wet conditions in the tunnel.

From an oil circuit breaker in the power house, protected with disconnecting switches, a 2,300-volt line of standard three-conductor steel-armored parkway cable is laid below ground to top of shaft, terminating in a sheet-steel cabinet containing three

disconnecting cutouts. From this cabinet, a vertical riser type of parkway cable, designed for vertical suspension, is dropped down the shaft. At the bottom is another cabinet containing the necessary primary disconnecting cutouts. From here the line goes to a dry transformer bank for power and another separate dry transformer for light. The transformer banks, mounted on solid platforms high and clear of derailment and flooding, are moved down the heading in 1,000-ft. jumps as the tunnel pro-

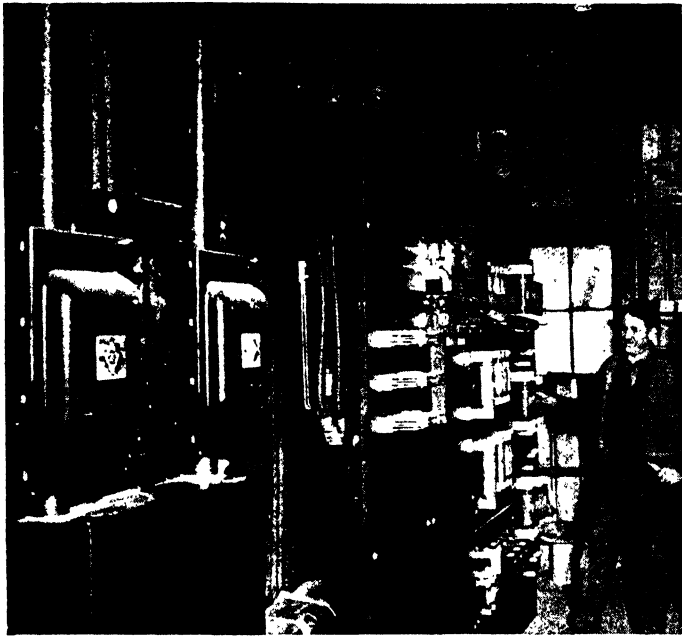

FIG. 163.—Switch room on a Chicago subway tunnel section. Electrical installations should be simple, safe and easy to operate.

gresses. The parkway cable is strung high on the tunnel wall for safety. The steel armor of the cable, as well as the dry transformers, are grounded to a copper ground wire. Dry transformers eliminate the fire hazard of the oil-filled transformers.

Although this is an installation required only for long headings in large tunnels, it indicates sound electrical practice that should be followed on every tunnel job. By all means, experienced electricians should install all electrical work, for the hazards of high voltages are greatly increased by wet tunneling conditions.

The maximum power demand can be estimated by figuring the total installed horsepower of all electrical units, plus the lighting requirements. An example of the amount of electric power required for tunneling is shown in Table VI from *Engineering News-Record*, Mar. 30, 1939, giving the power consumption for

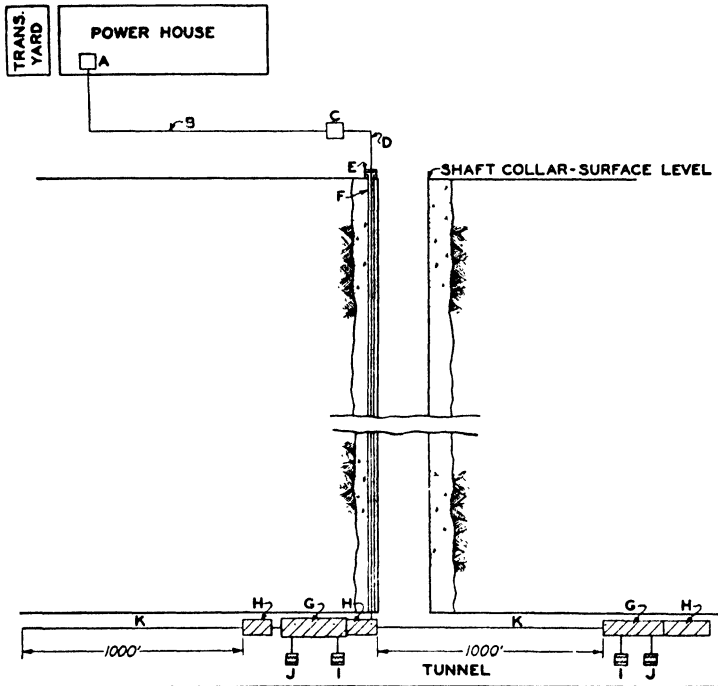

FIG. 164.—High-voltage system used by Walsh Construction Co. on the Delaware Aqueduct. A, suitable oil circuit breaker in power house with disconnecting switches or cutouts; B, three-conductor parkway cable, standard steel-armored type; C, steel cabinet box with primary disconnecting cutouts; D, three-conductor vertical riser parkway cable; E, special three-plate clamp; F, 4-in. service pipe in shaft lining; G, sheet-steel cabinets with primary cutouts; H, same for future extension of parkway cable; I, dry transformer banks 2,300/440 volts; J, dry transformer banks 2,300/220-110 volts; K, future extension of standard parkway cable in 1,000-ft. lengths. (From *Delaware Water Supply News*.)

nine months in driving the $9\frac{1}{2} \times 11$ -ft. Stanislaus Tunnel in California.

Tunnel lighting is a matter of both utility and safety. As a safety measure, lighting was discussed in Chap. 4. Regardless of safety features, good lighting is essential to efficient tunneling. It pays to have plenty of lighting at points of operation and equip-

ment stations—the shaft bottom, underground repair shops, pump and transformer stations, switches, turnouts and passing tracks, drill carriages and other jumbos, and drilling and mucking zones.

TABLE VI.—MONTHLY CONSUMPTION OF ELECTRICAL POWER ON THE STANISLAUS TUNNEL

Month	Feet of tunnel	Total kilowatt-hours	Kilowatt-hours per foot of tunnel	Cost of power for tunnel driving ¹	Cost of power, feet of tunnel	Camp and cook house kilowatt-hours	Cost of camp and cookhouse power ¹
January, 1937.....	468.8	62,500	133	\$ 540.44	\$1.15	140,000	\$1,211.14
February.....	514.2	102,770	200	867.94	1.69	110,230	930.99
March.....	1,143.5	153,600	134	1,172.30	1.02	108,900	831.00
April.....	1,546.5	188,620	122	1,527.01	.99	81,380	659.10
May.....	1,594.5	193,640	121	1,523.42	.96	46,360	364.73
June.....	1,771.7	219,900	124	1,731.95	.98	39,600	311.90
July.....	1,627.7	223,030	137	1,945.20	1.20	33,470	277.00
August.....	1,919.1	241,970	126	1,937.35	1.01	34,630	272.60
September.....	1,975.8	248,510	126	2,004.83	1.02	37,990	306.50
October.....	1,963.2	252,450	129	1,943.88	.99	67,050	516.50
November.....	1,106.6	180,390	163	1,515.50	1.37	95,610	803.80
December.....	958.0	169,870	177	1,395.33	1.46	111,980	920.82
January, 1938.....	689.1	111,440	162	860.92	1.26	107,390	829.63
Total.....	17,278.7	2,348,690	...	\$18,966.07	1,013,990	\$8,235.71
Average per month.....	1,329.0	136	1,459.00	\$1.10	633.52

¹ Cost of power is based on commercial rate less 10 per cent.

Usually the lighting circuit is 110 volts, though some contractors, to save installation of a separate circuit, use a 220-volt circuit for both light and power, which, of course, requires special 220-volt light bulbs. A safe and common light installation is a parallel circuit of two heavily insulated wires strung about 6 in. apart, which can be tapped wherever desired for single lights or a connection for another circuit. In unlined tunnels, the electric wires may be fastened to wooden dowels driven into holes drilled for the purpose high on one side of the tunnel. In timbered sections, insulators for carrying the circuits are fastened to the steel or wood timbering.

The spacing of lights along the tunnel for general lighting depends upon the size of tunnel, wattage of bulbs used and color of ground. Fewer lights are required, for example, in a small head-

ing in light-colored limestone than in a large tunnel in dark granite. The lights should be spaced so that the entire tunnel is well lighted, especially the tracks and floor. More lights of small wattage are preferable to fewer lights of larger size, as failure of a bulb in the latter case leaves a dangerous dark spot in the tunnel.



FIG. 165.—Sometimes it pays to generate electric power at the site. Diesel-electric generating set on Montebello water tunnel, Baltimore. Electric-drive ventilating fans are at extreme right. (Courtesy of Bureau of Water Supply, Baltimore.)

S. A. Healy, on his sections of the Delaware Aqueduct, uses photoflood lamps at the heading for the drilling and mucking zones. Of course, the life of the lamps is only a few hours, but the intense light they produce illuminates the headings as if they were in daylight.

COMPRESSOR PLANT

The compressor plant should be both adequate and flexible. Regardless of the total amount of compressed air required, it is best to install at least two or more units, of different sizes, if

possible, to make up the total required capacity. Compressed-air requirements in tunneling vary with the type of operation under way, and a multiple-unit arrangement of compressors allows maximum efficiency and economy in running only that part of the compressor plant needed at the moment.

Compressed-air power operates the rock drills, pumps, drill steel furnaces and sharpeners, small hoists, and many small tools. As explained in Chap. 19, the compressed-air requirement for

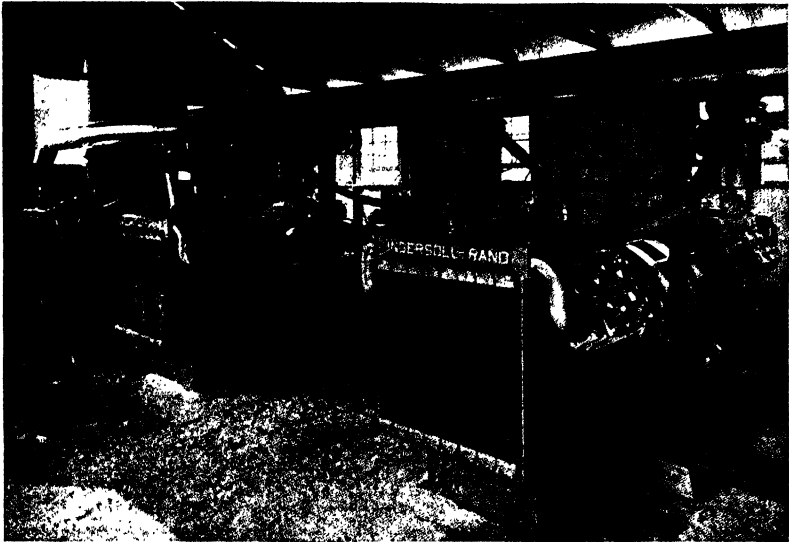

FIG. 166.—Radiator-cooled electric-drive compressors, Bates & Rogers Construction Corp., Pennsylvania Turnpike tunnels. Compressors are double compound units, driven by a single motor. (Courtesy of Ingersoll-Rand Co.)

drills is not in direct proportion to the number of drills in use. The compressor table given in that chapter shows the customary ratio of compressor requirements to number of drills. The same general principle, which can be taken into consideration when estimating the compressor requirements, is applicable to all air-driven equipment.

A medium-sized drill sharpener will use about 150 cu. ft. of air per min.; two will use about 270 cu. ft. The larger sharpeners require 200 c.f.m.; two of them need about 360 c.f.m. The gathering and sump pumps, working against low head, will use from 25 to 125 c.f.m. Pneumatic concrete placers used for blowing the lining concrete into place are not usually used until

the drilling is completed; therefore the compressor capacity required for drilling is more than ample for the placers. Of course, if concrete lining is to proceed with drilling operations, the air requirements of the placer must be added to the compressor requirements. It is well to have some reserve capacity in the compressor plant, to operate small hoists, extra pumps and other emergency equipment. An inadequate air supply seriously handicaps a job; excess capacity is a good insurance investment. A general rule for estimating compressor capacity is to figure the

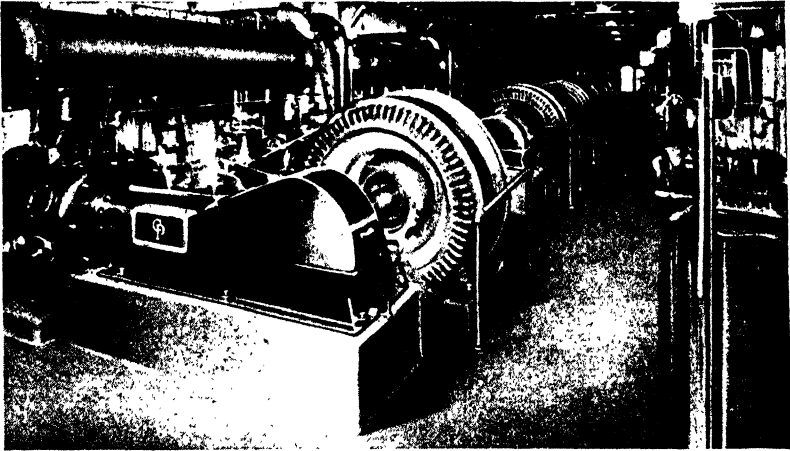

FIG. 167.—Bank of electric-drive compressors on a large tunnel job. Note individual controls for each machine at right. Sometimes the control of compressors is automatic. Additional machines cut in as the pressure drops and more air is required. (Courtesy of Chicago Pneumatic Tool Co.)

underground requirements as carefully as possible, then add 25 per cent reserve capacity for surface plant and emergencies.

The larger electric-drive compressors are usually driven by synchronous motors. A two-stage compressor, for example, having a piston displacement of 1,300 c.f.m. and actually delivering 1,208 c.f.m. (the latter figure is what counts in operating equipment) will require a 225-hp. synchronous motor. Similarly, a compressor delivering 1,480 c.f.m. will use a 300-hp. motor; one delivering 1,888 c.f.m. a 400-hp. motor, and one delivering 2,195 c.f.m. a 450-hp. motor. Synchronous motors require an exciter or motor-generator set. A customary electrical hookup includes a magnetic full-voltage across-the-line starting panel. If desired, compressors may be driven by direct-connected diesel

engines. As most compressed-air tools operate at air pressures from 85 to 100 lb. per sq. in., a pressure of 110 to 115 lb. at the compressor is ample to overcome the usual friction losses in transmission through the pipes.



FIG. 168.—Aftercooler at Shaft 6, Delaware Aqueduct. (Courtesy of Ingersoll-Rand Co.)

AIR COOLERS AND RECEIVERS

For efficient use of compressed-air operated equipment, and for the comfort of underground workers, it is necessary to relieve the heat in compressed air created by the act of compression. In the two-stage compressors, intercoolers or compressor radiators remove much of the heat from the air between the first and second stages of compression. Aftercoolers are required for removing the heat from the last compression stage. Intercoolers and radiators are part of the compressors; aftercoolers are a separate plant item.

Aftercoolers and intercoolers are tanks containing a number of small tubes through which cold water is pumped. Automatic traps are installed to collect the moisture condensed from the

cooling air. Aftercoolers should have a capacity of 1 gal. of water per 100 cu. ft. of air per min., which is sufficient to reduce

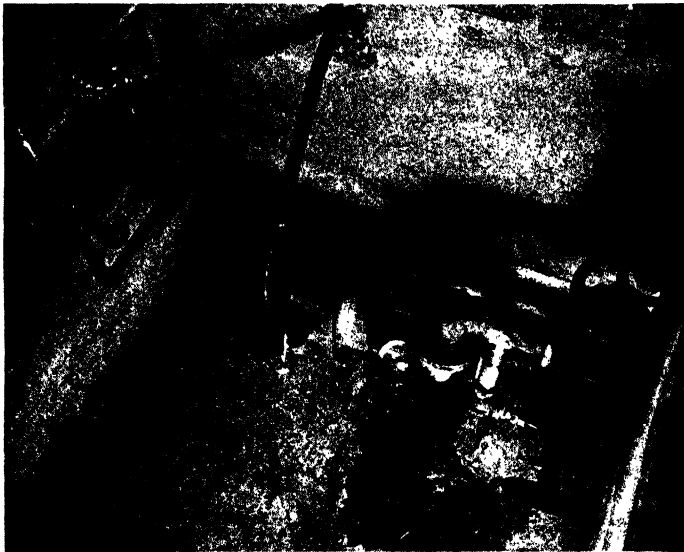

FIG. 169.—Motor-driven pump for circulating cooling water through the compressor intercoolers and aftercoolers. (Courtesy of Ingersoll-Rand Co.)

the air temperature to 70°F. if the water is kept cool. If there

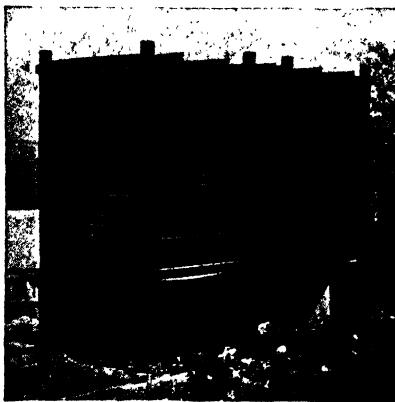

FIG. 170.—Spray tank for cooling compressor water, Shaft 8, Delaware Aqueduct. Louvers protect the water spray from wind.

is an ample supply of running cold water available, it may be used for the intercoolers, radiators and aftercoolers. However, the usual procedure is to recirculate the water with a small centrifugal pump. Hot water from the coolers is pumped through a series of sprays, liberating the heat through contact with the atmosphere. The spray tank is protected by an inclosure of wooden louvers, as shown in Fig. 170, to prevent disturbance by wind.

To provide for a steady flow of compressed air and a temporary reserve capacity, large tanks or air receivers are installed at the

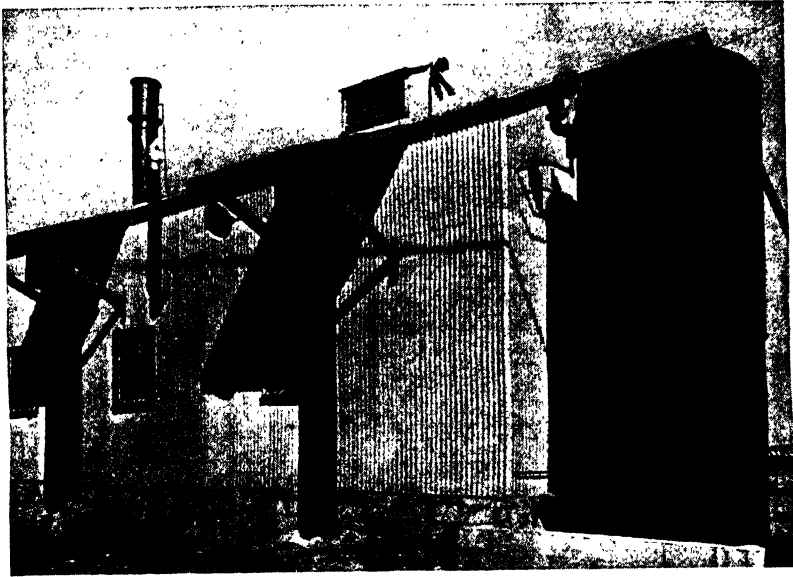

FIG. 171.—Air receiver outside of compressor house, Shaft 6, Delaware Aqueduct. Note compressor intakes protected by canopies at left. (Courtesy of Ingersoll-Rand Co.)

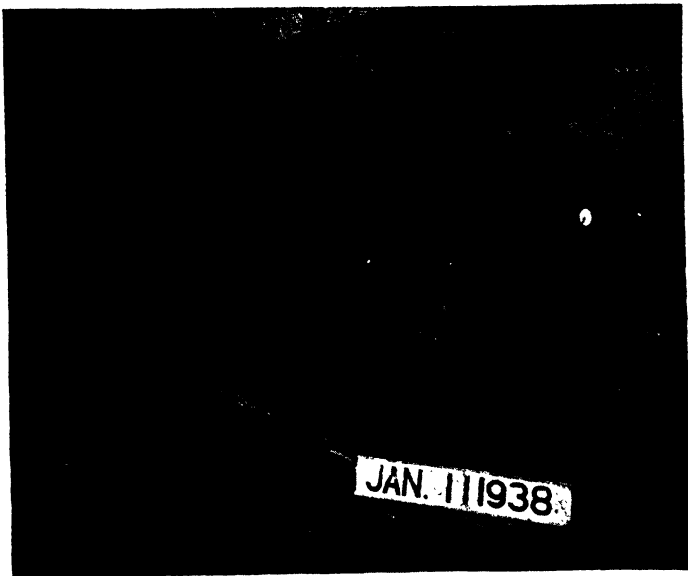

FIG. 172.—Air receiver in the heading, Montebello water tunnel, Baltimore. On long headings such installations provide more uniform air pressure and volume at the face. (Courtesy of Bureau of Water Supply, Baltimore.)

compressor plant, and, in case of long headings, within the tunnel also, Figs. 171, 172. Receivers should be built to withstand a working pressure of at least 125 lb. per sq. in. An air receiver of a cubical capacity about one-tenth of the total volume of air produced per minute is sufficient. For example, a tank of 500 cu. ft. capacity will amply serve a compressor plant producing 5,000 c.f.m.

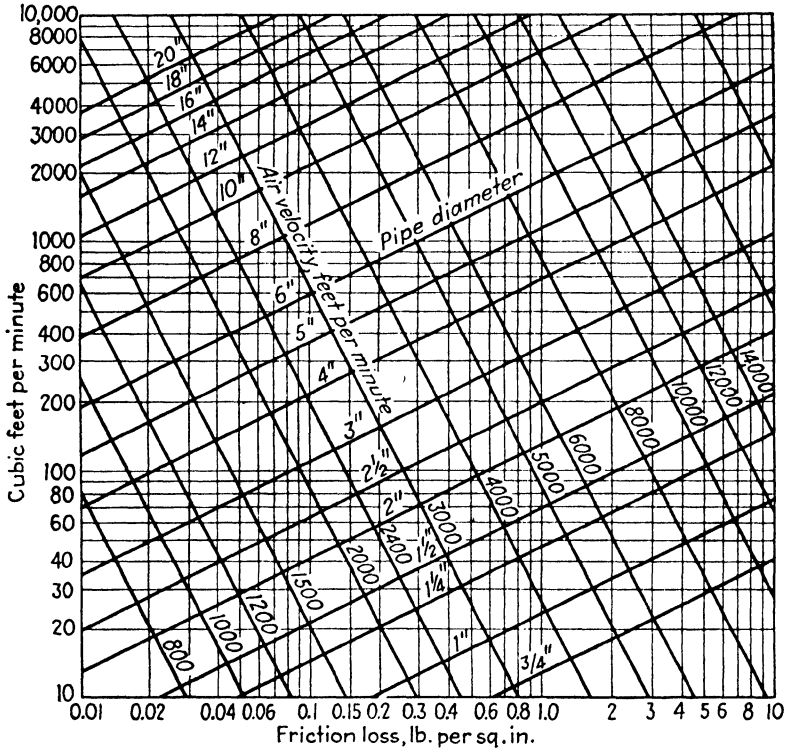

Fig. 173.—Chart showing friction losses through air pipelines.

AIR LINES AND UTILITY ARRANGEMENTS

There is a considerable friction loss in the transmission of compressed air through pipes. The chart Fig. 173 shows the friction loss in pounds per square inch for various volumes of air delivered through 100 ft. of pipe of various sizes. From a study of this chart, it will be evident that too small a transmission pipe causes excessive losses in pressure. For example, the chart shows

that, for a given volume of air, the loss in a 4-in. pipe is roughly ten times that in a 6-in pipe. In choosing the size of pipe, the cost of pipe and installation and handling costs must be weighed against cost of friction losses. For small and fairly short headings, a 4-in. pipe is common, but 6-in. is considered the minimum size for most tunnels.

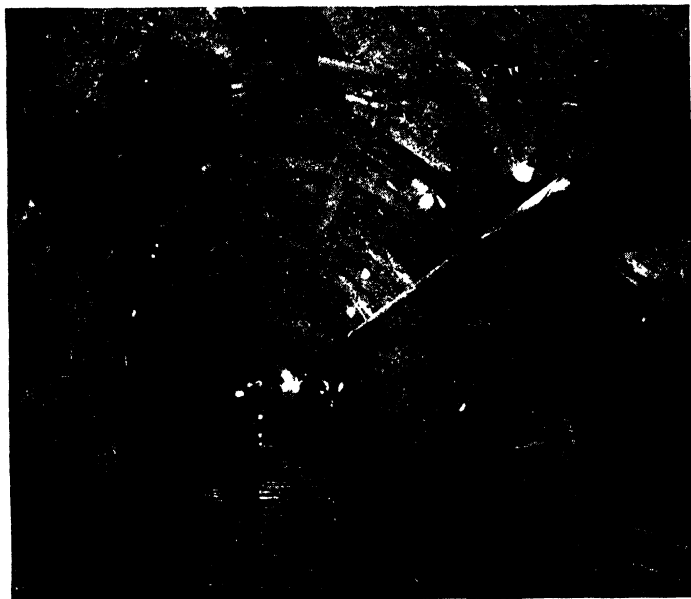

FIG. 174.—Typical arrangement of utilities in a tunnel. At upper left is the blasting circuit, on opposite side of the tunnel from the power and light circuits. The vent pipe is just below the lighting circuit. Pipes at lower right are air supply, water supply for drills and two pump discharge lines. (Courtesy of Bureau of Water Supply, Baltimore.)

A 2-in. pipe is usually sufficient in size for supply of water to the drills for wet drilling. Size of drainage and ventilation pipes was discussed in the two previous chapters. In arrangement of air, water, drainage and ventilation pipes, and power, light and blasting circuits, care should be taken to place the various utilities out of the way as far as possible, and yet keep those needing frequent maintenance within easy reach. The blasting circuit must, by all means, be kept on the opposite side of the tunnel from power and light circuits. Typical utility arrangements in the tunnel are shown in Fig. 174.

REPAIR SHOPS AND FACILITIES

Every tunnel job should be equipped with proper repair facilities. A small machine shop, blacksmith shop, carpenter shop, electric and gas welding equipment, and electrical repair shop are indispensable.

A drill-sharpening shop (see Chap. 19) will be required where forged drill bits are used; or, if detachable bits are used and

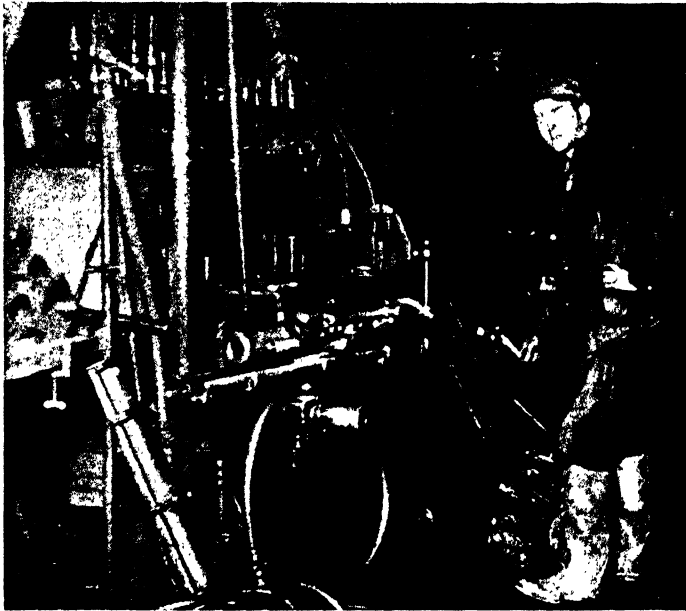

FIG. 175.—An underground drill repair shop. The "drill doctor" is an indispensable mechanic on every tunnel job.

resharpened on the job, facilities will have to be provided for this purpose. It is not wise to combine the drill-sharpening shop with other repair facilities, for on the sharpening shop's efficiency depends an uninterrupted flow of steel in and out through the shop. The presence of other repair facilities might interfere with sharpening operations.

Drill repair facilities must be established, either above ground or in a niche off the tunnel, Fig. 175. More important than location is a competent "drill doctor" to keep the drills in good repair.

If storage battery locomotives are used, a battery charging station is required. Proper hoisting equipment is necessary for easy removal and installation of the batteries. On some of the larger tunnels driven from shafts, the battery charging station is located underground, in a niche driven off the tunnel. Such an installation saves hoisting the locomotives to the surface to change the batteries.

BUILDINGS

Care in design and construction of the necessary buildings is worth while. Shops, compressor houses, tool houses and warehouses should be ample in size, and the facilities arranged for efficient operation. Too often office facilities are skimpy and inadequate. Much important office work must be done on the job. Large, well-heated, ventilated and properly equipped offices are a good investment.

Change houses or workers' quarters are absolutely essential, in fact, in many states they are required by industrial codes. The quarters should be clean, ample, well heated and ventilated, and equipped with toilets, washing facilities, shower baths, seats and tables, and lockers for each worker where he may keep his work clothes. The New York State industrial code prescribes the following standards for change houses:

All men shall have individual lockers not less than 14x15x72 in., preferably of metal construction, and the room shall be equipped with heating facilities for the purpose of drying clothing kept therein before the worker returns to work. One shower bath, with hot and cold running water, shall be provided for every 10 drillers employed on a shift. One basin or 18 in. of wash trough, with hot and cold running water, shall be provided for every 8 drillers employed on a shift. One toilet and one urinal shall be furnished for every 15 men employed on each shift, protected from the weather. A minimum temperature of 70 deg. shall be maintained in wash and dressing rooms. Suitable waterproof clothing shall be supplied to drillers by the employer.

On isolated jobs, the contractor usually has to build a camp to house his labor. Buildings required will be an office, storehouse, commissary, mess hall, bunk houses and houses for employees with families. The cheapest type of shanty construction is shown in Fig. 176. All lumber may be rough, except the flooring. Walls are 1x12-in. boards, set vertically and nailed to the platform

that forms the floor. Floor joists are 24-in. centers; rafters are 30-in. centers; both are 2x4 in. The roof is roofing paper with cemented joints. Walls are covered with tar paper on the outside, battened with laths. Windows are plain sash, sliding horizontally in a groove in the chair rail; there is no frame for either windows or doors.

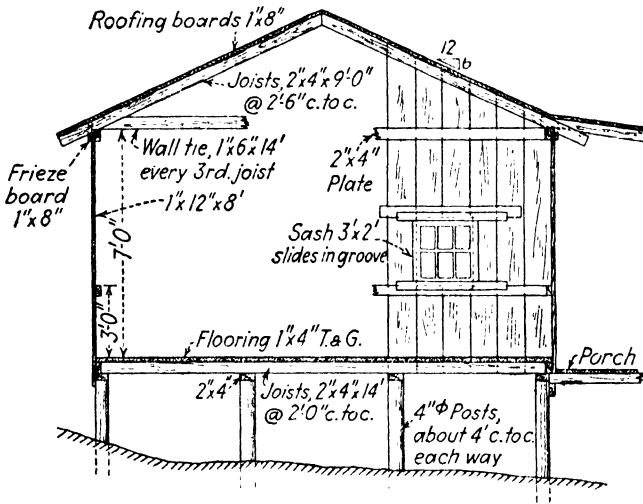

FIG. 176.—Details of simple job shanty, suitable for office, warehouse or bunkhouse.

In northern climates, additional rafters will be necessary to carry the snow load, the inside must be sheeted with wallboard or other insulating material, and the outside sheeting carried to ground level to keep the floors warm.

Southern contractors standardize on shanties of this type, 14x28 ft., divided into two rooms by a partition. Such a building will bunk four foremen or eight workmen. Fitted with lean-to kitchens, they are suitable for families. All cabins and bunkhouses should have small porches. The cost of such a shanty, including three doors and six windows, is about \$400.

CHAPTER 12

SOFT-GROUND TUNNELING WITH TIMBERS

Timber was the sole material used for supporting soft ground until the introduction of steel liner plates a few years ago. The timbering methods developed for soft ground may prove very economical on present-day jobs. Almost every tunnel job will involve short stretches of bad ground, requiring special methods of driving. Even the contractor on an open-trench job may find places where it will be better to tunnel than to excavate in the open; for example passing under a busy highway or a number of railroad tracks. The methods outlined in this chapter require no expensive equipment. Required lumber and timber can be obtained from the local lumberyard; the tools are the time-honored tools of the tunnel man—pick, shovel, sledge hammer and ax.

DEFINITION OF SOFT GROUND

In outlining the various schemes of soft-ground tunneling, it is necessary to define the types of ground to which each method is best adapted. The following definitions are the authors':

Running Ground.—This is ground which must be instantly supported. It may be dry sand or gravel, water-bearing sand or gravel (called quick sand), silts and muds.

Soft Ground.—In this ground, the roof must be instantly supported, but the side walls can be depended upon to stand on a vertical face for a few minutes. This may be soft or squeezing clay, damp sand, certain types of gravel, or soft earth. Some formations of decomposed or caved rock require the same methods of support.

Firm Ground.—This is ground where the roof can be depended upon to carry itself unsupported for a few minutes, and the side walls and face will stand vertically for an hour or so. In this group are firm clays, dry earth, cemented sands and gravels, and loess. Certain treacherous rocks also come under this definition.

Self-supporting Ground.—This is ground which will stand unsupported while the entire tunnel is driven a distance from 4 to 16 ft. before timbering is placed. Included are shales, hard clays and earth, sandstones and certain cemented sands and gravels.

Of course, the definitions are very elastic, since the nature of the soil will change in even a day's drive, and the method of mining will vary with the ground.

OTHER FACTORS INFLUENCING METHOD OF ATTACK

Many other factors may influence the method of attack. A skilled fast-working gang of miners can often penetrate bad ground by using methods which in slower hands would prove disastrous. The size of the tunnel may also affect the scheme adopted, for a wide tunnel will require more ground support, placed more quickly, than will a narrow one. Thus, in bad ground, a method should be selected which permits only small areas to be opened at a time, for the smaller the area the more quickly it can be worked and the less danger there is of accident.

Compressed air will work wonders in many, though not all, types of bad ground. A few pounds of air in running ground may give it all the characteristics of firm ground and simplify the problem of support.

FOREPOLING

Forepoling is an ancient method and, until the adoption of compressed air, the only system for driving through running ground. It is a slow and tedious operation but, with ordinary care it is a safe one. Unless the miners are skilled and experienced, it will require close supervision. There are no short cuts in this method; every move must follow in its correct order, and every operation must be safely completed before the next is started.

While this method has been mentioned in most books on tunneling, often the sketches are misleading, making it appear more dangerous than it is. Therefore, in this work this important scheme will be carefully and full explained and illustrated.

The following description is of a tunnel driven through fine wet sand. The cross section was 4 ft. 6 in. by 5 ft. 4 in. in the clear. After the tunnel was driven, a 36-in. sewer was installed in the bore.

After the shaft was sunk to grade, a bent was set up, Fig. 178A, a few inches from the sheeting and securely braced; it was of the dimensions shown in Fig. 178B. Holes were then drilled through the sheeting so that sections of it could be chiseled out later.

There were two lines of these holes just above the cap, about 3 in. apart, and another line about 18 in. below the cap.

The forepoles, or spiles, were 2x6-in. planks, 5½ ft. long, sharpened to a chisel point. A piece of the sheeting just above the cap was chopped out, and the spiles were entered one at a time and driven into the ground for about half their length. These were driven with an upward inclination of 2 in. per ft. A few side spiles were then started, flared outward with a pitch of about 1½ in. per ft.



FIG. 177.—A forepoled tunnel with inclined posts to resist side pressure. Note method of framing the posts into the caps.

The pitch of the spiles is very important; it is better to have too much than too little. If there is not enough pitch, the next cap cannot be set up to grade. Also, and most important, there must be enough pitch to permit the next set of spiles to be entered and driven without fouling them behind the leg or cap of the previous set. The matter of pitch will not seem important on the first set of spiles, but it will be apparent when starting the second. Pitch should be checked with a hand level.

After all the roof and part of the side spiles are driven about half their length, a timber is laid across the back ends, Fig. 178E, and the spiles are then wedged down from this timber. This

serves to cantilever the front end of the spile. The sheeting is next broken out at the lower line of holes, 18 in. below the cap, and the ground is allowed to run into the tunnel until it assumes its natural angle. A false set is then set about 2 ft. from the sheeting. This set, called the "horse head," is supported on a centerpost resting on a small footing block. The spiles are then driven to their full penetration.

More earth is then carefully raked into the shaft, and, as the ends of the spiles are uncovered, a board about 18 in. long is set vertically under the point, Fig. 178F. This board principally acts

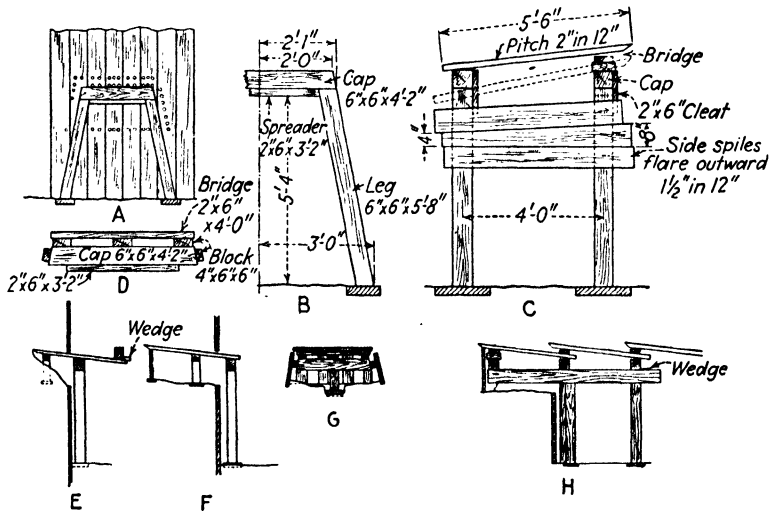

FIG. 178.—Steps and details of the forepoling method of tunneling.

as a breast board, but it also serves as a support for the spiles cantilevered from the sub-cap.

The next cap is then set in its correct position for line and grade, 4 ft. c. to c. from the last one. The new cap is held in position temporarily by a single post set on the bench, as shown in Fig. 178G. Note that this cap has a "bridge" of 2x6-in. lumber attached to the top of the cap, but separated from it by 4-in. blocks. This is shown in Fig. 178D.

Meanwhile, the remainder of the side spiling is driven. Note that certain of the side spiles are tapered and driven big end first. This gives an upward inclination to the side spiles, keeping the top edge of the topmost side spile parallel to the inclination of

the roof spiles. In really bad ground, several of these tapered side spiles are used, and the lower side spiles are tipped to a downward inclination so they will come below the foot block of the next set, thus permitting this block to be more readily set.

A pair of booms, or bars, is used to support the forward cap while the remaining ground is taken out. These are heavy timbers, generally of hardwood, about 6x8 in. and 10 ft. long for

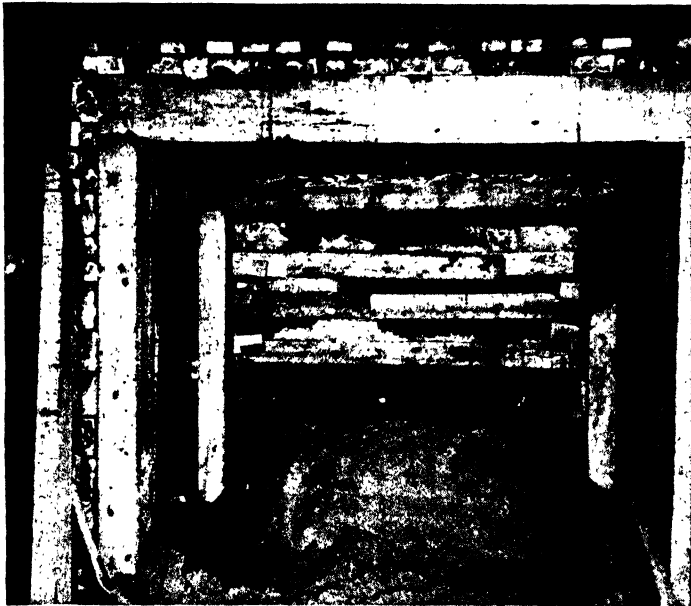

FIG. 179.—Forepoling through fine sand. Note the breast boards packed with excelsior to prevent runs. The bridge for carrying the ends of the roof spiles can be seen on top of the nearest cap.

a tunnel of this size. These are set, as shown in Fig. 178H, on each side of the tunnel with a post under the middle. The back end of the boom is wedged down from the set behind to support the forward cap by cantilever action of the booms.

When the booms are set, the breasting can be removed one board at a time and the muck raked into the tunnel. The breast boards are immediately reset, one at a time, at the front end and secured in some manner, generally by spiking a cleat to the side spiles. As soon as the tunnel is excavated down to grade, the legs and foot blocks are set, and the load is then transferred from the boom to the legs by wedging between leg and foot block.

The roof spiles have already been wedged from the top of the bridge on the forward cap. The side spiles are next wedged out from the legs of this set. Before the legs are set, it is generally necessary to brace the side spiles outward temporarily; this can best be done by setting a soldier on each side held by a transverse brace.

This completes the cycle. The next set of roof spiles is entered through the slot under the bridge. The 4-in. blocks are knocked out after the bridge is wedged up from an adjoining spile. The side spiles are entered one at a time by knocking out the wedges between the old spile and the leg.

It requires skill to drive the spiling skintight. Whenever cracks are discovered between adjacent spiles, they are immediately stuffed with hay or excelsior or packed with wood. (Marsh grass is best for calking, for this hay is tough and wiry.) There will always be a gap at the top, increasing as the end is approached, between the roof and the side spiles; it is covered by tacking on 1-in. boards, called lacing, and packing with hay.

Scabs and collar braces between the sets are essential to safety. A scab from the cap to the side of the leg will tie the two together. There also should be a collar brace from cap to cap and from leg to leg. As it is often necessary to take the bulkhead pressure against the front of the leg, it must be well braced back to the previous leg. Sometimes it is necessary to blast a boulder in the heading, and without collar bracing there is danger of blowing out a set and collapsing the tunnel.

Runs.—The most important thing in tunneling through running ground is not to let a run get started. A run will make a cavity near the tunnel which may concentrate heavy pressures on the timbering. Old-time tunnel men claim they prefer timber to steel supports, because timber has a "groaning point," which gives audible warning of unusual pressures.

Driving the Spiles.—Spiles are almost always driven with a sledge hammer. The spile should not be too wide, or it may split longitudinally. On some jobs, a small air hammer has been used to drive the spiling. In driving through caved rock, sometimes even the jar of a sledge hammer will start serious runs. Under such conditions jacking each spile forward may be necessary, but this is a slow process.

In driving through caved rock or glacial gravel, rocks or boulders, which prevent driving, may be encountered ahead of the

spiles. In such cases, one of the miners must work the boulder into the tunnel with a bar while another stands ready to drive the spile before a run can start.

Flooring the Tunnel.—In clays or silts, it will be well to floor the tunnel to prevent the miners' boots from churning up the

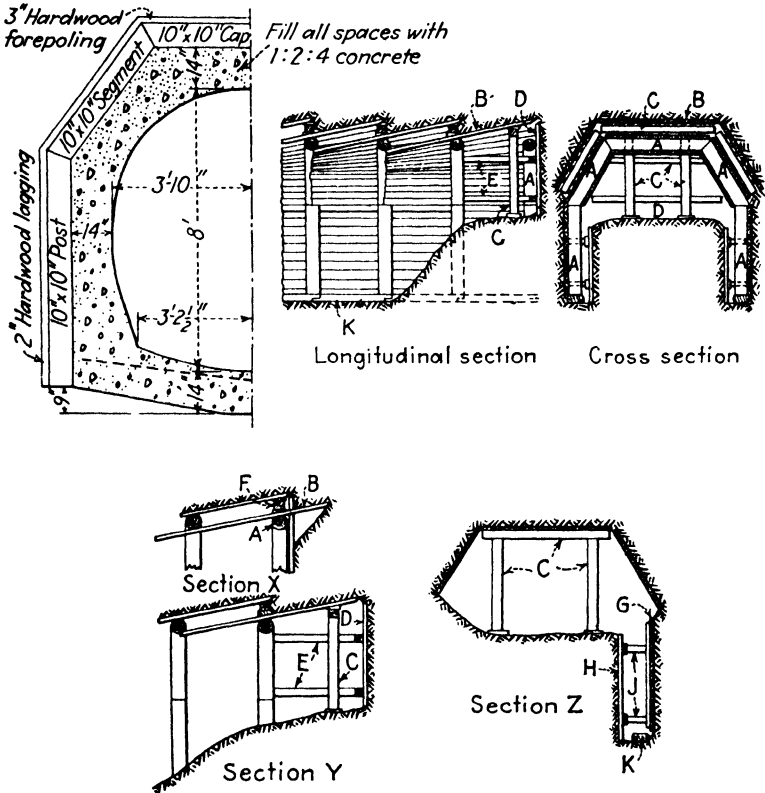

FIG. 180.—Forepoling a tunnel through glacial drift, St. Paul. Top left: typical tunnel timbering and lining. Top right: driving and timbering methods. Below: successive details of driving and timbering. *A*, advance set; *B*, forepoles; *C*, temporary cap and posts; *D*, breast boards; *E*, bracing to breast boards; *F*, bridge blocking to carry forepoles; *G* and *H*, sheeting for side drifts; *J*, bracing for side-drift sheeting; *K*, bottom sill.

ground into a soup, which will allow the foot blocks to settle. In sand or silt, if the tunnel is making very much water, it will be well to lay a tile drain to keep the running water from undermining the foot blocks.

Boiling Bottom.—In extremely running ground, the bottom may boil upward above the bottom of the side spiles. It is, of

course, possible to drive floor spiles, wedging them downward from a mudsill set under the posts. But if the ground gets this bad, it is time to consider some other scheme for doing the work. It may be possible to predrain the soil by well points either from the surface or jetted forward from the tunnel. Otherwise, an air lock should be installed and compressed-air methods should be used.

Forepoling at St. Paul.—A sewer tunnel was driven by the forepoling method at St. Paul, Minn., several years ago. The clear dimensions inside of timber were 10 ft. by 10 ft. 4 in. As shown in Fig. 180, a five-piece set was used, made up of 10x10-in. timbers; the sets were spaced 4 ft. 10 in. Pole boards were

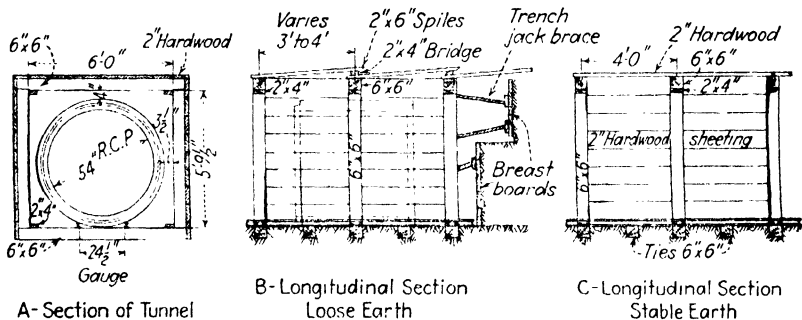

A- Section of Tunnel

B- Longitudinal Section
Loose EarthC- Longitudinal Section
Stable Earth

Fig. 181.—Driving and timbering details, Liberty St. storm sewer tunnel, Erie, Pa.

hardwood, 3 in. thick for the top pieces, 2 in. for the sides. Note how the poling boards were “fanned” to fit the corners, and also that the posts were set on longitudinal 8x10-in. sills.

Forepoling at Erie.—A forepoled tunnel through water-bearing sandy soil at Erie, Pa., is shown in Fig. 181A and B. In general, the sets were 4 ft. c. to c., but in heavy ground the spacing was reduced to 3 ft. Breast boards were always used when conditions required forepoling; these were braced back to the nearest set with trench jacks. Note that a mudsill was used under the posts. This served also as a sleeper to support the 54-in. concrete pipe installed later in the tunnel. The spiles at first were driven with a pneumatic sheeting hammer, but it was found more desirable to use a sledge hammer.

Whenever the ground proved to be self-supporting for an hour or so, the system of timbering was immediately changed to that shown in Fig. 178C. The tunnel was mined out 4 ft.; the roof

lagging was then placed, the back ends being supported on the last set while the front ends were temporarily carried on a false cap held by two trench jacks from the floor until the new set could be placed.

Forepoling in Firm Ground.—It is often necessary to drive through ground where the roof must be supported instantly, but where the sides and face can be depended on to stand for about an hour. There are also types of ground where the roof is temporarily self-supporting, but treacherous. In these cases, it is necessary to forepole the roof only. As illustrated in Fig. 182, the roof spiles are driven to their full penetration. Ground is then raked from under the spile till the mid-point is exposed. A false set is then placed to support the roof.

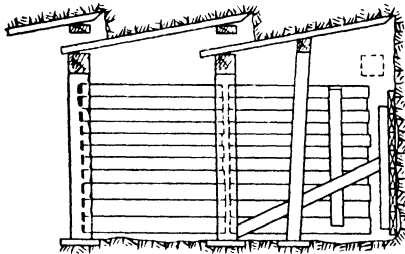

FIG. 182.—Use of the false set in forepoling.

The tunnel is then mined out and the face and walls dressed to correct size, the men being protected by the roof spiles. The breast boards are next set and braced back. The side lags are set by slipping one end behind the post of the last set and holding the front ends by soldiers and a strut across the tunnel. When this is done, the next cap and posts may be set and braced. The strut holding the side lagging and the false set can then be removed, thus completing the cycle.

Swinging False Set.—Figure 183 illustrates the use of the swinging false set for forepoling. It can, of course, be used for any of the sets described in this chapter. The false set consists of a top member of heavy pipe supported by two legs. It is placed with the legs resting on the sill, top inclined forward as indicated by the dotted lines, being held in this position by a turnbuckle back to another set. The roof spiles are all started at the inclination as indicated by the spile, shown in dotted lines.

After the spiles are about halfway in, the false set is tipped farther forward by slacking off the turnbuckles. This allows the spiles to settle to a more nearly horizontal position, and they are then driven on in. The false set is of course used over and over. At least six of the permanent previous sets must be bolted together in order to distribute the pull from the turnbuckle.

Note that in this case the spile is started at a sharp angle and then allowed to settle to a flatter pitch. Though this is a very common practice in forepoling, it is not to be recommended when the tunnel is near the surface and ground settlement is to be

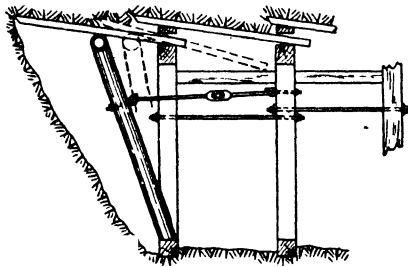

FIG. 183.—Swinging false set, forepoling method.

avoided. Downward rotation of a spile is an indication of loss of ground into the tunnel.

NEEDLE BEAM AND TIMBER

The needle-beam system of ground support can be used with timber, and, in soils where the roof can be depended upon to stand for a few minutes, will prove safer and often more economical than other schemes.

Figure 185A shows the method used for tunneling through quicksand in Cleveland. This job was done under compressed air. The theoretical pressure was 12 lb., but 8 to 10 lb. of air was found to be sufficient. The first mining shift drove a monkey drift, as indicated, for at least 3 ft. beyond the next day's drive. The roof of this drift was lagged with 3-in. matched sheeting carried on a wood segment. This segment in turn was carried on two trench jacks set in hitches in the sides of the monkey drift.

After the drift was completed, the needle beam, made up of two steel channels 18 ft. long, with a wood filler bolted between them, was skidded ahead into the monkey drift. The front end

of the needle rested on a mat of planks at the bottom of the drift, while the back end was carried on a post resting on the lined invert of the previous day's drive. The load from the roof segment was then transferred to the beam by a trench jack set on center line.

The tunnel was next widened sideways; lagging, segments and trench jacks were set as fast as sufficient room was available.



FIG. 184.—Needle-beam tunneling through Detroit soft blue clay. The advance end of the steel forms can be seen at the top.

Lagging was always carried down to the spring line, and sometimes below, depending on soil conditions.

This tunnel was 10 ft. in diameter and was lined with three rings of brick; 10- to 12-ft. advance was considered a day's work. As the brick lining was laid, the segments and jacks were removed, the lagging of course remaining in place.

This system worked out all right on brick, but it would not be successful on concrete lining. Brick can be laid in steps in such a manner that the ends of all longitudinal lagging can be supported before the wood segments need be removed. Concrete, however, rises in horizontal layers; therefore, when the jack was

removed and the wood segments pulled out, some of the upper lagging on each panel would be unsupported. This could be eliminated by using a piece of rolled channel, Fig. 185B, for the

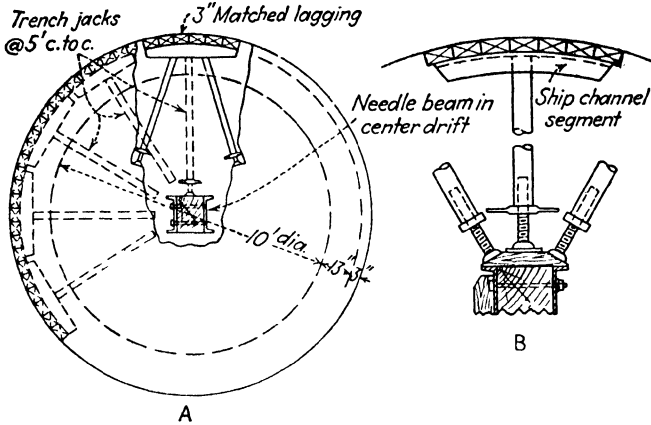

FIG. 185.—Needle-beam method of tunneling. The needle beam is carried ahead in a center monkey drift.

segment, which could be left in place. In case of heavy pressure on the segment, a temporary jack may be set at the upper end of the channel until the steel is completely buried in the concrete.

Of course, where there is little soil pressure or where the pressure is slow to act, the lagging and the wales can be robbed.

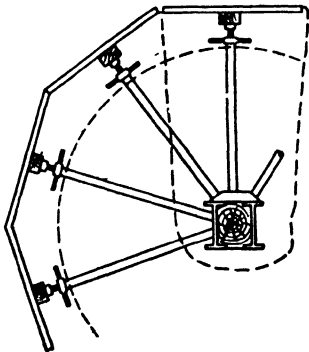

FIG. 186.—Needle beam with segmental lining.

This method has a slight advantage in concrete-lined tunnels in that, when the concrete has risen to the wale and it is necessary to take out the jack, about half of all the lagging boards are buried in the concrete, thus holding them in place while the next lift of concrete is placed.

OTHER TIMBERING METHODS

Five-piece Sets.—Figure 187 illustrates a method of mining used for driving a sewer tunnel $10\frac{1}{2}\times 10\frac{1}{2}$ ft. through blue clay in Chicago. The clay was rather soft and on occasions developed considerable squeeze.

The first mining shift drove a drift 4 ft. wide and 6 ft. high about 4 ft. into the face. The length of this drift varied with the soil. Eight caps of 6x6-in. timber were then set on a wale supported by a trench brace. These caps were generally set 1 in. high to allow for settlement and were very carefully checked for line and grade. The heading was then widened out and the

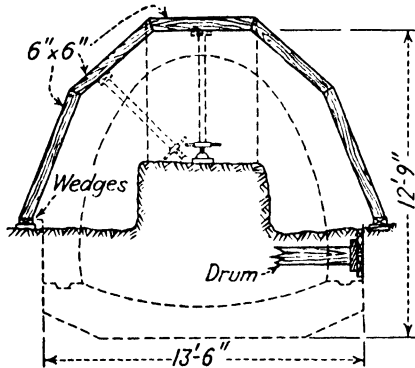

FIG. 187.—Needle-beam timbering and driving method in a 10-ft. Chicago sewer tunnel.

other timbers placed. A large foot block was set under the legs, and then wedges were driven until the load was carried in the arch. Occasionally, if the ground was very soft, it was necessary to set the shoulder timber and hold it with a trench jack as shown in the sketch before the mining was done for the leg price.

The timbers were always set skintight. On some jobs, it is possible to space them 1 ft. or more apart. In such cases, it is necessary to nail a longitudinal 2x6-in. piece near each joint to eliminate danger of the arch's twisting sideways under load.

The second mining shift took out the bench as indicated. In bad ground, lagging planks were set against the wall below the arch timbers, braced transversely with an 8x8-in. timber fitted with a screw jack, known in Chicago as a drum. This brace and

the lagging planks were taken out as soon as the invert concrete was placed.

The third shift set the forms and concreted. An advance of 15 ft. was considered a day's work.

Horse Cups.—This is an old method of timbering in fairly good ground, but is seldom used now. The tunnel is driven to full size for a certain distance. Roof lags are laid longitudinally

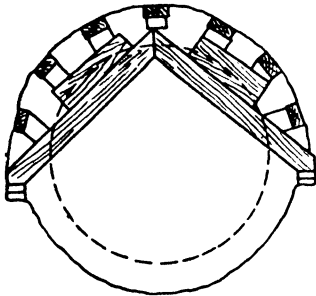

FIG. 188.—Horse-cup method of timbering.

and blocked up from horse cups made up of two 8x8-in. timbers, their lower ends resting on a sill set in a hitch in the side wall. This system works satisfactorily when a brick lining is used, but is awkward when a concrete lining is to be placed, Fig. 188.

Square Sets and Lagging.—Another type of timbering was used for tunneling for a 24-in. sewer through blue clay north of Chicago. Sets were made up of 4x6-in. timbers resting on a 2x8-in. sill. They were spaced 6 ft. c. to c. It was of course, necessary to drive the full 6 ft. before timbering could be placed.

The contractor had planned to trench the sewer but found that it was cheaper to tunnel than to open-cut to a depth of 21 ft. Shafts were sunk about every 400 ft. and drifts driven 200 ft. each way. It was necessary to drive each section complete before the pipe and backfill could be placed; this meant that the timbers had to support the ground for several weeks. The lagging did not have to be skintight in certain types of soil.

Driving with Cases.—The U.S. Army Engineer Field Manual outlines a tunneling method that should prove very valuable to contractors driving small tunnels through soft, but not running, ground. For what the Army calls a "common gallery," $3\frac{1}{2}$ x6 ft., 2-in. lumber, either 8 in. or 10 in. wide, is called for. As shown in Fig. 189, the cap is 3 ft. 10 in. long with a 2-in.-deep mortise at each end. The sill is of the same dimensions, but without the mortise. The posts are of 2-in. lumber, 6 ft. 2 in. long, with a 2-in. tenon at the top to fit the mortise on the cap.

In practice, the top breast board is removed and the ground mined for 8 or 10 in. ahead; the breast board is then set and

braced back to the breast soldier. The next cap board is then carefully set, being checked for level, and is held in position by a "crutch" or trench jack set at a slight inclination. Under this protection, the miner then removes the breast boards one at a time, removing the earth and resetting the board on the new face. When this operation is completed, the sill board is set and the sides are dressed down to line. The legs are set by entering the tenon into the mortise, then driving the foot of the leg out to a plumb position, held there by a 2x4-in. cleat spiked to the sill. It might be more economical to eliminate the top tenon and mortise, depending on a scab to hold the leg to its top position.

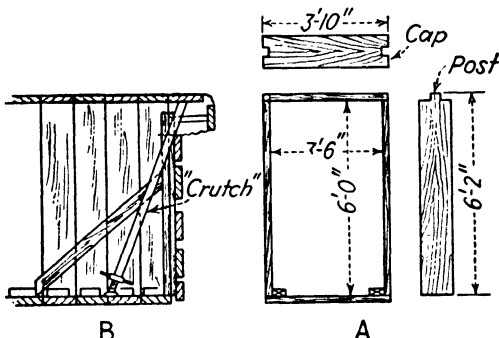

FIG. 189.—Casing method of timbering.

This system requires little lumber. With ordinary care, unskilled labor could drive such a tunnel with a minimum of voids outside the cases. If the contractor, for instance, then laid a 24- or 36-in. tile sewer in the tunnel, it would be a simple matter to backfill this type of lining. There are no projecting timbers to make tamping of the backfill difficult.

For the "great galleries," 7x6 ft., the Manual recommends caps of 5-in. lumber, legs of 4-in. plank and a 3-in. sill.

American Method.—The timbering scheme shown in Fig. 190A and known as the American method is occasionally used in this country in driving railroad tunnels. A drift is driven at top of arch, in which is carefully set a cap timber supported by two posts resting on a sill. The sides of the drift are then broken out and the shoulder timber placed, supported by an inclined strut from the sill. The top heading is then widened out until the wall plates can be set in place. The plates should be in long lengths,

16 to 24 ft. if possible. Next, the legs are placed and wedged tight to take the load off the center sill, after which the temporary posts may be removed.

The wall plates are then underpinned with the plumb posts by cutting out a short wall drift in the bench, deep enough to take either one or two posts. If the walls are stable enough to exert

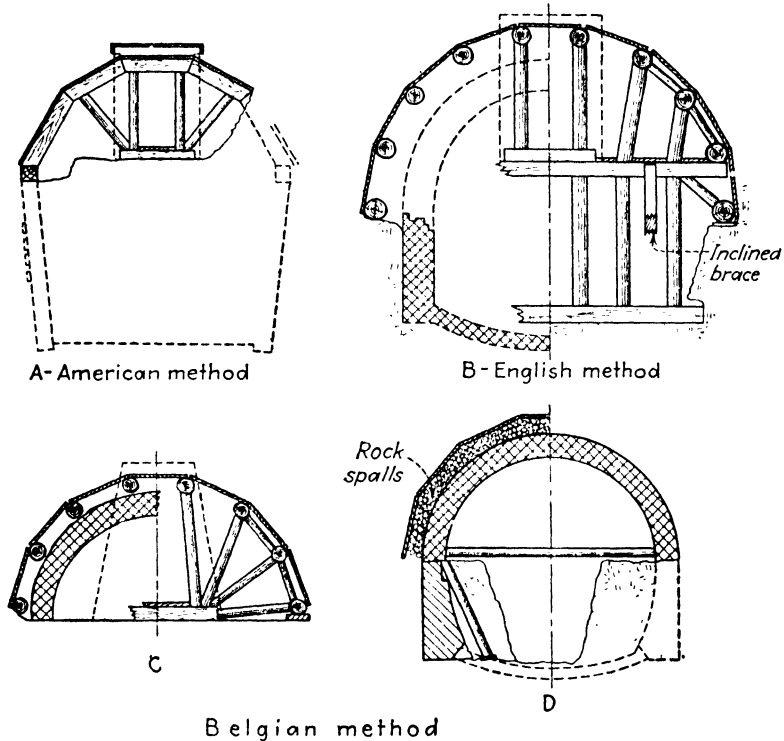

FIG. 190.—Various typical methods of driving and timbering large soft-ground tunnels.

no side pressure on the plumb posts, the posts should be well tied at the top to the wall plate by scabs and dowels. However, in case a heavy side pressure does exist, it will be necessary to set the plumb posts at an angle (as shown) to resist the tendency to kick out at the bottom.

English Method.—Figure 190B shows the timbering scheme known as the English method. A center top heading is driven 16 to 24 ft. ahead of the masonry arch. In this drift are erected two heavy timbers, known as crown bars. The back ends of the

timbers are blocked off the arch, and the front ends are carried on posts resting on a sill on the floor of the drift. The drift is then widened and another crown bar and lagging placed. This method is continued until the entire arch is carried on longitudinal bars. The forward posts are then underpinned and supported on posts from a sill at floor level.

This method results in an entire section of tunnel, 10 to 20 ft. long, depending on the size of the bars and the heaviness of the ground, without intermediate posts within which the masonry arch can be built.

Ample room must be allowed between the back of the arch and the underside of the bars to allow for settlement. After the arch is completed, the lagging is blocked off the masonry, and the bars are loosened to be skidded ahead to their new position. This method demands considerable mining skill. There is liable to be considerable settlement due to the method of transferring load back and forth, and also because the roof load is concentrated at the front bent. The English method is now seldom used in this country.

Belgian Method.—The Belgian method, or variations, is sometimes employed in this country, being known as the “flying arch” system. In this method, Fig. 190C and D, the top center heading is driven first, and two crown bars set as in the English method, being supported on sills on the bench. The tunnel is widened in the same manner, the additional bars being carried off the same mudsills. These sills and posts are, however, considerably closer together than in the English system, enabling a lighter bar to be used and avoiding the concentrated loads on the mudsills. The arch is then built; the bars are sometimes removed, but are more often buried in the masonry.

A trench is excavated down to grade in the center of the tunnel and a muck track laid therein. From this trench, side cuts are made to the edge of the arch, which at that point is carried on shores from the floor. Pockets are then cut under the arch and the masonry side wall built to underpin the arch. The shores are set and the pockets excavated in alternate spaces until the arch is entirely supported on masonry.

The disadvantage and danger of this system is the method of underpinning the arch. At times, due to yielding of the bench and of the temporary shores, the masonry arches have been

seriously cracked. This system has been used with reinforced-concrete arches with fair success.

German Method.—This method employs three drifts: one at the crown and two at the bottom along the wall. In the two lower drifts, as much of the wall is built as can be laid. Meanwhile, the top center drift is widened out by methods similar to those of the Belgian method until the enlargement takes in the roof of the wall drifts. The roof timbering of these wall drifts is then removed and the masonry arch constructed on the side walls.

This system is economical of timbering in that there is a large core of earth left in the tunnel from which the shores are supported. The masonry arch is built from the footing up. This system was used for the construction of the Baltimore Belt R.R. tunnels under the main streets of Baltimore in 1895.

Austrian Method.—A center cut is taken for the full height of the tunnel. This is then widened out full face to allow short sections of the masonry to be completed. This has not, to the authors' knowledge, been used in this country.

Italian Method.—This is an emergency system only for penetrating short stretches of extremely heavy ground. A bottom drift is driven the full width of the tunnel, and in this drift are constructed the invert and masonry side walls. The drift, about one-third the height of the tunnel, is then firmly backfilled with well-rammed earth.

A top center drift is then enlarged by extra heavy timbering, as in the Belgian method, until it is full width and about one-third the height. Pits are then sunk from this bench to the top of the masonry wall completed in the bottom drift, and the masonry arch is completed in alternate rings.

SOFT-GROUND MINING METHODS

Mining in soft ground is generally by hand. In working in running ground, sand, gravel or earth, a round-pointed shovel with the handle cut short is the only tool used, because of the crowded conditions in the heading. The shovel not only is used for digging, but also serves to trim the sides and roof. As the ground gets harder, a grub hoe or heavy mattock will be required for trimming as well as for loosening ground for shoveling. Grub hoes, fastened to pick handles, generally come with rather

narrow blades; the back of the hoe is fitted with a hammer face for use in driving wedges.

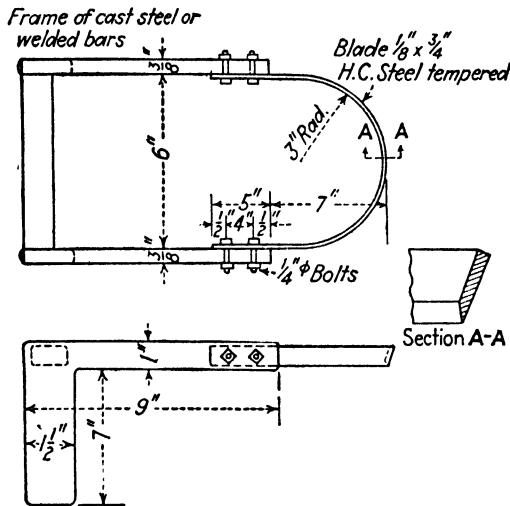

FIG. 191.—Two-man clay knife.

In soft clay, a draw knife is generally used, Fig. 191. This is a curved blade of high-carbon steel fitted to extra-heavy handles. Two miners grasp the knife and cut a strip of clay from the face. This strip or "dog" is generally 6 in. wide, 4 in. deep and 3 or 4 ft. long. During the slicing operation, the mucker stands behind the miners and adds his weight to the knife. As the dog is cut loose, the mucker grabs it and passes it back to the muck car. With clay of the right consistency, this is a rapid way of mining the face and roof. To take out the bench, it is general practice to use a small-blade spade. Water should be provided, as dipping the shovels occasionally in a bucket of water will prevent the clay from sticking. Air spades,



FIG. 192.—Power knife, operated by cable and air hoist, used for mining the bench in a soft-clay tunnel, Chicago sewers.

fitted with a blade 4 in. wide and 8 in. long, may be used for taking out the bench if the clay is not too soft.

The power knife can often be used for taking out a soft clay bench. A knife, similar to but heavier than that used for hand cutting, is attached to a cable from a portable air hoist set back in the finished tunnel. The knife is taken to the forward end of the bench and forced into the clay. While a man holds the handles to guide the knife, it is pulled by the hoist, cutting off a dog of clay from the full length of the bench. The dog is then cut with a spade into pieces which can be handled back to the cars.

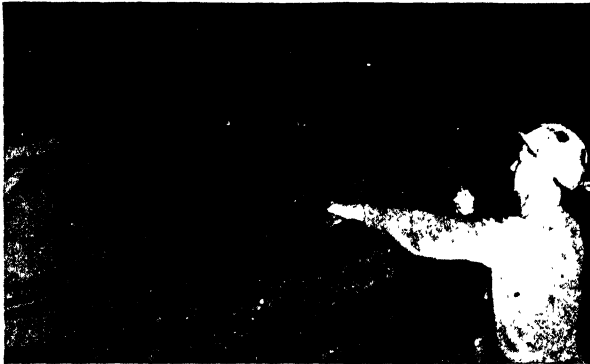

FIG. 193.—Power knife cutting horizontal slabs from face, Chicago subway. Cable operates through a tail sheave hanging from steel lining off to the left.

In tunnels through clay that will stand up until the concrete lining can be placed, the power knife has been economical for mining almost the entire section. A pilot drift is driven at the crown of the tunnel and is kept 15 to 20 ft. ahead of the main tunnel. This is driven as small as practicable for a man to work in, generally 2 ft. wide and 3 ft. high; such a small tunnel will not require ground support even if it stands for 48 hr. At the beginning of the day's drive, the miner with the power knife first "bells out" the mouth of the pilot drift to obtain a bench to work on; thus the first 5 ft. of the pilot drift is deepened to a height of 6 ft. and widened to the full shape of the tunnel. As the dogs are cut off, they are thrown down onto the floor until such time as there is room on the bench for the muckers to work.

This heading is then deepened by working from the sides of the pilot drift until a bench 6 ft. high the full length of the day's drive

is obtained. Then the knife can be used to peel out dogs the full length of the bench; these dogs are cut into pieces for hand loading. In order that the knife will start its cut full depth, a trench about 6 in. deep is cut out at the end of a drive by a miner using an air spade.

On a Detroit job a few years ago, the gang consisted of three miners—one driving the pilot tunnel, one using the power knife



FIG. 194.—Two-man clay knife cutting face of Chicago sewer tunnel; third man catches slab as it is cut loose. Note how walls were trimmed to shape with knife, as no timbering was required in this particular section of tunnel.

and the third digging the trench. They kept 11 muckers busy. This tunnel was of 15-ft. diameter, and a day's drive, generally 15 ft., was completed in 12 hr.

Sometimes, in wide tunnels, the bench is excavated by transverse cutting with a power knife. In this case, the cable from the hoist passes through a snatch block hung from the timbering close to the face of the bench. This method is in wide use on the present Chicago subway tunnels.

SOFT-GROUND MUCKING

Mucking is done by hand in soft-ground tunnels. The muck tracks are, of course, kept as close to the face as possible, but with the needle-beam method of ground support the cars must stay back within the finished concrete.



FIG. 195.—Pneumatic clay spade used in mining clay, Chicago sewer tunnel.

In clay, the muck is passed back from hand to hand from the miners to the car. In mucking out sand and gravel, the muckers shovel the material back to the cars in relays. It is often possible to work a belt conveyor through the braces, which, of course, will save a large amount of labor. Power excavators or mucking machines can rarely be used in soft-ground tunnels because of the number of braces and the limited space.

CHAPTER 13

SOFT-GROUND TUNNELING WITH LINER PLATES

Light steel plates were first used in Haskin's Tunnel in 1879, but only within the last few years have methods of pressing the plates produced a product that can compete with wood under almost all tunneling conditions.

The advantages of the pressed steel liner plate are many. They are light and easily handled and can be erected by unskilled labor; being in larger panels, there are fewer joints through which water can enter or air escape. They are fireproof, which is very important when working under compressed air. Finally, they save a great deal of excavation and concrete.

TYPES OF PLATE

The standard pressed steel liner plate is 16 in. wide and 36 in. long with all four edges flanged over 2 in. The skin is corrugated to stiffen the plate. A plate of $\frac{1}{8}$ -in. metal weighs 27 lb.; a $\frac{3}{16}$ -in. plate weighs 40 lb., and a $\frac{1}{4}$ -in. plate weighs 53 lb. Plates are also pressed from $\frac{5}{16}$ - and $\frac{3}{8}$ -in. metal. To make up the required circumference plates of $\frac{3}{4}$, $\frac{1}{2}$ or $\frac{1}{4}$ length are available.

Another common plate is 16 in. wide and 3 ft. $1\frac{1}{8}$ in. long. As this length is π in feet, the number of plates in a complete circle will be the same as the diameter of the tunnel in feet.

Plates are bolted to each other through holes in the flanges. The holes around the circumferential joint are spaced about 9 in. apart; there are three holes in the longitudinal flange. Bolts of $\frac{1}{2}$ -in. diameter are used on the $\frac{1}{8}$ -in. plate, $\frac{5}{8}$ -in. diameter for $\frac{3}{16}$ -in., and $\frac{3}{4}$ -in. diameter for $\frac{1}{4}$ -in. plates. The bolts are the coarse-threaded, quick-acting type known as "fitting-up bolts." The miners should be provided with standard steel erection wrenches with pointed handles to tighten the bolts and "spud" the holes. Plates are always erected to break longitudinal joints.

Another type of plate has wide, deep corrugations running the full length. There are no flanges at the ends; when installed,

the plates overlap endwise. The ring load is transmitted through shear in the bolts. Because of the continuous corrugations, this type plate has a high section modulus and can be used on larger tunnels without ribs. A standard plate is 18 in. wide and has a "useful" length of 50 in.

STIFFENING RIBS

Ribs are needed for strengthening and stiffening the liner plates on tunnels greater than 10-ft. diameter. The simplest ribs are a T or an I-beam, Fig. 196, inserted between the flanges of each ring of plates. Weight for weight, the I-beam is far more effi-

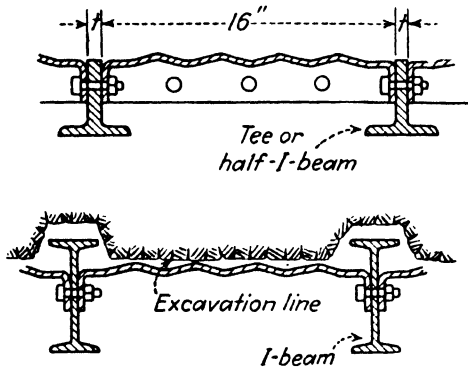

FIG. 196.—Assemblies of liner plates and ribs, with ribs bolted between rings of plates.

cient in bending than a T, but has the disadvantage that a groove must be cut for it beyond the neat line of excavation.

Ribs must always be spliced at or near the crown. Sometimes, in large tunnels, the ribs will be spliced in several places to allow them to be handled by hand or to meet the system of mining. All splices must be on the flange, for a web splice would interfere with the liner plates. Ribs assembled in place can be spliced only on the inner flange. For convenience, splice bolts should be of the same size as the plate bolts.

Another method of placing the ribs is shown in Fig. 197 in which complete rings of I-beams are assembled within the liner plates and blocked to them with precast concrete blocks and wood wedges. The ribs must be well collar-braced to adjacent rings to prevent twisting. The advantage of this system is that the

rib is entirely encased in concrete and may be considered as reinforcing for the permanent lining.

If the ribs are to rest on the bench, large foot plates must be welded to the bottom end to distribute the load to the footing block. Most failures of liner plates in soft ground can be attributed to foot blocks of insufficient size or to the rib slipping off the foot block. Straight ribs are to be avoided. If the walls of the tunnel are plumb, the ribs should be curved on a 200-in. radius to resist side pressure better. Plumb ribs on one section

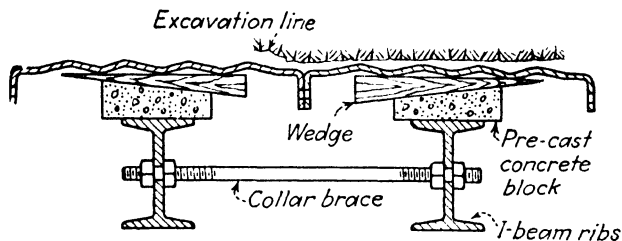

FIG. 197.—Ribs set inside of liner plates; rings of liner plates bolted to each other.

of the Chicago subway tunnels were trussed with light sets of hog rods to resist horizontal load.

SELECTING THE PLATE AND RIB

There is no way of accurately estimating the load to be carried by the primary lining. Methods have been outlined in Chap. 2 for determining the loading on the permanent lining, but it may be days or even months before this pressure develops fully. In driving through bad ground, most contractors organize to concrete every day and keep the concrete close behind the miners. In such cases, the liner plates actually support the ground from one to three days only.

The following empirical rules will serve as a guide in estimating plates and ribs required for the average tunnel in soft ground. The diameter is the excavated width of tunnel.

For tunnels 6 or 7 ft. in diameter: use $\frac{3}{8}$ -in. or $\frac{1}{2}$ -in. liner plates without ribs.

For tunnels 8 to 10 ft. in diameter: use $\frac{1}{2}$ -in. or $\frac{3}{8}$ -in. liner plates without ribs.

For tunnels larger than 10 ft. in diameter: use $\frac{1}{2}$ -in. liner plates with I-beam ribs at 16-in. centers, the I-beams to be 1 in. in depth for every 3 ft. of diameter.

For tunnels of 8 to 10-ft. diameter, there is no great difference in weight between using $\frac{1}{2}$ -in. liner plates with I-beam ribs, or using $\frac{1}{4}$ -in. plates without ribs; but there will probably be a saving in labor in omitting the ribs and using the heavier plates.

ERECTING PLATES AND RIBS

The standard method of erecting liner plates without ribs is shown in Fig. 198. The miners break out a hole 16 in. deep, carefully trimming the roof, and set the crown plate, which should be checked with a carpenter's level to see that the roof is running in the desired plane. The crown should be kept 1 to 3 in.

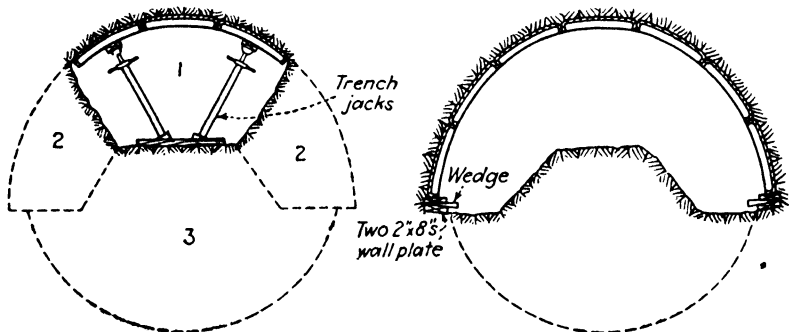

FIG. 198.—Sequence of excavation and setting of liner plates in a small tunnel.

high to allow for settlement and errors in grade; it is always better to be too high than too low. The excavation is then widened out and the adjacent plates set on each side. If there is any ground pressure against the plates, they can be supported by trench jacks from the bench. Usually, this method is repeated until at least three rings of plates have been started, the rings, of course, breaking joint.

Excavation is then carried down sideways to the spring line, and the rest of the plates making up the three rings are bolted in. The wall plates, or footing boards, each consisting of two 2x8-in. planks, long enough to take all three rings, are then carefully placed at each side on an even bedding. Wedges are entered between these two boards and driven tight until the temporary trench jacks can be removed. A few spikes should be driven through the bolt holes of the lower flange of the plate into the upper plank to prevent the plate from slipping or kicking out.

When ribs are bolted between plates, it is necessary to complete the assembly of each ring before the next one is started, Fig. 199.



FIG. 199.—Liner plates with ribs between each ring of plates in a 13-ft. circular sewer tunnel, Richmond, Va. Plates are $\frac{1}{4}$ in. thick, 16 in. wide; ribs are 4-in. 9 $\frac{1}{2}$ -lb. I-beams. (Courtesy of Truscon Steel Co.)

When excavation is completed 16 in. ahead and grooved for the new rib, the new plates are bolted to the old rib and cantilever

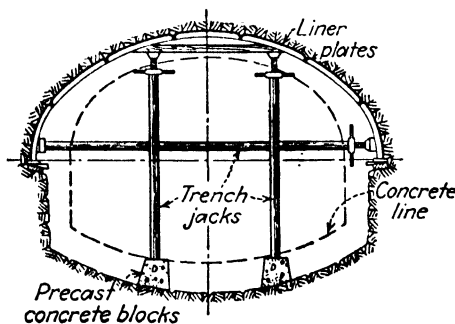

FIG. 200.—Liner plates supported on precast concrete blocks, later buried in the invert concrete.

ahead. The new rib is then set and bolted to the forward edge of the plates and tightly wedged up from the foot block to carry the load. The nuts on the bolts connecting the new rib must all

be on the forward side of the rib, for they must be removed for bolting up the next ring of plates.

Contractors on the last sections of the Chicago subway improved on the methods outlined above. The first step was to drive a 2x3-ft. wall plate drift on each side at spring line, floored with 3-in. maple heart planks upon which the wall plate, an 8-in. H-beam, was set. The drifts were kept at least 12 ft. (length of wall-plate beam) ahead of general excavation. Next the arch

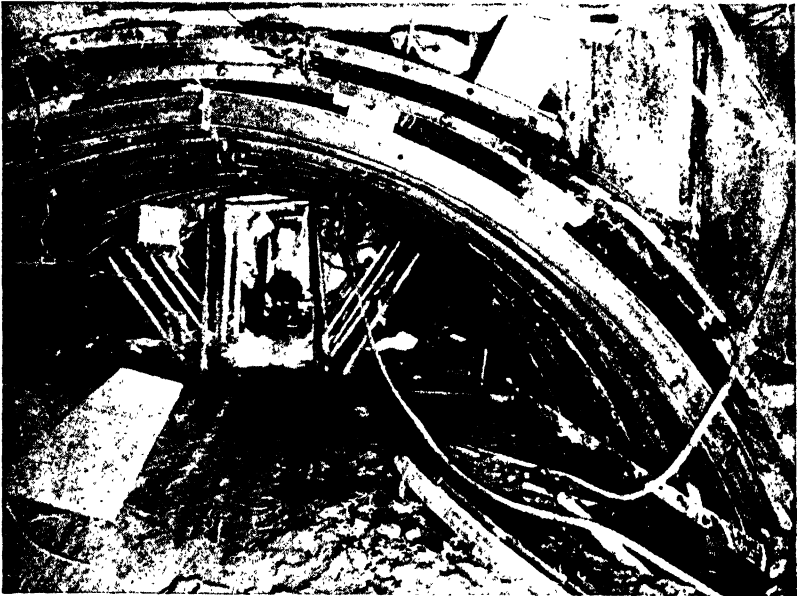

FIG. 201.—Top heading driven with liner plate and rib support. Liner plates are carried on trench jacks off the bench until ribs can be set up and the load picked up by wedging. When the bench is excavated, the steel wall plate must be underpinned until the lower half of the rib is placed. (Courtesy of Commercial Shearing & Stamping Co.)

was mined ahead the width of a liner plate, leaving a central core, and a new I-beam arch rib, in two sections jointed at the crown, was placed, bearing on the wall plates. The new rib was spaced by angle irons bolted to the webs of the new and old ribs. A new type of plate was used, flanged on the edges, but flattened on the ends to ride against the outside of the outer flanges of the ribs. Plates were inserted at the crown and pushed down toward the sides, coming to rest against the wall plate and then the previously

set plate. No bolts were required. Side drifts were carried full height from subgrade to wall plate for installation of plumb posts to carry the wall plates. Long hydraulic jacks temporarily supported the wall plates as the drifts advanced until the permanent plumb posts were set. In this method the roof was firmly held from the start of each cycle of operations.



FIG. 202.—Ribs and plates in a Chicago sewer tunnel. As this was fairly good ground, plates were placed longitudinally to allow wider spacing of ribs. Reinforcing bars were set in the invert concrete which was carried to the face of the bench. (Courtesy of Commercial Shearing & Stamping Co.)

Another method, setting ribs inside the liner plates, is shown in Fig. 201. The plates are carried forward in the arch and are supported on trench jacks until the ribs are set and the load taken by wedging. These ribs are carried on a steel wall plate blocked from the bench. When the bench is excavated, this wall plate must be underpinned while the lower half of the rib is placed and blocked from the bottom liner plates.

MINING METHODS WITH LINER PLATES

Needle Beam.—The needle-beam method is considered the safest for driving through really bad ground. The liner plates are carried at all times by trench jacks, eliminating steel ribs. As shown in Fig. 203, the heading is carried forward the length of the day's drive, all plates being carried on trench jacks resting on foot blocks on the bench. A trench is then excavated along

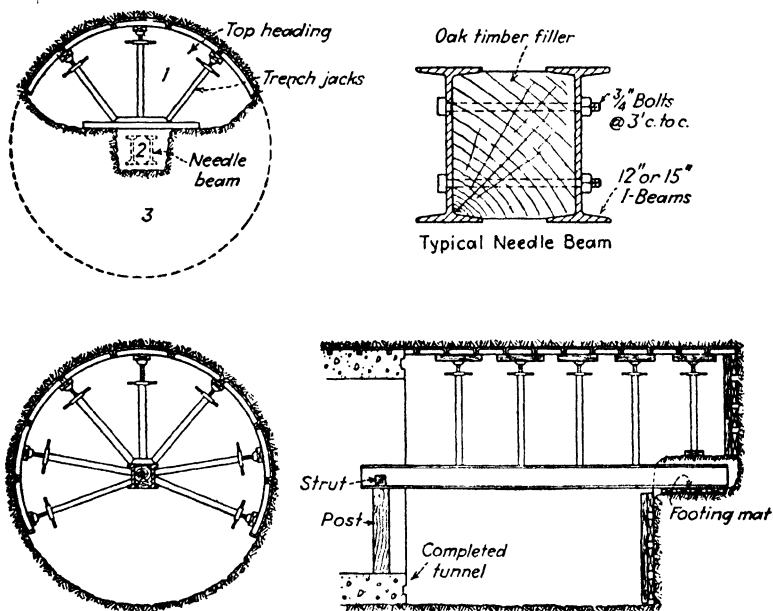

FIG. 203.—Needle-beam method of tunneling with steel liner plates.

the center of the bench and the needle beam moved forward and laid in this trench.

The needle beam consists of two heavy I-beams with a hardwood filler, all bolted together. The length of the needle is such that it will span the day's drive and still have about 4 ft. projecting at each end on the supports. The front end is carried on a mat of planks resting on the bench; the back end is supported by a post resting on the concrete invert of the previous day's pour. A needle beam weighs a ton or more and is hard to move by hand. Generally, a timber dolly is set under the front end, and the back end is raised by a block and tackle hanging from the roof.

After the needle beam has been moved ahead, the liner plates of the arch are reblocked to the beam, the old trench jacks being taken out as the new ones are set. Once the roof is supported from the needle, the bench can be taken out and the remaining liner plates set, bracing them from the beam. Trench jacks on lower diagonals are very valuable in heavy ground since they tend to prevent the needle beam from deflecting too much, and also support the ground. Deflection or rolling of the needle is the only real hazard in this method. Sometimes a center post will be required under the beam.

After the bench has been taken out and trimmed, the concrete forms are carried forward and assembled. These forms must be of a hand-handled, hand-filled type, either wood or steel, with removable lagging. The form ribs are set up around the needle and aligned and then the lagging or form plates for the lower quadrant attached. Concreting is commenced, form plates being added as the concrete arises. The trench jacks are removed one at a time as the concrete takes the load.

The needle-beam method has some disadvantages: the heavy beam must be moved forward by hand; there are numerous trench jacks, which interfere with efficient working of the gang, to be set and reset. Also the beam and braces preclude the use of traveling forms and mechanical methods of concrete placing.

Needle Beams with Inside Ribs.—The needle-beam method may prove very valuable in setting inside ribs in a circular tunnel through heavy ground. On a job in Buffalo, the arch plates were carried on a needle until the lower plates were all in. Then the inside ribs were assembled around the beam. The load was picked up by wedging between these ribs and the liner plates until the needle beam could be released. This method gave an unobstructed section, and concrete was placed behind traveling steel forms with a pneumatic gun. Corrugated sheet piling was used for breasting the bench.

Flying Arch.—The flying arch method is shown in Fig. 204. A top heading is driven, the liner plates of the arch being supported by trench jacks resting on the bench. Each day's drive is concreted with half-round arch forms, handled and filled by hand. A plank footing under the concrete is necessary for a clean, even joint.

After the heading has been driven 60 to 80 ft., the bench is taken out and the invert concrete placed. The invert pours break joints with the arch sections to afford as much support as possible for the arch concrete while it is being underpinned.

There are several objections to this method. All muck and concrete cars must be pulled up an incline onto the bench. It is difficult to get a good watertight joint between the invert and the arch concrete, and there is danger that the arch concrete may crack if the structure settles during the underpinning.

Poling Plates.—Occasional stretches of running ground may be encountered where the roof will refuse to hold long enough for a 16-in. liner plate to be set. Such ground may be penetrated by the use of poling plates.

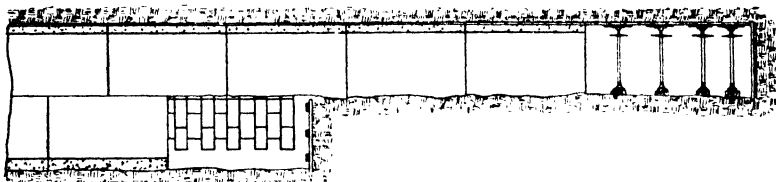

FIG. 204.—Flying arch method of tunneling. Top heading is advanced and concreted every day. The bench is removed under protection of the concrete arch, and invert and side walls are poured together three or four days later. (Courtesy of Commercial Shearing & Stamping Co.)

Poling plates are of steel, 12 in. wide and $3\frac{1}{2}$ ft. long, with flanged edges that interlock when assembled. Thus they form an articulated roof shield, any plate of which may be advanced independently of the others, Fig. 205. A lug is attached to the poling plates, at the front end, on the inside. A removable ratchet jack engages this lug to drive the plate ahead.

The plates are jacked forward a few inches at a time. Care must be taken that the plates do not “nose down”; usually some kind of support is required at the front end. If a boulder is encountered, the plates on each side of it are advanced; then the boulder is pulled into the tunnel.

The poling plate method may avoid the use of compressed air or a tunnel shield but should be employed only on short stretches of tunnel. Poling plates are sometimes used when sinking circular shafts, lined with plates, through running ground.

Grouting Liner Plates.—Mining can never be so carefully done that voids will not be left outside the liner plates. Even with a

carefully trimmed surface, the liner plates will bear only on the high points, leaving hollows at each corrugation. If I-beam ribs are used between the plates, a groove will be cut for this beam, wider and deeper than necessary, to allow easy erection. Around

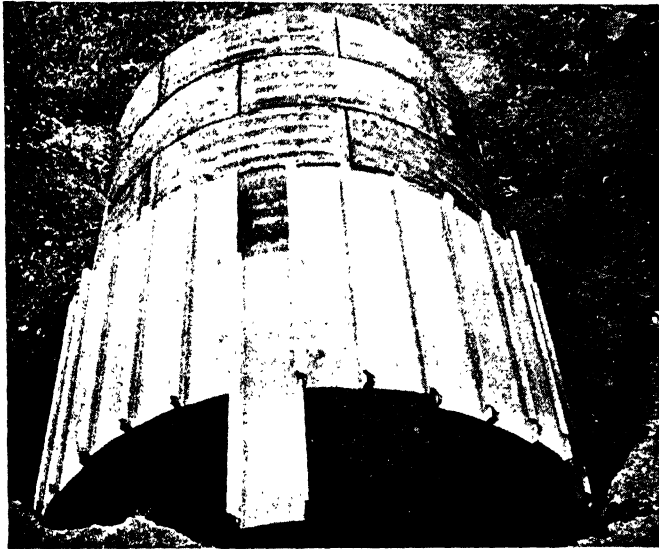

FIG. 205.—Steel poling plates for tunneling through running ground with liner-plate support. (Courtesy of Commercial Shearing & Stamping Co.)

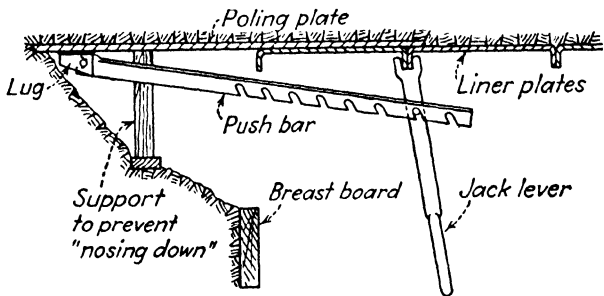

FIG. 206.—Jack for shoving poling plates.

the entire external surface of the tunnel, the total volume of these voids may be considerable.

Eventually the ground will flow or settle to fill these voids. In soft clays or sand, the movement may start in a few hours; in shales or hard pan, it may take months or years before the

settlement is detected at the surface. This explains why a street over a tunnel may eventually show settlements although the contractor will swear, and the inspector will verify it, that there was absolutely no settlement of the liner plates and that the permanent lining was promptly placed.

Under important streets, or in other places where settlement might be dangerous or expensive, grout should be forced behind the plates immediately after placing. To that end, a certain number of the liner plates, generally, 10 per cent, are furnished with a $1\frac{1}{2}$ -in. tapped hole. When a section of lining is completed, grout is forced through the tapped holes to refusal. The grout should be rather dry; otherwise it will leak out through the joints in the plates; yet it must be wet enough to flow. In applying the grout the pressure should not be very great; 25 lb. per sq. in. should be sufficient. Gravel and screenings have been used for packing the voids outside liner plates, but they will not flow into small cavities. Grout has the further advantage of checking any flow of water.

Robbing Plates.—When the contractor is being paid a unit price per foot of tunnel, it is quite common to “rob” or remove part of the liner plates from a section just before concreting. The re-use of these plates means quite a saving to the contractor, and generally there is nothing wrong with this practice. If there is no load against the plates removed, it means that they were not needed in the first place. Plates carrying load, however, should not be removed, even in clay.

CHAPTER 14

SHIELD-DRIVEN TUNNELS

The tunnel shield was first patented in England in 1818 by Sir Marc Brunel and was used by him in driving a tunnel under the Thames. This tunnel, 37 ft. 6 in. by 22 ft. 4 in., was intended for vehicular traffic. Started in 1823, it was not completed for twenty years, and then stood idle for a long time until it was incorporated in the East London Subway.

The shield as we know it was patented in 1865 by Barlow, who showed in his claim the circular shield with a primary lining of cast-iron plates. In 1869, he drove 1,300 ft. of tunnel of 7 ft. 3 in. diameter under the Thames. Beach used a shield for driving a few hundred feet of experimental tunnel under lower Broadway in New York City for a proposed pneumatic rapid transit system. Beach was the first to use hydraulic jacks.

The use of compressed air in tunnels, or the plenum process, was patented by Lord Cochrane in 1830. Compressed air was first used on a small job in Antwerp in 1879, the same year Haskins also used air (without a shield) in his ill-fated attempt to tunnel under the Hudson.

James Henry Greathead (1844–1896) was the first to combine all the features of shield-driven tunnels with the plenum process when he undertook to drive the tubes for the City & South London Subway through clay and water-bearing gravel. These tunnels were 10 ft. 3 in. finished diameter, and were the first of an extensive system. It was Greathead who first used a grout machine for filling the annular space left by the tail of the shield. Greathead was the real father of shield-driven tunnels.

SHAPE OF SHIELD-DRIVEN TUNNELS

Shield-driven tunnels are usually of circular cross section. There are several reasons for this: First, the circular shape is most ideally suited to resist the semifluid pressures of soft ground and provides the greatest cross-sectional area with a minimum of perimeter.

The second and most important reason for the circular shape is the rotation of the shield. All shields show a mysterious tendency to spiral as they advance, and a circular shield can rotate without affecting the primary lining which is being erected

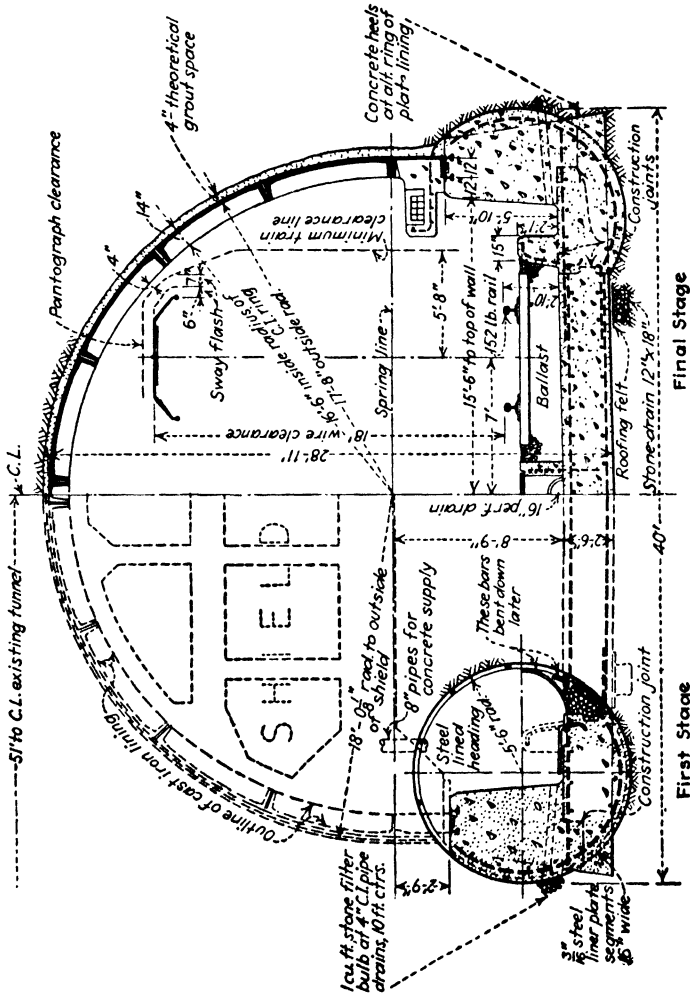

FIG. 207.—Shield-driven double-track Union Tunnel, Pennsylvania R.R., Baltimore. Steel-plate-lined side drifts were driven first with 11-ft. shields. Side walls were then built in the drifts. The remainder of the excavation was then removed under protection of a roof shield that rode on rails on top of the side walls. Cast-iron primary lining was left exposed.

within the tail. The rotation of a horseshoe-shaped shield, for example, would tilt the axis of the tunnel, but this may be putting the cart before the horse. There have been few opportunities to study the action of any but a circular shield. Perhaps an

irregular shaped shield would offer more resistance to rotation than a circular one; and there is no reason why a steering fin could not be affixed to the outside of the shield, like the diving rudders on a submarine, to prevent or correct the tendency to rotate.

Certainly if a shield were to travel all or part of its journey in a mixed ground face, with rock for the floor, there should be no hesitation in adopting some other type of cross section if it proved more desirable.

An interesting use of shields for driving an exceptionally large tunnel was that for the double-track Union Tunnel for the Pennsylvania Railroad at Baltimore. A cross section of the tunnel is shown in Fig. 207. First operations were to drive two 11-ft. side drifts by the shield method; the primary lining was pressed steel plates. Then heavy concrete side walls were built within the drifts, capped by a railroad rail. A semicircular roof shield, 36-ft. diameter, riding the rails on the walls, was used for excavating the arch. The primary lining of the arch was cast-iron segments, left exposed without a secondary lining.

PRIMARY LINING

The primary lining, whatever type it may be, must meet several requirements. It must be able to withstand the full soil pressure immediately as the shield is advanced for the next ring, and it must take the thrust of the shield jacks. Also it must be of a design that can readily be erected within the tail of the shield.

The jack stress is greatest on the first one or two shoves after erection, after which a part of the jacking pressure passes out into the ground; the jack pressure passing through a ring is quite small after the shield gets 15 to 20 rings ahead. This means that the primary lining must be designed as much for the temporary stresses of erection as for the permanent soil pressures.

The segments or blocks should be alike, as far as possible, to avoid confusion. The two blocks adjacent to the key must, of course, have one end tapered so that the key can be placed. In general, the design is such that the blocks break joint, which adds stiffness to the ring. Cast iron has been the principal material for primary linings, and is still generally used in tunnels through water-bearing ground. In recent years, linings of precast concrete blocks have become quite common. With the development

of welding, there have been several big jobs in which the primary lining has been of steel plates strengthened by welded structural shapes. The pressed steel liner plate has been used on a number of small jobs.

Design.—The design of primary lining follows, in general, empirical rules based on previous practice. For a complete discussion of the theory employed in this design, the reader is referred to *Shield and Compressed Air Tunneling*, by Hewett and Johannesson.

These rules may be roughly summarized as follows:

Cast Iron.—The depth of flange should be $\frac{1}{2}$ in. for every foot of outside diameter. The skin thickness runs from 1 to $1\frac{1}{2}$ in.

Concrete Blocks.—Precast concrete block thickness should be 1 in. for every foot of outside diameter.

Pressed Steel Liner Plates.—Plates $\frac{1}{2}$ in. thick should be used on tunnels up to 7-ft. diameter, and $\frac{3}{4}$ -in. plates for tunnels up to 10 ft. Above 10-ft. diameter, the economy of standard pressed steel plates is doubtful. To resist the soil pressures, some kind of stiffening rib is required between each ring of plates. The delay and difficulty of placing curved ribs between the jacks and the last ring of plates would be considerable. Standard plates are poorly adapted for resisting the shoving pressures exerted by jacks on large shields.

Fabricated Liner Plates.—Not many tunnels have, as yet, been driven with welded plates, but from a few jobs the following can be stated: Rib channels should be $\frac{1}{2}$ in. deep for each foot of diameter. The skin should be $\frac{1}{2}$ in. thick for each 10 ft. of diameter, the skin should be stiffened longitudinally at frequent intervals by small I-beams, which also bear the brunt of pressure of the jacks.

Cast-iron Lining.—Cast iron has been used as the primary lining in most large shield-driven tunnels and many small ones. It is particularly valuable in water-bearing soils, for it is the only lining that is practically watertight as soon as it is bolted up.

This lining is cast in segments, Fig. 208, with a skin thickness of 1 to $1\frac{1}{2}$ in. The flanges have a depth of $0.033 \times \text{O.D.}$ for tunnels in impervious clays and $0.042 \times \text{O.D.}$ for subaqueous tunnels. The flanges are knee-braced to the skin at intervals. These braces should be in line with the jacks.

The length of the segment is rarely more than 6 ft., as longer segments are difficult to cast. The actual length is, of course, dependent on the number of segments to a circle but, in any case, should not be more than the radius of the tunnel, which means a minimum of six segments per ring.

The rings break joint; therefore, it may be very difficult to line up the boltholes in the new ring if the previous ring has been distorted, since it is very difficult to "drift" cast iron. Short segments have the advantage of giving a little more flexibility to the assembly.

The width of the ring has been pretty well standardized at 30 in. In a few small tunnels, rings 18 in. wide have been used to

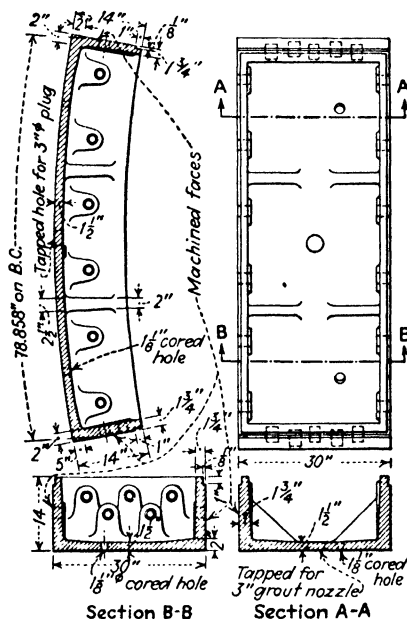

FIG. 208.—Typical segment of cast-iron lining for shield-driven tunnels. This segment was used on the Union Tunnel in Baltimore.

reduce the weight of segments to about 350 lb. for erection by hand.

The rings are attached to each other by bolts through the vertical flanges, spaced about 12 in. c. to c., the boltholes are cored $\frac{1}{4}$ in. larger than the bolts. The end flanges of the segments have cored holes for 4 to 5 bolts. Bolts are $1\frac{1}{2}$ to $2\frac{1}{8}$ -in. diameter, with a cut washer at each end. For watertightness, a hemp gasket or grommet, saturated in red lead, or a lead washer is placed under each cut washer. All bolts must be tightened at least twice, the first time during erection, with a 4-ft. wrench, Fig. 210. After six or eight shoves of the shield, the bolts will

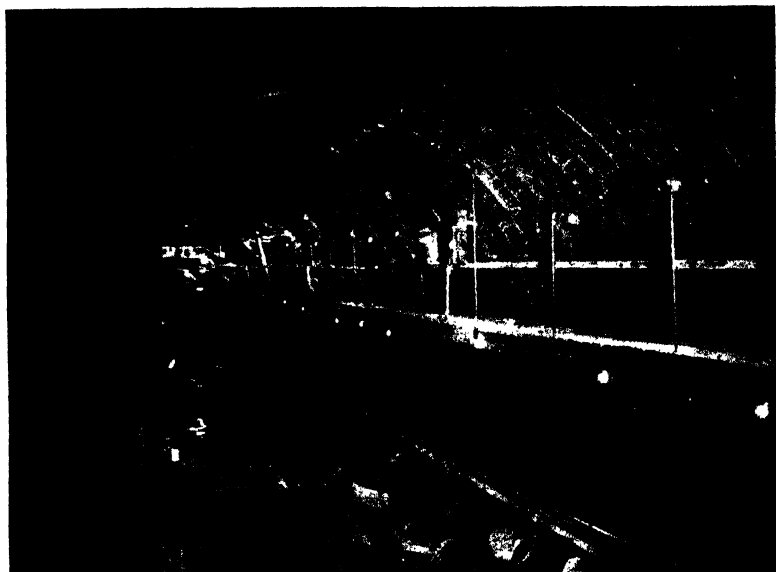

FIG. 209.—North tube, Queens Midtown Tunnel, typical example of cast-iron-lined shield-driven tunnel. View is looking toward the shield. Primary lining is made up of rings of cast-iron segments 30 in. wide.



FIG. 210.—Tightening cast-iron lining bolts by hand, Lincoln Tunnel, New York. Note narrow key segment in top of arch. White streaks are red lead squeezed from rope grommets placed under washers to make boltholes watertight.

be found loosened, they must be tightened again; this time by two or three men on a 5-ft. wrench. On the Lincoln Tunnel, a large mechanical wrench was developed, Fig. 211, which tightened the bolts to desired stress the first time, eliminating the second tightening. In connection with the mechanical wrench, the nuts were run up snug by an air wrench.

Standard practice is to machine all four edges of the segment, to ensure the squareness of the ring and tightness of joints and to make the rings easier to erect. On some of the earlier tunnels, machining of the edges was omitted for economy, and the rings were erected with $\frac{1}{2}$ or $\frac{3}{4}$ -in. wood

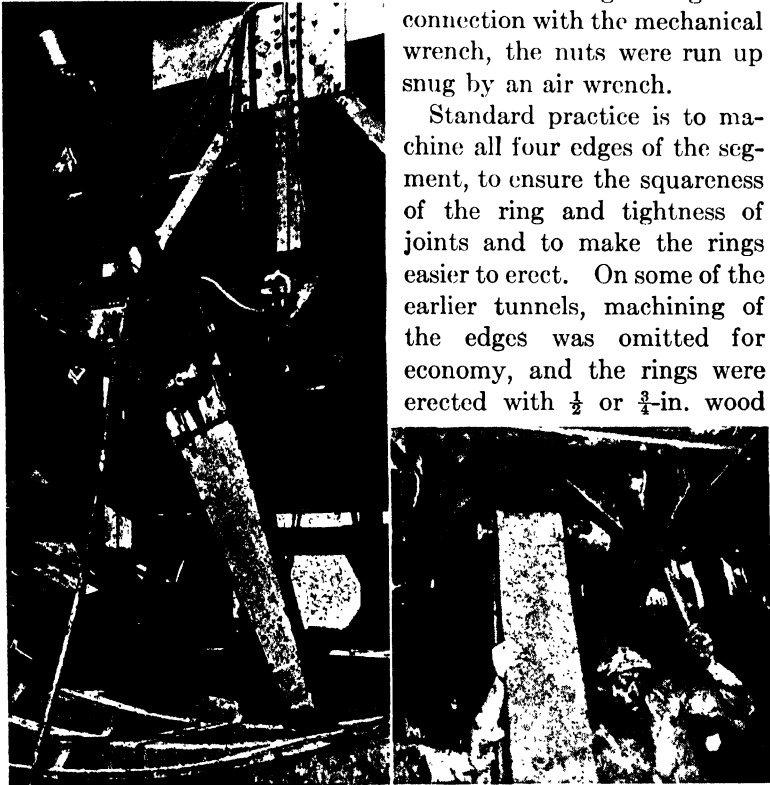

FIG. 211.—Hydraulic wrench for tightening lining bolts, Lincoln Tunnel, New York. Left: socket is turned by endless chain actuated by hydraulic piston in arm pointing upward. Right: wrench in use.

fillers at all joints to insure full-bearing of the segments and watertightness. The result was not satisfactory, for squeezing or crushing of the wood fillers was not uniform, throwing the face of the ring out of square.

A calking groove is cast along the inside edges of the segments, which, after the rings are erected, forms a calking space about $\frac{1}{2}$ in. wide and 2 in. deep. Following well behind the shield, a

calking crew scrapes and cleans the grooves and applies the calking material. Formerly a "rust calking" was used, consisting of a mixture of 4 lb. sal ammoniac, 3 lb. sulphur, and 125 lb. iron filings. Applying this mixture was a messy and disagreeable task. Now cast-iron lined tunnels are calked with lead wire hammered into the groove with pneumatic calking hammers, Fig. 212. After the air pressure has been taken off the tunnel, the lining is checked and all wet spots are recalked.



FIG. 212.—Calking cast-iron lining with lead wire, Lincoln Tunnel, New York. Pneumatic hammer was used to force lead into calking groove cast into the lining segments.

The weight of cast-iron lining for tunnels may be estimated by the following formulas as given in Hewett and Johannesson's book referred to above:

$$W = 14D^2 \text{ for dry clay.}$$

$$W = 19D^2 \text{ for firm water-bearing ground.}$$

$$W = 22D^2 \text{ for subaqueous tunnels in silt.}$$

where W = weight, lb. per lin. ft. of tunnel.

D = outside diameter, ft.

Cast-steel Lining.—Cast steel has been used in short sections of tunnels, but its high cost prevents its use except in special cases. Cast-steel segments are frequently specified for points of unusual stress in the lining, such as the transition from rock to soft ground, or at the mid-river sump.

Segments for Tunnel Curves.—Curves in cast-steel or cast-iron lining are made with taper rings. A complete ring of standard segments is bolted up in the shop; and then one face is milled in a flat inclined plane until the ring at one side is $\frac{3}{4}$, $1\frac{1}{2}$ or 3 in. narrower than full width, tapering uniformly to full width at the opposite point. One or more taper rings can be inserted in the lining in any position, to give any desired curvature to the tunnel in any direction.



FIG. 213.—Hydraulic jack with special distributor shoe for shoving the shield against the steel-plate primary lining. (Courtesy of Watson-Stillman Co.)

Pressed Steel Liner Plates.—The standard pressed steel plate is occasionally used for the primary lining of small shield-driven tunnels. These plates are usually 16 in. wide and approximately 3 ft. long. They are light to handle and easily erected.

The difficulty in their use is the distribution of the jack thrust over the plate. Since the flanges of these plates are generally not more than 2 in. wide, there must be some kind of distributor shoe to carry the jack thrust directly into the plate itself, not only to distribute the stresses but also to avoid eccentric loading on the ram of the hydraulic jack, Fig. 213. Another device is the "target plate," Fig. 214, which carries part of the stress back into the next ring behind. The target plate must be moved each time by hand.

On some jobs, a heavy ring made from eye beams has been used to distribute the jack stress uniformly. Before erection of the new ring can be started, however, the whole ring must be

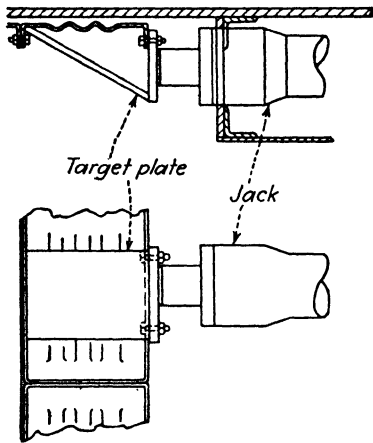

FIG. 214.—Target plate for distribution of shoving-jack pressures against steel-plate primary lining.

moved ahead. This "floats" the shield and, if there is active pressure against its face, the shield may drift backward.

The standard liner plate is not well adapted to withstand longitudinal pressures. The plate itself is corrugated; excess pressures across the corrugations are apt to cause the plate to buckle. However, the plates can be readily strengthened by welding longitudinal steel shapes between flanges to carry the jack thrust.

Corrosion may or may not affect steel liner plates. However, there is no reason to believe, from the records at hand extending as far back as 50 years, that corrosion would be sufficient to weaken the lining dangerously.

Fabricated Plates.—In the last few years, plates fabricated by pressing and welding have been used on some larger tunnels, particularly those which were shield-driven. These segments are made by pressing a plate to the desired radius, at the same time breaking the edges over to form the webs of the ribs. Straps are welded to this web to form a flange to increase the strength and stiffness. Punched plates are welded at each end for bolting the segments end to end.

If the segment is to be used in a shield-driven tunnel, Fig. 215 (top), rails, I-beams or tees are welded transversely to the plate to stiffen it and to carry the jack thrust. Where the lining is erected in self-supporting ground, the plate is stiffened by a curved rib, Fig. 215 (bottom).

Weights of fabricated steel tunnel lining may be estimated by the following formula:

$$W = 7\frac{1}{2} \times D^2$$

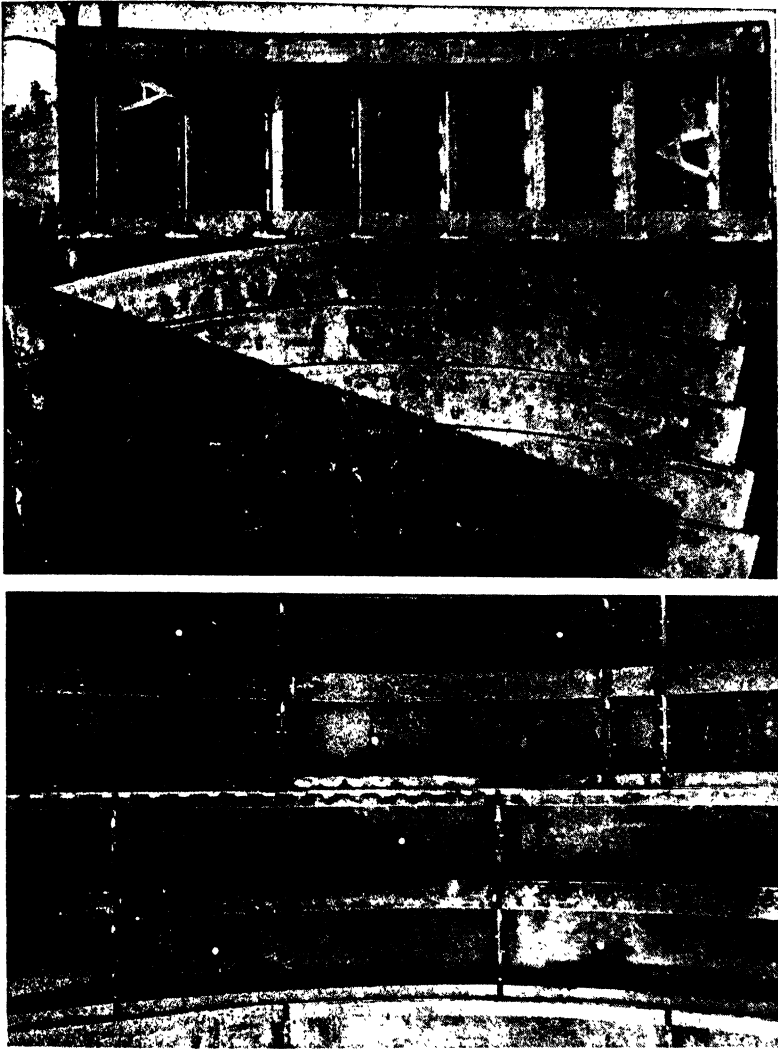

FIG. 215.—Two types of fabricated steel liner plates for shield tunnels. Top: segments reinforced with longitudinal rail sections. Bottom: segments reinforced with intermediate rib. (Courtesy of Commercial Shearing & Stamping Co.)

where W = weight, lb. per lin. ft. of tunnel.

D = outside diameter, ft.

A groove can be machined into the inner edges of the rib, which later can be calked with lead wire, but it would probably

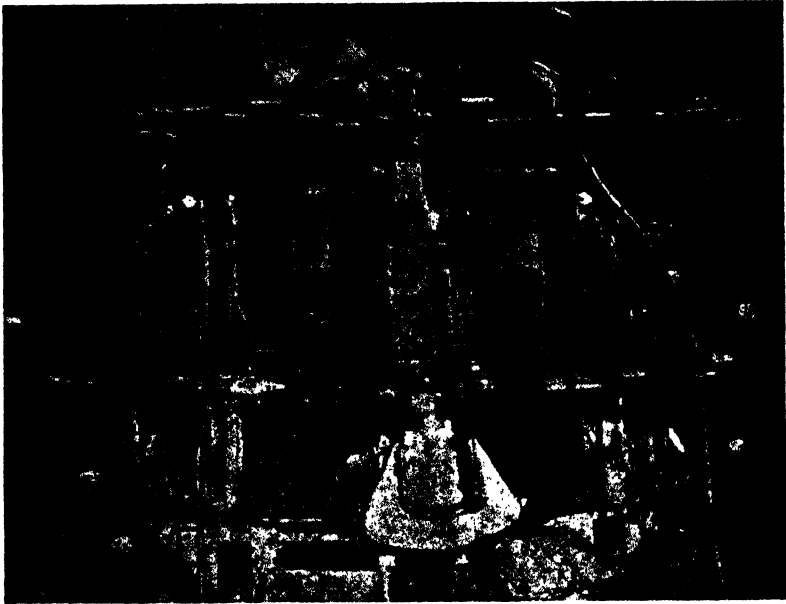

FIG. 216.—Fabricated steel lining in shield-driven section of Detroit-Windsor Tunnel. This is a good view of the shield, driven with all pockets open. (Courtesy of Commercial Shearing & Stamping Co.)

be better and cheaper to arc-weld the ribs after erection to ensure watertightness of the joints.

CONCRETE BLOCK LINING

To avoid the high cost of cast-iron lining, early attempts were made to develop some type of primary lining made from precast concrete units. Several patents were taken out on one type or another. The difficulties with the first block were the numerous breaks developed from the jack pressures during the first and second shoves.

The blocks could be cast with fair accuracy, but it was difficult to erect them in the tunnel with the ring joint in full bearing; so the block was called on to carry the jack thrust in bending from point to point. This could, of course, be overcome by reinforcing

the block; but the reinforcing steel was an item of expense which was only required for the first shove and added no strength to the permanent structure.

Another difficulty with the early concrete blocks was to find some method of holding the upper blocks in position until the ring was keyed. Cast-iron segments are held in position by bolting to the previous ring, but concrete blocks must be held by some system of braces until the arch was completed.

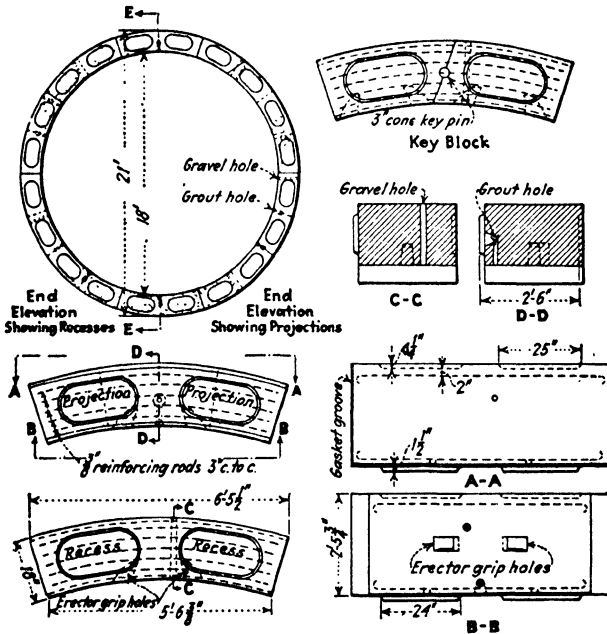

FIG. 217.—Details of the O'Rourke concrete block for primary lining of shield-driven tunnels.

Another difficulty was the key block. At first a standard block was used for the key; this block could not be placed until the shield had advanced another ring, since it had to be shoved in from the front end, which required a longer tail on the shield. A dummy key block of wood was set in the uncompleted ring during the shove; but this meant that the upper jack could not be used and made it more difficult to steer the shield.

O'Rourke Blocks.—The O'Rourke block has been used on a number of jobs. Unusual progress was made with these precast

units in driving sewer tunnels through blue clay in Detroit. As shown in Fig. 217, this type of block has two kidneys on each side; those on the forward edge are depressed $1\frac{1}{4}$ in., and those on the rear edge project $1\frac{1}{2}$ in. The heads of the jacks bear against an oak cushion in the depressed kidney. These blocks are erected to break joint. When the projecting kidney is

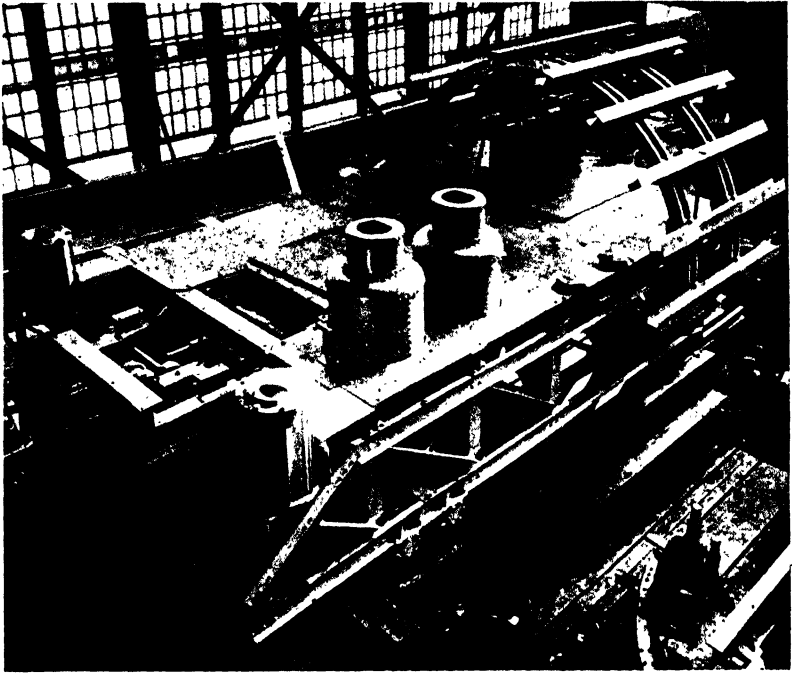

FIG. 218.—Trailer jumbo used in driving shield tunnels lined with O'Rourke concrete blocks. At the forward end (right) are the sliding needle beams used to hold the blocks in place as they are erected until the key is placed and the ring is complete. The erector is mounted on the front end of the jumbo. Gravel shooters and pneumatic grout guns are carried on the rear of the jumbo.

set into the depressed kidney, the body of the block is separated $\frac{1}{4}$ in., ensuring that all jack stress will be transmitted in a straight line through the kidneys.

Cored holes, $1\frac{1}{2}$ -in. diameter, are provided in some of the blocks for shooting gravel into the annular void left by the tail of the shield. Another cored hole is used for grouting the $\frac{1}{4}$ -in. space between the rings after the lining has had a chance to adjust itself to soil pressure.

The key block is in two pieces, the two sections having an overall length equal to a typical block. After the last piece has been placed in position, a concrete pin is shoved into a groove to lock the two key pieces. The erector arm is carried on a trailer following immediately behind the shield, Fig. 218. At the front of the trailer is a frame carrying a series of telescoping steel beams which support all the blocks in a new ring above the spring line until the key is set and the ring is self-supporting. These beams



FIG. 219.—A New York subway tunnel, shield-driven with primary lining of concrete blocks.

are pushed forward one at a time as the blocks are set. Each beam has a handwheel for adjusting the block to grade. At the back end of the platform are two "peashooters" for filling the tail space with gravel, and two grout machines for filling the transverse joint of the block lining.

The blocks are cast in accurately made steel molds. A top panel is pressed into the wet concrete to form the depressed kidneys. Tapered horns are attached to the side form to mold "finger grips," 6 in. deep, for the erector arm. The side molds are stripped in 12 hr. At the end of 24 hr., the blocks are lifted off the pallet car and allowed to cure for 28 days.

T. & M. Block.—The T. & M. block is trapezoidal in shape, tongued or grooved on all four sides, Fig. 220. They are laid up in the ring with the big end alternately to the front and to the rear; in effect every other block is a key block. In order to avoid bending in the block, only one jack bears against a block. All the tongues are coated with thick asphalt, which acts as a cushion

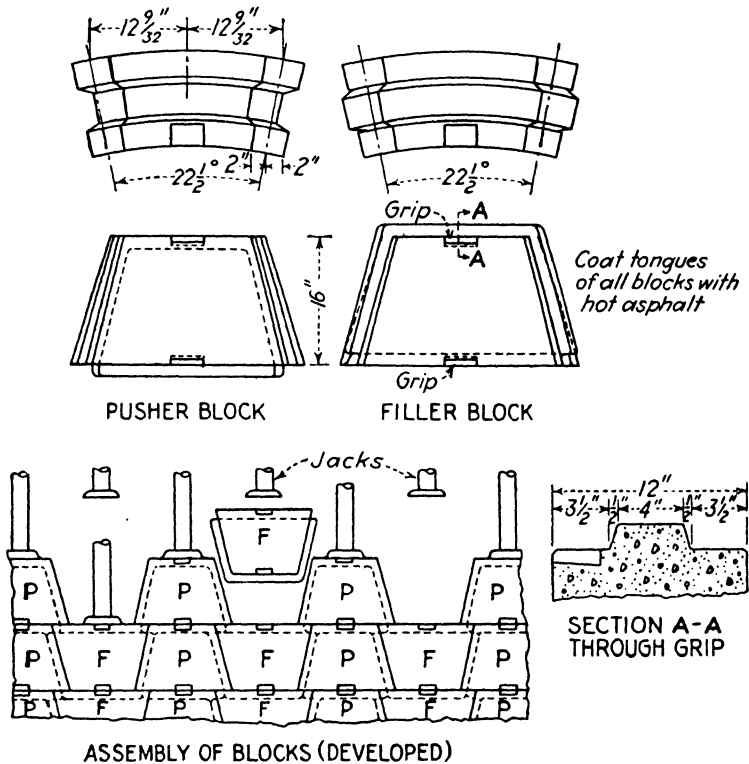

FIG. 220.—Details of the T. & M. type of concrete block for small shield-driven tunnels.

when the jack pressures are being transmitted and squeezes into the joint to act as a water seal.

There is a shield jack for every block, operating from a dual hydraulic system. A low pressure of 200 lb. per sq. in. is used for holding the blocks in place during erection; high pressure (1,000 to 3,000 lb.) is used for shoving the shield. As each block is erected in the ring, its individual jack is advanced under low pressure to hold that block until the ring is completed.

The blocks are manufactured in hydraulic presses from rather dry concrete. Since the side mold is slipped off the block immediately, there must be a slight "draft" to the block, and there can be no inserts through the mold. Therefore, the erector grips must be placed in the ends of the blocks. Blocks remain on the pallets for 24 hr. The mix generally used is 1:1.8:2.2, the coarse aggregate being $\frac{1}{2}$ -in. gravel, which gives more than the desired 3,500 lb. compressive strength in 28 days.

WOOD LINING

A number of small jobs and several big ones have been shield-driven with wood for the primary lining. The timbers, generally 8x8 in., have been cut into segments and laid up to break joints. The rings are spiked or drift-bolted to each other.

There must be a distributor shoe of ample size on the shield jack. The allowable side grain compression, with a factor of safety of 4, is 350 lb. per sq. in. for yellow pine and 500 lb. for oak. The factor of safety may be reduced to 2 for the temporary shoving stress, permitting a side grain compression of 700 lb. for yellow pine and 1,000 lb. of oak. If the shield is equipped with 60-ton jacks, the distributor should have a minimum bearing on 170 sq. in. against the wood when yellow pine is used.

Because of the large number of joints, it is impossible to make a wooden primary lining water- or airtight. Therefore, it is customary to keep the secondary lining close to the shield.

Wood lining in compressed-air tunnels is a serious fire hazard. Following a disastrous fire in wood lining in a Chicago sewer tunnel several years ago, the Sanitary District of Chicago prohibited use of wood segments in its tunnels.

OTHER TYPES OF PRIMARY LINING

There have been many attempts to eliminate the primary lining entirely by erecting the secondary lining within the tail of the shield. The earliest scheme was to build a lining of brick or cut-stone masonry directly in the shield and then jack against it. The great pressures from the jacks simply squeezed the green mortar from the joints.

Others have tried to place concrete in the tail, taking the jack thrust through steel forms. The difficulty here was that the bulkhead retaining the green concrete could not be stripped for

at least 6 hr., which tied up operations that long. If the shield stood too long, the concrete "froze" to the tail. One job was successfully pushed through in Boston using iron bars embedded in the masonry to transmit the jack thrust.

With the recent development of the concrete pump, there may be an opportunity of using this machine not only to force the concrete into the forms, but also to move the shield.

DISTORTION OF PRIMARY LINING

As the shield advances, there is an annular space left at the tail, which includes the tail thickness plus the tail clearance. This space, as shown in Fig. 221, is equivalent to 1.33 cu. yd. per

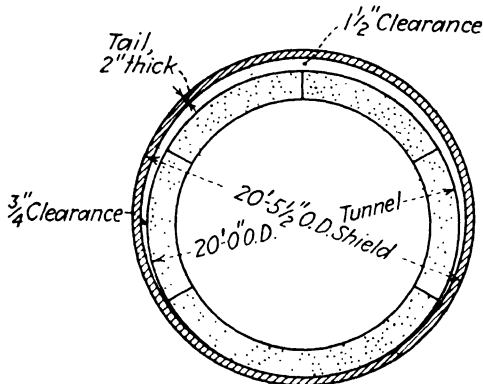

FIG. 221.—Shape of the annular void under tail of the shield.

30-in. ring in a 20-ft. tunnel. In most soils this space must be promptly filled, or there will be a perceptible, or even dangerous, settlement of the surface.

In temporarily *self-supporting soils*, the arch will sag, as shown in Fig. 222, unless the cavity at the spring line is filled rapidly as the shield advances. The space at the crown must be filled before the ground settles. Another way to prevent sag of the arch until the space at the sides has been filled is to use temporary turnbuckle rods horizontally across the tunnel. These can be attached to cast-iron or fabricated steel linings, but it is difficult to make a suitable connection for concrete blocks. As the rods may be in the way of operations on the next ring, and their cost of setting and removing is considerable, it is better to fill the void promptly.

In *plastic clay*, all or most voids can be filled by proper manipulation of the shield. If the shield is of the bulkheaded type, by careful adjustment of the ports, sufficient pressure can be maintained on the face to cause the clay to flow around the shield and fill all the cavity, except perhaps right at the crown.

Silts also will flow into the tail space as the shield moves ahead. Apparently in this material the horizontal pressures are greater than the vertical pressures, for the tunnels under the Hudson River have exhibited a tendency to distort by an increase in the vertical dimension, amounting sometimes to $1\frac{1}{2}$ in. In a few weeks, however, the ratio of pressures changes, and in a few months the tunnel returns to its correct shape.

Running gravel or sand is probably the most difficult soil through which to drive a shield without serious settling of the ground. In these materials, it is practically impossible to build up a pressure ahead of the shield to force the ground to flow around the shield to fill the cavity. Lack of cohesion permits the ground to cave into annular space before it can be filled by back-packing.

The only remedy in such ground is to shove the shield very slowly so the packing can keep up with the movement. In some cases contractors have used a shield tail shorter at the bottom than at the top.

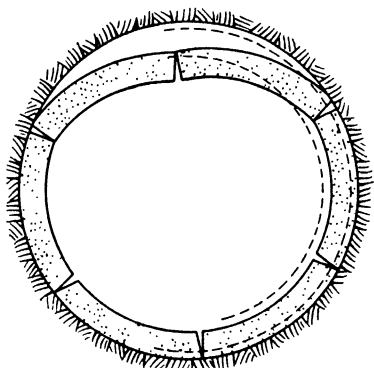

FIG. 222.—Exaggerated diagram illustrating sagging of the arch of a tunnel.

GROUTING THE TAIL VOID

Grout was at first the only material used for filling the annular void left by the tail of the shield. This is generally a 1:2 mix, fairly wet, forced in at the bottom grout plugs, as the tail clears them. The plug next above is removed to serve as an air vent. When mortar appears at the upper hole, the grout hose is transferred to that plug where the injection of grout continues till that sector is filled.

As shown in Fig. 223, a stopcock is screwed directly into the grout plug. The grout hose, with an air vent, is connected to the stopcock. When grouting is completed, the inner stopcock is turned to retain the pressure in that hole until the grout sets. Meanwhile, the hose is transferred to the next plug. Pressures of 80 lb. per sq. in. are generally used to place grout.

The great objection to grout, besides the high cost of the cement, is the difficulty of preventing it from flowing around the

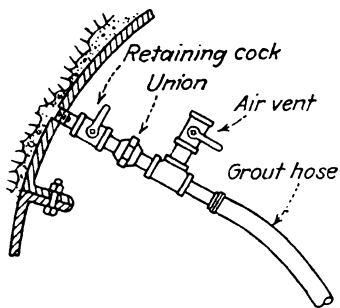

FIG. 223.—Grout plug and connections.

blocks and into the shield. This can be prevented by using "circle boards," segments of wood cut to a radius equal to the inside of the tail, under the jacks. These fit tightly against the tail and, with very little calking, prevent leakage. Another bad thing about grouting is that it may, under too great pressure, travel too far and appear at the surface or perhaps flow into a sewer. On certain

jobs, lime or "natural cement" have been used in place of cement. Their advantage is low cost, and their disadvantage is slow setting.

Recent uncovering of an old tunnel in New York in which grout was used revealed numerous thin-shell bubbles of hardened grout, apparently blown up by the original air pressure. In some cases, these bubbles had collapsed, with resulting loss of ground.

GRAVEL PACKING

Gravel packing was developed for filling the tail space within recent years. Usually this material is what is known as bird's-eye gravel, but granulated slag and screenings have been used. In any case, the material must be of uniform size. Bird's-eye gravel passes a $\frac{1}{4}$ -in. screen and has approximately 33 per cent voids.

The gravel is stored in a pressure tank, or "peashooter," Fig. 224, on a trailer behind the shield. As the tail of the shield uncovers the grout plugs, the gravel is shot by compressed air through a $1\frac{1}{2}$ - or 2-in. hose into the voids. Filling generally

begins at the bottom; the air being vented through one of the upper holes. As this material will not flow like a cement grout, it is generally unnecessary to set circle boards to prevent the gravel running into the shield.

While an 80-lb. pressure is generally used on the peashooter, gravel will not pack so tightly as grout, and there may be occa-

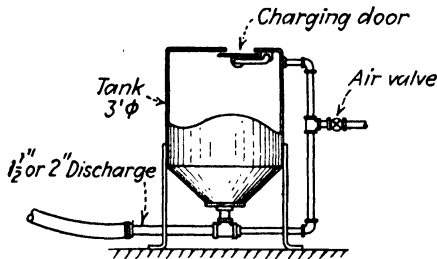

FIG. 224.—Simple type of gravel peashooter for filling the void left by tail of shield.

sional spots into which the gravel fails to flow. Therefore, it is customary to follow the gravel with a cement grout, from one to 20 rings behind the gravel packing, depending on the ground and surface overhead, Fig. 226. This grout is a 1:1 mix, quite wet. It consolidates the gravel and fills the voids in the gravel itself. A secondary benefit of this cement grouting is that it stops most of the leaks into the tunnel.

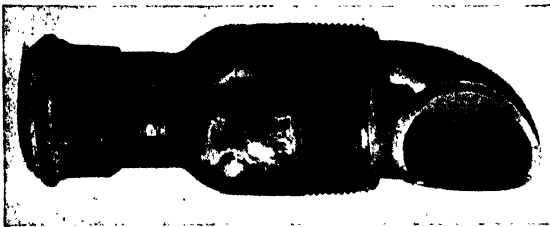

FIG. 225.—Special nozzle to direct flow of gravel shot behind tail of shield, used on Union Tunnel, Pennsylvania R.R., Baltimore.

Grouting and gravel-packing require great skill on the part of the operator. The selection of the proper consistency of grout and the proper pressure is a knack that is acquired only through long experience.

NECESSITY FOR SECONDARY LINING

It is customary to place a secondary lining, generally of concrete, within the primary lining of shield-driven tunnels. For-

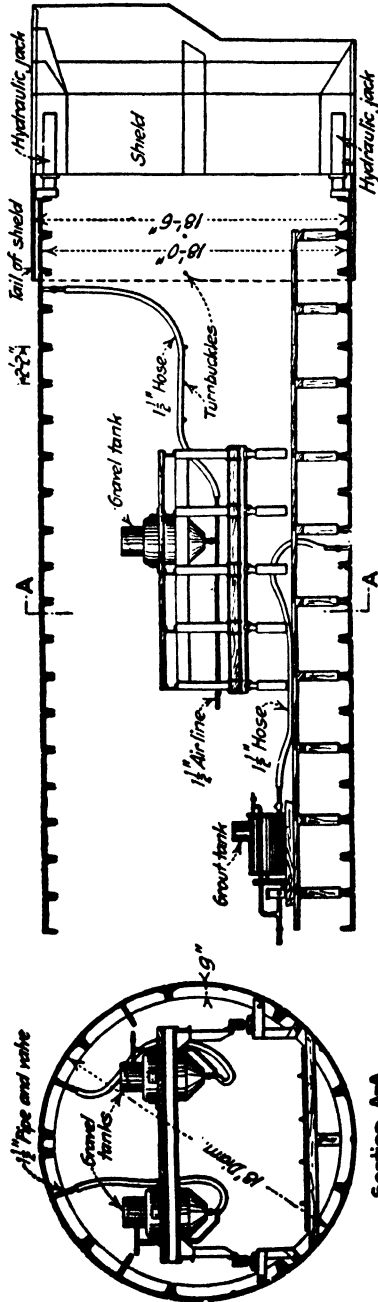

FIG. 226.—Trailer for packing tail voids behind the shield.

merly, this lining was designed to withstand the full permanent load with the idea that the primary lining would eventually be weakened by corrosion. Present practice, however, uses very little concrete for the secondary lining within cast-iron tunnels. In fact, only 2 or 3-in. thickness of concrete is usually placed over the flanges of the iron, hardly enough for satisfactory placing.

Shield-driven tunnels with a primary lining of precast concrete blocks have generally had a secondary concrete lining of approximately equal thickness. Several tunnels have been built of precast blocks without secondary lining. A 10-ft. tunnel for the Cleveland water intake, built through dense impervious clay in 1918, has had no secondary lining. Many storm sewers have also been built without a secondary lining.

CHAPTER 15

THE SHIELD

ESSENTIAL PARTS

The essential parts of the shield, shown in Fig. 227, include:

Skin.—The skin plate is the outer shell, usually made up from several curved plates, but in single lengths from front to rear to eliminate radial joints. In small shields, those which can be assembled in the shop and shipped to the job in one piece, the skin may be fabricated from single plates with welded butt seams.

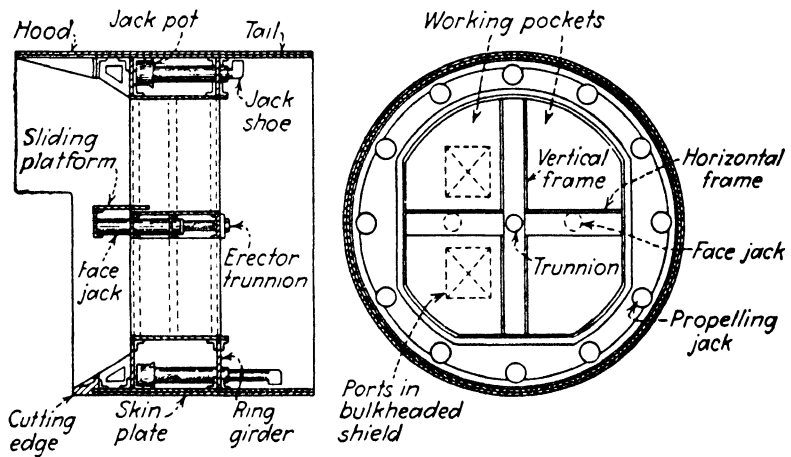

FIG. 227.—Various parts of the shield.

However, most shields, because of their size, must be assembled on the job, at the portal or at bottom of shaft, and the skin will be of two or more thicknesses of plate, fabricated with broken lap joints. All external rivet heads must be countersunk.

Tail.—The tail is that part of the shield extending to the rear, within which the primary lining is erected. As the tail is not braced or supported from the inside, it must be designed to resist all external pressures without distortion. The length of the tail is generally that sufficient to cover one and a half rings

of the primary lining; that is, when the shove has been completed and erection of a new ring started, the tail projects back over the last previously set ring at least half the ring width. However, a longer tail, one that covers more than the last ring at the completion of a shove, is better, for under its protection a broken segment in the last ring can be replaced. Yet a longer tail must

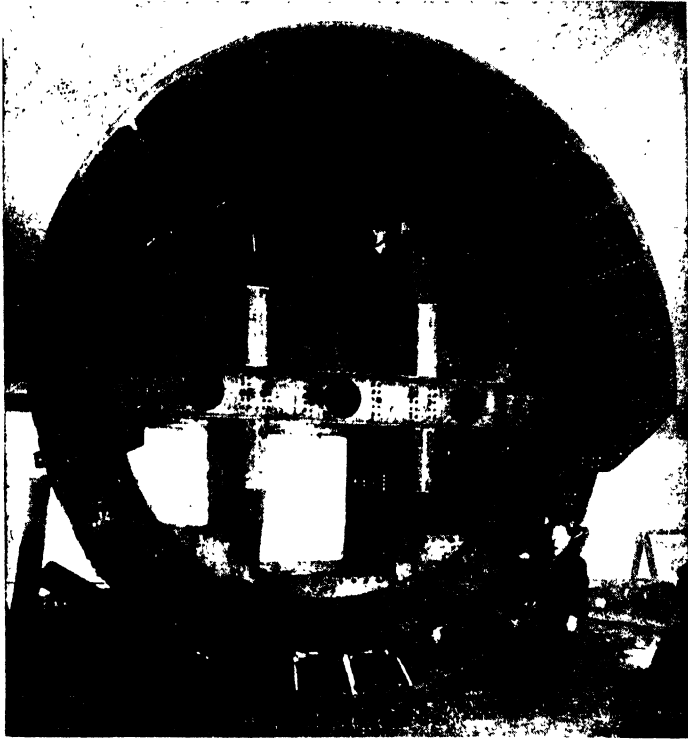

FIG. 228.—Face view of an 18½-ft. shield. Note the hood and the cast-steel cutting edge. The three pockets are for face jacks. (Courtesy of Union Iron Works.)

be thicker than a shorter one, thus increasing the void behind the tail; and another disadvantage is that a long tail makes the shield harder to steer and control. All rivets through the tail must be countersunk at both ends.

Cutting Edge.—The cutting edge on small shields is usually the skin plate itself, protected against abrasion by a coating of tungsten carbide or similar hard-surfacing material and stiffened by knee braces back to the forward ring girder. On large shields,

the cutting edge is cast steel, in segments, bolted to the front end of the shield. One big advantage of this type of cutting edge is that individual segments may be removed and replaced if damaged by collision with boulders or other obstructions.

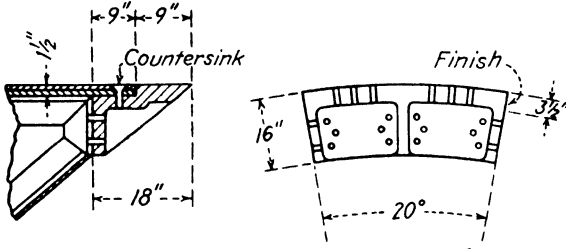

FIG. 229.—Details of cast-steel cutting edge.

Hood.—The hood is a forward extension of the top section of the cutting edge, usually extending through the top 150 deg. of circumference. A hood is of great value in ground that must be

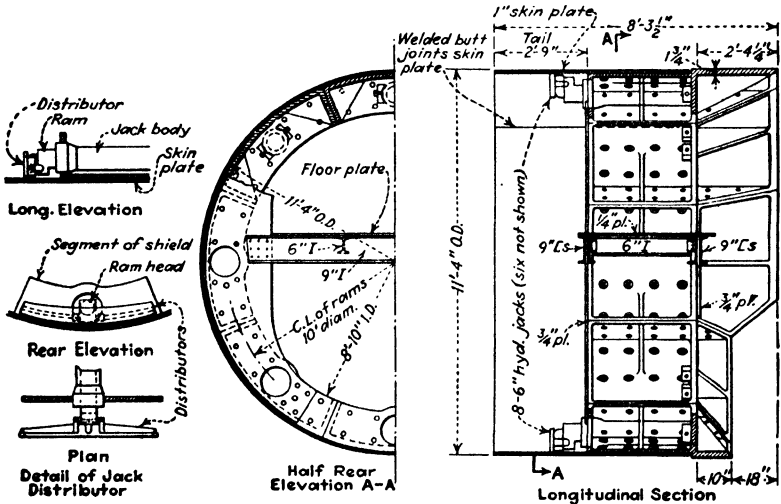

FIG. 230.—Details of 11-ft. shield for side-drift tunnels, Union Tunnel, Baltimore, designed for pressed-steel plate primary lining. The stiffening ring is of cast iron.

breasted before each shove, for under its protection the miners can set the breast boards far enough ahead of the face of the shield to permit a full-length shove. As there is little doubt that

the hood adds to steering and control difficulties, it is well to design the hood for removal when the ground for which it was required has been passed.

Inner Structure.—Ring girders, two or three in number, stiffen the skin plate against distortion. Usually the ring girders are fabricated structural members, but occasionally they are castings, Fig. 230. In the rear ring are large holes or jack pots, through which the shoving jacks extend. The shoving thrust of the jacks is transmitted to the skin plate and cutting edge through the center ring girder of the shield, which must be framed and braced to take the jack thrust. An inner skin plate, attached to the ring girders, stiffens the whole shield structure and also keeps muck out of the jack pots. Handholes through the inner skin, opposite each jack, provide access to the jacks for making adjustments.

Pockets.—Horizontal and vertical frames or diaphragms divide the front part of large shields into pockets, usually about 4 ft. wide and 6 ft. high. The primary purpose of the diaphragms is to stiffen the shield structure against distortion from eccentric loads on the cutting edge, but the horizontal frames also provide convenient scaffolds or platforms for the workmen to stand on when attacking the face. Platforms in the pockets are often mounted on hydraulic jacks and can be extended under the hood as working platforms or, under thrust of the platform jacks, can be used as bracing for the face breasting.

Bulkheads.—For certain kinds of ground, the pockets are closed off at the face by bulkheads. The bulkhead type of shield should be used either in silt or soft clay of a consistency such that some or all of the material can be forced to flow into the tunnel, or in ground where there is danger of an inrush of material. A port or door is built into the bulkhead of each working pocket. At least some, and perhaps all, of the ports should be equipped with hydraulic gates. By manipulating the gates, the operator can control the amount of material admitted to the tunnel through the shield. As the sandhogs may have to pass through the doors to remove obstructions from the cutting edge, the openings should be not less than $2\frac{1}{2} \times 2\frac{1}{2}$ ft. Shoving the shield with the ports closed is known as shoving "blind," an accepted practice in cases where the bulging or rise of the displaced material causes no damage.

Shields without bulkheads are known as the open type, and are used in driving through self-supporting ground or that requiring breasting of the face. Open shields, however, should be fitted with grooves around the front end of the pockets into which can be slipped stop logs as emergency bulkheads in case bad ground is unexpectedly encountered, or if the shield is to be shut down for some time.

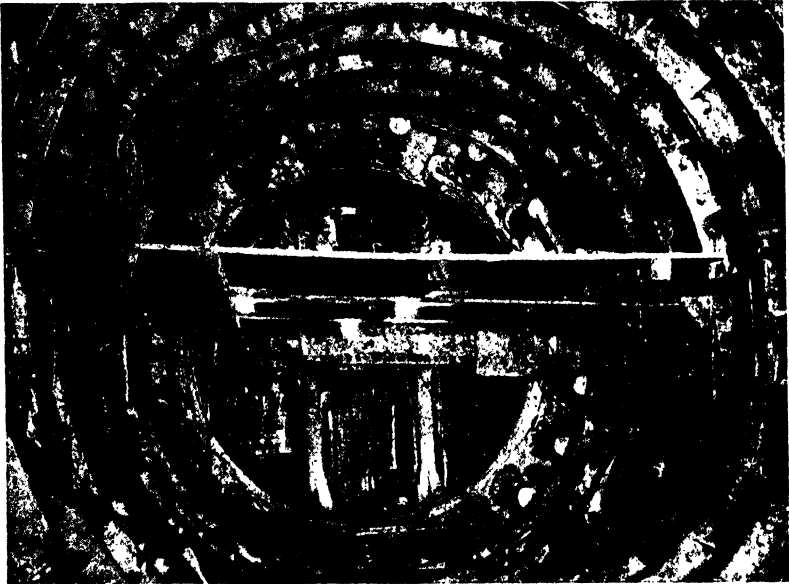

FIG. 231.—Open-type shield, New York subway East River tunnel. Face is bulkheaded with timber stop logs.

Weight.—The weight of a shield, complete with hydraulic equipment, may be roughly estimated from the following formula:

$$W = 15(D - 10)$$

where W = weight of the shield, tons.

D = outside diameter, ft.

Articulated Shields.—The shorter the shield, the easier it is to steer and control. As small shields are relatively long in proportion to their diameter, sometimes they are jointed or articulated in the center. Through manipulation of heavy screw bolts, the front half of an articulated shield may be slightly tilted in any direction, thus aiding the steering.

Over-cutter.—The over-cutter has been used on a number of jobs through self-supporting ground. To establish the lead in this type of ground, it is necessary to crowd the ground bodily

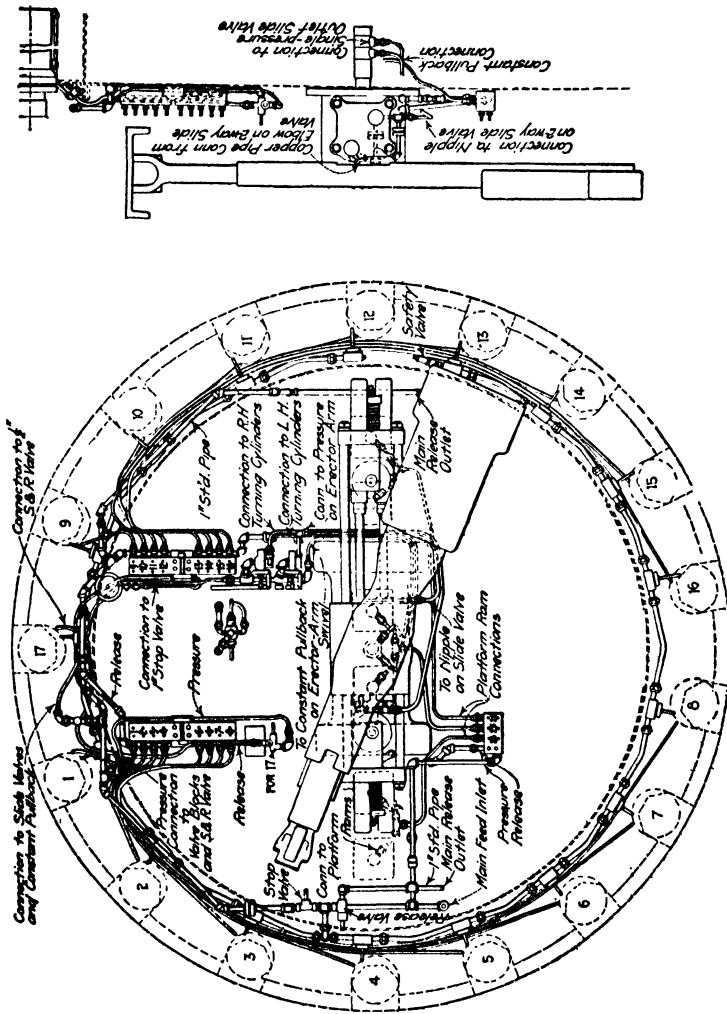

Fig. 232.—Rear view of a shield, showing hydraulic equipment.

away from one side. The over-cutter, which consists of a plate about $\frac{3}{8}$ in. thick attached to the outside nose of the shield, sometimes over the upper half and sometimes on the right and

left quadrants only, serves to cut the excavation slightly greater than the diameter of the shield. This not only aids steering of the shield, but also greatly reduces the skin friction.

HYDRAULIC EQUIPMENT

The hydraulic equipment consists of the propelling jacks, the face or platform jacks, their piping and control valves, the piping

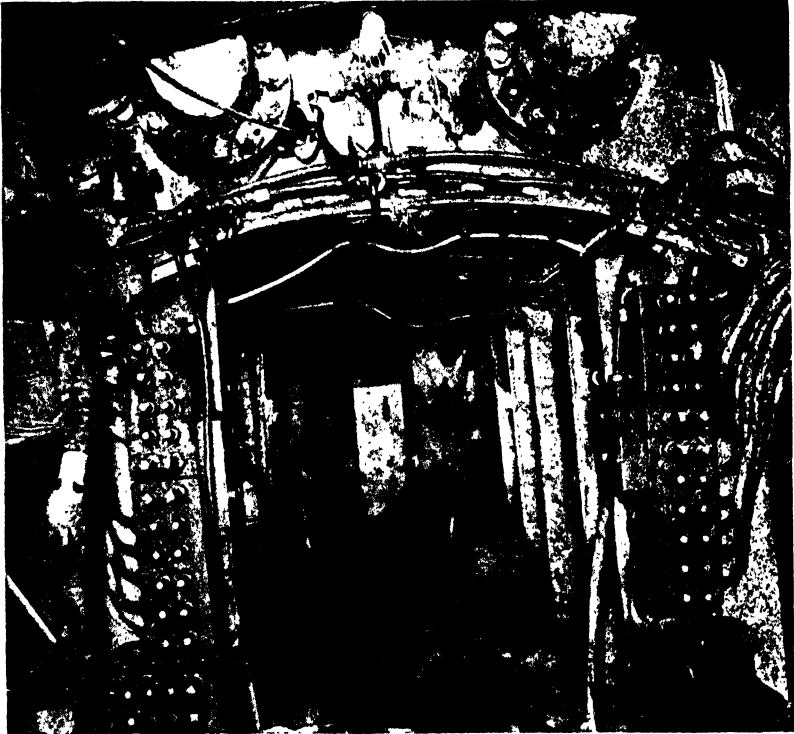

FIG. 233.—Valves for controlling shoving jacks on a shield. Valves are arranged in two banks, one for each side of the shield; master valves are at lower left.

from the shield to the pump, and the hydraulic pump and accumulator. Most erector arms, which pick up and set the primary lining segments, are hydraulic-operated.

Jacks.—The propelling jacks are located around the inner periphery of the shield in holes in the rear ring girder, Fig. 232. Usually the jacks are equally spaced, but on occasions an extra jack at the bottom has been used to prevent the shield from

“nosing down.” The jacks should be located as close as possible to the outer skin plate to place their axis near the skin of the primary lining.

The number and diameter of the jacks are governed by the diameter of the shield and the type of primary lining. In any case, the combined capacity of the jacks, at maximum pressure, should be sufficient to give a pressure of $6\frac{1}{2}$ tons per sq. ft. over the face area of the shield.

The jacks are double-acting, Fig. 234, consisting of the shell, the ram, the distributor shoe and the jack pot. The jack pot is a casting bolted to the ring girder and holding the butt of the jack in correct position. The ram should be of the largest possible

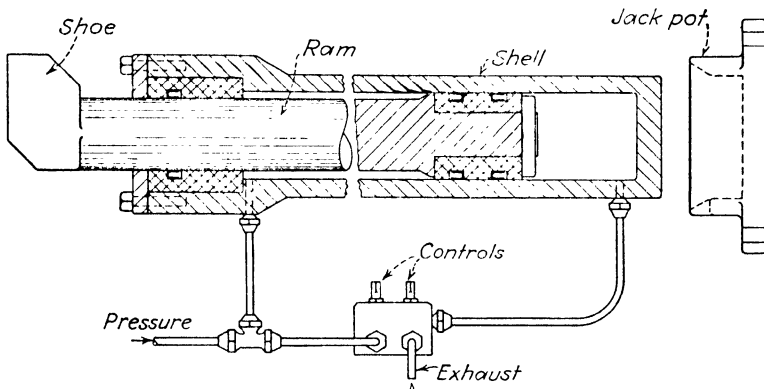

FIG. 234.—Details of a typical shield jack.

diameter to avoid bending. The distributor shoe may be a simple head for cast-iron lining, but for concrete blocks or pressed steel plates the shoe should be large in bearing area and be connected to the ram by a ball-and-socket joint. Most jacks depend on leathers for tightness, although on occasions steel piston rings have been used. The stroke should be 2 to 4 in. longer than the width of the lining ring.

Jacks frequently fail in service, from bending of the ram or leakage through the leathers; therefore an extra jack should always be kept ready for replacement.

Valves.—The control valves for the jacks are divided into keyboards or manifolds, each controlling the jacks of one sector of the shield. Each jack is equipped with two valves, one to admit the pressure, the other to release it. The reactive pressure,

constant at all times, is not controlled by valves. Usually a master valve controls each manifold.

In the larger shields, water is the hydraulic fluid used for operating the jacks and, when released from the jacks, is wasted on the tunnel floor. On some small shields, where the pumps are mounted right in the structure, Fig. 235, oil is used as the

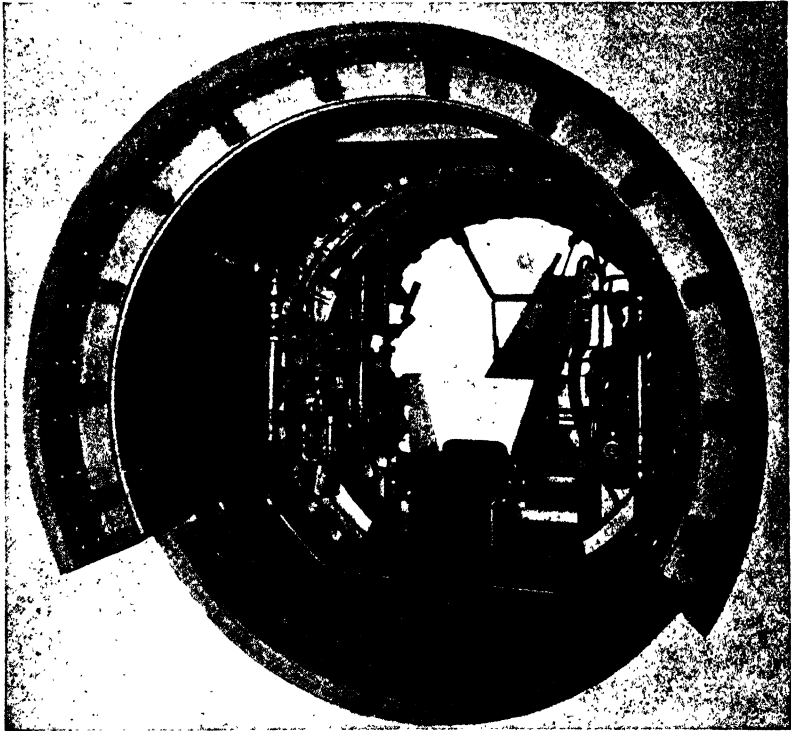

FIG. 235.—Articulated T. & M. shield for 6-ft. concrete-block-lined tunnel. The air-operated hydraulic pumps are mounted within the shield. Muck cars are loaded by the belt conveyor. (Courtesy of Link-Belt Co.)

hydraulic fluid. This, of course, means that the oil operates in a closed circuit and is exhausted into a storage tank.

For larger jobs, the hydraulic power is brought into the tunnel in 1½-in. extra heavy steel pipe and is distributed around the shield to the various valve manifolds through 1-in. extra heavy pipe. Copper pressure tubing is used from the valves to the jacks.

Pumps.—The hydraulic pump on large jobs is located in the power house at the shaft and may serve several shields. The pump, electrically driven, feeds into an accumulator designed to maintain a constant hydraulic pressure. For small shields, the pump is mounted either in the shield or on a trailer right behind it: such pumps are generally air-operated. Pump capacity should be calculated on a shield speed of 3 in. per min. with at least a 10 per cent leakage loss. All pumps must be equipped with a manually operated pressure regulator.



FIG. 236.—Hydraulic pumps and accumulator on a large shield tunnel job. This equipment is located on the surface. (Courtesy of Watson-Stillman Co.)

Hydraulic Pressure.—In most cases, the shield and jacks are designed for a maximum working pressure of 5,000 lb. per sq. in.; however, this much pressure is seldom required. Pressures of 2,000 to 2,500 lb. are generally sufficient to shove the shield properly. Most superintendents figure that, if the shield does not move at a satisfactory rate at such pressures, something must be wrong, and they stop and investigate. Often they will find a boulder caught on the cutting edge which must be broken up before it damages the shield.

Face Jacks.—Face jacks, or platform jacks, are used in the face of shields designed to work through ground which will require breasting. Sometimes the jack is set in the face and is designed

to extend directly against the soldier; more often they work against a sliding platform in the upper pockets. The edge of the platform is advanced against the breasting to hold it. The platform protects the jacks against falling muck and at the same time is a very convenient scaffold for the miners. The face jack is of 3- or 4-in. diameter, generally single acting.



FIG. 237.—Small shield-driven tunnel with primary lining of steel plates and ribs. Hydraulic pressure for operation of the shield is created by air-driven pump in foreground, kept within 50 ft. of the shield. Note how this particular shield has rolled to the right. (Courtesy of Commercial Shearing & Stamping Co.)

The face jacks are used in place of the stretcher and walking stick, shown in Fig. 243, for holding the face during the shove, and are much safer and more convenient. As the shield advances during a shove, the face jacks retract, yet maintain a constant pressure against the breast.

Erector Arms.—The erector arm is a power arm or boom required when the weight of the lining segments is such that they cannot be put into position by hand. For cast-iron segments, the erector arm is mounted directly on a trunnion attached to the

rear of the shield frame, Fig. 238. For concrete block lining, standard practice is to mount the erector on the trailer which carries the small needle beams used to hold the upper blocks in position during erection. Erectors are usually hydraulically operated, but some have been built for electric motor operation, Fig. 239.

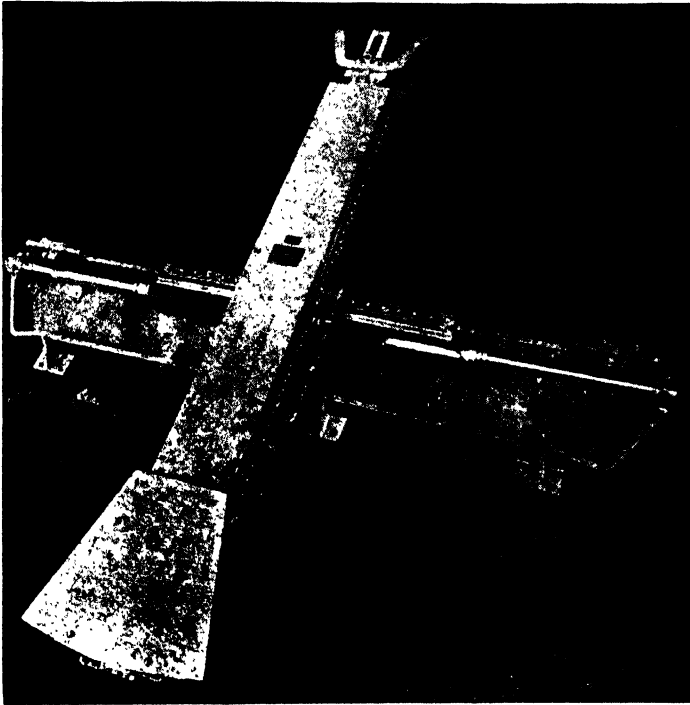

Fig. 238.—Updegraff erector used on shield for erecting cast-iron segments of primary lining. It is hydraulically operated. (Courtesy of Watson-Stillman Co.)

The grip by which the erector arm picks up cast-iron segments is simply a pin passed through a lug cast in the center of each block. Grip holes are cast in concrete blocks, and the erector arm is equipped with “fingers” inserted in the holes and tightened by a handwheel.

HANDLING THE SHIELD

Proper operation of the shield demands great skill and experience. Mysterious forces deflect the shield, and constant vigilance

on the part of the foreman and engineers is required to keep it close to line and grade. On a Lake Erie tunnel, the shield drifted as much as 185 ft. off line, an indication of what can happen if the shield is not watched.

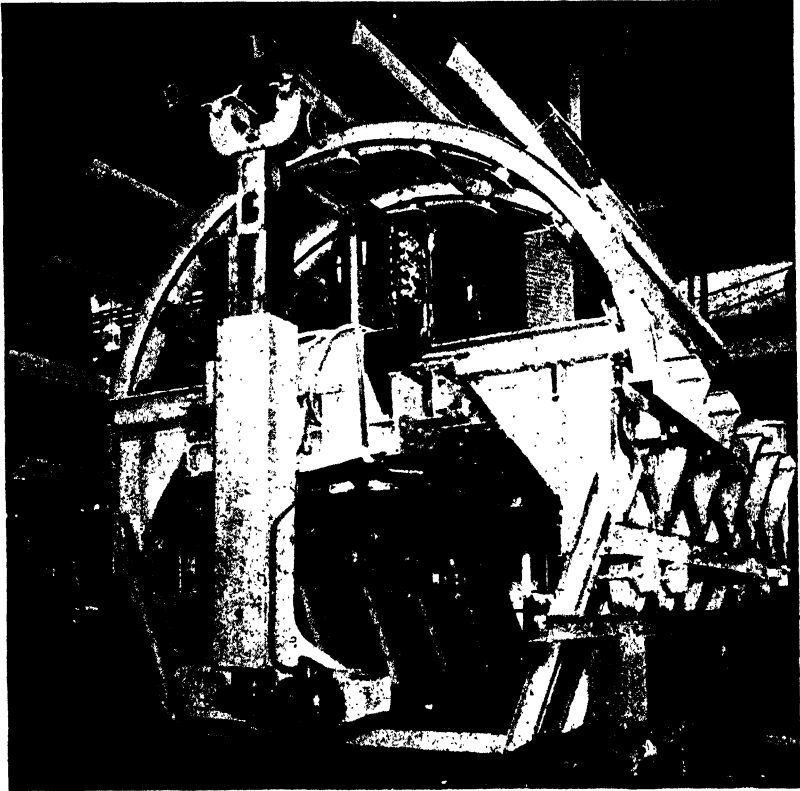

FIG. 239.—Electrically operated erector arm for placing concrete block lining in a shield tunnel. In contrast to the hydraulic erectors on cast-iron lined tunnels, this erector is mounted on a trailing jumbo. The fingers grip cored holes in the blocks. Above the erector arm are the sliding needle beams that hold the blocks in place as they are erected until the key has been placed and the ring is complete.

Each type of ground requires different technique in handling the shield; and, as the ground may vary from week to week, the system of driving must be flexible enough to meet all anticipated ground conditions. The following outlines methods which have proved to be successful for different types of ground and which have become more or less standardized.

Silt.—The bulkhead type shield is always used for tunneling through silt or liquid mud, Fig. 240. It is shoved directly into

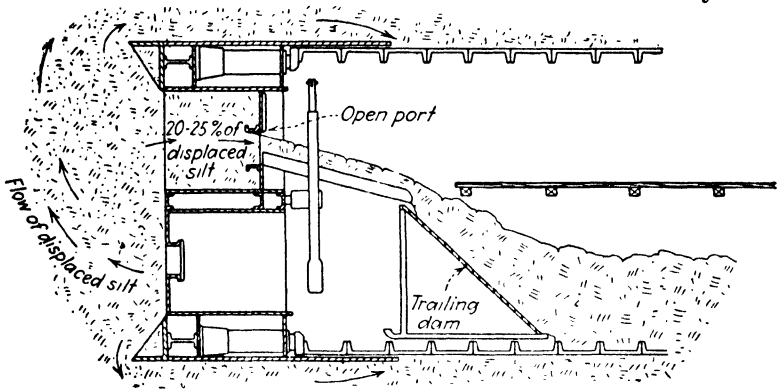

FIG. 240.—Operation of the shield in soft silt where only part of the displaced material is taken into the shield. This method was used on both tubes of the Lincoln Tunnel in New York. The silt brought into the tunnel was left as ballast until the tubes were holed through and the air pressure taken off.

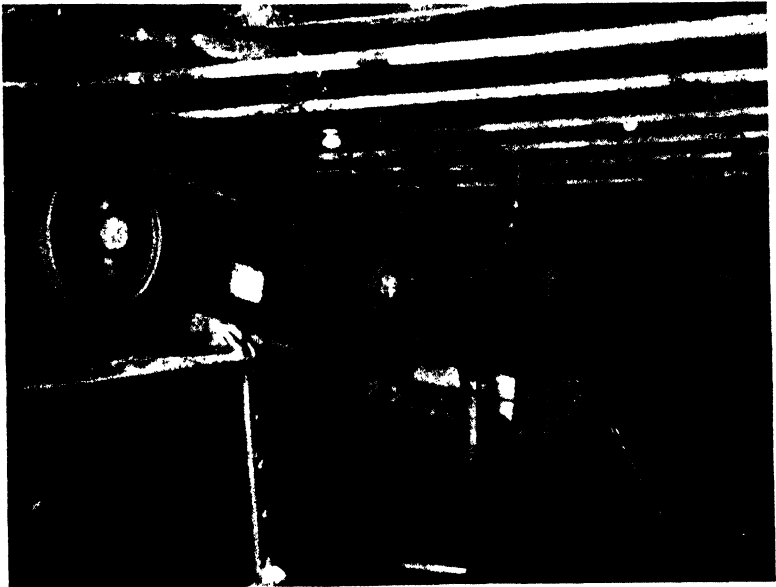

FIG. 241.—Removal of muck from a shield by belt conveyor. This method is popular when the shield is passing through fairly firm ground.

the ground, and muck is taken into the shield by opening one or more ports, generally the upper ones. Under the Hudson River,

it is customary to take in 20 to 25 per cent of the muck displaced, the rest being plowed aside. The muck taken in is thrown onto the bottom of the tunnel, where it remains as ballast to aid in checking any tendency of the tunnel to float.

Soft Clay.—Tunnels have been driven successfully through soft clay under city streets with a shield of the bulkhead type. Pressure sufficient to cause the clay to flow through a 2x2-ft. port is used against the face. As the clay flows into the tunnel, it is cut into chunks with a wire loop and thrown into muck cars.

Experience has shown that it is desirable to take in about 99 per cent of the displaced ground. Such operation of the shield may raise the surface of the street about $\frac{3}{4}$ in., but this has less effect on the adjacent buildings and utilities than a settlement of

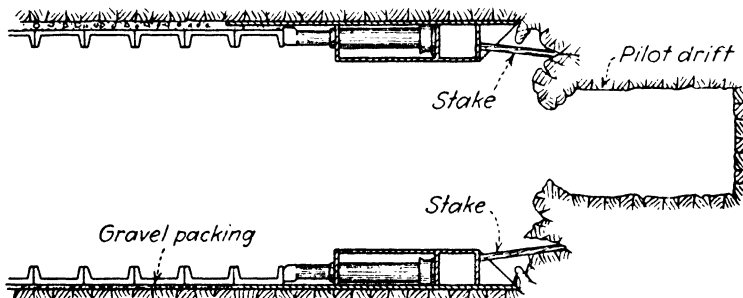

FIG. 242.—Operation of the shield in dry, swelling clay. (After Copperthwaite.)

the same amount. The excess pressure against the face will cause the clay to flow around the shield to fill the tail void, thus eliminating gravel packing. The quantity of clay admitted on each shove must be carefully measured, either by volume or by weight, for correct handling of the shield.

Dry Clay.—In dry clay, shale, cemented gravel or other self-supporting grounds, mining must be done ahead of the shield before the shove, leaving only enough ground so the cutting edge will trim the hole to a tight fit of the shield. The material is shoveled through the lower pockets onto a belt conveyor, Fig. 241, for loading.

In the dry, swelling clay of London, a method has been worked out to reduce mining to a minimum, Fig. 242. A small drift, just big enough for one miner to work in, is carried a few feet ahead of the shield at all times, one miner being employed in this drift except during the actual shove. When the shield is ready

to move, sharp-pointed stakes are set from the front frame of the shield against the remaining clay face. As the shield advances, the stakes break down this face into the drift ready for the muckers. Gravel packing must follow close behind the tail to fill the annular space before the ground has a chance to swell.

Numerous attempts have been made to mount a mechanical excavator on the front of a shield being driven through clay, this excavator to deliver the muck by belt conveyor directly into the car. In some instances, these have worked very successfully. Their principal drawback, besides mechanical breakdowns, is the inability to excavate all the various types and consistencies of

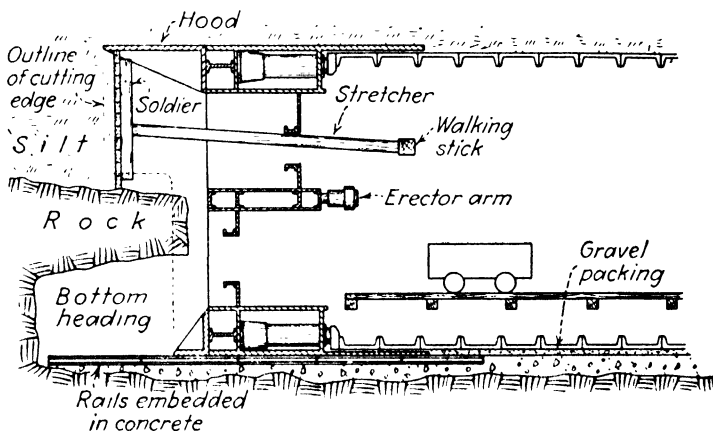

FIG. 243.—Operation of a hooded shield in a mixed face of silt and rock.

ground found even in short tunnels. When a nest of boulders is encountered, the machine is not only useless but is in the way of the miners.

Mixed Faces.—When passing from one type of ground to another, the miners will be confronted with a mixed face. An example of a silt-rock face is shown in Fig. 243. The shield for such ground should be of the hooded type; under protection of the hood, the miners can set the breasting about two rings ahead. The miners then pass through the lower ports and open up a bottom heading. In this heading are laid steel rails, carefully concreted to line and grade, on which the shield will travel. Of course the mining and rock blasting must be carried on very carefully to prevent a flood or blow of the face.

Sand or Gravel.—Certain kinds of sands may be tunneled by simply burying the nose of an open-type shield into the material until the sand lying on the floor and platforms has reached its angle of repose. As the shield is advanced, excess muck is shoveled out, care being taken that enough material remains on the platforms to prevent a run around the nose of the shield. This scheme presupposes a sand which will hold the air pressure

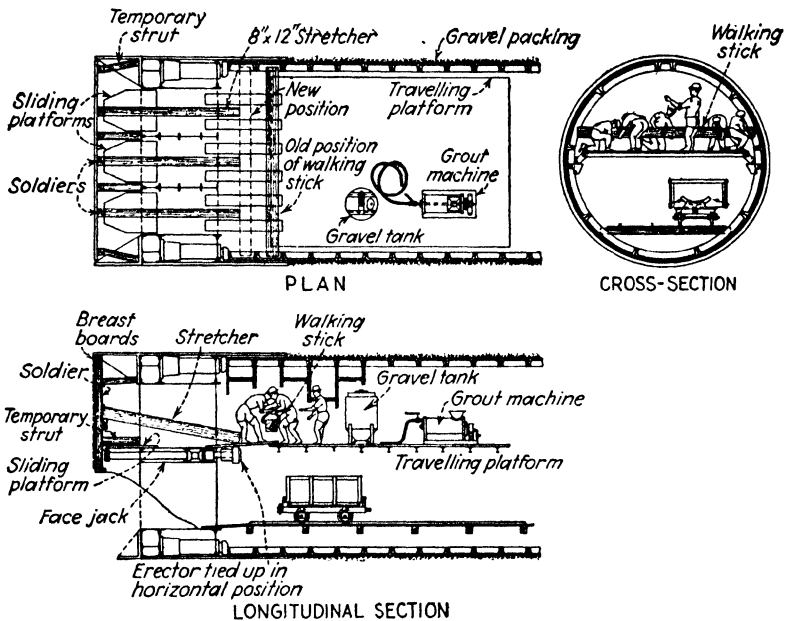

FIG. 244.—Operation of the shield in sand or gravel. The breasted face is held by both face jacks and stretchers. (Courtesy of Mason & Hanger Co.)

and which has a fairly steep angle of repose. A disadvantage of this method is that control of the shield is practically lost.

Most sand or gravel faces require breasting, Fig. 244, to retain the air; sometimes the breast-board joints must be plugged with wet clay to prevent loss of air. Under the protection of the hood, the miners advance the breast boards one at a time, holding them with temporary struts back to the shield. When the boards are all advanced to the new face, they are held by soldiers which are either braced back to a walking stick or held by the face jacks. The lower third of the face is rarely breasted, the ground being allowed to take its natural slope.

Grout or gravel packing must be placed in the tail space simultaneously with the shove, to prevent the ground from caving into the void.

Rock.—A shield is not required in a rock tunnel, but frequently subaqueous tunnels are started from a shaft in rock. Then the contractor has a chance to drive a few hundred feet of tunnel in

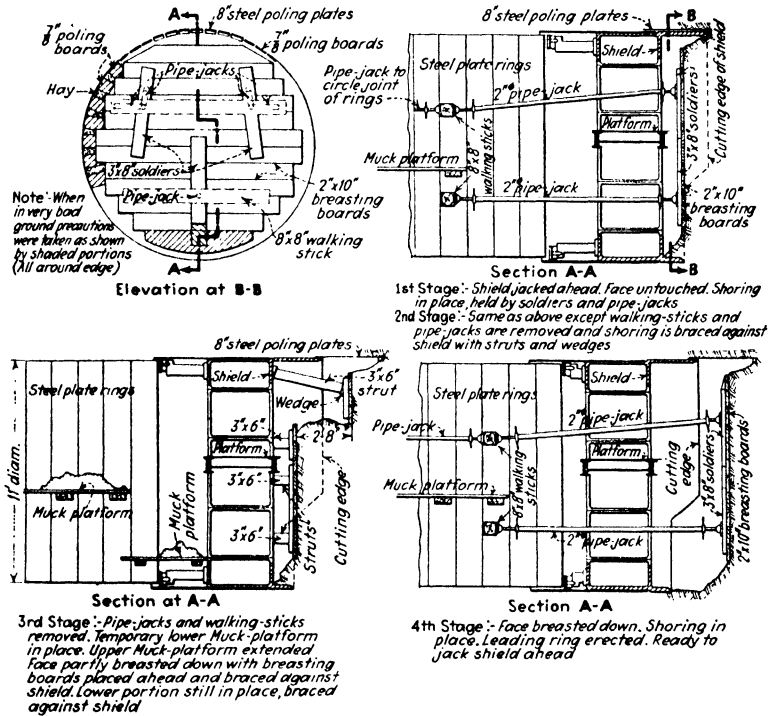

FIG. 245.—Step-by-step procedure in advancing the breasting in the 11-ft. shield-driven side drifts, Union Tunnel, Baltimore. Note the use of steel poling boards over the crown of the shield. Under protection of the poling boards the bulkhead was set far enough ahead to allow two 16-in. shoves, the width of two rings of plates.

which to assemble the shield and permanent air locks in free air. A concrete cradle is laid in rock tunnels for the shield to travel on; this cradle is at least a 90-deg. quadrant and sometimes is 180 deg.

Steering the Shield.—Steering the shield requires a good deal of skill and care. To correct the alignment of a shield, a "lead" is first established at the beginning of the shove. This is done

by placing pressure on only one group of jacks until the shield has kicked around to about the correct direction. The shield is then shoved in this new direction by using all jacks. The amount of steering possible depends upon the clearance between the lining and the inside of the tail, Fig. 246. A shield is said to be "iron-bound" when the tail is binding on opposite corners due to too much lead.

The operator can determine the amount of vertical lead required for moving the shield up or down by means of a plumb bob hanging on the frame. The side lead can best be detected

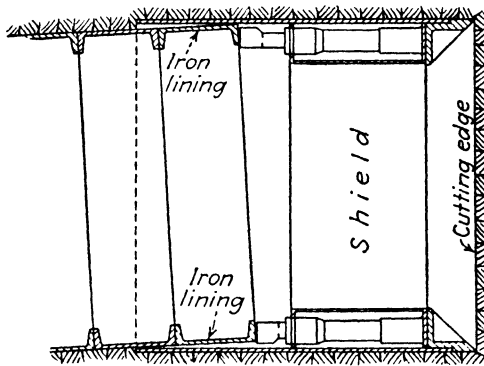

FIG. 246.—Diagrammatic illustration of how the shield can be steered. At start of the shove the jacks in one sector (in this case the top) can be pushed out first to start the shield in the direction desired. Then all jacks are pushed uniformly.

by "lead boards" which are carefully set by the engineers on each side of the tunnel. Tapes stretched from the lead boards to the side of the shield will indicate the horizontal lead, which should be watched carefully during every shove to prevent the shield from drifting off line. Lead boards should be placed not more than 50 ft. apart.

It is very difficult to drive a smooth curve with a shield. The minimum radius on the Hudson and Manhattan tunnels was 150 ft., but such curvature is most unusual. Usually the curves in shield tunnels are built to a radius of 600 to 800 ft. The primary lining on curves is made up with tapered rings. Sometimes every ring will be tapered, but it is a more common practice to install tapers in every second or fourth ring.

CHAPTER 16

THE PLENUM PROCESS

The plenum process, or compressed-air method, of driving tunnels through soft water-bearing ground is comparatively new. The principal of the diving bell, known for several centuries, had been used in the construction of foundations for bridges and lighthouses. Lord Cochrane took out a patent in 1830 for the use of air in subaqueous tunnels, but it was not until 1879 that compressed air was first used on a small tunnel at Antwerp. That same year Haskin started his railroad tunnels under the Hudson River, comprising two brick-lined tubes, each 21 ft. high and 20 ft. wide, outside dimensions. He used no shield; in fact, he did not even breast the face. The roof was supported by a lining of $\frac{1}{4}$ -in. plates until the masonry could be placed. In spite of several serious accidents, 1,500 ft. of one tunnel was driven before the work was suspended in 1883 because of financial difficulties and opposition of the railroads. Since that time, compressed air has been widely used on subaqueous tunnels and those through water-bearing soils. Usually air is used in conjunction with a shield, but numerous small tunnels have been driven using only liner plates or wood cants.

When the pressure does not exceed 15 lb. per sq. in., the plenum process is neither dangerous nor complicated. The authors believe compressed air could be profitably employed on many small jobs which are now driven only by good luck and bull strength without the use of air. When the required pressure exceeds 15 lb., the hours of labor and the length of shift are reduced, rapidly increasing the cost of driving.

AIR PRESSURE REQUIRED

Theoretically it requires 0.43 lb. per sq. in. air pressure to balance a head of 1 ft. of water. Thus, a tunnel with a 20 ft. head would theoretically require an air pressure of 8.6 lb. However, experience has shown that the actual pressure required to keep a

tunnel dry seldom follows the theoretical hydrostatic pressures. Therefore, tunnel men approximate the pressure by the following rule:

1 ft. head of water requires $\frac{1}{2}$ lb. of air.

In most grounds, the actual air pressure required to support the ground and satisfactorily dry out the face will be less than theoretical. This is because there is considerable resistance to the flow of water between the soil particles, which may enable the

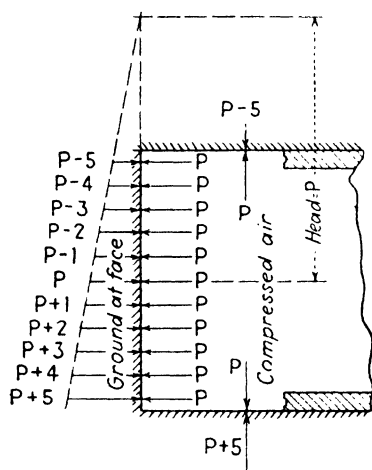

FIG. 247.—Unbalanced pressures at face of a compressed-air tunnel.

air pressure to be reduced 10 to 30 per cent, depending on the nature of the ground and the depth of cover.

In rare cases, an air pressure much greater than theoretical hydrostatic head may be necessary to keep the face dry, because of an impervious clay blanket overlying the water-bearing strata. Air escaping from the heading is trapped under the blanket and serves to increase the pressure on the water. Such a situation was met recently in Memphis by

keeping a number of well points in the floor of the heading, all connected with the blow line, providing an escape for the water and allowing the air pressure to be reduced considerably.

Unbalanced Pressures.—An unbalanced pressure exists on the face of the tunnel because of the difference in hydrostatic head at the top and bottom of the heading, Fig. 247. In large tunnels, the difference is quite considerable and sometimes causes trouble. For example, in a tunnel of 20 ft. diameter, with a hydrostatic head of 50 ft. on the crown, the head at the axis of the tunnel will be 60 ft., corresponding to a pressure of 25.8 lb. per sq. in. This means that there is an excess pressure at the crown of the tunnel of about 5 lb.; if the ground is at all pervious, there will be a continual loss of air at this point. At the same time, the pressure at the invert is 5 lb. too low, and water will flow into the tunnel under a head of about 10 ft.

In most tunnels this unbalanced pressure is not serious, but occasionally a tunnel must be driven through porous ground with very little cover; under such conditions it will be difficult to hold an air pressure equal to the head at the crown. Referring to the example in the previous paragraph, a pressure on the face equal to the head on the crown would be only 21.5 lb per sq. in., which means that at the bottom of the tunnel the air pressure would be 10 lb. too low and water would flow into the tunnel under a head of about 20 ft.

PLENUM PROCESS IN VARIOUS MATERIALS

Clay.—Clay is almost a perfect soil for tunneling by the plenum process. It is so nearly impervious that the pressure acts to support the ground, Fig. 248, and very little, sometimes no timbering is required to hold the ground until the permanent lining is placed. An unbalanced pressure on the face, whether high or low, rarely makes any difference in a tunnel driven through clay.

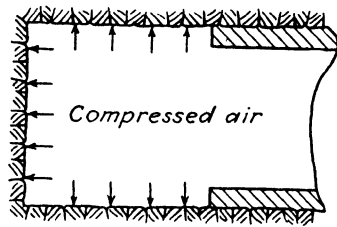

Fig. 248.—Action of compressed air in a clay tunnel.

Assuming a tunnel through blue clay (weighing 110 lb. per cu. ft.) with a cover of 30 ft. at the crown; then the maximum possible load will be 3,300 lb. per sq. ft. Thus, an air pressure of 23 lb. per sq. in. will theoretically support the clay. Actually, because of the natural arching of the ground, an air pressure of $\frac{1}{3}$ or $\frac{1}{2}$ of theoretical requirements, in conjunction with liner plates, will probably support the ground with a minimum of surface subsidence, provided concreting is done every 24 hr. Specifications for the construction of the Chicago Subway through blue clay required a minimum of 5 lb. of air, but most contractors are using 12 to 15 lb. Many clays are practically self-supporting for the length of time it takes to drive and concrete a section. A few pounds of air may eliminate need of timbering.

Silt.—Silt, or liquid mud, when first encountered and exposed to compressed air looks and acts like clay, Fig. 249. It will stand on a vertical face, and the roof will be self-supporting while it is trimmed and the liner plates placed.

However, silt is a pervious soil. Any excess of air pressure at the crown drives the water back into the voids, drying the silt until it cracks and finally sloughs off. At the same time, a deficiency of pressure at the bottom allows water to percolate through the ground, in fact, if there is too much differential in top and bottom pressure, the lower part of the face resumes its mudlike consistency and starts to flow.

Driving a tunnel through silt without a shield requires close watch to maintain an air pressure that will permit the maximum



FIG. 249.—Soft silt stands up like stiff clay when dried out by compressed air. This is a heading in the Lincoln Tunnel under the Hudson River.

progress with safety. Often it will be found desirable to vary the pressure several times a day to meet the requirement of the work in hand. A low pressure will be used while the arch is being mined, but once the arch liner plates are set, the upper part of the face bulkheaded and all joints well mudded to hold the air, the pressure is raised 5 or 10 lb. to dry up the silt in the bench and invert. This higher pressure will be held until the invert is excavated and plated or concreted.

Sand.—Water-bearing sand, or quicksand, is quite pervious. The air, instead of acting on the surface as in clay, penetrates a

certain distance into the sand until a point of equilibrium is reached, where it forms the surface of support, Fig. 250. The bulb of ground beneath or inside the air-supported material is all that theoretically need be held by the liner plates.

At the invert, the deficiency of air pressure will allow a flow of water into the tunnel. The lower part of the face must be tightly breasted with plenty of hay stuffed between the boards to prevent the sand running. A few well points jetted into the lower part of the face and connected to the blow line may work wonders in drying the bottom without increasing the air pressure.

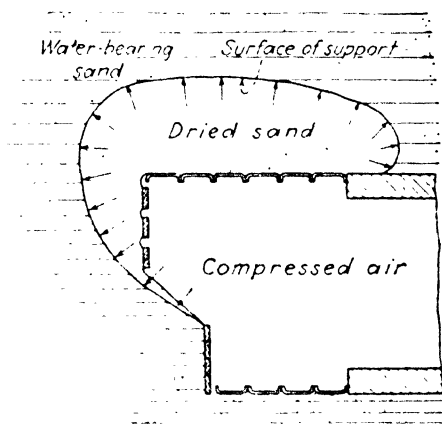

FIG. 250. —Action of compressed air in wet sand.

Most sands have some cohesion; when the water is forced out by air, the sand remains in a damp condition. This material will stand in a vertical face long enough to move the breast boards forward, and generally will be self-supporting until crown plates are set. Occasionally granular sands without any cohesion will be encountered. These will run whether wet or dry, and must be penetrated by forepoling methods.

Gravel.—Coarse water-bearing gravel (known as “ballast” in England) is about the worst ground for tunneling. Because there is practically no resistance to the escape of air, it is difficult to carry sufficient air pressure to work the crown. All that can be done is to use plenty of well-pugged clay, in addition to the breasting and liner plates, on the crown and face to retain the air. Only a small area may be attacked at one time.

HOLDING THE AIR

Air will escape from all tunnels except those in impervious clays, taking the path of the least resistance. Sometimes, in case of a mantle of clay overlying the water-bearing sand, the air will find its way to the surface along some well or bore hole several hundred feet away. This escaping air might damage

an old brick sewer but will seldom affect a tile sewer or other utilities.



FIG. 251.—Conserving air by mudding up the joints in pressed-steel liner plates in a wet sand tunnel. Chicago sewers.

The best way to conserve air in porous ground is to keep the concrete lining close to the heading. Where the ground is bad, most contractors organize to drive for two shifts and place concrete on the third shift. Sometimes the concrete lining follows one or two drives behind. Air may escape through porous concrete in the arch. Air leaks are often spotted by watching the flame of a candle, but this is a hazardous procedure and should be forbidden. A wash of neat cement

applied with a whitewash brush will generally stop air leaks through concrete.

Loss of air between the liner plates is prevented by "mudding the joints," Fig. 251. When clay of the proper consistency is not available, it may be obtained from the local brickyard and mixed to the correct plasticity in the pug mill. Silt is sometimes used for plastering the joints, but it dries and cracks after a short time and then must be replaced.

Building paper was used on a job through coarse black sand in Seattle to cut down the escape of air. As the roof was exposed, it was lagged with 1x12-in. boards. After an advance of 3 ft., these boards were covered with building paper held in place by a layer of lags 3 in. thick, which were, in turn, covered with paper. All joints were plastered with pugged clay.

BLOWS

Blows occur when the air opens a direct channel of escape to the surface. Instantly the pressure drops within the tunnel, and the atmosphere becomes so fogged that the lights are invisible a yard away. It takes cool-headed, experienced sand hogs to fight a blow.

The only way to fight a blow from within the tunnel is to throw anything—boards, tools, bags of hay or cement—into the vent until something lodges and checks the escape of air. Then the hole is plugged with clay. Meanwhile, at the surface, all reserve compressors are cut in to try to maintain the pressure. Many jobs have stop-log grooves several hundred feet back from the heading, with stop logs ready, so that an emergency bulkhead can be quickly built to save part of the tunnel if the worst happens.

Blows can be fought from the outside, on subaqueous work, only by dumping bargeloads of clay. On most big jobs, a loaded scow is kept ready for such an emergency. When the ground is bad and the cover shallow, a clay blanket should be dumped on the river bed ahead of the tunnel. That for the East River Tunnels of the Pennsylvania Railroad was 150 ft. wide and 12 ft. thick, and cost \$300,000.

Blows are hazardous in the extreme, and an ounce of prevention will be worth many tons of cure. Every man in the tunnel should be always on guard for the hissing sound which denotes an air leak. Several small leaks may suddenly unite to open a large hole to the river bed, which may then be difficult to plug. Blows are more serious in short tunnels than in long ones, for in a long tunnel a greater volume of air can escape before the pressure is dangerously lowered. When the pressure falls below a certain point, the lower breast boards will give way, flooding the tunnel with water, sand and silt.

Volume of Air Required.—The actual volume of air required in a tunnel to maintain the desired pressure depends entirely on the porosity of the soil and the number of passages of the lock. Many contractors use the following rule in estimating the probable number and size of compressors:

Provide 20 cu. ft. free air per min. for each sq. ft. of face area.

The amount of air lost with each passage of the locks can be readily calculated, and in small tunnels should be added to the total.

This rule assumes that a practically airtight lining is kept close to the face: in a liner-plate tunnel this will mean that the joints of the plates may have to be "mudded" until the concrete lining has been placed. If large quantities of air escape behind the tail of the shield, this opening must be temporarily calked with wood strips and burlap bags.

The Queens-Midtown Tunnel under the East River penetrated the worst ground through which a large shield had ever been driven. Compressor capacity was specified as 45,000 cu. ft. free air per min., at 50-lb. pressure, for two shields or 30 cu. ft. per sq. ft. of face. Specifications allowed 80 per cent of the "high air" compressors to be included in this total. At one time, the loss of air in one heading was so great that it was necessary to close down one shield and divert all the air, 46,700 cu. ft., to that heading in order to maintain pressure.

When sand or gravel ground is so porous that there is difficulty in maintaining the required pressure, the ground water might be lowered by means of well points or deep wells.

FIRE HAZARD

Fire is as hazardous in compressed-air tunnels as a blow and just as hard to control. Wet wood or hay will burn fiercely in the excess oxygen of compressed air. Smoking must be absolutely prohibited under air. Extraordinary precautions should be taken when an acetylene torch or welding outfit is used.

Inflammable materials taken into the tunnel should be kept to the absolute minimum. There should be several fire extinguishers always near the heading. Larger jobs will have a fire hose attached to the water line and coiled ready for use. All jobs large or small, should have a 2½-in. pipe through the concrete bulkhead at the shaft, equipped with *proper threads* for use of city firemen in case of a bad fire. As a last resort the air pressure may be removed and the tunnel allowed to flood.

PREDRAINING TUNNEL GROUND

Well Points.—The ground water may sometimes be lowered in tunnels through sand or gravel by well points. Drainage of

the ground by well points may reduce or even eliminate the need for compressed air. Some of the well points are driven into the face, others into the tunnel floor, Fig. 252. If the tunnel is being driven under air pressure, the well points are connected to

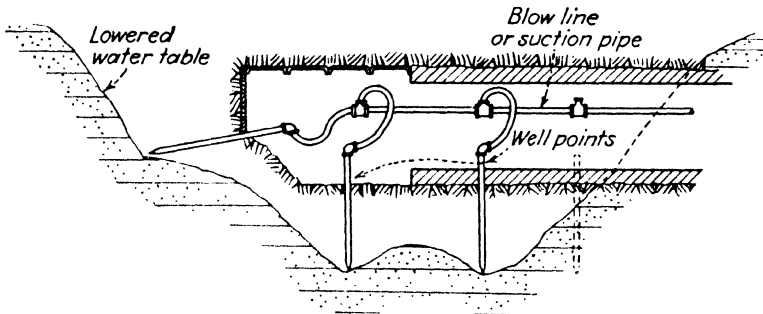

FIG. 252.—Draining ground at face of tunnel by well points driven from the heading.

the blow line; in free air they are hooked to the suction line of a self-priming pump.

Where the cover over the tunnel is not too great, well points can be driven down from the surface on each side of the heading at frequent intervals to predrain the soil in conventional manner.

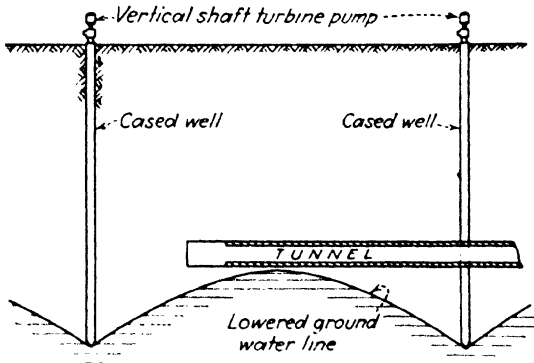

FIG. 253.—Draining ground around a tunnel by wells sunk from the surface.

Wells.—Certain soft-ground tunnels have been predrained by wells from the surface. These wells are generally of 10- or 12-in. casing in holes drilled about 10 ft. below grade, Fig. 253, the lower end of the casing being slotted and screened. Pumps are 6-in. vertical shaft turbine type, electrically operated. This

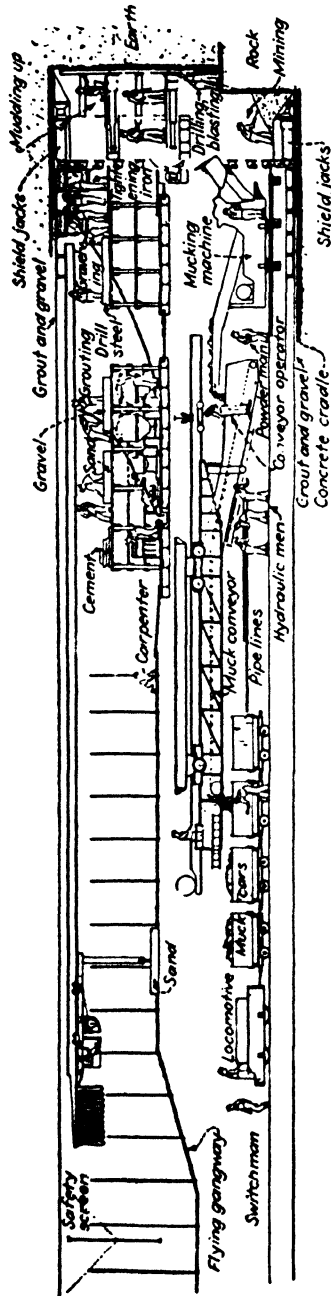

FIG. 254.—Sequence of shield-driving operations, Queens-Midtown Tunnel, New York.

method has proved successful in coarse sands or gravels where the volume of water is not too great, but it rarely works well in silt or sand-clay soils.

HOURS OF LABOR

Hours of labor in compressed air are strictly limited by law in most states. Where there are no local regulations, the insurance company will insist that the contractor follow usual practice. Table VII gives the working periods specified in the New York code.

TABLE VII.—SAFE WORKING TIME UNDER COMPRESSED AIR

Pressure	First work period, hours	Rest period in free air, hours	Second work period, hours	Total hours per day
Up to 18 lb.	4	$\frac{1}{2}$	4	8
18 to 26 lb.	3	1	3	6
26 to 33 lb.	2	2	2	4
33 to 38 lb.	$1\frac{1}{2}$	3	$1\frac{1}{2}$	3
38 to 43 lb.	1	4	1	2
43 to 48 lb.	$\frac{1}{2}$	6	$\frac{1}{2}$	1

Safe rates of decompression are as follows:

Up to 15 lb.: 3 lb. per min.

15 to 20 lb.: 2 lb. per min.

20 to 30 lb.: $1\frac{1}{2}$ lb. per min.

Over 30 lb.: 1 lb. per min.

Men in good health can be compressed at any practical rate. No one with a cold in the head should be allowed to enter the lock, since he is very liable to become "blocked." A block causes excruciating pain and delays the rest of the gang while the afflicted person is being locked out.

CHAPTER 17

AIR LOCKS

An air lock must be fitted in the mouth of every tunnel being driven by the plenum process. The lock is an airtight chamber with a door at each end, both doors opening toward the pressure. Through valves at each end the pressure within the lock may be equalized with that of the tunnel or with the normal atmosphere of the shaft. When the pressure in the lock is the same as that of the tunnel, the inner door can be opened and men or material can enter the lock from the tunnel. The inner door is then closed and the pressure within the lock reduced to zero (atmospheric). The outer door can then be opened allowing the men to go to the surface. Both doors of an air lock can never be open at the same time.

Tunnel locks may be either bolted or riveted. If they are to be dismantled and moved during the job, they are usually of bolted construction, made airtight by red-lead gaskets between the plates and lead washers under the bolts. An angle riveted to the outside of the shell anchors the lock securely in the concrete bulkhead.

Both doors open toward the heading; when closed, they are held tightly against a heavy gasket by air pressure. A "bull's-eye" or glass port, about 4-in. diameter, in each door provides visibility from both inside and outside the lock. Every lock must be well lighted and equipped with duplicate valves on each end to permit operation from either inside or outside.

GENERAL TYPES

There are several general types of lock according to the purpose for which they are used.

Materials Lock.—The material lock is used for passing cars and materials in or out of the tunnel. The size of the lock will be governed by the size of the door required to pass the muck cars; a door $3\frac{1}{2}$ ft. wide and $4\frac{1}{2}$ ft. high will require a 6-ft. diameter

lock; a door 4x5 ft. will require a 7-ft. lock; whereas a door 5 ft. 9 in. wide and 6½ ft. high is used in a 9-ft. diameter lock.

The length of the lock depends upon the number of cars to be passed through at one time or the longest timber or rail to be carried into the tunnel. As the outer door swings into the lock, the useful length of the lock will be 4 or 5 ft. less than the actual length. Muck locks are rarely less than 6 ft. in diameter and 25 ft. long.

The cars are pushed into the lock by one or two trammers, who then retire and close the door. The pressure is then equalized with that of the other end, the door is opened and the cars are pushed out by other men. If the cars are too heavy for two men to switch, a locomotive or a power winch must be used. In recent years, big jobs are using locks of 8 or 9 ft. diameter, and 75 to 80 ft. long. This allows an entire train, complete with locomotive, to pass through without switching.

The track is laid on a floor in the bottom of the lock, but the track section under the swing of the doors must be removable to permit the doors to close tightly against the sill. These removable sections should be light enough for one man to handle; when in place, they are held in pockets to prevent shifting.

At each end of the lock, on the outside, is a 4-in. or larger valve, for admitting or exhausting the air. Often a similar valve is provided on the inside of the lock at each end so the car pushers or the locomotive driver can operate the lock while passing through.

In small tunnels, there is room for only one lock, which must serve for both material and men. In this case the lock must be fitted with a set of 1-in. valves for decompressing the men at the legal rate. Single locks are very undesirable, especially when working at high pressures; for the lock will be tied up much of the time decompressing the gang, and no material can pass in or muck come out.

Man Locks.—Man locks, Fig. 255, are almost always of 6-ft. diameter, they are fitted with plank seats along both sides, and the length must be such that there is room, allowing 15 in. of seat per man, to take the entire gang including inspectors and survey crew. Doors on a man lock are generally 2½ ft. wide and 4 ft. high. They need be only wide enough to pass a stretcher.

During long decompressions, the lock becomes foggy and cold. Therefore, electric heaters should be installed under the seats to keep the men from becoming chilled. A concrete floor is preferred to a wooden one for cleanliness. The lock should be well lighted.

Valves of 1-in. diameter are provided for decompressing the men at the specified rate, grouped at the head end convenient to the lock tender. Larger valves are also placed at each end to permit the lock tender to lock in and out quickly when by himself. Through external valves at each end, the lock can "be sent through empty." A clock and pressure gage are essential for the lock tender to maintain the desired rate of decompression. A telephone is also a necessity.

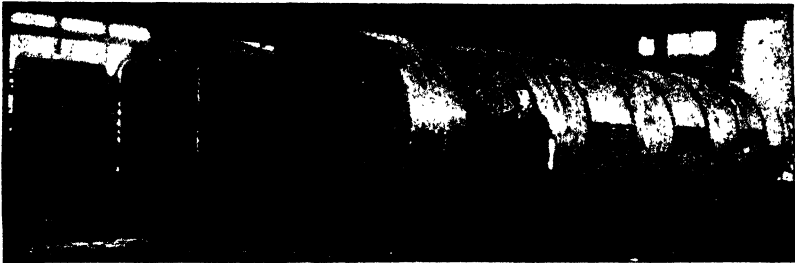
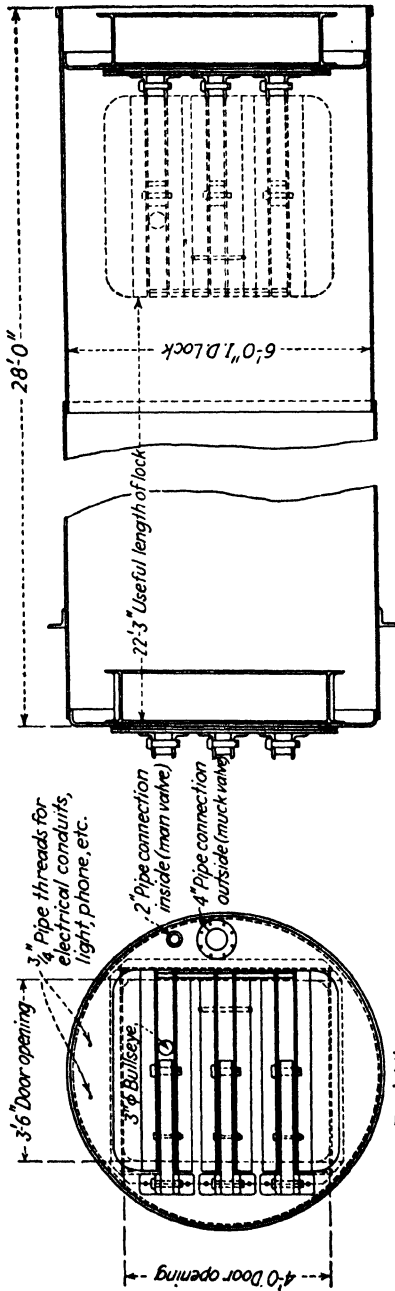

FIG. 255.—Pair of 6-ft. standard air locks. (Courtesy of Union Iron Works.)

The Lock Tender.—The lock tender is one of the key men on a compressed-air job and should be the coolest and most reliable man available. It is up to him to see that the men do not avoid the tedious decompression period by slipping out through the material lock or by opening the larger valves of the man lock.

When a blow threatens to flood the tunnel, the sand hogs fighting the trouble in the heading want to know that there is a reliable lock tender waiting with an open door and that the door will not be closed until the last man is accounted for. The lock tender should keep a record of the number of men in the tunnel.

Emergency Locks.—An extra lock for use only in emergencies should be provided whenever possible. In subaqueous tunnels, it is set high in the bulkhead, so as to be the last lock flooded. Generally these locks are 5 or 6 ft. in diameter, but occasionally, in smaller tunnels, an oval lock, $3\frac{1}{2} \times 4\frac{1}{2}$ ft. has been used. Emergency locks are equipped with both internal and external valves for operation from within or from either outside end. These



End View
(Opposite head the same)

FIG. 256.—Details of a standard 6-ft. air lock. (Courtesy of Lancaster Iron Works.)

locks are lighted but have no seats or heaters. The locks always stand with the door open to the high air ready for the escape of the men.

The emergency lock is also used by the engineers for carrying line into the tunnel. Therefore, it is desirable that the lock be on center line. When the survey party is using the lock, it is not available for escape. This can be avoided by adding a third door to the rear of the lock; the engineers can then do all their



FIG. 257.—Emergency escape lock in a Chicago sewer tunnel. The lock was connected to a manhole leading to the surface and was moved ahead every time a new manhole was opened up.

work between the middle and outer doors, the inner door always standing open to the tunnel. Otherwise, as a matter of safety, the material lock should be held open for emergencies when the emergency lock is in use by surveyors.

Escape Locks.—Escape locks differ from emergency locks in that they have an independent connection to the surface. In shallow tunnels, particularly sewers, the manholes are used for emergency exits. The simplest lock is two steel bulkheads embedded in the concrete lining of the manhole. In each bulkhead is an oval opening, at least 18x24 in., closed by a door

swinging downward, and valves on each side for admitting or exhausting the air. Such locks are of limited capacity, for the men must cling to the ladder rungs during decompression. The inner door must stand open at all times ready to receive the gang.

Escape locks of the horizontal type may be located in the tunnel, Fig. 257, or at the surface, Fig. 258. By all means these locks should be of the three-door type to enable rescue crews to enter from the outside in case of disaster. The locks and man-holes must be lighted at all times.

Medical Locks.—Recompression is the only known cure for caisson disease, or the "bends." Whenever the air pressure is likely to exceed 15 lb. per sq. in., a medical, or hospital, lock should be installed at the change house, kept ready for use.



FIG. 258.—Surface type of emergency escape lock, Chicago sewer tunnels. This is a three-door type of lock, permitting the rescue squad to enter from the outside or workmen to escape from the tunnel. It is connected to a manhole leading to the tunnel.

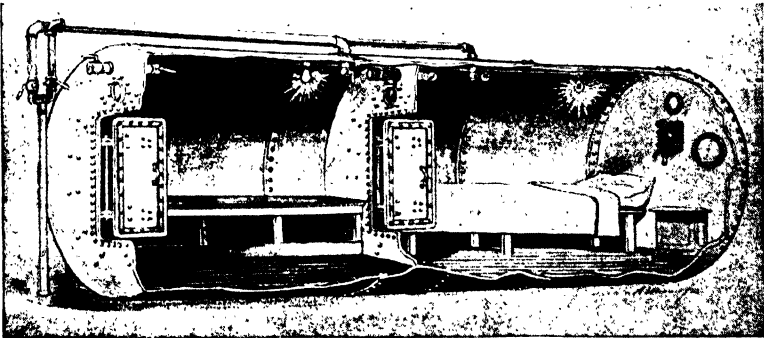

FIG. 259.—Diagram of a standard two-compartment medical lock. The patient is placed in the inner compartment for treatment; the doctor may lock in or out without changing the pressure in the inner compartment. Air to both compartments may be controlled from either inside or outside the lock. (Courtesy of New York Tunnel Authority.)

The standard medical lock is 6-ft. diameter, 18½ ft. long, Fig. 259. It may be of welded or riveted construction, since it never need be dismantled. The rear end is a standard dished tank head. A bulkhead at the other end, and another in the middle,

with doors, divide the lock into two compartments. All three diaphragms are fitted with bull's-eyes, and connections to each compartment for telephone, electric lights, air line and gages. Both compartments are fitted with bunks and electric heaters.

The patient is placed in the inner compartment, and the pressure is run up quickly to equal that at which the man last worked. The patient is then decompressed at about half the rate at which he left the tunnel. The outer chamber allows the doctor to enter or leave the lock without reducing the pressure on the patient.

All men should be instructed in the use of the medical lock. About 90 per cent of the bends are "rheumatic pains" in the elbows or knees, and the men should feel free to use the lock even for mild cases. Every compressed-air worker should wear a badge on his clothing saying: "This man is a compressed-air worker. If found unconscious *do not take to hospital!* Rush at once to Medical Lock at ——— (address given),"

VARIOUS DESIGNS

Bulkhead Locks.—The bulkhead type lock is sometimes used in small tunnels, Fig. 260. Two airtight steel bulkheads are fitted into the concrete lining the desired distance apart to form the lock. In each bulkhead is a door of the required size swinging against a rubber gasket. Most bulkheads of this type are bolted to an anchor ring about 12 in. wide, of which 9 in. is embedded in the concrete and 3 in. projects into the tunnel. The bulkhead is bolted to the projecting portion. When the lock is to be moved ahead, it can be unbolted readily from this ring and bolted to another one.

All the pipes and conduits required in the heading pass through flanges in the bulkheads. Generally this type of lock takes longer to operate and is more wasteful of air, since there is more "dead space." Single bulkheads are often set in tunnels as emergency doors to prevent flooding in case of blows.

Tee Locks.—Tee locks, Fig. 261, are rarely used except in very small tunnels approached by a "monkey drift." They may save the labor of one lock tender but are wasteful of air. Their big disadvantage is that the same pressure of air must be carried in both headings, which on many jobs is impossible.

Vertical Locks.—Vertical locks are designed for sinking caissons. Occasionally they will also be used for tunneling when

the ground is so bad that air pressure must be used when breaking away from the shaft. Muck is hoisted out through two vertical locks of the Mattson type. The bucket, raised by a small air hoist whose cable passes through a stuffing box at the top of the lock, is dumped through the side door of the lock onto a chute without unhooking the cable. The inner door is of the vertical swinging type.

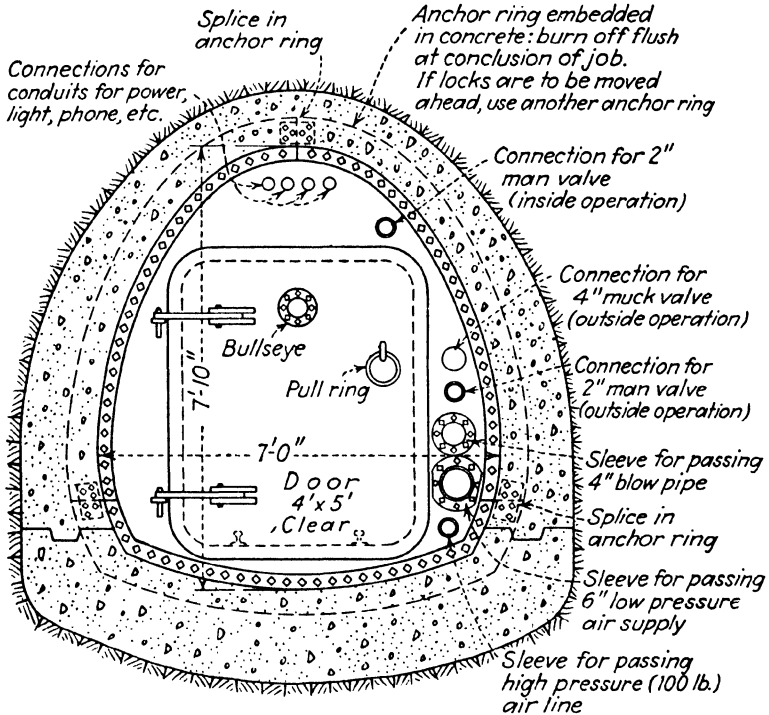

FIG. 260.—Bulkhead type of lock for small tunnels. Sleeves must be provided in the bulkhead for passing all pipes required in the tunnel.

When the caisson reaches grade, the working chamber is sealed with concrete. Then the air locks and bulkhead are removed and the shield and other equipment assembled in the caisson opposite the "eyes" through which they must pass. The bulkheads and vertical locks are replaced and tunneling commenced, all muck and men passing through these locks. After the tunnel has progressed about 200 ft., the concrete bulkhead and horizontal locks are installed in the tunnel itself. The

eaisson bulkhead and vertical locks can then be removed to allow the installation of cages. Tunneling is then resumed under more economical conditions.

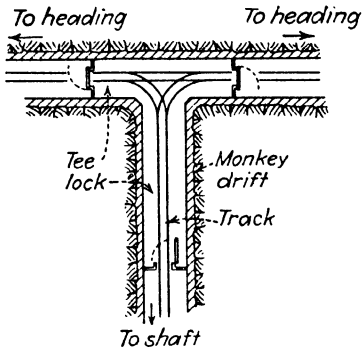

FIG. 261.—Diagram of a standard tee lock.

Concrete Locks.—Concrete locks are often used in shallow tunnels for dropping concrete directly into the cars, rather than locking the car through the main lock, Fig. 262. These are funnel-shaped tanks, set on the surface, with downward opening doors top and bottom. The bottom of the lock is connected with a large pipe which intercepts the tunnel.

Valves are arranged for outside operation. The gasket of the lower door must be so arranged that it will not be cut or fouled by the flowing concrete. A bell

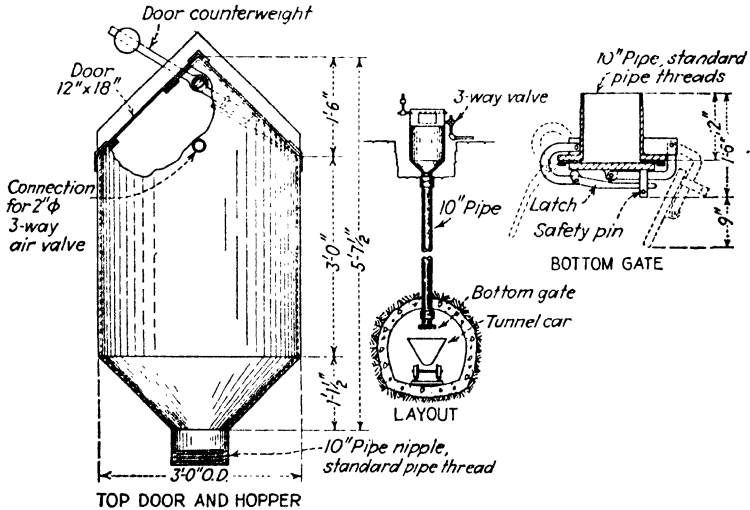

FIG. 262.—Concrete lock for passing concrete from the surface into a compressed air tunnel.

must be arranged so that the bottom man can signal to the top man.

OTHER COMPRESSED-AIR EQUIPMENT

Bulkhead.—The bulkhead is the airtight wall in which the air locks are embedded, Fig. 263. Generally they are of concrete, but steel bulkheads have been used occasionally. The bulkhead must resist a tremendous pressure. For example, a 20-ft.-diameter bulkhead, under a pressure of 30 lb. per sq. in. on an area of 314 sq. ft., must be designed to resist a total pressure of

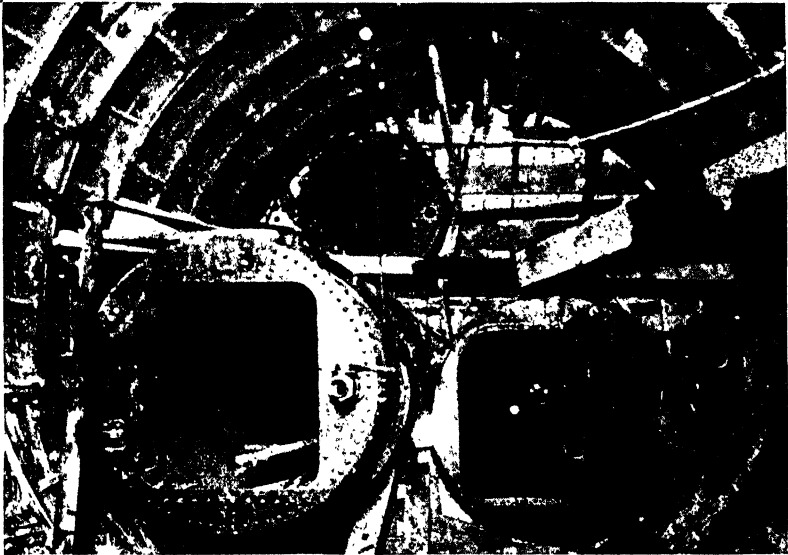

FIG. 263.—Concrete bulkhead being built in a cast-iron lined tunnel. The locks are set in place, and the bulkhead, usually 10 ft. thick, is built around them. The contact between concrete and iron lining is later grouted for airtightness.

1,356,480 lb., or 678 tons. Not only must the bulkhead be structurally designed to resist this pressure, but it also must be well keyed into the lining to prevent slipping. The lining must be checked to see that there is no danger of pulling apart under this load.

Concrete bulkheads, according to Hewett and Johannesson, should have a thickness equal to 0.4 or 0.5 of the tunnel diameter. Because of this great thickness in proportion to their length, they should be considered as a dome rather than a beam. The concrete bulkheads of the Holland and Lincoln Tunnels were 10 ft. thick, or approximately one-third the tunnel diameter.

Locks are generally set in the bulkhead with their inner end flush with the pressure side of the wall and the body of the lock projecting into the free-air side. Thus the lock need only be designed for inside pressures. If the locks project on the pressure side, they are subject to crushing and require heavy stiffening frames. Wide platforms and ramps on both sides of the bulkhead are required for easy access to the upper locks.

Piping.—Provisions must be made for passing all pipes and conduits through the bulkhead. If some pipe is forgotten, it is practically impossible to put it in later. These lines will be:

- Low-pressure air supply.
- High-pressure air supply.
- Blowpipe, or exhaust line.
- Water supply.
- Pump discharge line.
- Hydraulic fluid supply.
- Emergency fire pipe (for use of city firemen).
- Safety valve exhaust.
- Low and high-pressure alarm.
- Pressure gages.
- Telephone conduits.
- Electric light conduits, 110 volt.
- Power conduit, 220 volt, a.c.
- Trolley conduit, 220 volt d.c.
- Conduits for recording instruments, etc.

It is a simple matter to embed some extra pipes, properly threaded and capped, in the bulkhead during construction as spares. One of these spares should be of the same diameter as the low-pressure air supply.

Low-pressure Air Line.—The low-pressure air supply will be 6-, 8- or 10-in. diameter as required to supply the probable volume of air with a minimum friction loss. It is better practice to use two lines, say two 8-in. pipes instead of one 10-in., for then there would be an opportunity of maintaining pressure should an accident occur to one line. The low-pressure pipe may terminate just inside the bulkhead, but should be equipped with a flap valve on the discharge end; then, if the pipe breaks, all the tunnel air will not blow out through the broken pipe.

A pop valve or a high-and-low-pressure alarm through the bulkhead will give warning of variations of tunnel pressure. Lack of such an alarm nearly caused trouble on a Detroit tunnel where the contractor used a pneumatic concrete placer. The

first day of concreting, the pressure in the tunnel built up 50 per cent before anyone realized it. The same thing could happen if a high-pressure air line burst.

Incidentally, if a pressure of 100 lb. per sq. in. is required at the heading to operate the pneumatic tools, and the plenum pressure is 30 lb., then the high-pressure compressor must be set at about 135 lb.

Blow Line.—The blow line, or exhaust pipe, is peculiar to compressed-air tunnels and has a number of important uses. This pipe, generally of 4-in. diameter, runs from the heading to the sump at the shaft. At the heading end it is fitted with a stopcock and about 20 ft. of flexible suction hose.

In tunnels which are not losing much air, the blowpipe is kept open to exhaust the foul air from the heading. In case of blasting, it is always opened just before each shot to remove the powder fumes quickly. When water collects on the floor of the tunnel or in the tail of the shield, the hose is used to blow the water out to the shaft. The blowpipe will also handle liquid silt in small quantities. In caissons, the same principle is used for removing sand, but this is not considered economical in tunnels, as there is not only a great loss of air but considerable wear on the pipe. The discharge end of the pipe should always point downward into the sump to prevent injuries by flying gravel or sand. Workmen should be warned to keep clear of the blow-line intake, for several serious accidents have been caused by loose clothing being sucked into the pipe.

Safety Screen.—Subaqueous tunnels through bad ground are liable to serious blows which will quickly flood the tunnel. The safety screen, Fig. 264, is designed to retain part of the air in the tunnel to make possible escape of the heading crew in case of such a disaster and to prevent the upper locks from being flooded. The screen makes regaining the face after a flood much easier.

As the safety screen extends down to the spring line of the tunnel, the smallest tunnel on which it can be used is about 12-ft. diameter. Theoretically, it need not resist much pressure, but it must be airtight and should be kept not more than 150 ft. from the heading.

The flying gangway or hanging walkway is used between the screen and the locks; the floor should be above the bottom edge

of the screen. This walkway is an economical investment, and the men should be required to use it all the time. It saves flooring the ties on the haulage level and eliminates the danger of men being struck by material trains.

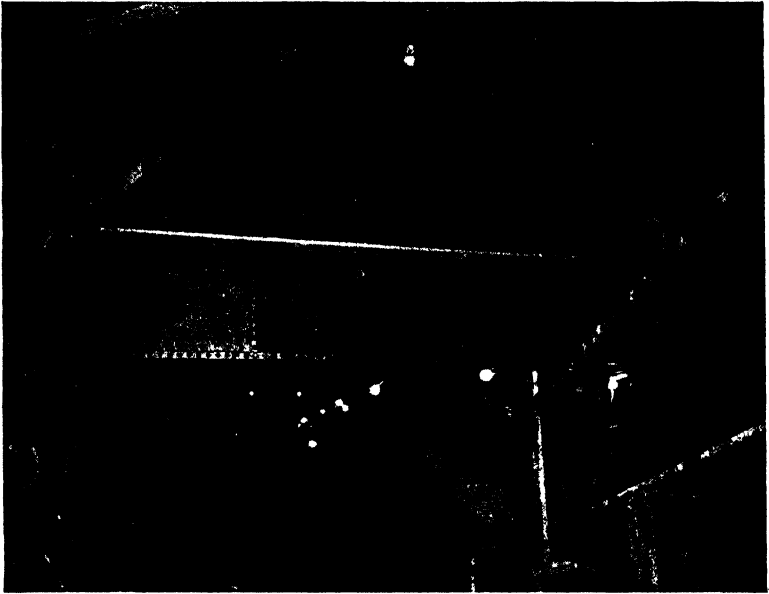

FIG. 264.—Safety screen in a compressed-air subway tunnel under East River in New York. In case the tunnel is suddenly flooded the screens will trap air in the top of the tunnel and give the men a chance to escape. Note the flying gangway, used as both a regular and emergency walkway.

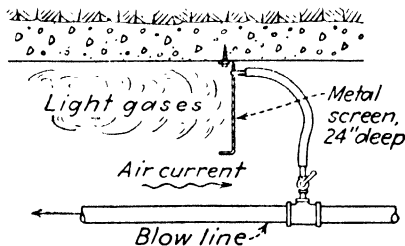

FIG. 265.—Trap for removing dangerous gases from a compressed-air tunnel.

Gas Traps.—Certain soils, particularly clays, give off considerable amounts of explosive or poisonous gases. These may seep into the tunnel through the joints of the primary lining or even through porous concrete of the secondary lining. Most of

these gases are lighter than air and will collect at the roof of the tunnel, where they remain as a constant source of danger.

In compressed-air tunnels, the gases may be promptly removed by an occasional trap set in the roof of the tunnel in the gassy zone, Fig. 265. These traps may be of 20-gage iron, at the top of which is a nipple for attaching a $\frac{3}{4}$ -in. hose connected to a valve in the blow line. This valve need only be cracked open enough to remove the probable volume of dangerous gas.

CHAPTER 18

TUNNELING IN ROCK

There are several methods of driving tunnels in rock. The method of attack depends upon several factors, such as ground conditions, equipment available, extent of timbering required and the scheme of mucking. Often the general method will change with variations in ground or because of other conditions. Following are briefly described the main variations in hard-rock methods.

FULL-FACE ATTACK

Small Tunnels.—Small tunnels are always driven full face. Drilling is usually from vertical columns, Fig. 266, set up after

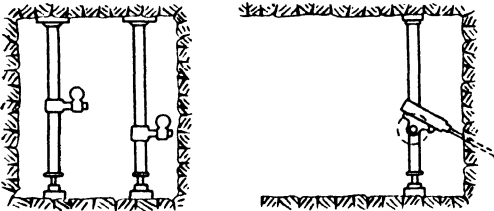

FIG. 266.—Full-face attack from vertical drill columns.

the muck from the last round has been cleaned out. Where vertical columns only are used, miners and muckers alternate in the heading.

If the tunnel is 8 to 10 ft. high, drilling is often from a horizontal bar, as shown in Fig. 267. Immediately after the blast, the miners return to the heading and set up the drill bar near the top of the tunnel, from which they drill the upper set of holes, standing on the muck pile. Meanwhile, the muckers have started cleaning up and, if operations are properly scheduled, by the time the miners get through with the upper set of holes the muck pile will have been removed and the bar can be set up in a second position. This scheme is particularly useful when mucking is done by hand, since the miners can start drilling

without waiting for the cleaning up of the tunnel. Both these schemes are limited to tunnels about 10x10 ft.; in larger tunnels the drill column or the drill bar is too heavy to handle.

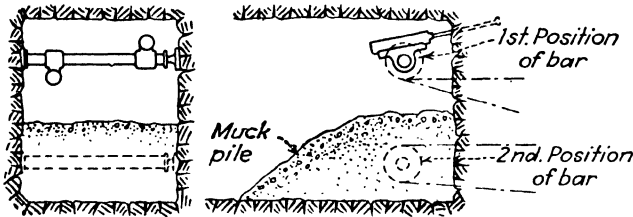

FIG. 267.—Full-face attack from horizontal drill bars.

Large Tunnels.—Formerly the full-face method of attack was reserved for small-size tunnels, but, with improvements and



FIG. 268.—Full-face tunneling, Gila Canal project, Arizona. The drill carriage, running on the muck track, also makes an efficient timbering scaffold car. (U.S. Bureau Reclamation Photograph.)

developments in tunneling equipment, more and more large tunnels are now being driven by this method. The 92 miles of

tunnels on the Colorado River Aqueduct were driven by full-face methods, and the Delaware Aqueduct tunnels are now being driven full face. Economical driving of large tunnels by the full-face method was made possible by the development of the drill carriage or jumbo, Fig. 268. A battery of drills is mounted on the front end of the jumbo, permitting drilling of a large section of the face at one time, and saving the time formerly required in setting up and removing drill columns and bars. The jumbos are equipped with folding side platforms for clearing the mucking machine when being moved to and from the face and to allow storage of the drill carriage on a side track.

In bad ground, the jumbo serves as working platforms for placing of top timbering, Fig. 268.

HEADING AND BENCH

The heading-and-bench system is an American method of hard-rock tunneling largely developed in driving railroad tunnels.



Fig. 269.—Heading-and-bench system. The bench is being drilled with hand sinker drills from the floor of the top heading.

It is being rapidly superseded by the full-face method on medium-size tunnels but is still popular on large tunnels.

As shown in Fig. 269, the top heading is usually carried 8 or 10 ft. (the length of one round) ahead of the bench. The holes for the top heading are drilled from vertical columns set up on the bench. Holes in the bench are usually down-drilled with jackhammers, provided that there is headroom for changing steel; otherwise the bench must be drilled from a horizontal bar after the muck pile has been cleaned up, Figs. 270 and 294.

All holes are loaded together, but the bench is fired an instant before the top heading holes. If the heading holes are properly loaded, most of the muck will be thrown off the bench back to the

floor of the tunnel. As soon as the air is clear, the gang cleans up the bench by hand, and then sets up the drill columns. While the heading is being drilled, the mucking machine starts to work on the muck pile. Down holes in the bench may also be drilled while the mucking machine is working.

The heading-and-bench system has this advantage of simultaneous drilling and mucking and also requires less powder than the full-face system.



FIG. 270.—Heading-and-bench system. The bench is being drilled with drifters mounted on bars and curved columns.

Top Heading.—When bad ground is encountered, the heading-and-bench system may be modified to work a longer top heading, Fig. 271. The heading is advanced 50 to 75 ft. ahead of the bench. Roof timbers, set by the heading crew, are temporarily blocked up from the bench.

The bench crew excavates the bench in short advances, placing the plumb posts one at a time to pick up the arch timbers. If there is much of a load on the arch timbering, the wall plate must be underpinned during bench excavation operations until the permanent plumb posts can be set.

If the bad ground is in short stretches, muck from the heading is loaded by hand and dumped over the bench within reach of the mucking machine. For haulage in such cases, it is common practice to use a low car, similar to those used in coal mines, with

a cantilever dump as shown in Fig. 272. The cantilever dump throws the muck clear of the men drilling the bench. However, if a long stretch of bad ground is anticipated, a small mucking machine might be placed in the top heading for loading and a dinkey used for hauling the cars back and forth from face of heading to face of bench.

A clever scheme for holding the top timbering in position while excavating the bench and setting plumb posts in bad ground was developed by the late George Lewis on the Moffat Tunnel. He designed and patented the Lewis Cantilever Girder, consisting of two plate girders, about 75 ft. long, framed about 6 ft. apart, carrying a belt conveyor and equipped with numerous outriggers and jacks. The girder was placed in the top heading, riding on a track on the

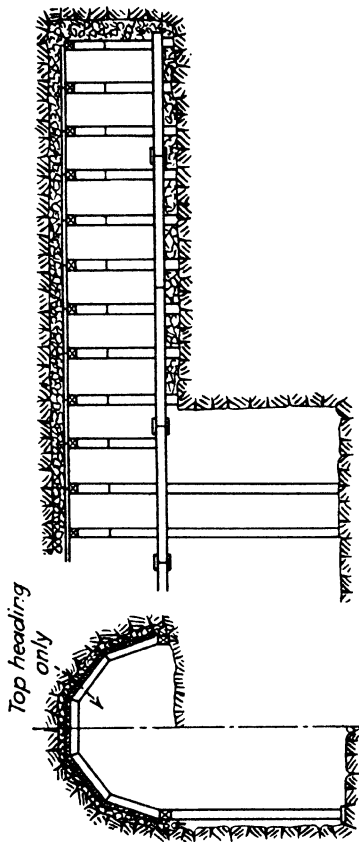

Fig. 271.—Top-heading method in bad ground.

heading floor. The rear end of the girder projected back into the full section of tunnel beyond the face of the bench. The front end of the girder was blocked down from top of heading; the middle was blocked up from floor of heading just ahead of the point to which the bench was to be advanced on the next round. Top timbering along the back part of the girder was blocked up from outriggers attached to the lower part of the girder assembly; the outriggers then supported the arch timbers

while the bench was drilled, shot and mucked out and the plumb posts installed under the wall plates in the full section of tunnel. The top heading was then advanced, the muck being loaded onto the belt conveyor and discharged at the rear end of the girder onto the tunnel floor for loading by the mucking shovel. The girder was then moved ahead on its rails and the cycle repeated.

Bottom Heading.—The bottom heading method of attack is seldom used. In this system, a heading, full width of tunnel and about 8 ft. high, is driven first in the lower section of the tunnel. The ground over the heading is then shot down. The

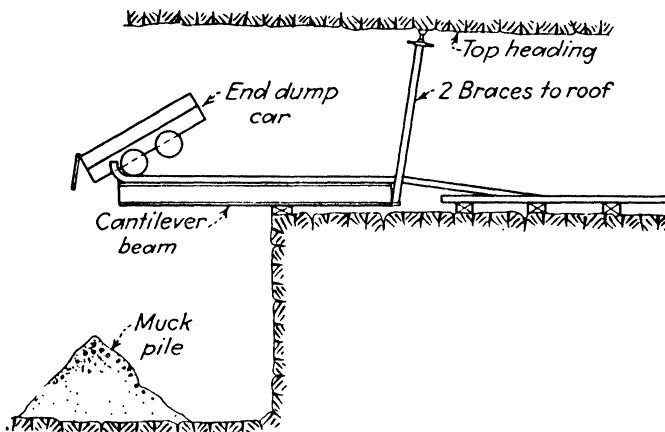

FIG. 272.—Cantilever car dump in heading-and-bench system.

main disadvantage of the system is blocking of the heading by muck shot down from the roof. Also, there is no chance to set the permanent timbering until the heading has been raised to full height of tunnel. In this method of tunneling, timber placing may be an awkward and hazardous operation.

DRIFTS

Center Drift.—Many railroad and other large tunnels have been driven from a center drift. The center drift, generally 10x10 ft., is first driven through from portal to portal. When the driving of the center drift is completed, or when some other exit for the muck from the heading has been reached, the enlargement is started. Figure 273 illustrates this method. Holes for the enlargement are ring drilled with a drill set up on the axis of the tunnel; the rings are usually 4 ft. apart. The ring drillers

work with a simple clinometer, or "sunflower," which spots the holes to the correct angles. Of course, the center drift must be large enough to permit changing the longest steel. The ring drilling is kept 50 to 75 ft. ahead of blasting and mucking opera-

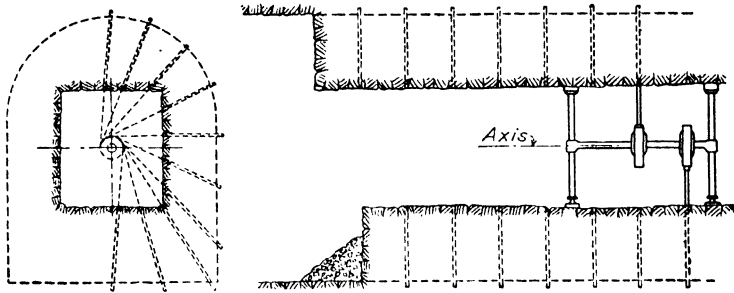

FIG. 273.—Ring drilling for enlargement to full size from a center drift.

tions. In the Cascade Tunnel, driven by this method, 29 radial holes were drilled for each ring.

The center-drift system is economical of powder and provides good ventilation. Its disadvantage is that the enlargement cannot be started until after the center drift is holed through; otherwise there is too much interference between the ring drillers and the muck trains from the heading. Another disadvantage is that the ring drillers are working to a standard drill pattern and, in working far ahead of blasting, often have a large number of holes drilled to this pattern when it is discovered that ground conditions require a change in ring spacing.

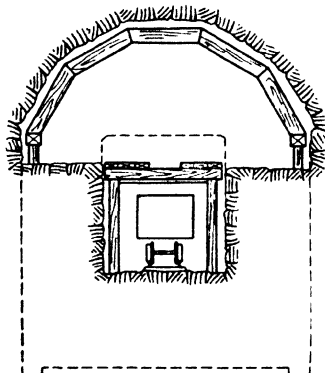

FIG. 274.—Center drift in bad ground, followed by top heading enlargement.

Center Drift in Bad Ground.—If bad ground is encountered with the center-drift method, a raise or breakup is made from top of drift to top of arch, in which the arch timbers are set, as shown in Fig. 274. After drilling for the breakup, but before shooting, the roof of the center drift is usually decked over to provide a platform on which the muck is caught. From this deck, the muck can easily be trapped into cars on the drift floor. The

arch timbers are then set, being temporarily supported by blocking up from the floor. As the bench is removed later, the wall plates are underpinned until the plumb posts can be set. As the

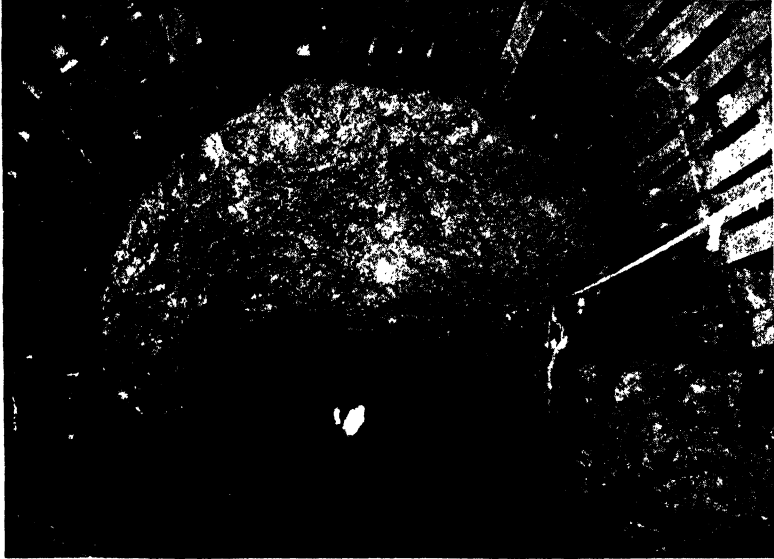

FIG. 275.—Breakup from center drift to set arch timbers.

necessary breakups can be made in advance at any number of places along the center drift, Fig. 275, all spots requiring such treatment can be ready by the time the enlarging crew reaches them.

Side Drift.—The side-drift method is occasionally used in large tunnels in bad ground, Fig. 276. Two drifts are advanced along the sides of the tunnel and in these drifts are set up the permanent plumb posts and wall plates. Breakups are then made

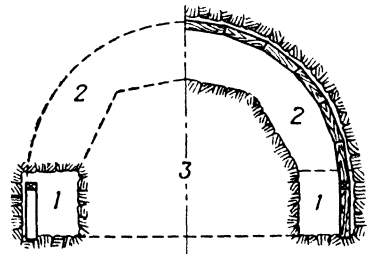

FIG. 276.—Sequence of excavation in side-drift method of tunneling.

into the arch, and the permanent timbering is erected to support the roof, which leaves a center core to be removed after the tunnel is completely timbered. The core provides a working floor, conveniently close to the roof, from which the timbering

can be placed. Temporary braces to hold the roof can be set against this core until the permanent timbering is in. On some jobs the concrete lining has been placed before the core was removed.

Drifting for Wall Plates.—Drifting for wall plates is sometimes resorted to in the top heading method in extremely treacherous ground, Fig. 277. Drifts are driven on each side, as small



FIG. 277.—Side drifting for wall plates in very bad ground. Note that the arch timbers are carried tight against the face. (Courtesy of E. G. Rice, Chesapeake & Ohio Railway.)

as possible, and the wall plates are laid and set in them. Then, as the face is shot down, the arch timbers can be erected, one ring at a time. This is, of course, a slow and expensive method of advance; but the arch timbering can be kept tight against the face to protect the workmen.

PILOT TUNNEL METHOD

Long railroad tunnels have sometimes been driven by means of the pilot tunnel, Fig. 278. The pilot tunnel, of minimum cross section, generally 8x8 ft., is driven parallel to and about 75 ft. away from the main tunnel. Meanwhile, a center drift is being driven from the portal on the line of the main tunnel. At

intervals of $\frac{1}{4}$ mile or so, a crosscut is driven from the pilot tunnel to intersect the line of the main tunnel. From the end of every crosscut, two crews can then start driving the center drifts of the main tunnel, the muck being hauled out through the pilot tunnel. Once the center drift is holed through, either between the portal and the first crosscut, or between any other two crosscuts, enlargement by ring drilling can be started, as shown in Fig. 273. Any time bad ground is encountered in the center drift which requires timbering, a breakup can be made as shown in Fig. 275,

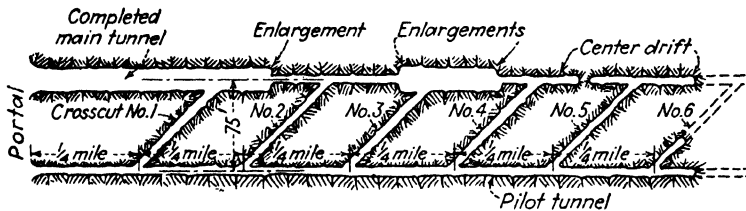

FIG. 278.—Pilot tunnel method of driving.

and the timber will be in place by the time the enlargement crew reaches the point.

While this system necessitates the driving of two tunnels, it permits a great number of operations to be carried on at different points, thus speeding up the completion of the job. Once the center drift is holed through, the pilot method lends itself to efficient ventilation, as air can be brought in through the pilot tunnel and sent out through the main tunnel. Moffat, Rogers Pass and Cascade Tunnels are notable examples of the pilot tunnel method.

ENLARGING OLD TUNNELS

The enlargement of an old tunnel requires great patience and skill. If old timbering or masonry must be removed, the work becomes extremely hazardous, as the removal of support may bring down a cascade of old dry packing. When traffic must be maintained, the problem becomes much more complicated.

Larger locomotives and cars, electrification and faster schedules have made some of the older railroad tunnels inadequate in size. In the last few years, numerous old tunnels have been enlarged, and many more will be tackled in the near future.

Probably the best way to obtain additional tunnel capacity is to drive a new tunnel parallel to the old one. Then all traffic can be diverted to the new one while the old one is being enlarged.

One method of enlarging a short double-track tunnel under traffic was to use a steel gantry spanning the tracks, erected at the portal, which served for both drilling and erecting the temporary supports. Small sections of roof were shot down between trains and the muck allowed to fall onto planks laid on the main line.



FIG. 279.—Double-tracking an old tunnel under traffic, Chesapeake & Ohio Railway. The traveling shield extended into the old single-track tunnel, protecting trains from the enlarging operations. (Courtesy of E. G. Rice, Chesapeake & Ohio Railway.)

This was hand-mucked into low cars, running in the drainage ditch, one on each side, and trammed out to the far end. Progress on this job was about 12 ft. per week.

Double-tracking an Old Tunnel.—Enlarging an unlined single-track tunnel to double-track size was done on one occasion by using a traveling shield over the track, Fig. 279. This shield, 60 ft. long, consisted of a steel frame to which wood lagging was bolted, straddling the main line track. Once a week it was run ahead and firmly braced to withstand blasting. With the main line thus protected, the contractor was delayed but little by

trains. There was sufficient clearance on the side to use a tunnel shovel for mucking.

Enlarging a Lined Tunnel.—To enlarge a tunnel lined with masonry or timber under traffic is a slow and tedious operation. Figure 280 illustrates one such operation. Muck was moved to the portals in wheelbarrows. The bad ground required drifting for the wall plates. After all the roof timbers had been set, a traveling falsework was placed under a section of the old masonry, which was then broken up and wheeled to the portal. Had the



FIG. 280.—Enlarging an old double-track tunnel, Chesapeake & Ohio Railway, by enlarging around the original masonry lining. Muck from the top section was wheeled to the portals over the old masonry arch. Wall plates were set in side drifts. (Courtesy of E. G. Rice, Chesapeake & Ohio Railway.)

railroad been able to abandon one track or to operate on a gauntlet track, the job would have been simplified in that, instead of wheeling all the muck to the portal, it could have been shoveled directly into the muck cars through holes knocked in the old lining.

Daylighting an Old Tunnel.—Short, shallow tunnels are often “daylighted” rather than enlarged. The overburden is cut away in alternate steps Fig. 281, until the crown of the tunnel is uncovered. Blasting must be done carefully and lightly, and after each shot the tunnel should be inspected for rock falls and any loose rock scaled down. The contractor should have avail-

able a number of push cars to run into the tunnel to clean up possible falls.

If the tunnel is supported by an old masonry arch, it may be necessary to build an inside falsework to prevent the masonry from cracking and falling. This falsework is generally of 4-in. H-beams or old rails bent to shape and jointed at the center. Lagging, widely spaced, is laid longitudinally over the ribs and wedged tightly from the rib to support the old masonry.

Once the overburden is removed, the old masonry is broken out by hand and the falsework removed. If there is no masonry

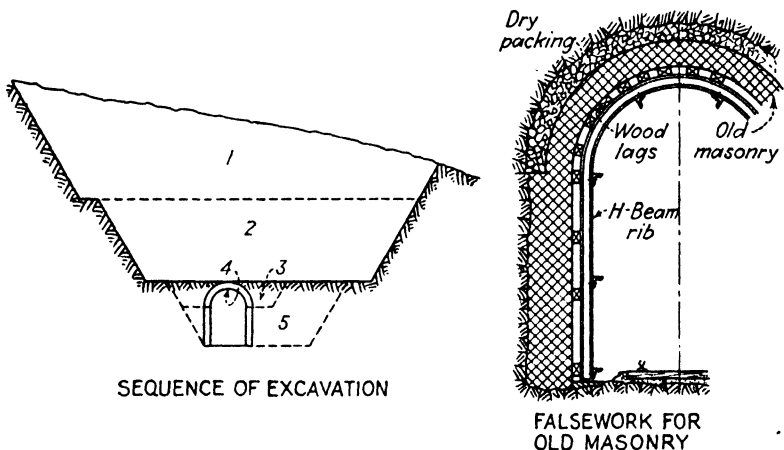

FIG. 281.—Steps in daylighting an old tunnel by excavating an open cut from above.

lining, some kind of a traveling shield as shown in Fig. 279 can be used to protect the traffic.

Cooperation from the Owners.—Working in tunnels under traffic requires the closest cooperation between the contractor, the engineers, and the operating department. On one series of such jobs, the operating department was continually complaining about delays to trains, and the contractor was continually handicapped because the flagmen assigned to each job would not permit start of an operation if there was any chance of over-running the clear time. Finally an assistant trainmaster was assigned to the work. He studied the situation and, by rearranging the schedule of several freight trains, gave the contractors several daily work periods of 3 or 4 hr.

CHAPTER 19

DRILLS AND DRILLING

DRIFTER DRILLS

The standard rock drill for tunnel driving is the drifter. As drifters weigh from 117 to 240 lb., they must be mounted on a column or bar. In general, the medium-weight models are used in hard, tough rock, and also for a drilling program that calls for deep holes. The cylinder bore of drifters varies, about proportionally with the weight, from $2\frac{5}{8}$ to $3\frac{3}{4}$ in.; the drills operate on air pressures from 90 to 110 lb. per sq. in. Obviously, under the same air pressure, the larger bore drills strike a harder blow.

All drifters are equipped with devices that automatically rotate the drill steel a part turn between blows of the piston. They come in wet or dry styles, but for underground work the wet models, in which the water is passed through the drill down through hollow drill steel to the bottom of the hole to reduce dusting are universally used.

Drifters are attached to the bar or column by a clamp that engages a cone projecting from the drill shell. The cone permits swinging of the drill to any position in one plane, and this plane can be tilted or pitched to any desired position by adjusting the clamps. On some models of drifters the cone slides in an auxiliary frame for additional flexibility in spotting the drill to the position desired. Drifter drills work in any position—horizontal or vertical, or on any slope, in normal or upside-down position.

Normally the length of feed of a drifter is 24 in.—that is, a hole can be drilled 24 in. deeper before it is necessary to change to a longer drill steel. However, feed lengths up to 48 in. are available in most models, and on many tunnel jobs today feeds of 30, 36, and 48 in. are popular. Better metallurgy of drill steel, resulting in tougher, sharper and more durable bits is responsible for the longer feeds. Yet, for any given rock, the length of feed is dependent upon the ability of the bit to remain sharp enough for efficient drilling. It would be folly, for example, to use a

30-in. feed in rock that wears a bit down to uselessness in a run of 24 in.

Formerly, the feed or advance of drill steel into the hole was always through a screw on the drifter shell turned by a hand crank, but recently automatic or self feeds have been introduced that increase the drilling efficiency, resulting in faster drilling and greater footage. Automatic feeds are of three general types: (1) the pneumatic type, where an auxiliary air piston pushes or pulls the drill ahead, commonly called the trombone feed; (2) an air motor operating the screw feed formerly turned by hand; and (3) a screw feed that is operated by vibration of the drill through a series of interlocking cams. All three types retract the drill as well as advance it. Drills with pneumatic or air-motor feeds work well on any kind of mounting, but the vibrator feed requires a fairly rigid mounting that will not vibrate with the drill, as it is the difference in vibration between mounting and drill that operates the feed. A mounting, for example, that puts the drifter on one end of a long bar supported only at the other end is not satisfactory for a vibrator feed drifter.

Air Consumption.—Because of the wide variation in types of valves and pistons and number of blows struck per minute in the various makes and models of drifters, it is impossible to prepare charts or curves showing air consumption by drills. Then, too, the amount of air required by a particular drill will vary with kind and hardness of ground penetrated. Under normal operating conditions, drifters will use from 170 to 220 cu. ft. of air per min., depending upon size and type of feed. In high altitudes, more air per drill is required than at sea level.

When a number of drills are operating off the same compressor plant, there is little likelihood that *all* the drills will be operating at once. Experience has shown that it is not necessary to provide compressor capacity in the exact ratio of number of drills used. The well-known compressor conversion table, given in Table VIII, shows the compressor capacity recommended for various numbers of drills, at various elevations above sea level, in terms of multipliers of air consumption of one drill. For example, if 10 drills are used at sea level, compressed air at 7.1 times that of one drill is all that is normally required, but at 10,000 ft. elevation, the conversion table gives an air consumption of 9.37 times that of one drill at sea level.

TABLE VIII.—COMPRESSOR MULTIPLIER TABLE¹
 (Multipliers to determine capacity of compressor required to operate from 1 to 70 rock drills at altitudes compared with sea level)

Altitude above sea level, feet	Number of drills																			
	1	2	3	4	5	6	7	8	9	10	12	15	20	25	30	40	50	60	70	
	Multipliers																			
0	1.	1.8	2.7	3.4	4.1	4.8	5.4	6.0	6.5	7.1	8.1	9.5	11.7	13.7	15.8	21.4	25.5	29.4	33.2	
1000	1.03	1.85	2.78	3.5	4.22	4.94	5.56	6.18	6.69	7.3	8.34	9.78	12.05	14.1	16.3	22.0	26.26	30.3	34.2	
2000	1.07	1.92	2.89	3.64	4.39	5.14	5.78	6.42	6.95	7.60	8.67	10.17	12.52	14.66	16.9	22.9	27.28	31.46	35.52	
3000	1.10	1.98	2.97	3.74	4.51	5.28	5.94	6.6	7.15	7.81	8.91	10.45	12.87	15.07	17.38	23.54	28.05	32.34	36.52	
4000	1.14	2.05	3.08	3.88	4.67	5.47	6.15	6.84	7.41	8.09	9.23	10.83	13.34	15.62	18.01	24.4	29.07	33.52	37.8	
5000	1.17	2.10	3.16	3.98	4.8	5.62	6.32	7.02	7.61	8.31	9.48	11.12	13.69	16.03	18.49	25.04	29.84	34.4	38.84	
6000	1.20	2.16	3.24	4.08	4.9	5.76	6.48	7.2	7.8	8.52	9.72	11.4	14.04	16.44	18.96	25.68	30.6	35.4	39.84	
7000	1.23	2.21	3.32	4.18	5.04	5.9	6.64	7.38	7.99	8.73	9.96	11.68	14.39	16.55	19.43	26.32	31.36	36.16	40.84	
8000	1.26	2.27	3.40	4.28	5.17	6.05	6.8	7.56	8.19	8.95	10.21	11.97	14.74	17.26	19.9	26.99	32.13	37.04	41.83	
9000	1.29	2.32	3.48	4.39	5.29	6.19	6.96	7.74	8.38	9.16	10.45	12.26	15.09	17.67	20.38	27.6	32.9	37.92	42.83	
10000	1.32	2.38	3.56	4.49	5.41	6.34	7.13	7.92	8.58	9.37	10.69	12.54	15.44	18.08	20.86	28.25	33.66	38.8	43.82	
12000	1.37	2.47	3.70	4.66	5.62	6.57	7.4	8.22	8.9	9.73	11.1	13.02	16.03	18.77	21.64	29.32	34.94	40.28	45.48	
15000	1.43	2.57	3.86	4.86	5.86	6.86	7.72	8.58	9.3	10.15	12.58	15.58	18.73	21.59	24.59	32.6	38.46	42.04	47.47	

¹ Courtesy Ingersoll-Rand Co.

Example—Required the amount of free air necessary to operate thirty drills at 9,000-ft. altitude, the drills to be operated at a gage pressure of 80 lb. per sq. in. The sea-level air consumption per drill is assumed 100 cu. ft. per min.

From the table we find that the factor for 30 drills at 9,000-ft. altitude is 20.38; multiplying 100 cu. ft. by 20.38 gives 2038.0 cu. ft. of free air per min., which is the actual delivery required of a compressor for the above outfit under average conditions, to which must be added pipe-line losses, such as friction and leakage.

OTHER ROCK DRILLS

While drifters are the principal drills in tunneling, other types will also be used. The hand-held sinker or jackhammer (so-called from Ingersoll-Rand's registered name "Jackhamer" for this type drill) is used for opening up the portal, for drilling pin holes for support of pipes, etc., for trimming "tight" spots in the tunnel, for block holing of boulders too large for the mucker to handle, and for many other duties. Jackhammers are either wet or dry. For occasional use in tunnels, the dry drill is permissible, but, for repeated or continued use, it is advisable to use the wet model to keep down the dust.

For heavy approach cut work, the larger drifters mounted as wagon drills are often used. Wagon drills are also handy for other work, such as drilling out the large center drain under

the floor on the Pennsylvania Turnpike tunnels now under construction.

Drifters can be mounted to drill overhead or up-holes, but, if there are many holes to drill in this position, the stoper is much better for the purpose. This drill, mounted on the end of a long pneumatic cylinder, can be quickly blocked to position, is self-feeding, automatic rotating, and can be operated wet or dry.



FIG. 282.—Line oilers for lubricating drifter drills, Allegheny Tunnel, Pennsylvania Turnpike. The oilers are placed in the air-line manifold. (Courtesy of Ingersoll-Rand Co.)

Drifters are usually lubricated by an air-line oiler, an oiling device that is inserted in the compressed-air supply line, Fig. 282. Hand drills may be lubricated by pouring oil into a small reservoir in the drill shell.

Water for wet drills should be supplied at the drill under pressure about that of the air pressure. This pressure may be supplied by pumps, by an elevated tank or supply at top of shaft, or by an air booster tank for which air is taken off the main supply line at the same pressure the drills are operating.

DRILL STEEL AND BITS

There are two general types of rock drill bits: (1) the forged or solid bit, in which the cutting head is forged from and is part of the drill rod or shank; (2) the detachable bit, in which a separate cutting head is threaded onto the shank. Both are used in tunnel driving, though the detachable bit is a recent development and is not so widely used on underground work as it undoubtedly will be in the future.

Forged Bits.—Forged bits are made up from single lengths of drill steel. The steel comes in several shapes: circular, hexagon,

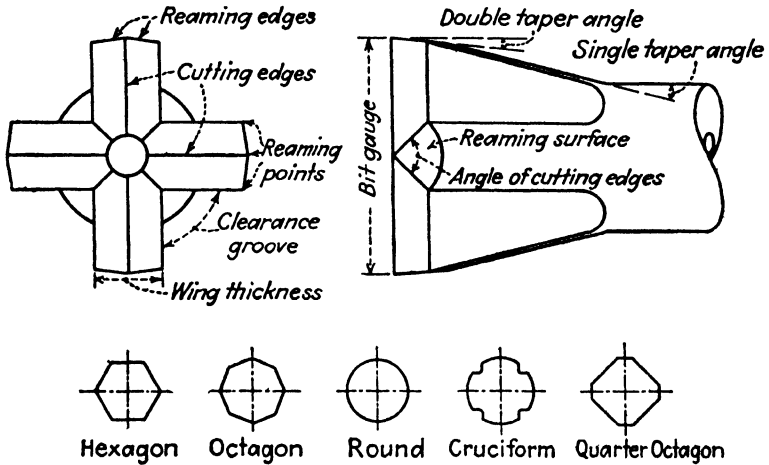

FIG. 283.—Nomenclature of standard rock drill bit (above) and various shapes of drill steel (below).

quarter-octagon, octagon and cruciform, in sizes from $\frac{7}{8}$ to $1\frac{1}{4}$ in. for drifter drills, equipped with a small hole through the center for passage of water. The shape used is largely a matter of personal preference. On the shank end of the steel that fits into the drill a lug or collar is forged, the exact type depending upon the shape of steel and model of drill used, though some drills use a straight shank without any lug or collar. The cutting end or bit is forged at the other end.

Conventional bits are the cross or four-point double taper bit, as shown in Fig. 283. Other shapes of bits, for special work in unusual rock formations, are the Carr or chisel and six or rose

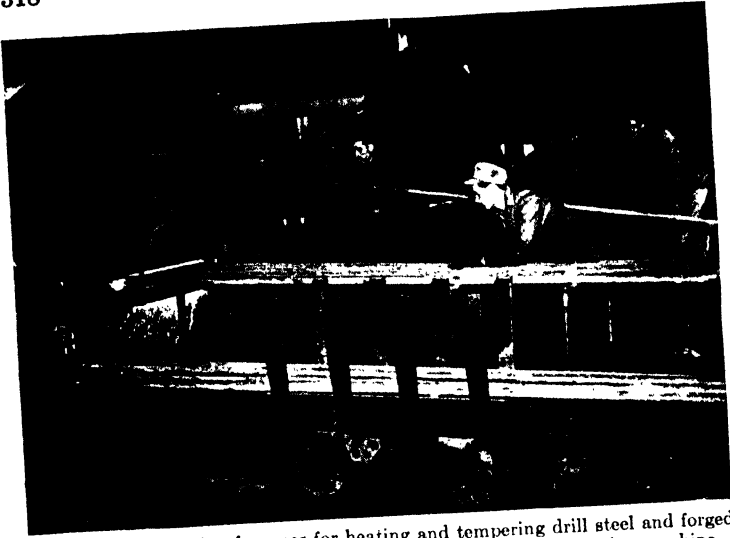

FIG. 284.—Oil-burning furnaces for heating and tempering drill steel and forged bits. Between the furnaces is a pneumatic forging and sharpening machine.

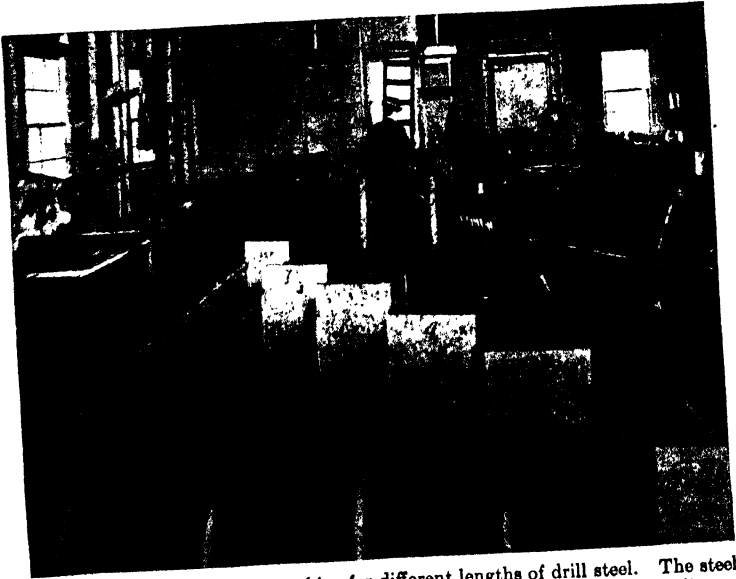

FIG. 285.—Convenient storage bins for different lengths of drill steel. The steel is placed in the bins after sharpening for proper distribution to the headings.

point, Fig. 288. These types also may be varied as to angle and depth of cutting edges, slope of cutting edges, taper, etc., for special operations.

Sharpening.—Shanks and bits are forged in an air-operated drill sharpener, set up in a shop at the job, Fig. 284. The sharpener also reshapes and sharpens the bits after each use at a rate of 75 to 100 bits per hr. Bits and shanks are heated preparatory to forging or sharpening in an oil-burning furnace, and are tempered during and after the sharpening process by quenching in water. The metallurgy of heating and quenching the steel is beyond the scope of this book, but full instructions can be obtained from the manufacturers of sharpening equipment. Quenching tanks may be of the simple type, which is a tank through which running water flows at a predetermined level and which is equipped with trays or racks that submerge the steel to a definite depth; or they may be of the automatic type, in which the steel is annealed by heating and then carried by a slow-moving rack that immerses the steel in the quenching water at a uniform rate of speed and for a definite time limit.

The arrangement of the furnaces, sharpeners and quenching tanks in the shop should permit straight-line operations, with a minimum of moving of steel. A typical suitable layout is shown in Fig. 286.

Each successive change of steel in the drill requires a smaller gage or width of cutting bit so the new steel can follow down the hole to its cutting position without binding. The gage of the first or starting bit is determined by the size of dynamite being used: the last or deepest cut should be $\frac{1}{16}$ in. greater than the diameter of the powder cartridge. Each prior change of steel must have a larger gage bit. While a difference of $\frac{1}{16}$ in. in gage would usually be sufficient, practical considerations in sharpening and in handling the steel make a $\frac{1}{8}$ -in. change more desirable. Too large a change in bit gage is uneconomical, for the smaller the hole the faster it can be drilled.

Removable Bits.—Detachable bits, screwed onto the end of drill rods instead of being forged, are coming into use in tunneling. Although they offer many advantages over forged bits, their acceptance for underground work up to now has been somewhat retarded by a reluctance on the part of the older tunnel men to change over from time-tested forged bits and a belief on the part

of some others that detachable bits were still in the experimental stage. However, detachable bits are here to stay; they have been

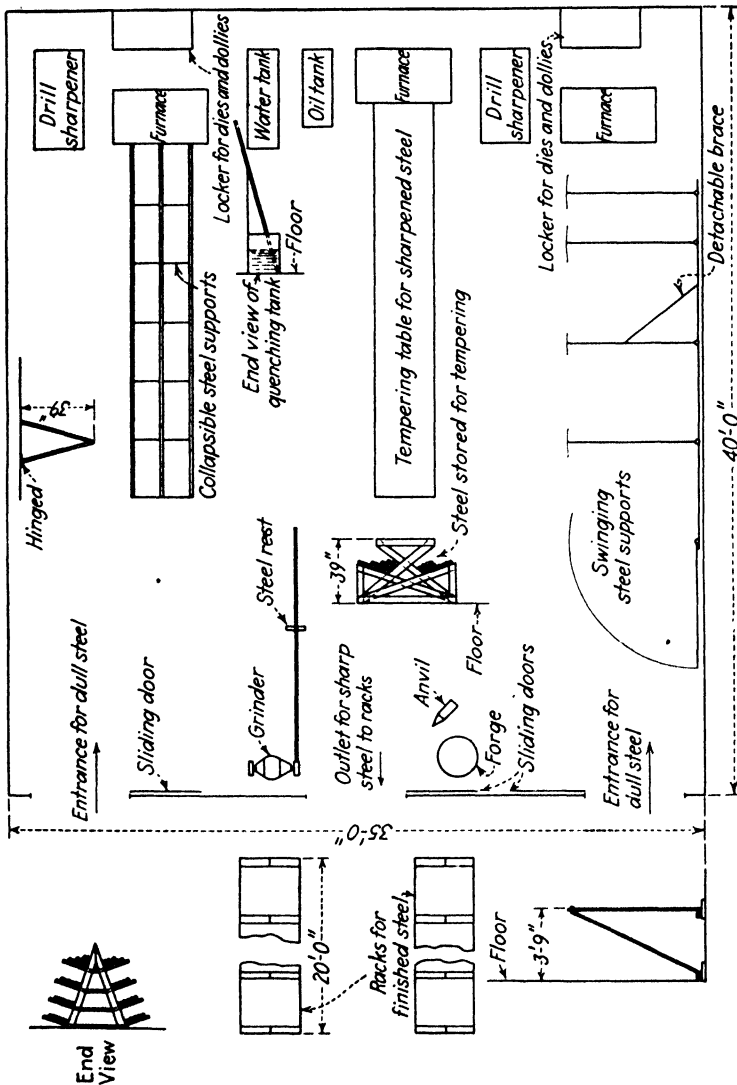

FIG. 286.—Drill-shop layout recommended by Sullivan Machinery Co.

proved satisfactory under all drilling conditions, and eventually they will undoubtedly largely replace forged bits.

They have several advantages over the older type. As they are a factory-made product, their metallurgy and manufacture

can be carefully controlled; they can be, and are, made with a chrome steel facing that is harder and tougher than the carbon steel in forged bits and thus stays sharp longer. Because they can be changed underground, they reduce the movement of steel in and out of the tunnel. Bits of special shape can easily be obtained when required. They usually come in $\frac{1}{8}$ -in. changes of gage.

Detachable bits may be resharpened from two to six times by cold grinding, though the gage is reduced by this process. Just



FIG. 287.—Two machines for forming threads for detachable bits on drill steel shanks. Left, thread forger; right, thread cutter. (Courtesy of Ingersoll-Rand Co.)

recently a hot mill has been perfected that permits heating and grinding with metal cutters, in which process the gage is retained for the first one or two resharpenings, Fig. 289. The heating also restores the temper of the bit.

On the ordinary tunnel job, a grinder is advisable, as the hot mill is economical only if a large number of bits is to be handled. However, bit service facilities are now being established throughout the country. Operators of such service plants will collect the dull bits, sharpen them in a hot mill and deliver the sharp bits to the job at a cost comparable with, or even cheaper, than job sharpening costs on forged bits.

There are several makes of detachable bit now on the market. In one type the bit screws against a shoulder on the drill rod; on another the rod bottoms into the bit. The screw threads on the

rod are formed for the former type by cutting; for the latter type by forging or cutting.

It is not advisable to change bits right at the face, as this interferes with drilling operations. A successful procedure in use

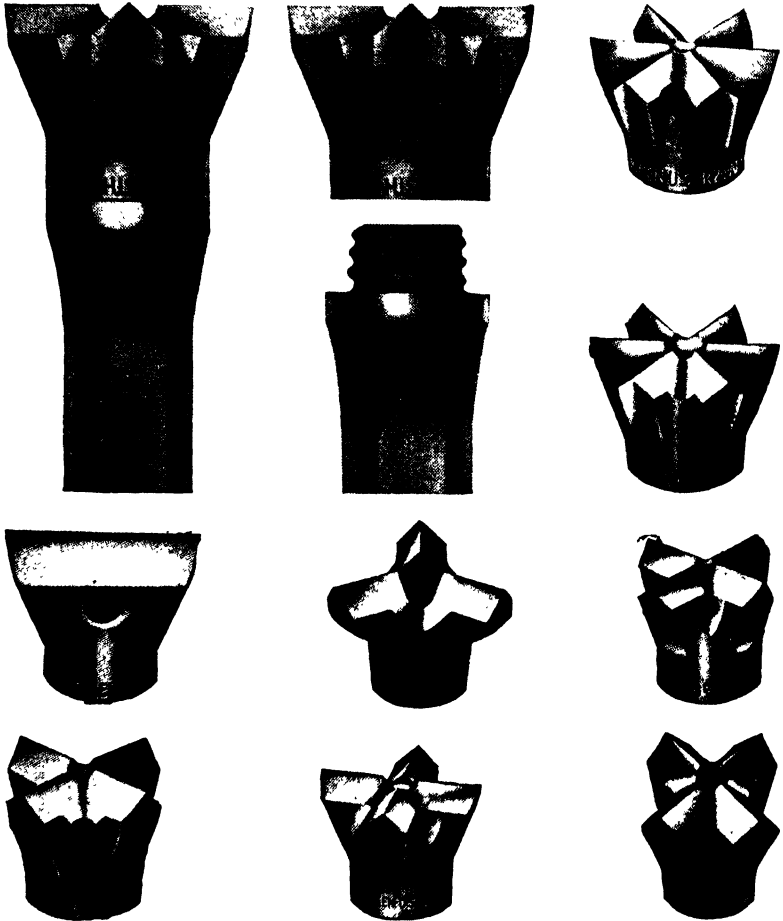

FIG. 288.—Various types of detachable bits for regular and special services. This make of bit has an upset shoulder which bears against a shoulder on the steel shank. (Courtesy of Timken Roller Bearing Co.)

on one of the Delaware Aqueduct tunnel contracts is to provide freshly-bitted rods for an entire round of drilling, just as if forged bits were being used. The used bits, still attached to the rods, are stacked on the drill jumbo. During the mucking

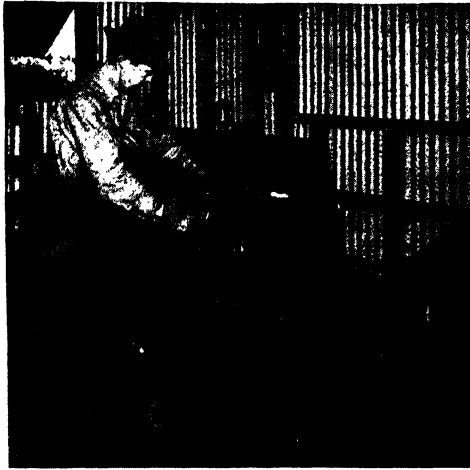

FIG. 289.—Hot mill for resharpener detachable drill bits, particularly economical for large jobs. (Courtesy of Ingersoll-Rand Co.)



FIG. 290.—Furnace and quencher for tempering detachable bits after resharpener. Furnace is also used for heating the bits for hot-mill sharpening. (Courtesy of Ingersoll-Rand Co.)

operations, when the drill carriage is pulled back out of the way, the bits are changed.

Nipper Cars.—Unless the drill carriage can be run directly to the drill-sharpener shop, a nipper car should be provided for carrying drill steel to and from the face. On many small jobs the sharp steel is thrown into a muck car and hauled to the face, where it is unloaded. Time lost in unloading and sorting steel from a muck car will soon pay for a nipper car.

It is standard practice, in rock of ordinary hardness, to drill only 2 ft. with each steel. Thus, if 10-ft. holes are being drilled,

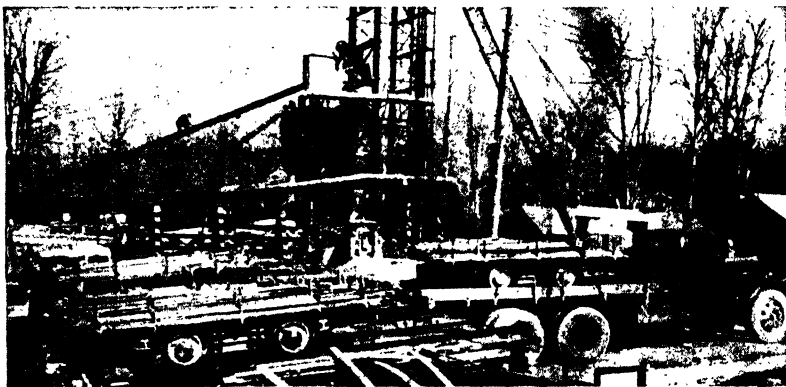

FIG. 291.—Transporting drill steel from sharpening shop to shafts, Montebello water tunnel, Baltimore. Steel for a complete round is loaded on the car at the shop, pulled onto tracks on the truck, hauled to the shaft and placed on the tunnel tracks for hauling to the drill carriage at the face. After the round is drilled, the steel is reloaded on the car at the face and sent back to the shop for resharping.

there will be required for each hole a 2-ft., 4-ft., 6-ft., 8-ft., and 10-ft. drill, or five pieces of steel. In a 32-hole round, for example, 160 steels must be handled.

If detachable bits are being used, only five pieces of steel, one of each length, will be required for each drill; extra steels should be carried in case the threads become battered. The bits come from the shop wired in tagged bundles for each gage. Dull bits are returned to the shop for regrinding.

The nipper car carries racks to hold the required amount of each length steel. Dull steel is thrown onto the deck of the car, unsorted. Under the car are hooks to carry spare drills and clamps, ready for replacement. At the back end of the car is a box for tools and oil cans. Often flood lights are mounted on top of the racks to illuminate the heading during drilling.

On the Baltimore water tunnel, the contractor sharpened the steel from all three shafts and the portal at one central shop. Steel for each round at each of the six headings was handled on a nipper car that was hauled between shaft and shop on trucks fitted with rails, as shown in Fig. 291.

DRILL MOUNTING

Drill mounting has an important bearing on the efficiency of drilling. Drilling time is made up of the following operations:

- Setting up drills.
- Drilling.
- Tearing down drills.
- Blowing, loading and firing holes.

Setting up and tearing down is dead time, directly influenced by the type of drill mounting adopted. Drilling time is affected by the efficiency of the drills and the toughness of the rock; but drill mounting must be such that the drills can be shifted from hole to hole with a minimum of delay.

It takes from 20 to 40 min. to set up the bars or columns, mount the drills, stretch the air hose and begin drilling. A drill carriage can be set and made ready in about 10 min. Knowing the length of job and the factors that influence drilling, the engineer can readily estimate whether the job can stand the greater investment required for drill carriages.

Number of Drills.—The number of drills is governed by the area of the face, by the number of holes to be drilled for each round, and by the toughness of the rock. In general, one drill is required for each 30 to 45 sq. ft. of face area. Nothing is gained by crowding too many drills into a heading; the driller and the chucktender must have sufficient room to work efficiently.

In this connection, it is important to install adequate air lines in the heading to supply the required volume of air to the drills with a minimum loss of pressure. Four drills working at 100-lb. pressure will do just as much work as five drills at 80-lb. pressure.

Bar Mounting.—Bar mounting for drills is usually preferred in small full-face tunnels in which the width is less than the height. The bar is a length of extra-heavy pipe, with a jack in one end, set horizontally across the tunnel, to which the drills are clamped. Bars (or columns) are of $3\frac{1}{2}$, 4 or $4\frac{1}{2}$ -in. pipe, depending on the number and weight of the drills and the width of tunnel.

The bar is held in the desired position by extending the jack to the wall. Care must be taken to make the bar tight; otherwise it is apt to shake loose. Numerous accidents have been caused by a bar falling on the miners. In most small tunnels

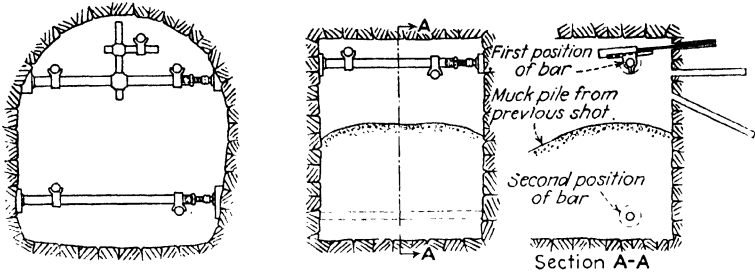

FIG. 292.—Bar-drill mountings for small tunnels. Left, typical set-up for arched tunnel; short arm carries drill for top holes. Right, set-up for simultaneous drilling and mucking; muck pile from previous round is used as scaffold for drilling upper holes from top bar.

driven full-face, two bars are used, Fig. 292, one near the top and one near the bottom. The hole pattern should be such that the entire round can be drilled from the two bars without change.

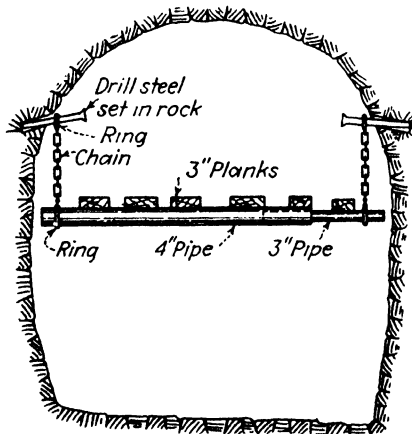

FIG. 293.—Drillers' scaffold utilizing telescoping pipes hung from pins in the walls as deck support.

In high-arch tunnels, it may be necessary to use a vertical arm, or short column, in the center of the top bar to reach the top holes.

Scaffolds are generally required for the men drilling from the upper bar. A common type of scaffold is made up of telescoping

pieces of pipe hung by adjustable chains from pins set in shallow holes drilled in the walls, Fig. 293. The pipes are planked with 2- or 3-in. lumber to provide a working platform.

Drilling from the muck pile permits simultaneous drilling and mucking and sometimes greatly shortens the round cycle. As soon as the powder smoke has cleared and the roof has been scaled, the miners set the upper bar, Fig. 292, and start drilling the upper holes, using the muck pile for a scaffold. Meanwhile the mucking crew starts to load out. By the time there is any interference, the miners should have finished the top holes. The miners retire until all the muck is cleaned up; then they lower the bar to the second position and complete their drilling. When

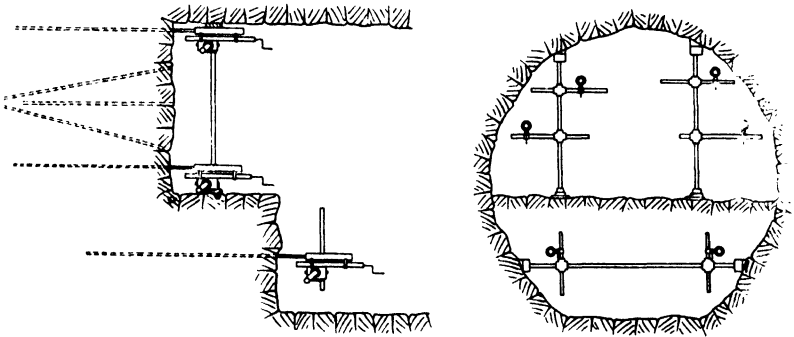

FIG. 294.—Column-and-bar set-up for horizontal drilling of heading and bench.

mucking is being done by hand, or when drilling is rapid, the bottom-cut pattern, Fig. 300, should be used, for then only the four "lifters" need be drilled from the second position.

Column Mounting.—Columns instead of bars are preferred for drill mounting when the height of tunnel is less than the width. The columns are simply extra-heavy pipe, $3\frac{1}{2}$, 4, or $4\frac{1}{2}$ in. in diameter, fitted with either one or two jacks at the bottom for wedging the column tight against the roof. The drill is mounted on a short horizontal arm, usually about 36 in. long, clamped to the column. The drill may be moved horizontally on the arm, which, in turn, may be raised or lowered on either side of the column, so a column-mounted drill covers a larger area than one mounted on a bar. Generally two drills are carried on one column.

Good practice in setting up a drill column is to clean out all loose muck down to solid rock under the foot block which carries

the jacks. Otherwise, the vibration of the drills mounted on the cantilever arms from the column is apt to shake the column loose.

One disadvantage of column mounting is that drilling cannot be started until the heading is mucked out, for the column cannot be blocked up on the muck pile. Also, a longer time is required to set up a column than a bar.

Drill Carriages.—Modern tunnel practice is to drive all except the largest tunnels full-face. Columns or bars become unwieldy in large tunnels, and scaffolds must be erected for reaching the

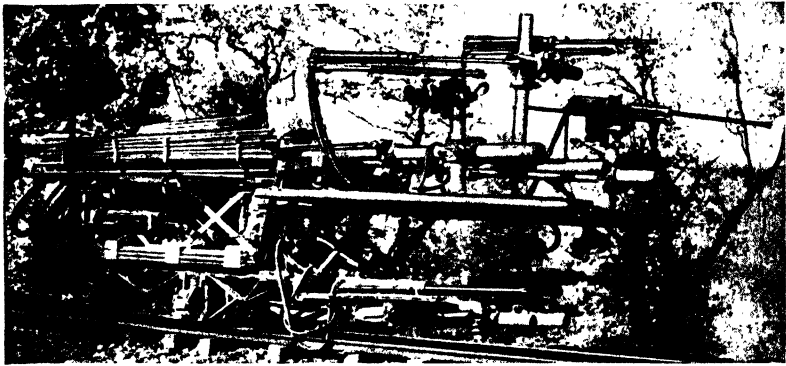

FIG. 295.—Drill carriage used on the Stanislaus Tunnel. The tunnel was 9 ft. 6 in. x 10 ft. 9 in., excavated dimensions. Note the racks for the drill steel, the extra drills hanging ready for replacement and the flood light. (Courtesy of Gardner-Denver Co.)

top holes; thus setting up the drilling equipment becomes quite an item.

Drill carriages or jumbos, as they are usually called, of one type or another, have been used on all long tunnels driven in the last 10 years. Generally the drill carriage is mounted on a flat car running on the muck track. Folding scaffolds at convenient levels provide platforms for reaching the face. The drills are mounted on bars or columns permanently attached to the front of the jumbo. Some of these bars or columns are fitted with jacks in their outer ends; and, when the car is run up to the face, it is held in position by jacking against the walls, roof and floor.

Racks are provided to store sharp drill steel ready at hand for the chucktender, Fig. 295. Dull steel is piled on the deck of the car. There should be one or more extra drills ready to replace any that fail suddenly.

All drills are permanently connected to an air manifold attached to the frame of the carriage; sometimes the pipe frame of the jumbo serves as the manifold. When the carriage is run to the face, it is necessary only to unreel about 50 ft. of 3- or 4-in. hose and connect it to the air pipe to put air on all the drills. A well-

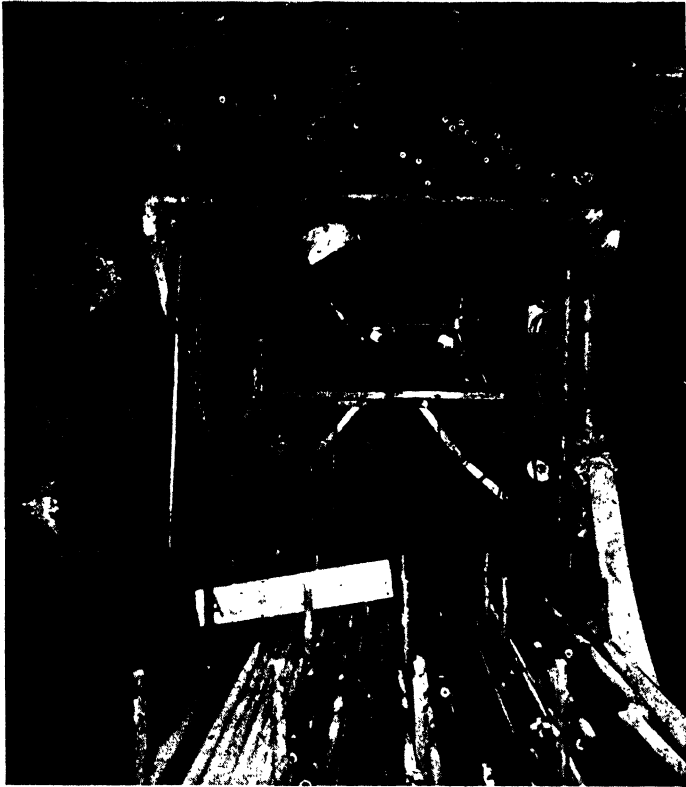

FIG. 296.—Drill carriage and steel car, Montebello water tunnel, Baltimore. The drill-carriage frame is tubular steel, which serves as the air supply manifold for the drills. (Courtesy of Bureau of Water Supply, Baltimore.)

designed drill carriage should not require more than 10 min. to be run in from the nearest siding and set up ready for drilling.

Most drill carriages must fold up to pass under the car switcher or to run on a siding. The platforms are hinged to drop against the sides, and the bars or columns can then be swung around in the clear. Locks must be provided for holding the drill mountings in working position.

Where possible, the drill carriage is usually run out to the shop at the end of each drilling shift. Mechanics then check and oil all drills. All dull steel is removed for resharpener. The drilling foreman sees that all tools and supplies are aboard the jumbo before it is sent into the heading on the last muck train. Drilling cannot be started until all muck has been cleaned up and the track extended to the face.

Often the drill carriage is used as a timbering jumbo when the heading must be supported after each round. An air hoist lifts

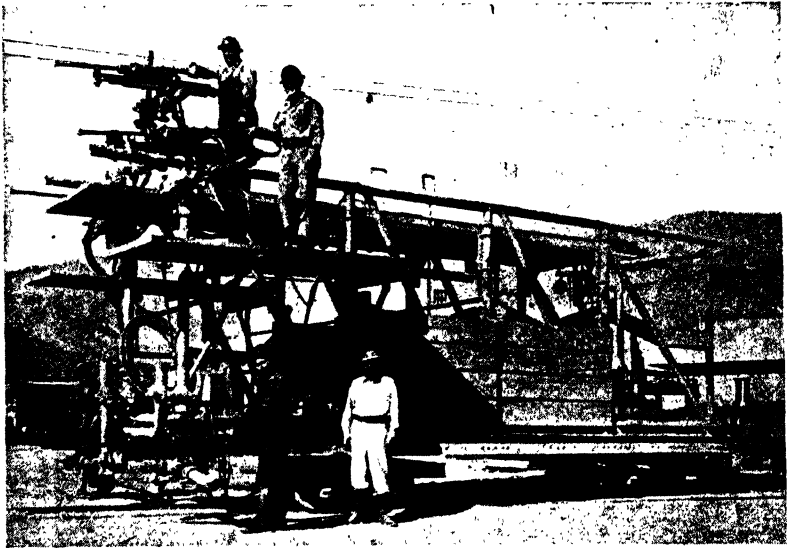

FIG. 297.—One type of drill carriage used on the Colorado River Aqueduct tunnels, mounting six drifter drills. (Courtesy of Worthington Pump & Machinery Corp.)

the timbers to the top deck, either with a jib-crane or by skidding them up an inclined slide. If the timbering is to be dry-packed, buckets of fine muck are hoisted to the top platform to be convenient for the shovelers.

Drills Mounted on Car Switcher.—A number of contractors on the Los Angeles Aqueduct mounted their drills on the front end of cherry picker or grasshopper car switchers. Since these car switchers pass cars and mucking machines, and as they never go out to the portal, the scaffolds and drill supports may be rigidly mounted on the front end.

The wide-gage track carrying the car switcher must be extended to the face before drilling can be started. Before blasting, the rig must be run back far enough to protect the equipment from fly rock.

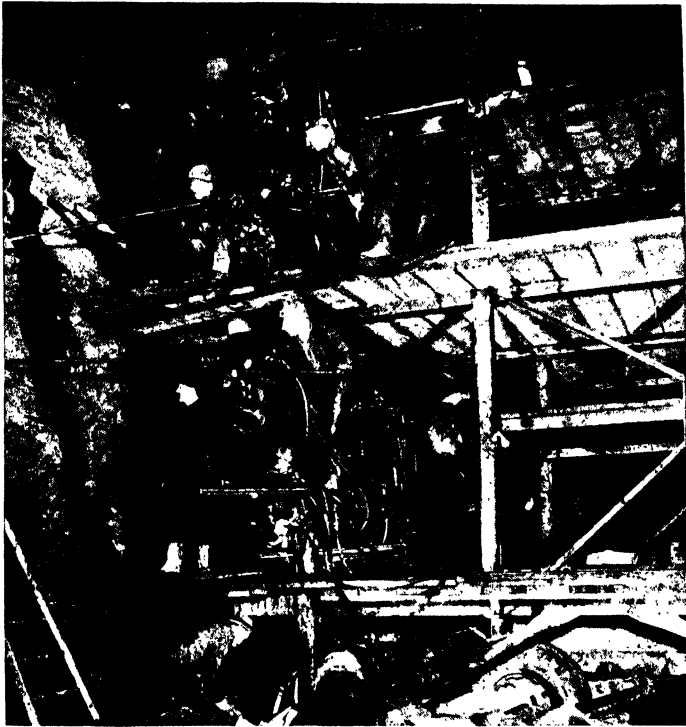

FIG. 298.—Drill carriage mounted on a truck chassis at Boulder Dam diversion tunnels, carrying 32 drills. (*Courtesy of Ingersoll-Rand Co.*)

DRILLING PATTERNS

Efficient blasting procedure depends on many factors, some intangible. The volume of ground broken will depend on the texture of the rock, the depth of the hole, the quantity and rapidity of the explosive and the amount of stemming.

In general, a drill hole, normal to the face, charged with the correct amount of explosive and well stemmed, will break out a crater whose sides have a slope of 45 deg., *A*, Fig. 299. If two similar holes, *B*, Fig. 299, are fired simultaneously and are not too far apart, they will break out the ground between them as well as

their craters. An inclined, or "cut," hole, *C*, Fig. 299, is more efficient than a horizontal one, as the explosive acts normal to the axis of the hole, and there is less chance of blowing out the stemming. The most efficient angle for a cut hole is 45 deg. A charge of explosive placed an equal distance from two free faces, *D*, Fig. 299, will break out $2\frac{1}{4}$ times the material broken when there is only one free face. If the charge can be placed equidistant from three free faces, it will break out $3\frac{1}{2}$ times the amount of a single crater.

Because of the restricted area of a tunnel and the necessity of controlling overbreak, it is impossible to point the holes to obtain the theoretical maximum efficiency of the explosives.

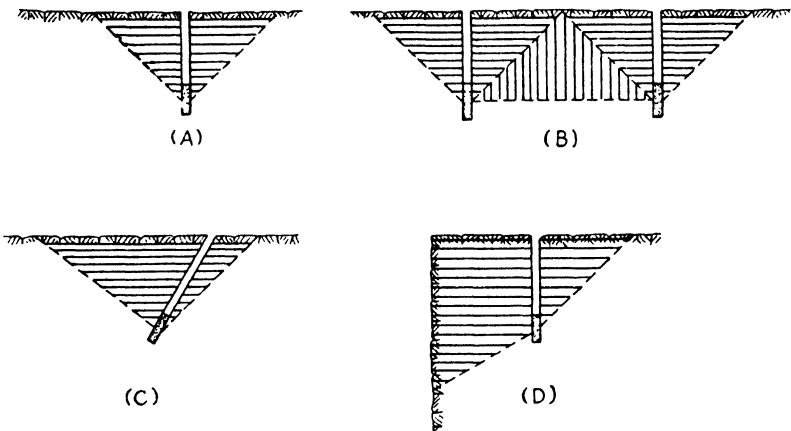

FIG. 299.—Theory of blasting.

The practice in tunneling is to make a "cut" in the face to the full depth of the round. The cut holes are 6 to 12 in. deeper than the rest of the hole and are more heavily loaded to throw the muck out of the face. The cut provides a space into which the rest of the ground can expand, or "grow," when it breaks. The "relievers" are fired next, followed by the "rim holes." The upper rim holes are known as "back holes" and the bottom rim holes as "lifters." Each job requires some experimenting to locate and point the rim holes to find the pattern that will give the desired breakage with no trimming and little overbreak.

Choosing the Hole Pattern.—Until about 60 years ago, all holes were drilled by hand, either "single-jacked" or "double-jacked." The single jack was a hammer weighing about 4 lb.

swung with one hand while the steel was held in the other. The double jack was a 6 or 8-lb. sledge swung with both hands. There were generally two men striking with double jacks, while a third held and turned the steel. A three-man team could drill about 1 ft. of hole per hour. Holes were 1 in. in diameter and seldom were deeper than 3 ft. The only explosive was black powder; hard to load and uncertain in action.

Before starting a round in those days, the miner carefully studied the face before deciding how he would point his holes. Full advantage was taken of all irregularities, joints and bedding planes. If one hole could be eliminated from the face, it might save half a day in drilling the round.

With the present high-speed drills and powerful explosives, the drilling pattern is chosen more to fit the drill carriage than for economies in drilling or explosives. However, the superintendent should carefully study the effects of the blasting. A change in the texture of the rock may cause the round to break tight. Perhaps the cure is a slight relocation of a few of the holes rather than more dynamite. If the round is overbreaking badly, the omission of a few holes may sometimes correct the trouble and speed up the drilling as well.

There are as many drilling patterns as there are superintendents, and all these patterns have proved themselves on some type of ground. The adopted pattern must fit in with the arrangement of drill mounting. For example, if drilling is to be done from two columns, all holes must be located so that they can be reached without resetting the columns. Only the basic drilling patterns will be illustrated here.

Depth of Holes.—Drill holes will rarely break to the very bottom; the round pulled will average about 18 in. less than the depth of hole. The depth of holes, except in unusually free breaking ground, are not deeper than the width of the tunnel.

Long drill steels have so much "spring" in them that the blows of the drill are cushioned. As the size of the bit reduces $\frac{1}{8}$ in. for each change of steel, a deep hole will require a "starter" much larger in diameter than that for a short hole. Therefore, it may take as long to drill a 12-ft. hole as two 8-ft. holes. Deep holes require more explosives in proportion to length, and are liable not to break so well. Considerable study and good judgment

are necessary to find the depth of round best suited to the job organization and ground to produce the maximum advance.

It is always very desirable to choose a length of round so that the complete cycle of mucking, cleaning up, setting up drills, drilling, loading, firing and clearing smoke will be the same as the shift time. Thus, each shift has a set production schedule, and an inefficient shift boss can soon be detected. If shooting is done just before the lunch period or at the end of the shift, the time lost waiting for the smoke to clear will not be entirely wasted.

It is a common fault to drill too deep. Many a contractor has discovered that he could get three 8-ft. rounds every day but only two 10-ft. rounds. When working in treacherous rock which must be timbered immediately, it is desirable that the length of round correspond with the spacing of the timber sets.

Horizontal Wedge Cut.—The horizontal wedge cut is shown in Fig. 300. This cut is generally used when drilling from a bar, but it can also be used when working from columns. The order of firing is indicated by the numerals. The “cut holes” are fired first by instantaneous detonators; the “relievers” are fired on the first delay followed by the “rim holes” on the second delay. This pattern is generally used when the height of the tunnel is greater than its width.

Vertical Wedge Cut.—The vertical wedge cut is shown in Fig. 300. This is the best cut when drilling from columns, but it can be drilled from bars in small tunnels.

Bottom Cut.—The bottom cut, shown in Fig. 300, is used more in mining than in tunneling, but there are many cases where the dip of the strata is such that this would be the most efficient pattern. Modifications of this pattern are the top cut and the side cut used in wide headings.

Pyramid Cut.—The pyramid cut, Fig. 300, is well adapted to circular or horseshoe-shaped tunnels. The apex of the cut holes should not be more than 6 in. apart.

Buster Cut.—The buster or baby cut, Fig. 300, is occasionally used when drilling unusually deep holes. The buster cut is drilled about half the depth of the regular cut hole. Its object is to relieve the main cut holes of some of their burden and thus enable them to pull to their full depth. Sometimes the buster may be only a single hole.

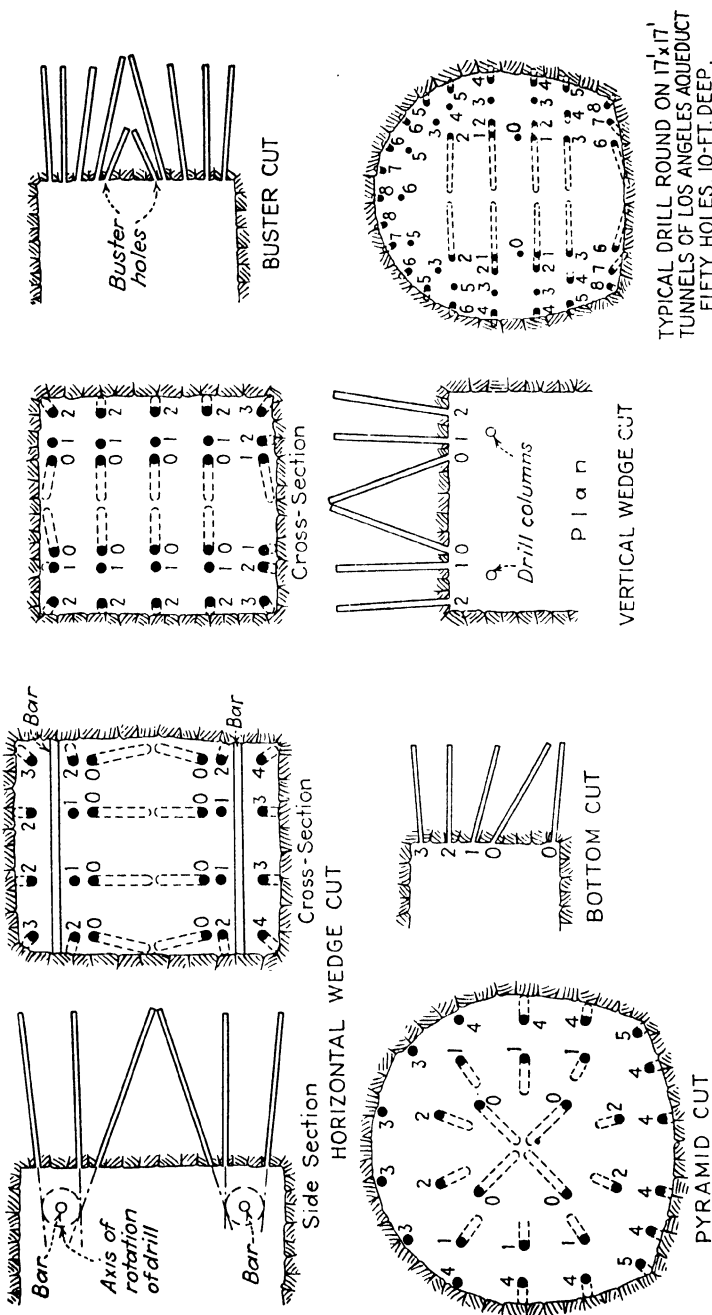

Fig. 300.—Various drilling patterns for full-face operations. Numbers refer to delays in firing holes.

Cuts on the Los Angeles Aqueduct.—The Colorado River Aqueduct in Southern California included 32 tunnels totaling 92 miles. These tunnels were horseshoe shaped, 17x17 ft. in the rough. All drilling was done from jumbos. Most of the carriages mounted five drills; three on the top and two at the bottom.

Drilling patterns varied with every job. The number of holes ranged from 32 to 55, with 45 as an average. Depth of holes ran

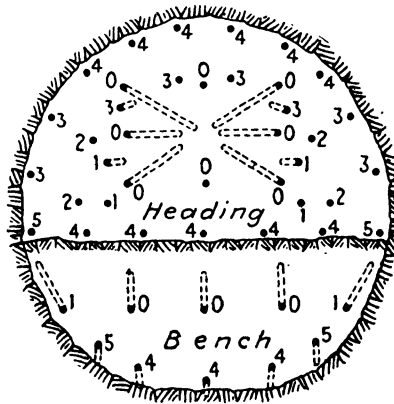

FIG. 301.—Drilling and shooting diagram for a 17-ft. tunnel driven by heading-and-bench method. Bench is shot with the heading. Numbers refer to blasting-cap delays.

from 4 to 15 ft. and pulled 3 to 12 ft. The average depth of hole on contract work was about 8.8 ft. and the average pull 7 ft.

Time studies in *The Explosives Engineer* give the average drilling time for the Long Canyon and Seven Palms tunnels as follows:

Moving in drill carriage and setting up.....	10 min.
Drilling 38 holes, 9 ft. deep.....	2 hr.
Tearing down, blowing holes, loading and firing.....	25 min.
Average time for one round.....	2 hr., 35 min.

On this job it took 2 hr. to muck out, and about 25 min. to clear the powder smoke from the heading; thus the cycle for an 8-ft. advance was 5 hr.

Ring Drilling.—Ring drilling is employed in enlarging a center heading to full size. The drill is mounted on a bar, set up longitudinally on the axis of the tunnel. The holes are drilled

radially from this axis, the depth of the hole corresponding to the distance to the outside of the tunnel. A clinometer on the drill enables the miner to point the holes correctly. All holes in one ring may be fired simultaneously, although it is common to fire the lower half of two or three rings first, then shoot down the upper holes. Rings are generally spaced 4 ft. apart.

Bench Drilling.—Benches are often drilled from the top with jackhammers. The holes, drilled vertically, are spaced about 4 ft. apart in both directions. They are fired by delays, one row at a time. When the bench holes are drifter-drilled horizontally from a bar, Fig. 301, they are fired in rotation starting in the upper center.

Sometimes a bench will be drilled both vertically and horizontally, such as on unusually high benches when the headroom on top of the bench is insufficient for handling steels long enough to bottom the holes to grade. Then lifters are drilled from a bar mounted across the bottom of the tunnel. In this case the upper vertical holes will all be fired before the horizontal holes.

CHAPTER 20

EXPLOSIVES

The use of explosives is the heart of all hard-ground tunneling and shaft-sinking operations. Correct use of the proper kind and amount of explosives is essential to the success, safety and efficient progress of every job. There are dozens of different types of explosive, but only five types are generally applicable to tunneling. These are: Straight dynamite, ammonia dynamite, gelatin dynamite, semigelatin dynamite and blasting gelatin. All dynamites are made in various strengths and come packed in wooden boxes containing 50 lb. of explosives in cartridges varying in number from 87 to 172 per box. Their properties and characteristics will be briefly described.

PROPERTIES OF VARIOUS TYPES

Straight Dynamite.—Straight dynamite was the first type made and is still the standard with which all high explosives are compared for strength. It is straight nitroglycerin held by an active absorbent material and comes in strengths varying from 15 to 60 per cent—that is, from 15 to 60 per cent of the mass is nitroglycerin. Straight dynamites are highly sensitive; their sensitivity increases with their strength and they are highly water-resistant, a desirable property for submarine blasting. However, because of their bad fumes, they have largely been replaced by other types for underground work except for trimming “tight” spots in the tunnel, and for block holing or mud capping boulders and pieces of rock too large to handle.

Ammonia Dynamite.—The ammonia, or extra dynamites, as they are commonly called, contain about equal parts of nitroglycerin and nitrate of ammonia as the explosive material. They come in strengths from 15 to 60 per cent, and are not so sensitive or so quick and shattering as the straight dynamites, and are therefore more suitable for soft rock. The extra dynamites are fairly water-resistant, and their fumes are fair.

Gelatin Dynamite.—There are two types of gelatins—straight and extra or special. In both, the explosive is a jelly of nitroglycerin and nitrocotton; in the extra and special gelatins, part of the nitroglycerin is replaced by nitrate of ammonia. Straight gelatins come in strengths from 20 to 90 per cent; extra gelatins from 30 to 90 per cent. Both types are highly water-resistant, and their fumes are good; in fact, they rank as the least objectionable of all explosives in regard to fumes. Their jelly-like plastic consistency permits solid loading in the hole, and, when properly confined, this type of dynamite has a quick and high-shattering effect. They are useless for mud capping, for they are slow acting when not confined. Because their properties meet most underground conditions, the gelatin dynamites are chosen for most rock tunnel work.

Semigelatins.—This type is a fairly recent development, consisting principally of nitrate of ammonia with some gelatinized nitroglycerin and nitrocotton. The semigelatins are bulkier than the straight or extra gelatins, come in only two strengths, 45 and 60 per cent, and their water-resistant and fume qualities are good. Because of their lower density, they are cheaper than extra or gelatin dynamites and are finding favor in soft rock and limestone work.

Blasting Gelatin.—This a recently developed type of explosive, fast and strong. Its consistency is like that of soft rubber; it is fully waterproof and therefore adaptable to very wet work, though the fumes are extremely bad. Blasting gelatin is rated at 100 per cent strength.

Other High Explosives.—There are several special types of high explosive on the market, developed for special conditions. They are rarely used in tunneling, except that the so-called "permissible explosives" are occasionally required for very gassy ground. These special types should not be used without expert advice of the manufacturers, which will gladly be given upon request.

Comparative Strengths.—As stated before, straight dynamites are rated in strength according to the percentage of nitroglycerin they contain. However, the relative strengths are not directly proportional because of certain other ingredients in the explosives. A 40 per cent dynamite is not twice as strong as a 20 per cent powder; nor is a 60 per cent dynamite three times as strong.

Table IX gives the comparative strengths. The strength of all other dynamites is their explosive force, weight for weight, compared with that of straight dynamite. Thus a 40 per cent gelatin has the same explosive force as a 40 per cent straight dynamite.

TABLE IX.—COMPARATIVE STRENGTHS OF DYNAMITE
(Number of cartridges of any given weight strength required to equal one cartridge of same density of any other strength)¹

One cartridge	60%	50%	45%	40%	35%	30%	25%	20%	15%
60%	1.00	1.12	1.20	1.28	1.38	1.50	1.63	1.80	2.08
50%	0.89	1.00	1.07	1.14	1.23	1.34	1.45	1.60	1.85
45%	0.83	0.93	1.00	1.07	1.15	1.25	1.36	1.50	1.73
40%	0.78	0.87	0.94	1.00	1.08	1.17	1.27	1.40	1.59
35%	0.72	0.81	0.87	0.93	1.00	1.09	1.18	1.30	1.50
30%	0.67	0.75	0.80	0.85	0.92	1.00	1.09	1.20	1.38
25%	0.61	0.69	0.74	0.78	0.85	0.92	1.00	1.10	1.27
20%	0.55	0.62	0.67	0.71	0.77	0.83	0.90	1.00	1.15
15%	0.48	0.54	0.58	0.61	0.66	0.72	0.78	0.86	1.00

¹ From Du Pont's *Blaster's Handbook*.

HANDLING AND CARE OF EXPLOSIVES

Practically all the states and most cities have laws regulating the transportation, storage and use of explosives. Those in charge of tunnel work will do well to become familiar with all such laws applicable in the locality of the project and govern themselves accordingly. Furthermore, there are many safety rules and regulations that apply to explosives. The Institute of Makers of Explosives, 103 Park Ave., New York, has compiled a list of common-sense rules in handling of explosives, available upon request. Remember that explosives are dangerous unless handled right. Never take chances, and never let familiarity breed contempt of possible disaster. The Institute of Makers of Explosives and all explosive manufacturers are glad to give advice and help in the use of their products.

Transportation.—The transportation of explosives and the amount that can be moved and stored at one time are regulated by law, especially in populous communities. In many places the manufacturers will deliver direct to the job to meet daily requirements. A cardinal rule in transporting explosives is to keep the

dynamite and detonators in separate loads. This also applies to dynamite and primers—dynamite sticks in which the detonating caps have been placed—in transportation from the job magazines to the point of blasting.

When transporting explosives on public highways, the vehicle should carry warning signs or red flags and must be operated with care, avoiding heavily traveled routes and congested areas as far as possible. Wiring on motor trucks used for moving dynamite should be heavily insulated and placed in locations away from the cargo.



FIG. 302.—Magazine and explosives car used on Colorado River Aqueduct tunnels. (*Metropolitan Water District Photograph.*)

Magazines.—Dynamite and exploders should be stored in dry, ventilated, bulletproof and fire-resistant magazines, away from other buildings, railroads and highways. In the absence of local regulations, a safe distance in locating magazines from other buildings, highways, etc. is: up to 5,000 lb., detached; 5,000 to 25,000 lb., 200 ft.; over 25,000 lb., 200 ft. plus $2\frac{3}{4}$ ft. for each additional 1,000 lb. Dynamite and exploders should not be stored together.

On large tunnel jobs in congested areas, an underground magazine is desirable, driven off the tunnel heading near the bottom of a shaft. Figure 303 shows the type of underground magazine required by the New York Board of Water Supply on its large aqueduct tunnels in the New York City area.

Outside magazines to meet safety requirements can easily be built. Foundations are of concrete, stone or brick, upon which

a raised wooden subfloor is built for ventilation purposes. Double wooden walls filled with 6 to 12 in. of sand are bulletproof, and the roof should be of the same construction if it is exposed to

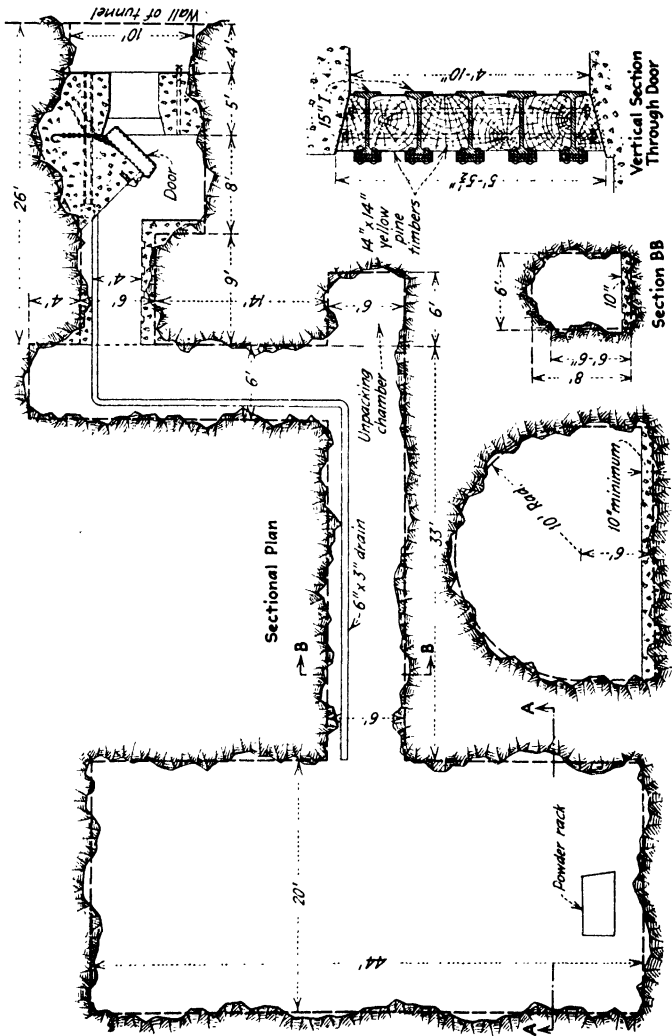

Fig. 303.—Underground storage magazine used in inhabited areas, New York City water tunnels. Door will close automatically in case of explosion.

rifle fire from above; otherwise a metal-covered wooden roof is satisfactory. A wooden door clad with $\frac{3}{8}$ -in. steel plate is bulletproof. Doors should be securely padlocked and the keys entrusted only to responsible parties. Be sure that stray

exploders and loose sticks of dynamite do not fall into the hands of children or persons not authorized to handle them.

Most modern explosives used in tunneling are low-freezing; but if dynamite does become frozen, do not use it until it is thawed out, as it is liable to explode prematurely or to cause misfires. To thaw large quantities of frozen explosives, use an isolated steam-heated chamber, where the dynamite can be spread out on racks away from the radiators. Small quantities may be thawed out in double jacketed containers by first pouring hot (not boiling) water, that has been heated outside of the container, into the outer compartment and then placing the frozen explosives in the dry inner compartment.

PRIMING

Open the wooden dynamite cases with wooden mallets and wedges only; never use metal tools. Avoid gouging or breaking the cartridges and spilling their contents.

Firing the shots with electric detonators is now standard practice on tunnel and shaft work, entirely replacing the older fuse and blasting cap method of firing. Electric detonators are much more certain and safer, are waterproof if desired, and permit successive firing of holes or groups of holes in a round through the use of delays. Though electric detonators are safer than the fuse blasting cap, they must be handled with care. A sharp blow may explode them, and a jerk on the wires may break the electric bridge within the detonator or pull a wire loose. They come with their leg wires in an accordion fold or spiral winding, which can easily be pulled out straight. The "smart" practice of snapping the wires to unfold them is too dangerous to be tolerated.

Correct preparation of the primer—the cartridge containing the detonator—is essential to successful blasting. Two basic rules govern all methods of making up the primer: (1) placing the detonator well within the cartridge and parallel to its axis so that the full force of the exploder is directed against the mass of the powder and not against the stemming or the walls of the hole, and (2) protection of the exploder from accidental firing and the wire from injury. There are numerous methods of making up the primer, but those shown in Fig. 304 are satisfactory and common for tunnel work.

In priming small cartridges, trouble may be experienced with the standard methods especially with the larger delay exploders. In such cases the cartridge may be primed by splitting it length-

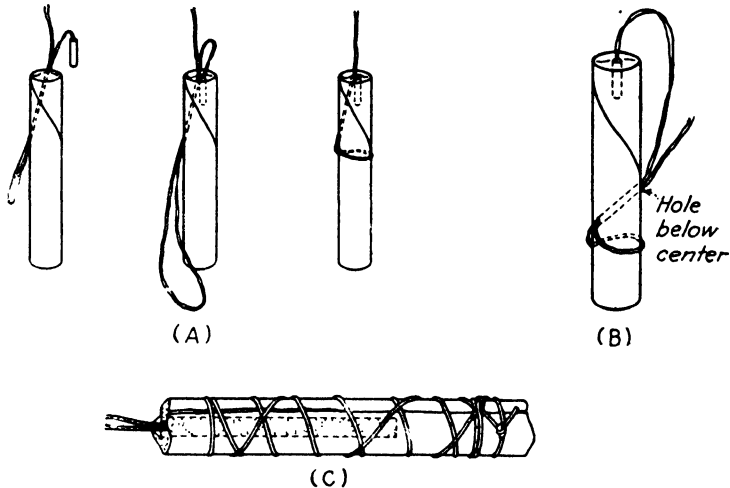

FIG. 304.—Methods of making up primers with electric detonators. A, instantaneous or first delay caps; B, longer delay caps; C, long delay caps in small cartridges, requiring splitting of the cartridge.

wise and laying the exploder in the slit, as shown in Fig. 304, then binding the cartridge tightly with cord. The wax lining paper from inside a box of dynamite may be used as additional wrapping.

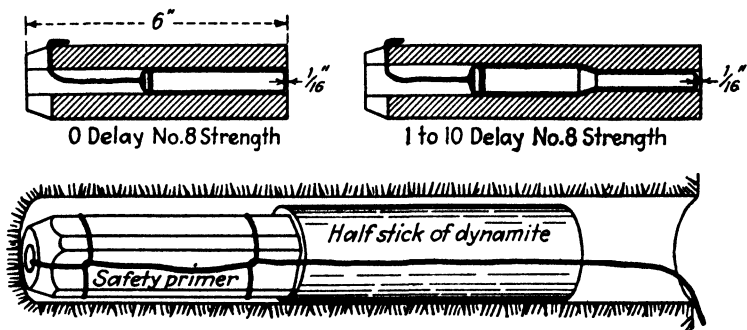

FIG. 305.—Wooden-plug safety primer.

A special type of primer—a wooden plug cored to receive either instantaneous or delay detonators—has been developed on tunnels driven for the Los Angeles water system. As shown in

Fig. 305, the primer is placed at the bottom of the hole, exploder pointing toward the charge, followed by a half stick of dynamite in contact with the face of the plug.

When any dynamite other than the gelatins, which are waterproof, is used in wet ground, the openings in the cartridges should be sealed with grease or with a waterproof compound made for the purpose by powder manufacturers.

LOADING AND STEMMING

Just before loading is started, each hole must be blown out with a high-pressure air jet to remove loose cuttings and water. Then, as a matter of safety, all light and power lines are taken down and moved back at least 500 ft. from the face before the dynamite and primer cartridges are brought up to the point of loading. This is very important for two reasons: (1) there is always a possibility of current leakage in the electric circuit that might cause the electric detonators to explode prematurely; (2) the electric lines must be moved back far enough to escape damage by the blast. In tunnels equipped with drill carriages, the holes are often loaded from the carriage platforms. All light and power lines must be disconnected from the carriage, even though the lights are turned out; otherwise the carriage framework may be charged with stray currents sufficient to explode an electric detonator. Remember the detonator leg wires are bare or lightly insulated and thus are susceptible to stray currents.

For lighting the face during loading, some contractors use powerful flood lights, hooked to the light wires, but set far back from the face. A better practice, which keeps the light lines entirely out of the loading zone, is to use flood lights hooked to the storage batteries of an electric locomotive. However, some of the contractors on the Delaware Aqueduct tunnels in New York are using safety flashlights fastened to the hats of the loading crew as the safest possible method of lighting the face.

Never use any but the new safety type flashlights, either hand or cap model, in the loading zone, or better yet, any place on a tunnel job. These have rubber-covered, waterproof cases, fully insulated. A premature explosion on the Quabbin Aqueduct tunnel in Boston, in which five men were killed, was attributed to the use of ordinary metal-case flashlights causing a short circuit in an electric blasting cap.

Although tunnel men all have their pet methods of loading a hole, the accepted practice is to place the primed cartridge next to the bottom—first insert a full cartridge, tamped well into the bottom, then insert the primer, with the detonator pointed toward the collar of the hole, shooting into the main charge of dynamite. The primer and the next-placed cartridge are tamped lightly to prevent jarring of the detonator. Then the remaining cartridges are tamped firmly into place. In loading gelatin dynamite, the wrapping of the cartridges, except the primer, is slit lengthwise to permit more complete filling of the hole. A wooden pole—never an iron rod or pipe—is used for tamping. Care must be used in tamping to prevent breaking of the detonator wires.

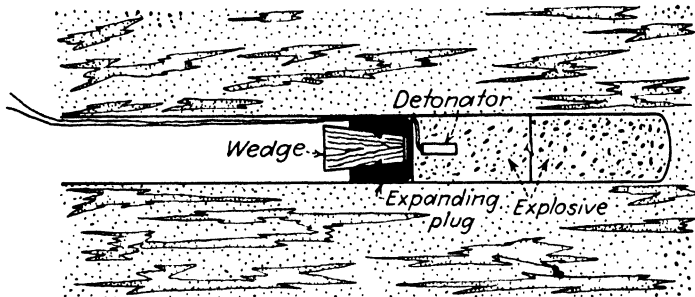

Fig. 306.—Heitzman patented rubber plug for stemming a blast hole.

Stemming—that is, filling the remainder of the hole not occupied by explosives with an inert material—is recommended by all explosives experts to obtain the full force of the blast, though many tunnel men consider the practice unnecessary. A damp mixture of sand and clay, packed in paper bags supplied by powder makers, is a satisfactory stemming material, although loose material may be used. Free running sand is often used on down holes, but health authorities now frown on the use of sand as adding additional silica dust to the tunnel air after the blast. The Heitzman patented plug, Fig. 306, a rubber plug with a wooden core, is popular on many tunnels. This device provides a tightly sealed hole with little trouble and expense. When sand or a sand clay mixture is used for stemming, a wad of paper should be placed against the charge of explosives as an indicator of the powder location in case of misfire.

DELAYS AND WIRING

A varying sequence in firing of the shots in a round is obtained by use of delay exploders. The exact arrangement of the delays depends upon the method of attack—heading and bench or full-face, and the drill-hole pattern, as discussed in the previous chapter. In general, instantaneous or zero delay exploders are placed in the cut or center group of holes to first pull out the core. First, second and higher delays are placed in their numerical order radiating out from the center to break down concentric rings of the rock toward the core in successive order. The outer or rim holes carry the longest delay shots, and those on the bottom are usually fired later than corresponding holes in the sides and top, a procedure that aids in keeping the muck from

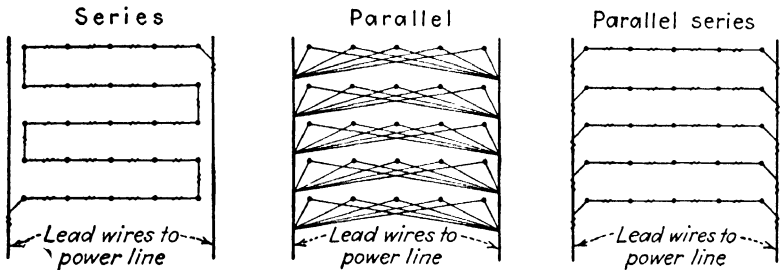

FIG. 307.—Diagrammatic sketch of three circuits used for blasting hookups. Parallel and parallel series are most common.

flying too far from the face. Arrangement of delays in several typical cases is shown in the previous chapter. Arrangement of delays, like amount of dynamite to use, and the hole pattern, is best determined by experience with the particular rock being encountered. The amount of powder required varies greatly, with ground and other conditions, from 2 to 11 lb. per cu. yd. of rock in place.

Circuits.—Blasting circuits may be divided into three general classes as illustrated in Fig. 307. Series, parallel, and parallel series. In a series circuit, the leg wires from adjacent holes are so fastened together that the path of the current is through each cap in succession. Of course, the speed of the current is such that the ignition of all caps is practically simultaneous; the current passes through the entire circuit long before the first cap explodes. This is a preferred circuit for a small number of caps.

However, most tunnel blast circuits are hooked up in parallel or parallel series. In the parallel circuit, each of the two leg wires is fastened to separate leading wires of the main circuit. When groups of series connections are connected in parallel, the circuit becomes a parallel series. This type of circuit is becoming popular for large tunnel hookups.

During making of the primers and loading of the holes, the two leg wires of each detonator are kept twisted together to short-circuit them and prevent possible premature ignition from stray

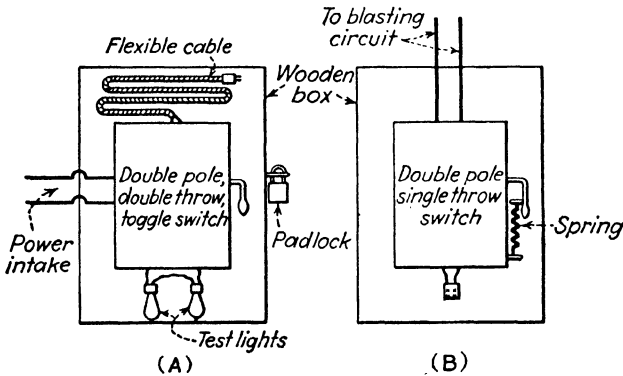

FIG. 308.—A safe blasting switch arrangement. The flexible cable on the power intake box A is plugged into the switch in box B just before the blast is fired by throwing switch B. The lights in box A are used to test the power line but are not in the circuit when the blast is fired, as the double-throw switch is closed on the flexible cable side.

currents. After the holes are loaded, the first procedure—for parallel circuits—is to stretch two bare bus wires of No. 20 wire across the tunnel from 3 to 6 ft. from the face. For parallel series circuits, one pair of bus wires is required for each series. These are held by wooden pegs driven into drill holes. Then the individual leg wires are hooked to the bus wires in proper order, care being taken to make the splices tight. Bus wires and all connections must be kept free of the ground and out of all water. In parallel series circuits it is important to place about the same number of caps in each series.

After all connections are made, the circuit should be checked with a blasting circuit tester, a type of galvanometer. This instrument, a magnetic device, has two contact posts for connection with test wires. In testing, a pointer on the face of the

instrument will move if the circuit is complete and ready—the weak current of the instrument passes through the circuit, but is not strong enough to set off the detonators. If the pointer does not move, a break in the circuit is indicated. The break can be found by testing the individual circuits. No attempt should be made to fire the round until the circuit has been tested.

Next the bus or connecting wires are spliced to the two main lead wires that carry the firing circuit. Of course there is a switch in this line, locked open, at the shot firing station. These main connections must be made thoroughly, as they carry a heavy charge. The lead wires, for safety's sake, are carried on the side of the tunnel opposite the location of the light and power line. Lead lines should be No. 14 or heavier, insulated wire.

The location of the firing station must be one of safety. In short tunnels or where the heading is short, the firing switch should be located outside of the tunnel—at the top of shaft, or outside the portal clear of possible flying rock. In long headings, the switch should be at least 1,000 ft. from the face, though 1,400 ft. is safer. A shot firer and his assistant standing 1,240 ft. from the face were killed by flying rock in Water Tunnel No. 2 in New York, incredible as it may seem.

A satisfactory and safe firing switch is shown in Fig. 308. This is a double switch, the first—connected to the power line—is a double-throw switch, one side for testing the power circuit through lights, the other side for closing the circuit to the second switch. The second switch is a single-throw, kept in locked open position. The switch box was large enough to permit a rapid throw of the switch without danger of barked knuckles. When the charge is ready for firing, the power circuit is tested, then closed at the first switch. Then two leads from the live circuit of the first switch are plugged into the second switch. Rapid closing of the second switch fires the shot.

Whatever the firing switch arrangement may be, it is essential that the switches be kept locked in open position and the keys entrusted to only one man—the man responsible for firing the shot.

Current for firing the blast is usually obtained from power circuits. Most tunnel men prefer a 440-volt current when available, though 220 and even a 110-volt lighting circuit is often used. For occasional shots, and sometimes on small, short tunnels, a

blasting machine is used to fire the shots. These are small electric generators, operated by hand, and their capacity in number of caps is plainly marked on each machine. It is folly to try to fire more caps in a round than the rated capacity of the machine, for misfires are almost certain to result. On the Carlton Tunnel in Colorado firing from the 110-volt battery of the storage-battery locomotive is proving successful.



FIG. 309.—Safety blasting switch on the Colorado River Aqueduct tunnels. The arrangement is similar to that shown in the previous illustration, with the switch boxes located on opposite sides of the tunnel. (*Metropolitan Water District Photograph.*)

Electrical Resistance.—Those responsible for handling explosives should know how to figure the electrical resistance of a circuit in order to determine the amount of current required to fire the shot without danger of misfires, or to determine if the current available is ample. The calculating procedure differs between series and parallel hookups. Examples will be given of both. Ohm's law $E = IR$ (voltage = current \times resistance) is the basis of both calculations.

To fire a series circuit, a current of at least 1.5 amp. is required, though some authorities call for 2 amp. The resistance of electric blasting caps and various types of wire used in the circuit is given in the chart, Fig. 310. Consider a series of 6 regular and 20 delay caps, all with 12-ft. leg wires; these are connected directly to

leading wires 500 ft. long. From the charts, the resistance of the circuit is calculated as follows: 6 caps at 1.5 ohms each plus 20 caps at 1.3 ohms each plus 1,000 ft. of No. 14 lead wire (two wires 500 ft. long) at 2.5 ohms per 1,000 ft. gives a total resistance of

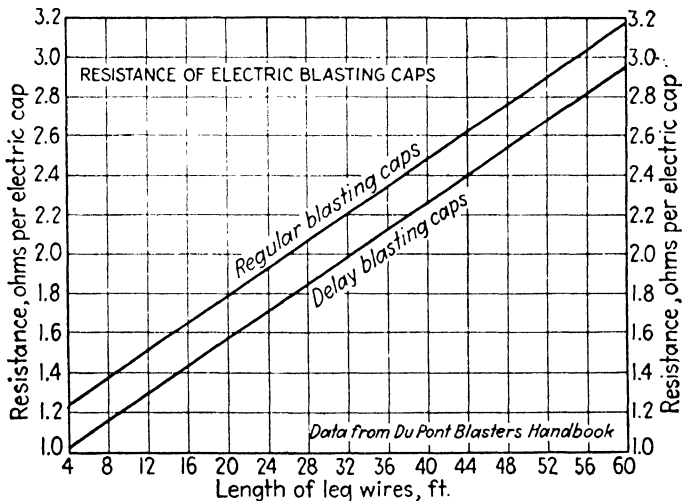
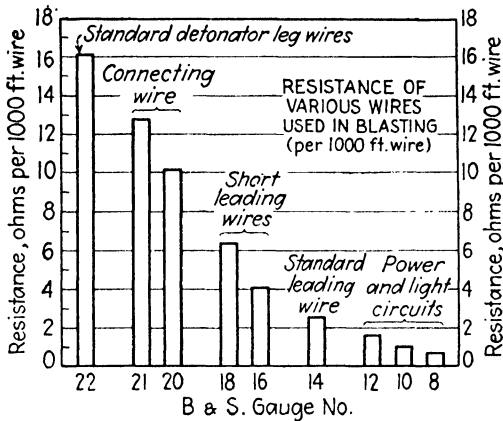

FIG. 310.—Electrical resistance of blasting wires and detonators.

9.0 + 26.0 + 2.5 or 37.5 ohms. Using Ohm's law, the voltage required to fire this blast is 1.5×37.5 or 56.3 volts. Thus the charge can be safely fired from a 110-volt light line. Either direct or alternating current may be used, but alternating current of less than 60-cycle frequency is not recommended.

A different procedure is used in calculating voltage requirements of a parallel circuit. In a parallel hookup, each blasting cap requires 0.6 amp. Consider the same charge as in the previous paragraph: 26 caps, but requiring, say, 100 ft. of No. 20 connecting wire in addition to the lead wires. Hooking the caps in parallel reduces their resistance to the extent that their total resistance is that of one cap divided by the number of caps. Therefore, the resistance of the caps in this circuit would be 1.5 ohms divided by 26, or 0.06 ohm; of the connecting wire (from the chart) $\frac{1}{10}$ of 10.2 = 1.02 ohms; of the lead wire, 2.5 ohms, same as before. The total resistance is 0.06 + 1.02 + 2.5 or 3.58 ohms. From Ohm's law, the voltage required to fire this circuit would be $26 \times 0.6 \times 3.58$, or 55.84 volts.

In figuring the voltage required to fire a parallel series circuit, consider each series in turn. Consider a circuit of eight series of five caps each, all with 12-ft. leg wires, hooked up through 200 ft. of No. 20 connecting wire to No. 14 lead wires 500 ft. long. As each series requires a current of 1.5 amp., the total will require 8×1.5 amp., or 12.0 amp. The cap resistance of each series is 5×1.5 ohms (from the chart), or 7.5 ohms. The total cap resistance in this hookup then is the resistance of each series divided by the number of series, or 7.5 divided by 8, which is 0.94 ohm. The connecting and lead wire resistance is $0.2 + 2.5$ ohms, or 2.7 ohms. The total resistance of the circuit becomes $0.94 + 2.7$ or 3.64 ohms. From Ohm's law, the voltage required to fire the round is 12.0×3.64 , or 43.68 volts.

By transposing the formula $E = IR$ to $I = E/R$, calculations can be made to determine if, with a known voltage, a circuit will get enough amperage to overcome the resistance of caps and wires.

INSPECTION AND HANDLING MISFIRES

As soon as the smoke has cleared away from a blast, the first thing to do is to inspect the results. All loose rock should be barred down before men are allowed to work in the newly-blasted face of the heading. Then a careful inspection of the face is made to check misfires—holes that have failed to explode.

Handling misfires is the most dangerous of all tunneling operations and must be done with extreme care by an experienced blaster. There are several ways to fire the unexploded shot.

If the leg wires are still intact, they may be hooked up to the firing circuit and the charge refired. Otherwise, if possible, the stemming is washed out by a water jet down to the explosive. Some blasters use an air jet for this purpose, but such practice is not recommended by safety experts who point out the danger of blowing part of the powder out of the hole into the muck pile, where it may be unexpectedly exploded later by friction in mucking out. When the hole has been cleaned to or almost to the charge, a new primer is inserted and fired. This will usually fire the entire charge in the hole. When Heitzman plugs are used for stemming, it is not necessary to remove the plug; simply insert the new primer against the plug, and the entire charge will fire. Another method is to drill a new hole about 2 ft. from the unfired hole, load and shoot. The shock will, in most cases, fire the unexploded charge. In such cases, it is wise to examine the muck pile for possible powder blown out of the old hole.

Familiarity breeds contempt, but smart tunnel men never let familiarity with explosives dull their respect for them. A little extra care and time in handling explosives, making the primer, loading, tamping, hooking up, checking and firing are well worth while in the light of the terrible consequences of a premature blast or the trouble and expense of a poor shot.

CHAPTER 21

GROUND SUPPORT IN ROCK TUNNELS

There is no practical method of estimating the ground pressures in rock tunnels that must be resisted by the timbering; therefore, analytical design of the ground support system is virtually impossible. Timbering in rock tunnels—the term applies to all types of ground support: wood, steel sections, liner plates—serves one or both of two main purposes: (1) as an “umbrella” to protect the workmen from spalling and falling rock loosened by blasting; and (2) support of larger masses of blocky or seamy rock whose natural support has been removed by excavation of the tunnel. In the latter case the important thing is to prevent the initial movement of the rock if possible. In both cases, of course, prevention of large or small rock falls reduces the amount of overbreakage.

The lagging, or support between the timber sets, must be tight for ground that slacks off in small pieces. In blocky or seamy ground, the lagging may be wide-spaced, or even eliminated, but the sets must be capable of supporting large blocks of rock.

GROUND PRESSURES

Pressures in Shallow Tunnels.—Where the depth of overburden on the tunnel is 500 ft. or less, pressure on the timbering is small or nonexistent. The heaviest possible load coming on the timbers is the weight of the “core” between the roof of the tunnel and the natural arch of the rock, plus the weight of the dry packing, which may be considerable in some cases. This is well exemplified in the St. Peter sandstone found around the twin cities in Minnesota, a soft, friable sandstone, remarkably uniform in composition. The roof of a tunnel through this ground will stand indefinitely if trimmed to a “Gothic” or pointed arch, Fig. 311; but if the roof is cut to any flatter arch, the central core must be supported immediately, or it will fall within a few hours. The load on such timbering can be roughly estimated.

Pressures in Deep Rock Tunnels.—In tunnels with an overburden in excess of 500 ft., rock under stress is apt to be encountered. The action of such ground varies with different formations. Sometimes the rock simply crumbles off slowly; again, the rock will suddenly spall or pop off, the spall flying across the tunnel with great force. Some types of rock will squeeze slowly into the tunnel, exerting tremendous pressure against the timbering. This squeezing pressure may be uniform around the entire perimeter, or it may be directed horizontally from one side only or only upward from the floor. In extreme cases of the last type of squeeze, as much timbering has been required to hold the floor down as to support the roof. Fortunately, squeezing ground is usually confined to short stretches of faulted, decomposed or fractured rock.

Often the true nature of squeezing ground is not recognized until after the excavation has passed through the zone and conventional timbering has been placed. Several days, even weeks, may elapse before sufficient pressure is built up to distress the timbers.

By that time, the ground has had a chance to “work,” and much more timbering will be required than would have been necessary to keep the ground from working in the first place.

In some types of squeezing ground, especially if the flow of rock is very slow, no attempt is made to install timbering sufficient to resist the ground pressures. Instead, crushing blocks will be placed between timbering and the rock, and, as they are demolished by the squeeze, they are removed and the rock trimmed back a ways; then new crushing blocks are placed.

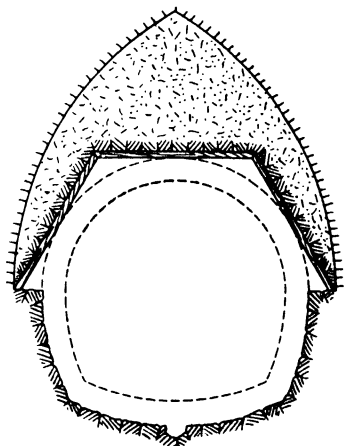

FIG. 311.—Natural arch in sandstone.

DESIGN OF TIMBER SUPPORTS

Design of timber supports follows accepted practice, modified by the size of the job and probable ground conditions. A timber is most efficient when carrying its load in end-grain compression.

sion; therefore, designs which carry the load by bending or side-grain compressions should be avoided as much as possible.

Allowable end-grain compression on most woods is 1,000 to 1,200 lb. per sq. in., while side-grain compression on soft woods is only 350 lb. per sq. in. Thus the wall plate or the foot block will first fail by crushing, Fig. 312A. White oak has a side-grain compression of 600 lb. per sq. in., but dimension timbers of this wood are scarce and expensive. In bending, a maximum fiber stress of 1,600 lb. per sq. in. may be used. For columns, when

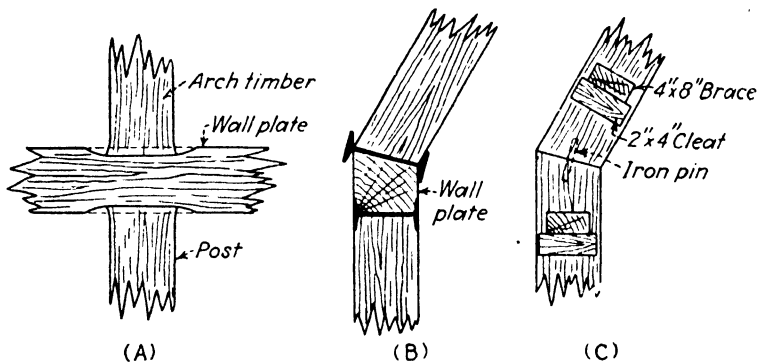

FIG. 312.—Typical joints between posts and arch timbers. A, post and rib in direct bearing on side grain of wall plate, wall plate subject to crushing. B, armored wall plate, posts and ribs bear against webs of steel beams. C, wall plate eliminated, posts and ribs in direct bearing; dowel pin keeps them from slipping; braces between sets are required to provide longitudinal stability otherwise given by wall plate.

the unbraced length is greater than 16 times the least dimension, the unit stress must be reduced by multiplying by the following formula:

$$f = fw \left(1 - \frac{L}{60d} \right)$$

where L is the unsupported length in inches and d is the least dimension.

The most efficient joint for tunnel supports is shown in Fig. 312c, in which the timbers butt and transmit their load in end-grain compression. This joint is always used between segments of the arch, but its use between the arch and the post is only practical in full-face mining, Fig. 313, where the post can be set first.

Spacing of sets depends upon the load and may vary widely in any tunnel from skintight to a maximum of about 8 ft. Usually the spacing will be increased or decreased as, in the opinion of the engineer or superintendent, the need for support changes.

Selecting the System.—The choice of timbering system depends upon the size and shape of the tunnel, and the method of

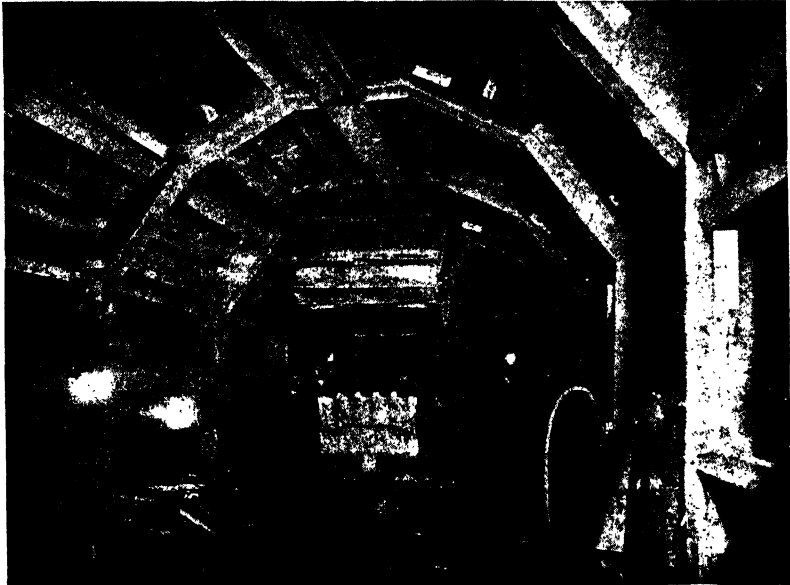

FIG. 313.—Five-piece arch sets in treacherous shale, full-face mining, Fort Peck Dam tunnels.

attack (see Chap. 18). Where the tunnel is driven by the heading-and-bench method, a wall plate is required between the roof timbers and the posts. The wall plate is of considerable aid in placing the plumb posts when the bench is being taken out, for it will bridge (if the load is not too great) between the bench and the last plumb post, simplifying the underpinning.

In tunnels driven by the full-face method, the full timbering set can be erected at one time and the need of a wall plate is eliminated, Fig. 313. Many types of ground need not be supported for a week or two after they have been opened, in which case the timbering can be placed by a single gang following several hundred feet behind the miners, working from a timbering jumbo.

Cap and Post.—The simplest system of timbering for small rock tunnels is the cap and post, or square set, as shown in Fig. 314A. This type of support is simple to frame and easy to erect, but it has the disadvantage of not following the outside contour of most tunnels and thus requires an excess of concrete in the final lining. It is rarely used on tunnels of greater rough dimension than 8x8 ft., since the cap will fail by bending under much of a load.

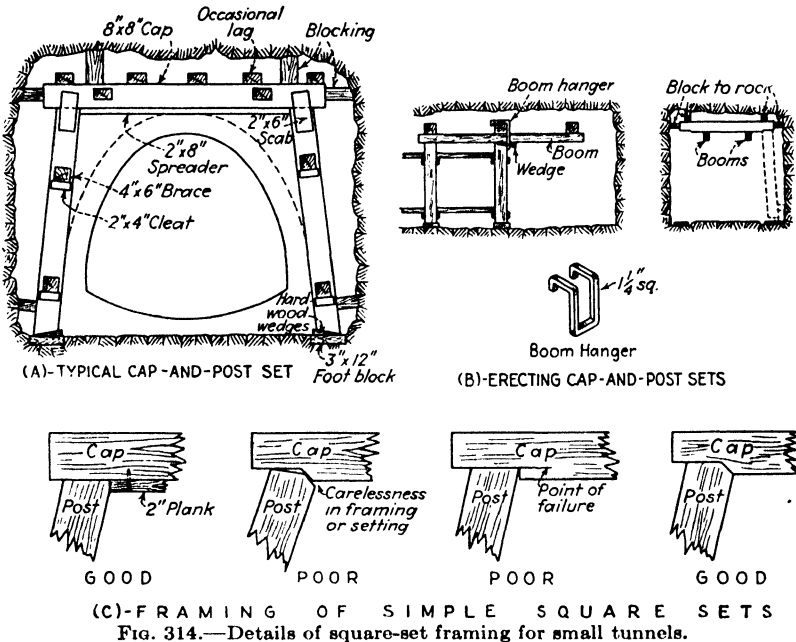

FIG. 314.—Details of square-set framing for small tunnels.

The standard method of erection of square sets is shown in Fig. 314B. The cap is supported on temporary “booms” projecting from the last set while it is being blocked to its correct position. The posts are then set and tightly wedged from the foot block, thus prestressing the entire set. All sets must be well braced to each other to prevent shifting under load or kicking out during the blast.

Three-piece Arch.—The three-piece arch set, Fig. 315, is common in medium-size tunnels. This type can be erected without a wall plate, the foot of the arch being supported on a hitch cut in the side walls.

Five-piece Arch.—The five-piece arch set is very common on larger tunnels, particularly on railroad work. Figure 316 gives the framing dimensions of the 12x12-in. timbers on a recent single-track tunnel. Spacing of the sets varies with the anticipated weight of the ground from 6 ft. to skintight, but a 5-ft. spacing is typical for most jobs.

Jump Sets.—Jump sets are placed between the regular sets when there are indications of overload. The original design of

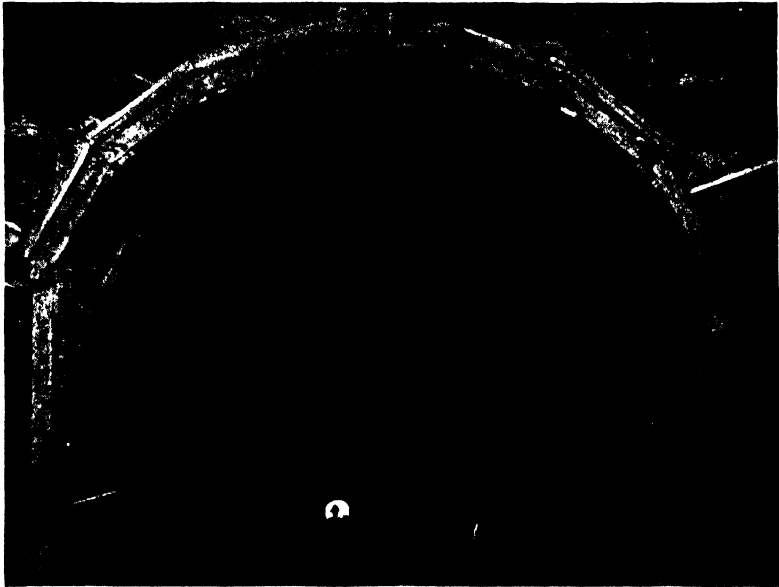

FIG. 317.—Seven-piece arch sets for double-track railroad tunnel, Chesapeake & Ohio Railway. (Courtesy of E. G. Rice, Chesapeake & Ohio Railway.)

timbering should be based on the possibility that occasional jump sets will be required, and the adopted design should be such that these auxiliary sets can be placed quickly and safely. Generally the jump set is made about 2 in. smaller in outside dimensions than the regular sets, so that they can be erected from the inside. Wedges are driven to take part of the load from the lagging and to relieve the adjacent sets.

Segments.—Segments, or caps, should not be too long, since it is best to carry the load under arch action rather than beam action. When possible, all segments should be sawed alike to make them fully interchangeable.

Needless to say, cutting and framing must be carefully done in order that the timber joints will fit tightly when erected in the arch. As the actual dimensions of timbers will vary from the nominal dimension by $\frac{1}{2}$ in., more or less, a working point on the template is necessary for uniform length and bevel, and the timbermen must work to this point when erecting the segments.

Wall Plate.—The wall plate, or longitudinal beam at spring line supporting the arch ribs, is the weak link in timber lining,

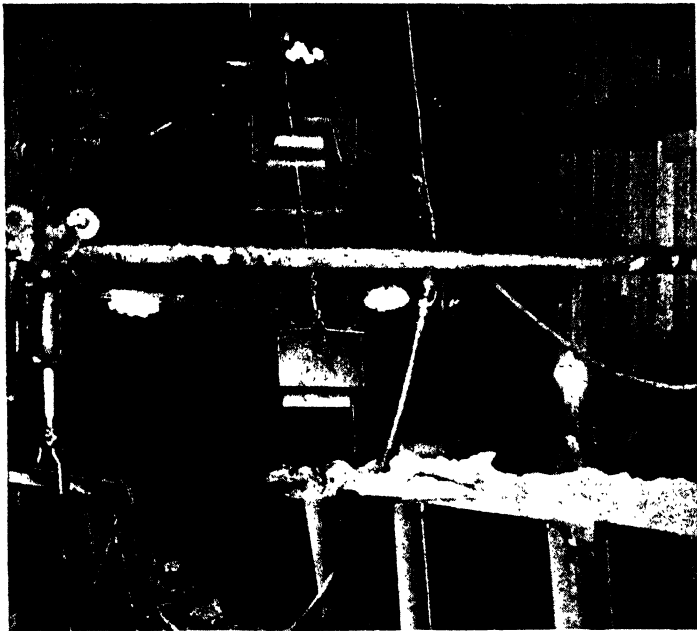

FIG. 318.—Skintight timbering and steel wall plate in heavy ground, Moffat Tunnel. In the background is the rear end of the Lewis traveling cantilever designed to support the wall plates while the bench was excavated and the plumb posts set in place.

but it is an essential part of the ground support in tunnels driven by the heading-and-bench method. The plate should be of selected sound timber, and as great a length, in multiples of the arch rib spacing, as can be placed.

Sometimes, in case of excessive pressure on the timbers, a single I-beam is used for the plate, Fig. 318, and the timbers are set skintight. Another type is the armored plate, shown in Fig. 312*B*, which consists of a timber placed between two steel

I-beams. It must be remembered that a single I-beam, placed with web horizontal, is weak in bending and will not safely bridge the gap if one plumb post is shot out or becomes loose.

Timbering is part of the permanent lining. If it is to be correctly set, line and grade must be established for the timbermen. Customary practice is to set the wall plate from 2 to 6 in.



FIG. 319.—Five-piece arch sets with tight lagging. Note the inclined posts to resist possible horizontal pressures.

high to allow for “take-up” of the joints and for settlement under load.

Posts.—Posts are generally of dimension timber, but round poles may be used. Usually they are set plumb; but when there is possibility of side pressure, the posts may be inclined to resist it, Fig. 319.

The tops of the post should be doweled or scabbled to the wall plate, so that in case the foot blocks yield, the post will not fall out before it can be wedged up again.

Foot Blocks.—Foot blocks are an often neglected detail. These blocks are of selected 4 or 6 in. lumber and must be carefully

set and bedded before the plumb post is raised. The general practice is to drop a plumb bob from the wall plate to locate the center, then tape (or use a measuring rod) downward from the plate to establish the elevation of the block. If the bottom of all posts is cut with a bevel to match the wedge, then the foot block can be leveled in both directions with a carpenter's level.

The wedges, not more than 6 in. wide, must be carefully sawed with an even pitch of 1:12 or $1\frac{1}{2}$:12. The wedges must be driven tight and with full bearing on the foot block, which prestresses the entire ring of timbering.

✓ **Collar Bracing.**—Lack of sufficient collar bracing is probably the greatest source of trouble in rock support, either wood or steel. Braces are generally 4x6 in., resting on cleats, and toenailed to the timbers. There should be a brace at each joint of the arch to prevent the segments from twisting out of line. The plumb posts are particularly vulnerable to heavy blasting; they should have a collar brace top and bottom and one or more intermediate struts.

✓ **Lagging.**—Lagging in large tunnels is generally of 3- or 4-in. planking laid on top of the segments. The greater the spacing of sets the heavier the lags must be.

Where the arch is packed with spalls or lean concrete, the lagging must be placed tight to retain the fill; but where the sets are blocked to the roof, the lags may be widely spaced, as their only function is protection against falling small pieces of rock.

In some cases the lagging is spiked to the inside face of the segments. This method has several advantages. It means less excavation, since the dry packing is placed between the timbers rather than outside them. Also, the lagging acts as an outside form for the concrete lining which may save a great deal of concrete. Its big disadvantage is that the lagging must be held by spikes in tension; a failure of one nail may start a serious run of the dry packing. Use of a jump set is practically impossible with inside lagging.

Tight lagging is rarely used on the sides outside the plumb posts, but usually an occasional lag on the side is necessary to prevent slabs from falling into the tunnel.

Packing.—As soon as the arch timbering has been erected, it should be well blocked from the rock, Fig. 315. Then the wedges at the foot blocks may be driven to refusal without dis-

torting the arch. This stresses the set uniformly and gives immediate support to the rock. Blocking should be used even when the arch is to be dry-packed, since uneven placing of the packing may shift the timbers.

Dry packing consists of fine muck shoveled behind the lagging as it is placed. Packing at the crown must be thrown in from the end and then well rammed. To develop the full efficiency of the timbers, the space outside the arch must be completely filled. Unfortunately, this is a tedious and disagreeable job and is seldom done properly.

In case of an excessive overbreak, it is common practice to fill the void by laying up a dry wall of "one-man stone." In pressure tunnels, specifications generally call for two grout pipes to be placed in the dry wall, one at the top and one at the bottom. After the concrete arch has been placed, grout is forced through the lower pipe until it appears at the top vent pipe.

Packing of very lean concrete, 1:3:6, or even 1:4:8, is sometimes specified. This can be shot into the arch with a pneumatic placer providing the sets are well blocked. This concrete must be very dry, or else it will leak out through the cracks of the lagging.

Wood packing outside the arch consisting of slabs, poles, and cordwood wedged into the space, was used much more in the past than at present. It is lighter than dry packing and easier to place, but it will eventually decay and leave large voids outside the tunnel, inviting rock movement. It is of real value in squeezing ground, since the wood acts as a cushion to delay failure of the sets.

Portal Bracing.—Many engineers overlook the fact that there may be a horizontal force on the sets at the portal if the cut starts to slide. This possibility should be guarded against by inclined rakers, Fig. 320, against the first set. Some kind of parapet over the portal is necessary to catch loose rocks rolling into the cut.

Permanent Timbers.—Railroads sometimes postpone placing of concrete lining in tunnels for 10 to 15 years by depending upon the timber ground support as lining for that time. In case of deferred placement of the concrete lining, a concrete footing course, 2 to 3 ft. high, should be placed around the bottom of the plumb posts to check rotting of the posts and loosening of the

foot blocks. Timbering should be inspected at least twice a year by the engineering department for wet rot, dry rot, crushing, and shifting. The use of creosoted or other treated timber may be well worth while under these conditions. Once the timber starts to go, the concrete lining should be installed. Usually it is cheaper to concrete, even in piecemeal schedules, than to retimber.

Many timbered tunnels are a serious fire hazard. Adequate fire-fighting equipment should be installed at the portals, and

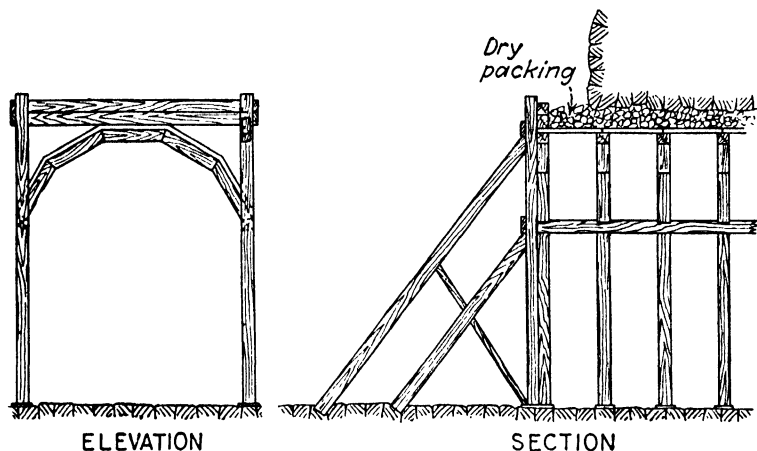

FIG. 320.—Typical portal bracing.

the tunnel should be patrolled by a watchman after passage of trains.

STEEL TUNNEL SUPPORT

In the last decade, steel supports have become very popular in rock tunnels. There are many advantages in their use, the greatest being that, even for quite large tunnels, the ribs may be of only two pieces, which simplifies and expedites erection.

The next big advantage is in the saving in excavation. For a strength equal to wood supports, steel ribs need be only about half as thick. Most specifications permit all or part of the steel rib to project within the outside neat line of the concrete lining, considering it as reinforcing. On small tunnels, this saving in excavation may run as much as 30 per cent, while the saving in concrete will be about 50 per cent.

Steel ribs have certain disadvantages, the most serious being liability to damage from blasting. Old-time tunnel men claim they are not so safe as wood, since they have no "groaning point" to give audible warning of overload or stress.

Design of Steel Ribs.—Steel ribs are generally designed to a unit stress of 24,000 lb. per sq. in. The ribs are rolled to the radius of the arch, usually in two sections with a plate at the

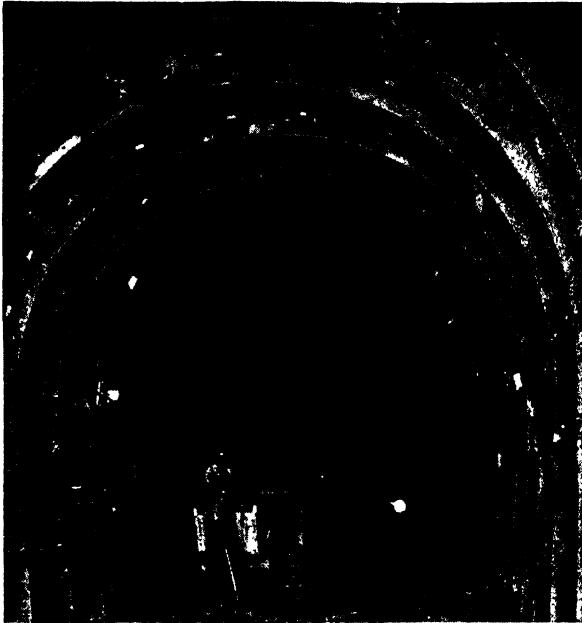

Fig. 321.—Typical steel supports with wood lagging and collar bracing, Colorado River Aqueduct tunnels. (*Metropolitan Water District Photograph.*)

crown end of each section for a butt joint between the two legs. The rib segments should straighten out near the crown joint to assure that the joint is entirely in compression. If a joint is necessary in the ribs at any point other than the crown or spring line, it must be designed to transmit the full bending stresses, yet be as simple as possible for speedy assembly. The rule of thumb for design of steel ribs in ordinary rock tunnels is to make the ribs 1 in. in depth for every 3 ft. of tunnel diameter, when ribs are spaced from 4 to 5 ft. apart.

Whenever possible, the ribs and legs should be in one piece, Fig. 321, separated into two halves with a butt joint at the crown.

In large tunnels the two-piece ribs become too big and heavy for economical erection by hand, and in other cases the heading-and-bench method may require a joint at spring line, thus requiring a wall plate.

Wall Plates.—Two types of wall plates for steel supports are shown in Fig. 322. The most common type consists of a single

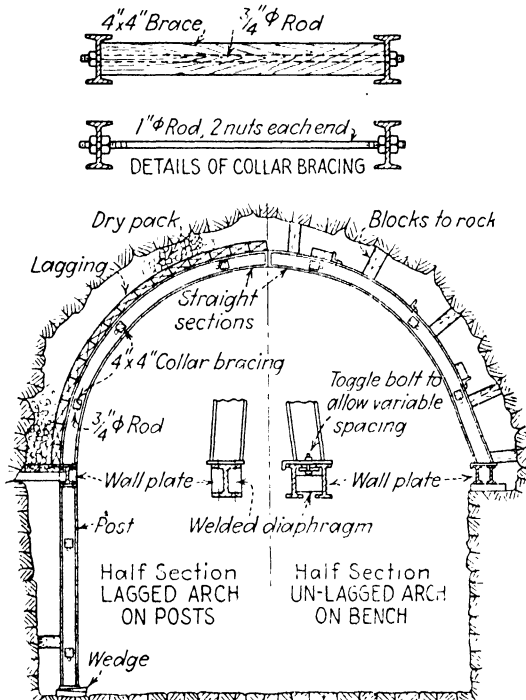

FIG. 322.—Steel rib supports with wall plates.

H-beam with holes in both the upper and lower flanges for bolting to the ribs and posts. Diaphragms should be welded to the web at all rib seats, for single beams sometimes have failed by twisting from the horizontal component of the rib thrust. Extra holes should be punched in the wall plate at half the regular spacing for installation of extra ribs when necessary.

Another type of wall plate is also shown in Fig. 322, consisting of two I-beams tied together by welded diaphragms, a better design to resist twisting. The ribs are not bolted directly to the beams, but to a toggle plate fitted between the flanges. In this

system the ribs can be spaced as desired. A lug or cleat must be welded to the bottom plate to transmit the horizontal thrust.

Posts.—Posts in rock tunnels rarely resist any appreciable amount of side pressure, and therefore can be designed as columns, the unit stress being reduced in conformity with the formulas for the ratio of slenderness, which will govern the theoretical spacing of the collar bracing.

H-beams are more efficient than I-beams as posts, as they require less lateral bracing to carry a given load; but frequent



FIG. 323.—Forepoling dry running ground, Colorado River Aqueduct tunnels. Miners' scaffold is supported on pipes chained to ribs. (*Metropolitan Water District Photograph.*)

collar braces are required in any case to prevent the posts from buckling when struck by fly rock.

At the top of the post is welded a cap plate for bolting to the wall plate. At the bottom is a larger plate for bearing on the foot block.

Collar Bracing.—Steel ribs and posts must be closely collar-braced to each other, not only to reduce the slenderness ratio, but also as a protection against damage from blasting. The two most common types of bracing are shown in Fig. 322. The simplest, and best, consists of a 4x4-in. wood strut laid on top of a $\frac{3}{4}$ -in. rod. The rod is then tightened against the strut.

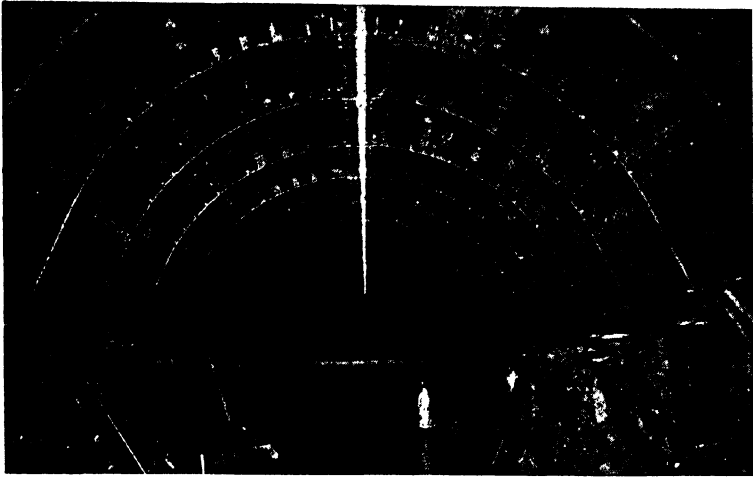

FIG. 324.—All-steel roof support, Delaware Aqueduct. Ribs of 8-in. I-beams, 40 lb., carried on wall plates made up of two 8-in. I-beams, 18.4 lb. Lagging is 6-in. channels laid flat.

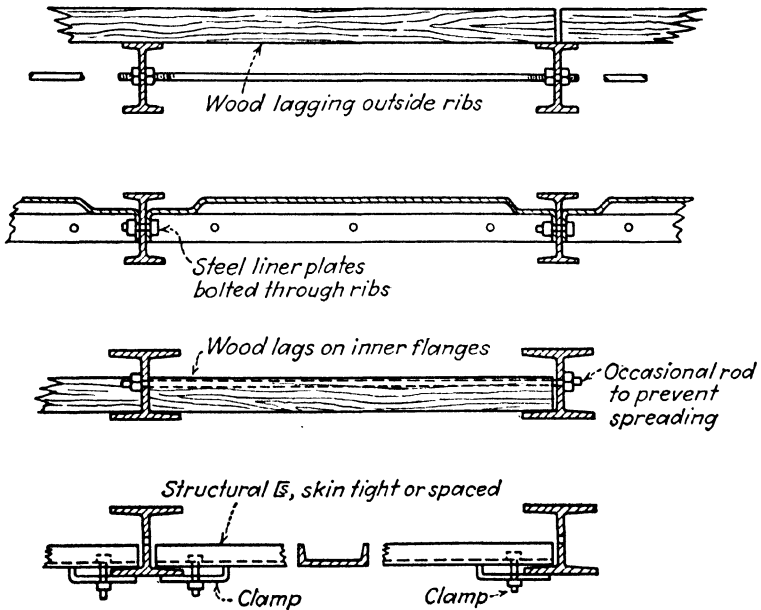

FIG. 325.—Various methods of lagging steel ribs.

Another type, where wood is not permitted within the neat line of the concrete, is a 1-in. rod with two nuts on each end. After the new rib is aligned, all four nuts are tightened so that the rod acts in both tension and compression. In all ribs and posts, pairs of holes should be punched in the webs, about 3 ft. apart for collar bracing.

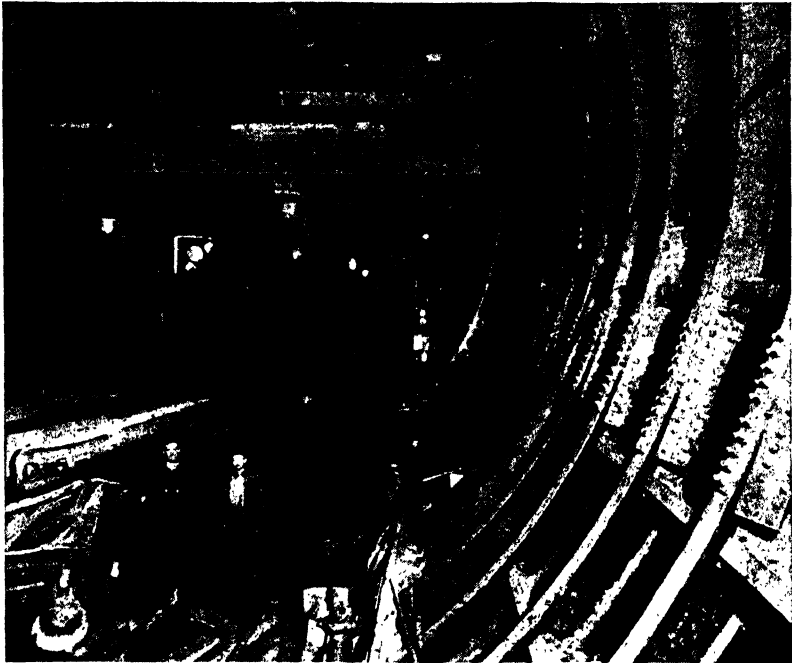

FIG. 326.—Steel supports for 32-ft. tunnels at Fort Peck Dam. No lagging was used on some sections; instead, two strips of 18-gage steel, 20 in. wide, were draped over the steel collar braces. Note the full-section splices in the ribs. In the background is the timbering jumbo with movable platforms for attacking the face. Three of the five segments could be assembled on a small carriage on the jumbo and then rolled forward when required; the two lower segments were handled by a chain hoist on an I-beam trolley.

In some cases, the collar bracing will be of 4- or 5-in. I-beams with clips at each end for bolting to the web. When the arch is supported by steel liner plates bolted through the web of the rib, no collar bracing is required.

Lagging.—The most common lagging for steel ribs is 3- or 4-in. planking laid on top of the ribs, Fig. 321. Steel liner plates are frequently used; these are generally longer than the standard

pressed plate used in soft-ground tunnels to correspond with the greater rib spacing used in rock tunnels. Sometimes the wood lagging is set against the inner flanges of H-beam ribs. Although no struts will be required between ribs in this case, there must be occasional tension rods to prevent the ribs from spreading far enough for a lag to fall out.



FIG. 327.—Shale painted with bituminous sealing coat to retain moisture and prevent air slaking, Fort Peck Dam tunnels. The atomizer, connected to the water line, maintained the air at a high relative humidity to retard evaporation from the exposed shale.

Structural channels, 6 or 8 in., laid flat, are sometimes used as lagging on H-beam ribs, Fig. 324. Ordinarily they are laid tight to retain the packing; but if they are widely spaced, some kind of clip, Fig. 325, will be needed to keep them from slipping down the rib.

In the Fort Peck tunnels, Fig. 326, through shale, the steel ribs were of 10 in., 29 lb. I-beams $3\frac{1}{2}$ ft. c. to c., collar braced by 5-in. I-beams at $3\frac{1}{2}$ -ft. intervals. These ribs were securely blocked to the shale and were not lagged. To prevent small

pieces of shale from falling through, two strips of 18-gage steel, 20 in. wide and 20 ft. long, were "draped" side by side over the collar braces of the arch.

PROTECTIVE COATINGS

Some types of rock and shale are subject to air slaking and will spall off after being exposed to the air for some time. Air slaking can be prevented by coating the freshly exposed surfaces with Gunitite or a bituminous compound. Usually a $\frac{3}{4}$ -in. layer of cement mortar is sufficient to seal the rock surface, but occasionally a second or even a third layer will be required. In cases where the ground is structurally sound but is subject to air slaking, application of Gunitite may eliminate the need for timbering.

Bituminous coating of the tunnel surface is satisfactory in ground, particularly shales, that air slake either by drying out or by absorbing moisture upon exposure to the air. The compound should be applied with a spray gun just as soon as possible after the fresh surface is exposed. Sometimes two or three applications of the compound will be necessary. Every bit of the surface of the Fort Peck diversion tunnels was treated with a bituminous compound upon exposure to the air, as shown in Fig. 327. Furthermore, the relative humidity of the air within the tunnels was maintained at 90 per cent by use of atomizers connected to the water supply line.

CHAPTER 22

CONCRETE LINING

The placing of the concrete lining in a tunnel is worth considerable study and careful planning. Even though the lining represents from 30 to 40 per cent of the cost of the tunnel, many tunnel superintendents still regard concrete work as something that can be done by the labor crews without much advance planning or supervision. In the last decade or so, many mechanical aids to placement of concrete lining have been developed. Their use eliminates the old backbreaking job of shoveling into the forms and greatly speeds up the rate of pouring. Improvements have been made in equipment and methods for mixing, hauling, and placing, and in form design and construction. Steel forms, applicable to most tunnel lining conditions, have become very popular in the past few years, for they have proved economical and easy to handle, and they leave the smooth finish called for in modern specifications.

GENERAL LINING PROCEDURE

Concrete lining procedure falls naturally into two main divisions: (1) rock tunnels and (2) soft-ground tunnels. However, these two classifications of lining procedure do not follow similar classifications in tunnel driving. As far as lining is concerned, rock tunnels include not only those driven through self-supporting and timbered hard ground, but also soft-ground tunnels that have been sufficiently timbered or otherwise supported so placement of concrete lining can be deferred until the driving is complete, or at least well along. Shield-driven tunnels fall in the latter class.

Soft-ground tunnel lining, on the other hand, is concrete lining that must be placed almost simultaneously with the excavation or immediately following excavation of a short advance. Tunnel driving by the needle-beam method is an example of conditions requiring immediate placement of the concrete lining.

Lining Rock Tunnels.—Usually, in rock tunnels, placing of the lining can be deferred until all driving operations have been completed. Therefore, the forms, placing equipment and general plan of procedure can be designed and planned to get the maximum progress consistent with the allowable investment, and no thought need be given to interference with drilling and mucking operations.

Sometimes, to save time in the completion of the project or to hold treacherous and heavy ground that threatens the temporary support system, concrete lining of a rock tunnel will follow along with the driving operations. For example, on a 1,500-ft. tunnel, driven and lined from one portal only, time may be saved in completion of the job by starting the lining before driving has been completed. Suppose the rate of driving is 15 ft. per day, requiring 100 days for the excavation, and that lining can be placed at a rate of 30 ft. a day. Waiting for driving to be finished before starting the lining means 150 days will be required for the job. However, by starting lining when the excavation is half through, the concreting could be finished along with the driving, theoretically saving 50 days in the completion schedule. Actually, the saving in time would not be so great, and the cost of both lining and driving would be somewhat increased, because of interference between the two operations.

Concreting Sequence.—There are three general methods of placing concrete lining in rock tunnels: (1) placing the invert first, then the side walls and arch; (2) side walls and arch first, then the invert; and (3) lining the entire perimeter in one operation.

The usual sequence is to place the invert first, then follow with the side walls and arch in the second operation. This method provides a firm base upon which to carry the arch forms and should result in a better job.

In recent years, however, a number of tunnels have been lined by placing the side walls and arch first, then the invert. Some economy is possible in this method, as it eliminates tearing up the muck track, pouring the invert and then replacing the track for the concrete trains serving the wall and arch lining. Also, it eliminates the final cleaning up of concrete slopped on the invert in the arch placing operation. When the invert is to be placed last, concrete pedestals should be cast to line and grade along each wall footing, about 10 ft. c. to c., to carry the wall

and arch forms. Otherwise, the forms are hard to align and hold on an uneven or soft muck foundation. The method of placing the invert last is better adapted to horseshoe or flat-bottom tunnels than to circular sections. In tunnels where there is considerable horizontal thrust on the timbering, the walls and arch should not be placed first, for the invert is needed to act as a transverse strut system to keep the walls from kicking in when the arch is poured.

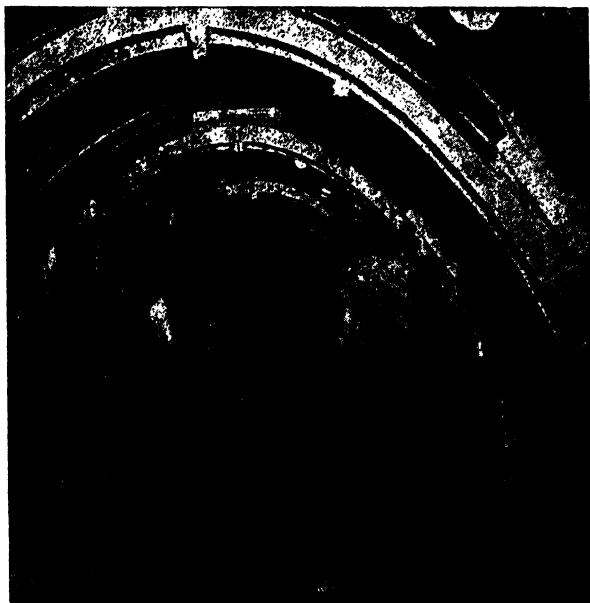

FIG. 328.—Placing concrete by hand, Chicago sewer tunnels. Forms are wood lagging placed behind steel ribs as sides fill up. Ribs rest on steel sills set to line and grade.

Lining the full section in one operation is possible only with circular or nearly round tunnels. The chief problem with this method is the support of the forms, which must span the full length of the pour without intermediate support. Usually in such cases the forms are carried on needle beams or trusses through the center, one end blocked up on the invert of the previous pour, the other carried on supports from the subgrade beyond the limit of the new pour.

Lining Soft-Ground Tunnels.—In soft-ground tunnels, the concrete lining is often advanced each day with that day's

advance in excavation; the usual procedure is to mine for two shifts and concrete on the third shift. However, in firmer ground, it may be possible to defer concreting from 1 to 3 days, the lining following a short distance behind the mining, which greatly lessens the interference between driving and concreting. The length of forms and the yardage placed in each pour will be governed by the length of daily advance of the face, which is usually 15 to 25 ft.

Simultaneous mining and concrete placing introduce several problems, one of which is the necessity of some kind of bridge to carry the muck cars over the fresh concrete in the invert. As the invert pour is seldom more than 25 ft. long, the bridge may consist of two steel beams supporting the track, blocked up at the rear end on the previous invert pour, and the front end supported on blocking on the subgrade ahead of the last pour, thus spanning the last-placed section of invert. The bridges are rolled ahead on timber dollies, and often they are also used for paving the new section of invert.

In certain sections of the country, the practice is to pour the invert very dry, screeded about $1\frac{1}{2}$ in. low, then to cover the pour immediately with planking. The track is placed directly on the planking. Later the invert is brought up to grade with a top course of cement mortar.

FORMS

The traveling form, either steel or wood with metal facing, has largely replaced all other types of form for tunnel lining, except the rib-and-plate or rib-and-lagging type required for lining soft-ground tunnels when the needle-beam system of ground support is used.

There are several types of traveling form. Some ride on wide-gage track; others are moved by a traveler—a carriage riding the same track as the concrete trains. Some concrete lining procedures permit use of nontelelescoping forms—that is, a type that collapses just enough to break away from the concrete surface when moved. Again, a telescoping type of form is required, one that will fold up to pass through a section of form in place. This is the usual type for fast concreting schedules. In all types of traveling form, the sections must be hinged to permit collapsing to break way from the concrete, must be equipped with jacks for

bracing and aligning and must, by all means, be rigid and strong enough to resist distortion under their loads.

For tunnels driven by the needle-beam method, the forms are merely transverse ribs, between which are placed lags or plates that comprise the skin of the form. Such forms must be completely dismantled and rebuilt after each pour. A typical installation of this type is shown in Fig. 328, used on the Chicago



FIG. 329.—Telescoping steel forms, Chicago sewer tunnels. Usually the forms were handled on the traveler shown here, but in bad ground they could be dismantled and used as a rib-and-plate form around a needle beam. (Courtesy of Blaw-Knox Co.)

intercepting sewer tunnels. On another section of the same project, a composite form was developed, Fig. 329, designed primarily for use as a conventional form carried by a traveler. However, if the ground became so bad that needle beams were necessary, the form could be dismantled for hand erection between the trench jacks.

Time of Stripping.—The length of time that the forms must be left in place after the pour is made will determine the type and

length of form the contractor must use. Specifications are often based on open-cut practice, where the arch must have gained sufficient strength to resist distortion before the support is removed, generally 2 or 3 days. Two days is generally interpreted as 40 hr. actual setting time, which permits concreting to be carried on in a 48-hr. cycle.

Actually, in a rock tunnel, the concrete arch cannot distort. The concrete adheres to the rock surface or to the timbers, and, when the concrete has attained sufficient strength to hold

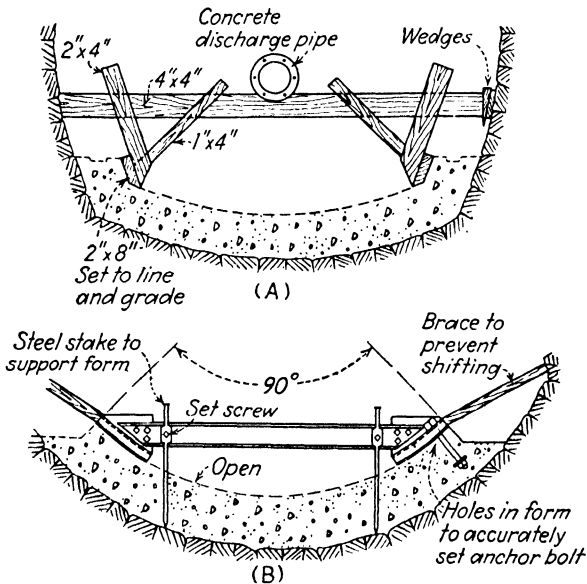

FIG. 330.—Two types of invert forms. A, typical wood form for horseshoe section; B, hand-handled steel form for a circular tunnel.

together, the form may be removed. Forms on all the tunnels of the Los Angeles Aqueduct, 16 ft. wide, were stripped in 16 to 20 hr. Specifications for the tunnels of the Pennsylvania Turnpike, 28½ ft. wide, permit the vertical side-wall forms to be stripped when the concrete has attained a strength of 400 lb. per sq. in.; and the arch forms may be dropped when the concrete attains a strength of 600 lb. When forms are stripped in 16 hr., they must be designed so that they can be collapsed without driving wedges between the forms and the concrete, for the concrete is still quite soft and easily damaged.

In soft-ground tunnels, the forms must remain in place longer than in rock tunnels; 40 hr. is generally the accepted time. This means the forms must be of the telescoping type, and the traveler must be designed to straddle the muck car tracks and permit the cars to pass through; or it must be small enough to be disconnected from the forms and run to a siding.

Separate Side-wall and Arch Forms.—The separate side-wall and arch form, as shown in Fig. 331, was once the standard arrangement for tunnel forms but is now used only on unusually

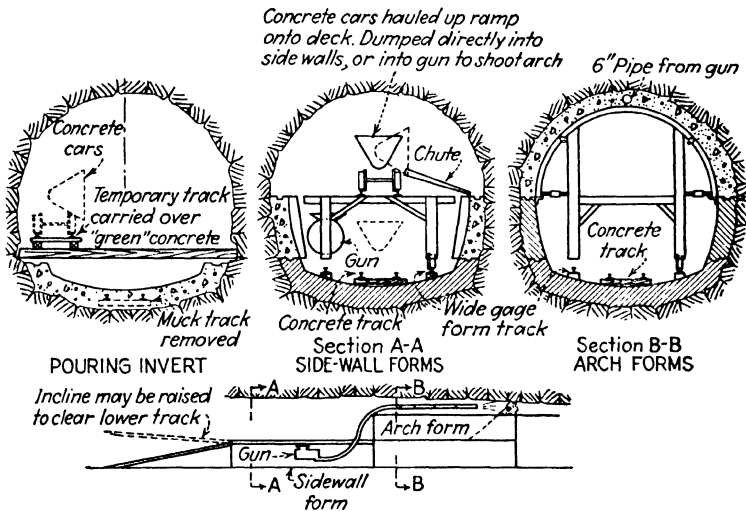

FIG. 331.—Separate side-wall and arch form system.

large tunnels. With this arrangement, the invert must be placed first; upon it is laid the track for carrying the two form units. As the side-wall unit is open at the top, it is possible to run the concrete cars up a ramp to a deck at top form level, where the cars are dumped directly into the side walls, Fig. 332.

Formerly it was necessary to shovel the concrete into the arch form, but now the arch forms are filled by a concrete placer. The gun is set below the side-wall form carriage in such position that it may be charged directly from the cars.

The arch form follows immediately behind the side-wall unit in this arrangement. Both forms are of the nontelelescoping type.

Single Unit Forms.—On small and medium-size tunnels, current practice is to use a single unit form for the side walls and

arch, in which a length of tunnel lining, all except the invert, is poured as a unit. Two different types of such forms are described in the next two sections.

Some provision should be made when placing the invert concrete for later lining up the arch forms. The simplest scheme is to pour a curb or shoulder, 6 or 8 in. high, at the base of each wall, along with the invert. A 2x6-in. board on edge will serve as a form for the curb, but it should be set to exact alignment of the inside face of wall at the base. Then, when the arch form is



FIG. 332.—Steel wall forms, New York subways.

blocked out against the curb, it will automatically be in correct alignment. The arch forms should lap over the curb to permit the crown of the arch to be set to correct grade, even if the invert is slightly high or low. Use of the curb also prevents spreading of the wall forms, even when tightly wedged to place.

Nontelelescoping Forms.—The nontelelescoping type of form, Fig. 333, is the most economical to move. In general, these forms are designed to place all the concrete, in both side walls and arch, in a single operation. In this type of form, the traveler is built directly into the form and is part of the load-carrying structure.

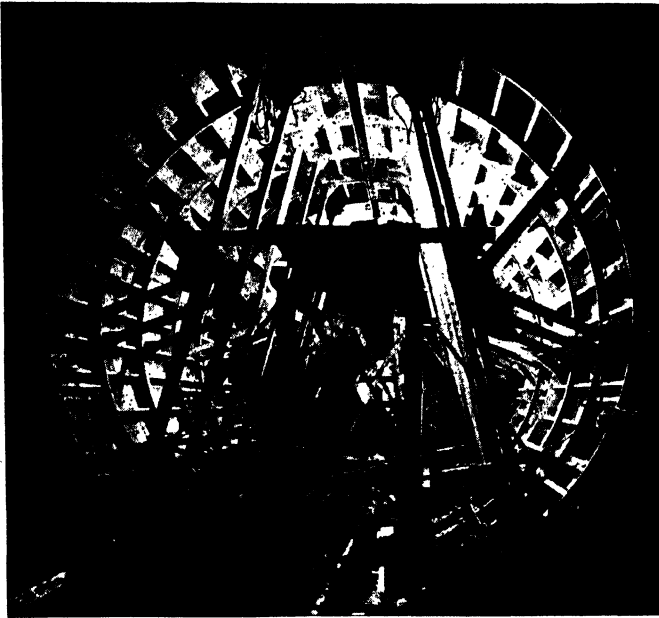

FIG. 333.—Nontelescoping steel forms, Crooked Creek Dam diversion tunnel, 15½ ft. in diameter. Note that the bottom of the form is clamped to anchors cast into the invert concrete. (Courtesy of Blaw-Knox Co.)

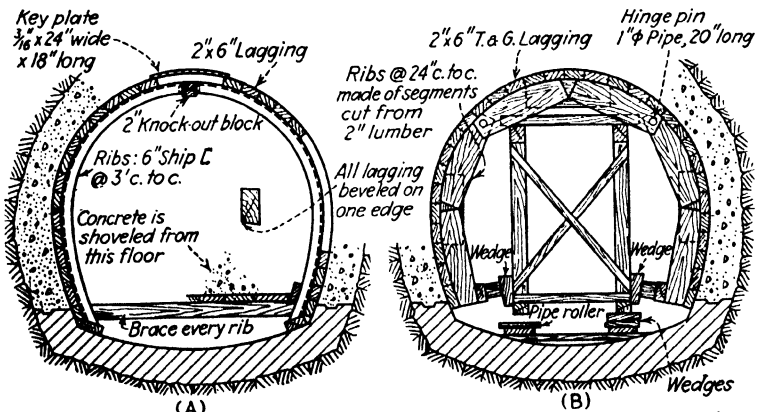

FIG. 334.—Wood forms for small tunnels. A, hand-handed and hand-filled form; B, traveling form, mechanically filled.

If the forms can be stripped in 16 hr., the nontelelescoping form is usually the most economical type. They are made up in units from 30 to 50 ft. long, and can be stripped and moved ahead in about 2 hr., which leaves 6 hr. for concreting on an 8-hr. shift. However, if the forms must remain in place for more than 16 hr., this type cannot be poured on a regular 24-hr. cycle; under such conditions the telescoping form probably would be better. Some



FIG. 335.—Well-built wood forms, Buffalo sewer tunnels. These forms were lined with sheet metal to give a smooth surface to the concrete.

contractors use two units of nontelelescoping form, concreting them on alternate days to allow a 40-hr. setting time.

Concreting operations with nontelelescoping forms must be carefully scheduled, for, when the forms are working in the same direction, there will be closures to be made between the follow-up unit and the lining started by the leading unit. Concreting a closure is quite a job, even when provision has been made in the adjoining monolith for the insertion of the discharge pipe from the concrete gun.

Telescoping Forms.—Telescoping forms are made up with hinged sections, Fig. 336, to permit the back unit to be collapsed and moved through forms in place without disturbing the bracing. There is a practical limit in size to which telescoping forms can be built, for on tunnels above 20-ft. diameter the hinged sections become so heavy that special equipment must be used for raising

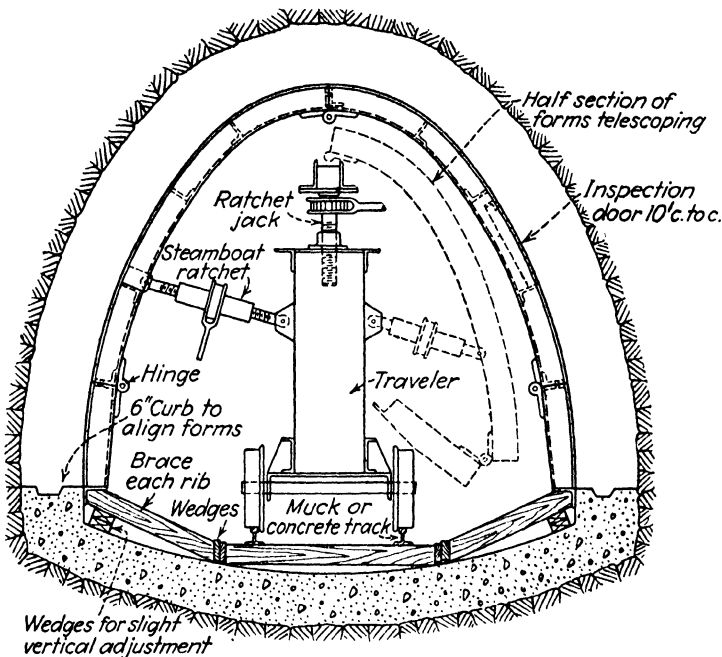

FIG. 336.—Telescoping steel forms. As soon as a unit has been moved and set, the traveler is disconnected and run to a siding to clear the track for muck or concrete trains.

them. There can be no transverse bracing in telescoping forms. Therefore all deflection of the form structure due to unequal loading must be resisted by the ribs.

The traveler is equipped with jacks for vertical movement and steamboat ratchets for horizontal collapse. Ordinarily the traveler runs on the concrete track, but may be built, Fig. 337, of the "straddle" type running on wide-gage tracks to clear muck or concrete cars underneath.

Forms of all types are equipped with several doors so that progress of concreting can be watched. General practice is to space the crown doors 5 ft. c. to c., and the side doors 10 ft. apart. Doors should be of ample size, say 15x30 in., to pass tools or sections of pipe. They should be hinged in their frame; otherwise they may become misplaced or lost.

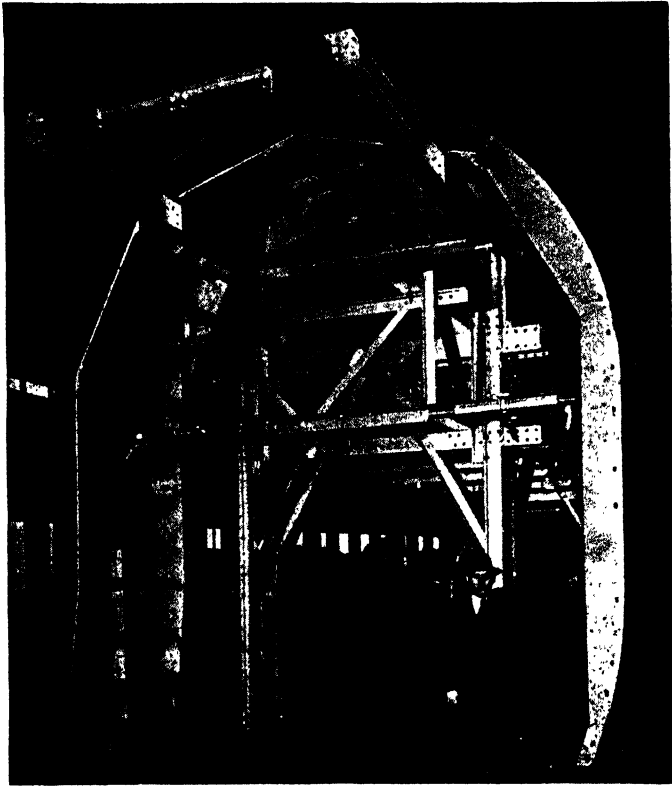

FIG. 337.—Telescoping steel forms, Chicago subways. The traveler, equipped with hydraulic jacks, runs on a wide-gage track to pass muck cars beneath.

Forms for Continuous Concreting.—In recent years a number of the longest tunnels have been concreted by the continuous method, Fig. 338. In this system the concrete is mixed in the tunnel and is placed directly in the forms without haulage. The forms are of the telescoping type in units 20 or 30 ft. long. The concrete rig backs away as the forms are filled, and, whenever it is backed away far enough, the rear section of form is collapsed,

moved to the front and set up. The travelers for this scheme of lining should be self-propelled and fitted with power-driven hydraulic jacks for collapsing the forms and power winches for raising the aprons.

This method eliminates the use of bulkheads and utilizes the concreting equipment to its greatest efficiency. However, it

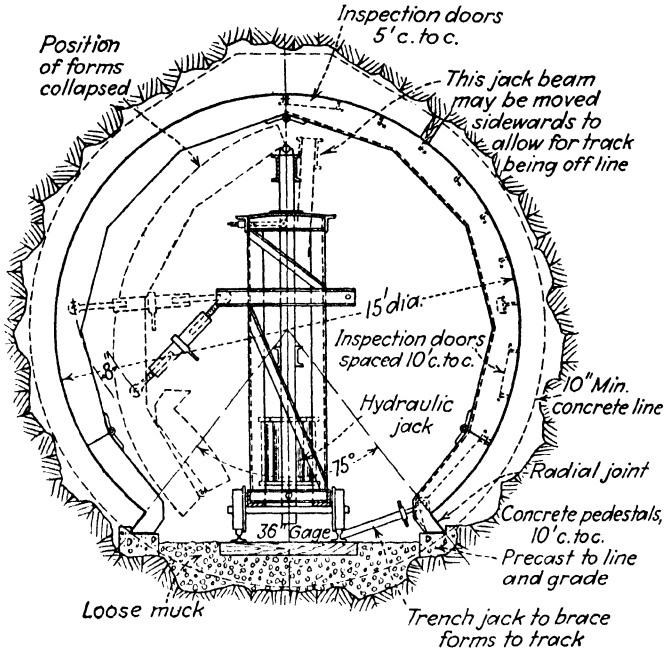

FIG. 338.—Continuous form, a type of telescoping form.

requires a very careful scheduling of all operations, including haulage of the dry batches, to prevent costly delays.

Monolithic Forms.—Circular tunnels may be concreted monolithically by the use of a full-round form. While forms for monolithic pours have been made as long as 70 ft., 30 ft. generally is considered the limit on this type of pour. Unless great care and judgment are exercised while concreting, air pockets will occur on the bottom of the invert. They can be avoided by pouring from one side only, until concrete flows underneath and appears on the other side. Full-round forms have a very decided tendency to float, and must be blocked down from the roof, Fig. 340.

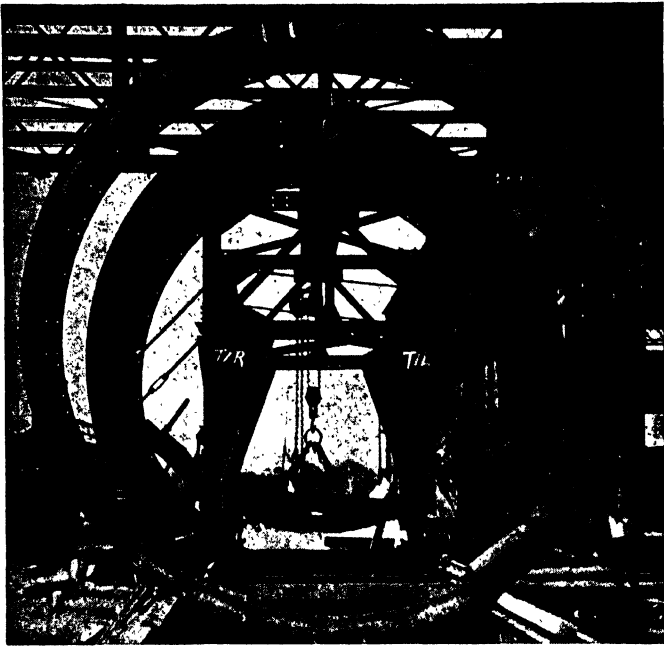

FIG. 339.—Full-round telescoping steel forms, Detroit sewers. The arch is telescoped on the straddle-type traveler, while the invert panels are carried on a chain hoist on a projecting boom.

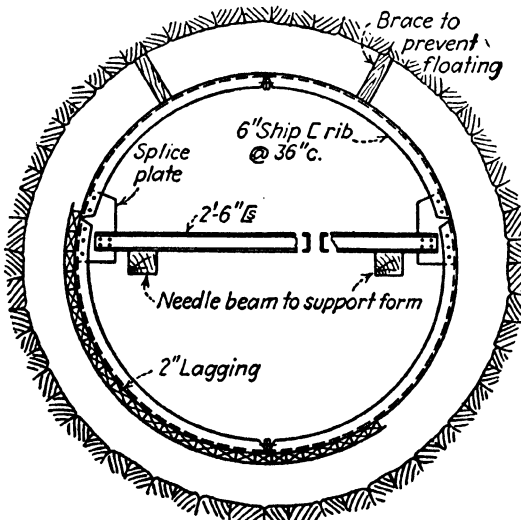

FIG. 340.—Full-round form, hand-handled and hand-filled, supported from two needle beams.

Horseshoe tunnels, because of their flatter bottoms, cannot be concreted monolithically; but it is possible to screed in the invert and then quickly erect the arch forms and continue the pour before the invert has attained its final set. This practically eliminates the joint between the invert and side wall.

Economy of Steel Forms.—Steel forms cost three to five times as much as wood forms, but usually longer length of wood form is required to attain the same progress. In general, steel forms must be used about 30 times before their labor-saving advantages overcome the higher initial cost. Therefore, small tunnels less than 1,000 ft. in length may be more economically formed in wood. This is not always true in big tunnels where wood forms become so cumbersome that steel forms can tie their cost in about 15 uses.

A composite form, wood lagging attached to a steel frame with carriage bolts, is often practical and economical on short tunnels. With steel ribs, it is possible to build a telescoping form not practical when wood ribs are used.

Steel forms give a much smoother finish to the concrete than can be obtained with wood, even when the wood is sanded and oiled. Under ordinary conditions, wood lagging on a tunnel form must be replaced every 12 to 15 uses. However, if the concrete is shot into the form, the blast from the gun may damage the lagging so badly that it must be replaced after 8 uses.

Bracing the Forms.—Tunnel forms, either wood or steel, must be securely braced to prevent movement or deflection. Non-telescoping forms may be braced straight across from rib to rib, but telescoping forms must be braced in such a manner that the bracing, or "kickers," do not interfere with moving a collapsed form unit through the standing unit. Sometimes the kickers are set against the ends of the ties; but it is always best to put a continuous waler at the ends of the ties and then brace to the waler. This longitudinal waler prevents the slipping sideways of any one set of braces under load. The kickers are generally cut 4 in. short to allow for wedges.

A special trench jack has been developed for bracing forms. The head of this jack is set against the bottom of the rib while the foot bears against the web of the muck rail. Another jack is set between the rails as a strut to transmit the thrust from wall to wall.

In a previous section was mentioned the desirability of casting a shoulder or curb with the invert, against which to set the arch form. Unless there is such a curb, it is impossible to set the kickers more than snug; otherwise the empty form will be shoved outward. After about 2 ft. of concrete has been deposited it is very important that these kickers be wedged up tightly.

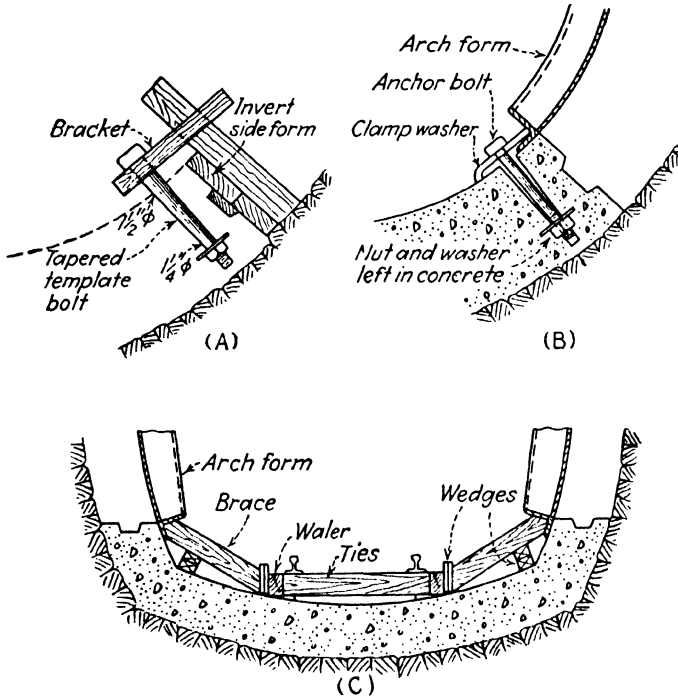

FIG. 341.—Methods of fastening and bracing forms at the invert. A, template for setting anchor bolts in the invert; B, clamp for holding bottom of arch form; C, typical bracing at invert for telescoping forms.

Several braces should always be set against the roof from the upper quarters of the forms. These prevent "floating" or "rolling" of the form. They can be removed safely when the form is almost full.

Bolting the form to the invert concrete is a very satisfactory method of bracing, particularly on circular tunnels. A tapered template bolt, Fig. 341, is used for setting an anchor nut and washer in the concrete. This bolt should be well greased, for,

as soon as the concrete has set, the bolt is withdrawn, leaving the nut embedded in the invert. When the arch form is set on this invert, an anchor bolt is used to clamp the bottom of the form tightly to the concrete. These anchor nuts must be located fairly accurately, since there can be only a limited amount of play in the clamp washer.

Bulkheads.—A bulkhead must be built at the front end of the form for each pour. The simplest and most satisfactory type of bulkhead is shown in Fig. 342. A curved angle is bolted to the

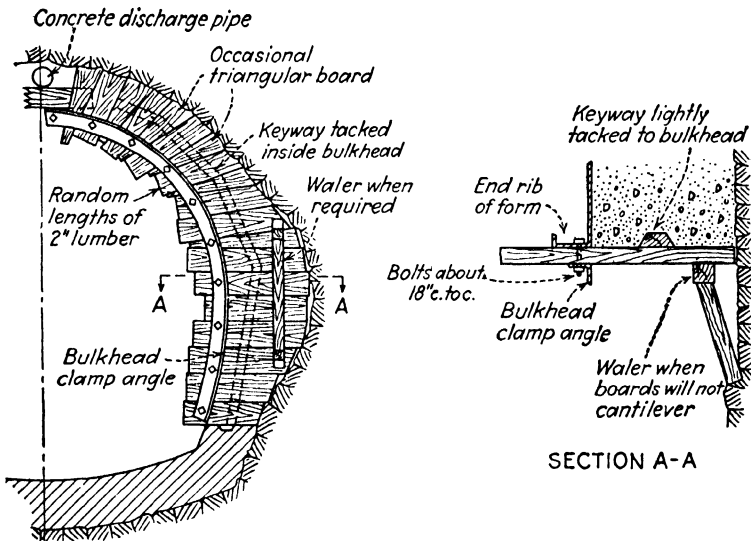

FIG. 342.—One method of bulkheading the end of the form.

front rib of the form, using bolts about 3 in. long, spaced about 18 in. apart. Random lengths of boards are shoved through the slot between the angle and the rib, against the rock. By using boards of different widths, the joints in the bulkhead can be made to come directly over the bolts; thus, instead of boring a hole, the edge of a board can be notched with a hatchet to fit around a bolt. An occasional triangular board is used to keep the joints of the bulkhead roughly radial.

Where the thickness of concrete is 18 in. or less, this type of bulkhead will need no other support, but, for greater thicknesses, the outer ends of the boards must be braced to the wall. If a keyway is specified, it is cut in chords and tacked lightly to the

inside face. An opening about 12x18 in. is left at the top for the insertion of the concrete delivery pipe and to vent the air. This opening should be as high as possible to enable the form to be filled brimful.

In starting a job, the first form must have two bulkheads. The rear bulkhead should be of double strength at the crown and

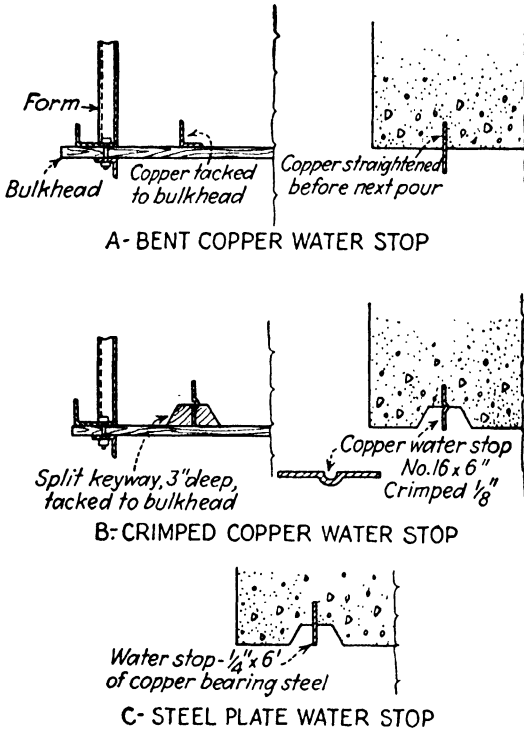

FIG. 343.—Various types of water stops in concrete lining.

unusually well braced; for it must withstand the blast of the concrete placer.

Metal bulkheads are rarely practical for tunnel work. They are too heavy for convenient handling, and it is difficult to make a steel bulkhead that can be readily adjusted for overbreak.

Water Stops.—Water stops in construction joints are always a nuisance to the contractor, for they are difficult to place and hold. Figure 343 shows methods of placing several types of water stop. One form of water stop consists of a strip of 16-gage

copper, 6 or 8 in. wide, folded into an angle. This is tacked lightly to the bulkhead to be straightened out after the bulkhead is stripped. This water stop is attached in short straight sections, for the leg against the face of the bulkhead must be cut at every bend. When the copper strip is straightened out later, the cuts should be soldered.

Another type of copper water stop is a copper sheet set into a split keyway; when the keyway is stripped, the sheet is in correct position. Copper water stops should not be too wide, for the projecting portion is liable to be bent down when concrete is placed. Water stops are also made of copper-bearing steel strips $\frac{1}{4}$ or $\frac{3}{8}$ in. thick. Designs of water stops that require a split bulkhead should be avoided.

Concreting Curves.—Tunnel curves are generally constructed as a series of chords, the length of chord being governed by the radius of the curve and by the allowed deviation from true curvature. Most engineers will accept a deviation of 1 or $1\frac{1}{2}$ in., but 3 in. is satisfactory for sewer tunnels.

The amount of deviation (the middle ordinate of a chord) may be found from the following approximate formula:

$$D = \frac{C^2}{96 \times R}$$

where: D = deviation, in.

C = chord length, ft.

R = radius of center line, ft.

After the form sections have been split up into chords and set along the curve, the adjacent ends of the forms will be separated by a distance varying from nothing on the inside of the curve to the maximum on the outside. The best way to take care of this opening is to cut a piece of 20-gage sheet iron about 4 in. wider than the opening and lay it over the ends of the forms to lap about 2 in. on each unit. The sheet is held in place by wiring through small holes punched in this metal.

Careful form setting is needed to get a good even curve in a tunnel. Therefore, the contractor should not expect to maintain the same progress on curves as on a tangent. If specifications will not permit the curve to be put in in chords, the best scheme is to jump the steel forms beyond the curve and resume work, on the straightaway. A set of wood forms built to true curvature is later used on curved portions.

MIXING AND PLACING

Careful planning of the concrete plant and methods of operation to fit the particular conditions at hand will be worth while. There are several arrangements of plant possible, one of which will prove most economical for a specific job. The concrete may be mixed at top of shaft and dropped down a pipe to a receiving hopper at tunnel level, or the mixer may be placed at bottom of shaft and charged by batched aggregates dropped down a pipe; in both cases the mixed concrete will be hauled to the forms in tight-body cars. In tunnels driven from portals, the mixer may be set outside the tunnel and the concrete hauled to the forms in cars, or aggregates may be hauled in cars to the mixer at the forms. On shallow tunnels, it is sometimes possible to sink pipes from the surface, tapping the tunnel at various points, through which either concrete or batched aggregates may be dropped. In all of these cases, except, of course, situations where the mixer is inside the tunnel, transit-mix concrete may be used. Where car haulage of concrete is used, storage hoppers at the loading point will speed up loading of the train and thus increase the tempo of concreting operations.

Telephone or bell-cord communication between point of placement and the mixer is essential for smooth operations. Breakdowns of placing equipment and other delays at the forms are bound to occur; in such instances, quick communication with the mixer crew will prevent piling up of concrete in the hoppers or cars beyond the allowable waiting time, designated in most specifications as 45 min. to 1 hr. from time of mixing to final placement. On some jobs it is possible to provide a place for deposit of surplus concrete or of that already loaded in cars when a blockade happens, such as a ready section of invert or a big overbreak behind the ground supports.

Concrete Haulage.—The V-bottom, tipover car is probably the best type, for hauling concrete from the shaft to the placer. This type will not leak and has a tendency, when dumped, to correct any segregation which may have occurred. Special hopper cars with a bottom gate are sometimes used, but on long hauls the heavier aggregates settle to the bottom, often requiring considerable poking before the concrete starts to flow. Several big jobs have used 2-cu. yd. buckets on flat cars; but this requires

some kind of crane to pick up the buckets, unless they can be dumped through a hole in the deck of the car.

Concrete is delivered down shafts through pipes of 8- or 10-in. diameter. There is no segregation in the falling, but some form of cushion is necessary to prevent separation. Therefore, the receiving hopper should be kept about half full of fresh concrete at all times. In starting off a run, it is well to drop about $\frac{1}{2}$ yd. of grout into the hopper to cushion the first concrete. On the



FIG. 344.—Concrete for the San Jacinto Tunnel was mixed underground and placed in portable agitators for transportation to the forms.

New York City Water Tunnel No. 2, concrete was dropped almost 1,000 ft. through a 10-in. pipe. The receiving hopper was paved with concrete, and directly under the drop pipe the floor was armored with old drill steel, set vertically and embedded in the concrete.

Long hauls of concrete should be avoided, and advantage should be taken of all manholes for concrete delivery. In shallow tunnels, a pipe may be driven down, or a hole drilled, through which concrete may be delivered. The placer should be

set directly under this pipe whenever possible, and concrete shot directly to the form until the cost of air consumed equals the cost of haulage.

Tunnel Mixers.—On large tunnels, it may prove economical to mix the concrete in the tunnel. The mixer may be mounted on a gantry, Fig. 345, or may run on the muck track.

Tunnel mixing has the advantage that fresh concrete is delivered to the gun without segregation, and in case of delay the mixer can be stopped instantly. However, it is a dusty

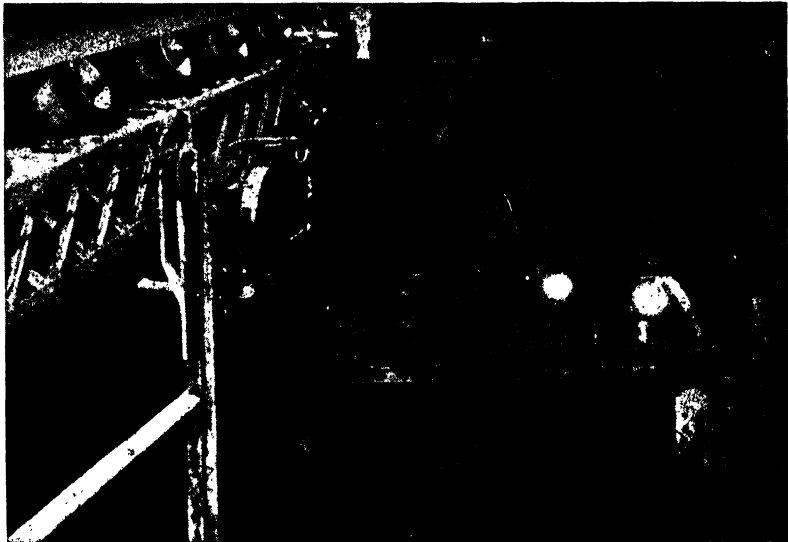

FIG. 345.—Tunnel mixer carried on a gantry, Chicago sewer tunnels. Dry batches were fed to the mixer by belt conveyor.

operation for a tunnel, and the mixer is generally so big that it blocks the tunnel for other operations, such as grouting.

The mixer is charged either by a belt conveyor into which the batches are dumped from side-dump cars or by an overhead trolley, which picks the bottom-dump batch boxes off a train of flat cars. Tunnel mixers are generally of 1-cu. yd. capacity, though dual-drum 34E paving mixers are in use on the Delaware Aqueduct to speed up concrete lining operations.

Hand Placing.—Placing concrete by hand is rarely resorted to except in very small or short tunnels. Forms designed for hand placing must have removable lagging or plates, which can

be set one at a time as the concrete rises. Ordinarily the lagging is attached to the ribs waist-high before starting to concrete.

For a medium-size tunnel, say 10x10 ft., two men can work, one on each side, for every 5 ft. of form. Concrete is dumped on the floor, and the men shovel it behind the form, adding lagging as required. This operation goes fast enough if the concrete can be distributed on the floor within reach of all shovelers

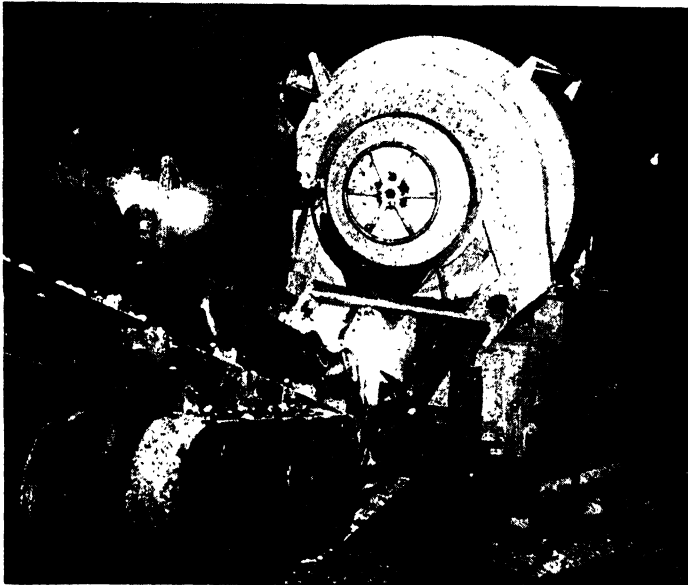

FIG. 346.—Rail-mounted transit mixer discharging onto a belt conveyor that feeds the concrete gun, Owyhee tunnels. The mixers were powered by internal-combustion engines. (Courtesy of Blaw-Knox Co.)

without undue crowding. Each man can shovel 1 to 1½ cu. yd. per hr. Forms designed for hand placing in large tunnels should carry a deck as high as possible, onto which the concrete cars are ramped, so that the side walls can be filled by direct dumping.

Keying up, or filling the crown, is the tedious operation in hand placing, for only one man can work at a time. All concrete possible is shoveled over the lagging, leaving only the key slot about 20 in. wide. The key plates should be of steel, Fig. 334A, wide enough to span the slot and should not be longer than 30 in.; in fact, many contractors use a key plate 20 in. long. The back plate is set first. A man then kneels on a scaffold at a

convenient height and shovels concrete onto this plate, pausing occasionally to ram it back against the roof. This key concrete must be dry enough to stand on a 1:1 slope and, unless it is well rammed, is likely to be porous. Plates are added one at a time as keying progresses. The concrete men spell each other on this work.

Pneumatic Placers.—Pneumatic concrete placers consist essentially of an airtight receptacle into which concrete is charged through a door at the top. This door is then closed, and the

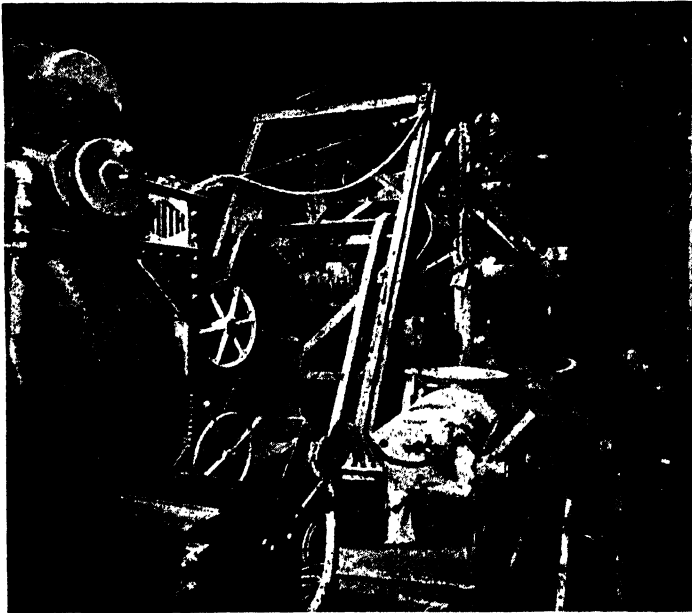

FIG. 347.—Tunnel mixer and concrete gun, Cascade Tunnel.

concrete is forced out through a 6-in. diameter pipe at the bottom by air pressure.

The Ransome placer has a horizontal body with an air-operated charging door in the top near one end. A worm, driven by an electric or air motor, feeds the concrete to an outlet where an air jet blows it through a 6-in. pipe. These placers are built in $\frac{1}{4}$, $\frac{1}{2}$ and 1-cu. yd. sizes.

The Prestweld placer is very popular. Concrete is fed by gravity to the discharge pipe, the flow being regulated by an automatic flapper. The charging door is actuated by an air

cylinder and has an outside gasket. A hopper gate, Fig. 348, is part of the machine. This hopper gate is connected to the charging door in such a manner that, after the door is opened, the gate begins to fill the gun. When the gun is filled, the hopper gate shuts off the flow before the charging door is closed. These guns are built in $\frac{1}{2}$ -, $\frac{3}{4}$ - and 1-cu. yd. sizes.

The Hackley placer, Fig. 349, has been much used on the west coast. It consists of a horizontal cylinder with a number of air jets to move the concrete to the discharge pipe. The charging door is hand-operated. The guns are built in $\frac{1}{2}$ -, 1-, 2- and 3-cu. yd. sizes. The larger models are wheel-mounted, as shown in the illustration, and are used for carrying the concrete as well as shooting it.

The controls on a pneumatic placer are simple and "anyone can operate one." However, it takes lots of experience to develop good gunmen. Frequent blockades and large air consumption are always signs of a poor operator.

Operation of the Placer.—The pneumatic placer should be set as close to the forms as possible in order to conserve air. The discharge pipe from the gun should lead over the crown of the arch to within 10 ft. of the rear of the form. Concrete is shot through this pipe and discharged on the top of the form, running off both sides until the walls are filled. As the arch begins to fill, the pipe must be withdrawn about 5 ft. at a time. This can be done either by backing the gun away and pulling out the entire pipe assembly, or by disconnecting 5-ft. sections of the pipe. It is a good rule not to shoot more than 15 ft. or less than 5 ft. When the end of the nozzle becomes buried in the concrete, there is danger of blocking the pipe line.

Concrete shoots from the end of the pipe at high velocity, probably 30 ft. per sec. This high velocity packs the concrete tightly against the roof and gives a dense arch but causes segregation unless the nozzle is directed into fresh concrete. For this reason it is wise to shoot about $\frac{1}{2}$ yd. of mortar first to provide a cushion before starting to shoot the concrete.

The $\frac{1}{2}$ -yd. gun requires about 400 cu. ft. of air per min. at 100-lb. pressure for each shot when the discharge pipe is not more than 100 ft. long. The 1-cu. yd. gun requires about 600 cu. ft. of air per min., and will require another 100 cu. ft. of air for each additional 100 ft. of discharge pipe, as will also the $\frac{1}{2}$ -yd. gun.

Most of the smaller placers will operate at the rate of one shot per minute.

The gun requires its greatest volume of air in the first 15 or 20 sec. of each shot cycle. Therefore, a large air receiver should be located close to the gun to supply the starting volume with-



FIG. 348.—Pneumatic concrete gun, Buffalo sewer tunnels. Concrete was dropped down an 8-in. pipe from a truck mixer on the surface into the wooden hopper over the gun; it was then shot a maximum of 800 ft. into the form.

out too great a drop in pressure. Shooting should not be resumed until the pressure has been restored to about 90 lb. after each shot. An inexperienced gun operator wastes a lot of air in trying to blow every bit of concrete out of the gun after each shot.

In shallow tunnels where it is possible to drop the concrete down pipes or manholes at intervals along the tunnel line, con-

tractors often set the pneumatic placer directly under the point of discharge into the tunnel, Fig. 348, and shoot through long pipes to the forms to eliminate haulage. As the maximum economical shooting distance seems to be from 600 to 800 ft., the charging pipes should be located from 1,000 to 1,500 ft. apart.

Gun Discharge Pipes.—The pipe used for the discharge line from a pneumatic placer is standard 6-in. size. Flanges and other fittings should be of wrought or malleable iron, not cast

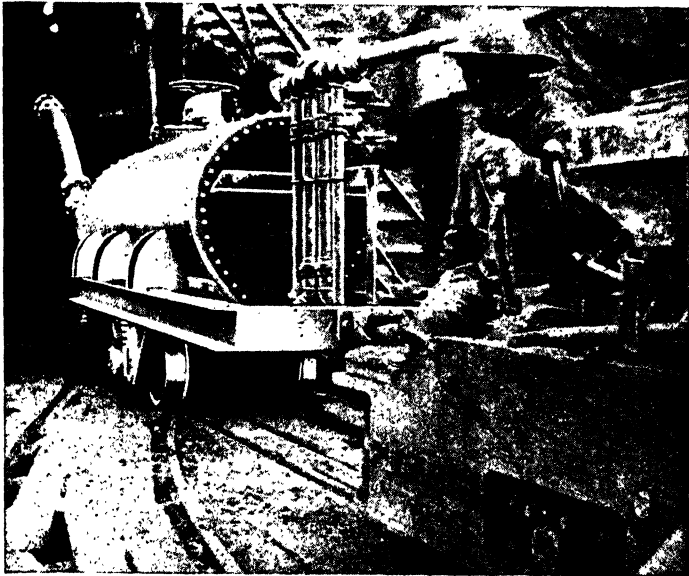

FIG. 349.—Rail-mounted 3-yd. pneumatic concrete gun used to transport as well as place the concrete. (Courtesy of Union Iron Works.)

iron. Steel pipe on straight sections should handle around 15,000 cu. yd. of concrete before needing replacement, though the exact life of a concrete discharge line depends a great deal upon the abrasive qualities of the aggregates being used, as well as the position of the pipe.

Opinions differ as to whether the bends in the discharge line should be of steel pipe or rubber hose. There are just as many advocates for one type as for the other. However, use of hose for the bends certainly gives a much needed flexibility to the line.

Concrete discharge hose is manufactured by several rubber companies. It should be wire-wrapped to prevent kinking, and

the connecting pipe nipples should be vulcanized in place. The hose should not be bent to a radius less than 5 ft., and should be turned 90 deg. after each pour to distribute the wear around the inside lining. Occasionally the hose section should be turned end for end to prolong its life. Rubber hose in a discharge line should handle from 3,000 to 8,000 cu. yd. of concrete.

Curved pipe sections will wear through quickly on the outside of the bend, but patches and reinforcing plates can be welded over the weak spots as they show up. A piece of old truck tire, about 3 ft. long, should be kept on hand for emergency patching during a pour; when a leak develops in the steel pipe, the piece of tire can be wired on as a temporary patch for the remainder of the pour. Sometimes 45-deg. wrought-iron elbows are used as bends in the discharge line.

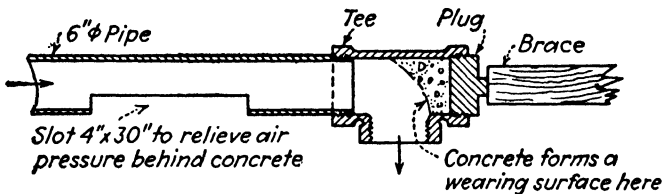

FIG. 350.—Side-discharge nozzle for pneumatic placer.

As far as possible, bends in the pipe line should be made close to the gun. The velocity of the concrete is least at this end of the line; thus the shock and wear on the bends are less. An upsweep right at the gun is desirable in all cases for efficiency in operation, as this lessens the chance of the air "overrunning" the concrete. All curves and bends must be chained or lashed securely to prevent weaving under the force of the charge. Also, the nozzle must be well fastened or lashed down to avoid thrashing.

Concrete may be shot into open forms or invert sections by means of a side-discharge nozzle, Fig. 350. The long slot allows the air to escape. Concrete builds up in the Tee at the end, thus the shock is taken by the concrete instead of the metal.

Blockades will happen, particularly with inexperienced operators. In almost all cases, they will occur in the bends. By leaving the throttle in the gun open, sufficient pressure may be built up in the line to break the blockade. The block may be located by tapping the pipe or hose. If it is in a hose section,

shaking the hose may clear the block; if it is in a pipe section, pounding with sledge hammers may jar it loose. Only as a last resort should the nearest joint be uncoupled, and then only after the air pressure has been released from the gun and from the pipe line between the gun and the blockade.

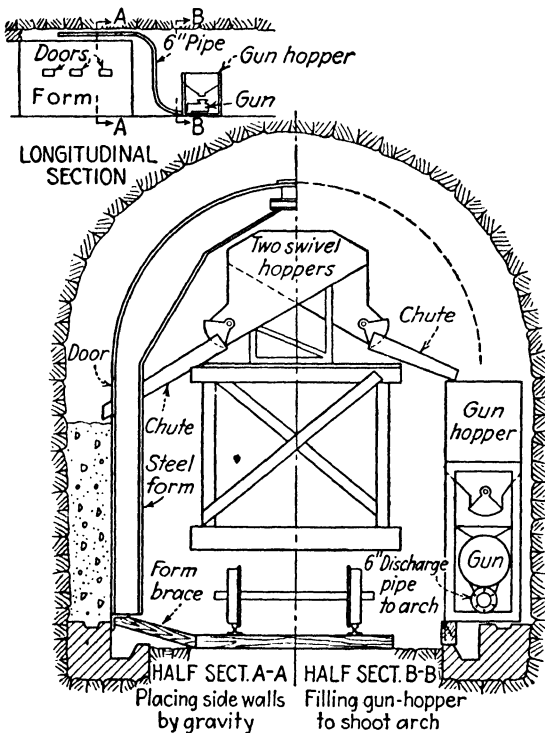

FIG. 351.—Typical method of concreting a single-track railroad tunnel. Concrete is carried into the tunnel in two 4-yd. hoppers on the scaffold car and can be discharged into either the side walls or the gun hopper.

Charging the Placer.—To work a concrete placer to its full efficiency requires a storage hopper mounted directly over the charging door of the gun. This hopper should have a capacity of from 2 to 4 cu. yd., to allow the gun to continue shooting while the train is going out for another load. The simplest way of getting concrete into this hopper is to run the concrete cars up a 10-per cent incline until the cars are high enough to dump into it. In railroad tunnels, it is possible to transport the concrete in hoppers on top of a scaffold car for discharge into the gun hopper,

Fig. 351. It is surprising how top-heavy a narrow-gage scaffold car will appear to be, while operating safely over rough track.

Belt conveyors, Fig. 352, are often used for elevating the concrete into the gun hopper in small tunnels. For handling wet concrete, the belt should not be much steeper than 26 deg. A baffle board at the top of the conveyor will prevent segregation. At Fort Peck, the concrete was carried into the tunnels in 2-cu. yd. buckets on flat cars; an electric gantry hoist picked them up and dumped them into the gun hopper.

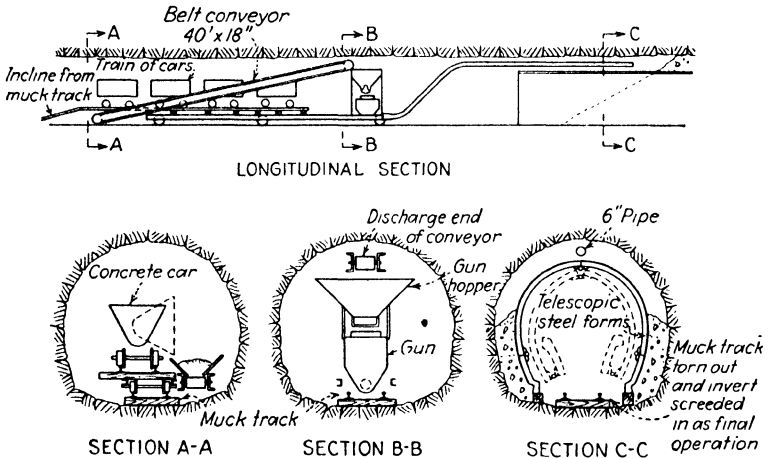

FIG. 352.—Concrete-placing layout for a small tunnel. The belt conveyor, dump track and pneumatic placer are all mounted on one carriage which runs on the muck track.

Charging the gun is difficult in very small tunnels. One simple scheme is to build a flat pan around the door of the gun. The cars are ramped just high enough to dump into this pan, from which the concrete is raked by hand into the gun. Another scheme is to use special bottom-dump cars, each compartment holding just one shot. These cars are ramped over the gun and the charge dropped in. End-dump concrete cars can be used sometimes, but they require switching of the train, which is undesirable. Figure 353 shows a scheme which was used in an unusually small tunnel in Virginia. The cars were pulled up a ramp by means of the air hoist until the floor of the car just cleared the door of a special low-height placer. The same hoist was then used for pulling a scraper that cleaned out the car.

Concrete Pump.—Placing concrete by the Pumperete method has proved successful on many recent tunnel jobs, including more than half the Los Angeles Aqueduct tunnels and the Baltimore water tunnel.

This machine consists of one or two single-acting pumps, delivering concrete through asingle 7- or 8-in. pipe. The single pump will average about 25 cu. yd. per hr., and the dual unit will place about 40 cu. yd.

Concrete flows from the end of the discharge pipe in a slow steady stream, which makes it easy to handle when pouring inverts or side walls. This slow velocity will not fill the crown properly unless the pipe is deeply buried in the concrete. Therefore, it is customary when keying an arch to insert an air jet into the concrete delivery pipe about 50 ft. from the nozzle. About every fourth stroke of the pump, the jet valve is opened manually and the concrete blown out at high velocity. The volume of air required is very small.

Usually the concrete pump is located on the outside, and the concrete pipe is led into the tunnel directly to the form, Fig. 354. Since there is no hauling to be done and no machinery in the tunnel, mining can be carried on while concrete is being placed. The practical limit to pumping is considered about 1,000 ft.

At the completion of the pour, the concrete is cleaned out of the pipe by a plunger (called a "go-devil"), which is forced through the pipe by water pressure. When the go-devil appears

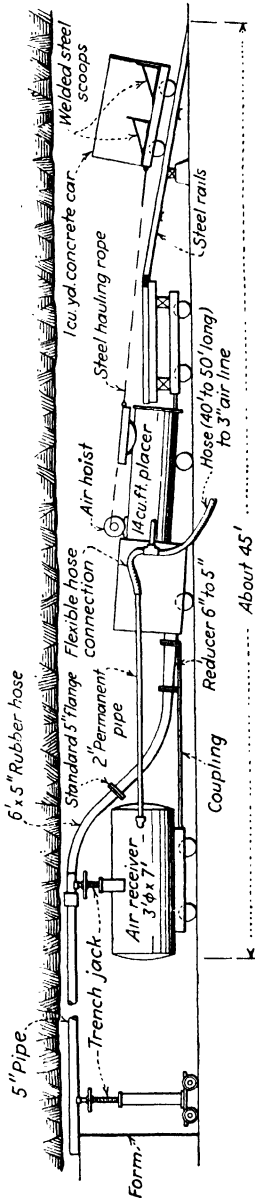

FIG. 353.—Placing rig for a small tunnel, Meadows-of-Dan, Va.

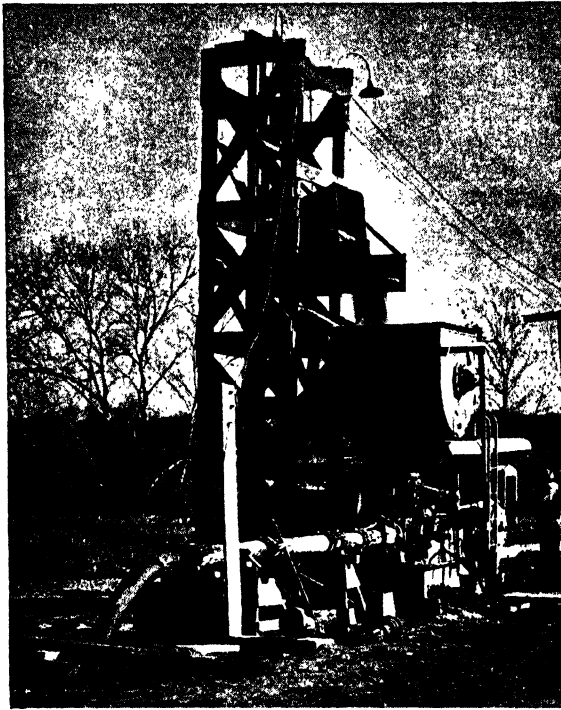

FIG. 354.—Pumping concrete down a well-drill hole directly into the form, Minneapolis sewer tunnels. Concrete was delivered to the hoist tower in transit mixers, then dumped into the pump hopper.

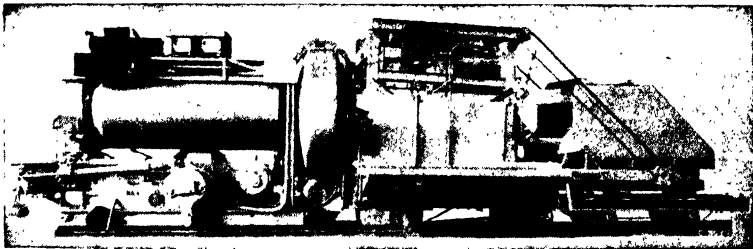

FIG. 355.—Combination of tunnel mixer and Pumperete machine, Montebello water tunnel, Baltimore. Dry batches are brought to the mixer in steel hoppers shown at extreme right, lifted off the car and raised as a skip for charging the mixer. The mixer discharges directly into the concrete pump. (Courtesy of Chain Belt Co.)

at the nozzle, it is removed and the water drained onto the floor of the tunnel.

The pump has several disadvantages. Concrete is highly abrasive, and maintenance costs are high. The amount of concrete in a pour must be very carefully estimated, for once the go-devil has been started through, it is practically impossible to supply 1 or 2 yd. more to make up for overbreak or loss.

Continuous Placing.—Continuous placing has worked out very economically on many of the long tunnels lined in the last few years. By this system, concreting is carried on 24 hr. a day, week in and week out. Phenomenal records were made on sections of the Los Angeles Aqueduct. Runs of over 5,000 ft. in one month were not unusual.

For continuous placing, the forms must be of the telescoping type, and enough form must be provided, in 20- or 30-ft. units for the concrete to attain the specified set before it is necessary to strip the forms. The traveler should be equipped with electrically operated hydraulic jacks for collapsing and expanding the forms quickly. Horseshoe-shaped tunnels will be concreted "invert last." A curb, or pedestals, carefully set to line and grade, are necessary with this method; thus, as a form section is brought from rear to front, the form setters need only set it on the curb to have it correctly aligned.

As shown in Fig. 356, the concrete discharge pipe is laid over the crown of the arch and is dragged back as the gun retreats. The pipe must be long enough to prevent flowing of the fresh concrete out the front end of the forms as it lies on its natural slope. No bulkhead is used

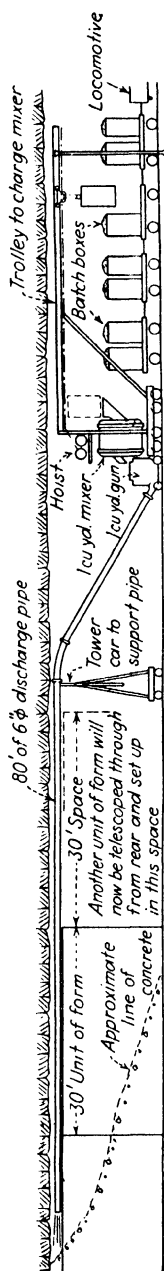

Fig. 356.—Forms and placing rig for continuous placing. Concrete is hauled into the tunnel in dry batches. Mixing and placing continue day and night without stopping. The forms are telescoped from rear to front as required. In the procedure shown here the invert, covering the bottom 75-deg. segment, is screeded in after the arch concrete has been completed.

at the head end of the form except when the job is to be shut down.

After the placing rig has backed away 20 or 30 ft., depending on the length of form unit, the back unit is telescoped to the front end, where it is set up as the next form to be concreted.

Assuming that the arch requires 3 cu. yd. per lin. ft. and that the mixer can produce 30 cu. yd. per hr.; then every hour 10 ft. of tunnel will be completed, and every 3 hr. it will be necessary to telescope a 30-ft. unit of form ahead and set it up. The daily progress will be 240 ft. of tunnel. If forms must remain in place 16 hr., eight 30-ft. units of form will be required.

As the placing rigs are designed to travel on the muck track, taking up and relaying a special track are eliminated.

After the arch is complete, the invert is screeded in. Generally, two shifts will be devoted to cleaning up the loose muck from the bottom and tearing up track. Concreting is done on one shift, and 600 to 1,000 ft. of invert have been placed in one day.

Continuous concreting can be economically applied only to long tunnels. The process requires the best of equipment and experienced men. All operations, especially the haulage of the batches, must be carefully scheduled.

Vibration.—Vibration has not been widely used in tunnel concreting. Internal vibrators must be handled through a door in the form, which is very difficult when space is limited or if there is reinforcing in the way. External vibrators "play hob" with a form. If vibrators are required, they must be used sparingly and intelligently; otherwise the forms will shift or deflect.

The real purpose of vibration is to consolidate low-slump or dry concrete. Concrete for tunnel walls and arches should be quite wet, about $3\frac{1}{2}$ -in. slump, and, with proper mixing and placing conditions, a dense lining should be obtained with ordinary spading.

Concreting the Invert.—Concreting the invert is generally harder than it looks. The simplest method is to build a bridge, Fig. 357, from which the concrete can be dumped into place with a minimum of shoveling. Concreting should begin at the far end of the invert, and the bridge is torn out as the form is filled.

Engineers will generally permit wide, flat inverts, such as used in railroad or vehicular tunnels, to be concreted in half widths.

The track is shifted to one side and half the invert completed. After 24 hr., the track is thrown onto the completed side and the remaining section made ready and poured.

Concreting inverts with the Pumperete machine is simple. The pipe line is carried on wooden horses high enough to permit a short section of chute to be used for distributing the concrete to either side of the tunnel. Concreting is begun at the far end, and the sections of pipe and their supports are removed as the

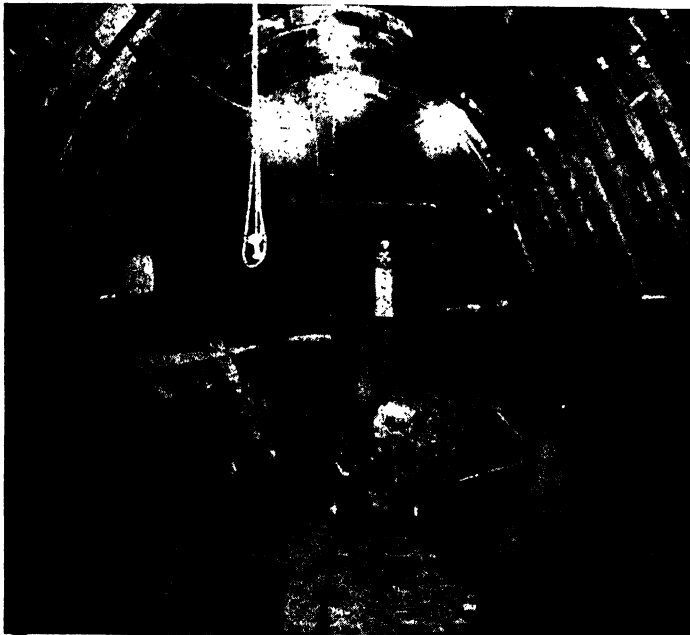

FIG. 357.—Dumping invert concrete from a temporary trestle, Chicago sewers.

work progresses. Shooting inverts with a pneumatic placer is carried on in a similar manner, using a side-discharge nozzle at the end of the pipe, Fig. 350. The nozzle must, of course, be replaced as sections of the pipe are removed.

Making the Closure.—A closure pour must be made when the form is set up connecting two sections of previously placed concrete. This set-up, of course, requires no bulkheads, but the final key concrete cannot be placed from the end as usual.

Figure 358a shows a method of introducing concrete into a hand-filled form. The form is keyed up as usual until a keying-up

opening about 14x14 in. is left. All the concrete that will possibly stay in place is then shoved through this opening. A box is made of four pieces of 2x12-in. planks, about 3 ft. long, and nailed into this opening. At the bottom of this box is a loose-fitting plunger, resting on the head of a jack. The box is then

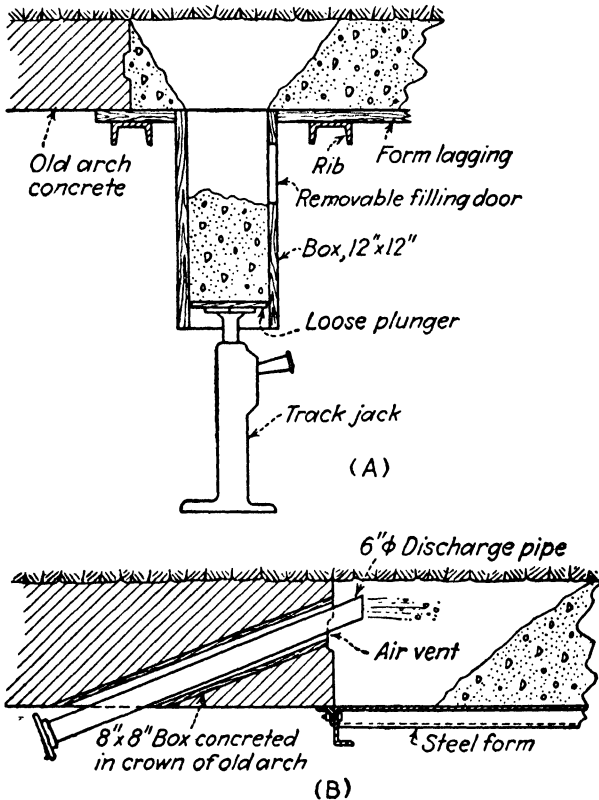

FIG. 358.—Two methods of making the closure between concreted sections. *A*, method for hand placing; *B*, method used with pneumatic placers.

filled with concrete through a door in the side and the concrete forced into the form by jacking up the plunger. After 2 hr., the box can be wrecked and the remaining concrete smoothed off.

Figure 358*B* shows a successful scheme used for closures when the concrete is being placed pneumatically. A wooden box, 8x8 in., is set diagonally in the previous form, with the upper end, through which the 6-in. pipe passes to shoot the arch, as high as possible. This box also vents the air. Closures with

the concrete pump are simpler, as it is only necessary to bolt a flange around a hole burned in the form skin plate and pump the concrete directly into place. However, great care is necessary to see that the pump does not build up sufficient pressure in this confined space to collapse the form.

Closures are always a time-consuming operation; the operations should be scheduled to reduce them to a minimum, or to eliminate them entirely.

Concrete Crews.—Experienced tunnel concrete men are few, and on most jobs the contractor will have to develop them. A miner or a mucker usually looks down on this type of work; therefore it is a waste of time to hire them for concreting purposes.

The secret of efficient concrete placing is the same as for rapid mining: have the same man perform the same operation at the same time every day.

PRECAST PIPE

Precast concrete pipe is occasionally specified as a tunnel lining. Pipe cannot be placed until the tunnel is holed through and mucking completed. Pipe laying is commenced at the far end, or the mid-point, and the sections are laid toward the shaft or portal.

The first step is to lay a 24-in. gage track carefully to line and grade; this track is permanent and serves as a support for the pipe. The sections of pipe are carried from the shaft on a special car, Fig. 359, with a wheel base longer than the length of the pipe. The pipe hangs from a needle beam, which can be raised or lowered by means of two jacks. As the car reaches the previously placed section of pipe, the jacks are lowered, allowing the new section to rest on track, and the carriage is then removed.

A portable hand winch, or crab, anchored back in the completed tunnel is used to skid the section of pipe into the bell of the previous one. The joints must be of a type that can be calked or pointed from the inside, for there is seldom room outside the pipe for a man to work.

After the pipe is laid, it is necessary to backfill the space between the pipe and the rock. Generally a lean concrete is specified for this backfill. The procedure is to assemble about 30 ft. of pipe, then build a wood bulkhead and shoot the concrete with a pneumatic placer. A recent innovation is the use of stabi-

lized earth as the backfill. Sandy soil from a sewer excavation was mixed, very dry, with cement in the ratio of one part of cement to 10 parts of soil. This mixture was rammed by hand around each section of pipe as it was laid. When set, this stabilized earth had a hardness equal to a hard shale.

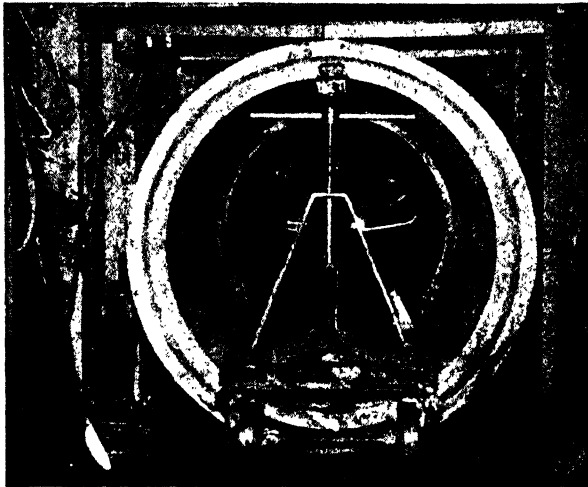

FIG. 359.—Laying 54-in. concrete pipe in a tunnel at Erie, Pa. Each section of pipe as laid was backpacked with well-rammed stabilized earth. (Courtesy of C. K. Pulling, Deputy City Engineer, Erie, Pa.)

GROUTING

Grouting to seal off water in rock tunnels is done before the concrete lining is placed. Nipples are set into the fissure and cemented in place; the rest of the seam, if possible, is calked with oakum or burlap, held in place by wooden wedges. Two or more grout pipes are required for each seam, to permit both water and air to escape from one while the other is being grouted.

Grouting starts at the lower nipple, continues until grout appears at the next pipe, and progresses until the flow is concentrated in one grout pipe. Generally this last nipple is then grouted to seal off the water, but, if the ground water is under a head, it may be best to wait until the concrete lining is in place; otherwise the water may find another course into the tunnel.

After the tunnel has been concreted, it may be necessary to grout again. The object of this second grouting is to fill any space left between the concrete and the rock. If the tunnel is

untimbered, concrete placed pneumatically will be packed tightly against the roof; but if ground supports are used, there will be voids behind the lagging or liner plates which should be filled. Grout pipes are often specified to be placed at regular intervals in the crown, say 20 ft., to ensure the filling of these voids and to compensate for shrinkage of the lining away from the crown.

At places where the seepage is so small that it is not worth while to dry it up before the lining is placed, a nipple is set at each spot and later grouted. When the tunnel lining is hand-

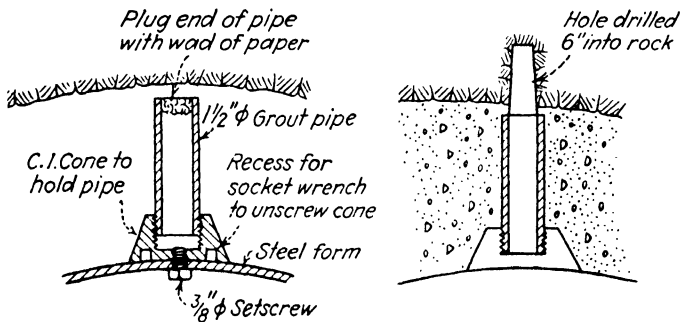

FIG. 360.—Method of holding grout pipes in a form.

placed, the key concrete must be so dry that it is often porous. Frequent grout pipes must be set to waterproof the crown later.

When possible, it is best to dry up the tunnel before starting the concrete lining. If this is not done, ingenuity is often necessary to divert water to weeper pipes to allow concrete to be placed in the dry.

Grout Machines.—Grout is placed by pneumatic or mechanical machines. Low-pressure grouting is usually done by pneumatic placers. A popular type of machine has a horizontal drum within which is a series of paddles mounted on a shaft revolved by an air motor. These machines have a 2-in. discharge, but for ordinary work the discharge pipe is bushed down to take a 1½-in. grout hose. Most machines both mix and place the grout. The first type mixes by agitating the water with air, the second by action of the paddles. If there is a great quantity of grout to be placed, it will be best to have a small mixer to prepare the grout, thus releasing the grout machine for full-time placing.

High-pressure grout, above 100 lb. per sq. in., is always placed with a reciprocating pump. The pump should have renewable liners on the pump end, for grout is highly abrasive. Grout is prepared in a small mixer and dumped into a shallow box from which it is removed by the pump suction. The grout in the box must be agitated and pulled to the suction inlet by a man with a hoe.

Grouting Procedure.—Grout is either a neat mix of portland cement and water, or a 1:1 or 1:2 mix of cement and sand. Sufficient water is added to give a consistency somewhere between that of thick cream and the stiffest which the grouter will place. Generally, a hole is started with a thin grout, the grout being

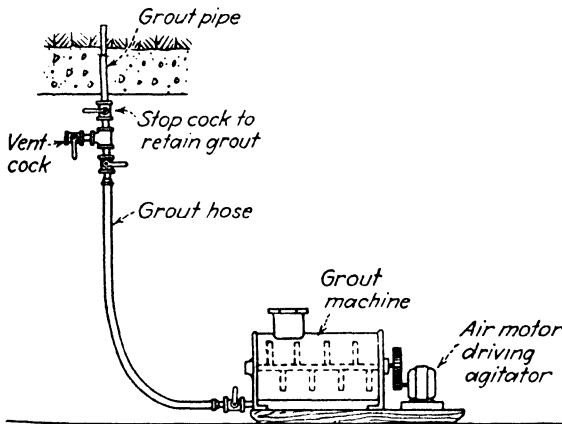

FIG. 361.—Grout machine and accessories.

stiffened as the hole is filled. Grout is forced into a pipe until it appears at the next hole of that series. The final hole of the series is grouted to refusal at the specified pressure.

In grouting a calked fissure, thin grout may leak out through the calking. Sometimes it is necessary to introduce a thick grout at first and allow it to set. The grout pipe is then redrilled to open the fissure again so that a thin grout may penetrate to a greater distance.

Sometimes a fissure will be so wet that the grout is washed out with the flow. In this case it is necessary to introduce cinders, sawdust or chopped manure which will lodge in the seam and check the flow enough to permit the grout to set.

Many grout pipes will not take any grout. For this reason it is customary to pay the contractor under an item "connection to grout pipe" for the work involved in trying to grout a hole.

Grouting is a highly skilled operation, and considerable experience and good judgment are required to determine the proper consistency of the mix and the best procedure to use.

Grout Pipes.—Grout pipes are generally $1\frac{1}{2}$ -in., with one end threaded to take the grout hose. They are set radially as ordered by the engineer. With wood forms, it is possible to set the pipe in a hole through the forms, leaving the threaded end projecting into the tunnel. This method is not satisfactory if steel forms



FIG. 362.—Grout machine in operation, Detroit water tunnel.

are used, as the projecting ends interfere with collapsing; therefore some device, such as that shown in Fig. 360, should be used to avoid cutting the form. This also keeps the end of the pipe back about an inch from the surface when the hole is finally pointed up. Before trying to grout a hole, it is good practice to run a drill into the pipe to make sure that the end is not blocked with concrete.

A stopcock is screwed on each pipe before attaching the hose. After the hole is filled, the stopcock is shut to retain the grout in the hole until it sets. The end of the grout hose should have two stopcocks, Fig. 361, one to vent air from the hose and the other to retain grout in the hose while it is being shifted from pipe to pipe.

CHAPTER 23

TUNNELS IN EXCEPTIONAL GROUND

Once in a while, because of the peculiar nature of the ground, tunneling methods depart from the orthodox and usual procedure. Two such cases will be given here. Both are examples of ingenious methods developed to meet the situation at hand.

HYDRAULIC MINING IN SANDSTONE

Taking advantage of the peculiar characteristics of the sandstone rock that underlies the Twin Cities, contractors and city construction forces on several sections of the Minneapolis-St. Paul intercepting sewer tunnels developed a most unusual method of muck removal. Spoil was handled from the heading by pumping, and the whole operation resembled hydraulic mining rather than normal tunnel driving. The process was described in full in *Engineering News-Record*, Nov. 7, 1935, p. 627.

The white sandstone rock, very stable in the undisturbed state and requiring timber supports only in the arch of the largest tunnel sections, was easily broken down to fine sand by air chisels or spades or by blasting; when mixed with water, the sand goes into a suspension that could easily be pumped through long pipe lines to the portal or, with the aid of boosters, to the top of access shafts. One contractor conceived the idea of using pumps for muck removal and tried it out with a vacuum-type steam pump. The result proved the method feasible, and soon standard centrifugal pumps were introduced, followed by centrifugals fitted with rubber bearings, rubber impellers mounted on steel disks, and rubber-lined casings. The last form of pump made the process a practical success, for, until the rubber-equipped pump was introduced, the metal parts wore out quickly under the abrasive effect of the sand.

On a 5,300 ft. length of tunnel 11 ft. 9½ in. in diameter, the Frazier-Davis Construction Co. drove headings both ways from the bottom of the 200-ft. shaft. The section was extremely wet, requiring heavy pumping equipment. The wet ground also

made a tile underdrain necessary. Driving was by the heading-and-bench method; final trimming of the sides and bottom was done later when the drain trench was dug. In advancing the heading face, the first step was to undercut the face by means of an air saw, a five-fingered manifold high-pressure jet on the end of a $\frac{3}{4}$ -in. pipe. The air jet cut a deep horizontal slot through apparently hard rock with ease.

After the undercut was made, the face was broken down for a depth of 4 to 5 ft. with sharp-pointed air chisels. The chisels cut off a slice of rock several inches thick, the rock disintegrating



FIG. 363.—Tunneling in sandstone, St. Paul sewers. The rock broke down into sand when mined with pneumatic chisels, and was sluiced to within reach of pumps for pumping to the surface.

into fine sand. As fast as the heading was advanced, five-segment timbering, consisting of 3x10-in. timbers laid flat and jointed skintight, was placed in the arch, bearing on a wall plate set on the bench.

A narrow ditch was carried along each side of the heading floor through which the sand muck was flushed from face of heading back to a collecting pool beyond the bench, usually about 25 ft. away. Most of the time, the flow of water from seams in the heading face and sides was sufficient to wash down the sand, but, if not, flushing was done with a water jet from a hose line through which water was pumped by a small force pump.

The bench was advanced in a preliminary cut along with the heading progress, the bench face being broken down with sharp-

pointed air chisels. Water jets also washed the sand produced by this operation down into the collecting pool. In cutting out the bench, a wide shoulder was left along each wall to support the arch timbering, and these shoulders were removed when the trimming was done.

In the collecting pool, a rail-mounted 4-in. centrifugal pump of 500-g.p.m. capacity, electrically driven, pumped the water-sand



FIG. 364.—The mucking machine on one section of the St. Paul sewer tunnel consisted of a rail-mounted centrifugal pump that picked up the mixture of sluiced sand and water at the heading and pumped it back to booster pumps at the shaft. Note the skintight timbering.

mixture through a 4-in. pipe line to the bottom of the shaft, a maximum distance of 3,600 ft. To reduce abrasion, the pump was water lubricated, leaving a net pumping capacity of 400 g.p.m. At the shaft, two booster pumps picked up the mixture and forced it to three bins above street level through 4-in. risers.

At the street surface, adjacent to the shaft, were three overhead steel-lined wooden bins. The pumps delivered into one of these bins, and the sand settled out almost immediately while the supernatant water passed over a waste weir to a drain leading to a sewer. When one bin was almost full, the flow was diverted to an empty bin. Each bin was equipped with two well points,

and operating these for 5 min. dried out the sand sufficiently to permit dumping through bottom gates into trucks for disposal.

On another section, the George R. Cooke Co. drove 5,000 ft. of tunnel through the same sandstone from an intermediate shaft. The same general process was used, although the sand broken down from the heading face was washed down a central trough cut in the bench.

The city of Minneapolis drove 14 miles of smaller tunnel on this same project with the same general procedure, except that



FIG. 365.--Booster pumps in tandem on another section of St. Paul sewers for pumping the sand to the shaft. Impellers and casings were lined with rubber to resist abrasion.

light drilling and blasting were preferred to the air jets in breaking down the face. Here the pulverized muck was shoveled by hand into a mixing box, into which a water line also discharged. A rubber-fitted pump, the same as used in the larger tunnels in St. Paul, picked up the sand and water from the mixing box and pumped it to portal or shaft.

TUNNELING THROUGH MARL

Fast and unusual tunneling methods were used by the city of Charleston, S.C., in driving 18.6 miles of tunnel through marl. As described in *Engineering News-Record* July 8, 1937, p. 59.

this tunnel, 7 ft. in diameter, was driven in nine months by a crew of 1,000 men. The tunnel was driven from 17 shallow shafts, and a high record of 7,032 ft. was driven in one week.

Light blasting was resorted to for advancing the heading. Usually five holes were drilled with a fishtail pipe auger bit to a depth of about 5 ft.; four of the holes were spaced radially around the circumference, with an inclination toward the center of the section, and one center hole was driven horizontally, so that the



FIG. 366.—Mining through marl, Charleston, S. C., water tunnel. Note how sides and roof could be trimmed with clay spades, yet stood without timbering.

back or the base of the four holes formed a circle about $3\frac{1}{2}$ ft. in diameter around the center hole. The powder was tamped very lightly, as it was found that less difficulty was experienced with the products of combustion by this method than by tamping the charges hard. All charges were fired by dry-cell batteries, and the mass was lifted forward into the tunnel about 3 or 4 ft. The larger pieces were broken up with pneumatic spades, and then the section was trimmed to within a few inches of full size by pneumatic spades. The final trimming of the tunnel was done by hand, using a carpenter's adz with a 4-in. blade and with the curvature increased slightly so as to enable workmen standing on

the floor to trim from overhead down each side to the floor. By this means a smooth-surfaced uniform section was obtained.

At a distance of 600 to 800 ft., sidings were cut in the tunnel for passing loaded and empty muck cars. Muck was loaded by hand and was removed in industrial mine cars of 20-cu. ft. capacity, fitted with roller bearings and running on light rail

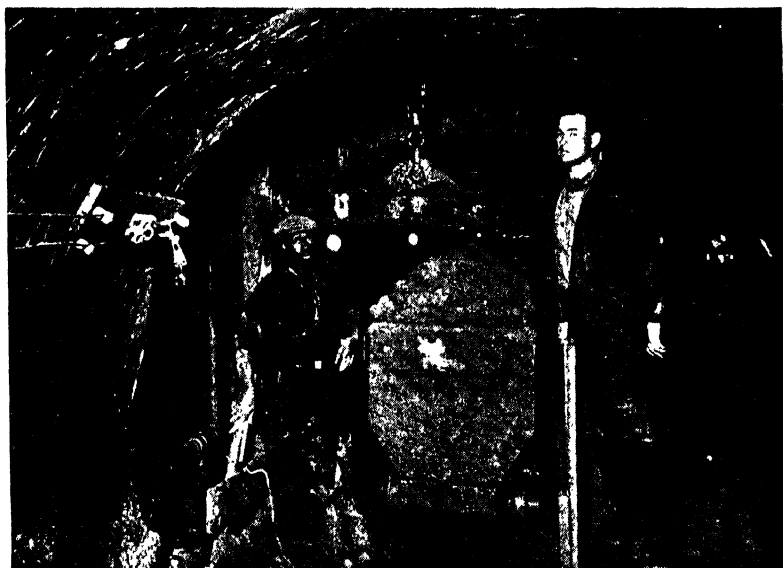

FIG. 367.—Intersection of shaft and tunnel in marl, Charleston water tunnel. This material is soft enough to cut with spades, yet stands without timbering, and the water tunnel was left unlined.

fastened to steel ties. The cars were pushed by hand in relays from 700 to 800 ft. long; that is, a man would push a loaded car toward the shaft for this distance and would return with an empty over his station.

The character of the work was such that no ground support was required and the tunnel was not lined, even though it is used as an aqueduct.

CHAPTER 24

PIPE JACKING

Pipe jacking may not, strictly speaking, be a branch of the tunneling art. However, the authors feel that a brief chapter should be devoted to this simple and economical method of securing an opening under the streets or fills. Most applications of this method have been to put a culvert under an existing fill, but some contractors have jacked pipes through virgin ground under railroads or busy streets in order to lay sewer or water lines without disturbing the surface.

The maximum length to which a pipe can be jacked is quite limited; it depends on the type of ground and the diameter of the pipe. A 36-in. corrugated pipe has been jacked 200 ft., but this is unusual; 100 ft. is considered the maximum for 48-in. pipe. On most jobs 50 ft. is all that can be jacked with ordinary equipment. If a longer tunnel is required, it will be better to go to the other side and jack the remaining distance, rather than purchase special jacks.

A pipe of 36-in. diameter is about the minimum within which a man can work efficiently. Pipes of 8-ft. or larger diameter require elaborate distributing frames and powerful jacks, and the economy and simplicity of the jacking method disappear.

PROCEDURE

Pipe.—The pipe may be of sheet steel, precast concrete or corrugated metal. There should be no outside sleeves or bells at the joints. It is customary to use a smooth longitudinal strip on the outside top and bottom of corrugated pipes to reduce friction. Pipes of sheet metal may be rolled into position on the guides, but a tripod or I-beam trolley must be set up for handling the sections of precast concrete or cast-iron pipe.

Jacks.—Two jacks will be used, of 50, 75, or 100 tons capacity. They should have a long stroke to eliminate as much as possible the time lost in reblocking. The foot of the jacks is set against a thrust block at the rear end of the jacking pit, Fig. 368. This

base should be of ample area to distribute the pressure. The jacks are fastened firmly in this position, as they are not moved until the operation is completed.

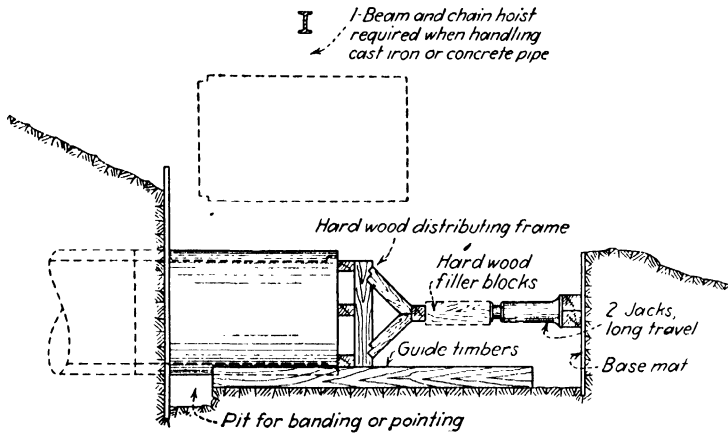

FIG. 368.—Typical set-up for jacking pipes.

The heads of the jacks bear against a frame of timber which distributes the pressure around the end of the pipe. After the jacks have been run out to their full stroke, they are retracted,

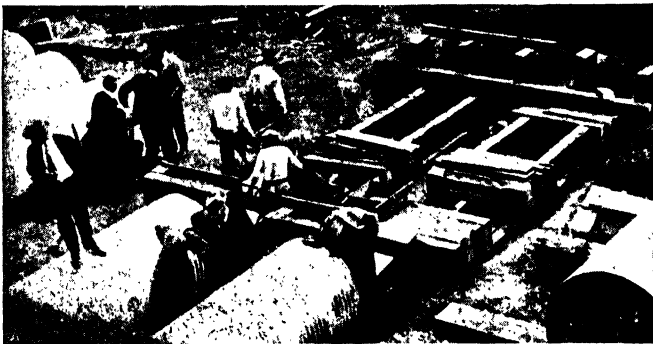

FIG. 369.—Jacking twin pipes through a heavy fill. Note the "lug" boxes for carrying muck. (Courtesy of Armco Railroad Sales Co., Inc.)

and blocking is placed between the jack head and the distributing frame. The blocking and the frame should be of hardwood to eliminate crushing and take-up of joints.

If a contractor has very much pipe jacking to do, it would be a simple matter to rig up a distributing frame of steel which slides along two H-beams. Instead of reblocking the jacks each time, lugs may be dropped into holes in the flanges of the bed beams to provide an anchor for the jacks.

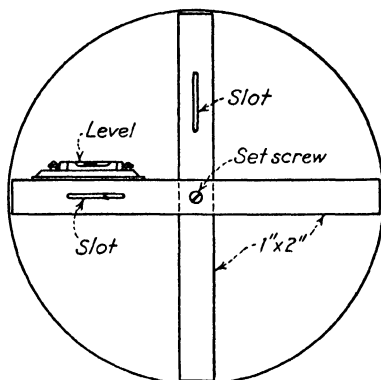

FIG. 370.—Sighting square for checking alignment of pipe in jacking.

Mining.—The face is excavated about 12 in. ahead of the end of the pipe by pick and shovel. In very small pipes, special short-handled tools will be required. Hard ground will require a pneumatic spade. Boulders can be broken by plug-and-feathering to avoid blasting so close to the end of the pipe.

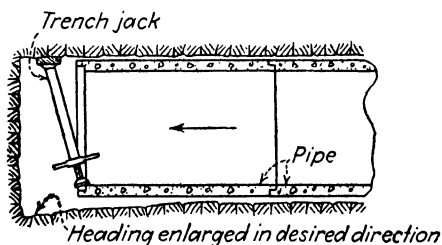

FIG. 371.—Method of correcting alignment when jacking pipe.

Muck is wheeled to the portal in wheelbarrows in pipes of 5-ft. diameter or larger. In smaller pipes, muck boxes are hauled back and forth on a small wagon running on a track made of 2x4-in. wood rails. The distributing frame at the rear of the pipe must be arranged to pass the muck without disturbing jacking operations.

Steering.—The pipes are assembled and started on their journey from two guide timbers set in the bottom of the jacking pit. These timbers are set parallel and at a distance apart equal to half the diameter of the pipe. Their top inner edge should be

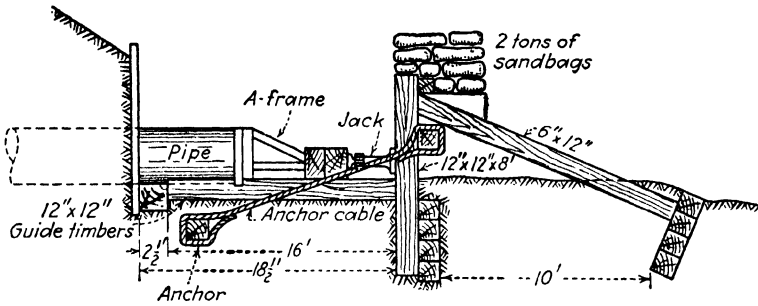

FIG. 372.—Special design of jack thrust block for swampy bottom.

armored with a small angle when handling heavy pipe. The timbers should be carefully set to line and grade, for on them depends the initial alignment of the pipes.

The head end of the pipe must be checked frequently for line and grade. The device shown in Fig. 370 has been used success-



FIG. 373.—Excavation is carried about 1 ft. ahead of the pipe for best results in jacking. (Courtesy of Armco Railroad Sales Co., Inc.)

fully for checking. The frame is unfolded and then held in position with one arm horizontal and the other vertical. The miner then holds a light behind the slots while the foreman checks the position by sighting across two nails driven in the timbering of the jacking pit.

If the pipe is off line, the drift is corrected by widening the excavation a few inches in the desired direction. A post or trench jack, Fig. 371, is then set to deflect the head of the pipe in the new direction. A pipe cannot be steered by the main propelling jacks. With ordinary care, a pipe should break through very close to the desired spot.

Friction.—Friction on pipes jacked through fills will range from 100 to 500 lb. per sq. ft. of external surface. The miner usually excavates the sides and roof about 1 in. larger than the size of the pipe. As the pipe advances into the hole, the ground will settle and cave around it, building up the friction. Large excavations will settle faster than small ones, hence skin friction on large pipes will be greater per square foot than on small ones. Once started, jacking should be carried forward night and day, for uniform and continuous motion will prevent the ground taking a "set" around the pipe.

INDEX

A

Accumulator, for shield, 265
Acker Drill Co., 12, 15, 16
Advantages of tunneling, 9
Aftercoolers, 191
Agricola, Georg, 1
Air consumption, by drill, 314, 315
Air lines, 194
 friction loss in, 194
 oilers in, 316
Air locks (*see* Locks, air)
Air pressures, plenum process, 275
 unbalanced, 276
Air spades, 217, 220
Allegheny Portage Tunnel, 5
Alpine-Draper Tunnel, 92
American method of driving, 213
Animal haulage, 131
Approach and access, 10
Armco Railroad Sales Co., Inc., 421,
 423
Articulated shield, 260
Atlas locomotives, 132
Auger drilling, 12
Austrian method of driving, 216

B

Baltimore Belt Tunnel, 7, 8
Baltimore water tunnel (*see* Montebello water tunnel)
Bar drill mounting, 325
Battery locomotives, 134
 charging stations for, 134
Battleships, 128
Belgian method of driving, 214, 215
Belt conveyors, 92, 94, 107, 269
Bench drilling, 337
Bins, muck, 150
 steel storage, 318
Bits, detachable, 319
 forged, 317

Blasting, cuts, 334
 delays in, 347
 explosives for, 338
 holes, depth of, 333
 patterns of, 331, 332
 misfires in, 352
 theory of, 332
 wiring for, 347
 resistance, 350
 (*See also* Explosives)
Blasting circuits, 347
Blaw-Knox Co., 377, 381, 395
Block system, track, 122
Blowers, 137, 155, 157, 158, 160,
 161
Blows in compressed-air tunnels,
 281
Boiling ground, 205
Bond, rail, 112
Boston Harbor Tunnel, 94
Bottom cuts, 334
Bottom headings, 305
Box Hill Tunnel, 4
Broadway Low-level Tunnel, 23
Brunel, Sir Marc, 233
Bucyrus-Erie Co., 95, 96
Buffalo sewers, 175, 382, 398
Buildings, 197
Bulkheads, compressed-air, 295
 in form, 389
Buster cut, 334

C

Cages, 142, 145, 147
Caissons, Chicago wells, 86
 drop, 87
 pneumatic, 88
California switch, 103
Cap and post timbering, 358
Car changers, 102

- Car changers, California switch, 103**
 cherry pickers, 95, 105
 Dixon conveyor, 107, 108
 as drill jumbo, 330
 King Grasshopper, 107
 passing track, 102
 simple, 102
 spur track, 104
Car couplings, 63, 130
 for Conway muckers, 100
Carlton Tunnel, 97
Cars, 125
 Easton, 117, 119
 nipper, 324
 quarry, 130
 safety, 60
 safety couplings for, 63
 types of, 126
 Western, 117
Cascade Tunnel, 306, 309, 396
Cases, driving with, 212
Cast-iron lining, 236
 weight of, 240
Cast-steel lining, 240
Center drifts, 305
Chain Belt Co., 404
Chaining, 40
Change houses, 197
Charleston water tunnel, 418
Cherry pickers, 95, 105
Chesapeake & Ohio Railway tunnels, 308, 310, 311, 360
Chicago Pneumatic Tool Co., 190
Chicago sewers, 68, 71, 97, 146, 151, 211, 217, 219, 220, 227, 280, 290, 291, 377, 394, 407
Chicago subways, 82, 143, 184, 185, 218, 277, 384
Chicago water tunnels, 7
Chicago well caissons, 86
Churn drilling, 13
Circuits, blasting, 347
 electrical-resistance, 350
Clay knives, 217
Cleveland sewers, 208
Coatings, Gunite, 372
 protective, 372
Cochrane, Lord, 233, 275
Collar bracing, 363, 368
Colorado River Aqueduct (see Metropolitan Water District)
Column drill mounting, 327
Commercial Shearing & Stamping Co., 226, 227, 231, 243, 266
Compensation insurance, 70
Compressed-air tunneling, 275
 air lines for, 296
 friction loss, 194
 air pressure required, 275
 blows in, 281
 bulkheads for, 295
 early use of, 233
 equipment for, 295
 fire hazard in, 282
 gas traps in, 298
 holding air in, 280
 labor hours in, 285
 locks, 286
 (See also Locks, air)
 predraining ground for, 282
 well points, 282
 wells, 283
 safety in, 67
 safety screen, 297
 sequence of operations, 284
 in various materials, 277
 clay, 277
 gravel, 279
 mixed face, 271
 sand, 278
 silt, 277
 volume of air required, 281
Compressor multiplier table, 315
Compressor plant, 188, 189
 air coolers, 191
 pumps, 192
 requirements, 189
 spray tank, 192
Concrete block lining, 244
Concrete lining, 25, 26, 273
 charging placer, 401
 closure of, 407
 concrete pump, 403
 continuous pouring, 384
 crews, 409
 curing, 33

- Concrete lining, curves, 391
 forms, 376
 arch, 379
 bracing, 387
 bulkheads, 389
 continuous, 384, 405
 invert, 378, 388
 monolithic, 385
 nontelelescoping, 380
 sidewall, 379, 380
 single unit, 379
 steel, economy of, 387
 stripping time, 377
 telescoping, 383, 386
 wood, 382
 grouting, 410, 412
 gun discharge pipes, 399
 hand placing, 394
 haulage, 392
 invert placing, 406
 mixing and placing, 392
 placer operation, 397
 placing layout, 402
 pneumatic placers, 396
 procedure, 373
 Pumpcrete, 403
 rock tunnels, 374
 sequence of operations, 374
 soft-ground tunnels, 375
 tunnel mixers, 394
 vibration of, 406
 Concrete locks, 294
 Conway mucker, 98, 99
 couplers for, 100
 as slusher, 100
 Core drilling, 16
 samples, 17
 Couplings, car, 60, 63, 100, 130
 Conway mucker, 100
 safety, 63
 vent-pipe, 162
 Crawler shovels, 96
 Cross-sectioning, 49
 pantographs, 51, 53
 sunflowers, 53
 Curves, concreting, 391
 in primary lining, 241
 Curves, surveying, 54
 final line, 56
 offsets from tangent, 55
 in track, 113
 middle ordinates, 114
 Cuts, drilling, 334
- D
- Daylighting of old tunnels, 311
 Delaware Aqueduct, 72-74, 137,
 140, 141, 145, 148-150, 154,
 160-162, 168, 170, 172, 176,
 186, 188, 192, 193, 322, 342,
 345, 369
 Design, of lining, 26
 in firm ground, 26
 in rock, 28
 shield, 236
 in soft ground, 29
 of Pennsylvania Turnpike, 22
 size and shape of, 23
 of timber supports, 355, 365
 of tunnels, 9
 Broadway Low-level, 23
 Lincoln, 21
 typical cross sections of, 24
 Detachable bits, 319
 Detroit sewers, 309, 386
 Detroit water tunnel, 413
 Detroit-Windsor Tunnel, 244
 Diamond drilling, core boring, 16
 drainage, 176
 Diesel generators, 188
 Diesel locomotives, 136
 Ditching, 174
 Dixon conveyor, 107, 108
 Double tracking of old tunnels, 310
 Drainage, 171
 diamond drilling for, 176
 of ditches, 174
 heading installations, 174
 predraining shafts, 85
 compressed-air tunnels, 282
 special heading conditions, 176
 from surface, 175
 weepers for, 32

Drill carriages, 328
 combined with vent plant, 169

Drill holes, depth of, 333
 patterns of, 331

Drilling, auger, 12
 bench, 337
 core, 16, 18
 cuts, bottom, 334
 buster, 334
 pyramid, 334
 wedge, 334
 diamond, 16, 176
 ring, 336
 shaft, 75
 wet, for dust control, 166-168

Drills, bits, 317
 detachable, 319
 forged, 317
 hot-milling, 321
 doctor, 196
 drifter, 313
 air consumption, 314, 315
 jackhammers, 315
 mounting, 325
 bar, 325
 on car changer, 330
 column, 327
 number of, 325
 oilers for, 316
 repair shops for, 196
 sharpening, 319, 320
 furnaces, 318
 hot-milling, 321
 steel, 317
 storage bins for, 318
 stopers, 316
 wagon, 315

Drop caissons, 87

Du Pont Co., 340

Dump cars, 126

Dust control, 153, 164
 auxiliary plant, 169
 combined systems, 168
 respirators, 170
 vacuum hood systems, 166
 wet drilling, 166, 167

Dynamite (*see* Explosives)

E

Easton cars, 117, 119

Eimco loader, 97, 98

Emergency locks, 288

Engineering and design, 9
 office, 36
 organization, 35
 surveying, 37

English method of driving, 214

Enlarging old tunnels, 309, 311

Erector, shield, 246, 266

Erie sewers, 206, 410

Escape locks, 290

Euclid trucks, 138

Explosives, 338
 delays, 347
 dynamite strengths, 336
 types, 338
 handling and care, 66, 340
 loading and stemming, 345
 magazines, 341
 misfires, 352
 primers, 343
 transportation, 340
 wiring circuits, 347
 electrical resistance, 350
 (*See also* Blasting)

F

Fabric vent tube, 164

Fabricated plates, 242

Fans (*see* Blowers)

Fire protection, 67

First aid, 69

Five-piece timber sets, 211, 360

Flooring, for soft ground, 205

Flying arch, 229

Foot blocks, 362

Forepoling, 200, 206, 230

Forged bits, 317

Forms, 376
 (*See also* Concrete lining, forms)

Fort Peck tunnels, 84, 124, 357, 370,
 371

Friction, in cars, 130
 loss of, in air lines, 192
 in vent pipes, 157

Frogs, track, 115
 Full-face tunneling, 300
 Furnaces, drill steel, 318

G

Gardner-Denver Co., 97, 328
 Gas traps, 298
 Gelatins (*see* Explosives)
 Geological investigations, 11
 auger, 12
 churn drilling, 13
 core drilling, 16, 18
 samples, 17
 mapping, 21
 punch borings, 11
 wash borings, 14
 German method of driving, 216
 Gila Canal Tunnel, 301
 "Glory-hole" shaft sinking, 79
 Grade lines, 48
 Grasshopper car changer, 107
 Gravel packing, 246, 252, 254
 Greathead, James Henry, 233
 Ground pressures, 354
 Ground support, rock, 354
 soft, 199, 221
 Grout machines, 411
 Grout pipes, 413
 Grouting, 410, 412
 concrete blocks, 246
 liner plates, 230
 plugs, 252
 shield tail voids, 251
 for water sealing, 410
 Gunite, 372

H

Hackley concrete placer, 397
 Hand mucking, 90
 Harecastle Tunnel, 3
 Haskins Tunnel, 8, 221, 233, 275
 Haulage, 109
 animal, 131
 battleships, 128
 cars, 125
 concrete, 392
 friction, 130

Haulage, locomotives, 132
 battery, 134
 charging station, 134
 internal combustion, 136
 steam, 136
 tractive effort, 132
 trolley, 134
 trolley-battery, 135
 muck boxes, 128
 safety, 62
 track, 109
 train resistance, 131
 trammers, 130
 truck, 137
 Headframes, 74, 139, 141, 150
 Heading-and-bench drilling, 337
 Heading-and-bench driving, 302
 Healy rotary dumper, 144
 Heitzman stemming plug, 346, 353
 Hennes, Robert, 30
 Hetch Hetchy Tunnel, 69
 Hoisting, 139
 bins and hoppers, 150
 cages, 142, 145, 147
 functions of plant, 139
 general layout, 139
 headframes, 74, 139, 141, 150
 mine hoists, 140
 rotary car dumpers, 143, 144
 signalling and safety, 149
 skips, 142, 145, 147
 track layout, 121, 122
 trolley hoist, 146
 Holland Tunnel, 295
 Hoosac Tunnel, 5
 Hoppers, 150
 Horse cups, 212
 Hot milling bits, 321
 Housekeeping, for safety, 59
 Hydraulic mining, sandstone, 414
 Hydraulic pressures, on shield, 265
 Hydraulic wrench, 239

I

Indicators, for switches, 117
 Ingersoll-Rand Co., 6, 161, 171, 173,
 174, 182, 189, 191, 192, 315, 321,
 323, 331

- Institute of Makers of Explosives, 340
- Insurance, compensation, 70
- Intercoolers, 191
- Internal combustion locomotives, 136
- Invert cleanup, 91
concreting, 406
forms, 378, 388
- Italian method of driving, 216
- J
- Jackhammers, 315
- Jacking pipe, 420
- Jacks, shield, 241, 256, 261, 262, 265
- Jeffrey Manufacturing Co., 108, 135
- Joints, mudding up, 280
- Jumbos, drill, 325
erecting, 246, 268
grouting and packing, 246, 254
- Jump sets, 360
- Jumper switches, 117, 119
- K
- Kelley, Charles F., 184
- Kelley dust control system, 166, 167
- King Grasshopper, 107
- Koehring Co., 138
- Koppel car, 126
- Kruse Engineering Co., vent system in, 160, 169
- L
- Labor, hours in compressed air, 285
- Lagging, shafts, 78
tunnels, 363, 370
- Lancaster Iron Works lock, 289
- Leveling, 40
- Lewis, George, 304
traveling cantilever, 304, 361
- Light boxes, 46
- Lighting, 62, 183, 187
- Lincoln Tunnel, 21, 45, 93, 96, 238-240, 278, 295
- Liner plates, 221
erecting, 224
flying arch, 229
grouting, 230
needle-beam system, 228, 229
poling, 230
robbing, 232
selecting, 223
shafts, 82
shield tunneling, 236, 241, 266
stiffening ribs, 222
- Lining, brick, 25
concrete (*see* Concrete lining)
design, 27
firm ground, 28
reinforcing, 31
rock, 28
soft ground, 29
water stops, 32
distortion of, 250
- Gunite, 25
primary, for shields, 235
cast-iron, 236, 240
cast-steel, 240
concrete block, 244, 245, 248
distortion of, 250
fabricated plates, 242
hydraulic wrench, 239
liner plates, 236, 241, 266
other types, 249
segments for curves, 241
target plate, 242
wood, 249
secondary, 253
selection of, 25
- Link-Belt shield, 264
- Linn tractor truck, 137
- Loading explosives, 345
- Locks, air, 286
air lines, 296
bulkheads for, 295
lock tender, 288
piping, 296
surveying through, 47
types, emergency, 288
escape, 290

Locks, types, general, 286

- man, 287
- materials, 286
- Matson, 293
- medical, 291
- tee, 292
- vertical, 292

Locomotives, 132

- battery, 134
 - charging station, 134
- internal combustion, 136
- steam, 136
- trolley, 134
- trolley-battery, 135

M

Magazine, explosives, 341

Malpas Tunnel, 3

Man locks, 287

Manholes, in rock, 79

- in soft ground, 86

Mapping, subsurface, 21

Marl, tunneling in, 417

Marsden Canal Tunnel, 3

Material locks, 286

Maughmer, G. E., 156

Meadows-of-Dan Tunnel, 403

Medical locks, 291

Meem, J. C., 29, 80

Methods of tunneling, 22

Metropolitan Water District tunnels, 60, 67, 99, 107, 158, 159, 177, 178, 302, 330, 335, 336, 341, 350, 366, 368, 378, 393

Middle ordinates, track curves, 114

Mine car loaders, 97

Mine hoists, 140

Minneapolis sewer tunnels, 404, 414

Misfires, 352

Moffat Tunnel, 304, 309, 361

Montebello water tunnel, 104, 142, 180, 188, 193, 195, 324, 325, 329

Muck bins and hoppers, 150

Muck boxes, 128

Mucking, 90

- belt conveyors, 92

Mucking, cleaning invert, 91

- hand, 90

mechanical loaders, 93

Bueyrus-Erie, 95, 96

Conway, 98-100

crawler shovel, 96

Eimco, 97, 98

full-revolving shovels, 94

Gardner-Denver, 97

mine car, 97

Nordberg, 97

Osgood, 95

railroad type, 93

slushers, 100

Sullivan, 97

turntable, 118

safety, 62

shafts, 76

soft ground, 220

trapping, 91

Mudding up joints, 280

N

National Safety Council, 59

New York compressed-air laws, 285

New York subways, 168, 169, 247, 260, 298, 380

New York Tunnel Authority, 291

New York tunnels (*see* Delaware Aqueduct; Holland Tunnel; Lincoln Tunnel; Queens-Midtown Tunnel)

Needle beam, with liner plates, 228, 229

with timber, 208

Nipper cars, 324

Nordberg shovel, 97

O

Office, for engineers, 36

Ohio Brass Co., 112

Oilers, air line, 316

Olmstead Tunnel, 92, 98

O'Rourke cherry picker, 105

O'Rourke concrete blocks, 245

Osgood shovel, 95

P

Packing, 363
 of gravel, 246, 252, 254
 Pantographs, 51, 53
 Patterns, drilling, 331
 Payment, for tunnels, 33
 Payments lines, 34
 Pennsylvania Turnpike, 22, 137,
 138, 189, 316
 Pilot tunnel method, 308
 Pipe, jacking, 420
 precast, 409
 Piping, air, 194, 296
 air friction losses, 194
 air lock, 296
 concrete discharge, 399
 ventilation, 155, 158, 160, 161, 163
 couplings, 161
 fabric tube, 164
 friction losses, 157
 installation, 158, 160, 161
 protecting tip, 165
 stresses, 161
 weight of, 163
 working pressures, 163
 Plenum process (*see* Compressed-air
 tunneling)
 Plumb candles, 46
 Pneumatic caissons, 88
 Poling plates, 230
 Portal bracing, 364
 Posts, 362, 368
 Power, 183
 consumption of, at Stanislaus, 187
 high-voltage circuit, 184
 switch room, 185
 Power clay knives, 217
 Predraining, of compressed-air tun-
 nels, 282
 of shafts, 85
 Prestweld concrete placer, 396
 Primary lining, shields, 235
 cast-iron, 236
 weight of, 240
 cast-steel, 240
 concrete block, 244, 245
 distortion of, 250

Primary lining, shields, fabricated
 plates, 242
 hydraulic wrench, 239
 liner plates, 236, 241; 266
 other types, 249
 segments for curves, 241
 target plate, 242
 wood, 249
 Priming explosives, 343
 Public safety, 70
 Pumcrete, 403
 Pumping, 171
 heading installations, 174
 horsepower required, 181
 shafts, 78, 179
 special heading conditions, 176
 from surface, 175
 Pumps, 171
 air coolers, 192
 centrifugal, 171
 hydraulic, 265
 sump, 172, 173
 turbine, 175, 182
 (*See also* Drainage)
 Punch boring, 11
 Pyramid cut, 334

Q

Quarry cars, 130
 Queens-Midtown Tunnel, 137, 238,
 282, 284

R

Rail, 110
 Raising shafts, 78
 Ransome concrete placer, 396
 Reinforcing, lining, 31
 Removable bits, 319
 hot-milling, 321
 Repair shops, 196
 Resistance, blasting circuit, 350
 Respirators, 170
 Ribs, steel, 366
 Richmond sewers, 225
 Ring drilling, 336
 Robbing liner plates, 232

- Rock falls, 65
 Rock tunneling, 300
 bottom heading, 305
 center drifts, 305
 daylighting old tunnels, 311
 double tracking old tunnels, 310
 drifting for wall plates, 308
 drilling, 313
 (See also Drilling)
 enlarging old tunnels, 309, 311
 full-face attack, 300
 ground pressures, 354
 ground support, 354
 grouting, 410
 heading and bench, 302
 lining, 28, 374
 pilot tunnel method, 308
 protective coatings, 372
 Gunite, 372
 side drifts, 307
 timbering, 354
 top heading, 303
 Rogers Pass Tunnel, 309
 Roots-Connersville blower, 154
 Rotary car dumper, 143, 144
 Route selection, 10
 Runs, in soft ground, 204
- S
- Safety in tunneling, 58
 compensation insurance, 70
 compressed air, 67
 labor hours, 285
 dust control, 153, 164
 (See also Dust control)
 escape locks, 290
 explosives, 66, 340
 fire protection, 67
 first aid, 69
 gas traps, 298
 haulage, 62
 housekeeping, 59
 lighting, 62, 183
 medical locks, 291
 mucking, 62
 personal protection, 66
 public, 70
- Safety in tunneling, rock falls, 65
 shaft devices, 149
 shaft operation, 64
 signalling, in shafts, 149
 silicosis, 70, 164, 165
 Safety cars, 60
 Safety screen, 297
 Saint Paul sewers, 206, 414
 San Jacinto drainage, 177
 Sandstone hydraulic mining, 414
 Sarnia International Tunnel, 8
 Schuylkill Canal Tunnel, 4
 Secondary lining, 253
 Segments, cast-iron, 236
 cast-steel, 240
 iron, weight of, 240
 timber, 360
 Shaft sinking, 72
 caissons, 87, 88
 Chicago wells, 86
 drainage, 177
 drilling, 75
 glory holing, 79
 headframes, 74
 lagging, 78
 layout, 145
 liner plates, 82
 mucking, 76
 predraining, 85
 pumping, 78, 177, 179
 raising, 78
 safe operation, 64
 sheet piling, 84
 soft ground, 79
 steel ribs, 77
 support, design of, 80
 surveying, 41
 timbering, 76, 80
 track layout, 120
 Sharpeners, drill steel, 319
 hot milling, 321
 Sheet piling, shafts, 84
 Shield, 256
 accumulator for, 265
 annular void, 250
 articulated, 260
 breasting, 272, 273
 design of, 256, 258, 261

- Shield, Detroit-Windsor, 244
 erector, 246, 266
 essential parts of, 256
 gravel packing, 246, 252, 254
 grouting, 251, 254
 handling, 267
 history of, 233
 hydraulic equipment, 261-263, 265
 hydraulic pressures on, 265
 jacks, 241, 256, 261, 262
 pumps in, 265
 steering, 273, 274
 target plate, 242
 T. & M., 264
 Union Tunnel, 234
 valves, 262, 263
- Shield tunneling, 233
 clay, 270
 history of, 233
 mixed face, 271
 primary lining (*see* Primary lining, shields)
 rock, 273
 sand and gravel, 272
 shape, 233
 silt, 269
 steering the shield, 273, 274
 Union Tunnel, 234
 (*See also* Compressed-air tunneling; Shields)
- Shops, repair, 196
- Shovels, mucking, 93
- Side drifts, 307
- Signalling in shafts, 149
- Silicosis, 70, 164, 165
- Size and shape of tunnels, 23
- Skips, 142, 145, 147
- Slushers, 100
- Soft-ground tunneling, 199, 221
 American method, 213
 Austrain method, 216
 Belgian method, 214, 215
 boiling bottom, 205
 cases, driving with, 212
 definition of, 199
 early methods, 7
 English method, 214
- Soft-ground tunneling, Five-piece sets, 211
 flooring for, 205
 forepoling, 200
 German method, 216
 horse cups, 212
 Italian method, 216
 liner plates, 221, 236
 (*See also* Liner plates)
 lining design, 29, 80, 82
 lining procedure, 375
 mining methods, 216
 air spades, 217, 220
 clay knives, 217
 mucking, 220
 needle-beam method, 208, 228, 229
 runs in, 204
 shaft sinking, 72, 79
 caissons, 86-88
 design of lining, 80
 timbering, 80, 82, 199
 (*See also* Shaft sinking)
 shield tunneling, 233
 (*See also* Compressed-air tunneling; Shield; Shield tunneling)
- Spiles, steel, 230
 wood, 404
- Spray cooling tank, 192
- Spur switch, 104
- Square sets and lagging, 212
- Stanislaus Tunnel, 164, 165, 186, 328
- Station surveying, 49
- Steam locomotives, 136
- Steel liner plates and methods (*see* Liner plates)
- Steel supports, shafts, 77
 tunnel, 365
- Steel timbering, 365
- Stemming explosives, 345
- Stoper drills, 316
- Storage bins, 150, 151
- Sullivan Machinery Co., 18, 97, 101
- Sunflowers, 53
- Surface track layout, 123
- Surveying, 37
 accuracy, 37
 chaining, 40
 checking, from surface, 48

- Surveying, cross sectioning, 49
 pantographs, 51, 53
 sunflowers, 53
 curves, 54
 chords and deflection angles, 55
 final line, 56
 offsets from tangent, 55
 grade, 48
 leveling, 40
 light boxes, 46
 line dropped down shaft, 41
 locks, surveying through, 47
 monuments, locating, 39
 plumb candles, 46
 portals, surveying from, 44
 prolonging line, 45
 running ground line, 38
 special conditions, 43
 station, 49
 triangulation, 40
 tunnel line, 44
 Switch indicators, 117
 Switch stand, 115
 Switches, California, 103
 characteristics of, 118
 diamond, 119
 finger, 115
 frog, 115
 jumper, 115
 points of, 115
 selection of, 115
 spring, 115
 spur, 104
 track, 114
- T
- T. & M. block lining, 248
 T. & M. Shield, 264
 Thor pumps, 172
 Three-piece timber sets, 358
 Ties, tracks, 113
 Timbering, American method, 312
 Austrian method, 216
 Belgian method, 214
 cap and post, 358
 collar bracing, 363, 368
 erecting, 224
 Timbering, five-piece sets, 211, 359,
 360
 flying arch, 229
 foot blocks, 362
 German method, 216
 horse cups, 212
 Italian method, 216
 jump sets, 360
 lagging, 363, 369, 370
 liner plates, 221
 (See also Liner plates)
 needle-beam system, 208, 228, 229
 packing, 363
 permanent timbering, 364
 poling plates, 230
 portal bracing, 364
 posts, 362, 368
 ribs, 366
 robbing plates, 232
 rock, 355, 357
 segments, 360
 selecting, 223
 shafts, 76
 soft ground, 199
 square sets and lagging, 212
 steel supports, 365
 stiffening ribs, 222
 three-piece arch, 358
 wall plates, 356, 361, 367
 wood supports, 355
 Timken bits, 322
 Top heading, 303
 Track, 109
 block system, 122
 bond, rail, 112
 curves, 113
 middle ordinates, 114
 gage, 110
 layout, 120
 foot of shaft, 120
 surface, 123
 passing, 102
 rail, 110, 112
 spur, 104
 ties, 113
 turntable, 118
 wheel loads, 110

- Track switches, 114**
(See also Switches, track)
Tractive effort, 132
Train resistance, 131
Trammers, 130
Transformers, 183
Trap mucking, 91
Triangulation, 40
Trolley-battery locomotives, 135
Trolley hoist, 146
Trolley locomotives, 134
Tronquoy Tunnel, 3
Truck haulage, 137
Truscon liner plates, 225
Tunnels, in exceptional ground, 414
Turntable, 117
- U
- Union Canal Tunnel, 4**
Union Iron Works, 148, 257, 288, 399
Union Tunnel, 234, 253, 258, 273
Utilities, 183
 air lines, 194
 friction losses, 194
 arrangement, 194
 compressor plant, 188
 compressor requirements, 189
 diesel generators, 188
 high-voltage circuit, 184
 lighting, 183, 187
 power, 183
 repair shops, 196
 switch room, 185
 transformers, 184
- V
- Vacuum hood dust control systems, 166**
Valves, shield, 261, 262
Ventilation, 153
 auxiliary plant, dust control, 169
 blowers, 154, 155, 157
 costs, 156
 equipment selection, 156
 fabric tube, 164
 fan and pipe layout, 158, 160, 161
 fans *(see Blowers)*
 friction losses, 157
 jumbo mounted plant, 169
 piping, 155, 158, 160, 161, 163
- W
- Wagon drills, 315**
Wall plate drifts, 308
Wall plates, 356, 361, 367
Wards Island sewer tunnel, 19
Wash borings, 14
Washington St. Tunnel, Chicago, 5
Water handling, 171
 grouting off, 410
 horsepower required, 181
 weepers, 32
Water stops, 32, 390
Watson-Stillman Co., 241, 265, 267
Wedge cuts, 334
Weight, of cast-iron lining, 240
 of rail, 112
 of shields, 260
 of steel lining, 242
 of vent pipe, 163
Well points, 282
Wells, predraining, 283
Western cars, 117
West Virginia Rail Co., 115, 119
Wet drilling, 166, 167
Wheel loads on track, 110
Wiring, blasting circuits, 347
Wood lining, 249
Wood timbering, 355
Worthington Pump & Machinery Corp., 239
Wrench, hydraulic, 239

TABLE OF LOGARITHMS

Natural numbers											Proportional parts								
	0	1	2	3	4	5	6	7	8	9									
											1	2	3	4	5	6	7	8	9
10	0000	0043	0086	0128	0170	0212	0253	0294	0334	0374	4	8	12	17	21	25	29	33	37
11	0414	0453	0492	0531	0569	0607	0645	0682	0719	0755	4	8	11	15	19	23	26	30	34
12	0792	0828	0864	0899	0934	0969	1004	1038	1072	1106	3	7	10	14	17	21	24	28	31
13	1139	1173	1206	1239	1271	1303	1335	1367	1399	1430	3	6	10	13	16	19	23	26	29
14	1461	1492	1523	1553	1584	1614	1644	1673	1703	1732	3	6	9	12	15	18	21	24	27
15	1761	1790	1818	1847	1875	1903	1931	1959	1987	2014	3	6	8	11	14	17	20	22	25
16	2041	2068	2095	2122	2148	2175	2201	2227	2253	2279	3	5	8	11	13	16	18	21	24
17	2304	2330	2355	2380	2405	2430	2455	2480	2504	2529	2	5	7	10	12	15	17	20	22
18	2553	2577	2601	2625	2648	2672	2695	2718	2742	2765	2	5	7	9	12	14	16	19	21
19	2788	2810	2833	2856	2878	2900	2923	2945	2967	2989	2	4	7	9	11	13	16	18	20
20	3010	3032	3054	3075	3096	3118	3139	3160	3181	3201	2	4	6	8	11	13	15	17	19
21	3222	3243	3263	3284	3304	3324	3345	3365	3385	3404	2	4	6	8	10	12	14	16	18
22	3424	3444	3464	3483	3502	3522	3541	3560	3579	3598	2	4	6	8	10	12	14	15	17
23	3617	3636	3655	3674	3692	3711	3729	3747	3766	3784	2	4	6	7	9	11	13	15	17
24	3802	3820	3838	3856	3874	3892	3909	3927	3945	3962	2	4	5	7	9	11	12	14	16
25	3979	3997	4014	4031	4048	4065	4082	4099	4116	4133	2	3	5	7	9	10	12	14	15
26	4150	4166	4183	4200	4216	4232	4249	4265	4281	4298	2	3	5	7	8	10	11	13	15
27	4314	4330	4346	4362	4378	4393	4409	4425	4440	4456	2	3	5	6	8	9	11	13	14
28	4472	4487	4502	4518	4533	4548	4564	4579	4594	4609	2	3	5	6	8	9	11	12	14
29	4624	4639	4654	4669	4683	4698	4713	4728	4742	4757	1	3	4	6	7	9	10	12	13
30	4771	4786	4800	4814	4829	4843	4857	4871	4886	4900	1	3	4	6	7	9	10	11	13
31	4914	4928	4942	4955	4969	4983	4997	5011	5024	5038	1	3	4	6	7	8	10	11	12
32	5051	5065	5079	5092	5105	5119	5132	5145	5159	5172	1	3	4	5	7	8	9	11	12
33	5185	5198	5211	5224	5237	5250	5263	5276	5289	5302	1	3	4	5	6	8	9	10	12
34	5315	5328	5340	5353	5366	5378	5391	5403	5416	5428	1	3	4	5	6	8	9	10	11
35	5441	5453	5465	5478	5490	5502	5514	5527	5539	5551	1	2	4	5	6	7	9	10	11
36	5563	5575	5587	5599	5611	5623	5635	5647	5658	5670	1	2	4	5	6	7	8	10	11
37	5682	5694	5705	5717	5729	5740	5752	5763	5775	5786	1	2	3	5	6	7	8	9	10
38	5798	5809	5821	5832	5843	5855	5866	5877	5888	5899	1	2	3	5	6	7	8	9	10
39	5911	5922	5933	5944	5955	5966	5977	5988	5999	6010	1	2	3	4	5	7	8	9	10
40	6021	6031	6042	6053	6064	6075	6085	6096	6107	6117	1	2	3	4	5	6	8	9	10
41	6128	6138	6149	6160	6170	6180	6191	6201	6212	6222	1	2	3	4	5	6	7	8	9
42	6232	6243	6253	6263	6274	6284	6294	6304	6314	6325	1	2	3	4	5	6	7	8	9
43	6335	6345	6355	6365	6375	6385	6395	6405	6415	6425	1	2	3	4	5	6	7	8	9
44	6435	6444	6454	6464	6474	6484	6493	6503	6513	6522	1	2	3	4	5	6	7	8	9
45	6532	6542	6551	6561	6571	6580	6590	6599	6609	6618	1	2	3	4	5	6	7	8	9
46	6628	6637	6646	6656	6665	6675	6684	6693	6702	6712	1	2	3	4	5	6	7	7	8
47	6721	6730	6739	6749	6758	6767	6776	6785	6794	6803	1	2	3	4	5	6	7	7	8
48	6812	6821	6830	6839	6848	6857	6866	6875	6884	6893	1	2	3	4	4	5	6	7	8
49	6902	6911	6920	6929	6937	6946	6955	6964	6972	6981	1	2	3	4	4	5	6	7	8
50	6990	6998	7007	7016	7024	7033	7042	7050	7059	7067	1	2	3	3	4	5	6	7	8
51	7076	7084	7093	7101	7110	7118	7126	7135	7143	7152	1	2	3	3	4	5	6	7	8
52	7160	7168	7177	7185	7193	7202	7210	7218	7226	7235	1	2	2	3	4	5	6	7	7
53	7243	7251	7259	7267	7275	7284	7292	7300	7308	7316	1	2	2	3	4	5	6	6	7
54	7324	7332	7340	7348	7356	7364	7372	7380	7388	7396	1	2	2	3	4	5	6	6	7

TABLE OF LOGARITHMS

Natural numbers										Proportional parts										
	0	1	2	3	4	5	6	7	8	9	1	2	3	4	5	6	7	8	9	
	55	7404	7412	7419	7427	7435	7443	7451	7459	7466	7474	1	2	2	3	3	4	5	5	6
56	7482	7490	7497	7505	7513	7520	7528	7536	7543	7551	1	2	2	3	3	4	5	5	6	7
57	7559	7566	7574	7582	7589	7597	7604	7612	7619	7627	1	2	2	3	3	4	5	5	6	7
58	7634	7642	7649	7657	7664	7672	7679	7686	7694	7701	1	1	2	3	3	4	4	5	6	7
59	7709	7716	7723	7731	7738	7745	7752	7760	7767	7774	1	1	2	3	3	4	4	5	6	7
60	7782	7789	7796	7803	7810	7818	7825	7832	7839	7846	1	1	2	3	3	4	4	5	6	6
61	7853	7860	7868	7875	7882	7889	7896	7903	7910	7917	1	1	2	3	3	4	4	5	6	6
62	7924	7931	7938	7945	7952	7959	7966	7973	7980	7987	1	1	2	3	3	4	4	5	6	6
63	7993	8000	8007	8014	8021	8028	8035	8041	8048	8055	1	1	2	3	3	4	4	5	6	6
64	8062	8069	8075	8082	8089	8096	8102	8109	8116	8122	1	1	2	3	3	4	4	5	6	6
65	8129	8136	8142	8149	8156	8162	8169	8176	8182	8189	1	1	2	3	3	4	4	5	6	6
66	8196	8202	8209	8215	8222	8228	8235	8241	8248	8254	1	1	2	3	3	4	4	5	6	6
67	8261	8267	8274	8280	8287	8293	8299	8306	8312	8319	1	1	2	3	3	4	4	5	6	6
68	8325	8331	8338	8344	8351	8357	8363	8370	8376	8382	1	1	2	3	3	4	4	5	6	6
69	8388	8395	8401	8407	8414	8420	8426	8432	8439	8445	1	1	2	2	3	3	4	4	5	6
70	8451	8457	8463	8470	8476	8482	8488	8494	8500	8506	1	1	2	2	3	3	4	4	5	6
71	8513	8519	8525	8531	8537	8543	8549	8555	8561	8567	1	1	2	2	3	3	4	4	5	6
72	8573	8579	8585	8591	8597	8603	8609	8615	8621	8627	1	1	2	2	3	3	4	4	5	6
73	8633	8639	8645	8651	8657	8663	8669	8675	8681	8686	1	1	2	2	3	3	4	4	5	6
74	8692	8698	8704	8710	8716	8722	8727	8733	8739	8745	1	1	2	2	3	3	4	4	5	6
75	8751	8756	8762	8768	8774	8779	8785	8791	8797	8802	1	1	2	2	3	3	4	4	5	6
76	8808	8814	8820	8825	8831	8837	8842	8848	8854	8859	1	1	2	2	3	3	4	4	5	6
77	8865	8871	8876	8882	8887	8893	8899	8904	8910	8915	1	1	2	2	3	3	4	4	5	6
78	8921	8927	8932	8938	8943	8949	8954	8960	8965	8971	1	1	2	2	3	3	4	4	5	6
79	8976	8982	8987	8993	8998	9004	9009	9015	9020	9026	1	1	2	2	3	3	4	4	5	6
80	9031	9036	9042	9047	9053	9058	9063	9069	9074	9079	1	1	2	2	3	3	4	4	5	6
81	9085	9090	9096	9101	9106	9112	9117	9122	9128	9133	1	1	2	2	3	3	4	4	5	6
82	9138	9143	9149	9154	9159	9165	9170	9175	9180	9186	1	1	2	2	3	3	4	4	5	6
83	9191	9196	9201	9206	9212	9217	9222	9227	9232	9238	1	1	2	2	3	3	4	4	5	6
84	9243	9248	9253	9258	9263	9269	9274	9279	9284	9289	1	1	2	2	3	3	4	4	5	6
85	9294	9299	9304	9309	9315	9320	9325	9330	9335	9340	1	1	2	2	3	3	4	4	5	6
86	9345	9350	9355	9360	9365	9370	9375	9380	9385	9390	1	1	2	2	3	3	4	4	5	6
87	9395	9400	9405	9410	9415	9420	9425	9430	9435	9440	0	1	1	2	2	3	3	4	4	5
88	9445	9450	9455	9460	9465	9469	9474	9479	9484	9489	0	1	1	2	2	3	3	4	4	5
89	9494	9499	9504	9509	9513	9518	9523	9528	9533	9538	0	1	1	2	2	3	3	4	4	5
90	9542	9547	9552	9557	9562	9566	9571	9576	9581	9586	0	1	1	2	2	3	3	4	4	5
91	9590	9595	9600	9605	9609	9614	9619	9624	9628	9633	0	1	1	2	2	3	3	4	4	5
92	9638	9643	9647	9652	9657	9661	9666	9671	9675	9680	0	1	1	2	2	3	3	4	4	5
93	9685	9689	9694	9699	9703	9708	9713	9717	9722	9727	0	1	1	2	2	3	3	4	4	5
94	9731	9736	9741	9745	9750	9754	9759	9763	9768	9773	0	1	1	2	2	3	3	4	4	5
95	9777	9782	9786	9791	9795	9800	9805	9809	9814	9818	0	1	1	2	2	3	3	4	4	5
96	9823	9827	9832	9836	9841	9845	9850	9854	9859	9863	0	1	1	2	2	3	3	4	4	5
97	9868	9872	9877	9881	9886	9890	9894	9899	9903	9908	0	1	1	2	2	3	3	4	4	5
98	9912	9917	9921	9926	9930	9934	9939	9943	9948	9952	0	1	1	2	2	3	3	4	4	5
99	9956	9961	9965	9969	9974	9978	9983	9987	9991	9996	0	1	1	2	2	3	3	4	4	5

