

BIRLA CENTRAL LIBRARY
PILANI [RAJASTHAN]

Class No. 621.38

Book No. H 867

Accession No. 18279

TELEVISION
PROGRAMMING AND PRODUCTION

TELEVISION

by

RICHARD HUBBELL

MURRAY HILL BOOKS, INC.
New York **Toronto**

PROGRAMMING & PRODUCTION



**CHAPMAN AND HALL, LTD.
37, Essex St., London, W.C.2**

COPYRIGHT, 1945, BY RICHARD W. HUBBELL
PRINTED IN THE UNITED STATES OF AMERICA
BY J. J. LITTLE AND IVES COMPANY, NEW YORK
ALL RIGHTS RESERVED

Preface

THE purpose of this book is to provide a foundation for the techniques of television program production. Because no backlog of experience has been made available previously, new telecasters have been forced to operate on a trial-and-error basis, often repeating some costly mistakes of predecessors.

From the end of 1936 through August, 1939, the British Broadcasting Corporation conducted the first serious effort to develop program production techniques, and shortly thereafter extremely limited telecasts were begun in France and Germany. In the United States a considered study of the problem was inaugurated in 1936 by the National Broadcasting Company and in 1937 by the Columbia Broadcasting System. Additional broadcast experiments were also conducted by Balaban and Katz (Chicago), Don Lee (Hollywood), Du Mont (New York), General Electric (Schenectady), Philco (Philadelphia), and Television Productions, Inc. (Hollywood).

Out of this work certain facts were established and basic methods evolved; but, to date, no one with extensive practical and theoretical experience has coordinated and evaluated this knowledge and presented it in book form. I have undertaken to do so in the hope of providing broadcasters, advertising men, writers, directors, actors, designers, students, technicians, and theatrical, radio, and motion-picture people with a foundation on which they can build their television plans and projects more rapidly and astutely. I have attempted to achieve this aim by analyzing the fundamental nature of television, by evaluating the progress made, and by suggesting practical ways in which the techniques of television may be improved.

It is not expected that all the theories propounded here will

meet with unanimous approval. Of necessity many of my conclusions are highly personal reactions, based on a ten-year study of television and conditioned by fifteen years of experience in the established arts of theatre, radio, motion pictures, music, and journalism.

In effect, this book is an introduction to the art of television, picking up where my earlier book, *4000 Years of Television*, left off. Although the material is condensed as much as possible, with emphasis on fundamentals, it is not a predigested popularization of things artistic. For this reason the benefits derived by the reader will be directly proportional to the amount of thought given to the problems under discussion.

If this book achieves its purpose in any degree, if it saves television broadcasters some of the costly months of trial-and-error operations through which others have gone, it will have helped to solve one of television's all-important problems, namely, the production of good programs.

I wish to acknowledge the debt I owe to Gilbert Seldes for many discussions of television since 1937 and for the opportunity of having worked with him as a member of his original CBS Television Program Department, perhaps the only true "laboratory" of television programming in prewar America.

This group talked, thought, and experimented with all phases of television seven days a week, from 1939 until its disintegration under the impact of war at the end of 1942. Working in close cooperation, the members of the group freely interchanged ideas, and out of this interchange grew many progressive theories about television which have had a direct bearing on the writing of this book. Therefore an acknowledgment of debt is due also to the members of this group—variously referred to as the *avant-garde* of American television, as the "brain trusters," and as "the nine old men of television." Actually they were not nine old men but ten young men and a woman: Ruth Norman, Worthington Miner, Rudolf Bretz (to whom I am also indebted for assistance on the drawings in this book), Phillip Booth, Edward Anhalt, Paul Mowrey, Stephen Marvin, Marshall Diskin, James Leaman, Richard Rawls,

and I. In addition to the original group there were the many others who joined the staff in 1941 when CBS Television went on the air after two years of nonbroadcast experimentation; these included Charles Holden, Robert Bendick, Carl Beier, Frances Buss, Gilbert Fates, and Robert Skedgell. Included in most of the discussions of aesthetics and exercising an influence over the entire experimental period were the administrators of the department, Adrian Murphy and Leonard Hole.

For permission to quote copyrighted material, my thanks to *Television*, the Magazine of Video Fact; Crown Publishers of New York; Jonathan Cape of London; Oxford University Press of New York; *American Cinematographer* magazine; the *Journal of the Society of Motion Picture Engineers*; the British Broadcasting Corporation; and Kamin Publishers.

For photographs I am indebted to the Bell Telephone Laboratories, the British Broadcasting Corporation, the Columbia Broadcasting System, the Allen B. Du Mont Laboratories, General Electric, Metro-Goldwyn-Mayer, the National Broadcasting Company, Paramount Pictures, the Philco Corporation, RKO Radio Pictures, the Radio Corporation of America, and Television Productions, Inc.

R. W. H.

Cincinnati, Ohio
May, 1945

Contents

	PAGE
Preface	v
<i>Part One: Introduction</i>	
CHAPTER 1. Introduction	3
<i>Part Two: The Nature of Television</i>	
2. The Nature of Television	11
3. Distinctive Characteristics of Television	17
4. The Theatre and Television	25
5. Television and Motion Pictures	34
6. Blind Radio vs. Television	44
<i>Part Three: The Camera</i>	
7. The Television Camera	57
8. The Ideal Camera	70
9. Camera Mobility	76
<i>Part Four: Video Technique and Theory</i>	
10. A Background for Camera Technique	85

CHAPTER	PAGE
11. Camera Techniques	91
12. Composition and the Cameraman	103
13. Editing the Television Picture	114
14. Video Effects and Lighting	122
15. Fundamental Problems and Theory	133
16. Toward a Video Technique	141
<i>Part Five: The Audio</i>	
17. The Microphone and the Audio	149
18. Realism and Acoustic Perspective	154
19. The Use of Sound	165
20. The Use of Music	175
<i>Part Six: BBC in Retrospect</i>	
21. Television Programming in England	183
Index	205

List of Figures

FIGURE	PAGE
1—Stop-openings in camera diaphragm	60
2—Light meter	61
3—Views with varying lenses	64
4—Focal depth illustrated	65
5—A problem in depth of focus	68
6—Pan and tilt shots	92
7—Trucking and boom shots	95
8—Camera angles	98
9—Rules of composition	105
10—Rules of composition	106
11—Rules of composition	107
12—Rules of composition	108
13—Rules of composition	108
14—Rules of framing	109
15—Rules of framing	111
16—Rules of framing	111
17—Rules of framing	112
18—Acoustic perspective curve	157

Photographs

Photographs appear in four sections. General classification headings are as follows:

between pages

PLATES I TO XIII

Television studios and programs compared with radio;
television cameras and equipment 36-37

PLATES XIV TO XXIII

Design and operation of television studios, cameras, lights,
video effects, and control rooms 100-101

PLATES XXIV TO XXXIX

Motion picture practice compared; television production
shots, U.S.A., 1939-44 132-133

PLATES XL TO LIII

Television production shots, England and U.S.A., 1936-40 164-165

Part One

INTRODUCTION

Chapter 1

INTRODUCTION

IN 1892 Max Plessner wrote a little piece about something called the telectroscope (the name "television" had not yet been coined). He predicted it would present "the stage, opera, important events, parliament, lectures with demonstrations, church services, visits to watering places, races, regattas, parades, city sights, and the head of the state addressing the whole nation." About the only thing Plessner omitted was that television, as we now call it, would create a new art form—partly out of the techniques to be established by its journalistic side and partly out of the artistic revolution it will cause by opening a world of new opportunities to artists in every field.

Whether he knew it or not, Plessner was establishing a pattern for most speeches and writings on the subject for the next half century and more. He was speculating on *what* television would present, not on how to present it.

Post-Plessner discussions of television have hewed to the scientific or politico-economic line wherever possible. When the subject of programs arises—about which most people want to hear more—it is usually dealt with in a most vague and superficial manner, invariably concluding with a glowing prediction of wonderful things to come. Now rosy daydreams are all very well, and we know that many of them will come true, but between the daydream stage and the realization of our hopes there lies a rather large and unbridged gap. That gap may be summed up in one question: how do you go about producing good television programs? The gap remains unbridged because there has been very little serious inquiry

into the nature of television program production. Only a handful of people have acquired any broad knowledge of the medium.

This probably constitutes the most serious bottleneck in television, something which can delay its rapid development at a time when television is important to almost every one of us. Why? Not only because it is potentially a new art form, but also because it can be the most efficient medium of education and the molding of public opinion which man has devised. In the difficult years of postwar reconstruction and reconversion it can play an important role in the building of a better world.

As Paul Raibourn, television executive of Paramount Pictures, put it, "Television can prove tremendously important in building good relations among nations since it can bring the peoples of far places face to face with each others' manners and customs. Out of such contact, genuine trust and understanding can be born. . . . No other instrument in our hands . . . promises a greater contribution to the winning of an enduring peace, especially if the international channels are supplied to make the flow of television world wide.

"It is easy to say that the problem and costs are terrific, both in engineering and programming. So is a series of world wars; the first cost tens of billions of dollars; the second is now costing hundreds of billions of dollars; and the third might cost thousands of billions of dollars and our children's freedom.

"Our citizens and our statesmen should decide which is cheaper, a great standing army, or an effective ambassador of good will, paid for by the people because it renders a service and satisfies a want."

As a postscript to Mr. Raibourn's observations on cost it might be noted that a tabulation of prices of television equipment, as estimated by leading American manufacturers, reveals that a coast-to-coast domestic network of seventy to one hundred stations can be built for less than the cost of one modern naval cruiser.

Planners of a better postwar world have found that television has a number of equally striking aspects. For example, this is the first time in history that man has had the opportunity to take a highly developed but completely unexploited science and out of it create a new industry—an industry which is being built from the

ground up and which will provide hundreds of thousands of new jobs. This is an opportunity and a challenge to our system of free enterprise which we cannot overlook. The circumstances which make it so are simple—and indisputable.

Shortly before the outbreak of this war, television had reached a state of technical perfection which seemed to make it ready for introduction on a commercial basis. But, perfected though it was, its economics frightened many prospective telecasters, who already were engaged in the highly profitable radio and motion-picture business.

They reasoned as follows: If pushed aggressively, it might out-mode the existing motion-picture and radio industries. On the other hand, if introduced very gradually, so as not to jar the *status quo*, it might conceivably take years to become a paying proposition.

Then, too, receivers were expensive and prices could not come down until they were built on a mass production basis, which meant building them in extremely large quantities. But the public would not buy receivers until good programs were available, and somebody had to break the ice. RCA, through the National Broadcasting Company, was willing to go ahead—and the FCC put a halt to that, perhaps fearing RCA would corner the market.

Television slumped into an era of squabbling and indecision, which it took a war to end. But end it the war did. Every available engineer, every manufacturing facility went into military production. Warring factions suddenly learned how to cooperate with each other in a common effort. The introduction of television as a new medium of entertainment and education was, of necessity, postponed until the end of the war.

The outbreak of hostilities delayed the public introduction of television, but it also had a most unexpected and far-reaching end result. It removed many of television's prewar economic problems and replaced them with a set of favorable conditions.

In April, 1942, the radio manufacturing industry suspended commercial operations, converting itself 100 per cent to war work. To satisfy the staggering demands for military electronic equipment enormous new manufacturing facilities were constructed. As the end of the war came in sight a troublesome question began to present itself: what to do with these huge factories after war pro-

duction eased off. The demands of aural radio alone would not be sufficient to keep many of them going. The aggressive promotion of FM might tend to fill the gap for a short period, but its long-term possibilities seemed considerably less sound than those of television, which offered a completely *new* public service. Many of the war factories, convertible to peacetime use, were particularly suited to the production of television equipment. In short, the facilities necessary for the *mass production* of *popular-priced* television receivers had been brought into existence because of the war.

Another end result of the war, even more important, was the new insight gained in the field of electronics. Because of its importance as a weapon, the science of electronics was subjected to the most intensive research and forced development. The knowledge and experience gained by manufacturers during the war makes possible the production of better television equipment at lower costs in less time than previously was thought possible.

To apply this knowledge of electronics, to build and service television equipment, trained technicians are, of course, necessary. As a direct result of the war several hundred thousand electrical technicians of one sort or another were trained and have been staffing the electronic war factories at home and operating communications equipment overseas in the Army and Navy. It was obvious that many of these men and women would seek postwar employment in the communications field, but that only a small percentage could be absorbed by the existing radio services. To find jobs for most of these technicians an entirely new frontier would have to be opened up in electronics, and by far the most attractive frontier in sight was television. The consensus of most industry leaders was that television, in all its aspects, could offer new jobs to several hundred thousand men and women during the first years of the reconstruction period. It could do this without destroying jobs in any other industry, without causing technological unemployment.

There has been, of course, some resistance to the growth of television, notably from established industries who viewed it as a threat to their profits. This is inherent in the structure of our economic system and was to be expected. Back in the 1930's, before radio or sound pictures had become very profitable, broadcasters

and producers of the latter were looked upon as "radicals," disturbers of the peace in the realm of (highly profitable) silent pictures and old-fashioned, acoustical phonographs. In more recent years, as these enterprises got out of the red and became highly profitable, some of the old "radicals" turned into conservatives and television became the "radical," even though it was backed by some eminently respectable corporations and inventors.

Technological improvements have always faced a measure of opposition from "vested interests" even though they are beneficial to mankind as a whole. Sometimes this opposition has caused an improvement to be withheld from the public for decades. The history of communications is full of examples.

The resistance to television in the United States probably was inspired largely by a lack of understanding—and because of the pressing necessity of keeping one's business out of the red, or else. But as more and more people took a considered look at television, they realized it would not "kill" radio or motion pictures any more than the telephone "killed" the telegraph, than the airplane "killed" the train. Resistance to television was also lessened by the remembrance of what happened to the old gramophone business. It did not pay attention to technological advance and the rise of radio with its improved sound reproduction. Result: it went out of business almost entirely and then experienced a phenomenal rebirth when it took advantage of technical improvements.

Our free enterprise system has come in for considerable criticism, has been called inefficient and outmoded. *In the development of television we have a nearly perfect test case to prove or disprove these charges.* All the elements of a laboratory experiment are present: A set of known quantities and circumstances, i.e., the technical state of television and the economic situation of the electronics industry. We have a specific force—American freedom of enterprise—which, barring governmental restrictions, is being applied to these quantities. The conditions under which the experiment is being conducted are relatively favorable, and we can estimate what the result should be. Whether or not it approximates our estimate depends on the potency and flexibility of our specific force. *It is an opportunity which American industry and government have never had before and may never have again.*

Part Two

THE NATURE OF TELEVISION

Chapter 2

THE NATURE OF TELEVISION

BEFORE going any farther it might be a good idea to make sure we have the answer to a rather necessary question—What is television?

“That,” you may say, “is a silly question. Everyone knows what television is.”

Maybe yes. Maybe no. Have you a definition for it? Have you ever asked anyone else that question? Your answers are likely to bear a strange similarity to the fable of the blind men who described their impressions of an elephant after each had felt a different part of the beast—tail, trunk, leg, and side.

As a matter of fact it is almost impossible to find anyone who can give you a comprehensive and accurate description of television. Two of the more “popular,” if unbalanced, definitions are (1) free movies in your radio set, and (2) a new kind of visual telephone through which a peeping Tom can leer into your boudoir whenever the telephone bell rings—electronically, of course.

When I was writing *4000 Years of Television*, it took several weeks of searching to establish with any reasonable degree of certainty how and why the very name “television” was created. As pointed out in that book, it apparently was coined in 1900 by a French librarian who was trying to catalogue some material on the electrical transmission of pictures—which was then called telescopy, electrical telescopy, or telectroscopy. This librarian con-

cocted the word "télévision," which we have adopted without the accent marks. Although it has been well publicized, it might be in order to note that the word "tele-vision" comes from Latin and Greek roots, and means, literally, "distant-seeing."

Scientifically, television is an electronic method of transmitting visual and aural images over a considerable distance, reproducing these visual-aural images in an unlimited number of places—and doing the whole thing so rapidly that for all practical purposes it is instantaneous.

Materially, television must have the following vital organs in order to function: (1) an "eye" or camera, and an "ear" or microphone with which to pick up the picture and sound; (2) a control arrangement, by means of which the apparatus may be controlled and the visual-aural program regulated; (3) a transmitting system, by means of which the visual-aural program is broadcast through the air or disseminated via wires and cables; (4) a receiving set, which receives the program and converts it into a visual-aural replica of what the camera and microphone saw and heard at the point of origin.

Psychologically, it is an extension of seeing and hearing over great distances. Vision and hearing are our two most important senses, through which we acquire approximately 98 per cent of all our knowledge. Because of this, and because the process of visual-aural extension is instantaneous, television can achieve the effect of making you feel that you are in two or more places at one time: watching your receiver in your home (or wherever it may be placed) and at the scene of the telecast. This feeling is most pronounced when you know that you are viewing a "live" program, not a previously exposed motion-picture film. A viewer's reaction to a successful program often takes one of three forms, which can be controlled by a skilled program director. These reactions are:

(1) The effect of "looking in" on the program from the sidelines, without actually taking part in it. This is usually the effect achieved in viewing sporting events, news events and newscasts.

(2) The effect of not only "looking in" on the program, wherever it may be, but of actually taking part in it. The "subjective" method of handling a program, in other words. Examples would be audience-participation programs, including not only such things as quiz

shows, but also many types of informal "meet-a-celebrity" show, demonstrational, and educational programs. Also this would include most successful dramatic programs, and some types of variety and dancing shows.

(3) The person or persons on the program seem to step into your living room and converse with you. A simple example is the television announcer, viewed by a close-up camera, looking straight into the camera and addressing the audience as "you" while speaking in a conversational tone of voice.

Historically, television is perhaps the only invention of modern times which fills a basic human desire never fulfilled before: "You can be in two places at one time." Most if not all other inventions of modern times have been improvements on existing methods of doing things. This is particularly true in the field of communications and transportation. Even the airplane which permitted men to fly at will is basically an improved method of transportation. The telephone and aural radio anticipated television; but both of them lacked sight. And vision is our most potent sense. Of the 98 per cent of our knowledge which we acquire through our eyes and ears, roughly 90 per cent is learned through seeing—only 8 per cent by hearing. (The other 2 per cent is acquired through the other senses: smell, touch, taste, and allegedly feminine intuition.) Since radio and the telephone are blind, it is more accurate to say they are incomplete forms of television rather than that television is merely an improvement upon them.

Sociologically, television should be our most potent medium of education and propaganda. Its powers of persuasion have still to be tabulated by researchers, but rough and somewhat primitive estimates indicate they will far surpass other media and may be roughly equal to the combined impacts of aural radio, motion pictures, and the press.

Gilbert Seldes has called it "the instantaneous and complete transmission of actuality . . . the transmission of the image of an event while the event is taking place."

David Sarnoff once referred to television's ultimate contribution as "its service towards unification of the life of the nation, and, at the same time, the greater development of the life of the individual," a sentiment subsequently echoed by Winston Churchill.

Television is big. It is wide open. Its future is all before it, and it depends primarily on the programs we build. Its technical future is assured, but without entertaining programs it cannot advance.

Television programs are divided into two general fields: those which involve *transmission only*, and those which involve *creative* or interpretive effort.

Programs of pure transmission, in theory, would be limited only to the showing of motion pictures not especially made or edited for television. Every other conceivable type of *program*—even just poking a camera out of the window—would involve some exercise of editorial judgment and therefore would necessarily include some interpretive or creative effort, no matter how slight. The straightforward transmission of a regular motion picture uses television only as a method of distribution, a substitute for celluloid in tin cans.

The very fact that all other types of programs involve some degree of creative or interpretive effort should be sufficient to indicate that television is potentially a new art form. To be sure, it has certain qualities of motion pictures, radio, stage, and press, but the sum total of television is more than just the sum of these parts. It has characteristics of its own, which are either peculiar to television or present in a greater degree than in any other medium. Because these distinctive characteristics give television an extra something all its own, they must be recognized and developed. If television is to become an art, it cannot remain as merely an imitation of some other medium, no matter how successfully the imitation may be carried off.

The Russian motion-picture director and theorist, Lev Kuleshov, who in the early 1920's propounded the theory upon which the Russian school of film production was based—and which in turn affected motion-picture technique throughout the world—reasoned that *in every art there is (1) a raw material, and (2) a method of composing that material which is best suited to its essential nature*. After working out many experiments in arranging strips of motion-picture film in different ways, Kuleshov found he could achieve predetermined effects by the relation, interrelation, and juxtaposition of the different strips of film. This led him to the conclusion that for *silent motion pictures* the raw material was the strip of exposed film carrying a photographic record, not the action

depicted in that record. The truly cinematic method of composing, Kuleshov determined, was the act of piecing strips of film together in the right order and rhythm—editing, in other words. From this developed the Russian school of editing which is known by the name *montage*.

The degree to which the cinematic theory of montage may hold true in television will be interesting to determine. This is a subject about which considerable controversy will undoubtedly arise. In the meantime it will be helpful to keep in mind the method of reasoning by which Kuleshov arrived at his theory. It is a process which has been followed, in one form or another, by virtually every “prime mover” of the arts from Aristotle to Lev Kuleshov in motion pictures and Gilbert Seldes in television.

Now I am not saying we should cast a jaundiced eye on the use of film in television (telecine) because of the danger of making television an imitation of the cinema. Neither do I necessarily look down on programs which are imitative of theatre, radio, or the press—as long as they are reasonably entertaining. Obviously such programs are going to make up a sizable and perhaps necessary portion of the daily television fare, and as such they will constitute a legitimate part of television’s commercial growth. This will be true not only because television is going to use a lot of program material, all it can get, but also because the art of television is in an embryonic state. No art can be pulled out of a hat overnight, or even in a decade or two. The history of every art shows that in its infancy it imitated other forms, and that examples of genuine artistic progress were classic rarities rather than everyday occurrences. A motion-picture version of a drawing room comedy may not begin to realize the potentialities of the cinema, but it can result in an entertaining show which grosses several million dollars. Those dollars often make possible the financing of artistic progress.

The point I do want to make is that the characteristics inherent in television give it powers far beyond being just a substitute for celluloid, a new way to distribute motion pictures—or, for that matter, stage plays, picture magazines, and audience-attended radio shows. Television is a new art of the first magnitude, waiting for us to develop it. Let’s not cripple that development by confining

television within arbitrary boundaries, by failing to recognize and exploit all its potentialities.

There is a natural tendency for motion-picture people to think of television as a new branch of motion pictures, for radio people to see it as visualized radio programs, for theatre people to look on it as an extension of Broadway, for advertising people to think of it only as a better way to sell laxatives and soap, for educators to regard it solely as a new dimension in audio-visual education, for manufacturers to dream of it only as a wonderful way to sell more equipment. This adds up to a lot of people with limited perspectives and therefore limited capabilities. The tele-woods are full of them now, for very few have had the foresight and initiative to learn something of all of these contributory fields, to get the broad knowledge and experience which television will demand of its top-flight artists and executives.

Chapter 3

DISTINCTIVE CHARACTERISTICS OF TELEVISION

IN MAKING a closer examination of some of the characteristics of the medium, let us first divide television into two parts, giving each its standard name. The visual portion is called the *video*, after the Latin "I see." The aural portion is known as the *audio*, Latin for "I hear." The eyes and ears of television have interesting similarities and dissimilarities to their human counterparts.

The human eye, being "wide-angle," takes in a broad field of vision. The camera, with its restricted, funnel-like lens, views only a selected portion of a given scene. The microphone is more like the ear, both being essentially nondirectional and capable of picking up low- or middle-register sounds coming from any direction.

Light waves travel in straight lines for all practical purposes in television production. They can be reflected, still in straight lines, by any surface—the amount of reflection depending on the color and texture of the given surface. Sound waves, however, tend to go around corners at low frequencies while higher-frequency sounds do not. Sound waves can be reflected from most surfaces in varying quantities, the lower frequencies reflecting more readily.

The eye is a very discriminating organ and when viewing a television picture will easily recognize any distortions or defects. The ear, on the other hand, is far less discriminating and will tolerate sound of poor quality. It will also accept and appreciate abstract sounds which convey little or no literal meaning (music,

for example) much more readily than the eye will accept abstract visual material.

Although television duplicates the functions of the human eye and ear to a remarkable extent and exceeds them in the ability to reach over thousands of miles, it is less effective than the human organs in three respects. None of these deficiencies are vitally important. All of them are shared to some extent by motion pictures, radio, phonographs, and the press.

Normal human beings see with two eyes and hear with two ears. This is called *binocular* (two-eyed) vision and *binaural* (two-eared) hearing. The advantage of having two seeing-systems and two hearing-systems working in synchronization is that (a) it enables our eyes to perceive distance or depth very accurately, to see stereoscopically, three dimensionally; and (b) it enables our ears to "focus" on sound and determine the horizontal and vertical position of a given source of sound, as well as its distance from the listener, in what is known as stereophonic or three-dimensional hearing. If an ear or an eye is shut off, one's three-dimensional powers are greatly impaired. A single eye cannot judge distance accurately, although it can still judge vertical and horizontal position. A single ear cannot judge horizontal-vertical position although it can judge distance.

Television, like radio and motion pictures, differs from the human equipment in that it is "single-system"—i.e., it is not binocular and binaural, but rather *monocular* (one eyed) and *monaural* (one-eared). As a result it does not have the three-dimensional perception of the human system. These deficiencies are partly compensated for by careful camera handling and lighting in the video, and by the judicious handling of aural or acoustic perspective in the audio. Three-dimensional stereoscopic sight and stereophonic sound are possible in television, but certain problems of practical application will probably limit their use for a good many years. In the meantime, we shall be able to get along quite nicely with a monocular, monaural system—just as motion pictures and radio have managed to survive with the same handicap.

At the present time television is primarily monochromatic—its pictures are in shades of gray, and white—while the human eye sees color. Without any doubt we shall have television in color, perhaps

in a few years, and when it is ready program producers will welcome it with open arms. But even if it is not made ready for another five or ten years, it need not delay the growth of the television art. Monochromatic motion pictures have managed pretty well without color for some fifty years, and the black and white television picture now available should be quite satisfactory—not as good, perhaps, as the 35 mm. Hollywood film, but better than good 16 mm. home motion pictures.

Television is less effective than the average human ear-eye combination in that it does not yet see and hear quite as clearly, cannot reproduce the same degree of visual definition and aural quality. This gap is rapidly being closed and does not constitute any serious obstacle to television programming. On the other hand, the television eye and ear may eventually be capable of greater sensitivity than the human eye and ear, may be able to see and hear where human beings cannot.

It might be of value to note in passing that the quality of a television picture is determined by a variety of elements—not just by the rated number of lines of horizontal definition.

Fineness of definition, a major and easily comprehended factor in television quality, is popularly thought to depend entirely on the *frequency response* of the complete television system—camera to receiver. Definition is also affected by changes in the size of the scanning spot according to current intensity which may harm the definition. The number of *scanning lines* and the number of *frames* likewise exercise a direct effect. The apparent quality of the picture also changes with the *distance* of the viewer from the screen, for if one is too close, the line structure becomes noticeable. The ideal viewing distance for television runs from about five times the height of the picture to ten times or more, the picture appearing to be sharper at greater distances. (If the picture is ten inches high, one should sit fifty inches or more away.) Motion-picture operators have found that if a viewer is less than four times the picture height from the screen, eyestrain usually ensues. Adequate viewing conditions have been found to be up to twelve times the height of the screen.

If the television picture flickers, its quality is lowered. (With

present standards flicker is eliminated from the television picture.) The *size* of the pictures is likewise important, and audiences do not like them small. The over-all color of the picture has a bearing on matters. A tube giving a pure white light has been found most desirable for monochromatic television even though greater efficiency can be secured with chemicals giving a green picture. And, of course, *full color* television is infinitely more attractive than monochromatic.

Picture quality is harmed by distortion, whether it be *lens distortion* in the camera, or *scanning distortion*, or distortion caused by *curvature of the picture tube* in the receiving set—a problem which has been largely eliminated by the new flat-face tubes and projection sets.

A good picture must have an accurate rendering of brightness differences over the complete contrast range, although it is not necessary to reproduce on the screen the general brightness of the original setting. (The picture will be satisfactory if rendition of brightness differences is constant and accurate with the original even though the average brilliance is different.)

A motion picture or a still photograph can give on the average a satisfactory picture with a contrast range (the shades from black to white) of around 35 to 1, although the average human eye can perceive a far greater range of contrast. The prewar type of cathode ray picture tubes had a maximum contrast range of not over 30 to 1 but *only* between widely separated points on the screen when viewed in a dark room. This 30-to-1 range could not be obtained between two adjacent portions of the picture, that being limited to around 10 to 1. Factors limiting this contrast range included the *halation* on the fluorescent screen, reflections inside the tube, the curvature of the tube, as well as outside light striking the screen. A contrast range equal to that of the motion pictures would more than double the apparent quality of the picture, and this seems to have been partly achieved in recent models of flat-face, "dark screen" picture tubes. Fine detail in the picture often cannot be seen by the eye without a minimum contrast range of 30 to 1 between two adjacent parts of the picture.

The resolution of the prewar, cathode-ray tube picture was limited not only by variations in the size of the scanning beam spot

out also by the *shape* of the spot itself—a small round spot with a diameter less than the theoretical width of one line. Engineers point out that the ideal theoretical shape for the scanning beam spot would be a rectangle with a height equal to the theoretical vertical width of a single scanning line, and its horizontal width a fraction of its height. The maximum brilliance of a spot of this rectangular shape would be greater than that of the round spot, because its area would be greater.

Another factor directly affecting the quality of the television picture is man-made electrical “noise” or atmospheric static. Principal sources of *interference* are unshielded diathermy machines and automobile spark plugs. Diathermy machines cause a herringbone pattern to appear in the picture; spark plugs cause specks to appear. If the signal strength of a transmitter is weak and the receiver must be turned up full to get a picture, the picture may have a “grainy” appearance caused by “noise” in the circuits of the set itself.

Then there is the very important factor of ghost images, which can spoil a picture of the best quality. A ghost image is the result of *multi-path reflections*. In everyday language, the television broadcast reaches an antenna direct from the transmitter, but a fraction of a second later one or more “echoes” arrive and are picked up. These “echoes” are caused by the reflection of the broadcast signal from such things as the sides of buildings or mountains to the antenna. Because of the indirect and longer path they follow, these “echoes” arrive shortly after the original signal. The effect on the screen is of one or more extra, weaker pictures superimposed on the original picture in not quite the same position, causing blurring and ghostlike extra images.

The way in which a scene is lighted is just as important in getting a good picture as the acoustics of a studio are in securing good sound reproduction. A television system may have all the definition and contrast range in the world, but unless the lighting director, in cooperation with the cameraman and director, has done a good job, the picture will look flat or blotchy and uninteresting. Lighting prerequisites for a good picture are (1) sufficient over-all illumination to produce a signal on all parts of the camera’s mosaic (photosensitive plate), and (2) the artistic use of modeling lights (side lighting, back lighting) to give the picture depth and charac-

ter. The lighting must also be strong enough to give a good depth of focus, steady and unwavering to avoid any flickering or unexpected variations in intensity, and it must have color characteristics which make it possible for the camera to "see" all parts of, and colors in, a given scene.

Although thus far there have been no reliable studies made of the viewing habits of the television audience, it seems a good guess to assume that in a given period of time the average family will watch television many more hours than it spends in a motion-picture theatre—after all, it is free and right there in the home available at the flick of a switch. On the other hand, because it takes more concentrated attention—one has to watch it and *theoretically* cannot do household tasks or anything else while enjoying television—it has seemed reasonable to many people to assume that it will not displace aural (blind) radio, and indeed will not be used by a given family as extensively as radio is today. This may prove to be the case—and it may not. There are some pretty sound arguments to back it up—but there is also just the beginning of a little theory, based on a few, incomplete experiments, which may prove to be correct and upset the conventional theories on "Why television cannot displace radio."

Television service probably will be made available in two ways in the United States. There already is the regular broadcast service to the home, paid for by advertising just as standard broadcasting is. It will be viewed largely by small groups of people in the privacy of their homes, and subject to the usual distractions of home life. It will also, in all probability, be presented in motion-picture theatres along with the regular feature films. This service would be paid for primarily by the admissions paid by the audience to see the entire show—television and motion pictures. Plans have also been laid for the opening of theatres presenting nothing but television. This theatre service, viewed on large screens by large groups of people seated in a darkened auditorium, will undoubtedly require a different programming technique from that of the more important home service. This will apply primarily to the choice of program material and the type of showmanship used. The material to be covered in this book applies to both types of service.

In the creation of any television show two sensory appeals, two fundamental "rhythms"—visual and aural—are fused to produce a desired effect. They may be joined harmonically or contrapuntally, to use musical terminology.

A fundamental characteristic of the video is the *literal restatement* of what the camera sees—the transmission of actuality. *But the element of suggestion can be introduced into the video in almost any quantity desired* by the use of techniques already achieved in motion pictures and presumably to be developed in television. Some of these techniques are lighting effects, camera angles, optical effects and distortions, and symbolizations in the scenery and costuming. Perhaps the most powerful technique which the films have developed for adding suggestion to the literal camera is *montage*, the art of arranging pictures (or sounds) in such a sequence that an extra effect is achieved through the association of ideas. The classic film example of this was displayed by Kuleshov in 1921. He showed a medium close-up of a man's face, with the man looking down. Next came a close-up of a plate of food, and the audience knew the man was hungry. Then came another close-up of his face, followed by a shot of a corpse in a coffin. To the audience it now seemed as though the character wore a frightened, guilty look and had just murdered someone. The third time the close-up of the man was intercut with a view of a nude girl lying in bed, and this time the mental processes of the audience led them to quite another conclusion.

This is just one of the ways in which the element of suggestion may be introduced in films, or in the video of television.

In rounding off any summary of the characteristics of television, it should be noted that for practical purposes it has the widest scope of program material of any medium. It can *transmit* an aural-visual image of anything done in the theatre, radio, press, or motion pictures—using it on its own or in conjunction with a "live" program. In addition to this vast reservoir of material, television has a potentially vast quantity of programs which it alone can do.

It has the same *speed of transmission* possessed by radio but which motion pictures lack. And like radio, but unlike motion pictures, television is *flexible* up to the instant of transmission. Like

radio it is also at its best when presenting an *infinite variety* of programs.

Summing up: the audience can be made to feel a *sense of participation*, of being in two places at one time—as noted in Chapter 2. In “live” programs, particularly of news and sporting events, there is that *sense of immediacy, of actuality*. One knows that what he is seeing and hearing is actually taking place at that moment.

In certain other types of programs, it is possible to create a feeling of intense *intimacy*, far greater than is obtained in motion pictures or the legitimate theatre. The reviewer feels that people in the program are right there with him as they look him in the eye. He can reach out and seem almost to touch them. The *transference of personality* can be very strong; he “feels” people thinking as they concentrate on a problem before the close-up camera. But it should be remembered also that this intimate close-up transmits everything, magnifying mannerisms and over- or underemphasis—and there are no retakes.

Possibly there are other characteristics which might be added to this list at a later date, but for the present this is sufficient. These points seem to be pretty well established, and to go further would be to indulge in sheer speculation that might lead up a blind alley.

Now let us make a comparison of television with radio, motion pictures, and theatre—to note similarities and dissimilarities and in so doing to acquire a broader knowledge of our art-to-be.

Chapter 4

THE THEATRE AND TELEVISION

THE THEATRE in its various forms is familiar to most people, if for no other reason than that most of us have at one time or another seen or taken part in a play, amateur or professional. It is also a few dozen centuries older than motion pictures and radio, so let us consider it first and see how it compares with television.

The modern theatre—as we know it today—came into being during the Restoration in England. It makes use of a number of “theatrical” conventions, the acceptance of which is necessary on the part of the audience. Every art has certain conventions which are acceptable to the public. In viewing a motion picture we accept as real the illusion of reality induced by moving shadows on a screen. Television, which gives promise of becoming a new art form, has not yet produced any established and universally accepted conventions and only a few satisfactory techniques. Perhaps this is a good thing, for it gives us a chance to evaluate what has been done so far and to do plenty of advance planning and theorizing. This, plus the fact that our civilization is highly receptive to new arts, should result in the early maturity of television.

The more successful forms of theatre have not attempted to be realistic in the ordinary sense of the word—naturalistic, if you prefer. They have made use of selected elements of reality, blended into a whole which is frankly artificial, theatrical. In the acceptance of this convention lies the charm of the theatre; in theatrical make-believe nothing is impossible. The human eye sees this make-believe exactly as it is in full color, binocular vision, but somewhere inside the

brain, alchemy is achieved and an illusion created, because we accept the theatrical convention.

The camera, on the other hand, does not have any brain or emotions. It sees a given scene and passes along what it sees as a straightforward, realistic image. At the receiving end of the system this scene is reproduced in terms (at the moment) of a two-dimensional, monocular, monochromatic picture accompanied by one-dimensional, monaural sound. In the course of this transmission the psychological give-and-take between an actor on the stage and his audience is partly or entirely lost, along with an as yet undetermined proportion of the impact of the living flesh-and-blood personality.

But, although the television system loses these advantages, it gains others: multiple viewpoint through many cameras with infinite camera angles; the ability to extend one's vision and hearing over many miles and to "be in two places at one time;" the psychological magic of montage and of visual effects; intensification, or "canalizing" of attention; and exclusion of irrelevant detail through use of close-ups.

A production of the legitimate theatre is usually played on a three-walled stage which represents the interior of a building. Three walls are seen in the form of scenery, but there is also a fourth and imaginary wall. In real life it would complete the circumference of the room, but in the theatre this would be inconvenient since it would prevent the audience from seeing what is happening on the stage. A theatrical convention takes care of matters. The fourth wall is omitted, but the actors pretend it is there, and the audience feels as though it is looking through the side of a house with X-ray eyes. The location of this imaginary wall is defined by the proscenium arch, the "picture frame" of the stage.

In a theatre each member of the audience views the show from a single, fixed position—his seat. The entire production is viewed from this one angle, varied only by the movement of the actors from one part of the stage to another or by an actor coming out from behind the proscenium arch, stepping "out of the frame" into a close-up on the apron or front portion of the stage. Because of this it has become customary for directors to stage their plays with all action turned toward the imaginary fourth wall. In order to project

a personality over the footlights and reach the back of the house, it has become a necessary convention to accentuate and enlarge an actor's way of speaking and method of acting.

The theatre is essentially limited by the unities of time, place, and action. A scene, once started, must continue to run for a number of minutes, representing an equivalent or longer period of time. Failure to observe this unity usually causes confusion. A scene, once established, cannot be changed every other minute except at prohibitive cost, and the action of a given scene must progress logically from point to point within the limited confines of the stage.

The fundamental sensory appeal of a stage play is aural; the spoken word comes first. The script of a drama is primarily dialogue, and each director and actor fills in his interpretations. The visual part comes after the aural, with the broad physical action so necessary in motion pictures relatively unimportant on the stage. A stage play is easily adapted to radio, less easily to motion pictures.

Of course certain forms of theatre, taken in its broader sense, are exceptions to this rule: these include ballet and dance, circus, pantomime, and certain variety acts, such as jugglers, acrobats, and magicians.

The aural portion of the play and the general plot structure depend upon the writing talents of the dramatist—assuming the actor has a decent voice. The visual part of a play depends almost entirely on the skill of the actor, director, and scenic artist, as well as on the personality of the actor. He has no close-up camera, no mobile camera, no ever-present microphone to help him. He has to project himself by himself. He must know his lines by heart, and he must be able to sustain a performance from beginning to end. By psychological good fortune the impact of personality is strong in the living theatre. More than that there is an "electric" give-and-take, a bond, built up between actor and audience—as every actor knows.

Now let us balance "live" television with "live" theatre and note the similarities and differences.

Television, like theatre, demands the ability of a performer to sustain a performance from start to finish, despite the continual distracting movement of cameras, lights, microphones. It calls for memorized lines—no reading from scripts as in radio. The only

exception to this would be in the presentation of extemporaneous programs or of up-to-the-minute news in which there is no time to learn lines and in which the audience usually wants to get its news accurately and without benefit of the commentator's extemporaneous speculations.

A theatre training is invaluable, for television artists must have a sense of showmanship, a flair for the dramatic. Some of the most dreary examples of early television programming have come from producers who have talked and thought a lot about the subject but had no opportunity to develop showmanship. Despite all rationalizations to the contrary, television is show business, whether one is presenting a documentary, an "educational," or a variety show.

Unlike the audience in a theatre, the television audience does not see the program from a single, fixed viewpoint. It sees the show from myriad, moving viewpoints—via a number of cameras, all mobile—and the whole effect is enhanced by the techniques of *montagé*, visual effects, and regulated sound.

The audience is separated from the performers, and therefore the "electric" give-and-take between cast and audience cannot be built up in the same way. Possibly this may be offset to some limited extent by the presence of a studio audience, but in any case the performers must play for the cameras (unseen audience) since that is the important group. Failure to observe this rule will kill any program, no matter how good it may seem in the studio. A form of give-and-take may be achieved by the presence of a studio audience plus a skillful handling of cameras and microphones to exploit television's characteristics of intimacy and "being in two places at one time." This will aid the performer in his timing of audience reaction and provide the home audience with a mass-audience reaction, but whether this synthetic form of give-and-take can ever approach that of the "live" theatre seems doubtful. The research departments of the television networks can look forward to years of fun trying to evaluate it.

Unlike a stage play, which can be seen only by going to a theatre, television will be viewed largely by small groups of people in the privacy of their own homes. They will be subject to the inevitable disturbances of the home: phones ringing, children yelling, a disagreement about which program to view, neighbors visit-

ing. They will also be subject to the psychological difference of being at home instead of in a crowd—and because of the physical difference involved they will be able to stretch out in their favorite chairs, take off their shoes, enjoy a drink, a smoke, and other luxuries of the living room—not the least of which will be the privilege of switching to another program if the first one drags. And—it will all be free, unlike the theatre or the movies.

Television rejects many purely theatrical conventions. Most noticeable is “theatre style” acting. If an actor uses theatre technique, projecting voice and gesture as he would to get over the footlights and up to the balcony, the result is ludicrous on television. All forms of mannerisms are exaggerated by the microphone and camera, particularly when in close-up. Instead of having an audience fifteen to a hundred feet away as in a theatre, the television audience may be no more than three feet away, in psychological effect, during a close-up shot. (And during the early days of television—particularly on pre-war imperfect-definition, small-screen receivers—we had lots of close-up shots and few very long shots.) Therefore exaggeration of gesture and voice is unnecessary in television, something which early motion-picture producers also had to learn.

Another more subtle difference arises from the fact that in a theatre the audience identifies itself with the protagonist and gets its emotional satisfaction primarily from *listening to him talk and watching his actions*. In motion-pictures the audience is most profoundly moved not by watching the actions of the protagonist but by watching his *reactions* to the actions of other characters or incidents. In theatre it is a character's *actions* which count most. In motion pictures it is the *reactions*, a point which will be discussed in more detail later on. What the case will be in television—actions or reactions—has not yet been proven, because of the extremely limited program experience we have to draw on, but I believe it will be like motion pictures: the reactions will count most in drama.

A theatrical convention which is most ineffective in television is the traditional theatre method of staging a play, framing it inside a proscenium arch and viewing it from one angle. This method of staging has been tried over and over and over on television, and it just does not work. Early motion pictures went through the same

phase, both in silent pictures and when sound pictures came in, and until the mistake was recognized the results were sad. This convention, nevertheless, was slavishly copied in most early television shows without any apparent attempt to discover if it is worth copying, if it is even a really good convention in the theatre.

In all fairness to some early directors it must be pointed out that this practice was forced upon them by poorly designed studios. In other cases it has been used simply because inexperienced directors could not think of any better method. Still other cases may have arisen out of this thought process: theatres have a proscenium arch to frame the picture of the scene; television sets have a frame around their screens; therefore since there is a "proscenium arch" on the front of your television set, why not use theatre techniques!

To limit oneself to a comparatively fixed viewpoint seems the wrong way to go about things, especially when one remembers that cameras can, and should, be highly mobile and flexible, and when one remembers the fundamental characteristics of television outlined in the previous chapter.

In television and in motion pictures the angle of view is theoretically unlimited in a physical as well as in a psychological sense, and the sequence of place, action, and time may be juggled around with ease. In the theatre there may be one or two "flash-back" sequences, while in television there may be dozens. The theatre is limited to a single scene progressing in an orderly fashion in one spot. In television, as in motion pictures, there may be three or four different scenes progressing simultaneously (in the audience's mind). They can be achieved by the technique of cutting back and forth from one scene to another or by superimposing one picture on top of another (double-exposure).

Whether "live" television will eventually juggle time, place, and action around as much as motion pictures do is a matter for conjecture. Certainly it is physically difficult today without using film sequences. Beyond that the questions arise: Will it be desirable from an artistic point of view? Will there always be a noticeable difference between "live" and film? Theatre sticks pretty closely to the unities of time, place, and action, while the cinema largely ignores them. Where does television fit in? The attempted answer must be separated into two parts: in the handling of news, sports,

and documentary material the goal must be *as completely unrestricted as in motion pictures*. In the first years of television this was impossible, because of limited network facilities. However, there is no reason why television should not eventually exceed motion pictures in flexibility and freedom from the three unities.

In considering the handling of *drama* the answer can only be speculation, based on what limited evidence is available to date. It would appear that television would fit about midway between the flexibility of the cinematic drama and a strict adherence to the three unities. This is not an attempt to straddle the issue. It is a forecast of a new form of dramatic art peculiar to television, with visual and aural techniques quite different from stage or screen—and it may take many years to develop.

These, then, are some of the points of similarity and dissimilarity between the theatre and television as far as can be determined today. But what effect will television have on the theatre, after it borrows certain of its techniques?

For one thing, it may develop new techniques of its own which can be borrowed back by the theatre for regular stage practice. Who can so "No" at this stage?

With television stations springing up all over the country, professional actors, directors, writers, and designers will find new sources of employment to a greater extent than they ever have in radio. More talent will be needed than in radio, for people may tire of seeing the same faces on program after program even though they may accept the same voice over and over in radio.

It seems quite probable that seeing new personalities, or familiar ones, on television will stimulate a desire to see them in the flesh. Television also may stimulate the theatre for two other reasons: it is a new and powerful cultural medium, and one cultural medium usually stimulates another. Secondly, I do not think that television and the stage are fundamentally in commercial competition with each other as are motion pictures and the theatre.

Stage plays can be seen only in theatres; that is their natural habitat. When motion pictures came along they invaded the theatres, probably for two main reasons. Motion-picture equipment was too expensive for the average family to purchase and operate—

aside from the serious fire hazard it entailed. In the second place, the general public had not been conditioned to receiving free entertainment (paid for by advertising) in the home as it has today. It was only logical to put motion pictures into theatres, which were meant for entertainment. How else could one collect huge revenues, except by charging admissions for hundreds of people who could see a single showing of a single film at one time? So, into the theatre went motion pictures—in competition with the legitimate theatre and to the detriment of the theatre's financial well-being.

Now we have television offering free sight and sound entertainment in the home, acted by living performers. It is presented without charge to an audience already conditioned to home entertainment by radio. Furthermore, television can *also* transmit a motion picture perfectly well. One could see for nothing, via television, the same photoplay he pays fifty cents to see in the motion picture house, if film companies did not withhold their better products from broadcasters.

The standard reply of motion-picture people to this situation was summed up by one leading producer, who said, "Television can't hurt us, because people are gregarious. They like to go out Saturday night." With that he dismissed television from his mind. (If television cannot effect motion pictures, then why did his company refuse to permit its films to be shown on television or its stars to appear on television?)

Certainly people like to leave their homes and go out occasionally. But I think it is usually true that when we go out we like to see and do something we cannot do at home. If we can see motion pictures over television, then will we want to go outside and pay money to see them—assuming good films are available on television? The motion-picture theatre has less potential distractions than the home, but these are probably offset by the comfort of the home and the fact that the entertainment is *free*. Motion-picture exhibitors will answer to this that people like to be in a crowd, and when watching a film in a crowded theatre they get an extra added "something" from their neighbors, which they would not get at home. This undoubtedly is true in "live" legitimate theatre, but its complete accuracy is open to doubt when it is applied to motion-picture theatres versus motion pictures in the home via television.

Television is a new way to distribute motion pictures and is being used as such. It is quite possible that as the television audience reaches mass proportions, making practical the charging of proportionately large advertising fees, motion-picture companies may find it desirable to distribute more and more of their films via television. This conceivably would tend to decrease the audiences in theatres, and film companies own a lot of real estate in the form of theatres.

Motion-picture companies are perfectly aware of this danger, and some of them have long since begun to move into television to protect their futures. But a point to speculate upon is this: suppose cinema audiences fall off, because motion pictures are distributed over television to the home. This would mean the partial removal of the competitive force that pushed the legitimate theatre pretty much out of business save for amateur little theatre groups and Broadway. Nevertheless people will still "want to go out on Saturday night" to see something they cannot see at home. Legitimate theatre fits into that category. One cannot get it at home.

Is it possible that an end effect of television may be a great renaissance of the theatre in the next few decades?

Chapter 5

TELEVISION AND MOTION PICTURES

THEATRE people may think of television in terms of the theatre, and radio people in terms of old-fashioned, blind radio, but motion-picture people and the general public are likely to think of it in terms of motion pictures. It is a natural reaction. Both are "moving pictures"; both use cameras, microphones, lights, and studios which look superficially alike.

Motion pictures were made technically ready for commercial and artistic development nearly a half century ahead of television. Edison made his first "movie camera" in 1877, and twelve years later he shot a motion picture on his first strip of Eastman-Kodak film. This was the famous sneezing sequence acted by one of his assistants, Fred Ott. The commercial birth of the motion-picture industry is usually pegged around 1894, but pictures of that era remained pretty much on the primitive side. Technically and artistically, motion pictures did not reach maturity until the third decade of this century.

Television was under scientific development during most of these years, but it was not technically ready to make its debut until the last part of the 1930's. A few tentative bows were made at that time—notably by the British Broadcasting Corporation. The American excursions into television programming were for the most part on a limited, amateurish basis. There was little serious effort, particularly when viewed in terms of the accomplishments of BBC television from 1937 to 1939—a time when the American television companies were bickering as to whether or not television was ready.

Almost all experimental program development was ended by the war, so that for practical purposes the beginning of serious *commercial* development of the art of television programming may be pegged around the middle of the 1940's. This will be roughly three thousand years after the birth of the theatre, half a century after the commercial start of silent pictures and a quarter of a century after its artistic flowering, two decades after the commercial sprouting of radio, and fifteen or sixteen years after the commercial and artistic beginnings (on a large scale) of sound pictures. In terms of technical perfection, however, television will be roughly about as far along as talking pictures were in 1930.

Both television and motion pictures are based on science; without the accomplishments of science neither could exist. Both are industries as well as arts, with motion pictures one of the largest of American industries and television giving every indication that it will be even bigger within a decade. Like motion pictures, television depends for its success on the cooperative efforts of many artists, technicians, and businessmen. It is too vast in scope, too complex, for an individual artist to create and produce an entire program by himself—all of which leads inevitably to a high degree of specialization, such as we find in motion pictures and in radio.

The danger in this is obvious, and the radio and motion-picture industries are full of living, walking, breathing illustrations of the danger. People tend to specialize on one job and never learn about the rest of the business. This puts an artificial limit on the development of the technician or artist, as well as on the medium itself—tending to result in a mass-produced “art” product without individuality or distinction.

This danger is no more acute in motion pictures than in television. In the former there is a long period of time elapsing between the moment a film is “shot” and the time the audience sees it. A great many different people can do a great many things to the film after it has left the director's hands, and in many cases he has nothing to do with the editing, which is the basic process of the film. In television the entire production is created and distributed at the same time. The director has a much greater opportunity to put his own stamp on the show, and after it leaves his hands no man alters it.

By the same token every camera man, sound man, and artist exercises a direct control on the program. If he is expert, a cameraman can put his own stamp of individual artistry on a production. Conversely, if he is inexperienced or unreliable, one man can destroy an entire production.

In the production of motion pictures, teamwork, cooperation, and efficiency are necessary in order to avoid excessive production costs. In television these qualities are necessary for the same reasons and are vital if the destruction of a program's effectiveness is to be avoided. Good television demands even more than teamwork, cooperation, and efficiency. It demands a perfect working harmony between all members of a production crew, in precisely the same way that this is demanded of a bomber crew—and for precisely the same reason: if one man slips, the venture is finished; there are no retakes.

On the other hand, the dangers of mass production on unimaginative formulas are as real in television as they are in radio. Television will use many more hours of entertainment than the motion-picture industry distributes, perhaps as much as standard radio, and a good many of these programs will undoubtedly slip into ruts just as in radio.

One of the surest ways for a technician or artist to avoid the dangers of stagnation through lopsided development is to get a thorough grounding in all branches of television before specializing in any one branch. Now that would seem to be a perfectly obvious thing to do. It is a procedure followed in most schools, but unfortunately very few people have the inquisitiveness or opportunity to follow this practice after they leave the campus. Let the reader take any business, for example, whatever occupation he may have, and figure out how many of his associates have tried to learn everything they can about all phases of their business. The chances are that the percentage will be low.

The problem is particularly acute in television today, for the simple reason that there has been almost no opportunity to learn about television programming. All of which leads to the conclusion that prospective television broadcasters will find it a highly profitable investment to set up on a large scale laboratory studios in pro-



PLATE I.—A typical studio scene during a radio broadcast of *The March of Time*. Note that in aural radio no consideration is necessary for visual aspects of a scene. Everything is built for the ear. Microphones are placed in a fixed position, and the members of the cast are grouped around them. Sound effects, at right, supply aural impressions of actions which would be seen by audience in television. At extreme right are turntables, for many sound effects are recorded. Huge libraries of these recorded sounds have been built up by radio stations because of the ease of handling and storing recordings. Dramatic illusion of radio program is usually lost when the actual broadcast is viewed.

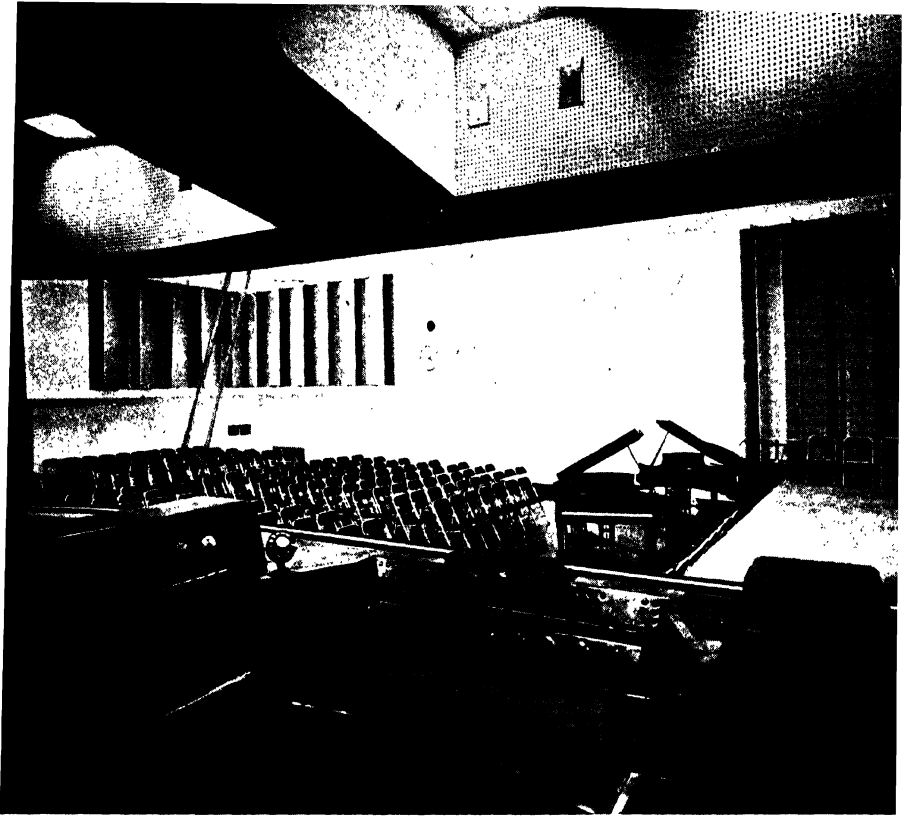

PLATE II.—A view of a modern radio control room and studio at CBS, suitable for programs requiring a studio audience. The control engineer sits at the desk in the foreground, and the director stands or sits at another desk (*unseen*) at the right. The row of black knobs at the far edge of the desk controls the sound volume from the microphones. Each knob controls one microphone, and the knob at the extreme right governs the over-all volume. Just above this row of "mixers" is a clock and to the left of the clock is the volume indicator, the constantly moving needle of which indicates the strength of the sound being transmitted. Directly overhead is the loud-speaker. The audio portion of a television control room contains these same basic elements.

The control room is separated from the studio by a double plate glass window. The dead air space is left between the two panes of glass to make it soundproof. The window is set at an angle to diffuse reflections of sound waves. If it were directly parallel with the wall on the opposite side of the studio, sound waves would be reflected back and forth. These are called "standing echoes" or "flutters." A similar visual effect is achieved when two mirrors are placed opposite each other. As you look into one, you see the second which in turn reflects the first, and so on back and forth, with an endless series of reflections. Note the reversible, acoustic panels on the far walls. One side is a smooth, hard surface which reflects sound waves. The other side is a "soft," "dead" surface which absorbs sounds waves. Thus, by varying the position of these panels, the acoustical characteristics of the studio may be changed at will.



PLATE III.—A typical view of the CBS control room and studio (*in part*) in New York. Audio control desk (*unseen*) is at left. Man at extreme left is in director's chair. He hears the program from loud-speaker overhead, sees the over-all layout of the studio through the double window, and sees the picture being picked up by each camera on the screens in front of him. Picture at extreme left (*close-up*) is being picked up by right-hand camera on floor. It is not yet on the air, but it is being made ready. The director gives instructions to studio crew through telephone, not visible in this picture. Studio crew members wear headphones through which they hear him. They, in turn, can communicate with him either by hand signals or by telephone. Picture on middle screen, picked up by left-hand camera, is going out on the air. When director wishes to use close-up shot, he instructs switching engineer (*second from left*) to "take two." The engineer presses button which switches camera number two on air. As switch is made, a little numbered light over the screen changes, and the number two lights up, showing that camera two is "on the air." Shading engineer (*at right*) adjusts the pictorial values of picture by varying the shading, using his own, separate screen for reference. At extreme right (*unseen*) is a television receiver, facing at right angle to the three screens. By looking to the right anyone at the control desk can see what the picture looks like as it comes back through the air. Or, upon occasion, the program of another station can be switched on.

On studio floor a broadcast of a television quiz program is in progress. Formula is the same as that for radio quiz programs, but all questions are visualized. Note two cameras, connected to control room by thick cables through which program travels. Stage is lighted by overhead banks of "cold," fluorescent light, with sidelighting done by mobile, 5 kilowatt and 2 kilowatt incandescent spotlights on the studio floor. Man crouching between two cameras is the "floor manager," comparable to stage manager in the theatre.

Note edge of another set, not in use, at left. This set, used for news programs, is illuminated by banks of overhead, 1 kilowatt, incandescent floodlights, ten lamps in all. To this are added several spotlights on the floor.

Note also that people at the control desk have perfect view of all parts of the studio and at the same time are close to the viewing screens. To keep brilliant studio illumination from dazzling director and engineers in semidarkened control room, a sheet of Polaroid material is included in the double window to cut down the light.



PLATE IV.—Example of a radio program successfully adapted for television, *The Missus Goes A' Shoppin'*, with John Reed King working on one of his guests and Paul Mowrey looking on at the right. Studio audience (seated at rear) participated in program. Aside from use of a visually designed setting, effectiveness of television version depended on use of audio-visual questions and stunts, the personalities and many antics of the performers, the reactions of the audience and participants, and the viewing audience's feeling that it was part of the studio audience. Highly amused man seated in front of audience is one of the participants, who has just been put through a stunt.

Note edge of camera at upper left and overhead microphones mounted on extensible booms.

PLATE V.—Side view of television quiz broadcast. Table in foreground contains properties for use in the visualized questions. Note spotlights and edge of overhead bank of fluorescent lights at left. At right is motion-picture type of microphone boom. Note distance of microphones from people.

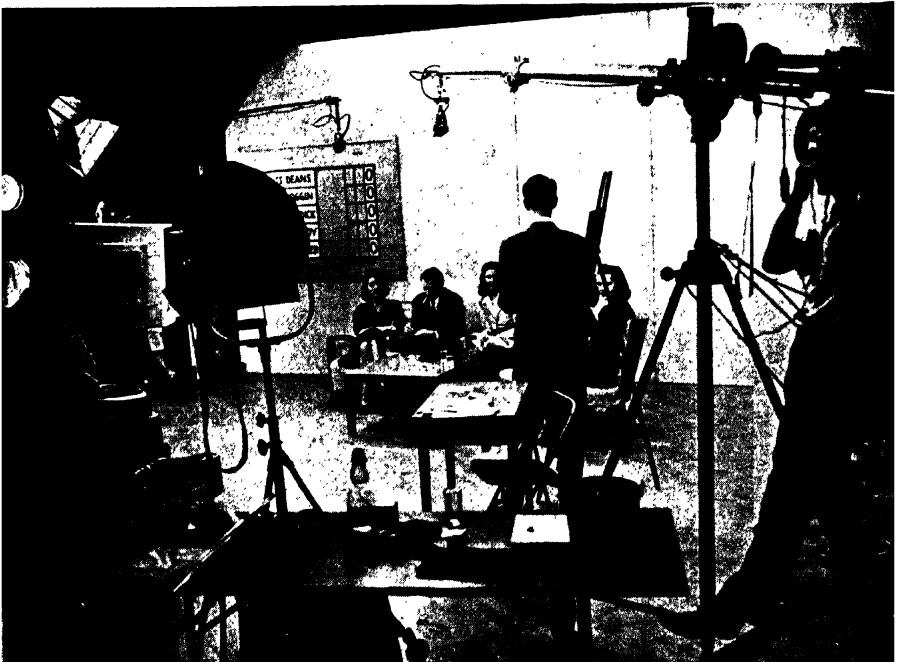

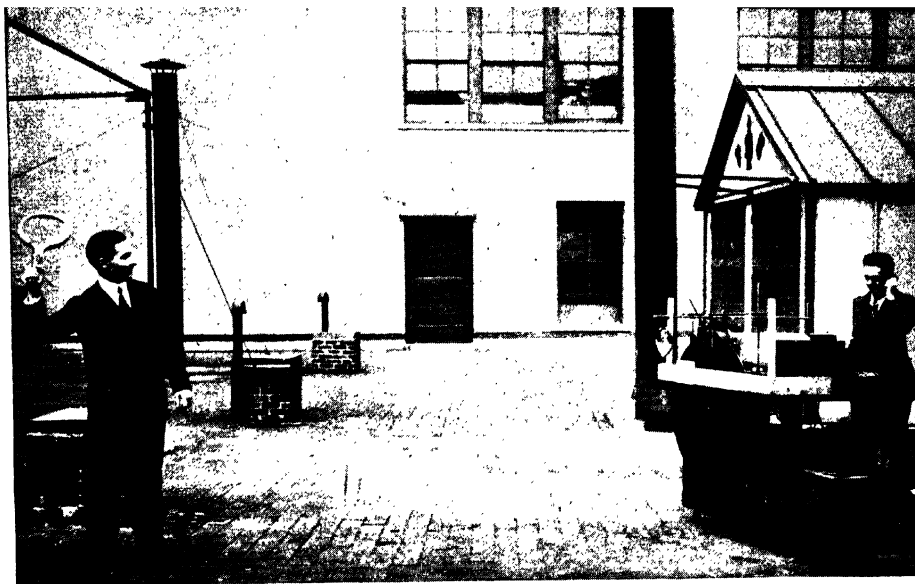

PLATE VI.—A television scanner developed in 1928 by the Bell Telephone Laboratories, using the mechanical scanning-disk method which became obsolete in 1933 because of the clumsiness of this camera and its low-quality picture.

PLATE VII.—The most flexible and satisfactory of the prewar studio cameras, an Iconoscope mounted on a Fearless motion-picture type of camera dolly. Cameraman sits on movable seat and peers through view finder, using either upper or lower opening. Left handle is used primarily for panning or tilting camera, while right handle twists around at two speeds to control focus of lens and view finder. The two large crank wheels coming out of the base of the dolly are used to change its position. Left-hand one raises the boom on which the camera is mounted. Right-hand wheel rotates the boom on its vertical axis. These wheels are usually operated by assistant cameraman, who also pushes the dolly around the floor, using pusher handle at left which also steers rear wheels. The second seat, at the right, is usually removed in television practice, for the assistant seldom gets a chance to sit down. The dolly can be anchored in any spot by screwing down the floor-brake wheel directly in front of rear wheel. Note the coil of cable which connects camera with control room. This cable contains thirty-two separate wires, including the program

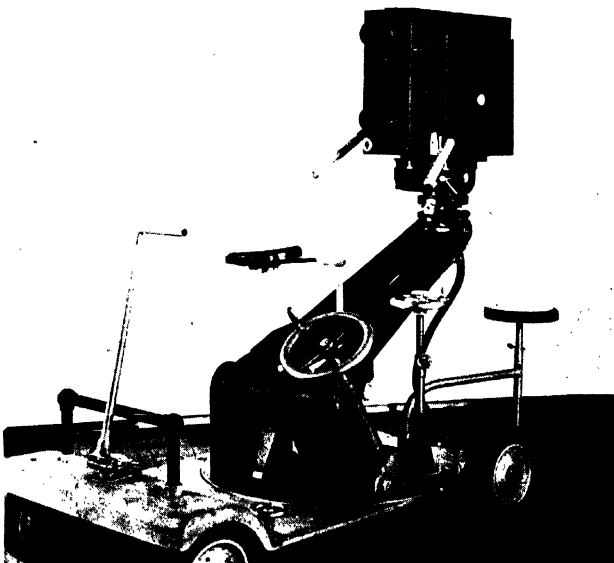



PLATE VIII.—Three studio cameras used by the British Broadcasting Corporation studio at Alexandra Palace in London for a telecast of *An Expert in Crime* (1939). Note that all three cameras (*third one barely visible at extreme left*) appear to be mounted on tripods, which in turn are set on movable dollies. This type of mounting would not permit raising or lowering of cameras while the program was on the air, and limited camera movements to pans and tilts and forward and backward movements of the dolly. Note the large, pneumatic-tired wheels on right-hand dolly, and the ingenious way in which the three wheels of the middle camera dolly are chained together. When the camera pusher (*holding pusher rod*) turns the rear wheel, the two front wheels will turn simultaneously. Note also theatrical type of setting and manner of staging which has all cameras viewing the scene from one general direction, as in a theatre.

These cameras are Emitrons, based on the Iconoscope patents. The handle controlling pans and tilts is at right, and lever adjusting focus is at left under the hood of the view finder. Note also the telephone headsets on cameramen.

PLATE IX.—Football game being televised in Philadelphia by Philco, using Orthicons. These particular cameras are not focused by cameraman but by technician in control booth who focuses by remote control using small electric motors. Cameraman has no view finder save a "gun sight" arrangement—a wire frame on the front of the camera and a peephole sight at the rear. With

this method accurate framing is difficult. Camera is set on cage hung from edge of balcony. Second cage is placed about seventy-five feet away, giving second camera different viewpoint. Gadget projecting from front of camera is telephoto lens mounting. Note additional lenses of different sizes beside the seated assistant cameraman.

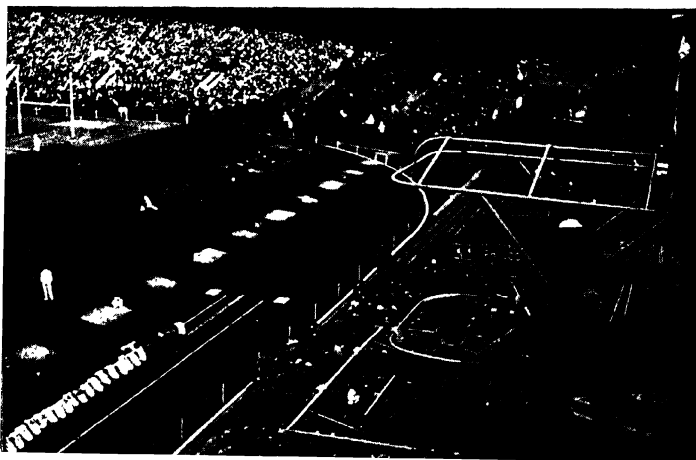

PLATE X.—Close view of Orthicon camera equipped with telephoto lens used to pick up football game. Upper lens is for view finder, lower lens for camera tube. Fixture with handle and heavy cable at right is end of cable linking control room with camera.

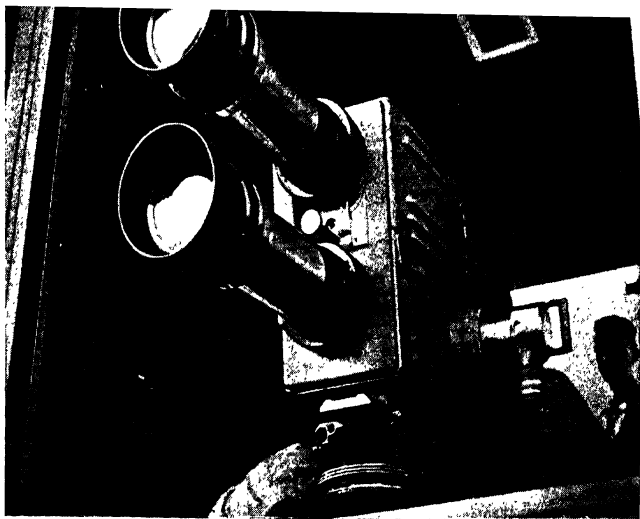

PLATE XI.—Inside view of Orthicon camera, equipped with normal lenses, with covering raised to expose mechanism. Small tubes at top are used to amplify the picture signal after it leaves the Orthicon tube (*large cylinder below*). This camera is equipped with standard signal light on front, just to left of upper lens. This light goes on when camera is switched on the air.

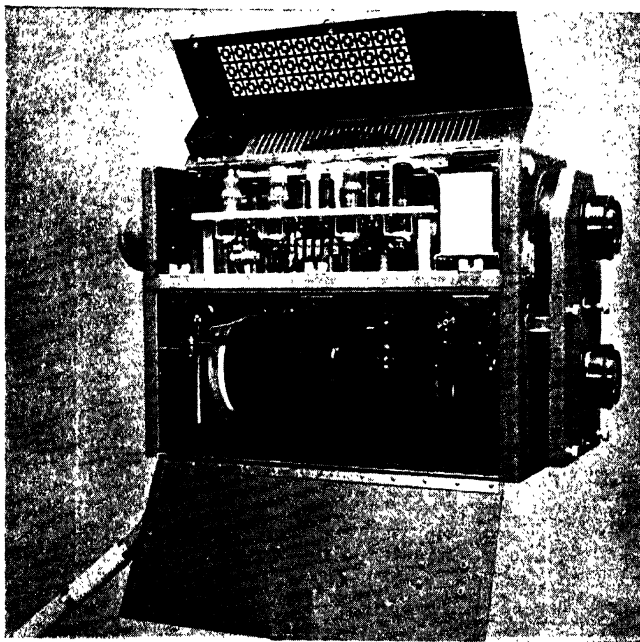



PLATE XII.—Example of prewar television mobile unit originally built in 1938 by RCA for NBC and subsequently remodeled. The truck at the left contains a portable control room and is equipped to handle two cameras, one of which is seen on top of the truck. To the left of the camera, also mounted on a tripod, is the microphone. The large parabolic reflector acts as an ear trumpet, concentrating sound waves into the microphone which is at the very center. The left-hand truck is connected by a detachable cable to the right-hand truck, which contains the portable transmitter. The antenna mast on top of the front truck is collapsible and folds down on top of the truck when not in use.

PLATE XIII.—Example of smaller portable television unit developed around 1942 by Paramount Pictures' television branch. All of the equipment fits into small delivery truck. Current designs for mobile units are even more compact.



gram development for the training of their future program workers on a professional basis.

Checking through some of the more obvious similarities between motion pictures and television, we find that both appeal to the same senses, seeing and hearing, via moving pictures and electrically reproduced sound. In both, the picture system is monocular and the sound system monaural. Motion pictures started out by being entirely monochromatic, with color pictures gradually introduced at a later date. Television seems to be following the same pattern.

The motion picture reaches the audience as a varying pattern of light reflected from a flat white screen. Since the theatre auditorium is usually darkened, the ordinary picture has a screen brilliance of about 12 foot-lamberts. Television receivers are usually observed in a partially lighted room and therefore need a brighter picture. With the prewar television system the picture could sometimes have a brilliance up to about 20 foot-lamberts, and it reached the viewer either as a varying pattern of reflected light (in a projected picture) or as a varying pattern of direct light (in a direct-viewing or mirrored tube).

The contrast range of the television picture—in the varying shades between white and black—was comparatively restricted on prewar receiver tubes when compared with the contrast range of motion pictures. However, with continually improving equipment it is possible to get a contrast range comparable to what is normally in motion pictures.

The same situation applies to the sensitivity of the television camera. Prewar cameras needed very intense illumination, especially if any satisfactory depth of focus was to be obtained. To get a really good picture one needed somewhat more light than was necessary in motion pictures, but newer cameras are progressively more sensitive to light. The problem of flicker is unimportant in motion pictures and in television. Silent pictures were projected at a frequency of 16 pictures per second. Below that frequency the eye could detect an objectional flicker. When sound pictures came in, the picture frequency was raised to 24 per second—or 90 feet of film per minute. This change was made primarily because good

quality sound could not be recorded on the amount of space available in the sound track of 35 mm. film when projected at 16 frames (60 feet per minute). In television the picture frequency is considerably higher: 60 "half-pictures" per second interlaced to form 30 complete pictures. This figure was selected for American television primarily because most electric current supply in the United States is 60 cycle. In England, where current is 50 cycle, the television system has 50 "half-pictures" interlaced to form 25 complete pictures per second. And in any country, television—like motion pictures—depends upon *persistence of vision* to achieve the illusion of motion.

In definition, the amount of detail in the picture in prewar television was theoretically capable of a picture better than 16 mm. film but not as clear as that of 35 mm. film. Detail in ordinary 16 mm. motion pictures is roughly comparable to a 375 line television picture. A 35 mm. film is about the same as a 700 or 800 line picture might be. Television standards, as set in 1941, call for a 525 line picture, but most transmitters and receivers operating during the wartime period could not reproduce a picture of more than 350 to 400 line definition. Many prewar sets were designed in 1937 or 1938 and by the end of the war were pretty well worn out, some of them giving no more than the equivalent of about a 250 line picture.

Since the amount of detail in a picture is governed by the number of picture elements in it, it might be noted here that the average 16 mm. motion picture contains about 125,000 picture elements. A 525 line television picture, on a 6 megacycle channel, can have about 250,000 picture elements, and a 35 mm. motion picture has approximately 500,000. It should be noted also that there is a point at which the human eye does not appreciate added detail—a law of diminishing returns applies. When the television picture was raised from 343 lines to 441 in the mid-1930's there was a much more noticeable improvement in the picture than when it was raised from 441 to 525 lines in 1941. The improvement in going from 525 lines to somewhere around 700 lines would presumably be slight, almost unnoticeable to the human eye unless the picture is viewed at very close range, or unless it is viewed on a large motion-picture theatre screen. (Screens of this size obviously will not be used in

homes. Most home receivers have screens ranging up to not more than 3 by 4 feet).

The shapes of the television pictures and the motion picture are the same. Each has an *aspect ratio* of 3 by 4, which means it is three units high by four units wide: i.e., 3 feet high by 4 feet wide, or 18 inches high and 24 inches wide, or 15 by 20 feet.

The production methods of television and motion pictures look alike in still photos. Both have cameras, lights, microphones on booms, and both are housed (or should be) in large, flexible stages, the walls of which are covered with acoustically dead material to absorb sound reflections.

A motion-picture camera exposes rolls of celluloid film, which are later developed in laboratories. The television camera uses no film, except in specialized cases which we can disregard here. It is entirely electric¹, as is the human eye, and it is "seeing" all the time—no need to take time out to change a reel of film. Since television is not a photographic process, it entails none of the bothersome details of handling film, chemical processing, fire precautions, storage conditions, distribution in cans.

For these reasons actual television camera work can, in one respect, be simpler than in motion pictures. All control of cameras and microphones is accomplished as in radio, by turning a few knobs or throwing a few switches. By merely pressing a button here and there one can get superimposures (double exposures) and other visual effects which are difficult and costly in film work.

On the other hand, television equipment cannot yet do all visual tricks as perfectly as motion pictures can. For example, on early equipment when one made a video "board fade"—that is, faded out the picture by turning down the camera control, or video gain—the picture faded out but in its place one often saw five or six diagonal white lines across the front of the television screen. Undoubtedly this defect and many other minor ones will be eliminated as television broadcasting goes ahead.

From a practical point of view there are certain very strong points which favor the extensive use of film in the early years of television. Perhaps the strongest of these is the fact that it takes time

¹ See *4000 Years of Television*, pp. 5-6, 108-116.

to build extensive television network facilities so that one program can be broadcast in all parts of the country at one time. Until such facilities are ready in any given area, films offer the easiest method of syndication, a "celluloid network." Another very practical reason why films have been widely used during television's first years, when equipment and good studios were scarce and skilled personnel even more so, is that entertaining programs can be filmed with regular motion-picture techniques. The public prefers the most entertaining material available, and the chances are that established film companies will be able to compete successfully on this score for some time to come.

Then, of course, there are certain uses of motion pictures which are standard practice, just as there are certain fixed uses for electrical transcriptions and recordings in radio. Programs can be transcribed on film for reference purposes as well as for later rebroadcasts in different time zones, or they may be even flown to Europe or South America by airplane to establish a form of international television before such networks can be built. Films can also be used to record news events which may happen at odd hours of the night, when there is little or no audience looking in. These films are then telecast at a time when the audience is tuned in.

Perhaps it all boils down to this: motion pictures are going to play an important part in television no matter how one looks at it. The obvious conclusion is that their use parallels that of electrical transcriptions and records in radio. Some stations may be primarily film-playing telecine stations. Perhaps, as in radio, these may be the smaller, independent stations. Other television stations, affiliated closely with networks, may tend to broadcast more and more "live" shows with each passing year. In short, film can be transmitted over television, just as easily as a "live" program. But, *although motion pictures can provide a permanent record for television, they cannot transmit television in its true sense—cannot retain its speed of communication, its immediacy.*

Fundamentally, television exists only at the instant of its transmission and then is gone forever. In this it is like the human eye and ear, without any permanence, without any memory, for in human beings it is the brain which does the remembering. Motion pictures differ from television in this respect, since film contains a per-

manent record of what has been seen and heard—a record which can be taken out of the storehouse and repeated at any time. Television can acquire a “memory” by being recorded on motion-picture film either at the point of origin or directly off a receiving set.

Because television can use films, stills, or motion pictures to repeat things which have happened in the past, it is not restricted to “live” programs, which must progress without interruption from start to finish with the production of one sequence following another. The fact that previously prepared and photographed material can be inserted at any point just as in motion pictures gives television a potential scope and flexibility which equals or exceeds that of the film.

There are various psychological aspects of motion pictures which seem to hold true in television. For instance, we cannot concentrate our attention on more than one thing at a time. This means, in television production, that at any given instant one must have the audience’s attention focused on either the visual or the aural part of the program, but not *equally* on both. (Since television is predominantly a visual medium, the attention will usually be on the video.) The moment both audio and video become equal in importance the audience becomes distracted and confused.

Think how many times you have been watching a motion picture and have suddenly become conscious of the music. If you will recall, the chances are your attention was flitting back and forth from the sound to the picture, causing you to be confused and breaking the mood of the story. In early television a particularly noticeable example has been found in sports programs, when a typical radio sports announcer handles the commentary. Accustomed to working in a blind medium, he rattles on describing everything. Unfortunately the audience can see all this before the announcer can begin to talk about it—and the effect is confusion and irritation. The most successful sports announcers of television are those who know when to keep quiet; in most cases these more successful announcers have been able to watch both the television screen and the actual events as they talked.

In Chapter 4 it was pointed out that one of the basic differences between the stage and screen is the difference between “actions” and

"reactions." In the theatre the audience identifies itself with the actor, who builds up that indefinable "give-and-take" between the audience and himself by his direct actions and words. In motion pictures the "give-and-take" is built up when the audience identifies itself with "the person acted upon the screen, and not with the person acting," to quote motion-picture writer Dudley Nichols.

In discussing this point in his preface to *Twenty Best Film Plays*,² Mr. Nichols sagely points out:

At any emotional crisis of a film, when a character is saying something which profoundly affects another, it is to this second character that the camera instinctively roves, perhaps in close-up; and it is then that the hearts of the audience quiver and open in release, or rock with laughter or shrink with pain, leap to the screen and back again in swift growing vibrations. The great actors of the stage are actors; of the screen, re-actors.

If anyone doubts this, let him study his own emotions when viewing a good film. . . .

Mr. Nichols recalled that he had recently checked on this theory by experimenting with some friends after seeing Noel Coward's *In Which We Serve*. All were most profoundly moved by reactions rather than action. Particularly effective, he found, were such scenes as the shot of a woman as she receives word that her husband has been killed, and the face of an officer as he learns that his wife is dead. He is writing a letter to his wife when the news is brought to him by the radio operator, and the reaction shot is continued beyond the usual facial expression, for he goes on deck, looks over the rail, and lets the unfinished letter flutter down into the water—extending reaction into action.

Another highly moving scene was the final one in which the captain says good-by to what is left of his crew. We saw the faces of the men as they came forward to shake hands, and we heard their tired voices. This appeared to be straightforward action, whereas Mr. Coward actually staged it as a reaction shot. It showed the reaction of the men to their harrowing experience, all summed up in their weary faces and laconic speech.

² Edited by John Gassner and Dudley Nichols. Crown Publishers, New York, 1943.

Although Mr. Nichols did not note the fact, it is interesting to observe that these most effective scenes were all close-ups or medium close-ups. Obviously, to show clearly the reaction of an actor to a given situation, the scene must be a close-up. Now the most *effective shots of early television have all been close-ups*. Undoubtedly this was due, in part, to the fact that early television receivers gave small-size, imperfect pictures in which small figures did not stand out clearly. However, this may also have been due to television's qualities of intimacy and effective transference of personality. Television directors should find it profitable to investigate thoroughly the possibilities of the television close-up. The close-up may continue to be our most effective shot, and perhaps we shall find ourselves learning a great deal more about its potentialities.

The fact that "live" television programs require a continuous and sustained performance, with no retakes and leisurely editing over a period of weeks, is not necessarily a handicap. On the contrary, it will undoubtedly prove to be a most important factor in making a new art form out of television. It is physically impossible to imitate motion-picture technique beyond a certain point. This will make us develop new techniques which suit the demands of television. Camcras, lights, microphones, and studios themselves leave much to be desired. New designs are needed to provide more flexible cameras, microphones, and lights. But beyond this we must look for new kinds of program material which television can do to perfection. We must look for more expert acting than is called for in either theatre or motion pictures. The actor must be able to sustain a performance from start to finish and at the same time adapt his technique for the moving camera, now in close-up, now in long shot. And most of all we must evolve a new technique for handling the video and the audio, a technique which will be built according to the essential nature of television.

Chapter 6

BLIND RADIO VS. TELEVISION

IN COMPARING standard radio and television, the first and most obvious point is the technical difference: although television and radio programs are both broadcast in the same way, television uses two complete transmission systems—one for sight and one for sound—while radio needs only one. Surely this is so self-evident that we can proceed immediately to our next point—the ways in which television seems likely to be a continuation of radio practice.

Earlier in this book the statement was made that radio is incomplete television, and that, like the telephone, it anticipated television. Then it was pointed out that television could not be considered merely an improvement on blind radio, when considered from a psychological, artistic, or historic point of view, because our sense of vision is of far greater importance than our sense of hearing. This line of thought needs to be qualified in one respect: the business structure, the selling of time for advertising purposes, the distribution of receiving sets, network operational methods, legal and union procedures—in all these departments television broadcasting has given a fairly clear indication that it will be a *continuation* of radio methods. Similarly, television does not seem to be introducing any *new* sociological trends; rather it is continuing those started by aural radio, but giving every indication that it will greatly intensify them—particularly in the fields of propaganda (or molding of public opinion), commercial advertising, and mass education.

Although these points do not specifically affect the technique of program production, they do have a very important bearing on it: they provide a solid and reasonably well-explored foundation on which television can develop. This is just as important for the development of an "art of television" as the technical end. Television programmers are like farmers. They may have plenty of seeds (ideas and talents) but they must have fertile soil (technical perfection) in which to plant the seeds, and plenty of water, sun, and air (economic justification, business organization, and distribution methods) to get a decent crop and harvest it.

It may seem unnecessary to point this out to people who have a professional radio or motion-picture background, but some aspiring actors, producers, writers, and other artists are prone to overlook it, amid the crop of little "television workshop" groups which are springing up, paralleling a similar growth in theatre and radio.

For those who are perfectly aware of this, I would like to make only one more point: when radio broadcasting began in 1922, few people realized how it was going to pay for itself. As an advertising medium of importance it did not exist—at least not in the minds of the average advertiser and his advertising agency. It took years of selling and promotion by the broadcasters to establish it as an advertising force. Today the position is quite different. Advertisers and their agencies are thoroughly aware of television's potentialities; they do not have to be sold on it. Even during the war what little air time was available was snapped up by sponsors, while others waited their turn—despite the small audience, poor-quality picture, and exceedingly bad shows of the period. Advertisers have clearly demonstrated an eagerness to use television, and this should make no little difference in its rate of development. Television is "sold" before it starts, whereas a decade or more was needed to "sell" radio completely. In the middle of the 1930's time salesmen were still being asked every other day to prove that radio was a sales medium, that it really could sell merchandise.

Radio has often been called "one-dimensional" since it appeals to one sense only, and since that sense (hearing) is played upon by a monaural sound system, which—as has been pointed out—is unable to distinguish horizontal or vertical movement of the sound

source except as its distance from the microphone increases or decreases. In radio the audience is induced to make up for this deficiency by stimulation of the imagination. The sounds and words we hear stir our imagination, which supplies the missing pictures. The radio director hopes that he can get all the various imaginations of his audience to work the same way, to "see" the same thing, and not to drift off to something else. Television, on the other hand, supplies those pictures for the audience, and the director *knows* precisely what his audience is seeing—as in motion pictures. This gives the director more precise control over his audience's reactions and attention without killing off the imaginative qualities, as die-hard, blind-radio people are wont to argue. It stands to reason that aural radio is basically more limited than sight-and-sound television. A director has more to work with in television. Instead of having to stir imaginations just to create mental pictures (different in each person), he can use the audience's imagination to get an extra effect out of both sound and pictures, which results in a more powerful effect than is possible in radio.

Although radio is contributing a complete business structure to television, and radio scientists played a major role in the perfection of the science, radio is contributing comparatively little to the art of television programming. Radio writing and acting have very little to do with television, but one program technique of radio which will contribute materially is that of sound effects. Before radio began to grow up in the 1920's, the technique of sound effects was extremely limited and used only in the theatre (crudely) for such things as doorbells, off-stage automobile horns, gun shots, bass drum thunder, and the like. Radio had to develop its own effects, which in turn were drawn upon by the theatre and by sound pictures, when they began a few years later. Television programmers will also draw upon the sound effect techniques developed by radio men, although many radio sound effects will be unnecessary in television—a point to which we will return later.

Another radio technique which will prove of value in television, particularly to the director, is the business of controlling a program by means of twirling a few dials and fusing it into a unified whole at the instant of its creation, timed to the split second for network operations. The television director must learn to work with both

sight and sound simultaneously. In the control room the audio is controlled exactly as in radio, and so is the video, with a few added complications. The director hears his audio with the usual loudspeakers. He sees his video on several screens: one shows what is going out on the air, and one or more additional screens show what each of his other cameras is picking up. In radio the director gives his instructions orally to the engineers. In television he usually gives his instructions (still orally) to two or more engineers, one on the audio and one on the video, and simultaneously (through telephone headsets) to the stage manager, cameramen, and complete crew.

This calls for speed, precision, a "sense of theatre," and a complete familiarity with the medium. Despite distractions of all sorts, the director must keep the production under his control at all times. Experience in radio directing is the ideal form of training for this complex work; the radio director can adapt to it more quickly than a person without radio experience—provided he has a *picture sense* and can *think in terms of both pictures and sounds at the same time*. It is not as difficult as it sounds, provided the director takes the pains to study the medium first. It simply demands that he learn to work at a higher level of efficiency, and once this is accomplished he will look back at radio production as something rather dull and tame.

In preparing a radio program, a director has the following ingredients with which to work:

- (1) Statements of fact, factual sounds transmitted as they occur with no attempt to heighten the effect by polishing or rehearsing the material. The microphone is used in a naturalistic technique.

- (2) Carefully selected and rehearsed prose or poetry, achieving an emotional effect beyond the intellectual content of the language as well as added significance and intellectual appeal through the association of ideas.

- (3) Realistic sound effects, recognizable sounds which evoke a definite picture in the mind's eye, serving as a substitute for visual scenery or to indicate an action which would otherwise have to be described in words: i.e., a door slam instead of a narrator

saying, "So-and-so got up, opened the door and went out, closing it behind him."

(4) Abstract sound effects and music, which mean little or nothing to our sense of reason but which appeal directly to the emotions. These are generally used to establish or heighten a mood, make a "bridge" or transition from scene to scene, and of course for their own sake in the case of music.

In television we have all these four ingredients plus their visual counterparts, which are:

(5) The straightforward transmission of whatever scene the camera is trained upon, without any attempt to prepare or rehearse the material, or to achieve effects with lighting and camera handling.

(6) Carefully composed pictures in which the camera angles, lighting effects, video effects, and sequence of pictures are calculated to create a specific effect over and above that of the straightforward transmission of a given scene.

(7) Realistic video effects such as microscope views, miniature scenery, and "process shots" such as back projections.

(8) Abstract or semi-abstract video effects such as cartoons, maps (animated, three-dimensional, graphic), visualized statistics, kaleidoscopes, puppets, optical effects, paintings, etchings, sculpture, and such purely delightful abstractions as the mobiles and stabiles of Alexander Calder.

There are eight ingredients to work with in television, twice as many as in radio. And remembering how much more potent the sense of vision is than hearing alone. One cannot escape the conclusion that the possibilities of television programming are as vast as they are unexplored.

Let us carry the comparison between radio and television a step further and see how these ingredients are blended together.

In a radio control room the director can accomplish the following effects:

(1) A *cut from one source of sound to another* by switching one microphone channel off and another one on, which would produce a jarring break in the sound useful only for special effects.

(2) A *fade-in* or *-out* by turning the sound control up or down.

(3) A *cross-fade* or dissolve from one source of sound to another by fading in one microphone channel while fading out another.

(4) A *blend* of two or more different sources of sound by opening up two or more channels.

(5) *Illusions of distance* by increasing or decreasing the amount of echo (reverberant sound), thus altering the acoustic perspective.

(6) *Filtering* out certain high or low portions of the sound to create special impressions: i.e., a person talking on a telephone requires the filtering out of all but the middle frequencies.

In a well-equipped television control room all these same audio effects will be available. The video will also be controlled by a similar group of dials and switches. With the video the director can, in a properly equipped studio, get these effects:

(7) *Cuts* from camera to camera, instantaneously and without any break in the picture.

(8) *Fade-in* and *fade-out*, "fading" the picture either to black, white, or neutral gray.

(9) *Dissolves* from picture to picture.

(10) *Superimposures* (double exposure) of one picture on top of another.

(11) *Effects of distance* and depth by use of lighting.

(12) Assorted *distortion* effects, accomplished optically and electronically—such things as exaggerated contrast, shading out of part of the picture, altering shape of the picture, changing focus.

(13) *Movement of the entire camera* up and down, forward and backward, from left to right, turning of the camera head through the same fields, and simultaneous combinations of these movements: i.e., moving in on a wheeled dolly, raising the camera up, and turning from right to left all at the same time. A microphone could, of course, be put through the same maneuvers, but the audience would notice only an unexplained wavering of the level of sound and its quality.

Television, then, can do everything that radio can do and—given an adequate set of facilities—do it better. Even something as completely aural in appeal as music can be presented on television with certain visual enhancement—and I do *not* mean those endless, boring shots of pianists pounding on pianos or rows of violinists

sawing away. The only qualification I am willing to make is on programs of the supernatural; "lights-out," thriller types are probably best when listened to in complete darkness.

One of the more prevalent misconceptions about television is the assumption that to produce programs one simply takes television cameras into regular radio studios and televizes the radio show. The favorite "evidence" presented in support of this belief is the large number of sightseers who flock in to watch radio programs. Television programmers long ago learned that most radio shows are designed to be heard, not seen, and they make exceptionally unsatisfactory video fare when telecast without adaptation. The reason is obvious if one thinks about it.

The differences between radio acting and television acting are self-evident. In radio the actor reads interpretively from a written script while standing in front of the microphone. In television he acts, and instead of his walking up to the microphone, the microphone and cameras come to him and follow him wherever he goes. Probably the only things useful for television which an actor will learn in radio are the technique of speaking simply, softly, unaffectedly, and a familiarity with network procedure and stop-watch timing.

Similarly, a knowledge of these two points is one of the few things a radio writer will be able to carry over to television. Since television is both visual and aural, a writer cannot hope to get consistently good results by writing dialogue first (a radio script) and then trying to fit the video to it. The television writer must think simultaneously in terms of pictures and sound, and if he was not born with that faculty he must acquire it. He must be able to make sight and sound jell in his own mind; he should be able to see and hear every scene and situation before he puts it on paper, before he tries to get an integrated whole. If the television writer and director can do this instinctively, he can work with twice the speed and ten times the sure-footedness of the writer or director who has not been able to acquire the skill.

Obviously the structure of a television script is going to vary widely, according to the type of program. The structure of a television drama may be similar to that of a motion-picture scenario, a quiz program or a discussion forum may be similar to a radio

show; a news program may be similar to a news and picture magazine. They may all be like radio in one respect—the opening minute. In radio it is axiomatic that one must capture his audience's attention in the first thirty seconds to one minute. If their attention is not caught by then most of the listeners are lost. Perhaps this axiom is predicated on the inherent limitations of the aural appeal, but more likely it is based on the fact that radio is free and many different programs are available at the flip of a switch. In motion pictures or the legitimate theatre, where people have paid admission and cannot switch to another theatre with little effort, the first five to ten minutes of a production are usually taken up with inconsequential material. In legitimate theatre it is usually chitchat to establish characters. In motion pictures, it is partly this and partly a long series of screen credits. The purpose of this is to quiet the mass audience—get them in their seats, stop the whispering, talking, and sundry noises, and get everybody into a receptive mood and an attentive frame of mind.

With a home audience, attention can be focused almost instantaneously. The director does not have to bring massed audience of hundreds or thousands of people under control, which is what takes the time. His audience is one or two or three people at home. Their attention is won or lost in a matter of seconds, and when competition between various programs on the air at the same time develops, as it has in radio, the first minute may prove to be critical in holding an audience.

Because a great many programs are going to be needed in television schedules, and because personnel and facilities usually will be at a premium (if for no other reason than because broadcasters, unlike motion-picture producers, will always try to do things as inexpensively as possible), there are certain faults now common to radio broadcasting which can easily become implanted in television. Many of them have already become apparent as the result of inexperienced directors trying to put shows on with little or no rehearsal time and with poorly organized studio staffs. This is leading to what may prove a serious danger to television as it has to radio: a welter of mediocre, routine programs which dulls the audience's interest and encourages "background listening."

As a general practice in radio, the writer of a program has

nothing more to do with a script after he sends it to the typing department. More often than not he is grinding out a number of scripts, which are slapped together according to hackneyed formulae, and which come to the average director as a mediocre product. The director, invariably rushed, seldom has time to give much thought to the script in hand. Perhaps the first time he studies it at all is at the initial rehearsal, when the cast is assembled and the minutes are ticking away. He may realize, when and if he stops to think about it, that the script is weak and should be done over—if only there were time.

In the rehearsal the script is chopped down or padded out. The main emphasis is on the more superficial aspects—timing, cutting out passages which may require extra rehearsal, and making sure the actors *read* the lines exactly as written. In other words, the emphasis is on the mechanical problems of production, and if the actors give a fairly decent reading without stumbling, the director is usually satisfied to let it go at that. The “radio director” is, therefore, not a director in the theatre sense of the word but rather a “stage manager.”

Wild waving of arms to cue in sound effects and actors, a profusion of ground-out cigarette butts and empty coffee containers, unbuttoned vests, and flagellated nerves all provide an illusion of expert direction for the studio audience and the director himself, even though this part of the show is not transmitted over the air and will not save it from being “just another program” to the listener. (Very often this will be the same feeling with which the director approached the program in the first place.)

In all fairness to the average director it should be pointed out that external circumstances do not help. Radio is an artistically limited medium to begin with. Scripts usually are uninspiring, and a director may have a number of them to produce in a given day. By accepting and using certain stereotyped formulae he can grind out something which will pass in the welter of daily programs. Besides, if he took time out thoroughly to analyze each script and get it in perfect shape, there would be no thanks in most cases. Whether radio people like to admit it or not, the premium is placed on mediocrity, not on perfection, originality, initiative.

To illustrate, here is an example which I observed and jotted

down verbatim one day. One of the best-known directors in radio was rehearsing a featured program on a network. It was after the third "read-through," which also was "dress rehearsal," that one short passage was singled out and rehearsed again. It still went badly, being poorly written and ineptly played, but it contained material important to the structure of the play and which, with a little working over, could have been fixed. But the director was bored.

"I don't like it, he sighed, "but it's as good as it ever will be."

Nothing more was done about it. Everyone sat down for a smoke, or a chat, and half an hour later the program was broadcast without further ado.

This incident is set down here simply as an illustration of a situation all too common in radio. The ear, being much less critical than the eye and conditioned to "background listening," will let these imperfections pass without too much objection. In an aural *and* visual medium, however, the eye will not accept comparable slovenliness of production technique.

Let us move on now to the subject of the television camera and microphone, remembering that when sound pictures came in, the producers forgot about the established and valid techniques of silent pictures (cameras) and turned out some pretty poor shows. Today, with television coming in, many video producers are forgetting (or never knew) the principles of both good camera handling and the techniques of sound developed in radio and motion pictures.

Part Three

THE CAMERA

Chapter 7

THE TELEVISION CAMERA

LIKE THE human eye but unlike the motion-picture camera, the television eye is always "seeing" whenever any light reaches it. The motion-picture camera "sees" only when it has a strip of film in it, but the photosensitive plate in the television camera generates a *signal* constantly. (Whether or not that signal is "seen" depends on whether the camera is turned on, and whether the control apparatus is amplifying the signal and reproducing it on a screen.) The camera is so sensitive to light that, when it is not in use, a cap is placed over the lens to exclude all light and thus prolong its useful life. Excessive light can "burn" a spot on the mosaic of the tube, ruining it for broadcast usage.

Cameras in commercial use (1936-45) were manufactured under RCA or Farnsworth patents, with the RCA types more widely used for studio and outdoor pickups. Most cameras of prewar vintage are built around RCA Iconoscopes, and a few around RCA Orthiconoscopes, popularly called Orthicons. The Farnsworth type of camera tube is known as the Image Dissector and has been used largely for picking up motion-picture film telecasts.

Intense illumination is required to produce a good picture with prewar Iconoscopes and Image Dissectors. In general a greater amount of light is needed with prewar models of these tubes than in black and white motion-picture production, a minimum over-all lighting level of 350 to 500 foot-candles being desirable on all parts

of a given scene. Highlighting and modeling lights are added to this.

If sufficient light is not reflected from all parts of the scene viewed by the camera, the photosensitive mosaic is not sufficiently activated by the underlit portions. The result is an "undermodulated" picture which does not transmit well, or a picture in which the edges suffer from "edge flare."

In 1939, RCA began to introduce a few models of its improved type of camera, the Orthicon, which was four to five times more sensitive to light than the Iconoscope, although not capable of transmitting as sharp a picture as the Iconoscope because of lower powers of contrast and resolution. During the war, improvements in design made possible new cameras of infinitely greater sensitivity, capable of transmitting much sharper, clearer pictures.

Both the Image Dissector and the Orthicon are free from a peculiarity of the Iconoscope: the need for "shading" of the picture by an extra engineer. In order to control a technical quirk of the Iconoscope, a special video engineer must constantly be fiddling with knobs and dials to keep the picture correctly shaded. The visible effect is the lightening of an overly dark portion of the screen.

The high level of illumination needed for prewar television cameras caused extreme discomfort for actors and studio personnel, particularly in small, ill-ventilated studios equipped entirely with hot, incandescent lights. Air conditioning helped considerably but did not solve the problem, which was to produce either more sensitive cameras or "cold light." There are two types of "cold light"—*mercury vapor*, and *fluorescent*—both of which offer much promise for the future.

A camera takes pictures because light waves enter it and affect a photosensitive surface. The human eye works in the same way and so does the television camera. Since the photosensitive surface, in any camera or eye has a fairly uniform and constant degree of sensitivity to light, and since most sources of light can vary considerably from bright to dark, some device is needed to regulate the amount of light entering the camera or eye.

In the human eye the device is automatic. Look closely in the

mirror at your eyes, noting the size of the black spot in the center. Suddenly increase the amount of light shining on your eyes, and notice how the spot becomes smaller. Since the intensity of the light has increased, more light will enter your eye and "overload" it unless the flow of light is decreased. The black "spot" in your eye does just that. It is called the pupil and it is the opening through which the light waves enter. It is automatically closed down when the light increases. Turn off that light and it will again become bigger in order to admit more light so that you can see.

In a television camera, as in most photographic cameras, there is a similar device, usually called the *diaphragm*. Instead of being automatic it is adjusted by hand. If the lighting on a scene is weak, the *stop-opening* is opened wide. If the lighting is very strong the stop-opening is closed down.

Just as in measuring weight, or distance, or time, we have standard measures—pounds, yards, and minutes—so some sort of universal measuring terms is needed to provide a gauge of the amount of light used in cameras. Such a system has been worked out by photographers and lens manufacturers all over the world. The diaphragm of every lens has a control lever or ring which is calibrated with this standard measuring unit—called *stop numbers*. These numbers always mean the same thing, no matter how big or small a lens may be. A tiny, 8 mm. motion-picture with its lens adjusted for stop number 11, and a television camera with a lens ten times as big and set at stop number 11, get the same *relative* amount of light. The numbers mean the same thing on all lenses, regardless of their size.

These stop numbers are also known as "f" numbers, because the letter "f" is generally used to identify them—just as the \$ sign is used to indicate dollars and the % sign is used to indicate per cent. (See Figure 1.)

Lenses are usually so calibrated that each division indicates approximately an increase of 100 per cent in the amount of light which can pass through the opening. The largest "f" number indicates the smallest possible opening of the diaphragm, while the smallest "f" number indicates the largest possible diaphragm opening. (For example, the "f" numbers of a television camera lens might run f/2.8, f/4, f/5.6, f/11, f/16, with the latter the smallest

opening of the lens. No settings smaller than $f/8$ could be used on the prewar type of cameras because of their low sensitivity.) As the lens is opened up from $f/16$ to $f/11$, it will admit twice as much light, and so on up the scale. Each division admits twice as much light as the one ahead of it, with $f/2.8$ admitting 32 times as much light as $f/16$, and so on.

Of course "f" numbers other than the ones just listed are also used. Some lenses may open up to $f/2.7$ —just a bit wider than $f/2.8$. Or a "fast" lens might open up to $f/1.9$, which passes 100

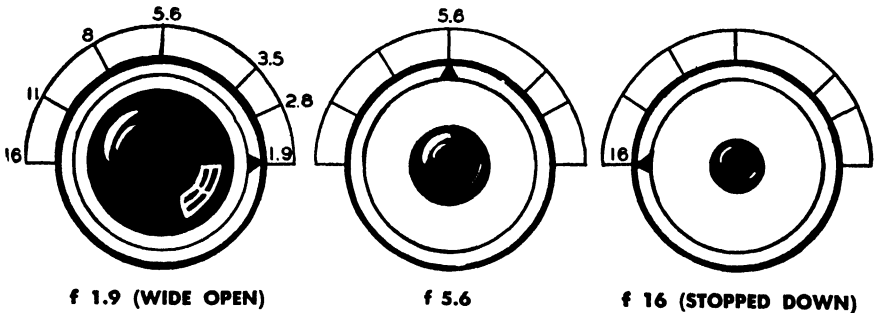

FIG. 1.—As in the human eye the opening in the diaphragm of a camera can be widened or made smaller to admit more or less light. At $f/1.9$ it is opened wide and the maximum amount of light can pass through the hole. At $f/16$ the opening is much smaller, admitting only $1/64$ as much light.

per cent more light than $f/2.8$, while a very fast lens might go to $f/1.5$, which is considered about half a stop number better than $f/1.9$ —and would therefore pass about 50 per cent more light than $f/1.9$.

In general, lenses are identified by their largest opening, which is called a lens's *speed*. A very fast lens, such as an $f/1.9$ or an $f/1.5$, is a more expensive lens than a slow $f/4$ —assuming both lenses are the same size. A fast lens can take a picture of a scene with less illumination than a slow lens because a fast lens can be opened up much wider.

The correct stop number (lens opening) for most studio television programs can usually be determined by the cameraman on the basis of previous operations in that studio, but when any radical lighting changes are made, or when the cameraman is working in

unfamiliar surroundings, he will usually check his lighting with an exposure meter. The standard type of exposure meter uses a photoelectric cell and gives a cameraman an instantaneous and accurate reading of the intensity of light on any given object. From this reading he can immediately determine the largest and smallest openings of the diaphragm which can be used for that scene with each lens of each camera. (See Figure 2.)



FIG. 2.—Light waves, indicated by arrows, cause photoelectric cell to react, registering intensity of light on calibrated scale.

Different types of lenses are used for different purposes with any type of camera, television or photographic. The “normal” lens, the basic lens, is the one which gives the camera—and hence the viewer of the picture—the same perspective and view he would get with his own eyes.

Suppose you are watching a horse race, and you can see everything quite well with your own eyes—race track, crowds of people, sky and clouds, and the horses coming down the track. Now you want to see the horses more clearly, so you raise a pair of field glasses to your eyes—or perhaps it is a small telescope—and then you can see the horses clearly. They appear much larger to your

eyes, but you no longer see the crowds of people and the sky. You have focused on one part of the view and magnified it for better seeing while excluding the rest of the scene.

If you are using a camera on the same race, you would be putting a special lens on the camera, which then would magnify the part of the scene you wish to photograph more clearly. This lens will be longer than the ordinary lens on your camera. It probably will stick out several inches in front. In addition to magnifying the view of the horses, it will exclude the rest of the over-all scene, just as the field glasses or telescope did when you peered through it. It has the effect of making the horses seem much closer than they were with the original, "normal" lens.

The value of having various types of interchangeable lenses is that they increase the flexibility of your camera. Without moving your camera at all you can get a variety of different shots of the same scene, ranging from infinitely long shots to extreme close-ups. The same variety can also be achieved by moving the camera back and forth, but sometimes this is not practical or convenient—as at a horse race. On many occasions in studio programs it is desirable to get an extreme close-up without having to move your camera up to within a foot or so of the subject—thus distracting the actors, getting in the way of other cameras, and getting between the lights and the subject, thereby casting a shadow upon it.

The use of a close-up lens gives a form of distortion to the picture, since it shows the image with a spatial relationship different from that which the unaided eye would perceive. Distortion by close-up lenses, desirable because it can be accurately controlled, is not the only type of optical distortion available to the television producer. It can be carried in the other direction by using a lens which, instead of decreasing the sense of distance by magnifying the image, increases the sense of distance—the effect obtained when one looks through the wrong end of a pair of opera glasses. This type of lens, known as a very short, wide-angle lens, exaggerates perspective. It can make an ordinary room seem like a long hall. If a person standing before the camera raises his hand toward the lens, it can be distorted into a huge fist, bigger than anything else in the picture. Some early television stations with very small studios have experi-

mented with this type of lens—to make their tiny studios seem larger.

In general, the more a lens magnifies a scene, the greater it is in length. For this reason lenses are designated by their *focal length*—as well as by their speed. Thus we might describe a television lens as having a focal length of six inches and a speed of $f/2.8$. Immediately a cameraman will know what sort of view the lens will give and the minimum amount of light which can be used.

The normal lens—comparable to the human eye—varies with the size of the camera. An 8 mm. motion-picture camera has a normal lens of one-inch focal length; a 16 mm. camera uses a one-and-a-half-inch length, and a 35 mm. takes approximately a two-inch lens. Note that in each case the increase in the length of the lens is comparable to the increase of the *area* of photosensitive surface of the film; 16 mm. film is twice as wide as 8 mm., and therefore the area of each frame is four times larger. To focus the larger picture needed to cover this greater frame area a 50 per cent longer lens is required. The bigger the photosensitive surface upon which the image must be focused, the longer and bigger the lens must be. For example, in prewar Iconoscopes, the photosensitive mosaic is quite large, something like 3 by 4 inches. The normal lens used with this camera has a focal length of six or six and a half inches—which would be a powerful, telephoto length on a small motion-picture camera.

If the basic, normal lens on this type of Iconoscope is six inches in focal length, then the magnifying close-up lenses are correspondingly larger—nine, twelve, and eighteen inches. Any lens less than six inches would exaggerate distance, be extra wide-angle. A twelve-inch lens would include a picture area *half* of that covered by the six-inch lens, but this area would fill the screen and thus be magnified *two times*. An eighteen-inch lens would include only *one third* of the picture area of the six-inch lens, and would thus magnify the subject *three times*. A thirty-six inch telescope lens, which might be used at a football game, would magnify the subject *six times*. (See Figure 3.)

Needless to say, lenses as big as this are clumsy to handle and very expensive—particularly if they are “fast,” and prewar television cameras had to have “fast” lenses. (Telephoto lenses are

**WIDE ANGLE****12 INCH****NORMAL****18 INCH****36 INCH**

FIG. 3.—How a view differs when different lenses are used. “Normal” lens views scene with same perspective as human eye. Extra wide-angle lens (*upper left*) takes in wider view than is possible with human eye, and when used for close-ups, exaggerates perspective.

usually not as fast as those of shorter lengths, because it is difficult and costly to make a lens which has both high power of magnification and great speed.) The trend in postwar cameras is toward

smaller size, photosensitive surfaces placed close to the lens, which will make possible the use of smaller lenses.

The importance of *focus* is so elemental that it needs little elaboration. If the television camera is not kept in focus, the scene is not clear—if it is seen at all. That much is simple, but how to keep the picture in sharp focus is another matter. Each shot cannot be carefully measured off and triple-checked as in motion pictures. The cameras of television are constantly moving and must be in focus all the time. The cameraman must be continually adjusting his focusing mechanism if the picture is to be sharp and clean, and

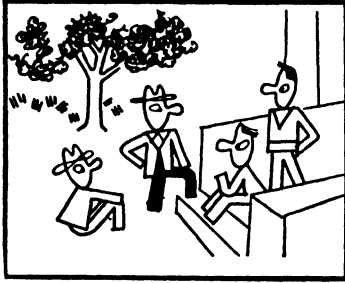
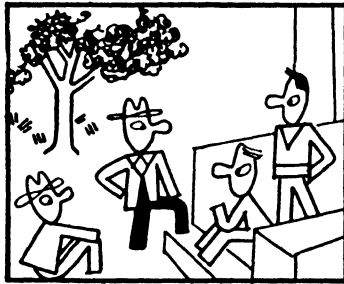
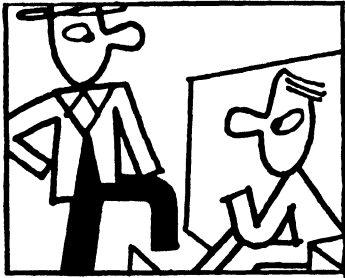
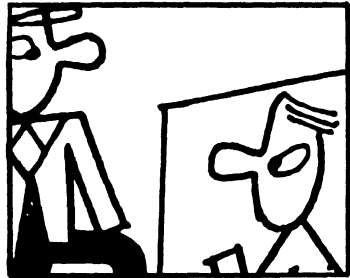
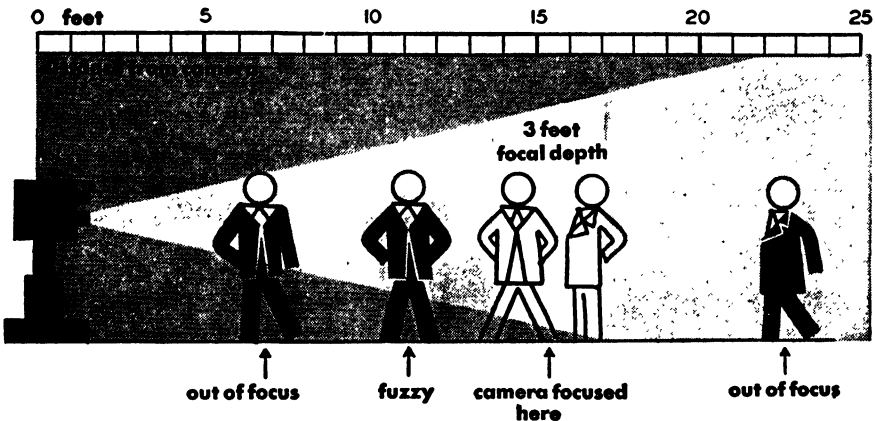

FIG. 4.—Focal depth illustrated, based on the use of a wartime Iconoscope using a 12-inch lens, set at $f/4.5$.

for this reason his view finder—through which he sees what the camera is picking up—must be connected with the focusing device. If the camera is out of focus, so is the view finder, and he sees the error and corrects it immediately.

Fundamental to the problem of getting a good focusing view finder is the problem of *depth of focus*, a thorn in the side of pre-war television directors, which went hand in hand with the low sensitivity of cameras. Depth of focus means simply that portion of the area in front of the camera in which objects will appear in sharp, clear focus, without adjustment of the camera. It extends from the closest point to the camera at which an object will be in

focus to the farthest point. The distance *between* these two points is the *focal* depth of a scene. In most television studios it has been pitifully small. (See Figure 4.)

Depth of focus is determined by three things in practical television production:

(1) The size of *the stop-opening* of the diaphragm. The wider the opening, the shallower the focal depth. Prewar cameras, being very insensitive, needed plenty of light on the scene, but that illumination could be raised only to a given point—beyond which it became too hot to be endured by actors and studio crew. Therefore in many prewar cameras it was necessary to open the diaphragm to a low “F” number, such as $f/2.8$ or even lower. This resulted in such a shallow depth of focus that production of satisfactory programs was severely limited, as was the case at the Du Mont studio in New York. At the CBS studio, where most of the lighting was “cold”—mercury vapor and fluorescent—and it was possible to use more light on the set without discomfort to the actors, lenses could be stopped down to $f/4.5$ and sometimes to $f/5.6$, which helped considerably.

This problem will be eased by the introduction of more sensitive cameras which can operate at much smaller stop-openings and thus give a reasonable focal depth.

(2) Focal depth is also determined by the *distance of the camera from the subject*. The greater the distance, the greater the focal depth. On close-ups the focal depth is very shallow. With a prewar type of Iconoscope camera, using a six inch lens set at $f/2.8$, the focal depth on an extreme close-up may run about two to three inches—not enough to keep both nose and ears in sharp focus! If the camera is moved back ten feet from the subject, the resulting focal depth would be perhaps eighteen to twenty inches. When the camera is moved back to twenty feet, the focal depth in a long shot might be about three feet.

(3) Focal depth can also be changed without moving the camera by *changing the lens*. If a long lens is substituted for a short one, the focal depth of the picture is decreased but the picture is changed as well since the subject appears to be larger and closer to the camera. And if a short lens is substituted for a long one, the

focal depth is increased but the objects in the picture appear smaller.

Perhaps the importance of focal depth can be made clear by the following hypothetical situations in which an Iconoscope with a nine-inch lens set at $f/4.5$ is used:

Assume that you are directing a television show, and you wish to get a shot of two people seated at a table. You line up a picture which you think will be very nice, shooting at an angle which should make one person appear very large—because he is close to the camera—and the other person small and far away. This seems nice and dramatic in your mind's eye, until you see the result on the screen. If you have one person in sharp focus, the other one is blurred and out of focus—and vice versa. The shot appears to be impossible, because your depth of focus is too shallow. One person is six feet from the camera, and the other one is nine feet—three feet farther away.

“And you see,” says your cameraman, “our depth of focus is only fourteen inches.”

Possibly the shot still can be used, but you will have to make *one or more* of the following adjustments as illustrated in Figure 5. (This problem in depth of focus uses a wartime Iconoscope with a 9-inch lens set at $f/4.5$. For easier reading the focal depth is slightly exaggerated in these diagrams. Actually the focal depth at a lens setting of $f/4.5$, with the camera as shown on the next page, would be around 14 inches. If the lens were set at $f/2.7$, the focal depth would be about 8 inches. In the diagrams, the lens would have to be stepped down to about $f/16$ to get the focal depth indicated in the drawings. In solution 3, the shift to a wider angle lens, the drawing is made on the assumption that a 6-inch lens is used.)

(1) Use a smaller stop opening on your cameras. But to do this you will have to (a) greatly increase the amount of light on the set, or (b) get a more sensitive camera, or (c) try to compensate for the loss of light by having your control engineer raise the “gain,” increase the power of the circuits amplifying the picture. He will undoubtedly object, because the picture may be too weak and too washed out to transmit the way he wants it to be transmitted.

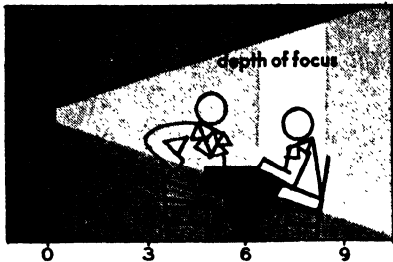

THE PROBLEM

THE EFFECT out of focus | in focus
BECAUSE depth of focus limited

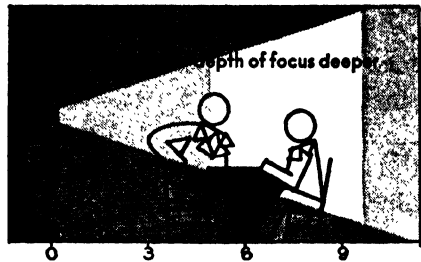

SOLUTION 1

LENS STOPPED DOWN (more light needed)
THE EFFECT both in focus
BECAUSE greater depth of focus

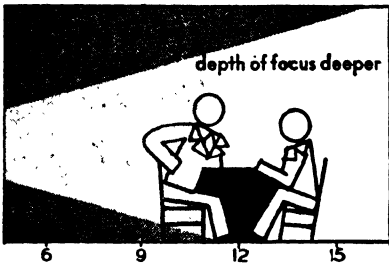

SOLUTION 2

CAMERA FARTHER FROM SUBJECT
 (figures smaller in frame)

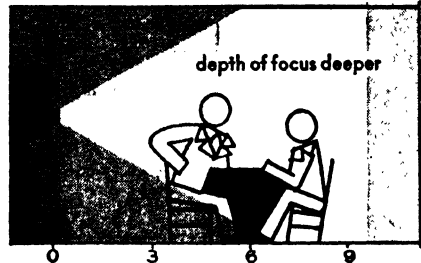

SOLUTION 3

LENS OF WIDER ANGLE
 (figures smaller in frame)

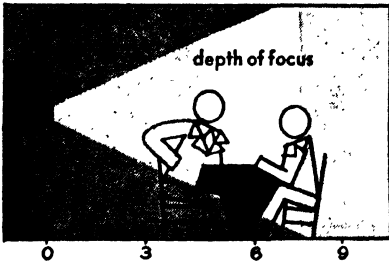

SOLUTION 4

SPLIT FOCUS

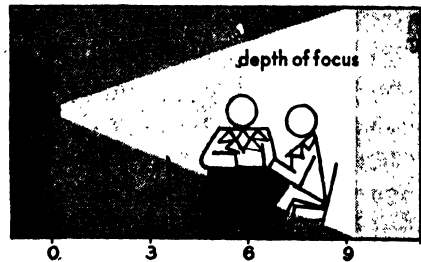

SOLUTION 5

CHANGE THE SUBJECT

FIG. 5.—A problem in depth of focus.

Nevertheless, maybe he can squeeze just a little bit more out of the system.

(2) Move your camera farther away from the subjects, increasing your depth of focus but also bringing other objects into view—which may or may not upset the purpose of the shot.

(3) Change lenses, if you cannot move your camera back. Use a shorter, wider-angle lens, which will include more area in the picture, make the subjects seem further away and give more depth.

(4) “Split” the focus of your camera. Instead of trying to keep one person in perfect, sharp focus at the expense of losing the other, focus on a point between the two. This may give acceptable focus on both subjects. The focal point should be closer to the nearer subject, for the focal area is one-third in front of the focal point and two-thirds behind it.

(5) Change the position of your camera in relation to the subjects, or change their positions to bring them closer together and within the focal depth of the camera—which, of course, may make the shot look awfully stiff.

Any summary of outstanding characteristics of early cameras should also include the fact that the Iconoscopes and Image Dissectors transmitted a reasonably high amount of definition. The Iconoscope, although more sensitive than the Image Dissector, needs extra amplifying tubes in the pickup head itself, which increases the size and weight of the camera. In general, cameras of the 1935–45 decade were clumsy, heavy, bulky, and awkward to handle because of the heavy coaxial cable which links the camera to the control room. They were not often designed from a practical cameraman’s point of view, focusing devices being awkward, view finders unreliable and lacking in certain desirable qualities, and seating arrangements for the cameraman uncomfortable or non-existent. These characteristics introduced a problem of fatigue: if a cameraman kept his camera highly mobile, he soon became physically tired and had to be replaced.

These are the outstanding characteristics of the television camera, circa 1935–45. Now let us see how it can be improved. What are some of the characteristics of the ideal television camera?

Chapter 8

THE IDEAL CAMERA

A NUMBER of different models of cameras have been or are being designed for television programming. Although they are all built around the three standard pickup tubes—Iconoscope, Image Dissector, and Orthicon—they differ widely in design. Some have been designed in consultation with experienced directors and cameramen, and others have been designed with only a superficial knowledge of the needs of a practical studio cameraman. No matter how advanced this second type of camera may be from an electronic point of view, it is likely to be a costly failure under actual working conditions. With this in mind it becomes desirable to check over minimum requirements of the ideal camera—and by ideal camera I mean something we can reasonably expect in the next few years.

First and foremost comes *sensitivity to light*, on which score all prewar cameras were unsatisfactory. The postwar Image Orthicon, released late in 1945 by RCA, has a maximum sensitivity roughly 100 times greater than that of the prewar camera. This approximates the sensitivity of the human eye. It means that lighting is no more serious a problem than it is in the theatre, and that great depth of field can be achieved with comparative ease—a major step forward.

The color response of most prewar cameras favored the violet end of the light spectrum. They were more sensitive to a given amount of blue-violet light than to an equal amount of green or red-yellow light. This not only distorted color values in the picture but also aggravated the heat problem. Studios equipped with incandescent lights (which have much more red and infrared light

than blue-violet and are consequently hotter) were forced to pile on extra wattage in order to get a picture, making an oven out of the studio. Ideally, the color response should parallel that of the human eye, and all standard tubes should have a standard color response and not vary widely from tube to tube.

The ideal camera must be able to perceive a picture and transmit its image with quality approaching that of the human eye in *definition, contrast range, and freedom from electronic or optical distortion.*

Smaller-size mosaics are needed, and they must be placed *closer to the lens* system. This will make possible the use of smaller, less costly lenses. Lenses in use from 1937 through the war were so big and heavy that a very long one would often throw a camera off balance and make the changing of lenses a major operation, one not to be undertaken in the course of a broadcast. With the coming of smaller lenses, it is possible to develop practical lens turrets for cameras. A lens turret is simply a group of several different lenses mounted on a rotating disk. By one movement of the disk the cameraman can switch from lens to lens in a matter of seconds—making possible a greater variety of shots on any given camera with a minimum of effort, thus increasing its flexibility and stepping up production values without increasing the *number* of cameras or crew members on the floor.

Naturally each improvement in the sensitivity of the camera increases the effectiveness of a lens, as indicated in the preceding chapter. Therefore if a highly sensitive camera has a lens with a speed of $f/2.8$, it need not be kept wide open in order to get a picture. The operator may be able to “stop” it down to $f/11$ or $f/16$ for average use and still have those very wide openings in reserve for use in special cases. In other words, the extra money paid for a very fast lens will be worth the extra value in terms of greater flexibility under widely varying conditions of illumination.

A certain amount of light is lost in any lens, partly because the quality of the glass itself and partly because of reflection. Lens makers minimize light loss through the use of the finest optical glass available and by careful polishing, but they cannot control the fact that from 4 to 7.5 per cent of all light is lost because of reflection at the surface of *each* lens. If a camera's lens system has four

lenses, with eight surfaces, the light loss may run to 50 per cent or more. (Actually, the number of reflecting surfaces in such a lens system is reduced by cementing some of the lenses together, but this can only be carried so far.)

✓ In addition to the actual loss of light at the glass-air surface, part of the reflected light reaches the image, where it reduces the contrast range by forming a haze. At times this haze may become a flare spot or a "ghost" image, causing still more deterioration of picture quality.

It has been found that this problem may be controlled by coating the lens surface with a thin film, usually of magnesium fluoride, cryolite, or silica. That reflection loss could be lowered by covering the lens with a film has been known since 1892, but methods of practical application were not perfected until shortly before the present war.

Very considerable picture improvement has been noted with the use of *coated lenses*. In one experiment conducted by a film studio, the light transmission of an untreated lens was 69.5 per cent. The same lens when coated gave a transmission of 95.1 per cent, cutting the loss of light from 30.5 per cent to 4.9 per cent. Another studio reported an even greater improvement in light transmission. In addition to minimized light loss, coated lenses give a very noticeable improvement in both the contrast and the brilliance of the image. Motion-picture producers have found that coated lenses so reduce the lighting ghosts and flares, particularly when low-key lighting is used, that they have been able to use methods of set illumination which previously were impossible.

The value of coated lenses is not limited to use in cameras. Film companies have applied it to *projection* systems to increase screen illumination, noting gains of 10 to 20 per cent on the average. In some cases, tests have shown gains up to 30 per cent in screen illumination.

These figures would seem to indicate that the use of coated lenses will become standard practice in television and will step up the efficiency of the entire system to no small degree.

Of equal importance with the lens is the mechanism used to keep it in sharp focus on the scene being viewed. Whether or not

the camera lens is in focus can be determined by the cameraman upon peering into his view finder, which is part of his focusing device. Different focusing methods have been tried, all of which can be discussed under the heading of *focusing view finders*.

For practical operations any good view-finding system must be simple and easy to operate, and it *must not impose any undue strain* upon the cameraman. Several types of focusing devices have made it necessary for the cameraman to keep his arm extended in an awkward position, causing fatigue. Beyond these simple requirements, a focusing view finder must be *reliable in service* and not likely to get out of adjustment at the slightest provocation.

It must always indicate accurately when the camera is in perfect focus, and when the *slightest deviation* from perfect focus takes place the *cameraman must be able to detect it before the audience becomes aware of it*. With some types of early cameras this was not possible, and it caused disturbance to the audience for two reasons: the camera would get noticeably out of focus before the cameraman could correct it, and he then would be able to judge perfect focus only by moving the lens back and forth over the area of reasonable focus, aiming for a point somewhere in the middle of this range. Even when this procedure does not throw the image completely out of focus it has the disturbing effect of causing the picture to move in and out on the screen.

The view finder must give an *accurate picture of the precise area* being viewed by the camera if the cameraman is to know what he is getting. A less obvious requirement in this category is the desirability of being able to see, on the view finder, what lies just *outside* the area being viewed by the camera. The need for this becomes apparent the moment one goes into active television production. Without removing his eyes from his view finder, the cameraman is able to see in advance what he will pick up if he moves in any direction. If the view finder does not give him this margin for error, he must lift his head away from the finder and look around the edge of the camera. This procedure is not only inconvenient, but during the interval in which the cameraman looks up, his camera may get out of focus, his picture may become badly composed, or he may even lose the action altogether. Beyond this, the difference in light intensity between the view finder and the studio scene is

considerable, and a moment is lost while his eyes readjust themselves to the changes in light values.

Another basic requirement is that the view finder must give a *clear, bright picture* which is easy to see and which, preferably, is *right side up*. Some types of view finders give an inverted image, so that the cameraman must readjust his reflexes to suit the camera. When he receives an instruction to "tilt" his camera down, the view-finder picture appears to move up. If he is instructed to "pan" (turn) to the left, the view-finder picture appears to move to the right. With proper training a cameraman can get used to this minor deficiency, but we might just as well try to eliminate inverted images while we are about it.

The focusing view finder should not cause any particular complications when lenses are changed during the course of a program. With certain types of duplicate system view finders this problem might be solved by having a fixed-lens view finder suitably marked with hairlines on a lucite insert indicating the picture area for various lenses. In cases where exceptionally long lenses are used, it might then be necessary to provide a way for the cameraman to get his eyes closer to the view-finder screen in order to see a scene which might otherwise be too small.

Finally the view finder *should not add materially to the size or weight* of the camera.

Prior to 1946, manufacturers had not made available a focusing view finder which met all these requirements, some of which are more important for studio cameras, while others are more important for portable, remote pickup cameras. The most successful in studio practice had been the duplicate-lens variety of the type used in the Rolleiflex photograph camera. This system was used on the RCA-built studio cameras of CBS and NBC. It meets the requirements of the ideal camera except that it adds to the weight of the camera, gives an inverted image, must be connected for parallax, and requires special adjustment when lenses are changed. With it the use of turret lenses is difficult, and when camera tubes of the Image Orthicon type are used it often will not provide a sufficiently bright picture in the cameraman's view finder. On the credit side, however, it fills all the other requirements—particularly that of giving the cameraman a view of what lies just outside the

picture area and indicating clearly the sharpest focus. Because of the duplicate-lens arrangement—one lens for the camera pickup tube and the other for the view finder—it is possible to indicate critical focus very easily by opening the diaphragm of the view-finder lens to its widest stop-opening, wider than the lens on the pickup tube. In this way there will always be a shallower depth of focus on the view finder, and the cameraman can detect the slightest deterioration of focus before it is noticeable or even exists in the transmitted picture.

While this duplicate-lens type seemed the most satisfactory in 1935-1945 vintage cameras, it is not practical when the light level on the subject is low. To meet this problem, improved electronic view finders, using a cathode-ray tube picture, have been developed, as in the case of the Image Orthicon. This type can be made to meet all the qualifications previously mentioned, with the exception of indicating a change in critical focus before it becomes apparent to the audience. However, with the great focal depth now possible, this is of secondary importance.

The qualifications for the ideal camera which we have discussed thus far all concern the inside of the instrument. Now let us go on to its over-all requirements and particularly to that highly important subject of mobility.

Chapter 9

CAMERA MOBILITY

THE IDEAL camera must be smaller and lighter in weight than its 1935-45 forebears. It must be rugged and reliable in operation, not likely to blow a tube if someone discharges a pistol twenty feet away. It must cost less, far less, than the \$13,000 to \$15,000 quoted by some manufacturers. It must become standardized in its operational methods and characteristics, just as microphones and radio equipment have become standardized. It must be easy to handle so that the cameraman can keep it completely under control at all times.

From a production point of view, the mobility and flexibility of a camera are of the greatest importance. Early cameras were all relatively floor-bound, clumsy, immobile. A satisfactory television camera must be as much more mobile than the best of these as the finest velocity microphone is superior to a 1925 carbon microphone.

In order to make a studio floor camera really mobile it must be mounted on a wheeled boom. Television manufacturers have done little to develop camera booms, and they can find valuable hints and ideas in equipment developed by the motion-picture industry. Take, for example, the boom developed by John Arnold, of M-G-M (see Plate XVII, between pages 100 and 101). In describing this boom at the 1940 Fall Meeting of the Society of Motion Picture Engineers, Mr. Arnold said:

With the popularization of the modern moving-camera technic there has been an increasing trend toward the development of camera-supporting units capable of serving as virtually universal camera carriages for use not only in stationary but in most types of moving-camera

shots. Obviously, questions of bulk and weight have consistently been limiting factors, as have those of operational facility.

Accordingly we have seen the evolution of two principal types. On the one hand, there is a variety of small, mobile camera carriages such as the "rotambulator" and the "velocitator." On the opposite extreme are the much larger crane or boom-type units capable of lifting a camera and its crew twenty or thirty feet into the air.

In some instances, intermediate-size cranes have been built; but, in general, various conditions of design and operation have limited their usefulness.

Nonetheless, it has been admitted generally that if some single device had been available, capable of fulfilling all the camera-carriage requirements of modern technic, with the exception of those few demanding the use of the largest cranes, production would have gained a valuable tool.

A new type of intermediate size boom, apparently incorporating most of these desirable features, has been placed in service at the Metro-Goldwyn-Mayer studio. It features not only unusual versatility, but in many respects it differs radically from all accepted practice.

The device is of the crane-arm or boom type, with a boom 9 feet in length carrying an underslung camera mounting. The camera may literally be laid on the stage floor, or lifted to a maximum height of 16 feet. The entire boom arm may be raised or lowered bodily, by means of a motor-driven, helical hoist.

The boom arm rotates freely through a full 360-degree horizontal circle, while, in addition, the camera-head may, by an independent, extra quick-action pan movement, be panned through a full 360-degree circle. The tilt-head likewise operates through a 360-degree vertical circle. The device is considerably lighter, and may be operated much easier than any comparable unit.

Radically new principles of construction have been employed throughout, and full use has been made of the modern, light-weight, high-tensile alloys and stainless steels.

The chassis is of unusually simple tubular construction. Instead of the usual channel sections conventionally employed for the purpose, the main frame consists of a single tube of high-tensile steel.

Welded to this, at right-angles, are two smaller tubes forming the axles. No springs are employed, as these devices invariably are used on special plank or metal tracks, and it has long since been found that any form of springing introduces an undesirable unsteadiness, especially with the camera at the end of a long boom.

All four wheels are mounted in conventional steering knuckles. The rear wheels, however, are at present locked in a non-steerable position, though the design makes provision for rendering them steerable if any future need should arise.

The front wheels are steerable, being controlled from an automobile-type steering wheel mounted before an underslung seat on the left side. The design is such that the steering wheels may be turned almost parallel to their axle, for sharp maneuvering.

A fifth wheel is provided at the rear of the tubular main frame. This may be dropped down to raise the rear end from the rear wheels, so that the device can be turned in its own length, or moved sidewise into position. All four service wheels are ball-bearing equipped.

Extending upward from this tubular frame is a tubular vertical member. Upon this is mounted a power-driven helical hoist strikingly similar to that employed in the "rotambulator."

The mounting of the crane arm slides up and down this main shaft in a friction mount. It is propelled upward or downward by a suitably proportioned screw paralleling the main shaft.

This screw or helix is rotated by a $\frac{3}{4}$ -hp motor controlled through a d-c reversing circuit and controller. Automatic stop switches limit the upward and downward travel of this unit.

This hoist is not intended primarily for changing the height of the camera during a scene, but instead for more accurate positioning, after which the boom arm raises or lowers the camera. The drive, therefore, while quiet, is not noiseless. In addition, it is low-g geared, to simplify construction.

The crane arm itself embodies a type of construction not hitherto applied to this type of studio equipment. Instead of the conventional girder or box-truss construction, this arm employs a stressed-skin or "monococque" construction combining unusual rigidity with extremely light weight.

The outer end of the boom curves upward to afford increased clearance. At this end is the camera mount, which is of the underslung type.

In this the camera is slung beneath the panning mechanism, though of course the pan and tilt controls are in their usual places, beside and slightly under the camera. Each gives the camera a full 360-degree rotation in its plane; the crank-wheel controls favored at M-G-M are used.

The panoramic movement is geared to unusually high speed: only 14 revolutions of the control wheel are required to revolve the camera through a full 360-degree circle.

A single, well-upholstered seat, of tubular metal construction, is

provided for the operative cameraman. This seat is quickly removable when not needed.

Provision is made for mounting a second camera above the crane arm. This has a conventional M-G-M type pan-and-tilt head, and pans and tilts wholly independently of the lower camera.

A source of constant irritation, and in some cases even of danger, in conventional crane designs is the system of counterbalancing the weight of camera and crew, which is usually done by means of removable lead weights placed in a box at the opposite end of the arm.

The counterbalance is built permanently into the arm. Compensation for the varying weights of equipment and crew is made by turning a large control wheel at the inner end of the arm. This moves the counterweight toward or away from the fulcrum, accordingly decreasing or increasing its leverage.

By this means it is possible to counterbalance the boom so accurately that it may literally be raised or lowered with one finger. A set-screw type of friction lock, operating on a quadrant, permits locking the arm in any position. A similar lock is provided to limit the boom's horizontal rotation, and brakes of the automotive type are provided on the rear wheels.

A full circular catwalk is provided for the boom-operator. This is made in four sections, all of which are demountable. At the front end are two telescopic tubular members, either or both of which can be extended—one on either side—for the stage crew to use in pushing the crane for dolly-shots.

A non-extensible, curved bumper is fixed at the rear for the same purpose, and also as a guard-rail. All these units—catwalk, pushing arms and bumper—are instantly demountable.

The elevated crane arm and underslung camera mount give the camera crew more clear working space about the camera than any conventional type of tripod or boom. At the same time the crane arm, together with the power-driven hoist and free-rolling chassis, makes accurate positioning of the camera quicker and easier.

The suitability of the unit for the majority of moving-camera shots will of course be obvious. The precise controllability of the counterbalancing facilitates one-man operation in scenes where the camera must quickly follow an actor from a low position to a normal or high one, or the reverse.

In addition, the underslung camera mount will permit the boom arm to be extended completely over such a prop as a café table or even an automobile, and, with the boom extended to the side of the chassis, to

dolly from or to such a position without interfering with the use of the prop in the wider angles of the same shot.

For television purposes a few modifications in this boom might be desirable or at least worth looking into. For instance, in order to decrease the weight, it might be constructed out of magnesium instead of steel. (The M-G-M boom weighs 3,100 pounds, as contrasted to a weight of over 7,600 pounds for earlier booms of comparable quality. By use of such a light metal as magnesium the weight might be brought down to little more than three quarters of a ton. Remember, too, that the television camera itself is considerably lighter in weight than a standard motion-picture studio camera.)

The boom is designed to be moved on wooden or metal tracks but probably would function perfectly well in any studio with a firm, smooth floor, whether it be hardwood, asphalt, plastic, linoleum, or concrete.

For increased mobility and ease of operation such a boom might be moved about by an electric motor if the hum of the alternating current motor can be kept from interfering with the camera. The boom could then be operated entirely by the cameraman and one assistant. It should be so constructed that the cameraman can cause the boom instantaneously to dolly in any direction without having to signal a studio crew to do the pushing. Possibly the cameraman could control this movement himself by means of foot pedals, although this would introduce the danger of collision with other pieces of equipment while his face is glued to the view finder. For this reason it seems desirable to have the assistant control the actual movement of a dolly around the studio, and if the two men are trained to work closely together they can achieve satisfactory coordination.

The M-G-M boom also makes provision for a second camera mounted above the crane arm. The idea of using two television cameras on the same boom is an unorthodox one for television but not uninteresting. At the present time the high cost of a camera plus its racks of associated equipment would make this seem impractical, but some day the cost of a single camera is going to be a lot less than \$13,000 or \$15,000. In the meantime it is interesting

to speculate on the production values of such a two-camera boom, particularly in complex programs when it is desirable to keep the floor as free of equipment as possible. The two cameras might operate independently of each other or as a unit, with the second one used for different angles or close-ups of the scene transmitted by the first camera.

Still another type of camera boom is that which does not rest on the studio floor at all, but is suspended from the ceiling of a studio. The advantage of this is that it can move all through a set without tangling up the scenery and floor equipment. On the other hand, such a boom would introduce the problem of keeping clear of the overhead lights. It might be necessary to take many of the lights down and set them on the floor—in which case we would be robbing Peter to pay Paul. For mobility comparable with a floor boom, a camera suspended from the ceiling would have to be mounted on overhead tracks like an overhead crane. This type of mounting, coupled with a highly flexible boom, would give unsurpassed mobility—barring complications with lighting fixtures. One highly desirable characteristic would be the elimination of the clumsy cable which links the camera with the control room. It would be removed from the floor, eliminating a source of noise and irritation and a factor which hampers all camera movements.

The two big drawbacks to the overhead boom-mounting would seem to be expense and conflict with lights. The cost of the simplest, thoroughly flexible mounting would probably run well into five figures, and this may limit such installations to major studios.

The other drawback, interference with lighting, will be minimized with the advent of more sensitive cameras, for then fewer lights will be needed. At the same time the trend is toward small size, highly efficient lighting units, with remote, electronic control—a trend clearly evident in the General Electric television developments.

Another problem which would seem to arise in this connection is that of the camera casting shadows as it weaves in and out among the lighting units. With the size of prewar cameras, plus the cameraman, this would be a really serious obstacle, but it is possible to look forward to cameras of much smaller size and weight. And it

is also perfectly reasonable to look forward to cameras which, like microphones, are placed on the ends of long, telescopic booms and operated by remote control. Just because we have been used to seeing cameramen glued to their cameras it does not follow that this is the only way. It is possible to foresee specialized cameras of small size and weight operated entirely by remote control, perhaps by a cameraman located at the base of the boom. In such an installation his view finder would be a small television screen showing what the camera sees plus a bit extra.

The different types of camera booms mentioned so far are suitable only for studio operations or in places where a smooth flooring is available. This does not answer the problem of remote pickups, such as sporting events, spot news events, and the like. Super deluxe dollies and booms are out of the question. The ideal camera for this would be a video (and audio) counterpart of a walkie-talkie; in other words a "walkie-talkie-lookie" with quality suitable for broadcast purposes and a light tripod or collapsible wheeled dolly on which to mount it. Early portable camera units were being developed along this line. For example, the RCA-NBC mobile units used in 1938 and 1939 required two large trucks to carry the two cameras, the remote relay transmitter, a generator, and other assorted equipment. By 1941-42, a two-camera mobile unit, including a generator and portable lights could be transported in a light delivery wagon. Further refinements of design, which went on during the war, are expected to make practical a portable camera and relay transmitter (without lights or generator) which can be carried by one man. It is believed that in the near future such a unit can be built for a cost in the lower four-figure bracket and can weigh less than one hundred pounds.

So much for the ideal camera. Now let's get it built!

Part Four

VIDEO TECHNIQUE AND THEORY

Chapter 10

A BACKGROUND FOR CAMERA TECHNIQUE

WHEN motion pictures were first being made, there was little or no "camera technique." The camera was simply set up in front of a stage area at a sufficient distance to enable it to photograph the entire scene, and the action of the motion picture was staged in that area with regular theatre technique, circa 1890. The camera viewed the action from a fixed point of view, just as a member of a theatre audience would watch a stage play from his seat. No movement of the camera was used as it dutifully recorded whatever happened to take place. The novelty of the early motion picture was sufficient to carry it along, aided by what story, news, or travelogue interest was injected into the production. Occasionally, further novelty values were achieved by exploiting trick effects possible with cameras—as in the case of the fantastic films of Georges Méliès. These productions, the first to exploit the potentialities of the camera and among the first to use "artificially arranged scenes," introduced an element of real imagination into motion pictures.

Méliès's work is generally credited with having fired the imagination of Edwin S. Porter, a cameraman for the Edison Company. Porter brought a great advance to the embryonic art of motion-picture making when he developed the principle of *editing* on which all motion-picture and television production depends today. After carefully examining the films of Méliès, Porter discovered they contained not one long drawn-out camera shot but a number of different shots, which were strung together to tell the story,

Porter then proceeded to make a motion picture by joining together various pieces of film, shot at different times and places. When joined together, these film strips became little scenes which told a definite story and related that story to the preceding and following scenes. Each scene was dependent on the other scenes, and each one reinforced and heightened the meaning of the others. The process of selecting various shots and combining them in a specific sequence was what we now call *editing*, and the earliest known example is Edwin Porter's film *The Life of an American Fireman*, made in 1902.

This film was also notable as the first example of the use of a close-up shot, interspersed between two long shots to show clearly an important piece of action. In the next few years Porter also contributed to the art by his development of direct film story construction, parallel construction, and contrast construction.

All these techniques were expanded and improved in the work of D. W. Griffith, who raised motion-picture making to the status of an art and made the motion-picture camera a truly expressive and flexible instrument. Griffith is credited, among other things, with the first use of a "trucking shot"—a mobile, moving camera which traveled about with the action, and with the first "panorama" or "pan" shot—in which the camera is turned horizontally on a pivot to sweep across a wide scene.

The next great advance in camera technique came after the First World War in the German film studios and was introduced by that extraordinary picture, *The Cabinet of Dr. Caligari*. Made in 1919, it was the first expressionist film and was completely divorced from the average run of motion pictures of that period. The technical use of the camera was straightforward, with the usual long and close shots taken from normal eye level. The difference came in the imaginative handling of dramatic mood by means of distorted and exaggerated perspective in the scenery, and by contrasting lighting effects. The film was *subjective* in its approach. The audience "saw" through the eyes of a character, "took part" in the action. (Most films were *objective* in structure, since the audience watched a story being unfolded before its eyes and only participated in the action vicariously, by identifying itself with a character.)

The expressionist treatment of scenery, lighting, and acting in *The Cabinet of Dr. Caligari* was used by the director to heighten the effect of the original scenario which, although not expressionist itself, did demand a completely subjective treatment. The audience is forced to see everything through the madman's eyes, but not until the very end of the film does the viewer discover that he has been looking at things from the point of view of an insane person.

The Cabinet of Doctor Caligari, although theatrical in many respects, created a sensation in motion-picture and art circles. As Paul Rotha has pointed out in *The Film Till Now*,¹ "For the first time in the history of the cinema, the director had worked through the camera and broken with realism on the screen . . . A film, instead of being realistic, might be a possible reality, both imaginative and creative. . . . A film could be effective dramatically when not photographic. . . . the mind of the audience was brought into play psychologically."

Although this film does not seem to have been directly copied, it started a ferment, particularly in the German film studios. During the first half of the 1920's, the German film makers perfected the use of *camera angles*—the shooting of a scene from a position other than normal eye level which emphasizes the dramatic mood by unusual perspectives—and they greatly developed the technique of subjective treatment of a film by means of this improved camera handling and also by making the camera exceptionally mobile. It moved in three dimensions, going through doors and windows and up the outside of buildings. They made use, too, of extensive *dissolve* and *multiple-exposure* shots, dramatic lighting, and pantomimic action in close-up.

By 1925 the German films were creating a cinematic revolution. Two productions were particularly noteworthy, *The Last Laugh* and *Variety*. They are of importance to television programmers because of their subjective approach and fluidity of camera handling, assuming the viewpoint of a character and forcing the audience to see things as he does. In *Variety*, the camera swings back and forth on a trapeze with the acrobat, and the audience experiences his dizziness. In *The Last Laugh* the camera is constantly moving, participating in the action. (These two films, along with other

¹ Jonathan Cape, London, 1930.

classics, are revived from time to time at the Museum of Modern Art in New York.)

The next great advance in camera technique and motion-picture making followed closely after the appearance of these two German films. It was made in the Soviet Union from 1926 through 1928, reaching its finest expression in such productions as Eisenstein's *Potemkin* (released in 1926), *Ten Days That Shook the World* (released in 1927), and *Old and New* (1929), along with Pudovkin's *Mother* (1926), *The End of St. Petersburg* (1927), and *Storm Over Asia* (1928).

Russian film makers had evaluated all the visual principles of motion-picture making from the time of Méliès and Porter on. They reasoned soundly that in every art form there are certain characteristics and certain methods of handling which are peculiarly right for that one particular medium. Utilizing the educational and propaganda powers of the film, Soviet motion pictures were made to instruct the citizens, indoctrinate them, and inspire them to social and political development. As a result these pictures dealt with actual facts and occurrences. They were *documentaries*, not fiction. The casts were often made up not of professional theatre actors but of people portraying themselves, and many productions were made on location instead of inside a studio.

This purpose led Soviet directors "away from realism to reality," as Eisenstein put it. It led them away from the German techniques of the moving camera and the subjective approach. It led them to concentrate on what they considered the essence of motion-picture art—*editing*. If the editing of any production were skillfully carried out, if successive frames of film were properly joined together, an entire motion picture could be created from a series of still photos—a possibility later realized in the American production of animated cartoons in which each frame is drawn and individually photographed. In the Russian school the editing became the most important step in motion-picture production.

Perhaps it would be better to substitute the word *cutting* (of the film strips) for *editing*. The over-all process of editing actually begins with the writing of the scenario and is continued by the director and cameraman in the way in which they stage and photograph a scene. The Russian film makers carried the techniques

of cutting far ahead of their contemporaries, crystallizing the art of filming into something peculiarly suited to the celluloid medium. The whole process of cutting and editing was made into a creative instrument, an art within an art, and the Russians called this *montage*.

Basically montage stems from a phenomenon found in every aspect of life when we have a joining of two things which affect each other and produce more than the sum of the parts. Put a cat beside a dog, and you have one cat, plus one dog, plus something extra—a fight. Pour one bottle of whiskey into one man, and you achieve an extra reaction which is more than the sum of the original parts. The same thing applies when two or more different pictures are placed side by side in motion pictures or in television—as noted in Chapter 3 when the subject of montage was first mentioned.

Eisenstein has defined montage in these words: “Two film pieces of any kind, placed together, inevitably combine into a new concept, a new quality, arising out of that juxtaposition. . . . the montage principle . . . obliges spectators themselves to create and . . . achieves that great power of inner excitement in the spectator.”

The Russian theory of montage includes another fundamental point; the various pictures or sounds (or both), which make up the montage must be so chosen from all possible features of the theme under development that their juxtaposition—the juxtaposition of those specific elements and not of any others—will evoke in the perception and feelings of the spectator the most complete image of the theme itself.

The evolution and practice of montage by Russian motion-picture makers had a profound effect on film studios all over the world, and evidences of it are to be found in the structure of nearly every professional motion-picture production made today. The practice of achieving special effects by very complex “montage sequences,” using exceptionally rapid cutting and plenty of double-exposure and triple-exposure shots, has led to the appearance of specialists who do nothing but prepare short “montage effects.” Perhaps the best known of these Hollywood technicians is Slavko Vorkapich.

Since the appearance of montage there have been no radically

new developments in techniques of *camera* handling. Rather have there been improvements and refinements of these fundamental techniques introduced over the quarter century from Méliès and Porter to Eisenstein and Pudovkin. These have given a rich legacy to the television cameraman and director out of which they must create a new camera technique peculiarly suited to the nature of television.

Chapter 11

CAMERA TECHNIQUES

ALTHOUGH there is an "electrotechnical" similarity in the way in which the television camera and the human eye see, there is a distinct difference when it comes to practical, daily use. As one looks at any given scene with his eyes, his brain may select a particular object in that scene upon which his attention centers. He may look at a crowd of a hundred people and see them all—or he may center his attention on one single person and, for practical purposes, not see the other ninety-nine. This mental process of visual selection, this involuntary montage, is automatic and without benefit of mechanical adjustments.

The television camera faithfully transmits an image of everything which comes before its lens, transmits it by means of varying light values which excite a photosensitive surface. There is no brain in the camera which does the editing, which alters the uniform emphasis with which the camera records everything. Visual selection is accomplished only by mechanical and physical adjustments. The cameraman selects a lens which gives a narrowed, funnel-like view of a particular part of the scene; he aims the camera in a specific direction; he forces the camera to record only what he desires in the way he desires it, in a process of editing which is dictated by his brain.

Because this editing is possible, because a cameraman and director exercise precise control over the sequence of pictures, they can tell a predetermined story and exercise a desired effect on those who view their efforts. The television camera (and micro-

phone) can do certain things and cannot do others; they have limitations and peculiar powers. By the exploitation of these powers within the limitations, television—like any other art—can grow as an art and can touch the sensibilities of the audience with increasing effectiveness.

The ways in which the camera sees a scene are controlled in four general ways: optically, “physically,” electronically from within, and by variations in external light. Optical control is exercised by the lens, which we have discussed. “Physical control” means simply the way in which you move and aim the camera. It can be divided into three subheadings:

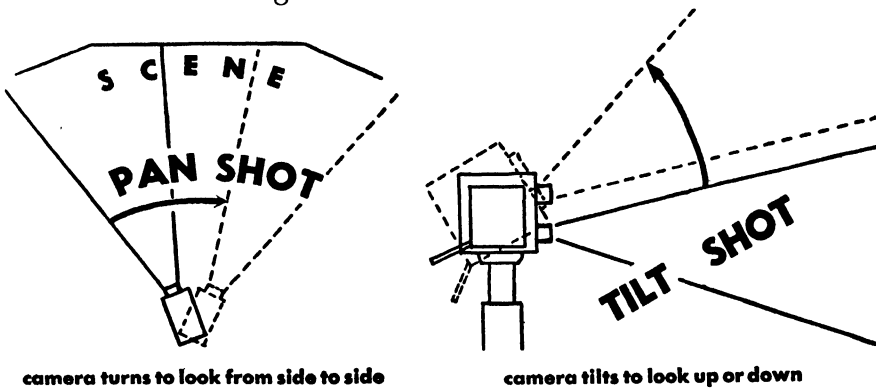

FIG. 6.—A pan shot moves in the horizontal plane, and a tilt shot moves in the vertical plane.

(1) Shots in which the *camera is not moved* in any way. It is merely focused and the picture taken without further changes.

(2) Shots in which the *head of the camera is moved*. It may be panned, rotated on a pivot through the horizontal plane so that it sweeps across a scene wider than the area visible on the screen at any one time. It takes in a panorama of the scene, and is called a panorama shot, or for short, a *pan*.

A camera may also be panned up and down in the vertical plane, tilted back or forward. To differentiate this movement from a horizontal pan, it is usually called a *tilt*. (See Figure 6.)

A thoroughly flexible camera should be able to tilt through an angle of at least 120 degrees and pan through a complete circle

of 360 degrees. This movement should be silent, ruling out certain types of motion-picture camera mounts which give off a whirring sound of moving parts when panned.

Since a tilt shot is the same thing as a pan, both are controlled by the same principles and both give similar effects—that of surveying a broad scene. Pans and tilts are easier to handle in television than in motion pictures. In films there is a sequence of 24 separate, still pictures flashed on the screen each second. The picture is not continuous, and unless the motion picture camera is panned very slowly the resulting picture will appear to be jerky when projected on the screen. Television with sixty pictures per second (30 complete pictures with interlaced scanning giving 60 fields per second) does not suffer from this weakness. The cameraman can pan as rapidly as he wishes without causing the picture to break up.

There are a few simple rules about panning, and tilting, which have shown merit in actual production:

(1) Pan smoothly. Don't suddenly jerk the camera around. Ease into the pan very slowly so that the beginning of the movement is imperceptible to the audience. After this you may pick up speed, but be sure to taper off and ease into your final stopping position without a jolt.

(2) Make up your mind where you are panning before you start. Don't start a pan and then stop, hesitate, go back a bit and haltingly move on again. Make your pan shot with assurance but do not rush it unless you wish to blur the picture.

(3) If you pan as somebody is moving and you wish to follow the action, keep ahead of him. Do not let your subject get off center and crowd the frame line. If you are shooting a group of people or things and wish to pan, stick with the center of interest. Never pan away from the important action.

(4) If you are shooting several people, and one or more of them walk away leaving a lopsided grouping in the frame area, pan slightly to adjust your composition for those who remain.

(5) As a general rule do not try to pan in an extreme close-up or anything closer than a "bust-shot"—which shows your subject's head and chest, and do not try to pan rapidly with a long lens.

Pan shots are generally used to connect two or more different

objects at a distance from each other, as the camera moves from one to the other. Such a shot not only links these objects together without the necessity of cutting, but it also shows their spatial relationship to each other. In some instances the action and subject matter will demand the use of a pan shot. In other cases the action might be handled by either a pan shot or by cutting from object to object. It is clear that it will take longer for the camera to pan (slowly) from object to object than it would to cut from one to another. Pan shots used in this way tend to slow down the pace of a scene while cutting tends to speed it up.

A pan shot may also be used to add a sense of excitement and speed to an otherwise static scene. A character moves across a scene and the camera pans with him, causing the background to appear to move. In some instances action might be tightened up by starting a pan with the character and then increasing its speed until the camera gets ahead of the character, leaving him out of the frame area and rushing ahead to center on the object he is approaching.

The apparent speed of a character's movement may be increased by panning in a direction opposite to that in which he is moving, or it may be reduced by panning with him. The same thing, of course, applies with movement toward or away from the camera. A character's movement toward the camera may be speeded up by moving the camera simultaneously toward the character, or the apparent movement may be decreased by pulling the camera back as the character approaches. Similarly, movement away from the camera may be speeded up by pulling the camera back as the character moves away, or it may be slowed down by moving the camera forward in the wake of the character.

Sometimes, for special effects, a very fast pan will be used. This is called a *whip*, and is used to blur the scene by the very speed of turning, achieving the same effect one gets if he looks to the right and then suddenly snaps his head around to the left.

(3) The third type covers shots which involve more *complete movement of the camera* and can be accomplished only when the camera is mounted on a mobile boom or dolly. (The first two categories can be handled by a camera mounted on an immobile tripod.)

The camera head may be raised or lowered and swung out to

right or left on a boom in what is called *tonguing*, or a *boom shot*. The entire camera unit-head and boom may also be pushed forward, backward, or sideways on wheels in what is variously called a *trucking*, *traveling*, or *dolly shot*. Never start a traveling shot (on the air) with a jerk. Ease into it imperceptibly and then increase your speed, as in a pan shot, and stop the same way. Avoid trucking with a long lens. (See Figure 7.)

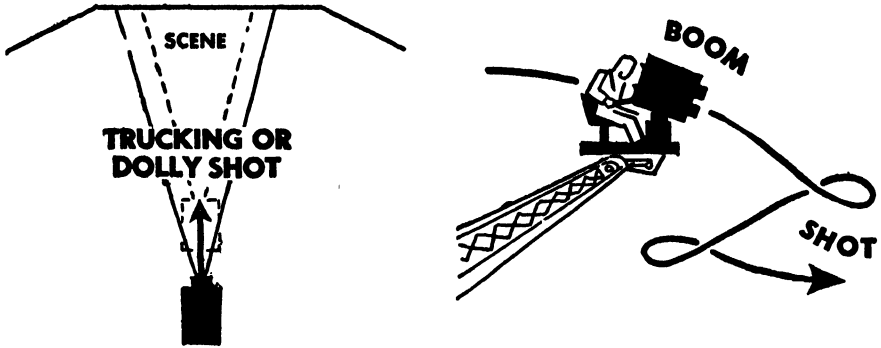

camera moves forward or back

camera moves all over the place

FIG. 7.—A dolly shot moves the camera about the studio floor. Pan and tilt shots give two-dimensional movement to the camera. Dolly shots give a third dimension to the movement, and a boom shot adds still a different type of movement by raising or lowering the entire camera. It may also add a two-dimensional movement when swung horizontally. Thus the television camera can have an infinite combination of movements in any well-designed studio.

The fixed, unmoving shot of the first type represents the minimum any camera can do, and a television camera limited to this one type of shot would be suitable only for picking up film transmissions, lantern slides, and visual effects.

The “two-dimensional” type, pan and tilts, represents the minimum requirement for a studio or remote pickup camera, but it is safe to say that any studio camera limited to pans and tilts is obsolete.

The fluidity of movement essential in television is not possible unless a camera is designed for traveling and boom shots. These introduce a “third dimension” to the movement: while a camera is panning and tilting through two dimensions—or being raised

vertically and swung out horizontally on a boom—its entire foundation may also be moved about, changing the viewpoint completely and adding a third type of movement. The varieties of angles and movements which can be thus achieved by a skilled cameraman with a well-designed, mobile camera boom are nearly endless: fixed shots, pans, whips, tilts, raising or lowering the boom, moving the boom horizontally, trucking, and all possible combinations of these. The camera may be moved as far as the connecting cable can be stretched in the horizontal and vertical planes, all the way from a hole in the ground to a boom shot towering above the floor.

With all this maneuvering theoretically available, just how does one go about shooting a scene? How does he bring his cameras up to the subject?

Just as there is a “normal” or basic lens for the camera (the lens which gives the same sort of view one gets with his unaided eyes), so there is also an average, basic camera angle for any scene. This may be arrived at by placing the camera squarely in front of the subject at normal eye level and at a distance which will permit the inclusion of the complete scene area—precisely what your unaided eyes would see if you stood before the subject. This is the standard *long shot*. When it is used at the beginning of a scene it is sometimes described as an *establishing shot*, since it establishes the nature or location of the action by showing all important parts of the scene.

The conventional variations on the shot follow approximately the same pattern which your own, brain-controlled eyes would follow. After establishing the over-all nature of the scene, your eye would probably center on one particular part of it. In camera terms, this is called the *medium shot* and would be achieved in one of two ways: (1) by dollying the camera in to a closer position, or (2) by switching to a second camera which either has a longer lens or is in a closer position.

After you have identified the important objects in the medium view of the scene, your eyes (in everyday life) would probably center on some particular detail—a book, the face of a person, a chair, or a glass on the table. The camera equivalent, the *close-up*, is the second conventional variation on the establishing long shot,

and it would be achieved in the same way as the first variation: either by moving the camera in closer or by switching to another camera which is in a closer position or has a longer lens.

There are no fixed distances or positions for these conventional shots. Precise positions are determined by the subject matter and conditions prevailing in the studio. Obviously there can be a considerable number of minor variations, all the way from an extremely long shot ranging up to infinity down to an extreme close-up showing only the lips, or ear, or eye of a face, or even a microscopic view of an amoeba.

These are all variations in distance (or apparent distance) of the subject from the camera and are one dimensional in nature.

The next type of variation on the original long shot is the introduction of the second dimension, which is *movement from right to left*—as opposed to movement toward and away from the subject. In other words, the camera is moved laterally and *changes the horizontal angle* at which it faces the scene. This angle can be shifted through 360 degrees of the complete circle around the subject, limited, of course, by the subject matter and the flexibility of studio equipment. Camera positions to the right or left of the “normal” long shot are often loosely referred to in television production as *angle shots*, and when one camera is placed so that it is shooting the subject at an angle approaching 180 degrees from the other camera, it is called a *reverse angle*.

Still another basic variation is the *high-angle* or *low-angle* shot, achieved by changing the viewpoint of the camera in the vertical plane—moving it up and down, or using one or more additional cameras at different distances above or below the horizontal plane of action. (See Figure 8.)

For practical television production all these three types of variation on the basic shot call for highly mobile cameras which can be moved in any direction and raised and lowered with ease. To be sure, variations can be achieved with immobile cameras mounted on tripods or caster-equipped boxes of various heights, but to achieve the same production values one would need five or six times as many cameras (and camera crews) which is prohibitive from an economic as well as a production point of view.

The cameraman has theoretically an infinite number of camera



LONG SHOT

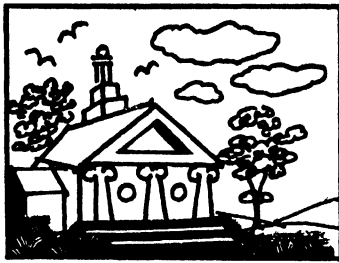

LONGER LONG SHOT

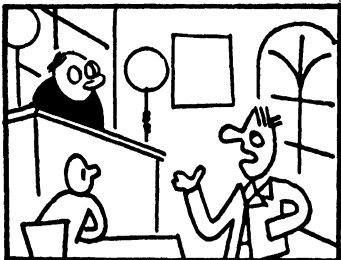

MEDIUM SHOT

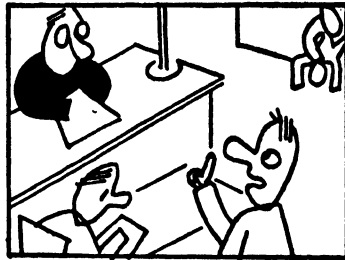

ANGLE SHOT

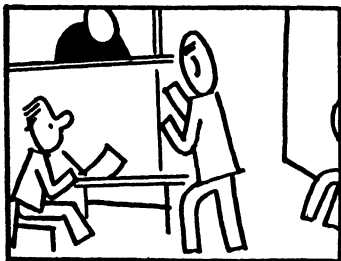

ANGLE SHOT

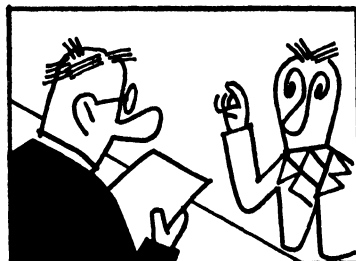

REVERSE ANGLE



CLOSE-UP



CLOSER CLOSE-UP

FIG. 8.—Types of camera angles. The “longer long shot” also would be used as an establishing shot. Close-ups show details. Angle shots add visual interest by changing the viewpoint to accentuate important details.

angles and positions at his command, plus the extensive optical effects available in an assortment of lenses. Like the infinite variety of shades and tones available in a painter's palette, each angle and each lens can be used to produce a predetermined effect on the viewer, but they cannot be used indiscriminately unless an impression of chaos is desired. The cameraman and director should know in advance what they wish to accomplish with each shot, and they must know through experience how they can achieve the desired effect with the equipment at hand.

For example, by trucking in from a long shot to a close-up of a subject, the cameraman forces visual attention on that object, stressing its importance. Assume that you are televising an interview with a famous personality, surrounded by five or six people, all of them drinking tea. The announcer tells the audience whom it is about to meet, and the picture fades in on a long shot showing the entire group seated in a drawing room. The camera is trucking in, closer and closer. The figures on the screen become larger and larger. Those on the edges are excluded from the frame area as you get closer to the famous personality, until finally only his head and shoulders are seen, filling the frame. He looks into the camera and says "Hello" to the audience.

The effect is fine. You have centered attention on him and given him a visual build-up which makes him the focal point of the program.

Now, just to illustrate, suppose the camera, instead of centering on the personality's face, had gone into a close-up of the cup of tea in his hand. The attention of the audience would have been centered visually on the cup of tea, and aurally upon the personality when he said "Hello"—producing a beautiful bit of confusion and irritation in the audience's mind, especially if it turned out to be a commercial plug for X brand of tea.

To take another example: having shown this group of six or seven people in a long, establishing shot, you wish to show details without making the guest conscious of the camera and at the same time to speed up the action. Instead of trucking all the way in with your "normal" (wide-angle) lens camera, you might start the trucking shot and carry it only as far as a medium-shot position. Then you could dissolve into a close-up taken with a second camera

equipped with a long lens, making possible a close-up even though the camera is fifteen or twenty feet away from the subject.

Perhaps as the program progresses, you wish to emphasize the importance of your guest personality when he utters some particularly sage comment. With this in mind you might bring in close a camera with a "normal" lens, lower the camera head somewhat below eye level, and then tilt it back to get a close-up of his head and shoulders. This would give the audience a sense of looking up at the man. Since the "normal" lens is fairly wide-angle, the lines of perspective would be somewhat exaggerated in this position, making the man seem bigger and more imposing than he actually is in real life.

Reversing this procedure, you may belittle him visually and make him seem insignificant if you raise your wide-angle lens camera considerably above eye level, tilt the camera head forward, and shoot downward at him.

These are just a few of the many ways in which a subject may be built up or played down. The next time you go to a motion picture sit through it twice and analyze the way in which camera angles are used. Note also that in any well-photographed, well-directed motion picture or television show technical tricks are not used for their own sake or in an attempt to make each shot overly striking and "arty" in appearance. Technical tricks and effects of all kinds should be used only to achieve a predetermined purpose, to create a desired effect with a given shot. This shot, in turn, combines with all other shots to merge into a finished, unified production.¹

The television camera is more than an electromechanical extension of the eye. It is a tool which, in the hands of an artist, may be used to interpret a situation by the very angle at which it is made

¹ The English film director, Basil Wright, points out in *Footnotes to the Film* (Oxford University Press, New York, 1937): "The filming of a scene may be likened to the construction of a sentence. If you like you can regard the standard long-shot of an object as the noun. Pans, changes of angle and distance, trick-shots or what you will, these are the verbs, adjectives, adverbs, prepositions, and so on which when put all together make up a coherent sentence." Mr. Wright also observes that a flowery style is not an advantage; the more succinct the statement the better, and two good shots, carefully chosen for distance and angle, are much better than twenty careless ones or those taken only with an eye for the unusual.



PLATE XIV.—An example of multi-stage setting in one studio. Note the reasonably large floor area available for camera movements. Sets are laid out so that they can be shot from several angles covering an arc of about 150°. Notice predominance of overhead lighting, using incandescent lights at right and fluorescent lamps in overhead banks at rear left. Mercury vapor lighting units visible at the top of picture are not in use.

This picture was taken at the CBS studio in New York, the largest prewar studio, 80 x 60 feet with a 30-foot ceiling.

PLATE XV.—Camera at left is an Iconoscope equipped with "gun sight" type of view finder and with normal lens. Orthicon camera at right is equipped with optical view finder and has telephoto lens for close-ups. Note that cameras are bolted to railing and can be panned horizontally or vertically. Entire camera setup is suspended from edge of balcony. Wire mesh extending in front of cameras prevents anything from falling on heads of people below.

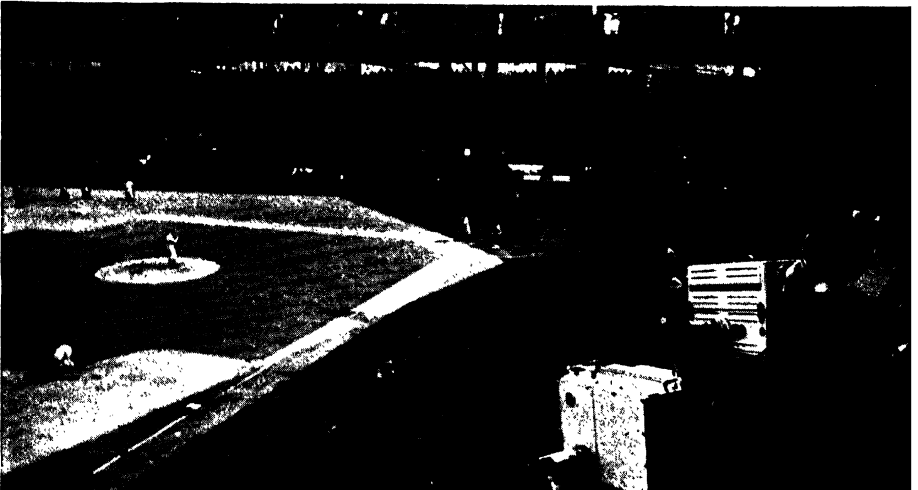



PLATE XVI.—An example of a relatively immobile floor-bound studio camera used at Du Mont during the war. Note awkward mounting on four casters, bulk of wires, tubes, and box. Note also view finder into which cameraman is peering. This is an electronic view finder which is a small television screen tapping the camera amplifier. Focusing on this camera is accomplished by pushing lever (*at right*) forward and backward. Routine of studio operations is marked on paper clipped to back of camera. Camera head itself is mounted on a motion-picture type of device which emits whirring noise when panned. This camera is limited to pans and tilts through a limited range. Raising the camera or dollying while the program is on the air is not practical.



PLATE XVII.—Motion picture camera boom developed by John Arnold of M-G-M (*seated behind camera*). Boom is described in detail in Chapter 9.

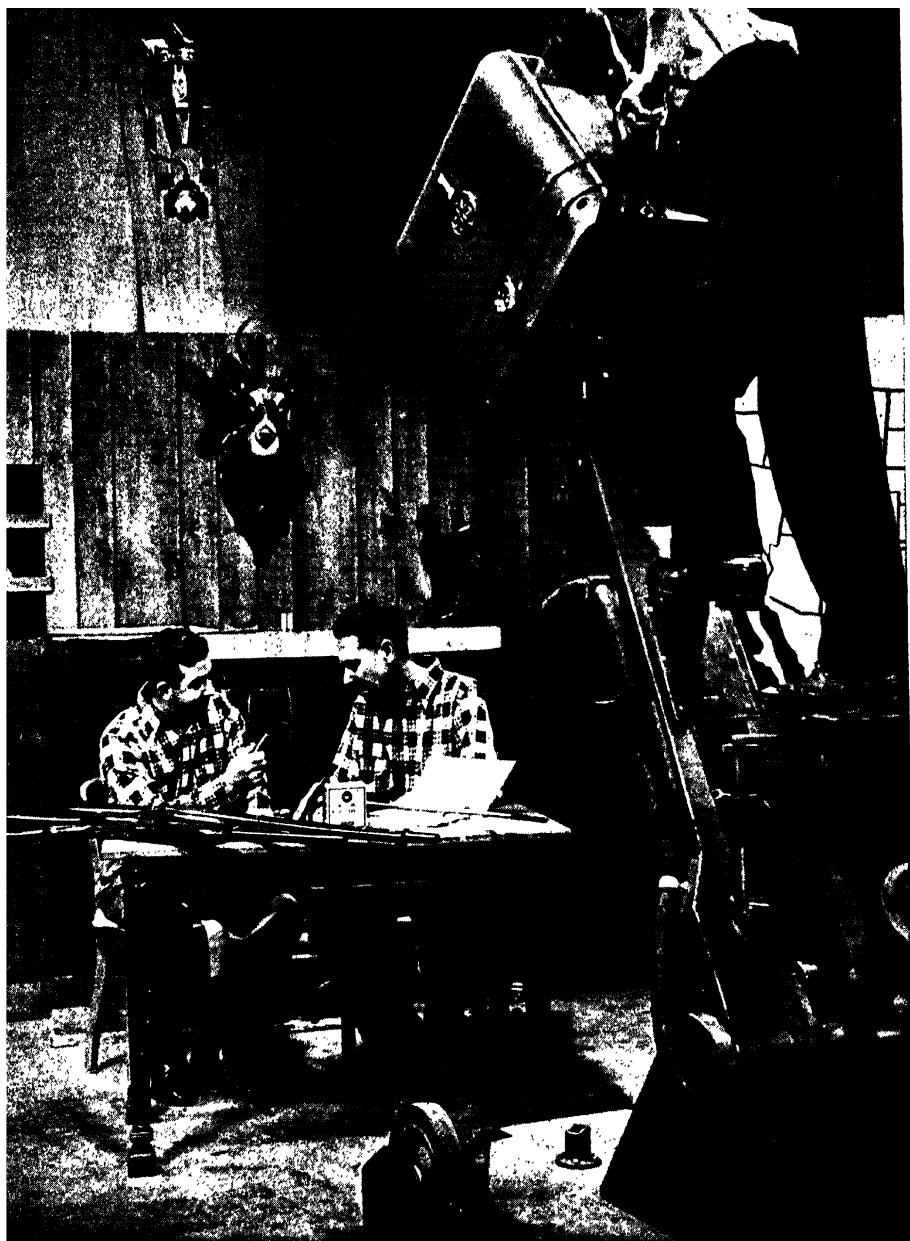

PLATE XVIII.—Studio Iconoscope camera mounted on mobile boom used for a high-angle shot at General Electric in Schenectady. Round knob on side of camera is used for focusing. Note shock absorbent type of microphone mounting (*upper left*) and guard placed around wheels of dolly (*lower center*) to keep cables from getting caught under the wheels.



PLATE XIX. —CBS television control room during a rehearsal. Man in foreground at left is shading engineer, operating controls which govern shading of picture. Picture does not show on viewing screens because of brilliance of flash bulb used to make this picture. Small screens to the right of big screens give an electrical "diagram" of the video signal.

Man with eye shade is switching engineer with fingers placed on the buttons which control each camera. Black knobs on desk in front of him are used to control the contrast and intensity of light for each camera channel. At center is Worthington Miner, director, giving instructions over telephone to stage crew. Behind him sits assistant director, Carl Beier. In background sit audio engineer and girl keeping the program log. On wall directly behind her is Iconoscope used for film pickups. Studio is viewed through plate glass window at right, which in this picture appears to be a mirror because of reflection caused by flash bulb exposure.

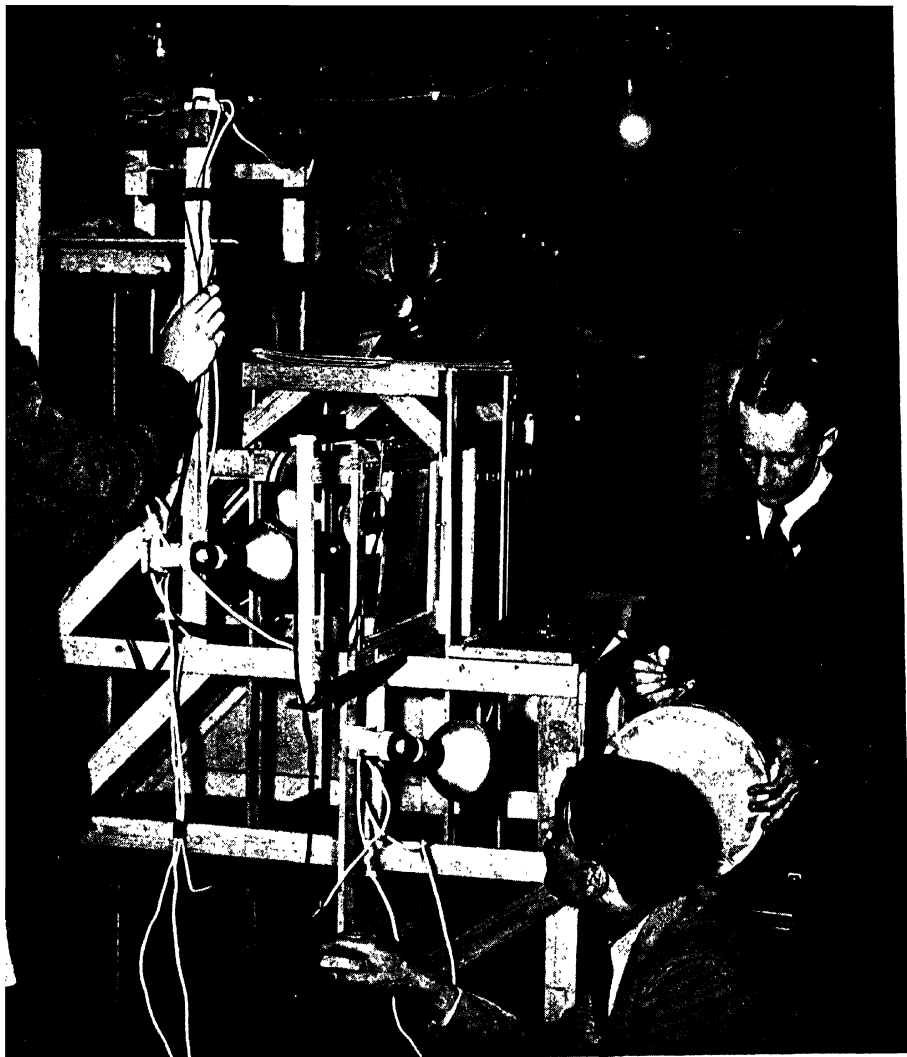

PLATE XX.—First experimental model of a “shadow box” built at CBS Television in 1939–40. Camera comes in from the left at same level as pocket in jacket of man at left. Directly in front of it is two-way mirror placed at 45° angle. When stage at lower right (*filled here by revolving drum*) is illuminated, camera sees through the two-way mirror. On middle level is second stage, filled here with rack of title cards on which earphones are hung. When this stage is illuminated, view of it is reflected by second two-way mirror (*directly under elbow of man*) down to first two-way mirror, which in turn reflects view into camera lens. At top is third stage, being used here for silhouette type of background projection. When this stage is lighted, view goes through upper two-way mirror and is reflected by lower mirror into camera. Note that all three stages are the same optical distance from the camera. By fading light in and out on two or three stages simultaneously, dissolves and superimposures can be obtained.

Three pioneer television programmers shown from left to right are: Rudolf Bretz, James Leaman, and Marshall Diskin.

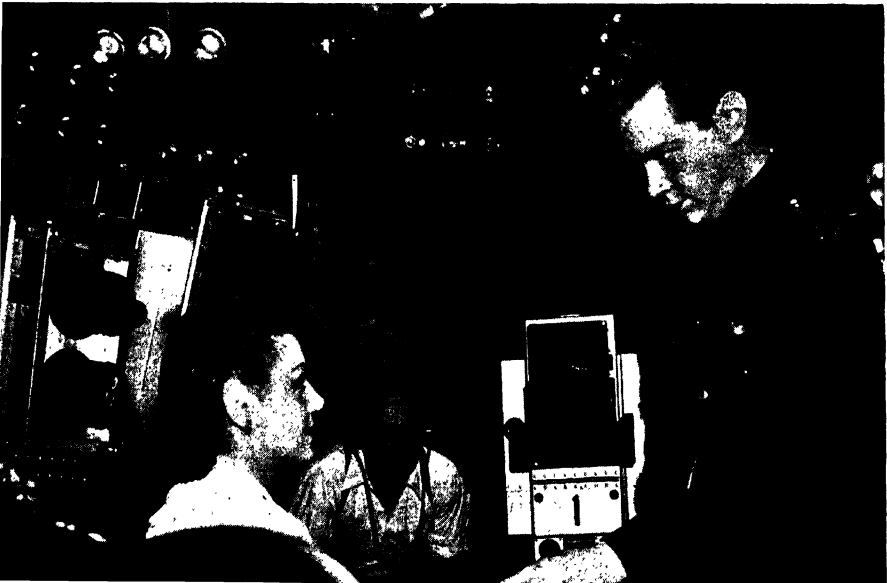

PLATE XXI.—Another view of CBS control room and studio during rehearsal of *The Missus Goes A'Shoppin'*. Close-ups and long-shot views on viewing screens (*in foreground*) show demonstrations of artificial respiration. Notice placement of overhead banks of fluorescent lights.



PLATE XXII —Marionette performance given as part of children's party in General Electric television studio. Note lamps at upper right, mounted on wheeled tripods. These are 1 kilowatt mercury vapor flood lights, with water cooling system.

PLATE XXIII—The three cameras grouped around these actors give some idea of how the cameras appear to the performers. The upper lenses serve the view finder and the lower lenses the camera tube. Notice that caps have been placed over the bottom lenses so that the light from the flash bulb will not damage the Iconoscopes. Man with headphones crouching in the center is the floor manager. Directly behind him is the microphone boom operator. In actual performances, lights seen in the background would be glaringly bright. These lights are of the Birdseye type.



to view the scene. And the process of pointing a camera at a given scene is in itself an editing one. One scene is selected in preference to another, excluding certain subjects and including others. The director switches from one camera to another to give the audience a fresh viewpoint. This is editing in its broader, artistic sense.

The same methods can also be used for editing in its more restricted sense—censoring. An example is a disagreement between a star and NBC Television one spring day in 1944. The NBC director in charge of programs objected to the words of a song which were about to be sung on a television program. He also objected to certain gestures which accompanied the song. The star refused to change either. The program went on the air smoothly until the song in question was reached. The gestures were deleted, according to those who viewed the program, by taking the scene in close-up of the actor's face and at one point blurring it into unrecognizability by putting the camera out of focus. A viewer watching the show in Philadelphia, however, never realized what had happened and thinking his set was out of order, called a repairman.

The use of the camera to create is entirely the province of the artist. There may be a hundred possible ways to shoot a given scene, but there is only one which is best. The other ninety-nine shots may be adequate. They may get by without upsetting the continuity of the show. But the one perfect shot will so catch the essential elements of the action that it will contribute more to the program than just continuity from one bit of action to another. The next time you see a really good motion picture you probably will be able to recognize a number of such shots. A great film like *The Informer* is full of examples, while wartime television programs in America contained almost no examples.

The moral is that there is a great deal of progress to be made. Manufacturers must build more sensitive and more flexible cameras; broadcasters must provide well-designed and spacious studios; and prospective program people must know their medium. One of the first and biggest problems is to learn how to use the television camera effectively. The successful solution of this riddle does not depend on luck. It depends on cameramen who are artists, not mechanics. It depends on men and women who have studied tele-

vision and its contributory arts and who have put in years of work in actual production experience and experimentation—experimentation on a scientific basis with a purpose and a predetermined plan and goal, not ill-planned and loosely organized work on an amateurish basis the sloppy results of which are excused as “experimentation.”

Chapter 12

COMPOSITION AND THE CAMERAMAN

THE TELEVISION cameraman is faced with a particularly important and difficult problem in the composing of a good picture in a minimum amount of time. The television action is continuous; there is no opportunity to spend hours over the composing of each angle. The cameraman, equipped with a flexible camera, must be able to select the proper angle (with assistance from the director as to general approach) and polish up the fine details which bring the shot to perfection all in a few seconds or "instantaneously" if he is "on the air."

This demands, among many other things, an artistic instinct and a knowledge of what makes a good television picture. About the former this book can do nothing—except to point out that you are either born with it or you are not. (Even if you are, it will not do you much good unless you nurture and develop it through hard work and strict training. If you were not born with it, do not try to be a cameraman or a director-writer.) About the latter there are a few suggestions which can be offered, but do not expect to learn all about composing a picture in a few pages. Take these as suggestions, and go on from there on your own initiative. Your classroom is the motion-picture theatre, the art museum, the better picture magazines, and the television receiver.

As the television cameraman—or should he be called a "videographer"?—is composing a picture he must think of both the position of the subject with relation to his camera and the placement

of lights with relation to the subjects and the camera. The general layout and positioning of characters, scenery, props, and lights will have been largely predetermined (in rehearsed programs, as opposed to extemporaneous pickups) by the director in consultation with the cameraman, the lighting director, the scene designer, and the floor manager (stage manager) who is the director's representative on the studio floor.

In composing his picture the cameraman will find that the principles followed in painting and still photography do not always apply, despite the fact that they constitute part of the background which must be acquired by television programmers. Even a casual examination of a motion picture will reveal the reason for this seeming paradox: the objects seen on the screen are constantly moving, changing the composition of the picture. These *movements within the frame area* are the most important single factor in the composition, superseding the static composition of the objects in that frame area at any given *instant*. Only when there is little or no physical action on the screen do the principles of linear design (paintings, photography, drawings) become of primary importance. Even then, movement may be given to a static picture by changing the positions of the cameras.

The composing of a picture, then, is not limited to the relationship between various objects or masses. That is just one of several basic ingredients. The others are the relationship between two or more movements, between one or more objects and one or more movements, between high lights and shadows, as well as the visual texture of objects, and eventually the contrasts between various colors. Also of distinct importance in television is the relationship between the video and the audio with its various types of sound and silence. In many cases the relationship of the picture with the source of sound will be of primary importance in composing the television picture.

In observing the composition of pictures in television a few general rules will be noticed immediately:

(1) Movements toward and away from the camera are more dramatic, give better picture values than lateral movements going sideways or across the camera. (See Figure 9.)

(2) Don't let a vertical line in the scenery or background divide your picture into two *equal* halves, and don't let any horizontal or diagonal line do the same thing. It kills pictorial value. A slight change of camera angle will usually remedy it. (See Figure 9.)

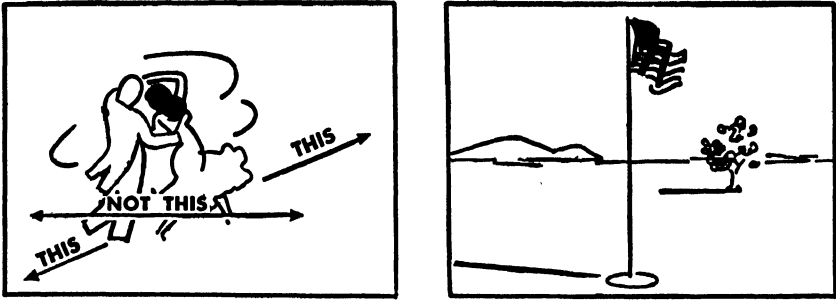

FIG. 9.—Rules of composition, illustrating points 1 and 2.

(3) Compose the picture as unit.

(4) Don't let anyone cross right in front of your camera, especially up close, unless you plan it that way for a specific purpose and will pan with the person.

(5) Don't use a confused, fussy picture which is difficult to make out. Straightforward, simple pictures are the rule, particularly until television is much further developed.

(6) Don't use unusual or distorted camera angles for their own sake. They must have a reason and contribute to the telling of the story.

(7) Try to get interesting perspective into your picture, as opposed to shooting a scene from squarely in front of it and using a flat, blank wall for a background. Try to include several horizontal and vertical planes in the composition. Horizontal planes might include an inanimate object in the foreground, such as the edge of a chair, or the branch of a tree, or somebody's back; then a little farther away, your subject; and still farther off, something in the background. Vertical planes might include two or three walls of a room, or several trees and buildings. This adds an illusion of depth to your two-dimensional picture. (See Figure 10.)

(8) Don't compose your picture so that it is perfectly symmetrical in its balance, for perfect symmetry kills all feeling of

movement and visual interest. Such a composition is monotonous and jolts the audience—the wrong way. (See Figure 11.)

(9) Any object which is framed slightly at an angle usually has more pictorial appeal than when it is framed straight. (See Figure 12.)

(10) Since the shape of the television frame is rectangular, avoid any compositions which are rectangular or square in shape,

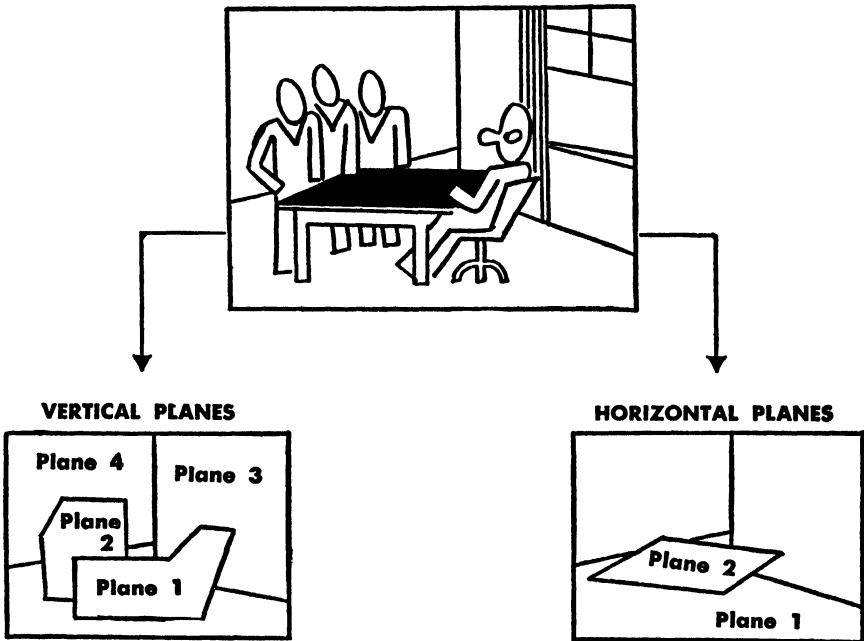

FIG. 10.—Rules of composition, illustrating point 7.

unless they are at an angle which contrasts with the position of the frame. (See Figure 13.) As a general rule a triangular composition is both pleasing and easy to get. Failing this, a diagonal line can usually be obtained by shooting at an angle. In picking up motion, try for an angle that will show it moving across the frame on a diagonal line as opposed to a horizontal line. (See Figure 9.)

(11) Try to get a variation in illumination on different planes of the framed area—a dark foreground, a light center area, and a darker background.

These are just a few suggestions which generally hold true in television production, but they are not to be considered as hard and fast for all time. It is a little too early to try to freeze any rules into permanence, for the art of television is not the same thing as the art of photography or cinematography. Some conventional rules may prove to hold true in all three mediums, some in two, some in only one.

One aspect of television may upset any rules, at least insofar as the owner of the receiving set is concerned. Because of the way in which sets are built now, the owner—generally inexperienced in adjusting apparatus—can vary the controls for tuning, contrast range, brilliance of the picture, focus, size and shape of the picture, position of the picture, linearity, in addition to sound volume and quality. The transmitted picture and sound may go out in first-rate condition, but the wrong adjustment of the receiver may distort or destroy the entertainment quality of the program. Until receivers are made more foolproof, the television cameraman must “work as a photographer, who knows his pictures will be developed by unskilled amateurs using the wrong acids”—to quote Tony Miner of CBS.

In addition to incorrect settings of contrast (usually too much) and intensity of light, part of the picture as seen in the view finder is lost. In transmission of the picture, the outer edge of the frame area is often chopped off—from 1 to 3 per cent of the picture area. When the picture is reproduced in the receiver an additional 7 to

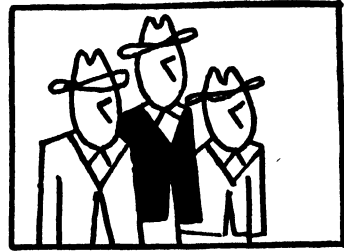

YES

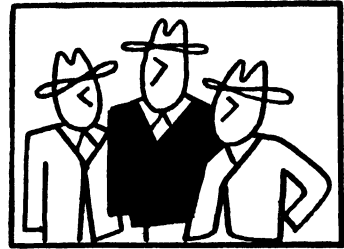

YES

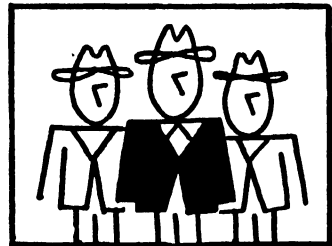

NO

FIG. 11.—Rules of composition, illustrating point 8.

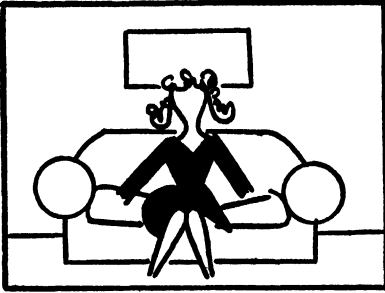

FIG. 12.—Rules of composition, illustrating point 9.

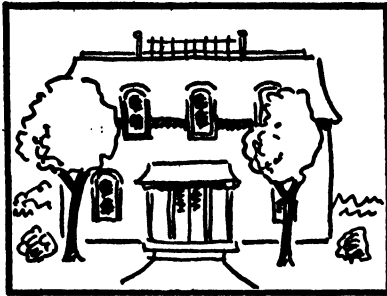

FIG. 13.—Rules of composition, illustrating point 10.

12 per cent of its area is often masked off when the picture is set too large, or off-center, on the cathode ray tube. Possibly this danger will be removed with the improvement in sets, particularly the projection type, but until it is, the cameraman will find it desirable to include no important subject matter in the outer 10 to 15 per cent of the frame area. If he does, it may be completely or partly cut off in most receivers.

At the same time the subject matter of the picture must appear in sufficient size to insure instantaneous recognition. An audience does not like pictures it cannot understand.

Each composition will have a center of interest, determined by the nature and arrangement of the objects in the picture. The camera should be focused on this center of interest. If two main subjects are at varying distances from the camera, the center of interest will probably be a compromise between them—the halfway

point; hence the focus should be split and centered on that halfway mark.

In selecting any television picture you should have a definite purpose in mind, and the picture should be composed to accomplish that purpose. Its composition and duration should, ideally, be determined by the importance of that shot to the production as a whole, and if it does not contribute to the development of the story it should not be used.

For the time being at least, avoid extreme contrast ranges in your picture. Steer clear of large expanses of black or white, particularly when they are right next to each other. The middle range of contrasts will televise much better—from a dark grey, dark green, dark blue, or dark brown through to light pastel shades and light greys which are several shades darker than a dead white.

Keep an eye on your backgrounds when you compose a picture, because the background usually shows and is as much a part of your composition as the foreground. An awkward line or figure in the background can spoil the best of foreground arrangements. Corollary to this you must always keep your depth of focus in mind so that you will know how clearly the background is going to be picked up. You will also want to make sure that you know the maximum and minimum range of your lenses and what they can do in the space available. Don't insist on taking extreme close-ups (of anything

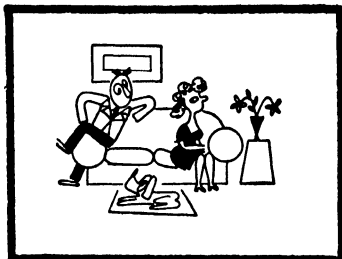

NO

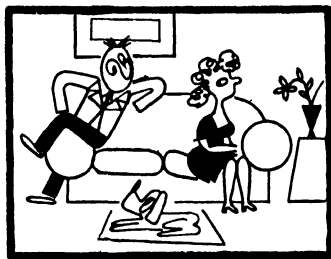

YES

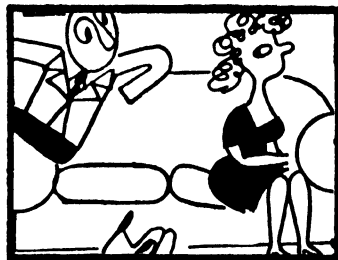

NO

FIG. 14.—Rules of framing, illustrating point 1.

other than a flat surface) with a "normal," wide-angle lens. You introduce bad optical distortion when you do.

Here are a few additional suggestions of practical value in the studio or on the remote pickup:

(1) Line up your shots without striving for exact, symmetrical balance. Get the full composition well within the frame, without including irrelevant details. But keep that margin of safety around the outer 10 to 15 per cent of your frame area as a protection against unexpected movements as well as against masking losses which can chop off tops of heads or sides of faces. (See Figure 14.)

(2) Do not cut people off at awkward lengths, particularly just above the ankles. Compose a bust shot to go below the line of the shoulder, a three-quarter shot to go between the knees and hips, and a full-length shot to include head and feet. (See Figure 15.)

(3) When framing a close-up of a person who is looking off to one side, leave a bit more empty frame area on the side toward which he is looking. Do not have him crowding the edge of the frame with his nose. (See Figure 16.)

(4) When you have two subjects in frame, and it is not necessary for the action to split focus, try to keep the off-focus subject within a reasonable focal range. The limit of this range is the point at which the viewer becomes conscious that it is out of focus and something is wrong. (See Figure 17.)

It must be clear from the stress laid upon camera handling that the television cameraman, the videographer, is a most important person. A television show is only as good as its poorest cameraman. What does it take to be a cameraman? Hollywood cinematographer Phil Tannura wrote an article on the subject (referring to motion-picture cameramen) in the February, 1944, issue of *American Cinematographer*, and a few passages seem equally pertinent for television cameramen:

First, a cameraman must be an artist. A commercial artist perhaps, but an artist nevertheless. He must have a pictorial mind. Be able to see, in his mind's eye, the effect he would achieve of light, shadow and composition to best suit the mood of the scene he is about to shoot. To properly evaluate the mood of a scene, he must possess a sense of

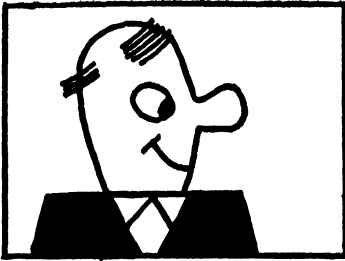

THIS

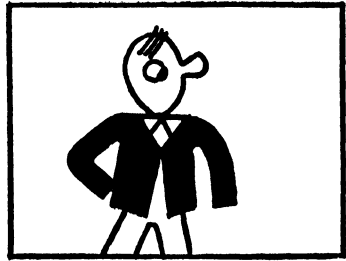

THIS

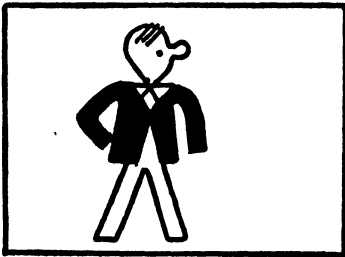

THIS

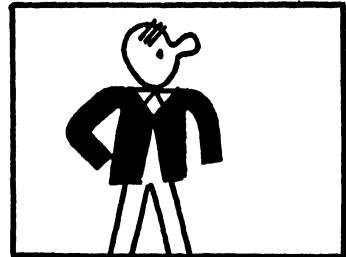

NOT THIS

FIG. 15.—Rules of framing, illustrating point 2.

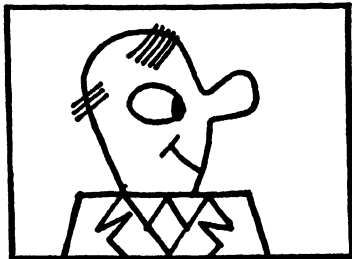

THIS



NOT THIS

FIG. 16.—Rules of framing, illustrating point 3.

**THIS****NOT THIS**

FIG. 17.—Rules of framing, illustrating point 4.

the dramatic, and be able to implement and heighten the work of the actors and the director.

But a cameraman can only make full use of these attributes when he is working with a director who is himself pictorially minded. Such a director is conscious of the contribution a cameraman, with his more specialized knowledge, can make; and, being sympathetic to pictorial values, is receptive to the cameraman's suggestions and point of view.

Photographically the modern cinematographer becomes commercial by the demands of the motion picture-going public, who want to "see" the stars, and from the commercial consideration that the play is the thing. If one could light every set according to the principles of pictorial perfection, and ignore the necessity of lighting the characters in the story, every scene could be like a painting and every cameraman a real artist.

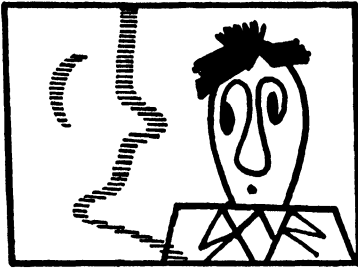
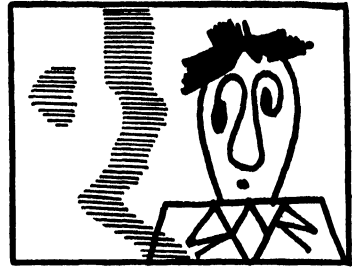
But a cinematographer does not strive to be a pictorial perfectionist in this sense. The characters in the story, particularly the stars, have to receive lighting preference for story value and commercial reasons. To be too "arty" is to fail in the role of the dramatic entrepreneur; to be too commercial is to violate the artistic canon. The successful cameraman must know how to balance one against the other.

A cameraman must guard against becoming too methodical; in the sense that his work becomes typed. Within the elastic framework of the fundamentals of his profession he must continue to experiment. The good cameraman is he who dares. Like all other creative work his will be better for spontaneity and nuance. He will be defeated in this objective if he is forced to turn out motion pictures on a mass-production method. No cameraman can go on endlessly from one picture to another without sacrificing something of the picture and of his professional self.

No matter how superb the program material, no matter how expert the director and writer, everything must pass through the camera and microphone and be altered for better or worse in the process. Cameras and microphones are tools which the director uses to express the meaning of the program, and a close artistic sympathy and teamwork must exist between all members of the production unit—director, cameramen, audio men, lighting men—if good results are to be obtained.¹ In television as in motion pictures, the members of the studio crew are “extensions” of the director. Putting it in other words, the director is the coordinating link in a group of artists—the members of the studio team who must have sufficient technical and artistic knowledge to carry out his demands quickly and precisely.

¹ As Basil Wright expressed it (*Footnotes to the Film*, Oxford University Press, New York, 1937): “This teamwork aspect crops up again and again. . . . This give-and-take collaboration, in which the director, of course, always has the last word, is the ideal but all too rare state. The next best thing is for the cameraman to be supremely gifted as to technique, but without much artistic conscience of his own. In this case, the director evolves all the effects himself and is limited only by the competence of the cameraman or the physical possibilities at the disposal of a modern camera. In any case, a director seldom takes No for an answer.”

Chapter 13

EDITING THE TELEVISION PICTURE

IN THE process of editing the television picture, in the actual cutting, we find the most striking difference between television and motion-picture technique—the time element. The difference is so obvious that it has been pointed out by nearly everyone who ever wrote an article, made a speech, or even said “boo” about the art of seeing-at-a-distance. Nevertheless it must be repeated because it is of basic importance.

Motion pictures are photographed at various times and places, and afterward the strips of exposed film are assembled into a finished production over a long period of time—weeks or even months. The motion-picture director and cutter may experiment and fiddle about, running the picture over and over until they have made all possible improvements in the montage.

In television all elements of the production must be assembled *before* it is shot. Everything is preplanned and prepared in advance, so that when the telecast begins the production is televised in continuous, unbroken action—just as in a stage play. If it calls for efficient organization and expert craftsmanship on the part of the studio crew, it also calls for a high degree of efficiency and instinctive artistry on the part of the director in the control room. His function bears striking resemblance to the combined duties of a motion-picture director and cutter, an orchestral conductor, and a radio director. He must have learned everything there is to know about television production, which includes most of the major problems of motion pictures and stage, plus the technical com-

plexities of radio network operation and timing. This is not an insurmountable task by any manner of means. It calls for extensive training and study, coupled with perfect concentration on the task at hand and the ability to force oneself to work at a higher degree of efficiency than that required for motion-picture or radio production. Indeed, a television director who knows theatre, motion-picture, and radio work will tell you they seem comparatively simple and tame in comparison—and after learning television a director will find straight, old-fashioned motion-picture, theatre, and particularly aural radio much easier than before.

We have seen some of the resources a director has in his cameras—lenses, mobility, composition, and angles. Now let us examine his resources in the control board where he edits the pictures and sounds, fusing them into a unified whole.

When the sound and pictures reach the director in the control room they have already gone through a “processing” comparable to the photographing, development, printing, and rough cutting of the picture and sound track in motion-picture production. In motion-picture studios the physical handling involved might take a minimum of several days. In television the developing and handling of the film is, of course, nonexistent, and the pictures and sound are “processed” and reproduced on screen and loud-speaker instantaneously.

The director has before him several small screens, and on each screen is the picture being picked up by one camera. Over each screen is an illuminated number identifying the camera feeding that screen. The screen on which the picture from camera 1 appears will bear the number 1, and the screen serving camera 2 is so identified. By observing these screens the director can select and perfect each shot before switching it on the air. There is another screen which shows the picture going out on the air, and an illuminated number above this screen changes each time a different camera is switched on the air so that the director can tell at a glance which camera is “on the line.”

The physical operation involved in switching a camera on the air is nothing more than the pressing of a button or the turning of a dial. In some instances the director will do it, in others an engineer. As a rule the director will do it on unrehearsed programs,

sporting events, and remote pickups in which no prepared script is used. When a detailed script must be followed and action has been rehearsed, the engineer usually does the switching on cue from the director, who is likely to be pretty busy following the script and giving instructions to the studio crew.

The television director can employ approximately the same type and variety of transitions from camera to camera as a motion-picture director-cutter. In most cases these are easier to use in television, since it is all-electric and instantaneous with none of the bother of developing, cutting, splicing, and storing film. The methods of transition and their uses include the following:

Fades: A fade-in is accomplished by turning up the dial which controls the "video gain," the power of the picture amplifier. A fade-out is accomplished by turning the video gain down. *Fades* are used primarily to *open and close* a program or a sequence in the program. A fade-out evokes the feeling of an ending, and for that reason it is almost never used except to end a sequence or a program. A fade-out is to a television program what a chapter ending is to a book—a complete break, giving a sense of finality. The duration of the fade depends entirely on the mood and subject matter of the scene at hand and may range from a split-second fade, which is almost a cut, to five or ten seconds but seldom longer.

Some studios can also "fade grey" or "fade white." The former consists of producing an even grey screen without cutting the signal off the air, and a fade-white is produced by increasing the intensity of the picture to produce an all-white screen. This latter method, however, is not too satisfactory, because the brilliance of the all-white screen dazzles the eye.

Cuts: A cut is the abrupt transition from one image to another, done instantaneously by pressing a button which switches in one camera and cuts out the order. A cut produces a subconscious shock in the viewer's mind by the sudden change from one picture to another. The recognition of a picture and its impact on the mind are almost instantaneous (assuming the picture is clear and easy to see), and if the director has selected his two images correctly an *immediate association of ideas* takes place in the viewer's mind. He receives an emotional effect greater than he would receive had he not seen the two images one after another. But if the director has

not calculated correctly in selecting his shots, the resulting effect will be one of confusion in the viewer's mind. Because a cut dispenses with all unnecessary, intermediate action, it tends to *speed up* the pace of a scene. It adds crispness.

The tempo of a scene can be varied greatly by the type of cutting used. If shots are short (frequent cuts), a scene will have a lighter, faster tempo. A solemn scene with no comedy in it will be sustained better with longer shots and less frequent cutting.

A cut is the standard method of effecting a transition from one camera to another, standard in that it is used most frequently because it does speed up the action instead of slowing it down. In addition to being used to get from one camera (angle) to another on the same subject, it is also employed almost exclusively in contrasting two different subjects (cutting for contrast), in showing resemblance between two different subjects, for reference purposes to remind the audience of something which has been "planted" earlier in the program, to show reaction of characters to action on the set, and to show parallel action—different bits of action in different places which the viewer accepts as going on simultaneously.

Obviously it is difficult for a television show to have as extensive, complex, and rapid cutting as is possible in the films. But it is possible to maintain a brisk pace with reasonably rapid cutting *if* the director has a well-trained, first-class camera team. Fast cutting can and has been done with only two cameras on the studio floor, but the physical strain on the cameramen is so great that it cannot be continued for any length of time. As cameras become lighter and more mobile, and as studios are equipped with four or more cameras, the problem of using rapid cutting will be considerably reduced.

Cuts, and for that matter all transitions, should be so smoothly handled that the viewer is not conscious they are taking place. Do not call attention to the technical aspect of the art. A few practical suggestions on avoiding this follow:

Make certain your lens apertures are correctly matched and the two pictures correctly shaded before making the cut.

Make sure the picture is sharply focused before cutting it in. Cutting to an out-of-focus picture makes your cut stick right out, and after that *faux pas* you will still be correcting focus on the air.

As a general rule do not cut on more than a 3 to 1 ratio. If you have two cameras on the same subject, do not have the subject more than 3 times as large in one picture as it is in the other—unless you are after a special effect.

As a general rule, try to cut on action so that wherever possible each shot ends and the next one begins on movement. For example, if you have two cameras trained on a person in a chair—one close-up and one medium shot—and the person stands up, cut as the action takes place instead of before or after it occurs.

Again it should be stressed that these are not to be considered hard-and-fast rules. For veteran cameramen it is old stuff, and these suggestions are intended only as practical hints to give new cameramen and directors something to start on.

Dissolves: A dissolve is just what the name implies, one picture dissolves into another. It is the same thing as a cross-fade and is achieved in that fashion. You begin to turn up the “video gain” dial of one camera as you begin to turn down the gain of the camera on the air—precisely as you accomplish a cross-fade or mix in aural radio.

The dissolve effects a *smooth, restful, easy transition* from one image to another. It does not break off the action and continuity as a fade-out does, although it may slow down the action to some extent if it is a very gradual dissolve. It creates in the viewer’s mind a “mental dissolve” as opposed to the staccato shock obtained with a cut. Its rhythm is easy, smooth, and harmonious, while the rhythm of a cut is nervous, exciting, stimulating. The psychological effect of cutting might be likened to the sparkling effect of the bubbles in the carbonated water of a highball. A dissolve, on the other hand, has been described as a momentary condensation of one train of thought into another, which has yet to fulfill its purpose. The actual rhythm of a dissolve can be greatly varied by speeding it up or slowing it down. It may take only half a second—practically a cut—or it may take five or six seconds, according to the mood of the program.

Dissolves may be used in going from long shots to medium shots and close-ups, and vice versa. They are used for bridging a jump in time or space without breaking or slowing down the action, and may even replace a fade and connect two separate sequences.

A dissolve may be used in this way to show a contrast or change. It also may be used to show a relationship between similar shapes and objects, associating old and new things in the viewer's mind. And, on occasion, a rapid dissolve or series of rapid dissolves may be used in a series of closely associated scenes to show parallel action—as opposed to using cuts.

Defocusing: A trick variation on the standard dissolve, one that should be used sparingly for special effects, is a transition achieved by throwing one camera out of focus until the image is completely blurred and unrecognizable. Then cut to your next camera, also equally out of focus, and bring it into focus revealing the new image.

Superimposures: A useful improvement on the dissolve is the superimposure, which corresponds to what photographers call a double exposure. In motion pictures a double exposure is a fairly costly device, usually made up in the optical printer of the laboratory. In television it is supremely easy and inexpensive—two cameras are turned on instead of one. *One image is superimposed on another.* Naturally the cameras must be lined up carefully, and lighting carefully arranged, but those details are minor. The major limitation on using superimposures in early television equipment has been contrast range, for unless the dark and light areas of each image are carefully balanced, the two pictures can blend into each other and produce a washed-out image. The answer to this is rehearsal before the superimposure is used, and the time needed will decrease as improved equipment lessens the problem. As a general rule, a superimposure shot will be done with only two cameras, one image on top of another. However, with careful rehearsal triple superimposures should be possible. To my knowledge this has not been demonstrated successfully in America prior to 1945, although a quadruple exposure was reported as successfully used in a BBC telecast before the war.

Printed titles: The use of printed caption cards has also been employed in making transitions, a heritage from the days of silent films. This completely breaks the action in an audio-visual medium. It is used for four purposes: To serve as an “intermission”—usually a “Please stand by” when the equipment breaks down—or for title cards to open and close a show; and for station identification. It is

also used to punctuate continuity, to call a pause in the action while an idea is driven home. This last use is apparently a hang-over from silent pictures and probably has no place in television except for special effects. Although it is still used on occasion in motion pictures, notably in "The March of Time" where the audience is seated in a theatre and cannot move away, it seems obsolete for television. If the action must be broken off to plug an idea in so many words, then the announcer's voice should be used; it will give a useful change of pace instead of a printed title which demands complete visual attention from the audience. The screen should be left blank, or should show a neutral grey surface, or should focus on some subject which is pleasing to look at and related to the program content.

Video effects: Visual effects, used on occasion to achieve a specific aim, are divided into two types. The bulk of them will be done by special technicians in front of the camera, just as most sound effects in radio are handled today. The other and more limited type is that of electronic effects handled at the control board, most of which we have already discussed: fades, dissolves, cuts, superimposures. Under the heading of rarely used trick electronic effects come:

(1) Exaggerated contrast and lowered intensity to make high lights stand out and dark objects disappear. An example might be a dancer, dressed all in black, face covered with a black veil, who is going through elaborate movements with her white hands. Lighting is centered on her hands, and in the control room the contrast is raised way up and brilliance cut down. The effect is one of rapidly moving hands which look like abstract blobs of white light moving in interesting patterns.

(2) A picture reversed from "positive" to "negative" so that white transmits as black, and black as white. A highly practical by-product of this trick makes it possible for negative film to be televised and give a positive picture. This has particular application when an event has been filmed, the film rushed to the studio and hurriedly developed and put on the air immediately. By reversing the picture, the negative may be run through the telecine projector even before it is dry, thus saving considerable time otherwise needed to dry the film, make a print, and then put it on the air.

Two minor effects often used in motion pictures cannot be handled by the television system as it exists today. These are *wipes*, in which the picture is "pulled" off the screen and immediately followed by another which is "pushed" in behind it, and *slow-motion*, *fast-motion*, and *frozen-action* pictures. These, however, can be used in television through the use of film or through special video effects equipment.

The television director can, by varying the length of each shot and the type of transitional effect used, speed up or slow down action, give it lightness and life and sadness and weight. By controlling the order in which successive images are seen he cannot tell a story but, through the alchemy of montage, build up tensions, excitement, and a wide variety of emotional reactions.

The resourceful director will never repeat the same shot taken from the same angle, unless he wants to emphasize that shot for some special reason. To repeat the same shot one or more times introduces a dullness, a monotonous quality which will kill a program's interest. The actual program content may not be exciting, but by continually varying the camera angles you may give it, visually, a freshness and interest it otherwise would not possess.

A successful director will not hold a shot indefinitely. He will hold it only as long as the audience will need to catch the visual significance and receive the desired effect. It is a matter of perfect timing, a skill which the director develops only through long experience plus instinct.

In the moment of creation the director's function is not unlike that of the conductor of a symphony orchestra. Selected out of the raw material of human experience, a number of continuous and constantly changing aural and visual images of reality are assembled before him in the control room. These he must fuse into a unity which best expresses the preconceived purposes of the program, and the fine details of this aural-visual montage can be determined only by the director as the program progresses. In this final stage, his artistic instinct, knowledge of his medium, and sense of timing spell the difference between a good and a bad show.

Chapter 14

VIDEO EFFECTS AND LIGHTING

THE SUBJECT of video effects is one which appeals to the “gadget instinct” in people as well as to their interest in things “magical,” because video effects often have an aura of mystery about them. Indeed that has been the greatest pitfall of video-effects men—calling attention to trick effects, permitting them to stand out in a production and thus throwing off-balance the show as a whole. The importance of sight effects is primarily that of being an inexpensive, easy way to accomplish rapid, complex montage in the video.

Actually there is nothing radically “different” about video effects. All those demonstrated thus far are based on well-known principles of physics and optics, and they serve certain specific purposes in television.

The field is divided into two groups: electronic effects created *within* the television system itself and centered in the control room, as discussed in the previous chapter; and effects which are created *in front* of the camera by various optical and mechanical devices. The function of all such effects is fivefold:

(1) To effect *transitions* from scene to scene, place to place, time to time, and to condense or speed up action through impressionistic sequences (sometimes described as “montage sequences”) which use rapid cutting, dissolves, superimposures, and process shots.

(2) To *reduce production costs* by replacing large, expensive sets either with miniature or by the back-projection of scenery. (As television develops technically we may be able to use some of the

motion-picture process shots developed in Hollywood, such things as glass and matte shots.)

(3) To give *animation* and *eye appeal* to otherwise static and uninteresting objects—maps, cartoons, visualized statistics, time signals, weather reports, product displays.

(4) To serve as a visual *station identification* device and as a *stand-by* in case of equipment failure.

(5) For surprise or *novelty* purposes, frankly using a trick for its own sake and then (we hope) discarding it before the audience has seen it too many times.

The six types of video effects which have been demonstrated to date are:

(1) *Film inserts* and *direct projection* devices showing changes of locale, vast outdoor scenes, fires and sundry disasters, commercial plugs, and screen credits. These inserts, sometimes prepared by a studio's cameramen and sometimes by professional motion-picture producing companies, can draw on all the techniques of the cinema—including the tricks of the *optical printer*. Film inserts will usually be employed where complex effects and rapid cutting are desired, or where a station has inferior or inadequate equipment.

This category also includes the use of the other direct projection devices—*slide films*, *lantern slide projectors* including both 35 mm. and 3 by 4 inch, hand-operated, and automatic feeding types, *balopticons*, and all the other forms of *magic lanterns* which project a picture from a flat, opaque surface, whether it be a postcard, a photographic print, or a drawing. The cost of these devices is relatively low, ranging from about fifteen dollars for a magic lantern to two hundred and fifty for an automatic feeding 35 mm. slide projector with a magazine holding thirty to fifty slides. These can all be operated on telecine channels.

(2) The television equivalent of a motion-picture optical printer is a useful gadget called a *shadow box*, which works on principles long familiar to display men. A hand-operated shadow box is comparatively inexpensive to build and operate, but an automatically operated, precision-built model would run to several thousand dollars—and be worth it.

This type of device has several stages, each of which can ac-

commodate flat or three-dimensional objects such as moving title cards, puppets, animated maps, product displays, and even close-ups of live actors. Each stage is separately lighted and controlled by standard dimmers. A simple system of two-way mirrors is used to connect them visually and make possible dissolves, cuts, fades, and superimpositions within the box itself. Only one camera is needed to make the pickup. Thus an inexpensive shadow box will do the work of several expensive cameras without tying up more than one.

(3) Interesting abstract effects may be obtained by *kaleidoscopes*, used either as part of a shadow box or as a separate camera attachment. In monochrome television the effectiveness of a kaleidoscope is largely limited to brief novelty purposes or to transitions from scene to scene as a substitute for a dissolve. However, with the advent of large screen color television, both the kaleidoscope and the *color organ* may provide interesting visual accompaniment for musical programs.

Closely allied with the use of a kaleidoscope are *convex and concave mirrors and* various "distortion" lenses which twist normal images into weird shapes.

(4) *Miniature sets*, realistic and built to scale, can give the illusion of vast scenes which would be prohibitively expensive to construct in full size.

(5) *Back projection* has proved enormously useful in the making of animated maps and charts where little fine detail is required. With the introduction of more sensitive cameras, making possible a reduction in the front lighting of a set, back projection of scenery will come into its own as it has in the cinema.

(6) *Mechanical gadgets* cover a wide range, including such things as the close-up of a wrist watch for a time signal; mechanically animated, visualized statistics; synthetic snowstorms created by shooting through a rectangular tank of water containing a flaky, white chemical used in children's snowstorm globes; rotating display cases; puppets and marionettes.

These are the six general classifications of sight effects, and since the purpose of this book is to concentrate on a survey and analysis of the fundamentals of television, without delving too deeply into any of its secondary problems (such as video effects),

let us move on to the next portion of this chapter which is concerned with lighting.

Television studio lighting is, of course, a basic problem, but unfortunately one which cannot be resolved until the question of new cameras is settled. The reason is simple: the type and quantity of light needed depend largely on the sensitivity and color response of the camera.

The standard studio camera tube from 1935 through 1945 was the Iconoscope. It was low in sensitivity, requiring extremely high levels of light to get a good picture. Its color response was uneven—low for yellow and green light, medium for red, and very high for blue-violet. This gave an unnatural black-and-white reproduction of color values which could be corrected by using several kinds of light, each with a different color characteristic. Where this was not possible, producers resorted to heavy make-up and the elimination of certain colors from backgrounds and clothing. In some instances studios went so far as to use only shades of gray and white for all scenery and make-up. While this simplified some production problems, it introduced others of a psychological nature. Actors do not feel natural in surroundings of such an unnatural color. Beyond that it is difficult for an actor to do a convincing love scene when the girl in his arms has light grey skin and black lips.

The exact type and amount of lighting equipment needed in any given studio is impossible to determine without knowing the sensitivity and color response of the cameras with which it is equipped. Therefore it might be best to indicate the various general types of lighting equipment which are available, and then discuss certain lighting problems which need further development and experimentation.

Manufacturers of lighting equipment have reported that they have no radically new developments hidden in their laboratories, only improvements on the four major types: carbon arc, tungsten incandescent, mercury vapor, and fluorescent.

Carbon arc lights, the brightest source of illumination available, can give a pure white light and have a high output of visible light in proportion to the wattage used. They have been standard equipment in motion-picture studios for decades, both before and after

the coming of sound pictures. Perhaps because they need thoroughly professional handling by skilled electricians they have received little attention from early, amateur-staffed television studios.

Incandescent lights, similar to those in most home lighting fixtures, have been widely used for television. They are easy to handle, noiseless and comparatively safe from a fire prevention point of view, but the light from this type of lamp is weak at the blue-violet end of the visible spectrum and heavy at the red and infrared end. While it compensates for the extreme blue-violet sensitivity of the iconoscope, and also takes advantages of the small peak in sensitivity on the red end, it still leaves the green-yellow response low and introduces a serious problem of heat. In a studio lit entirely with incandescents the heat is almost unbearable if there is sufficient light to get any kind of focal depth. When incandescents are used in conjunction with the cooler type of lights, the problem tends to disappear in a well air-conditioned studio. At the CBS studio, incandescent 5 kilowatt spots were used for modeling lights along with overhead banks of "cold" light (mercury vapor and fluorescent) and the heat problem was negligible.

The General Electric Company developed two types of lighting equipment which gave off almost no heat in the studio. One of these is the mercury vapor lamp, a small glass cylinder about the size of a cigarette, rated at 1000 watts and giving off 65 lumens per watt. The actual source of light is a drop of mercury in a tiny cylinder inside the cigarette-size tube. Because so much electricity is applied to so small an area, this lamp—the AH6—is water-cooled to keep it from cracking. (A steady stream of cold water flows through the outer tube, cooling the inner one.) The necessity of having this circulating water system introduces problems of its own, including noise and danger of breakdowns which flood the inside of the lamp housing and the floor beneath. A newer type of mercury vapor lamp, the AH9, is air-cooled but considerably larger in size. The light from both these lamps contains a great deal of blue-violet and ultraviolet and little red-yellow.

The other type of "cold" light is the fluorescent lamp, a long, glowing cylinder widely used in other fields besides television. This lamp can give a light almost as white as daylight, just a bit more on the violet end of the visible spectrum and less on the red. Because

the actual source of illumination is the entire inside surface of the tube, no one spot is so bright that one cannot look directly at it with unshielded eyes or touch it without danger of being burned. On the other hand, because it is large in size—a 40 watt lamp is four feet long and an inch and a half thick—it is difficult to concentrate intense light on any given subject, and it can be used only for flat, over-all lighting.

The lamps must be mounted in banks, made up of a number of silvered, parabolic reflectors which concentrate as much of the light as possible on the scene. With one lamp per reflector it is only possible to get around 280 foot-candles of light on any given object even when using a dozen banks of twelve lamps each. This light level was insufficient for the prewar type of iconoscopes. By mounting two lamps in each reflector, one on top of the other, CBS was able to get up to about 350 foot-candles on a given object. However, to maintain this level the lamps and reflectors had to be cleaned about once a week.

These are the four types of light, not counting sunlight, which television broadcasters can draw upon. All have peculiar advantages and disadvantages, and it would seem likely that most studios will continue to use combinations of two or more types. It is probable that all types will continue in service, except possibly the very hot Birdseye, inside-silvered incandescent lamps. Coming in 150 and 300 watt sizes, these have been used in clusters of six to sixty to give diffused pools of light. In addition to generating intense heat they cannot be focused in beams and tend to give a flat picture. Although light in weight and inexpensive, they are fragile since the bulb is completely exposed and unprotected.

There are certain general problems, mainly concerned with the way in which lights are installed and controlled, which will apply in most studios and which need extensive investigation.

Here *flexibility* is the keynote. Because of the sustained performance in television, it is desirable to keep the floor as free as possible of equipment in order to facilitate camera movements. One way to accomplish this is to have a small number of high-power, mobile lighting units on the floor instead of a large number of low-power units or big, clumsy clusters of low-wattage lamps. On this score 40 watt fluorescent lamps and 1000 watt *water-cooled* mercury vapors

are less desirable than incandescents and carbon arcs, both of which are commercially available in single units up to 10,000 watts and more. Also, as an economy note, at a given color-temperature, high-wattage, incandescent lamps have a longer life than low-wattage incandescents, because their tungsten filaments are thick and do not evaporate as rapidly as the thinner filaments of low-wattage lamps.

Another answer is the installation of *overhead* lighting fixtures which leave the floor relatively uncluttered. Obviously the usefulness of such units will be increased if they can be easily adjusted, either by hand or by remote control.

Hand control means a larger staff of electricians, hence higher operating costs, more noise and confusion in the studio, but lower capital investment in equipment. Remotely controlled lighting costs much more to install, but because it may be instantaneously and noiselessly adjusted during the course of a program, it provides greater flexibility and can be operated by a small studio crew.

The first major step toward a remotely controlled lighting system was made by NBC in 1938, under the direction of its technical director, William C. Eddy, now in charge of the Balaban and Katz television station in Chicago. This system used clusters of inside-silvered Birdseye lamps, mounted on hollow pipe frames, which could be rotated horizontally and vertically as well as elevated or lowered by a system of ropes (four to a lighting unit), terminating in a series of cleats to which the ropes were lashed. Control of all overhead lights is centered in a compact lighting bridge placed outside the control room window.

General Electric carried this approach a step farther in 1940 by equipping its WRGB studio in Schenectady with twelve "luminaires." These units each contain three water-cooled, AH6 mercury lamps and are suspended from the ceiling of the studio. Each "luminaire" can be rotated in the horizontal and vertical axis by means of small, built-in, electric motors which are controlled from a console on the lighting bridge outside the control room window. The console, about three feet wide and a foot and a half high, has several rows of small switch-levers—looking not unlike a small telephone switchboard. Adjustment of these switches gives instantaneous control over each "luminaire."

This general type of remote-control installation could be applied

not only to mercury vapor lights but also to banks of fluorescent lamps, incandescents, and even carbon arcs. It would seem to be a sound approach toward an ideal method of achieving flexibility in the over-all, *foundation* lighting. However, it does not seem likely that it would always be satisfactory for modeling lights, which require rather precise movement and focusing. A certain number of spots will need hand control, not only those on the floor but also those used for elevated side and back lighting.

Television lighting from 1930 to 1945 was crude, perhaps because the insensitivity of cameras forced engineers to concentrate all their energies on getting maximum illumination without roasting the actors. The average studio lighting system consisted of overhead lamps which poured a flood of uniform light straight down. This not only gave a flat, uninteresting picture and cast unfortunate shadows on the under portion of faces, but it also meant that a person's head was much more brightly illuminated than his feet. This introduced a serious production problem, particularly on high angle shots, for the face would be overlit while the floor and feet were washed out. One way in which this can be corrected is by a greater use of side and back modeling lights. Since modeling lights will usually be shooting diagonally, it means they must be handled largely from the floor or from raised platforms along the sides of the studio.

For these reasons it would seem that a flexible studio illumination system might include several general types of installations, such as:

(1) *Foundation* lighting in overhead banks with electrically operated remote control, providing for horizontal rotation through a complete circle and vertical rotation through a 180 degree angle. The "cold" lights, mercury vapor and particularly daylight-color fluorescent, would seem to be logical choices for this.

(2) *Floor lights*, for modeling and booster purposes, which would be highly mobile, perhaps mounted on wheeled tripods. Choices for these units might include 5 kilowatt and even 10 kilowatt incandescent spots equipped with the Fresnel type of lenses. For close work 2 kilowatt spots would be desirable, and very possibly the new AH9 air-cooled mercury vapor lamps would prove excellent where floodlights are needed.

(3) *Elevated modeling lights* will undoubtedly come into large

television studio practice, mounted on catwalks and gridirons patterned after theatre and motion-picture practice. It would seem logical to assume that a well-equipped studio will have overhead catwalks, some in fixed positions, some in temporary mountings, and others on wheeled tracks which may be moved with ease to various parts of the studio. This last type might be mounted on tracks suspended from the ceiling or running along the sides of the studio, depending on the way in which the studio building was constructed.¹

Batteries of high-power spotlights can be mounted on these catwalks and gridirons at some distance from the actors. To keep the cameras from getting in the way and casting shadows, it might prove valuable to use lenses of long focal length and work the cameras at a distance from the cast. This will not only minimize shadows but production noises as well, and at the same time it leaves more room for camera movements.

Depending on the size of the studio and set, 5 kilowatt and 10 kilowatt incandescent and carbon arc spots would seem to be likely choices for this type of installation; 2 kilowatt incandescent spots might also be installed for close work and in between the banks of overhead foundation light, where they could be adjusted either by hand or by remote control.

(4) In laying out a first-rate television studio it would be unwise to omit making any provision for footlights. The familiar troughs of permanent footlights used in the theatre are not desirable, but two other methods are possible. One is to use small spots or floodlights mounted on wheeled racks which can be pushed (like a lawn mower) into the foreground of any scene without coming into camera range. The other way is to design the studio so that there

¹ These mobile catwalk installations presuppose the building of large studios, similar to the huge sound stages of motion-picture production. It seems inevitable that key television stations originating major programs will sooner or later be equipped with spacious, flexible sound stages located not in the heart of the city but out in the suburbs where more room is available. The idea that a television plant must be in the center of a city, where rents are high and space limited, is a hang-over from blind radio—as well as a most uneconomic practice. Of course, a few small studios will always be operated in the heart of a great city for interview purposes, programs built around visiting celebrities, and audience-participation shows. But it seems reasonable to assume that most programs will come eventually from suburban studios—paralleling the out-of-town movement of the motion-picture industry in Hollywood.

is a cellar made under the studio floor. If expensive elevator stages are out of the question, it is a very simple matter to cut trap doors in the studio floor at various strategic places. By raising the trap door footlighting can be introduced from a subterranean angle—without running wires across the floor of the set. If the raising of the trap door will show or if action must take place directly over it, the regular door can be replaced with one having a heavy glass or lucite panel through which light can be projected. Trap doors can be useful, not only for lights, but also for camera-cable outlets, electric sockets, outlets for special-effects equipment such as steam pipes, water, and dry-ice fog, and for making people, corpses, and announcers disappear.

(5) Still another type of installation seems possible, one which is useful when other types of lighting cannot be brought to bear on the subject matter. One or more small spots or floods can be attached to the camera, dolly, or boom and controlled by the assistant cameraman (dolly-pusher). While this type of direct, front lighting tends to flatten out a picture, it may come in handy in programs of complicated movement—as, for instance, when the dolly camera goes into the middle of a group of dancers and moves about with them. With it any unexpected dark spots and shadows can be eliminated. Logical places for mounting these lights might be on top of the camera head, on one side, on the bottom under the lens, or down at the bottom of the dolly to serve as a footlight, or even somewhere along the camera boom if it is big enough to permit such an installation. On a boom of the M-G-M type described earlier, a single large spot, or a brace of spots on a crossbar might be mounted in place of the second camera.

Because the carbon arc can give such a brilliant light, it will be useful when it is desirable to break through the general illumination of a scene to establish a very high light level on some particular object or to produce a very sharply defined circle of light. Incandescent spots are more suitable for broader, less sharply defined illumination, and in situations where high light levels are not needed. (Perhaps this is another reason why carbon arcs so seldom have been used in television—because studios have been so small that the intensity and sharpness of the carbon arcs would be too much for the limited contrast range of the prewar type of video equipment.)

The radiation of carbon arcs developed for Technicolor motion pictures so closely resembles sunlight that it is the standard light for color cinematography and can be mixed with sunlight without needing color-correction filters. The spectral energy distribution of most motion-picture arcs is quite similar to solar radiation at sea level, the only marked difference being a peak at around 3900 Angstrom units in the invisible ultraviolet band. This peak, known as the "cyanogen band," is characteristic of the carbon arc. It is suppressed in the radiation of Technicolor carbon arcs by the selection of a relatively low arc voltage, and in "high-intensity" carbons by a light, straw-colored filter (Y-1). The light from both types also passes through glass which can further suppress ultraviolet light and at the same time eliminate any noise and fire hazards from the arcs. Since the daylight fluorescent lamp also gives a light very similar to sunshine, it would seem that these two types of illumination can be widely used in television. Their color-characteristics are suitable for full color television as well as for monochromatic.

The glamorous subject of television make-up goes hand in hand with lighting. The methods and colors used will vary directly with the lights, and the whole thing depends on the sensitivity and color response of the cameras. From time to time various studios and cosmetic companies have played about with make-up—it is always good for free publicity in the papers. All sorts of grotesque make-up formulas have been evolved: grey and black, navy blue lipstick, green rouge. All these have been tried in studios equipped with reddish incandescent lights, which wash out orange-red colors. It never has been really necessary to resort to weird concoctions of this variety, which usually make people look like zombies. Some stations equipped with various types of lights have managed quite well without any make-up, except regular street make-up for girls and a light base for men with very heavy beards. In actual practice television make-up seems to be boiling down to something very much like a light-weight, panchromatic motion-picture film make-up. For color television it is about the same as Technicolor make-up, light-weight and sticking to natural colors.



PLATE XXIV.—Example of motion-picture lighting from Paramount's *Lady in the Dark*. Note that equipment is not mobile as in television. Everything is set for one shot, then broke down and reassembled for the next shot. Note use of carbon arc spotlights as well as small incandescent spots. Notice also back lighting by bank of overhead spotlights mounted on catwalk at top of picture.

PLATE XXV.—Aerial view of RKO motion-picture studio plant in Hollywood. Large building are studios, giving plenty of room for all types of operations. Plant is largely self-contained including restaurants, infirmary, fire department, and so forth. Major television studios may locate something like this.





PLATE XXVI.—Production shot of an NBC mystery play. The play was acted up to the denouement, when action was halted and a group of guests was asked to guess who committed the murder. The correct solution was then acted out. Note two separate sets which adjoin, coming together at the middle of the picture. Lighting fixtures overhead are of Birdseye incandescent lamps.

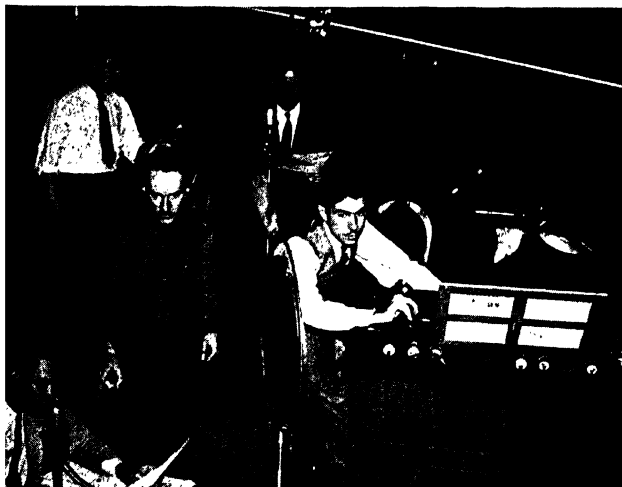

PLATE XXVII.—Part of the *avant-garde* at work on an experimental documentary program in 1940 at CBS. Accent was on development of programs using visual effects, special motion-picture film, and still pictures in combination with live narration, sound effects, and music. Attention of production crew is centered on television screen (*at bottom of picture*) on which video could be followed. From left to right, James Leaman, Richard Rawls, Rudolf Bretz, Phillip Booth, and Richard Hubbell.

PLATE XXVIII.—Almost all sports are first-rate television entertainment. At right is a demonstration at General Electric television studio by Andrew Ponzi, pocket billiards champion. Notice raised platform on tripod of microphone boom at left, giving boom operator elevation above floor for easier handling of the boom.



PLATE XXIX.—Below is boxing match at CBS studios in New York, refereed by Jack Dempsey. Ring was set up in center of large studio and several hundred invited guests sat in ringside seats.

Advantages of staging boxing matches in studio included both better lighting facilities and opportunity to use highly mobile cameras on studio floor. Lighting for actual boxing matches came from banks of overhead fluorescent and mercury vapor lights. Mercury vapor units had diffusers over them. No spotlights were used during actual boxing match because of possibility of contestants' looking directly into a spot and being momentarily blinded by it.

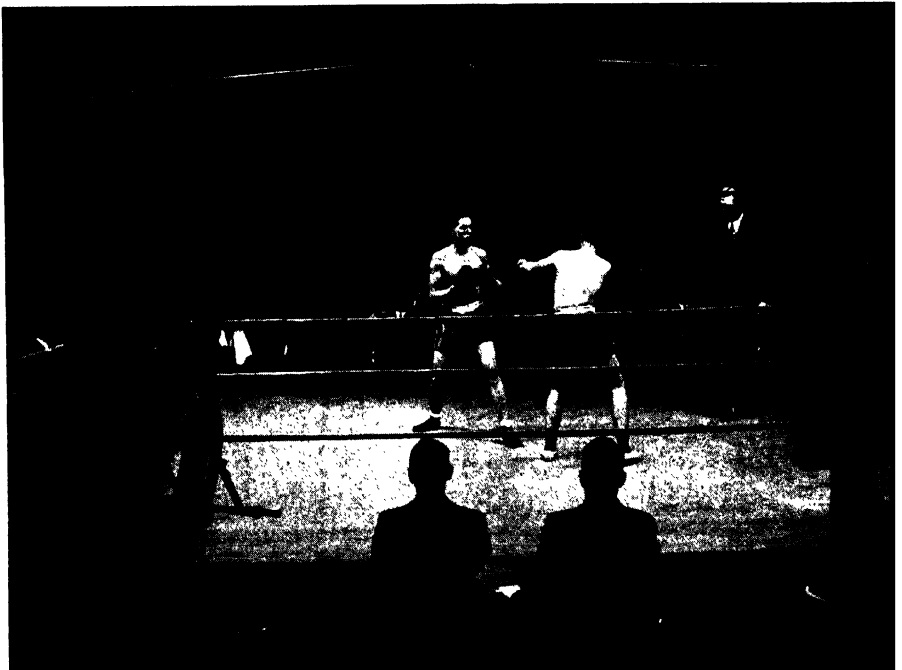



PLATES XXX AND XXXI.—Early wartime television programs. Upper picture shows part of a bond-selling program. Audience phoned into studio and calls were received by Jack Dempsey (*answering phone*) and various other personalities who took orders over the phone while audience and bond buyer watched proceedings by television. Below is production shot of program put on by Army Air Force to show how New York City was being protected from enemy air attack. Notice microphone boom extended to full length to place microphone directly in front of Gilbert Seldes, director of CBS television programs. Large dark objects at upper left-hand corner are the covers of light units.

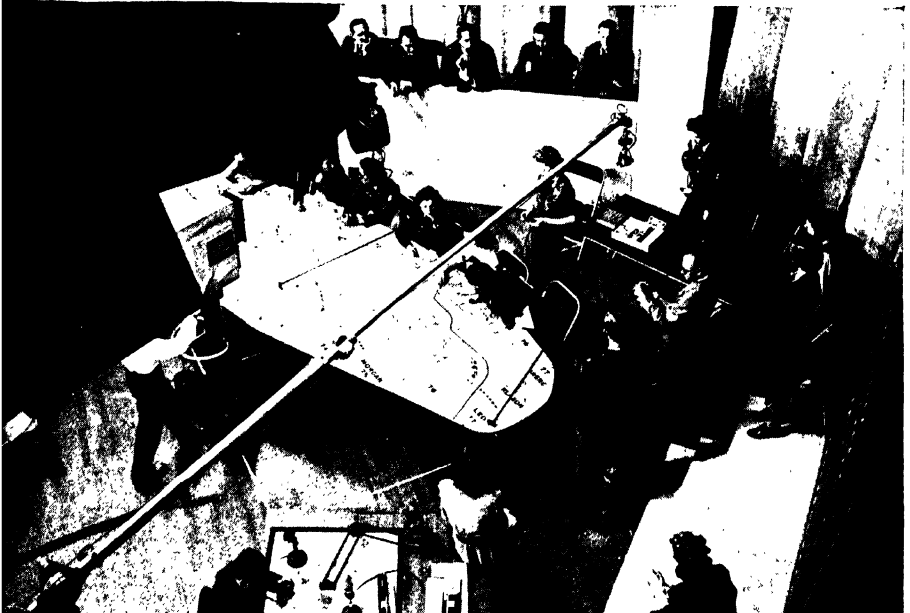

PLATE XXXII.—Early experimentation in handling of news at CBS. Note details of motion-picture type of microphone boom at left. Black rod grasped in left hand of man on stepladder rotates microphone on its axis when twisted and also serves as handle to rotate boom vertically and horizontally on its tripod. Crank just above man's head is used to telescope boom in and out.



PLATE XXXIII.—Production shot of television news program in 1942. Shown here are map mounted on rotating panels, and on panels which were slid in and out on cue (*at left*). Also used on these programs were three-dimensional maps, animated maps, visualized and animated statistics, still and motion pictures, live objects, and a variety of process shots such as superimposure and dissolves. This CBS series of news programs, four a day, was the first up-to-the-minute visualized news service in the world.





PLATES XXX AND XXXI.—Early wartime television programs. Upper picture shows part of a bond-selling program. Audience phoned into studio and calls were received by Jack Dempsey (*answering phone*) and various other personalities who took orders over the phone while audience and bond buyer watched proceedings by television. Below is production shot of program put on by Army Air Force to show how New York City was being protected from enemy air attack. Notice microphone boom extended to full length to place microphone directly in front of Gilbert Seldes, director of CBS television programs. Large dark objects at upper left-hand corner are the covers of light units.

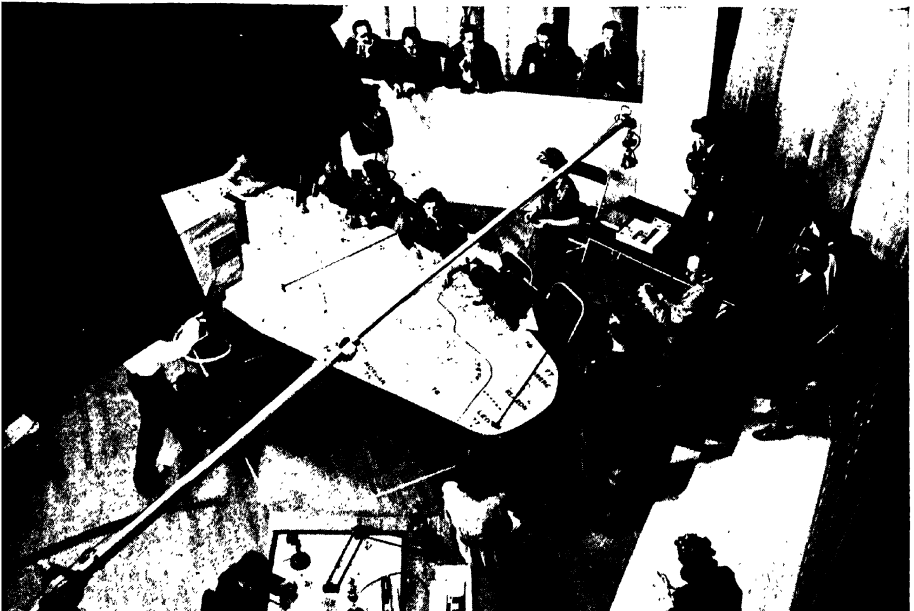

PLATE XXXII.—Early experimentation in handling of news at CBS. Note details of motion-picture type of microphone boom at left. Black rod grasped in left hand of man on stepladder rotates microphone on its axis when twisted and also serves as handle to rotate boom vertically and horizontally on its tripod. Crank just above man's head is used to telescope boom in and out.



PLATE XXXIII.—Production shot of television news program in 1942. Shown here are maps mounted on rotating panels, and on panels which were slid in and out on cue (*at left*). Also used on these programs were three-dimensional maps, animated maps, visualized and animated statistics, still and motion pictures, live objects, and a variety of process shots such as superimpositions and dissolves. This CBS series of news programs, four a day, was the first up-to-the-minute visualized news service in the world.





PLATE XXXIV.—Immense potentialities of television as a medium of public instruction were indicated by NBC's excellent series of Air Raid Warden instruction courses at outbreak of war. Photo above shows outdoor set simulating a bombed building. Actors in this scene are all employees of the New York Police Department who are giving demonstration of how to rescue trapped victims, remove live wires, and shut off leaking gas. At extreme right, police officer shuffles his notes preparatory to addressing the camera. Note the banks of lights needed to provide adequate light because of shadows caused by overhead structure. Arrow points to chain on camera at right which connects two wheels on the side. This connects lens system with small electric motor for remote-control focusing handled by technician in mobile unit parked outside. Both cameras are mounted on tripods, which in turn are set on improvised dollies. Microphone over head of police officer at the right is suspended in fixed position, since the officer did not move about. No other sound pickup was needed since the officer did all the talking.

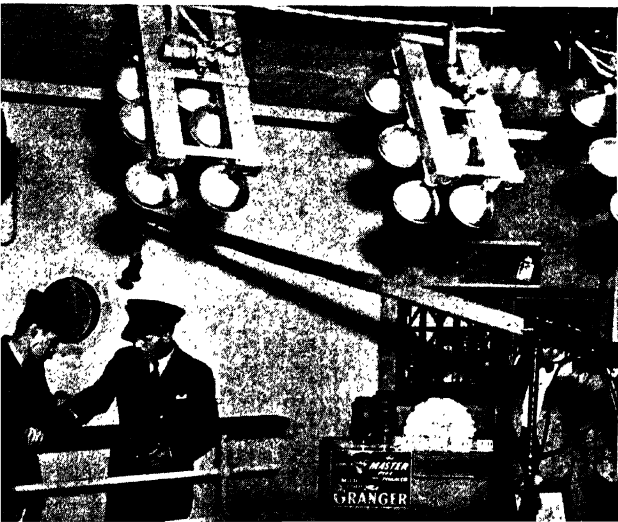

PLATE XXXV.—Selling cigarettes on television. The commercial message for the Fred Waring program on Du Mont television involved a short dramatic sketch between a lonesome soldier on board a ship and a petty officer who cheered him up by giving him a Chesterfield. Note how shipboard setting ends abruptly in center of picture and a cigar counter is placed at the right, giving ample opportunity to display all products of the sponsor. Notice overhead bank of hot Birdseye incandescent lights.

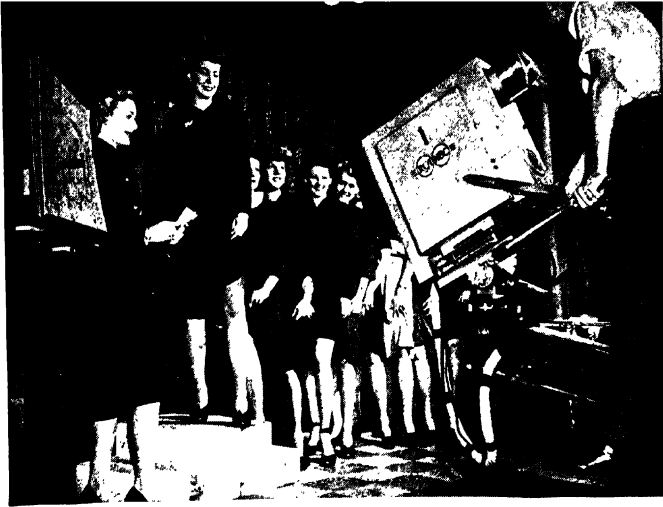

PLATE XXXVI.—Demonstration is the thing in television commercials, and this is one way to sell silk hosiery. It would seem reasonable to assume that there will always be programs like this.

PLATE XXXVII.—Demonstrates program showing how to bake a cake with Spry. Cameraman is looking into electronic view finder which is attached to the camera proper. Girl with print dress in center of picture is Patricia Murray, pioneer television mistress of ceremonies.





PLATES XXXVIII AND XXXIX.—Commercial program at Du Mont studio with Samuel Cuff as newscaster. Note poster at right. Now look at bottom picture and see how it is brought to life for commercial message. Script held by little girl did not show on the air. Girl is same one used as model for printed advertisement similar to view here.



Chapter 15

FUNDAMENTAL PROBLEMS AND THEORY

THEORIZING is at best an uncertain business. With proper eloquence one can make out a convincing theory for almost anything, and it may or may not prove true. Theorizing about the nature of an art form before it exists is doubly dangerous since it is largely speculation. Nevertheless there is a bit of this advance theorizing which must be done about television. Certain fundamental points of technique must be investigated, and the sooner the better. By calling attention to these problems we may arrive at a solution much sooner than if we leave things to chance—and then not recognize the correct solution when it does appear.

Edwin S. Porter found the basis of motion-picture technique in 1902, but the full value of his principle of editing and use of the close-up was not fully realized until some years after. It was not fully developed and raised to maturity for a quarter of a century.

To answer the question “What is the core of the television art?” we must first find the answer to several key questions. These answers may be deduced by theorizing, but we shall never be sure until they are tried and proven in actual practice. Serious television experimentation of the prewar era, notably at BBC and CBS, has suggested possible answers, but more extensive exploration and demonstration are needed.

These key questions are as follows:

(1) What is the primary tool of television—the camera as in the cinema, or the actor as in the theatre, or the microphone as in aural radio? Or is it a combination of two or three? Does the answer to

this question hold true at all times, or does it vary for different types of programs?

(2) What is the primary process in television? Is it video cutting as in the cinema, or is it camera handling, or is it an equal measure of audio and video editing?

(3) Is the single shot the basic unit of television as it is in motion pictures?

(4) How should the video be used to develop a technique for television without flatly imitating motion pictures? How can we evolve an audio-visual technique as right for television as the Russian theory of montage is for motion pictures?

If it seems academic to theorize about television and seek the answer to such questions, if you feel like saying, "The success of television depends on pleasing the public, which is not interested in aesthetics, so let's find a couple of good tricks and formulas and forget about basic theories"—then it might be pointed out that the techniques and artistry by which a director creates an effect on his audience act unconsciously. The vast majority of the television audience neither knows nor cares anything about the way in which the pictures and sounds of television are fused into an entertaining program. The audience is not even conscious of dissolves and montages and superimposures if they are expertly used, but when they are correctly used the audience cannot help reacting to and being influenced by them.

For this reason it follows that the most successful television programmers will be those who understand the fundamental nature of the medium. A producer, with no understanding of television, may happen to stumble on a successful program out of sheer luck. He may even do it twice, but the law of averages asserts itself sooner or later and he runs into trouble.

A good definition of the word "art" (and a doctrine of the post-impressionist school) stresses that art is neither nature nor truth but a pattern or rhythm imposed upon nature. Moving ahead from this point, let us recall the way in which television can be divided into two types of programs: those of *creation* and those of *transmission*.

Programs of creation or the interpretation of a mood are in themselves a design and rhythm imposed on nature and truth. They are intended primarily for purposes of entertainment, and include drama, the dance, music, graphic arts, and certain types of documentaries and variety programs.

Programs of truth and fact have the fundamental purpose of transmitting a true and accurate record of an actual event, the essential elements of which have been carefully selected in the interests of brevity and economy. In these a certain design is imposed upon truth because of practical necessity, and this is based upon a technique of editing and production. But, since the purpose of the program is to *transmit* truth rather than create a transient mood for the sole purpose of enjoying the beauty of that mood, and since these programs are not designed primarily as entertainment but to instruct and inform, then it is clear they should not be considered as fundamentally an art.¹

The same distinction exists in motion pictures and radio. In motion pictures the larger part of production is of films involving creation. Films of the second type, transmission, are largely confined to a few shorts and the rather undeveloped field of the newsreel.

In radio the situation is more complex. The programs which constitute the backbone of radio—music and news—are transmissions of an actual event. On the other hand, the purpose of music is enjoyment, not instruction. But since music sounds about the same on or off the radio, since most music is not composed especially for radio, and since music existed in roughly the same form long before Marconi, radio must inevitably be considered as, primarily, an improved method of distribution for music—as well as for news, talks, commercial plugs, and most other types of shows except drama.

If we must find an art form in blind radio, the only possible spot is in the field of dramatic programs—and here we shall have to look rather closely, for a heated controversy has been going on about this subject for some time. The radio drama field breaks down, roughly, into two general groups: the unpretentious, unending, “soap operas,” and the more pretentious half hour and hour “radio

¹ To this category should be added a subheading for programs which involve only the physical process of transmission, i.e., the use of a standard motion picture, slide film, or lantern slide series not specially prepared for television.

plays." Soap operas in general resemble long-drawn-out aural counterparts of newspaper comic strips, taking fifteen minutes (minus thirty seconds for chain break, minus two minutes to open and close, minus two minutes for commercials) to accomplish what a comic strip does in one episode (reading time: less than thirty seconds). It has been said that soap operas sometimes rise to heights of artistic achievement. Possibly they do, just as cartoons sometimes are superb, but such instances are so rare that soap operas hardly rate as more than a stereotyped "dramatic formula."

Longer "radio plays" are, for the most part, closely patterned after stage plays and short stories. Only occasionally have there been examples of patterns peculiar to radio, most of them being described as experimental to excuse the fact that they do not pull a big audience and therefore are not commercially sponsored. Perhaps the only type of true radio play which has been commercially successful is the thriller dealing with mystery, the supernatural, and horror themes. Fear is best aroused by things unseen and only vaguely described, which may be the fundamental reason for the success of this type of radio dramatic art.

In other words, radio is primarily a method of transmission and secondarily an art form. The reason for this seems to be the basic limitation of the medium itself. It appeals only to a minor sense, and it has no characteristics which can be developed beyond a certain point.

To answer the first question, "What is the primary tool of television?" we must first decide what its fundamental sensory appeal is. Is it hearing or seeing—or an equal mixture of both? A stage play is aural first, visual second. Radio is, of course, aural. Motion pictures have proven themselves to be visual first, aural second. Perhaps the best test of these assertions, if you wish one, is to:

(1) Watch a play with your fingers in your ears so that you cannot hear.

(2) Listen to a motion picture with your eyes closed.

But what is television? Is it visualized radio? Is it motion pictures in your radio set? Or is it a legitimate theatre in your home?

Again it is necessary to move out of the field of fact into speculation and opinion. I believe it is primarily visual, if for no other reason than that vision is the dominant sense. Most "real television"

programs will be visual first, aural second. On the other hand many "acceptable" programs of future television schedules will probably be primarily aural with a visual accompaniment. They will not be "pure television," but they will constitute a sizable portion of the daily fare and will be commercially profitable.

Moreover, in the final analysis, we shall probably find that there is no "primary tool" in television, that under varying conditions we shall find the camera, the microphone, and the actor each taking the lead.

In motion pictures the camera is the "primary" tool, but as the art stands today it is usually meaningless without its sound track, just as the sound track is silly without the pictures. In some motion pictures—"The March of Time" is a possible example—the sound track may be even more important than the pictures. The Voice tells the story and is usually intelligible without the pictures, but the pictures often are meaningless without the commentary.

Television can absorb techniques and materials from the stage, and by discarding purely theatrical conventions it can do a fairly good job on many television-adapted stage plays.

And television can do just about every type of program radio can do. All types of radio programs are necessarily aural in appeal, although some of them could be better if they were primarily visual, for example, sports. Others, such as news, talk programs, and varieties, can be greatly improved with sight and may turn out to be equally important in both video and audio. Then there is a great mass of radio programs—including music and possibly some soap operas—in which the basic appeal will be to the ear, enhanced by a visual accompaniment, or illustration, or visualization, which does not have to be closely followed in order to appreciate the program.

Proceeding on the assumption (not very popular in radio circles) that blind radio is obsolescent and may be replaced almost entirely by sight-and-sound broadcasting in a comparatively short span of years, I feel that television will have a good many programs in which the microphone (audio) will be the primary tool. There may also be a good many more in which the personality of the actor will be of primary importance, forcing the camera and microphone into a secondary position. The camera technique here will be primarily to get a clear view of all important action. We have seen this happen

even in the motion pictures, notably in such French films as *The Baker's Wife*, *Harvest*, and the Sacha Guitry films. However, the programs which will *establish* television, and which exploit the "You can be in two places at one time" aspect of the medium, will be primarily visual and secondarily aural, because of the dominance of sight over hearing. These programs include sports, news—as it happens and also visualized completely in summaries—programs involving demonstration, and maybe half of the dramatic programs and variety shows.

This third group, let us call them "pure television" programs, may not take the bulk of air time—assuming that television will finally be broadcast at all hours of the day as radio is now—but it is the most important group. Without them television cannot become a mass entertainment medium, although it can get along without many of the other types of programs. For this reason, and for the reason that they include all television problems, they warrant the most attention.

Turning to the second key question—"What is the primary *process* of television; is it video cutting, or camera handling, or audio-handling, or an equal measure of audio and video editing?" We find that the last portion is already partly answered. In certain types of programs the over-all editing of audio and video will be of equal importance, sometimes more audio than video. But in "pure television" program material, I feel that the video cutting or editing in the control room will remain the most important single process, as it is in most films, but with one qualification: The handling of the cameras, the fluidity of movement, will be of much greater importance than in motion pictures and much more closely linked with the control-room cutting, thereby becoming almost as important as the control-room editing itself.

It follows, therefore, that the answer is "yes" to question three—the *single shot is the basic unit* of television. Practical experience to date seems to back up theoretical conclusions that the individual video shot is the basic unit, the "building brick." It may be a short brick or a long one. Most shots will not exceed thirty seconds, but some shots may be held as long as five minutes without losing interest. Shots of this length, however, are usually in programs of transmission, showing an actual event as it happened, not in pro-

grams of creation staged in the studio. Perhaps this may be because the entire program takes place "beyond the camera" in the transmission of an actual event, and the audience is sitting on the side lines looking in at living history. The camera technique is not used to evoke a fictional mood but merely to get a clear picture. In a program staged in the studio, in which every movement and angle of the camera is calculated to achieve a specific emotional effect on the viewer, a single shot of five minutes' duration probably would unbalance the rhythm of the show completely.

Just how important will camera technique be in the production of these programs? To answer this question we must divide the subject of camera technique into two sections. For lack of better titles let us call these sections "minimum essentials" and "overtones."

Under "essentials" comes the business of getting a clear, sharp picture. The cameraman must keep in focus at all times, maintain reasonable depth of field, and keep his camera pointed at the most important subject matter so that the viewer can at all times see clearly the essentials of the program. Unless these minimum requirements are fulfilled, no program can succeed. With only these minimum requirements filled, a program may contain fairly satisfactory audience appeal *if* the material before the camera is of extreme interest. When the program content is less than first rate, the program is likely to become dull and unsatisfying.

Under the heading of "overtones" would be placed all the finer points of camera handling: traveling shots, boom shots, the selection of the best possible angle to bring out the meaning of the program to best advantage. These points are not essential to secure a clear picture and keep a program on the air, but they are necessary for first-rate shows. If top-flight program material will get by with only the minimum camera requirements, it will be much more effective with professional camera work. If a program with medium interest program material will not click with only the minimum essentials of camera handling, it often can be made successful by stepping up video production values.

For these reasons it seems obvious that the most pressing problem to be solved by television programmers is the evolution of a

satisfactory video technique and complementary to that, an audio technique.

As noted before, these techniques cannot be the same as those for motion pictures for the double reason that (a) it is physically impossible to equal the photographic perfection and complexity of the visual image obtainable in the process of film editing, and (b) the cinematic technique is right for the medium of film but does not exploit to the fullest the peculiar characteristics of television. With this in mind, how *are* we going to evolve a television video technique as right for television as the cinematic technique is for films? What is the answer to question four, the most difficult of the key questions?

Chapter 16

TOWARD A VIDEO TECHNIQUE

IN ANALYZING the psychology of the silent film, Paul Rotha has pointed out that the inner reality of a film's characters is revealed by their outward actions, and it is "these outward phenomena which the camera photographs in order to recreate and transfer to the mind of the audience the inner reality of the characters. . . . It is by the subtle arrangement of the visual images . . . which photographically record these phenomena that the dramatic content is conveyed clearly to the audience."¹ He has observed also that the camera itself is unable to penetrate the world before it, but the director can by his *selection* of the visual images reveal the intrinsic essence of life through use of the basic resources of the cinema. The camera's faculty for the representation of detail builds up situations by putting their exact ingredients before the audience.

Mr. Rotha was speaking of the silent film, but he might just as well have referred to the television camera which, under the control of the director, sees whatever is necessary to tell the visual story and excludes all unnecessary details. This is augmented in television by the emotional stimulation of music and sound effects, plus spoken dialogue which also reveals the inner reality of a character. Dialogue, properly written for the medium, need not slow up the action as it did in the early days of talking pictures and television. Motion-picture dialogue, for example, is written in a condensed, synoptic style which is quite different from radio or theatre

¹ *The Film Till Now*, Jonathan Cape, London, 1930.

dialogue and which is applicable to many types of television programs.

Every picture, every sound in a television program registers an impression on the mind of the viewer, and the combined effect of these impressions determines the success of the program. Theoretically the aural and visual attention of the audience is completely at the command of the director—subject only to distractions occurring at the place of viewing.

Here are seven logical steps toward the perfection of a camera-video technique. The first three concern the broadcasting executive and the manufacturer as well as the artist, but the last four are primarily the concern of the writer, director, cameraman, and producer:

(1) Before any real progress can be expected, programmers must be equipped with good equipment, and reasonably large, flexible, intelligently laid out studios. The best talent in the world won't "come through" on the screen without a good studio and good equipment. Prewar television studios and equipment were, for the most part, absolutely inadequate. Only the CBS and General Electric studios could be classed as fairly serviceable, and both of these leave much to be desired since they are in buildings built for other purposes and adapted for television. Some studios were so completely inadequate, badly designed, and poorly organized that it was physically impossible to produce a good show in them, judging by professional standards.

(2) Television studio staffs must be free to work full time on television, unencumbered by the existing routines of radio and film production staffs. Television is different, and it is hamstrung when set up as one subdepartment of a radio or film producing company. It must be a separate division with a tightly organized structure, for teamwork and organization are essential in television to a greater extent than in motion pictures or radio, if costs are to be kept in line.

(3) Production units must work together as a team, each man knowing the way in which everyone else works, thinks, reacts. The longer a unit is together, the better it is likely to function.

(4) Principles of editing pictures remain the same in television as in motion pictures. Scenes are cut, dissolved, and faded for the

same reasons. Two images are joined together for the identical purpose in both media. The difference in editing for television is that a more leisurely cutting technique may be employed. In addition there is a more extensive use of dissolves and superimposures to provide speedier transitions and to enhance pictorial interest.

(5) To compensate for the leisurely pace that comes with slow cutting, a greater use must be made of the *mobility* of the camera. Extensive camera movement has often been frowned upon in film production for both technical and aesthetic reasons, and perhaps as much as anything because movement could always be achieved through rapid cutting of an otherwise visually static scene. Since television cannot equal the tempo of film cutting but can exceed the mobility of the motion-picture camera, it seems obvious that a promising field of development is to be found in this characteristic.

It has been argued by film directors that extensive camera movement makes the audience dizzy, that a "firm platform" for the camera is necessary to keep the audience feeling secure. This does not necessarily hold true in television—although I am not advocating that one sweep about with a camera just for the sake of swooping. Far from making the audience dizzy, the extensive but judicious use of all forms of camera movement has proven highly successful. The viewpoint, the camera angle, may be constantly changed, keeping the picture alive and fresh. This is particularly effective in television, because the viewer is seeing something real as it happens, because the camera is an extension of himself and through it he can snoop around and view things from all angles.

If you shoot a scene first with mobile cameras and then with static cameras, the difference becomes apparent at once. You may speed up the static camera version by more rapid cutting in motion-picture technique but this will entail extensive camera movement *between* shots, and the chances are you will end up with something that looks like a sloppy, unprecise imitation of a motion picture even after double rehearsal time.

(6) In handling the cameras there are two basic types of approach—*objective* and *subjective*. The audience can be made to view a scene objectively or subjectively. The objective approach is to view things from the side lines without becoming involved in

the action. The subjective approach brings the audience into the action, shows the scene as it would appear to one of the characters.

For example, if one goes to a football game he views it from the side lines—objectively. Similarly, television cameras are used objectively in picking up a football game. To use the subjective approach, the camera has to get right in with the players and move around with them.

The objective approach is easier to use and is simply achieved by setting up the camera as a “third party” looking in on something. The subjective method is more ticklish to handle, requiring careful preparation to be effective.

The borderline cases between the two types have caused more than one argument in motion-picture circles. Should the camera be used as the unseen observer, the “hidden eye,” which can rove about and look into anything without becoming part of the action? Or should the camera assume the point of view of one of the characters in the show and see things through his eyes?

Although the objective method is more widely used, the subjective approach is particularly effective for many types of programs. However, a great deal of experimentation is needed, employing the greater mobility of the camera. Remember that two of the distinctive characteristics of the television video are the feeling that you are present at the scene of the action “in two places at one time” and the sense of intimacy and transference of personality. This, in itself, suggests the validity of the subjective method.

Many programs involve demonstration, show how something works. Although the objective approach would ordinarily be used to start, a switch to the subjective is likely when one gets to the point of learning how to use the demonstrated object. A subjective approach often will accentuate the feeling of participation, not only in demonstrational programs but also in such diverse things as quiz programs and all types of audience-participation shows, dramas, and dance programs.

One of the most successful examples of television I have seen—as well as the only really interesting telecast of dancing—used a subjective camera. After starting with an objective approach, the camera moved right into the dancing group and stayed with them, giving the audience the feeling that it was taking part in the ballet.

Ballet has been described by the critic Irving Deakin as the "idealization of human movement," its beauty, grace, and seemingly easy movement defying gravity. It is something which, like expert diving, most of us would subconsciously like to be able to do, and we experience a vicarious pleasure in watching it. The subjective use of the camera in television ballets seems logical. It can take the viewer out of his chair and make it possible for him to participate in the dance, in effect giving him wings and—vicariously—the ability to perform as a great artist.

The opportunity to progress in the use of highly mobile cameras which rove about the studio, taking both objective and subjective approaches to a program, was severely limited in the early years of television by the shallow focal depth of insensitive cameras and by the lack of mobile equipment and large studios. As these deficiencies are remedied, more producers will be able to explore the techniques of mobile cameras and the subjective approach. Certainly they offer a most promising clue to the development of a true television technique. This is corroborated not only in theory but also in the practical experience.

(7) Another promising step toward the perfection of video technique will be the introduction of full color pictures. There has been considerable discussion as to just when color will be ready, and this is a problem to be settled by the engineers. Without question it will be one of the most important of program techniques. (All the points of technique discussed so far apply equally to monochrome or color pictures.)

Television in color presents such a pleasing picture to the eye that it becomes possible in many cases to hold a given shot longer in color than in black and white. The use of color fits neatly with the idea of slower cutting in television than in motion pictures, for by heightening the appeal of the picture with color, the slower cutting will not tend to drag as much as in monochrome. (Notice the length of the average shot in a Technicolor motion picture as compared to a black-and-white picture.) Slower cutting in color television also minimizes the danger of jarring color conflicts in a sequence of cuts.

Color fits nicely with the theory of extensive camera movement by offering a possible simplification of the lighting problem. In

monochrome television or motion pictures we depend for picture values on *contrasting shades of grey and white*, on high lights and shadows. Therefore extensive use must be made of modeling lights with each shot carefully arranged. In color pictures one can get his *contrasts largely between colors which are on the stage* and not primarily controlled by the placement of spotlights. Experience with Technicolor motion pictures has evolved a fairly flat, over-all illumination quite different from the lighting for a monochrome picture. If this holds true in television, which seems likely, then it will make the lighting problems much easier. Mobile cameras, roving all over the set, will not need as extensive readjustment of lights on each move—all of which adds up to less production headaches and lower operating expenses.

Part Five

THE AUDIO

Chapter 17

THE MICROPHONE AND THE AUDIO

THE MICROPHONE bears the same relationship to the audio of television as the camera bears to the video. In a radio studio, designed for sound pickups only, the microphone is placed in the best acoustical position, and the cast is grouped around it without regard for visual considerations. Everything is balanced for sound. In a television studio, as in a motion-picture sound stage, the visual aspects, setting, and position of cast are dictated by the camera requirements. The cast must act visually as well as aurally, and it certainly would not do to have each actor saying his lines into one or more microphones standing about in the middle of a set. Of course this has been done, but if you are going to have your audio equipment in the picture, then why not also show your cameras and allow them to be heard as they are being pushed about. Theoretically this should not destroy the illusion any more than seeing the microphone.

Since the microphone must be placed outside the frame area of the camera, it will often be difficult to get the best possible pickup and exclude background noise and echoes. And, since the actors will be moving about, it will be necessary to follow them with the microphone as well as with the camera.

The primary problem of the audio is, therefore, to get a good pickup at all times without dropping the microphone into view. (It looks silly to see a microphone coming into the top of the picture and bobbing up and down.) The microphone not only must be kept out of the picture but it also must not get in between lights

and visible objects and thus cast shadows. This is not as simple as it might seem at first glance, for many productions use, three, four, or more cameras all viewing from different angles—and there will also be a battery of lights shooting from various positions. The microphone, mounted on the end of a long, telescopic boom, is moved from character to character and from one side of the set to the other. Inevitably it will cast shadows somewhere, and the trick is to make sure they are not cast squarely across the heroine's face, the sponsor's product, or some equally vital point in front of the cameras.

On rare occasions the problem can be eliminated by hiding microphones inside lamp shades or bowls of flowers, or behind some books close to the actors—provided the actors are going to remain rooted in one spot for some length of time. Usually, however, actors will be moving about and will get out of range of a microphone. (The term "actor" is used to indicate anyone appearing on any program, not just a dramatic show.) It is not much better to solve the problem by hiding a number of microphones all over the set. This not only complicates the control job of the engineer and introduces an element of risk, but it also tends to cause fluctuations in sound volume and quality as actors move closer to and away from the microphones. Additional sound distortion is often introduced by the proximity of the microphone to a solid object, especially when it is inside a vase or a lamp shade.

The type of sound system presents another problem; the television audio is monaural—all sounds going through a single sound system and coming out of one source, the loud-speaker. Unlike the human hearing system, the microphone cannot be exposed to a number of different sounds and yet focus only on the desired sound. Therefore unwanted noises must be eliminated before the microphone makes its pickup. The two classifications of unwanted sound are *extraneous* and *reverberant*.

Extraneous sounds include background noises, such as people whispering, moving of cameras and scenery, and anything else that has nothing to do with the program content. The desirability of eliminating these needs no elaboration.

Control of reverberant or "echo" sound is somewhat more complex, for a certain amount is desirable according to the require-

ments of the particular scene. If there is no reverberation, the sound will seem dead and lifeless in many instances, particularly in the case of music. If there is too much, the sound may become confused and unintelligible, especially in the case of speech.

Because of the loss of "focusing powers" in monaural hearing, echo is much more noticeable than in binaural hearing. This can be strikingly illustrated by placing two people in an empty, "live" room with bare walls and no rug. They can converse without difficulty and can understand what is being said. But put a nondirectional microphone between them and listen to the conversation on a loud-speaker, and you will find it a strain to follow the conversation because of the excessive reverberation.

The further a microphone is from a source of sound, the greater is the ratio of reverberant or reflected sound to direct sound. Direct sound is that which comes direct from the source to the microphone without being reflected one or more times from the walls or floor or ceiling or properties. If sound is reflected, it reaches the microphone a fraction of a second later than the direct sound. This time lag produces an echo. When many varying echoes—of different pitches and with different time lags—go into a microphone, they produce a reverberant effect.

Reverberation may be defined as the *persistence of sound, caused by repeated and varied reflections.*

One technique for the control of unwanted sound is that of using a directional microphone—one which picks up sound coming from preselected directions only. Of course, if the studio walls, floor, and ceiling have a high degree of acoustic reflection, unwanted sounds may be bounced around the room away from the "dead" side of the microphone and into the "live" side and thus transmitted.

Reflection of sound can be cut down or eliminated by acoustically deadening all flat surfaces in the studio—particularly the walls, ceiling, and, where possible, the floor and scenery. Another way to suppress unwanted sound is to place the microphone very close to the source of sound, so that a greater volume of direct sound will reach the microphone and the indirect or reflected sound will be less noticeable.

As a general rule the higher frequencies of sound tend to go in

straight lines only, like light. Therefore they are easier to control than very low tones, which, unlike light, tend to "go around corners." For this reason many microphones are directional at higher frequencies and not at low. Even if a microphone is theoretically directional at all frequencies, it loses its directional properties in the lower frequencies whenever there are sufficient reflective surfaces to bounce the sound waves around to the "live" side of the microphone.

The main factors, then, to be considered in making an audio pickup are these:

(1) The *acoustics of the production set* (floor, walls, ceiling if any, and props) which are close to the microphone and the source of sound and thus give a fairly short "slap-back," reverberation with a short time lag. Very short time lags, such as those produced when talking inside a telephone booth or a rain barrel, are described as "barrel quality." Medium-length time lags, produced by talking in a medium-size empty room, are described as sounding "drummy." Long time lags are called "echoes."

(2) The *acoustics of the studio sound stage as a whole*, which can either soak up all sound reaching them or give echoes.

(3) The *characteristics of the microphones and the way in which they are placed and used*.

The general qualities to be desired in microphones include the following:

(1) High-fidelity quality with wide range audio-frequency response as uniform as possible at all frequencies.

(2) Maximum control of directional characteristics for easy adaptation to varying acoustical conditions.

(3) High signal-to-noise ratio.

(4) Small-size, light-weight, rugged construction.

(5) Dull, neutral grey finish to avoid reflecting light and distracting the actors.

The basic method of microphone handling requires the use of a mobile boom, similar in type to that used in motion-picture studios which makes possible the movement of the microphone in three dimensions: up and down, around in a circle, and forward

and backward as the boom is telescoped in and out. These booms, usually mounted on a wheeled tripod, can be moved about with ease, especially if a "pusher" handle is attached to one of the wheels so that it can be pushed and steered by one man.

Auxiliary methods of microphone placement include the hanging of microphones in semipermanent positions over the set in cases where action is limited or where it is inconvenient to use a boom, as well as the hiding of microphones in the set as mentioned earlier in this chapter. A special type of "hidden" microphone is the so-called lapel microphone, a very small instrument which hooks on to the lapel of the wearer's jacket and is connected to the control room by a thin wire which can be run down the inside of the jacket and then out across the floor of the set. With a little practice satisfactory results can be attained with this technique for picking up speech. Because the microphone is so close to the speaker's mouth, almost all background noise can be excluded. On the other hand, the quality is inferior to standard microphones, and the sound volume is subject to unexpected drops when the speaker turns his head too far to one side. This, however, may be partly corrected by using two microphones, one on each lapel.

Other types of microphones which offer promise are the so-called "line microphone" and "parabolic reflector" developments. These obtain extremely high directional characteristics at medium and high sound frequencies so that a person's voice may be picked up out of a crowd. Prewar models, under development by both Western Electric and RCA, never thoroughly satisfied the engineers who built them, although broadcasters have reported successful use. This type of microphone, which can effect pickups from twenty-five to one hundred and fifty feet from the source of sound, would seem to have a definite place in television—particularly when perfect sound quality is unnecessary in picking up parades or sporting events, public forums, and programs involving audience participation. In short, these "line microphones" are to the audio what the telephoto lens is to the video.

Chapter 18

REALISM AND ACOUSTIC PERSPECTIVE

SINCE the microphone and the camera are essentially realistic in that they transmit precisely whatever reaches their sensitive surfaces, the question arises as to just what the “realism of television” is.

In the coverage of current events as they happen it is the reproduction of a faithful image of reality without distortion or change. In the audio this means the inclusion without undue editorializing of all pertinent sounds which occur as part of the action, and the exclusion of extraneous sounds which our binaural hearing would isolate if we were present at the event.

This rough definition breaks down immediately (in pure theory but not in practice) because a commentator can hardly avoid making his own selection of the most interesting happenings and therefore builds up additional dramatic effect by a process of editing. As a commentator proceeds with his spoken comments he omits certain things of necessity, and the resulting audio image of reality cannot possibly be a completely realistic (naturalistic) record of what is occurring—although it may be so in spirit and effect.

In programs which are rehearsed in advance, television’s realism is largely (but not entirely as in motion pictures) a predetermined sequence of selected elements of reality blended together with a dramatic purpose and rhythm to create a new reality. The elements of reality which are employed include the various forms of the video and the complete audio—speech, natural sound, sound effects, and music.

Speech and natural sound can be both *synchronized*—that is, spoken or created by visible actors or actions on the set with sound and sight coinciding—or *nonsynchronized*. Nonsync speech and sound would include any and all sound the source of which is not seen in the video, whether it be off-camera dialogue and natural sound (created by action on the set), or commentary and narration. It would also include sound effects (sync and nonsync, realistic and abstract) and music used for background effects or for its own sake.

Spoken words convey an intelligible meaning which must be comprehended by our *sense of reason* before they can affect our emotions and actions. Abstract sound, such as music, conveys little or nothing intelligible to our sense of reason, but it can affect us emotionally. It exercises a power of suggestion by cutting past our sense of reason and speaking directly to our *unreasoning emotions*. Suggestion is such a potent way to put over an idea and influence people that a great measure of television's effectiveness lies in its aural and visual employment.

Like the video, the audio can be used either for literal statement or suggestion—with the emphasis on the latter. Spoken words can express ideas which influence our emotions not only through our sense of reason; they can also be made to influence our emotions directly by emotional shading and coloring of words.

A textbook on astronomy is completely literal and appeals solely to reason, while a political speech, a spoken commercial advertisement, or a poem is calculated to appeal to our emotions as well. Every word, every shade of meaning, every vowel and consonant sound is chosen for that purpose. The extent of the emotional reaction is directly proportional to the excellence of the writing. Perhaps it can be summed up by the way in which Ford Maddox Ford described the power of poetry. It is "not the power melodiously to arrange words, but the power to suggest human values." Carrying the example still farther, a writer of highly "personal" poetry like Wallace Stevens often conveys little or no meaning to one's sense of reason but does affect one's sensibilities. Unless the reader (or listener) is most perceptive, or familiar with the "vocabulary," he gets no literal, coherent meaning out of it. The power of this type of poetry lies almost entirely in suggestion.

The greatest problem of a television production department in handling synchronized speech and natural sound is to get a pickup which sounds as though it really were originating in the video scene and not in a room which is both noisy and an acoustical monstrosity.

As noted before, when we observe anything in real life we see it binocularly, with two cameras (our eyes) and we hear it binaurally, with two microphones (our ears). Each of these is a *separate* sight or sound system in itself, capable of functioning independently or in concert with any combination of the others. With this system of binocular seeing and binaural hearing we can accurately judge distance and direction. If we view with only one eye it is more difficult to judge *distance* than with both eyes. If we listen with only one ear it is more difficult to determine *direction*, and the reverberation of sound becomes more noticeable, thus exaggerating the apparent distance of the sound source.

Television, possessing neither a stereoscopic video nor a stereophonic audio, is like a one-eyed, one-eared man observing real life. Fortunately there are ways to make up for this. The visual image can help to indicate the source of a sound and show its movement. Acoustic perspective in speech and sound can assist the eye in determining the spatial relationships of the objects in a two-dimensional picture.

There are two ways in which the human ear notices the extension of space through acoustic perspective:

(1) By the kind of reverberation, or lack of it—as in a “dead” room, or out of doors.

(2) By the “distance” between places where sounds occur—*aural contrast*. If two sounds are “crowded” together, a “narrow” effect is achieved. If sounds are “separated,” a sense of distance is felt. For instance, we might hear voices in close-up position with a church bell ringing more softly, perhaps with some echo effect as though it were far away.

These factors control *acoustic perspective*:

(a) The amount of sound reflection (reverberation).

(b) The type of reverberation caused by varying time lags and quality of reflection (degrees of reflection at varying frequencies).

(c) The increase or decrease of the over-all *volume range*.

It is important that the correct perspective of sound to sight be preserved. If it is not, the illusion that the speech or sound is being created by the actors seen in the video is lost and confusion is created. On more than one occasion people viewing television for the first time have complained of this.

In the balancing of the relationship of the microphone and the camera to get correct acoustic perspective there is a very definite ratio between the apparent visual distance of a shot and the apparent aural distance.

In the June, 1938, issue of the *Journal of the Society of Motion Picture Engineers*, Messrs. Maxfield, Colledge, and Friebus presented a system, used in motion pictures, for insuring correct acoustic perspective. It is quoted here in part for what interest and use it may be in television:

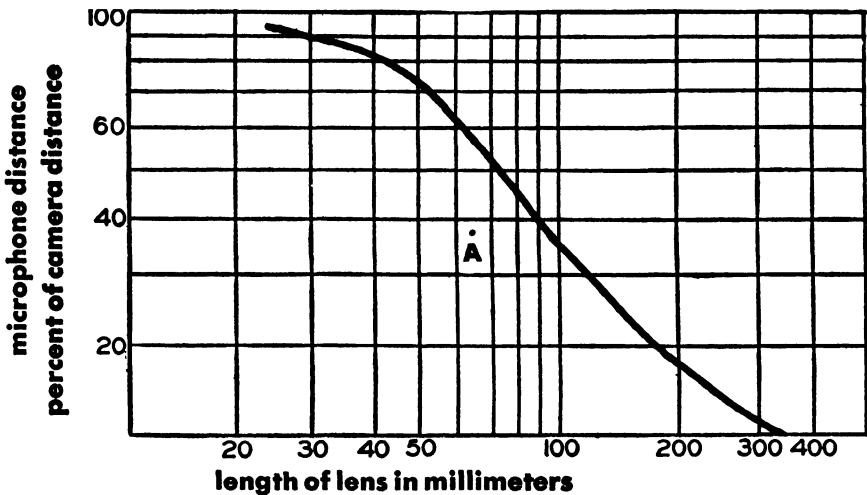

FIG. 18.—Curve developed in motion-picture practice by Maxfield, Colledge, and Friebus, for determining distance of microphone from subject in terms of percentage of apparent camera distance.

Practical experience . . . has led to the use of a single curve of the type shown. On the first close-up made in a given set, the microphone distance for properly coordinating the sound and the picture can be determined by ear. This is the standard practice for all the takes made. As an illustration of the use of this curve, let us assume that the camera is equipped with a 65-mm. lens and that the microphone position, for

the first take, falls at a point A. A line sketched through A, parallel to the curve then shows the correct relation for all further takes made in this set. It is believed that this procedure, which takes but very little time, has merit, in spite of the fact that many skilled operators can make a reasonably satisfactory ear adjustment for any given take. On the other hand, where some time has elapsed between the first use of a set and its subsequent use, changes of judgment may occur so that the two groups of takes do not inter-cut as satisfactorily as they should. The use of the suggested technic avoids such mis-matches.

It has been the authors' experience, and that of some microphone men with whom they have discussed this problem, that unless some such guide is used there is a tendency to set the close-up takes correctly and to make the microphone positions for the long-shot and semi-long shot takes decidedly too close. The use of the curve, of course, helps to keep the judgment of the operator calibrated.

There are occasions when it is necessary to use several cameras on the same scene simultaneously. When the acoustic perspective is of no dramatic importance, a single close-up track can be used for all the picture takes, the sound being "dubbed" at slightly lower level for the long-shot scenes.¹ If, however, the perspective contributes materially to the dramatic effect, it is possible to obtain full acoustic perspective by the use of two simultaneous sound-tracks. The first track has a microphone position corresponding to the closest close-up, while the second track has a position corresponding to the longest long-shot. By mixing these two tracks in the proper portions in the dubbing process, the sound can be made to appear to come from any intermediate distance necessary to fit the picture.

In television productions there will almost always be more than one camera in use, and cutting will be going on from long shot to close-up. In order to get correct perspective, the microphone boom operator would have to be continually swinging the microphone back and forth with each cut—an impossible situation.

One possible solution to the problem—paralleling the use of two sound tracks in film—would be to use two microphones, one in close-up position and one in the longest long-shot position. By mixing the output of these two microphones in varying degrees

¹ The overall volume range drops as the source of a sound gets further away. Hence, by lowering the volume slightly, one gets a rather neutral, semi-distant effect for the whole thing. This is a compromise used only in cases when there is neither time nor money to do it perfectly.—R. W. H.

variations in acoustic perspective can be obtained. However, experience has shown this is not completely satisfactory for two reasons:

(1) It is difficult to determine accurately and instantaneously the correct mixture of the two microphone channels. It leaves too much to chance.

(2) The second microphone, set at a sufficient distance from the cast to get an extremely long perspective, will also pick up every bit of background noise in the studio.

Another possible method would be to use a directional microphone and when cutting to a long shot, from a close-up, rotate the microphone on its pivotal housing so that the actor goes "off beam." This method might work reasonably well under certain conditions, but it, too, has serious drawbacks:

(a) It is inaccurate, being rough guesswork on the part of the boom operator.

(b) It might introduce unexpected distortions or reflections, cause by the position of the microphone in the set at that particular minute.

(c) While throwing one voice, or group of voices "off beam," it might unexpectedly throw someone else "on beam" and so upset the perspective.

(d) It might introduce unwanted studio noises, particularly since the volume might have to be increased (the "gain" turned up) because of the drop (in volume) of a voice going "off beam."

A third possible method for the control of acoustic perspective would be the use of filters, to cut off high and low frequencies. The National Broadcasting Company has experimented with a variable equalizer which drops the low and high sound frequencies when a long shot is cut in, but judging from prewar examples observed on the air it was not completely successful. In motion-picture work an increase in response around 2,500 cycles has sometimes been used to increase the feeling of "presence"—the feeling that the voice is really coming from the image seen on the screen.

There is still another way to attack the problem of acoustic perspective, a method which has not yet been applied to television and which seems worthy of further investigation. It is based on the use of *synthetic reverberation* apparatus, two systems of which

have been developed. The Hammond Organ Company has evolved a commercially marketed reverberator for use with its electric organs—to add echo quality to the completely nonreverberant tone of the organ. This reverberator is electromechanical, based on a system of vibrating springs, and has given a good record of performance in radio work—although it requires delicate handling to keep it from getting out of adjustment. Another synthetic reverberator, which seems even better in basic design, was experimentally developed in 1939 by Peter Goldmark and Paul Hendricks of the CBS Television Engineering Department. Although it has received no further improvement since the first laboratory model was made, it offers considerable promise for television practice.

The farther we go away from the source of a sound, the more our ears notice the reverberation, “room quality,” “liveness,” or whatever one wishes to call it. And as the ratio of reflected sound to direct sound increases, the over-all volume decreases. Thus by control of reverberation and volume, fore and aft perspective in sound is achieved. Listen to almost any dramatic radio program, and you will notice the application of this. In radio it is usually accomplished by having the actors move closer to or away from a microphone which is in a *fixed* position. In motion-picture practice the procedure is reversed, and the microphone is moved closer to or away from the actors. Since only one camera shot is made at a time in motion-picture production, this method is satisfactory. In television, as we have noted already, it is not satisfactory because of multi-camera, continuous shooting. Any technique which can satisfactorily control acoustic perspective without involving complex movements of the microphone is a step forward. This is exactly what synthetic reverberation apparatus can accomplish.

The technique of using a synthetic reverberator calls for an acoustically “dead” studio, making it possible to set the microphone in correct aural perspective for a close-up shot without having to bring it as close to the actor as would be necessary in a “live” studio, and giving the director greater freedom in his cutting.

This gives only close-up acoustic perspective for all shots—until the synthetic reverberation apparatus is brought into use to add reverberation and thus alter perspective as desired. The experimental model developed by Goldmark and Hendricks is an electro-

optical system which introduces any desired degree of reflection into the sound channel without degrading the quality of the original sound. Its control is centered in a small box with a start-stop switch and two mixing dials. One mixer controls the sound volume, and the other controls the amount of reverberation introduced into the original sound signal as it comes from the studio. By adjustment of these two mixers instantaneous control of fore and aft perspective can be obtained.

In the use of this type of equipment a script containing all video cues would be needed for the microphone boom operator as well as for the control room personnel—the director and the audio and the video control engineers. The cues might be marked with the desired acoustic perspective shown in terms of apparent distance and with any characteristics of the scene which would affect the audio quality also shown. In the following sample script note how this might be handled. The desired perspective is marked in feet at the beginning of the dialogue for each shot, although the dialogue is omitted here to save space, and its position is merely indicated:

<i>Video Cues</i>	<i>Audio Cues and Text</i>
FADE IN CAMERA #3 (<i>Long shot in cave, Soldier addressing crowd.</i>)	SOLDIER—(60 feet, fade in) . . . And fellow citizens . . . (Dialogue con- tinues) . . . and this is the issue facing us.
CUT TO CAMERA #1 (<i>Dolly in long shot to medium c.u. Soldier</i>)	SOLDIER, cont. (<i>Same, dolly in to 6 feet</i>) . . . What shall we do . . . (Dia- logue continues) . . . therefore we must strike as one man.
	CROWD—CHEERS OF APPROVAL. DISSOLVE TO:—
DISSOLVE TO CAMERA #4 (<i>Interior, bedroom, c.u. of Governor</i>)	GOVERNOR (3 feet c.u.) . . . But, my good man, these people have no will to fight . . . (Dialogue continues)

The audio engineer by following his script can instantaneously adjust for any type of acoustic perspective by turning the two control dials of the reverberation apparatus, or in the case of the last shot he would instead cross-fade the dials controlling the micro-

phones used for each pickup and eliminate all reverberation in the bedroom shot. In short, this control of perspective provides flexibility, simplicity of operation, low cost, and a reduction of possible errors to a minimum.

By using an extremely "dead" studio and set it will be possible for the boom microphone to be much farther way from the actors than is possible in a "live" studio. In most cases all vertical movements of the microphone will be eliminated; the boom operator will not have to raise and lower it rapidly as the video cuts from close-up to long-shot camera. This is the most difficult type of movement and source of most errors. Only two-dimensional, horizontal movement will be necessary to follow the actors as they move about the set.

And, since the microphone will be farther way from the actors, its "beam" will cover a correspondingly wider area and thus lessen the danger of actors getting "off beam." The end result of this is a reduction of three-dimensional microphone movements—all of which adds up to better shows and lower costs.

While this synthetic reverberator technique will provide fore and aft perspective, it will not provide certain frequency distortions needed in getting special effects, such as the familiar "telephone quality" used in radio to indicate a telephone conversation. This is accomplished by the use of a filter which removes the low frequencies from the original sound signal. Another scene might be laid in the steel hold of a ship, requiring a metallic quality of reverberant sound, which probably would call for a special, metal-lined echo chamber. In the main, however, a synthetic reverberator will take care of most acoustic perspective problems.

Just as a special technique has been evolved for sound effects and speech on radio and in the cinema, so a special set of techniques will be evolved for television.

The microphone is a searching instrument capable of great intimacy. We know from observation how badly "stage" diction sounds in television, and from the example of the cinema it seems not improbable that television dialogue will be most effective when used sparingly, when every word is made to count but is given lightly, evenly, and without overpointing in conventional stage

technique. In most television shows best results will be obtained by leaving as much of the storytelling as possible to the video, while using the audio to heighten and expand the emotional content as set forth in the video.

When sound pictures first came in, producers indulged in an orgy of speech and the resulting pictures were often long-winded and dull. They failed, for the most part, to realize that although the technique of motion pictures was revolutionized, pictures still were primarily attractive because of their visual action—because the pictures moved on the screen.

These early sound pictures were often little more than stage plays photographed, with the technical problems of synchronized speech dominating the scene and restricting visual action. Sound pictures poured forth a welter of dramatic speeches—ideal for the medium of legitimate theatre but not for motion pictures. Visual action and eye appeal were greatly diminished for the sake of long speeches. Opportunities for effective use of sound effects and music suffered likewise. Almost the only sound effects used were the simple, synchronized things like a telephone or doorbell, a knock on the door, an automobile motor or horn. Most early (1936–44) television plays were an exact parallel.

These television dramatic shows are likely to remain dull unless we profit by the mistake that early sound pictures made. From the example of early television and early sound pictures we may be justified in making these conclusions:

(1) Speech is usually subordinate to visual action, and should be used sparingly—*not* as in the legitimate theatre. However, the sense of reality one gets when viewing a televised scene may make it possible to achieve things which are impossible in motion pictures. It may turn out that we can use a good deal more talk in television than in the cinema. This is a problem which can be settled only by extensive experimentation and observation of regular programs over a number of years. This reaction (acute sense of realism) may be only a result of our being conditioned to television and aware of its problems and procedure. Some observers do not get this acute sense of reality at all.

(2) Immense powers of suggestion lie in the imaginative use of commentary, specially composed television music—which for the

moment is economically beyond our reach—and sound effects, “sync” and “nonsync.”

Early talking pictures made little use of nonsynchronized speech and commentary, a technique highly developed in radio. Most speech was straight dialogue, synchronized with the visible movements of the actors' lips. About the only extensive use of nonsync commentary in the first half decade of talking pictures was in travelogues and newsreels. In 1934 the first releases of “The March of Time” advanced the technique of nonsync commentary, and by the middle of the 1930's, a number of documentaries of a new type were being prepared in England and the United States. These raised the technique of commentary or narration to the status of an art, effecting a blend of music and spoken narration used in both contrapuntal and harmonic relationship to the visual image.

Because of the close ties of television with standard radio, and perhaps also because of the preoccupation of the *avant-garde* of American television with all forms of documentary treatment, narration and commentary by unseen or occasionally seen speakers has been widely used in early television. It seems certain that nonsync commentary will continue to enjoy this vogue and be used as extensively as straightforward dialogue spoken by visible actors.



PLATE XL.—Grand opera as televised by NBC. Armand Tokatyan appears in *Pagliacci*. Biggest problem with opera has been its highly theatricalized conventions which appear stilted and ridiculous on television. Spacious studios are desirable for opera productions, which suffer when crowded onto small stages. Conductor in foreground of picture is leading orchestra in the studio (*unseen in this picture*).

PLATE XII.—One of the more obvious types of television programming is the appearance of a singer in front of a microphone. However, by exploiting television's qualities of intimacy and transference of personality, this can still produce a good program if the singer has the personality and voice of Jane Froman.





PLATE XLII.—Dancing in all its forms has proved to be good television material. One of the first television cabaret programs, *Café Cosmopolitan*, produced in London (1937) featuring Ernest and Lotte Berk. Notice the spelling of Myrrh (Byrrh) and Bubonnet (Dubonnet) in keeping with the BBC policy of no advertising.

PLATE XLIII.—An early experiment with English music hall material. Tom Costello appearing at BBC (1937).



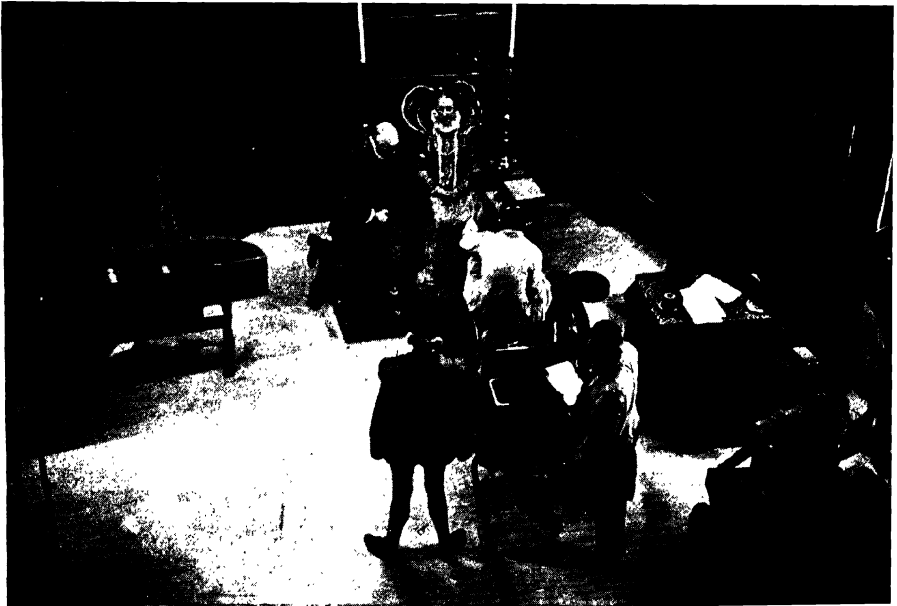

PLATE XLIV.—Costume drama at BBC. Basil Gill and Nancy Price in Clemence Dane's *Will Shakespeare* (1938). Director was George More O'Ferrall.

PLATE XLV.—*Bardell against Pickwick* (1938). Dickens, adapted for television, at Alexandra Palace. Note camera at left, which is raised on extensible mount.





PLATES XLVI AND XLVII.—Ballet at BBC. *At top*, the Covent Garden Russian Ballet Company of Colonel de Basil in a rehearsal of *Les Sylphides* (1939). Notice the camera moving right into the center of the dancing group, and notice small stage space which cramps form of dances. *At bottom*, the Vic Wells Ballet in a performance of *Checkmate* (1939) produced by D. H. Munro. Notice camera moving inside the group of dancers and placement of two additional cameras at right, one on raised platform, and the other on floor directly beneath.



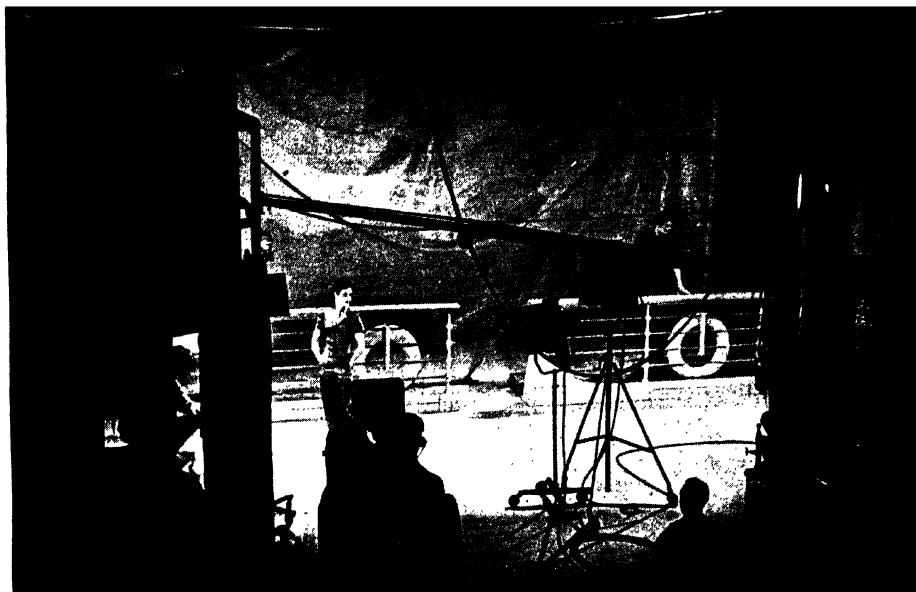

PLATE XLVIII.—Fashion parade on BBC (1939). Note raised control room at left, theatrical type of staging with scrim curtain in background, and cameras viewing from one angle only.

PLATE XLIX —Pianist Esther Fisher appearing before the BBC cameras (1939). Camera at right is concentrating on keyboard.



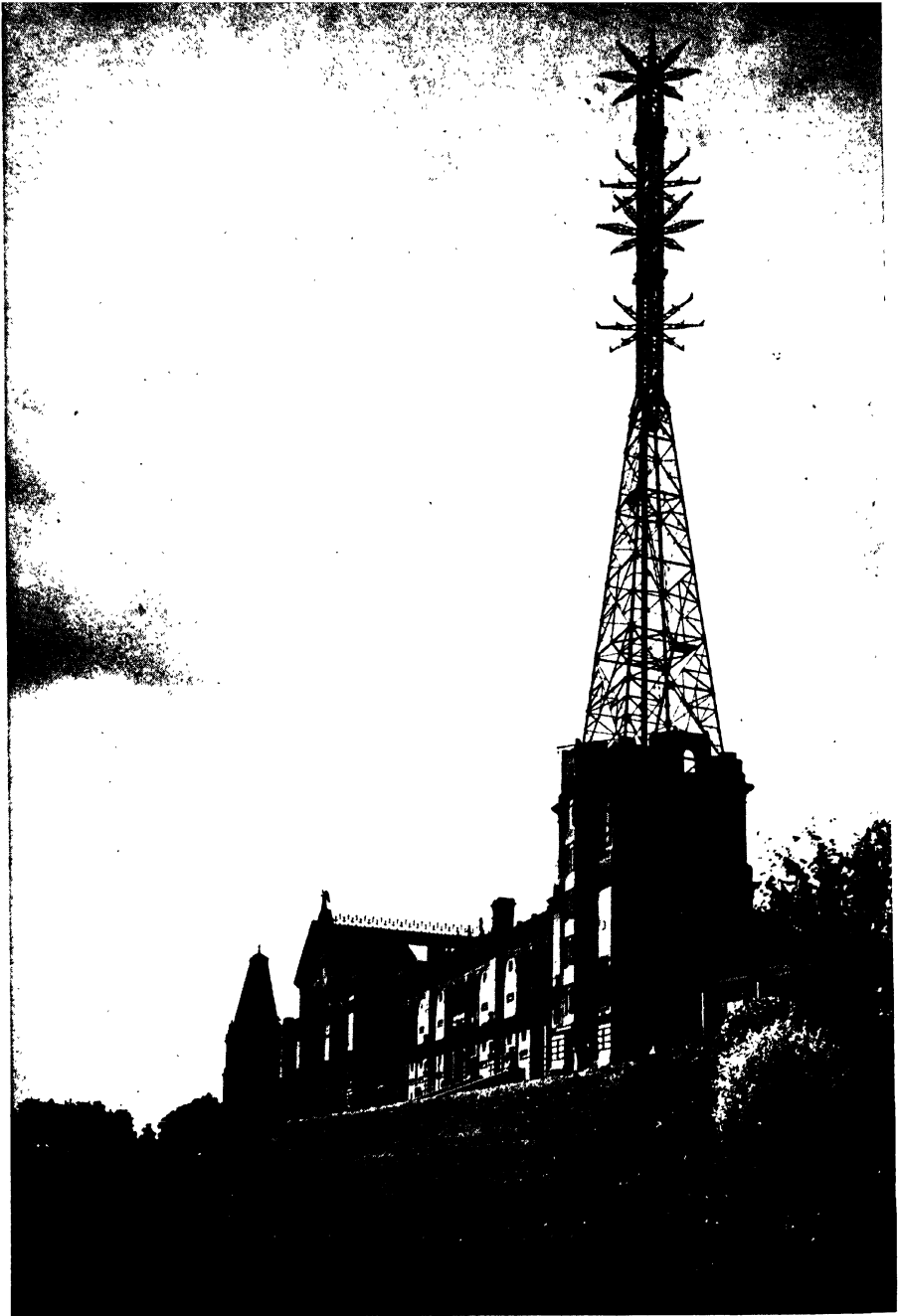

PLATE L.—Alexandra Palace in London where BBC Television began. The building was adapted for television (1936) and the transmitting tower was erected at one end, after suitable reinforcement of the structure of the building—which accounts for the architectural incongruities.



PLATE LI.—British television producers dramatizing the everyday life of England (1939). *At top*, the television unit visits BBC farm near London. Note focusing device on Emitron camera at right and portable fish pole microphone boom balanced on technician's shoulder. *At center*, BBC televises model boats at Kensington Gardens. *At bottom*, Archie Compston gives a golf demonstration.





PLATE LIII.—Expressionistic drama, *The Insect Play*, televised at London (1939). Note shadows projected from rear on white backdrop. Note, also, overhead incandescent lights with silk diffusers before them.

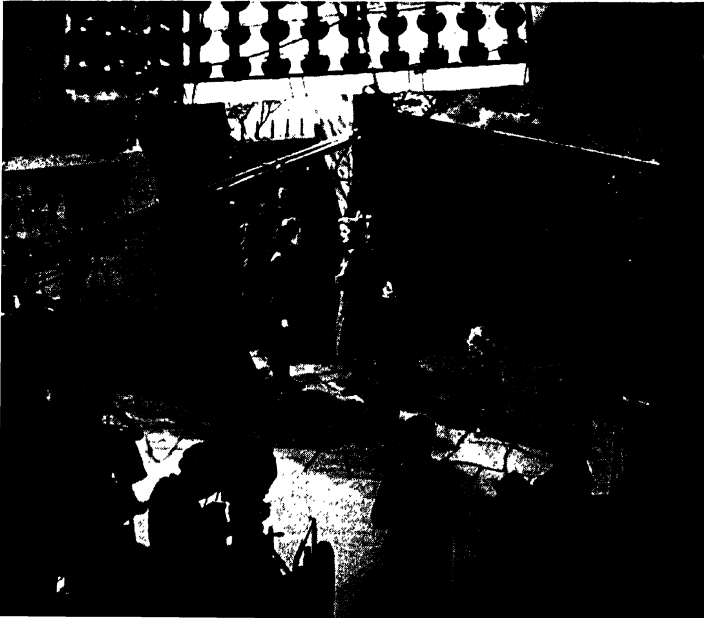

PLATE LIIII.—*Prison without Bars* was televised on August 29, 1939, three days before BBC Television was closed down by the outbreak of war. Note the design of the setting and its placement which enabled cameras to shoot from several angles. Note also that most of the lighting is coming from one direction, which has resulted in all shadows falling the same way.

Chapter 19

THE USE OF SOUND

THE EFFECT of a visual image on the mind is almost instantaneous, but the effect of the spoken word is delayed, since the literary meaning (the appeal to reason) takes time to be comprehended. When speech and visual action are synchronized, the scene can be absorbed in a flash by the eye, and a delay may be imposed on the visual action until all the words have been spoken and their meaning has been absorbed.

This may produce a conflict between the aural and the visual appeal, one which was noticeable in early sound pictures and in early television. Sound pictures have largely overcome this conflict by learning to blend the two appeals smoothly, by developing a condensed method of handling film speech and a better technique for film music and sound effects—coupled with pictures which tell most of the story (visualization as opposed to illustration). Music and sound effects can be almost as rapid in their effect on the audience, because they appeal directly to our emotions and do not have to be filtered through our sense of reason. For this reason music and sound effects often displace speech in motion pictures during scenes with rapid action.

In radio the function of sound effects is to supply impressions of backgrounds, scenery, properties, and various actions. Sound is also used to effect transitional passages. With a few easily recognized sounds one can cover a situation which would otherwise require a good deal of talk by a narrator or a group of actors. It

should also be noted that in blind radio practically all effects are of this simple, easily recognized type—a necessary limitation, because if the sound effect is not so completely familiar to the listener that it instantaneously evokes a mental picture, it only causes confusion in his mind.

In television the video will show most backgrounds, scenes, and properties, as well as most actions performed by the actors. These actions, involving properties on the set, will make their own natural noises which will be picked up by the speech microphone. As a result most sound effects of the radio type will be unnecessary, and the development of a technique for television sound effects will have to begin just about where radio left off. Artistically there will be many points of similarity with motion-picture sound effects (which derived partly from radio) though, of course, there is little technical similarity in methods of handling.

The method of producing sound effects in television is similar to that used in regular radio broadcasting. The effects are created on the spot as the program progresses—using records or mechanical gadgets. (In picture work sound effects are “dubbed in” *after* the finished film has left the cutting room.)

When sound effects are used in legitimate theatre, the audience can usually detect the difference between recorded and “live” methods. These are the reasons:

(1) Because most sound-effect amplifiers and loud-speakers do not have “high-fidelity” quality, and the difference between natural and “canned” sounds becomes unmistakable.

(2) Because sound systems are not stereophonic or binaural. They are usually monaural.

In television as in pictures and radio these problems are not present, because the entire audio system is monaural, and so all sound is produced in the same way—without the binaural contrast one gets in the theatre. What one sees in television is not as wide-angle as what he sees in the legitimate theatre, and there is no need for stereophonic reproduction in which the sound seems to move all around the screen.

Most of the sound effects used in motion pictures and the theatre have been illustrative and synchronized, i.e., the sound of a motor to indicate an automobile is arriving. The same is true of radio, in

which some effects have been used until they have become clichés. An instance is the standard "night noises" effect of chirping crickets.

Closely allied to this is the "symbolic" sound effect, one which is so familiar that a brief aural whiff produces a stereotyped reaction: a typewriter clicking to indicate an office, a telephone operator answering a call to indicate a business office, or the playing of "Over There" to indicate a war theme.

Sound effects and background music achieve results by establishing a continuity of thought, an affinity of the ideas of the main theme and its desired overtones. This is done by a suggestive use of sound to force a mental association of ideas. This power of suggestion is brought into play by aural symbolism, comparison of likeness, and contrast.

Aural contrasts may be created in various ways, one of the simplest being a contrast of space between interior and exterior, a small room and a large room, a four-walled room and a two-walled terrace, a large room full of people and empty, a large, empty room and the interior of a cathedral.

Then there are contrasts in quality between a voice coming through a telephone and a natural voice, the clink of coffee mugs and the tinkle of champagne glasses, a knock on a thin door and one on a massive, oak door.

There are contrasts between small and large, thin and squat, empty and full, near and far, fast tempo sounds and slow, between extremes such as laughter of playing children and the scream of automobile tires on the pavement. These are all contrasts of volume, tonal quality, and rhythm.

The opposite of contrasts is the comparison of likeness; the snore of a sleeping person and the sawing of wood, the roll of a drum and the tread of marching feet, the pulse beat of a person's heart and the throb of an engine idling.

The next step from here would be the association of ideas: Hitler's voice and the screech of an old vulture.

Sound and picture are often used in a contrapuntal relationship which can be illustrated by the familiar example of the French film *Pepe Le Moko*, or its American version, *Algiers*. In the scene in which the informer is killed by the other members of the gang, he bumps into an automatic piano while backing away before his

executioners. The bump sets the piano going, and it grinds out a ragtime tune as the murder is committed on the screen.

Sound effects may be used subjectively to show the inner feelings of a character, although this is usually done with music. Sound can be used to indicate unseen action, to indicate a transition not only from one scene to another but also from one thought to another and from one time to another. It can provide an aural "curtain" or "blackout." Sound may be used to establish time, place, and situation, and the manner of its use may ruin a good scene, bolster a weak one, and, of course, make a good scene better.

The most elementary type of sound effect is a single synchronized sound—such as a knock when a hand is seen to rap on the door. (The hand will usually make its own sound, picked up by the voice microphone, while in radio a sound-effects man would do it.)

Slightly more complex in point of quantity would be the synchronized use of several sounds at once: a boat going through water and the sound of a motor, wind, and waves.

More imaginative uses of synchronized sound include such technical tricks as a "carry-over." In the classic British documentary film, *Night Mail*, there is a scene in a railroad switchhouse. A man throws the levers of the switches in order that the trains may pass by. Synchronized with the action is a metallic clank as the switch lever goes into place. It is repeated several times, firmly establishing the rhythm. The last time the lever is thrown, the camera cuts to a shot of a signal arm by the track jumping into position. The same metallic clank used for the throwing of the lever is "carried-over" and used for the signal arm, making clear the fact that the lever controls the signal arm. This provides a continuity of effect which tells in a few seconds what would take at least a minute with words only.

The same trick is used again in a railroad station scene in which bags of mail are being moved about. One sees the mail carts rolling along and hears the sound of their heavy wheels rumbling over concrete. This sound effect is carried over for possibly forty-five seconds, during which period one sees a number of shots of the handling of mail—scenes which would be passed by an observer standing on the moving mail cart. The sustained sound of rumbling wheels holds the sequence together.

Perhaps it should be pointed out that this sound effect was "dubbed in" after the scene was photographed. If the actual sounds in the station had been recorded, one would have heard only a welter of confusing noises because of the fact that the monaural sound system of a microphone would be unable to distinguish between various noises and to focus on the desired sound. Therefore the sound director has simulated on the sound track only the particular noise wanted, the one sound which added meaning to the movement of the cart. The myriad other sounds present in the station were excluded since they had no connection with the effect the scene was to convey.

By such discriminating and intelligent use of sound effects it is possible to produce (on a monaural system) the same psychological effect one would receive if he were actually present at such a scene in real life.

In the process of the "carry-over" a straightforward sound effect becomes nonsynchronized—and by "nonsync" is meant an effect which is not directly caused by some specific action seen in the video but which is motivated by the inner meaning of a production.

The potential uses of nonsynchronized sound are almost as numerous as those of nonsync speech, although less actual use has been made of it. It is next to impossible to set down any principles for their control, beyond citing example of previous use. The successful use of nonsync effects depends on the imaginative powers of the individual television programmer, especially as effects become abstract.

The remarks of one of the pioneers in the use of sound film illustrate this point. Alberto Cavalcanti, the French (and later British) director and sound expert, wrote in the November, 1939, issue of *Films*:¹

You remember in Fritz Lang's "M" (German film made in 1934), the murderer has the habit of whistling a few bars of Grieg's Troll Dance. Lang, with his usual brilliance, built this up to the climax of his film, at which the murderer was recognized by a blind man. Now, quite apart from the fact that Lang made the tune part of the plot, do you remember anything noteworthy about the effect of the sound on the dramatic intensity of the film? I do. I seem to recollect quite clearly that this

¹ Kamin Publishers, New York, 1939, 1940.

harmless little tune became terrifying. It was the symbol of Peter Lorre's madness and blood-lust. Just a bar or two of music. And do you remember at what points (towards the end) the music was most baleful and threatening? I do. It was when you could hear the noise, but could not see the murderer. In other words, when the tune was used "non-sync," as film people say.

Now let us go further. Have you ever heard a noise in the night—non-sync—i.e., without having any notion of what caused it? Of course. And you left your bed and went down to find out what caused the bang, or the thump.

These two examples—Lang's whistle and the bump in the night which you got up to investigate—lead us to consider two ways of using sound for dramatic effect, both methods based on suggestion. Lang's way was to use a *recognized and identified* sound. He used it to *suggest the menacing nearness of his character—without showing the character. Suggestion is always more effective in drama than statement.* This particular trick is capable of great development. A black screen, feet crunching on gravel; and so on. A friend of mine, making a comedy, made an amusing effect out of the tick of a clock in a dentist's waiting room; he speeded up the tick when the nurse came to claim the victim. I have a bit of dog-barking in my sound library which I sometimes stick into the track when I wish to suggest the open air, and a pleasant, gay atmosphere. It is almost essential that there should be no dog on the screen, or the effect is lost, because then suggestion becomes statement. The crying of seagulls was a sound-suggestion-device which became so common with film experimenters that it was laughed out of court.

The other device is the use of unrecognized and unidentified sound. Now, let us go back to the noise that got you out of bed. Had it been a voice, you could have recognized it as your wife's or your son's, or your neighbor's, or an unknown, and it would not have disturbed you. But noises have this quality—they do not inevitably suggest what made them. This means that certain types of noise can be used "incognito." An example: when we made *North Sea* we had to do a studio-crash, to represent a sudden catastrophe on board a ship. The sound staff approached the B.B.C. and everybody else, but they could not get a combination of sounds that would be sufficiently terrifying. They asked me. I told them at once that they would have to get a loud, unidentifiable sound to stick into the crash. They got it. A horrid metallic squeal which suggested that the vessel had been squeezed diagonally and had started all her seams. It was a wonderful noise—because it was *unrecognizable*. To take an example from the so-called "silent" days. An airplane was

flying towards us. The music-director "cut" the orchestra, and a strange, frightsome sound began, and got louder and louder. It was nothing like an airplane, but very frightening. When I got home, I was still wondering how this noise was done. Then I got it. It was a noise I had known all my life—an open cymbal beaten with two soft-headed drumsticks. How familiar! Yet it had lost its identity, and retained only its dramatic quality, used in conjunction with the picture. Pictures are clear and specific, noises are vague. The picture had changed a cymbal noise into an air noise.

Human beings are naturally afraid of something they do not know or understand. Coupled with the suggestive power of sound, an unknown, unrecognizable sound, or something vaguely recognizable (a muffled gasp, a creak on the stairs) can be highly effective.

The sound effect which Cavalcanti used in *North Sea* probably even caused something akin to physical pain by its associations. It was a "horrid metallic squeal." If it had been used alone, without any motion picture, it probably would have made people writhe a little—as when a finger nail scrapes across a blackboard. It sounds painful because of the associations it suggests to our minds.

Cavalcanti points out in the same article:

With noise, we must include silence. Even in the so-called silent days, a clever musical director would sometimes cut the orchestra dead at a big dramatic moment on the screen (producing an effect similar to Handel's general pause just before the end of the Hallelujah Chorus). Yet sound-film directors do not appear to be aware of the possibilities of the use of silence. One brilliant early example, however, will remain always in my memory. It is in Walter Ruttmann's *Melody of the World*. He built up a big climax of guns in a war sequence, worked it up to a close-up of a woman emitting a piercing shriek, and cut at once to rows of white crosses—in silence.

In the hands of an artist of Ruttmann's calibre silence can be the loudest of noises, just as black, in a brilliant design, can be the brightest of colors.

Cavalcanti might also have noted that this use of silence was objective in approach. A striking, *subjective* instance of silence as a sound effect was its employment in the film *The Life of Beethoven*,

made in the late 1930's. The desired effect was to underscore the tragedy of Beethoven's deafness. Outside his house we see and hear a thunder and lightning storm. Inside Beethoven is pounding on his piano, obviously composing under difficulties. At the climax of the scene the camera cuts to a close-up of his face, and at the same instant the sound track becomes silent. Not a sound is heard, no matter how heavily he strikes the piano. The audience realizes the tragedy of his deafness with far greater effect than if the actor had simply stated he had lost his hearing. If I recall correctly it was in the same film that another striking use of silence was made. A group of children are playing, laughing, and shouting in the village street. As the deaf man draws near the children, the camera is placed (subjectively) in his position, shooting the children from his viewpoint. Simultaneously the sound track goes dead.

In pointing out that the imaginative employment of sound is as unlimited as the shadings and angles of the camera, Leon S. Becker, of Warner Brothers Pictures, has laid stress on the point that the ear is more imaginative than the eye and can be used very easily for purposes of suggestion. In the *Journal of the Society of Motion Picture Engineers*, August, 1942, he wrote:

The sound of a coloratura soprano gradually becoming a basso conjures up a picture of a phonograph record slowing down, but a visual image of the record slowing down does not define the sound—it might be a symphony or it might be a baby crying. We hear the sound of crickets and we imagine night; but a picture of a night scene does not necessarily make our brain hear the sound of crickets. We associate the chirping of birds with trees and the country, a siren with an ambulance. The eye will not violate actual experience, but varying impressions to the ear will be credible to the brain. The implications of these psychological phenomena for the purposes of the motion picture are tremendous, and have not been fully realized.

In the decade and a half of the sound-film's existence we have learned many things. The writer, actor and director have developed a mode of approach and a background of technic through experience as have the technicians. It was learned rather early that if the motion picture was to be dramatic and realistic, the technical elements that go into its creation should be so utilized that they return into oblivion as they do their work. And, axiomatically, if the film is to be effective

as a medium of expression, the elements that go into its creation must merge into the whole.

Dramatically, one of the unfortunate results of the employment of sound-effects has been its over-use—the cluttering up of a film with sound-effect because they are suggested by the environment. Psychologically we shut out sounds in real life—then why not in the film? Suppose a scene opens with a mother sewing. She is waiting for her child to come home from school. Initially, we hear the sound of a ticking clock in the corner, the laughter and shouts of children as they dawdle on their way, and the chimes of an ice cream man. The mother knows that her child is among them. Suddenly we hear the screech of brakes and a scream. The mother rushes to the window, the camera panning with her. Now, from the moment she hears the scream, there is no need for the ticking clock and the noises below. Everything suddenly goes dead; except the chimes of the ice cream man.

We achieved two things in this scene with sound: first, the cessation of the natural sounds after the scream pointed up the woman's reactions with picture; and second, increased the dramatic effectiveness by the use of sound contrast in the tinkling chimes. The suspension of background sounds is acceptable, because subjectively it occurs similarly in real life.

In the rush to get television started, in the confusion of mental hazards built up about the handling of the video, most television broadcasters made a mistake similar to one made by motion picture producers at the beginning of sound pictures. The latter were so overcome by the miracle of synchronized speech that they forgot much of what they had learned about basic film technique. They concentrated their attention on the microphone and turned out shows which were pretty poor.

Similarly in the early days of television nearly all telecasters ignored what had been learned about sound technique in radio and motion pictures. The audio technique of most early television shows was on a par with 1922 radio or 1926 sound pictures, which meant that even if the video part were first rate (which it seldom was) the program still did not click. Many broadcasters have been declaring that the future of television programming lies in motion pictures, because of the obvious ease with which a film can be run off, and they have failed to recognize the inherent audio-video possibilities of many of their own radio programs. While it will seldom

be possible to transfer a radio program to television without any changes, a large proportion of standard radio programs can be adapted without much trouble. Perhaps the first entirely successful example of this—other than sports and spot news—was the CBS Television 1944 version of CBS Radio's program, *The Missus Goes A-Shoppin'* with John Reed King and Paul Mowrey.

Television audio has a heritage from motion pictures and radio that is rich in technique, artistry, and showmanship. The sooner this is generally recognized and exploited the faster television will develop.

Chapter 20

THE USE OF MUSIC

THE THIRD audio classification is music, and the principles which govern its use for "background" purposes are the same as for sound effects: there must be real motivation, whether it be synchronized or nonsynchronized, lyric or a more "elliptical," commentative style. This is determined by the mood, the meaning, and the intention of the program, leavened by the taste and skill of the writer and director.

In a television musical program, the music becomes the backbone of the show, whether it be ballet, dance, opera, musical comedy, orchestra, or straight singing. Only when the musical scene in a revue or musical comedy gives way to a spoken dramatic scene does the music cease to be the guiding force. Then, if used, it becomes an illusion-building ingredient. But when a show is *built around* a musical composition, not specially composed for the program, then the general handling of the production will probably be determined by the mood and character of the music. On the other hand, if music is specially composed for a program, and all parts of the show are created at the same time, then the music will not necessarily dictate the general handling of the production. (All this may seem like "double-talk" about a simple, obvious thing, but there has been so much confusion on this score that it seems best to define it and try to get it out of the way.)

In these respects, music is used as it is in ballet, opera, musical comedy, and motion pictures. The magical powers of music can make incredible things credible, unreal things real.

In a nonmusical television show, music is the servant of the visual images. Like sound effects, it is a medium of suggestion which the director may use to heighten the impact of his production as a whole. When a director is unable to find or unwilling to use a convincing sound effect for a scene, music may be employed as an alternative emotional stimulant. Effective examples of this are found in the prewar French film *Katia*—here music is used for the scene in which the Czar is murdered by a bomb-throwing terrorist—or throughout the 1944 American film *Voice in the Wind*. And if a director feels that a scene is flat and needs picking up, he generally will use music to lift it.

Other familiar uses of music include such self-explanatory techniques as these:

Theme songs identifying a program as a whole.

Wagnerian *leitmotifs*, or “character themes,” heralding or accentuating the approach or presence of a character by use of a theme identified with him. This used to be common practice in the cinema until it was so overdone that it became a burlesque device.

Recalling past events by repeating music identified with those happenings.

Predicting future events by suggestive themes such as “mystery” music, or by using familiar music.

Imitating sounds, actions, or characteristics, in musical caricature.

Building *atmosphere* and indicating *time*, *place* or *unseen action*.

Providing a *transition* from scene to scene, place to place, thought to thought, period to period.

Suggesting a *blackout* or a slow “fade-out.”

Showing *subjectively* the inner thoughts, feelings, and meanings or a character or a scene.

Achieving *montage* effects with two or more themes or types of music played contrapuntally for special effects or distortions. A familiar example is Prokofieff's *Lieutenant Kije* music.

Another technique, but one that should be employed sparingly, is the use of music to “annotate” the dialogue. The practice of pointing up the dialogue by “parallel annotation” calls attention to the trick usage and tends to lower the emotional content of the music

and the authenticity of the speech—unless it is skillfully handled as a stylized sound effect.

Specially composed annotation music might include such things as a tinkling chord down the scale as the little girl trips lightly down the stairs; a lumbering theme by the bass viols as an elephant lumbers along; a shivering, shattering chord as a stone breaks a window, followed with a chattering, scolding, noodling effect by the oboes as an old lady peers angrily out through the hole, scolding at the little boy who runs away to the accompaniment of an elliptical twiddle by the clarinets. One of the classic examples of annotation was John Ford's motion picture *The Informer*.

Music can bring to television a method of achieving an element of unreality, of fantasy, or an overtone of "super-reality" (not "naturalism") which might not be achieved without its use. It can make a weak scene click and can fuse a broken scene into a unified whole. Even in the early days of television, when the economic factor precluded the use of specially composed scores played by large orchestras, it was still possible to achieve good effects with a small orchestra or by the painstaking and tasteful use of recordings, the latter having been amply demonstrated in the biweekly experiments by Bud and Edna Gamble over Du Mont television in 1944, and before that in experiments at CBS television from 1939 through 1941.

The person who selects and edits recorded music for a program must possess certain qualifications, if the results are to be satisfactory. In addition to a sound knowledge of music, he must be familiar with recording processes and the available stock of records, and he must understand the position of music in relation to a television production, whether it be a musical or a nonmusical show.

What can happen when this is not the case can spoil a performance. In one 1939 production, *Roosty*—a modern, realistic, problem melodrama set in an American farmhouse—incidental music for dramatic scenes included the symphonic poem *Finlandia*. In *Jane Eyre* (locale—rural England in the early Victorian era) incidental music for the poignant scenes of this rather intimate play, full of the atmosphere of the Brontës and their times, was a rendition by full symphony orchestra of the searing *Prelude in E Minor* of Shostakovich and the *Symphony Number One* by Sibelius.

Not only was this music completely wrong for the productions in mood, style, and content, but it was faded in and out at odd moments when there was no motivation. It was used under a large portion of the dialogue, and when the time came for lyric music to be used, when an "overtone" scene began, all the audience got was a continuation of what had been going on throughout the entire play.

If music possessing an emotional and aesthetic link with the content of the production cannot be found, it is better to use nothing at all than to botch up the show with music which is completely wrong. Good taste and showmanship are just as important in the selection of recorded incidental music as in any other phase of television.

Perhaps the problem of familiar versus unfamiliar and specially composed music might be mentioned here. When a familiar bit of music is used, it can create desired effects by its emotional associations. But familiar music can also confuse the audience, unless it is perfectly suited to the purpose of the show. It can, *by its very familiarity*, steal the center of attention from the visual action and story. Unfamiliar music, or specially composed music, may be more difficult to find. It may cost more money, but it can be tailored more perfectly for a given production and so produce more powerful effects.

Perhaps the most interesting use of music can come at that point of departure (from the strictly realistic) at which the director wishes to add an "overtone" passage of heightened intensity, to enlarge and develop a basic theme and meaning of the production. When such a sequence is introduced, there is a change which must be made by the audience in its sensory adjustment. This must be carefully handled and motivated, so that the audience is not suddenly conscious of the intrusion (distracting and seemingly unnecessary) of music. For example, in one "overtone" passage in the film *Night Mail*, the music was introduced by blending the sound of a locomotive steaming at high speed into music descriptive of the same thing. Then the music gradually changed its character from that of a stylized sound effect to a good narrative style and finally to a lyric style as the mood of the picture changed from realistic to poetic.

To sum up: in a nonmusical telecast, the music (as is true with all sound) is a potentially valuable ingredient but subordinate to the visual image. It supports the plastic quality of the video with its impersonal texture. The more it is subordinated to the video the more effective it is likely to be.

By this token music composed for a television production is not written for the achievement of a strictly musical end. If it were, the audience might focus its attention on the music and be distracted from the video. (This danger would increase directly as the quality of the music was raised.) For the most part, the music should keep to a plastic narrative style until the specific points at which a more lyrical "overtone" scene is introduced.

This brief discussion of some of the problems and uses of the audio possibly has indicated the need for a great deal of experimentation before we can hope to arrive at an effective audio technique. In the rush to perfect the video, it is to be hoped that the audio is not completely ignored. The following problems of the audio, for example, seem worthy of immediate investigation:

- (1) Acoustical design of studios, and the physical structure and handling of audio equipment.
- (2) Complete elimination of extraneous noise in the studio.
- (3) Control of sound reflection by permanent acoustical treatment, and by flexible and portable devices, such as reversible acoustical panels and portable "gobos" (acoustic screens).
- (4) Control of acoustic perspective by synthetic reverberators.
- (5) Experimentation with various types of microphones for various purposes, and perfection of highly directional line microphones (of the "machine gun" type) and parabolic reflectors.
- (6) Study of techniques for speech, sound effects, and music.

Part Six

BBC IN RETROSPECT

Chapter 21

TELEVISION PROGRAMMING IN ENGLAND

THE ART of television programming had its beginning in England. The British Broadcasting Corporation blazed the first trail, and television broadcasters in other countries patterned their early program efforts after the BBC. With this in mind I am including in this book a number of photographs of BBC Television productions. Unfortunately many of the original photos of British television (1936–39) were destroyed during the blitzkrieg against London, but enough remain to provide a reasonably good record.

In addition this chapter contains a record which should be of considerable interest to television programmers all over the world. It is a discussion of BBC Television programs by some of the people who created them. The discussion took place in 1944, eight years after television production started at Alexandra Palace and five years after it was ended by the war. The discussion took the form of ten question-and-answer sessions, with the questions being asked by various Americans and Canadians in England. Since the identity of the questioners is unnecessary and would cause confusion, their names have been omitted. All have been lumped together under the heading of "Questioner." These discussions ran to considerable length, and the material has been condensed to include only the essential material. Some rearrangement of order has been made to provide better continuity of subject matter, but the thoughts and original dialogue are unchanged, save for the abridgment. The material has been kept in dialogue form for easier reading and identification of each speaker:

QUESTIONER: Looking at television from the point of view of its audience, what did the viewer see? He frequently saw the faces of television announcers Leslie Mitchell and Elizabeth Cowell. Leslie, you were one of the first people to appear on the screen, weren't you?

MITCHELL: Yes, if you mean when our regular television service began. I was an announcer. Apart from announcing the various items, the announcer had to keep the show going in between whites. Television isn't like radio; you can't read off a script in front of a camera. Either you have got to memorize what you have got to say or improvise, and that very often without any warning. If anything goes wrong in the studio, the announcer is put on the screen to keep things going. The announcer also had to act as stooge for a variety of wild beasts from the London Zoo and elsewhere. He had to take part in various demonstrations by the London Fire Brigade, fall in bathing pools, take off in helicopters, and what have you. And, of course, we were never allowed to look surprised or agonized. Still it was great fun and we lived through it. In fact, Elizabeth Cowell, one of my colleagues, is here right now.

COWELL: Now I am back in radio it seems odd to have only the microphone to think of.

QUESTIONER: I suppose you had to wear special clothes, make-up, and so forth?

COWELL: At first we did. Jasmine Bligh and I used to wear dresses with bold floral patterns and our make-up was very heavy—blue lips, you know. But by 1939 we could wear everyday clothes, and even our make-up wasn't very different from the one we normally used. But I wasn't really thinking of that.

QUESTIONER: Oh, what then?

COWELL: The approach. The approach to your audience is so different in television. You were talking to an unseen audience who could see you. It was so difficult to decide on the proper approach. And, of course, there was no one to advise us in 1936 at the beginning.

QUESTIONER: And you had to find out by experience?

COWELL: Yes, and the reactions of friends and viewers.

QUESTIONER: Wasn't it something like motion-picture work?

COWELL: Well, in television your picture is not being projected

to an audience of, say, two thousand people in a crowded theatre. Your picture is being seen by one or two people at a time—well, not more than four or five anyway. Obviously it was no use playing to the gallery under those conditions.

QUESTIONER: That is true of the movies too. You have got to underplay to the camera if you want to be natural.

COWELL: Yes, but you are still playing to a big audience in a theatre. We were not. We found that the most effective way was "friend talking to friend." The great point was to be as natural as possible and avoid any sort of mannerisms. We appeared so often in the picture that any characteristic mannerism became exaggerated with each appearance. It is very odd how many little personal tricks you can acquire without getting at all conscious of them. You have to watch (remember) the camera, and don't forget there may be several cameras trained on you. You have got to remember the microphone. You have got to sense what the producer wants in an emergency, and you have got to keep track of the continuity all the time.

QUESTIONER: I would like to hear something about the subjects and types of programs you televised.

MITCHELL: That is where Cecil Madden [*BBC Television program organizer*] comes in. He can tell you best.

MADDEN: In the early days it was to some extent a matter of trial and error. With the tremendous variety of subjects open to us in 1936, it was almost impossible to lay down any rules about what was good and what was bad television. Right from the beginning our object was everything—real variety. In the very first television program we did, we had a complete variety show in which we showed everything, even the orchestra. That was August, 1936, for the benefit of a big radio exhibition called Radio Olympia. And very soon after we were showing all kinds of events in our park, extracts from plays and so on. We often took our cameras onto the balcony of our studio and just showed the viewers the view.

QUESTIONER: And what did you do in the later productions?

MADDEN: The same kind of thing. Only, for one thing, our camera could travel almost anywhere within a radius of twenty-five miles. Then the full length play took the place of the extract, and

our variety became more ambitious—there were famous stars and so on.

QUESTIONER: How did television suit the stars? Did you make use of personalities as such?

MADDEN: Yes, television is a very fine medium for personalities. I created a series called *Starlight* to exploit the biggest stars of variety, cabaret, or music world: Paul Robeson, Pyatigorsky, Alice Marble, Lou Holtz, Sophie Tucker, Bebe Daniels.

QUESTIONER: Did television make any stars on its own?

MADDEN: Yes indeed, and I am sure it will make the stars of the future. They won't necessarily be variety stars or even artists at all. They are more likely to be personalities who get known and liked by the public and so become the stars of the future. It is very dangerous ground to say which stars television made in our three years of working. We worked with so many vital personalities. But I think the comedian, Cyril Fletcher, would be the first to admit that television helped him quite a long way along the road to fame.

QUESTIONER: Tell me more about planning an evening's entertainment.

MADDEN: I worked it out like this. A feature film of average length is about ninety minutes—that is a fairly standard length to work to. So, in an evening's entertainment, we would open up with a personality—that might be a famous entertainer; then a newsreel film, then perhaps a game of bridge; a Mickey Mouse film next; and then your feature, a ninety-minute play. That will give you a direct evening's entertainment of two hours and a bit.

QUESTIONER: A ninety-minute play isn't very easy to find, is it?

MADDEN: Well, apart from a play written especially for television, we used ninety-minute adaptations of successful stage plays.

QUESTIONER: And did you ever put on a full-length play?

MADDEN: Yes, and we did actually telecast from several London theatres, taking our cameras down to the West End and televising absolutely everything: the play, the audience, the foyer, dressing rooms, backstage and all.

QUESTIONER: What did the theatre audience think?

MADDEN: It was a first-class thrill for them and for us.

QUESTIONER: What sort of plays went into the repertoire?

MADDEN: Everything from Shakespeare to Kaufman and Hart.

QUESTIONER: And how about light entertainment?

MADDEN: Music hall, as we understand it in Britain, is quite unsuitable. For home television, at any rate, the floor show is the goods.

QUESTIONER: Miss Bebe Daniels is going to ask questions about light entertainment. Miss Daniels, I think you appeared on many occasions in television over here.

DANIELS: Yes, I did, and it was great fun—very interesting too. One had to experiment in those early days in order to see what type of entertainment would televise best. I remember Ben [Lyon] and I tried everything—songs, comedy dialogue, sketches with all kinds of sound and visual effects, even to a ghost. Cecil Madden was our impressario in those early days. Everything was new, and because it was all so new, where did you get your best talent from, Cecil? Was it from the theatre? From motion pictures? From the music hall? Or from radio?

MADDEN: Not an easy question. Of course, we got artists from all those fields, but on the whole, I'd say that cabaret and theatre people were best—acts from music halls to some extent—and the radio field was the least promising. That may sound sweeping, but you've got to remember that television is an intimate medium where projection of personality counts. Tell me, Bebe, how did you feel about the intimacy of television?

DANIELS: I liked it. I always felt as though I'd received a special invitation from the audience to visit them in their homes. It was so intimate; they always seemed so near.

MADDEN: And it was near, Bebe. Don't forget, if you were four feet from the camera in the studio and the viewer was four feet from the screen in his own living room, well, you were only eight feet apart. And that makes for intimacy. Television is a living-room show. Whatever may happen about big movie-size screens, there'll always be a place, and a most important place, for the small-size domestic screen.

DANIELS: I agree. But with the small-size screen you needed many more close-ups—so many, in fact, that I used to feel that every eyelash counted.

MADDEN: Yes, I know what you mean. You had to be very careful not to overact.

DANIELS: Yes, but the same rule applies to radio, too, Cecil, and I thought you said--

MADDEN: Radio's intimate, too. And yet radio is a scripted medium and that makes all the difference. In radio, you create an illusion of a place in words. In television you have to see the place.

DANIELS: What about music hall, or vaudeville as we call it in America?

MADDEN: Well, I'd say "apt to be too broad," and a joke that would pass on the stage just might not work in television.

DANIELS: I can understand that. But what about sex appeal? Surely the television camera doesn't shy at that.

MADDEN: Of course not. A charming artist like Hildegarde was certainly tops. Chorus girls, dancing troupes, leg shows—fine. I did a series of all-American programmes. I called them *100 Per Cent Broadway*. We used to begin them with film shots of Broadway, mixing in the artist's name in lights, as on Broadway. We had the Chester Hale Girls, Robert Alton's Girls, and so on.

DANIELS: And didn't you use M.C.'s in the American fashion for those shows?

MADDEN: Yes, and one of the best was Russell Swann, the Magic Man.

DANIELS: What about magic—I mean conjuring? How did that fare in television? Didn't the camera see through the tricks?

MADDEN: Not a bit. It increased their interest, if anything. Taking a close-up of a card trick is a pretty high test.

DANIELS: How about floor shows? You used to specialize in floor shows, didn't you?

MADDEN: We devised floor shows—cabaret—which were pure television, not copied from films, or radio, or night clubs. I did a series called *Cabaret Cartoons*, which made use of pure television techniques. As the turns [acts] came up, I got a cartoonist to write up their names on sheets of paper. While the act was working, the cartoonist would make a quick sketch of it, and then by a series of dissolves, one could show how the artist was getting on with the sketch and then take a look at his subject. We timed it so that the act and the drawing were finished simultaneously. And then we could superimpose the subject on the finished drawing.

QUESTIONER: Now some facts about play production for tele-

vision from Constance Cummings, the actress, and Major George More O'Ferrall, one of television's most distinguished drama producers.

O'FERRALL: To begin with, you have got to remember that the television camera doesn't take photographs of the scene. It views the scene; it is like a human eye looking at what is actually going on. Now, before a television production we spend a long time making an accurate shooting script, which after the first week of rehearsals I adhere to strictly.

QUESTIONER: In other words there is no shooting off the cuff. But certainly that should mean a tremendous amount of rehearsals.

O'FERRALL: Well, under ideal conditions, about the same number of rehearsals as for a theatre production.

CUMMINGS: But, George, you used to rehearse for only about two and a half weeks.

O'FERRALL: Yes, because I like to rehearse at high pressure.

QUESTIONER: So as not to get stale?

O'FERRALL: Well, yes, partly. You see, during the actual transmission, the television producer plays an important part. He is in control of the movement and the speed of the cameras. [Note: In Britain the producer is the same as the director in America, whereas the producer in America is the executive in over-all charge of a production.] As he sits there in the control room, he can, by turning a switch, use any of eight cameras. It's only by seeing a scene with the actors that the producer can get the correct rhythm into the movement of the cameras, and it is also while feeling the part with the actor that he makes his cut to another camera.

CUMMINGS: So you see how different it is from motion pictures?

QUESTIONER: I feel this continuity in television compensates for not being able to retake.

CUMMINGS: It is an advantage.

QUESTIONER: Then the likeness between motion pictures and television, in the production that is, is really quite superficial. It's really the look of the studio and the conditions on the studio floor.

O'FERRALL: There is one important way in which television is like the movies. You can go on location.

QUESTIONER: You mean by taking your television cameras along with you?

O'FERRALL: Yes, or by using movie cameras, filming any scene you may use, and incorporating it in the actual transmission. Crowds are always difficult; you can do them much better in film than in television, but it is very different when you've got a single actor or a couple of actors.

QUESTIONER: Speaking about actors, I would like to know a little more about the acting side of it.

CUMMINGS: It is a very intimate kind of acting.

O'FERRALL: You've got to underplay, if anything.

QUESTIONER: Don't you miss an audience, Miss Cummings?

CUMMINGS: Yes, I always miss an audience, especially when I am acting before a camera. In the theatre the audience is taking part in the performance, and that helps the actor a good deal.

QUESTIONER: What about television? You don't have any audience there.

CUMMINGS: Well, you know, I acted quite a lot in television, and after a bit I found I was able to visualize a family in front of their television set at home.

O'FERRALL: Yes, the secret of television, before the war at any rate, was a small group of people sitting at home. As far as they were concerned the whole play was for them.

CUMMINGS: Here's a thing that might interest you. The effect of a play is often immensely heightened in television. Do you remember that occasion, George, when you produced *Night Must Fall*? Several people wrote and told us that the play became almost too exciting in their own home. They had been obliged to switch off their sets. That would never have happened in the cinema or in the theatre.

QUESTIONER: Philip Doughty arranged and produced many newscasts, among the most exciting pictures the BBC brought to its audience—the Coronation [of George VI], the Derby, the boat race, London theatre first nights, and so on.

DOUGHTY: I used to classify outside broadcasts under four types: actuality, sporting events, features, and direct from the theatre.

QUESTIONER: Actualities? I suppose you mean events which are going on irrespective of the presence of television cameras?

DOUGHTY: Yes, events such as the Coronation procession in May, 1937. That was the first big event actually televised. And there

was Prime Minister Chamberlain arriving back at the airport from one of his meetings with Hitler in 1938. And then the King and Queen leaving Britain for Canada and coming back from the United States.

QUESTIONER: And the television cameras went to work on these occasions just like the newsreel cameras?

DOUGHTY: Yes, but with this difference. In a newsreel an event is seen many hours after it has happened, after the film has been edited and anything dull or unpleasant has been cut.

QUESTIONER: You mean television must bring the unpleasant or the unfortunate incidents—it may bring dullness as well, simply because that is the nature of television?

DOUGHTY: Well, not quite, no. It is up to the television producer to eliminate dullness and to act as editor on mishaps if necessary. There was the famous occasion when we were televising the Armistice celebrations in Whitehall. The two minutes of silence were the most solemn part of the service. The King and other personages taking part were around the Cenotaph, and at that moment a fanatic disturbed the silence and tried to rush up to the Cenotaph.

QUESTIONER: And what did you do?

DOUGHTY: Nothing. I continued to hold the scene in long shot. I resisted what was, after all, a great temptation and didn't switch over to a close-up.

QUESTIONER: You mean you were anxious that the solemnity of the occasion should not be disturbed for viewers?

DOUGHTY: Yes, the viewers heard the shout "Hypocrisy!" and saw the crowd sway in long shot. Nothing more. What would you have done?

QUESTIONER: How is the studio organized? What kind of scenery is best for television? What about models? These questions will be answered by D. H. Munro, who was television's production manager, and Peter Bax, design manager.

MUNRO: Just imagine for a moment that I am sitting at the control desk two minutes before we are due on the air. I see the studio through a window. The studio manager has everything ready—his lights, sound, cameras, artists. Now I am looking at two screens in front of me. The one on the right is the picture actually being transmitted to the public, while the one on the left insures that the

producer may have the picture from any other camera in use, because you usually have four cameras in studio production.

QUESTIONER: You were really checking the picture before the viewer saw it?

MUNRO: Yes. Now to continue—the chimes of Big Ben at three o'clock in the afternoon or nine in the evening introduced our daily programs in sound, while in vision a short, specially photographed film showed pictures of the Houses of Parliament and Westminster Bridge, and finally as Big Ben boomed the hour, the clock face of Big Ben itself. Usually the announcer is waiting for his cue light to begin. The chimes of Big Ben fade. I give the cue, "*sound mix, vision following*," and the audience sees the picture of the announcer speaking his lines. While the announcer's face was being transmitted, the producer was having a look at the opening shot on his preview monitor. And then, as he had a complete cue script in front of him, he would be ready to give the O. K. to his studio manager, on headphones, to start the show. As soon as we gave the cue over the talk-back microphone—and, by the way, we always gave simultaneous light cues—the show was on.

QUESTIONER: And the producer was working from his script?

MUNRO: Yes, a detailed sound-and-vision script—that's very essential—with all the camera positions worked out on it beforehand. But, of course, at dress rehearsal we molded the thing into shape, and frequently during actual production.

QUESTIONER: And that's the real difference between television and movie production?

MUNRO: Absolutely. Television production depends on the utmost cooperation by every member of the team—cooperation of everyone engaged in the show, and the producer anticipating every shot. As a matter of fact, we almost got to know each other's minds. A good cameraman, for instance, would anticipate the producer's directions, and his feeling for his subject could make or mar the show.

QUESTIONER: You mean the cameramen are artists as well as technicians?

MUNRO: Yes, I cannot stress that too strongly.

QUESTIONER: How did you ever find time for rehearsals?

MUNRO: We didn't. The trouble was we never had enough time

for rehearsals. We'd put on a full-length play and only have time for a single full rehearsal with lights and cameras—if we were lucky. And the studios never stopped working. We would frequently televise a newsreel and sometimes a cartoon film as well during both the afternoon and evening transmissions. Each newsreel gave us a merciful breather of about ten minutes or so, because we had to move the old sets, put up the new ones; the cameramen would have to get on their new marks; artists take up positions; the microphone had to be moved round, and it gave time to re-arrange lighting.

QUESTIONER: Apart from those newsreels and cartoons, didn't you use films sandwiched into a single production?

MUNRO: Frequently. Perhaps the producer would want an outside scene in the play sequence—the hero or heroine walking through a leafy wood or taking an aeroplane from Paris to London. We'd have that scene specially filmed beforehand and then fused in, with the appropriate sound, at the appropriate moment during the studio production. Those special bits of film had to be very carefully shot and edited in order to preserve exact continuity. You had to be very careful not to overdo the use of film. Film is an accessory in television production; it is not television production.

QUESTIONER: Why do you stress that?

MUNRO: Because of the instantaneous character of television. The producer must always exploit that to the full.

QUESTIONER: Yes, I agree. Television happens right now, and in that it is unique.

MUNRO: Now, Ed [Murrow] you tell me something. What else impressed you, as you sat in our control room seven years ago?

QUESTIONER: The complicated nature of the thing. And then, I think, the speed at which everything seemed to happen. The way the studio would be transformed in a matter of seconds. I seem to remember a ballroom just crumbling into a forest in a few minutes. Peter Bax, scenery was under your direction, wasn't it?

BAX: Yes, and a fine time we had with it. Most of it was made of plywood, and that can be pretty heavy. And it was worked very hard, so it had to be very strongly built.

QUESTIONER: But you started with curtains only, didn't you?

BAX: That was the early days. Very soon we began to use flats.

Our scene construction was really a compromise between the flat painted theatre type and the three-dimension movie variety. The top had to be solid, but not too heavy for quick moving, and it had to be flexible and capable of being put to many uses. The answer to all that was the unit system. I designed a number of unit sets. We had twelve or fifteen in the end, each of which could be used for a particular historical period or for a particular kind of show. There was our "wallpaper" set. It consisted of a number of standardized panels covered with identical wallpaper, some containing a window, others a door, a fireplace, a cupboard, and so on. We could ring the changes with these standardized pieces or produce different effects for different productions. Then there was the "seventeenth century English panel" set, with furniture, pictures, and hangings of the period. There was the "French gold room—Louis XIV," which we first used for the production of *Le Bourgeois Gentilhomme*. That was pretty magnificent. There was the "modern" set; with suitable adjustments it could be used for Noel Coward or Shakespeare in modern dress. And there were outside sets, too. A garden set with an assortment of flower beds, pergolas, trees, lawns, rustic seats, and so forth. We often used models, although the big stuff is the backbone of television scenery. We put on many puppet shows and, of course, model props and scenery were essential there. We often used miniature backdrops and models of buildings. We used models for special purposes: for example, scenes on a farm. We had a real farm in Hertfordshire, with a real pond in it and live ducks. But in the studio we had a thirty inch model of the farm, with glass water and papier-mâché ducks. Now, before going over to the farm, we would show viewers the model in the studio, point out to them just what part we would be visiting—the stables, or the sheep pen down by the haystack, or the ten acre meadow.

QUESTIONER: I see, and then you'd switch over to the actual farm. And, apart from models, I suppose you used all the special gadgets and paraphernalia of the movie studio?

BAX: Of course. Revolving stages and rolling ships and shaking railway carriages, smoking fires, real fires, and all the rest of it. And our visual effects, just as they do in the movies, came from a combination of mechanical design and optical illusion.

QUESTIONER: You just had to be ready for anything?

BAX: Yes, I'd be asked to produce at a moment's notice anything from a volcano to a ghost. In the same transmission we might need a harpsichord, a train, a live elephant, a baby carriage, a Greek statue, or a forest. The biggest set I ever designed was a forest one hundred and twenty feet long. It was all around the studio, and it contained a castle and many a rustic log for Tristan to sit upon.

QUESTIONER: So you did opera too?

BAX: *Tristan* was one of the biggest shows we ever did, and one of the most original. The actors mimed their parts in one studio, and the singers sang in another. Then, a few weeks after, the Emperor Jones wandered through the same forest.

QUESTIONER: You know, Munro, I've got to be convinced about ballet in television. I've never seen any of your big ballet productions, but I've seen ballet in movies, and frankly it did not excite me very much.

MUNRO: Well, the answer to that is television is not motion pictures. Television is a new medium. I agree with you that to see ballet on the movie screen is not very satisfactory. Somehow the dancing becomes a background and at times a bore.

QUESTIONER: But why and how is television different?

MUNRO: Television has at least two trump cards: immediacy and intimacy. Moreover, it's been my experience that dancers believe in it. They give their best to it. Many people remark they had never seen Margot Fonteyn [ballerina of the Sadlers Wells Ballet] dance so well as she danced before the television cameras.

QUESTIONER: And you enjoyed it, Miss Fonteyn?

FONTEYN: Yes, I did. It was very exciting—completely different from a stage performance, of course. And what D. H. Munro said is true: dancers do believe in television and its future. Fokine said that he thought it would be one of the greatest influences in spreading abroad a love of the ballet.

MUNRO: The viewer gets the best, too. The viewer becomes richer by seven pairs of eyes, and in the hands of an understanding director endless new possibilities are opened up.

QUESTIONER: You mean the use of television cameras gives you the chance of seeing ballet from new angles?

MUNRO: Yes, the viewer can actually be in several different places at once.

QUESTIONER: Are you talking now about using camera tricks?

MUNRO: No, tricks is not quite the right word. Movie tricks, such as *The Invisible Man*, for example, are purely mechanical tricks and have nothing to do with a flesh-and-blood performance. Television cameras can give you several views. We can mix them, put one on top of the other, cut and edit as we go along. We can give you fades and close-ups, bring out all the essential parts of the work—something that is actual, and yet something fantastic. We were helped tremendously by our designs department. The fellows in charge of decoration very quickly seized on the opportunity of using special models and backgrounds to assist producers and directors.

In *The Sleeping Princess* we had many chances of showing what the cameras could do in that way. Malcolm Baker-Smith designed the settings. There were several very clever models, which enabled me to dissolve from the stage set to the model without the viewer noticing the change-over. Malcolm, you explain.

BAKER-SMITH: *The Sleeping Princess* is based on the old fairy story, of course, and there comes a moment in the ballet when the Princess on her couch falls asleep for a hundred years. The trees grow through the floor and cobwebs hang all over the place, until Prince Charming comes to give her the awakening kiss. Well, I made a model exactly like the stage set, so that when the witch cast her spell over the assembled company, we dissolved to the model, and everyone appeared to freeze where they stood. D. H. Munro, having dissolved to the model which was in front of another camera, was able in the meantime to have the stage set for the moment of awakening, in which case the superimposition process was put the other way round.

MUNRO: I got several little interesting bits of ghosting in that particular show. For example, a fairy floated down from the sky over an enchanted lake. Many tricks like these, with the use of models and two studios and six vision channels—five cameras and a moving-picture channel—could give a continuity to the ballet which even the theatre could never attain. Television was able to

abolish all those irritating pauses and hold-ups which become necessary when scenes have to be changed on a single stage.

QUESTIONER: How many people were working with you on the big production of *The Sleeping Princess*, or any other large ballet production?

MUNRO: Any major television production would take from forty to sixty people. There were sound-and-vision engineers, lighting experts, studio staff under the direction of the studio manager, the make-up and wardrobe department, the design people, the carpenters, painters, model makers, and so on.¹

QUESTIONER: I'd like to know how the whole thing was co-ordinated.

MUNRO: After the production had been approved and a date fixed on our program schedule, the producer would hold a series of conferences with the heads of the various departments and state his requirements. He did not always get them. It might be, for example, that his show would need a specially designed setting, in which case a considerable burden would fall upon, say, Malcolm Baker-Smith.

BAKER-SMITH: Yes, and *The Sleeping Princess* gave me special opportunities. You see, I always built three-dimensional models of my settings, because that enabled the producer to visualize the thing in terms of studio space, acting area, and camera angles, and so on. But in *The Sleeping Princess* the models which I had built were also used in front of the camera.

QUESTIONER: I suppose your settings were in color?

BAKER-SMITH: Yes, they were, and for two reasons: colors give a softer set of tone values on the screen, and they also have an important psychological effect upon the actors.

QUESTIONER: How do television settings differ from the ordinary theatrical decor?

BAKER-SMITH: In the first place they've got to be more easily movable, and, in the second place, they must be capable of being

¹ The total personnel of the BBC television operation was roughly 190 people, including the cleaning staff but excluding building employees such as doormen and elevator boys. It broke down as follows: Program Department, ninety-nine, of whom twenty-five were on the clerical-stenographic staff; Engineering Department, seventy-eight; Administrative Department, two executives, six secretaries, plus part-time assistance from some members of the aural radio operation, plus a booking department of two executives and three typists.—R. W. H.

taken in close-up. You see the Emitron camera [Iconoscope] would be far too candid for ordinary theatrical settings.

QUESTIONER: What about the costumes for *The Sleeping Princess*? Did you take them straight from the theatrical production?

BAKER-SMITH: Yes, but that was by no means the end of the story. Miss Jeanne Bradnock was in charge of the wardrobe and make-up for this particular production.

QUESTIONER: Miss Bradnock, what were your particular problems?

BRADNOCK: The first thing was to find out the number of [people in] the cast and then the amount of quick changes you would have to arrange for. I went down to the theatre to watch the show and brought back some of the costumes to test them for color before the television cameras.

QUESTIONER: Some of the colors were unsuitable for television?

BRADNOCK: Yes, a few. But in any case we had to find out beforehand the exact amount of close-ups we were going to produce on the screen. That would help us in deciding what form our make-up would take. We had to find out from the producer on what occasions during the production facial close-ups of any members of corps de ballet [would be used].

MUNRO: Naturally, one just couldn't transfer the ballet from the theatre stage to the television studio. One had to select and adapt to provide a television setting. But we were talking about continuity. Another very important member of the production conference and much more important still during the actual show is the studio manager, Roland Price.

PRICE: My duties were many and varied. My word has to be law and I have to keep discipline. Then I act as the producer's deputy in the studio and see that all goes smoothly on the studio floor. During rehearsals, of course, we could all hear the producer's voice over the loud-speaker. But during the actual telecast all key studio staff wore headphones. And then through a studio telephone I could talk directly back to the producer.

QUESTIONER: Did you have any special difficulties over *The Sleeping Princess*?

PRICE: Oh yes, several. I always remember when Margot Fonteyn had to dash quickly down a fifty yard corridor from one studio to

another. You see, we had no intermissions during a telecast. She had to do this while the orchestra held a chord.

FORTEYN: I'll never forget. I thought I should have no breath left by the time I arrived.

PRICE: It was the poor horn players in the orchestra whose wind was getting rather short that really worried me, Margot.

QUESTIONER: And what else do you remember about that production, Miss Fonteyn?

FORTEYN: The number of close-ups D. H. [Munro] seemed to be taking. And also, I remember having to collapse at one point in the ballet right in front of a very low camera.

MUNRO: Stanley Lake was known as [low-angle camera] 2A in the production.

LAKE: Yes, my camera was number 2 in studio A. I was to take low-angle shots, entrances, and close-ups of feet.

QUESTIONER: Were you on the same camera for the whole production?

LAKE: Yes, and it lasted about one hour and twenty minutes—compared with a movie cameraman, whose average camera shot cannot be more than two minutes. There was the strain of continuous focusing, and there was also the psychological strain, because the camera view finder showed the scene upside down. Then there was the continuous panning of the camera from left to right. It was rather like waking up from a dream when the production was all over.

FORTEYN: Yes, Mr. Lake. I felt like that after my first television show. There was no audience, only cameras and lights. I missed an audience.

QUESTIONER: But you got over that?

FORTEYN: Yes, very soon. The studio staff and orchestra became my audience. They were always very helpful.

QUESTIONER: Did you mind the strong light?

FORTEYN: Not a bit.

QUESTIONER: How about having to adapt your movements and directions—I mean making a television production out of a theatre show?

FORTEYN: That didn't worry me at all. Dancers are used to

adapting themselves, especially nowadays, touring Army camps and working on open-air stages.

QUESTIONER: Stephen Thomas, a distinguished theatre and television producer, and Philip Bate, made many interesting experiments in musical production just before the war. I imagine British composers were writing for television, weren't they, Stephen?

THOMAS: Yes, William Walton wrote pieces for us, and Constant Lambert conducted his own music and ballet. Symphonic music has no place in television—at any rate, that's my view. There will always be incidental music written for television, but great musical works of art don't need visual assistance. Music is such a complete art—

BATE: I don't altogether agree with you, Stephen.

QUESTIONER: I know you specialized in musical production, Stephen.

THOMAS: Yes, of a certain type. But I was interested in opera, pantomime, and ballet. These are legitimate ways of using music in television.

QUESTIONER: What was your line, Bate?

BATE: I had been trying to provide a visual interpretation, or parallel if you like, for many different kinds of music. I put on a series called *The Conductor Speaks*, in which British conductors came to conduct a full orchestra and show their methods of rehearsal. Then I produced individual performers in vision—the Hambourgs at two pianos, Szigeti, the violinist, and so on. And then I quite frankly attempted to provide visual interpretation for the musical equivalent.

THOMAS: I don't believe his experiments led anywhere. Of course, all experiments are interesting, and Philip was very ingenious. But he was trying to help people to understand music. He was teaching them about music. When a composer decides to write music for vision, he writes an opera or a ballet. In my opinion you are destroying the composer's purpose by putting over straight music in television.

QUESTIONER: You probably don't even want to see a work performed in a concert hall.

THOMAS: No, I'd sooner shut my eyes, especially in an English concert hall. When I first joined television, it occurred to me that

the medium was probably suitable for pantomime illustrating narrative poetry or dramatic music. I did a series of pantomimes. We first did Keats' *St. Agnes' Eve* and a couple of the *Canterbury Tales* of Chaucer. Pure mimes, these, with the poems read off stage and the action taking place on the screen.

QUESTIONER: And that led you to pantomime opera?

THOMAS: Yes, it was at Christmas time, and I thought of Humperdinck's *Hänsel und Gretel*, because everybody knows the story and the music. I did the opera as a pantomime, with the music sung by a distinguished cast, and the action was played on the sets before the cameras.

QUESTIONER: But you didn't always produce opera in that convention, did you?

THOMAS: No, I did many operettas on much the same lines as I should do in the theatre.

BATE: Many of my later experiments were based on a production of Stephen's which was called *Fugue for Four Cameras*, danced by one dancer, Maud Lloyd, and four television cameras. On the screen we saw a girl dancing to the first subject of the fugue. Toward the end of that her movements took her to one side of the screen. As the second subject started in the music, a second Maud Lloyd appeared on the other side, and at the appropriate musical moment there appeared a third and a fourth Maud Lloyd.

QUESTIONER: I see, you had four dancing figures on the screen at once, dancing the four parts of the fugue.

THOMAS: Yes, and at the end the separate figures came forward and resolved, on the final major chord, into one figure.

QUESTIONER: Sounds to me like pure magic. Would you mind telling me how you did it?

THOMAS: By making friends with the engineers. They showed me how easy it was in television to see several pictures of the same subject at the same time. And then I thought of a Bach fugue with the figure of a girl dancing—seen simultaneously from four different angles by four different eyes.

BATE: I realized that the trickery which Stephen used for his dancer could be developed in the visual interpretation of abstract music. I like to think that the senses of sight and sound are complementary and equally important. I took a perfectly simple,

clearly shaped tune—the Bach *Air on the G String* from the *Suite in D*—and then, helped by Peter Bax, I selected a number of abstract forms from Gothic architecture—arches, columns, capitals, and so forth.

QUESTIONER: You mean, you could watch them on the screen producing a constantly changing pattern as you listened to the music?

BATE: You've got it exactly. A pattern which grew and developed with the music. And each fresh form appeared on the screen exactly at the point where a fresh musical phrase came in.

QUESTIONER: You presented a parallel experience for the eye and ear?

BATE: Just that. But I didn't pretend for a moment that I was showing viewers what Bach was thinking about when he wrote that air. But I do claim that the eye part of my experiment was a satisfying experience.

QUESTIONER: I want to hear a little bit more about the series you called *The Conductor Speaks*. You said you showed the conductor himself at rehearsal.

BATE: Yes. You know what a tremendous lot of work the conductor puts into preparing his orchestra for a performance. And, if you are interested, your only chance to find out about that is to wangle into a rehearsal somehow. We put on the screen what went on at rehearsal. And those marvelous telephoto lenses we had—they gave a wonderful opportunity for analyzing and comparing the finger technique of, say, different famous artists who played for us. Mark Hambourg and his daughter used to play on two pianos for us. Sometimes I would show one keyboard diagonally across the screen, and then as the melody passed from one player to another, I would fade in the other keyboard across the first one, so that as the two lines crossed in the musical scene, so did the keyboards in the visual one. I remember what a thrill it was the first time we got that effect right, and you saw Mark Hambourg's strong, very masculine hand start on a long theme in the bass and then rush up the keyboard—and suddenly his daughter's long, slender hands appeared out of nothing and literally lifted the melody away from her father. . . .

QUESTIONER: In conclusion, Gerald Cock, who was Director of BBC Television.

COCK: The first of September, 1939, was truly Black Friday for British television. At noon on that day the BBC Television service closed down for the duration—on the threshold of certain success. Actually, we think we had passed that threshold. After organizing and directing it since 1936, this cutting off in its prime of all that our efforts had built up was a real tragedy. We certainly went through tough times. There was the awful, ever-present problem of discovering and providing fresh program material, but in this crisis the whole organization—producers, engineers, designers, secretaries, and all the little people everywhere—became one in their determination to see this thing through. I have never known a mixed crowd work together with a better will or more successfully. At first there was plenty of sniping at the programs. After all, people paid seventy-five pounds [\$325] or more for their receivers, which were later reduced to thirty-five pounds—about \$140. But we profited from our mistakes and after the Radio Exhibition of 1937 things really began to move. More staff and money were forthcoming. Equipment and studios were improved. Rehearsals were possible. Thereafter, progress was rapid, proof of which was the almost overnight appearance of a most appreciative audience. We learned a lesson from those three years—1936 to 1939. It cost a lot of money and hard work—and I am quite sure a new and better television service will start again when the war ends, despite all the urgent demands of a brave new world.

INDEX

- acoustic perspective, 18, 154–59
actions vs. reactions, 29, 41–43
Algiers, 167
Alton, Robert, 188
Aristotle, 15
Arnold, John, 76–80
aspect ratio, 39
audience in studio, 28
- Bach *Suite in D*, 201, 202
“background listening,” 51
Baker-Smith, Malcolm, 196–98
Baker’s Wife, 138
Balaban and Katz, 128
ballet in television, 144–45, 195–202
basic ingredients of television programs,
47–49
Bate, Philip, 200–02
Bax, Peter, 191, 193–95, 202
Becker, Leon S., 172–73
Big Ben, 192
binaural hearing, 18, 151, 156
binocular vision, 18, 156
Bligh, Jasmine, 184
“board fade,” 39
Bradnock, Jeanne, 198
British Broadcasting Corporation (BBC),
34, 133, 170, 183–203
- Cabinet of Dr. Caligari*, 86–87
Calder, Alexander, 48
camera movement, 92–100, 143, 145
Canterbury Tales of Chaucer, 201
Cavalcanti, Alberto, 169–171
Cenotaph, 191
Chamberlain, Neville, 191
Churchill, Winston, 13
close-ups, 43
- Cock, Gerald, 203
Colledge, 157–58
color television, 18–19, 132, 145–46
Columbia Broadcasting System (CBS),
74, 107, 126, 127, 133, 142, 160, 174,
177
contrast range, 20, 37
Coronation of George VI, 190
Coward, Noel, 42, 194
Cowell, Elizabeth, 184–85
Cummings, Constance, 189–90
cuts defined, 116–17
- Daniels, Bebe, 186, 187–88
Deakin, Irving, 145
defocusing defined, 119
Derby, 190
detail in video, 38
diaphragm, *see* stop-opening
dissolves defined, 118–19
double exposure, *see* superimposure
Doughty, Philip, 190–91
Du Mont Television, 177
- Eastman-Kodak film, 34
Eddy, William C., 128
Edison Company, 85
Edison, Thomas A., 74
Eisenstein, Sergei, 88, 89, 90
Emperor Jones, 195
End of St. Petersburg, 88
- “f” numbers, *see* stop-opening
fades defined, 116
Farnsworth, 57
FCC, 5
Finlandia, 177
Fletcher, Cyril, 186

- focal depth, *see* focus, depth of
 focus, depth of, 37, 65–69
 Fokine, Michel, 195
 Fonteyn, Margot, 195, 198–200
 Ford, Ford Maddox, 155
 Ford, John, 177
 Friebus, 157–58
Fugue for Four Cameras, 201
- Gamble, Bud and Edna, 177
 General Electric, 81, 126, 128, 142
 George VI of England, 190, 191
 Goldmark, Peter, 110
 Griffith, D. W., 86
 Guitry, Sacha, 138
- Hale, Chester, 188
 Hambourg, Mark, 201, 202
 Hammond Organ Company, 160
 Handel, George Frederick, 171
Harvest, 138
 Hendricks, Paul, 160
 Hildegarde, 188
 Hitler, Adolf, 191
 Holtz, Lou, 186
 home television service, 22
- Informer*, 101, 177
Invisible Man, 196
In Which We Serve, 42
- Jane Eyre*, 177
- Katia*, 176
 Kaufman and Hart, 186
 King, John Reed, 174
 Kuleshov, Lev, 14–15, 23
- Lake, Stanley, 199
 Lambert, Constant, 200
 Lang, Fritz, 169–70
 lapel microphone, 153
Last Laugh, 87
Le Bourgeois Gentilhomme, 194
 lenses, 59–65
 lenses, coated, 71–72
 lens turret, 71–72
Lieutenant Kije, 178
Life of an American Fireman, 86
Life of Beethoven, 171–72
- light, “cold,” 58
 lighting, 21–22, 57–58, 125–132
 light meter, 60–61
 “line microphone,” 153
 Lloyd, Maud, 201
 London Zoo and Fire Brigade, 184
 Lyon, Ben, 187
- M*, 169
 Madden, Cecil, 185–88
 make-up, 132
 Marble, Alice, 186
March of Time, 164
 Maxfield, 157–58
 Méliès, Georges, 85, 88
Melody of the World, 171
 Metro-Goldwyn-Mayer (M-G-M), 16,
 78, 79, 80, 131
 Mickey Mouse, 186
 microphone handling, 149–153
 Miner, Worthington, 107
Missus Goes A-Shoppin’, 174
 Mitchell, Leslie, 184–85
 monaural hearing, 18, 151
 monocular vision, 18
 montage, 14–15, 23, 88–89
Mother, 88
 Mowrey, Paul B., 174
 multi-path reflections, 21
 Munro, D. H., 191–93, 195–98
 Murrow, Ed, 193
 Museum of Modern Art, 88
- National Broadcasting Company (NBC),
 5, 74, 101, 128, 159
 Nichols, Dudley, 42–43
Night Mail, 168, 178
Night Must Fall, 190
North Sea, 170, 171
- objective approach, 86, 144
 O’Ferrall, Major George More, 189–90
Old and New, 88
100 Per Cent Broadway, 88
 Ott, Fred, 34
- parabolic reflector, 153
 Paramount Pictures, 4
Pepe Le Moko, 167
 picture quality determined by, 19–22

- Plessner, Max, 3
 Porter, Edwin S., 85–86, 88, 90, 133
Potemkin, 88
Prelude in E Minor, by Shostakovitch, 177
 Price, Roland, 198–99
 Prokofieff, Sergei, 176
 Pudovkin, V., 88, 90
 Pyatigorsky, Gregor, 186
- Radio Corporation of America (RCA),
 5, 57, 58, 153
 Radio Olympia, 185
 Raibourn, Paul, 4
 realism, 25–26, 154
 reverberation, 150–52, 156, 160
 reverberation, synthetic, 159–62
 Robeson, Paul, 186
Roosty, 177
 Rotha, Paul, 87, 141
 Ruttmann, Walter, 171
- St. Agnes Eve*, by Keats, 201
 Sarnoff, David, 13
 Seldes, Gilbert, 13, 14
 Shakespeare, 186, 194
 Sibelius' *Symphony Number One*, 177
Sleeping Princess, 196–99
 Society of Motion Picture Engineers, 76,
 157, 172
 sociological effects of television, 44
 speed of lens, 60
Starlight, 186
 stereoscopic and stereophonic television,
 18, 156
 Stevens, Wallace, 155
 stop-opening, 58–61, 65–68
Storm Over Asia, 88
 subjective approach, 86, 144–45, 171–72
 suggestion, use of, 23, 155, 170
 superimposure, 39, 119, 201
 Swann, Russell, 188
 Szigeti, Josef, 200
- Tannura, Phil, 110–11
 Technicolor, 132, 146
Ten Days That Shook the World, 88
 theatre television, 22
 Thomas, Stephen, 200–01
Tristan und Isolde, 195
 Tucker, Sophie, 186
- unities of time, place, action, 30–31
- Variety*, 87
 video effects, 122–24
 video effects (electronic), 120
 view finders, 65, 72–75
 viewing distance (of screen), 19
 viewing habits of audience, 22
Voice in the Wind, 176
- Walton, William, 200
 Warner Brothers, 172
 Western Electric, 153
 Wright, Basil, 100, 113

This book must be returned within 3/7/14 days of its issue. A fine of ONE ANNA per day will be charged if the book is overdue.

--	--	--	--	--	--

