

# Birla Central Library

PILANI (Rajasthan)

Class No. 637.142  
Bec. No. H951C  
Accession No. 31469

Acc. No. 31469

**ISSUE LABEL**

**Not later than the latest date stamped below.**

--	--



CONDENSED MILK  
AND  
MILK POWDER



‘  
CONDENSED MILK  
AND  
MILK POWDER’

PREPARED FOR  
FACTORY, SCHOOL AND LABORATORY

SIXTH EDITION

COMPLETELY REWRITTEN

BY  
OTTO FREDERICK HUNZIKER  
B.S.A., M.S., D.Sc.

PUBLISHED BY THE AUTHOR  
LA GRANGE, ILLINOIS  
(1946)

Copyright  
1914, 1918, 1926, 1935, 1946  
By O. F. Hunziker  
La Grange, Illinois

Copyright 1946, in Great Britain, Canada and other countries  
All Rights Reserved under Inter-American  
Copyright Union (1910).

March 1946  
Printed in U. S. A.

*To the Memory of  
My Father,  
Doctor Karl Otto Hunziker  
1841-1909  
Professor of Education and Pedagogy,  
University of Zurich,  
This Volume is Dedicated*





## PREFACE

The sixth edition of this book is written for the student of dairy manufactures, the research worker on problems relating to condensed, sterilized and dried milk products, the pure food official and his law-enforcing agencies, and for the operator of the dairy products factory.

It is primarily organized as a text for class room instruction on the condensed and dried milk industry. It aims to present the fundamentals of the technical, operating and industry problems in their proper sequence, to convey to the student a tangible picture of the industry as a whole, and to provide him with a dependable source of important facts for later reference.

It is intended to serve as a stimulus to the research worker. It endeavors to call to his attention the real problems of the industry, supplemented by suggestions of new problems and new angles of old problems that are awaiting his study and solution.

It is meant to facilitate acquaintance on the part of the pure food official and his law-enforcing agencies, with current industry practices, and to promote understanding of the possibilities and limitations of helpful regulatory control.

Above all, it has for its purpose to serve the busy plant operator, with dependable facts that are scientifically sound and proven by practical experience. It is hoped that the manner of their presentation will assist him in the constructive solution of his problems of manufacture and distribution.

The text of this new (sixth) edition represents the sum total of painstaking study, digestion and assimilation of the vast array of available scientific data and the latest commercial developments in the condensing and drying of milk and milk products. It deals with improved equipment, methods and products accomplished in this country and abroad. These improvements have been expedited by the food emergency of World War II. Their usefulness has stood the acid test of practical experience in plant operation, and in distribution under climatic and handling conditions of extreme severity.

It is the author's cherished hope that this volume may be found useful for its intended purpose, the purpose of service to a great industry that benefits mankind.

*The author regrets that the paper in this volume is not up to his standard of weight and quality, but it is the best obtainable.*

O. F. HUNZIKER

La Grange, Illinois  
February 1946

## ACKNOWLEDGMENTS

*In presenting this volume to the Dairy Industry, the author desires to express his grateful appreciation to:*

*Arnold W. Baumann, Chief Engineer of Arthur Harris & Co., Chicago, for information on the latest designs of condensery equipment, on thermodynamic and engineering aspects dealing with the manufacture of concentrated milks, and for part of the mechanical drawings and photographs of special equipment illustrated in this book;*

*George E. Grindrod, President of Grindrod Process Corporation, Oconomowoc, Wisconsin, for technical advice on Grindrod processes and patents;*

*Philip L. Haymes, Executive, United Milk Products Co., Cleveland, for helpful counsel and current facts and figures on important Industry developments;*

*Dr. George E. Holm, Head, Division of Dairy Research Laboratories, and Dr. Byron H. Webb, Dairy Manufacturing Specialist, and Associates, Bureau of Dairy Industry, U. S. D. A., for a wealth of experimental data and helpful technical advice;*

*Mahlon K. Jordan, Vice President of Avoset, Incorporated, San Francisco, for valuable suggestions on processing stabilized cream;*

*Roud M. McCann, Director of American Dry Milk Institute, Chicago, and his able Staff, for research data and the privilege of access to the Institute's library;*

*Dr. S. H. Parfitt, In Charge of Sanitary Standards, Evaporated Milk Association, Chicago, for helpful information on Sanitary Standards, and Marketing Agreement for the Evaporated Milk Industry;*

*Dr. Horace L. Smith, Jr., Chief Research Engineer of Chain Belt Company, Milwaukee, for important engineering and technical data relating to the manufacture of dried milk by the Freeze Drying Process;*

*Peter H. DeVries, Director of Economic Information, Bureau of Agricultural Economics, U. S. D. A., for helpful co-operation in providing important special dairy statistics.*

*Roger V. Wilson, Director Customer Res. Div., and William J. Mutschler, Manager Packaging Res. Div., Continental Can Company, Chicago, and William E. Pearce, Chief Packaging Res. Sec., American Can Company, Maywood, Illinois, for helpful information on gas packing whole milk powder.*

*I am indebted to the many individuals and firms in the field of dairy equipment and supplies for their generous co-operation in the form of information on special phases related to dairy manufactures, and who enhanced the service of this volume to the industry by their generous advertisements.*

*I feel deeply grateful also to my daughter, Mrs. C. D. Galvin, for constructive assistance in organizing the physical make-up of this book and for her efficient supervision of its progress.*

O. F. HUNZIKER

## INTRODUCTION

The food emergency of World War II has emphasized, as never before, the dependence of man upon an adequate supply of milk and milk products in his daily food ration. The food shortage during the war years was aggravated by the widespread decline of dairy production in the occupied regions and enemy countries, chiefly due to absence of imported feed concentrates, desperate shortage of man power, and slaughter of dairy cattle for beef supply.

**TABLE A.—MILK PRODUCTION IN UNITED STATES IN 1944.  
ITS UTILIZATION, AND MILK EQUIVALENT OF  
MAJOR MANUFACTURED PRODUCTS.**

Manufactured Products	Quantity of Manufactured Product* X 1000	Fluid Milk Equivalent X 1000	Percentage of Total Milk Production
	pounds	pounds	per cent
<b>Total Milk Produced</b>		<b>118,952,000</b>	
Creamery butter.....	1,488,552	35,725,248	30.03
Farm butter.....	329,148	7,899,552	6.64
Cheese, all kinds.....	1,016,675	10,166,750	8.50
Evaporated milk.....	3,435,222	7,213,966	6.06
Plain condensed milk.....	113,387	324,287	.27
Sweetened condensed milk.....	201,662	451,722	.38
Dried whole milk.....	177,877	1,423,016	1.28
Dried cream.....	193	3,667	
Dried malted milk.....	38,655	100,503	
Ice cream (1000 gal.).....	446,889	5,362,668	4.50
<b>Total milk used for all manufactured products..</b>		<b>68,671,379</b>	<b>57.74</b>
<b>Total milk used for buttermaking.....</b>		<b>43,624,800</b>	<b>36.68</b>
<b>Total milk used for products other than butter..</b>		<b>25,046,579</b>	<b>21.04</b>
<b>Whole milk fed to calves.....</b>		<b>3,274,000</b>	<b>2.75</b>
<b>Whole milk used for fresh consumption and miscellaneous unspecified purposes.....</b>		<b>47,006,621</b>	<b>39.53</b>
<b>Total milk used for all purposes.....</b>		<b>118,952,000</b>	<b>100.00</b>

\*Farm production, Disposition and Income from Milk, 1943-44; and Production of Manufactured Dairy Products, 1944 (Preliminary); Bur. Agr. Econ., U.S.D.A., April and July 1945, respectively.

This vastly increased the demand for dairy products upon the free nations within the dairy belt of the world, that escaped the ravages of war on their own soil. In some of these countries dairy development has been much accelerated, resulting in increased cow population and in record-breaking annual production of milk and dairy products. Simultaneously great strides have been made in improving keeping quality. Due to these efforts, immense quantities of transportable dairy products have reached, in

sound condition and without serious damage to palatability, the men in service on every front, and the hungry civilian populations of many lands.

The industry has responded wholeheartedly to this urgent need for increased production. It has made good and its phenomenal achievement has contributed immeasurably to the maintenance of health and vigor and the preservation of life of service men everywhere, and of the men, women and children in the war-ridden countries.

### COW POPULATION AND MILK PRODUCTION IN THE UNITED STATES

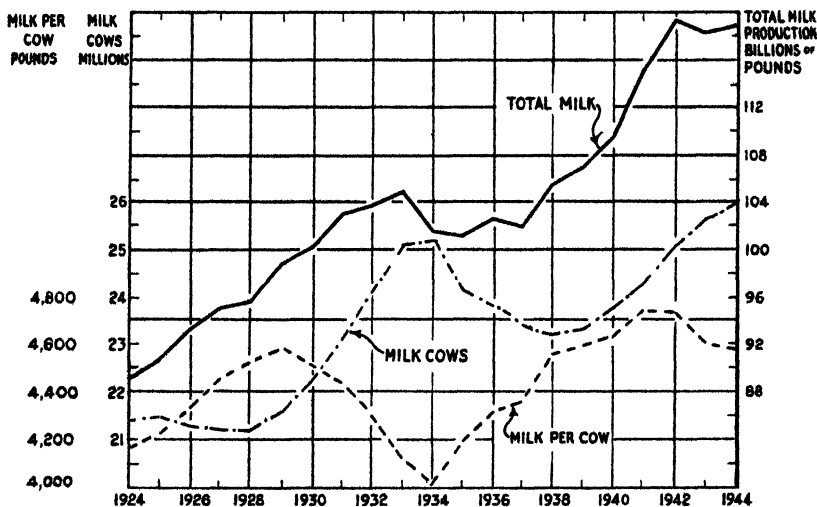

Fig. 1. Computed from Statistics of Bur. Agr. Econ., U.S.D.A., April 1945

**Increase in Cow Population.**—Thus, in the United States the dairy cow population reached its record high of 25,982,000 head in 1944. Figure 1 indicates graphically the cow population and production of milk, (total and per cow) for the years 1924 to 1944, inclusive. Table B contains a comparison of the average annual production of each dairy product between the four pre-war years (1937-40) and the four war years (1941-44).

**Decrease in Butter Production.**—(Table B) shows an increase during the four war years over the average of the four prewar years of all manufactured dairy products except creamery butter. The 1944 butter production of 1,488,552,000 pounds was the lowest since 1925 when it amounted to 1,363,300,000 pounds. The year 1941, also counted as one of the war years, was the all-time record high production year of 1,872,183,000 pounds of factory butter. As the war progressed, butter production dropped off rapidly with each succeeding year.

**Percentage Increase of Manufactured Dairy Products During War Period.**—The increase of the individual manufactured dairy products, other than butter, ranged from 375% for whole milk powder to 30% for dried skim milk. The phenomenal increase of dried whole milk was made com-

mercially feasible by tangible improvement in process of manufacture and method of packaging (gas-packing), that prolonged its storage life even under tropical temperature conditions.

TABLE B.—AVERAGE PRODUCTION DURING FOUR WAR YEARS AND FOUR PREWAR YEARS, AND PERCENT INCREASE, IN THE UNITED STATES.

Milk Product	Average* Annual Production for 4 Prewar Years 1937-1940 X 1000	Average* Annual Production for 4 War Years 1941-1944 X 1000	Increase of Production
Dried whole milk . . . . .	pounds 22,263	pounds 105,859	percent 375.0
Sweetened condensed milk . . . . .	46,418	108,141	133.0
Dried whey . . . . .	65,325	121,876	86.0
Evaporated milk . . . . .	2,160,503	3,313,170	53.0
Ice cream (1000 gal.) . . . . .	296,362	428,329	45.0
Cheese (all kinds) . . . . .	717,041	1,019,611	42.0
Dried skimmilk . . . . .	427,919	558,954	30.0
Milk . . . . .	106,004,000	117,957,000	11.0
Milk cows . . . . .	23,378	25,293	8.0
Creamery butter . . . . .	1,757,176	1,699,644	decrease 3.0

\*Computed from statistics on cow population and annual production of milk and manufactured dairy products supplied by Bur. Agr. Econ., U. S. D. A., 1944 and 1945.

Next in magnitude of percentage increase during the war years was sweetened condensed milk. Its output averaged 133% larger than during the prewar period. Its large increase bespeaks its high value nutritionally. Its concentration of sucrose insures dependable keeping quality under adverse climatic conditions even after the container is opened. In addition, the profligate expenditure of human energy in war activities called for an ample supply of readily digestible, energy-generating carbohydrates in the food ration. Sweetened condensed milk with its high sucrose content provides a particularly well balanced food for the purpose.

Another product with nearly 100% increase of the war year average over the average of the prewar period was whey powder. Heretofore, the bulk of dried whey had been largely used for animal feed. However, this product, containing about 70% of milk sugar, is also a valuable source of energy. In addition it has beneficial tonic and laxative properties.

**Increase in Tonnage During War Period.**—The manufactured dairy products that averaged the largest increase in actual tonnage of produc-

tion during the war period over the prewar years are evaporated milk (increase over one billion pounds), cheese (increase over 300 million pounds), dried skimmilk (increase 132 million pounds), and ice cream (increase 132 million gallons).

TABLE C.—QUANTITY OF SKIMMILK PRODUCTS MANUFACTURED IN THE UNITED STATES IN 1944 AND THEIR FLUID SKIMMILK EQUIVALENT.

Manufactured Skimmilk Products	Quantity Manufactured Product* X 1000	Fluid Skimmilk Equivalent X 1000	Percentage of Total Volume of Fluid Skimmilk Used
	pounds	pounds	per cent
Dried skimmilk . . . . .	598,861	6,587,471	54.87
Condensed skimmilk . . . . .	758,083	2,274,249	18.95
Cottage cheese . . . . .	226,772	1,417,325	11.80
Casein . . . . .	14,883	531,323	4.42
American skim cheese . . . . .	2,628	42,048	0.86
Concentrated sour skimmilk . . . . .	20,489	61,467	0.86
Condensed buttermilk . . . . .	156,769	470,307	3.92
Dried buttermilk . . . . .	56,573	622,303	5.18
Total fluid skimmilk used . . . . .		12,006,493	100.00

\*Production of Manufactured Dairy Products 1944 (Preliminary), Bur. Agr. Econ, U.S.D.A., July 1945

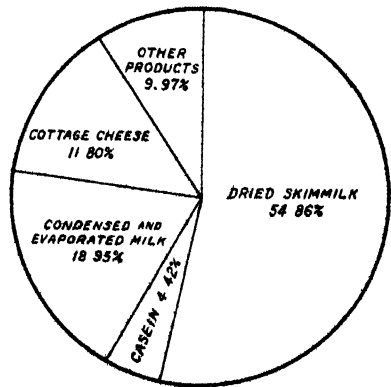
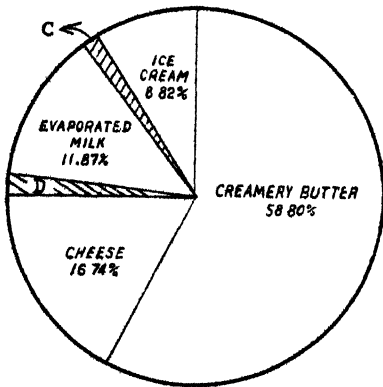

Fig. 2. Factory utilization of whole milk 1944

Fig. 3. Factory utilization of skimmilk 1944

C—Condensed milk  
D—Dried whole milk

**Basis for Computation of Milk Equivalents.**—The utilization of whole milk in the United States in 1944 is shown in Table A, and the milk equivalent of the dairy products made in the factories is graphically illustrated in Figure 2. The skimmilk equivalent of skimmilk products manufactured in 1944 is indicated in Table C and illustrated in Figure 3. The

units of the milk and skimmilk equivalents used in computing the pounds of milk or skimmilk utilized for each manufactured dairy product are listed in Table D.

TABLE D.—FLUID MILK, SKIMMILK, BUTTERMILK, AND WHEY  
EQUIVALENTS PER POUND OF MANUFACTURED PRODUCT.

Manufactured Milk Product	Composition	Equivalent* of Milk (M) Skimmilk (SM) Buttermilk (BM) Whey (W)
	per cent	pounds
Butter . . . . .	80.5 F, 83.5 TS	24.0 M
Casein, dried . . . . .		35.7 SM
Casein, dried . . . . .		32.5 W
Cheese, American, whole milk . . . . .		10.0 M
Cheese, American, skim . . . . .		16.0 SM
Cheese, Cottage, Bakers, etc . . . . .		6.25 SM
Condensed buttermilk . . . . .	27 SNF	3.00 BM
Condensed milk, plain . . . . .	10 F, 26 SNF	2.86 M
Condensed milk, plain skim . . . . .	20 SNF	2.22 SM
Condensed milk, plain skim . . . . .	27 SNF	3.00 SM
Condensed milk, plain skim . . . . .	34 SNF	3.78 SM
Condensed milk, sweetened . . . . .	8.5 F, 20 SNF, 48.5 Sucrose	2.24 M
Condensed milk, sweetened skim . . . . .	30 SNF, 42 Sucrose	3.30 SM
Evaporated milk . . . . .	7.9 F, 18.1 SNF	2.10 M
Dried buttermilk . . . . .		11.00 BM
Dried cream . . . . .	70 F	19.00 M
Dried malted milk . . . . .		2.60 M
Dried skimmilk . . . . .		11.00 SM
Dried whey . . . . .		16.00 W
Dried whey . . . . .		17.50 SM
Dried whole milk . . . . .	26.5 F	8.00 M
Ice cream gallons X 12 for ice cream lbs . . . . .		12.00 M
Lactose . . . . .		33.33 SM
Lactose . . . . .		30.00 W

\*These equivalents will be found not in exact agreement with composition values and yields of concentrated and dried milk products given in Chapters XXXI and XII. The equivalents given in Table D represent recognized values for manufactured milk products calculated on the basis of legal standards and definitions and of other specific compositions, while the values given in the two chapters mentioned above have to do with analyses of products of average compositions, varying according to consumer preference, market demands, et cetera.



## CONTENTS

<i>Chapter</i>	<i>Title</i>	<i>Page</i>
	INTRODUCTION .....	ix
I	COMPOSITION AND REACTION OF MILK.....	1
II	PHYSICAL PROPERTIES OF MILK.....	7
III	PROPERTIES OF MILK CONSTITUENTS.....	12
IV	DEVELOPMENT OF THE CONDENSED MILK INDUSTRY... .	33
V	THE MILK CONDENSERY.....	43
VI	THERMODYNAMICS OF CONDENSING.....	52
VII	DESCRIPTION OF VACUUM PAN.....	63
VIII	OPERATION OF VACUUM PAN.....	84
IX	STEAM REQUIREMENTS .....	92
X	FACTORY SANITATION .....	108
XI	MILK SUPPLY .....	115
XII	QUALITY OF MILK AND ITS CONTROL.....	122
SWEETENED CONDENSED MILK		
XIII	INTAKE AND STANDARDIZATION.....	133
XIV	FOREWARMING AND ADDITION OF SUGAR.....	142
XV	CONDENSING THE MILK.....	156
XVI	COOLING SWEETENED CONDENSED MILK.....	164
XVII	SWEETENED CONDENSED SKIMMILK.....	180
XVIII	PACKAGING SWEETENED CONDENSED MILK.....	186
EVAPORATED MILK		
XIX	STANDARDIZATION AND FOREWARMING.....	191
XX	CONDENSING FOR EVAPORATED MILK.....	200
XXI	IRRADIATION AND HOMOGENIZATION.....	205
XXII	COOLING, STANDARDIZING, CANNING.....	221
XXIII	STERILIZING EVAPORATED MILK.....	229
XXIV	STERILITY AND HEAT STABILITY.....	238

<i>Chapter</i>	<i>Title</i>	<i>Page</i>
XXV	VISCOSITY, COLOR, FLAVOR, MINERAL DEPOSITS . . . . .	248
XXVI	TECHNICAL CONTROL OF EVAPORATED MILK . . . . .	257
<hr/>		
XXVII	PLAIN, SUPERHEATED, FROZEN CONDENSED MILKS . . . . .	265
XXVIII	CONCENTRATED BUTTERMILK AND SOUR SKIMMILK . . . . .	271
XXIX	STERILIZED SWEET MILK AND SWEET CREAM . . . . .	283
XXX	CONDENSED MILK MARKETS . . . . .	291
XXXI	COMPOSITION AND FERMENTS OF CONCENTRATED MILKS . . . . .	303
XXXII	CONCENTRATED MILK DEFECTS . . . . .	318
 THE DRIED MILK INDUSTRY		
XXXIII	HISTORY AND DEVELOPMENT . . . . .	332
XXXIV	MILK DRYING SYSTEMS . . . . .	338
XXXV	SPRAY-DRYING SYSTEM . . . . .	355
XXXVI	THERMODYNAMICS OF MILK DRYING . . . . .	364
XXXVII	MANUFACTURE OF DRIED WHOLE MILK . . . . .	379
XXXVIII	MANUFACTURE OF DRIED BUTTERMILK . . . . .	399
XXXIX	MANUFACTURE OF DRIED WHEY . . . . .	409
XL	MANUFACTURE OF MALTED MILK AND DRIED ICE CREAM MIX . . . . .	416
XLI	YIELD, COMPOSITION AND PROPERTIES OF DRIED MILKS . . . . .	425
XLII	KEEPING QUALITY OF DRIED MILKS . . . . .	442
XLIII	MARKETS OF DRIED MILKS . . . . .	449
<hr/>		
XLIV	VITAMINS IN MILK AND MILK PRODUCTS . . . . .	458
XLV	MANUFACTURE OF MILK SUGAR OF COMMERCE . . . . .	467
XLVI	FACTORY TESTS AND ANALYSES . . . . .	477
XLVII	DEFINITIONS AND STANDARDS . . . . .	487
	INDEX . . . . .	495
	LIST OF ADVERTISERS . . . . .	503



## CHAPTER I

### CHEMICAL COMPOSITION AND REACTION OF MILK

**Definition.**—Milk is the opaque, whitish fluid secreted by the mammary gland of the female mammals for the nourishment of their young.

Milk is the only suitable food available to the young during the early period of life after birth. Hence it is a complete food, endowed by nature with all the properties necessary to fully sustain life and to adequately provide for normal development and growth. The complexity of the composition and nature of milk is shown below under “Milk Constituents”, which presents a brief summary of the major nutrients and accessory substances contained in normal milk.

#### Milk Constituents

Water	Mixed glycerides containing 'at least 11 known fatty acids.
Milk fat	Also contain substances associated with the fat, such as: vitamin A, provitamin A (carotene), vitamin D, provitamin D (cholesterol), vitamin E, and the phospholipids lecithin and cephalin.
Milk protein	$\left. \begin{array}{l} \text{Casein} \\ \text{Lactalbumin} \\ \text{Lactoglobulin} \end{array} \right\}$ These are complete proteins containing all (20 or more) known essential amino acids.
Lactose (sugar of milk)	Provides the carbohydrates. Mostly calcium, potassium and phosphorus; also small amounts of chlorine, sodium, magnesium, sulphur and iron; minute amounts of zinc, iodine, copper, silicon, fluorine, and manganese; and traces of aluminum, boron, lithium, rubidium, strontium, titanium and vanadium.
Milk ash	
Pigments	Carotene, xanthophyll, lactochrome.
Vitamins	A, B <sub>1</sub> , B <sub>2</sub> (G), B <sub>6</sub> , C, D, E, Niacin, Pantothenic acid.
Enzymes	Amylase, catalase, diastase, galactase, lipase, peroxidase, phosphatase, reductase.
Gases	Carbon dioxide, nitrogen, oxygen.
Cellular material	Leucocytes, epithelial cells.

**Contents of Chapter.**—It is not the purpose of this volume to present a detailed discussion of the chemistry of milk. The present chapter is intended to provide a general survey of the average percentage composi-

tion of milks used for human consumption, and of average cow's milk, as affected by breed, lactation, season and feed.

### CHEMICAL COMPOSITION

Composition of Mammalian Milks.—The percentage composition of the milk of woman, cow, goat, ewe, buffalo, mare and ass are shown in Table 1.

TABLE 1.—COMPOSITION OF MAMMALIAN MILKS

Kind of Milk	Analyst or Author	No. of Analyses	Specific Gravity	Water %	Total Solids %	Fat %	Total Protein %	Cassin %	Albumin %	Lactose %	Ash %
<b>WOMAN—</b>											
Minimum	Koenig <sup>1</sup>	.....	1.027	81.09	8.60	1.43	.50	.18	.32	3.88	.12
Maximum	Koenig <sup>1</sup>	.....	1.032	91.40	18.91	6.83	4.32	1.96	2.36	8.84	1.90
Average	Koenig <sup>1</sup>	200	.....	87.41	12.59	3.87	2.29	1.08	1.26	6.21	.31
	Grimmer <sup>2</sup>	.....	1.0348	88.13	11.87	2.24	2.41	1.96	.46	.....	.25
	Grimmer <sup>2</sup>	1	1.0285	89.47	10.53	3.02	1.89	.95	.94	4.87	.32
<b>COW—</b>											
Minimum	Farrington & Woll <sup>3</sup>	.....	1.0290	83.0	10.00	2.3	2.5	.....	.....	3.5	.60
Maximum	Farrington & Woll <sup>3</sup>	.....	1.0340	90.0	18.00	7.8	4.6	.....	.....	6.0	.90
Average	Farrington & Woll <sup>3</sup>	.....	1.0320	87.4	12.60	3.7	3.2	2.7	.50	5.0	.70
	Van Slyke <sup>4</sup>	.....	.....	87.1	12.90	3.9	3.2	2.5	.70	5.1	.70
	Babcock <sup>5</sup>	5552	.....	87.17	12.83	3.69	3.55	3.02	.53	4.88	.71
<b>GOATS—</b>											
Minimum	Koenig <sup>1</sup>	.....	1.0280	82.02	9.84	3.10	3.22	2.44	.78	3.26	.39
Maximum	Koenig <sup>1</sup>	.....	1.0360	90.16	17.98	7.55	5.05	3.94	2.01	5.77	1.06
Average	Koenig <sup>1</sup>	200	.....	1.0305	85.71	14.29	4.78	4.29	3.20	1.09	4.66
	Fleischmann <sup>6</sup>	Avg.	.....	1.0330	85.80	14.20	4.50	5.00	3.80	1.20	4.00
	Scheuren <sup>2</sup>	1	1.0313	87.11	12.89	4.45	3.67	2.00	1.67	4.09	.72
<b>EWE—</b>											
Minimum	Koenig <sup>1</sup>	.....	1.0298	74.47	12.98	2.31	4.42	3.59	.83	2.76	.13
Maximum	Koenig <sup>1</sup>	.....	1.0385	87.02	25.53	9.80	7.46	5.69	1.77	7.95	1.72
Average	Koenig <sup>1</sup>	82	.....	1.0341	80.82	19.18	6.86	6.32	4.97	1.55	4.91
	Hucho <sup>3</sup>	2500	.....	1.0377	78.70	21.30	8.94	6.34	.....	5.02	1.00
	Fleischmann <sup>6</sup>	Avg.	.....	1.0369	83.00	17.00	6.30	6.30	4.60	1.70	4.60
<b>BUFFALO—</b>											
Minimum	Szentkiraly <sup>9</sup>	.....	1.0310	81.56	15.77	6.69	3.99	.....	.....	4.16	.72
Maximum	Szentkiraly <sup>9</sup>	.....	1.0336	84.23	18.44	9.19	7.78	.....	.....	5.18	.85
Average	Szentkiraly <sup>9</sup>	.....	1.0323	82.69	17.31	7.87	5.88	.....	.....	4.52	.76
	Fleischmann <sup>6</sup>	2	.....	1.0339	82.98	17.07	7.46	4.59	.....	4.21	.86
	Rimini <sup>10</sup>	.....	.....	81.67	18.33	9.02	3.99	3.63	.73	5.06	.86
<b>MARE</b>											
	Fleischmann <sup>6</sup>	.....	1.0310	90.70	9.80	1.20	2.00	.....	.....	5.70	.40
	Koenig <sup>1</sup>	47	.....	1.0347	90.78	9.22	1.21	1.99	1.24	.76	5.67
	Vieth <sup>11</sup>	.....	1.0350	90.13	9.87	.94	1.65	.....	.....	6.98	.30
<b>ASS</b>											
	Schlossman <sup>7</sup>	.....	1.0330	88.85	11.15	.36	1.31	.98	.33	4.94	.31
	Koenig <sup>1</sup>	5	.....	1.0360	89.64	10.36	1.64	2.22	.67	1.55	5.99
	Eilenberger <sup>8</sup>	.....	1.0320	91.23	8.77	1.15	1.60	.94	.63	6.00	.60

TABLE 2.—AVERAGE COMPOSITION OF THE MILK OF SEVEN BREEDS OF DAIRY CATTLE

Breed	Water	Total Solids	Solids-not-fat	Fat	Protein	Lactose	Ash
	per cent	per cent	per cent	per cent	per cent	per cent	per cent
Guernsey <sup>9</sup>	85.13	14.87	9.68	5.19	4.02	4.91	0.74
Jersey <sup>9</sup>	85.31	14.69	9.51	5.18	3.86	4.94	0.70
Shorthorn <sup>11</sup>	86.58	13.41	9.25	4.20	3.51	5.03	0.71
Ayrshire <sup>9</sup>	86.89	13.10	8.96	4.14	3.58	4.70	0.68
Shorthorn <sup>11</sup>	87.43	12.57	8.94	3.63	3.32	4.89	0.73
Holstein <sup>9</sup>	87.50	12.51	8.95	3.55	3.42	4.86	0.68
Brown Swiss <sup>7</sup>	87.54	12.46	8.76	3.70	.....	.....	.....

## RATIO OF SNF TO F.

Guernsey.....	1 : 0.536	Shorthorn.....	1 : 0.406
Jersey.....	1 : 0.545	Holstein.....	1 : 0.397
Simmenthal.....	1 : 0.454	Brown Swiss.....	1 : 0.422
Ayrshire.....	1 : 0.462	Average.....	1 : 0.46

**Composition of Cow's Milk.**—Table 2 gives a general idea of the percentage composition of milk according to breed of dairy cattle. The figures in this table represent averages of analyses of several hundred samples of milk from each breed listed.

TABLE 3.—EFFECT OF PERIOD OF LACTATION ON PERCENTAGE COMPOSITION OF MILK.  
ECKLES AND SHAW<sup>12</sup>

Lactation	Total Solids	Solids -not-fat	Fat	Protein	Lactose	Ash
Period No.	%	%	%	%	%	%
1	12.74	8.74	4.00	3.25	4.87	0.62
2	12.26	8.41	3.85	3.06	4.84	0.51
3	12.29	8.50	3.79	3.06	4.94	0.50
4	12.24	8.47	3.77	3.13	4.82	0.52
5	12.35	8.53	3.82	3.25	4.80	0.48
6	12.50	8.71	3.79	3.25	4.75	0.71
7	12.61	8.78	3.83	3.32	4.88	0.58
8	12.70	8.85	3.85	3.32	4.83	0.70
9	12.78	8.81	3.97	3.57	4.62	0.62
10	13.16	9.05	4.11	3.83	4.55	0.67
11	13.46	9.24	4.22	3.89	4.74	0.61
12	14.04	9.50	4.54	4.08	4.91	0.51
13	14.23	9.57	4.66	4.34	4.50	0.73
14	15.29	10.21	5.08	4.08	5.01	1.12
Grand total Average	13.05	8.98	4.07	3.51	4.79	0.68

Table 3 shows the changes in the percentage composition of cows' milk due to advancing lactation. The figures represent averages of three Jerseys, three Holsteins, two Ayrshires and three Shorthorns by 4-week periods from beginning to end of the lactation period of each cow.

**Colostrum Milk.**—The tabulated figures of the effect of the period of lactation on the percentage composition of milk shown earlier in this chapter, referred principally to milk produced after an interval since calving time sufficient for the milk to have become normal and fit for human consumption. Milk produced five days after calving is usually considered normal.

Colostrum is the name given the first milk secreted after parturition. It is reddish-yellow in color, of heavy body, strong odor and bitter taste. It curdles upon boiling. Published results of chemical analyses giving the changes in percentage composition which colostrum undergoes are not numerous. The majority of available figures appear to refer to detached or chance samples of colostrum without adequate record of the hours since

calving. Engel and Schlag,<sup>14</sup> however, reported a complete series of analyses from the first milking after parturition to the time when the milk had returned to normalcy. Their figures are shown in Table 3-A. These analyses represent the milk of one cow only. However, the figures appear well within the range of percentage compositions shown by a diverse assortment of compositions of chance samples of colostrum.

TABLE 3-A.—PROGRESSIVE CHANGES FROM COLOSTRUM TO NORMAL MILK  
ENGEL AND SCHLAG<sup>14</sup>

Time after calving	Specific gravity	Total Solids %	Fat %	Casein %	Albumin <sup>1</sup> %	Lactose %	Ash %	Acidity <sup>2</sup> %	Coagulates on boiling
At once	1 0670	26 99	5 10	5 08	11 34	2 19	1 01	414	yes
6 hours	1 0437	20 46	6 85	3 51	6 30	2 71	0 91	324	yes
12 hours	1 0368	14 53	3 80	3 00	2 96	3 71	0 89	252	yes
24 hours	1 0343	12 77	3 40	2 76	1 48	3 98	0 86	243	yes
30 hours	1 0318	13 63	4 90	2 56	1 20	4 27	0 83	220	yes
36 hours	1 0320	12 22	3 55	2 77	1 03	3 97	0 84	225	yes
48 hours	1 0319	11 46	2 80	2 63	0 99	3 97	0 83	216	yes
3 days	1 0331	11 86	3 10	2 70	0 97	4 37	0 84	225	no
4 days	1 0335	11 85	2 80	2 68	0 82	4 72	0 83	207	no
5 days	1 0334	12 67	3 75	2 68	0 87	4 76	0 85	191	no
7 days	1 0320	12 13	3 45	2 42	0 69	4.96	0 84	202	no

<sup>1</sup>Includes lactalbumin and lactoglobulin.

<sup>2</sup>Calculated as lactic acid. Originally reported in terms of degrees Soxhlet-Henkel.  $^{\circ}\text{S H} \times 0.0225 = \% \text{ lactic acid}$ .

The figures given in Table 3-A show that by the fifth day the milk had fully returned to its routine normalcy of composition. There is an abrupt decrease in the first 12 hours, of total solids, specific gravity, acidity, fat, protein and ash, and an equally marked increase in lactose. By the 36th hour all the constituents except the albumin, lactose and acid, have adjusted themselves to figures that appear normal for that milk. Albumin and acidity are still slightly high and lactose low. At the end of the third day, boiling no longer curdles the milk. By the fifth day the composition and properties of the milk appear to have become well established within their normal range, with the possible exception of the acidity. Though the acid has been calculated as lactic, it appears obvious that the abnormally high acidity immediately after parturition is in fact not lactic acid, but is caused by the natural acidity of the high mineral salts (calcium phosphate) and high protein.

The abnormal composition of colostrum milk renders this milk both unfit for human consumption and unsuitable for processing. Its high content of casein, lactalbumin, lactoglobulin, ash, (especially calcium, see Table 18), and acid causes its heat stability to be abnormally low. It is generally considered that by the sixth day after parturition the milk has returned to normal and is suitable for condensary purposes.

TABLE 4.—PERCENTAGE COMPOSITION OF CREAM AND FRESH MILK BY-PRODUCTS

Products	Water %	SNF %	Fat %	Protein %	Lactose %	Ash %
Table cream <sup>1</sup>	72 46	7 54	20 0	2 95	4 00	0 59
Heavy cream <sup>1</sup>	63 41	6 59	30 0	2 58	3 50	0 52
Whipping cream <sup>1</sup>	54 35	5 65	40 0	2 21	3 00	0 44
Skimmilk <sup>2</sup>	90 38	9 47	0 15	3 70	4 99	0 78
Buttermilk { sweet cream <sup>3</sup>	90 98	8 67	0 35	3 51	4 43	0 73
from ripened cream <sup>4</sup>	91 28	8 32	0 40	3 40	4 27(c)	0 65
Cheese whey <sup>5</sup>	93 04	6 60	0 36	0 84	5 76(d)	0 72
Acid- (HCL. <sup>6</sup>	92 09	7 10(a)	0 00	1 60(b)	5 50	see (b)
Casein						
whey { acetic acid <sup>6</sup>	93 1	6 90(a)	0 00	1 70(b)	5 20	see (b)
Separator slime <sup>2</sup> . .	68 7	29 80	1 50	22 00	4 70	3 00

<sup>1</sup>Associates of Rogers' Fundamentals of Dairy Science, II Ed. 35, 1935

<sup>2</sup>Average data of several authors

<sup>3</sup>Richmond Dairy Chemistry, 1914

<sup>4</sup>Calculated from average TS of Minn local creameries, Miller,<sup>9</sup> Chapter XXXVIII.

<sup>5</sup>Van Slyke, L. L., and Price, W. V. Cheese, Average for Season, p. 58, 1936.

<sup>6</sup>Waite, R. Jour. Dairy Res. XII p. 71, 1941.

<sup>a</sup>Contains in addition 0.4 to 0.5% acid (calculated as lactic acid).

<sup>b</sup>Includes % ash    <sup>c</sup>Includes 0.5% acid    <sup>d</sup>Includes % ash and acid

#### THE CHEMICAL REACTION OF MILK

The chemical reaction refers to the status of the acidity or alkalinity of milk. The values obtained by its determination vary with the yardstick that is used for measuring it. They may be expressed in terms of reaction to litmus, to phenolphthalein or to the hydrogen ion concentration.

**Reaction to Litmus.**—The reaction of freshly drawn milk is said to be amphoteric. This applies to its relation to sensitive litmus paper only. It means that it reacts both weakly acid and weakly alkaline to litmus. It gives blue litmus a reddish tinge and turns red litmus faintly blueish. This double reaction is due to the simultaneous presence in the freshly drawn milk, of primary acid-reacting phosphates and secondary alkaline- (to litmus) reacting phosphates.

**Reaction to Phenolphthalein, or Titratable Acidity.**—This is determined by titration of a measured amount of milk with an alkali of known strength in the presence of the color indicator phenolphthalein. The result is calculated as lactic acid (in the U. S. commonly expressed as per cent lactic acid). This is known as the titratable acidity. In freshly drawn normal milk the titratable acidity has been found to range between the extreme limits of 0.086<sup>73</sup> to 0.295<sup>74</sup> per cent. In freshly drawn herd milk it usually lies within the approximate range of 0.135 and 0.175 per cent, averaging about 0.15 per cent.

**The Hydrogen Ion Concentration or pH Value.**—The hydrogen ion concentration ( $C_H$ ) is called the "true acidity". While the titratable acidity measures the volume of acidity, the hydrogen ion concentration expresses the intensity or strength of the acids present. The acid principle of all acid solutions depends upon the presence of hydrogen ions.

In weak organic acids, such as are present in milk, the concentration



of hydrogen ions is not great. In order to avoid cumbersome figures to express exceedingly minute fractions, the hydrogen ion concentration is usually not expressed in terms of a normal solution of  $C_H$ . It is expressed by the symbol pH. This symbol thus has come to mean the exponent of ten with a negative sign. It expresses the concentration in gram-ions of hydrogen per liter. The letter "p" refers to the word "potential," and the letter "H" to hydrogen ions. The purpose of the arrangement of the symbol as pH is to distinguish it from the standard abbreviation of the word phenol, which is PH.

Pure water, which is considered neutral, has a  $C_H$  value of  $1 \times 10^{-7}$ , or 0.000,000,1 moles per liter. The logarithm of the reciprocal of 0.000,000,1 is taken. This gives the figure 7. Pure water thus has a pH of 7.0. This is the neutral point in the pH scale. At this point the concentration of hydroxyl ions ( $OH^-$ ) equals that of the hydrogen ions ( $H^+$ ). If less than pH 7.0 the solution is acid; if greater than pH 7.0 it is alkaline. Freshly drawn milk has an average pH of 6.6.

**Natural Acidity.**—This is the total acidity that is present in freshly drawn milk. The natural acidity is made up largely of the casein acid and acid phosphates. Rice and Markley<sup>78</sup> have listed the sources of natural acidity as follows:

Carbon dioxide equivalent to	0.01 — 0.02%	lactic acid.
Citrates	" "	0.01% lactic acid.
Casein	" "	0.05 — 0.08% lactic acid.
Albumin	" "	0.01% lactic acid.

Phosphates remainder of natural acidity.

The natural acidity of milk tends to increase with the solids-not-fat. It is highest in the colostrum. (See Table 3-A.) It has no noticeable effect on heat stability, and it appears not to jeopardize the marketable properties of concentrated and dried milks.

**Developed Acidity.**—This acidity is produced after the milk is drawn. It is caused by fermentation due to bacteria, yeasts or molds. The developed acidity, together with the natural acidity, make up the total acidity of milk. This constitutes the titratable acidity. Hence any increase in titratable acidity that occurs after the milk has been drawn, is developed acidity. The developed acidity decreases the heat stability of milk. Thus McInerney<sup>75</sup> showed that the fresh milk with which he experimented coagulated at 185° F. when the titratable acidity was 0.25 per cent. At an acidity of 0.56 to 0.58 per cent the milk coagulated at room temperature. An increase in titratable acidity after the milk has been drawn also greatly decreases the heat stability of evaporated milk and lowers the solubility of dried milks. (See also Chapter XXIV under "Effect of Acidity on Heat Coagulation of Evaporated Milk.")

#### REFERENCES

See list at end of Chapter III.

## CHAPTER II

### THE PHYSICAL PROPERTIES OF MILK

The physical properties of milk are controlled largely by its composition and by the physical properties of the individual constituents.

**Specific Gravity.**—Milk is heavier than water. One gallon of average normal milk weighs approximately 8.6 pounds. All the milk solids-not-fat are heavier than water. Hence the specific gravity of milk that has a relatively high solids-not-fat content, generally is high. Thus the colostrum, because of its high percentage of solids-not-fat, has a very high specific gravity. Engel and Schlag<sup>14</sup> found the first milk drawn after parturition to have a specific gravity of 1.067. (See Table 3-A.)

The milk fat is the only prominent milk constituent with a specific gravity lower than that of water. An increase in fat content therefore tends to lower the specific gravity of milk unless it is accompanied by other factors that have the opposite effect. This fact is convincingly illustrated in Tables 5 and 6. The figures in Table 5 show a consistent drop in specific gravity with every increase in fat content. These figures are based on values of specific gravity and coefficient of expansion. They are evidently the result of theoretical calculations intended to show the influence upon the specific gravity of milk, of variations in fat by standardizing milk to progressively higher fat contents by the addition of milk fat. The figures show a definite and uniform drop in specific gravity with every increase in fat content.

**TABLE 5.—INFLUENCE OF PERCENTAGE OF FAT UPON SPECIFIC GRAVITY AND WEIGHT PER GALLON OF MILK AND CREAM\*78**

Milk fat per cent	Specific gravity at 20° C. (68° F.)	Weight per gallon at 20° C. (68° F.) pounds
0.025	1.035	8.63
1	1.034	8.62
2	1.033	8.61
3	1.032	8.60
4	1.031	8.59
5	1.030	8.58
6	1.029	8.57
10	1.023	8.53
15	1.016	8.47
20	1.011	8.43
25	1.007	8.39
30	1.002	8.36
35	.998	8.31
40	.993	8.28

\*Figures based on values of specific gravity and coefficient of expansion determined by Bureau of Standards.

The above results do not bear out observations as to the relation of fat content in natural, unmodified milk to specific gravity. Table 6 gives the composition and specific gravity of natural milk by breeds. It shows that in milk as it comes from the cow, variations in fat content are accompanied by variations of the specific gravity in the same direction. The larger the fat content, the higher the specific gravity. This phenomenon is obviously due to the fact that the solids-not-fat also increase and decrease with the fat, although within a considerably narrower range.

TABLE 6.—INFLUENCE OF BREED ON SPECIFIC GRAVITY OF MILK  
PALMER AND ANDERSON<sup>77</sup>

Breed	No of Cows**	Fat per cent	S N F. per cent	Specific Gravity
Jersey	5	5.62	9.64	1.0340
Guernsey	11	4.77	9.37	1.0336
Ayrshire	2	4.62	9.13	1.0331
Holstein	19	3.41	8.81	1.0325

\*\*Each cow's milk was analyzed separately. The above figures are the average of the samples from each breed.

The specific gravities of the individual constituents and groups of constituents of milk are listed in Table 7.

TABLE 7.—SPECIFIC GRAVITIES OF MILK CONSTITUENTS

Milk Constituents	Specific Gravity		
	Sharp & Hart <sup>78</sup> at 30° C	Richmond <sup>79</sup> at 15° C.	Fleischmann <sup>6</sup> at 15° C.
Fat	0.913	0.93	0.93
Solids-not-fat	1.592	1.616	1.600
Lactose	1.63	1.666	
Proteins	1.35	1.346	
Ash	5.5	4.120	

**Specific Heat.**—The specific heat, or thermal capacity, of a substance is the ratio of the quantity of heat required to raise that substance one degree, to the quantity of heat required to raise an equal weight of water one degree at 15° C. (59° F.)<sup>80</sup>

The specific heat of a substance depends upon its chemical nature and its physical state. In milk condensing and drying work, where the processing of large volume and heating over a wide range of temperatures are involved, attention to the specific heat is of economic importance. It enables the operator to determine accurately the amount of heat required in manufacture on the basis of the weight and specific heat of the products handled.

The specific heat of dairy products was experimentally studied by Hammer and Johnson, whose tabulated results are given in Table 8.

TABLE 8.—SPECIFIC HEATS OF MILK AND MILK DERIVATIVES (INCLUDING HEAT REQUIRED TO MELT FAT IF THIS FACTOR ENTERS)  
HAMMER AND JOHNSON<sup>81</sup>

Milk Product	At 0°C. 32°F.	At 15°C. 59°F.	At 40°C. 104°F.	At 60°C. 140°F.
Whey	0.978	0.976	0.974	0.972
Skim milk	0.940	0.943	0.952	0.963
Whole milk	0.920	0.938	0.930	0.918
15% cream	0.750	0.923	0.899	0.900
20% cream	0.723	0.940	0.880	0.886
30% cream	0.673	0.983	0.852	0.860
45% cream	0.606	1.016	0.787	0.798
60% cream	0.560	1.053	0.721	0.737
Butter*	(0.512)	(0.527)	0.556	0.580
Butter Fat*	(0.445)	(0.467)	0.500	0.530

\*Values in parenthesis were obtained by interpolation, under assumption that specific heat is about the same in the solid and liquid states.

**Boiling Point.**—The presence of a dissolved substance that increases the specific gravity raises the boiling point of a solution. The boiling point of milk and condensed milk at different vacua (pressures) was studied by Hunziker and Nissen.<sup>82</sup> Under atmospheric pressure at sea level the results showed the boiling points to be as follows:

TABLE 9.—BOILING POINT OF MILK, CREAM, EVAPORATED MILK AND SWEETENED CONDENSED MILK OF KNOWN SPECIFIC GRAVITIES  
HUNZIKER AND NISSEN<sup>82</sup>

Product	Specific Gravity at 60°F.	Boiling point at barometric pressure of exactly 760 mm.	
		°C.	°F.
Pure water	1.000	100	212
Whole Milk	1.0320	100.17	212.31
Cream	18% fat	100.24	212.43
Evaporated Milk	1.0660	100.44	212.79
Sweetened Condensed Milk	1.3085	103.2	217.80
Whole Milk containing 18% sucrose	1.0913	100.5	212.90

**Freezing Point.**—The presence of dissolved substances lowers the freezing point of a solution. The principal dissolved substances in milk are the sugar and the salts. These dissolved substances are maintained in equilibrium with those in the blood and are, therefore, the most constant constituents of milk. Because of the milk-blood equilibrium, the freezing point is one of the most constant physical properties of milk. Thus variations in freezing point constitute highly dependable sentinels for the detection of adulteration of the milk with extraneous water.

The Hortvet Cryoscope<sup>88</sup> has been found especially valuable for freezing point determinations, because, unlike other methods available for this purpose, the accuracy of its results does not depend upon data on the percentage composition of the milk sample, which are often not available at the time needed.

Pure water freezes at 0° C. (32° F.). The value generally accepted for the average freezing point of normal milk is -0.55° C. with normal variations from -0.53 to -0.57° C. Hortvet<sup>87</sup> found the variations for normal milk to range from -0.534 to -0.562° C. The work of Bailey<sup>89</sup> and of Doan<sup>90</sup> shows a range of -0.530 to -0.566° C. Filippo,<sup>88</sup> whose work with the Cryoscope covers a period of about 20 years and involves many thousands of milk inspections for adulteration, states that milk with a freezing point nearer to 0° C. than -0.53° C. (31.046° F.) is adulterated with water. He further observed that, as a general rule, each 0.01° C. (0.018° F.) indicates about two per cent of added water. In Holland<sup>85</sup> about one milk sample is analyzed yearly per 30 inhabitants, and the freezing point is taken of any milk with a solids-not-fat content of 8.2 per cent or less in winter, or 8.0 per cent or less in summer.

Doan demonstrated experimentally that cream and skimmilk have the same freezing point as the original sample of milk from which they are separated.

The Associates of Rogers<sup>23</sup> give the following figures for the calculated freezing point of sweetened condensed milk and evaporated milk:

Sweetened condensed milk	-14.96° C. (5.07° F.)
(8% fat, 20% M.S.N.F., 42% sucrose)	
Evaporated milk	-1.34° C. (29.59° F.)
(7.8% fat, 17.7% S.N.F.)	

#### THE COLOR OF MILK

The color of fresh milk is influenced by several constituents and reactions. The white color is due to the permanently dispersed casein. The opaqueness is caused by the minute particle size of the colloiddally suspended casein and the fat globules, which obstructs the unhindered passage of the light and further accentuates the whiteness. The color other than white, is due to the presence of two separate types of pigment, lactochrome and carotene.

**Lactochrome.**—Lactochrome is a water-soluble pigment that gives the whey its yellowish color. Its general characteristics suggest that it may be identical to urochrome, the yellow pigment of urine. Lactochrome appears to be a breed characteristic. Palmer and Coolidge<sup>84</sup> found the units of yellow in the whey of Ayrshire and Jersey milk nearly twice those contained in the whey of Holstein and Shorthorn milk. It has also been found in the whey of ewe's milk and human milk.

**Carotene.**—The carotenes belong to the group of provitamins A. They occur in plants together with chlorophyl. They are fat-soluble. While milk and butter, and certain vital organs and glands of animals contain some provitamins A, the most important sources of the carotinoids are all green or yellow parts of vegetables. Carrots, cabbage, spinach, lettuce are especially rich in carotenes. In the milk they are associated with the milk fat, to which they are directly transferred through the blood stream. It is their presence in milk that gives it its creamy tinge, and butter its yellow color. Since green feeds are richest in carotenes, the milk fat produced in the spring and early summer has a deeper yellow and the milk is a richer, creamy yellow than that produced in winter. The ability to incorporate carotene in the milk fat varies with the breed. When on green feed the Jerseys and Guernseys produce more highly colored milk and milk fat than the Holsteins and Ayrshires.

**Color of Concentrated Milk.**—Prolonged exposure to heat in manufacture and in storage, as well as aging, tends to darken the color of condensed, evaporated and dried milks. Excessive discoloration jeopardizes the market value of the product. The ideal is to preserve in the concentrated product the bright, light color of the fresh milk.

The cause of discoloration is now known to lie in a reaction between the sugar of milk and certain of the amino acids of the casein in the presence of heat. The formation of the resulting sugar-protein complexes is accompanied by a darkening of color. (For details see Chapter XXV.)

#### TASTE OR FLAVOR OF MILK

The most recent researches on milk flavor have revealed that the cooked flavor of heated milk is due to the liberation of the sulphides of milk. It has also been demonstrated experimentally that it is the time factor of the temperature-time ratio of heating that influences the flavor most. The latest research results give promise of further adjustment in the heat treatment that will ultimately provide a product in which the natural flavor of fresh milk is so well preserved in the concentrated product as to eliminate the cooked flavor problem as a consumer objection. (For details see Chapter XXV.)

#### REFERENCES

See list at end of Chapter III.

## CHAPTER III

### PROPERTIES OF MILK CONSTITUENTS

#### THE FAT OF MILK

The fat contained in cows' milk is commonly spoken of as butter fat. It averages approximately 3.8 per cent. It varies considerably, principally with breed, individuality, and period of lactation.

**Influence of Breed on Fat Content.**—The influence of breed on the percentage of milk fat is shown in Table 2. The breed variations of milk fat are greater than the breed variations of all the other milk solids combined. The maximum fat variations were over 1.6 as large as the maximum variations in solids-not-fat. In fact, the breed variations of milk fat largely controlled the breed variations of the total solids. The table shows that the Jerseys and Guernseys with fat averages above 5.0 per cent top all breeds. The Ayrshires, Brown Swiss and Simmental breeds come next, with fat averages slightly above 4.0 per cent; followed by the Shorthorns and Holsteins whose milk fat averages hover around or slightly above 3.5 per cent.

**Influence of Individuality.**—Appreciable variations in fat content of the milk of individual cows within the breed are a common occurrence. Such variations occur both above and below the breed average. They are generally attributed to inheritance of characteristics of certain strains or families. It is not uncommon for variations between individual cows of the same breed to exceed the differences between breed averages.

**Influence of Period of Lactation.**—The milk fat is highest at the beginning and toward the end of lactation. The highest percentages usually occur shortly before the cow ceases to give milk. After reaching bottom early in the lactation, the fat content continues low up to about the 8th month, when it begins to rise gradually. From about the eleventh month on to the end of the period the increase in fat content progresses more rapidly. The average variations in milk fat from four breeds, by 4-week periods during the entire period of lactation are shown in Table 3.

**Influence of Feed.**—From the standpoint of pounds of milk fat produced the feed has no noticeable influence. However, in the case of overfeeding, the tendency is for the percentage of fat to decrease with the increase in volume of milk. Similarly, on a subnormal ration the tendency is for the percentage of fat to rise with the decrease in volume of milk.

The feed has a marked effect on the fat constants, color and flavor, however. These factors are of great importance relative to quality and marketable properties of butter. They are discussed in detail in "The Butter Industry."<sup>15</sup> Most of the feed and weed flavors commonly encountered in milk and in cream are fat-soluble and volatilizable. Many of the feed flavors, if present in the milk, are therefore automatically volatilized and expelled by the heat and vacuum treatment used in the manufacture of con-

centrated and dried milk products. Moreover, condensery milk, in general, is produced in territory accustomed to whole milk requirements. The problem of growing feed that does not jeopardize the flavor of milk, and the obnoxious weed problem in such regions are usually under sufficient control to yield milk reasonably free from quality damaging feed flavors.

**Influence of Season.**—Other conditions being the same, and aside from the influence of period of lactation and feed, the average fat content varies somewhat with season of year. It is usually highest in late fall and winter and lowest in spring and early summer. These seasonal variations are attributed to atmospheric, temperature, and humidity conditions.

**Daily Variations.**—Considerable variation in the percentage of milk fat from the same cows may occur from day to day and from milking to milking. These variations are generally due largely to irregular intervals between milking. The fat content is usually highest after the shorter interval.

**Influence of Environment.**—Any unusual conditions that cause fright or other excitement at or immediately preceding milking time, may cause marked changes in the fat test. Such excitement often causes the cow to "hold up" her milk. The milk of that milking will be lower in fat content because it fails to contain the strippings which are the richest portion of the milking. Under normal conditions the fat content of the next milking will be above the average.

**Fat Globules.**—The milk fat is present in the form of globules that are microscopic in size. According to Fleischmann<sup>6</sup> the fat globules of cows' milk were first discovered and described by A. Van Leeuwenhoek in 1697. The maximum range of fat globule diameter reported appears to be from less than 0.1 to 22 microns. Normally the great majority of microscopically visible fat globules fall within a diameter range of 1.5 to 6.0 microns, with an approximate average of three microns. The range and average size of diameter vary appreciably, however, with breed, individuality, period of lactation, feed and environment.

**Factors Influencing the Size of the Fat Globules.**—1. The product of breeds of high-testing milk, such as Jersey and Guernsey milk, contains a larger proportion of large-diameter fat globules (diameter about 2 to 5 microns) than that of breeds of relatively low testing milk, such as Holstein and Shorthorn milk (diameter about 1 to 3.5 microns).

2. The fat globules of the milk from individual cows within the same breed have been found to vary considerably.

3. The fat globules of the milk of all breeds and individual cows are largest at the beginning of the period of lactation and gradually decrease in size as the lactation advances.

4. Change from succulent to dry feeds makes for smaller fat globules. Change from dry feed to pasture and feeding rations high in oil content tends to produce larger fat globules.<sup>18</sup>



5. Change in environment, such as causes fright or excitement of any kind, temporarily increases the size of the fat globules.<sup>16</sup>

The fat globule size is an important factor in the stability of the fat-in-skimmilk emulsion (prevention of fat separation) in evaporated milk and control of uniformity of composition of whole milk powder. See also Chapter XXI on "Homogenization of Evaporated Milk."

**Fat Globule "Membrane".**—The question of fat globule "membrane", its presence and its character, has been the subject of much study during the past half century. The conclusions reached are far from final as yet. For a brief but comprehensive survey of findings the reader is referred to the review by the late Doctor Leroy S. Palmer<sup>17</sup> whose own extensive experimental study of the subject has contributed greatly to our knowledge of the structure and properties of the fat globule membrane.

Briefly, the present conception on the part of the student of the structure of the fat globule in milk is that the immediate surface of the fat globules is surrounded wholly or partially by a natural covering of adsorbed substances, consisting of a phospholipid-protein complex. The phospholipid fraction consists mainly of lecithin. The protein fraction differs in composition from the major milk proteins such as the casein, lactalbumin and lactoglobulin. The outer layers of the fat globule surface (between the natural "membrane" that lies nearest to the fat and the milk) is believed to constitute an undetermined concentration of milk plasma, consisting principally of major milk proteins (mainly casein). This outer layer is readily removed when cream is washed by dilution with water. The phospholipid-protein membrane is in part removed in the churning of cream. It is recovered in the buttermilk and in the butter serum. (See also "Lecithin" later in this chapter.)

**Components of Milk Fat.**—Milk fat is made up of the glycerides of a considerable number of fatty acids. The fatty acids constitute the radicals which, in chemical combination with glycerol as the base, are known as the glycerides. The fatty acids of milk fat that are definitely known are 12 in number. In addition, traces of other fatty acids, as yet undetermined, have also been found.

Some of the free fatty acids of milk are water-soluble and steam-volatile. This group constitutes approximately from 8 to 12 per cent of the total fatty acids. The remaining 88 to 92 per cent are insoluble and non-volatile. All the fatty acids of milk fat except oleic and linoleic acid are saturated acids. The different fatty acids contained in milk fat vary in percentage composition with breed, individuality, period of lactation of cow, and especially with feed and season of year, as shown by Eckels and Shaw,<sup>11, 12, 18</sup> Hunziker, Mills and Spitzer,<sup>16</sup> Hilditch and Sleightholme,<sup>19</sup> and Dean and Hilditch.<sup>20</sup> The known fatty acids of milk fat, their percentage composition and properties are listed in Table 10.

TABLE 10.—PERCENTAGE COMPOSITION AND PHYSICAL CONSTANTS OF FATTY ACIDS OF MILK FAT\*

Kind of Fatty acid	Molecular Weight	Proportion present in the milk fat		Melting Point °C.	Water-soluble	Steam-volatile	Saturated
		Range	Average				
		per cent	per cent				
Butyric.....	88	2.24 to 4.23	2.93	-7	+	+	+
Cap. jic.....	116	1.29 to 2.40	1.90	-8	+	+	+
Caprylic.....	144	0.52 to 1.04	0.79	16.5	+	+	+
Capric.....	172	1.19 to 2.01	1.57	31.3	+	+	+
Lauric.....	200	4.53 to 7.69	5.85	43.6	.....	appreciably	+
Myristic.....	228	15.55 to 22.62	19.78	54	.....	very slightly	+
Palmitic.....	256	5.78 to 22.86	15.17	63	.....	.....	+
Stearic.....	284	7.80 to 20.37	14.91	69.3	.....	.....	+
Arachidic.....	342	0.50 to 1.00	0.62	77	.....	.....	+
Oleic.....	282	25.27 to 40.31	31.90	16	.....	sl. vol. in superh. steam sl. vol.	.....
Linoleic.....	280	1.90 to 5.90	4.14	-18	.....	.....	.....

\*Assembled from tables by Holland et al.<sup>21</sup>, Lea<sup>22</sup>, and Associates of Rogers<sup>23</sup>.

**Substances Associated with the Milk Fat.**—Milk contains fat-soluble substances of which the milk fat is the carrier. To these substances associated with the fat belongs the group of fat-soluble vitamins, such as Vitamin A and its provitamin carotene, Vitamin D and its provitamin cholesterol, and Vitamins E, of the Tocopherol Group. Vitamin E has active anti-oxidant properties, while carotene, the provitamin A, is largely responsible for the yellow color of milk fat.

Other substances associated with milk fat are the phospholipids or phosphatides. To this group belong lecithin, cephalin and sphingomyelin. Of these products, lecithin is quantitatively the most prominent. It is in fact more or less common practice to refer to the phosphatides as lecithin. The phosphatide content of several dairy products is shown in Table 11.

TABLE 11.—PHOSPHATIDE CONTENT OF MILK AND MILK PRODUCTS<sup>24</sup> AS DETERMINED BY THREE SEPARATE INVESTIGATORS

Milk product	Mohr, Brockmann and Mueller <sup>25</sup>	Horral <sup>26</sup>	Holm, Wright and Deysher <sup>24</sup>
	per cent	per cent	per cent
Whole milk.....	0.037	0.0276	0.0337
Skim milk.....	0.0155	0.0166	0.0169
Cream.....	0.1685 (23%)	0.155 (37.67%)	0.1816 (41%)
Butter.....	0.2060	0.1685	0.1819
Buttermilk.....	0.1142	0.1415	0.1872
Separator Slime.....	.....	0.68	.....

It was shown under "Fat Globule Membrane" earlier in this chapter, that the immediate surface of the fat globules is surrounded by a more or less complete covering of material consisting principally of a phospholipid-protein compound. This observation is supported by the fact that

buttermilk and the serum of butter contain the bulk of the lecithin that is present in the original milk. Horrall's<sup>26</sup> results further show that the separator slime is relatively rich in phospholipids. According to Ritter and Nussbaumer,<sup>30</sup> the *Buttereinsiederückstand* (residue from boiling down melted butter when making cooking butter) has a higher phosphatide content (5-20 per cent phosphatide) than any other dairy product.

Horrall<sup>26</sup> found that the lecithin content of milk was increased by udder infection with mastitis. The fat of milk from diseased quarters ranged from 0.648 to 5.32 per cent lecithin, with the majority of samples above 0.9 per cent. The fat of the milk from normal quarters tested from 0.504 to 0.743 per cent lecithin.

According to the findings of Kurtz, Jamieson and Holm,<sup>27</sup> the fatty acids of the lecithin-cephalin fraction which constitutes over 90 per cent of the lipolipids contained in milk, are very high in unsaturated fatty acids. They consist of over 70 per cent of oleic acid, which readily oxidizes and is high in active oxidant property. It is, in fact, an active oxidant.

The phosphatides of milk are believed to play an important part in flavor deterioration of whole milk powder in the presence of atmospheric oxygen. Holm, Greenbank and Deysher<sup>28</sup> demonstrated that removal of separator slime by centrifugal clarification of the milk definitely made dried whole milk keep fresh and sweet longer. Dahle and Josephson<sup>29</sup> also reported that the removal of part of the lecithin definitely improved the keeping quality of whole milk powder. The appearance of tallowy flavor, which invariably accompanies autoxidation of the milk fat, was appreciably retarded, if not prevented. See also Chapter XII on "Removal of Impurities by Use of the Centrifugal Clarifier."

A further indication of the close relationship between phosphatides and keeping quality of whole milk powder lies in the reaction of lecithin to heat. Mohr et al<sup>25</sup> found that pasteurization has but slight effect on the lecithin content of milk, while Bordas and de Raczowski<sup>31</sup> observed that temperatures of 95 to 110° C. (203 to 230° F.) destroyed as high as 28 per cent of the lecithin content. These findings suggest that the improvement of the keeping quality of whole milk powder accomplished by the use of high preheating temperature (above boiling point) may be due, in part at least, to the destruction of oxidants such as the phosphatides. Improvement in keeping quality when using high forewarming temperatures has been observed in commercial manufacture of whole milk powder.

#### THE PROTEINS OF MILK

The milk proteins constitute approximately 3.4 to 3.8 per cent of the composition of average normal milk. Their properties are of great importance in the manufacture of all forms of concentrated and dried milks. Their reaction to processing heat largely determines the heat

stability and viscosity of concentrated milks, and the solubility of milk powder. The proteins are built up of amino acids in various combinations. The principal milk proteins are: casein, lactalbumin and lactoglobulin.

**Casein.**—Casein is the chief protein of milk. It is found in milk only. It is a complex of numerous amino acids and is nutritionally one of the most complete proteins known. According to Fleischmann,<sup>6</sup> it is composed of 52.95 per cent carbon, 22.78 per cent oxygen, 15.65 per cent nitrogen, 7.05 per cent hydrogen, 0.85 per cent phosphorus and 0.72 per cent sulphur.

The casein is present in fresh milk as a calcium salt (calcium caseinate). It is dispersed in milk in colloidal suspension and forms a homogeneous emulsion. The particle size of calcium caseinate is reported to range from a radius of 100 millimicrons to molecular size, averaging 40 to 50 millimicrons.<sup>85</sup>

Calcium caseinate reacts acid to phenolphthalein. It reacts toward bases in a similar manner as do acids, forming salt-like combinations. It is soluble in weak alkalies and strong acids. It coagulates by the action of strong alkalies, weak acids, the salts of numerous metals, rennet, alcohol, and heat. At ordinary temperatures it coagulates at a titratable milk acidity of 0.6 to 0.7 per cent, yielding free casein and calcium lactate. When rennet or products containing the enzyme rennin are added, the milk coagulates yielding calcium paracasein.

Heat coagulation of the casein means heat coagulation of the milk. Control of heat stability of the milk is of compelling importance in the manufacture of evaporated milk. Upon it depends the reaction of evaporated milk to sterilizing heat and attainment of the desired viscosity. Bardach<sup>72</sup> found that fresh milk curdles at 100° C. in about 12 hours, at 130° C. in about one hour, and at 150° C. in about three minutes. According to Sommer and Hart,<sup>87</sup> and Milroy<sup>88</sup> the heat treatment of milk results in the precipitation of calcium, rendering the casein unstable to heat. In evaporated milk the resulting concentration of the casein, albumin and acidity, together with the salt balance, are important factors in their influence on the heat stability of the concentrated product. See also Chapter XXIV.

**Variations in Casein Content.**—The casein content of milk varies within wide limits. Van Slyke<sup>89</sup> shows that in mixed market milk it may vary between two and three per cent, in milk from single herds from 1.80 to 3.0 per cent, and in single milkings from individual cows from 1.50 to 4.50 per cent. The per cent casein in milk is influenced primarily by such factors as breed, individuality of cow, period of lactation and probably feed.

**Effect of Breed on Casein Content.**—Table 12 shows the influence of breed on the casein content of milk.

TABLE 12.—INFLUENCE OF BREED ON CASEIN CONTENT OF MILK

Breed	Casein in Milk of			Average Casein
	Cow 1	Cow 2	Cow 3	
	per cent	per cent	per cent	per cent
Jerseys.....	2.93	2.65	3.13	2.93
Shorthorn.....	2.74	2.87	2.62	2.74
Ayrshires.....	2.62	2.81		2.70
Holsteins.....	2.49	2.11	2.49	2.36
Average.....	2.69	2.61	2.74	2.68

The figures in the first three columns of Table 12 represent the averages of the casein content of the milk by 4-week periods for the entire lactation period of each of the 11 cows (three cows each of Jerseys, Holsteins and Shorthorns, and two Ayrshires). The table shows that the casein content for the whole lactation period averages highest for the Jerseys and lowest for the Holsteins. The variations of the averages between individual cows within the same breed are nearly as great as those of the breed averages.

**Influence of Lactation on Casein Content.**—Hunziker<sup>33</sup> reported the casein content of the milk of three cows of the first 14 milkings and by monthly periods thereafter, for the entire lactation period of each cow. The results are given in Table 40, Chapter XXIV.

TABLE 13.—MAXIMUM, MINIMUM AND AVERAGE PER CENT OF ALBUMIN AND CASEIN ENTIRE LACTATION PERIOD OF EACH COW  
HUNZIKER<sup>33</sup>

Cow No.	Maximum			Minimum			Average after 7th day		
	Albumin	Casein	Total Protein	Albumin	Casein	Total Protein	Albumin	Casein	Total Protein
	%	%	%	%	%	%	%	%	%
1	1.15	3.21	4.36	0.60	2.23	2.76	0.66	2.68	3.34
2	6.62	6.80	13.42	0.44	2.11	2.63	0.56	2.80	3.05
3	6.63	6.68	12.79	0.49	2.45	2.93	0.64	3.09	3.62

The casein is highest immediately after parturition. Table 13 shows that the first milk drawn contained over 6.8 per cent casein after parturition. The first 14 milkings averaged 3.82 per cent. The casein content then dropped to about 2.60 per cent, where it remained without appreciable change up to the seventh month. From there on it increased continuously to the end of the lactation period when it was about 3.0 per cent. Omitting the first 14 milkings, the casein content averaged 2.76 per cent for the lactation periods of the three cows.

**Influence of Feed on Casein Content.**—Eckles and Palmer<sup>34</sup> studied the influence of a supernormal plane of nutrition on the composition of milk. Their results show a marked increase in milk flow and a decrease of the percentage of fat and lactose sufficient to maintain the normal yield of these components.

In the case of the total proteins, however, the intense overfeeding was accompanied by a constant higher protein level of 0.4 to 0.5 per cent throughout the overfeeding period. When the plane of nutrition was reduced to normal the total protein content also returned to normal. Because of the accompanying increase in volume of milk, the yield in pounds of total protein was thus actually increased due to overfeeding. The results further show that the supernormal plane of nutrition had no appreciable influence on the lactalbumin content. The increase in percentage of total protein, therefore, was in fact an increase of similar magnitude of the percentage of casein.

**Lactalbumin.**—In chemical composition, lactalbumin differs from casein chiefly in that it contains no phosphorus and its sulphur content is over twice that found in casein. Fleischmann<sup>6</sup> reports the following composition for lactalbumin: carbon 52.19 per cent, oxygen 23.13 per cent, nitrogen 15.77 per cent, hydrogen 7.18 per cent, sulphur 1.73 per cent.

Lactalbumin is soluble in water, dilute acids and dilute solutions of sodium chloride and sodium carbonate. Rennet does not coagulate it. It coagulates more readily by heat than casein, as shown in Table 14.

TABLE 14.—COAGULATION OF LACTALBUMIN AT DIFFERENT TEMPERATURES  
P. RUPP<sup>40</sup>

Per Cent Lactalbumin Coagulated			
Held 30 Minutes at	Albumin Coagulated	Held 30 Minutes at	Albumin Coagulated
	Per cent		Per cent
145° F. (62 8° C.)	none	160° F. (71 1° C.)	30 87
150° F. (65 6° C.)	5 71	212° F. (100° C.)	99 85*
155° F. (68° C.)	12 76		

\*Determination by Hunziker<sup>33</sup>. Analyses yielded from 0.14 to 0.16% lactalbumin not precipitated by heat.

**Percentage of Lactalbumin in Milk.**—The albumin content of milk averages approximately 0.6 per cent. It is highest in the early milkings of the colostrum, then drops below average until about the fifth month. It then increases slightly to the end of the lactation period. It is definitely highest in the colostrum. Hunziker<sup>33</sup> found the albumin content in the first milking after parturition to be over six per cent, and Engel and Schlag<sup>14</sup> reported the first milking of the colostrum of one cow to have been 11.34 per cent (Table 3-A). These figures emphasize the impor-

tance of vigilance on the factory receiving platform to avoid costly heat coagulation trouble from colostrum in condensery milk.

**Relation of Lactalbumin to Heat Stability.**—The lactalbumin is regarded by some investigators as a major factor in the control of heat coagulation of the evaporated milk in sterilization. It is held that the stabilizing effect of preheating at relatively high temperatures is due largely to the coagulation of the lactalbumin contained in the fresh milk. This assumption is based on the reasoning that if the albumin has been coagulated in the fresh milk, it cannot later contribute to the gel formation when the concentrated milk is being sterilized. On the other hand, at low forewarming temperatures, the lactalbumin will have been less completely coagulated, and the danger of objectionable curdling in the sterilizer is augmented. The marked improvement in heat stability that has been found to result from the use of the high-short forewarming treatment supports the above reasoning. (See also Chapter XXIV.)

**Lactoglobulin.**—The lactoglobulin content of normal milk averages approximately 0.05 per cent. According to Emmerling<sup>41</sup> its content in colostrum is very high, amounting to as much as eight per cent immediately after parturition, dropping to about 0.93 per cent after 12 hours, and to 0.04 per cent after six days. Emmerling reports the following composition for lactoglobulin: Carbon 49.83 per cent, hydrogen 7.77 per cent, nitrogen 15.28 per cent, oxygen 25.88 per cent, sulphur 1.24 per cent. Lactoglobulin in solution is completely coagulated at 72° C.<sup>6</sup>

#### THE SUGAR OF MILK

Lactose, the sugar of milk ( $C_{12}H_{22}O_{11} + H_2O$ ), is the chief carbohydrate of milk. It is much less sweet to taste than sucrose. This lack of sweetness is accentuated with the solid sugar because of its relatively low solubility and the hardness of its crystals. But even in solution lactose is only about one-sixth as sweet as sucrose.<sup>56</sup> Solid lactose feels like sand to the tongue, hence the designation sandiness of sweetened condensed milk and ice cream containing coarse lactose crystals. The industry is indebted to Whittier<sup>45</sup> for his most comprehensive review of the history, properties and use of lactose.

**The Lactose Content of Milk.**—The lactose content of normal milk averages approximately 4.8 per cent. Milk sugar is the least variable constituent of milk except the ash. Extreme variations on record range from 2.41 to slightly over 6.0 per cent, but such variations are very rare. In mixed herd milk variations in lactose content are usually well within the range of 4.50 to 5.0 per cent.

**Factors That Influence the Lactose Content.**—These factors are largely limited to individuality of cow, breed and period of lactation. Table 2 shows the average lactose content of milk from each of seven breeds of dairy cows. Each breed average involves several hundred samples of

milk. The maximum variation between these breed averages is 0.33 per cent. Table 15 gives the average lactose content of the milk of 11 cows by 4-week periods during their entire periods of lactation.<sup>11</sup> The maximum difference between the 4-week periods was 0.41 per cent. The variations appear to lack systematic continuity as the period of lactation advances. However, Eckles and Shaw,<sup>12</sup> and Riddet, Campbell, McDonald and Cox<sup>62</sup> reported a trend to a slight but definite decrease in lactose content toward the end of the lactation period.

TABLE 15—AVERAGE PER CENT LACTOSE IN MILK OF 11 COWS BY 4-WEEK PERIODS DURING ENTIRE LACTATION PERIOD\*<sup>11</sup>

Four-week Periods	Lactose per cent	Four-week Periods	Lactose per cent
1st	4 90	8th	4 86
2nd	4 83	9th	4 85
3rd	4 96	10th	4 55
4th	4 74	11th	4 78
5th	4 81	12th	4 95
6th	4 76	13th	4 76
7th	4 90		
		Grand Average	4 80

\*The 11 cows consisted of 3 cows each of Jerseys, Holsteins and Shorthorns, and 2 Ayrshires.

The work of Eckles and Palmer<sup>34</sup> on the influence of plane of nutrition upon the composition of milk suggests that there is no consistent trend of influence of feed on lactose content. Variations both above and below the normal percentage of lactose for the cows on test occurred during the periods of overfeeding. Riddet et al, however, observed a definite decrease in lactose content when the cows were transferred to a sub-normal ration.

**Role of Milk Sugar in Manufacture of Concentrated Milk Products.**—The sugar of milk plays an important part in the successful control of some of the marketable properties of condensed milk and dried milk products in their manufacture. The size of lactose crystals determines the relative smoothness of sweetened condensed milk (see Chapter XVI). The intense hygroscopic properties of lactose while in the "glass" stage (un-crystallized in high supersaturation), cause stickiness and caking in dried milks, a defect which is accentuated particularly in the case of sour-cream buttermilk powder and whey powder (see also Chapters XXXVIII and XXXIX). Furthermore, the percentage of lactose in milk fundamentally determines the yield in the manufacture of milk sugar of commerce (see Chapter XLV).

**Structure of Milk Sugar Crystals.**—Lactose crystals are of complex crystallographic structure. They belong to Class C<sub>2</sub>. They are mono-



clinic sphenoidal and have only one axis of symmetry. They have trapezoidal side faces and rhombic tops and bottoms. The fully developed lactose crystal has, in addition, beveled faces at base and apex which may terminate in a sharp edge giving the crystal a distinct tomahawk

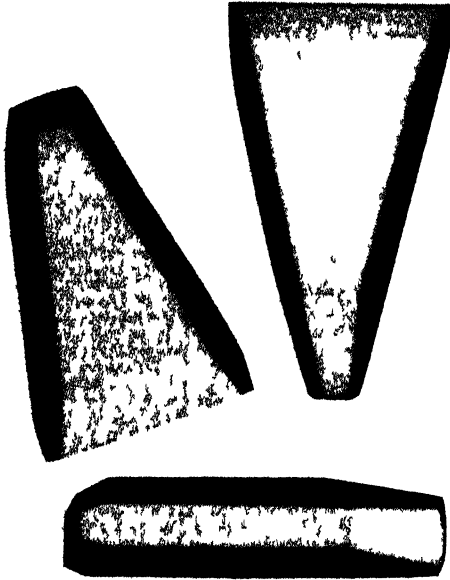

Fig 4. Lactose crystals



Fig 5 Sucrose crystal



Fig 6 Lactose crystals from pure lactose solution, mag, x 230



Fig. 7. Lactose crystals from 62% sucrose solutions, mag, x 160

appearance. It may have ten faces and its length is approximately 1.8 times its width at its widest portion.

Hunziker and Nissen<sup>42</sup> demonstrated experimentally that fully developed typical lactose crystals, as described above, are characteristic of the crystals obtained from supersaturated lactose solutions in water, in

skimmilk, in whole milk, in milk serum, and in plain condensed milk (unsweetened). It appears evident, therefore, that the presence in the milk sugar solution of milk colloids and milk fat does in no way modify the appearance or the structure of the lactose crystal obtained.

The presence of sucrose in the supersaturated lactose solution causes an apparent modification of lactose crystals. In the case of dilute sucrose solutions, such as solutions containing 14 per cent sucrose, the change is only slight. The lactose crystals are fully developed, but they are shorter and thicker than the crystals from solutions containing no sucrose. This is the type of lactose crystals found in sandy ice cream. In concentrated sucrose solutions, such as solutions containing 62 per cent sucrose, the change in the appearance of the lactose crystal is very marked. The crystals resemble short, truncated pyramids with flat rhomboid bases and apexes, the beveled faces at base and apex being entirely absent. This is the type of crystal found in normal sweetened condensed milk. In "sandy" sweetened condensed milk the above crystal forms are interspersed with relatively large diamond shaped crystals, such as Williams and Peter<sup>91</sup> have found in "sandy" ice cream, and which they have identified as alpha lactose hydrate.

Under "Sucrose" it will be shown that, while concentrated sucrose solutions modify the appearance of the lactose crystal, supersaturated solutions of both sugars do not yield a mixed crystal of both lactose and sucrose.

Herrington<sup>49</sup> observed that both alpha hydrate and beta anhydride will form needles if crystallization is sufficiently rapid. He distinguished the two forms of lactose readily by the fact that the prisms of alpha hydrate were always straight, while those of beta anhydride were curved. Herrington concluded, on the basis of his extensive study of the crystalline habit of lactose, that the principal factor governing the crystalline form of lactose is the rate of crystal growth, to which function he gives the designation "crystallization pressure."

**Modifications of Milk Sugar.**—In solution lactose exists in two forms, i.e., alpha lactose and beta lactose. Crystallized lactose may exist in three forms, namely, alpha lactose hydrate, alpha lactose anhydride, and beta lactose anhydride.

**Alpha Lactose Hydrate** ( $C_{12}H_{22}O_{11} + H_2O$ ) is the milk sugar of commerce. It is crystallized from lactose solutions at ordinary temperature. It contains one molecule of water. Its water of crystallization amounts to about five per cent. It is a monohydrate, and its specific optical rotation in water solution is  $+89.4^\circ$ .<sup>45</sup> Its melting point is  $201.6^\circ$  C. (See also Chapter XLV.)

**Alpha Lactose Anhydride** ( $C_{12}H_{20}O_{11}$ ) is obtained by dehydrating alpha lactose hydrate at a temperature below  $93.5^\circ$  C. but not below  $65^\circ$  C., preferably under reduced pressure. It has a melting point of  $225^\circ$  C.

Its solution in water shows the same rotation and mutarotation as a solution containing a similar quantity of alpha hydrate. The anhydride is stable in dry air. In the presence of moisture at temperatures below 93.5° C. it reverts to the hydrate form; at temperatures above 93.5° C. it changes to beta lactose anhydride.<sup>45</sup> According to Herrington<sup>52</sup> alpha anhydride has never been prepared by direct crystallization.

**Beta Lactose Anhydride** ( $C_{12}H_{22}O_{11}$ ) results when an aqueous solution of lactose is concentrated and crystallization is caused to take place at a temperature above 93.5° C. It has a specific rotation in water solution of +35.0, changing gradually to +55.5, and its melting point is 252.2° C.

**Beta-Alpha Mutation in Sweetened Condensed Milk.**—In sweetened condensed milk which normally is a supersaturated solution of alpha lactose hydrate, it will crystallize until the solution is no longer saturated as to alpha lactose. This then destroys the beta-alpha equilibrium and more beta lactose in solution changes to alpha until equilibrium is reestablished. But this again causes supersaturation and crystallization of alpha-lactose.

In this manner, the simultaneous succession of alpha crystallization and mutation of more beta to alpha continues until finally equilibrium is attained without supersaturation. Because of the necessity of the mutation from beta (that is highly soluble) to alpha lactose (that is of relatively low solubility), the rate of lactose crystallization is slow. The rate is further retarded by the presence of the milk colloids and the resistance to diffusion caused by the high viscosity of the sweetened condensed milk.

For details on alpha-beta equilibria, see Chapter XLV, under "Manufacture of Quickly Soluble Lactose."

**The Solubility of Milk Sugar.**—According to Hudson's<sup>48, 58</sup> findings the sugar of milk may be considered to have three points of solubility, namely, initial solubility, final solubility, and super solubility. Hudson's

TABLE 16.—INITIAL AND FINAL SOLUBILITY OF LACTOSE  
(Based on lactose anhydride  $C_{12}H_{22}O_{11}$  and not the hydrated form  
 $C_{12}H_{24}O_{12}$ )

Temperature		Initial Solubility		Final Solubility	
°C.	° F.	Lactose per cent	Parts Lactose to 100 parts of water	Lactose per cent	Parts Lactose to 100 parts of water
0	32	4.8	5.0	10.6	11.9
15	59	6.8	7.3	14.5	16.9
25	77	8.2	8.9	17.8	21.6
39	102	11.0	12.4	24.0	31.5
49	120	15.0	17.6	29.8	42.4
64	147	21.0	26.6	39.7	65.8
74	165	26.0	33.1	46.8	56.2
89	192	37.0	56.7	56.2	139.2

figures for initial and final solubility of milk sugar at different temperatures are assembled in Table 16.

**Initial Solubility.**—When ordinary powdered milk sugar, the alpha hydrate, is placed in water and vigorously shaken in order to secure a saturated solution rapidly, a certain portion of the sugar dissolves immediately. The amount that goes into immediate solution represents the initial solubility of the hydrate form of lactose. The initial solubility, however, is temporary only, as the lactose that has gone into solution changes to beta anhydrous lactose and this change continues until at ordinary temperature (20° C.) a ratio of approximately 1.6 beta to 1 alpha lactose is attained. This change is progressively decreasing the amount of alpha lactose in solution. It reduces the state of saturation to undersaturation, causing more beta lactose to go in solution.

**Final Solubility.**—In the presence of continuous shaking the change of alpha to beta lactose and the progressive solution of alpha lactose continue until equilibrium is reached. This occurs when the ratio of beta to alpha lactose is approximately 1.6 to 1 (at 20° C.) and the alpha lactose represents a saturated solution. The amount of lactose that is in solution at this final point represents the final solubility. The initial and final solubilities vary with temperature as shown in Table 16 and in chart Fig. 47.

**Supersolubility.**—When a saturated solution is cooled below the temperature of saturation it becomes supersaturated. If the cooling is done moderately only, crystal nuclei often do not form immediately, the solution maintaining its supersaturation for a prolonged period of time. When the cooling is continued to lower temperatures, crystallization will set in and, when once initiated, will spread through the entire mass. Cooling below the temperature of saturation is called supercooling and the state of solubility that exists in a supercooled solution is termed supersolubility.

Ostwald<sup>63</sup> names that state of supersolubility in which nuclei of crystals do not readily form a "meta-stable" condition and that state of condition induced by further supercooling which results in crystallization, a "labile" condition.

**Effect of Milk Colloids and Sucrose on Lactose Solubility.**—Hunziker and Nissen<sup>61</sup> studied the solubility of lactose in water, whole milk, skim-milk, and also in water and milk containing sucrose at 65° F. and at 50° F., respectively. They found the solubility in water at 50° F. slightly under 15 grams (14.97), and at 65° F. slightly over 18 grams (18.34), per 100 grams of water.

The lactose solubility in whole milk and in skimmilk was the same as that in water at the same temperature. In whole milk at 65° F. containing 62 per cent sucrose, which is the approximate sucrose concentration in normal sweetened condensed milk, the lactose solubility was approximately 15 grams (15.20) per 100 grams of water.

Peter<sup>50</sup> studied the solubility of lactose at low temperatures. He found that at 0° C. it was reduced nearly one-half by saturating the lactose solution with sucrose. The above results show that the milk solids have no effect on the solubility of lactose, but that sucrose solutions definitely diminish lactose solubility.

**Control of Crystal Size.**—The crystallization of the sugar of milk functions fundamentally in accordance with the generally observed crystallization procedure. If a liquid containing a crystallizable substance is cooled rapidly below the saturation temperature, the resulting crystals are of uniformly very small size. While slow cooling yields definitely larger crystals, they are of irregular size and subject to further growth.

**Rate of Lactose Crystallization.**—As stated earlier, lactose is relatively slow to crystallize. Whittier<sup>45</sup> points out that solutions supersaturated to a degree not exceeding the supersolubility value, will not crystallize, even if the solution is agitated, unless lactose crystals or particles of some isomorphous substance are introduced. Herrington<sup>52</sup> likewise demonstrated that solutions saturated with lactose at approximately 50° C. may be cooled to 0° C. without spontaneous crystallization taking place, in the absence of agitation. Whittier and Gould<sup>53</sup> found the rate of crystallization greater at 30° C. than at 25° C. or at any lower temperature.

It was pointed out in earlier paragraphs that in sweetened condensed milk the rate of crystallization is further impeded by the presence of colloids and the high viscosity of the medium, emphasizing the need of seeding and vigorous agitation at the proper temperature (see Chapter XVI.)

**Lactose Crystallization in Dried Milk Products.**—Dried milk products are relatively high concentrations of lactose. In the majority of commercial milk drying processes now used, the milk is precondensed to a relatively high concentration (about 30 to 45 per cent solids). In drying, the remainder of the removable water is evaporated very rapidly (almost instantaneously). Neither seeding nor agitation is resorted to to facilitate lactose crystallization. Due to the rapidity of drying and the very low moisture content in the finished product, the lactose in the resulting powder is present in the form of a non-crystalline glass. This fact was experimentally established by Troy and Sharp<sup>54</sup> and was later confirmed by Herrington.<sup>52</sup>

If protected from moisture, such glasses are stable at room temperature. They are very hygroscopic, however. They absorb moisture from the air readily and will continue to do so until the absorbed moisture has caused sufficient dilution to induce crystallization. Dried milk, by reason of its high lactose content, inherits more or less of the pronounced hygroscopic properties of the lactose glass. Therefore, unless protected from contact with a humid atmosphere, milk powder readily absorbs moisture from the air. This causes the milk particles to adhere to one another,

making the product moist and sticky. Due to this dilution with absorbed moisture, crystallization takes place, the glass solidifies and causes the milk powder to cake.

**Lactic Acidity Augments Hygroscopicity of Milk Powder.**—The tendency of milk powder to stickiness and caking increases with the lactose content. In addition, it is much augmented by lactic acidity, such as is present in sour-cream buttermilk powder and in cheese whey powder. In the fluid sour buttermilk and sour whey, lactic acid is the major fermentation product. Thus, one molecule of osmotically active lactose is broken down into four molecules of osmotically active lactic acid. It could be reasonably expected, then, as Sharp and Doob<sup>55</sup> point out, that the powder made from these sour milk products would have more pronounced hygroscopic properties because of the conversion from lactose to lactic acid.

Therefore, trouble with stickiness and caking that is prone to occur, especially in sour cream buttermilk powder and in whey powder held in storage, may be largely avoided by organizing the routine of manufacture in a manner that will cause crystallization of a considerable portion of the lactose content by the time the dried product passes through the bolter, flaker or grinder, and before the powder is sacked. (See also Chapters XXXVIII and XXXIX on "Dried Buttermilk" and "Dried Whey," respectively.)

#### THE ASH OF MILK

**Composition of Ash.**—The ash or mineral content of milk constitutes about 0.7 per cent of the composition of milk. The ash content is highest in the colostrum milk. Engling-Leach<sup>63</sup> show the per cent ash in milk during the first 72 hours after parturition. Immediately after calving the milk contained 1.18 per cent ash, after 10 hours 1.55 per cent. From then on it decreased rapidly and was .82 per cent after 72 hours. Hills<sup>71</sup> reports that German analyses give the maximum ash content of 22 cows, milked immediately after calving, at 2.31 per cent. The ash content of milk after the first 14 milkings is quite uniform, ranging between about .65 to .75 per cent throughout the period of lactation and to within a short time before the cows dry up. It is, in fact, the most constant constituent of cow's milk, and because of this the average ash content of .7 percent furnishes a reasonably dependable basis for calculating the ratio of concentration of a condensed product by dividing the ash content of the latter by the factor 0.7.

The ash of milk consists chiefly of potassium, sodium, calcium and magnesium, combined with phosphoric acid, hydrochloric acid and citric acid. Citric acid is destroyed in the ash determination of the milk. The figure 0.7 per cent given as the average ash content of milk, therefore, does not include the citric acid content. A portion of the lime is com-

bined with the proteins as calcium caseinate. There are also present small amounts of iron and sulphur.

Babcock<sup>64</sup> gives the composition of ash as follows:

TABLE 17.—COMPOSITION OF ASH IN NORMAL COW'S MILK

Mineral Constituents in Milk	In Ash Per Cent	In Milk Per Cent
Potassium oxide (potash).....	25 02	.175
Sodium oxide (soda).....	10 01	.070
Calcium oxide (lime).....	20 01	.140
Magnesium oxide (magnesia).....	2 42	.017
Iron oxide (ferric).....	13	.001
Sulphur trioxide.....	3 84	.027
Phosphoric pentoxide.....	24 29	.170
Chlorine.....	14 28	.100
Total ash.....	100.00	.700

Söldner<sup>65</sup> suggests the following grouping of the milk salts:

Sodium chloride, NaCl.....	10.62
Potassium chloride, KCl.....	9.16
Mono-potassium phosphate, $\text{KH}_2\text{PO}_4$ .....	12.77
Di-potassium phosphate, $\text{K}_2\text{HPO}_4$ .....	9.22
Potassium citrate, $\text{K}_3(\text{C}_6\text{H}_5\text{O}_7)_2$ .....	5.47
Di-magnesium phosphate, $\text{MgHPO}_4$ .....	3.71
Magnesium citrate, $\text{Mg}_3(\text{C}_6\text{H}_5\text{O}_7)_2$ .....	4.05
Di-calcium phosphate, $\text{CaHPO}_4$ .....	7.42
Tri-calcium phosphate, $\text{Ca}_3(\text{PO}_4)_2$ .....	8.90
Calcium citrate, $\text{Ca}_3(\text{C}_6\text{H}_5\text{O}_7)_2$ .....	23.55
Lime, combined with proteins.....	5.13

**Importance of Salt Balance in Controlling Heat Coagulation.**—When evaporated milk is heat-treated in the sterilizer at a temperature-time ratio sufficient to render the product dependably sterile, its tendency is to curdle. In order to preserve its marketable properties, this coagulation must be limited to an increase in viscosity that will give the finished product a pleasing full body without the precipitation of visible lumps of curd. In this effort the calcium and magnesium and the citrates and phosphates contained in the milk play an important role.

**Relation of Ash Constituents to Heat Stability of Evaporated Milk.**—It is shown in Chapter XXIV that, for optimum heat stability, the calcium and magnesium must balance the citrates and phosphates, and that an excess or deficiency of either group of salts yields milk of objectionably low heat stability. It was further shown that almost invariably the occurrence of low heat stability is due to an excess of calcium. In such cases the calcium excess may be corrected and satisfactory heat

stability established, by the use of the high-short heat treatment in fore-warming, or the addition of a chemical stabilizer such as di-sodium phosphate or sodium citrate. (See Chapter XXVI.)

**High Calcium Content in Colostrum and Stripper Milk.**—Low heat stability causing curdling difficulties in the sterilizer is confined largely to late fall, winter and early spring. This is the period of the year in the temperate zone of the Northern Hemisphere when the majority of cows are well along in their lactation or have recently freshened.

It was further shown by Sommer and Hart<sup>66</sup> and Van Slyke and Bosworth<sup>67</sup> that the calcium content of milk is highest at the beginning and during the advanced stages of the period of lactation. These findings are confirmed by the results of Trunz,<sup>13</sup> given in Table 18, who further shows that the calcium content is highest in proportion to the phosphorous content at the beginning and end of the lactation period, and lowest during the middle. In addition, the unstabilizing effect of the excess calcium in the winter milk is further aggravated by the fact that the citric acid content of winter milk is abnormally low due to absence of green feed.

TABLE 18.—COMPOSITION OF ASH DURING ENTIRE PERIOD OF LACTATION  
TRUNZ<sup>13</sup>

Constituents of Ash	Cow 1				Cow 2			
	Colostrum	First period	Second period	Third period	Colostrum	First period	Second period	Third period
	per cent	per cent	per cent	per cent	per cent	per cent	per cent	per cent
K <sub>2</sub> O .....	0.174	0.168	0.165	0.148	0.176	0.186	0.186	0.172
Na <sub>2</sub> O .....	0.080	0.086	0.086	0.048	0.051	0.044	0.046	0.087
CaO .....	0.205	0.168	0.109	0.222	0.181	0.181	0.180	0.184
MgO .....	0.025	0.019	0.017	0.025	0.028	0.020	0.020	0.025
Cl .....	0.089	0.076	0.074	0.100	0.101	0.099	0.131	0.171
P <sub>2</sub> O <sub>5</sub> .....	0.180	0.147	0.151	0.163	0.168	0.162	0.161	0.158
Total Ash .....	0.705	0.598	0.599	0.675	0.684	0.651	0.701	0.771

### CITRIC ACID

Citric acid (C<sub>6</sub>H<sub>8</sub>O<sub>7</sub>) is a natural constituent of normal milk. The citric acid content of milk as cited in the literature ranges from 0.07 to 0.4 per cent.<sup>68</sup> Its approximate average is 0.2 per cent or slightly lower. The stage of lactation has no noticeable effect on the per cent citric acid present.

**Effect of Feed on Citric Acid Content.**—Green feeds increase the citric acid content of milk. Winter feed decreases it. Sommer and Hart<sup>66</sup> showed experimentally that the citric acid together with the phosphates of milk play an important role in the salt balance which, in turn, influences the heat stability of the casein.

There is a tendency in evaporated milk, upon aging, to precipitate citric acid crystals as tricalcium citrate, forming a whitish granular sediment in the bottom of the can. This tendency is greatest in high solids milk and at relatively high storage temperature. See also Chapter XXV.

Citric acid is fermented by various species of bacteria. Bosworth and



Prucha<sup>69</sup> observed that the citric acid of milk disappears during the normal souring process.

**Minor Inorganic Milk Constituents.**—In addition to the composition of the ash given in Table 18, milk contains very minute amounts of other inorganic elements. The quantitatively more prominent of these are iron, copper, zinc, aluminum, manganese and iodine. Most of these are known to be important from the physiological and nutritional angle<sup>86</sup>. Some of these elements can be determined quantitatively and all can be determined qualitatively, by micro-chemical analysis.

#### REFERENCES

##### For Chapters I, II, and III

1. LEACH, A. E.: Food Inspection and Analysis. 1920.
2. GRIMMER, W.: Chemie und Physiologie der Milch. 1910.
3. FARRINGTON, E. H., AND WOLL, F. W.: Testing Milk and its Products. 1908.
4. VAN SLYKE, L. L.: Modern Methods of Testing Milk and its Products. 2nd ed. 1916.
5. BABCOCK, S. M.: Quoted by Wing: Milk and Its Products. 1909
6. FLEISCHMANN, W.: Lehrbuch der Milchwirtschaft. 1915.
7. ECKLES, C. H.: Dairy Cattle and Milk Production. 1916 and 1923.
8. HUNZIKER, O. F., AND NISSEN, B. H.: Boiling Point of Milk at Different Concentrations and under Different Vacua. 1925. (Results not published.)
9. OVERMAN, O. R., SANMANN, F. P., AND WRIGHT, K. E.: Illinois Bul. 325. 1929.
10. LANDW. JAHRBUCH D. SCHWEIZ. 1905.
11. ECKLES, C. H. AND SHAW, R. H.: Bur. An. Ind. U.S. Dept. Agr. Bul. 156. 1913.
12. ECKLES, C. H., and SHAW, R. H.: Bur. An. Ind. U. S. Dept. Agr. Bul. 155. 1913,
13. TRUNZ, A.: Zeitsch. f. Physiol. Chem. 40 p. 263. 1903.
14. ENGEL, H., AND SCHLAG, H., FROM ASSOCIATES OF ROGERS: Fundamentals of Dairy Science, 2nd ed. p. 467. 1935.
15. HUNZIKER, O. F.: The Butter Industry, 3rd ed. 1940.
16. HUNZIKER, O. F., MILLS, H. C., AND SPITZER, GEO.: Purdue Agr. Expt. Sta. Bul. 159. 1912.
17. PALMER, L. S.: Jour. Dairy Sci. XXVII. 471. 1944.
18. ECKLES, C. H., AND SHAW, R. H.: Bur. An. Ind. U.S. Dept. Agr. Bul. 157. 1913.
19. HILDITCH, T. P., and SLEIGHTHOLME, J. J.: Biochem. Jour. 24. 1098. 1930.
20. DEAN, H. K., and HILDITCH, T. P.: Biochem. Jour. 27. 889. 1933.
21. HOLLAND, F. B., GARVY, M. E., PIERCE, H. B., MESSER, A. C., ARCHIBALD, J. G., and DUNBAR, C. O.: Jour. Agr. Res. 24. 365. 1923.
22. LEA, C. H.: Rancidity of Edible Fats. 1939.
23. ASSOCIATES OF ROGERS: Fundamentals of Dairy Science. 2nd ed. 1935.
24. HOLM, G. E., WRIGHT, P. A., AND DEYSHER, E. F.: Jour. Dairy Sci. XIX. 631. 1936.
25. MOHR, W., BROCKMANN, C., and MUELLER, W.: Molk. Ztg. Hildesheim. 35. 1932.
26. HORRALL, B. E.: Purdue Agr. Expt. Sta. Bul. 401. 1935.
27. KURTZ, F. E., JAMIESON, G. S., and HOLM, G. E.: Jour. Biol. Chem. 106. 717. 1934.
28. HOLM, G. E., GREENBANK, G. R., AND DEYSHER, E. F.: Jour. Dairy Sci. IX. 512. 1926.
29. DAHLE, C. D., and JOSEPHSON, D. V.: Milk Plant Monthly. 32. p. 28. 1943.
30. RITTER, W., AND NUSSBAUMER, T.: Milch Ztg. Nos. 54 and 55. 1939.
31. BORDAS, F. and DE RACZKOWSKI, SIG.: Ann. Chim. Analyt. 7. 372. 1902.
32. HUNZIKER, O. F.: The Butter Industry, 1940.
33. HUNZIKER, O. F.: Purdue Agr. Expt. Sta. Bul. 143. 1910.
34. ECKLES, C. H., AND PALMER, L. S.: Missouri Agr. Expt. Sta. Res. Bul. 24. 1916.

35. NICHOLS, J. B., BAILEY, E. D., HOLM, G. E., GREENBANK, G. R., AND DEYSHER, E. F.: *Jour. Phys. Chem.* XXXV. 1303. 1931.
36. ASSOCIATES OF ROGERS: *Fundamentals of Dairy Science* 2nd ed. 1935. (Quoting B. Bardach.)
37. SOMMER, H. H., AND HART, E. B.: *Jour. Biol. Chem.* XL. p. 137. 1919.
38. MILROY, T. H.: *Biochem. Jour.* IX. p. 215. 1915.
39. VAN SLYKE, L. L.: *The Chemistry of Casein. Proc. Worlds' Dairy Congr. II.* Washington, D. C. 1923.
40. RUPP, P.: *Bur. An. Ind. U. S. Dept. Agr. Bul.* 166. 1913.
41. EMMERLING, A.: *Zentralbl. fur Agrikulturchemie* s. 861. 1888.
42. HUNZIKER, O. F., AND NISSEN, B. H.: *Jour. Dairy Sci.* X. 139. 1927.
43. HUDSON, C. S.: *Jour. Am. Chem. Soc.* 26, 1904.
44. GILLIS, J.: *Revue Trav. Chim.* 39. 1. 1920.
45. WHITTIER, E. O.: *Jour. Dairy Sci.* XXVII. 505. 1944.
46. *Methodus in Dysnoeam seu de Respirationibus. Libri V.* 400. Bonomia 1633.
47. ETTMULLER, MICHAEL: *Opera Omnia Bd. II.* 163. Frankfurt. 1688.
48. ERDMANN, E. O.: *Jahresber. Chem.* 671. 1855.
49. HERRINGTON, B. L.: *Jour. Dairy Sci.* XVII. 533. 1934.
50. PETER, P. N.: *Jour. Phys. Chem.* 32. p. 1856. 1928.
51. HUNZIKER, O. F., AND NISSEN, B. H.: *Jour. Dairy Sci.* IX. 517. 1926.
52. HERRINGTON, B. L.: *Jour. Dairy Sci.* XVII. 501. 1934.
53. WHITTIER, E. O., AND GOULD, S. P.: *Indus. and Engin. Chem.* 23. 670. 1931.
54. TROY, H. C., AND SHARP, P. F.: *Jour. Dairy Sci.* XIII. 140. 1930.
55. SHARP, P. F., AND DOBB, H., JR.: *Jour. Dairy Sci.* XXIV. 679. 1941.
56. BEESTER, A., WOOD, M. W., AND WAHLIN, C. S.: *Am. Jour. Physiol.* 73. 387. 1925.
57. HUDSON, C. S., AND BROWN, F. C.: *Jour. Am. Chem. Soc.* 30. 960. 1908.
58. HUDSON, C. S.: *Jour. Am. Chem. Soc.* 30. 1767. 1908.
59. GILLIS, J.: *Rev. Chim.* 39. 88 and 677. 1920.
60. PARISI, P.: *Chim. Indus. ed. Appl.* 12. 225. 1930.
61. OSTWALD, W.: *Zeitschr. Phys. Chem.* 22. 1897.
62. RIDDET, W., CAMPBELL, I. L., McDOWALL, F. H., AND COX, G. A.: *Dairy Res. Inst. (N.Z.) Publ.* 152. 1942.
63. LEACH, A. E.: *Food Inspection and Analysis.* 1920.
64. BABCOCK, M. S.: Quoted by Leach (63).
65. SÖLDNER, F.: *Landw. Versuchst.* 35. 1923.
66. SOMMER, H. H., AND HART, E. B.: *Wisconsin Agri. Expt. Sta. Res. Bul.* 67. 1926.
67. VAN SLYKE, L. L., AND BOSWORTH, W. A.: *Jour. Biol. Chem.* 20. 135, 1915 and 24. 199. 1916.
68. ALLEN, L. A.: *Jour. Dairy Res.* III. p. 1. 1931.
69. BOSWORTH, A. W., AND PRUCHA, M. J.: *New York (Geneva) Agr. Expt. Sta. Tech. Bul.* 14. 1910.
70. CAMPBELL, M. H.: *Vermont Agr. Expt. Sta. Bul.* 341. 1932.
71. HILLS, J. M.: Quoted in *Stocking's Manual of Dairy Products.* 1917.
72. BARDACH, B.: *Monatschrift* 18. 199. 1897. Quoted by Associates of Rogers (36).
73. RICE, F. E., AND MARKLEY, A. L.: *Jour. Dairy Sci.* VII. 468. 1924.
74. CAULFIELD, W. J., AND RIDDELL, W. H.: *Jour. Dairy Sci.* XIX. 235. 1936.
75. MCINERNEY, T. J.: *Jour. Dairy Sci.* III. 227. 1920.
76. *Standard Density and Volumetric Tables.* 6th ed. U. S. Dept. Com. Bur. Standards Circ. 19. p. 42. 1924.
77. PALMER, L. S., AND ANDERSON, E. O.: *Jour. Dairy Sci.* IX. 1. 1926.
78. SHARP, P. F., AND HART, R. G.: *Jour. Dairy Sci.* XIX. 683. 1935.
79. RICHMOND, H. D.: *Dairy Chemistry.* London. 3rd ed. 1920.
80. HODGMAN, C. D.: *Handbook of Chemistry & Physics.* 28th ed. 1943.
81. HAMMER, W. B., AND JOHNSON, A. R.: *Iowa Agr. Expt. Sta. Res. Bul.* 14. 1913.
82. HUNZIKER, O. F., AND NISSEN, B. H.: *Boiling Point of Milk and Condensed Milks at Different Pressures. Results first published in Condensed Milk and Milk Powder.* 4th ed. 1926.
83. FILIPPO, J. D.: *The Freezing Point of Milk. Proc. Worlds' Dairy Congr.* p. 723. London. 1928.
84. PALMER, L. S., AND COOLIDGE, L. H.: *Missouri Agr. Expt. Sta. Res. Bul.* 13. 1914.

85. VAN RAALTE, A.: *Analyst* 54. 266. 1929.
86. HORRALL, B. E.: Information by correspondence. Sept. 7, 1933.
87. HORTVET, JULIUS: *Jour. Ind. and Eng. Chem.* XIII. 198. 1921.
88. HORTVET CRYSCOPE: *Office Methods. Asso. Official Agr. Chemists.* 319. 1930.
89. BAILEY, E. M.: *Conn. Agr. Expt. Sta. Bul.* 236. 1922.
90. DOAN, F. J.: *Jour. Dairy Sci.* X. 353. 1927.
91. WILLIAMS, O. E., AND PETER, P. N.: *Jour Dairy Sci.* XIII. 471. 1930.

## CHAPTER IV

### DEVELOPMENT OF THE CONDENSED MILK INDUSTRY

Condensed milk is cow's fresh milk from which a considerable portion of the water has been evaporated and to which sugar may or may not have been added. A small amount of unsweetened condensed milk is also made from goat's milk.

There are principally two kinds of condensed milk, namely, sweetened and unsweetened. Both reach the market in hermetically sealed tin cans intended for direct consumption, and in bulk intended for bakers, confectioners, ice cream manufacturers and makers of diverse prepared food products. Unsweetened condensed milk sold in tins (canned) is known by the trade name "Evaporated Milk." The condensed milk products also include evaporated cream and concentrations of the by-products of milk, such as plain condensed whole milk and skimmilk, superheated condensed skimmilk, concentrated sour skimmilk, condensed buttermilk, and condensed whey. For definitions see Chapter XLVII on "Definitions and Standards."

**Invention of Process.**—The advent of condensed milk belongs to the nineteenth century. The condensed milk industry was introduced at about the same time as the factory system of butter and cheese making. Its rapid development stands in sharp contrast to the production of butter and cheese on the farm, the beginning of which antedates the chronicles of the Ancients, and to which recorded reference is made in the Old Testament\*, and in the Vedas\*\* of Asiatic India approximately 1400-2000 B.C.<sup>1</sup>

It was especially toward the close of the 18th century and during the first half of the 19th century that food scientists of France and England gave thought to the possibilities of preserving milk in concentrated form. Thanks to the several editions of the publication on Preservation of Foods by the French research worker Nicolas Appert,<sup>2</sup> of Chalons-sur-Marne, France, information is available regarding the earliest attempts at milk condensing.

According to Robinson<sup>3</sup> written records of Appert's experiments dealing with the preservation by heat, of a great variety of human foods, both animal and vegetable; date back to 1796. Appert's original method of preserving milk was to condense it in a waterbath over fire to about two-thirds of its original volume. The condensed milk was strained, cooled and poured into glass bottles, filling them full and corking them tightly,

\*Book of Genesis, C. 18, V. 8: "And he took butter and milk and the calf he had dressed and set it before them."

Book of Job, C. 10, V. 10: "Hast thou not poured me out like milk and curdled me like cheese."

\*\*Books of hymns of the Ancient Hindus.

and boiled in a waterbath for two hours. The milk so treated held up so well, even under unfavorable temperature conditions, that the French Marine Department made use of the product for provisioning its warships in the early years of the 19th century.

Several other investigators experimented with methods to preserve milk shortly after Appert's discovery. Thus the American, William Underwood, in 1828, the Frenchmen, Malbec, in 1826, and Martin de Lignac, in 1847, and the Englishman, Newton, in 1835, condensed milk with added sugar; and the Frenchman Grimaud in 1835 condensed milk without artificial heat by exposing it in a thin film flowing over an inclined surface to currents of fanned air. However, it was Nicolas Appert who first conceived the idea of preserving milk without the admixture of sugar or other

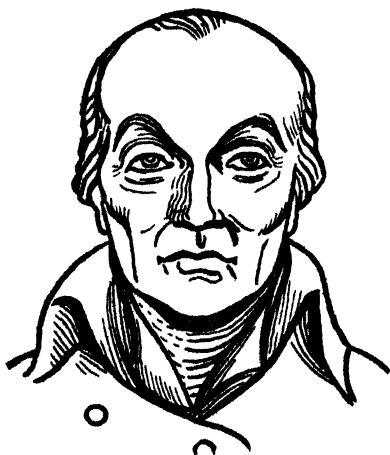

Fig. 8. Nicolas Appert

preservative, or substance foreign to natural milk, by condensing it and giving it heat treatment in a permanently sealed container. He successfully demonstrated the economic value and commercial practicability of his procedure. Appert died in 1840 at the age of 91.

The commercially successful manufacture of condensed milk was initiated by the American, Gail Borden.<sup>4</sup> He is the father of the process of milk condensing upon which a great and successful industry has been builded. Gail Borden is said to have experimented some ten years before he finally decided that a semi-fluid state, produced by evaporation in vacuo, was the best form of preservation. He first applied for a patent in 1853, but it was not until three years later that the Patent Office appreciated the originality and value of his claim sufficiently to grant him a patent.<sup>5</sup> In August, 1856, he received a patent both from the United States and from England.

While the claim of the patent granted Gail Borden was that of "producing concentrated sweet milk by evaporation in vacuo without the admixture of sugar or other foreign matter," records show that Gail



Fig 9. Gail Borden

Borden manufactured sweetened condensed milk, sold under the famous Eagle Brand label as early as 1856.

**Development of Industry.**—The first factory was operated by Gail Borden in Wolcottville, Connecticut, in the summer of 1856, but disap-

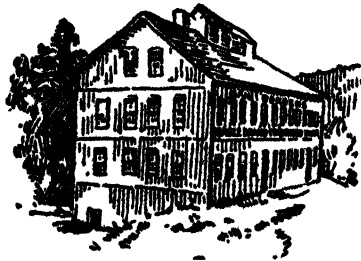

Fig. 10. The first milk condensery in America, Wolcottville, Conn.

pointed in not obtaining means, nothing was accomplished. A second attempt was made at Burrville, five miles distant, in 1857, by a company consisting of the owners of the patent. A small quantity of milk was here successfully condensed and its introduction into New York began. Although admitted by all to be superior to any before made, it was slow

in meeting with sales proportional in magnitude to the expenses incurred. Yielding to the monetary revulsion of that year the company suspended operations, leaving Mr. Borden liable for bills drawn, on which he was sued.

It was not until February 1858 that Mr. Borden could be said to enjoy adequate means to develop his invention and at which time the New York Condensed Milk Company was formed. Abandoning Burrville, the new company established work on a more extensive scale in Wassaic, New York, in 1860.

In the early sixties of the last century, the Anglo-Swiss Condensed Milk Company was organized in Switzerland under the leadership of Charles A. Page, then United States Consul at Zurich, Switzerland, and his brother



Fig. 11. The first milk condensery in Switzerland, Cham, Ct. Zug<sup>a</sup>

George H. Page, with the assistance of Swiss and English capital. The first factory of that company was built and operated in 1866 at Cham, Lake Zug, Switzerland, under the direction of George H. Page, who was its president until his death in 1898.

This company prospered and grew rapidly in Europe. In the eighties of the last century it invaded the United States, where it built and operated several large factories in New York, Wisconsin and Illinois. The American factories were managed by David Page and William B. Page, brothers of George H. Page. In 1902 the Anglo-Swiss Condensed Milk Company sold its entire American interests, factories and business, to Borden's Condensed Milk Company. In 1904 the Anglo-Swiss Condensed Milk Company consolidated with Henry Nestlé, of Vevey, Lake Geneva, Switzerland, another successful manufacturer of condensed milk, forming the Nestlé-Anglo-Swiss Condensed Milk Company.

It was especially during the strenuous years and the resulting food shortage of the War of Secession that the value and usefulness of condensed milk as a nutritious and wholesome food commodity became fully

recognized. Its keeping quality made possible its transportation to all parts of the country and its concentrated form economized space in storage and in transportation.

Up to the early eighties of the last century, sweetened condensed milk was the only condensed milk that was put on the market and sold in hermetically sealed cans, while unsweetened condensed milk was manufactured and sold open, largely direct to the consumer, in a similar way as market milk.

Early in 1885 the Helvetia Milk Condensing Company was organized at Highland, Illinois. This company confined its efforts exclusively to the manufacture of evaporated milk (unsweetened condensed milk, sterilized by heat and sold in hermetically sealed cans). For several years before the organization of this company, the possibilities of producing a sterile unsweetened condensed milk were assayed in laboratory investigations by scientists. Simultaneously with the commencement of operations of this company, several other companies experimented with this form of condensed milk, but the Helvetia Milk Condensing Company was the first organization that succeeded in producing a marketable unsweetened condensed milk that was sterile and would keep indefinitely.

The basic principle of the process of preserving unsweetened condensed milk by heat sterilization was introduced by Mr. John B. Meyenberg,<sup>6</sup> a native of Switzerland, born Nov. 13, 1847, in Zug, Switzerland. Mr. Meyenberg was operator in the mother plant of the Anglo-Swiss Condensed Milk Company at Cham, Switzerland. He conceived the idea of making condensed milk keep without the addition of cane sugar or other preservatives, and without the necessity of keeping it cold. Mr. Meyenberg experimented with the sterilization of condensed milk by steam under pressure over a period of three years, 1880 to 1883. As the result of these experiments, he decided that it was possible to preserve milk without the aid of sugar, by the use of a revolving sterilizer which he designed.

He migrated to this country in 1884, and in the same year he was granted a basic patent on his invention of a sterilizer. Later in 1884, and in 1887,<sup>7</sup> he was granted patents on his process of preserving milk. The patent drawings of the original Meyenberg sterilizer are shown in Fig. 13. The claims are as follows:

"I claim as my invention

"1. The combination of the revolving frame adapted to receive cans, the outer inclosing cylinder, and the air and steam pipes, arranged and operating substantially as and for the purpose set forth.

"2. The combination of the revolving frame H, cylinder I, surrounding the frame, steam pipes U within the cylinder beneath the frame, air pipes entering one end of the cylinder, and a door at the other end of the cylinder, through which the frame passes as set forth."

Mr. Meyenberg's process patents provide sterilization by steam under



pressure at a temperature not to exceed 240° F. while the cans are continuously agitated by the revolving reel.

Mr. Meyenberg was attracted to Highland, Illinois, by its large Swiss population. He was introduced to the community by Mr. A. J. Pagan, a leading Highland citizen. Mr. Meyenberg associated himself with Mr. John Wildi, then a merchant of Highland, who at once took a leading part in the organization of the Helvetia Milk Condensing Company, early in the year 1885.

Evaporated milk was first packed in this country on a successful basis



Fig. 12 John B Meyenberg

under the Meyenberg process on June 15, 1885, at Highland, Illinois.

After serving as technical manager at the Highland factory in 1885, Mr. Meyenberg severed his connections with the Helvetia Milk Condensing Company and became engaged in the promotion of numerous factories in the middle west and on the Pacific Coast. Mr. Meyenberg died October 27, 1914.

The response on the part of the consumer to the product of this new and outstanding accomplishment of preserving milk without the admixture of sugar, was by no means spontaneous. He had become accustomed, over a period of a quarter of a century, to the pleasant sweet taste and heavy consistency of sweetened condensed milk. The early unsweetened,

heat-sterilized product with its pronounced cooked flavor and comparatively thin body failed to appeal to him. However, the gradual perfection

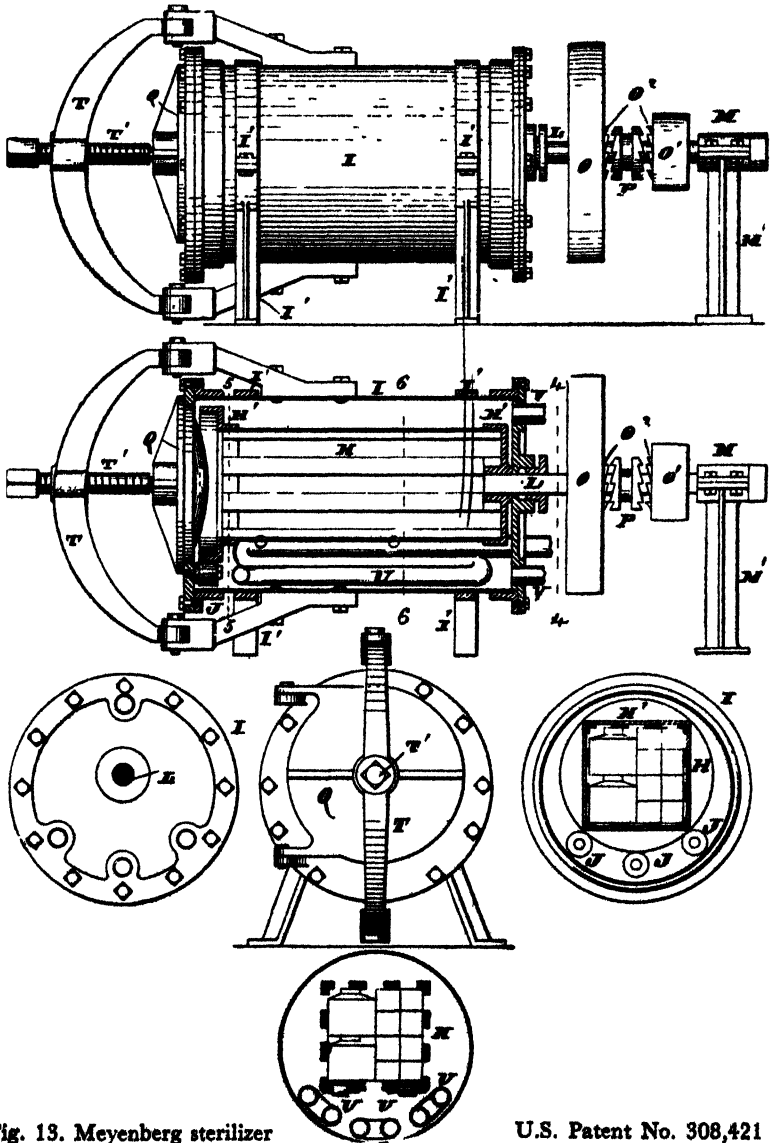

Fig. 13. Meyenberg sterilizer

Courtesy of Meyenberg Milk Products Co.

U.S. Patent No. 308,421

of equipment and process, the introduction of the homogenizer and the newer knowledge of the control of viscosity and heat stability greatly improved the marketable properties of the unsweetened condensed milk.

These developments have practically eliminated the cooked flavor, objectionable darkening of color, and instances of fat separation and of curdiness.

These improvements in the general character of this unsweetened product, together with its relatively low consumer cost, the versatility of its uses for culinary purposes and its adaptability for use in diverse food industries, have converted its initial consumer resistance to consumer appeal and consumer acceptance, culminating in phenomenal consumer demand. Of the present annual production of approximately 4,000,000,000 pounds of all condensed whole milk made in the United States, fully 90 per cent is of the unsweetened variety known as evaporated milk.

Originally the unsweetened sterilized condensed milk was sold under the trade name of evaporated cream. The Federal Food and Drug Act of 1906 caused the name "Evaporated Cream" to be changed to "Evaporated Milk."

Since the introduction of the process of milk condensing by Gail Borden, numerous modifications of the Borden process, as well as fundamentally different processes, have been invented in this country and abroad. The better known among these are: condensing by boiling under atmospheric pressure; by passing heated air over or through milk; by use of centrifugal force; and by refrigeration. Most of these and other new processes have not proved commercially satisfactory, and none appear to have become an important factor in the industry.

Thus, the fundamental equipment used in the early days of the industry has not materially changed in principle. Condensing is still largely done in the vacuum pan or vacuum evaporator under the Gail Borden process, and sterilizing is still done by steam under pressure in sterilizers embracing the principles introduced by John B. Meyenberg.

Yet, the profound researches of recent decades dealing with the science and art of dairy and food technology, assisted by the diligent application of the sciences of thermodynamics of condensing in vacuo and of food engineering, have brought about important improvements in equipment and process. These developments have been instrumental in perfecting the marketable properties and wholesomeness of the finished product, and they have lowered the cost of manufacture, increasing the returns to the milk producer and reducing the price to the consumer.

In this country, as well as in Canada, Europe, Australia, and New Zealand, and within recent years in Latin American countries, the condensed milk industry has grown rapidly. Every succeeding decade has marked the organization of new companies and the erection of new factories until today, there are milk condensing factories in nearly every civilized country within the dairy belt. The annual output of condensed milk in the United States and foreign countries is given in Tables 19 and 20, respectively.

TABLE 19.—ANNUAL PRODUCTION OF CONDENSED AND EVAPORATED MILK IN THE UNITED STATES OF AMERICA  
From Statistics of Bureau of Agricultural Economics, U.S.D.A.

Year	Sweetened Condensed				Evaporated		Plain Condensed			Total Sweetened and Unsweetened Whole and Skimmed 1000 lbs.
	Case Goods		Bulk goods		Case goods		Bulk goods			
	whole	skimmed	whole	skimmed	whole	skimmed	whole	skimmed		
	1000 lbs.	1000 lbs.	1000 lbs.	1000 lbs.	1000 lbs.	1000 lbs.	1000 lbs.	1000 lbs.		
1869									3,786	
1879									13,053	
1889									44,867	
1899									186,921	
1909									494,796	
1914									883,112	
1919	573,044		38,394	72,844*	1,194,496		77,514	74,665	2,030,957	
1920	340,391	7,700	23,524	84,223	979,373	5,526	72,474	64,304	1,578,015	
1930	121,626	2,092	62,421	158,971	1,449,149		128,203	156,212	2,080,324	
1931	97,469	1,757	45,887	140,361	1,428,993		110,038	145,416	1,969,921	
1932	70,285	1,167	42,628	120,923	1,570,612		96,052	138,646	2,040,313	
1933	53,880	1,260	40,964	114,936	1,716,700		86,992	127,197	2,141,929	
1934	60,652	1,696	43,383	120,365	1,711,570		92,414	140,913	2,170,993	
1935	52,985	1,825	36,907	133,417	1,838,890		102,833	164,372	2,331,229	
1936	47,361	1,702	49,618	155,640	2,043,759		129,601	190,404	2,618,085	
1937	47,446	2,150	48,293	154,755	1,902,545		133,124	219,378	2,507,691	
1938	41,539	2,045	48,021	165,136	2,104,198		128,594	230,143	2,719,676	
1939	34,732	1,454	54,897	152,886	2,170,601		107,426	223,001	2,744,997	
1940	61,955	1,872	76,188	166,017	2,464,668		128,017	246,910	3,145,577	
1941	114,772	2,334	79,299	173,658	3,246,547	3,861	113,965	326,535	4,067,110	
1942	62,453	4,839	75,382	225,840	3,518,504	1,213	125,880	318,379	4,332,490	
1943	117,247	697	66,588	305,654	3,052,408	479	117,202	326,094	3,985,982	
1944	133,098	102	63,564	372,731	3,435,222	64	113,387	385,288	4,508,455	

\*Includes skim case goods.

TABLE 20.—PRODUCTION OF CONDENSED AND EVAPORATED MILK IN SPECIFIED COUNTRIES\*

Country	1934	1935	1936	1937	1938	1939	1940	1941
	1,000 lb.	1,000 lb.	1,000 lb.	1,000 lb.	1,000 lb.	1,000 lb.	1,000 lb.	1,000 lb.
Australia <sup>1</sup> .....	46,538	32,067	41,004	42,931	38,292			
Canada <sup>2</sup> .....	70,062	79,899	83,762	108,453	120,342	128,662	155,116	197,940
Denmark <sup>3</sup> .....	45,022	39,533	34,081	36,592	37,727	36,980		
United Kingdom <sup>4</sup>	204,288	227,040	402,192	419,328	436,800			
Japan <sup>5</sup> .....	39,308	44,836	39,908					
Netherlands <sup>6</sup> .....	266,757	260,143	293,212	383,600	346,122	315,258		
Switzerland <sup>7</sup> .....	19,841	19,841	19,841	22,046	25,353	26,455	30,964	
United States <sup>8</sup> .....	2,170,938	2,331,229	2,618,085	2,507,691	2,719,676	2,744,697	3,145,577	4,060,971
Czechoslovakia <sup>9</sup> .....	220	220	441					
Sweden <sup>10</sup> .....	3,087	3,422	3,583	4,079	4,502	5,240		
Germany <sup>11</sup> .....	187,234	141,754	181,939	221,481				
France <sup>12</sup> .....				28,953				

\*Division of Statistical and Historical Research, Bureau of Agricultural Economics.  
<sup>1</sup>Year beginning July—condensed or concentrated. Does not include other milk products.

<sup>2</sup>Total condensed and evaporated whole and skimmed.

<sup>3</sup>Condensed.

<sup>4</sup>Condensed milk whole and skimmed

<sup>5</sup>Condensed and powdered.

<sup>6</sup>Evaporated and condensed, sweetened and unsweetened, case and bulk, skimmed and unskimmed.

<sup>7</sup>Condensed or evaporated.

<sup>8</sup>Condensed and powdered and similar.

#### REFERENCES

- MARTINY, BENNO: Die Milch II. P. 7. 1871.
- APPERT, NICOLAS: L'Art de Conserver, Pendant Plusieurs Années, Toutes les Substances Animales et Végétales—1810. English translation of second edition published by D. Longworth. Shakespear Gallery, New York, 1812.
- ROBINSON: Les Corps Gras Alimentaires, cited by Benno Martiny (1).
- GOODALE, S. L.: A Brief Sketch of Gail Borden. Maine State Bd. of Agriculture (1872).
- BORDEN, GAIL: U. S. Patent No. 15553. Aug. 19, 1856.
- MEYENBERG, JOHN: Biographical Sketch of John B. Meyenberg. Information by correspondence 1925.
- MEYENBERG, JOHN B.: Invention of Apparatus and Process for Sterilizing Evaporated Milk. U. S. Patents Nos. 308,421 and 308,422 (1884), and No. 358,213 (1887).
- ANDEREGG, F.: Geschichte der Milchwirtschaft 1884.

## CHAPTER V

### THE MILK CONDENSERY

When contemplating the establishment of a milk condensing factory there are certain essential factors to consider. Among the more important of these are: milk supply, water supply, transportation facilities, sewage disposal, financial resources.

**Milk Supply.**—The condensery should be located in a region where climatic, soil, and rainfall conditions are suitable for the growing of dairy feed, the raising of healthy dairy cattle and the economic production of a large flow of milk.

Locations in, or in close proximity to, a large consuming center are of doubtful desirability for milk condensing purposes. Even if situated in a highly developed dairy section, the continuous and inevitably growing

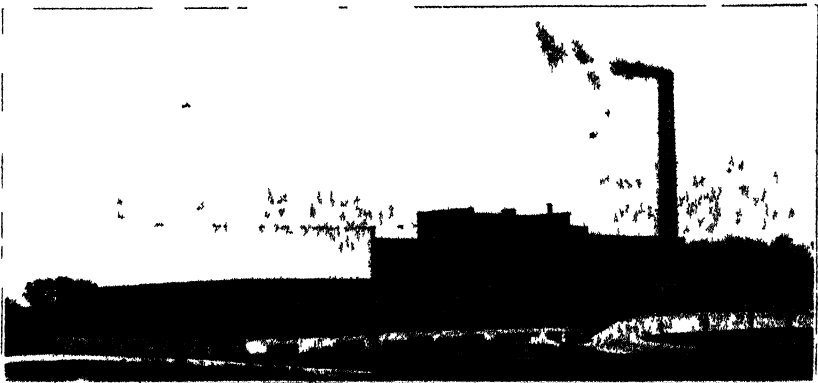

Fig 14 A modern milk condensery  
(courtesy of the Page Milk Co Coffeyville Kan.)

demand for milk for fresh consumption tends to limit the volume and boost the price of the milk supply available to the condensery.

**Water Supply.**—The value to the condensery, of an abundant and never-failing supply of clean, cool water cannot be overestimated. In addition to the water needed in the boilers, for refrigeration, and for maintaining a satisfactory standard of sanitation of plant and equipment, a large volume of water is used in the process of condensing. As shown in a later chapter, approximately 2 to 3 gallons of water is necessary to condense the vapors of each pound of water evaporated from the milk.

The cooler the water, the smaller the volume that is necessary for condensing a given volume of milk and the easier is the operating control of the vacuum pan. Low-temperature water also assists in the rapid and economical cooling of the fresh milk and the finished concentrated milk,

and makes for efficiency and economy in every form of plant refrigeration.

**Sewage Disposal.**—The satisfactory solution of the problem of factory sewage disposal is an important factor in all dairy products manufacturing plants. The milk condensery is no exception to this fact. Under certain conditions the large volume of condensery waste water may further complicate the difficulty. The availability of adequate natural or municipal drainage facilities, therefore, constitutes a valuable asset to a locality under consideration for a condensery site.

Absence of already available local means of sewage disposal may, and often does, necessitate the installation of a properly laid-out system of septic tanks with efficient filter beds, entailing a considerable financial outlay. In such case the importance of the problem suggests the wisdom of soliciting the advice and cooperation of the local or State sanitary engineer. For additional information see also available publications on the subject of dairy plant sewage and waste water disposal by Walker,<sup>1</sup> Cavanaugh,<sup>2</sup> Steel and Zeller,<sup>3</sup> Eldridge,<sup>4,5</sup> McDowall,<sup>6</sup> Warrick,<sup>7</sup> and Veale.<sup>8</sup> The work of Eldridge is of special significance here in that it reports the installation and successful operation of a full-scale, high-rate recirculating filter for the milk waste of a commercially operated condensery. (Borden Company condensery at Perrington, Michigan).

**Transportation Facilities.**—Adequate transportation facilities are necessary. There is need of dependable rail service to bring in factory equipment and supplies and to ship out the finished product. Available rail service, both interurban and steam roads, even in this motor transportation age, still provides a convenient, practical and economical channel in many regions for daily transportation of large volumes of milk from farm to factory.

In addition, the condensery needs an ample network of year-round highways servicing the nearby milk supply and radiating far enough to reach the more remote dairy sections located within the theoretical milk shed of the condensery. The flexibility of the highway artery provides opportunity for the most diverse types of conveyance for milk transportation, such as the private auto, station wagon, auto truck and tank truck. Locating the condensery on the shore of a navigable body of water such as a river or small lake, provides a further opportunity for cheap transportation. Such opportunity has the added advantage that, for competitive reasons, it tends to regulate freight rates of other available carriers.

**Financial Resources.**—The financial investment involved in establishing a milk condensery is generally larger than the capital needed to start a creamery or cheese factory. The initial outlay for building and equipment is larger. Provision must be made for a much greater steam supply, and for more expensive machinery in every department from milk intake to packaging room.

In addition, there must be available sufficient funds to adequately pro-

vide for the operating expense. Considerable capital is "tied-up" in the form of milk, supplies, labor, sales expense and other overhead charges, before a return from the sale of the manufactured product can reasonably be expected.

### BUILDING AND EQUIPMENT

**Building Materials and Plans.**—The establishment of a milk condensery involves the investment of considerable capital. Such outlay is predicated by faith on the part of the investor in the permanency of the prospective business. For housing a permanent business substantial construction promises maximum economy. A lastingly successful business requires dependable quality of finished product. In the manufacture of quality food products, sanitation is an indispensable requisite. In addition to durability, therefore, consideration must also be given to the sanitary aspects of materials and construction.

It is beyond the realm of this volume to provide detailed plans and specifications for building and building materials. Such details must of necessity vary with locality, availability of materials, personal preferences of prospective owner, type of equipment, contemplated capacity of plant and financial resources of sponsors. They are commonly best decided on and worked out to suit each specific occasion at the time needed.

It is further recommended that the prospective builder of a condensed milk factory, contact other newly constructed plants. Such visits and the exchange of ideas and experiences with other operators thus made possible, are usually fruitful of information on the latest ideas of modern construction, exterior architecture, interior arrangement and type of equipment. Not infrequently through such efforts plans and specifications of other model factories are made accessible. These diverse sources of well thought-out information place the prospective builder in a strategic position to profit by the experiences and mistakes of others and to incorporate in his new plant the features that have proven most valuable in modern factories designed to facilitate efficient operation in the manufacture of quality products.

**Equipment.**—The processing equipment must necessarily vary with the kind of product or products manufactured. The major pieces of manufacturing equipment are listed in connection with graphs 37 and 60, showing the flow sheets for the manufacture of sweetened condensed milk and evaporated milk, respectively. In the selection of processing equipment for the condensery and milk drying plant, consideration of the metal that comes in direct contact with the milk and milk product is of increasingly recognized importance.

### METALS IN CONDENSERY EQUIPMENT

The metal used fundamentally controls the life and upkeep of the equipment as affected by resistance to metallic corrosion. In addition, the influ-



ence of the metal on the flavor and keeping quality of the milk product is of very great importance.

**Action of Milk on Metals.**—It is now definitely known that many of the metals and metallic alloys used in dairy equipment are more or less soluble in such milk acids as lactic, butyric, citric, and acetic acid. There is evidence also that some of the mineral salts and even the colloids of milk are capable of inciting metallic corrosion. The corrosive action of milk on metals is not infrequently intensified by electrolysis such as may be caused by the presence of metals with different electrical potentials in contact with each other in one and the same piece of equipment, the milk product acting as the electrolyte. Corrosion due to electrolysis is further aggravated by the presence of stray electric currents in the factory.

**Effect of Metals on Milk.**—The metallic salts formed by the reaction between milk and metals are capable of damaging the milk product in several ways: Many of the metallic salts themselves have a pronounced metallic, astringent, or bitter taste and their mere presence impregnates the milk product with the metallic flavor. The use of a copper vacuum pan with tarnished surface on the milk side invariably gives the concentrated milk a pronounced coppery flavor. The tarnish on the copper surface is due to copper oxide or other copper salt which is readily soluble. Unless removed by thorough scrubbing, followed by adequate rinsing with clean water, it will dissolve in the milk of the succeeding batch. The copper surface on the milk side of all condensery equipment should be kept bright and shining. It is especially the salts of copper, and of copper alloys, and the salts of iron and of zinc, that have an intense metallic taste and to a lesser extent the salts of nickel, while those of tin and of aluminum are of such relatively mild taste that their presence is not noticeable in the milk product.

Again, the salts of some metals are active oxidizers and catalyzers. Their presence tends to incite complex chemical changes in the milk product. These changes usually involve the milk fats and particularly the unsaturated fatty acids such as oleic. The resulting oxidation and its catalysis in milk products with high fat content such as butter and whole milk powder, is generally accompanied by an intense tallowy odor and flavor. Both copper and iron have been found very active as oxidizers of the unsaturated fatty acids leading to tallowiness. The same is true of the alloys of copper such as brass, and the so called white metals, nickel silver, Ambrac, et cetera. Nickel, while not immune to oxidation, does not cause tallowy flavor in butter. Tin, aluminum, 18-8 chrome-nickel-steel, and chrome-nickel alloy do not incite such oxidation and do not produce tallowy flavor in milk products.<sup>9, 10, 11</sup>

The flavor-damaging reaction of some metals may involve also a selective influence on bacteria, causing acceleration of certain objectionable forms

of germlife. Metals that are oxidizers (copper, copper alloys, iron) are destructive also to certain vitamins, especially those of the Vitamin C group.

#### METALS THAT ARE UNSUITABLE FOR CONDENSERY AND MILK POWDER EQUIPMENT

As indicated in preceding paragraphs, such metals as *copper, iron, zinc* (in the form of galvanized iron), and to a lesser extent *nickel*, are unsuitable to be used on the milk side of condensery equipment. While these metals have structurally highly desirable properties, their contact with milk at any temperature, but especially at the customary processing temperatures, definitely jeopardizes the flavor and keeping quality of the finished product.

For similar reasons the various *alloys of copper*, such as *nickel silver, Ambrac, Waukesha metal*, and other so-called "*White Metals*", also *Monel metal, brass, bronze*, and any other alloys with a considerable copper content in their composition, are unsafe metals from the standpoint of their influence on the quality of the milk product. When they are acted upon by the milk it is usually copper salts that are formed. However, certain of these alloys, when they contain 3 to 8 per cent of tin and 3 to 4 per cent of zinc, are more stable, less subject to the solution of copper and, therefore, less detrimental to the flavor of the milk as shown by Henderson and Roadhouse.<sup>18</sup>

Tin coating of copper, copper alloys and iron fails to dependably protect the milk product against the flavor and keeping quality damaging effect of the base metal. Tin plating of the milk side of condensery equipment cannot be recommended.

Tin also is not entirely immune to attack by the milk acids and alkaline washing compounds, but its salts have no noticeable influence on the flavor of milk, and of its concentrated products. The softness of pure tin, however, precludes its use for structural purposes in plant equipment. But tin has proved serviceable in plating copper and iron surfaces, and as long as the tin coating is intact the milk product is dependably protected against the flavor and keeping quality jeopardizing effect of the base metals.

Due to its relative softness and its appreciable solubility, the tin coating in equipment where the milk is heated, processed and held or conveyed at relatively high temperatures is of too short life to justify the expense of tinning and re-tinning. Tinning of the milk side of copper forewarmers, hot wells, recirculating preheaters, vacuum pans, drop tanks, et cetera, fails to provide lasting protection of the milk against damaging action by the base metal. In such equipment the abrasive means that must be employed in order to remove burnt-on milk from the heating surface soon wears off the tin coating, exposing the quality-damaging copper or iron of the base metal.

Tinned copper sanitary tubing has been widely used for about one-half

a century, and apparently with immunity. Yet inspection of such pipes that conduct heated milk has shown that their internal tin coating is of short duration and that they soon expose the milk to large areas of bare copper. Such milk tubes jeopardize the quality of the finished product and are not suitable for use in the milk condensery.

#### METALS THAT ARE SUITABLE FOR CONDENSERY AND MILK POWDER EQUIPMENT

This group includes stainless steel, chrome-nickel alloy, aluminum, aluminum-manganese alloy and glass enameled steel.

**Stainless Steel.**—The composition of stainless steel that has been found most suitable for milk work and that is now commonly used in dairy equipment is the alloy containing 18% chromium, 8% nickel, and the balance low-carbon iron. 18-8 stainless steel has come into condensery and milk powder equipment to stay. It distinguishes itself from other steel alloys that are less suitable for milk work in that it is Austenitic, which means that its carbon is present in solid solution. Austenitic steels, therefore, are non-magnetic.<sup>14</sup> This property can be readily determined by the use of a magnet to insure the purchaser that he is getting the desired non-magnetic, 18-8 type of stainless steel. Ordinary steel and chrome-steel (without nickel) are not of Austenite character below an alloying temperature (1800° F.) and they retain the magnetic property of ordinary steel. The high resistance of stainless steels to atmospheric corrosion is due to their protective coating with a continuous, self-perpetuating chromium oxide film.

The work of Hunziker, Cordes and Nissen<sup>11</sup> demonstrated that, under the conditions of their investigation, 18-8 stainless steel in the form of Allegheny Metal showed no visible corrosion in sweet and sour milk and cream ranging in titratable acidity (calculated as lactic) from sweet milk at 0.15 per cent to acidophilus milk at 1.78 per cent acid, and from sweet cream at 0.16 per cent to sour cream at 1.0 per cent and sour neutralized cream at 0.15 per cent acid. Nor did one per cent solutions of the individual milk acids, such as lactic, butyric, citric or acetic acid corrode it. The stainless steel proved inert also to 0.5 per cent solutions, hot and cold, of the alkaline washing powders used, such as sodium hydroxide, sodium carbonate and mixed sodas, alkali Special and tri-sodium phosphate, nor was it attacked by chlorine sterilizers, such as sodium hypochlorite, Diversol, chloramine-T and neutralizer lime. It had no effect whatsoever on the flavor and stability of flavor of the dairy product.

These early results and similar later findings of other investigators showing the superiority of 18-8 stainless steel in milk work have since been conclusively confirmed by corrosion study of metals in condensery equipment in commercial operation, and by observation and experience in commercial use in general. These findings have brought about within the past decade an industry shift in new construction of major dairy plant

equipment from copper and copper alloys to stainless steel. This refers to practically all types of processing equipment such as weigh tanks, milk receiving tanks, forewarmers, hot wells, recirculating preheaters, vacuum pans and evaporators, condensed milk storage tanks, sweetened condensed milk crystallizer tanks, condensed milk coolers, homogenizers, irradiators, milk drying flumes, sanitary milk tubing, metal screen strainers, as well as truck tanks and car tanks for milk transport.

The improvement in quality of the finished product wherever the change to stainless steel has materialized is so manifest that the industry appears to be irrevocably "sold" on the use of chrome-nickel-steel in the place of copper. There is every indication that in case of new equipment such as may be needed for replacement or for expansion, preference for stainless steel will continue until the industry shall have been emancipated in its major equipment from the quality-jeopardizing copper.

**Chrome-Nickel Alloy**, of which Inconel is a representative, and containing approximately 13 per cent chromium, 80 per cent nickel and 6 per cent iron, has been found equally as resistant to corrosion by milk as the 18-8 stainless steel. The chrome-nickel alloy has the advantage of superior ductility, lending itself better for the fabrication of helical coils in vats and vacuum pans, et cetera. The material cost of this alloy, however, is somewhat higher than that of 18-8 stainless steel.

**Aluminum**.—Aluminum has never become a factor in the milk plant equipment of the United States, yet its properties merit favorable consideration for milk work.

The experimental results of Hunziker, Cordes and Nissen<sup>12</sup> show that aluminum in sweet and moderately sour milk and cream is not corroded and though it may become slightly tarnished, it has no noticeable effect on the flavor of the milk product. In dairy products of intensely high acidity, slight corrosion and a very slight metallic flavor appeared to be discernible. This was noticeable in acidophilus milk. Visible corrosion, however, was very slight, being mostly confined to a light tarnish.

Similar resistance to corrosion and absence of metallic flavor is characteristic also of aluminum-manganese alloy (aluminum containing about .25 per cent manganese).

Resistance of aluminum and aluminum alloy increases with its purity. Aluminum should be at least 99 per cent pure. Impurities in the metal, such as particles of other metals, dross, or slag, also pores, incite corrosion and pitting. Thus, wrought aluminum, which tends to be of relatively high purity, has been found to resist corrosion far better than cast aluminum, which commonly contains greater quantities of impurities. Contact with nobler metals, such as iron, copper, bronze, et cetera, in aluminum equipment causes intense corrosion due to electrolysis.

Aluminum is severely attacked by alkalis in the form of conventional alkaline washing powders. Damage to aluminum due to alkaline washing

compounds, however, is readily avoided by the addition of a small amount of sodium silicate. To a soda ash solution of usual strength (containing 0.15 to 0.5%  $\text{Na}_2\text{CO}_3$ ) add 0.05% sodium silicate. Furthermore the newer special phosphates, such as Tripolyphosphate—a complex glass-like phosphate, also Hexametaphosphates known as Calzone, appear to constitute suitable aluminum cleaners. In addition, washing compounds especially prepared for use as aluminum cleaners are obtainable from washing powder manufacturers and dairy supply houses. Thus, the sensitiveness of aluminum to alkaline washing compounds need no longer discourage the use of aluminum on the milk side of dairy equipment.

The suitability of aluminum for dairy equipment has been exploited for decades in European milk products plants, a large portion of whose factory equipment and the majority of milk shipping containers are constructed of aluminum. This is true especially of milk shipping cans, storage tanks used for fluid milk and concentrated milk, milk heaters and coolers such as the tubular and plate heat exchangers, weigh tanks, vacuum pans, et cetera.

Glass Enamel Steel has been successfully used in the construction of dairy equipment for several decades. The glass enamel has proven a complete protection to milk against damage from metallic salts. It is not acted upon by the milk and it has no damaging effect on the flavor and keeping quality of the milk product.

The glass coating is applied by spraying a sodium silica mixture of the desired color over the surface of the steel tank in a furnace in which it is then baked at a temperature of 1800° F. that fuses the silica deposit with the metal. While the enamel coating is not indestructible, its durability under normal conditions of use is sufficient to preserve it in satisfactory condition over a considerable period of service. Care must be taken, however, to avoid chipping such as may be caused by dropping heavy tools upon the enameled surface.

The low heat conductivity of both the glass enamel and its heavy background of steel, and the corrosive character of the steel side, render glass enameled steel unsuitable as a heating or cooling surface. The proper place for glass enameled steel is for linings of coil vats and for shells of milk storage tanks. For these purposes it has amply proven its great usefulness and satisfactory service.

#### REFERENCES

1. WALKER, C. L.: New York (Cornell) Agricultural Expt. Sta. Bul. 425. 1923.
2. CAVENAUGH, G. W.: Dairy Industry I. p. 20. 1936.
3. STEEL, E. W., AND ZELLER, P. J. A.: Texas Agr. Expt. Sta. Eng. Bul. 38. 1930.
4. ELDRIDGE, E. F.: Mich. Agr. Expt. Sta. Special Bul. 272. 1936.
5. ELDRIDGE, E. F.: Mich. Eng. Expt. Sta. Bul. 87. 1939.
6. McDOWALL, F. H.: N. Z. Dairy Res. Instit. Bul. 27. 1931.
7. WARRICK, L. F.: The Creamery Journal August 1942.
8. VEALE, P. O.: N. Z. Dairy Res. Inst. Public. 160. 1942.

9. HUNZIKER, O. F., AND HOSMAN, D. FAY: Jour. Dairy Sci. I. 320. 1917.
10. HOLM, G. E., AND GREENBANK, G. R.: Associates of L. A. Rogers. Fundamentals of Dairy Science. Sec. Ed. p. 91. 1935.
11. HUNZIKER, O. F., CORDES, W. A., AND NISSEN, B. H.: Jour. Dairy Sci. XII. 140. 1929.
12. HUNZIKER, O. F., CORDES, W. A., AND NISSEN, B. H.: Jour. Dairy Sci. XII. 252. 1929.
13. HENDERSON, J. L., AND ROADHOUSE, C. L.: Jour. Dairy Sci. XXIII. 215. 1940.
14. HOSTETTLER, L. W.: Stainless Steel in Dairy Equipment. Dairy Eng. Inst. Nat. Dairy Exposition Atlantic City, N. J. October 29, 1931.

## CHAPTER VI

### THERMODYNAMICS OF MILK CONDENSING

This chapter deals with the physical factors that underlie the evaporation of water from milk by heat under reduced pressure, as practiced in the commercial manufacture of concentrated milk products.

**Advantages of Condensing in Vacuo.**—The chief advantages of condensing milk in a partial vacuum, over evaporation under atmospheric pressure are threefold; namely, economy of operation, rapidity of evaporation, and protection of milk against heat damage.

**Effect on Economy of Operation.**—The total heat units expended when condensing in the vacuum pan at the usual temperature of about 130° to 140° F. is slightly greater than the total heat units required for evaporation under atmospheric pressure. There is no saving in total heat units due to evaporation under reduced pressure.

However, evaporation in vacuo has the distinct advantage of making possible the economical utilization of steam at low temperature and of exhaust steam. Hence, where exhaust steam is available, there is opportunity for a considerable saving in fuel by its use.

The heat units involved in the evaporation of water may be conveniently classified into 4 groups. These are:—sensible heat, internal latent heat, external latent heat and thermal equivalent of energy expended by the operation of the vacuum pump. For exact heat units at different temperatures and corresponding vacua and pressures see Table 21.

**Sensible Heat.**—This is the heat required to raise the temperature of the liquid—milk—from any given temperature to its boiling point, or to the temperature of its vapor. To raise the temperature of one pound of water one degree Fahrenheit requires 1 B. T. U. Since the specific heat of milk is .93, it requires .93 B. T. U. to raise the temperature of one pound of milk 1° F.

In vacuum, water boils at a lower temperature than 212° F. Fewer heat units are required to bring the liquid to the boiling point under reduced pressure than under atmospheric pressure. The difference in heat units, or the heat units saved in the vacuum pan, depends on the absolute pressure or vacuum and its corresponding boiling point. With the boiling point of water at 140° F. this difference is  $212 - 140 = 72$ ° F. Boiling at 140° F. therefore requires 72 B. T. U. less per pound of water. This multiplied by the specific heat of milk ( $72 \times .93$ ) is 66.96 B. T. U. To bring the milk to its vapor temperature, or the temperature at which it is usually boiling in the vacuum pan, therefore, effects a saving of 66.96 B. T. U. per pound of milk over heating the milk to the boiling point at atmospheric pressure.

**Internal Latent Heat.**—This is the heat required to convert the water,

TABLE 21.—PROPERTIES OF SATURATED STEAM AT DIFFERENT VACUA AND PRESSURES  
(Figures calculated and assembled from G A Goodenough, "Properties of Steam and Ammonia," 1915 )

Absolute Pressure		Vacuum inches by Mercury Column Vacuum Gauge	Boiling Tempera- ture of Water ° F	Volume Cubic Feet per Lb	Total Heat Units B T U	Sensible Heat of Liquid B T U	Latent Heat		
Inches of Mercury	Lbs. per Sq Inch						Internal or Heat of Evaporation B T U	External or Energy Equivalent B T U.	Total B. T. U.
0 2	0 0982	29 72	34 55	2992	1074 2	2 56	1016 3	55 4	1071 7
0 4	0 1965	29 52	52 67	1550	1082 8	20 75	1005 7	56 3	1062 0
0 6	0 2947	29 32	63 98	1056	1088 1	32 06	998 4	57 6	1056 0
0 8	0 3929	29 12	72 35	805	1091 9	40 42	993 0	58 5	1051 5
1 0	0 4912	28 92	79 06	652	1095 0	47 11	988 7	59 2	1047 9
1 2	0 589	28 72	84 64	549	1097 6	52 72	985 0	59 9	1044 9
1 4	0 688	28 52	89 54	474 3	1099 8	57 57	981 9	60 4	1042 3
1 6	0 786	28 32	93 83	418 2	1101 8	61 84	979 1	60 9	1040 0
1 8	0 884	28 12	97 67	374 3	1103 5	65 68	976 6	61 3	1037 9
2 0	0 982	27 92	101 17	338 9	1105 1	69 16	974 3	61 7	1036 0
2 036		27 884	101 76	333 3	1105 4	69 76	973 9	61 7	1035 6
4 072		26 848	1116 10	173 6	1116 2	94 02	957 9	64 3	1022 2
6 108		23 812	141 49	118 7	1122 9	109 38	947 6	65 9	1013 5
8 144		21 776	152 99	90 6	1127 9	120 9	939 9	67 1	1007 0
10 180		19 740	162 25	73 5	1131 7	130 1	933 6	68 0	1001 6
12 216		17 704	170 07	62 0	1135 0	137 9	928 2	68 9	997 1
14 25		15 67	176 85	53 7	1137 8	144 7	923 6	69 5	993 1
16 29		13 63	182 87	47 35	1140 3	150 8	919 4	70 1	989 5
18 32		11 60	188 28	42 41	1142 5	156 2	915 6	70 7	986 3
20 36		9 56	193 21	38 43	1144 2	161 1	912 2	71 1	983 3
22 40		7 52	197 75	35 16	1146 2	165 7	909 0	71 5	980 5
24 43		5 49	201 96	32 41	1147 9	169 9	906 0	72 0	978 0
26 47		3 45	205 88	30 07	1149 4	173 8	903 2	72 4	975 6
28 50		1 42	209 56	28 06	1150 8	177 5	900 6	72 7	973 3
29 92		0 00	212	26 81	1151 7	180 0	898 8	72 9	971 7



at its boiling point, into steam or vapor. To convert one pound of water at 212°F. into steam at the same temperature requires 898.8 B. T. U. Lowering the boiling point by a corresponding decrease in pressure below that of the atmosphere increases the number of heat units required. In a vacuum of 23.81 inches, which is equivalent to a pressure of 3 pounds and to a temperature of 141.49° F., the evaporation of one pound of water requires 947.6 B. T. U. of internal latent heat, or 48.8 B. T. U. more than at atmospheric pressure at which the corresponding boiling temperature is 212° F.

**External Latent Heat.**—This is the heat representing the thermal equivalent of the energy expended by the vapors in making room for themselves against the pressure of vapors and air over the boiling liquid—the milk. When evaporating under atmospheric pressure with the corresponding vapor temperature of 212° F., the air pressure over the boiling liquid is 14.7 pounds. This air pressure retards the removal of the vapors, and energy must be expended by them to overcome it. When condensing in the vacuum pan a large portion of this external heat work done by the vapors in making room for themselves against the atmosphere is eliminated.

This is made possible by the continuous removal of the air by the vacuum pump and of the vapors by the condenser and the vacuum pump. The actual saving of heat units as external latent heat accomplished in the vacuum pan is not as great as would be indicated by the difference in pressure over the milk, i.e., between atmospheric pressure (14.7 pounds) and vacuum pan pressure (about 3 pounds), because of the much greater expansion of the vapors under reduced pressure. Thus, one pound of saturated vapor at atmospheric pressure has 26.81 cubic feet, while one pound of saturated vapor at 23.8 inches vacuum (3 lbs. pressure) has 118.7 cubic feet.

**Thermal Equivalent of Energy Expended by Vacuum Pump.**—When milk is evaporated in the vacuum pan the vapors are condensed in the condenser and the air and the discharge of the condenser consisting of water of condensation and water used for condensing, are forced out through the vacuum pump. In discharging the air and water the pump must overcome the difference in pressure between the reduced pressure in the suction and the atmospheric pressure at the discharge. The atmospheric pressure is 14.7 pounds and the reduced pressure about 3 pounds per square inch. In case of a wet-vacuum pump the pump, therefore, must overcome a pressure difference of approximately 11.7 pounds per square inch, and for every pound of water evaporated it must discharge against this pressure about 20 pounds of water plus all the air which is entering through the milk, water and leaks. The thermal equivalent of the energy thus expended by the vacuum pump is estimated approximately at 50 B. T. U. per pound of water evaporated.

In the case of evaporation under atmospheric pressure there is no pump energy expended but more external latent heat must be used by the vapors in making room for themselves against the pressure of air and vapors

When the pan is equipped with a barometric condenser, the water column of the condenser provides the hydraulic seal between inside and outside of condenser. No energy need be expended for the discharge of the water. But for the creation and maintenance of the vacuum which controls the height of the water column, there is need of an air pump (dry vacuum pump or ejector), that is employed to expel the air and non-condensable gases that enter the system with the milk, the cooling water, and through leaky joints. For details see "The Condenser," Chapter VII.

**Fuel Economy by Ability to Use Exhaust Steam.**—The fact that under reduced pressure milk boils at a relatively low temperature (130° to 140° F.) makes possible the use of low-pressure steam such as exhaust steam, without sacrificing rapidity of evaporation. This assists in saving fuel and reduces operating cost. Most condenseries have some exhaust steam from steam piston and turbine pumps. In factories where exhaust steam is plentiful, much, if not all, of the condensing can be done by the use of exhaust steam.

**Summary of Comparison of Heat Units Required by Evaporation under Atmospheric Pressure and in Vacuo.**—The comparative economy of condensing milk under atmospheric and reduced pressure is shown by the following figures. In this example it is assumed that the milk before condensing and heating has a temperature of 60° F. and that the evaporation in the vacuum pan is done in a vacuum of 23.81 inches and at the corresponding temperature of 141.49° F.

TABLE 22

Heat Required	Evaporation	
	Under Atmospheric Pressure	In the Vacuum Pan
Sensible heat .....	152. B.T.U.	81.4 B.T.U.
External latent heat.....	898.8 B.T.U.	947.6 B.T.U.
Internal latent heat.....	72.9 B.T.U.	65.9 B.T.U.
Total heat units (expended as heat) ..	1123.7 B.T.U.	1094.9 B.T.U.
Plus thermal equivalent expended by vacuum pump .....		50.
Total heat units expended.....	1123.7 B.T.U.	1144.9 B.T.U.

The above example clearly illustrates that, from the standpoint of heat

units required to evaporate a given volume of water or milk, evaporation in vacuo is of no advantage. In fact, the total heat units required to condense in vacuo is slightly greater than the total heat units necessary to condense the same quantity of water or milk, under atmospheric pressure.

**Effect of Vacuum on Rapidity of Evaporation.**—The fundamental factor that determines the rapidity of evaporation is the rate of heat transmission or the amount of heat transmitted by the steam to the milk per square foot of heating surface per hour. The rapidity of heat transmission in turn depends largely on the temperature difference between steam and milk. The greater this difference the more heat is transmitted per square foot per hour.

Under atmospheric pressure milk boils at about 212° F. Operating under a temperature difference between steam and milk sufficient to accomplish reasonably rapid evaporation would require the use of high-temperature steam. This would expose the milk to too hot a heating surface and to too high a boiling temperature to preserve its natural character and its marketable properties.

On the other hand, under vacuum the milk boils at a much lower temperature (under a 25-inch vacuum the boiling temperature is about 135° F.). This greatly increases the temperature difference between steam and milk and thus makes for more rapid heat transmission and accelerates the rate of evaporation.

The amount of water evaporated per square foot heating surface per hour under atmospheric pressure and in different vacua, using saturated steam of 5.3 lbs. and 10.3 lbs., respectively, is shown in the following calculations. These calculations are based on the heat values given in Table 21 in this chapter, and Table 29 in Chapter IX.

**POUNDS OF WATER EVAPORATED PER SQUARE FOOT HEATING SURFACE PER HOUR**

Overall heat transmission coefficient 350 B.T.U. per sq. ft., per hour, per 1° F. temp. diff.

All steam pressures referred to in these calculations are gauge pressures.

**EVAPORATION AT ATMOSPHERIC PRESSURE**

(Using saturated steam at a pressure of 5.3 lbs.)

Heat of evaporation per pound of water (Total latent heat) ..	=	971.7 B.T.U.
Temperature of 5.3 lbs. saturated steam.....	=	228° F.
Boiling point of milk under atmospheric pressure.....	=	212° F.
Temperature difference between steam and milk (228-212)....	=	16° F.
Heat transmission per sq. ft. per hour 16x350.....	=	5600 B.T.U.
Pounds of water evaporated per sq. ft. per hour.....	$\frac{5600}{971.7}$	= 5.76 lbs.

**EVAPORATION IN VACUUM PAN, VACUUM 23.81 INCHES**

(Using saturated steam at a pressure of 5.3 lbs.)

Heat of evaporation per pound of water.....	=	1013.5 B.T.U.
Temperature of 5.3 lbs. saturated steam.....	=	228° F.
Boiling point of milk at 23.81 inches vacuum.....	=	141.49° F.
Temperature difference between steam and milk.....	=	86.51° F.
Heat transmission per sq. ft. per hour 350 x 86.51.....	=	30,278.5 B.T.U.
Pounds of water evaporated per sq. ft. per hour....	$\frac{30,278.5}{1013.5}$	= 29.9 lbs.

**EVAPORATION IN VACUUM PAN, VACUUM 27.884 INCHES**

(Using saturated steam at a pressure of 5.3 lbs.)

Heat of evaporation per pound of water.....	=	1035.6 B.T.U.
Temperature of 5.3 lbs. saturated steam.....	=	228° F.
Boiling point of milk at 27.884 inches vacuum.....	=	101.76° F.
Temperature difference between steam and milk.....	=	126.24° F.
Heat transmission per sq. ft. per hour 126.24 x 350.....	=	44,184 B.T.U.
Pounds of water evaporated per sq. ft. per hour.....	$\frac{44,184}{1035.6}$	= 42.66 lbs.

**EVAPORATION AT ATMOSPHERIC PRESSURE**

(Using saturated steam at a pressure of 10.3 lbs.)

Heat of evaporation per pound of water.....	=	971.7 B.T.U.
Temperature of 10.3 lbs. saturated steam.....	=	240.1° F.
Boiling point of milk at atmospheric pressure.....	=	212° F.
Temperature difference between steam and milk.....	=	28.1° F.
Heat transmission per sq. ft. per hour 28.1 x 350.....	=	9835 B.T.U.
Pounds of water evaporated per sq. ft. per hour.....	$\frac{9835}{971.7}$	= 10.12 lbs.

**EVAPORATION IN VACUUM PAN, VACUUM 23.81 INCHES**

(Using saturated steam at a pressure of 10.3 lbs.)

Heat of evaporation per pound of water.....	=	1013.5 B.T.U.
Temperature of 10.3 lbs. saturated steam.....	=	240.1° F.
Boiling point of milk at 23.81 inches vacuum.....	=	141.49° F.
Temperature difference between steam and milk.....	=	98.61° F.
Heat transmission per sq. ft. per hour 98.61 x 350.....	=	3451.35 B.T.U.
Pounds of water evaporated per sq. ft. per hour.....	$\frac{3451.35}{1013.5}$	= 34.05 lbs.

**EVAPORATION IN VACUUM PAN, VACUUM 27.884 INCHES**

(Using saturated steam at a pressure of 10.3 lbs.)

Heat of evaporation per pound of water.....	=	1035.6 B.T.U.
Temperature of 10.3 lbs. saturated steam.....	=	240.1° F.
Boiling point of milk at 27.884 inches of vacuum.....	=	101.76° F.
Temperature difference between steam and milk.....	=	138.34° F.
Heat transmission per sq. ft. per hour 138.34 x 350.....	=	48,419 B.T.U.
Pounds of water evaporated per sq. ft. per hour.....	$\frac{48,419}{1035.6}$	= 46.75 lbs.

**TABLE 23.—SUMMARY OF ABOVE FIGURES**

Vacuum in pan Inches mercury column	Temperature of milk ° F.	Lbs. of water evaporated per sq. ft. heating surface per hour	
		5.3 lbs. steam pressure	10.3 lbs. steam pressure
atmospheric pressure.....	212	5.76	10.12
23.81 inch vacuum.....	141.5	29.90	34.05
27.884 inch vacuum.....	101.76	42.66	46.75

The above figures show that evaporation in vacuo is far more rapid than under atmospheric pressure, and that, under these conditions, the higher the vacuum the greater the speed of evaporation. They also indicate that the rapidity of evaporation in the vacuum pan does not materially increase by increasing the pressure of the steam used in jacket and coils.

**Effect on Quality of Milk.**—Condensing in the vacuum pan makes possible evaporation at a relatively low temperature. With present evaporating equipment, milk temperatures of 125° to 135° F. are usually maintained. Exposure to high evaporating temperatures jeopardizes quality. The low boiling temperature under vacuum in itself, therefore, protects the milk from heat damage.

In addition, the low boiling temperature widens the temperature difference between milk and steam. This makes feasible the use of low-temperature saturated steam, minimizing the danger of exposure to a damagingly high-temperature heating surface. Thus, objectionable heat damage is avoided. The natural character of the milk is not appreciably altered. Its flavor, color and other marketable properties remain essentially normal.

Further objections to the use of high-temperature steam are that the milk tends to burn on to the heating surface, insulating it, retarding evaporation, and causing the appearance of dark specks in the finished product.

#### THE VACUUM GAUGE AND ITS FLUCTUATIONS

**Relation of Vacuum to Pressure.**—Vacuum means a complete void. In the operation of the vacuum pan or other vacuum evaporator, such a condition does not exist. What does exist is a partial vacuum, which means a pressure lower than atmospheric pressure.

**The Absolute Pressure Gauge.**—The pressure is measured by the absolute pressure gauge. The readings of this gauge are independent of the barometric pressure, or changes of level of mercury in the mercury cistern. In this gauge, pressure is measured by the inches of mercury column which it sustains. The absolute pressure gauge shows the actual pressure in the pan, regardless of fluctuations in altitude or barometric conditions.

The exact height of mercury column sustained by the atmospheric pressure at sea level, which has been accepted as standard, is 760 mm. or 29.92 inches. For simplicity and convenience of calculation the generally adopted "round" figure of 30 inches will be used in the discussions in succeeding paragraphs.

**The Mercury Column Vacuum Gauge.**—Direct readings of the vacuum are obtained by the use of the mercury column vacuum gauge, such as is in general use in American condenseries. This gauge is so designed and connected that the vacuum is measured in inches of mercury column. This gauge shows only the difference between the vacuum inside the pan and the pressure of the outside atmosphere. Under atmospheric condi-

tions other than the standard atmospheric pressure at sea level these readings do not show the true or absolute vacuum in the pan, because they are not independent of altitude and other atmospheric conditions. They, therefore, must be corrected for atmospheric pressures other than 30 inches of mercury, or 14.7 lbs. per square inch, as shown later in this chapter.

The pressure corresponding to 1 inch of mercury column may be conveniently expressed by the following formula:

$$1 \text{ inch mercury column} = \frac{14.7}{30} \times (30 - 29) = .49 \text{ pounds pressure.}$$

In order to find the absolute pressure in pounds per square inch, it is necessary to determine the absolute pressure in inches of mercury which is the difference between the atmospheric pressure expressed in inches of

TABLE 24.—BAROMETRIC READING AND CORRESPONDING PRESSURES AT DIFFERENT ALTITUDES<sup>1</sup>

Barometric reading in inches of mercury	Atmospheric pressure in pounds per square inch	Altitude above sea level in feet	Barometric reading in inches of mercury	Atmospheric pressure in pounds per square inch	Altitude above sea level in feet
30 0	14.70	0	23 5	11.54	6412
29 7	14.60	264	23 0	11.30	6977
29 5	14 47	441	22 5	11 05	7554
29 2	14 35	710	22 0	10.80	8144
29 0	14 23	890	21 5	10 56	8747
28 7	14 11	1163	21 0	10.31	9366
28 5	13 98	1347	20 0	9 81	10648
28 2	13 86	1625	19 0	9 32	11994
28 0	13 74	1812	18 0	8.82	13413
27 5	13 50	2285	17 0	8 33	14914
27 0	13 26	2767	16 0	7.84	16506
26 5	13 02	3257	15 0	7.35	18201
26 0	12 77	3758	14 0	6.86	19996
25 5	12 53	4268	13 0	6.37	21891
25 0	12 27	4787	12 0	5.88	23886
24 5	12 03	5318	11 0	5.39	25981
24 0	11.78	5859			

mercury and the pan pressure expressed in inches of vacuum, and then multiply this difference by .49.

EXAMPLE.—Atmospheric pressure is 30 inches mercury column, vacuum gauge reading is 25 inches mercury. What is the absolute pressure in pan?

The absolute pressure is  $(30 - 25) \times .49 = 2.45$  pounds per square inch.

Effect of Altitude on Reading of Mercury Column Vacuum Gauge.—

The higher the altitude the lower the atmospheric pressure and the fewer the inches of mercury column sustained. Table 24 shows the atmospheric pressure and barometric reading in inches of mercury at altitudes ranging from the sea level to 25,981 feet above the sea level and in Table 25 may be found the altitudes of various cities in the United States.

TABLE 25.—ALTITUDE IN FEET OF VARIOUS CITIES IN THE UNITED STATES  
UNITED STATES DEPARTMENT OF AGRICULTURE

Akron, Ohio	940	Los Angeles, Calif.	267
Albany, N. Y.	22	Louisville, Ky.	453
Atlanta, Ga.	1032	Memphis, Tenn.	256
Baltimore, Md.	92	Milwaukee, Wis.	593
Birmingham, Ala.	600	Minneapolis, Minn.	812
Boston, Mass.	16	New Haven, Conn.	10
Buffalo, N. Y.	583	New Orleans, La.	6
Burlington, Vt.	112	New York City	54
Butte, Mont.	5555	Oklahoma City, Okla.	1197
Charleston, S. C.	12	Omaha, Neb.	1016
Chattanooga, Tenn.	672	Philadelphia, Pa.	42
Chester, Pa.	22	Phoenix, Ariz.	1082
Chicago, Ill.	590	Pittsburgh, Pa.	743
Cincinnati, Ohio	490	Providence, R. I.	11
Cleveland, Ohio	582	Richmond, Va.	51
Dayton, Ohio	740	Rochester, N. Y.	510
Denver, Colo.	5183	St. Louis, Mo.	455
Dallas, Tex.	430	Salt Lake City, Utah.	4238
Des Moines, Iowa	805	San Francisco, Cal.	15
Detroit, Mich.	588	Santa Fe, N. M.	6952
Duluth, Minn.	609	Seattle, Wash.	10
Houston, Tex.	46	South Bend, Ind.	717
Indianapolis, Ind.	708	Spokane, Wash.	1908
Ithaca, N. Y.	411	Tampa, Fla.	15
Kansas City, Mo.	750	Washington, D. C.	25
Knoxville, Tenn.	890	Wichita, Kan.	1294
Lexington, Ky.	955	Vicksburg, Miss.	196
Little Rock, Ark.	264		

According to Kent<sup>2</sup> the relation of altitude to atmospheric pressure per square inch is as follows:

TABLE 26.—RELATION OF ALTITUDE TO ATMOSPHERIC PRESSURE (KENT<sup>2</sup>)

Altitude*	Pounds Pressure Per Square Inch
At sea level	14.7
¼ mile above sea level	14.02
½ mile above sea level	13.33
¾ mile above sea level	12.66
1 mile above sea level	12.02
1¼ miles above sea level	11.42
1½ miles above sea level	10.88
2 miles above sea level	9.80

\*1 mile = 5,280 feet, or 1,609.3 meters.

"For a rough approximation we may assume that the pressure decreases one-half pound per square inch for every 1,000 feet of ascent."

In factories located at altitudes higher than sea level, the vacuum gauge will show fewer inches of vacuum at a given pan temperature than at sea level at the same temperature. This is due to the change in pressure difference between the absolute pressure in the pan and the atmospheric pressure outside. The following example may suffice to illustrate this fact:

**EXAMPLE.**—The pan is operated at a boiling temperature of say  $141.49^{\circ}$  F. At this temperature the absolute pressure in the pan is 3 pounds per square inch. What is the mercury column vacuum gauge reading at sea level? What is the corresponding reading at Santa Fe, New Mexico?

**ANSWER.**—The pressure difference between atmosphere and pan is  $14.7 - 3 = 11.7$  lbs. This pressure difference corresponds to a vacuum gauge reading of  $11.7 \times \frac{30}{14.7} = 23.8$  inches. The vacuum in the pan operated at  $141.49^{\circ}$  F. as recorded by the mercury column vacuum gauge at sea level, therefore, is 23.8 inches.

Santa Fe, New Mexico, is located at an altitude of 6,952 feet as indicated in Table 25. Table 24 shows that at this altitude the atmospheric pressure is 11.54 pounds per square inch. The absolute pressure in the pan at the same temperature ( $141.49^{\circ}$  F.) is 3 lbs. Hence, the pressure difference is  $11.54 - 3 = 8.54$  lbs. per square inch. This pressure difference corresponds to a vacuum reading of  $8.54 \times \frac{30}{14.7} = 17.43$  inches.

The vacuum in the pan operated at  $141.49^{\circ}$  F., as recorded by the mercury column vacuum gauge at Santa Fe, New Mexico (altitude 6,952 feet), therefore is 17.43 inches.

The above example shows that at a given pan temperature the number of inches of vacuum recorded by the mercury column vacuum gauge decreases as the altitude increases, although the absolute pressure and absolute vacuum in the pan remain the same as they are at sea level.

**Effect of Air in Pan on Reading Vacuum Gauge and Pan Thermometer.**—The pressure in the pan corresponding to the vacuum indicated at any given temperature represents the sum of vapor pressure and of air pressure present. Some air is always present in the pan. The vacuum pump is never 100 per cent efficient, and air is continuously entering with the incoming milk, with the incoming cooling water in the condenser and through leaky joints and fittings.

The absolute pressures shown in Table 21 for different temperatures represent the absolute vapor pressure of saturated steam at corresponding temperatures. In the practical operation of the vacuum pan it will be found that the pressure indicated in the table is always slightly lower (the vacuum recorded is slightly higher) than its equivalent shown by the recorded vapor temperature in the pan. This is so because the temperature



of the vapor corresponds to the vapor pressure only and not to the gauge pressure which represents the sum of vapor pressure and air.

The above discrepancy between the absolute vapor pressure shown in Table 21, and the actual pressure shown by the vacuum gauge in terms of inches of vacuum, applies only where the temperature recorded is that of the vapor space over the milk as determined by a vapor thermometer.

In practice, however, the temperature recorded by the milk thermometer in the pan at any given vacuum gauge reading also fails to consistently correspond to the temperature-pressure relation shown in Table 21, because of the influence of such uncontrolled variables as, specific gravity of milk, presence of vapor bubbles and height of the body of the milk in the pan.

Different milk strata show different specific gravities, and the higher the body of the milk the greater is the difference in specific gravity between bottom and top. The milk in the bottom of the pan is heavier and therefore hotter than the milk near the surface. Differentials as wide as  $5\frac{1}{2}^{\circ}$  F. have been observed in the case of sweetened condensed milk toward the finish of the batch.

These discrepancies in temperatures recorded by the pan thermometer become of special significance at the time of "striking" the batch if the results of the density test happen to be interpreted on the basis of the pan temperature at that time. They suggest that for a dependably accurate temperature record the temperature of the pan sample at the time of "striking" should be used. See also "Striking" the Batch, Chapter XV.

**Effect of Boiling Point of Liquid on Reading of Vacuum Gauge.**—The actual vacuum over the milk in the pan, as recorded by the mercury column vacuum gauge, is always slightly higher than that shown for water at the same temperature in Table 21. This is due to the fact that the boiling point of milk is slightly higher ( $212.3^{\circ}$  F.) than that of water ( $212^{\circ}$  F.). Hence at a given pan temperature a slightly higher vacuum is required to make milk boil. The difference in boiling point between milk and water and in inches of vacuum required to make the milk boil is further widened by the concentration of the milk toward the end of the condensing process and, in the case of sweetened condensed milk, by the added sugar content. The boiling points of fluid milk, cream and concentrated milks, are shown in Chapter II, Table 9.

#### REFERENCES

1. Buffalo Foundry and Machine Company: Information by correspondence. 1941.
2. KENT, WM.: Mechanical and Engineering Handbook. 1915.
3. HUNZIKER, O. F., AND NISSEN, B. H.: Experimental Study of Milk at Different Concentrations and under Different Vacua. 1925. Results not published.

## CHAPTER VII

### DESCRIPTION OF THE VACUUM PAN

The vacuum pan or vacuum evaporator is the heart of the milk condensery. It is the retort in which the condensing proper is accomplished. It is used in the manufacture of every type of concentrated milk, such as sweetened condensed milk, evaporated milk, plain condensed milk,

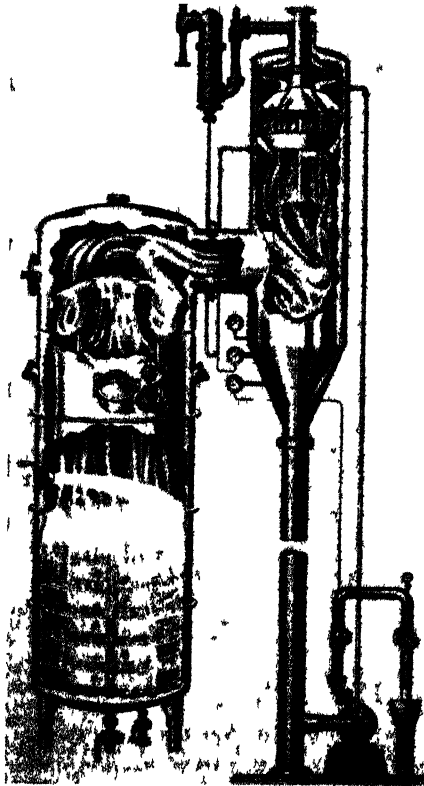

Fig 15 Vacuum pan showing deflector-type entrainment separator chamber and counter-current condenser  
Courtesy of Arthur Harris & Co

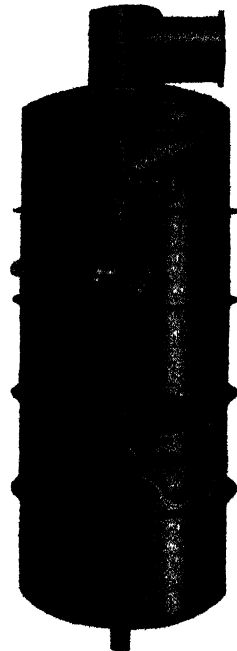

Fig 16 Vacuum pan showing baffle-type entrainment separator  
Courtesy of C F Rogers Co

condensed skimmilk and condensed buttermilk, and whether intended for use as such or for the preparation of other forms of milk food, such as dried whole milk, dried skimmilk, dried cream, dried whey, malted milk, ice cream mix, et cetera.

While unchanged in principle from that originally used by Gail Borden, the vacuum pan unit has undergone marked improvement in design

and usefulness since its early invention. As a result of the efforts of the evaporator engineer, the vacuum pan of today (1946) has increased capacity due to type and arrangement of heating surface and of condenser; it is capable of greater fuel economy, more efficient use of condenser water, better control of entrainment losses and more effective protection of the milk against heat damage. One of the most beneficial improvements in vacuum pan construction has been the change from copper to 18-8 stainless steel. See "Metals in Condensery Equipment," Chapter V.

The vacuum pan unit consists essentially of five major parts; namely, heating surface, vapor space, entrainment separator, condenser, vacuum pump, and numerous accessories.

**The Heating Surface.**—The area, design and arrangement of the heating surface play an important part in determining the evaporative capacity of the vacuum pan. The latter is directly proportional to the total area of heating surface, the temperature difference between steam and milk, and to the overall heat-transfer coefficient. The overall heat-transmission coefficient is influenced by such factors as: velocity of milk and steam flow, viscosity, density, specific gravity, specific heat and thermal conductivity of milk; conductivity of metal, milk film, steam film, incrustation.

The heating surface is provided either by a steam jacket, or a series of steam coils, or both, or by milk tubes inclosed in a steam chest or calandria as described later in this chapter.

**The Jacket** is located at the bottom of the pan. It is equipped with steam inlets, and outlets for the steam condensate discharge. At the lowest point of the bottom (usually in the center) there is an opening, about 2 to 4 inches in diameter for the discharge of the condensed milk. As shown in succeeding paragraphs, the steam jacket tends to decrease the velocity with which the milk passes over the heating surface, thereby affecting heat transmission and rapidity of evaporation unfavorably. While many of the pans now in operation still have steam jackets, in present-day pan construction the jacket is usually omitted.

**The Coils** are located in the lower part of the pan. Most pans have multiple short individual coils with steam inlets and condensation water discharges through the wall of the pan. Today the coils are made of stainless steel and the round profile has been superseded by a flat or oval shape which offers less resistance to the circulating milk. The coil arrangement is that of the single-layer, multiple-ring, horizontal coil. Each coil is confined to only one or one-half convolution. The pan contains numerous short independent coils, installed one on top of the other and spaced to permit of ready access for cleaning.

**Effect of Velocity of Circulation of Milk on Evaporative Capacity of Pan.**—The effectiveness of the heating surface, or its ability to transmit heat to the milk, is materially influenced by the rapidity with which the milk passes

over it. The greater the velocity at which the milk circulates, the more rapid is the transmission of heat from steam to milk. According to Ser and Joule<sup>1</sup> this additional heat transmission resulting from the circulation of the milk is approximately proportional to the cube root of the increase of liquid (milk) flow.

In addition to accelerated heat transmission resulting from maximum direct contact of milk with heating surface due to maximum velocity of milk circulation, this movement also promotes convection which distributes the heat rapidly to all parts of the body of the milk regardless of heat conductivity of the milk.

The reason that the milk in the pan circulates, lies in the effect of successive heating and cooling on its specific gravity and buoyancy. The milk that comes in contact with the heating surface becomes hotter and therefore lighter than the remainder of the milk in the pan. The buoyancy of this heated milk forces it upward. When it reaches the vapor space it cools rapidly due to evaporation. It thereby becomes heavier, "rolls" toward the center, and returns to the bottom where it is again heated, becomes lighter and rises to the top anew, thus circulating continuously from bottom to top and return.

The velocity of circulation of the milk over the heating surface is controlled by the temperature difference between heating surface and milk, the viscosity of the milk and the arrangement of the heating surface. In pans with both jacket and coils, the distribution of the heating surface is of a nature that prevents the milk from circulating in one direction only. The jacket causes the milk to "kick up" in the center, while the coils cause it to rise up near the pan wall and then "roll" toward the center where its return to the bottom is retarded by milk "kicked up" by the jacket. In pans which have no jacket and in which the bottom is not dished downward but is preferably convex, countercurrents are largely avoided; the milk circulates in one direction only.

**Effect of Velocity of Steam in Jacket and Coils on Evaporative Capacity of Pan.**—Rapidly moving steam carries more fresh molecules to the same area and therefore transmits more heat than slowly moving steam or steam at rest. For this reason the greatest heat transmission takes place at the point at which the steam enters the jacket or coil. Heat transmission decreases as the steam travels farther from the intake and is least at the point of exhaust. This fact is readily observed when the vacuum pan is in operation. The milk boils most violently at the point of steam intake. The ebullition diminishes at points farther removed from the steam intake.

The larger the space into which the steam enters, the slower is the velocity of the steam and the lower the amount and rate of heat transmission. Long, wide coils are less effective than short, narrow coils. Hausbrand<sup>2</sup> believes that, within reasonable limits, the increase of heat transmission is approximately inversely proportional to the square root of

the decrease of the diameter and the shortening of the length of the coils.

Therefore, several short coils, each with one turn or one-half turn only, and with large independent steam inlets and exhausts, furnish more efficient heat transmission than one or two long coils of the same area of heating surface. They make for maximum evaporative capacity and economy of operation.

Furthermore, the presence in the coils of condensation water hinders heat transmitting efficiency of the steam. The film of water coating the inside of the coil walls acts as an insulator. The more rapid and complete the removal of the condensation water, the more effective is the transmission of the steam heat. Short coils, slightly inclined, accelerate the removal of the water of condensation.

The installation of numerous short coils, located one on top of the other, with large independent steam inlets and exhausts, has the further advantage that such arrangement of heating surface permits the condensing of small batches and makes possible the utilization of at least a portion of the heating surface from beginning to end of the condensing process.

The short coils with large steam intake are ideally adapted, especially to the economical utilization of exhaust steam, as they make possible the simultaneous use of large volumes of steam. The uniformity of heat distribution in all parts of the milk is further assisted by the proper staggering of steam intakes and exhausts, respectively.

Through the wall of the pan the coils connect with the laterals of the steam header, located outside of the pan.

**Effect of Evaporating Surface of Milk on Evaporative Capacity of Pan.**—The larger the disengaging surface of the milk in the evaporator the more rapid the evaporation. The surface of evaporation is determined by the width and the height of the pan and the character of ebullition of the milk.

**The Vapor Space.**—That portion of the body of the pan which extends above the level of the milk constitutes the vapor space. It is here where the water contained in the boiling milk is converted into vapor. In most vacuum pans the vapor space is cylindrical and it should be sufficiently high to avoid danger of excessive entrainment losses in normal operation. The exact height must necessarily vary with the arrangement of the heating surface; i. e., the higher its elevation the taller must be the vapor space.

The wall of the vapor space is equipped with manhole, thermometer, vacuum gauge, vacuum break, observation glass and illumination glasses with lights. In case of an internal condenser, it will also house the condenser, or it may connect, through a short vapor pipe, with the entrainment separator and condenser located outside of the vapor space. A mercury column may be used in the place of the vacuum gauge.

**The Milk Intake Pipe.**—Through the wall of the vapor space also enters the milk intake pipe. This pipe connects with the forewarmer and discharges the hot fresh milk into the pan. Its size varies with the capacity of the pan, pan temperature of the milk, and height of lift between forewarmer and milk inlet. The larger the pan, or the hotter the milk, or the higher the lift, the larger must be the diameter of the milk intake pipe. Under average conditions a 3-inch diameter pipe is normal for a 6-foot pan. At the inlet to the pan the milk intake pipe is equipped with a valve to regulate the inflow. Inside the pan the milk intake pipe should be turned down, otherwise the impact of the intruding milk upon the opposite pan wall will tend to atomize the milk, and the dense spray so formed may be partly drawn over into the condenser, causing excessive loss.

Or, the milk inlet pipe may be fitted into the wall of the pan in tangential direction. The milk thus assumes a helical motion imme-

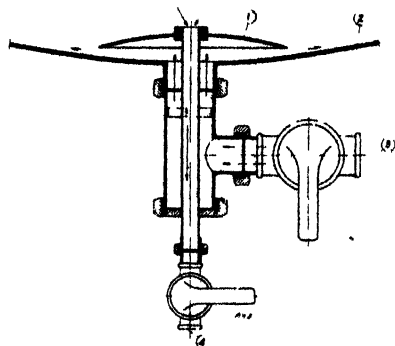

Fig. 17. Milk intake through bottom of vacuum pan

1. Mushroom milk distributor
2. Pan bottom
3. Fluid milk inlet
4. Condensed milk outlet

Courtesy of Arthur Harris & Co. Patent Pending

diately upon its entrance. This, together with the fact that the tangential entrance decreases the velocity of its inrush, assists in preventing excessive entrainment losses. Furthermore, the milk enters at a temperature above the temperature that is maintained in the pan. This is necessary for satisfactory pan operation. Thus the velocity-reducing helical motion enables the hot incoming milk to surrender its superheat before it mixes with the milk already in the pan. This in turn accelerates the speed of evaporation.

The milk intake pipe within the pan should have a progressively increasing diameter. This will further facilitate the surrender of the superheat of the entering milk before it is released into the vapor chamber. In this type of milk intake the flared end of the pipe should terminate above the milk level in the vapor space.

One of the latest improvements of milk intake in the coil-type vacuum pan introduces the incoming hot milk through the bottom of the pan, discharging it radially through horizontal nozzles or through a circular opening located underneath a deflector plate, both of which are turned slightly upward. The "superheated" milk (due to high forewarning tem-

perature) leaves the discharge nozzles or the circular slot underneath the deflector plate with great velocity. This increases the rapidity of milk circulation over the heating surface, especially over the jacket and lower coils where the movement of the milk is otherwise relatively sluggish. In addition, part of the water content of the incoming hot milk immediately flashes into vapor. This greatly expands the volume and generates definite circulation into the "dead" milk space that covers the bottom of the pan, further accelerating the rate of evaporation. This boosting of the milk circulation has the further advantage that it makes for more uniform density of the product in the evaporator.

#### CONDENSED MILK SAMPLERS

Another important accessory of the vacuum pan is the condensed milk sampler. Its purpose is to draw samples representative of the boiling milk in the pan for determination of its density, without interrupting pan operation. Several different types of pan sampling arrangements have been developed for this purpose. These samplers belong to one or the other of the following two groups: (1) batch samplers, and (2) samplers for continuous pan operation.

**Batch Samplers.**—The initial samplers were exclusively batch samplers. Probably the earliest device used for taking pan samples of condensed milk was the sugar syrup sampler.

Another very simple arrangement of the early days for drawing samples from the pan consisted of equipping the bottom outlet of the pan, that serves to discharge the finished batch, with two valves connected by a short pipe nipple. When drawing a sample the opening of the upper valve permits the nipple to fill with the condensed milk.

The so-called striking cup shown in Fig 18 is another of the useful early batch samplers. This very practical sampler is still in use today with the majority of copper pans as well as with many of the stainless steel pans of more recent construction.

The latest type of batch sampler is shown in Fig. 19. This sampler is usually attached to the bottom of the vacuum pan. It consists chiefly of a standard, vacuum-tight, sanitary milk valve terminating at its bottom end in a flat-type rubber gasket seat. Between valve and gasket seat there is a small pet cock to release the vacuum. For withdrawing a sample, a standard 2-inch sanitary pipe hydrometer cylinder or a one-quart milk bottle is pressed against the flat rubber seat. Opening the sanitary milk valve immediately evacuates the container and permits it to be filled with the condensed milk. When full, the valve is closed again, and upon opening the pet cock the container can be removed from its seat for the density test.

**Samplers for Continuous Pan Operation.**—The sampler shown in Fig. 20 is used in continuous pan operation. It is suitable for evaporated and plain condensed milk. It is preferably installed near the pan plat-

form so that the operator can observe continuously the density of the finished product. It is located near and above one of the hot wells into which the overflow is discharged. The milk that flows through this sampler is supplied from the pressure side of the continuous milk discharge pump underneath the pan. It enters the sampler cylinder at the bottom and overflows back to the hot well. A sanitary milk valve in the feed pipe to the sampler regulates the milk flow. The hydrometer



Fig. 18. Batch sampler

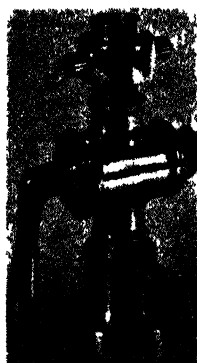

Fig. 19. Batch sampler

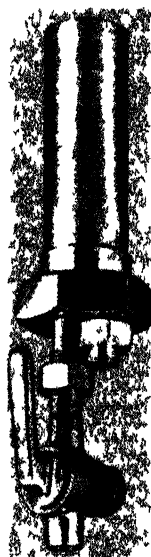

Fig. 20. Continuous sampler

is freely floating in this sampler and its scale is readily readable from the pan operator's platform, giving the operator a continuous reading of the discharged finished product.

#### OTHER TYPES OF VACUUM EVAPORATORS

Retorts of more recent design, that lend themselves admirably to the condensing of milk and fluid milk products, are conveniently grouped as rapid-circulation, tubular evaporators. Outstanding examples of this group are the Kestner Vertical Film Evaporator, the Buflovak Vacuum Milk Evaporator, the Scott Forced-Circulation Evaporator, the Mojonnier Tubular Evaporator, and the Peebles Single-Pass Evaporator.

**Kestner Vertical Film Evaporator.**—While differing somewhat in detail of design, these tubular, rapid circulation evaporators appear to embody the general principle of the Kestner Vertical Film Evaporator invented by the eminent French engineer, Paul Kestner of Lille, France, and first patented in 1899. Numerous United States patents were granted to Kestner in 1906-1914.<sup>3, 4, 5, 6</sup> This evaporator is shown in Fig. 21. It



consists of a long narrow calandria with tubes 16 to 92 feet long. In the up-draft Kestner evaporator, the tube length is limited to 23 feet. The velocity of the liquid in the tubes is reported to range from about 90 to 150 feet per second with natural circulation, i.e., without mechanical pumping. This high velocity is attained by virtue of the temperature difference between the steam and the milk, the great length of the tubes and the low level of the milk in the tubes. The bubbles of steam formed when the liquid begins to boil, rise and carry the liquid upward in the form of a so called "film" on the tube walls. The mixture of liquid and vapor discharging from the tubes at high velocity is trapped in the vapor belt located above the calandria. The vapor belt houses the Kestner stationary centrifugal entrainment separator which causes the

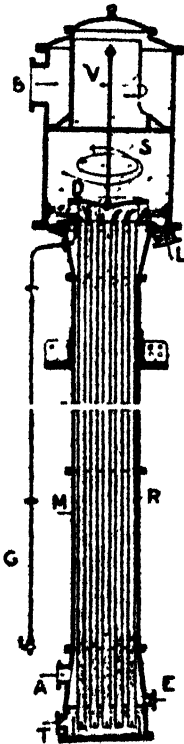

Fig. 21. Kestner tubular evaporator  
By Permission of Wehre and Robinson<sup>8</sup>



Fig. 22. Mojonnier tubular evaporator  
Courtesy of Mojonnier Bros. Co.

mixture to impinge against the walls of the vapor belt, returning the liquid to the feed tank of the next effect, or discharging it into the concentrated liquor (milk) tank in case of a single-effect unit or in case of the last effect of a multiple-effect unit. The vapor, being lighter, rises to the top and escapes to the condenser or discharges into the steam chest of the next effect.

**Bufflovak Vacuum Milk Evaporator.**—In this tubular evaporator the steam chest is located outside the vacuum pan body. As shown in Fig. 23, the steam chest and the vapor body are connected alongside each other. The upper pipe discharges milk and vapor from evaporator into vapor chamber. The upper pipe returns the partially condensed milk to the bottom of the evaporator for recirculation. In addition to low pan temperature, speed of evaporation and minimum entrainment losses, this outstanding design of rapid circulation evaporator provides easy access for cleaning. With the hinged covers open or removed the milk tubes are readily cleaned by the use of a flue brush of suitable diameter. The high velocity

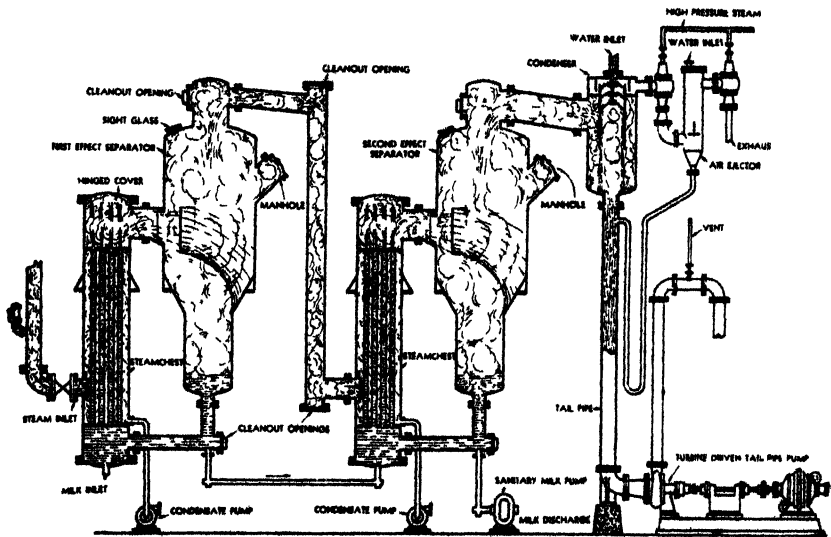

Fig. 23. Bufflovak tubular double-effect evaporator with centrifugal-type entrainment separator

Courtesy of Buffalo Foundry & Machine Co.

of the circulating milk assists in keeping the milk tubes free from objectionable coating. In addition, the unique centrifugal introduction of the mixture of milk and vapors into the lower portion of the large separate vapor space endows the vapor belt with the function of a highly efficient entrainment separator.

**Other Tubular Rapid Circulation Evaporators.**—The Peebles Single-Pass Evaporator, similar to the Kestner Film Evaporator, is adapted to construction for down-draft as well as for up-draft operation. In contrast to other tubular evaporators which operate on a recirculating basis, the Peebles Machine is designed to concentrate the milk in one operation (single pass). It has been found advisable, however, to recirculate a very small portion of the second effect in order to assure complete coverage of the heating surface. In the design of the Scott Forced-Circulation Evaporator, the vapor-separating pan is placed above the tubular calandria

and the milk is circulated down through a central nest of tubes and up through the outer tubes by the use of a low lift, low power, centrifugal impellor. This design, by reason of the forced circulation unit, causes the milk to pass over the heating surface at a higher velocity than is possible under natural circulating conditions. Hence the rate of heat transmission is increased and the size of the heating system can be reduced. This is important in fabrication when using an initially expensive metal such as stainless steel, etc.

**Summary of Advantages of Rapid Circulation Tubular Evaporators.**—These evaporators differ from the conventional standard vacuum pan chiefly in arrangement of heating surface and vapor space. The steam coil and jacket are eliminated and the heating element consists of straight milk heating tubes surrounded by a steam chest. The main advantages of the rapid circulation tubular evaporator are:

1. High rate of evaporation, because of
  - a. high velocity of milk over heating surface,
  - b. high velocity of steam over heating surface,
  - c. wide temperature difference between milk and steam,
  - d. efficient removal of air and non-condensable gases.
2. High operating economy, because
  - a. facilitates use of exhaust steam,
  - b. well adapted to multiple effect evaporation which provides important economies of fuel and water.
3. Efficient protection against heat damage to milk, because of
  - a. small amount of milk in tubes,
  - b. rapid circulation over heating surface,
  - c. short exposure to pan heat.
4. Minimum entrainment losses, because of efficient centrifugal entrainment separator.

Because of its recognized advantages, the tubular evaporator is gaining rapidly in popularity. It appears destined to supersede the conventional, standard vacuum pan in factories with large volume of production, especially for the manufacture of evaporated milk and other forms of unsweetened condensed milk, as well as for precondensing in the manufacture of milk powder.

**Evaporators Utilizing the Thermal Energy Contained in the Milk Vapor.**—To this group of evaporators belong the multiple-effect, the thermo-compression, and the mechanical vapor compression evaporator. These evaporators differ from the conventional vacuum pan and the tubular evaporator in that they utilize the latent heat contained in part or all of the vapor arising from the milk. They make possible improved economy in the use of fuel and water.

In the multiple-effect unit the vapor arising from the milk in the first evaporator is supplying the heat energy for the second pan. The thermo-

compression evaporator consists of a single-effect evaporator. A portion of the milk vapor generated in the evaporator is re-used as heating steam in compressed form, its pressure and temperature being increased by injection of high-pressure steam. The mechanical vapor compressor re-utilizes all the heat energy contained in the milk vapor generated in the vacuum evaporator. In this case, compression to higher pressure and higher temperature of the vapors is accomplished by mechanical thermo-compression without the help of high-pressure steam. The mechanics of evaporators that re-use the thermal energy contained in the milk vapor, and their fuel and water economy, are discussed in Chapter IX.

#### THE ENTRAINMENT SEPARATOR

**Purpose.**—The purpose of the entrainment separator is to reclaim particles of milk entrained by the vapor currents that pass from the vacuum pan to the condenser at a high velocity. It is to prevent excessive entrainment losses.

**Present Day Pan Operation Emphasizes Importance of Entrainment Separator.**—The entrainment separator has become an integral part of the vacuum pan unit. Its installation is more necessary today than it has been in the past. Efforts to expedite the rate of evaporation have increased the danger of excessive milk entrainment. These efforts have yielded improvements in design of heating surface and condenser that have appreciably lowered the pan operating temperature and increased the vacuum. This change vastly increases the specific volume of the vapor. This, in turn, necessitates higher velocity of the vapors in their passage from pan to condenser. The higher vapor velocity greatly increases the danger of milk particles being carried over into the condenser and lost.

TABLE 27.—RELATION OF PAN TEMPERATURE TO VACUUM, SPECIFIC VOLUME OF VAPOR AND VELOCITY OF VAPOR<sup>7</sup>

Pan Temperature ° F.	Vacuum inches	Specific Volume of vapor cu. ft. per lb.	Velocity of vapor (4-ft. pan, 105 sq. ft. heating surface)		
			ft. per min.	miles p. h.	increase %
140	24.12	123.0	5,260	60	0
130	25.48	157.3	6,710	77	28.3
120	26.56	203.2	8,650	99	65.0

Table 27 shows that, in the case of a 4-foot pan, a drop in pan temperature from 140 to 120° F. increases the vapor volume from 123 to 203.2 cubic feet and augments the vapor velocity from 60 to 99 miles per hour. Checks on milk losses at low pan temperatures have shown that even

under careful operation the losses may run as high as two per cent of the milk in the batch in the absence of an efficient entrainment separator.

A baffle in the pan or in the vapor line will do some good. It prevents the spray from directly entering the vapor pipe. But it lacks the basic engineering elements of the scientifically correct entrainment separator, such as is capable of reclaiming the milk entrained in the vapors above the boiling milk.

The latest designs of dependable entrainment separators are capable of reducing entrainment losses to a small fraction of one per cent. These belong to one or the other of two general types of separators, namely, (1) the centrifugal type, and (2) the deflector type of separator chamber. These entrainment separators are extensively used in chemical engineering to precipitate solids or liquids from a gas or a vapor. Similarly they are needed in the condensing of milk where they are installed between pan and condenser for the purpose of recovering the milk solids that are entrained in the vapors.

**The Centrifugal Entrainment Separator** consists of a vertical cylinder with tangential vapor inlet near its bottom. Near its center there is a vertical downpipe with inlet near the top. The vapors, in their concentric movement, impinge against the peripheral walls of the separator and surrender part of the milk particles which pass down the walls to the bottom where they are reclaimed, the bottom being connected with the vacuum pan over a loop. The vapors, freed from much of the entrained milk particles, climb to the top and pass down through the downpipe and out to the condenser. The centrifugal entrainment separator is of sanitary construction throughout. It is made of stainless steel, has a full-size manhole, observation glass and illumination glass. In some cases the down-pipe is removable for easy cleaning. This type of separator lends itself especially to pan units arranged for continuous operation, because of its vapor velocity. It is effective down to a certain minimum velocity below which its usefulness diminishes rapidly.

**The Deflector Type of Entrainment Separator Chamber** is usually built concentrically on top of the vacuum pan and its diameter is equal to that of the vacuum pan itself, see Fig. 16. The vapor travels from the pan through a concentrically located stack which narrows toward the top. A flexible spring-loader head is attached to the top of the stack. Underneath this head the direction of the vapor is changed about 90 degrees, discharging the vapor radially into the separator chamber. Because of the larger diameter of this chamber, the vapor velocity is greatly reduced (about 9 times). All the milk particles that have been carried against the flexible head travel tangentially into the chamber where they impinge against its side wall, and return from the separator chamber through a drain tube to the pan below. The vapors having thus surrendered the entrained milk particles rise to the top of the chamber and are drawn over into the

condenser. The vapor outlet of the chamber is protected by a protruding baffle, which prevents any precipitation from being washed into the condenser and lost. Because of the spring-regulated deflector head, a slightly higher vacuum is maintained in the separator chamber than in the vapor space of the pan. This differential in vacuum is responsible for the efficiency of the separator.

This type of entrainment separator lends itself especially well to batch operation, as the spring-operated deflector functions on a constant pressure drop principle.

#### THE CONDENSER

**Purpose of the Condenser.**—The purpose of the condenser is to condense the milk vapors and to cool the entrained air and non-condensable gases. The condensing of the milk vapors is indispensable in order to make possible their elimination as fast as they are generated and thereby maintain the desired vacuum in the pan. The cooling of the entrained air and non-condensable gases is necessary to reduce the load on the vacuum pump or ejector and to avoid difficulties in pan operation. The condenser thus supplements the function of the vacuum pump.

**The Surface Condenser and the Spray Condenser.**—The condensing of the vapors is accomplished by removing from them the heat of vaporization. The condenser is, in fact, a huge water heater in which all the boiler heat utilized for the preheating and condensing of milk, is wantonly dissipated. The condensing of the vapors may be done either by bringing the vapors in contact with cold metal surfaces, or by passing the vapors through sprays of cold water. The first system requires the use of the surface condenser which discharges the vapor condensate separately from and without admixture with the cooling water. This system uses the cooling water very uneconomically. Its use is justifiable only where the resulting condensate has commercial value and must be reclaimed.

The condensate of the vapors of fresh unfermented milk has no commercial value. Hence, the spray type condenser is used, exclusively in the milk condensery. This may be provided in several different forms such as the jet- or cataract-condenser, parallel- or counter-current condenser, the condenser installed inside or outside the vacuum pan, and having the removal of the condenser water provided for by pumps or by barometric drain.

**Parallel-Current Versus Counter-Current Condenser.**—The type of condenser most commonly used in the earlier days of the milk condensing factory was the horizontal or vertical parallel-current spray condenser, both the internal and the external type. In both the horizontal and the vertical spray condenser, the cooling water and the vapors enter in close proximity, and travel in parallel direction. In most of these installations the condenser discharges the cooling water and vapor condensate, as well as the entrained air and non-condensable gases, together

and at the same temperature, through a wet-vacuum pump.

Within the last decade the counter-current condenser, usually with cataract water dispersion arrangement, has practically monopolized the field of new installations. Here the water enters at the top. The vapors enter at the side near the bottom, passing upward through a spray or film of water. The air and non-condensable gases are drawn off at the top where the cold water enters and where the temperature, therefore, is lowest. They are drawn out by a dry vacuum pump or a steam ejector. The water is discharged from the bottom of the condenser either by a centrifugal or a turbine pump or by means of a barometric drain.

The counter-current condenser provides for maximum area of contact between vapor and cooling water and for efficient elimination of air and non-condensable gases. It therefore accomplishes highly efficient utilization of the water supply and facilitates pan operation unhindered by interfering obstructions to the free transmission of heat units. It brings the temperature of the condenser water discharge to within a few degrees Fahrenheit of the pan temperature, thus permitting the use of relatively high-temperature water without interfering with the proper functioning of the vacuum pan. For the same reason it makes possible the advantageous use of a water-cooling tower, spray pond, or other system of cooling large volumes of water, operated for the re-use of air-cooled water, at temperatures as high as 100° F. These economies in the water supply, under conditions of water shortage or water temperature that would practically preclude the satisfactory operation of the pan, are especially helpful in dairy sections of the warmer regions of the Temperate Zone, in the Near-Tropics and the Tropics. Also, because of the absence of small spray holes that readily clog, this condenser permits the use of water containing diverse foreign matter.

Above all, the counter-current condenser has been instrumental in making possible the adoption of a definitely lower pan-operating temperature, thereby accomplishing a greater temperature difference between milk and steam, a higher rate of heat transmission, more rapid evaporation and more dependable protection of the milk against heat damage. Its chief drawback is that it takes up much space, requiring a large, tall condenser shell, high vapor line, an air pump or steam ejector at the top, and a barometric column with an overflow cistern or a water pump at the bottom. These handicaps limit its suitability somewhat in the case of plants with small volume.

**Condenser Located Inside Pan.**—The internal condenser is located in the upper part of the vapor space on the inside of the pan. Its principle advantages are that it condenses the vapors inside the pan, insuring the highest vacuum in the pan itself. It eliminates vapor friction between pan and condenser, because it makes unnecessary the mechanical

expulsion of bulky vapors and only water and entrained air and gases must be discharged. It does away with cumbersome, insanitary and costly goosenecks and vapor tubes, and diminishes the number of joints that invite air leaks.

The inside-condenser, however, is in principle a parallel-current condenser and, therefore, lacks the basic advantages of the counter-current principle. It is incapable of providing the water-economy of the latter, because its terminal temperature difference is from about 15° F. to 25° F. as compared to about 5° F. or less for the counter-current condenser. Its air and non-condensable gases are discharged together with the water at the highest temperature that exists in the condenser, while in the counter-current condenser they are discharged separately and at the point of lowest temperature as they should be, because of smaller volume. The internal condenser is of service, however, in smaller pan units where the limited volume of milk handled does not justify the installation cost of the counter-current condenser.

**The Barometric Condenser.**—The barometric condenser is any type of water spray condenser that discharges its water by means of a barometric drain. This drain consists of a water column that serves as the hydraulic seal between inside and outside of condenser. The height of the column is proportional to the pressure difference between inside and outside of pan. For each inch of mercury column (specific gravity of mercury at 0° C., 13.6) there is 1.133 feet of cold water (specific gravity 1.0). At sea level this is equivalent to a water column of approximately 34 feet ( $30 \times 1.133$ ). Any additional water that reaches the above level causes the same amount of water automatically to flow out at the bottom of the column, because the atmospheric pressure can only sustain a water level corresponding to any given pressure difference.

The water column of the barometric condenser connects with and discharges its water into a tight cistern, usually located in the ground. At or near sea level, the condenser is so placed that its water outlet to the barometric drain pipe has an elevation of about 35 feet above the water level of the cistern near the bottom of which the drain pipe terminates. The necessary height of the condenser decreases as the altitude of the factory increases. The cistern should have sufficient capacity to keep the lower end of the barometric drain pipe submerged at all times. Thus, during operation, or when the maximum vacuum in the pan unit has raised the water column in the drain pipe to its full barometric level, the bottom of the pipe should still be submerged to an approximate depth of at least six inches of water. The diameter of the barometric drain pipe varies from about 4 to 10 inches, depending on the capacity of the vacuum pan unit and the temperature of the cooling water. The cistern is provided with a large overflow. When the pan is in operation



the level of the water column remains constant and the excess water overflows from the cistern.

Since the condenser with barometric drain pipe does not discharge the entrained air and non-condensable gases with the water, its use necessitates the installation of a dry vacuum pump or steam ejector, drawing the air and gases out at the point of lowest temperature. This point is at the water inlet to the condenser. Because of its simplicity and automatic functioning, the barometric condenser is in use in many milk condenseries whose general arrangement permits of the height of this equipment.

**Factors That Affect the Efficiency of the Condenser.**—Aside from the volume and temperature of the available water, the efficiency of the condenser is affected by such factors as: (1) surface of water spray, and (2) duration of exposure of vapors to water spray.

**Surface of Water Spray.**—The efficiency of the condenser increases with the increase of the surface of the water spray that is exposed to the vapors. Other conditions being the same, the surface of the spray depends primarily on the fineness of dispersion. The smaller the particle size, the larger the surface of contact between spray and vapors. The fineness of the spray is controlled largely by the temperature and pressure of the water, and by the size and arrangement of the openings.

**Duration of Exposure of Vapor to Water Spray.**—The longer the time of exposure of the spray or film of cooling water to the vapors, the more of the heat of evaporation will it consume and the more efficient will be the water utilization and the performance of the condenser. It is the prolonged and intimate contact between water and vapor that constitutes the basis of the superior performance of the counter-current condenser.

**Amount of Water Required in the Condenser.**—The amount of cooling water that is required in the condenser is determined by the temperature of the water supply, the pan temperature and the temperature of the condenser discharge water. The calculation of pounds of cooling water required to condense the vapors of one pound of water contained in the milk is illustrated in the following example:

**EXAMPLE.**—Temperature of water supply to condenser is 60° F. Temperature of water discharge of condenser is 120° F. Pan Temperature is 125° F., vacuum is 26 inches. How much water is required to condense the vapors of one pound of water contained in the milk?

**ANSWER.**—To raise the temperature of one pound of water from 32° to 212° F. requires 1 B.T.U. for each degree Fahrenheit. Therefore, one pound of water at 120° F. contains  $120 - 32 = 88$  B.T.U. The total heat units contained in one pound of water vapor at 125° F. is 1115.1 B.T.U. See Table 28. Hence, the heat units that must be removed from one pound of vapor and the resulting water cooled to 120° F.

is  $1115.1 - 88 = 1027.1$  B.T.U. Pounds of cooling water at  $60^{\circ}$  F. required to remove 1027.1 B.T.U. is  $\frac{1027.1}{(120 - 60)} = 17.1$  lbs. of water.

It takes 17.1 lbs. of cooling water at  $60^{\circ}$  F. at a pan temperature of  $125^{\circ}$  F. and a condenser discharge water temperature of  $120^{\circ}$  F. to remove the vapors of one pound of water contained in the milk. The total amount of water discharged from the condenser is equal to the sum of the cooling water and the water of condensation; in this case  $17.1 + 1 = 18.1$  lbs. of water discharged from the condenser per pound of water evaporated.

TABLE 28.—POUNDS OF WATER REQUIRED TO CONDENSE VAPOR EQUIVALENT TO ONE POUND OF WATER CONTAINED IN MILK<sup>6</sup>  
Based on Water Supply Temperature at  $60^{\circ}$  F.\*

Vacuum pan temperature ° F.	Vacuum mercury column inches	Total heat units B.T.U.	Condenser discharge temperature ° F.	Temperature differential between pan and condenser discharge ° F.	Water required to condense vapors of 1 lb. water in milk lbs.
140	24.1	1121.4	120	20	17.2
			135	5	18.5
135	24.8	1119.3	115	20	18.8
			130	5	14.5
130	25.5	1117.2	110	20	20.8
			125	5	15.7
125	26.0	1115.1	105	20	23.1
			120	5	17.1
120	26.5	1113.0	100	20	26.1
			115	5	18.7

\*Note:

- (1) The lower the pan temperature the more cooling water is required in the condenser.
- (2) The lower the temperature of the condenser water discharge, the larger the volume of cooling water required.
- (3) The smaller the temperature difference between pan temperature and condenser discharge temperature, the more efficient is the use of the cooling water and the less water is required.

In factory practice the following temperature differentials between pan and condenser discharge water for the major groups of condensers may be considered normal:

Counter-Current condenser .....  $5^{\circ}$  F.  
 Parallel-Current external condenser.....  $15^{\circ}$  F.  
 Parallel-Current internal condenser.....  $20^{\circ}$  F.

**Thermometer for Condenser Water.**—The importance of the pan operator's attention to the temperature of the condenser discharge water and its relation to the pan temperature, emphasizes the need of an accurate thermometer in the condenser discharge water pipe, preferably at a point where this thermometer, the pan thermometer and the vacuum gauge are readily and simultaneously visible to the pan operator. Any temperature adjustments, up or down, should be done gradually, so that

the milk can assume the changed temperature without ceasing to boil and without causing excessively wild behavior.

**Protection of Milk Against Bad Condenser Water.**—It is obviously desirable to use potable water in the condenser because, unless special precautions are taken, condenser water may get into the milk in the vacuum pan at any time. In many factories, however, the condenser water available is not potable. This is generally the case with water from a creek, pond or lake, or when cooling and re-using the condenser water, using a water cooling tower or other air cooling arrangement.

In case of the barometric condenser, all danger of accidental flooding of the pan with condenser water is eliminated by the barometric leg with its constant water level. In the case of all other spray condensers, the possibility of condenser water flowing back into the pan is ever-present. It may occur during accidental stopping of the vacuum pump or for any other reason that reverses the suction between condenser and pan. This danger is dependably avoided by installing in the lower part of the condenser a flow-controlled switch which will stop water flowing to condenser in case the pump should stop.

#### THE VACUUM PUMP

The purpose of the vacuum pump is to produce and maintain a partial vacuum, so as to make possible the condensing of milk in the vacuum pan under reduced pressure and at a correspondingly reduced temperature. The same result could be obtained by the use of a water ejector in the condenser, in the place of the mechanical vacuum pump. The efficient operation of the water ejector, however, requires large volumes of water used under high pressure. The average milk condensery is usually not in position to meet these requirements in a manner that is readily practicable and economical. Because of these facts, and for other reasons, the water ejector is not used to any extent, if at all, in the manufacture of concentrated milks. In its stead, the partial vacuum is produced and maintained by a mechanical vacuum pump, or by a steam ejector, which removes the air and non-condensable gases as fast as they are liberated.

**The Wet Vacuum Pump.**—There are principally two classes of vacuum pumps; namely, the wet vacuum pump and the dry vacuum pump. The former requires the condenser discharge water, as well as the air and non-condensable gases, to discharge through the pump, while the dry vacuum pump disposes of the air and non-condensable gases only.

The early vacuum pumps used in milk condensing factories were wet vacuum pumps, operated in conjunction with the parallel-current spray condenser. These pumps have a much enlarged valve area. The valves are of soft rubber with low-tension springs, and their stuffing boxes are water-sealed. Most of them are direct-acting steam piston pumps. Nu-

merous of the old style copper vacuum pans in operation today are equipped with wet vacuum pumps. The pan with barometric condenser, however, requires a dry vacuum pump for the removal of the air and non-condensable gases, the barometric drain disposing of the condenser water through the cistern.

**The Dry Vacuum Pump.**—Present day installations of vacuum pan units with counter-current condenser are equipped with the dry vacuum pump or a steam ejector for the removal of the air and non-condensable gases, while the condenser discharge water is drawn from the condenser by means of an efficient water pump of suitable capacity.

The air and non-condensable gases are discharged from the condenser at the point of lowest temperature (at the top where the cooling water enters). The dry vacuum pump that has been found most suitable and that is in predominate use in our American milk condenseries is the water-sealed rotary type of vacuum pump, such as is illustrated in Fig. 24.

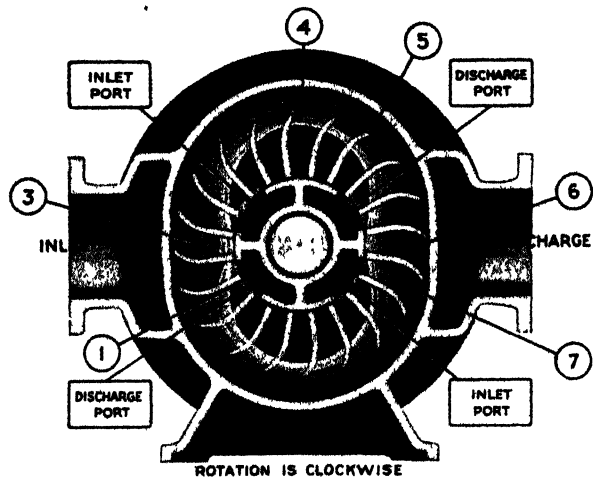

Fig. 24. Nash Hytor vacuum pump  
Courtesy of Nash Engineering Co.

**The Steam Ejector.**—In the place of a mechanical pump, a steam ejector may be used, thus eliminating all moving mechanism. For a small evaporator, usually up to a 5-foot pan, the single-stage ejector is generally used. For large capacity pans, the double-stage ejector with intermediate condenser is recommended. Suitable steam ejectors are illustrated in Figs. 25 and 26.

The steam ejector has the advantage of simplicity of construction, low cost of initial installation and absence of maintenance cost. It has the further advantage that its exhaust steam can be used to heat the water that may be returned to the boiler. On the other hand, the steam ejector requires a large and unfailing steam supply and dependably uniform steam pressure, for satisfactory operation of the vacuum pan unit.

It should be used only where there is available plenty of boiler horsepower, and where there is no fluctuation of steam pressure. Furthermore, by reason of the large amount of air and gases in its exhaust steam, and because the discharge pressure of an ejector must never exceed one pound of pressure, the steam ejector cannot be used for purposes of heating surface, such as in jacket, coil, or steam chest of the evaporator.



Fig 25 Single-stage steam ejector

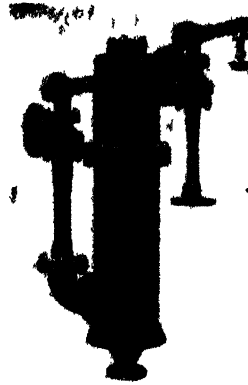

Fig 26 Double-stage ejector with intermediate condenser

Courtesy of Arthur Harris & Co

**Steam Turbine Drive for Condenser Water Pump.**—In this case (using the counter-current condenser<sup>1</sup>), the condenser water is discharged from the bottom of the condenser leg. For this purpose any efficient centrifugal pump may be used. These pumps usually have either motor drive or steam turbine drive. The turbine in such case acts as a pressure-reducing valve, providing saturated steam for use in jacket, coils, or steam chest in the evaporator. The turbine will operate against any back pressure up to 10 lbs. Since the condenser water pump is running only when the vacuum pan is in operation, there is no waste of exhaust steam from the turbine. The turbine exhaust is all utilized, therefore, to provide heat units needed for evaporation. Moreover, this steam is clean. There is no oil in the exhaust steam from the turbine. The fuel economy thus effected is obvious. Experience has demonstrated that the steam turbine drive of the pump that disposes of the condenser discharge water proves economical for any unit above five horsepower.

**Combination Pump for Water, Air and Gases.**—One of the latest developments for the efficient removal of both the condenser discharge water and the air and non-condensable gases, is a combined pump unit consisting of a water-sealed rotary type of dry vacuum pump and a centrifugal water pump, both operating on the same shaft with either direct motor drive or with steam turbine drive, as shown in Fig. 27.

**Proper Installation of Vacuum Pump.**—The vacuum pump should be installed as close to the pan as practicable, in order that the full benefit of the vacuum may be realized. The connections and fittings must be of the size specified by the manufacturer. The suction pipe should be as short and with as few and as easy bends as possible, so as to prevent



Fig 27. Nash combination pump  
Courtesy of Nash Engineering Co

excessive friction. The grade of the suction pipe should be uniform in order to avoid air pockets.

#### REFERENCES

1. SER, AND JOULES: Hausbrand, Verdampfen, Kondensieren and Kuhlen, 1918.
2. HAUSERAND, E.: Verdampfen, Kondensieren and Kuhlen, 1918.
3. ROYDS, R.: Heat Transmission in Boiler, Condensers and Evaporators. 1921.
4. BADGEE, W. L.: Heat Transfer and Evaporation. 1926.
5. WEBER, A. L., AND ROBINSON, C. S.: Evaporation. p. 434, 1926.
6. INGERSOLL-RAND Co.. Cameron Hydraulic Data. 1934.
7. ARTHUR HARRIS AND COMPANY: High Velocity Evaporator Catalog. 1943.

## CHAPTER VIII

### OPERATION OF THE VACUUM PAN

**Systems of Vacuum Pan Operation.**—The vacuum pan is operated either by the batch system or the continuous system. For sweetened condensed milk and unsweetened superheated condensed milk the batch system is as yet used exclusively. Much of the plain condensed and some of the evaporated milk is also made by the batch system. For large volume evaporated milk and plain condensed milk the continuous system of condensing is preferred. The principle of pan operation is the same in both systems. This chapter deals with pan operation by the batch system. For details of equipment and operation by the continuous system, see "Condensing of Evaporated Milk," Chapter XX.

**Starting the Pan.**—Before admitting the milk to the vacuum pan, the interior of all parts of the pan should be rinsed thoroughly with hot water, then steamed to a temperature of 185° F. or higher, shutting all ports except the vacuum relief near the top to facilitate escape of air, and the condensed milk discharge at the bottom to eliminate the steam condensate. An unsteamed pan greatly increases the bacterial count in the finished product (see Chapters X and XXXI). The steaming must be done with care to avoid heat-cracking of illumination glasses in the periphery of the vapor space. After steaming, all pan openings are closed, the valve in the water supply line to the condenser is partly opened to insure proper functioning of the wet vacuum pump, and the vacuum pump is started.

**Pan Operation.**—When the vacuum gauge shows a vacuum of about 25 inches, the pan is ready for the milk. The valve in the milk intake pipe is now opened. The milk is drawn in automatically and rapidly due to the reduced pressure in the pan. When the milk covers the jacket steam is turned into the jacket. As each coil becomes submerged in the milk it is charged with steam. At no time should there be steam on any of the heating surface when not completely covered by milk. The milk splashing upon the hot exposed heating surface evaporates quickly, causing an increasing accumulation of milk solids on the steam-heated metal surface. This milk coating tends to convey to the milk a scorched flavor. It likewise insulates the heating surface and retards evaporation due to diminished heat transmission.

Before steam is turned onto the heating surface, circulation of milk is apparently at a standstill. The milk foams profusely and the foam tends to build up high in the pan. When heat is then turned into the coils, the milk begins to boil vigorously, quickly dissipating the foam, and settling down to a routine circulation, as explained in Chapter VII under "The Heating Surface." With increasing concentration the milk be-

comes heavier and more viscous. The increasing viscosity is augmented further in the case of sweetened condensed milk by the added sugar. Velocity of circulation and rate of heat transmission decrease, and evaporation becomes progressively slower.

The entrance of the hot forewarmed milk is usually accompanied by a drop in vacuum and a corresponding rise in temperature. This is attributable to its super-heat and to the entrained air it contains. As soon as steam is turned into the coils and the milk starts boiling, this air is liberated and expelled through vacuum pump or steam ejector and the super-heat is dissipated. When the milk begins to boil, evaporation increases rapidly, the volume of vapors that must be condensed increases; hence more water is required in the condenser.

When all the heating surface is fully covered with milk, the milk intake is throttled down to synchronize with the rate of evaporation. The boiling milk is thus held at a uniform level in the pan. At this point it is important for the operator to realize that nothing is gained by carrying the milk at a level higher than is necessary to amply cover the top coil. Crowding the pan does not increase the rate of evaporation. On the contrary, it may, and usually does, retard evaporation due to interference with optimum circulation of the milk. See also "Effect of Velocity of Circulation of Milk on Evaporative Capacity of Pan," Chapter VII.

Crowding the pan also may cause milk to splash over into the condenser, and its general tendency is to increase entrainment losses. If the milk persists in boiling dangerously high, the milk intake should be throttled down or closed completely until the boiling milk has dropped to a safer level. If the pan has a steam jacket, it will be helpful to shut the steam off the jacket. The water supply to the condenser should now also be decreased somewhat. As soon as the milk has dropped to a more normal level, the milk inlet, the water to the condenser, and the steam to the jacket may be gradually readjusted to normal operation.

Any change in the rate of milk inlet should be made gradual in order to avoid the danger of sudden wild behavior of the boiling milk by reason of the superheat (the incoming milk has a higher temperature than the milk in the pan), and also because of liberation, under the reduced pressure, of the air and gases contained in the milk.

**Steam Pressure in Jacket and Coils.**—High steam pressure is neither necessary nor desirable. In the vacuum pan of earlier construction, the steam coils were few (two at the most) and they were long. The steam had to travel a relatively long distance from coil entrance to exit. A comparatively high steam pressure was then used in order to push the steam through the coil with sufficient velocity to prevent complete condensation long before reaching the exhaust end, which would render a considerable



portion of the coil useless. The steam pressure used then ranged from about 10 to 15 pounds.

In modern pan construction the jacket is omitted entirely because its persistence in "kicking-up" the milk in the center of the pan disrupts the cycle of circulation, hampers the rate of heat transfer and to that extent retards evaporation. In the modern pan, the area and arrangement of heating surface are designed for maximum heat transmission. The pan contains from four to six short coils. The length of each coil is limited to one-half convolution with separate steam inlet and condensate outlet. Each coil inlet serves an inner and an outer half convolution to both the left and the right of the inlet, thus supplying steam to four one-half convolution coils. The steam in these coils travels only a very short distance, and but little steam pressure is required for the steam to reach the exhaust end of each one-half convolution. The pressure actually used in the standard vacuum pan ranges from about one to five pounds. The pressure for all coils is controlled by the gauge on the steam header. All coils receive the same steam pressure. In the recirculation type of evaporator, the pressure carried in the steam chest surrounding the milk tubes is even lower.

Pan operation with low-pressure steam is obviously desirable from the standpoint of protecting the milk against heat damage resulting from excessively high temperature heating surfaces. Furthermore, it eliminates the added mechanical strain which high-pressure steam imposes upon the equipment; and it provides the further important economic advantage of permitting the use of part exhaust steam without interference from back pressure.

**Pan Temperature.**—Fundamentally, the pan temperature coincides with the boiling point of the milk at any given vacuum. It varies inversely with the vacuum, the higher the vacuum the lower the pan temperature. Table 21 gives the theoretical boiling point of water at different vacua, ranging from atmospheric pressure at sea level to a complete vacuum.

The boiling point of milk is slightly higher than that of water. This difference increases with the addition of sugar in the case of sweetened condensed milk and with the increasing concentration due to evaporation. See Table 9, in Chapter II.

The temperature of the vapor space over the boiling milk in the pan is always slightly higher than the temperature of boiling water as recorded for the same vacuum in Table 21, because the temperature of the vapor space in the pan corresponds to the gauge pressure which represents the sum of vapor pressure and air present, while the temperature of the vapor corresponds to the theoretical vapor pressure only. For details see "Effect of Air in Pan on Reading of Vacuum Gauge and Pan Thermometer," Chapter VI.

The temperature of the boiling milk is slightly higher than that of

the vapor space above the milk. This difference increases with increasing concentration of the milk. Due to hydrostatic pressure, the milk temperature also varies with different stratas of milk in the pan. See above reference in Chapter VI. Because of these facts the pan temperature recorded by either the vapor thermometer or the milk thermometer may be misleading and should not be depended upon in connection with tests for density of pan samples.

**The Optimum Pan-Operating Temperature.**—Earlier in this chapter it was emphasized that the fundamental reason for condensing under reduced pressure is that of making possible evaporation at temperatures below the boiling point of water, thereby protecting the milk from objectionable heat damage. It follows, therefore, that the optimum temperature represents the lowest temperature that is consistent with maximum rapidity of evaporation and economy of cooling water to the condenser.

At a given steam pressure in jacket and coils or steam chest, the pan temperature is regulated largely by the volume and temperature of water supply to the condenser. An increase of water admitted to the condenser lowers the pan temperature and vice versa. However, when the point is reached where the volume of condenser water is sufficient to condense the vapors as fast as they are generated, a further increase in condenser water is incapable of further lowering the pan temperature and constitutes, therefore, a useless waste of cooling water.

Formerly, when the heating surface in the vacuum pan consisted of jacket and basket-type coils, when the free passage of the vapors was hampered by a tapering vapor space and vapor conduits with inadequate diameter, constricted goose necks, and when the available condenser was limited to the parallel-current principle, the pan temperatures ranged from about 140° to 150° F. and higher, and the rate of evaporation was correspondingly slow.

In modern pan construction the area and arrangement of heating surface are such as to make for high rate of heat transmission and greatly accelerated rapidity of evaporation without excessive steam pressure on the heating surface. Also, the advent of the counter-current condenser has greatly increased its capacity of condensing the resulting vapors and has improved the efficient use of its cooling water, as shown in Chapter VII.

Due to these improvements, present-day pan temperatures are decidedly lower and water is used more efficiently. The pan temperatures at which milk is now condensed range between about 120° to 135° F., and the temperature difference between cooling water and condenser discharge water has been reduced from about 15°-20° F. to about 5° F. This present-day favorable combination of relatively low temperature of heating surface due to use of low pressure steam, of comparatively low pan temperature due to efficient use of condenser water, and of

short heat exposure of the milk due to high rate of heat transmission and rapid evaporation, greatly assists in preventing heat damage and in preserving the natural chemical properties and the good flavor of the milk.

The pan operator will find it helpful to install an accurate thermometer in the condenser water discharge pipe, as suggested under "Thermometer for Condenser Water," in Chapter VII.

**Abnormal Behavior of Milk in the Pan.**—For the commonly encountered irregularities in the routine daily pan operation see "Pan Operation" earlier in this chapter. The term "Abnormal Behavior" here refers to the type of abnormal pan behavior that may range from unmanageable wildness that threatens heavy loss due to the milk being drawn over into the condenser, to the sudden and complete cessation of boiling of the milk in the pan.

**Irregular Pan Behavior Caused by Minor Air Leaks.**—The wildness and high temperature may be due to seemingly minor air leaks. These may be found in fittings, joints or valves in the milk-, water-, or vacuum lines to the pan unit, a damaged manhole cover, ill-fitting and cracked observation and illumination glasses, or ports in the condenser spray pipe that have become clogged to an extent that causes incomplete condensation of the vapors and encourages the building up of pressure. Any one of these conditions is sufficient to preclude the normal functioning of the pan. If the air leak happens to be below the level of the boiling milk, such as through a cracked fitting or leaky valve in the bottom of the pan, the milk may become unmanageable and pan operation may have to be completely stopped until the cause is located and removed.

**When Milk Stops Boiling.**—The sudden cessation of boiling, with the milk dropping and the temperature rising is commonly caused by a large air leak such as can occur by air rushing into the condenser through the water supply pipe, due to an empty water supply tank, or when the milk level in the hot well drops below the suction end of the milk inlet pipe. It may also be caused by the accidental stopping of the vacuum pump, or the collapse of a cracked illumination glass, or by steam ejector difficulties caused by irregularities in the steam pressure.

These causes may be purely accidental and difficult to foresee. In general, however, their occurrence suggests negligence on the part of the personnel. The procedure to remedy or remove the cause quickly enough to avoid serious damage to or loss of milk is, **in all cases**, to immediately shut off the steam to jacket and coils, so as to prevent the scorching of the stagnant milk that contacts the heating surface, then shut off the milk inlet, and find the cause of the sudden drop in vacuum. If due to shortage of condenser water, close the valve in the water supply pipe. Absence of condenser water is readily detected by consulting the water level scale of the water storage tank, or by the abnormal heat of

the condenser shell and by the characteristic pounding of the water pump. If the vacuum pump balks, likewise shut off the water supply to the condenser in order to prevent flooding of the pan and possibly irreparable damage to the milk in the pan. If collapse of a pan illumination glass is the cause, also shut off the water to the condenser and stop the vacuum pump. Replace with new glass and resume operation. These pan windows do not collapse unless they are cracked before pan operation begins. Do not overlook cracked glasses, and replace them before starting the pan. Keep live steam away from pan illumination glasses to prevent cracking. The use of pyrex glass for pan windows is an added safeguard.

**Resumption of Boiling After Cessation.**—Satisfactory resumption of pan operation that has been thus interrupted requires the type of judgment that comes from experience. Partly open the water valve to the condenser and start the vacuum pump. When the gauge shows about 20 or more inches of vacuum, enough air has usually been eliminated to turn on the steam without much danger of causing unmanageable wildness. With the steam on the coils the milk immediately starts boiling, the foam collapses and the milk settles down to normal behavior. When building up the vacuum again, the tension of the immobile foamy milk may cause the body of the milk to rise threateningly high before boiling recommences. At such times, loss of milk is prevented by the diligent use of the vacuum relief. While this safety accessory is intended as a last resort only, a quick decision is indispensable in order to keep the batch in the pan whenever its use is necessary.

If the vacuum pan happens to be equipped with a superheater, air may be drawn direct into the milk through this device, by a simple change in connections. The entering air in this case breaks the immobilizing tension at once, the milk starts rolling normally and the danger is passed without loss of time. It is wisdom to provide all superheater installations with connections for injection of air.

**Finishing the Batch.**—By the time all the milk is in the pan, and the sugar added in the case of sweetened condensed milk, condensation is nearly completed and from about 10 to 20 minutes of further boiling usually gives the milk the desired density. It is good practice to reduce the steam pressure on jacket and coils toward the end of the process. When the milk approaches the desired density, it is relatively heavy and viscous, it has lost its buoyancy, it boils less vigorously, and its movement has become sluggish. Consequently, the interval between film replacements on the heating surface is prolonged. These conditions increase the danger of cooking onto the hot heating surface and scorching. Low steam pressure at this time minimizes this danger. It also lessens the danger of superheating and its tendency to accelerate objectionable age-thickening. It has the further advantage of slowing down evaporation which is helpful at the time of "striking."

**Shutting Down the Pan.**—When the milk has reached the desired concentration and is ready to be discharged, pan operation is shut down, using the following succession of steps to protect the batch against heat damage and condenser water:

1. Shut off steam to coils and jacket or steam chest.
2. Shut off water to condenser.
3. Stop vacuum pump and open vacuum relief.
4. Empty the pan by opening milk discharge valve.

**Entrainment Losses.**—Entrainment losses consist of particles of milk that are entrained and carried over by the vapor current in its surging passage from vacuum pan to condenser. This escape of milk is fundamentally due to the high velocity of the vapor currents. Thus, in the case of a six-foot pan with 290 square feet heating surface and a vapor outlet diameter of 26 inches, operated at a pan temperature of 120° F., the vapor velocity is 120 miles per hour.<sup>1</sup>

In addition to the suction produced by the vacuum pump and the action of the condenser water, the high vapor velocity is augmented by the physical law of expansion as applied to conversion from liquid to vapor:<sup>2</sup>

1 cu. ft. water at 62° F. weighs            62.355 lbs.

1 lb. water at 62° F. =  $\frac{1}{62.355}$  = 0.016 cu. ft.

1 lb. water vapor at 120° F.            = 203.2 cu. ft.

Thus, at a pan-operating temperature of 120° F., one pound of vapor takes up  $\frac{203.2}{0.016}$  or 12,700 times as much space as one pound of water.

A further factor contributing to the velocity of the vapor currents between pan and condenser is the constricted diameter of the conduits, such as a tapering vapor space and narrow goose necks. This group of causes, indirectly responsible for excessive entrainment losses, is being practically eliminated by the use of improved designs in present-day pan construction.

**Entrainment Separators.**—In addition, considerable progress has been made by the vacuum pan engineer in the design of entrainment separators, some of which are capable, under proper operating conditions, of reducing entrainment losses to a negligible minimum. See "Entrainment Separators," Chapter VII.

Up to comparatively recent years, attempts at the use of entrainment separators were limited to so-called milk-traps of primitive design and undetermined performance. The milk-trap never was popular in American condenseries. Its general design was not conducive to sanitation and could be readily visualized as a menace to quality. Organized efforts by the condensery to determine accurately the entrainment losses were

the exception, and the results of spasmodic attempts not uncommonly showed losses as high as two per cent.

**Importance of Care in Pan Operation.**—The mechanical improvements in design of vacuum pan and accessories discussed in this chapter are of benefit only in the presence of efficient management of pan operation. Their advantages are largely forfeited by careless pan handling that destroys control, encourages wildness and persists in permitting the milk to boil at a dangerously high or low level. For consistently low entrainment losses, the operator must be pan-minded both on and off the pan platform. Such an operator will keep the vacuum pan unit and its accessories in proper operating condition. His alertness will quickly sense the approach of abnormal behavior and “head it off.”

#### REFERENCES

- 1 ARTHUR HARRIS & COMPANY High Speed Evaporators, Descriptive Catalog  
p 8 1942
- 2 KENT, W : Mechanical Engineers Pocket-Book 9th Ed , p 27. 1916.

## CHAPTER IX

### STEAM REQUIREMENTS FOR FOREWARMING AND CONDENSING MILK

#### PROPERTIES OF STEAM

**Definition of Steam.**—Steam may be either what is known as saturated, wet, or superheated, according to its relation of temperature to pressure and presence or absence of free moisture.

**Saturated Steam.**—Steam as it is generated in the boiler is called saturated steam. All steam tables are assembled, and calculations are determined on the basis of saturated steam. Each given temperature of saturated steam has its definite pressure and each given pressure of saturated steam has its definite temperature. After this relation of temperature to pressure is destroyed, we no longer have saturated steam. Saturated steam is also called dry steam—that is, it contains no free moisture.

**Wet Steam.**—When steam contains free moisture in the form of a mist or spray, it is called wet steam. Wet steam has, however, the same temperature at any given pressure as saturated steam at the same pressure. Most of the saturated steam used is wet steam, because more or less spray is carried over from the boiler and also because the steam conduits are seldom, if ever, sufficiently insulated to completely prevent condensation. There is practically always some condensation in the pipes due to loss of heat by radiation.

In order to compensate for such condensation in the steam lines, large installations are frequently equipped with a superheating device at the boiler, thus supplying dry, saturated steam at the place where used.

Wet steam may also be found in the form of exhaust steam. In fact, exhaust steam is usually, though not necessarily always, wet steam, depending on the rate of expansion in the steam cylinder of the engine.

**Superheated Steam.**—Steam heated to a temperature above that of its pressure of saturation is called superheated steam. Superheated steam may be produced by carrying the boiler steam through a coil system where it comes in contact with the heat of escaping fire gases that have a temperature higher than the steam coming from the boiler. Or the steam may be superheated by expanding the saturated steam through a pressure-reducing valve under constant heat. Superheated steam is always dry steam.

**Exhaust Steam.**—Exhaust steam is the steam discharged from the steam-driven engine, or any discharge steam that has surrendered a portion of its heat units, or their equivalent, in mechanical energy.

In condensing practice it is assumed that saturated steam generally

is used. For properties of saturated steam above atmospheric pressure, see Table 29.

TABLE 29.—PROPERTIES OF SATURATED STEAM\*

Pressure Lbs. per Sq. In.		Temperature ° F.	Volume Cu. Ft. per Sq. In.	Total Heat of Vapor B. T. U.	Sensible Heat of Liquid B. T. U.	Latent Heat of Vaporization		
Gauge Lbs.	Absolute Lbs.					Internal B. T. U.	External B. T. U.	Total B. T. U.
0.0	14.697	212.	26.81	1151.7	180.0	898.8	72.9	971.7
0.3	15.	213	26.30	1152.2	181.0	898.1	73.1	971.2
1.3	16.	216.3	24.76	1153.4	184.3	895.8	73.3	969.1
2.3	17.	219.4	23.40	1154.6	187.5	893.5	73.6	967.1
3.3	18.	222.4	22.18	1155.7	190.5	891.4	73.8	965.2
4.3	19.	225.2	21.09	1156.7	193.3	889.3	74.1	963.4
5.3	20.	228.0	20.10	1157.7	196.0	887.3	74.4	961.7
6.3	21.	230.6	19.20	1158.7	198.7	885.4	74.6	960.0
7.3	22.	233.1	18.38	1159.6	201.2	883.6	74.8	958.4
8.3	23.	235.5	17.64	1160.4	203.6	881.8	75.0	956.8
9.3	24.	237.8	16.95	1161.3	206.0	880.1	75.2	955.3
10.0	24.7	239.4	16.51	1162.0	207.5	878.9	75.3	955.7
10.3	25.	240.1	16.32	1162.1	208.2	878.4	75.4	955.8
11.3	26.	242.2	15.73	1162.8	210.4	876.8	75.6	952.4
12.3	27.	244.3	15.18	1163.6	212.6	875.2	75.8	951.0
13.3	28.	246.4	14.67	1164.3	214.6	873.7	76.0	949.7
14.3	29.	248.4	14.20	1165.0	216.6	872.2	76.2	948.4
15.3	30.	250.3	13.76	1165.7	218.6	870.7	76.4	947.1
16.3	31.	252.3	13.34	1166.3	220.5	869.3	76.5	945.8
17.3	32.	254.0	12.95	1166.9	222.4	867.9	76.7	944.6
18.3	33.	255.8	12.59	1167.5	224.2	866.5	76.9	943.4
19.3	34.	257.6	12.24	1168.1	225.9	865.2	77.0	942.2
20.3	35.	259.3	11.91	1168.7	227.7	863.9	77.1	941.0
25.3	40.	267.2	10.51	1171.3	235.8	857.8	77.7	935.5
30.3	45.	274.4	9.41	1173.6	243.1	852.2	78.3	930.5
35.3	50.	281.0	8.53	1175.6	249.8	847.1	78.8	925.9
40.3	55.	287.1	7.80	1177.5	255.9	842.3	79.2	921.5
45.3	60.	292.7	7.18	1179.1	261.7	837.8	79.6	917.4
50.3	65.	298.0	6.66	1180.6	267.1	833.5	80.0	913.5
55.3	70.	302.9	6.22	1182.0	272.2	829.5	80.3	909.8
60.3	75.	307.6	5.82	1183.3	277.0	825.6	80.6	906.2
65.3	80.	312.0	5.48	1184.4	281.6	821.9	80.9	902.8
70.3	85.	316.3	5.18	1185.5	286.0	818.4	81.2	899.6
75.3	90.	320.3	4.905	1186.5	290.1	815.0	81.4	896.4
80.3	95.	324.1	4.663	1187.5	294.1	811.7	81.7	893.4
85.3	100.	327.8	4.442	1188.4	297.9	808.6	81.9	890.5
90.3	106.	332.0	4.202	1189.4	302.3	804.9	82.2	887.1
95.3	110.	334.8	4.057	1190.0	305.1	802.6	82.2	884.8
100.0	115.	337.9	3.900	1190.6	308.3	800.7	82.35	882.3
101.3	116.	338.7	3.857	1190.8	309.2	799.2	82.4	881.6
105.3	120.	341.3	3.735	1191.4	311.9	796.9	82.6	879.5
111.3	126.	345.0	3.566	1192.1	315.7	793.7	82.7	876.4

STEAM REQUIREMENTS FOR FOREWARMING

As shown later in this volume, the method of forewarming milk preparatory to condensing may vary considerably with condensery and with kind of concentrated milk made. From the standpoint of steam requirements there are fundamentally only two groups of steam application; namely, (1) forewarming by direct heat, such as by injection of live



steam direct into the milk; and (2) forewarming by indirect heat, such as by heat-transmission through steam-heated metal surfaces by means of steam jackets, coils or steam chests. The following calculations may serve to show the approximate amount of saturated steam required by either principle of steam application:

(1) Forewarming by Injection of Live Steam

EXAMPLE:

Amount of milk to be heated	1,000 lbs.
Initial temperature of milk	50° F.
Forewarming temperature	200° F.
Specific heat of milk	0.93 B.T.U.
Pressure of saturated steam	100 lbs.

CALCULATION:

Heat units required to raise temperature of milk  
from 50° F. to 200° F. =  $(200 - 50) \times 0.93 \times 1000$   
= 139,500 B.T.U.

Heat units in 1 lb. of saturated steam at 100 lbs.  
pressure (see Table 29) is 1,190.6 B.T.U.

Sensible heat in 1 lb. saturated steam at 100 lbs.  
pressure (see Table 29) is 308.3 B.T.U.

The full utilization of this sensible heat requires cooling to 32° F. Since the starting of the milk is 50° F., only partial utilization of the sensible heat of the steam is possible. In this case the difference between heat units available and heat units utilized is  $50 - 32 = 18^\circ$  F.; thus, instead of 308.3 B.T.U., only  $308.3 - 18 = 290.3$  B.T.U. is utilized.

By finishing the forewarming at 200° F.,  $308.3 - (200 - 32) = 140.3$  B.T.U. is actually utilized. Assuming that the average temperature of starting and finishing is the arithmetical average of the two extreme figures, the heat units then utilized are  $\frac{290.3 + 140.3}{2} = 215.3$  B.T.U.

For each pound of steam condensation, therefore, 215.3 of the 308.3 B.T.U. is utilized. Hence the heat units not utilized is  $308.3 - 215.3 = 93$  B.T.U.

The total utilization of heat units per pound of steam at 100 lbs. pressure, therefore, is  $1190.6 - 93 = 1097.6$  B.T.U. Pounds of steam required to forewarm 1,000 lbs. of milk is  $\frac{139,500}{1097.6} = 127$  lbs.

It requires 127 lbs. of saturated steam at 100 lbs. pressure to heat 1000 lbs. of milk from 50° to 200° F. by injection of live steam.

In practice, considering quality of heat, the steam requirements are slightly greater due to heat loss by radiation. Also, where steam at a lower pressure is used, the amount of steam required is correspondingly greater, see Table 29.

(2) Forewarming by Steam-heated Metal Surfaces

In factories that do not utilize the steam condensation from the forewarmer jacket or steam chest, the jacketed forewarmer or any other preheater that does not add the steam condensation to the milk obviously requires more steam than when heating by injection of live steam into the milk. At the most this difference, however, is small.

By returning the steam condensate back to the boiler, as is now the general condensery practice, the steam requirements for both systems of forewarming are practically the same. The only difference is that in the case of live steam injection, the steam condensation (sensible heat) goes into the milk, while in the other case, it goes into the boiler.

Moreover, heat transmission by steam-heated metal surfaces is far more economical than the injection of live steam from the standpoint of total requirements of steam, water and labor for condensing. It eliminates the addition of a large amount of water to the milk. The evaporation of this added water increases the amount of steam necessary to condense a given volume of milk to the desired concentration. Using the results of the calculations under "Forewarming by Injection of Live Steam," the steam condensation increases the volume of a batch of 1000 lbs. of milk to  $1000 + 127 = 1127$  lbs. For simplicity of calculation, assuming that the ratio of concentration is 2:1 (the ratio for standard American evaporated milk is about 2.1:1), then 500 lbs. of water must be evaporated from each 1000 lbs. of milk. From the 1127 lbs. of diluted milk the amount of water that must be removed is  $500 + 127 = 627$  lbs. This represents an increase of volume of water to be evaporated of  $\frac{127}{500} \times 100 = 25.4$  per cent. Thus when forewarming by injection of live steam into the milk, it requires approximately 25 per cent more steam for condensing than when using forewarmers that do not add the steam condensate to the milk. It will also require a 25 per cent increase in the water supply to the condenser to condense the vapors of the diluted milk.

By reason of the increased volume of milk containing the steam condensation, correspondingly more time is required for condensing. Park,<sup>2</sup> who conducted comparative tests, found that in changing from heating with live steam to forewarming by steam heated metal surfaces reduces the time required for condensing a batch of 9,000 pounds of evaporated milk at least 10 minutes.

**Steam Purifiers.**—An additional objection to the use of live steam has to do with impurities with which the steam may be associated, such as cylinder oil from engines and steam pumps, boiler compounds used in the boiler water, and sulfate scale and rust from the inside of the steam pipes. These impurities, if not removed, would jeopardize the quality of the finished product.

Where steam is used for direct injection in the forewarming of milk,

therefore, the installation of an efficient steam purifier is practically indispensable for fuel economy and the protection of the quality of the product. In general, the mechanism of the steam purifier, see Fig. 28, consists of a multiple baffle assembly in a properly designed enclosure through which the steam passes under pressure. The U-shaped baffles, staggered in the assembly, strip from the steam the entrained solid impurities and the condensate that results from heat loss due to radiation. The condensate, together with boiler water and solid impurities flows down the baffles into the drain reservoir of the purifier. A steam trap, piped to the drain reservoir, automatically disposes of the impurities and condensate stripped from the steam.

The steam purifier should be installed as close to the forewarmers as possible in order for the steam to be free from condensate when it reaches the milk. For a condensery or milk powder plant of average produc-

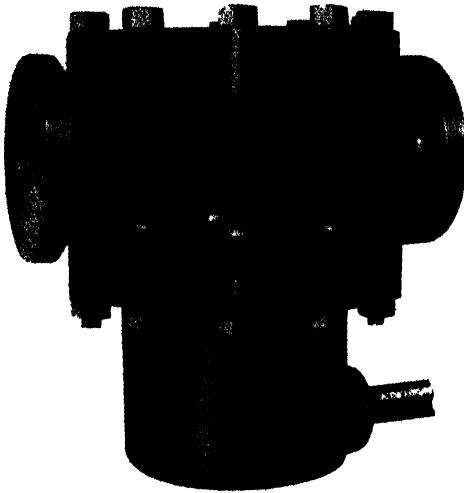

Fig 28. The Tracyfier (steam purifier)  
Courtesy of Blaw-Knox Co.

tion, a properly constructed steam purifier with 2 inch steam inlet, 2 inch steam outlet and  $\frac{3}{4}$  inch condensate discharge is considered adequate.

In the above type of steam purifier the boiler water and condensate caught by the vertically disposed baffles usually serves to keep the baffles flushed down for long periods of time. Until one has experience with his own kind of boiler feed water and operating conditions, it is recommended the purifier be inspected at least twice a year. If deposits are found on the baffles they may be readily cleaned with a wire brush and, if necessary, followed up with a soaking in a ten per cent solution of hydrochloric acid.

#### STEAM REQUIREMENTS FOR CONDENSING

The following figures illustrate the amount of saturated steam of varying pressures required to condense one pound of water boiling at different vacua and corresponding temperatures.

**POUNDS OF SATURATED STEAM REQUIRED TO EVAPORATE ONE POUND OF WATER USING 5.3 LBS. STEAM PRESSURE PER SQUARE INCH**

(Evaporating in pan under 23.81 inches of vacuum and with the steam condensate discharged from jacket and coils at 212° F.)

Heat units required to evaporate 1 lb. water	= 1013.5 B.T.U.
Heat units transmitted by condensation of 5.3 lbs. pressure steam	= 961.7 B.T.U.
Temperature of 5.3 lbs. pressure steam	= 228° F.
Temperature of steam condensate	= 212° F.
Heats units surrendered by steam condensate	= 16 B.T.U.
Total heat units transmitted to milk 961.7 + 16	= 977.7 B.T.U.
Lbs. of steam required to evaporate 1 lb. water	$\frac{1013.5}{977.7} = 1.036$ lbs.

**USING 10.3 LBS. STEAM PRESSURE PER SQUARE INCH**

Heat units required to evaporate 1 lb. water	= 1013.5 B.T.U.
Heat units transmitted by condensation of 10.3 lbs. pressure steam	= 953.8 B.T.U.
Temperature of 10.3 lbs. pressure steam	= 240.1° F.
Temperature of steam condensate	= 212° F.
Heats units surrendered by steam condensate	= 28.1 B.T.U.
Total heat units transmitted to milk 953.8 + 28.1	= 981.9 B.T.U.
Lbs. of steam required to evaporate 1 lb. water	$\frac{1013.5}{981.9} = 1.032$ lbs.

The above calculations show that an increase in the pressure of saturated steam used does not materially change the amount of steam required per pound water evaporated. There is but very slightly less steam required at the higher steam pressure. The per cent decrease at 10.3 lbs. steam pressure as compared with 5.3 lbs. steam is

$$\frac{(1.036 - 1.032) \times 100}{1.036} = 0.386\%$$

It requires 0.386% less saturated steam at 10.3 lbs. steam pressure than at 5.3 lbs. steam pressure to evaporate one pound of water.

An increase in the pressure of saturated steam used does, however, materially increase the rapidity of evaporation, as shown by the following calculations:

10.3 lbs. steam:

Temperature difference between steam and milk	
240.1 — 141.5	= 98.6° F.

5.3 lbs. steam:

Temperature difference between steam and milk	
228 — 141.5	= 86.5° F.
Increase in temperature difference	= 12.1° F.

The temperature difference is directly proportional to the heat transmission. The rapidity of evaporation also is directly proportional to

the heat transmission. Hence the increase in temperature difference of 12.1° F. is proportional to the ratio of 86.5 : 98.6 and the per cent increase in rapidity of evaporation in the case of 10.3 lbs. steam over 5.3 lbs. steam is  $\frac{12.1 \times 100}{86.5} = 13.9\%$ .

**Relation of Boiler Pressure to Steam Pressure Used in Pan.**—The average steam pressure generated in the boiler ranges from about 80 to 120 pounds per square inch. The steam, in order to balance the condensation in the pipes between pan and boiler may be slightly superheated, but in general practice the steam is carried at full boiler pressure to the steam header at the pan.

However, steam at full boiler pressure cannot be used in the pan, because the temperature corresponding to this pressure (100 lbs. pressure saturated steam has a temperature of 337.9° F.) is so high that it would seriously damage the quality of the milk. Also the usual construction of jacket and coils is not of sufficient strength to withstand so great a pressure difference between steam and vacuum in the pan.

It is therefore necessary to reduce the boiler pressure to a pressure suitable for safe operation. A pressure of from about 5 to 15 pounds is generally considered suitable for the purpose. This may be accomplished by merely regulating the valves controlling the steam intakes to jacket and coils. This, however, is a dangerous practice because, in the case of possible obstructions in the discharges, jacket and coils are subjected to the full boiler pressure and also there is always danger of the operator opening the valves too wide, thereby jeopardizing the quality of the milk and inviting accidents. Furthermore, the pressure in jacket and coils will lack uniformity, fluctuating with the boiler pressure which is subject to wide variations, especially in case of limited boiler capacity.

For ideal conditions, the low pressure side, which is the connection between steam valve and pan, should be of such diameter as to provide the same velocity of the steam as on the high pressure side, which is the line between valve and boiler. This is necessary in order to avoid excessive pressure drop in the steam connections. The total area of all the steam connections should be enlarged proportionately to the increase of the steam volumina from high pressure to low pressure. Each connection should also have a valve and gauge on the pan side of the header.

A better way of insuring a uniform steam supply of low pressure is to install an automatic pressure reducing valve on the boiler side of the steam header. By means of this valve the steam pressure may be reduced to any desired point. Reducing valves are available that maintain a constant pressure independent of variations of boiler pressure.

In this case the pressure reduction takes place in the main steam line, and the header is on the low pressure side, so that all pan connections receive a uniform low-pressure steam. Here, too, the velocity of the

steam should be kept constant by enlarging the low pressure side of the reducing valve. This may be conveniently illustrated by the following example:

One pound of saturated steam at a boiler pressure of 100 lbs. occupies 3.9 cubic feet. One pound of saturated steam of 10.3 lbs. pressure occupies 16.32 cubic feet. Therefore, the necessary increase in size of connections for the ideal area of the low pressure side of the reducing valve would be  $\frac{16.32}{3.9} = 4.18$  times the area of the high pressure side.

If the proper diameter of the high pressure side is 3 inches, then the proper diameter of the connection between reducing valve and header should be at least 6 inches. A properly designed steam header should always be larger than the supply line. In this case it should be about 9 inches in diameter and the connections to the pan should be proportional in diameter to the heating surface of the respective coils and jacket, so as to maintain a constant steam velocity. The header should be equipped with a safety valve and gauge, and each individual connection should have a valve and gauge on the pan side.

**Relation of Gauge Pressure to Steam Temperature When Steam Is Reduced.**—When reducing the pressure of dry saturated steam from boiler pressure to suitable pan pressure, the steam must be allowed to expand. Disregarding the loss of heat due to radiation, the steam expands through the pressure-reducing valve without loss of heat, and it passes on under the same velocity. This process progresses under constant heat. That is, one pound of steam contains the same heat units on both high pressure and low pressure side of the valve. This is so, because no heat units are removed, or converted into mechanical energy.

After the steam has passed the reducing valve, the temperature of the now low-pressure steam is higher than the corresponding pressure. This is due to the liberation of heat units by expanding under constant heat. For instance, one pound of 100 lbs. pressure saturated steam contains 1190.6 B.T.U. One pound of 10 lbs. pressure saturated steam contains 1162.0 B.T.U. Therefore, by reducing the pressure from 100 lbs. to 10 lbs.  $1190.6 - 1162.0 = 28.6$  B.T.U. are liberated. Since this heat is not taken out of the steam, it is utilized to superheat the steam on the low pressure side.

By using the Mollier's entropy diagram we find that 28.6 B.T.U. will raise the temperature of the low pressure steam  $62.98^\circ$  F. above its corresponding saturation temperature. Since the temperature of saturated steam of 10 lbs. pressure is  $239.4^\circ$  F., the total temperature of this low pressure steam will be  $239.4 + 62.98 = 302.38^\circ$  F.

The temperature difference of  $62.98^\circ$  F. is brought about by the liberation of the difference in properties of saturated steam by expanding from 100 lbs. pressure to 10 lbs. pressure. This difference of  $62.98^\circ$  F.

corresponds to 28.6 B.T.U. Thus the specific heat of the steam due to this pressure caused by expansion at a constant heat is  $\frac{28.6}{62.98} = 0.4541$  B.T.U. In other words, it takes only about one-half B.T.U. to raise the steam temperature 1° F. above its saturation temperature. The specific heat of steam varies with the pressure of the original saturated steam (boiler steam) and the ratio of expansion, as shown in tables and charts by Marks and Davis<sup>4</sup> of the properties of superheated steam.

The fact that the superheated steam of a pressure of 10 lbs. has a temperature of 302.38° F. emphasizes further the fact that this temperature in this case does not correspond with the gauge pressure of saturated steam. In the case of saturated steam the temperature for the corresponding pressure of 10 lbs. would be 239.4° F. On the other hand, the corresponding pressure for superheated steam with a temperature of 302.38° would be 54.8 lbs.

Such a temperature (302.38° F.) corresponding to a saturated steam pressure of 54.8 lbs. would be justly considered too high for vacuum pan work, especially in the case of pans in which all the steam inlets are located on the same side. This would cause exposure of the milk to excessive temperature.

The important point here is that the measurement of the steam by the gauge may be very misleading from the standpoint of actual temperature. Ten lbs. pressure, reduced from 100 lbs. saturated steam pressure to 10 lbs. superheated steam pressure, has a temperature much higher than 10 lbs. pressure of saturated steam.

It should be understood, however, that in this case of superheated steam, the heat units above those of the properties of saturated steam are transmitted to the milk without causing a drop in pressure until the point of saturation is reached. Each pound of steam has 28.6 heat units of superheat to transmit without forming any condensation. The liberation of the superheat reduces the temperature of the steam from 302.38° F. to 239.4° F. quickly, because the specific heat of superheated steam in this case is found to be only 0.4541 B.T.U. Therefore, each B.T.U. of one pound of steam results in a temperature drop of about 2° F. until the saturation point is reached. For this reason the milk is exposed to high temperature of the superheated steam over the first few inches of the coil only, where the steam surrenders its superheat.

Another factor that tends to modify the high temperature of the low pressure superheated steam is heat loss by radiation due to incomplete insulation. The above discussion is all based on the assumption that there are no heat losses between the pressure-reducing valve and the pan. In practical operation and even under conditions of high grade insulation, there is bound to be some loss of heat due to radiation. The longer the

distance and the less complete the insulation, the greater the loss of heat due to radiation.

**Transforming Superheated Steam Into Saturated Steam.**—Since it is undesirable to use such high temperature steam as results from reducing the pressure of boiler steam from 100 lbs. to 10 lbs., it is advisable to convert the superheated steam so formed into saturated steam. This may be done by injecting into the superheated steam the proper amount of water. A fine spray of a small amount of water is directed against the flow of the superheated steam. The water spray can be regulated by means of a thermostat set for constant temperature of the new saturated steam thus formed.

The use of water for reducing the temperature of the superheated steam to the saturation point of the steam under a given pressure does not cause any loss or waste of heat units. It merely lowers the temperature of the steam by increasing its volume and this increase in volume compensates for the drop in temperature.

**The Utilization of Exhaust Steam in Vacuum Pan Operation.**—Whenever possible, the exhaust steam available in the condenser should be utilized for condensing purposes. This is made possible because the evaporation of the milk is done in a vacuum, in which the milk boils at a relatively low temperature. This provides a comparatively wide temperature difference between milk and steam, even when low-temperature steam, such as exhaust steam, is used.

Under most factory conditions it is preferable to use the exhaust steam in conjunction with boiler steam, rather than exhaust steam exclusively. But where exhaust steam alone is to be used, provision must be made for a large steam header and full size connections to jacket and coils and the use of specially designed, short coils.

In the steam line from vacuum pump, or other source of exhaust steam, to header, there must be suitable provision for the discharge of condense water, such as by installation of condense water traps. The use of exhaust steam alone is seldom practical, however, because of the usually too limited supply, its constant variation in both volume and pressure and the wet character of the exhaust steam that is generally available.

In order to use exhaust steam to the best advantage, therefore, it is advisable to use boiler steam in connection with the available exhaust steam. The exhaust steam may thus be supplemented by injecting boiler steam into the main exhaust steam line leading to the header. The injection of the boiler steam is controlled by a pressure regulator in order to maintain a constant pressure. The supply of boiler steam is thus automatically governed by the supply of exhaust steam. As the supply of exhaust steam decreases, more boiler steam is automatically supplied.

An additional advantage of injecting boiler steam into the exhaust steam is that it improves the quality of the exhaust steam by utilizing the



heat units liberated by the expanded boiler steam, thus converting the exhaust steam into dry saturated steam.

By utilizing the exhaust steam and economizing the fuel requirements, the efficiency of the engine or pump supplying the exhaust steam is decreased. This is due to the back pressure under which the exhaust steam is discharged into the supply line to the pan, as against its otherwise free discharge into the atmosphere, or into the usual condenser.

This problem of back pressure, therefore, must be given consideration

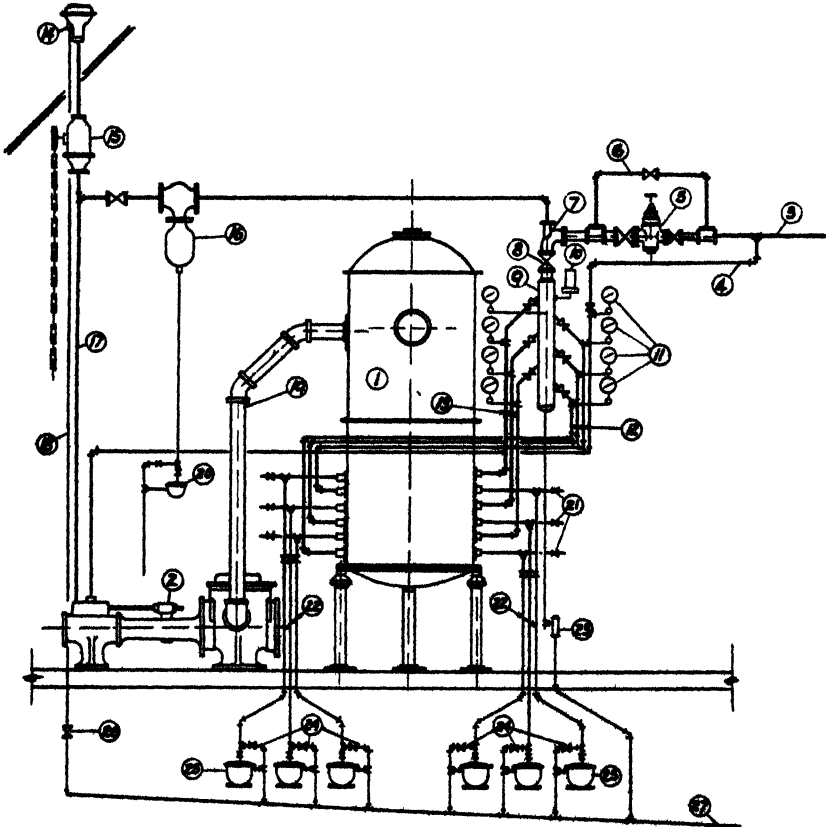

Fig. 29. Vacuum pan with exhaust steam connections  
Courtesy of A. W. Baumann

when selecting the steam equipment from which exhaust steam is to be utilized. The size of such equipment should be proportional to the back pressure under which the engine or pump must operate. A suitable installation for using both exhaust steam and boiler steam is shown in the accompanying illustration, (see Fig. 29.).

The utilization of exhaust steam without back pressure on the steam-driven engine may be arranged also by using the vacuum system of discharging the condensate water from jacket and coils, as explained under

the caption "Steam Traps" in succeeding paragraphs, or by the installation of a thermo-compressor in the place of the ordinary steam injector. The function of the thermo-compressor is to compress the exhaust steam on the pan side, from the pressure under which it is discharged from the steam engine, to the desired pressure for pan operation. The thermo-compressor operates best under constant supply of steam.

**Steam Traps.**—The economical operation of the pan demands that all the water condensed in jacket and coils be returned to the boiler, thus saving the heat units (sensible heat) contained in the condense water and avoiding the well known disadvantages of feeding the boiler with cold water.

The continuous discharge of the condense water from jacket and coils, without loss of steam, is made possible by the use of a suitable steam trap. The steam trap is an automatically controlled valve, the function of which is to allow the discharge of water and to prevent the escape of steam.

Each coil and the jacket should have an individual steam trap, located below the condense water outlet. In case there is only one steam trap

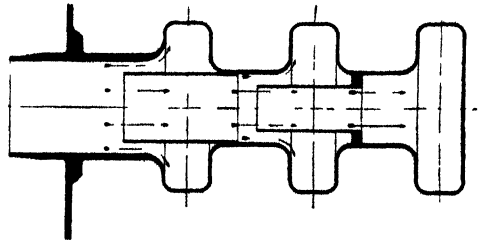

Fig. 30 Baumann steam distribution nozzles for pan coils  
Courtesy of Arthur Harris & Co

for all condense water outlets, there should be provided individual air vents for each condense water outlet.

The condense water usually discharges from the steam traps under atmospheric pressure and returns to the boiler feed water tank by gravity. From this tank it is pumped into the boiler. Instead of discharging the steam traps into the atmosphere, a vacuum system may be used. In this case a vacuum pump is attached to the discharge of the steam trap. This has the additional advantage of reducing the back pressure on the steam-driven engine supplying the exhaust steam.

Recent improvements in coil design provide a telescoping type of steam distribution nozzles as shown in Fig. 30. In this case each nozzle distributes the steam into each of the three coil rings in such a manner that a uniform pressure drop is accomplished in all three rings. The size of the steam nozzles is made proportional to the heating surface in each coil ring. This insures a uniform pressure at the discharge end of each ring. It thus permits the discharge of the condensate from all three rings through a single common outlet and only one steam trap is used as compared with the conventional steam coil which requires a separate steam trap for each coil ring.

### EVAPORATORS UTILIZING THE THERMAL ENERGY CONTAINED IN THE MILK VAPOR

As pointed out in Chapter VII, this group of evaporators embraces the multiple-effect evaporator, the thermo-compression evaporator, and the mechanical vapor compression evaporator.

**Multiple-Effect Evaporators.**—The conventional type of vacuum pan or evaporator is a single-stage evaporator. The water evaporated from the boiling milk is removed from the system with the condenser water. In this sense, the condenser is only a water heater. The cold water enters the condenser at about 60° F. and leaves it at a temperature approximately 5 to 10° F. below the vapor temperature in the pan (120 to 125° F.) Thus, all the heat energy supplied to the vacuum pan in the

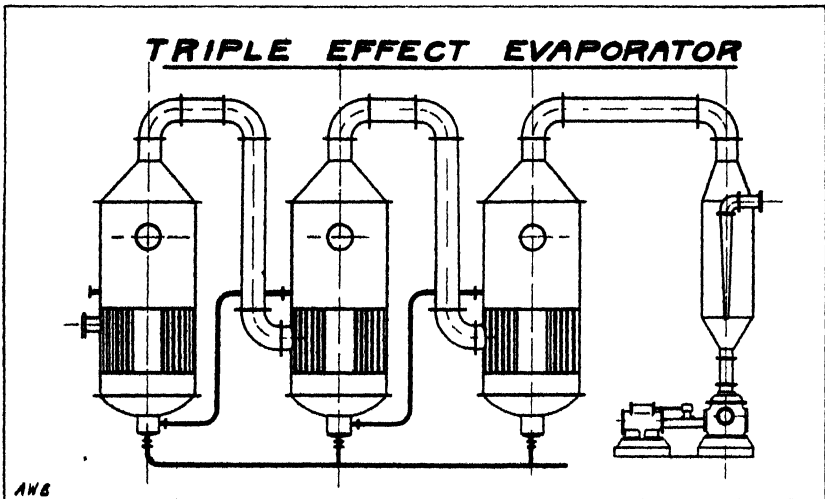

Fig. 31. Multiple-effect evaporator  
Courtesy of Arthur Harris & Co.

form of steam is used to raise the temperature of the condenser water and may be said to be lost for further use.

The above loss of heat energy is greatly reduced and the efficiency and economy of steam utilization improved by the use of the multiple-effect evaporator. As shown in Figure 31, these evaporators consist of two or more pans, installed in tandem formation and connected in a manner to cause the concentrating milk to flow from the first pan to the second, from the second pan to the third, etc. All the vapor from the boiling milk in the first effect is utilized to heat the milk in the second effect. The heating element of the second effect thus serves as the condenser for the vapor from the first effect.

This is made possible by operating each succeeding effect at a lower temperature. In the double-effect unit, for instance, the first effect (pan) may be operated at about 175° F. and the second effect at about 125° F.

The vapor from the last effect (in this case the second-effect evaporator) is precipitated in a condenser. Disregarding the possible heat loss due to radiation, the double-effect evaporator reduces steam consumption to about 50 per cent, and the triple-effect to about 33 per cent, of that incurred by use of the single-effect unit. It is especially the double-effect unit that has found wide application in evaporated milk plants equipped for large volume of production.

**Thermo-Compression Evaporators.**—The thermo-compression principle consists of the utilization of a portion of the milk vapor generated in the vacuum pan. The pressure and temperature of the milk vapor is increased by injection of high-pressure steam. The resulting compressed vapor is thus re-used in the pan in which it is generated. The thermo-compressor

Fig. 32 Scott thermo-compression evaporator  
Courtesy of Geo Scott & Son  
(London) Ltd.

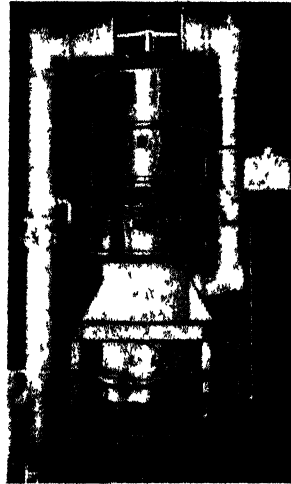

system combines, to a certain extent, the steam- and water-economy of the multiple-effect evaporator with the simplicity of construction and relatively low initial cost of the single-effect vacuum pan. The operation of the thermo-compressor is, however, somewhat more difficult to control, being more sensitive to even slight variations in steam pressure. Representative examples of the thermo-compression principle are the Zaremba Recompression Evaporator, and the Scott Forced-Circulation Thermo-Compression Evaporator shown in Fig. 32.

**Mechanical Vapor-Compression Evaporators.**—The principle of mechanical vapor compression is not new. It has been known, and used to a limited extent in Europe prior to World War II. Its recent development for use in milk condenseries by the firm of Brown-Boveri and Company, of Baden, Switzerland, is the result of the extreme fuel shortage in that country during the war emergency. It has been installed in many

condenseries and it made possible continuation of plant operation during the difficult years of World War II. (See Fig. 33.)

In the mechanical vapor-compression evaporator, all the milk vapor generated by the boiling milk is compressed and re-utilized. The vapor is compressed to higher pressure and higher temperature by mechanical means instead of by high-pressure steam. The compressed vapor is returned to the heating surface and the heating cycle started anew. The choice of motor power of the compressor depends largely on location and lay-out of plant. Diesel engine propulsion is economical in many locations in the United States. If low-pressure steam is used for other purposes in the plant, steam turbine drive may be advantageous. In the case of low



Fig. 33. Evaporator with mechanical vapor compressor  
Courtesy of Brown Boveri & Co

cost electric energy, such as in localities favored with cheap hydroelectric power, motor drive may prove most economical.

The potential possibilities of the mechanical vapor-compressor for plant operating economy are of a magnitude that may lead to a drastic change of the entire power plant arrangement of milk condensing plants. Even in its present status of development, this compressor eliminates the condenser, vacuum pump, condenser water discharge pump, and the amount of boiler steam is limited to that necessary to replace heat losses such as are caused by radiation, steam condensation, etc. Steam is used only for priming evaporation at the beginning of the process for a short period of time. After that the compressor is started. Low-pressure steam only is needed, and no condenser water is required. In addition, the above

advantages materialize in a single-effect evaporator or vacuum pan, where the boiling temperature of the milk can be held at a temperature sufficiently low (120 to 135° F.) to protect the milk from heat damage.

#### REFERENCES

1. KENT, WM.: Mechanical Engineers Pocket-Book 1922 Ed.
2. PARK, SAM, R.: Effect of Forewarming with and without Injecting Steam into Milk. Information by correspondence. 1925
3. KEENAN, J. H., AND KEYES, F. J.: Thermodynamic Properties of Steam. 1936.
4. MARKS AND DAVIS: Properties of Superheated Steam Kent's Mechanical Engineers Pocket-Book. 1922

## CHAPTER X.

### FACTORY SANITATION

The importance of protecting the milk at any stage in the process of manufacture against quality-damaging contamination is obvious. The important details of sanitary precautions as related to specific operations are pointed out in the discussions of the different steps in manufacture in later chapters. This chapter deals especially with the multitude of problems of cleaning plant equipment and milk cans and the means of keeping them in sanitary condition.

#### DAIRY CLEANERS

**The Basic Dairy Cleaners.**—The choice of alkali cleaners most effective in dairy work depends much on the character of the water. All of the commonly used basic alkali washing compounds have the objection when dissolved in hard water, of forming insoluble products that aggravate the tendency of depositing a film on the milk side of equipment and containers. This is true of such sodium salts as sodium carbonate, trisodium phosphate and sodium metasilicate, as well as caustic soda and soaps, and of combinations thereof. In general, trisodium phosphate and sodium metasilicate have been found somewhat less troublesome in this respect than the carbonate cleaners, and have, in fact, been given increasing preference as alkali cleaners for use in milk work. No one single compound embraces all of the properties needed in a suitable dairy cleaner.

**The Newer Phosphates.**—Within recent years the subject of suitable washing compounds has been subjected to renewed study, especially by the water chemist, the sanitary engineer and the manufacturer of washing compounds. These investigations have resulted in the development of a new group of sodium phosphates,<sup>1, 2</sup> such as hexametaphosphate, tetrasodiumpyrophosphate, tripolyphosphate. These newer phosphates are rapidly gaining recognition as water conditioners and as desirable components of a good cleaning compound. Their outstanding merit as dairy cleaners lies in their property of forming soluble compounds with the calcium and magnesium contained in the water. When present in alkali detergent solutions they thus prevent precipitation of the hardness of the water supply, and thereby assist in keeping the milk side of dairy equipment free from lime and milkstone deposit.

**Wetting Agents and Other Surface-Active Agents.**—In addition to these important new inorganic compounds, there are the wetting agents which are organic compounds with fatty acid radicals. Their presence in the cleaner allows the washing solution to penetrate into and under the dirt on the equipment, which function would not be possible in their absence. These wetting agents belong to the general group of surface active agents, the rapid development of which is conceded to rest on the ancient founda-

tion of soap manufacture. Some of the agents of this group have properties other than and in addition to wetting power, that are valuable added assets to dairy cleaners, such as the power of emulsifying fat, of deflocculation or breaking up and suspending dirt, etc. Some of the industrially available wetting agents also have "remarkable germicidal properties in solutions of acid cleaners."<sup>3</sup>

**Acid Cleaners.**—Of late, acid cleaners for use in milk work have received rapidly growing attention. They, too, appear to have their place in the dairy field. Published experimental data are as yet confined largely to their performance in can washing. However, they have also been found valuable as components of washing compounds for plant equipment. For details on acid cleaners see "Can Washing" later in this chapter.

**The Ideal Dairy Cleaners.**—It will be seen that the duties of suitable dairy washing compounds are many. For efficient performance they must possess a multitude of important properties. Furthermore, these properties and the agents must be present in such proportion as the available water supply and the character of the milk constituents require for an efficient cleaning job and for maintaining plant equipment and containers in fully approved sanitary condition. These facts emphasize the wisdom on the part of the condensery, of securing a correct analysis of its water supply and of enlisting the professional advice of a competent water chemist as to the choice of the most effective washing compound to use.

#### CLEANING AND STERILIZING CONDENSERY EQUIPMENT

To put and keep milk plant equipment (including condensery equipment) in approved sanitary condition calls for a definite system of cleaning and sterilizing. The succession of major steps includes rinsing, scouring, second rinsing and sterilizing.

**Rinsing.**—The purpose of the first rinse is to flush away loose remnants of milk, milk constituents and milk film, before they dry on to the metal surfaces. This facilitates and expedites subsequent washing and minimizes the tendency to troublesome milkstone formation. To be effective, the rinsing must be done immediately after use of the equipment. Use cold rinse water or water tempered just enough to melt the milk fat (not over 110° F.). The water hose is a handy means of rinsing.

**Scouring.**—Thorough cleaning of the milk side of all equipment requires an efficient dairy washing compound with a composition adjusted to dissipate the hardness of the plant water supply. See "Washing Compounds" in foregoing paragraphs. The washing solution containing the compound should be used hot, preferably at an approximate temperature of 135 to 150° F. and it needs to be applied with a stiff brush.

It has been suggested<sup>4</sup> in connection with mechanical can washing that the alkali strength of the washing solution should be sufficient (equivalent to .15 to .20% Na<sub>2</sub>O) to exert definite germicidal properties in order to



improve the efficiency of subsequent sterilization. The practice of depending upon the alkali strength of the cleaner for germ killing efficiency in sterilization, however, appears to be of doubtful merit and of questionable economy. In fact, Foter<sup>4</sup> demonstrated by experimental trial conducted under commercial conditions of operation and covering a period of over one year, that the conventional strength of alkali can washing solutions (equivalent to 0.05-.10% Na<sub>2</sub>O) had to be doubled in order to accomplish an appreciable reduction in bacterial count (from 1,000,000 - 10,000) and even then the count, after several weeks of this alkalinity, did not drop below 10,000 bacteria per can by standard can rinse count.

Milk pumps, milk pipes and fittings, filling machines, homogenizer fluid end, etcetera, should be dismantled and removable parts scoured separately. For steam-heated heating surfaces, such as steam jacket and coils, and in hot wells and vacuum pans the brush may have to be supplemented by emery cloth or sandpaper. For tubular heaters and evaporators and I.T. coolers, stiff rotary brushes should be rammed through the entire length of each tube, with end caps removed.

**Second Rinse.**—All equipment, after scouring, should be rinsed with clear hot water (temperature 180° F. or above). In the case of equipment that can be efficiently flooded by circulating the hot water rinse through it for 15 to 30 minutes at the above temperature, this rinse is usually also depended upon as the sterilizing treatment, although a final steaming will assist in further reduction of the germ count. This refers especially to reassembled milk pipe lines and milk tube systems such as in tubular heaters, tubular evaporators and I. T. coolers. In the case of large equipment such as fluid milk and concentrated milk storage tanks, the conventional vacuum pan and the like, the only hot rinse application that appears practicable is a spray upon the milk side of the equipment by means of the hot water hose. This is obviously not sufficient to render this equipment sterile. This applies also to the hot water rinse of the surface cooler which needs subsequent sterilizing treatment.

**Sterilizing.**—Steam sterilization can be considered effective only in the case of equipment that can be closed up, such as the pipe system, vacuum pan, and other closed tanks with manhole cover, and coil vats with covers down. When steaming, the vent is left open until the air has escaped and steam is discharging from the vent. The steam should be on the equipment for at least 30 minutes and until all parts of the milk side have been heated to the desired temperature. Open tanks and the surface cooler cannot be effectively treated with steam. Even under the most favorable conditions steam is not as dependable as hot water largely because of the tendency of the formation of air pockets that prevent access of steam to certain parts of the equipment.

**Importance of Vacuum Pan Sanitation.**—The vacuum pan constantly jeopardizes sanitation and low bacteria count of the finished milk product.

In the daily routine of washing and sterilizing of condensery equipment, the pan often escapes the intensity and thoroughness of cleaning and heat treatment necessary to eliminate it as a prolific source of contamination of the next day's run. The usual psychology of the average pan cleaner appears to be that when he has given coils and lower part of a pan a good scouring with sand paper, alkali cleaner, and hot water, and has rinsed down the rest of the pan with a squirt of warm water from the hose (all of which is very essential), the pan is in satisfactory sanitary condition.

Unfortunately, that is not enough. The vapor belt of the pan, the goose neck or other connecting link with the condenser, and condenser entrance, are coated with a film of milk that will decompose and cause a foul condition unless removed. All these parts, therefore, should be scrubbed with brush and hot water, followed by flushing down with clear, hot water. The pan should then be steamed as above directed for all equipment that can be closed up. After steaming for the full 30 minutes, the manhole cover should be removed to facilitate ventilation and to hasten the drying. This intensive steam treatment is essential for a low germ count in the finished product, and to prevent incipient flavor deterioration due to promiscuous contamination with quality-damaging germlife from a non-sterile pan. Ruehe<sup>6</sup> showed that superheated condensed milk, made in a properly washed pan that had not been steamed after washing, yielded a bacteria count 357.00 per cent higher than that of the original raw milk. See also Chapter XXXI, under "Micro-organisms."

**The Place of Chemical Sterilizers.**—For equipment which does not lend itself satisfactorily to sterilization by steam and to flooding with hot water, the use of a suitable chemical sterilizer provides a helpful solution. In the case of pipelines, pumps, homogenizer, filling machines, and small containers, flooding with the sterilizer solution is practicable. In the case of large tanks such as storage tanks, truck tanks and car tanks, the chemical sterilizer is sprayed against the milk side of the equipment by pump pressure. Spraying both sides of the surface cooler with the chlorine solution also provides the most promising means of sterilizing this cooler, since the refrigerant on the inside dissipates the sterilizing heat of both steam and hot water.

**Correct Concentration of Chlorine Sterilizers.**—Numerous chemical sterilizer preparations are available and new ones are constantly being developed. The most commonly used chemical sterilizer in dairy work appears to be sodium or calcium hypochlorite. When flooding the system with the hypochlorite, a chlorine concentration of 100 p.p.m. is adequate ( $\frac{1}{2}$  ounce of 3% chlorine solution per gallon of water). When spraying, a chlorine concentration of 200 to 300 p.p.m. (1 to  $1\frac{1}{2}$  ounce of 3% chlorine solution per gallon of water) is recommended. Because of the corrosive effect of hypochlorite solutions on most metals, it is good

practice to defer the chlorine treatment until the following morning.

**Sterilization at Start of Day's Operation.**—In the morning, before the circulation of the milk starts, all equipment needs a good flushing with hot water (temperature 180° F. or above). This is then followed by the chlorine treatment in case the chlorine solution is depended upon for sterilization.

**Importance of Air-Circulation for Idle Equipment.**—At the conclusion of the cleaning and sterilizing treatment at the end of the operating day, the equipment should be left in a position favorable for rapid drying. Vats and tanks especially should be left with covers cracked and bottom outlets open to permit drainage of loose water and circulation of air, such as will expedite drying of the equipment. This is necessary for both sanitation bacteriologically and protection against metallic corrosion.

#### CAN WASHING

**Potential Effect of Sanitary Condition of Can on Quality of Farmer's Milk.**—Another extremely important factor with potentialities to affect the quality of the condensery patron's milk is the sanitary condition of the milk cans which the factory returns to the farmer. In the mind of the milk producer, cans that are clean and free from greasiness, that are dry and without objectionable odor when opened at the farm, symbolize efficiency and integrity on the part of the factory, and such cans lend added dignity to the task of milk production. In the presence of unclean cans, greasy to the touch, foul smelling upon opening, and with a puddle of turbid wash water in the bottom, there lurks a tendency to encourage carelessness and lack of sanitation in milk production on the farm. In addition, the quality of the milk held and transported in such cans unavoidably suffers deterioration.

**The Mechanical Can Washer.**—Condensery milk cans are now practically all washed by the use of a mechanical can washer. In the machine washer, the force with which the jets of hot washing solution impinge against the sides and bottom of the inverted can take the place of the manual scouring with washing solution and brush.

As in hand washing, in order to return to the farm a sanitary can, the washed can must be clean, near-sterile, dry and sweet-smelling. The following six consecutive essential operations will accomplish this perfection of sanitation: recovery of entrained milk remnants, cold water rinse, hot wash water containing washing compound, clear hot water rinse, steam blast, and hot dry air blast.

**Maintenance of Can Washer Efficiency.**—In order for the mechanical can washer to perform efficiently, it must be in a satisfactory state of mechanical up-keep and it must be operated properly. There is need of a thorough-going overhauling of the can washer at reasonable, regular intervals, replacing worn parts and making sure that valves function

properly. that jets for wash water, rinse water and steam are free from obstruction and deliver full size `sprays at the pressure and temperature specified by the manufacturer, and that the heated air system supplies the specified cubic feet of air at the desired temperature. The washing solution must be maintained at the desired strength throughout the operating period by the proper functioning and control of the washing compound feed. The operator should make sure that the can moving mechanism is placing each can squarely over the successive jets and that mechanical parts are properly lubricated and move freely. For a daily check-up, the conscientious inspection of the washed cans is recommended. It usually provides a helpful index to the general operating efficiency of the machine. Such inspection has the added advantage of revealing the state of repair of the cans, making possible repairs where needed and the culling out of cans that have deteriorated beyond repair.

At the end of the operating day the can washer needs to be cleaned, tanks emptied and compartments cleaned out. Removal of scale is important to prevent its grinding action on wearing parts, and its clogging of pipes and jet perforations. New developments in can washer engineering within recent years have improved can washing efficiency.

**Washing Compounds for Can Washing.**—For a brief discussion on alkali washing compounds suitable for dairy work, see "Dairy Cleaners" earlier in this chapter.

**Acid Cleaners.**—In addition, the use of acid cleaners in the place of alkali compounds has been recommended for can washing. The relative merits of organic acids, such as gluconic acid and levulinic acid and cleaner compounds containing these acids, have been experimentally demonstrated. Perhaps the greatest advantage of these acid cleaners lies in their action on hard water and on deposit of films on metal surfaces caused by the hardness. Theoretically, because of the elimination of films of calcium and magnesium salts, and of milk stone in general, acid cleaners might be expected to be more effective as germicides than the conventional basic alkali cleaners. Thus Parker and Shadwick<sup>5</sup> report that cans treated with an acid cleaner in a manner that leaves the cans with an acid reaction of pH 6.0 to 6.5 showed a much lower count of spoilage organisms and also a lower total count of bacteria. The treatment varied from washing with the acid cleaner, to alkali-washed followed by an acid rinse, and alkali-washed followed by a sterile hot water rinse and then by acidified steam, respectively. Inspection of the cans after 48 hours showed the acid-washed and the acid-treated cans to have a "good, clean odor" without exception, while the alkali-washed cans with no acid treatment (rinsed with sterile water and steamed with ordinary steam) were reported to have either a bad or a very bad odor. The acid-treatment cans with a pH of 6.0 to 6.5 showed no active corrosion.

**Comparative Tests of Acid and Alkali Cleaners under Commercial Conditions.**—As noted early in this chapter, the attributes which a satisfactory washing compound is expected to possess are many. In the case of machine can washing, however, there is one qualification that is fundamental and that ranks above all others in importance, i.e., the washing compound must be capable of keeping out of the can washer, lime deposits and milk stone formation, such as is prone to score the wearing parts, fill up and clog the pipes, interfere with free action of the pumps, gum up the spray jets, and seriously interfere with the can washing efficiency of the machine.

Both alkali cleaners containing the newer phosphate complexes, and acid cleaners of the gluconic acid type, have demonstrated their power to eliminate these interfering lime and milk stone deposits. Doctor Foter<sup>4</sup> reached the conclusion that "as a result of our work we lean toward the position that perhaps more efficient can washing can be obtained if, for example, alkalies are used three weeks of the month and an acid cleaner which will maintain the water on the acid side of neutrality, for one week of the month."

A further observation of a comparison between an alkali and an acid cleaner used in can washing was reported by Scales and Kemp.<sup>8</sup> The alkaline detergent contained one of the polyphosphates. The acid detergent contained one of the wetting agents. The investigators observed a "very much lower bacterial count" and a "cleaner can that was really dry and odorless" in the case of the acid detergent containing the wetting agent than with the alkaline detergent containing the polyphosphate.

**Corrosive Effect of Detergent on Can Washer.**—Finally, the washing compound must perform the desired service without causing rapid corrosion of the bare metal parts of the can washer. Experimental evidence<sup>4</sup> has shown that the acid cleaner when used in moderately hard water (20 to 30 grains) in sufficient concentration for the washing solution to be on the acid side, caused no corrosion on tin but produced severe corrosion of the bare iron in the can washer, while no such corrosion was observed from the use of the alkali washing solution of a concentration equal to or greater than the acid cleaner solution as measured in terms of germicidal property.

#### REFERENCES

1. SNELL, F. D.: *Ind and Eng. Chem.* Vol. 35. p. 107. 1943.
2. ROLAND, C. T.: *The Application of the Newer Phosphates in Dairy Operations.* Abstracts of Dairy Conference Ohio State University, 1942.
3. SCALES, F. M., AND KEMP, M.: *The Wetting Agents, Their Properties and Applications.* Abstracts of Dairy Conference Ohio State University, 1942.
4. FOTER, M. J.: *Division of Bacteriology Research Laboratory Pet Milk Co.* By correspondence July 22—August 23, 1944.
5. PARKER, M. E., AND SHADWICK, G. W., JR.: *Am. Butter Rev.* June 1941.
6. RUEHE, H. A.: *New York (Cornell) Agr. Expt. Sta. Mem.* 76. 1923.

## CHAPTER XI

### MILK SUPPLY

#### BASIS OF BUYING MILK

The manner of arriving at the price paid to the producer for milk delivered to the milk condensery has undergone changes during the past half century. In the early days monthly milk prices for the coming season were announced by the condensery in advance. In many instances the advance schedule covered the entire 12 months of the year. Condensery prices then usually averaged from 25 to 50 cents per hundred-weight higher than creamery and cheese factory prices. It was customary then to pay the highest differential during the winter months and to drop condensery prices close to those paid by creameries and cheese factories in summer during the months of flush production.

**Relation of Condensery Price to Market Milk, Creamery and Cheese Factory Prices.**—Nardin<sup>1</sup> studied comparative milk prices paid by the condenseries, creameries, and cheese factories in the four main milk producing sections of the United States—Illinois, New York and Pennsylvania, Wisconsin, and the Pacific Coast States—for the years 1914 to 1918 inclusive. His findings showed that in some instances condensery prices exceeded creamery and cheese factory prices by over \$1.00 per hundredweight, while there were times in summer when condensery prices even dropped slightly below creamery and cheese factory prices.

Nardin's investigation further showed that the price paid by the condensery in the milksheds of large consuming centers was influenced by the price of fresh milk distributed in those regions, and in regions where creameries and cheese factories predominated condensery prices were largely influenced by butter and cheese prices. Thus Nardin's summary indicated that in Illinois the price was subject to prices of fresh milk distributed in Chicago and St. Louis. In New York State and Pennsylvania, prices were subject to influences of the New York Dairyman's League and the price of fresh milk for distribution in the city of New York. In Wisconsin the condensery price was pre-eminently affected by butter and cheese prices.

**Buying Milk on Basis of Hundredweight or by the Gallon.**—Formerly the milk was bought almost exclusively by the hundredweight regardless of fat content, and in many cases by the gallon, using the yardstick for remnant cans. This encouraged the development of breeds of low-testing milk in condensery territory and tended to give the erroneous impression that such milk was better suited for condensery purposes than that from breeds of high-testing milk.

**Buying Milk on Butter Fat Basis.**—Later many of the American condenseries changed to buying their milk either on the straight butter fat

basis or on the basis of an established price per cwt. of a specified standard fat content, plus bonus for richer milk and price deduction for milk below that standard. Thus, assuming that the fat content established for standard condensery milk was 3.5 per cent, an added bonus of say four cents was paid for each one-tenth per cent above 3.5 per cent, and a deduction of four cents was made for each one-tenth per cent below 3.5 per cent.

**Evaporated Milk Price Code.**—In 1933 the milk price code of the Evaporated Milk Association was established and has since been used as the price basis by the members of the above association.

The Evaporated Milk Association represents the manufacturers of evaporated milk. It does not embrace manufacturers of concentrated milks other than evaporated milk. Its price schedule therefore does not cover the price of milk used in the manufacture of sweetened condensed milk. However, the volume of production of evaporated milk overshadows that of any other form of concentrated milk. From a production, in 1919, of 1.4 times that of all other concentrated milks combined it has increased to 3.8 times in 1939, and in 1942 the production of evaporated milk amounted to 4.3 times the total volume of all other types of fluid concentrated milk manufactured in this country. The milk price code of the Evaporated Milk Association thus may justly be assumed to apply to the bulk of producer's milk received by American milk condenseries.

The price code of the Evaporated Milk Association has for its basis an Agreement entered into by and between the Secretary of the U. S. Department of Agriculture and each of the manufacturers of evaporated milk signing the Agreement. Pursuant to the Agricultural Adjustment Act, approved by the Congress of the United States, May 12, 1933, the purpose of such Agreement was to establish "the schedule governing the prices at which, and the terms and conditions under which, milk shall be purchased from producers by manufacturers for the manufacture of evaporated milk," as set forth in Schedule A following:

#### SCHEDULE A

##### SECTION 1. FOR EVAPORATED MILK PLANTS LOCATED IN ILLINOIS, INDIANA, IOWA, MICHIGAN, MINNESOTA, OHIO AND WISCONSIN.

(a) The minimum price to be paid for milk delivered to such evaporated milk plants each month and used for the production of evaporated milk shall be calculated as follows:

Multiply the average wholesale price of Chicago 92-score butter (as reported by U. S. D. A.) by 6 and add 2.4 times the average weekly prevailing prices of Plymouth twins during said month on Wisconsin Cheese Exchange at Plymouth. Divide this sum by 7 and multiply the resulting figure by 3.5 (The figure thus resulting is termed the "combined butter and cheese value"). Add to the combined butter and cheese value 30% thereof. The resulting figure shall be the minimum

price per 100 lbs. for milk with a butterfat content of 3.5% delivered to plants in the above states during such month.

"The minimum price paid for milk with a butterfat content below 3.5% and up to 4% shall be calculated on a direct ratio basis. For milk with a butterfat content above 4%, the minimum price shall be that for milk of 4% calculated on the direct ratio basis plus an extra payment for butterfat in excess of 4% on the basis of the average wholesale price of Chicago 92-score butter for said month as reported by U. S. D. A."

**EXAMPLE:**

Average of Chicago 92 score butter for month is 41c.

Weekly averages of Plymouth twins for month is 23¼c.

What is price paid per cwt. for 3.5%, 3.2%, 4%, and 4.6% milk?

**ANSWER:**

Combined butter and cheese value  $.41 \times \frac{6}{7} + \frac{(2.4 \times .23\frac{1}{4})}{7} \times 3.5 = \$1.5085$

Minimum price per cwt. of 3.5% milk =  $1.5085 + \frac{1.5085 \times 30}{100} = 1.96$

Minimum price per cwt. of 3.2% milk =  $\frac{1.96 \times 3.2}{3.5} = 1.79$

Minimum price per cwt. of 4.0% milk =  $\frac{1.96 \times 4.0}{3.5} = 2.24$

Minimum price per cwt. of 4.6% milk =  $2.24 + (.6 \times .41) = 2.48$

"(b) When not able to use for the production of evaporated milk all milk received, plants shall pay for the milk not so used as follows: the combined butter and cheese value plus any excess of (1) the value at which any milk not so used is disposed of (calculated at the prevailing price paid for milk purchased for such dispositions) over (2) the combined butter and cheese value. For determining the price to be paid to the producers during any month, the price paid for milk used for the production of evaporated milk and the price paid for milk not so used shall be blended pro rata, to the amounts used by the plant, during said month, of milk used for the production of evaporated milk and of milk not so used."

**SECTION 2. FOR EVAPORATED MILK PLANTS LOCATED IN NEW YORK, PENNSYLVANIA AND VERMONT.**

(a) The minimum price to be paid to producers for milk delivered to such plants each month and used for the production of evaporated milk shall be calculated as follows:

The same as given under section 1(a) and add 7 cents per cwt. of milk, which is an amount approximately equivalent to the per case freight differential on evaporated milk between the territories of the two sections.

(b) Same as section 1(b) except that New York City butter quotations and Gouverneur, and Cuba, New York cheese quotations shall be used in the place of Chicago butter and Plymouth cheese quotations.

**SECTION 3. FOR EVAPORATED MILK PLANTS LOCATED IN ALABAMA, KANSAS, KENTUCKY, MARYLAND, MISSISSIPPI, MISSOURI, TENNESSEE, TEXAS, COLORADO AND VIRGINIA.**

(a) The minimum price to be paid to producers for milk delivered to such plants each month and used for the production of evaporated milk shall be calculated as follows:

The average wholesale price of Chicago 92-score butter for said month as reported by U.S.D.A., from which shall be deducted 2 cents (the resulting figure



is termed "flat butterfat value"). Multiply the flat butterfat value by 4 and add to the resulting product 30% thereof. The figure so obtained is the minimum price per cwt. of milk containing 4% butterfat. For milk testing below 4% butterfat calculate the minimum price on a direct ratio basis. For milk above 4%, the minimum price is that of 4% milk plus an extra payment for butterfat in excess of 4% on the basis of the flat butterfat value.

(b) When not able to use for the production of evaporated milk all milk received, plants shall pay for the milk not so used as follows: The flat butterfat value plus any excess of (1) the value at which any milk not so used is disposed of (calculated at the prevailing price paid for milk purchased for such dispositions) over (2) the flat butterfat value. In determining the price paid to the producers during any month the price for milk used for the production of evaporated milk and the price paid for milk not so used shall be blended, pro rata, to the amounts used by the plant during the month, of milk used for the production of evaporated milk and of milk not so used.

#### SECTION 4. FOR EVAPORATED MILK PLANTS LOCATED IN ARIZONA, IDAHO AND UTAH.

The minimum price to be paid for milk delivered to such evaporated milk plants during each month and used for the production of evaporated milk shall be calculated as follows: Multiply the average wholesale price of San Francisco 92-score butter for said month as reported by U.S.D.A. by the butterfat content of the milk purchased.

#### SECTION 5. FOR EVAPORATED MILK PLANTS LOCATED IN OREGON AND WASHINGTON.

The minimum price to be paid for milk delivered to such evaporated milk plants during each month and used for the production of evaporated milk shall be calculated as follows: Multiply the average wholesale price for Seattle 92-score butter, as reported by Seattle Wholesale Butter, Cheese and Egg Exchange, by the butterfat content of the milk purchased.

#### SECTION 6. FOR EVAPORATED MILK PLANTS LOCATED IN CALIFORNIA.

The minimum price to be paid for milk delivered to such evaporated milk plants during each month and used for the production of evaporated milk shall be calculated as follows: The average wholesale price for San Francisco 92-score butter for said month, as reported by U.S.D.A., plus 3 cents shall be multiplied by the butterfat content of the milk purchased.

**Transportation of Milk to Condensery.**—Much of the milk supply still reaches the condensery in 10-gallon cans transported by wagon, motor truck, or by rail. The remainder comes in by tank truck and tank car. Some condenseries operate concentration points where the milk is inspected, sampled, tested for butterfat and cooled, and from which it is hauled to the condensery in large tanks mounted on motor trucks. In especially intense dairy sections, the milk is also precondensed at the concentration point and shipped to the central condensery in concentrated form.

It is customary for part of the cost of the transportation of condensery milk from farm to factory or to concentration point to be borne by the factory and part by the producer. Payments for condensery milk are generally made monthly.

**SAMPLING THE PATRON'S MILK FOR FAT TEST**

**Importance of Representativeness of Sample.**—The first requisite for dependable accuracy of the butterfat test is that the portion of sample that is actually tested be truly representative of the composition of the milk delivered by the patron. The representativeness of the milk that is pipetted into the test bottle depends on two important essentials, namely, (1) the milk in the farmer's can or in the weigh can must be uniform in fat content all through the can at the time the sample is taken, and (2) the sample must be made homogeneous in composition at the time the portion required for the test is transferred from the sample jar to the test bottle.

**Taking Samples from Farmer's Can.**—When the farmer's delivery is limited to a single can the common practice is to stir the milk in the farmer's can and take the sample. When the milk is in normal physical condition and it is stirred vigorously pushing the hand stirrer one half dozen times vigorously from the top to near the bottom of the can, the milk is usually well mixed, even if it contains the milk of the previous night.

When the farmer's delivery consists of several cans, the milk is usually dumped into the weigh can before sampling. Check tests to determine whether samples taken from the weigh tank (or "dump" tank) are representative of the fat content of the lot have been made by numerous investigators.<sup>3,4,5,6</sup> In general, the results showed that when the milk was thoroughly stirred in the farmer's cans before "dumping," the sample taken from any part of the weigh can was representative. When the milk was not stirred before dumping, the representativeness of the sample taken from the weigh can was uncertain. The tendency was for sample to be lower in fat at the point where the milk is dumped into the tank than at the farther end. This is believed to be due to the first milk out of the farmer's can (which is the richest in fat) automatically being washed to the farther end of the tank and staying there unless some manner of agitation is provided. This discrepancy appears to be of greater magnitude in the case of a shallow weigh tank and one of square or oblong shape, than in the case of a deep one that is cylindrical in shape. Thus Tracy and Tuckey<sup>5</sup> found that dumping the milk from the farmer's cans into a relatively small size cylindrical weigh tank yielded representative samples from all parts of the tank without agitation, while a more shallow square weigh tank yielded samples that showed an average difference of 0.2 per cent fat between front and rear ends of tank. Samples taken from near the center of the weigh tank corresponded closely with those taken after stirring.

**Representativeness of Samples Taken from Weigh Cans.**—Our present knowledge of the accuracy of samples from the various types of weigh tanks in use in the condensery suggests the wisdom of each plant deter-

mining the representativeness of samples taken from its weigh tank. This is readily done by testing samples taken from the milk in the weigh tank before stirring, and again after vigorously stirring. Mechanical agitators for this purpose may be purchased from dairy supply houses. In California the state law requires mechanical agitation of the milk in the weigh tank preparatory to taking samples for the fat test.

**Composite Samples.**—It is common practice among the milk condenseries to take composite samples that are tested at 7 to 10 day intervals. Theoretically the composite sample should consist of aliquot portions to accurately represent the fat content of the milk purchased. Samplers for proportional sampling are available. However, experimental results reported by Farrington,<sup>7</sup> Hunziker,<sup>8</sup> Sanmann and Overman,<sup>9</sup> and Tracy and Tuckey<sup>5</sup> indicate that there is no significant difference between composite samples assembled from aliquot portions and those assembled from equal portions by the use of a small dipper. It appears that, within testing intervals of 7 to 10 days, variations in fat content of milk are too slight, if there are any, to justify bothering with aliquot portions.

However, it is very important to observe the principle of aliquot portions when assembling figures for the monthly milk checks. For correct calculations the pounds of milk must be totalled for each test period and the sum multiplied by the test of that period. The product resulting from these calculations then represents the pounds of fat purchased for each test period.

**Representativeness of that Portion of the Sample that is Actually Tested.**—For accurate tests the portion of the sample that is pipetted into the milk test bottle must be representative of the composition of the sample. This requires proper care of sample between test periods and care in preparation incident to transfer to test bottle.

**Care of Sample and Preparation for the Fat Test.**—A suitable preservative, such as a corrosive sublimate tablet, should be added to each composite sample jar at the beginning of the sampling period. After each daily addition of milk the jar should be given a gentle rotary motion to mix the preservative with the new portion of milk. The seal of the sample jars must be tight to prevent evaporation and the samples are preferably held in a cool place and away from direct sunlight.

Immediately before pipetting to the test bottle, the sample must be thoroughly mixed. This is best done by proper shaking, turning the sample jar up-side-down a sufficient number of times to make the sample homogeneous and free from lumps.

**Importance of Temperature of Milk and Acid.**—Clear tests, free from a layer of curdy material at the bottom of the fat column that makes the reading uncertain, are facilitated by cooling both samples and sulphuric acid to 70° F. or preferably lower. This is readily done by setting sample jars and acid container in tap water several hours before use.

## REFERENCES

1. NARDIN, W. T.: Memorandum on Federal Trade Investigation of Milk Manufacturers, 1918.
2. EVAPORATED MILK ASSOCIATION: Marketing Agreement for Evaporated Milk. Sept. 11, 1933.
3. MARQUARDT, J. C., AND DURHAM, H. L.: N. Y. (Geneva) Agr. Expt. Sta. Bul. 605. 1932.
4. BAILEY, D. H.: Penn. Agr. Expt. Sta. Bul. 310. 1934.
5. TRACY, P. H., AND TUCKEY, S. L.: Ill. Agr. Expt. Sta. Bul. 459. 1939.
6. ROADHOUSE, C. L., AND HENDERSON, J. L.: The Market Milk Industry, quoting California Dairy Service. p. 145. 1941.
7. FARRINGTON, E. H.: Ill. Agr. Expt. Sta. Bul. 16, 1891.
8. HUNZIKER, O. F.: Ind. Agr. Expt. Sta. Ann. Rept., 1913-14.
9. SANMANN, F. P., AND OVERMAN, O. R.: Cry. and Milk Plant Monthly 15. No. 7. p. 39. 1926.

## CHAPTER XII

### QUALITY OF MILK SUPPLY AND ITS CONTROL

**Importance of Quality.**—The quality of the producer's milk is one of the indispensable cornerstones upon which rests the quality and marketable properties of every form of concentrated milk.

**Fundamentals that Determine the Quality of the Fresh Milk.**—The cardinal essentials in production and care that make for milk of high quality are: Healthy cows, freedom of milk from colostrum, cleanliness, prompt cooling and freshness.

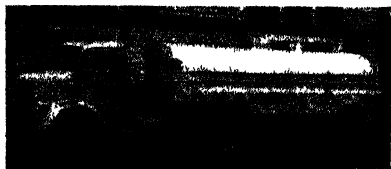

Fig 34 Pfaudler truck and trailer tank  
Courtesy of the Pfaudler Co

In order for milk to be suitable for condensery purposes it must conform to the Federal definition and standard for milk as promulgated by the United States Food and Drug Administration,<sup>1</sup> which reads as follows:

"1. Milk. The whole, fresh lacteal secretion obtained by the complete milking of one or more healthy cows, excluding that obtained within 15 days before and 5 days after calving, or such longer period as may be necessary to render the milk practically colostrum-free."

It should come from cows of herds fully accredited as tuberculosis-free by the United States Department of Agriculture or from healthy cows located in areas that are designated as modified tuberculosis-free areas by the United States Department of Agriculture, and it should be produced and handled in accordance with State and Federal sanitary laws and regulations.

Many milk condenseries have established their own rules, compliance with which determines the acceptability of the milk to the condensery. In addition, the Evaporated Milk Association<sup>2</sup> has established a sanitary code governing the details of sanitary precautions in the production, handling and transportation of milk suitable for use in the manufacture of evaporated milk.

#### QUALITY CONTROL

As indicated in the foregoing paragraphs, the sanitary quality of the milk on the receiving platform depends on its background on the farm. It is there, in the circumstances of its production and in its care during and after production, that its sanitary quality is made or unmade. Theoretically, therefore, control of quality lies on the farm.

However, theoretical control is not sufficient to insure dependably high quality milk for the condensery. In order to be effective, control must have teeth in it. It must be realistic enough to penalize the persistent offender, and to be helpful to the patron who needs help and is anxious to cooperate.

**Platform Inspection.**—Quality control of the condensery milk, in fact, begins on the milk receiving platform. There is need of systematic and thorough-going inspection of the patrons' milk by inspectors who are milk conscious and fully qualified by efficient training, experience and sound judgment; men who know milk and who have the courage of their convictions. Furthermore, the effectiveness of platform inspection and the quality improvement that will result will depend much on how proficiently the milk inspection on the receiving platform is supplemented by field work among the farms of patrons whose milk has been found unsatisfactory by the inspector on the milk receiving floor.

**Platform Tests.**—Numerous tests have been provided for the determination of specific properties of the milk relative to its suitability for condensery purposes. These tests may be conveniently grouped into three classes, as follows:

(1) Tests to determine the general sanitary quality as controlled by the fundamentals of freshness, cleanliness in production and handling, and temperature. To this group belongs inspection by the senses of smell, taste and sight, the acidity test, the sediment test and the methylene blue reduction test.

(2) Tests for Udder Disease, especially infectious mastitis. To this group belong the direct microscopic count and acidity test.

(3) Tests to determine the relative heat stability. To this group belong pH determination, the alcohol test, the phosphate test.

With the exception of inspection by the senses, none of the tests mentioned need be made on each patron's milk daily. Some are of value if made at semi-monthly, monthly or even longer intervals for general confirmation. Others may be of value as a last resort to confirm impressions of the senses or of the result of other tests.

**Inspection for Odor, Taste and Appearance.**—This form of inspection is, or should be, an integral part of the daily routine of receiving milk. It is expedited when done at a point where the cans are at a convenient elevation for noting the odor. The odor of the milk in the can is a fairly accurate index to the sanitary quality and age of the milk, if observed immediately upon removing the can cover. In case of a hollow can lid, raising the turned-up lid quickly to the nose usually tells the story. The fact that pure lactic acid is non-volatile, and therefore odorless, need not detract from the value of observing the odor. Milk represents a mixed culture of germ life. If bacterial action was sufficient to increase the lactic

acidity, other bacterial products with their own particular odors will have formed too and will be readily detected by the sense of smell. If in doubt as to odor, then tasting the milk will assist in confirming impressions. The presence of butter granules floating on the surface of the milk is dependable evidence of lack of proper cooling. Uncooled milk invariably gathers some butter granules in transit. Placing the hand on the side of the can will confirm this observation.

**Inspection by Use of Acidity Test.**—The acid test here refers to the titration of the measured milk sample with a solution of known strength of sodium hydroxide, using an alcoholic solution of phenolphthalein as indicator, and expressing the cc. of standard alkali solution required to change the color of the milk to a faint pink, in terms of per cent lactic acid.

In past decades, much importance was attached to the acidity test as an index to the quality of milk and its suitability for condensery purposes. That conception was logically based on the fact that carelessness in the production and handling of milk, high temperature and age, cause bacterial activity that is detrimental to quality and produce a high developed acidity, such as may cause damaging heat-curdling difficulties in processing. It was then customary to establish a maximum acidity limit above which milk was rejected. This maximum was commonly placed at 0.18 per cent acid. This acidity limit was based on the assumption that an acidity of 0.18 per cent or higher was due to quality-damaging "developed" acidity (developed by bacteria in the milk), resulting from carelessness on the farm and which was preventable. It is now recognized that the titratable acidity is not necessarily always a correct index of the freshness and sanitary quality of the milk and of its suitability for condensery purposes.

Freshly drawn milk has an inherent acidity. This is generally known as the "natural" or "apparent" acidity of milk, which is due to the acid reaction of some of the natural milk constituents, principally the phosphates and casein. This apparent acidity is not noticeable to the senses; it does not make the milk taste sour, nor does it affect the normal properties of milk or jeopardize its quality and its behavior toward processing heat. It does, however, register in the acidity test which expresses it erroneously as lactic acid. (See also "The Chemical Reaction of Milk" in Chapter I.)

Unfortunately the per cent acidity of freshly drawn milk varies considerably between individual cows, and to some extent between herds, with the stage of lactation, and with the physiological condition of the udder. Variations between individual cows have been found to range from slightly less than 0.10 to 0.30 per cent acidity. However, the acidity of fresh herd milk has been found much more uniform both between herds and from day to day, averaging from about 0.14 to 0.165 per cent. Yet occasional

herds have been reported where the acidity of the fresh milk is 0.18, and as high as 0.23 per cent.<sup>3</sup>

These findings make it clear that the practice of making an acidity test on every can or lot of milk received, and of accepting or rejecting milk on the basis of an arbitrarily set acidity limit, can serve no useful purpose. Nevertheless, the acidity test does have its proper place on the milk receiving floor. It has been found helpful in supplementing the nose and palate of the inspector in case of uncertainty or suspicion of the quality of any given can of milk. As suggested by Fleming and Nair,<sup>4</sup> the acid test should be applied mainly only as an adjunct to the senses of the experienced inspector, or as a means of checking on the cause of a definite rise in acidity in excess of what has been accepted as normal for a given herd. When so used, the acid test has distinct merit.

In view of the relative constancy of the apparent acidity in fresh herd milk from day to day, it has been suggested,<sup>5</sup> that in cases where the acidity runs persistently high (evidently due to high apparent acidity), the apparent acidity be determined at intervals of several weeks and that the maximum limit of titratable acidity be then placed at 0.03 per cent above the apparent acidity. This adjustment would thus allow for such slight fermentation as may be expected to occur between milking time on the farm and inspection of milk at the factory. The apparent acidity is determined by making the acid test on the freshly drawn milk on the farm.

**Determination of the pH.**—The hydrogen ion concentration represents the true acidity. Unlike the titratable acidity which is only a measure of the total acidity, the pH indicates the intensity of the acid reaction. The pH is not noticeably affected by the apparent acidity contained in the freshly drawn milk, but it is very sensitive to the developed acidity caused by the growth of bacteria in the milk. Hence, it is a more accurate index of the quality of the milk and its suitability for condensery purposes than the titratable acidity.

The true neutral point is pH 7.0. As the pH drops progressively below pH 7.0 the acidity increases in intensity. At pH values higher than pH 7.0 the reaction becomes increasingly more alkaline. The pH of normal, freshly drawn milk of a titratable acidity of about 0.15 to 0.25 per cent ranges approximately between pH 6.6 and pH 6.8. But if the difference between 0.15 and 0.25 per cent acidity were due to developed acidity because of bacterial activity, then the pH would drop to about 5.9 (i.e., the true acidity recorded would be greater). The pH also determines the processes of milk curdling, although its practical effect may be overshadowed by other factors such as the salt balance, for instance.

**The Sediment Test.**—This test shows the visible foreign matter contained in the milk. A definite amount (usually about one pint) of the patron's milk is passed through a white cotton disc. The presence or



absence of dark specks and the intensity of the general discoloration of the disc are indicative of the standard of sanitation and cleanliness observed in the production and handling of the milk on the farm. It thus provides the factory with a dependable index of the farms that need attention by the fieldmen.

If the interest on the part of the factory is limited to going through the motions of the test, it is of no worthwhile benefit. In such case sediment testing at the intake of milk is a waste of time. On the other hand, if the test is followed up by bringing the disc to the direct attention of the patrons, on the factory platform in case of direct deliveries and by routeman or mail in case of route or rail shipments, respectively, and in case of unsatisfactory discs, by personal visits to the respective farms, the sediment test is capable of serving as one of the most effective means of improving the sanitary quality of the factory's milk supply and of maintaining it on a high standard.

For dependable results the factory needs a definite time schedule that is followed consistently. For a general check of all the patrons, testing at monthly or even bi-monthly intervals is usually sufficient. In the case of unsatisfactory tests, weekly tests should be made until the tests show the desired improvement.

**The Methylene Blue Reduction Test.**—This test consists of the addition to the milk sample of a measured amount of the dye methylene blue, and incubating the mixture at 98.6° F. The rate at which the blue color disappears roughly suggests the number of bacteria present. The decoloration is due to chemical reduction caused by the action of bacteria. It is believed that this reaction is due to the accelerated activity of bacteria at this favorable incubation temperature in utilizing the oxygen dissolved in the milk. The rate of oxygen consumption is related to the number of microorganisms present. The greater the number, the more rapid the dissipation of the oxygen present and the shorter the time required for the change from blue to white.

This test is looked upon as an index to the extent of bacterial contamination of milk. It has been receiving increasing attention in milk condensery territories. As in the case of the sediment test, it is made at intervals the frequency of which is dictated by the urgency of quality improvement, usually every two weeks to two months. Here, too, the results serve as a guide to the fieldman.

The standard of minimum reduction time below which the condition of the milk suggests the need of special attention by the fieldman varies according to dairy development of the particular milk supply territory and on the extent of previous field service. In countries where dairying is still in its infancy and where sanitary control is largely limited to the printing of elaborate "Reglamentos Sanitarios," methylene blue reduction tests, as observed by Hunziker<sup>6</sup> at the milk intake of milk plants, showed

very short reduction times ranging from approximately two hours to less than five minutes. In condensery territory in the United States where quality improvement work has received but little attention, the reduction time is generally found to range between about two and three hours. In sections where dairying is more highly developed a reduction time within the range of four to five hours may reasonably be expected for condensery milk.

**The Direct Microscopic Count.**—The direct microscopic count has been found highly serviceable for daily use in the condensery laboratory. It consists of staining and microscopic examination of a smear of milk prepared on a glass slide. It makes possible an approximation of the number of organisms present. It enables the operator to recognize certain types of germlife by their morphological peculiarities, thereby spotting contamination of milk with germs of infected udders. It has proven outstandingly helpful in locating Mastitis milk with its characteristic streptococci and profusion of leucocytes. It thus may also become an effective means of determining the source of high-count milk. The value of the test is vastly augmented by the rapidity of its determinations that make it suitable for the routine checking of the quality of the patrons' milk.

**The Alcohol Coagulation Test.**—The alcohol test consists of mixing equal portions of 75 per cent alcohol and milk in a test tube and after repeated inversions, noting the presence of curd specks adhering to the tube walls. This test was originally intended as a measure of the freshness and sanitary quality of market milk. The work of Ayers<sup>7</sup> shows its unsuitability for this purpose. Later it was believed that there was sufficient correlation between alcohol coagulation and heat coagulation to use the alcohol test as an index to the heat stability of milk. Thus Ayers showed that milk rendered alcohol-positive by acidity or rennet treatment could be stabilized by forewarming to 90° C. (194° F.). Sommer and Binney<sup>8</sup> reported that alcohol coagulation is affected by the salt balance in a similar manner as heat coagulation. They found that the addition of small amounts of calcium and magnesium tends to induce alcohol coagulation, while phosphates and citrates have the opposite effect. Likewise, Dahlberg and Garner,<sup>9</sup> who applied the test in two evaporated milk plants, found the alcohol test more dependable than the acidity test in predicting the heat stability of evaporated milk. They concluded that milk giving a positive alcohol test will, when concentrated into evaporated milk, coagulate more readily than alcohol-negative milk.

**The Phosphate Test.**—This test was developed by Ramsdell,<sup>11</sup> Johnson and Evans.<sup>10</sup> It is based on the relation of heat coagulation and coagulation of milk in the presence of mono-basic potassium phosphate ( $\text{KH}_2\text{PO}_4$ ). This test is not intended to be used as a quality test of sanitary milk. Its chief aim is to aid in picking out those milks that impair the stability of the total composite during the seasons when sterilizing

trouble is encountered. It is claimed by its authors to be more dependable in determining the heat coagulation stability of milk than the alcohol test.

**Directions for Making Milk Inspection Tests at Milk Intake.**—For detailed directions for making the platform tests listed in this chapter, see Chapter XLVI.

**Importance of Follow-Ups by Condensery Fieldmen.**—For maximum effectiveness of the platform inspection of the patron's milk there is need of one or more competent fieldmen who are familiar with the farm problem of sanitary milk production. These fieldmen work in close cooperation with the platform inspector. Their task is to visit the farms whose milk deliveries fail to meet the requirements of the sanitary code of the condensery and they assist the farmer in his efforts to get right. Consistently sustained platform inspection, supplemented by a conscientious follow-up on the patrons' farms, provides the elements that promise lasting quality improvement of the condensery's milk supply.

#### CARE OF MILK IN FACTORY BEFORE MANUFACTURE

**Cooling the Fresh Milk.**—The weigh tank usually empties into a receiving tank from which the milk is disposed of according to the operating routine of the factory. In the absence of standardization of composition, it may be discharged direct into the hotwells as soon as enough milk has collected in the receiving vat to justify starting the circuit of processing. In such case the milk is generally utilized as fast as it is weighed in and no cooling is necessary.

**Conditions When Cooling Fresh Milk is Necessary.**—In most plants, however, the arrival of the farmers' milk is crowded into a few early morning hours. The milk comes in faster than the processing division can handle it. A considerable portion has to be held for a variable length of time before it can be processed. For this purpose one or more large fresh-milk storage tanks are provided in which the milk is standardized and held until needed.

In such case it is important to adequately provide for its rapid cooling to and holding at a temperature (45° F. or below) that will arrest bacterial activity. This precaution is necessary to protect the quality of the finished product. At favorable temperatures bacteria multiply rapidly. At 70° F. or above they double about every 20 minutes. Bacterial activity is accompanied by an increase of the acidity in the milk. This developed acidity lowers the heat stability of evaporated milk, tends to hasten objectionable age thickening of sweetened condensed milk, and shortens the life of whole milk powder.

The cooling is usually done by using storage tanks equipped with insulated jacket for circulation of the refrigerant, and with rotating agitator. For expediting the cooling, the entering milk may be sprayed against the cold milk side of the refrigerated jacket or by passing it over a surface cooler on its way to the storage tank.

### EXTRANEOUS MATTER

**Status of Extraneous Matter in Milk Sold for Manufacturing.**—In the majority of states, manufacturing milk (including condensery milk), does not have to meet Grade A milk requirements. Many of the milk condenseries are doing highly effective field work on quality improvement. In milk supply territory where these efforts have been consistently sustained over a period of years, a high standard of clean milk is usually attained. The average run of manufacturing milk, however, is not strictly Grade A quality and the general showing of sediment discs suggests the presence in the fresh milk of considerable extraneous matter.

**Effect of Process of Condensing on Elimination of Extraneous Matter.**—A considerable portion of the extraneous matter that enters the milk on the farm is soluble. Part of this material, therefore, is already in solution by the time the milk arrives at the condensery and can no longer be removed by any now available mechanical means. Furthermore, the process of condensing does not eliminate these extraneous impurities. As in the case of the nutritionally valuable, health-promoting milk solids, the worthless, quality-jeopardizing extraneous solids remain in the milk and are concentrated by the condensing process. This emphasizes the importance of the following facts:

(1) The basis for high quality and fine flavor of the milk must ever be **Clean Milk** in preference to **Cleaned Milk**.

(2). For sanitary as well as for ethical reasons, the fresh milk upon arrival at the factory should be given such treatment as will eliminate the removable extraneous material.

The available means of eliminating extraneous material and other impurities, that have been found practicable, are filtration and centrifugal clarification.

### REMOVAL OF IMPURITIES BY FILTRATION

**The Weigh Can Strainer.**—In some factories these efforts are limited to the metal or cloth strainer located on top of the weigh can. The removal of mechanical impurities by this means is largely confined to relatively coarse particles from feed or bedding and chance objects of diverse nature that may be present. The weigh can strainer is seldom of a mesh sufficiently fine to strain out insoluble matter of relatively small particle size. Moreover, in the absence of efficient routine inspection, there may be times when this strainer is not in a proper state of repair.

**Strainers and Filters in the Milk Line.**—Factory milk filters and strainers of diverse types installed in the flow line between milk weigh can and vacuum pan have been used for many years. The finer their mesh, or the more compact their fabric, the more efficient they are in removing insoluble extraneous matter from the milk. As the closeness of the weave or the density of the filter bed increases, the capacity of the filter decreases.

It clogs more quickly and dismantling and washing or changing of cloth must be done oftener. At best the hazard of a break-through due to built-up pressure is ever present.

Filters installed in the milk flow line, consisting of one or more metal cylinders of fine wire mesh (60 to 100 mesh to the inch), and covered with a fine but strong muslin sleeve, have been found very serviceable. In the case of multiple cylinders, they are nested and the mesh is graduated from 60 mesh for the first to 100 to 120 mesh for the last cylinder.

**Using Two Filter Units with By-pass Connections.**—In order to maintain the filter in efficient operating condition without frequent interruptions and delays in milk flow due to the necessity of dismantling for cleaning, it has been found good practice to install at least two filter units in the line, with by-pass connections. In such installations only one filter unit is used at a time. When ready to change cloth, the used filter is by-passed, and the valve to the other filter is opened. This arrangement encourages changing of the cloth sleeves at shorter intervals, improving the functioning of the filter and assuring more dependable results.

#### **REMOVAL OF IMPURITIES BY CENTRIFUGAL CLARIFICATION**

Where a very large daily volume of fluid milk must be handled in a limited span of hours, as is the case in the majority of evaporated milk factories, the more automatic and the more fool-proof the equipment, the better. The soundness of this maxim has been convincingly demonstrated by the highly efficient performance of the centrifugal clarifier. This fact is supported by a multitude of exact comparative tests made under commercial conditions of operation. These tests showed that the centrifugal clarifier provides in fact the most practical, efficient and dependable means of removing insoluble impurities from milk.

**Efficiency of Clarifier.**—The sanitary superiority of the centrifugal clarifier as compared with other systems of removing sediment is obvious. In its journey through the revolving clarifier bowl the milk does not have to pass through a wall made up of an increasing accumulation of unsightly sediment as is unavoidable in the case of the filter or strainer. The clarifier thus protects the milk against the danger of impregnation with objectionable flavors absorbed from intimate contact with a concentrated mass of promiscuous impurities which has been found to consist of particles of feed and bedding, leucocytes, blood cells, animal tissues and frequentlyropy and gargety material.

Furthermore, the latest improved models of centrifugal clarifiers, see Figure 35, accomplish clarification of cold milk fully as efficiently as hot milk. This means that the clarifier makes possible the elimination of the impurities while the milk is still cold, and before a large portion of the diverse extraneous material is broken down or dissolved, thus preventing its off-flavors from becoming established in the milk by the application of heat.

The maximum capacity of the modern centrifugal clarifier is 20,000 pounds of milk per hour. The bowl holds approximately 30 pounds of the rejected impurities. In order to maintain the highest degree of clarifying efficiency at every stage of the clarifying period, it is recommended that the bowl be stopped for cleaning at predetermined intervals, depending upon the condition of the milk coming into the plant.

**Effect of Centrifugal Clarification on Removal of Oxidants from Milk.—**

In addition to the quality improvement accomplished by the removal of insoluble extraneous impurities, centrifugal clarification has been found to eliminate from the milk substances inherent in the milk that cause or incite quality-damaging oxidation in the finished product. Thus, the work of Holm, Greenbank and Deysher<sup>11</sup> showed that the clarifying of milk before drying improves the keeping quality of whole milk powder. Holm et al found that this improvement appears to be due to the removal of the separator slime which may contain metallic and other catalyts.

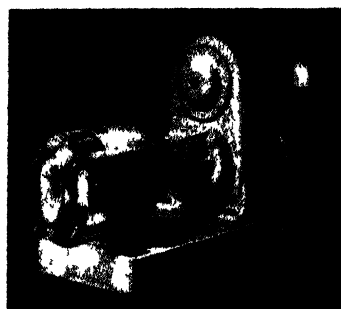
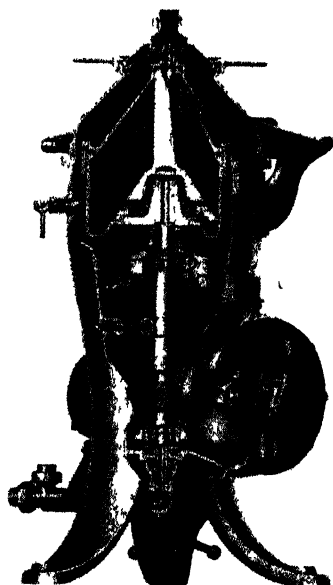

Fig. 35. DeLaval air-tight milk clarifier Fig. 36. DeLaval Waukesha pump unit  
Courtesy of DeLaval Separator Co.

Returning the separator slime to the clarified milk produced no better powder than did the unclarified milk. They further observed that the improvement is greatest when clarification is accomplished as soon as possible after the milk is drawn. Dahle and Josephson<sup>12</sup> as the result of more recent study observed that centrifugal clarification removes a portion of the lecithin that is contained in the surface layer of the fat globules. They reported that removal of one-half or more of the lecithin present improved the keeping quality of whole milk powder considerably. They

concluded that the oxidation of the lecithin is one of the major reasons for the early flavor deterioration of whole milk powder held in storage, but conceded that the improvement in keeping quality may have been due, in part, to the removal of oxidants other than lecithin by the super-centrifuging treatment.

**Place of Clarifier in Continuous System of Processing.**—The clarifier has the further advantage that it fits admirably into the ever-increasing trend in all branches of the dairy industry toward the continuous system of processing milk. Such a system facilitates the handling of the milk product from intake of raw material to sealing in the consumer package without contact with the surrounding atmosphere. In the evaporated milk plant this is accomplished through the use of a positive displacement pump, such as is shown in Figure 36, feeding a totally enclosed clarifier. This avoids exposure to outside contamination and at the same time serves as a dependable flow control. In factories with large volume the installation of two clarifiers, with by-pass connections, eliminates interruption of flow and operating delays occasioned by stopping the machine for emptying and cleaning the bowl.

#### REFERENCES

1. U. S. FOOD AND DRUG ADMINISTRATION: U. S. Dept. Agr. S.R.A., F.D. No. 2. Rev. 5. November, 1936.
2. EVAPORATED MILK INDUSTRY SANITARY STANDARDS CODE AND INTERPRETATIONS. Evaporated Milk Asso., Chicago, July, 1941.
3. SOMMER, H. H.: Wis. Agr. Expt. Sta. Res. Bul. 127. 1935.
4. FLEMING, R. S., AND NAIR, J. H.: Jour. Dairy Sci. IV. 536. 1921.
5. SOMMER, H. H., AND HART, E. B.: Jour. Dairy Sci. IV. 7. 1921.
6. HUNZIKER, O. F.: Observation in Some South American Countries 1942.
7. AYERS, S. H.: U. S. Dept. Agr. Bul. 202. 1915.
8. SOMMER, H. H., AND BINNEY, T. H.: Jour. Dairy Sci. VI. 176. 1923.
9. DAHLBERG, A. O., AND GARNER, H. S.: U. S. Dept. Agr. B.A.I. Bul. 944. 1921.
10. RAMSDALL, G. A., JOHNSON, W. T., AND EVANS, F. R.: Jour. Dairy Sci. XIV. 93. 1931.
11. HOLM, G. E., GREENBANK, G. R., AND DEYSHER, E. F.: Jour. Dairy Sci. IX. 512 (1926).
12. DAHLE, C. D., AND JOSEPHSON, D. V.: Milk Plant Monthly. 32. p. 28. 1943.

## CHAPTER XIII

### MANUFACTURE OF SWEETENED CONDENSED MILK

#### DEFINITION, INTAKE AND STANDARDIZATION

**Definition.**—Sweetened Condensed Milk is cow's milk condensed at a ratio that ranges between about  $2\frac{1}{3}$  and  $2\frac{3}{4}$  : 1, averaging approximately  $2\frac{1}{2}$  : 1. It contains some added sucrose and may contain added dextrose. The added sugar averages approximately from 40 to 45 per cent of the composition of the finished product.

The U. S. Federal Standard prescribes that sweetened condensed milk must contain not less than 8.5 per cent milk fat and not less than 28 per cent total milk solids. The British Standard calls for not less than 9.2 per cent milk fat and 31.0 per cent total milk solids. During World War II "Over-Standard" sweetened condensed milk was developed with an approximate composition of 9.5 per cent fat, 33.5 per cent total milk solids, and 42.0 per cent sucrose.

Sweetened condensed milk reaches the market in hermetically sealed tins intended for the consumer retail trade, and in bulk packed in fluid milk shipping cans, wooden barrels and steel drums intended for the prepared food industry. The smallest package of uncompressed commercial sweetened condensed milk is the "Army jam tin" for ration C, holding two ounces of over-standard sweetened condensed milk for use as the milk and sugar component of a canteen cupful of coffee in Army Combat Rations.

**Survey of Flow Line.**—The equipment required and the flow of the milk from weigh tanks on milk receiving platform to filling machine for finished product are diagrammatically illustrated in Fig. 37. The assemblage of equipment shown is not intended to be complete in every detail of accessories, nor is each apparatus contained therein necessarily most suitable in type, size and arrangement under all conditions. It does provide, however, a general survey of a practical "line-up" of equipment adapted to the manufacture of sweetened condensed milk.

From weigh tanks (A) the fluid milk flows over cooler (B) into holding tanks (C) where it is standardized to the desired proportion of per cent fat and solids-not-fat. It may be found desirable to install a milk filter or clarifier between weigh tanks and cooler. From the holding tanks the standardized milk is pumped by pump (E) into milk supply tank (D) from which it flows by gravity through forewarmers (F) and (G) into sugar mixer (H). From the sugar mixer (H) the milk enters vacuum pan (I) and the condensed milk drops through sampling valves (K) into drop tanks (L) where it may be standardized for total solids. These drop tanks



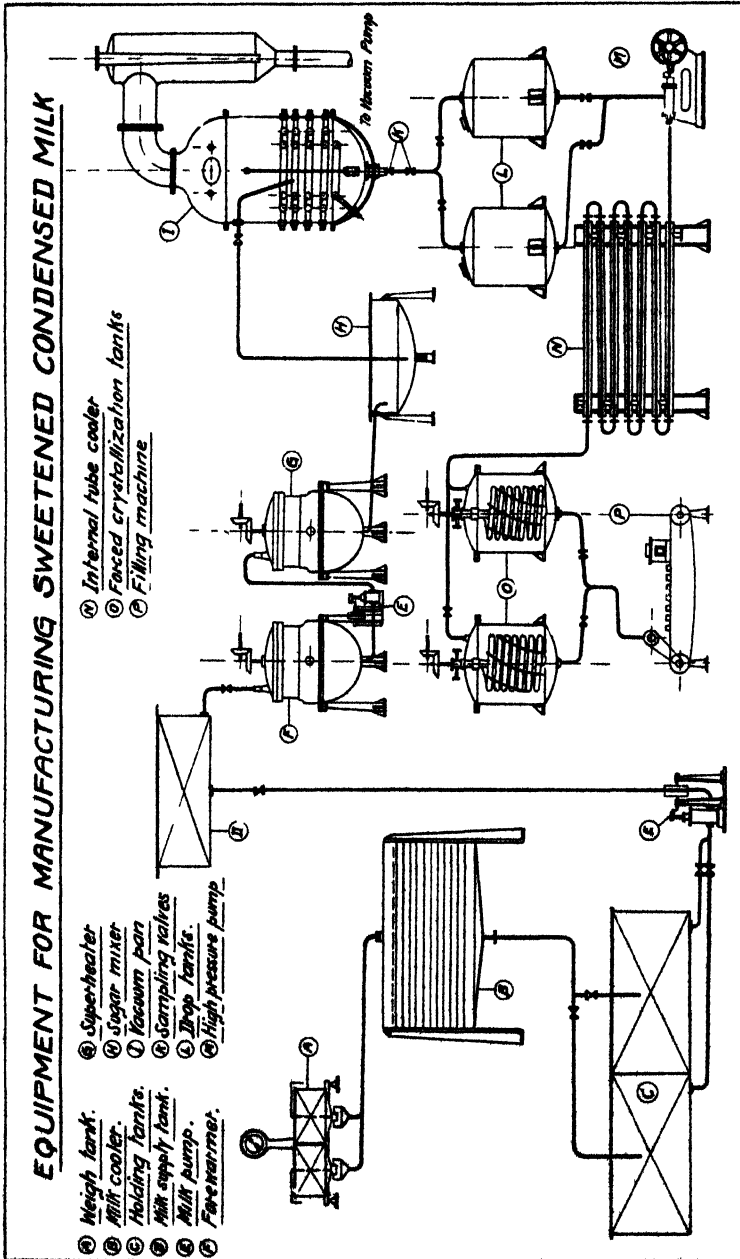

Fig. 37. Flow-sheet for manufacture of sweetened condensed milk  
 (Courtesy of A. W. Raumann)

might conveniently rest on scales so as to facilitate the determination of the exact weight of each batch.

The standardized sweetened condensed milk is then forced by pressure pump (M) through cooling coils (N). The cooling coils are either of the internal-tube cooler type, similar to an ammonia condenser, or they may be submerged in a tank through which the cooling water circulates. The cooling coils discharge the condensed milk into the forced-crystallization

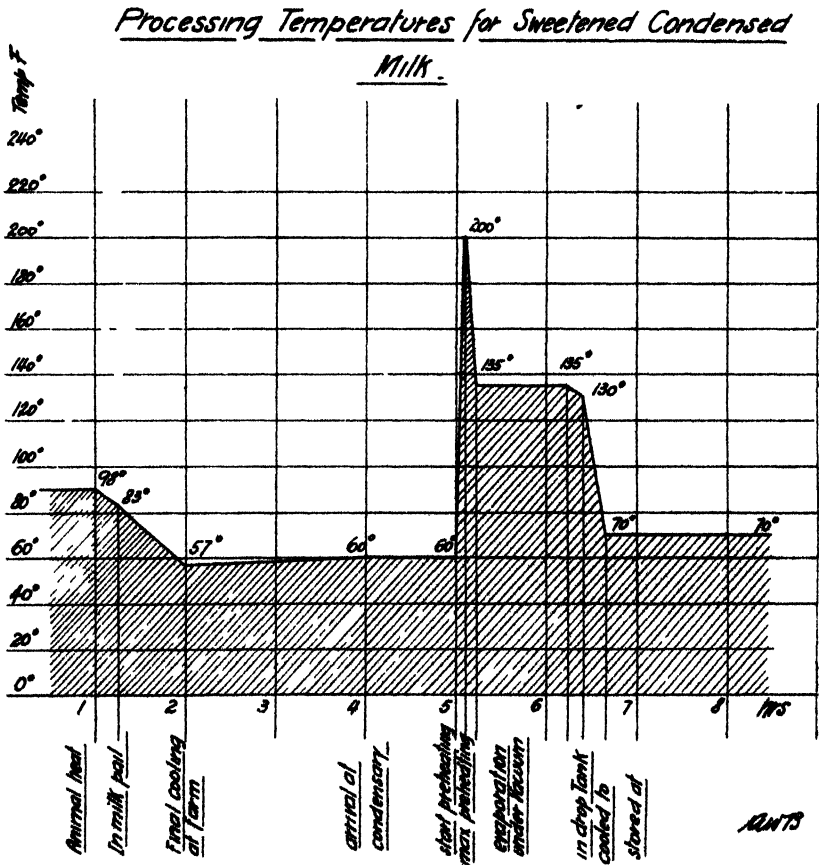

Fig. 38. Sweetened condensed milk temperature flow-sheet  
Courtesy of A. W. Baumann

tanks (O) and from here it drops into the filling machine (P) where the tins are filled and sealed. The temperatures to which the milk is exposed in its journey from cow to sealed tin are shown in graph Fig. 38.

**Weighing, Filtering, Cooling and Standardizing the Fluid Milk.**—The fluid milk, after inspection on the receiving platform, is “dumped” through

milk strainers into the weigh tanks on scales. Here each patron's milk is sampled for fat test, weighed and then filtered over a cooler and run into holding tanks. These tanks, as soon as filled, are sampled, the percentages of fat and solids-not-fat are determined and the milk is standardized to the desired proportion of fat to solids-not-fat as described below.

#### STANDARDIZING

In the manufacture of sweetened condensed milk standardization to a definite percentage composition is done in three separate steps. The first standardization establishes the desired ratio of fat to solids-not-fat; the second standardization establishes the desired ratio of added sugar to total milk solids, and the third step adjusts the concentration of the finished product to the desired percentage of total solids.

**Sampling and Testing the Batch of Fresh Milk.**—For correct standardization it is necessary to know, by accurate determination, the percentages of butter fat and total milk solids of the available milk that is to be standardized, and of the available milk products such as cream and skim-

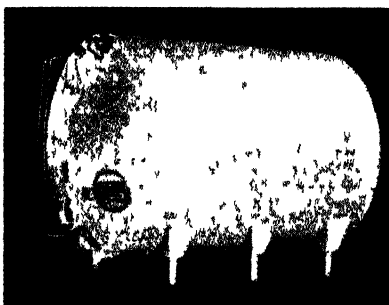

Fig 39 Fluid milk storage tank  
Courtesy of Cherry Burrell Corporation

milk, et cetera, that will be used for standardization. This, in turn, requires the taking of samples that are truly representative of the composition of the respective products.

In plants that forewarm by the batch system, as is the case in the majority of the condenseries that manufacture sweetened condensed milk, a sample of uniform size may be secured from each forewarmer full of milk. If taken from thoroughly agitated milk, a reasonably representative sample is practically assured. In plants where the forewarming before condensing is done and completed by the continuous flow system of heating, a drip sample may be collected. Usually a small petcock is installed in the pipe between weigh tank and fluid milk storage tank. The petcock should be so adjusted as to insure a uniform, moderate rate of drip. The drip is collected in a suitable receptacle such as a milk can. When all the milk of one pan batch has passed the drip, the milk in the can is thoroughly mixed and sampled for immediate analysis.

In factories with relatively large volume it is customary to provide numerous storage tanks for the fluid milk and to standardize the milk contained in each tank separately. These tanks are equipped with agitators, and the sample is taken from the agitated milk as soon as each tank is full. Some of these tanks have a sampling device in the manhole cover. With thorough and sufficiently sustained agitation it is thus possible to secure a reasonably representative sample from the fresh milk storage tank.

The sample is tested for percentages of fat and total solids. In this country as well as in many countries abroad, this is done almost exclusively by the use of Mojonnier Tester. Complete directions for making the Mojonnier test are supplied by the manufacturer of the tester and may also be found in "Technical Control of Dairy Products" by Mojonnier and Troy.<sup>1</sup>

**First Standardization.**—The fresh milk is standardized to the ratio of fat to solids-not-fat (SNF) desired in the finished product. The SNF in the whole milk varies in the same direction as the fat, but to a lesser extent. The relation of fat to SNF of milk produced in the United States and Canada has been studied by Overman, Sanmann and Wright,<sup>3</sup> Kelly and Clement,<sup>2</sup> and Jacobson.<sup>4</sup>

The most recent work done appears to be the extensive investigation undertaken in the laboratories of the Whiting Milk Companies, Boston, Mass., under the supervision of Jacobson.<sup>4</sup> This investigator tabulated the analyses for fat and total solids of more than 100,000 samples of milk over a period of sixteen months. These samples came from milk produced in the six New England States. The samples were taken from the milk of individual cows, of herds, and of mixed milk representing all breeds and grades of cows. The butter fat was determined by both the Babcock test and the Mojonnier test; the total solids by gravimetric analysis; the solids-not-fat by difference.

Jacobson found that, while small seasonal variations do occur, yet for each increase of 0.1 per cent in butter fat, there is a uniform increase of 0.04 per cent in solids-not-fat. It is interesting to note here that this is approximately the same value as shown for all samples of Illinois milk analyzed by Overman, Sanmann and Wright,<sup>3</sup> as calculated and reported by Roadhouse and Henderson.<sup>5</sup>

While some differences in the relation of fat to SNF, due to season, breed, and individual, have been found to occur, yet the findings of Jacobson suggest that the tabulation of his results, as reproduced here in Table 30, provides reasonably dependable SNF figures for use in calculations for the standardization of mixed milk in the plant.

**Calculation of SNF in Skimmilk.**—The last column to the right in Table 30 gives the per cent SNF in the skimmilk (so-called serum) portion of

TABLE 30.—RELATION OF FAT TO OTHER SOLIDS IN  
PRODUCERS' MILK, NEW ENGLAND STATES<sup>4</sup>

Fat	Solids-Not-Fat	Total Solids	Solids-Not-Fat in Skim milk Portion
F Per cent	SNF Per cent	TS Per cent	SNF Per cent
2 80	8 19	10 99	8 42
2 90	8 23	11 13	8 47
3 00	8 27	11 27	8 52
3 10	8 31	11 41	8 57
3 20	8 35	11 55	8 62
3 30	8 39	11 69	8 67
3 40	8 43	11 83	8 73
3 50	8 47	11 97	8 78
3 60	8 51	12 11	8 83
3 70	8 55	12 25	8 88
3 80	8 59	12 39	8 93
3 90	8 63	12 53	8 98
4 00	8 67	12 67	9 04
4 10	8 71	12 81	9 09
4 20	8 75	12 95	9 14
4 30	8 79	13 09	9 19
4 40	8 83	13 23	9 24
4 50	8 87	13 37	9 29
4 60	8 91	13 51	9 34
4 70	8 95	13 65	9 40
4 80	8 99	13 79	9 45
4 90	9 03	13 93	9 50
5 00	9 07	14 07	9 55
5 10	9 11	14 21	9 60
5 20	9 15	14 35	9 65
5 30	9 19	14 49	9 70
5 40	9 23	14 63	9 75
5 50	9 27	14 77	9 81
5 60	9 31	14 91	9 86
5 70	9 35	15 05	9 91
5 80	9 39	15 19	9 97
5 90	9 43	15 33	10 02
6 00	9 47	15 47	10 07

the respective whole milk. These calculations are based on the assumption that the process of separation of cream from milk does not alter the distribution of solids in the non-fat portion of milk. There is only very limited published experimental evidence on this question.<sup>6</sup>

With the percentages of fat and SNF of the whole milk known, the SNF in the skimmilk portion is determined by the following calculation:

$$\frac{\text{SNF in whole milk}}{100 - \text{fat in whole milk}} \times 100 = \% \text{ SNF in skimmilk}$$

EXAMPLE:

On hand milk containing 3.8% fat and 8.59% SNF. (See Table 30.)  
What is % SNF in skimmilk?

ANSWER:

$$\frac{8.59}{100 - 3.8} \times 100 = 8.93\% \text{ SNF in skimmilk.}$$

**Calculation of SNF in Cream.**—In case cream is used for standardizing the milk, the percentage of SNF of the cream is calculated on the assumption of absence of any change in the distribution of SNF in the skimmilk portion of the original milk. The calculation, therefore, is as follows:

$$\frac{100 - \text{fat in cream}}{100} \times \text{SNF in skimmilk} = \% \text{ SNF in cream.}$$

EXAMPLE:

On hand 3.8% milk, 40% cream is separated, the skimmilk contains 8.93% SNF. (See Table 30.) What is % SNF in the cream?

ANSWER:

$$\frac{100 - 40}{100} \times 8.93 = 5.358\% \text{ SNF in the 40\% cream.}$$

**Correcting Fat Shortage of Batch.**—Fat shortage is here corrected by the addition of cream.

EXAMPLE 1:

Wanted: 8.55% fat and 28% total milk solids in finished product.

On hand: 100,000 lbs. milk, fat 3.6%, total solids 12.11%, 40% cream.

How much 40% cream must be added to provide the desired ratio of fat to SNF?

ANSWER:

The finished product must contain 28 — 8.55 or 19.45% SNF. The ratio of fat to SNF desired is  $\frac{19.45}{8.55}$ , or 0.4395 : 1. Thus, for each per cent or pound of SNF there must be 0.4395 per cent or pound of fat.

The milk on hand contains 12.11 — 3.6 or 8.51% SNF. Hence, the fat content should be  $8.51 \times 0.4395$  or 3.74% fat. The fat deficiency, therefore, is 3.74 — 3.60 or 0.14% fat, amounting to a total fat deficiency of  $\frac{0.14}{100} \times 100,000$  or 140 lbs. This fat shortage is made up by the addition of the correct amount of 40% cream.

However, cream contains also SNF. Table 30 shows that the skimmilk portion of 3.6% milk contains 8.83% SNF. Therefore, 40% cream contains

$$\frac{100 - 40}{100} \times 8.83 = 5.3\% \text{ SNF.}$$

Hence, in order to attain the desired ratio of fat to SNF, it is necessary to reserve  $5.3 \times 0.4395$ , or 2.33% fat to balance the SNF added with the cream. This then leaves the fat available in the cream only 40 — 2.33, or 37.67% fat to cover the fat shortage of 140 lbs., and requires the addition of  $\frac{140}{37.67} \times 100$  or 372 lbs. of cream.

In order to have in the finished product the desired ratio of fat to solids-

not-fat, it is necessary to add 372 lbs. of 40% cream to the 100,000 lbs. of 3.6% milk.

**PROOF:**

	Fat lbs.	SNF lbs.
100,000 lbs. milk, 3.6% fat, 8.51% SNF	3600	8510
<u>372 lbs. cream, 40% fat, 5.3% SNF</u>	<u>148.8</u>	<u>19.7</u>
100,372 lbs. standardized milk containing	3748.8	8529.7
Ratio of Fat to SNF in standardized milk =	$\frac{3748.8}{8529.7}$	= 0.4395 : 1
Ratio of Fat to SNF desired		= 0.4395 : 1

**Use of Formula.**—The necessary calculations are simplified by the use of the following formula instead of the itemized procedure given above:

$$C = \frac{(\text{SNF} \times R_1) - F}{F_1 - (\text{SNF}_1 \times R_1)} \times M, \text{ in which}$$

C is lbs. 40% cream to add. M is milk on hand.

F is % fat in milk on hand.  $F_1$  is % fat in cream.

$R_1$  is ratio of fat to solids-not-fat desired.

SNF is % solids-not-fat in milk on hand.

$\text{SNF}_1$  is % solids-not-fat in cream from this milk.

$\text{SNF}_2$  is % solids-not-fat in skimmilk from this milk.

$$\text{Therefore, } C = \frac{\left( 8.51 \times \frac{8.55}{19.45} \right) - 3.6}{40 - \left( 5.3 \times \frac{8.55}{19.45} \right)} \times 100,000, \text{ or}$$

$$\frac{(8.51 \times 0.4395) - 3.6}{40 - (5.3 \times 0.4395)} \times 100,000 = 372 \text{ lbs. 40\% cream to add.}$$

**Correcting Fat Surplus of Batch.**—The fat surplus is here corrected by the addition of skimmilk.

**EXAMPLE 2:**

Wanted: 8.55% fat and 28% total milk solids in finished product.

On hand: 100,000 lbs. milk, fat 4.2%, TS 12.95%.

Skimmilk: Testing 0.05% fat.

How much skimmilk must be added to provide the desired ratio of fat to SNF?

**ANSWER:**

The ratio of fat to solids-not-fat desired in the finished product is  $\frac{8.55}{28 - 8.55}$  or 0.4395 : 1. The SNF content of the fresh milk is 12.95 — 4.2 or 8.75% SNF. With a fat content of 4.2% the SNF in the milk must be  $\frac{4.2}{0.4395}$ , or 9.556%. Hence, there is a deficiency of SNF of 9.556 — 8.75, or 0.806%. This SNF deficiency is to be made up by the addition of skimmilk. Table 30 shows that skimmilk separated from 4.2% milk contains 9.14% SNF.

But this skimmilk also contains 0.05% fat. We are thus adding fat as well as SNF. We must therefore reserve  $\frac{0.05}{0.4395}$  or 0.1138% SNF to balance the 0.05% fat contained in the added skimmilk. This then leaves only 9.14 — 0.1138, or 9.026% SNF available to cover the SNF shortage of 806 lbs. The amount of skimmilk needed, therefore, is  $\frac{806}{9.026} \times 100$ , or 8930 lbs.

In order to have in the finished product the desired ratio of fat to SNF, 8930 lbs. of skimmilk must be added to the 100,000 lbs. of 4.2% milk.

PROOF:

	Fat lbs.	SNF lbs.
100,000 lbs. milk, fat 4.2%, SNF 8.75%	4200	8750
8,930 lbs. skimmilk, fat 0.05%, SNF 9.14%	4.5	816.2
108,930 lbs. standardized milk, containing	4204.5	9566.2

Ratio of Fat to SNF in standardized milk is  $\frac{4204.5}{9566.2} = 0.4395 : 1$

Ratio of Fat to SNF desired = 0.4395 : 1

Use of the following formula instead of the above procedure will simplify the necessary calculations of Example 2:

$$S = \frac{F}{\frac{SNF_2}{R_1} - F_2} \times M, \text{ in which}$$

S is lbs. skimmilk to add. M is lbs. milk on hand.

F is % fat in milk.  $F_2$  is % fat in skimmilk.

$R_1$  is ratio of fat to solids-not-fat desired.

SNF is solids-not-fat in milk on hand.

$SNF_2$  is solids-not-fat in skimmilk from above milk.

$$\text{Therefore, } S = \frac{4.2}{\frac{0.4395}{9.14 - 0.05} - 8.75} \times 100,000, \text{ or}$$

$$\frac{9.556 - 8.75}{9.14 - 0.1138} \times 100,000 = 8930 \text{ lbs. skimmilk to add.}$$

#### REFERENCES

1. MOJONNIER, T., AND TROY, H. C.: The Technical Control of Dairy Products. 1922.
2. KELLY, E., AND CLEMENT, C. E.: Market Milk. Second Edition. 1931.
3. OVERMAN, O. R., SANMANN, F. R., AND WRIGHT, K. E.: Ill. Agr. Expt. Sta. Bul. 325, 1929.
4. JACOBSON, M. S.: Jour. Dairy Sci., XIX, 3, 171, 1936.
5. ROADHOUSE, C. L., AND HENDERSON, J. L.: The Market Milk Industry; 20, 1941.
6. SANMANN, F. P., AND OVERMAN, O. R.: Creamery and Milk Plant Monthly XVI, 4, 52, 1927.



## CHAPTER XIV

### FOREWARMING AND ADDITION OF SUGAR

#### FOREWARMING

The standardized milk is now ready to be forewarmed preparatory to condensing.

**Purpose of Forewarming.**—Forewarming is necessary to accomplish the following three major purposes:

1. To make possible satisfactory operation of the vacuum pan. The milk must enter the pan at a temperature at or above the operating temperature of the vacuum pan. This is necessary to insure uninterrupted boiling, maximum rapidity of evaporation and freedom from heat damage to the milk. See also "Vapor Space," Chapter VII.

2. To insure freedom of the finished product from germs and viruses of milk-borne diseases, and from quality-jeopardizing yeasts, molds and milk enzymes. The pan operating temperature lies approximately within the range of 120 to 135° F. which is inadequate to accomplish the above purpose. In the manufacture of sweetened condensed milk, forewarming provides the only processing temperature capable of controlling the attributes of a safe and marketable product.

3. To provide an effective means of controlling objectionable age thickening.

**Temperature of Forewarming.**—In condensery practice the forewarming temperatures used in the manufacture of sweetened condensed milk extend over a wide range, such as from pasteurization by the holding process at about 145° F., for 30 minutes, to approximately 120° C. (248° F.), and in some instances to around 300° F. In the United States the forewarming temperatures most commonly used fall within the approximate range of 180° F. up to boiling, with a usual time-exposure of about 10 to 30 minutes.

**Destruction of Disease Germs.**—As far as the possible presence of the germs and viruses of recognized milk-borne diseases is concerned, such as diphtheria, typhoid fever, tuberculosis, scarlatina, septic sore throat, and undulant fever, even the lowest temperature of the above forewarming range (145° F. for 30 minutes) appears to provide an adequate margin of safety.

**Inactivation of Enzymes.**—The heat treatment that is necessary to inactivate the milk enzymes is discussed in Chapter XXXI, on "Enzymes." It is shown that the presence in milk at forewarming time of considerable added sugar increases the resistance of enzymes to heat. It is further shown that in order to dependably protect sweetened condensed milk from quality-jeopardizing milk enzymes, it is necessary to use forewarming temperatures of 180° F. or higher.

In order to accomplish total inactivation of milk enzymes when the time-temperature ratio of forewarming is normally adequate, there must be complete absence of leaks of raw milk into the forewarmed milk. Rice<sup>1</sup> found that even a very small amount of raw milk (as little as 0.3% of the original whole milk) was sufficient to produce rancidity. Leaks of raw milk into the forewarmed milk are usually due to leaky valves and leaky fittings between raw milk storage tank and vacuum pan.

**Destruction of Yeasts and Molds.**—The microorganisms damaging to quality that are capable of thriving in the high sugar concentration of normal sweetened condensed milk are gas-forming yeasts of the *Torula lactis condensis* type<sup>7</sup> and "button-" forming molds of the *Aspergillus repens* type.<sup>8</sup> The thermal death point of either of these forms of germlife is well below 180° F.

**Effect on Age Thickening.**—This subject was studied experimentally by Leighton and Deysher,<sup>4</sup> Stebnitz and Sommer,<sup>5, 6</sup> and Hunziker.<sup>20</sup> The forewarming temperature is one of the most important steps in the manufacture of sweetened condensed milk from the standpoint of control of age thickening. It affects the fluidity stability as follows:

1. Forewarming temperatures within the approximate range of 75 to 60° C. (167 to 140° F.) definitely diminish viscosity and the thickening tendency. Below 150° F. there is danger of age thinning that causes fat separation, and that invites sugar deposit unless the lactose crystals average well under 10 microns in length and are of reasonably uniform size. These low temperatures are not recommended for case goods. (See "Requirements for Case Goods" later.)

2. Forewarming temperatures within the approximate range of 80 to 100° C. (176 to 212° F.) increase the age thickening tendency. This effect is only slight at 176° F., but it becomes very definite at 185° F. It is most intense within the range of 95 to 100° C. (203 to 212° F.)

3. Forewarming temperatures above the boiling point decrease the age thickening tendency. When heating by means of metal heating surfaces, such as are contained in the tubular heater or the steam-jacketed pressure tank, temperatures within the range of 110 to 120° C. (230 to 248° F.) are usually sufficient to control age thickening during the season (late spring and early summer) when milk is the least stable. Temperatures higher than the above range tend increasingly toward age thinning.

4. Forewarming by the use of live steam tends in the direction of superheating. The character of the effect is similar to that of superheated condensed (unsweetened), i. e., it causes hydration and swelling of the proteins. However, in the case of forewarming, the effect of the superheat is much less severe, because here we are dealing with the "fresh milk," while in the case of the "superheated condensed milk," the concentrated product is subjected to the superheat. Yet, even in the case of fresh milk, treatment with live steam has an unstabilizing effect and

causes the finished product to react in the direction of age thickening. Thus, while forewarming at say 300° F. definitely causes age thinning, finishing the upper 30° F. of heating with live steam prevents age thinning.

**Forewarming Temperatures Suitable for Bulk Goods.**—It appears the part of wisdom to standardize on a forewarming temperature sufficiently high to insure the destruction of the ferments that may be present in the milk. Therefore, at the time of the year when the milk is naturally stable (late fall, winter and early spring), temperatures of 190 to 212° F. are recommended. The same recommendation also holds for bulk goods manufactured at any time of the year, that are intended for quick consumption purposes, such as may be provided by the local or domestic market for use in prepared food factories. Some of these industries, in fact, prefer a heavy bodied, slightly age-thickened product to one of greater fluidity.

**Forewarming Requirements for Case Goods.**—This trade, whether domestic or export, requires a product of uniform, good body and stabilized fluidity. In addition, absence of deterioration due to bacterial or enzymatic causes is an indispensable necessity. Hence, the temperature of forewarming must be sufficiently high to eliminate with certainty the presence of quality-jeopardizing ferments. (See Chapter XXXI on "Micro-organisms and Enzymes.") This means that the lowest temperatures permissible are those approaching the boiling point. Withal, the forewarming temperature must be so chosen that it will contribute to the permanent stability of viscosity by dependably preventing both objectionable age thickening and objectionable age thinning. This further means that, during the season of relative instability, forewarming temperatures well above the boiling point should be used. As the seasonal instability diminishes and gradually gives way to seasonal stability, the forewarming temperature need be lowered gradually until, at the height of seasonal stability, it has dropped to, or slightly below, the boiling point.

**Effect of Holding at Forewarming Temperatures.**—Available data are meager regarding the stabilizing effect of the time factor of forewarming. Published information on the optimum holding time is lacking. Stebnitz and Sommer's<sup>6</sup> results showed a very slight stabilizing effect on unstable milk, while stable milk tended to be unstabilized by prolonged holding (15 to 30 minutes) at the forewarming temperature. Holding even for a short period at least insures the attainment of the same temperature by all the milk of the same batch. A 10-minute holding period appears ample for this purpose. At the higher forewarming temperatures (above 212° F.) it may be necessary to drop the holding temperature somewhat (about 5° to 10° F.) to guard against objectionable discoloration.

A definite stabilizing effect is also attained by momentary heating to forewarming temperatures much higher than those previously discussed, even as high as 300° F. This can be done without damage to color

(darkening) by quick heating, circulating the milk at high velocity through a tubular pressure heater, and finishing the top 20 to 30° F. by injection of live steam under pressure.

**Equipment and Methods of Forewarming.**—The several systems of forewarming used may be conveniently grouped as follows:

- |  |   |   |
|--|---|---|
| 1. Heating in the hot well   | } | By injection of live steam<br>With steam jacket supplemented by live steam  |
| 2. Continuous-flow heaters, heating to near 212° F. or below, with or without retarding hot well or timing tank. | } | With flash pasteurizer supplemented by live steam<br>Plate heat exchanger<br>Single-pass tube heater<br>Recirculation tube heater<br>Multi-velocity tube heater |
| 3. Forewarming by heating to temperatures above 212° F.  | } | Closed pressure tank<br>Tubular pressure heater<br>Live steam injector  |

**The Hot Well.**—The original forewarmer was the copper hot well, standardized to hold approximately 2500 pounds when one-half full, in which

Fig. 40. Fully closed hot well

1. Thermometer
2. Milk inlet
3. Steam inlet
4. Manhole cover
5. Steam rosette
6. Milk outlet

Courtesy of Arthur Harris & Co.

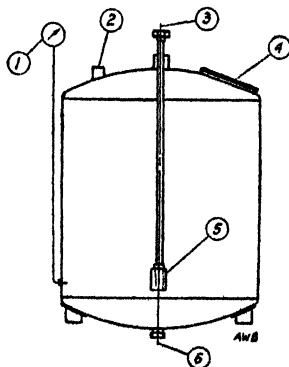

the heating was done by injection of live steam into the milk. The steam injection was continued until the milk began to foam up and threatened to splash over. At that point the temperature is approximately 208 to 210° F. At least two forewarmers were used with each vacuum pan, so as to provide a constant supply of forewarmed milk for the pan.

From the standpoint of factory operating economy, this method of heating has proved inefficient and uneconomical, as explained in Chapter IX on "Steam Requirements."

The hot well with live steam injector was later superseded in many condenseries by the hot well with steam jacket and rotating agitator. This forewarmer lowered the requirements of steam and water, but it prolonged the bringing-up time, especially when approaching the higher

temperatures. This led to the practice of heating with the steam jacket to about 170° F. and finishing the heating to boiling by live steam injection. Formerly the hot well was an open kettle. The newer hot wells are closed kettles with covered manhole on top.

**Continuous - Flow Heaters.**—Almost simultaneously continuous - flow heaters of the flash pasteurizer type also came into use for forewarming. In this case the hot milk from the flash pasteurizer was discharged into

Fig 41 Plate heat exchanger  
Courtesy of Cherry Burrell Corporation

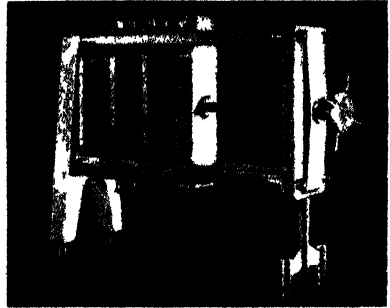

hot wells and heating to near the boiling point was completed by direct steam injection. Some manufacturers prefer to inject the live steam direct into the line between flash pasteurizer and hot well.

Still more recent improvement in heater construction for heating to near the boiling point eliminates the necessity of finishing the forewarming by direct steam injection. Among these heaters are single-pass heaters such as the plate heat exchanger and the single-pass tube heater, the recirculating, high-velocity tube heater, and the multi-velocity tube heater.

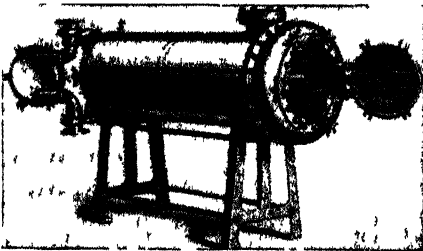

Fig 42 Peebles high-velocity preheater  
Courtesy of Anderson Baragrover Division

**Recirculating, High-Velocity Preheater.**—The milk flows back and forth six to eight times through a battery of parallel tubes enclosed in the heater shell. The velocity of milk flow through these tubes is 18 feet per second. The high velocity minimizes the danger of lactalbumin burning onto the tubes. When preheating from a starting temperature of 40° F. to a final temperature of 210° F., the average recirculating temperature is kept at about 170° F. These heaters are capable of raising the preheating temperature above the boiling point if desired.

**Multi-Velocity Type Single-Pass Preheater.**—This type of heater consists of three steam shells connected in a manner to effect a high steam velocity. The milk tubes are so arranged that the milk velocity gradually increases from four feet per second in the first shell, to 18 feet per second in the third shell. The multi-velocity feature reduces the pressure drop through the heater. Its high milk velocity in the high temperature zone minimizes the tendency of scorching. This heater permits milk to be preheated to 210° F. in a single pass through the heater.

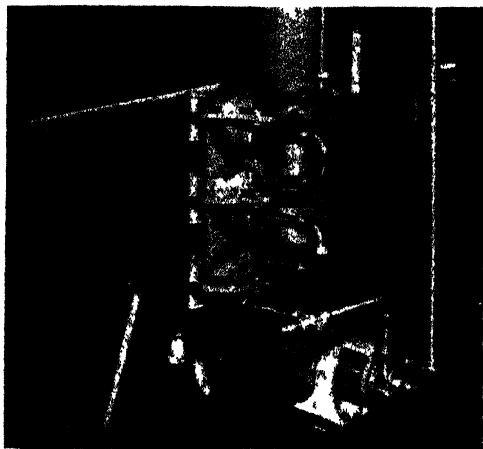

Fig 43 Baumann multi-velocity single-pass preheater

Courtesy of Arthur Harris & Co.  
(Patent Pending)

**Continuous-Flow Heater with Recirculating Hot Well.**—The continuous-flow heater has proven especially serviceable when used in combination with the recirculation hot well as shown in Fig. 65. The fresh milk from the whole milk storage tank, or the skim milk from the cream separator is pumped into the recirculating hot well. From its bottom outlet the milk is continuously circulated from hot well to continuous-flow heater and return. When the milk in the recirculating hot well has reached the desired forewarming temperature, the valve in the line to the holding hot well that supplies the vacuum pan is opened. Thus the hot milk of the recirculating hot well is continually recirculating through the continuous-flow heater with enough fresh, cold milk to take the place of the milk being by-passed into the vacuum pan.

**The Holding Hot Well or Timing Tank.**—The purpose of this part of the forewarming unit is to control the length of time during which the milk is held at the forewarming temperature.

In the case of the continuous-flow forewarmer with recirculating hot well, the duration of heat exposure can be accurately controlled by the installation of a holding hot well, as shown in Fig. 44. The size of this timing hot well should synchronize with the per hour evaporating capacity of the pan and the desired time of holding at the forewarmer tempera-

ture. Thus, if the pan has a capacity of 9,000 pounds of fluid milk per hour and it is intended to hold the milk at the forewarming temperature for 20 minutes, the holding hot well needs an operating capacity of at least  $\frac{9000}{3}$  or 3,000 pounds of milk.

Or, the recirculating hot well itself may serve also as retarding tank. In such case the size of this hot well should be sufficient, in relation to the per hour evaporative capacity of the vacuum pan, to insure the period of retarding desired.

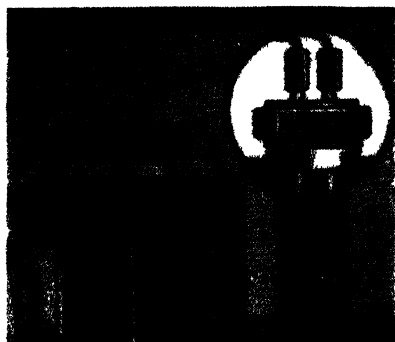

Fig. 44. Heater with Lactron liquid level control

Courtesy of Creamery Package Mfg. Company

**Equipment for Forewarming Milk to Temperatures Above the Boiling Point.**—Forewarming to temperatures above the boiling point by the use of the high-temperature, short-time process of heat treatment definitely improves the storage stability (prevents rapid age thickening) of sweetened condensed milk<sup>20</sup> and the heat stability of evaporated milk.<sup>11, 12</sup>

Either batch heaters or continuous-flow heaters may be used. The batch heater used for this purpose usually is a steam-jacketed, closed pressure tank with rotating agitator. It must be of sufficiently heavy construction to withstand at least 10 lbs. pressure per square inch. The continuous-flow heater for temperatures above the boiling point is of the tubular type such as the Peebles high velocity heater, the Harris high velocity preheater, the Mallory heat exchanger, and the Chester Ste-vac milk heater. Also, the heating may be finished, or done exclusively, by injection into the milk in continuous flow, of live steam under pressure. For description of equipment and methods used for heating above the boiling point, see Chapter XIX under "Forewarming of Evaporated Milk".

#### ADDITION OF SUGAR

**Purpose.**—Sugar is added to the milk for the purpose of preserving the condensed milk without resorting to sterilization by heat. The sugar used, therefore, must have known preservative properties. It must not be readily fermentable. It must have the power of inhibiting the activity

of the germ life normally contained in the finished product, when present in solution in such concentration as is suitable for a marketable sweetened condensed milk. Its solubility at the required concentration must be sufficient to avoid supersaturation and crystallization within the usual temperature range to which the condensed milk may be subjected between factory and consumer. The sugar used must convey to the milk a flavor that is pleasing to the palate of the consuming public. The sugar that has proved most suitable for this purpose is sucrose.

**Sucrose.**—Sucrose, or saccharose,  $C_{12}H_{22}O_{11}$ , when properly refined, ferments with difficulty in concentrated solution. It has the power of retarding or inhibiting the growth of bacteria and other organized ferments commonly present in sweetened condensed milk. It retains its solubility in the concentration required even at temperatures near the freezing point of water. Its flavor has the universal approval of the human palate.

The sucrose of commerce available to the milk condensery is highly refined cane sugar and highly refined beet sugar. As now manufactured, these two sugars are chemically identical. By no chemical test can the pure crystallized sugar from these two sources—the cane and the beet—be distinguished.<sup>13, 14</sup> They have been officially<sup>14</sup> declared equally valuable for canning and identical in their behavior when of the same fineness of crystallization.

**Dextrose.**—The use of corn sugar in sweetened condensed milk and in other food products in which sugar is a recognized element, without declaration on the label, was legalized by the Food and Drug Administration of the United States Department of Agriculture under date of December 26, 1930.<sup>15</sup> This concession places corn sugar within reach of the American manufacturer of sweetened condensed milk.

The possibilities and limitations of using refined corn sugar in the manufacture of sweetened condensed milk were first experimentally studied by Rogers,<sup>16</sup> Hunziker,<sup>17</sup> and Ramsey, Tracy and Ruehe.<sup>18</sup> The results on preservative power were not conclusive. Dextrose augmented the tendency to objectionable discoloration (darkening) and age-thickening. This danger was minimized, however, by adding the dextrose separately in concentrated solution in water near the end of the condensing period. Experience since those early trials has clarified somewhat the status of dextrose in sweetened condensed milk and skim milk.

The chief advantage of dextrose lies in its relative cheapness. In addition, it has certain recognized physical effects which some markets appear to desire. The ice cream maker claims that dextrose improves the texture of ice cream, making it smoother and more creamy, because dextrose crystallizes less readily and more slowly. The candy maker and confectioner favor dextrose because of the lesser tendency of their products to graininess. The verdict of consumer tests as to preference



of flavor between presence and absence of dextrose in ice cream showed no tangible difference; a great many individuals showed no preference either way, and where preferences did occur they were fairly evenly divided, as shown by the work of Corbett and Tracy.<sup>19</sup> Thus, in the case of sweetened condensed whole milk or sweetened condensed skim-milk intended for use in the manufacture of ice cream, candy or confections, substitution of a limited amount of the sucrose by dextrose appears practicable and free from objection. The approximate proportion of the two sugars in the condensed milk that has been found most suitable for such uses is  $\frac{3}{4}$  parts of sucrose and  $\frac{1}{4}$  part of dextrose.

For case goods, however, such substitution appears inadvisable. Condensed milk, containing added dextrose lacks the type of sweetness to which the consumer of sweetened condensed milk has become accustomed. In addition, dextrose greatly intensifies the tendency of sweetened condensed milk to rapid discoloration and age-thickening, especially when held at relatively high temperatures, such as room temperature or higher. Nor is there sufficient experimental evidence available to substantiate the theory that, because of its somewhat higher osmotic pressure, the preservative power of dextrose is at least equal to, if not greater than, that of sucrose. On the basis of our present information, the use of part dextrose in the manufacture of sweetened condensed case goods or bulk goods intended for direct consumption, appears unsafe and cannot be consistently recommended. The discussions relative to sweetened condensed milk will, therefore, refer to the use of sucrose only, unless otherwise stated.

**Quality and Care of the Sugar.**—Only the best quality of granulated sucrose is admissible. Low grade sucrose is an unsafe product for use in the manufacture of sweetened condensed milk. Such sugar may contain sufficient quantities of acid or invert sugar, or both, to invite damaging fermentation in the condensed milk.

Again, the sugar stock in the factory must be kept sealed in the original package and the barrels and sacks must be stored in a place that is kept clean and dry. This is important in order to prevent deterioration due to contamination and to absorption of moisture. The barrel provides more dependable protection than the sack. Sucrose has hygroscopic properties. In an atmosphere of high humidity it absorbs moisture rapidly. In damp storage it is prone to become lumpy, moldy, and even sour. In the absence of the above precautions, there is danger of gassy fermentation, causing complete destruction of the market value of the condensed milk containing such sugar.

Adulteration of the condensery sugar with foreign admixtures, such as white sand, white clay, starch, gypsum, powdered chalk, et cetera, is rare, and occurs usually only in the case of pulverized sugar. For detection of these and similar adulterants, add a spoonful of the suspicious sugar

to a glass of hot water. Pure sugar will dissolve completely, while most of the common adulterants and impurities are insoluble and settle to the bottom. The purchase of coarsely granulated sugar largely eliminates the danger of the presence of such adulterants. The condensery is no place for powdered sugar.

**Amount of Sugar.**—If the added sugar is to fulfill its intended purpose, it must be present in the condensed milk in such sugar-in-water concentration as will prevent bacterial spoilage. The sugar-in-water concentration in sweetened condensed milk will be referred to here as “the sugar ratio.” The “sugar ratio” is expressed in per cent. A 62.5 per cent sugar ratio means that the water present in the sweetened condensed milk contains 62.5 per cent of added sugar. On the basis of our present knowledge, a range in sugar ratio of 62.5 to 64.5 per cent is generally considered a reasonably safe range

A sugar ratio of 62.5 per cent is adequate to protect the product from age deterioration due to bacterial causes provided the milk is of good quality, is efficiently forewarmed, and that the practices in manufacture are sanitary. This sugar ratio will not, however, prevent the development of defects in condensed milk heavily contaminated with sucrose-fermenting yeasts, with molds, and with quality-damaging bacteria in highly invigorated form, nor is it sufficient to prevent age-thickening due to causes other than bacteria. Condenseries that are troubled with bacterial deterioration of their product will find a somewhat higher sugar ratio helpful.

However, given a range of sugar ratio of 62.5 to 64.5 per cent, the problem of control of damaging abnormal fermentation, is not so much a problem of exact sugar ratio as it is a problem of sanitation. Its successful and permanent solution lies primarily in relentless vigilance to prevent the causative contamination, through improved factory sanitation, and by proper adjustment and dependable control of the forewarming temperature.

Sugar ratios above 64.5 per cent should be avoided because such concentration approaches the point of sucrose saturation. This becomes objectionable if the condensed milk, between factory and consumer, happens to be stored or otherwise exposed to relatively low temperatures, such as near 32° F. or below. At these low temperatures the sugar status of such milk becomes one of sucrose supersaturation. Some of the sucrose that is then present in excess of saturation will tend to crystallize out, causing objectionable coarseness of texture (sandiness).

In the case of sweetened condensed bulk milk intended for certain purposes, it is frequently advantageous to have the fat, or the solids-not-fat, or both, higher than standard and the sugar lower. Thus, for example, a high-fat and low-sugar product of the following composition may be desired:

Milk fat .....	22%
Solids-not-fat .....	20%
Sugar .....	30%
Total solids .....	72%

Sugar ratio  $\frac{30}{30 + (100 - 72)} \times 100$  or 51.7 per cent.

At room temperature or above, this product would be subject to rapid age-thickening. However, if used while fresh, or if placed in cold storage (near 32° F.), the factor of damaging age-thickening is practically eliminated. Again, in the control of viscosity and age-thickening of sweetened condensed bulk milk it should be recognized that, in general (Government contracts excepted), the commercial user prefers goods on the heavy side to goods of subnormal viscosity.

**Second Standardization Calculations.**—The desired amount of sugar to add may be calculated on the basis of either the fat-sugar-ratio or the total milk solids-sugar-ratio desired in the finished product. The final results are obviously identical. Since accurate fat tests are more readily and usually more rapidly made, consideration of the fat-sugar-ratio appears preferable, except in the case of condensed skimmilk. See examples 1 and 2.

**EXAMPLE 1:**

(Calculated on basis of fat-to-sugar ratio.)

The standardized fluid milk contains 3.75% fat. Wanted, condensed milk containing 8.55% fat and 45% sugar. How much sugar must be added per 100 lbs. of fluid milk?

ANSWER:

$$Z = \frac{F}{F_s} \times Z_s, \text{ in which}$$

F is % fat in fresh milk.  $F_s$  is % fat in condensed milk.

Z is lbs. sugar to add per 100 lbs. fresh milk.

$Z_s$  is % sugar desired in condensed milk.

Therefore  $Z = \frac{3.75 \times 45}{8.55} = 19.74$  lbs., which is the amount of sugar that must be added for each 100 lbs. of fresh milk in batch.

PROOF:

$$\text{Ratio of concentration } \frac{F_s}{F} = \frac{8.55}{3.75}, \text{ or } 2.28 : 1$$

$$Z_s = Z \times 2.28 = 19.74 \times 2.28, \text{ or } 45\% \text{ sugar.}$$

The sweetened condensed milk contains 45% sugar.

**EXAMPLE 2:**

(Calculated on basis of milk-solids-to-sugar ratio.)

Skimmilk contains 9.09% total milk solids. Skim condensed must contain 24% total milk solids and 47.5% sugar. How much sugar must be added per 100 lbs. fluid skimmilk?

ANSWER:

$$Z = \frac{TS_2 \times Z_3}{TMS}, \text{ in which}$$

$Z$  is lbs. sugar per 100 lbs. skimmilk.  $Z_3$  is % sugar desired in skim condensed.

$TS_2$  is % total solids in skimmilk.  $TMS$  is % total milk solids in skim condensed.

Therefore,  $Z = \frac{9.09 \times 47.5}{24} = 18$  lbs., which is the amount of sugar that must be added for each 100 lbs. skimmilk in batch.

PROOF:

$$\text{Ratio of concentration} = \frac{TMS}{TS_2} = \frac{24}{9.09}, \text{ or } 2.64 : 1$$

$$Z_3 = Z \times 2.64 = 18 \times 2.64, \text{ or } 47.5\% \text{ sugar.}$$

**Method of Dissolving the Sugar and Addition to the Milk.**—The temperature and time of adding the sugar to the milk in the batch have a definite effect on keeping quality and physical stability (age-thickening) of the finished product.

The presence of added sugar in the fresh milk at the time of forewarming increases the heat resistance of the microorganisms and enzymes contained in the milk.<sup>6</sup> Unless the temperature of forewarming is sufficiently high and the holding time sufficiently long to compensate fully for the rise in thermal death point caused by the protective action of the added sucrose, the addition of the sugar during or prior to forewarming jeopardizes keeping quality because of the possible survival of flavor-damaging germ life and enzymes in the forewarmed milk.

Furthermore, the presence of added sugar in the milk at forewarming temperature decreases the physical stability and increases the tendency to age thickening of the finished product.<sup>6</sup> It is therefore recommended to dissolve the sugar in water at about 190° F. or above, making approximately a 60 per cent sugar solution and drawing this syrup into the pan separately during the condensing period. This eliminates the stability-weakening effect of sugar in the milk at high forewarming temperatures. For maximum stability improvement, the entrance of the sugar syrup into the pan may be deferred till near the end of the condensing period. If, under prevailing conditions, this procedure causes excessive thinness and danger of fat separation and lactose sediment, the sugar syrup should be added earlier during the condensing operation. (See Fig. 45.)

In the United States it is common practice to dissolve the sugar in the hot forewarmed milk. This is especially true in the case of sweetened condensed bulk milk intended for use in the manufacture of ice cream mix, confections, and other prepared foods. The special precaution of adding

the sugar in the form of a separately prepared syrup is confined largely to the manufacture of case goods, and especially those intended for the export trade. In order to insure freedom from chance foreign material, the sugar syrup may be passed through a pressure filter or a centrifugal clarifier. See also "Age Thickening," Chapter XXXII.

**Precautions When Using Dextrose.**—In case dextrose is used in the place of part of the sucrose, there is a definite tendency to early discoloration and age-thickening of the finished product, unless special attention is given to the manner of adding the dextrose. It was shown by Ramsey et al<sup>6</sup> that these defects are due to a peculiar action of dextrose on the casein, forming a protein-dextrose complex. The reaction in the milk is greatly intensified in the presence of high temperatures such as are used in forewarming. It is further enhanced by an alkaline condition.

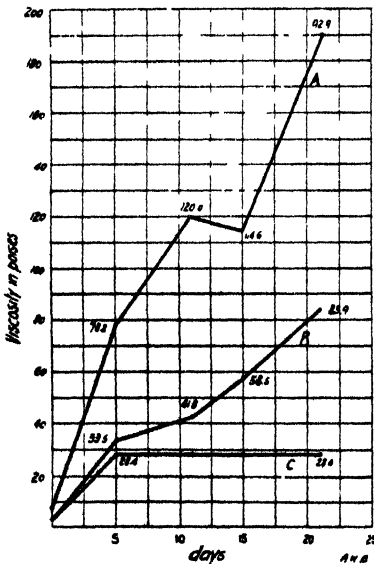

Fig 45 Effect of time of adding sugar computed from results of Stebnitz and Sommer<sup>6</sup>

- A—Sugar and milk forewarmed together
- B—Sugar and milk forewarmed separately, cooled to 135° F., then mixed together before drawing into pan
- C—Sugar added as a syrup near end of condensing period

The tendency of progressive thickening and discoloration of sweetened condensed milk containing dextrose can be largely avoided, as far as the effect of dextrose is concerned, by dissolving the dextrose in heated water, preferably making a 60 to 65 per cent dextrose-in-water solution, forewarming the fluid milk and the dextrose syrup separately, and drawing the latter into the vacuum pan separately near the end of the condensing period.

The preparation and forewarming of the dextrose syrup should be done in equipment that has been washed and rinsed completely free of milk remnants and of alkaline washing solutions. It is also important that the water used to make the syrup be on the acid side. In the case of hard water it is advisable to add a small amount of acid, such as acetic or hydrochloric acid, reducing the pH to approximately 6.8, in the Brom-Thymol-Blue test. For Brom-Thymol-Blue test, see Chapter XLVI.

**Use of Commercially Prepared Refined Liquid Cane Sugar.**—Liquid refined cane sugar is now available and is being used extensively in the manufacture of sweetened condensed whole milk, sweetened condensed skim, and in ice cream mix.

This sugar syrup has an approximate concentration of 65 per cent sucrose. It is derived from the crude cane sugar of the South. The crystallized crude sugar is centrifuged and washed to remove the bulk of its impurities and the syrup is filtered at its source. The filtered liquid sugar is free from visible extraneous material, though it may have a very slight amber color which is not objectionable for condensery purposes.

It is commonly transported in tank cars and tank trucks from which it is pumped into holding tanks in the condensery. When prepared in this form and manner it can be introduced into the pan via hot well with comparative absence of lint and dust, such as may accompany bag sugar. Its major advantages lie in lower cost of the sugar and in the economy and convenience of handling, such as absence of labor of handling and storage of granulated sugar, elimination of equipment for dissolving the sugar, ease of transfer from tank cars and tank trucks to condensery holding tanks.

The by-product or tailings of the preparation of liquid cane sugar is of dark color, similar to molasses. It is relatively free, however, from the flavor characteristics of molasses. It thus provides an economical and suitable sweetener of dairy products of naturally dark color, such as chocolate ice cream mix, chocolate milk drinks, etc.

#### REFERENCES

1. RICE, F. E.: *Jour. Dairy Sci.* IX. 293. 1926.
2. ASSOCIATES OF L. A. ROGERS: *Fundamentals of Dairy Science*, P. 30. 1935.
3. ROGERS, L. A., DEYSHER, E. F., and EVANS, F. R.: *Jour. Dairy Sci.* III. 468. 1920.
4. LEIGHTON, A., DEYSHER, E. F.: *Proceedings World's Dairy Congr.* II. p. 1276. 1923.
5. STEBNITZ, V. C., and SOMMER, H. H.: 27th Ann. Meeting Am. Dairy Sci. Asso. Abstracts. p. 48. 1932.
6. STEBNITZ, V. C. and SOMMER, H. H.: *Jour. Dairy Sci.* XVIII. 805. 1935.
7. HAMMER, B. W.: *Iowa Res. Bul.* 54. 1919.
8. THOM, C., and AYRES, S. H.: *Jour. Agri. Res.* VI. 1916.
9. MALLORY, W. E.: *Ann Arbor, Michigan. U. S. Patent No 2,270,540.* 1942.
10. COURTIS, J. W.: *Food Industries*, Sept. 1943.
11. WEBB, B. H., and BELL, R. W.: *Jour. Dairy Sci.* XXV. 301. 1942.
12. WEBB, B. H., BELL, R. W., DEYSHER, E. F., and HOLM, G. E.: *Jour. Dairy Sci.* XXVI. 572. 1943.
13. ABEL, MARY H.: *U.S.D.A. Farmers Bul.* 535. 1913.
14. G. W. SHAW: *Calif. Agr. Expt. Sta. Circ.* 33. 1907.
15. HYDE, A. H.: *U.S.D.A. Food and Drug No.* 2. 1931.
16. ROGERS, L. A.: *Information by Correspondence* (1924).
17. HUNZIKER, O. F.: *Experiments with Dextrose in the Manufacture of Sweetened Condensed Milk.* Results not published. 1931.
18. RAMSEY, R. J., TRACY, P. H., and RUEHE, H. A.: *Jour. Dairy Sci.* XVI. 17. 1933.
19. CORBETT, W. J., and TRACY, P. H.: *Illinois Agr. Expt. Sta. Bul.* 452. 1939.
20. HUNZIKER, O. F.: *Effect of High Forewarming Temperatures on Age-Thickening of Sweetened Condensed Milk.* Results not published. 1941-42.

## CHAPTER XV

### CONDENSING THE MILK

The milk is condensed to the desired concentration in the vacuum pan. The operation of the pan is discussed in detail in Chapter VIII. The present chapter deals with the "striking" of the batch, tests for determination of density, finishing and standardizing the batch to the desired percentage of total solids.

**Striking the Batch.**—The term "striking" refers to the drawing of a sample from the pan and testing it for density.

**The Pan Operator's Sentinels.**—When the boiling milk approaches the desired concentration, there are various indications that suggest to the experienced pan operator that the milk is nearly "done." The general behavior and appearance of the milk is characteristically different. The milk has "settled down" to a quiet boil. Its surface assumes a glossy, glistening lustre and there is a heavy roll from periphery towards center of the pan, forming a small "puddle" of foam in the center.

These observations are helpful sentinels to warn the operator as to the right time to "strike." However, their value is limited at best, depending much on his experience and judgment. They should not be looked upon as substitutes for sampling and testing the milk for density. The sampling should begin sufficiently early to permit of taking and testing several successive samples without risk of objectionable over-condensing. Attention to this precaution is especially important for beginners.

**Methods of Sampling.**—Numerous sampling devices have been developed, that make possible the rapid drawing of samples representative of the boiling milk in the pan without interrupting or disturbing pan operation. These samplers and their manipulation are described under "Condensed Milk Samplers", Chapter VII.

**Temperature of Sample for Density Tests.**—The result of the density test is influenced by the temperature of the sample at the time of the test. For accurate and comparable results, therefore, the adoption of a standard temperature is indispensable. Toward the end of the condensing period the pan temperature usually drops to near 120° F. The adoption of a standard testing temperature of 120° F. and the practice of finishing the batch at or near 120° F. have been found practical. The temperature of the sample used should be taken accurately.

It was shown in Chapter VIII, under "Pan Temperature", that neither the vapor thermometer nor the milk thermometer records the exact temperature of the boiling milk in the pan. For accurate density determinations, the temperature of the sample should, therefore, be taken at the time of the density test. If it varies several degrees Fahrenheit from 120° F., it should be adjusted to the standard temperature, or if this is not practicable,

the density readings should be corrected by applying the proper temperature correction factor. See "Temperature Correction of Baumé Reading" later in this chapter.

**Density Tests.**—The density tests that have been found most practical for use at the pan are: Judging density by appearance to the eye, the picnometer test, and the hydrometer test. These tests are described in succeeding paragraphs. Other density tests are the refractometer test and the viscosimeter test. The relatively high cost of some of the apparatus and the somewhat greater need of technical operating skill, is limiting them largely to laboratory checks. These tests are described in Chapter XLVI.

**Judging Density by Appearance to Eye.**—This is conveniently done by either of the following two methods:

1. A sample is drawn from the pan into a dipper transferred to a pail of ice water or snow. The condensed milk is quickly cooled to 70° F. by

Fig 46 Picnometer density tester  
(courtesy of Mojonmer Bros Co)



- stirring with a metal-back thermometer. The general appearance and the extent of "piling-up" in the dipper of the condensed milk when allowed to flow down from the raised thermometer is noted; or

2. A sample is drawn from the pan into a cup and examined at pan temperature. The milk is allowed to flow from a raised teaspoon held up against the light. The relative translucency of the milk and the rate of "piling-up" in the cup serve as indices of its relative density.

In the hands of operators skilled in the art, these methods provide a check that yields remarkably uniform consistency from batch to batch.

**Picnometer Test.**—This refers to the gravimetric determination of the density. For convenient and rapid operation of the viscous sweetened condensed milk, a special picnometer cup<sup>2</sup> holding 100cc., is used; see Fig. 46. This cup is constructed of copper. The tared picnometer cup is filled direct from the pan. The surplus milk and foam are scraped off the top and the outside is wiped clean. It is weighed on a beam scale having a sensibility reciprocal of 0.01 gram. The net weight divided by 100 gives the specific gravity.

**The Baumé Hydrometer.**—The hydrometer test is most commonly used for density tests of pan samples of sweetened condensed milk. The hy-



drometer scale may record the specific gravity direct, or it may consist of an arbitrary scale that bears a definite relation to the specific gravity. To these arbitrary scales belong the Baumé, Twaddell and Brix hydrometers. In American condenseries the Baumé scale is almost exclusively used. For sweetened condensed milk the usual Baumé scale ranges from 30 to 37° Bé. with subdivisions of one-tenth degrees.

**Temperature Correction Factor.**—If the temperature of the sample at the time of the density test varies from the adopted standard, the Baumé reading may be corrected to what it would be at the standard temperature by multiplying the temperature deviation by the factor 0.03 for each degree Fahrenheit of deviation. If the temperature of the sample is above the standard temperature, the product is added to the observed Baumé reading. If the temperature of the sample is below the standard temperature, the product is deducted from the observed Baumé reading.

**EXAMPLE:**

The standard temperature is 120° F. The temperature of the sample at the time of the Baumé reading was 130° F., and the reading was 32.1° Bé. What would the reading have been at 120° F.?

**ANSWER:**

$$32.1 + [0.03 \times (130 - 120)] = 32.4^\circ \text{Bé. at } 120^\circ \text{ F.}$$

It should be understood that the accuracy of the temperature correction is influenced by such factors as composition and concentration of the product. For most dependable results, the sample should be brought to the standard temperature adopted for density tests. The usual procedure is to set the hydrometer jar containing sample and hydrometer into a pail of water held at the standard temperature.

**Formula for Calculating the Correct Baumé Reading.**—The pan operator who is striking batches daily knows from experience what the Baumé reading of the next batch should be. In many cases, however, information is needed as to the correct Baumé reading for any desired composition or concentration of the finished product. In such case the availability of a suitable specific gravity formula is of tangible assistance.

The specific gravity of sweetened condensed milk of any given composition may be calculated by dividing the figure 100 by the sum of the quotients that result from dividing the percentage of each group of ingredients by its respective specific gravity. The specific gravity of sweetened condensed milk at 60° F. is thus represented by the following formula:

$$\frac{100}{\frac{\% \text{ Fat}}{\text{spec. grav.}} + \frac{\% \text{ MSNF}}{\text{spec. grav.}} + \frac{\% \text{ Sugar}}{\text{spec. grav.}} + \% \text{ water}} = \text{specific gravity of sweetened condensed milk at } 60^\circ \text{ F.}$$

**Conversion of Specific Gravity to Baumé Degrees.**—The composite specific gravity value of the milk thus obtained by the use of the above formula

is then converted to Baumé degrees (°Bé.) by means of the following formula which is in general use in the United States for liquids heavier than water:<sup>3</sup>

$$145 - \frac{145}{\text{spec. grav. at } 60^{\circ} \text{ F.}} = \text{°Bé. at } 60^{\circ} \text{ F.}$$

This is then corrected to the standard temperature used for the hydrometer test of the pan sample by the "Temperature Correction Factor" previously described in this chapter.

**Specific Gravity Values for Specific Gravity Formula.**—The constituents or groups of constituents, the specific gravities of which determine the composite specific gravity value of sweetened condensed milk, consist of the fat, milk-solids-not-fat, added sucrose, and the water.

Specific gravity values of milk constituents reported by Sharp and Hart, Richmond, and Fleischmann are given in Table 7, Chapter II. In order to make the values used in the specific gravity formula comparable, they must all refer to the same temperature. The only temperature common to the specific gravity values of all three groups of constituents is 15 to 15.5° C. (59 to 60° F.). Density values given at this temperature are shown in Table 31.

TABLE 31.—SPECIFIC GRAVITIES OF MILK CONSTITUENTS AND SUCROSE

Authors	Milk Fat	MSNF	Sucrose
	15° C.	15° C.	15° C.
Richmond <sup>4</sup> . . . . .	0 93	1.616	.....
Fleischmann <sup>5</sup> . . . . .	0 93	1 600	.....
Browne and Zerban <sup>6</sup> . . . . .	....	....	1.589
<b>Values adopted for use in Specific Gravity Formula</b> . . . . .	<b>0.93</b>	<b>1 608</b>	<b>1 589</b>

After entering the bottom line values of Table 31 in the specific gravity formula, as shown below, the formula is complete and ready for the calculation of the specific gravity and degrees Baumé of sweetened condensed milk of any percentage composition desired.

$$\frac{100}{\frac{\% \text{ Fat}}{.93} + \frac{\% \text{ MSNF}}{1.608} + \frac{\% \text{ Sucrose}}{1.589} + \% \text{ Water}} = \text{Sp. Gr. at } 60^{\circ} \text{ F.}$$

**EXAMPLE:**

What is Baumé reading at 120° F. for sweetened condensed milk containing 8.5% fat, 19.5% MSNF, and 45% sucrose?

ANSWER:

$$\frac{8.5}{.93} + \frac{19.5}{1.608} + \frac{45}{1.589} + \frac{100}{27} = 1.3057 \text{ spec. grav. at } 60^{\circ} \text{ F.}$$

$$145 - \frac{145}{1.3057} = 33.95^{\circ} \text{ Bé. at } 60^{\circ} \text{ F.}$$

$$33.95 - [0.03 \times (120 - 60)] = 32.15^{\circ} \text{ Bé. at } 120^{\circ} \text{ F}$$

**Limitations of Accuracy of Specific Gravity Formula.**—The accuracy of the formula obviously depends on the representativeness of the specific gravity values allotted to the three groups of constituents. The milk constituents vary somewhat with locality and season, as influenced in the case of mixed milk by such factors as breed, lactation and feed. These factors appear to have but a slight effect on the specific gravity of the milk fat. In fact, it is conceded by the foremost milk scientists that the figure 0.93 constitutes a fairly constant specific gravity value for this important milk constituent.

Information relative to the constancy of the specific gravity of the solids-not-fat is limited. This group comprises the proteins, minerals, and sugar of milk. As shown in Table 7, Chapter II, each group has a different density. In addition, the proteins and also the ash are made up of their own groups of constituents which are individually affected by breed, lactation and feed. Variations in specific gravity of MSNF in the condensed milk, due to locality or season, may, therefore, be expected.

A perusal of the dairy literature suggests that it is the able researches of the eminent dairy scientists Richmond,<sup>4</sup> of England, and Fleischmann,<sup>5</sup> of Germany, that provided much of the available knowledge relative to the specific gravity of the solids-not-fat of milk. Both men analyzed a great multitude of milk samples. Richmond's studies dealt with milk produced in Great Britain. He found the solids-not-fat to have an average specific gravity of 1.616. Fleischmann's study had to do with milk produced in North Germany. He reported the solids-not-fat to have an average specific gravity of 1.600734. It will be noted in Table 31 that the specific gravity value of milk-solids-not-fat, chosen for use in the specific gravity formula for sweetened condensed milk, is 1.608. This represents the average of specific gravities for solids-not-fat reported by Richmond and Fleischmann.

For sucrose the specific gravity of 1.589 (1.5892), given for granulated sugar (sucrose) by the eminent sugar authorities Browne and Zerban,<sup>6</sup> was chosen. The specific gravity of the sugar may reasonably be expected to be the most constant of that of any of the constituents recorded in the specific gravity formula.

**Comparing Results of Formula with Baumé Test of Pan Sample.**—As pointed out in earlier paragraphs of the present chapter, the specific gravity of the milk constituents, particularly the solids-not-fat, may vary somewhat with locality and season. The specific gravity value for solids-not-fat used

in the formula may even need slight adjustment in some instances. The results of the specific gravity formula should, therefore, be accepted in the light of an approximation.

In Table 31-A the results of formula calculations are compared with actual Baumé readings of pan samples. These comparisons, while few in number, embrace a wide range of compositions extending from over-standard sweetened condensed whole milk to high-solids sweetened condensed skim milk, and appear to indicate close agreement.

Table 31-A.—Sweetened Condensed Milk

A Comparison of Actual Baumé Readings with Degrees Baumé as Calculated by the Specific Gravity Formula.

For illustration, details of calculations for Batch 1 are cited. (Pan sample was tested at 130° F.)

$$\frac{10.16}{.93} + \frac{23.29}{1.608} + \frac{41.72}{1.589} + \frac{24.83}{1} = 1.3073 \text{ spec. grav. at } 60^{\circ} \text{ F.}$$

$$145 - \frac{145}{1.3073} = 34.1^{\circ} \text{ Bé. at } 60^{\circ} \text{ F.}$$

$$34.1 - [0.03 \times (130 - 60)] = 32^{\circ} \text{ Bé. at } 130^{\circ} \text{ F.}$$

Batch No.	Composition				Baumé Test of Pan Sample	Baumé Degrees Calculated by Formula	Pan Sample and Formula Temperature
	Fat	MSNF	Sucrose	Water			
	%	%	%	%	B.	B.	°F.
1 <sup>a</sup>	10.16	23.29	41.72	24.83	32	32.00	130
2 <sup>b</sup>	8.05	20.12	44.83	27.00	32.5	32.45	120
3 <sup>b</sup>	8.00	20.00	44.50	27.50	32.2	32.22	120
4 <sup>b</sup>	0.50	27.50	42.00	30.00	35.7	35.80	120

<sup>a</sup>Over-Standard. Courtesy of United Milk Products Co., Cleveland, Ohio.

<sup>b</sup>Record of percentage composition and Baumé tests as per Mojonnier and Troy.<sup>1</sup>

<sup>4</sup>Sweetened condensed skim milk.

**Finishing the Batch.**—When the desired density has been reached, the condensing process is stopped. All steam to the pan is shut off, the valve in the water line to the condenser is closed, the vacuum pump is stopped and the vacuum relief is opened. The above operations should be carried out in the order named to prevent milk from burning onto the heating surface and condenser water from flooding the pan.

When the vacuum has been dissipated the condensed milk is then drawn from the pan. This should be done promptly so as to avoid super-heating due to the static status of the hot milk in the pan, which has a tendency to

accelerate age-thickening, especially in the case of milk of naturally unstable viscosity.

**Third Standardization.**—The fat, solids-not-fat and the added sugar are already present in their desired ratio to each other. This ratio was established by the first and second standardization discussed in Chapters XIII and XIV respectively. The third and final standardization, therefore, has to do only with the adjustment of the percentage of total solids, if such adjustment is necessary or desired. In the case of sweetened condensed milk it is customary to depend upon the judgment of the experienced pan operator, assisted by rapid factory tests of the pan sample for density, (using the Baumé hydrometer) to attain the desired concentration of total solids in the finished product.

Some manufacturers prefer to slightly over condense and then standardize back to the concentration desired by the addition of the correctly calculated amount of water. If the weight of the batch is available, such as is made possible by emptying the pan into a drop tank on scales, the amount of water to be added is determined by dividing the percentage of fat of the finished batch by the percentage of fat desired and multiplying the quotient by the pounds of condensed milk in the batch.

**EXAMPLE 1:**

The batch sample tests 9% fat. The fat desired in the condensed milk is 8.75%. The batch weighs 10,694.4 lbs. How much water must be added to reduce the fat content to 8.75%?

**ANSWER:**

The per cent fat of the batch is  $\frac{9}{8.75}$ , or 1.02857 times as high as desired, hence the amount of water to be added is  $10,694.4 \times 0.02857$ , or 305.6 lbs. water.

**PROOF:**

10694.4 lbs. condensed milk in batch testing 9% fat	= 962.5 lbs. fat
305.6 lbs. water	0.0
11000.0 lbs. standardized condensed milk	962.5 lbs. fat
$\frac{962.5}{11000} \times 100 = 8.75\%$ fat in the condensed milk.	

If there is no means to weigh the batch, the amount of water required in order to standardize back to the desired concentration may be determined as shown by the following example

**EXAMPLE 2:**

Volume of standardized fresh milk, 25,000 lbs.

Per cent fat in standardized fresh milk	3.85%
---	-------

Per cent fat desired in condensed milk	8.75%
--	-------

Fat test of batch	9.00%
-------------------	-------

How much water must be added to reduce the fat in the batch to 8.75%?

ANSWER:

Pounds condensed milk desired  $\frac{3.85}{8.75} \times 25,000$ , or 11,000 lbs. condensed milk.

Pounds condensed milk in batch  $\frac{3.85}{9.0} \times 25,000$ , or 10,694.4 lbs. in batch.

Pounds of water required 305.6 lbs. water

## REFERENCES

1. MOJONNIER, T., and TROY, H. C.: The Technical Control of Dairy Products. 2nd ed. p. 238. 1925.
2. EVANS, F. R.: Jour. Dairy Sci. VIII. p. 37. 1925.
3. STANDARDS OF DENSITY: U. S. Dept. Commerce, B.S. Circ. 19. 1924.
4. RICHMOND, H. D.: Dairy Chemistry. 3rd ed. p. 97. 1920.
5. FLEISCHMANN, WM.: Lehrbuch der Milchwirtschaft. 4th ed. p. 63. 1908.
6. BROWNE, C. A., and ZERBAN, F. W.: Physical and Chemical Methods of Sugar Analysis. 3rd ed. p. 56, 1941.

## CHAPTER XVI

### COOLING SWEETENED CONDENSED MILK

The cooling process occupies an important place in the manufacture of a marketable sweetened condensed milk. Prompt cooling is desirable to delay the tendency of age-thickening and discoloration, which is accelerated by prolonged exposure to heat. In addition, and even more important, on the method of cooling depends in a large measure the smoothness of texture of the finished product and its freedom from objectionable sugar deposit.

**Effect of Cooling Process on Texture.**—The relative smoothness of the product is controlled by the number and size of the lactose crystals it contains. It is the treatment which the hot sweetened condensed milk receives during the cooling process, that determines very largely the number and permanent size of the lactose crystals. The solubility and other properties of lactose are discussed in more detail in Chapter III.

Sparks<sup>1</sup> reported the results of an extensive experimental study of the science of lactose crystallization made under the direction of Huguenin.<sup>2</sup> This research was conducted in the Nestlé-Anglo-Swiss condensed milk factory at Cham, Switzerland. In their basic study these investigators successfully applied the crystallization theories of von Weimarn<sup>3</sup> and Tammann<sup>4</sup> to the phenomena observed incident to the cooling of sweetened condensed milk in commercial manufacture.

By microscopic examination of sweetened condensed milk of smooth and velvety consistency, Sparks and Huguenin found such milk to contain approximately 400,000 lactose crystals per cu. mm. Using sweetened condensed milk of a representative composition and making their calculations on the basis of a lactose solubility of 15 parts lactose per 100 parts water<sup>5</sup> in the sucrose solution of the condensed milk, they determined, by calculation, the length of the lactose crystal of condensed milk containing 400,000 per cu. mm. Their calculations were based on condensed milk of the following composition: fat 9%; SNF, 22.5%; sucrose, 42.5%; water, 26%; lactose, 12.2%. The calculations also yielded the number and size of crystals for sweetened condensed milk ranging in smoothness of texture from "excellent" to "very sandy," as given in Table 34 which is here reproduced by permission of its authors.<sup>1,2</sup>

**Mechanism of Lactose Crystallization.**—The mechanism of lactose crystallization is discussed in Chapter III. For the purpose of the present discussion it may suffice to state that, under the temperature conditions that prevail in the manufacture of sweetened condensed milk, only the alpha hydrate form of lactose will crystallize out. Crystallization proceeds slowly because maintenance of the status of supersaturation of alpha hydrate in solution requires the continued mutation from the highly

TABLE 34.—CORRELATION OF NUMBER AND CORRESPONDING SIZE OF LACTOSE CRYSTALS WITH DEGREE OF SANDINESS<sup>1</sup>

(For a Representative Sweetened Condensed Milk Containing 12.2% Lactose)

N Number of Crystals per Cubic Millimeter	v Average Volume of Individual Crystal $v = \frac{V}{N}$ mm <sup>3</sup> (Where v = 0.0705 mm <sup>3</sup> )	D Diameter of Sphere of Equal Volume where $v = \frac{\pi D^3}{6}$	L Length of Longest Edge of Crystal $L = 1.33 D$ micron	Scale of Sandiness
400,000	0.177 x 10 <sup>-6</sup>	6.97 x 10 <sup>-3</sup>	9.3	Excellent 10
300,000	0.236 x 10 <sup>-6</sup>	7.76 x 10 <sup>-3</sup>	10.25	Good 11
200,000	0.363 x 10 <sup>-6</sup>	8.775 x 10 <sup>-3</sup>	11.7	Slight, pasty 12
150,000	0.472 x 10 <sup>-6</sup>	9.67 x 10 <sup>-3</sup>	12.9	Pasty 14
100,000	0.707 x 10 <sup>-6</sup>	11.05 x 10 <sup>-3</sup>	14.75	Fine mealy 16
75,000	0.943 x 10 <sup>-6</sup>	12.17 x 10 <sup>-3</sup>	16.2	Fine mealy 18
50,000	1.414 x 10 <sup>-6</sup>	13.92 x 10 <sup>-3</sup>	18.6	Mealy 20
25,000	2.838 x 10 <sup>-6</sup>	17.55 x 10 <sup>-3</sup>	23.4	Fine sandy 24
12,500	5.660 x 10 <sup>-6</sup>	22.10 x 10 <sup>-3</sup>	29.4	Sandy 30
7,500	9.430 x 10 <sup>-6</sup>	26.20 x 10 <sup>-3</sup>	34.9	Very sandy 35

soluble beta anhydride to the less soluble alpha hydrate form. In sweetened condensed milk the rate of lactose crystallization is further impeded by the presence of the milk colloids and the high viscosity which reduces the rate of diffusion.

**Sweetened Condensed Milk a Supersaturated Solution of Lactose.**—The solubility of lactose is relatively low. As shown by Hunziker and Nissen,<sup>5</sup> at room temperature, in pure water, it is approximately 18 parts of lactose per 100 parts of water; in a 62% sucrose solution such as is contained in commercial sweetened condensed milk, it is approximately 15 parts of lactose per 100 parts of water. At pan temperature, sweetened condensed milk is practically a saturated solution of lactose, or it may already be definitely supersaturated, depending upon the degree of concentration. At ordinary room temperature the condensed milk represents a highly supersaturated solution of lactose. There is more lactose present than the water contained in the cooled product is capable of holding in solution.



As the temperature drops there is an inevitable tendency for a portion of the lactose to crystallize out. During the early stages of the cooling process the amount of lactose present in excess of saturation is small and the crystal nuclei and crystals form slowly. As the temperature drops lower, supersaturation increases and the rate of crystallization becomes more rapid. This continues until a point is reached in the cooling process where the effect of increasing supersaturation is offset, in part at least, by the simultaneously increased viscosity and the increased concentration of the colloidal substance. The exact temperature that provides the optimum relation of supersaturation and viscosity for maximum velocity of crystal formation will, of necessity, vary with the ratio of lactose to water. This ratio, in turn, is largely controlled by the concentration of milk solids and added sucrose content. For normal sweetened condensed milk of average composition the temperature of maximum rapidity of crystallization is approximately 30° C. (86° F.).

**Importance of Mass Crystallization in Cooling.**—The problem of insuring a permanently smooth texture in the finished product is not a problem of preventing the formation of lactose crystals during the cooling process. It is a problem of preventing the crystals that are present at the conclusion of the cooling process from subsequently growing larger. This is accomplished by providing conditions at the conclusion of the condensing period; i.e., in the cooling process, that produce mass crystallization. A multitude of crystal nuclei and small crystals great enough to reduce the state of supersaturation to a state of saturation must be formed while the crystals are still exceedingly small. This eliminates sugar in solution in excess of saturation, and thereby precludes the possibility of objectionable further crystal growth after completion of the cooling and agitating period.

**The Forced Crystallization Period.**—In commercial manufacture, mass crystallization of lactose is accomplished by retarding and prolonging the cooling under vigorous agitation at the optimum temperature (about 86° F.) for maximum velocity of crystal formation. Crystallization is further expedited by seeding the milk with small lactose crystals at the beginning of the forced crystallization period.

For best results the condensed milk should be cooled rapidly from pan temperature to about 86° F. This will prevent slow initial crystallization such as would yield a relatively small number of crystals destined to grow to comparatively large size ultimately. Seed at about 86° F. and hold at or near that temperature for about 60 minutes under constant vigorous agitation. Then cool rapidly to the desired final temperature and continue agitation for several hours.

**Determination of Optimum Temperature of Forced Crystallization.**—As previously stated, the optimum temperature of forced crystalliza-

tion varies with the lactose-in-water concentration of the condensed milk. It may thus lie within a wide range, probably between 25° and 35° C. (77° and 95° F.).

The forced crystallization curve of Fig. 47 shows the theoretically optimal temperature of the forced crystallization period for sweetened condensed milk of any given lactose-in-water concentration. While the lactose content of milk varies somewhat with breed and period of lactation, these variations are relatively small. As the result of averaging a large number

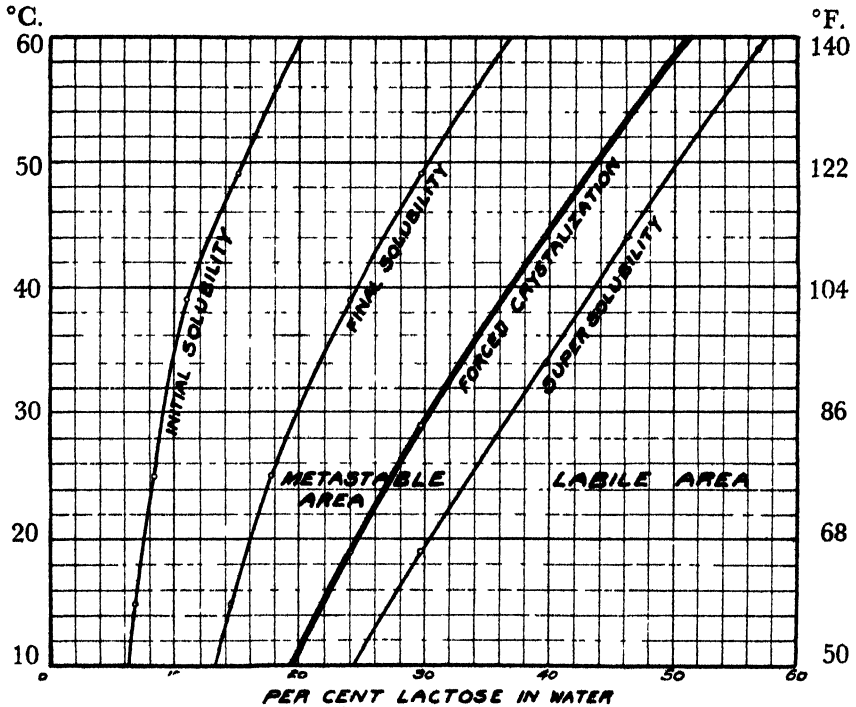

Fig. 47. Forced crystallization curve

of analyses of milk of all dairy breeds and grades, it appears that for mixed herd milk a lactose content of 4.8 per cent may consistently be accepted as a fair average. The lactose-in-water concentration (per cent lactose in the water contained in the sweetened condensed milk) is readily calculated as indicated by the following example:

**EXAMPLE 1:**

Fluid milk tests 3.6% fat; condensed milk contains 8.55% fat and 26.5% water. What is the per cent lactose in water? What is the optimum temperature for forced crystallization (optimum seeding temperature)?

ANSWER:

$$\text{Ratio of concentration} = \frac{8.55}{3.6} \text{ or } 2.375 : 1.$$

$$\text{Lactose in condensed milk} = 4.8 \times 2.375 = 11.4\%$$

$$\% \text{ lactose-in-water} = \frac{11.4}{(26.5 + 11.4)} \times 100 = 30.1\% \text{ lactose-in-water.}$$

Forced crystallization curve in Fig. 47 shows that when the per cent lactose in water is 30.1%, the optimum seeding temperature is approximately 85.5° F.

**Purpose of Seeding the Condensed Milk.**—The purpose of seeding is to give the lactose present in supersaturation an added incentive to crystallize. Von Weimarn<sup>3</sup> advanced the theory that the number of crystal centers present at any moment, that are capable of developing successively to crystal nuclei and to crystals, is a function of degree of supersaturation, and that the existing crystal centers will increase with the degree of supersaturation. This theory was proved correct by the experiments of Sparks and Huguenin on lactose crystallization in sweetened condensed milk.

It is further a fact long established in the science of crystallization that agitation increases the rate of mass crystallization. However, in the absence of crystal nuclei, or because of difficulty of migration of particles to existing nuclei, lactose even in highly supersaturated solution may refuse to crystallize or will crystallize only very slowly, which in turn means small number of crystals, large ultimate size, and sandy condensed milk. The addition of seed material consisting of fine lactose crystals at the beginning of the forced crystallization period, therefore, provides the means for satisfactory control of crystallization.

#### SEED MATERIAL

**Particle Size.**—The seed material commonly used is powdered lactose of commerce (alpha lactose hydrate), or sweetened condensed milk of a previous day's make. The lactose crystals in such milk are likewise of the alpha hydrate form. For best results the seed lactose should be of the smallest possible particle size consistent with preservation of sharp crystal edges. The smaller the particle size and the sharper the particle edges of the seed material, the greater the incentive to the formation of crystal centers and crystal nuclei that bring about mass crystallization, the more numerous and the smaller will be the permanent crystals and the smoother the texture of the finished product.

**Sterility of Lactose Seed.**—Furthermore, the seed lactose should be sterile or practically so, otherwise it may easily become the cause of the appearance of mold buttons and other microbial defects of the finished product.

**Alpha Hydrate Form Needed.**—Finally, it must be in the form of alpha lactose, since the beta form has a very high rate of solubility at ordinary

temperature. Seed material consisting of beta lactose anhydride, therefore, instead of yielding crystal centers and crystal nuclei and provoking mass crystallization, would immediately dissolve.

**Grinding the Seed Lactose.**—The standard powdered lactose of commerce normally is not of sufficiently fine particle size. It therefore should be reground. The colloid mill type of grinder that reduces the particle size by forcing the product through a very narrow clearance between stator and rotor is inadequate for this purpose because the resulting ground material is lacking in uniformity of fineness and its particles show

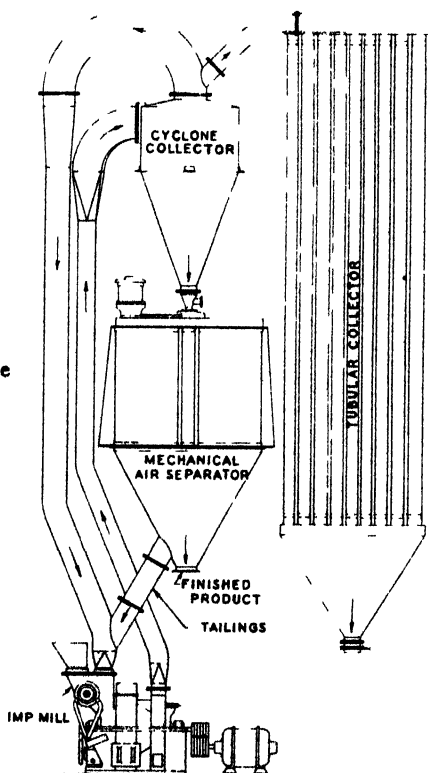

Fig. 48. Imp mill pulverizer for lactose seed material

Courtesy of Raymond Pulverizer Division

mutilated or otherwise dulled edges. The production of seed material of a physical character most effective for dependable control of lactose crystallization in sweetened condensed milk requires an impact-mill or hammer mill type of grinder that shatters the lactose units, sec Fig. 48. For maximum fineness and satisfactory uniformity of fineness, these mills are equipped with air separator that causes the tailings to be automatically reground until all the lactose fed into the mill has been reduced to a particle size of the desired fineness. Some of these grinders have a rated efficiency of producing a lactose dust of which 99.9 per cent, or better, will pass through a 325 mesh screen or finer.

**Sanitary Status of Powdered Lactose of Commerce.**—The process used in the manufacture of powdered lactose of commerce suggests that normally the commercial lactose may be expected to be near sterile. With reasonable attention paid to sanitation of the impact grinder and to the handling of the reground lactose, the resulting lactose dust may be expected to be free, or practically so, from germ life that would jeopardize the quality of sweetened condensed milk. On the basis of the accuracy of these assumptions as to its sanitary status, this lactose dust is, therefore, ready to be used as suitable seed material without further treatment.

**Sterilization of Lactose Dust Intended for Seed Material.**—In the event sterilization of the resulting lactose dust appears advisable or is desired, the following procedure suggested by Whittier<sup>7</sup> is recommended: Heat the powdered lactose of commerce to 93° C., preferably under vacuum. This converts the alpha lactose hydrate to the alpha anhydride form. Then grind the alpha anhydride using an impact pulverizer mill as previously described. Fill the resulting lactose dust into cans, preferably with friction top. Seal the cans and sterilize them at approximately 130° C. for one to two hours. The lactose dust is now ready to be used as seed material.

**Amount of Seed Lactose to Add.**—It has been found good practice to add about ten ounces of dry seed lactose, or about one gallon of sweetened condensed milk of a previous day's make, per 1,000 pounds of condensed milk.

The seed material should be quickly and uniformly dispersed throughout the batch. The dry seed material is best stirred into a sufficient amount (usually about three to five gallons) of milk taken from the cooling batch, to make a freely flowing batter. The stirring should be continued until all lumps have disappeared and the seed material is of smooth and homogeneous consistency. This mixture is then added to the vigorously agitated batch.

In the case of the continuous-flow system of cooling in which the milk tubes are still coated with milk of the previous day's run, the new batch is automatically seeded by the old milk that has remained in the cooler tubes. On days after the cooler has been completely emptied and washed, however, addition of prepared seed material is necessary. In such case it is now customary to seed the new batch in the vacuum pan near the end of the condensing period before the vacuum pump is stopped. This is readily done by drawing the seed material into the pan through the pan discharge valve at the bottom, or through the striking cup. Seeding in the pan is preferable, also, regardless of method of cooling, in the case of high-solids sweetened condensed milk.

**Final Temperature to Which to Cool.**—After the forced crystallization period, cooling to the desired final temperature may be continued as rapidly as facilities permit. However, the use of refrigerants colder than

ice water, such as refrigerated brine or direct expansion ammonia, is not recommended.

The final temperature striven for in different factories varies from approximately 70° F. to 60° F. or lower. In most condenseries, the sweetened condensed milk is cooled to a final temperature of about 65° F.

**Importance of Vigorous Agitation.**—Agitation enhances mass crystallization. Continued vigorous agitation during the forced crystallization period, therefore, is important. Agitation during the cooling period is necessary also to expedite the rate of cooling and to lower the temperature uniformly throughout the batch. This facilitates uniform distribution of the increasing lactose supersaturation, which in turn favors uniform crystal size.

Agitation should be continued for several hours after the cooling period proper. Cooling to the final temperature again causes a certain degree of supersaturation. In this now highly viscous product, migration and equalization of lactose concentration are retarded and crystal formation is slower. Thus, more time is required to develop a sufficient increase in crystal nuclei and stabilized independent crystals to dissipate the supply of dissolved lactose that is present in excess of saturation. There is need, therefore, of continuing the agitation for a limited time after the desired final temperature has been reached.

#### METHOD OF COOLING

Several distinct methods of cooling sweetened condensed milk have been developed. These methods are conveniently grouped into the following four systems:

1. Batch system
  - (a) in individual cans revolving in the cooling water.
  - (b) in vat with revolving helical coil.
  - (c) in jacketed crystallizer tank with rotating agitator and baffles, operated under vacuum.
2. Continuous-flow system
  - (d) by submerged coil cooler.
  - (e) by internal tube, counter-current cooler with removable return bends.
3. Combined batch and continuous-flow system
  - (f) internal tube milk cooler to 90° F plus batch cooler to 65° F.
  - (g) batch cooler to 90° F. and internal tube counter-current cooler to 65° F.
  - (h) internal tube cooler to 90° F., plus crystallizing tank with agitator, plus internal tube counter-current cooler to 65° F.
4. Vacuum cooling system
  - (i) in vacuum pan without heating surface, with rotating agitator, and exhausting through multiple steam ejectors into intermediate condensers.

**The Batch Cooling System.**—The earliest batch system consisted of cooling the condensed milk in straight-walled, 10-gallon cans which revolved in the cooling water contained in large iron tanks, and which were equipped with wooden paddles that scraped the can walls. This was later supplemented by seeding, which made control of lactose crystallization and smooth milk more dependably positive.

**The Vat with Helical Coil.**—This type of equipment has also been used to some extent for cooling sweetened condensed bulk milk. The principle involved by cooling in the coil vat, however, appears not conducive to uniformly optimum control of lactose crystallization.

In addition, the horizontal-coil vat has the further handicap of quality-jeopardizing submerged shaft bearings, and the tendency of pumping air into the milk unless the coil is completely submerged.

**The Crystallizer Batch Cooler.**—This is a closed cylindrical tank with removable top to facilitate cleaning, especially designed for cooling sweetened condensed milk. Its sides and bottom are water-jacketed and it is

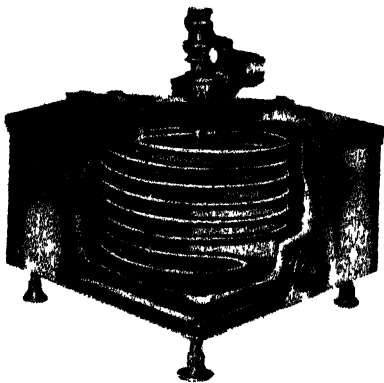

Fig 49. Vertical coil vat sweetened condensed milk cooler  
Courtesy of Jensen Machinery Co.

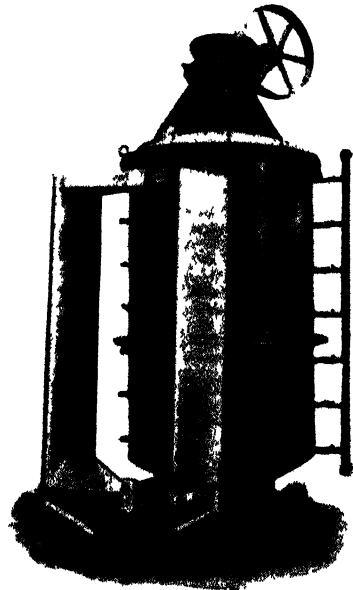

Fig. 50. Crystallizer batch cooler operated under vacuum, showing jacket on bottom and side, and heavy agitator  
Courtesy of A. W. Baumann

equipped with a powerful rotating agitator driven from a gear reducer overhead. It is provided with rubber scrapers that press closely to the cooling surface and are scraping it clean. The scrapers have a sharp, bevelled edge and are set at an angle of about  $45^\circ$ , lifting the cooled milk away from the periphery and causing it to mix with the warmer milk

in the center of the tank. In addition, the bottom cross bars of the revolving agitator are twisted into propellor shape, causing an upward movement of the milk in the cooler.

The cooling is done under vacuum to eliminate air that may be contained in the milk and to prevent incorporation of air from the atmosphere. When the milk has been cooled to about 90° F., it is seeded, preferably with lactose dust (finely ground lactose of commerce), as explained under "Seed Material" earlier in this chapter. The seed lactose is blown in through fittings in the side of the tank, the vacuum in the cooler providing the pressure difference. This type of batch cooler is used extensively in European condenseries where sweetened condensed milk is the main product.

**The Continuous-Flow Cooling System.**—This system is represented by the submerged coil cooler and the internal tube counter-current cooler.

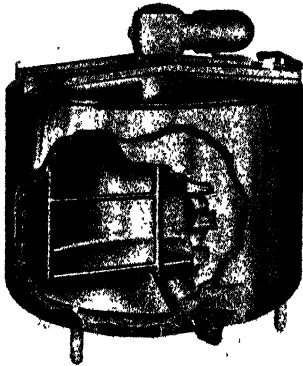

Fig. 51. Mojonnier sweetened condensed milk batch cooler with jacket on sides and bottom, and scraper agitator  
Courtesy of Mojonnier Bros. Co.

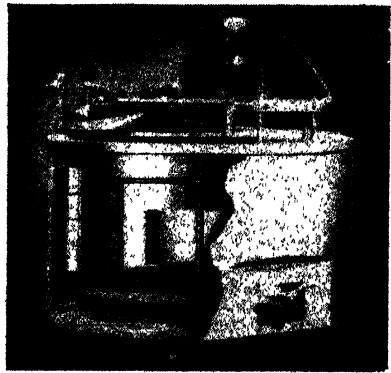

Fig. 52. Round Process sweetened condensed milk batch cooler with jacket on sides and bottom, and scraper agitator  
Courtesy of Cherry-Burrell Corporation

**The Submerged Coil Cooler.**—Fig. 53 illustrates the principle of this type of continuous cooler. It consists of a closed circular iron tank which houses an inner and an outer set of coil convolutions. The two coil sets are separated by a vertical baffle wall. The hot condensed milk enters at the bottom of the inner coil and the cooled product is discharged at the bottom of the outer coil. The cooling water enters at the bottom of the outer compartment, flows over the top of the baffle and leaves the tank at the bottom of the inner compartment. The cooler thus functions on the counter-current principle. It provides a compact, simple cooler, the initial cost and the operating economy of which are within reach of the factory of limited volume.

**The Internal Tube Counter-Current Cooler.**—This type of continuous



flow cooler is used in large volume operations, particularly when sweetened condensed milk is the main product of the plant. Coolers with single tubes and removable return bends appear to be the latest improved design. The header discharges into parallel, counter-current tube sections. Cooling the batch of condensed milk of a 6-foot vacuum pan from about 130° F. (pan temperature) to 60-65° F. requires 52 tubes of 20-foot tube length. These tubes are assembled in two sections, or banks, of 26 tubes each. One high-pressure piston pump may serve both sections. The milk flows through the two sections in parallel current. The milk of each section, therefore, travels 26 x 20, or 520 feet. This provides satisfactory speed and efficiency of cooling consistent with minimum pressure requirements.

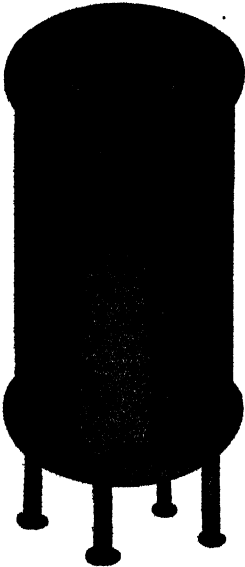

← Fig. 53. Submerged coil continuous cooler

Fig. 54. Internal tube coil continuous cooler

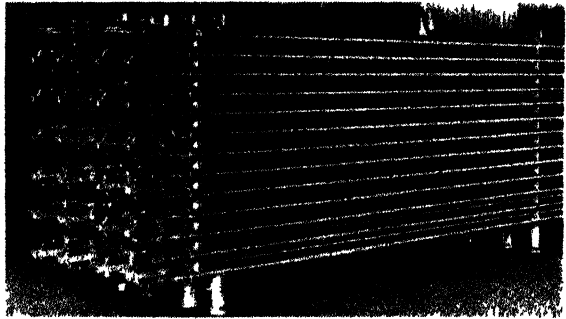

Courtesy of Arthur Harris & Co.

The temperature of the milk is controlled by regulation of the flow of the cooling water.

It is customary, after cooling operations are completed, and all the milk in the tubes has been cooled to the temperature of the cooling water by recirculation, to leave this milk in the cooler tubes. About 1200 pounds of pressure are required to start the milk flow the following day. After the previous day's milk that was left in the cooler tubes overnight has been forced out, about 200 pounds pressure are required to maintain uniform cooling operation throughout the cooling process. The cooler should be emptied completely and washed clean at least once every two weeks. This is advisable for reasons of sanitation and cooling efficiency. It is good practice also to return the old condensed milk contained in the cooler to the forewarmer for reprocessing with the milk of the next batch.

In operation the pan batch is usually discharged into a drop tank from which it is forced through the cooler tubes by means of a pressure piston pump (a homogenizer with homogenizing valve removed, is generally used if available). For seeding, the manufacturer commonly depends on the coating of lactose crystals that deposits on the milk side of the tubes. After emptying and washing the cooler, the seeding of the next batch may be done by dusting the end bends of the cleaned cooler tubes with lactose dust. (See also "Seed Material" earlier in this chapter.)

For bulk goods the cooled milk is filled direct from the cooler into barrels on scales. For case goods the internal tube cooler generally discharges the cooled milk into large, air-tight, evacuated storage tanks equipped with impellor. Here the milk is agitated for about an hour, preparatory to canning.

**The Combined Batch and Continuous-Flow Cooling System.**—This system obviously has possibilities of a variety of combinations. In the batch system, cooling from pan temperature to optimum seeding temperature (approximately 86° F.) may be expedited by emptying the pan through the water-cooled section of an internal tube milk cooler into the coil vat or crystallizer tank where it is then seeded.

Or, in the continuous-flow system, a jacketed drop tank with agitator may be used in which the milk is batch-precooled to about 90° F., then seeded and pumped through the continuous-flow cooler. Agitation in the drop tank is continued until the tank is empty.

Or, two sets of continuous-flow coolers, with a crystallizer vat between, may be used. The first unit of continuous-flow cooler cools the milk to the optimum seeding temperature (86 to 90° F.) and discharges it into the crystallizer tank where the milk is seeded, and vigorously agitated for 45 to 60 minutes. A second pump conveys it from the crystallizer tank through the second continuous-flow cooler that cools it to the final temperature.

The system last mentioned has been found highly efficient from the standpoint of dependable smoothness of finished product. Its major drawback lies in the large amount of high cost equipment required. Furthermore, because of the high viscosity of the milk entering the second continuous-flow unit, it has been found advisable to use two piston pumps in order to properly force this now sluggish product through this final cooler unit.

#### VACUUM COOLING OF SWEETENED CONDENSED MILK

**Principle of Vacuum Cooling System.**—This cooling system utilizes a high vacuum as the cooling medium. The milk temperature in this cooler is reduced by evaporation under vacuum. It was shown in Chapter VI that at pressures below atmospheric pressure, liquids boil at a lower temperature. Table 21 gives progressive drops in temperature from 212° F.

at atmospheric pressure (14.7 lbs. at sea level) to 34.55° F. at an absolute pressure of 0.0982 lbs. (29.72 inches of vacuum). With a high vacuum established above the milk level in the cooler, the milk is in a superheated condition with reference to the existing vacuum. This causes the milk to boil off its superheat, gradually reducing its temperature until cooled to the desired temperature. Lowering the boiling point of water to the temperature to which sweetened condensed milk is commonly cooled in commercial manufacture, i. e., about 68° F., requires a vacuum of approxi-

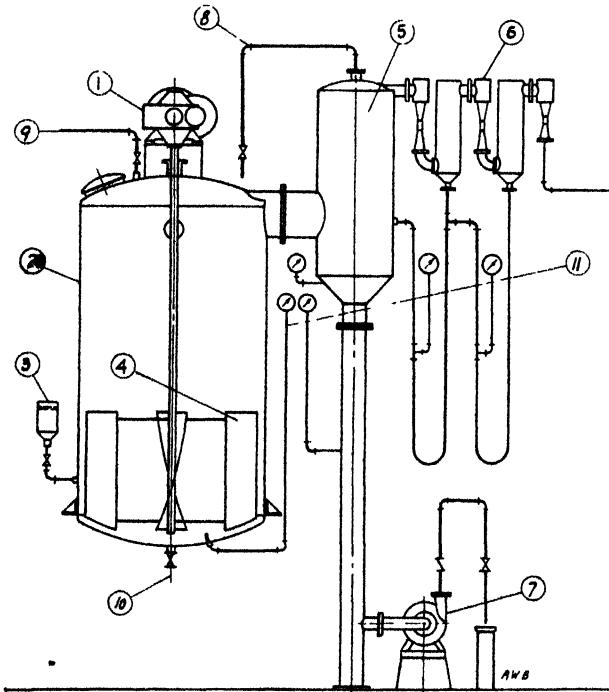

Fig. 54-A. Sweetened condensed milk vacuum cooler

Courtesy of A. W. Baumann

- |                                  |                                   |
|----------------------------------|-----------------------------------|
| 1. Motor-driven gear reducer     | 7. Condenser water discharge pump |
| 2. Body of pan                   | 8. Condenser water line           |
| 3. Lactose reservoir for seeding | 9. Hot milk inlet                 |
| 4. Agitator                      | 10. Cool milk outlet              |
| 5. Counter-current condenser     | 11. Dial thermometer              |
| 6. Multiple-stage steam ejector  |                                   |

mately 29.2 inches. The boiling point of normal sweetened condensed milk is slightly higher than that of water at the same pressure, as shown in Table 9, Chapter II.

**Equipment Needed for Vacuum Cooling.**—The equipment needed consists essentially of a vacuum pan without steam jacket and without steam coils—no heating surface. The vapors arising from the milk are being condensed in a counter-current condenser. The non-condensable gases and the air are compressed and eliminated by multi-stage ejectors with intermediate condensers. The water from the main condenser is discharged

over a barometric leg (see "The Barometric Condenser" in Chapter VII), or, if sufficient height is not available, it is discharged by a centrifugal pump. To accelerate the circulation of the increasingly viscous milk, the cooler is equipped with a powerful rotary agitator. This mechanism is so designed as to bring the milk that is near the bottom to the top, thereby assisting thermo-circulation, promoting uniform cooling throughout the batch and expediting the rate of evaporation and cooling. This mechanical agitation is particularly important during the final stages of cooling.

**Operation of Vacuum Cooling System.**—The milk is condensed in the regular vacuum pan or evaporator to a predetermined point. In the case of milk intended to be cooled in the vacuum type cooler, proper allowance must be made, when striking the batch in the pan, for the additional evaporation that will occur in the cooler. The point to which to under-condense is calculated on the basis of B.T.U. removed in vacuum cooling. Approximately 3 pounds of water must be evaporated to cool 100 pounds of sweetened condensed milk from 120° F. to 68° F.

**EXAMPLE:**

Sweetened condensed whole milk of average concentration (about 28% TMS) is cooled from pan temperature (120° F.) to 68° F. How much water must be evaporated from 100 lbs. of sweetened condensed milk?

**ANSWER:**

W = Water to be evaporated.

T<sub>1</sub> = Milk temperature at end of condensing period.

T<sub>2</sub> = Final temperature of cooled milk.

S = Specific heat of sweetened condensed milk = 0.57.\*

H = Total heat units required in cooling 100 lbs. sweetened condensed milk.

H<sub>1</sub> = Heat of evaporation of 1 lb. water vapor at a temperature of  $\frac{T_1 + T_2}{2}$ , or 94° F. = 1040.7 B.T.U.\*\*

H = 100 x T<sub>1</sub> — T<sub>2</sub> x S.

$\frac{T_1 + T_2}{2}$  = Average milk temperature in cooling process.

$W = \frac{H}{\text{Heat of Evaporation at average milk temperature during cooling}}$ , hence

$$W = \frac{100 \times (T_1 - T_2) \times S}{H_1} \text{ or } \frac{100 \times (120 - 68) \times 0.57}{1040.7}, \text{ or}$$

$W = \frac{100 \times 52 \times 0.57}{1040.7} = 2.84$  lbs. water must be evaporated.

The batch is dropped from the pan direct into the vacuum cooler. When the temperature in the cooler has been lowered to about 90° F., the batch is "seeded" by blowing lactose dust (finely pulverized lactose of commerce)

\*A. W. Baumann. \*\*Mollier.

through the side of the cooler, using the pressure difference as the motivating force. For amount and preparation of seed lactose, see "Seed Material" earlier in this chapter.

**Advantages of Vacuum Cooling System.**—Because of the rapid rate of evaporation, the time required for cooling is relatively short, depending upon the completeness of the vacuum maintained. A batch of about 750 gallons (approximately 8500 lbs.) of sweetened condensed milk can be cooled in about 30 minutes.

In this cooling system there are no refrigerated metal surfaces that would chill the contacting milk to temperatures much lower than the temperature of the remainder of the batch. This fact, together with thermocirculation assisted by vigorous mechanical agitation, provides uniform



Fig. 55. Scott high-vacuum cooler  
Courtesy of Geo. Scott & Son (London) Ltd.

temperature reduction of all the milk in the batch. In addition, the rapidity of evaporation and cooling in the presence of pulverized seed lactose, yields mass crystallization. This combination of factors and reactions makes for a lactose crystal system in the finished product of the desired minute particle size and of optimum uniformity of size. The crystals in the cooled milk have been found to range predominately from about 5 to 8 microns in length, yielding a product of exceptionally smooth and velvety texture.

This system of cooling enhances the quality of sweetened condensed milk in other ways. It eliminates all contact of the milk with atmospheric

air and its contaminating influences. Again, because of cooling with agitation under vacuum the milk is, in fact, vacuumized. Thus, its freedom from air and from contamination with germ life, practically precludes all danger of development of mold buttons and of age defects of bacterial origin. The vacuum type cooler constitutes the latest and most advanced cooling equipment used in the manufacture of sweetened condensed milk.

#### REFERENCES

1. SPARKS, J. B.: The Crystallization of Lactose from Volume Jubilaire Louis E. C. Dapples, Vevey, Suisse, 1937.
2. HUGUENIN, GUSTAVE, General Manager Nestlé and Anglo-Swiss Holding Co., Ltd., under whose direction the above research by J. B. Sparks was conducted.
3. VON WEIMARN, P. P.: Die Allgemeinheit des Kolloidenzustandes. Kolloides und Kristalloides Lösen u. Niederschlagen, 2nd Ed., 1925.
4. TAMMANN, GUSTAV: The States of Aggregation. Changes of the States of Matter in their Dependence upon Pressure and Temperature. 1925.
5. HUNZIKER, O. F., AND NISSEN, B. H.: Jour. Dairy Sci. IX. 517. 1926.
6. GRESSLY, K. E.: Information through Personal Contact. Chicago, 1941.
7. WHITTIER, E. O.: Information through Personal Contact. Washington, D. C. 1944.
8. BAUMANN, A. W.: Chief Engineer Arthur Harris & Co. Chicago. 1945.
9. KEENAN AND KEYES: Mollier Steam Tables. 1936.

## CHAPTER XVII

# MANUFACTURE OF SWEETENED CONDENSED SKIMMILK AND SWEETENED CONDENSED WHEY

### SWEETENED CONDENSED SKIMMILK

A considerable portion of the sweetened condensed milk output of the United States in normal times is marketed in bulk to bakeries, confectioners, candy factories, ice cream plants and other prepared food factories.

Generally speaking and exceptions reserved, the bulk milk market is more price conscious and less quality minded than the market for the product in the consumers' package, the tin can. In normal times the margin of profit on the sweetened condensed bulk milk supplying this trade is relatively small. The product is predominantly made from skimmilk and much of it is made on a relatively small scale. In some instances the available raw material is confined to separated surplus milk in the absence of other, more profitable outlets. Within the range of the above conditions, the volume of supply is often seasonal or otherwise irregular. The equipment available frequently is limited, if not inadequate. The experience of the operator may be unequal to the task of satisfying the more critical trade.

The common trend for the product of the plant with small output is to reach the market soon after manufacture and to be used while still comparatively fresh. Under these conditions, prolonged keeping quality is not a controlling factor. But there are also some large-scale manufacturers of bulk goods. Some of these are concentrating their efforts on quality products and have established an enviable reputation for dependably high quality. They are prepared to and do satisfy the most exacting markets, and the quality of their product justifies the risk of holding over from the season of surplus and low price to the time of shortage and top prices.

As shown in earlier paragraphs, the problems involved in the manufacture of sweetened condensed skimmilk are essentially the same as, and their solution is identical to, those of sweetened condensed whole milk. They are briefly summarized as follows:

**Standardizing Sugar Content.**—Unless otherwise specified by the buyer, it is advisable to maintain in the finished product a sugar-in-water ratio of approximately 62.5% (i.e., the water portion contains 62.5% of added sugar). Table 35 shows the amount of sugar to use per 100 pounds of fluid skimmilk, and the per cent sugar contained in the finished product, of a wide range of concentrations. For standardizing formula see Chapters XIII and XIV.

**Forewarming.**—This is commonly done by the use of a flash pasteurizer, or a steam jacketed hot well with rotating agitator. If necessary, in order

to attain the usual forewarming temperature (approximately 185° F. to boiling), the heating from about 170° F. up is finished by injection of live steam.

Condensed milk made in late spring and early summer (typical "grass milk") that is forewarmed within the above temperature range tends to thicken with age when stored at room temperature or above. The tendency to thicken is decreased by keeping the sugar out of the forewarming milk, adding it in the form of a syrup in water, and drawing it into the pan near the end of the condensing period. Storing at a temperature of 60° F. or lower will retard age-thickening, and at 45° F. or below will stop it.

Forewarming temperatures below 170° F. or above the boiling point would prevent age thickening, but the lower temperature range fails to provide dependable protection against flavor deterioration caused by survival of heat-resistant milk enzymes and germlife, and temperatures above the boiling point require equipment, the cost of which is not considered justifiable by the manufacturer of limited volume for the bulk trade. (See also "Effect of Forewarming on Age Thickening", in Chapter XIV.)

**Addition of the Sugar.**—Dissolve the sugar (granulated cane or beet sugar) in hot water making a syrup containing about 60 per cent sugar, and heat to 190° F. If this is not practicable under existing conditions, dissolve the sugar in the milk that has already been heated to forewarming temperature. Do not add the sugar to the milk before the full forewarming temperature has been reached.

**Use of Dextrose.**—If part dextrose is used, dissolve the dextrose in heated water, making an approximately 65 per cent dextrose solution, forewarm it separately to 190° F. and draw it separately into the pan at the end of the condensing process. Equipment for dissolving and forewarming the dextrose must be free from milk remnants and alkaline wash water. If hard water must be used, acidify it slightly by addition of a small amount of acetic acid or hydrochloric acid. Use just enough acid for the water to turn blue litmus paper red. These several precautions are necessary to prevent objectionable discoloration and age-thickening. (See also "Brom-Thymol-Blue Test" in Chapter XLVI.)

**Striking.**—For sweetened condensed skimmilk conforming to the U. S. minimum standard of 24 per cent solids-not-fat, and assuming a fat content of 0.05% and a sugar content of 47.5%, condense to a Baumé reading of 36.8° B<sub>e</sub>. at 120° F., or 36.6° B<sub>e</sub>. at 130° F. For Baumé readings of higher concentrations of sweetened condensed skimmilk, see Table 35. These Baumé readings may require slight modification due to effect of locality and season on specific gravity of solids-not-fat.

**Cooling.**—For large volume production, see methods of cooling recommended for sweetened condensed milk, Chapter XVI. The simplest and least expensive cooler for a factory with limited or irregular volume of production appears to be the submerged coil cooler. The principle of



TABLE 35. SWEETENED CONDENSED SKIMMILK  
SUGAR-IN-WATER RATIO APPROXIMATELY 62.5%  
SUGAR PER 100 LBS. FLUID SKIMMILK. BAUMÉ READINGS AT 120° F.

Skimmilk Solids per cent	Sucrose in Condensed Milk per cent	Sugar to Add per 100 lbs. of Skimmilk pounds	Degrees Baumé*	
			at 120° F.	at 130° F.
24	47.50	17.79	36.8	36.6
25	46.88	16.86	37.0	36.8
26	46.25	16.00	37.2	37.0
27	45.63	15.21	37.4	37.2
28	45.00	14.44	37.6	37.4
29	44.38	13.78	37.8	37.6
30	43.75	13.13	38.0	37.8
31	43.13	12.52	38.2	38.0
32	42.50	11.95	38.4	38.2

this cooler makes for reasonably satisfactory control of lactose crystallization. (See Figure 53.)

**Use and Care of Submerged Coil Cooler.**—In this case the batch is dropped from the pan into a vat or other drop tank. From this temporary storage tank it is pumped through the submerged cooling coil which discharges it under the same pressure direct into the final package—barrel, drum, 10-gallon can, or other bulk package—preferably using the homogenizer without homogenizing valve for pumping, if available.

When the milk passes through the submerged coil, the inside of the coil becomes coated with a layer of condensed milk and lactose crystals. This coating serves as the seed material for the next day's batch. If the cooler is used for the first time or has been emptied and washed since the last run, it may be supplied with seed material for the next batch by pumping through it a small amount of condensed milk of a previous day's batch. (See also "Seed Material" in Chapter XVI.)

The milk coil of the cooler is not emptied after each day's use. However, it should be emptied and washed at least once every ten days to two weeks. This is necessary not only for sanitation, but also for operating efficiency. The increasing thickness of the coating of milk solids and sugar on the coil wall reduces the flow capacity and acts as an insulator, decreasing the rate of heat exchange, dissipating the cooling efficiency and causing wasteful use of water. The emptying of the milk coil is facilitated by drawing the cooling water from the cooler shell, and then forcing the plug of condensed milk out of the coil with hot water under pump pressure. When all of the milk has been pushed out, the coil is thoroughly flushed out until its drain is clear, and this rinse is

\*Calculated on basis of 0.05% fat in fluid skimmilk.

then followed by steaming until dry. It is good practice to return the milk that was left in the coil overnight, to the forewarmer, to be re-run with the next batch.

In order to prevent the formation of large crystals and a sandy condition in the milk that stays in the cooler from one day to the next, it is necessary to circulate the milk contained in the coil at the end of the run until it is cooled to the temperature of the cooling water. This recirculation of the milk through the submerged coil is made possible by the installation of a by-pass that returns it from the coil discharge to the pump at the coil intake.

**Use of Coil Vat Cooler.**—In the absence of a submerged coil cooler, it may be necessary to use a coil vat. In such case the pan is emptied direct into the vat. The milk is cooled as rapidly as possible to about 90° F. It is then seeded, preferably with finely powdered milk sugar, at the rate of approximately 10 ounces per 1000 pounds of condensed milk,

Fig 56 Sweetened condensed milk drop tank, pump and cooler, with recirculating by-pass (see below)

(courtesy of A W Baumann)

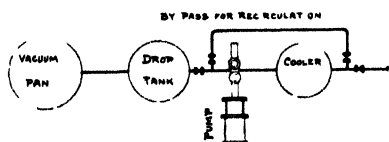
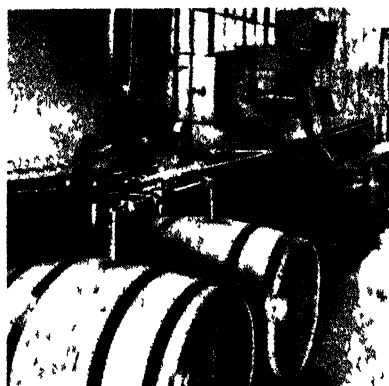

Fig. 57 Filling barrels direct from sweetened condensed milk submerged coil cooler  
Courtesy of Arthur Harris & Co



or with sweetened condensed milk of a previous day's batch (1 gallon per 1000 lbs. of the new batch). Under continuous agitation it is held at 90° to 80° F. for 60 minutes, then cooled rapidly to 65° F., and agitation continued for at least one hour longer. The vertical coil vat is preferable to the horizontal coil vat, because the former tends to draw air out of the milk while the latter tends to whip air into it. It also eliminates the ever-present danger of contamination from submerged stuffing boxes.

**Use of Surface Cooler and Coil Vat.**—If an internal tube milk cooler is available it can be used to advantage for precooling from pan temperature to seeding temperature (about 90° F.). In this case the batch is dropped from pan to coil vat via internal tube cooler, the milk is seeded in the vat, and is held for 45 to 60 minutes at the seeding temperature and then cooled to the final temperature. From the time it enters the vat until about one hour after reaching the final temperature it is vigorously agitated.

**Containers.**—The usual container for sweetened condensed bulk milk is the paraffined oak barrel holding about 630 pounds of the finished product. New barrels are preferred. For critical markets reconditioned barrels are not recommended. See also Chapter XVIII.

For nearby markets and customers sufficiently responsible to insure return of the empty container, the steel drum with removable end, capacity about 600 lbs., has been found highly satisfactory, and if re-used over a period of several years, more economical than the wooden barrel. The 10-gallon milk can, while convenient, is usually found a relatively expensive container for the storing and shipping of sweetened condensed milk.

**Storage.**—If the finished product is to be stored for a considerable period—over a month—it is advisable to hold it at a temperature of 60° F. or below. This will prevent the development of mold buttons and retard objectionable age-thickening, discoloration, and development of stale flavor.

#### SWEETENED CONDENSED WHEY

A limited amount of plain condensed whey is reported to be manufactured, packed in barrels or drums, and sold at a profit to poultry men and feed mills, much the same as is condensed buttermilk. It is condensed to a high concentration, however, i.e., to 35 to 50 per cent solids, as compared with 28 to 30 per cent solids in the case of the buttermilk product.<sup>1</sup>

**Procedure for Sweetened Condensed Whey.**—The manufacture of sweetened condensed whey was developed by Ramsdell and Webb<sup>2</sup> who established the following procedure: Fresh, sweet cheese whey (cheddar or Swiss), or rennet whey, is pasteurized at 143° F. for 30 minutes. It is then evaporated in a vacuum pan or evaporator in the usual manner.

The sugar (sucrose) is added at the approximate ratio of 1 : 1 of whey solids to sucrose, which has been found adequate to conserve the condensed whey. This means that for each 100 lbs. of fresh whey, approximately 6.7 lbs. of sucrose is used. The sugar is drawn into the pan and dissolved, either in fresh whey or in water, near the end of the condensing period. The mixture is condensed to a concentration of about 75 per cent total solids in the finished product. This gives the condensed whey a sucrose-in-water concentration of about 60 per cent.

The whey syrup is cooled to 86° F. and vigorous stirring must be continued for several hours to avoid large lactose crystals and coarseness of texture. The cooled sweetened condensed whey then may be canned, or packed in bulk into shipping cans, barrels or drums, in a manner similar to sweetened condensed milk. "The whey product kept well for six months at room temperature when packed in sealed containers".<sup>2</sup> As might be expected, there was some age thickening during this period, but this

caused no depreciation of its usefulness in the foods for which it was made.

**Properties of Sweetened Condensed Whey.**—Sweetened condensed whey has marked whipping properties. This renders it useful in the manufacture of food materials where incorporation of air and control of overrun are important. Ramsdell and Webb made a new type of candy of a light, porous texture with a sweetened condensed whey base. They whipped the concentrated whey-sucrose syrup to about 200 per cent overrun, and added cereal, nuts, cocoanut, chocolate or other similar flavoring materials. The stiff whip was then dropped into trays or molds and dried at approximately 158° F. for 24 hours. When completely dry it had a light crumbly texture which consisted of a sucrose-lactase glass, free from sandiness. In this form the candy was very hygroscopic, but absorption of moisture and stickiness were prevented by coating the outside with chocolate.

Sweetened condensed whey was utilized to advantage also as a major ingredient in the manufacture of fruit whips with the following optimum composition:

Fruit juice and pulp .....	50%
Whey solids .....	14%
Sugar .....	18%
Gelatin .....	1%

When the cold whip was mixed with whipped cream and the mixture was frozen without stirring, an excellent ice cream was obtained.

#### REFERENCES

1. TUFFT, J. E.: National Butter and Cheese Jour. XXII. 11. 1941.
2. RAMSDELL, G. A., AND WEBB, B. H.: Jour. Dairy Sci. XX. 448. 1937.

## CHAPTER XVIII

### PACKAGING SWEETENED CONDENSED MILK FOR MARKET

Sweetened condensed milk reaches the market in the form of bulk goods and as case goods.

**Packaging Bulk Goods.**—The bulk goods are packed in diverse types of containers such as regular milk shipping cans, steel drums and wooden barrels. The milk cans and steel drums have proven very satisfactory containers and they stand up well in transportation. Their initial cost, however, is relatively high, and unless they can be returned at low cost for repeated re-use, their use constitutes an excessively high package cost.

The wooden barrel is the most popular container of sweetened condensed bulk milk. Industry leaders<sup>1</sup> familiar with its early history report that the first packing of condensed milk in wooden cooperage took place fifty years ago. Haymes' further says:

“This production, processed in Illinois, was utilized in bread baking. Later the bulk product was adopted for chocolate and confection production. Other uses were developed year after year because of the economic advantages displayed by the inherent qualities of properly combined milk and sugar nutrients, the peculiar physical properties of the emulsion, safe keeping quality, the production and preservation in times of seasonal plenty for storage and use in times of low production.”

The barrels used in the early days of sweetened condensed bulk milk were made of gumwood, the grain of which is not particularly suitable for high grade cooperage. The best barrels now used are white oak, paraffin lined, 6-hoop barrels. Fir has also been found suitable for packing condensed milk, although even in the fir barrel, oak is usually used for the bunghole stave because fir wood lacks the toughness and the elasticity that is characteristic of oak wood. When pounding the stave with a hammer, as is commonly done to lift the bung, the oak stave suffers no noticeable damage. Its fibre is sufficiently resilient to spring back to normal. The life of fir fibre, on the other hand, is destroyed by such pounding. The wood loses its buoyancy, it becomes spongy and refuses to satisfactorily hold the bung.

New barrels require no treatment before filling. The cooperage paraffins and vacuum cleans them. The use of reconditioned barrels is looked upon as questionable economy. Men who have built up a reputation for high quality condensed milk invariably fill their product into new barrels. If used barrels must be re-used, the following method of reconditioning is recommended:

**Reconditioning Used Condensed Milk Barrels.**—Remove the barrel head. Scrub barrel and head thoroughly with hot washing powder solution using

stiff brush. Rinse clean with clear hot water, followed by a rinse with chlorine solution, using one pint of three per cent chlorine stock solution in 50 gallons of water (i. e., a 75 P.P.M. solution).

Reassemble barrel and roll it on sleepers with bunghole down. Inject steam hose up through opening and steam for fifteen minutes. Allow barrel to drain well. When dry turn barrel so the opening is up, and pour in two gallons of paraffin at the proper temperature (250° to 260° F.). Insert bung and roll barrel, also turn it end over end, so as to distribute the hot paraffin properly. Now remove bung, roll the barrel upon sleepers and drain the surplus paraffin into a pail.

The barrel is now ready for use. If not used until later, close it with bung and keep sealed until ready to fill. It is advisable to examine several of the barrels of the reconditioned lot by removing the head and making sure that the paraffin covers the entire surface, including also the grooves in the ends where the staves join the head.

As previously suggested, the re-use of reconditioned, used barrels cannot be considered good practice. Such barrels are a risk; they may jeopardize flavor and give rise to lumps and mold buttons, et cetera. If used barrels must be re-used, the more thorough the reconditioning treatment, the less the danger of damage to the keeping quality of the condensed milk.

**Filling the Barrels.**—The room in which the barrels are filled should be in sanitary condition and its atmosphere should preferably be one of filtered air. It is usually most satisfactory to have the submerged cooling coil, or internal tube cooler, or the crystallizing tank discharge direct into the barrel.

Before the bung is removed it is good practice to wipe the bilge around the bung with a clean cloth dampened with chlorine solution. This will prevent objectionable extraneous material from being blown into the barrel at the time the bung is lifted. If the filling is done from milk cans a suitable funnel may be provided in the form of an ordinary milk pail with a two-inch diameter nipple fitted into its bottom. The funnel should be clean and made sterile by thorough steaming. The barrels are preferably filled to an outage space of 2½ inches; i. e., with the barrel on its bilge, bung up, a vertical air space of 2½ inches, called "outage" is allowed, as measured from inside of bung to surface level of the condensed milk in the barrel. This is considered<sup>1</sup> a liberal provision for expansion under any conditions that might be encountered. It is customary to fill the barrels at about 60° F. A one-thickness unbleached muslin is placed under the compressed bung. The bung is trimmed and strapped. The hoops should be driven tight and fastened with three tenter hooks.

Haymes<sup>2</sup>, United Milk Products Company, Cleveland, Ohio, reported that owing to the shortage of tin cans during the war the half-size barrel of similar cooperage as the full size barrel, but holding only 30 gallons, was also tried. It has proved an excellent container of sweetened con-

densed whole milk for overseas shipment to our forces on land, sea and in the air, and for lend-lease shipments to our Allies. It has been found air tight, moisture proof and gas proof. It can be floated ashore and exposed to adverse conditions of climate and of handling, without damage to its contents. The sweetened condensed whole milk that is packed in small, paraffin-lined, tight oak barrels for overseas is mostly "over-standard." It averages approximately 9.25 per cent milk fat, 23 per cent SNF, 42.75 per cent sugar, and 25 per cent water. It is accepted upon Government examination and approved for quality, normal color, normal viscosity, smooth texture. It must be free from dark color, abnormal thickening, lumps and mold buttons, sandiness and sugar sediment. The barrels must be packed to an outage of 2½ inches. Two such barrels which had been held eight months at 70° F., 80 per cent relative humidity, on the bilge, bungs down, were tested for presence of oxygen. Flame of matches inserted through bung openings of both barrels was immediately extinguished, indicating no oxygen present, suggesting "that the oxygen content of the air in the air spaces was entirely consumed, possibly in the formation of the slightly increased acid, or of CO<sub>2</sub>. It would appear that the packages have remained air-tight."<sup>8</sup>

**Packaging Case Goods.**—Up to the early 90's, practically all the sweetened condensed milk manufactured was packed into the consumer's package, the hermetically sealed tin, which originally was made to hold 16 ounces. From then on there was a gradual development of the manufacture and marketing of bulk milk, both whole milk and skimmilk, for use in prepared food factories. The manufacture of case goods continued to increase and reached its peak during and immediately after World War I. For the year 1919, the production of case goods made from whole milk amounted to 573,000,000 pounds. It then declined, rapidly at first, and more gradually later, reaching its lowest volume (34,732,000 lbs.) in 1939. See also Table 19 in Chapter IV. With the beginning of World War II, the production of case goods has again increased greatly.

**Filling the Tins.**—The standard size can holds 14 ounces net weight. Sweetened condensed milk is also packed in "Babe" size cans holding six ounces net weight, and in gallon cans holding 133.37 ounces net weight. For the 14-ounce and 6-ounce can the so-called sanitary can is now used practically exclusively. This can is filled before the top end is crimped on. The gallon can is filled through an opening ¾-in in diameter in the center of the top end.

These cans are filled by means of automatic filling machines. In general principle, the filling machine consists of multiple piston pumps. The cylinder charge is adjustable to the size cans to be filled. The machine is equipped with an efficient "cut-off" to prevent objectionable slobbering of this highly viscous product. The gallon size can is usually filled by means

of a hand-operated filler. It is important to fill the cans full, in order to exclude as much of the air from the container as possible.

For sanitary reasons the filling machine should be emptied and washed after each day's use. For thorough cleaning, the filler is emptied. All detachable parts, such as pistons, tubes, valves, supply tank, and cut-off, are washed, scalded, steamed dry and replaced in the machine. It is good practice to reject the first few tins when starting the machine, returning their contents to the forewarmer.

**Sealing the Tins.**—It is important to close the tins promptly after filling. When left open their contents are exposed to air and light. Prolonged exposure may cause the surface to crust over and to develop a tallowy flavor. It may also invite contamination with chance insects.

**Kinds of Seals.**—The seal must be air-tight and sufficiently rigid to withstand rough handling between factory and destination without danger of springing leaks. The solder seal is the most substantial. The opening in the top of the tin has a peripheral groove. The beveled periphery of the closing cap fits in this groove. When the cap is in place the groove is filled with molten solder. The cap usually has a small vent hole in the center to permit escape of the air heated by the hot solder in the

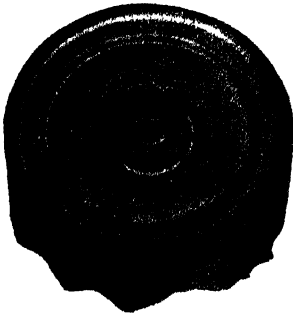

Fig 58. The solder seal



Fig 59 The sanitary seal

groove. The vent opening is closed by tipping with solder. The sanitary can is sealed by machine-closing the open end. A gasket of cement in the peripheral rim of the lid assists in providing a dependably hermetical seal.

**Sterilizing the Tins.**—In order to maintain a near-sterile condition until the milk is hermetically sealed in the tin cans, contamination between storage tank and sealing machine must be avoided. This means that the filling and sealing room must be kept in sanitary condition, clean, orderly, and free from accumulations of rubbish. It should preferably be closed to the outside and to visitors, and its air supply should consist of efficiently filtered, pure air. The cans on their passage to the filler should be sterilized. This is usually done by passing under or over a battery of suitable gas jets. The sanitary handling of the detached ends of the sanitary can is



also important. The filling and sealing machines themselves, and the pipes conveying the condensed milk need to be kept in scrupulously sanitary condition by efficient washing and thorough steaming. The filling machine should be hooded when not in use to protect it from dust, chance insects and other agencies of contamination.

Attention to the details of the above precautions is essential, especially in order to avoid the appearance of mold buttons. It is important also to prevent the development of other quality defects of biological origin.

#### REFERENCES

1. HAYMES, P. L.: The Sweetened Condensed Milk Situation. Cleveland, Ohio. Nov. 29, 1942.
2. HAYMES, P. L.: Information by Correspondence. Nov. 2, 1943.
3. HAYMES, P. L.: Report of Examination of barreled sweetened condensed milk at Bureau of Dairy Industry, U.S.D.A., Washington, D. C., Nov. 25, 1942.

## CHAPTER XIX

### MANUFACTURE OF EVAPORATED MILK

#### DEFINITION, INTAKE, STANDARDIZATION

**Definition.**—Evaporated milk is cow's milk condensed in vacuo at ratios within the approximate range of two and two and one-half parts of fluid milk to one part of evaporated milk. It is of a consistency of thin cream and reaches the market in hermetically sealed tins. Three different sizes are used in the United States, namely, Babe size, 6 ounces net weight; tall size, 14½ ounces net weight; and one gallon, respectively. The 14½-ounce can is the officially recognized standard size can. Evaporated milk is preserved by subjecting the sealed cans to steam under pressure.

The U. S. A. standard composition now in force (1945)<sup>16</sup> requires the finished product to contain not less than 7.9 per cent fat, and not less than 25.9 per cent total solids. The British standard calls for 9 per cent fat and 31 per cent total solids.

**Equipment Needed for Manufacture.**—The equipment needed and the flow of the milk from weigh can to sterilizer are shown in Fig. 60. It is briefly as follows:

From the weigh tanks (1) where the farmers' milk is inspected, weighed and sampled, the milk is pumped (3) through filter (4) over cooler (5) into holding tanks (6) where it is standardized to the desired ratio of fat to solids-not-fat. From the holding tanks it is pumped through fore-warmer (8) into hot well (9). From there the hot milk is drawn into vacuum pan (10) and the condensed milk is discharged from the bottom of the pan through sampling valve (22) into drop tank (16).

For the continuous process of condensing, requiring means for a continuous pan discharge while condensing, a low pressure pump (14) assisted by check valve (13) and primer (12) is provided. The condensed milk may pass to the homogenizer (17) without the use of the drop tank (16) but the availability of the drop tank may prove helpful in case of accidental interruptions in the flow of the milk between pan and storage tanks (19) and especially when using the batch system of condensing.

From the drop tank the condensed milk passes through homogenizer (17) over cooler (18) into storage tanks (19), where it is standardized for total solids and held cold until ready to be tinned. The standardized milk, made homogeneous by thorough agitation in the storage tanks, is then forced from these tanks by pump (7) through evaporated milk warmer (20) into a supply tank that feeds the filling machine (21) by gravity. From the filling machine the filled and sealed tins are conveyed through a leak detector to the sterilizer where they are subjected to steam under pressure, destroying the ferments contained in the milk and giving the evaporated milk the necessary keeping quality and the desired consistency.

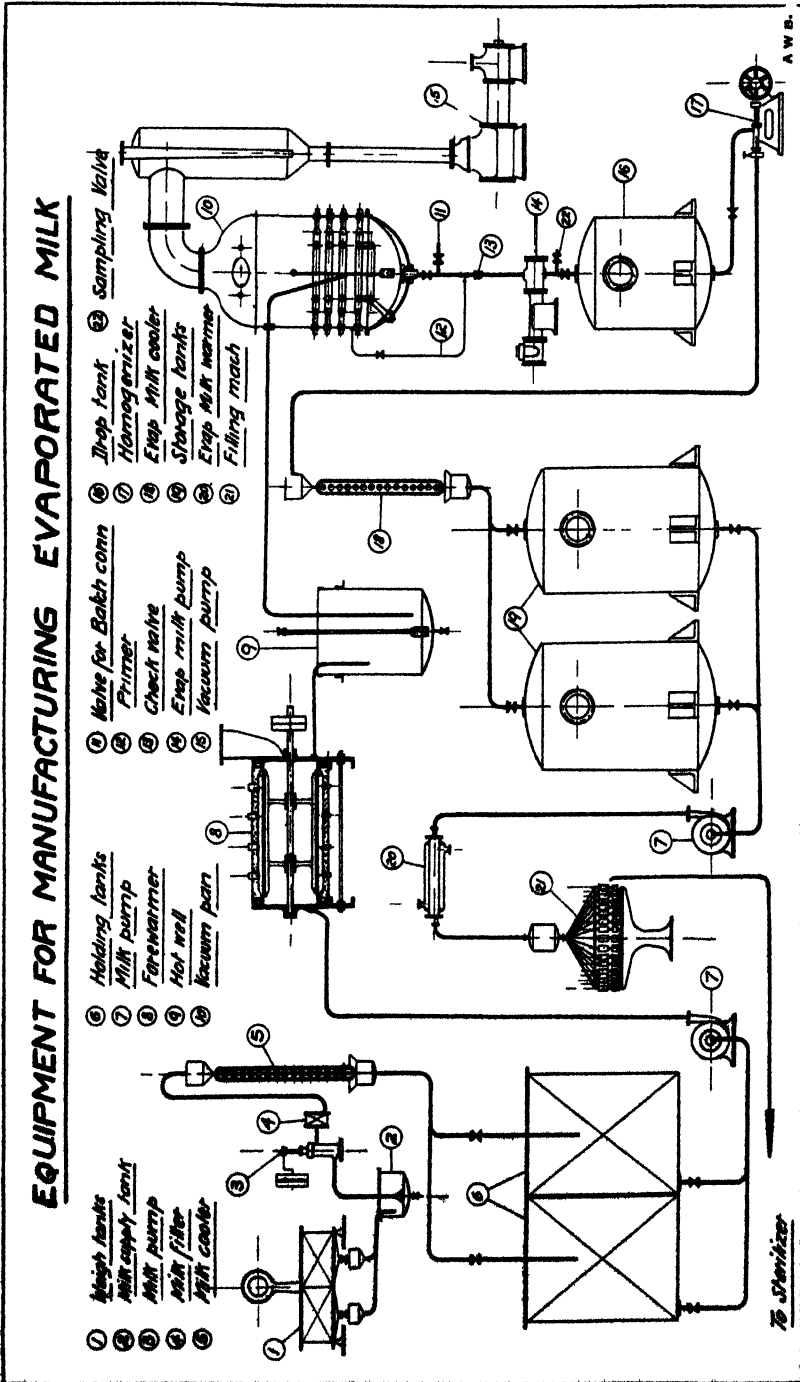

Fig 60 Flow-sheet for evaporated milk manufacture  
Courtesy of A. W. Baumann

Fig. 61 illustrates graphically the approximate temperatures to which the milk is subjected in its journey from cow to finished manufactured product.

**Inspection and Treatment of Milk Before Manufacture.**—The purpose and principle of the several quality tests and their merits as criterions of the fitness of the patrons' milk supply for condensing purposes are discussed in Chapter XII. Efficient inspection of the milk on the receiving platform is an integral and necessary step in the successful quality control of evaporated milk. Such inspection is especially valuable when supplemented by a vigorous program of quality improvement by a "live" staff of quality-conscious fieldmen.

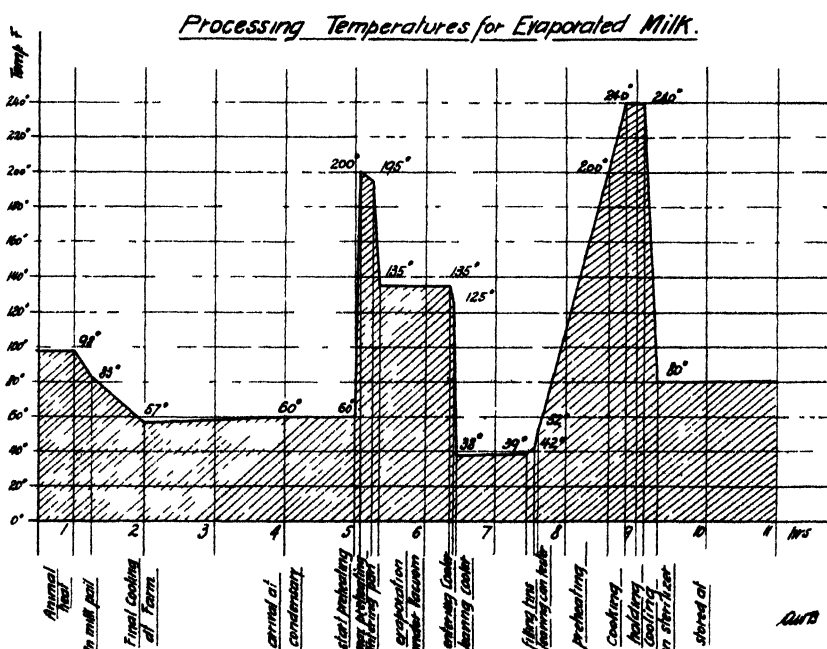

Fig. 61. Temperature flow-sheet for evaporated milk  
 Courtesy of A. W. Baumann

Aside from inspection by the senses of smell, taste and sight, the use of rapid chemical tests adapted to the routine of the receiving platform, such as the acidity test, the direct microscopic count, the methylene blue reduction test, the alcohol test and the phosphate test have proven helpful. The merits of these tests are discussed in Chapter XII, and directions for using them are given in Chapter XLVI. Some of these tests are especially valuable for confirmation of impressions and observations gained from inspection by the senses in the case of doubtful cans, and also at times of sterilizer trouble when it becomes necessary to ascertain the source of the

troublesome milk. Variations in the quality of milk have a direct effect on heat stability of evaporated milk and thus indirectly also influence the viscosity of the finished product.<sup>17</sup>

**Standardization of Ratio of Fat to Solids-Not-Fat Desired.**—The milk that has passed inspection is then “dumped” into the weigh tanks, and after sampling and recording weights, it is dropped into the supply tank from which it is pumped over or through a cooler into the holding tanks. Here it is tested for fat and total solids, and standardized to the ratio of fat to solids-not-fat desired in the evaporated milk. For method of standardizing the fluid milk, see Chapter XIII. Some evaporated milk manufacturers prefer to defer standardization until the evaporated milk is in the storage tanks just before canning, instead of adjusting the ratio of fat to solids in the fluid milk before condensing. In such case it is advisable to see to it that there is no shortage of fat in the evaporated milk before processing. The addition of fat in the form of cream or melted butter to the cooled, homogenized evaporated milk in the storage tank would require rehomogenization after such standardization in order to prevent objectionable fat separation after sterilization.

**Addition of Casein Stabilizers.**—In factories where casein stabilizers, such a sodium bicarbonate, di-sodium phosphate or sodium citrate are used for the control of heat coagulation in the sterilizer, it is considered good practice to add at least a portion of the required quantity anticipated to the fluid milk before manufacture, as explained in Chapter XXVI.

#### FOREWARMING OF EVAPORATED MILK

In the manufacture of evaporated milk the forewarming process is not depended upon for the elimination of pathogens and of quality-jeopardizing germlife and milk enzymes. Here the destruction of biological agencies injurious to health and damaging to keeping quality, that might be present in the raw milk, is the function of the process of sterilization by steam under pressure. However, aside from the indispensability of forewarming for satisfactory vacuum pan operation, as explained in Chapter XIV, the forewarming process is one of the most important steps in the manufacture, upon which the heat stability of evaporated milk depends. In addition, through their effect on heat stability, variations in forewarming procedures have a definite effect on the viscosity of evaporated milk as shown experimentally by the work of Deysher, Webb and Holm.<sup>17</sup> Increasing the temperature of forewarming and limited increase of the period of exposure to the forewarming temperature diminishes viscosity and increases the stability of the milk toward sterilizing heat. This fact has been established by long experience in commercial manufacture and by extensive experimental investigations.<sup>1, 2, 3, 4, 5, 6, 7, 8, 9, 10, 11, 14, 17.</sup>

**Temperature of Forewarming.**—The forewarming temperatures commonly used in American condenseries manufacturing evaporated milk that

conforms to the U.S.A. minimum standard of percentage composition (7.9% fat and 25.90% total solids) range from about 200° F. to boiling, with an approximate exposure of 10 to 25 minutes.

Efforts to save shipping space in connection with the war emergency have emphasized the importance of high-solids milk for overseas shipment. However, an increase in milk solids lowers the heat stability of evaporated milk. In addition, the higher concentration definitely increases the danger of objectionable cooked flavor, darkening of color, and the appearance of crystals of calcium citrate and of other mineral salts in the evaporated milk. The tendency to develop these latter defects is further accentuated by the use of heat-stabilizing high temperatures of forewarming.

The danger of developing these defects can be practically eliminated by a method of heating whereby the high forewarming temperature is attained quickly and the time of holding is limited to a few minutes. This was shown by the work of Webb and Bell<sup>9, 14</sup> and Bell and Webb.<sup>11</sup> In a recent report of the Bureau's findings, Webb, Bell, Deysner and Holm<sup>10</sup> offered in part the following conclusion:

"Low-heat stability can no longer be considered a factor which might limit evaporated milk to 26 per cent solids content. . . . From a heat stability view point it should be commercially possible to manufacture evaporated milk of approximately 32 per cent total solids content. A good grade of milk should be quickly forewarmed to about 120° C. (248° F.) and held 3 to 4 minutes, then drawn into the vacuum pan and handled in the usual way."

As previously stated, the need of forewarming at temperatures above the boiling point is limited to milk of abnormally low heat stability, or milk intended for the manufacture of high-solids evaporated milk. For the usual type of normal milk supply, forewarming temperatures below the boiling point are considered adequate to produce the desired heat stability in evaporated milk of U. S. standard composition, sterilized by the conventional process of 240° F. for 18 to 20 minutes.

It should obviously be recognized that each milk supply has its own peculiarities as to optimum forewarming treatment for accomplishing the viscosity and body desired. This can best be determined through practical experience in the application of high-temperature forewarming procedures in each individual case.

**Seasonal Adjustment of Forewarming Treatment.**—In the temperate zone and where the routine cattle breeding program aims to distribute milk production over the 12 months of the year, the tendency is for the evaporated milk made during the flush production of the summer months to show the greatest natural heat stability. In other words, it is the evaporated milk made from "grass milk" that is most stable, while that made during fall, winter and early spring shows the lowest heat stability. In

regions where these seasonal differences prevail, therefore, heat coagulation difficulties during late fall and winter may be materially lessened by the use of the higher forewarming temperatures (248° F., coming-up time five seconds, holding time three to four minutes), or the longer period of heat exposure, but not to exceed 25 minutes.

During the late spring and the summer months when the natural tendency is toward low viscosity, the lower range of forewarming temperatures, (from 200° F. to boiling) or shorter heating periods, or both, will assist in improving the body of the finished product.

**Equipment for Forewarming Evaporated Milk.**—Forewarming equipment listed in Chapter XIV for the manufacture of sweetened condensed milk applies also to the manufacture of evaporated milk. In addition, a new principle of continuous high-temperature heater has been designed by Hanrahan<sup>25</sup> and is being studied by Hanrahan and Webb<sup>26</sup> to determine its adaptability to high-temperature, short-time forewarming. As

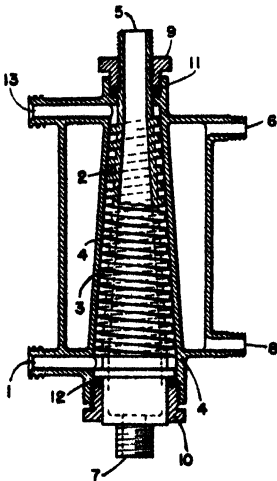

Fig. 62. High-temperature preheater, threaded with helical groove  
Courtesy of Dairy Research Laboratories,  
Bureau of Dairy Industry



Fig. 63. Chester Ste-vac high-temperature milk heater installation in Kendall Coop. Creamery, Kendall, Wis.  
Courtesy of Chester Dairy Supply Co.

shown in Fig. 62, this heater consists of a hollow core the surface of which is threaded with a helical groove. When the core is inserted into the tightly fitting, steam-jacketed housing, the groove provides an enclosed passage through which the milk flows. The heat is supplied to the hollow core and the jacket surrounding the housing wall.

In operation, the milk enters at (1) and discharges at (13). It travels the entire length of the helical passage (2) formed by the threaded core (3) pressing against housing wall (4). The steam enters at (5) and (6)

and exhausts at (7) and (8), respectively. Nuts (9) and (10) hold the core in place and are sealed with gaskets (11) and (12). The heater core is easily removed for cleaning. In experimental trials the milk was heated from 200° F. to 300° F. with but little milkstone deposited on the heater. However, when the temperature of small batches of milk was raised from 50° F. to 250° F., the heater capacity was small and milkstone deposits were soon built up. In most of the experiments the milk passed through the heater in less than 2 seconds, a pump pressure of 50 to 200 pounds per square inch was generally required, and the velocity of flow varied from one to two gallons per minute. Hanrahan and Webb<sup>26</sup> emphasize that the principle of this heater design has not as yet been adapted to commercial use. They report that "Experimental work is being directed toward improving the heater performance and increasing its capacity. An effort is being made to obtain data by means of which equipment manufacturers can design and build helical coil heat exchangers in commercial sizes."

In general, the manufacture of evaporated milk is centered in factories with large volume. This automatically favors the use of the continuous system of forewarming, although the practice of batch forewarming is also in use in some plants. Where continuous forewarming is practiced, the recirculation hot well and continuous-flow heater predominate, and the temperature-time ratio of operation, when forewarming below the boiling point, is 200° F. to boiling for ten to 25 minutes.

There is a growing tendency, however, to use temperatures above the boiling point. This is due largely to the increasing demand for high-solids evaporated milk.

**Two-Stage Forewarming.**—In order to be of commercial utility, the high-short heat treatment must be capable of practically preventing the laminar film\* from forming a solid, burnt-on layer of milk solids upon the heating surface, and it must prevent objectionable browning and the development of a pronounced cooked flavor. This requires a heater design endowed with a heat transfer of sufficient velocity to heat and cool almost instantaneously, limiting the coming-up period from ordinary temperature to say 250° F., to a few (3) seconds. For this purpose heaters with narrow diameter milk tubes of great length have been designed, such as the Mallory heat exchanger,<sup>9, 10</sup> through which the milk is forced under high pressure at a high velocity. Yet, Bell and Sanders<sup>18</sup> showed that even in these high velocity heaters, a growing deposit consisting essentially of milk protein, calcium and phosphorus,<sup>19, 20, 21, 22, 23</sup> builds up in these tubes. This in turn greatly increases the pressure in the course of the day's run.

\*Courtis<sup>24</sup> defines the laminar film as follows: "It is generally accepted that to every surface over which a liquid is flowing some adheres, and that the liquid near the surface moves at a slower speed. This volume of liquid, the velocity of which is greatly reduced is called a laminar film."



Webb and Bell,<sup>9</sup> and Webb, Bell, Deysher and Holm<sup>10</sup> further observed that if the heat is stepped up in two installments, such as by heating to 95° C. (203° F.) in the conventional hot well and then pumped through a high-temperature heater raising the temperature to approximately 250° F., the burn-on in a high-temperature heater, such as the Mallory, is not great.

In support of these findings the Chester Ste-vac heater<sup>23</sup> is designed to heat the milk in two stages with an intervening period of holding. The first-stage heater raises the temperature to 190° F. The milk is held at this temperature for 15 minutes, after which it is pumped through the second-stage heater which raises the temperature to 235° F. Unpublished results by Webb, Bell and Hufnagel<sup>24</sup> of experiments with two-stage forewarming are given in Table 35-A.

TABLE 35-A.—EFFECT OF TWO-STAGE FOREWARMING<sup>24</sup>

Sample	Forewarming Treatment				Heat Stability at 240° F. After Concentration*	
	First Stage Heated in Jacketed Hotwell		Second Stage Heated in H. T. S. T. Heater (Mallory)		T. S. 26%	T. S. 31%
	Temp.	Time	Temp.	Time		
Control	°F.	min.	°F.	min.	min.	min.
1	203	10	248	4	39	11
2	149	5	248	4	93	66
3	167	5	248	4	71	37
4	185	5	248	4	61	18
5	203	5	248	4	48	25
6	203	10	284	0	30	16
					...	35

\*The milk contained a fat to solids-not-fat ration of 1 : 2.28. It was homogenized at 2500 lbs. per sq. in. pressure after concentration.

## REFERENCES

1. ROGERS, L. A., DEYSHER, E. F., AND EVANS, F. R.: Jour. Dairy Sci. IV. 294. 1921.
2. LEIGHTON, A., AND DEYSHER, E. F.: Proc. World Dairy Congress, Washington, D. C., II. 1276. 1923.
3. SOMMER, H. H.: Proc. World Dairy Congress, Washington, D. C., II. 1241. 1923.
4. SOMMER, H. H., AND HART, E. B.: Wis. Res. Bul. 67. 1926.
5. GRINDROD, G.: Cry. and Milk Plant Monthly, 16. 9. 38. 1927.
6. WEBB, B. H., AND HOLM, G. E.: Jour. Dairy Sci. XI. 243. 1928.
7. DEYSHER, E. F., WEBB, B. H., AND HOLM, G. E.: Jour. Dairy Sci. XII. 80. 1929.
8. WEBB, B. H., AND HOLM, G. E.: Jour. Dairy Sci. XV. 345. 1932.
9. WEBB, B. H., AND BELL, R. W.: Jour. Dairy Sci. XXV. 301. 1942.
10. WEBB, B. H., BELL, R. W., DEYSHER, E. F., AND HOLM, G. E.: Jour. Dairy Sci. XXVI. 571. 1943.
11. BELL, R. W., AND WEBB, B. H.: Jour. Dairy Sci. XXVI. 579. 1943.
12. MOJONNIER, T., AND TROY, H. C.: Technical Control of Dairy Products 2nd Ed., p. 175. 1925.
13. American Evaporated Milk Asso.: Am. Cry. and Poultry Prod. Rev., 686, 1931.
14. WEBB, B. H., AND BELL, R. W.: Jour. Dairy Sci. XXIV. 535. 1941.
15. MALLORY, W. E.: U. S Patent 2,270,540. 1942.

16. U. S. Federal Standard of Composition of Evaporated Milk, Federal Register, July 2, 1940.
17. DEYSHER, E. F., WEBB, B. H., AND HOLM, G. E.: Jour. Dairy Sci XXVII. 345. 1944.
18. BELL, R. W., and SANDERS, C. F.: Jour. Dairy Sci. XXVII. 499 1944.
19. TUCKEY, S. L.: Address Annual Dairy Mfrs. Short Course. Univ Illinois. 1931.
20. SHERE, L.: Food Industries 14. 44. 1942.
21. BELL, R. W.: Jour. Biol. Chem. 64. 391. 1925.
22. ROWLAND, S. J.: Jour. Dairy Res. 5. 46. 1933, and 8. 1. 1937.
23. CHESTER DAIRY SUPPLY CO.: Information by correspondence. 1945
24. WEBB, B. H., BELL, R. W., AND HUFNAGEL, C. F.: Unpublished results of experimental data. Bur. Dairy Ind., U.S.D.A. January 1944.
25. HANRAHAN, F. P.: Bur. Dairy Ind., Agr. Res. Admin., U. S. Patent Pending. 1944.
26. HANRAHAN, F P, AND WEBB, B. H.: Bur. Dairy Ind, Agr. Res. Admin., U.S.D.A. Unpublished data 1943-45.

## CHAPTER XX

### CONDENSING OF EVAPORATED MILK

#### BATCH SYSTEM

The forewarmed milk is condensed to the desired concentration in the vacuum pan or evaporator in a similar manner as explained in the case of sweetened condensed milk. (See Chapter XV.) Evaporated milk boils somewhat more vigorously and needs somewhat closer watching because of absence of the stabilizing influence of the sugar. Its rate of evaporation, especially toward the end of the condensing period, is slightly faster than that of the more sluggish sweetened product. For preparation, starting and operation of the pan, entrainment losses, et cetera, see Chapter VIII.

**Ratio of Concentration.**—On the basis of fluid milk with an average total solids content of 12.25%, the ratio of concentration of evaporated milk is approximately as follows:

U.S. standard evaporated milk (25.90% TS) =  $\frac{25.90}{12.25}$  or 2.11 : 1.

British standard evaporated milk (31.0% TS) =  $\frac{31}{12.25}$  or 2.53 : 1.

**“Striking” the Batch.**—The striking, or sampling and testing for density of evaporated milk is more easily accomplished than that of the viscous, syrupy, sweetened condensed milk. When evaporated milk approaches the desired concentration its consistency resembles that of rich milk or thin cream. Its fluidity, therefore, ensures ready equilibration of the hydrometer.

The Baumé hydrometer, with a scale range from 0 to 15° Bé. subdivided into 1/10 degrees, is commonly used for testing the pan sample. The Baumé reading should be made at a known temperature. Establishing a standard striking temperature helps to avoid misleading results. A convenient temperature is the pan temperature which near the finish of the batch usually ranges from approximately 120 to 130° F.

**Temperature Correction Factor.**—If the temperature of the sample used for the density test varies from the adopted standard temperature, correction of the Baumé reading to standard temperature may be made by multiplying the temperature deviation by the factor 0.031 for each degree of deviation. If the temperature of the sample is above the standard temperature the product is added to the observed Baumé reading. If the temperature of the sample is below the standard temperature the product is deducted from the observed Baumé reading.

**EXAMPLE:**

The temperature at which the Baumé reading was taken was 130° F., and the reading was 6.7° Bé. What is the Bé. reading at 120° F.?

**ANSWER:**

$6.7 + [0.031 \times (130 - 120)] = 7.01^\circ \text{Bé. at } 120^\circ \text{ F.}$

**Formula for Calculation of Correct Hydrometer Reading for Desired Concentration.**—The specific gravity of evaporated milk of any desired percentage composition may be calculated by dividing the figure 100 by the sum of the quotients resulting from dividing the percentage of each ingredient (the fat, solids-not-fat, and the water) by its respective specific gravity. The calculation is represented by the following formula:

Specific gravity of evaporated milk at 60° F.

$$\frac{100}{\frac{\% \text{ Fat}}{\text{spec. gr.}} + \frac{\% \text{ SNF}}{\text{spec. gr.}} + \frac{\% \text{ Water}}{\text{spec. gr.}}}$$

Specific gravity values that were adopted for the milk constituents of sweetened condensed milk, Chapter XV, apply also to evaporated milk constituents. They are: fat, 0.93; solids-not-fat, 1.608. The formula ready for use then reads as follows:

$$\frac{100}{\frac{\% \text{ Fat}}{0.93} + \frac{\% \text{ SNF}}{1.608} + \frac{\% \text{ Water}}{1}}$$

EXAMPLE:

Evaporated milk with a composition of 7.9% fat and 26% total solids is desired. What is the correct Baumé hydrometer reading at 120° F.?

ANSWER:

Solids-not-fat = 26 — 7.9 = 18.1% SNF

Water = 100 — 26 = 74% water

$$\text{Specific gravity at } 60^\circ \text{ F.} = \frac{100}{\frac{7.9}{0.93} + \frac{18.1}{1.608} + \frac{74}{1}} = 1.0667$$

$$\text{Baumé reading at } 60^\circ \text{ F.} = 145 - \frac{145}{1.0667} = 9.07$$

$$\text{Baumé reading at } 120^\circ \text{ F.} = 9.07 - [0.031] \times [120-60] = 7.21$$

**Limitations of Accuracy of Results of Specific Gravity Formula.**—The accuracy of the specific gravity formula depends on the representativeness of the specific gravity values used for the individual milk constituents. It was shown in Chapter XV, under "Formula for Calculating the Correct Baumé Reading" (of sweetened condensed milk), that the specific gravity of the solids-not-fat is the least constant value in the formula. It was further pointed out that the specific gravity of SNF in milk may vary somewhat with locality and season.

In sweetened condensed milk the SNF constitutes only about 26 per cent of the total solids. Minor inconstancies in the specific gravity value of this group constituent, therefore, may be expected to affect the composite specific gravity of the condensed milk only slightly by reason of the overwhelming presence of constituents, such as the milk fat and added sugar, that are known to have relatively constant specific gravity values.

In evaporated milk the situation is somewhat different. Here the SNF constitute over 70 per cent of the total solids. Hence, even slight changes in the specific gravity of SNF are reflected by, and will cause, similar changes in the composite specific gravity of the evaporated milk. These facts inevitably conspire to limit the usefulness of the specific gravity formula in evaporated milk work.

**Over-Condensing and Re-Standardizing with Water.**—Some condenseries follow the practice of slightly over-condensing the batch, and then standardizing it back, in the evaporated milk storage tank, to the exact per cent of total solids desired in the finished product, by addition of the accurately calculated amount of water. In order to simplify the operation of standardizing, a large storage tank with suitable agitator may be provided in which the entire day's run of evaporated milk is mixed and standardized in one operation. Aside from saving much time and labor, this practice makes for maximum accuracy of results because conditions for accurate density testing are under better control than is often the case at the pan. The entire day's manufacture is of uniform composition, and the danger of accidental deficiency of total solids in the finished product is practically eliminated.

#### CONTINUOUS SYSTEM OF PAN DISCHARGE

This system synchronizes the intake of fluid milk to the pan with the rate of evaporation, thus making possible the continuous discharge from the pan of finished product of the desired concentration.

**Advantages of the Continuous System.**—In the batch system of condensing, considerable time is lost between batches, emptying the pan and starting up again. More time is wasted due to retarded evaporation that results from insulation of the heating surface caused by a film of milk that bakes onto the steam coils during the emptying of the pan between batches. Furthermore, it requires more work to properly clean a pan, the heating surface of which is coated with a dried on film of milk.

These objections are largely eliminated when condensing by the continuous system of pan discharge. Thus, in factories with sufficient volume for several batches of evaporated milk per day, the continuous system has proven advantageous. In addition to the greater economy of pan operation, large storage tanks are used so that one or two tanks may hold the output of the entire day. This simplified standardization gives the entire day's run exactly the same composition, and insures uniformity of viscosity in sterilization.

**Equipment Needed For Continuous System.**—For satisfactory operation of the continuous pan discharge, there is need of a sanitary milk pump capable of pumping evaporated milk from the bottom of the pan against the operating vacuum. Both the steam-driven piston pump and certain rotary pumps are being used for this purpose. The performance is facili-

tated by placing the pump at a level several feet below the pan outlet in order for the hydrostatic pressure to lessen the load on the pump.

However, sanitary rotary pump units of latest design for continuous pan discharge no longer depend on the elevation of the pan above the pump. Such a pump unit is illustrated in Fig. 64. Its completely water sealed stuffing box provides so nearly perfect a seal against vacuum as to practically eliminate the need of hydrostatic pressure.

The suction end of the milk pump is connected with the bottom outlet of the pan. The exact set-up for continuous pan operation depends somewhat upon the type of speed arrangement of the pump, whether variable speed or single speed. In the variable-speed pump, such as the steam piston pump, the pump speed is regulated to draw milk from the pan at the rate desired. The single-speed pump operates at a fixed rate of speed, and the



Fig. 64 Pump for continuous pan discharge of evaporated milk  
Courtesy of Taber Pump Co

volume of milk it discharges from the pan is in excess of that desired. Of this the desired amount goes to the homogenizer while the excess is bypassed back to the pan as shown in Fig. 65.

**Operation of Continuous System.**—The operation of the continuous pan discharge system is briefly as follows: The pan is started and operated in the usual manner until the milk is boiling at the customary level and has attained the desired concentration. Instead of completely emptying the pan at this point, as is done in the case of the batch system of condensing, the milk discharge pump is started. From here on the rate of discharge of evaporated milk and the rate of intake of fresh milk are synchronized in a manner to maintain a uniform milk level and concentration.

**The Continuous Density Tester.**—The discharge pipe leading from the milk pump at the bottom of the pan to the homogenizer also feeds the continuous density tester. This instrument is installed in a position to overflow into the retarding hot well. See Fig. 65. Its elevation is at the approximate eye-level of the operator on the pan platform. The milk enters the bottom of the tester. The hydrometer floats freely in the con-

tinuous-flow tester, indicating the density continuously. The density is controlled by the regulation of the by-pass valve. If the density is too low, a larger portion of the pump discharge is by-passed back to the pan; if the milk is too heavy, the by-pass is reduced.

**Precondensing at Milk Receiving Depots.**—Some of the large evaporated milk manufacturers, in order to extend the radius of the milk supply for their central processing plant, operate a chain of country milk receiving

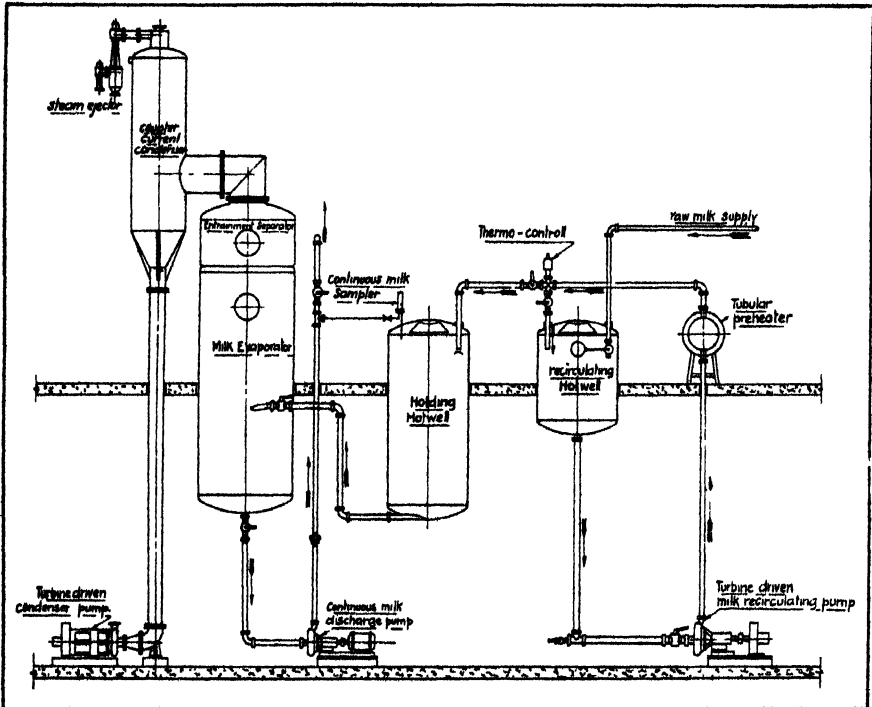

Fig. 65. Unit for forewarming by recirculation and holding, with continuous pan discharge and automatic density tester

Courtesy of A. W. Baumann

plants. In these plants the milk is forewarmed, and precondensed at the ratio of approximately 3 to 1. This concentrated milk is cooled and shipped to the central plant where it is diluted with the fluid milk of that plant, recondensed to the desired concentration, and processed and packed by the usual methods.

#### REFERENCES

1. MOJONNIER, T., AND TROY, H. C.: *Technical Control of Dairy Products*. p. 174. 2nd Ed. 1925.
2. HUNZIKER, O. F.: *Condensed Milk and Milk Powder*. 1st Ed. 1914.

## CHAPTER XXI

### IRRADIATION AND HOMOGENIZATION

#### IRRADIATION

The evaporated milk is usually passed through the irradiator on its way from vacuum pan to homogenizer.

**Purpose.**—The immediate purpose of irradiation of evaporated milk is to increase the vitamin D potency of the milk. It is to make "Vitamin D Evaporated Milk." For a discussion of the importance of vitamin D in the diet, and for methods other than irradiation, of incorporating vitamin D in evaporated milk, see Chapter XLIV on "Vitamins."

**Ultra-Violet Radiation from Artificial Sources.**—Milk contains some natural vitamin D. It also normally contains provitamins, such as cholesterol, capable of being activated by suitable ultra-violet radiation, to assume vitamin D properties. Ultra-violet radiation from the sun has the power of activating provitamins, but sunshine is not a dependable source of ultra-violet radiation in the temperate and colder latitudes. For dependable irradiation of milk commercially, artificial sources must be resorted to. This is done by the use of the electric arc.

**The Principle of the Electric Arc.**—When heating a non-combustible object to a high temperature it will radiate energy. When the heating of the object is excessive, the radiation becomes visible, first as a dull red, and with increasing temperature, as a white heat. With the approach of the white heat, ultra-violet radiation is given off. On similar grounds ultra-violet radiation may be artificially produced by the use of the electric arc.

The electric arc is essentially a column of very hot and highly conductive vapor brought forth by and bearing an electric current. The vapors are generated through the processes of volatilization and disintegration of electrodes, or by volatilization of materials within an enclosed tube. The discharge of radiation from the tube is caused by activity of the vapor particles and atoms, and of electrical stresses and disturbances of the atoms. It is through this activity that energy is released as radiation.

**Commercial Procedure of Irradiation of Evaporated Milk.**—For the commercial irradiation of milk by use of the electric arc, the usual sources are the carbon arc, the hot quartz mercury vapor arc, and the cold quartz mercury vapor arc.

The carbon arc consists of the luminous flame functioning between two carbon electrodes when an electric current passes between them. Several designs of carbon arc irradiators are available. One of the more recent devices was developed by the National Carbon Company, Inc., in cooperation with the Wisconsin Alumni Research Foundation.

This unit consists briefly of a stainless steel cylindrical drum with annular



trough around the top from which the milk overflows in a thin film down the inner surface of the cylinder. A powerful, three-phase carbon arc lamp is mechanically lowered down into the center of the drum. The carbon arc element, from its central position, thus emits the ultra-violet radiation at the same distance from all parts of the peripheral film of milk during the passage of the milk through the irradiator.

As stated earlier, it is general practice in plant routine to pump the milk from pan direct to irradiator. Irradiation appears to fit best into the factory flow system between vacuum pan and homogenizer. From the standpoint of the antirachitic properties of the resulting vitamin D evaporated milk, it is immaterial whether irradiation precedes or follows homogenization. Bioassay experiments<sup>2</sup> have conclusively demonstrated that homogenization has no effect on irradiation efficiency.

**The Potency of Commercially Irradiated Evaporated Milk.**—The researches of Scott<sup>2</sup> show that irradiation of evaporated milk yields about the same order of potency as irradiation of fluid milk at the same flow rate. Obviously the film of evaporated milk is somewhat thicker. This increases its opacity which tends to diminish the intensity of activation by the light rays upon the provitamins.

Nor does a longer film or a much longer exposure cause a significant increase in potency. Second and third recirculation enhanced the potency only 15, and 5 to 10 per cent, respectively. Scott<sup>2</sup> further suggested the use of a high wattage as the most effective fundamental means to secure maximum intensity of activation. The danger of objectionable irradiated flavor appears not to be great, and if such flavor is present it passes off before the evaporated milk reaches the consumer.

The activation-depressing tendency of the more opaque status of the thicker milk film is largely, if not wholly, offset by the greater concentration of provitamins. In evaporated milk condensed 2 : 1, the amount of provitamin with which the ultra-violet rays come in contact is doubled. Evaporated milk can be irradiated so that when diluted 1 : 1 it contains 400 units of vitamin D per quart of diluted evaporated milk.

In order for the irradiated product to qualify as vitamin D evaporated milk, it must contain not less than 270 units per quart of undiluted evaporated milk. This is equivalent to 135 units per quart diluted 1 : 1. This amount has been established as the protective minimum for fresh milk. It has been found sufficient to prevent rickets in the child, provided the proper amount of milk is being consumed. A vitamin D potency of 270 units is obtainable at a flow-rate of 12,000 pounds of evaporated milk.<sup>2</sup> For vitamin D requirements, see Table 71-A, Chapter XLIV.

The real problem that is confronting the manufacturer of vitamin D evaporated milk today is the problem of the mechanical handling of the enormous daily volume of milk. It is the problem of getting it into,

through, and out of the factory within the time limits of the daily operating routine and "winding-up" with a finished product that can be depended upon to fully conform to the required potency of standard vitamin D evaporated milk. New, improved equipment has been designed to master this problem mechanically, as well as qualitatively, but the very equipment that could do this, is and remains unavailable for the "duration."<sup>2</sup> Continuance of these difficulties may lead to consideration of resorting to fortifying by addition of vitamin D concentrate \*

### HOMOGENIZATION

From the pan the evaporated milk is pumped through the homogenizer, either direct or via irradiator. In case of condensing by the continuous-discharge system, the milk flow is continuous from pan discharge via homogenizer and cooler to the storage tanks. In case of the batch system of condensing, the pan discharges into a drop tank which then feeds the homogenizer.

**Definition.**—Clayton<sup>3</sup> defines homogenization as follows: "Emulsions usually contain dispersed globules of very different diameters. The process of subsequently reducing these globules to an approximately equal diameter many times smaller than the average previously attained in the emulsion is termed homogenization."

As applied to the dairy industry in general, milk, cream, evaporated milk, ice cream mix and other fluid milk products containing milk fat constitute the emulsion, and the fat globules contained in this emulsion are stabilized by subdivision that greatly increases the number, decreases the particle size, and makes for maximum dispersion. In the case of evap-

\*Since the manuscript of this volume has gone to press, due to continued equipment shortage caused by the protracted war emergency, the industry, in the United States at least, has almost completely shifted from "irradiated" vitamin D evaporated milk to "fortified" vitamin D evaporated milk, using a vitamin D concentrate.

Scott<sup>2</sup> reports that two procedures are generally used. In the first the vitamin in an oil solution is added to the milk somewhere in the flow line prior to homogenization. This form of concentrate in oil, which is used for either the form vitamin D<sub>2</sub> or D<sub>3</sub>, consists principally of a vegetable oil such as corn oil. Due to the high concentration of the vitamin in oil (200,000 U. S. P. units per gram), only very small quantities of the oil need be utilized in a day's operation. The vegetable oil carriers of the vitamin are not miscible with milk, therefore it is essential that they be added in such a manner as to insure proportionate inclusion during operations and to avoid early separation from the milk before canning and in subsequent storage of the finished product.

The second method consists of the addition to the standardized evaporated milk in the bulk storage tank, of a concentrate of vitamin D dissolved in corn oil or butter fat, emulsified in milk solids. This form of concentrate is provided in a concentration of 20,000 units per gram. It is readily miscible with the homogenized cold evaporated milk, which eliminates the danger of separation or oiling off. This form of concentrate places the procedure of fortification under the supervision of the laboratory rather than in the hands of plant workmen. Both vitamin D<sub>2</sub> (irradiated ergosterol) and vitamin D<sub>3</sub> (irradiated 7-dehydrocholesterol) are available in a canned sterilized product for the fortification of evaporated milk. An example of this form of vitamin D<sub>2</sub> concentrate is "Dyne", a canned sterile emulsion of the vitamin in milk solids.

According to Rosenberg,<sup>20</sup> experimental evidence indicates that, in human nutrition, vitamin D<sub>2</sub> is somewhat more effective than vitamin D<sub>3</sub>. In a more recent statement Scott<sup>2</sup> reports that such appears to be the case when the vitamin D potency of milk is limited to 125 U. S. P. units, but that when the concentrate is added to the extent of 400 U. S. P. units per quart of milk, vitamin D<sub>2</sub> and D<sub>3</sub> appear to be equally effective.

orated milk in particular, the primary purpose of homogenizing is to prevent objectionable fat separation after manufacture.

**Development of the Homogenizer.**—The history of the homogenizer is summarized in chronological order by Clayton.<sup>3</sup> It dates back to the year 1892 when Paul Marix<sup>4</sup> obtained two French patents on his idea of making emulsions relative to the manufacture of margarine, by forcing the ingredients under high pressure through a minute orifice. His homogenizing valve consisted of a bundle of capillary tubes against one end of which pressed a concave ball by means of a stout spring. The heated emulsion was forced through the tubes against this ball valve under a pressure of 250 atmospheres, thereby breaking down and dispersing the globules and achieving homogenization. In the same year this invention was subsequently improved by Marix and by Julien.<sup>5</sup> Later, further improvements were made in Germany<sup>3</sup> and in 1912 Schröder<sup>6</sup> obtained a German patent on his invention of an adjustable stepped valve. In this valve the face of each succeeding step was closer to the seat, causing a gradual breakdown of the fat globules. This valve design has prevailed to this day in some of the leading homogenizers used in Germany.<sup>7</sup> The Frenchman August Gaulin,<sup>8</sup> in 1899, conceived the idea of subdivision of the fat globules in milk to stabilize the emulsion and prevent fat separation.

**Introduction of Homogenizer in Manufacture of Evaporated Milk.**—The homogenizer was introduced in the manufacture of evaporated milk around the years 1909-1910. Prior to that time fat separation was a constant menace to the successful manufacture of a marketable product. There was a persistent tendency for a thick and leathery layer of cream to form on the surface of the milk in the tins held in storage. Not infrequently this cream would churn to lumps of butter in transportation between factory and consumer.

In the pre-homogenizer days the formation of at least a soft curd in the sterilizer was necessary in order to give the evaporated milk sufficient body and viscosity to minimize and retard fat separation. This was accomplished with varying success, at first, by superheating or "double cooking" after condensing; and later, by intermittent stopping of the reel in the sterilizer during the bringing-up period.

The homogenizer has eliminated fat separation as a serious problem in the manufacture of evaporated milk. While homogenization at a pressure sufficiently high to accomplish permanency of fat dispersion lowers the heat stability of evaporated milk somewhat, it actually improves control of heat coagulation, because it eliminates the need of precautions against fat separation, which themselves invite heat-stability uncertainties and difficulties.

Homogenization thus not only provides a dependable solution of the

Fig. 66 CP Multi-Flo homogenizer head

1. Intake manifold and strainer
2. Suction valve
3. Discharge valve
4. Single Service homogenizing valve assembly
5. Homogenizer outlet
6. Spring
7. Pressure regulator handle
8. Plunger
9. Packing
10. Water spray for cooling plungers
11. Homogenizing valve seat
12. Single service homogenizing valve

Courtesy of Creamery Package Mfg Company

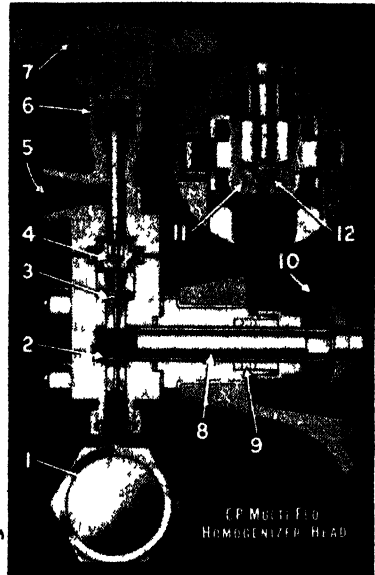

problem of damaging fat separation, but it economizes time by shortening the process of sterilization and eliminating the need of "shaking." Furthermore, it improves the quality of the finished product by preventing

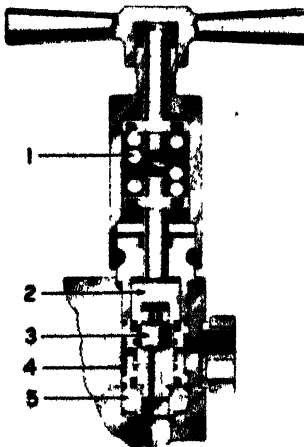

Fig. 67. Split-Flo valve sanitary viscolizer

1. Pressure regulating spring
2. Upper valve seat
3. Valve plug
4. Breaker ring
5. Lower valve seat

Courtesy of Cherry-Burrell Corporation

objectionable discoloration and excessive cooked flavor, such as are caused by prolonged exposure to sterilizing heat.

**The Homogenizer Valve.**—The homogenizer or viscolizer of today (1946) is a high-pressure, triple plunger, positive pump. The plungers function

successively, being controlled by an eccentric shaft. Each cylinder has a suction and a discharge valve. The homogenizing valve assemblies differ in design and size with different makes of machines, yet they all are based on the principle of passing the liquid under high pressure through very small apertures. In American condenseries the following homogenizer designs are used extensively: The Manton-Gaulin Two-Stage Homogenizer, the Creamery Package Multi-Flo Valve Homogenizer, and the Cherry-Burrell Split-Flo Valve Sanitary Viscolizer.

In the case of the C. P. Multi-Flo valve of the Creamery Package Mfg. Company, the valve itself consists of approximately 50 feet of fine stainless steel single-piece wire, compressed into a small cone-shaped plug that is seated into the ground Stellite valve seat, see Figure 66. This resilient cone constitutes a labyrinth of a great multitude of minute passages which provide the homogenizing elements. The Split-Flo Valve, which is the latest model viscolizer valve of the Cherry-Burrell Corporation, has a lower and an upper valve seat as shown in Figure 67. An opening through the valve plug causes the milk flow to split. One-half passes between the lower valve seat and the bottom end of the plug, and the other half passes up through the hollow plug and then between the upper valve seat and the upper end of the valve plug. Both halves of the flow are subjected to the same type and intensity of homogenization, after which they are brought together again at the outlet of the valve assembly. The split-flow principle makes possible proper homogenization with a relatively small diameter of valve, thereby enabling operation at lower pressure and with correspondingly less expenditure of power.

The pressure at which the homogenizer or viscolizer operates is adjusted by a manual regulating wheel that makes contact with a strong coil spring. This, in turn, presses the valve against the valve seat. This spring also serves as relief valve. The pressure could be regulated by means of a block in the place of the spring. In such case separate relief valves would have to be provided. The objection to separate relief valves lies in their additional expense due to initial cost, labor of cleaning and care. The resilience of the coil spring between manual wheel and homogenizer valve, together with the presence of the gasket rings and packing, provides emergency relief, in case of accidental clogging, sufficiently dependable to make unnecessary the installation of separate relief valves. The homogenizer valve and valve seat of the leading high-pressure, piston homogenizers is made of Stellite, a highly wear-resistant steel alloyed with chromium, cobalt, and tungsten.

**The Two-Stage Homogenizer.**—Milk that has been homogenized under high pressure (2,000 to 4,000 lbs. pressure per square inch) is subject to fat clustering. This tendency is especially pronounced in the case of milk that has been enriched, such as by the addition of cream. Such clustering restores the creaming ability and thereby tends to forfeit the primary

purpose of homogenizing fluid milk products, i. e., to prevent fat separation.

The tendency of the fat globules in the homogenized milk to clump is prevented by rehomogenization at a relatively low pressure, such as 500 to 1000 pounds per square inch. This may be done by the use of two homogenizers set up in tandem, or by the use of one two-stage machine. The first stage provides the high-pressure valve which is depended upon for subdivision of the fat globules sufficient for efficient homogenization. This stage is usually operated at a pressure of 2500 pounds per square inch or higher. The second stage provides the low-pressure valve which is depended upon to destroy the tendency of the fat globules to cluster, and to break up clusters that have already formed. This stage is usually operated at 500 pounds pressure per square inch.

The viscolizer with the Split-Flow valve depends upon the breaker ring or impact ring for the second stage. This ring automatically adjusts the secondary pressure needed to control clumping and the viscosity of the product. The breaker ring, or second-stage valve, or any other secondary pressure will accomplish the same result in preventing clumping.

**Theory of Prevention of Fat Separation Due to Homogenization.**—On the basis of Stoke's Law dealing with the rate of rise of globules or the fall of particles in a medium, the upward movement of the fat particles in evaporated milk is largely determined by the diameter of the fat globules and the viscosity of the dispersion medium which, in this case, is the skim-milk portion.

It is precisely the effect of homogenization on globule size and on viscosity that is largely responsible for the stabilization of the emulsion and the prevention of fat separation when homogenizing evaporated milk under the proper pressure. Thus, the major factors involved appear to be as follows:

1. The homogenizer reduces the fat globules to such small average size that the buoyancy of the majority of globules present is no longer sufficient to respond to the force of gravity and to cause them to rise to the surface.

2. The minute subdivision and the resulting vast increase in number of fat globules, greatly increases the ratio of surface area to cubic content of the individual globules, augmenting the protein covering adsorbed to the fat-liquid interfaces. This increases the specific gravity of the fat globules and further dissipates their buoyancy.

3. Homogenization increases the viscosity of evaporated milk. This further impedes particle movement, other than Brownian movement, enhancing stability of the fat globules.

Webb and Holm<sup>9</sup> studied the distribution of fat in cans of evaporated milk during storage by actual measurements of the rate and extent of separation. Their summary indicates that high pressures of homogenization, two-stage homogenization and high viscosity were effective in retarding separation.

Evaporated milk appears not to be subject to serious fat clumping, hence its homogenization is generally done by the use of the single-stage machine. The double-stage effect here is not only of no particular benefit, but it is, in fact, not desired by reason of its tendency to diminish the viscosity, and thereby to enhance the mobility of the fat globules and thus encourage fat separation.

Dependable freedom from damaging fat separation after manufacture requires sustained efficiency of homogenization. This is best ascertained by a systematic daily operating check up, such as by microscopic examination of the homogenized milk. Experience in commercial manufacture has demonstrated that commercially objectionable fat separation in evaporated milk, processed to a full body and normal viscosity, is usually prevented when microscopic examination of the homogenized evaporated milk shows about 85 per cent or more of the fat globules observed to have a diameter of two microns or less.

In order for the microscopic examination to reveal a reasonably accurate picture of the efficiency of homogenization, the use of standard apparatus and procedure is essential. The sample should be diluted at the rate of 1 cc. in 50 cc. of diluent, preferably consisting of 50 : 50 water and glycerine. For a magnification of 1000X, a 92X oil emersion objective, a 10X ocular (with ocular micrometer), and setting the draw tube at 17.1 mm. is used. Farrall, Walts, and Hanson<sup>10</sup> used an ocular micrometer that was ruled off into sixteen two-millimeter squares, with each division in the central scale being equivalent to two microns when using the above specifications. These same investigators perfected the above method of examination by providing a homogenizing index calculated from the measurements of the fat globule size.\*

**Effect of Homogenizing on Size of Fat Globules.**—Rahn<sup>11</sup> studied the distribution and size of the fat globules in skim milk and ~~in~~ homogenized

TABLE 36. RELATIVE NUMBERS OF GLOBULES IN SKIM MILK AND HOMOGENIZED WHOLE MILK

Diameter of Globule	Skim Milk	Homogenized Whole Milk		
		I	II	III
Microns	Number	Number	Number	Number
0-1	41.8	19.2	89.2	69.3
1-2	47.7	66.5	10.3	29.5
2-3	9.2	12.6	0.5	1.2
3-4	0.9	1.7	0.0	0.0
4-5	0.3	0.0	0.0	0.0
5-6	0.1	0.0	0.0	0.0
Over 6	0.0	0.0	0.0	0.0

\*The method developed by Farrall and co-workers is not as yet ready for publication in its entirety.

whole milk. Table 36, taken from the results of these investigations<sup>11</sup>, shows the relative number of globules within different diameter ranges.

Rahn and Sharp<sup>12</sup> question that these figures present the complete picture of the true fineness of the fat division. Quoting Wiegner<sup>13</sup>, they consider it probable that a larger portion of the fat is dispersed so finely that the globules are no longer visible by the 900X magnification used. In such case these figures would not mean much, since they would fail to show what portion of the total fat falls below the zone of visibility.

Wiegner<sup>14</sup> homogenized whole milk testing 3.13 per cent fat, at a pressure of 250 atmospheres (3675 pounds). The fat globules were reduced in size from an average diameter of 2.86 microns before homogenization to an average diameter of 0.27 microns after homogenization. Holm<sup>15</sup> points out that such reduction in size is equivalent to an increase in number of globules of 1200 times, and of their surface area 117 times.

The possibility is now generally conceded that such drastic subdivision of the fat globules may be the result of a combination of several forces. The most decisive factors in this combination appear to be:

1. The reciprocal shearing action which the globules suffer as they race by each other at unequal velocities in their passage through the microscopic clearance of the homogenizing valve. The clearance between valve and valve seat at 3,000 pounds pressure is about 0.002 inch.

2. The shattering effect on the fat globules caused by their violent impingement at high velocity and at a critical angle upon the wall of the chamber surrounding the valve. Experimental results by Doan and Minster<sup>16</sup> further show that aside from the velocity, the force with which the liquid strikes the wall of the valve chamber is determined by the distance between valve and wall, and by the angle of impact. The results emphasize that, other things being equal, the shorter the distance between valve and chamber wall and the more nearly the liquid strikes the wall at a right angle, the greater is the homogenizing efficiency.

3. Collapse of the fat globules when suddenly released from the high homogenizing pressure to atmospheric pressure.

**Effect of Homogenizing on Viscosity of Evaporated Milk.**—Homogenizing increases the viscosity of evaporated milk. This means that the resulting smaller fat globules must overcome a greater resistance if they are to move upward. The cause of the increased viscosity of homogenized milk has not been fully explained but it is believed to be due to the increased adsorption of casein to the much larger surface area of the finely dispersed fat globules, thereby considerably augmenting the volume of the dispersed phase and diminishing the volume of the continuous phase. A change in the physical properties of the casein may also be involved in the effect of homogenization on viscosity.

Buglia<sup>17</sup> and Wiegner<sup>14</sup> show experimentally an increased viscosity of homogenized over unhomogenized whole milk. Wiegner calculated from



viscosity measurements that of the total milk casein, 2.27 per cent was adsorbed to the fat globules in the unhomogenized sample, while in the homogenized sample 25.2 per cent of the casein was adsorbed. He attributes the greatly increased adsorption of casein in homogenized milk to the enormously increased number of fat globules which offer a vastly increased adsorbing surface. He holds that this augmented quantity of casein adsorbed to the surfaces of the fat globules is responsible for the increased viscosity.

Buglia found that while the viscosity, or outflow time, of homogenized whole milk is greater than that of the same milk before homogenizing, no increase in viscosity occurred in homogenized skimmilk. Skimmilk, being practically free from butter fat, obviously is incapable of materially increasing its adsorbing surface. Buglia further reports a slight increase in the electrical conductivity of homogenized milk, while Wiegner failed to find any difference in this factor. Rogers, Deysher and Evans<sup>18</sup> also demonstrated that homogenizing increases the initial viscosity of sweetened condensed milk, and experience in the manufacture of evaporated milk has amply shown that the higher the homogenizing pressure, the greater the increase in viscosity.

That homogenization definitely increases the viscosity of evaporated milk and does so increasingly with increasing pressure is shown experimentally by Webb and Holm.<sup>9</sup> Their results are given in Table 37.

TABLE 37. EFFECT OF HOMOGENIZING PRESSURE ON VISCOSITY OF EVAPORATED MILK

Milk Sample	Milk Composition		Homogenization Pressure	Viscosity of Sterilized Milk	Sterilization	
	Total Solids per cent	Fat per cent			Temperature ° F.	Time min.
1	26.10	8.3	1000	57.5	116	17
			2500	71.1		
			2500-1000	71.2		
2	27.70	7.9	1000	67.1	115	15
			2500	87.3		
3	26.71	8.3	2500	48.4	115	15
			2500-1000	57.4		
			4000	72.5		
			4000-1000	77.0		
			2500	125.1		

**Effect of Homogenization on Heat Coagulation of Evaporated Milk.**—While homogenizing definitely increases the viscosity of evaporated milk, its effect on heat stability is very slight in the case of milk of otherwise normal heat stability. The accompanying graph, Fig. 68, by Deysher,

Webb and Holm<sup>19</sup> shows that at homogenizing pressures up to 4000 pounds per square inch, the heat stability of evaporated milk containing 8 per cent fat and 18 per cent solids-not-fat decreases only very slightly with increasing pressure. These investigators further corroborate the commercial experience that while an increase in solids-not-fat definitely lowers the heat stability, it does not appreciably change the form of the characteristic stability curve obtained when homogenization is used.

Nor does the pre-homogenization heat treatment of the concentrated milk appear to have much stabilizing action. Webb and Bell<sup>20</sup> homogenized portions of the same pan batch at temperatures ranging from 37° C. to 80° C. with but slight effect on heat stability when sterilized as shown by the following figures:

Temperature of homogenization, ° C. . . . .	37, 50, 65, 80.
Time required to coagulate, minutes . . . . .	35, 35, 37, 38.

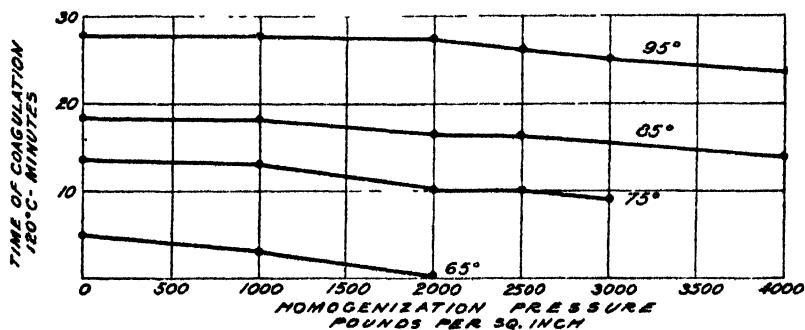

Fig 68. Effect of homogenizing pressure of different forewarming temperatures on heat stability of evaporated milk

Deysler, Webb, and Holm<sup>19</sup>

The concentrated milk used was made from fresh whole milk forewarmed to 130° C. The homogenizing pressure was 2500 pounds, and the sterilizing temperature, 115° C.

In the case of unstable evaporated milk, however, such as milk containing developed acid due to age or improper care of the fresh milk or high-solids milk, high homogenizing pressures definitely lower the heat coagulation point and may cause serious curdling difficulties in the sterilizer. The experience of a Middle Western condensery<sup>21</sup> may here be cited. The factory homogenizing at 4000 pounds of pressure suddenly encountered a protracted siege of objectionable curdling in the sterilizing process. Conditions, as revealed to the inspector, suggested that due to local conditions that were beyond immediate control the milk was too unstable to stand the high homogenizing pressure without damage to heat stability. When the pressure was lowered to 2500 pounds, the difficulty of abnormal curdling was eliminated. The milk withstood the sterilizing heat satisfactorily.

**Effect of Homogenizing Temperature on Efficiency of Homogenization.**—The temperature at which evaporated milk passes through the homogenizer affects the efficiency of homogenization. Generally speaking, and within certain limits, higher temperatures increase the efficiency. This is also shown by the work of Rahn<sup>11</sup> who homogenized whole milk at 20°, 40°, and 65° C. (68°, 104°, and 149° F.), respectively. His results are given in Table 38.

TABLE 38. RELATIVE PER CENT OF FAT IN EACH SIZE GROUP OF FAT GLOBULES AT DIFFERENT TEMPERATURES OF HOMOGENIZATION

Size of Fat (Globules)	Temperature of Homogenization		
	20° C. (68° F.)	40° C. (104° F.)	65° C. (149° F.)
Diameter, microns	per cent	per cent	per cent
0-1	2.3	1.9	4.3
1-2	29.3	36.7	74.4
2-3	23.3	21.1	9.0
3-4	29.8	25.2	12.3
4-5	0.0	15.2	0.0
5-6	15.4	0.0	0.0

The experimental results of Whitaker and Hilker<sup>22</sup> show that in the case of whole milk, even with milk that had been held overnight at 40° F., a homogenizing temperature of 120° F. was sufficient to attain as small fat globules (average size 1.3 microns) as any higher temperature used. Homogenizing temperatures as high as 175° F. failed to yield finer subdivision. At homogenizing temperatures lower than 120° F., the homogenizing efficiency diminished (average size 2.5 microns). The milk was homogenized at a pressure of 3000 pounds per square inch.

As explained by Holm<sup>15</sup> an increase in temperature diminishes the magnitude of the forces of viscosity, surface tension and interfacial tensions which must be overcome by the energy released by homogenization in order to accomplish the desired degree of dispersion. Low temperatures, such as apply to the cooled evaporated milk prior to canning, are obviously out of the question. Homogenizing at such low temperatures would tend to break the fat-in-skimmilk emulsion, causing the fat globules to unite into butter granules.

In commercial operation the evaporated milk is usually passed through the homogenizer at or near the vacuum pan temperature (125°-135° F.). This temperature range favors maximum homogenizing efficiency, other conditions being equal.

**Homogenizer Care.**—The efficiency of the homogenizer is largely controlled by the condition of the homogenizer valve. When the homogenizing effect is incomplete, as revealed by microscopic examination of diluted

specimen of the evaporated milk, the seat of the trouble usually lies in a scored valve or scored valve seat, or both. The homogenizing valve should be examined after each day's use. If the surfaces facing the valve clearance show signs of wear or unevenness, such as the beginning of grooves, the valve surface should be re-ground. If scored with visible grooves it needs resurfacing.

Grooved surfaces permit evaporated milk to pass through without being homogenized, inviting troublesome fat separation in the sealed tins. Unless ground down smooth and seated true, the valve is subject to become grooved in a short time. The milk flow persists in centering on these imperfections. In its passage through the homogenizer valve, the milk appears to simulate human nature's age-old weakness of following the line of least resistance. A scored surface opens the path for a break-through without the necessity of overcoming the resistance of the narrow valve clearance. In the presence of the high pump pressure, the bulk of the milk flow finds its exit through these imperfections, scores them deeper and misses the homogenizing effect completely.

Because of the high velocity of the milk, the valve surfaces are readily damaged by foreign impurities in the milk. The strainer in the manifold should always be in its place and it should be kept in good repair in order to prevent any extraneous material from reaching the homogenizer valve.

The cause of the trouble may lie in a defective pressure gauge which gives inaccurate and misleading pressure readings. The homogenizer subjects the pressure gauge mechanism to much vibration and heavy tension. The accuracy of this gauge is usually short-lived, the gauge needs daily checking and its readjustment requires its frequent return to the manufacturer. It is advisable to keep a spare gauge on hand as a standard to check against at the plant and to put into service in case the gauge on the homogenizer must be sent in for repairs.

For maintenance of a steady and uniform pressure as indicated by the relative poise of the pointer, the suction line must be free from air leaks. The suction and discharge poppet valve should be inspected regularly at frequent intervals for need of regrinding. The pump packing should receive regular attention, and the lubrication system should be serviced by a qualified engineer. Valves, pistons, cylinders, pipes, fittings and the strainer should be kept free from milk remnants and extraneous material by a thorough-going washing after the day's use.

#### **HOMOGENIZERS OTHER THAN THE PISTON-TYPE MACHINE**

To these belong the centrifugal emulsor and the sonic oscillator.

**The DeLaval Centrifugal Emulsor.**—This machine entered the dairy field in about 1915-16. In general principle it resembles the standard cream separator, see Figure 69. The lower part of the bowl serves as a clarifying

chamber where extraneous material (separator slime) is deposited. The main part of the bowl houses a series of tight-fitting discs with narrow, paper-like clearances between discs. The bowl revolves at about 10,000 R.P.M. and develops a centrifugal pressure of approximately 500 pounds per square inch. In operation, the intake tube in the center of the bowl discharges the milk into the clarifying chamber from where it is forced by the centrifugal pressure through the narrow clearances between the discs. At the point of exit from the periphery of the discs it explodes into a mist-like spray. This spray impinges upon the peripheral wall of the receiving cover, converting it back to liquid form.

The centrifugal emulsor played an important part in the early days of

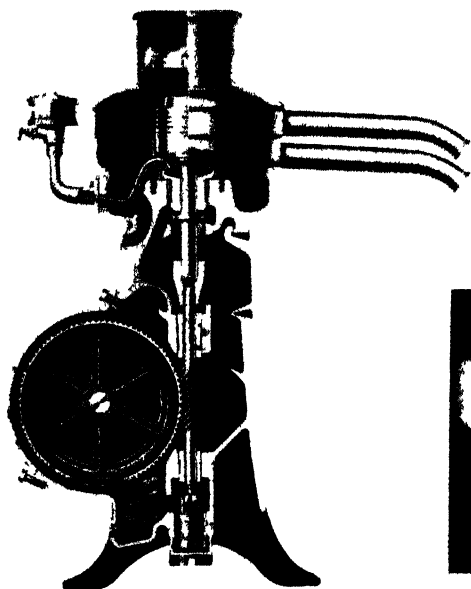
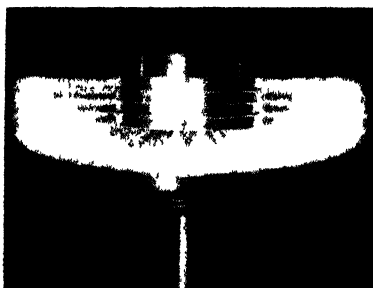

Fig 69. DeLaval Centrifugal Emulsor and emulsor discs (inset)



Courtesy of DeLaval Separator Co.

the factory development of the ice cream industry. It made practicable the profitable utilization of skimmilk powder and melted butter in the preparation of ice cream mix. Its relatively moderate initial cost brought it within financial reach of the small manufacturer with funds and volume of production too limited to justify the purchase of a high-pressure, piston-pump homogenizer. It is now widely used for the treatment of sweet cream, particularly coffee cream, for the purpose of retarding objectionable fat separation and of preventing the appearance of a skimmilk layer in the bottom of the cream bottle.

**The Submarine Signal Company Sonic Oscillator.**<sup>28</sup>—This homogenizer consists of a stainless steel diaphragm and cover as shown in Figure 70. The diaphragm is vibrated electromagnetically at a frequency of 360

vibrations per second. The milk enters at pasteurizing temperature through inlet at the outer end of the cover and passes over the center of the diaphragm, where it is subjected to the intense vibration of the latter. There is some subdivision of fat globules, but the dominating purpose and effect of the sonic oscillator lies in reduction of the curd tension and in improved digestibility. Because of this action of the oscillator principle, the sonic oscillator has been found especially valuable in the treatment of market milk, and particularly of milk intended for infant feeding.<sup>24</sup>

**Relative Merits of Non-Piston and Piston-Type Homogenizers.**—Either of the above non-piston homogenizers has its definite place in the industry and has become an integral instrument in its appointed branch. That

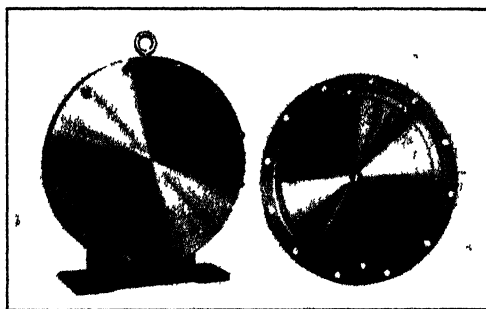

Fig 70 Sonic Oscillator  
Courtesy of Submarine Signal  
Company

place, however, is definitely other than the evaporated milk factory. The extent of subdivision of fat globules is insufficient to accomplish the magnitude of physical stabilization of the emulsion that is required for the dependable prevention of fat separation in evaporated milk during storage. The increase in emulsion-stabilizing viscosity is also relatively slight.

At the present stage of the art, the use of the high-pressure, piston-type homogenizer, with correctly seated homogenizer valve, appears to provide the only satisfactory means of keeping the fat in evaporated milk in commercially satisfactorily permanent emulsion.

#### REFERENCES

1. WECKEL, K. G., AND JACKSON, H. C.: Wis. Agr. Expt. Sta. Bul. 136. 1939.
2. SCOTT, H. T.: Wisconsin Alumni Research Foundation. Information by consultation and correspondence. 1944-1945.
3. CLAYTON, Wm.: Theory of Emulsions. 4th ed. p. 391. 1943.
4. MARIX, PAUL: French patents 218946-7 and 221583. 1892.
5. JULIEN: French patents 220446 and 224553. 1892.
6. SCHRÖDER, W. G.: German patent 277225. 1912.
7. LICHTENBERGER, B.: Milchwirtschaftliche Maschinenkunde. p. 338. 1932.
8. GAULIN, A.: French patent 295596. 1899.
9. WEBB, B. H., AND HOLM, G. E.: Jour. Dairy Sci. XXII. 363. 1939.
10. FARRALL, A. W., WALTERS, C. C., AND HANSON, R. L.: Abstr. Jour. Dairy Sci. XXIV. 539. 1941.
11. RAHN, O.: Milchwirtschaftliche Forschungen. 2. 382. 1925.
12. RAHN, O., AND SHARP, P. F.: Physik der Milchwirtschaft. 1928.
13. WIEGNER, G.: Kolloid Zeitschrift Bd. 8. 227. 1911.

14. WIEGNER, G.: *Kolloid Zeitschrift. Zurich.* 105. 1914.
15. HOLM, G. E.: *Fundamentals of Dairy Sci. Associates of Rogers.* 1935.
16. DOAN, F. J., AND MINSTER, C. H.: *Pa. Agr. Expt. Sta. Bul.* 287. 1933.
17. BUGLIA, G.: *Zeitschr. Chem. u. Indust. der Kolloide.* II. 1908.
18. ROGERS, L. A., DEYSHER, E. F., AND EVANS, F. R.: *Jour. Dairy Sci.* III. 468. 1920.
19. DEYSHER, E. F., WEBB, B. H., AND HOLM, G. E.: *Jour. Dairy Sci.* XII. 80. 1929.
20. WEBB, B. H., AND BELL, R. W.: *Jour. Dairy Sci.* XXV. 301. 1942.
21. FARRALL, A. W.: *Advice by private conversation.* December 1943.
22. WHITAKER, R., AND HILKER, L. D.: *Jour. Dairy Sci.* XX. 281. 1937.
23. *The Submarine Signal Co.: Sonic Oscillator. Descript. Bul. Boston, Mass.* 1943.
24. *Milk Commission of Medical Society: N. Y. State Jour. Medicine.* 41. Oct. 1941.
25. ROSENBERG, R. R.: *Chemistry and Physiology of the Vitamins.* p. 384. 1942.

## CHAPTER XXII

### COOLING, STANDARDIZING, CANNING OF EVAPORATED MILK

#### COOLING

The homogenized milk is cooled on its way to the storage tanks. The surface cooler or the internal tube cooler is commonly used for this purpose. The homogenizer provides the pressure to lift the milk to any reasonable height of the surface cooler or force it through the internal tube cooler. The surface cooler is usually placed at an elevation to permit the cooled evaporated milk to reach the storage tanks by gravity. In the case of the continuous pan discharge system, the flow from pan to storage tank thus is continuous and requires no pump other than the pan discharge pump and the homogenizer, unless the flow is broken by the process of irradiation. In the case of the batch system of condensing, the same type of coolers are commonly used. In some plants with limited output, the coil vat or other type of batch cooler is resorted to. The batch cooler then usually also serves as holding tank.



Fig. 71. Evaporated milk holding tanks  
Courtesy of Creamery Package Mfg. Company

**Evaporated Milk Holding Tanks.**—With the batch system, especially in plants with limited make, the evaporated milk is usually canned and sterilized on the same day. In this case, the cooled milk flows into a plain tank or vat, where it is standardized if desired, and from where it feeds the filling machine.

In factories with large make and where batches of each day's operation are mixed, all or a part of the evaporated milk is generally held over and is canned and sterilized on the following day. This requires cooling to a lower temperature (about 40° F.) and holding the evaporated milk under refrigeration until ready to can. For this purpose either large jacketed tanks with agitators, preferably glass-lined or of stainless steel, and heavily insulated on the outside, are used, or the tanks are single wall shells, installed in a refrigerated room. If the system of operation requires that the evaporated milk be standardized at this point, these tanks should



be equipped with suitable agitators to insure thorough mixing. In the absence of storage tanks or vats with refrigerating facilities, as described above, the cooled evaporated milk may be stored in milk shipping cans, such as 10-gallon milk cans. These cans are held in the cold room, or they may be submerged in a tank of ice water.

At this stage of the process the evaporated milk is not sterile, it contains no preservative such as cane sugar, and its concentration is insufficient to inhibit bacterial activity. At ordinary temperature, and especially during hot summer weather, its acidity will increase and other fermentations may occur, lowering its heat coagulation point and inviting sterilizing difficulties. Unless it is canned and sterilized promptly after it leaves the vacuum pan or the homogenizer, prompt cooling to about 40° F. and holding at that temperature until it reaches the sterilizer, are essential.

#### STANDARDIZING

Some condenseries are standardizing the fluid milk to the desired ratio of fat to solids-not-fat before condensing (see Chapter XIII) and then

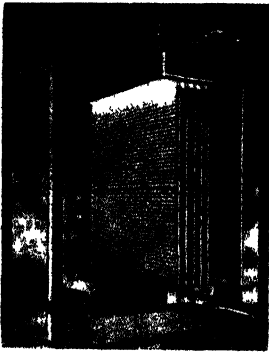

Fig. 72. Mojonnier evaporated milk cooler  
Courtesy of Mojonnier Bros. Co.

condense to the concentration desired in the finished product, as indicated by the density test at the pan. This system eliminates the necessity of further standardization in the storage tank. Other plants, while following the same practice of standardizing the fresh milk to the ratio of fat to solids-not-fat desired in the evaporated milk, purposely over-condense slightly and then add the calculated amount of water to reduce the concentration to the exact percentage of total solids desired in the finished product. Still others do not standardize the fluid milk before condensing, but defer all standardizing operations to the evaporated milk in the storage tank.

**Standardizing Over-Condensed Evaporated Milk.**—Having standardized the fresh milk before condensing to the ratio of fat to solids-not-fat desired in the evaporated milk, the slightly over-condensed finished product is brought back to the desired percentage of total solids by dilution

with water. The exact amount of water to add is calculated by the following formula:

$$\frac{\text{lbs. fresh milk}}{\left(\frac{\% \text{TS desired}}{\% \text{TS in fresh milk}}\right)} - \frac{\text{lbs. fresh milk}}{\left(\frac{\% \text{TS in batch}}{\% \text{TS in fresh milk}}\right)} = \text{lbs. water to add.}$$

EXAMPLE:

High-solids evaporated milk testing 31% TS is desired.

Batch in storage tank tests 31.8% TS.

50,000 lbs. fresh milk testing 12.25% TS was used.

How much water must be added?

ANSWER:

$$\frac{50,000}{\left(\frac{31}{12.25}\right)} - \frac{50,000}{\left(\frac{31.8}{12.25}\right)}, \text{ or } \frac{50,000}{2.5306} - \frac{50,000}{2.5959} = 19758 - 19261 = 497 \text{ lbs. of water to add.}$$

PROOF:

19261 lbs. evaporated milk in batch @ 31.8% TS contain 6125 lbs. TS  
497 lbs. water

19758 lbs. standardized evaporated milk contain 6125 lbs. TS

$$\% \text{ TS in standardized batch} = \frac{6125}{19758} \times 100 = 31.0\% \text{ TS}$$

**Standardizing Ratio of Fat to Solids-Not-Fat After Condensing.**—As indicated earlier in this chapter, some condenseries follow the practice of doing all the standardizing after condensing, deferring this operation until the evaporated milk is in the storage tank preparatory to filling the tin cans. This then means that the batch of evaporated milk must be standardized for both desired ratio of fat to SNF and percentage of TS desired. In this case the operator usually sees to it that the milk contains a surplus of fat so that standardization of the ratio of fat to SNF does not involve the addition of fat, which would require rehomogenization in order to prevent fat separation later.

EXAMPLE:

U. S. standard evaporated milk (7.9% fat, 18% SNF) is desired.

The batch in the storage tank tests 8.1% fat, 18.0% SNF.

25,000 lbs. fresh milk containing 3.8% fat was used.

Skim condensed testing 0.5% fat and 30% SNF is available.

(a) How much skim milk must be added?

1. Find pounds of evaporated milk in batch.

$$\text{Ratio of Concentration} = \frac{\% \text{ fat in batch}}{\% \text{ fat in fresh milk}}, \text{ or } \frac{8.1}{3.8} = 2.1316.$$

Pounds evaporated milk in batch  $\frac{25,000}{2.1316}$ , or 11728 lbs.

2. Find ratio of fat to SNF desired in evaporated milk.

$$\frac{\text{fat desired}}{\text{SNF desired}} \text{ or } \frac{7.9}{18} = 0.439 \text{ ratio of fat to SNF.}$$

3. Find pounds of skim condensed to add.

$$\frac{\frac{\% \text{ fat in batch}}{\text{ratio of fat to SNF desired}} - \% \text{ SNF in batch}}{\% \text{ SNF in skim cond.} - \frac{\% \text{ fat in skim condensed}}{\text{ratio of fat to SNF desired}}} \times \text{lbs. in batch} =$$

lbs. skim condensed to add, hence

$$\frac{8.1}{0.439} - 18.0 \times 11728, \text{ or } \frac{0.451}{28.86} \times 11728 = 183.3 \text{ lbs. skim cond. to add.}$$

$$30 - \frac{0.5}{0.439}$$

PROOF:

	Fat lbs.	SNF lbs.	TS lbs.
11728 lbs. evap. milk 8.1% fat, 18% SNF contain	950	2111	
183.3 lbs. skim cond. 0.5% fat, 30% SNF contain	0.9	55	
11911.3 lbs. of standardized batch contain	950.9	2166	3116.9
Ratio of Fat to SNF in standardized evaporated milk =	$\frac{950.9}{2166}$ , or 0.439.		

(b) How much water must be added to standardize the total solids content to 25.9%

4. Find pounds of standardized evaporated milk.

$$\frac{\text{lbs. TS in batch}}{\% \text{ TS desired}} \times 100 = \text{lbs. standardized evaporated milk, hence}$$

$$\frac{3116.9}{25.9} \times 100 = 12034 \text{ lbs. standardized evaporated milk.}$$

5. Pounds water to add = 12034 — 11911 = 123 lbs.

PROOF:

11911 lbs. evap. milk contain	3116.9 lbs. TS
123 lbs. added water	
12034 lbs. evap. milk product	3116.9 lbs. TS

$$\text{Per cent TS in finished product } \frac{3116.9}{12034} \times 100 = 25.9\%$$

#### CANNING

**Size of Container.**—The tin cans used for evaporated milk in the United States have been standardized to three sizes; namely, baby size (six ounces net), tall size (14½ ounces net), and confectioners' (gallon) size (128 ounces net). The dimensions, capacity and net weight of these cans are given in Table 39.

The bulk of American evaporated milk reaches the market in the tall-size can. Adoption of the 14½-ounce net container by the American Evap-

TABLE 39. STANDARD EVAPORATED MILK CANS IN U. S. A.

Type of Can	Net Weight of Evaporated Milk, ounces	Capacity cc.	Diameter inches	Height inches
Baby size . . . . .	6	182	2½	2½
Tall size . . . . .	14½	423	3	3½ <sup>5</sup> / <sub>16</sub>
Confectioners size	128	3546 5*	5 <sup>31</sup> / <sub>32</sub>	8 <sup>5</sup> / <sub>16</sub>

orated Milk Association is claimed to have had for its background the assumption that the American consumer thinks of evaporated milk in terms of quarts of fresh milk. The 14½-ounces of U. S. Federal standard evaporated milk is considered to be equivalent in total solids and food value to one quart of U. S. Federal standard fluid milk.

In international commerce there is as yet a multitude of different size containers, and there is no tangible indication of early standardization.

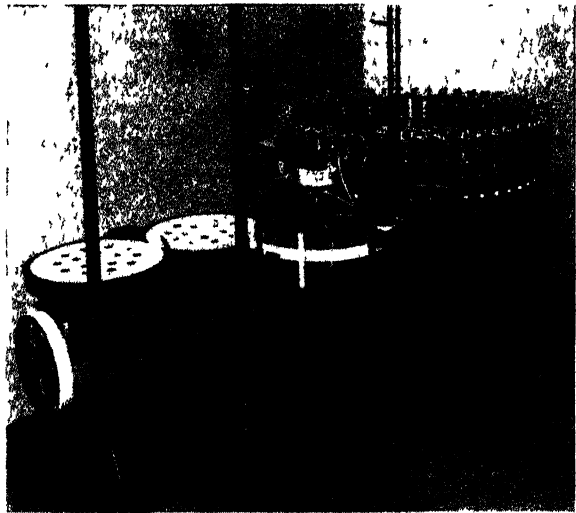

Fig. 73. The Dickerson evaporated milk filler

Courtesy of F. G. Dickerson Company

The Permanent Committee of the International Dairy Federation had under consideration for some years prior to World War II the passage of a resolution recommending "that the quantity of fluid milk represented by the container of the tin be indicated on the label."

**Filling.**—The evaporated milk container must withstand the pressure changes in the process of sterilization. Its seal must be absolutely air tight, and it must be strong. The types of cans used for this product are: the sanitary can, the can with solder seal, and the vent hole can. It is estimated that over 95 per cent of the evaporated milk made in the United States today is packed in the vent hole can which requires a filling ma-

\*Actual size 3629 cc., less head space 82.5 cc.

chine of special construction invented by the American, F. G. Dickerson. This can is filled through an orifice a small fraction less than  $\frac{1}{8}$ -inch in diameter, and the filled can is sealed by "tipping" the vent hole with a drop of solder.

The Dickerson filler is made in sizes to fill 6-ounce, 14½-ounce, and 16-ounce vent hole cans. It contains a battery of filling chambers arranged in a peripheral circle. The filling chambers of the 14½-ounce filler are 48 or 60 in number. Each chamber is equipped with a properly fitted piston, the stroke of which accurately measures the required amount of milk. The piston is operated by the hydrostatic pressure of the milk. Each chamber connects by a separate milk tube with the milk distributing head, located in the center of the circle. A valve with automatically turning plug at the bottom of each chamber times the charge of the piston. The entire assembly, including also devices for receiving, centering and holding of the cans, rotates around the hub of the circle.

**Temperature of Milk.**—The temperature of the evaporated milk at the time of filling needs attention because it is a factor affecting the tendency of the milk to foam. Foaming can seriously interfere with proper filling of the cans, and the foam has also been found to cause the appearance of streaks of baked-on milk in the can after sterilization. In addition an excessively low temperature invites the defect of "flipping."

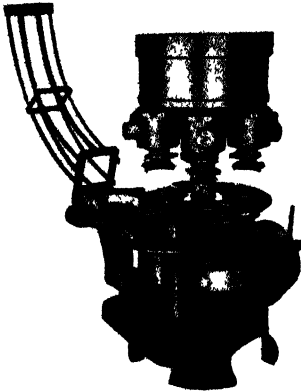

Fig. 74. Evaporated milk filler for confectioner's (gallon-size) cans

Courtesy of Anderson-Barngrover Division

By flipping is understood the sudden snapping of the can ends from their slightly concave contour to a convex outward bulge. The flipping is usually accompanied by an audible sound. It is due to the development of pressure in the can, such as is prone to occur when the cans have been filled with cold milk and, after sealing, are exposed to room temperature. In such case the tendency to flip is augmented if the cans have been filled excessively full, leaving insufficient head space for expansion of the milk due to warming up.

The filling temperature that is now considered most effective in avoiding these difficulties and that is, in fact, commonly used, is 38° to 42° F.

**Fullness of Cans.**—The cans should be filled as near full as possible without fouling the surface of the tin plate at or around the vent hole, causing interference with the solder. As pointed out under "Temperature of Evaporated Milk," filling the can too full has the further objection that it may cause flipping because of too limited air space to allow for unavoidable expansion. The trouble then is further aggravated when filling with cold milk. The bulged can tends to arouse suspicion, and possibly complaint, on the part of the customer to whom the bulging of the ends suggests spoilage.

Aside from attention to optimum temperature and proper filling, the danger of flipping is tangibly minimized by suitable specifications when ordering tin cans. Concave ends made of tin plate of suitable rigidity as influenced by gauge and method of annealing, are effective preventives.

**Sealing.**—When filling the vent hole can there is more or less of a tendency for the milk to wet the surface around the orifice. This condition interferes with the proper functioning of the solder. It has thus been found helpful to clean or dry, or both, the top of the can on its way to the tipper. This is done in various ways. The most common practice appears to be to apply a spray of steam or a blast of hot air to the top of the can. Others use a gas flame.

The vent hole can sealing machine is an integral part of the Dickerson filler. From the filling mechanism the filled cans proceed to the mechanical sealer. Here the mechanical arm that manipulates the soldering cone, fluxes the tip, lowers it into the venthole, and seals it with a drop of molten solder.

**Inspection of Cans for Leakers.**—Immediately after sealing and before they leave the last turn-table of the sealing machine, the cans are inspected for visible defective seals which are retouched with hand soldering cone as fast as discovered.

In order to minimize loss of cans and contents due to leaks in any part of the can, in the seams as well as in the seal, it is important to test all cans by means of a dependable leak detector before they reach the sterilizer. The can tester commonly used is the Henszey type, in which the cans pass, submerged, through a hot water bath. The heat of the water bath expands the air in the can causing slight pressure. In case of a leaky can, the pressure expells some of the excess air. The escaping air percolates upward in the water in the form of air bubbles that are readily seen. The operator standing over the water bath picks out the leakers and returns them to the can inspector for repair.

#### **SPECIAL REQUIREMENTS OF EVAPORATED MILK CANS FOR OVERSEAS SHIPMENTS BY CHICAGO QUARTERMASTER DEPOT**

**Strength of Cans.**—Two types of cans are used, namely:

- (1) A can similar to the standard vent hole evaporated milk can, but

with longer skirt (extended flange) on the ends to obtain a stronger solder seal. This can holds the standard 14½ ounces of evaporated milk.

(2) The other type of can has the same outside dimensions as the standard vent hole can, but the ends are double-seamed on the body of the can rather than soldered. This can also is filled through the vent hole and can be used on standard equipment with minor adjustments. The capacity of this can is 13½ ounces of evaporated milk.

No gallon cans for evaporated milk exports are at present accepted.

**“Pro-Coating” of Cans.**—The Quartermaster Corps requires an olive drab coating suitable for application on the exterior of sanitary food cans. The pro-coating must be non-toxic. It may be a lacquer-type material consisting of nitrocellulose, resins, plasticizer and solvents, or an enamel-type material consisting of resins, oils and solvents. These coating materials are used for the purpose of retarding corrosion, and the olive drab color serves to camouflage the tin cans.

The pro-coating is done by the canner after packing. The cans are coated either by dipping or spraying, followed by air drying, in continuous operation. Coating materials that will dry at room temperatures are now available. Further information may be obtained by contacting Chicago Quartermaster Depot, 1819 Pershing Road, Chicago.

#### REFERENCES

1. Chicago Quartermaster Depot. No. 200-B. June 14, 1944.
2. American Can Co. Res. Dept.: Installations for the Pro-coating of Processed Containers. October 1944.

## CHAPTER XXIII

### STERILIZING

The filled and sealed cans that have successfully passed inspection for freedom from defective seals and seams are now ready for the sterilizer. If they cannot be sterilized within an hour or two they should be held under refrigeration at 40° to 45° F. This precaution is especially important during the hot weather season.

**Purpose of Sterilization.**—The primary purpose of sterilization is to destroy all germ life and enzymes present, thereby preserving the product permanently. In addition, the sterilizing process is utilized to increase the viscosity and improve the body of the finished product. This gives the evaporated milk a more creamy consistency, lends it a pleasing semblance of richness and assists in keeping the fat in homogeneous emulsion and in lessening its tendency to separation after manufacture.

**Sterilizers.**—There are fundamentally two types of sterilizers in use. These are the batch sterilizer and the continuous sterilizer. In the former, the batch is the unit and the successive steps of loading, heating, holding, cooling and unloading must be completed for one and the same batch before the sterilizer can be used for the next batch. In the continuous sterilizer, the can is the unit. Its natural contour (cylindrical form) is taken advantage of. It rolls into, through, and from the sterilizer. The loading, heating, holding, cooling and unloading are continuous.

The **Batch** sterilizer is made in different sizes and is serviceable in plants with small output as well as large. The same sterilizer can be used for cans of all sizes—from Babe size to Confectioners (gallon) size. Its initial cost is comparatively low. On the other hand, the upkeep of the batch sterilizer is the user's responsibility, and the labor cost of operation is relatively high.

The **Continuous** sterilizer is best adapted for large plants, such as plants with a daily output of 500 cases or more. Its advantages lie in a large reduction of packing labor, elimination of incubation and hand inspection, and automatic rejection of leakers. In addition milk is saved, wooden trays are not needed, and the manufacturer of the machine assumes the responsibility for repairs and replacements. On the other hand, the continuous sterilizer is built for standard tall and standard baby size cans only. It will not handle odd size cans nor gallon size. The machine is not sold to the user. He pays a nominal rental per case of evaporated milk manufactured.

#### STERILIZATION BY THE BATCH SYSTEM

The batch sterilizer for evaporated milk was invented by John B. Meyenberg,<sup>1, 2</sup> see Chapter IV. In the main, the batch sterilizer consists of a large boiler-like, horizontal steam drum, opening at the top or at one or



both ends. Its hollow interior is equipped with a revolving frame or spider cage into which the cans are loaded. A perforated steam distributing pipe near the bottom extends over the entire length of the sterilizer drum. This pipe has a separate steam inlet at each end. Near the top there is a water distributing pipe with connections to the water main. In the bottom of the shell there is a drain. On the sterilizer drum are mounted also a pressure safety vent, water, steam and vacuum gauges, high-temperature thermometer, and preferably temperature control, recording, and safety devices.

There are principally two makes of batch sterilizers in use in American evaporated milk factories. These are known as the Fort Wayne sterilizer, and the Berlin-Chapman sterilizer. The former contains a revolving spider cage which accommodates the cans in trays. The latter contains one large rectangular, perforated, revolving crate into which the cans are stacked. In both types of machines the can carriage revolves on its own axis. The proper number of revolutions of the reel necessarily varies with the size of the sterilizer, ranging from about six to 12 R.P.M.

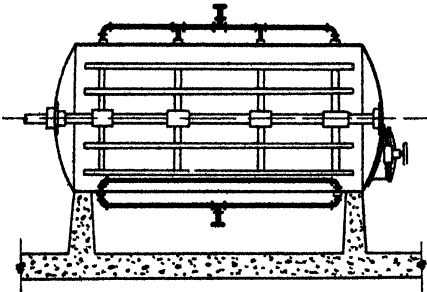

Fig. 75. Arrangement of steam supply for uniform heat distribution in batch sterilizer

(courtesy of A. W. Baumann)

**Importance of Uniform Heat Distribution.**—The cans in all parts of the sterilizer must be subjected to the same temperature for the same length of time. This is important, as faulty heat distribution tends to destroy control of uniformity of consistency and color throughout the batch, and usually increases the percentage of cans “going wrong” because of incomplete sterilization.

The heat distribution in the sterilizer is largely controlled by the type and condition of the steam distributing device. A satisfactory arrangement is shown in Fig. 75. The steam supply line is brought to the center under the sterilizer. From there, one lateral extends in each direction, entering the sterilizer at front and rear. Each end of a perforated pipe in the bottom of the sterilizer connects with the corresponding lateral of the steam supply line.

The perforations in the steam spray pipe must be of uniform size. This pipe needs watching to make sure that the perforations are not clogged and that each end is properly capped. When the perforations become unduly enlarged due to wear or corrosion, the pipe should be replaced by a new one. Uniformity of heat exposure throughout the sterilizer also de-

mands proper distribution of the intake of cooling water at the top as shown in Fig. 75, uniform spacing of the trays loaded with the cans, and uniform spacing of the layers of cans in the sterilizer crate.

**Sterilization in the Presence of Water.**—Rapidly and uniformity of heat transmission are enhanced by the use of water in the sterilizer. Water hastens the heating during the coming-up period, shortening the time by about five minutes, and it eliminates interfering air pockets between cans. It has been found most practicable to use just enough water in the sterilizer so that all the cans in one position of the reel are submerged. In this way each can is completely covered by water once with every revolution of the reel. Fuel is economized by storing the hot water between sterilizer batches.

**Temperature and Time of Exposure.**—The sterilizing process must provide a ratio of temperature-time exposure that is lethal to even the most resistant spore forms that may be present in the milk. This ratio may vary somewhat with such factors as condition and intensity of forewarming, treatment of fresh milk, concentration of evaporated milk, locality and season of year. It should be such as to insure absolute sterility consistent with sufficient body to prevent fat separation in subsequent storage. Yet the temperature should not be so high nor the duration so long as to jeopardize the finished product with an unshakable curd, objectionable discoloration, or excessive cooked flavor. In general, and from the standpoint of avoiding appearance of these defects, a process of high maximum temperature and short exposure is preferable, but such milk usually lacks the viscosity necessary to prevent subsequent fat separation, unless it has been efficiently homogenized.

Williams<sup>8</sup> summarizes the results of extensive experiments on sterilizing routine and efficiency, conducted by the National Canners Association, as follows:

“From heat-penetration and heat-resistance data a process of 11.6 minutes at 115.6° C. (240° F.) was calculated. In the experimental packs to check this value the inoculum, as an added safety factor, was planted within the tissue rather than on the surface. Cooks ranged at three-minute intervals from six to 24 minutes at 240° F. Non-sterile cans occurred in the cook of 12 minutes (1.9 per cent), but none in the cooks above this figure.”

In a later communication, Williams<sup>9</sup> supplemented the above statement with the following conclusion:

“Upon the basis of the results which we obtained it was our opinion that the commercial process of 20 minutes at 240° F. in use on the product under consideration (meaning evaporated milk) should not be lowered.”

The findings of Williams are in agreement with the long established practice of the sterilizing routine that is successfully used by the manufacturer of evaporated milk, as pointed out by Hunziker<sup>4</sup> and more in

detail by Mojonnier and Troy.<sup>5</sup> The "coming up time," i. e., raising the temperature from room temperature to 240° F. is intended to be not less than 15 minutes nor more than 20 minutes. It is further recommended that the rise in temperature during the last ten minutes of the "coming up" time be at the rate of 5° F. for every minute, that the temperature of holding be not lower than 240° F. nor higher than 245° F., and the time of holding not less than 15 minutes.

The reel is stopped during the holding period. This enhances the formation of a soft custard-like coagulum that shakes down readily to a creamy consistency free from objectionable particles of grainy curd. Some operators keep the reel in motion during the first few minutes (about two minutes) of the holding time.

**Heat Requirements for Cans of Different Sizes.**—The size of can has some effect on the sterilizing efficiency. Large cans sterilize somewhat more difficultly than small cans. It is not uncommon experience that the percentage of loss due to spoilage of gallon cans is greater than that of tall- and baby-size cans, unless the proper adjustment is made in the process. Thus in some of the condenseries the practice has been adopted of giving gallon batches at least one degree F. more heat than tall-size cans, and tall-size cans at least one degree F. more heat than baby-size cans.

**Cooling After Sterilization.**—Immediately after the holding time the evaporated milk is cooled. The steam is turned off, exhaust and drain are opened, and cold water is turned into the sterilizer with the reel revolving, and the cooling is continued until the temperature of the milk has dropped to 70 to 80° F. It should not take more than 15 minutes to cool the milk. Gallon cans cool somewhat slower than small size cans. Rapid and uniform cooling is important. This requires a plentiful supply of cold water and proper distribution of the water over the entire length of the sterilizer.

Insufficient water supply and uneven distribution of the water in the sterilizer exposes some of the cans to the sterilizing heat longer than others, causing lack of uniformity in the smoothness and color of the milk of different cans of the same batch. Delayed cooling, owing to insufficient water supply has the further disadvantage of causing the cans to bulge badly, owing to the difference in pressure between the interior and exterior of the cans. This is especially noticeable in gallon-size cans, the ends of which may become distorted, and their seams and seals may be weakened to the extent of producing "leakers." Excessive bulging and injury to the cans can be avoided by admitting to the sterilizer a sufficient quantity of compressed air to take the place of the released steam pressure, thereby equalizing the pressure between the outside and inside of the cans during the cooling process.

**Shaking.**—The purpose of shaking the evaporated milk is to mechanically break down the curd that may have formed during sterilization, to

a smooth homogeneous consistency. The only really satisfactory shaker for batch-sterilized milk is the batch shaker. This consists of a battery of two or more heavy iron boxes, or crates, made from suitable piping. These boxes are propelled back and forth violently by means of a rapidly rotating eccentric. Trays filled with the cans of evaporated milk are firmly wedged into these boxes, the shaking action of which causes mechanical disintegration of the curd.

This violent shaking causes a sharp decrease in viscosity. Excessive shaking, therefore, should be avoided. The period of shaking should be limited to the minimum time required to reduce the milk to a homogeneous, smooth texture. A shaking period from approximately one-fourth to two minutes is usually sufficient to completely break down a normally soft curd. When shaking for five minutes fails to produce a smooth milk, the product is usually permanently curdy. Reshaking such milk after a day or two may in some cases improve its texture somewhat.

The marked progress that has been made within recent decades in improving control of the heat stability of evaporated milk has largely, although not universally, eliminated the necessity of shaking as an integral operation in the process routine.

#### STERILIZATION BY THE CONTINUOUS SYSTEM

The continuous sterilizer was invented and is manufactured by the Anderson-Barngrover Manufacturing Company, now a Division of the Food Machinery Corporation, of San José, California. The machine was originally designed for the processing of fruits and vegetables. Its adaptation to the sterilization of evaporated milk dates back to the year 1922.

One of the important mechanical problems in the development and perfection of the continuous sterilizer was that of protecting the can against too great a strain due to pressure differences between the interior and exterior of the can. This was successfully solved by so designing the sterilizer as to preheat the cans gradually to a temperature a few degrees below the boiling point, before they enter the sterilizer proper, then release the sterilized cans into the cooler and cool them under air pressure. In addition, the design provides the intake and discharge of the cooker and the cooler with a type of rotary, pressure-tight valve that insures satisfactory continuous operation without loss of pressure.

These efforts also gave birth to the invention of ingenious devices for the detection and elimination of defective cans and light weight cans. These detector devices have been perfected to the point where they now constitute an integral part of the continuous sterilizer.

**Description of the Continuous Sterilizer.**—The evaporated milk continuous sterilizer consists of three principal units: the Preheater, the Sterilizer or Cooker, and the Cooler. Built on and operating as an integral part of the preheater and the cooler, are two ingenious devices that separate the

leaky cans and lightweight cans from the cans that are full weight and perfectly sealed.

Each of the three main units consists of a horizontal cylindrical steel drum, equipped in its interior with a revolving reel that causes the cans to travel in a spiral track from intake to discharge. By this arrangement of conveying the cans through the three units, each can is contained in an individual pocket or compartment, which keeps it separate from the other cans in the unit. The time required for the can to pass through the unit is, therefore, the same regardless of whether the machine is operating at full capacity or whether only a few cans are being processed. This time may be varied at will by changing the speed of the machine which is usually equipped with a Reeves Variable-Speed Drive.

**The Preheater.**—The preheater is the first unit which the can enters. Its purpose is to preheat the milk, raising its temperature from the filling

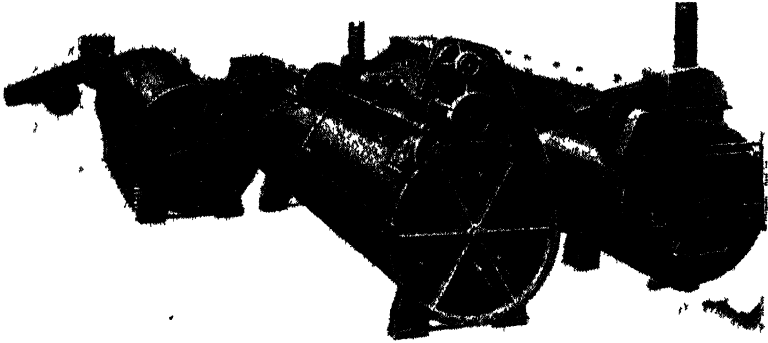

Fig. 76. Continuous evaporated milk sterilizer assembly of preheater, cooker and cooler, including leak detectors  
Courtesy of Anderson-Barngrover Division

temperature (40 to 65° F.) by a gradual rise to a temperature ranging from 180° F. to near the boiling point. It is divided into two sections, namely, the "coming up" section and the holding section. The temperature in the "coming up" section ranges from 80 to 95° F. at the feed end, to 200 to 206° F. near the holding section.

The temperature in the holding section of the preheater is maintained at about 208 to 210° F. The holding section is equipped with control valves and regulating circulation dampers, by means of which the heat can be extended back toward the feed end, thus increasing the holding time and hastening the "coming up" time, depending upon the character of the milk.

At the can exit of the preheater the cans pass through a leaky can detector. Tight cans have an end bulge making them about  $\frac{1}{4}$ " longer; leaky cans do not. This difference makes it possible to separate the leakers at

this point. The leakers are cut back into the general supply, thereby saving the milk.

**The Sterilizer or Cooker.**—From the leak detector the sound cans enter the sterilizer through a pressure holding valve. The usual time in the sterilizer is from 15 to 17 minutes and the temperature from 238 to 245° F., depending on the condition of the milk. For a sterilizing temperature of 238° F. hold 17 minutes. The Standard Process is 15 minutes at 242° F.

The sterilizer is equipped with a variable speed transmission and a quick-change temperature control device, so that the time and temperature of the process can be instantly changed at will, in order to provide the proper sterilizing process. The usual speed of the tall can line is 130 cans per minute for 48-cell filler, and 172 cans per minute for a 60-cell filler.

**The Cooler.**—From the sterilizer the cans transfer through a valve to the cooler. The cooler operates with about 10 pounds air pressure. This prevents the cans from being strained by their internal pressure, until they have been cooled sufficiently to practically eliminate the internal pressure, and to be discharged into the atmosphere.

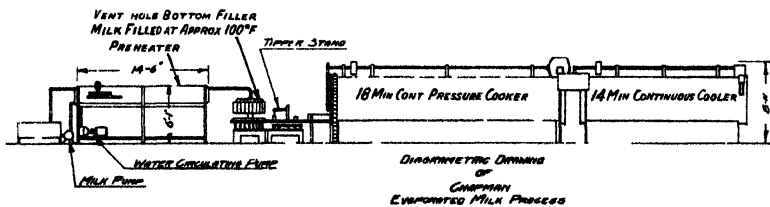

Fig. 77. New Chapman continuous pressure process sterilizer  
Courtesy of Berlin Chapman Company

Leaving the cooler they pass through a second leak detector. Here the appearance of the leaky cans is the exact opposite of that of the leakers entering the first leak detector when leaving the preheater. The ten pounds air pressure in the cooler forces air into the leaky cans causing their ends to remain bulged, while the good cans will have flat ends. In this case the cans with bulged ends (being the leakers) are rejected. This provides a double check on the presence and elimination of the leaky cans.

Within recent years the new Chapman Pressure Process sterilizer of the Berlin Chapman Company has become available. This sterilizer assembly consists of preheater, vent hole bottom filler, filler for filling cans at about 100° F., tipper stand, 18-minute continuous pressure cooker, leaky can detector and 14-minute continuous cooler, in addition to accessories. Fig. 77 shows a diagrammatic drawing of this assembly.

#### PRECAUTIONS AFTER STERILIZATION

**Detecting Underweight Cans.**—Some evaporated milk manufacturers are checking upon the weight of their evaporated milk units for the purpose

of detecting and eliminating from their packs such cans as may be underweight. Light-weight cans may be the result of faulty filling or spills before sealing, or mechanical weakness. Weak cans may spring a leak in the sterilizer (batch or continuous) causing a small quantity of milk to escape. These cans may seal over again and, in addition to being short weight, they usually result in bloats.

The mechanical detection of underweight cans has been made possible by the introduction of the Anderson-Barngrover Can Weight Checking Machine. This machine consists essentially of a horizontal rotating turret or circular disc carrying twelve weighing beams equally spaced around the periphery. The disc feed receives the cans at random and transfers them through the feed turret onto the weighing beams which cull out the off-weight cans.

**Incubating.**—Before the days of dependable leaky-can detectors, the general practice prevailed to hold all batches of evaporated milk for from 10 to 30 days. The purpose obviously was to detect and remove the spoils before releasing the goods to the trade. In most plants the holding or incubating was done at room temperature. In some factories, however, the temperature of incubation was higher, usually within the approximate range of 80° to near 100° F.

It was then observed that a large proportion of the spoils was due to leaky cans. The use of the leaky can detector decreased the percentage of spoils and largely eliminated the necessity of incubating large stocks of evaporated milk. Other serious objections to the incubation of the entire batch, or the entire day's run were:

1. The uncertainty of the viscosity of the milk by the time it reached the market, due to the variable thinning effect and tendency to jell formation of high-temperature storage; see also Chapter XXV.
2. The tendency to objectionable precipitation of calcium citrate crystals; see also Chapter XXV.
3. The delay of marketing, which required large storage space and "tied-up" much capital.

The elimination of the leaky can problem, together with the economic seriousness of the above listed objections, has led to the now more or less general practice of confining incubation to a limited number of sample cans, usually from about 24 to 48, from each batch, or from each day's run in the case of the continuous sterilizer. These sample cans are being held in laboratory incubators at several temperature levels, such as 86° and 98° F., respectively. In case of exports to the tropics, one incubator may be operated at about 120° F. These cans are opened for inspection at the intended intervals, and a record is kept of the findings. The record of each inspection is carefully examined for the purpose of making necessary adjustments in manufacture to avoid recurrence of defects if any are noted.

Regular and painstaking inspection of incubated samples, accurate records of the findings, and immediate steps to prevent recurrence of defects, constitute the most dependable sentinels of a uniformly high quality product.

#### REFERENCES

1. MEYENBERG, J. B : U. S. Patent No. 308,421. 1884.
2. MEYENBERG, J. B.: U. S. Patents Nos. 308,422, 1884; and 358,213, 1887.
3. WILLIAMS, O. B : Proceedings Food Confer. Instit. Food Technologists. Chicago, June 16-19, 1940
4. HUNZIKER, O F . Condensed Milk and Milk Powder, 3rd ed , p. 141, 1920.
5. MOJONNIER, T , AND TROY, H. C.: Technical Control of Dairy Products. p. 722, 1922.
6. WILLIAMS, O B · Information by Correspondence, February 10, 1944
7. DEYSHER, E F , WEBB, B H , AND HOLM, G. E.: Jour Dairy Sci XXVII. 345. 1944.



## CHAPTER XXIV

### FACTORS THAT INFLUENCE THE MARKETABLE PROPERTIES OF EVAPORATED MILK

The properties of evaporated milk that belong to this group are all more or less directly related to the heat treatment which the milk receives prior to and during the process of sterilization. Their discussion at this point will emphasize the importance and assist in clarifying the purpose of the procedure necessary for the control of heat coagulation in the sterilizer, described in Chapter XXVI.

The more important marketable properties of evaporated milk embrace bacterial sterility, heat stability, viscosity, light color, absence of pronounced cooked flavor, and permanency of emulsion as related to freedom from gel formation, from objectionable fat separation and from sediment of mineral salts. The present chapter deals with the factors that control or influence bacterial sterility and the heat stability of evaporated milk.

#### BACTERIAL STERILITY

The first and most indispensable requisite of marketable evaporated milk is that it must be sterile. The temperature treatment applied in the sterilizing process must be adequate to insure complete destruction of all germ life that may be present in the milk. It was shown in Chapter XXIII that the standard process of 240° F. for 20 minutes, or its lethal equivalent of a slightly altered time-temperature ratio, which is used in the commercial manufacture of U. S. standard evaporated milk (7.9% fat, 25.9% total solids), is ample to accomplish this.

**Each Can Must Receive Full Sterilizing Heat.**—In order to make sure that each and every can is subjected to the full sterilizing temperature there must be uniform distribution of heat to all the cans. This requires uniform distribution of steam over the entire length of the sterilizer, and absence of air pockets between cans. Air pockets in the batch sterilizer are readily avoided by the presence of water in the sterilizer. See also Chapter XXIII.

**Seals and Seams Must Be Tight.**—Experience in commercial manufacture and marketing has shown that the great majority of "spoils" of evaporated milk have to do with leakers. In order for the finished product to retain its quality until consumed, attention must be given to the use of dependable methods for the detection and elimination of leakers. For details see Chapters XXII and XXIII.

#### HEAT STABILITY

**Definition.**—The term heat stability of evaporated milk refers to the relative resistance of the milk to coagulation in the sterilizer. Webb, Bell, Deysher, and Holm<sup>22</sup> define heat stability as "the time necessary to initiate coagulation at 115° C. (239° F.)."

**Optimum Heat Stability.**—As will be shown under the heading “Viscosity” in chapter XXV, the problem of regulating the heat stability is not one of producing maximum heat stability but it is a problem of achieving optimum viscosity. Maximum heat stability will eliminate the danger of curdling difficulties in sterilization, but it would yield evaporated milk so lacking in body (viscosity) that it would cause objectionable fat separation after manufacture. Too low heat stability will cause the milk to be rough after sterilization. The heat stability may range from a few minutes beyond the time held at sterilizing temperature to slightly over double the time held at sterilizing temperature.

**Factors that Influence the Heat Stability.**—The factors that influence the heat stability of evaporated milk fall fundamentally into two groups, namely:

1. Factors that deal with the inherent properties of the milk, such as chemical composition and freshness.

2. Factors that have to do with the process of manufacture.

**Factors that Deal with Inherent Properties of Milk.**—The more important factors belonging to this group are: acid content, protein concentration and salt balance.

**Effect of Acidity on Heat Coagulation of Evaporated Milk.**—It was shown in Chapter I, under “Chemical Reaction of Milk,” that, in the case of average, normal milk, any increase in the acid reaction that is due to developed acidity lowers the heat stability of milk. This is true of the titratable acidity and of the hydrogen ion concentration.

It was further shown that the optimum acid reaction for maximum heat stability is dependent upon its relation to several variables of milk, such as salt balance, concentration, amount of milk proteins. Hence, the optimum acid reaction for one lot of milk may or may not apply to any other lot of milk. The normal range and average of titratable acidity of freshly drawn herd milk is given under “Chemical Reaction of Milk” in Chapter I. The sensitiveness of the heat stability of milk and evaporated milk to developed acidity emphasizes the importance of the freshness and sweetness of the farmer’s milk delivered at the factory for use in the manufacture of evaporated milk.

**Effect of Concentration and Sterilizing Process on Acidity of Evaporated Milk.**—The acidity of evaporated milk is higher than that of the fresh milk from which it is made. The titratable acidity of evaporated milk before sterilization is approximately equal to that of the fresh milk times the ratio of concentration. The acidity of evaporated milk after sterilization is slightly greater than that before sterilization. This is attributed to the formation of acids resulting from the action of the processing heat on some of the milk constituents.<sup>1,2,3</sup>

The hydrogen ion concentration of evaporated milk likewise is higher than that of the fresh milk. Fresh milk averages approximately pH 6.6,

while the pH of U. S. Standard evaporated milk falls within the approximate range of 6.15 and 6.3.

**Effect of Milk Proteins on Heat Stability.**—The nitrogenous constituents of milk are the pivot on which heat coagulation centers. It is to them that heat coagulation refers. They are the substances that are being coagulated. The relation of all other ingredients or factors to the heat coagulation of milk is important only insofar as they influence the sensitiveness of the major proteins of milk to heat. The milk proteins that are recognized as of greatest importance here, are the casein and the lactalbumin. Both are coagulated by heat. Mojonnier and Troy<sup>14</sup> reported that in their experiments, 68.6 per cent of the total albumin found in the fresh milk was precipitated in the evaporated milk after sterilization, and they concluded that, in normal evaporated milk of correct viscosity, the casein coagulated does not exceed ten per cent of the total present.

The **Casein** is of primary importance. It represents over 80 per cent of the total proteins of milk. In sour milk it curdles at ordinary temperature. In fresh, sweet milk it will coagulate at 278° F. or higher, but even at flash-pasteurizing temperature it loses its power to react normally to rennet. The condensing of milk lowers the heat coagulation point of casein. The heat stability of casein is greatly influenced by the balance of the mineral salts of milk, see later. In fact, as stated by Webb,<sup>15</sup> "the problem of heat coagulation in milk is in reality a problem of the heat stability of the calcium caseinate system."

The **Lactalbumin** is present to the extent of about 15 per cent of the milk proteins. It is partly coagulated by heat in normal milk and completely in the presence of an acid medium. It is not affected by rennet, nor by acid at ordinary temperature, nor by the mineral constituents of milk, as shown by Osborne and Wakeman.<sup>16</sup>

That lactalbumin is a factor in heat coagulation is shown by Rogers, Deysher and Evans<sup>17</sup> who determined its effect on the viscosity of sweetened condensed milk. Thus, when the forewarming temperature was above 90° C. (194° F.), the initial viscosity and the increased viscosity were in direct relation to the amount of albumin added. But, when the forewarming temperature was held below 60° C. (140° F.), the initial viscosity was the same for all lots and the changes, which were small, had no relation to the albumin content of the milk.

Sommer<sup>18</sup> demonstrated experimentally that even a small increase in the lactalbumin content of milk causes a considerable decrease in the time of sterilization required to coagulate the evaporated milk. His results further show that the effect of the preheating temperature on the heat stability of milk is due, in part at least, to the precipitation of the albumin.

Both the casein and the albumin content of milk vary with the season of the year. These variations are largely caused by changes in the period

of lactation of the cows. The variations are somewhat greater in the case of albumin than with casein, as shown by Eckles and Shaw<sup>19</sup> and by Hunziker.<sup>20</sup> Hunziker's results are shown in Table 40. This table gives the albumin and casein content of milk from three individual cows over an entire lactation period.

TABLE 40. EFFECT OF PERIOD OF LACTATION ON THE PERCENTAGES OF ALBUMIN, CASEIN AND TOTAL PROTEIDS IN THE MILK OF THREE COWS

Period of Lactation	Cow No. 1			Cow No. 2			Cow No. 3		
	Albu- min	Casein	Total Proteids	Albu- min	Casein	Total Proteids	Albu- min	Casein	Total Proteids
First 14 milkings	.98	3.18	4.16	1.59	3.81	5.40	1.72	4.46	6.18
1st month . . .	.57	2.55	3.12	.55	2.47	3.02	.58	2.88	3.40
2nd month . . .	.53	2.27	2.80	.47	2.37	2.84	.51	3.06	3.57
3rd month . . .	.52	2.54	3.06	.48	2.28	2.76	.55	3.25	3.80
4th month . . .	.56	2.51	3.07	.50	2.36	2.86	.60	3.05	3.65
5th month . . .	.55	2.62	3.17	.48	2.26	2.74	.60	3.05	3.65
6th month . . .	.53	2.65	3.18	.54	2.30	2.84	.73	2.96	3.69
7th month . . .	.86	2.62	3.48	.76	2.50	3.26	.62	2.99	3.61
8th month . . .	.75	2.79	3.54	.60	2.66	3.26	.64	2.94	3.58
9th month . . .	.73	2.84	3.57	.56	2.73	3.29	.72	3.30	4.02
10th month . . .	.77	3.02	2.79	.59	2.73	3.32	.82	3.39	4.21
11th month . . .	.91	3.08	3.99	.61	2.88	3.49	.....	.....	.....

Table 40 shows that at the beginning and toward the end of the period of lactation the casein, and especially the albumin content of the milk, is highest. Colostrum milk and milk from stripper cows, therefore, would tend to lower the heat stability. This is borne out in the manufacture of evaporated milk by the general experience that heat coagulation difficulties are greatest from late Fall to early Spring when most of the cows either are far advanced in their period of lactation or have freshened. Rigorous inspection of the milk on the platform is a helpful safeguard against the acceptance of milk distinctly abnormal in this respect. See also Chapter III, under "The Proteins of Milk."

**Effect of Products of Bacterial Origin Other Than Acidity on Heat Stability.**—Bacterial contamination of the milk may lower the heat coagulation point of evaporated milk through activities other than acid formation. Certain species of bacteria produce rennin and rennet-like enzymes. Heavy contamination with this type of organism is capable of lowering the heat coagulation temperature.

Rogers<sup>20</sup> inoculated milk with rennin-forming bacteria and held it at room temperature for three hours. After condensing, the milk was sterilized. His results show that the inoculated milk coagulated at 226° F., while the control samples coagulated at 240.4° F. Frazier<sup>30</sup> also showed that sweet-curdling bacteria, when present in considerable numbers, will hasten the heat coagulation of milk and that the addition of a culture of sweet-curdling bacteria lowers the acidity at which heat coagulation will take place.

These data, while limited in scope, indicate unmistakably that profuse contamination of the milk with microorganisms capable of forming rennin and rennet-like enzymes diminishes its heat stability. Under normal conditions of production and handling of the milk on the farm, the presence of this type of germ in large numbers is rare and heat coagulation difficulties from this source are exceptional. Yet the possibility is ever present and should not be overlooked when the milk behaves abnormally in the sterilizer.

#### EFFECT OF BALANCE OF MINERAL SALTS ON HEAT COAGULATION POINT

The temperature at which evaporated milk curdles in the sterilizer is affected and to a large extent controlled by the balance of the milk salts. This fact has been known by the industry in a general way for many years but the science of the relation of milk salts to heat coagulation was not well understood. Until the introduction of the Mojonnier Method of Evaporated Milk Control in 1916, no systematic method of preventing heat coagulation difficulties was available to the industry as a whole, though the scientific research laboratories of some of the larger evaporated milk concerns may have developed such methods for their own use. Timothy Mojonnier's<sup>21</sup> comprehensive researches covering an extended and careful study resulted in the development of the systematic use of bicarbonate of soda as a means of standardizing the heat coagulation point of evaporated milk. This, together with the use of the pilot sterilizer and viscosimeter, has been of great help to the industry. The Mojonnier Method is described in Chapter XXVI.

Later extensive study of the science of heat coagulation and of the relation of the mineral salts of milk to heat stability by Sommer and Hart,<sup>6,8,9</sup> Sommer,<sup>18</sup> Rogers, Deysher and Evans,<sup>7</sup> Benton and Albery,<sup>10</sup> Webb,<sup>11</sup> Holm, Webb and Deysher,<sup>13</sup> and Webb and Holm,<sup>12</sup> has added much to our knowledge on this subject.

**Sommer and Hart's Theory of the Salt Balance.**—Sommer and Hart<sup>8</sup> were the first to demonstrate experimentally that, aside from the effect of the albumin on heat stability, the heat coagulation point of milk is fundamentally controlled by the salt balance and that the influence of other factors, such as acid reaction and heat treatment in the process of manufacture, is dependent largely on their relation to or effect on the salt balance.

These investigators observed that casein has maximum heat stability when in combination with a definite optimum amount of calcium. When the calcium content available for the calcium-casein complex is above or below this optimum combination, the casein is less stable to heat. The calcium contained in the milk distributes itself between the casein, phosphates and citrates. In addition, the magnesium present reacts by replacing the calcium in the phosphates and citrates. The effect of

the calcium and magnesium, being basic radicals, is opposed to the effect of the phosphates and citrates which are acid radicals. The calcium-casein combination is at its optimum of heat stability when the above two groups of mineral salts are in balance, hence the term "salt balance." An excess or deficiency of either group accelerates heat coagulation.

If coagulation in the heat test is due to a deficiency of calcium and magnesium, it can be prevented by the addition of the proper amount of soluble calcium or magnesium salts, such as calcium or magnesium acetates or chlorides. Or such milk may be stabilized by a slight increase in acidity because the increased acidity changes secondary phosphates to primary phosphates. Since the primary phosphates have little or no effect on the salt balance, this change diminishes the amount of the phosphate that ties up the calcium, and more calcium is available to satisfy the calcium-casein equilibrium. In such cases a slight increase in acid thus improves the calcium-casein balance and actually raises the heat coagulation point.

If troublesome heat coagulation is due to an excess of calcium and magnesium, it can be prevented by addition of the proper amount of phosphate or citrate, such as di-sodium phosphate or sodium citrate. The authors reported full confirmation of these findings by laboratory experiments and by application to commercial batches for the correction of serious sterilizing difficulties.

Sommer and Hart<sup>6</sup> found low heat stability to be due in most cases to excess of calcium and magnesium. In later work Sommer<sup>18</sup> reported that "in evaporated milk where the coagulation is due to an unbalanced condition of the salts, this condition was due to an excess of calcium and magnesium in all cases." Hence, the heat stabilizers used in the commercial manufacture of evaporated milk are confined almost exclusively to the phosphate and citrate group. And since the phosphate is the cheaper of the two, it is given preference over citrate.

The use of sodium bicarbonate as a casein stabilizer has been discontinued by the industry because of its several objections: Sodium bicarbonate tends to darken the color and to jeopardize the flavor of evaporated milk. Its release of  $\text{CO}_2$  gas under sterilizer heat causes excessive bulging of the cans. It changes the acid reaction and when used in large amounts it may magnify the calcium excess, by combining with the casein and replacing the calcium in the calcium-casein combination. In such cases the bicarbonate impairs the calcium-casein equilibrium and causes a lowering instead of the desired raising of the heat coagulation point.

Benton and Albery<sup>10</sup> found that variations in concentrations of the ions of such buffer salts as phosphates, citrates and carbonates, especially those of the citrates, have a greater effect on the coagulation temperature than slight variations in pH from that of normal milk within

the range of pH 6.58 to 6.65. These investigators emphasize that both factors must be considered. They conclude that each lot of milk presents a separate colloidal system and that for each system there is an optimum combination of salt balance, due to such factors as pH, at which optimum the greatest heat stability is attained.

Holm, Webb and Deysher<sup>18</sup> studied the relationship between heat stability, composition and other properties of the milks of four cows during an entire lactation period. As did Rogers and co-workers,<sup>7</sup> they found no direct co-relation to heat stability of the samples, but observed that each of the individual milks, for the most part, retained fairly constant values in many of the tests, the values being characteristic of the milk of each cow. They pointed out that their results further corroborate the conclusions of Benton and Albery—that for each milk there is an optimum combination of pH and salt balance which will give maximum stability. Webb<sup>11</sup> concluded that the deductions of Benton and Albery apply also to his results of experiments with mixtures of milks of different grades. See also Chapter III under “The Ash of Milk” and “Citric Acid.”

**Factors that Deal with Process of Manufacture.**—The more important factors belonging to this group are: temperature and time of forewarming, concentration, homogenization, heat treatment after condensing.

**Effect of Temperature of Forewarming on Heat Stability.**—The effect of different temperatures of forewarming on the heat stability of evaporated milk was discussed in detail in Chapter XIX. It was there shown that the temperature at which the fresh milk is forewarmed is an important factor in the control of heat coagulation of the evaporated milk.

**Effect of Concentration on Heat Stability.**—The concentration of

TABLE 41. EFFECT OF CONCENTRATION ON ACIDITY AND HEAT COAGULATION OF EVAPORATED MILK<sup>23</sup>

Sample No.	Concentration Ratio	Total Solids	*Titratable Acidity as Lactic per cent	Condition of Sample	
				Visible Curd	Fat Separation One Month After Manufacture
1	1.58 : 1	21.12	0.30	none	considerable
2	1.74 : 1	23.25	0.34	none	considerable
3	1.9 : 1	25.48	0.40	none	none
4	1.99 : 1	26.62	0.43	none	none
5	2.11 : 1	28.28	0.48	small particles	none
6	2.25 : 1	30.10	0.54	large lumps	none

\*Refers to Evaporated milk after sterilization.

Total solids in fresh milk 13.40 per cent.

Titratable acidity in fresh milk 0.17 per cent.

Forewarming temperature 195-200 ° F., 30 minutes.

All samples represent same commercial batch of milk taken from pan at different stages of concentration and sterilized together with rest of batch.

evaporated milk has a marked effect on its heat stability. As the concentration increases, the heat coagulation temperature drops. This fact is shown experimentally by several investigators. Hunziker, in Table 41, gives his results covering concentrations over a range of 21.12 to 30.1 per cent total solids.

Table 41 shows that this particular milk, with a forewarming temperature slightly below the boiling point, and in the absence of chemical sterilizers, was fairly heat-stable, at concentrations approximating the percentage of solids of the commercial product. At higher concentrations, however, the evaporated milk became hopelessly curdy. The table further shows that the titratable acidity of the evaporated milk after sterilization, calculated as lactic acid, definitely exceeded the per cent acid contained in the fresh milk times the ratio of concentration.

It was pointed out earlier in this chapter that the increased concentration of acid, albumin and casein, respectively, tends to lower the heat coagulation. Sommer and Hart,<sup>9</sup> suggest that with the higher acid reaction in the concentrated milk there is an appreciably smaller fraction of the secondary phosphates, which in turn has the effect of accentuating the unfavorable influence of the usual excess of calcium in the milk.

Holm, Deysher and Evans,<sup>24</sup> using evaporated milks within the wide range of 16 to 26 per cent SNF, found that an increase in concentration lowers the coagulation temperature; that at the high concentrations there is a greater variation in the temperature of coagulation for every change in concentration than at the lower concentrations; that a change in concentration causes a somewhat greater change in the coagulating temperature of skimmilk than of whole milk and that the ratio of concentration to coagulating temperature was the same for milk of good and of inferior quality. They concluded that for every per cent difference in concentration within the limits of 16 to 26 per cent SNF there was a change of 1.25 to 1.50° C. (2.25 to 2.7° F.) in temperature of heat coagulation.

Subsequently Webb and Holm<sup>12</sup> showed that the concentration of solids-not-fat in evaporated milk appreciably influences the effect on heat stability of such factors as temperature of forewarming, acid reaction, and added electrolytes. Their results indicated that a concentration below 14 per cent SNF causes high forewarming temperatures (203° F.) to lower the heat coagulation point, while with concentrations above 14 per cent SNF the same forewarming temperature increases heat stability.

As a result of later extensive experiments, Webb, Bell, Deysher and Holm<sup>22</sup> concluded that "low heat stability can no longer be considered a factor which might limit evaporated milk to a 26 per cent solids content." By means of higher forewarming temperatures they were able to raise the per cent solids five points above that of normally-forewarmed



control samples, without coagulation when sterilized. They advise that to attain such an improvement the optimum forewarming temperature was 120° C. (248° F.), three to four minutes.

**Effect of Homogenization on Heat Stability.**—Homogenization tends to slightly lower the heat stability of evaporated milk. This tendency increases with increasing homogenizing pressure, and as the level of heat stability determined by the forewarming treatment drops. With milk of high heat stability, such as results from high-temperature short-time forewarming (248° F. for 4 minutes), the pressure of homogenization has

TABLE 43. EFFECT OF HOMOGENIZATION PRESSURE ON HEAT STABILITY.<sup>26</sup>  
MILK FOREWARMED AT 194° F. TEN MINUTES. TS 26.44%

Homogenization temperature	30° C. (86° F.)		45° C. (113° F.)		60° C. (140° F.)	
	1500	2500	1500	2500	1500	2500
Homogenization pressure	16	15	14	11	13	10
Heat stability at 115° C						

no effect on heat stability.<sup>26</sup> With milk of normal heat stability, such as results from forewarming at 194° F. for 10 minutes, the homogenizing pressure lowers the heat stability only very slightly (see Table 43). With milk of low heat stability, such as results from forewarming at 150° F., the heat stability drops considerably with increasing homogenizing pressure (see Figure 68).

**Effect on Heat Stability of Heating the Milk After Concentration.**—The work of Webb<sup>25</sup> shows that the stabilizing effect of high-temperature, short-time heating is not confined to forewarming the fresh milk before condensing. The special heat treatment may be applied either before or after concentration of the milk, but the temperature of the heat treatment that produces maximum stability was found to vary. Thus, when employed as a part of the forewarming process, a temperature of 120° C. (248° F.) for three to four minutes yielded maximum heat stability. When the high-temperature, short-time heating was applied to the milk after concentration, a temperature of 150° C. (302° F.) with no holding produced maximum stability.

Later, Bell, Curran and Evans<sup>27</sup> experimented with high-temperature short-time sterilizing procedures, to which they subjected the evaporated milk before canning, followed by aseptic procedures of canning. The aim was to improve the color and flavor of the finished product. The milk contained 26 per cent total solids. Heating periods of a fraction of a second, 15, and 30 seconds at temperatures of 150, 140, and 125° C. (302, 284, and 252° F.), respectively, were used. The high-short heat treatment did improve color and flavor. It rendered the milk dependably sterile and gave it satisfactory heat stability. But the viscosity was low,

the cream layer was firmer and the storage stability was not satisfactory. The finished product developed early gelation, accompanied by wheying off. Brief heating in cans at 115° C. improved its storage life. See also "Storage Stability" in Chapter XXV.

## REFERENCES

1. ORLA-JENSEN AND PLATTNER.: *Landw. Jahrb. d. Schweiz.* XIX. 235. (1905)
2. WHITTIER, E. O., AND BENTON, A. G.: *Jour. Dairy Sci.* IX. 481. (1926)
3. WHITTIER, E. O., AND BENTON, A. G.: *Jour. Dairy Sci.* X. 126. (1927)
4. MILLER, P. G., AND SOMMER, H. H.: *Jour. Dairy Sci.* XXIII. 405. (1940)
5. RICE, F. E., AND MARKLEY, A. L.: *Jour. Dairy Sci.* VII. 469. (1924)
6. SOMMER, H. H., AND HART, E. B.: *Jour. Biol. Chem.* 40. 137. (1919)
7. ROGERS, L. A., DEYSHER, E. F., AND EVANS, F. R.: *Jour. Dairy Sci.* IV. 294. (1921).
8. SOMMER, H. H., AND HART, E. B.: *Wis. Agr. Expt. Sta. Res. Bul.* 67. (1926).
9. SOMMER, H. H., AND HART, E. B.: *Jour. Dairy Sci.* V. 525. (1922).
10. BENTON, A. G., AND ALBERY, H. G.: *Jour. Biol. Chem.* LXVIII. 251. (1926).
11. WEBB, B. H.: *Jour. Dairy Sci.* XI. 471. (1928).
12. WEBB, B. H., AND HOLM, G. E.: *Jour. Dairy Sci.* XV. 345. (1932).
13. HOLM, G. E., WEBB, B. H., AND DEYSHER, E. F.: *Jour. Dairy Sci.* XV. 331. (1932).
14. MOJONNIER, T., AND TROY, H. C.: *Technical Control of Dairy Product* p. 754. 1922.
15. WEBB, B. H.: *Fundamentals of Dairy Science* 2nd Ed. P. 208. (1935).
16. OSBORNE, T. B., AND WAKEMAN, A.: *Jour. Biol. Chem.* XXXIII. 7. (1918).
17. ROGERS, L. A., DEYSHER, E. F., AND EVANS, F. R.: *Jour. Dairy Sci.* III. 468. (1920).
18. SOMMER, H. H.: *Proc. World's Dairy Cong., Washington, D. C.* II. 1241. (1923).
19. ECKLES, C. H., AND SHAW, R. H.: *U.S.D.A., B.A.I. Bul.* 155. (1913).
20. HUNZIKER, O. F.: *Purdue Agr. Expt. Sta. Bul.* 143. (1910).
21. MOJONNIER, TIMOTHY: *President Mojonnier Bros. Co., Chicago.*
22. WEBB, B. H., BELL, R. W., DEYSHER, E. F., AND HOLM, G. E.: *Jour. Dairy Sci.* XXVI. 579. (1943).
23. HUNZIKER, O. F.: *Purdue Agr. Expt. Sta. Bul.* 143. (1910).
24. HOLM, G. E., DEYSHER, E. F., AND EVANS, F. R.: *Jour. Dairy Sci.* VI. 556. (1923).
25. WEBB, B. H.: *Jour. Dairy Sci.* XXVI. 761. (1943).
26. WEBB, B. H.: *Information by correspondence.* Dec. 27, 1943.
27. BELL, R. W., CURRAN, H. R., AND EVANS, F. R.: *Jour. Dairy Sci.* XXVII. 313. 1944.
28. WEBB, B. H., AND BELL, R. W.: *Jour. Dairy Sci.* XXVI. 1071. 1943.
29. ROGERS, L. A.: *The Canner*, 165. (1921).
30. FRAZIER, W. C.: *Jour. Dairy Sci.* VIII. 370. (1925).

## CHAPTER XXV

### FACTORS CONTROLLING OR INFLUENCING VISCOSITY, PERMANENCY OF EMULSION, COLOR AND FLAVOR OF EVAPORATED MILK

#### VISCOSITY

**Importance.**—The relative viscosity or body constitutes one of the important attributes of a marketable evaporated milk. A full body is desired in order to convey to the trade and consumer the right impression of richness, and the magnitude of the food value of the product. Evaporated milk of low viscosity has a thin body that tends to suggest adulteration to the layman.

A full body is necessary further, in order to sustain the fat-in-skimmilk emulsion and retard the progressive creaming off. In thin evaporated milk the fat globules in their upward passage encounter but feeble resistance and they readily gather into a compact and firm layer of cream that refuses to disintegrate. The process conditions that are responsible for a full body usually retard the creaming off, and the resulting cream layer is of looser structure and softer texture that disintegrates and re-emulsifies into the body of the evaporated milk more readily and more completely.

**Definition.**—Viscosity is defined as being a resistance to the motion of the molecules of a fluid body among themselves caused by internal friction, as opposed to mobility.<sup>1</sup>

The relative viscosity may be determined by several different methods the best known of which appear to be the flow meters and resistance testers. For viscosity determinations of evaporated milk, resistance testers such as the MacMichael viscosimeter and the Mojonnier-Doolittle viscosimeter are generally used. These viscosimeters express the relative viscosity in terms of degrees of retardation. To make the results comparable, regardless of the type of viscosimeter used, conversion factors should be provided for conversion to centipoises. (See Chapter XLVI under "Viscosity Tests.")

**Effect of Process of Sterilization on Relative Viscosity.**—As shown in Table 44 the viscosity of fresh milk is not noticeably changed by the pre-heating of the milk. The condensing operation causes a slight but definite increase in viscosity. This is obviously due to the increased concentration of the milk solids. The decisive increase in viscosity that gives the finished product its full body, however, occurs during the process of sterilization.

In general, a high-temperature, short-time sterilizing process yields a thin body and low viscosity,<sup>2</sup> while a low-temperature, long-time process of similar lethal magnitude yields a full body and relatively high viscosity.

**Increase in Viscosity Caused by Progressive Coagulation of Milk Proteins.**—In the sterilizing process the rate of thickening is greatest shortly before

TABLE 44. VISCOSITY CHANGES DURING SUCCESSIVE STEPS IN MANUFACTURE OF EVAPORATED MILK. Relative Viscosity at 75° F. Mojonnier-Doolittle Degrees Retardation According to Mojonnier and Troy<sup>b</sup>

No. of Samples	Stage Manufacture	Viscosity °Retard.	No. of Samples	Stage Manufacture	Viscosity °Retard.
8	Fresh milk before forewarming	15.24	4	Evap. milk before sterilizing	20.20
8	Fresh milk after forewarming	15.26	4	Evap. milk just after sterilizing	150.00

Table 44 shows tests of the relative viscosity during successive steps in manufacture, from raw fresh milk to sterilized evaporated milk. Note the decisive increase in viscosity caused by sterilization.

the occurrence of a visible coagulation. Deysher, Webb and Holm<sup>8</sup> observed that the thickening does not proceed rapidly until about 10 minutes before coagulation. This is as might be expected since the thickening or increase in viscosity during sterilization appears to be a part of the function of coagulation. Thickening in sterilization is, in fact, the beginning of coagulation, but due to the phenomenon of heat stability, heat coagulation is very gradual and in the normal commercial process of sterilization covering a period of approximately 20 minutes at the full sterilizing temperature (about 240° F.), the proportion of milk proteins coagulated, while sufficient to increase the viscosity, is too limited for the curd to become visible. The increase in viscosity which milk undergoes toward the end of the sterilizing process has to do with progressive coagulation of the milk proteins.

Deysher et al further concluded that "for a heavy, creamy body the heat stability of the milk should not exceed 30 to 40 minutes;" that "when the cooking time approaches the heat stability time, extensive increases in viscosity may be encountered"; and "milks with stabilities in excess of 50 minutes will be exceedingly thin at the end of sterilization at 239° F. for 20 minutes unless an increase in solids content is depended upon to build up body."

These findings are supported, in general principal, by experience in commercial manufacture. The viscosity produced during the sterilizing process is controlled mainly by the heat stability of the milk. Low heat stability makes for high viscosity and heavy body in sterilization, while high heat stability decreases the viscosity and gives the finished product a thin body.

For above reasons, variations in the same factors that control heat stability during heat sterilization also affect viscosity. This effect, however, is indirect through their effect on heat stability and it is in the direction opposite to that on heat stability. Thus, such factors as high acidity of fresh milk, low forewarming temperature, high concentration, high homogenizing pressure (especially in the case of milk of inferior quality), and excessive holding of evaporated milk at ordinary temperature before sterilization, make for low heat stability, high viscosity and thick body.

On the other hand, freshness and low acidity of fresh milk, high forewarming temperature, low concentration, moderate homogenizing pressure, and management of the factory routine that will prevent development of acidity in the evaporated milk before sterilization (prompt cooling to near 40° F. after homogenizing) make for high heat stability and relatively low viscosity.

As has been shown earlier in this chapter, the consumer desires a product with a good, full body that suggests richness. While heat stability, sufficient to avoid visible curdling during the sterilizing process must be accomplished, maximum heat stability is not desirable because such high heat stability means objectionably thin milk.

Evaporated milk of satisfactory fullness of body immediately after sterilization averages approximately 100 degrees retardation by the MacMichael viscosimeter. For U. S. standard evaporated milk the commonly used sterilizing process of 240° F. for approximately 20 minutes, together with the standard forewarming procedure of 195° F. to boiling, for 10 to 25 minutes, has been found to yield a satisfactory combination of heat stability with summer milk and under otherwise reasonably normal conditions of factory routine. During late fall, winter, and early spring the tendency lies in the direction of too low heat stability and excessive body, even to the point of visible coagulation. This condition is generally corrected by the addition of casein stabilizer, see Chapter XXVI. It can be corrected, however, without addition of a chemical stabilizer, by using one of the high-temperature, short-time procedures of forewarming at temperatures above the boiling point, see Chapter XIX.

Similarly, for high-solids evaporated milk, such as British standard evaporated milk (31% TS), or milk of even higher solids content, forewarming at 248° F. for three to four minutes is recommended. In case of milk of low heat stability because of poor quality, high homogenizer pressure (3000 to 4000 lbs. pressure per square inch) should be avoided in order to minimize danger of curdling difficulties in sterilization.

**Effect of Storage on Viscosity.**—Evaporated milk becomes thinner with age. This loss of viscosity increases with the temperature of storage. The decrease in viscosity begins immediately. The rate at which viscosity is lost is accelerated at high storage temperatures. Thus, Deysher, Webb and Holm<sup>8</sup> found that at or above 86° F., evaporated milk sometimes lost as much as 40 per cent of its original viscosity during the first 10 days of storage, while at 60° F. or below, the age thinning effect was very slight. They further observed that after the initial thinning, a basic viscosity level was reached, after which the rate of thinning was much more gradual. On the basis of these results, age thinning of evaporated milk may, therefore, be definitely retarded and the attainment of final viscosity delayed by the use of relatively low storage temperatures. Mojonnier and Troy<sup>8</sup> reported a similar effect of storage temperature on the viscosity of evapor-

ated milk. Their tests show viscosity loss of 58.75% at 79° F., 40% at 60° F. and 11.25% at 45° F.

**Gel Formation in Storage.**—Deysher, Webb and Holm<sup>8</sup> called attention to the fact that in the case of some evaporated milks the viscosity increased later in the storage period, even to the point of gel formation. This tendency was greatest with milks that had received relatively light heat treatment and those of high solids concentration. These results of gel formation in prolonged storage are supported by commercial experience, especially with samples of high-solids evaporated milk incubated at "tropical" temperatures.<sup>6</sup>

The work of Bell, Curran and Evans<sup>2</sup> shows that evaporated milks that have been sterilized by the short-time, high-temperature process (275° F. for 0.5 minutes), such as was experimented with in efforts to preserve light color and freedom from cooked taste, thickened quickly during storage. When the gel was broken before it became firm, the product wheyed off. When sterilized in the conventional manner (240° F. for 20 minutes), gel formation was slow and it held the water better, and upon stirring or pouring it was more homogeneous. Since long fluidity in storage is a marketable property of primary magnitude, it appears that the more severe heat treatment of the commercial process (240° F.—20 minutes) that retards thickening in storage is commercially preferable to the less drastic treatment of momentary exposure to high sterilizing heat.

Neither the mechanism underlying age thinning nor that responsible for age thickening appears to be well understood. Regarding the tendency to gelation in prolonged storage at high temperature, Bell, Curran and Evans suggest that it may be due, when using the high-short method of sterilization, to insufficient time for the attainment of the new solubility equilibrium of the lime and magnesium salts. When solutions of salts are heated, considerable time is required for such attainment. Their peculiarity of being less soluble at the higher temperatures may be a contributing factor in the reaction of these salts.

In the high-short method of sterilization, conditions are thus less favorable than those of the low-long procedure (240° F.—20 minutes). This suggests the possibility that less of the calcium and magnesium are rendered insoluble. This condition might encourage the tendency for the protein particles to swell and to form a gel. Or, as suggested by Deysher et al, it may be a slow continuation of the coagulation process, accompanied by an orientation of the caseinate molecules, which finally produces an irreversible gel structure.

**Fat Separation in Storage.**—It has been shown earlier in this chapter that one of the aims of producing sufficient viscosity in the evaporated milk to give it a full body is to retard objectionable fat separation. During age thinning and before age thickening sets in, there is a definite tendency to objectionable fat separation. This tendency emphasizes the importance

of efficient homogenization that insures a reduction of at least 90 per cent of the fat globules to two microns or smaller. Such efficiency is made possible by a daily check-up of the homogenizing valve, keeping the clearance surfaces of valve and valve seat smooth and intact by regrinding or re-surfacing whenever necessary, making sure of the continued accuracy of the pressure gauge and examining samples of the homogenized milk during different periods of the daily run.

It was further observed by Bell and co-workers<sup>2</sup> that the high-short sterilization provides little opportunity to control body, and, through a heavier body, to control the extent of fat separation. Here again the low-long procedure of sterilization (240° F.—20 minutes) yielded better storage stability. Fat separation in this more viscous body was slower and less intense. The fat layer was less compact and softer, and it re-emulsified more readily into the body of the evaporated milk than was the case with the high-short sterilized product.

### COLOR

**Relation of Caramelization to Discoloration.**—The browning of milk, both sweetened condensed milk and evaporated milk, has long been attributed to caramelization of the sugar of milk in the presence of heat treatment during manufacture. This assumption has persisted in spite of the fact that numerous investigators have observed that the proteins of milk and milk products so discolored also showed a pronounced brownish color.

Webb and Holm<sup>7</sup> who studied color changes in evaporated milk concluded that the production of coloring (browning) is not a direct function of time, but that the reaction is of catalytic nature.

Ramsey, Tracy and Ruehe<sup>8</sup> demonstrated that water solutions of sucrose, dextrose, and lactose, respectively, when heated for 30 minutes to 250° F. showed no signs of discoloration, nor of caramel flavor. Similarly, distilled water emulsions of lactalbumin and casein so heated failed to darken. But when emulsions of lactalbumin or casein were heated with lactose or dextrose, a marked brown coloration resulted. The proteins were dark and the color could not be removed by washing with water, dilute acids, or alcohol. The whey was clear. These results are supported by the earlier observations of Leeds,<sup>9</sup> Hunziker and Hosman,<sup>10</sup> Wright,<sup>11</sup> Neuberg and Kobel,<sup>12</sup> Euler,<sup>13</sup> Ambler,<sup>14</sup> and Englis and Dykins.<sup>15</sup>

**Relation of Amino Acid-Sugar Complex to Browning of Evaporated Milk.**—It appears that in the lactose-protein reaction responsible for the darkening of the milk proteins, certain amino acids are involved. The sugar combines with the NH<sub>2</sub> group which is alkaline, neutralizing the alkalinity and leaving the acid group free, thereby causing a reduction of the pH accompanied by the formation of a highly colored product. It is well known that sugar heated with an alkali turns brown, hence the amino

acid-sugar complex which is alkaline would tend to assume a brown color. This would be the case especially with a reducing sugar such as lactose, because of the availability of the aldehyde or ketone groups which are naturally present in reducing sugars.

The theory of sugar-amino acid condensation is further supported by the inhibitive action of formaldehyde. It was found that the discoloration could be prevented by the presence of a small amount of formaldehyde. Ramsey et al point out that this is not surprising since this chemical is well known for its affinity for amino acids. When evaporated milk was sterilized in the presence of a sufficient amount of formaldehyde, the product appeared almost as white as normal milk.

**Effect of Steps in Processing on Color of Evaporated Milk.**—Webb and Holm<sup>7</sup> found experimentally that the time-temperature ratio of sterilization is the most important factor. This observation is supported by long experience in commercial manufacture. An increase in color resulting from an increased exposure to heat was accompanied also by a corresponding lowering of the final pH of the product.

Ambler,<sup>14</sup> and Englis and Dykins<sup>15</sup> observed that the coefficient of heat is very great, and the experimental results of Ramsey et al show the remarkable effect of heat in producing the brown color. They, too, found the time of heating to be an important factor, and concluded that milk can be exposed to a comparatively high temperature for a short period with development of less color than would be found in the same milk heated for a longer period at a lower temperature.

In addition, Webb and Holm noted that: (1) within the time of forewarming applied generally, the product suffers no decisive change in color, but that for long periods (30 minutes) the color is intensely affected; (2) homogenization tends to diminish the color of the product because of a finer subdivision of the fat globules which prevents such penetration of the rays of light as would reveal the butterfat more nearly in its natural color, which is yellow; (3) storage causes progressive darkening with increase in time and temperature at 5° C. (41° F.) there was no change in color.

Bell and Webb<sup>10</sup> concluded that for each 10° C. (18° F.) decrease in forewarming temperature, the holding period was increased approximately 2.5 fold without causing an increase in color.

#### COOKED FLAVOR

Heat treatment in processing tends to produce a cooked flavor in evaporated milk. This is true also of fresh milk and milk products in general. It has been common observation that the development of cooked flavor accompanies the darkening of color.

As in the case of darkening of color, the cooked flavor grows in intensity with a rise in temperature and with a prolongation of the time of heat



exposure. Likewise, high-temperature, short-time exposure produces less cooked flavor than lower-temperature, longer-time exposure of similar lethal effect.

The American consumer as a whole does not relish the cooked flavor in any food product, and evaporated milk is no exception. Scientific research has assisted the industry in diminishing the cooked flavor of evaporated milk to some extent, but complete freedom from cooked flavor still is an unsolved problem. Bell, Curran and Evans<sup>2</sup> demonstrated that cooked flavor can be decreased materially by the use of the high-short heat treatment in sterilization in the place of the conventional low-long process (240° F.—20 minutes). However, as previously shown, this change in temperature-time ratio is accompanied by a decrease in viscosity to an extent that jeopardizes the stability of the fat-in-skimmilk emulsion, hastening fat separation, increasing the extent of such separation and producing a cream layer that is compact and does not readily diffuse and redistribute the fat globules throughout the body of the milk. In addition, as has already been pointed out, the high-short sterilizing treatment interferes with the important storage stability, shortening the continuing fluidity desired by objectionable gelation.

**Reactions Involved in Production of Cooked Flavor.**—The reactions involved do not appear to be understood sufficiently as yet to accomplish the dependable prevention of cooked flavor in evaporated milk. Josephson and Doan<sup>17</sup> observed that when heating milk, skimmilk, cream and some other dairy products, respectively, to a sufficiently high temperature or for a sufficient length of time to a lower temperature, sulfhydryl compounds are formed from one or more of the proteins present. On the basis of their investigation they concluded that the presence of these sulfhydryl compounds is wholly responsible for the cooked flavor in milk products.

The above findings are supported by the work of Gould, Jr., and Sommer,<sup>18</sup> and Gould<sup>19, 20</sup> whose final conclusions were that the cooked flavor is due to the formation of sulphur compounds from the milk proteins, and that a close relation exists between cooked flavor and hydrogen sulphide liberation, with yet a closer relation between the flavor and the formation of sulfhydriyls. Gould, Jr. and Sommer's<sup>18</sup> heat treatment consisted of momentary heating to 76-78° C.; Gould's<sup>19, 20</sup> was momentary heating to 80-82° C.

#### SEDIMENT OF MINERAL SALTS

**Character of Sediment.**—There is a tendency in some evaporated milks upon aging for a granular deposit to form in the can. This deposit has a whitish color, it is gritty and insoluble and seemingly of non-crystalline character. Mojonnier and Troy<sup>5</sup> investigated the occurrence of this sandy granular material. They found it to consist of tricalcium citrate. Later, Sato<sup>21</sup> reported that his analysis of sediment in evaporated milk yielded

tricalcium citrate  $\text{Ca}_3(\text{C}_6\text{H}_5\text{O}_7)_2$ , tricalcium phosphate  $\text{Ca}_3(\text{PO}_4)_2$ , and magnesium phosphate  $\text{Mg}_3(\text{PO}_4)_2$ . These salts have the peculiar property of being less soluble in hot solutions than in cold. Thus, Chatterjee and Dhar<sup>23</sup> found that one liter of water dissolves 2.51 grams of calcium citrate at 30° C. and only 2.10 grams at 95° C. Pollacci<sup>24</sup> found the solubility of tricalcium phosphate to be 0.0216 gram at 12.5° C. and only 0.0120 gram at 100° C. in one liter of water. The amount of sediment that forms in evaporated milk varies widely. It appears to vary some with the season and it is known to be definitely affected by the concentration and the storage temperature of evaporated milk.

**Effect of Season on Mineral Sediment.**—It is believed that seasonal variations of the amount of sediment in evaporated milk have to do with well established wide fluctuations in the amount of calcium and citric acid content of the milk, caused by advancing lactation and seasonal change in feed. Thus the results of careful researches by Trunz<sup>25</sup> and others show that the calcium and magnesium content of milk is highest in the colostrum and again toward the end of the lactation period, and lowest during the intervening time. The citric acid content of milk appears not to fluctuate consistently with the lactation, but is affected by changes in feed. It is highest when the cows are on green feed and lowest when they are exclusively on dry feed. According to Sommer and Hart<sup>22</sup> it was found to be about 28 per cent higher on grass than on hay as roughage. Supplementing the grass with bone meal further increased the citric acid content of the milk to 41 per cent above the dry ration.

**Effect of Concentration of Milk Solids on Mineral Sediment.**—The tendency for increased concentration of milk solids to cause an increase in the amount of sediment produced is well known to the evaporated milk manufacturer. The danger of excessive sediment in stored high-solids evaporated milk, in fact, constitutes one of the objections to raising the solids content above the U. S. minimum standard of 28 per cent total solids.

An increase in concentration necessarily increases the calcium, magnesium, citric acid and phosphorus contained in the milk, and thus provides the possibility for the precipitation of a larger amount of calcium and magnesium salts. In addition, the higher concentration tends to diminish the heat stability unless offset by a suitable change in heat treatment (such as shifting to the high-short forewarming procedure), or the addition of a casein stabilizer.

**Effect of Temperature of Storage on Sediment Formation.**—The precipitation of mineral salts in the form of a white, sand-like deposit is an age defect of evaporated milk. The temperature of storage appears to be the most important factor in the control of this defect. Table 45 shows the amount of sediment found in evaporated milk samples of the same run that had been stored at different temperatures.

TABLE 45. EFFECT OF STORAGE TEMPERATURE ON AMOUNT OF SEDIMENT IN EVAPORATED MILK.  
MOJONNIER AND TROY<sup>5</sup>

Storage Temperature	Time	Relative Amount of Calcium Citrate Sediment
85° F.	30 days	Large amount of fine particles, many large particles
68° F.	78-110 days	Considerable amount of large particles
45° F.	4 months	No sediment

Table 45 shows that sediment formation can be prevented entirely by holding the evaporated milk at a relatively low storage temperature (45° F.). It was further shown by Mojonnier and Troy<sup>5</sup> that, when once formed, the gritty sediment does not dissolve at any temperature to which the evaporated milk may be exposed on its journey from factory to consumer.

#### REFERENCES

1. Century Dictionary and Encyclopedia VIII p. 6769. 1904.
2. BELL, R. W., CURRAN, H. R., AND EVANS, F. R.: Jour. Dairy Sci. XXVII. 913. 1944.
3. DEYSHER, E. F., WEBB, B. H., AND HOLM, G. E.: Jour. Dairy Sci. XXVII. 345. 1944.
4. WEBB, B. H., AND BELL, R. W.: Jour. Dairy Sci. XXV. 301. 1942.
5. MOJONNIER, T., AND TROY, H. C.: Technical Control of Dairy Products. First ed. 1922.
6. HUNZIKER, O. F.: Gel Formation in Evaporated Milk held in Storage at 140° F. Inspection of Samples Stored at Different Temperatures. 1942. Results not published.
7. WEBB, B. H., AND HOLM, G. E.: Jour. Dairy Sci. XIII. 25. 1930.
8. RAMSEY, R. J., TRACY, P. H., AND RUEHE, H. A.: Jour. Dairy Sci. XVI. 17. 1933.
9. LEEDS, A. R.: Jour. Amer. Chem. Soc. 13. 34. 1891.
10. HUNZIKER, O. F., AND HOSMAN, D. FAY: Jour. Dairy Sci. I. 320. 1917.
11. RAHN, O., AND SHARP, P. F.: Physik der Milchwirtschaft. Quoting N. C. Wright p. 241. 1928.
12. NEUBERG, C., AND KOBEL, M.: Biochem. Ztschrft. 174. 464 1926.
13. EULER, H. V., AND JOSEPHSON, K.: I. Z. Physiol. Chem. 153. 1. 1926.
14. AMBLER, J. A.: Jour. Ind. Eng. Chem. 21. 47. 1929.
15. ENGLIS, D. T., AND DYKINS, F. A.: Jour. Ind. and Eng. Chem. 3. 17. 1931.
16. BELL, R. W., AND WEBB, B. H.: Jour. Dairy Sci. XXVI. 579. 1943.
17. JOSEPHSON, D. V., AND DOAN, F. J.: Milk Dealer 29 pp. 35 and 54. 1939.
18. GOULD, I. A., JR., AND SOMMER, H. H.: Mich. Agr. Expt. Sta. Tech. Bul. 164. 1939.
19. GOULD, I. A.: Jour. Dairy Sci. XXII. 1017. 1939.
20. GOULD, I. A.: Intern. Asso. Milk Dealers. Rept. Lab. Sect. No. 21. 553. 1941.
21. SATO, M.: Proc. World's Dairy Congr. Washington, D. C. II. 1284. 1923.
22. SOMMER, H. H., AND HART, E. B.: Wisc. Agr. Expt. Sta. Res. Bul. 67. 1926.
23. CHATTERJEE, K. P., AND DEAR, N. R.: Jour. Phys. Chem. 28. 1009. 1924.
24. POLLACCI, E.: L'Orosi Giornale Di Chimica. 19. 217. 1896.
25. TRUNZ, A.: Ztschr. fuer Physiol. Chem. 40. 263. 1903.

## CHAPTER XXVI

### COMMERCIAL METHOD OF TECHNICAL CONTROL OF EVAPORATED MILK

#### CONTROL BY ADDITION OF CHEMICAL STABILIZERS

**Purpose.**—The purpose of this method of technical control of evaporated milk is ably expressed by Mojonnier Bros. Co.<sup>1</sup> It is threefold. It is to make possible:

"1. The adoption of a standardized process of sterilization designed and adapted for evaporated milk of superior quality for processing. This process provides a very narrow range of variation of temperature and of time exposure, in order to limit the personal factor with its inevitable uncertainties to the minimum.

"2. A standard method of determining, by means of a pilot sterilizer, a viscosimeter and a color test, the proper viscosity and color that the evaporated milk should have when it comes from the sterilizer.

"3. A standard method of determining the amount of stabilizer that must be added to any given batch of evaporated milk in case its properties are such that it is unsafe to subject it, without such treatment, to the temperature conditions that fall within the range of the standardized process of sterilization."

**Apparatus.**—The method almost universally used in the evaporated milk industry has for its basis the method originally developed by the above named firm.<sup>1</sup> The major apparatus needed is as follows:

Pilot sterilizer with accessories and motor

Viscosimeter

Vent hole sample can filler

Torsion balance

Glassware for making and measuring stabilizer solution

6-ounce vent hole sample cans

**General Description of How Stabilizer is Used.**—The amount of stabilizer to add to any given batch of evaporated milk is determined by trial as directed below. A number of 6-ounce vent hole sample cans (8 to 10) are used and the test is made in the pilot sterilizer. The samples are prepared by transferring various accurately measured amounts of the stabilizer solution to the individual sample tins which are subsequently filled with exactly six ounces, by weight, of the evaporated milk to be tested.

Sommer and Hart,<sup>2</sup> on the basis of their results, both in laboratory experiments and in evaporated milk factories, reported that in most cases of unbalanced salts in evaporated milk a range of two to 10 ounces of dry citrate or phosphate per 1,000 pounds of evaporated milk will cover the amount required to restore balance and to accomplish a satisfactory sterilizing process. They did, however, encounter isolated exceptional cases

that required as high as 16 to 20 ounces per 1,000 pounds of evaporated milk. They recommend, in part, the following procedure for determining the amount of stabilizer needed.

**Preparation of Stabilizer Solution.**—The citrate or phosphate is added in the form of a solution. The strength of the solution should be such that one-tenth of a cubic centimeter of the solution is equivalent to the addition of one ounce of the dry salt per 1,000 pounds of evaporated milk. This requires a solution containing 10.63 grams of the dry salt dissolved in enough water to make up 100 cc. of solution. This is so near a 10%-solution that under practical conditions a 10%-solution may be used, dissolving 10 grams of dry salt in enough water to make 100 cc. of solution. Thus, for each 0.1 cc. of this phosphate solution that had been added to the 6-ounce can, the inspection and test of which showed the viscosity desired, one ounce of dry phosphate salt is added for each 1,000 pounds of evaporated milk in the batch.

**Preparation of Sample Tins.**—Use a 1 cc. pipette graduated to one-tenth cc. The tip of this pipette should be drawn to a point sufficiently small so that it may readily be inserted into the vent hole of the usual evaporated milk can. In order to prevent loss of solution due to some of it being blown out with the air that escapes past the tip of the pipette, it is best to add the solution to the cans before they are filled with the milk.

**Compensating for Effect of Dilution of Sample.**—The addition of the salt solution dilutes the evaporated milk. This factor alone has a slight influence on the heat coagulation point of the milk. In order to eliminate this factor it is advisable to equalize the dilution in all samples of a given series. The exact procedure is shown in Table 46.

TABLE 46. METHOD OF PREPARING SAMPLES.  
SOMMER AND HART<sup>2</sup>

6 ounces of unsterilized evaporated milk, plus:	{ cc. of 10 63% di-sodium phosphate solution	0 0	0.0	0.2	0.4	0.6	0.8	1.0
	{ cc. of distilled water	0.0	1.0	0.8	0.6	0.4	0.2	0.0
Rate of addition required, and expressed as ounces of dry di-sodium phosphate per 1,000 pounds of unsterilized evaporated milk . . . . .		0	0	2	4	6	8	10

In the above table the first sample represents the evaporated milk without any addition. The second sample, contains no stabilizer but represents the milk in diluted form, the rate of dilution being the same as that of all the other samples. The remaining samples represent additions of stabilizer in increasing amounts, but with the dilution in all cases equal to the

second sample. By this procedure, it is possible to determine to what extent the improvement in heat stability is attributable to the dilution and to the stabilizer, respectively.

**Sterilizing the Samples.**—The sample cans containing the measured portions of stabilizer solution are now filled with evaporated milk from the batch. Exactly six ounces (by weight) of the milk is transferred to each can. They are then sealed and placed in the pilot sterilizer, where they are subjected to the following heat treatment for sterilization:

TABLE 47. TEMPERATURE-TIME SCHEDULE FOR STERILIZATION IN PILOT STERILIZER  
MOJONNIER BROS. Co.<sup>1</sup>

Actual Temperature in Fahrenheit Degrees	Actual Reading upon Thermometer Scale	Time at Which Mercury should be at any given point coming up
240°	8 points	20 minutes
230°	7 points	18 minutes
220°	6 points	16 minutes
210°	5 points	14 minutes
200°	4 points	12 minutes
190°	3 points	10 minutes

As shown in Table 47, after the steam valve is opened the heat is brought up to 190° F. in ten minutes. Then the heat is raised gradually from 190 to 240° F., or from 3 to 8 points on the thermometer scale, allowing one minute for each 5° F. The sterilizing schedule presented in this table is based on operation where the sterilizing is done with steam only. Mojonnier Bros. Co.<sup>1</sup> suggests that, when operating with superheated water (filling the sterilizer with water to a point half way up on the water glass), the coming up be shortened by taking only five minutes (instead of 10) to come up to 190° F.

They further recommend that in the pilot sterilizer the samples be heated to 243° F. and that the rise from 230° to 243° F. be accomplished in two minutes, holding the milk at this temperature for 15 minutes to the exact second. The cans are then cooled rapidly by opening exhaust and cold water intake valve. It is advisable to adopt a standard temperature to cool to because temperature influences the result of the viscosity test. Cooling to 75° F. has been found suitable. As soon as cooled, the cans are opened, examined for smoothness and color, and tested for viscosity. For Viscosity Tests, see Chapter XLVI.

**The Correct Viscosity of Evaporated Milk.**—The viscosity of evaporated milk is influenced by most of the factors that affect heat stability. For details, see Chapter XXIV. In general, as the viscosity increases, heat stability declines. Mojonnier and Troy<sup>3</sup> compared the viscosity of fresh milk

before forewarming with that of evaporated milk after sterilizing, as given in Table 48.

TABLE 48. CHANGES IN VISCOSITY DURING PROCESS OF MANUFACTURE  
MOJONNIER AND TROY<sup>3</sup>

Stage in Process of Manufacture	No. of Samples Tested	Viscosity at 75° F. Degrees of Retardation
Fresh milk before forewarming	8	15 24
Fresh milk after forewarming	8	15 26
After condensing and cooling before sterilization	4	20 20
Evaporated milk after sterilizing	4	150 00

Experimental study<sup>3</sup> of the viscosity of evaporated milk has further revealed that a considerable portion of the viscosity at the sterilizer is lost during the handling between sterilizer and departure from shipping department, and again in transport, until it reaches the consumer. The higher the temperature, the greater the sacrifice in viscosity.

Accordingly, these investigators<sup>3</sup> suggest that for domestic trade a retardation (Mojonnier-Doolittle viscosimeter) of 150 degrees represents the correct viscosity for evaporated milk as it comes out of the sterilizer. For export purposes the viscosity should be higher, around 200 degrees. A 150-degree viscosity at the sterilizer is equivalent to between 80 and 100 degrees by the time the milk leaves the shipping department. This has been found correct for summer milk, while for the winter months the viscosity should not exceed about 80 degrees retardation.<sup>1</sup>

**Importance of Viscosity Test.**—The viscosity of evaporated milk determines the body and permanency of the emulsion of fat-in-skimmilk, and it further determines the extent to which the evaporated milk may be expected to withstand the sterilizing heat without danger of curdling in a manner that would destroy its market value.

The value of the viscosity test on sample cans having passed through the pilot sterilizer lies in its ability to demonstrate whether the batch, without addition of stabilizer, will safely pass through the adopted, standard process of sterilization. If Can "X" that contains no stabilizer, comes out of the pilot sterilizer with a rough texture, the test shows that the batch must be treated with stabilizer. The can showing the desired body and smoothness indicates how much phosphate salt must be added to the batch.

**Adding the Correct Amount of Stabilizer to the Batch.**—Upon completion of the viscosimeter tests the batch is ready to be filled into the tin cans if no stability correction is necessary. In case the viscosity test shows that a certain amount of stabilizer must be added, the following procedure is recommended:

Let us assume that the cans were marked as follows:

Can X	Can No. 1	Can No. 2	Can No. 3
Control	Diluted with water only	Contains 0.2 cc. stabilizer solution	Contains 0.4 cc. stabilizer solution
Curdled	Curdled	Smooth 150° R.*	Slightly rough 250° R.

\*°R. = degrees retardation.

The above results show that can No. 2 has a viscosity adequate for a full body, and a stability sufficient to come out of the sterilizer with a smooth texture free from roughness or curdiness. To this can was added 0.2 cc. of the 10%-solution of the stabilizer. This amount is equivalent to two ounces of dry di-sodium phosphate crystals per 1,000 pounds of evaporated milk. The batch contains 24,000 pounds of evaporated milk.

Hence, the amount of phosphate to add to the batch is:  $\frac{24,000 \times 2}{1,000}$

or 48 ounces di-sodium phosphate crystals.

The stabilizer should be added to the evaporated milk in the form of a solution, using just enough water for complete solution of the crystals. The mixture should be added slowly, keeping the evaporated milk thoroughly agitated both during addition and for several hours after its addition.

The casein-stabilizing reaction of the sodium salt is most pronounced when the added stabilizer is in the milk during forewarming and condensing. It has been found advantageous, therefore, to add at least a portion of the required amount to the milk at the forewarmer and then complete the correction by adding the remainder to the evaporated milk in the storage tank. In order to do this, the operator may use the results of the previous day's work as a basis upon which to determine the approximate amount of the stabilizing salt that may safely be added at the forewarmer. While the salt balance may differ some from day to day, these differences from batch to batch and between successive days have generally not been found sufficient to require appreciable changes in amount of stabilizer needed. The major variations in salt balance are generally of seasonal occurrence, due to change in stage of lactation and feed. See also Chapter XXIV.

**Factors Which Influence the Viscosity, and Their Relation to the Sterilizing Process.**—The more important of the factors that are known to influence the viscosity and the heat stability of evaporated milk are briefly listed below:

- |   |   |   |
|---|---|---|
| Factors that<br><b>"INCREASE"</b><br>viscosity and<br>curdling tendencies | } | <ol style="list-style-type: none"> <li>1. Presence of developed acidity</li> <li>2. High protein content</li> <li>3. Excess or deficiency of calcium in calcium-casein combination</li> <li>4. Presence of bacteria producing rennet-like products.</li> <li>5. Low forewarming temperatures</li> <li>6. High concentration</li> <li>7. High homogenizing pressure, especially in case of milk of inferior quality</li> </ol> |
|---|---|---|



Factors that <b>"DECREASE"</b> viscosity and curdling tendencies	}	<ol style="list-style-type: none"> <li>1. Absence of developed acidity</li> <li>2. High-temperature quick-heat, short-held heat treatment in forewarming</li> <li>3. Low concentration</li> <li>4. High-temperature quick-heat, short-held heat treatment of concentrated milk</li> <li>5. Optimum calcium-casein balance</li> </ol>
---	---	--

**The Ethics of Adding Mineral Salts to Evaporated Milk.**—The addition to evaporated milk of stabilizing salts to the extent of 0.1 per cent by weight of the finished product has been legalized in the United States,<sup>5</sup> September 10, 1940 — effective March 1, 1941.

The results of experimental study of recent years, dealing with the factors that influence heat stability, emphasize the possibilities of control of the heat stability of evaporated milk by proper adjustment of the heat treatment of the milk prior to sterilization. This fact is further demonstrated by the work of Webb and Bell<sup>6</sup> who summarize their findings as follows:

"3. Use of the optimum high forewarming temperature brought about, in the milks tested, a greater increase in heat stability in the evaporated milk than could be attained by the addition of the optimum quantity of stabilizing salt to a normally forewarmed milk.

"4. High forewarming temperature should be a useful commercial procedure for increasing heat stability of milks which are difficult to sterilize without addition of stabilizing salts. . . ."

The above findings, as well as observations in commercial manufacture, suggest the possibility of developing a commercially practicable procedure of heat coagulation control of evaporated milk by way of high-temperature, short-duration forewarming. The accomplishment of rendering unnecessary the artificial adjustment of the natural composition of cow's milk is obviously desirable and appears practically assured by continued progress on the part of the equipment manufacturer in his efforts to perfect a milk heater entirely suitable for this purpose.

#### TECHNICAL CONTROL OF HEAT STABILITY AND VISCOSITY IN THE ABSENCE OF CHEMICAL STABILIZERS

In the foregoing paragraphs the discussion of technical control of heat coagulation has been confined to the procedure of using added chemical stabilizers. The remaining paragraphs of this chapter are devoted to consideration of technical control of heat coagulation and viscosity by means of heat treatment.

**Heat Stability Control by High-Short Heat Treatment.**—As reported in Chapter XXIV, the experimental work of Webb, Bell, Deysner and Holm<sup>7</sup> showed that the forewarming of whole milk to temperatures above the boiling point, by quick heating and short holding gave the milk, after concentration to a solids content of 26 per cent or higher, much greater heat stability than did the conventional forewarming at 203° F. for

10 minutes. Webb and Bell<sup>8</sup> reported that the optimum forewarming conditions for Beltsville Research Center raw milk are 248° F. for 3 to 4 minutes. They further observed that heating the concentrate to temperatures above the boiling point similarly increased the heat stability. The effect on heat stability varied much with changes in the temperature-time ratio of heat exposure of the concentrate.

**Control by Heat Treatment After Condensing.**—For dependable results when heat treating the concentrated milk, the effect of such treatment must be definitely determined by testing samples of the lot before attempting to heat-stabilize the entire lot of milk. In other words, samples must be given the pilot sterilizer test in a similar manner as has been outlined earlier in this chapter for the control of stabilization by the addition of a chemical stabilizer.

**Use of Pilot Sterilizer to Determine Proportion of Heat Stabilized Concentrate to Use.**—Obviously the pilot sterilizer test has merit only when made on the concentrate, for it is the behavior of the concentrate in the sterilizer that must be determined. In addition, Park<sup>11</sup> suggested the heat stabilization of evaporated milk by fractionating the proportion of Mallorized\* concentrate. When properly organized this procedure gives promise of fitting well into the operating routine of the factory. A sample of the evaporated milk is drawn from the storage tank and is Mallorized at the adopted temperature. From this sample varying measured amounts are added to 6-ounce test cans which are then filled with evaporated milk from the batch in the storage tank. One can containing no Mallorized portion serves as a control. The pilot sterilizer test is then made as previously described in this chapter under "Sterilizing the Samples".

Let us assume that the pilot tests show that 25 per cent of the evaporated milk in the storage tank should be Mallorized at the adopted stabilizing temperature. That proportion of evaporated milk is then drawn from the bottom of the storage tank, Mallorized, and returned to the top of the tank, followed by thorough agitation to make the batch homogeneous.

**Exchange of Large Number of B.T.U.**—Perhaps the chief disadvantage of this procedure lies in the exchange of B.T.U. over a relatively wide temperature range, possibly from about 40° F. to the high stabilizing temperature and back again to the filling temperature. However, the volume of milk to which this extreme range of heat exchange applies is much reduced by the method of operation. Heating the concentrate instead of the raw milk cuts the volume in half, and fractionating the Mallorizing may reduce the volume of concentrate that is actually

---

\*Referred originally to the high-short process of heating by the use of the Mallory Heat Exchanger.<sup>9, 10</sup> As used here "Mallorizing" refers to the high-short process of heating by the use of any now available heater suitable for this purpose.

heat-treated to about one-eighth of that of the raw milk. In addition, the Mallorized milk could be discharged at a temperature which would warm all the milk in the storage tank to the desired canning temperature.

**Effect of Heat Treatment of Concentrate on Color and Flavor of Evaporated Milk.**—The heat treatment of the concentrate, in lieu of heat stabilization by the high-short procedure of forewarming or the use of a chemical stabilizer, tends in the direction of slightly heightening the color and flavor of the evaporated milk.

#### REFERENCES

1. MOJONNIER BROS. COMPANY: Directions for Use of Mojonnier Evaporated Milk Controller, Courtesy of Timothy Mojonnier. 1919.
2. SOMMER, H. H., AND HART, E. B.: Wis. Agr. Expt. Sta. Res. Bul. 67. 1926.
3. MOJONNIER, T., AND TROY, H. C.: Technical Control of Dairy Products. 1925.
4. EIMER AND AMEND: The MacMichael Viscosimeter.
5. FEDERAL REGISTER: p. 2443. July 2, 1940.
6. WEBB, B. H., AND BELL, R. W.: Jour. Dairy Sci. XXV. 301. 1942.
7. WEBB, B. H., BELL, R. W., DEYSHER, E. F., AND HOLM, G. E.: Jour. Dairy Sci. XXVI. 579. 1943.
8. WEBB, B. H., AND BELL, R. W.: Jour. Dairy Sci. XXVI. 1071. 1943.
9. MALLORY, W. E.: U. S. Patent No. 2,270,540.
10. COURTIS, J. W.: Food Industries. September 1943.
11. PARK, SAM: Fractionating the Mallorized Concentrate in the Storage Tank. Results not published. 1942.
12. BELL, R. W., CURRAN, H. R., AND EVANS, F. R.: Jour. Dairy Sci. XXVII. 913. 1944.
13. BELL, R. W., AND WEBB, B. H.: Jour. Dairy Sci. XXVI. 579. 1943.
14. RAMSEY, R. J., TRACY, P. H., AND RUEHE, H. A.: Jour. Dairy Sci. XVI. 17. 1933.
15. JOSEPHSON, D. V., AND DOAN, F. J.: Milk Dealer 29 pp. 35 and 54. 1939.
16. GOULD, I. A. JR., AND SOMMER, H. H.: Mich. Agr. Expt. Sta. Tech. Bul. 164. 1939.
17. GOULD, I. A.: Intern. Asso. Milk Dealers. Lab. Sec. 21. 553. 1941.

## CHAPTER XXVII

# MANUFACTURE OF PLAIN, SUPERHEATED, AND FROZEN CONDENSED MILK

### PLAIN CONDENSED MILK

**Definition.**—This is an unsweetened condensed milk. It is made from whole milk, partly skimmed milk, or from all skimmilk. Its ratio of fat to solids and its percentage composition are adjusted to suit the particular requirements of the purchaser. It is condensed to concentrations ranging from  $2\frac{1}{2} : 1$  to  $4 : 1$ . Much of this product is superheated. The bulk of the plain condensed milk is packed in 10-gallon cans for ice cream factories. A limited amount is sold in milk bottles direct to the consumer. This product is not sterile, nor is it preserved by cane sugar. Its keeping quality is similar to that of a high quality of efficiently pasteurized milk.

**Quality of Fluid Milk.**—The manufacture of a fine quality of plain condensed whole milk or plain condensed skimmilk, superheated or un-superheated, that has a nice, smooth texture and full body, requires the use of fresh sweet milk or fresh skimmilk. The principles that underlie control of the heat coagulation point of evaporated milk apply here also. However, the relationship of the factors involved is different because neither the plain nor the superheated product is exposed to the rigors of high sterilizing temperatures. In fact, the problem here is not one of raising the heat coagulation point, but to keep it just low enough to secure maximum viscosity without causing objectionable flakiness in this highly concentrated product. Such control requires a high quality of fresh milk or of fresh skimmilk.

**Forewarming.**—The forewarming is done by the use of the same type of equipment and method as given for evaporated milk but the milk is not heated to so high a temperature. In case the condensed milk is superheated in the vacuum pan, the condensing is done by the batch system and the hot well is generally used for forewarming.

It was shown under evaporated milk, Chapter XIX, that high forewarming temperatures ( $190^{\circ}$  F. to boiling) tend to raise the heat coagulation point and lower the viscosity, while low forewarming temperatures (below  $175^{\circ}$  F.) lower the heat coagulation point and increase the viscosity. In plain and in superheated condensed milk and condensed skimmilk, a high final viscosity is desired; hence lower forewarming temperatures are preferred.

The optimum temperature will depend primarily upon whether the batch is to be finished with or without superheating. If superheating is not contemplated, forewarm at  $170^{\circ}$  F. or slightly higher. If the process includes superheating, forewarm within the range of  $150$  to  $160^{\circ}$  F. At forewarming temperatures above  $160^{\circ}$  F. milk of normal heat stability

does not respond so readily to superheating after condensing. It is more difficult to secure the desired "liver." In the case of excessively unstable milk due to inferior quality, the forewarming temperature may have to be raised above 160° F. in order to slow down the rate of coagulation and to prevent a rough and curdy texture in the superheated product.

**Standardizing.**—See Chapter XIX.

**Condensing.**—The whole milk or skimmilk is condensed in the vacuum pan in a manner similar to that described for sweetened condensed milk and evaporated milk, except that evaporation is carried to a higher ratio of concentration. Plain and superheated condensed milk is usually condensed at the ratio of 3 : 1 to 4 : 1. This concentration is equivalent to condensed skimmilk with an approximate range of composition of 27 to 36 per cent total solids. The Baumé readings for these concentrations at a striking temperature of 120° F. are shown in Table 49.

TABLE 49. BAUMÉ READING AT 120° F. FOR PLAIN CONDENSED SKIMMILK

Total Solids per cent	Baumé at 120° F. Degrees Bé.	Total Solids per cent	Baumé at 120° F. Degrees Bé.
27	12 7	32	15 5
28	13 3	33	16 0
29	13 9	34	16 5
30	14 5	35	17 0
31	15.0	36	17.5

**Striking.**—This is usually done by the use of the Baumé hydrometer in a similar manner as indicated for evaporated milk (batch system), Chapter XIX, except that by reason of the higher concentration, a Baumé scale extending from 12 to at least 18° Bé. is needed.

If the condensed milk is to be superheated, allowance should be made for dilution due to steam condensate added during superheating. Mojonnier and Troy<sup>1</sup> recommend that condensing to a concentration of 2° Bé. above the desired reading is sufficient to compensate for the added steam condensate. Unless the process includes superheating, the batch is now ready to be dropped from the pan and cooled.

#### SUPERHEATED CONDENSED MILK

**Purpose.**—The major purpose of superheating the plain condensed milk or plain condensed skimmilk is to increase its viscosity and thereby also augment to a limited extent the viscosity of the ice cream mix which contains the superheated product.<sup>2,3</sup>

In addition, both commercial experience and experimental results suggest that ice cream made from superheated condensed skimmilk has a smoother body than that made from plain condensed skimmilk,<sup>4,5</sup> and that the superheated product produces a better quality from the stand-

point of sales preference. Superheating does, however, give the product a slight cooked flavor. It likewise introduces the danger of a rough or curdy texture when the temperature or period of superheating exceeds the heat stability limit of the batch.

**Method of Superheating.**—The superheating is generally done in the vacuum pan by blowing live steam into the condensed milk at the end of the condensing period before the product is dropped from the pan. For this purpose the pan is equipped with a direct steam line without pressure reducing valve. This steam pipe terminates in the pan near the bottom in a steam distributing device.

When the milk has reached the desired concentration, showing a Baumé reading approximately 2.0° Bé. above that desired in the finished product it is ready for the superheat. The steam to jacket and coils is then shut off. The water supply to the condenser is closed. The vacuum pump is stopped. Then the valve in the superheating steam line is opened wide, permitting the steam to pass into and through the milk under full pressure. This is continued until the temperature has risen to 180 to 200° F. and the vacuum dropped to approximately 13 to 7 inches. The superheating temperature is maintained until the condensed milk has developed the "proper liver." Normally this thickening is accomplished in about 15 minutes.

This condition of the product is determined by its appearance and behavior in the pan as seen through the observation glass, as well as by sampling at the striking cup. Successful superheating requires some experience and especially familiarity with the status of heat stability of the milk supply of any given locality. It requires close watching by the operator. The process must be stopped as soon as a smooth coagulum has been attained. This is indicated when the sample first begins to show a very slightly flaky condition. Superheating beyond that state will lead to roughness, lumps, and the danger of "cracking."

**Temperature and Time of Superheat.**—The optimum temperature and time of superheating will vary with the heat stability of the product, and the heat stability in turn depends on locality, season of year, condition of milk, composition of milk with reference to salt balance and per cent albumin, and concentration of the condensed product. Inferior quality of milk and high concentration lower heat stability. For milk with high heat stability, the higher temperature of superheating and longer time is needed to accomplish the desired liver (200° F. and 15 minutes or longer exposure). For milk with low heat stability, the lower superheating temperature and shorter exposure must be used (180° F. and less than 15 minutes exposure) to prevent cracking and curdiness.

As soon as the superheat has produced the desired thickness, the steam valve in the superheating line is closed, the vacuum pump is started, water is supplied to the condenser and the pan is operated until the vacuum

has returned to 25 to 26 inches and the temperature has dropped to 130° F. or below. The product is then ready to be dropped from the pan and cooled.

It is important to take the superheat out of the condensed milk in the pan as soon as the desired coagulum has formed. This can be expedited by blowing air into the milk through the superheater, as suggested under "Abnormal Behavior of Milk in Pan," Chapter VIII. This immediately breaks the immobilizing tension of the stagnant milk and assists the vacuum pump in starting the milk to roll normally. Thus, the temperature drops quickly.

If the stability of the milk is abnormally low and this fact is known before manufacture, the danger of cracking or roughness can be minimized appreciably by raising the forewarming temperature to near the boiling point.

If it is desired to superheat the condensed milk after it has been dropped from the pan, this can be done by blowing steam into it in a coil vat or other container that permits of rapid cooling.

**Cooling.**—The plain condensed product is usually cooled by the use of a surface cooler or an internal tube cooler. For the cooling of the superheated product, because of its high viscosity, the coil vat or other container with suitable agitator is commonly used.

Because of its susceptibility to bacterial spoilage, the superheated as well as the plain condensed milk should be cooled promptly and to a low temperature, preferably to about 40° F. or slightly lower. If intended for quick use it may be held at that temperature until used.

#### FROZEN CONDENSED MILK

**Cold Storing Plain and Superheated Condensed Skimmilk.**—Williams and Hall<sup>6</sup> reported the results of a study of sales preference of ice cream, the milk solids of which were derived from different sources, representing 32 separate sets of experiments and 1,269 tasters of the ice cream samples. They found that spray-dried skimmilk, especially that made from skimmilk preheated at 83° C. prior to drying, was the best ingredient for ice cream. It proved somewhat superior even to the superheated condensed skimmilk which placed second, and definitely better than plain condensed skimmilk which placed third.

Ramsey<sup>7</sup> concluded "that fresh plain condensed skimmilk or fresh superheated condensed skimmilk is the best source of serum solids for ice cream, while sweetened condensed skimmilk and skimmilk powder can be used with fairly good success."

These several findings, while slightly at variance with each other in some instances, do emphasize the general conception that conversion of the surplus skimmilk during the flush of the milk-producing season (spring and early summer) into the form of these concentrated products,

freezing the latter and carrying them in cold storage over to the time of diminishing production and increasing shortage (midsummer and fall), promises to be a possibility of definite economic importance. The question of quality of the condensed product at the end of such storage period thus looms up as the chief deciding factor of the practicability of such a storage plan.

The keeping quality of frozen, plain, and superheated condensed milk has been studied by numerous investigators.<sup>7,8,9,10,11,12,13,14,15,16,17,18</sup> In details, the results are not in complete agreement. There is consistent accord, however, on the following basic points:

1. The freezing, as such, appears to have no noticeable detrimental effect, but prolonged storage in frozen condition tends to cause instability of the proteins.

2. The proteins of ice cream mixes made from frozen products are less stable than those of mixes made from fresh products.

3. Frozen superheated condensed skimmilk yields to protein precipitation sooner than plain frozen condensed skimmilk.

4. At 0° F. frozen plain condensed skimmilk may be held at best for about three months without noticeable damage to the quality of the ice cream. Longer holding tends to show a curdled appearance upon melting.

5. At 0° F. frozen superheated condensed skimmilk tends to show signs of protein precipitation after one month cold storage and the development of a rough and curdy appearance is accelerated with continued storage.

6. The above results suggest that plain unsuperheated condensed skimmilk, made from a good quality of fresh milk or fresh skimmilk, may safely be stored for a period not to exceed three months. It is apparent, also, that it is unsafe to hold in cold storage the frozen superheated condensed product for a period in excess of two to three weeks.

**Freezing Plain Condensed Milk for Consumer Use.**—Doan and Leeder<sup>19</sup> developed a process for the production of frozen plain condensed milk in the consumer package, and for use on shipboard and in other instances of lack or shortage of sufficient supply of fresh milk. When milk or cream is frozen without agitation, however, the fat-in-skimmilk emulsion is destroyed, causing churning or oiling off when the frozen product is defrosted. When freezing plain condensed milk for the purposes above indicated, oiling and churning must be prevented, the fat-in-skimmilk emulsion must be preserved intact.

The earlier work of Doan and Baldwin<sup>11</sup> suggested that the destruction of the fat-in-skimmilk emulsion, when freezing the milk product in the absence of agitation, is due to internal pressures developed in the congealing mass as a result of initial surface freezing followed by expansion of the water in the body of the product as it is converted into ice. On the strength of this observation, Doan and Leeder conceived the idea



that by initial partial freezing in an ice cream freezer and storage in small containers, the internal pressure would be much reduced, if not eliminated, and the fat-in-skimmilk emulsion would escape damaging disturbance. The objectional oiling off and churning, when defrosting for the purpose of reconstituting, would thus be prevented. The results of subsequent experimental trials by the authors confirmed the soundness of their deductions.

Accordingly, Doan and Leeder, as the result of careful trials, recommend the following procedure for the production of frozen plain condensed milk: Use high quality, sweet, fresh milk, pasteurize at 180° F. for 15 minutes, condense to a concentration of 3 : 1 using a stainless steel pan to avoid early oxidized flavor, homogenize at 3000 pounds pressure, cool to 40° F., do the initial freezing in an ordinary ice cream freezer such as the batch freezer or the continuous type, package into consumer packages, and do the final freezing under conditions the same as are provided for hardening ice cream. Hold at temperatures of—10° F. or lower (preferably —15 to —20° F.). Defrost and reconstitute by melting the frozen block of condensed milk in twice its volume of hot water (180° F.). Allow to melt undisturbed (no agitation).

The authors suggest that any dairy plant equipped with a vacuum pan and facilities for ice cream making, may manufacture a frozen milk food suitable for handling and distributing in a manner similar to ice cream and other frozen foods.

#### REFERENCES

1. MOJONNIER, T., AND TROY, H. C.: *Technical Control of Dairy Products*. 2nd Ed. p. 733. 1925.
2. TRACY, P. H.: *Jour. Dairy Sci.* VI. 205. 1923.
3. TRACY, P. H., AND HAHN, A. J.: Address III. Dairy Mfgs. Conference, Urbana, Ill. Nov. 1938.
4. PYENSON, H., AND DAHLE, C. D.: *Ill. Jour. Dairy Sci.* XXI. 600. 1938.
5. WHITAKER, R., AND HILKER, L. D.: *Jour. Dairy Sci.* XXI. 569. 1938.
6. WILLIAMS, O. E., AND HALL, S. A.: U. S. Dept. Agr. Circ. 179. 1931.
7. RAMSEY, R. J.: *Ice Cream Trade Jour.* 33. p. 21. 1937.
8. DOAN, F. J., AND FEATHERMAN, C. E.: *Milk Dealer* 27. p. 33. 1937.
9. ANDERSON, E. O., AND PIERCE, R. L.: *Milk Dealer* 18. p. 60. 1929.
10. WEBB, B. H., AND HALL, S. A.: *Jour. Dairy Sci.* XVIII. 275. 1935.
11. DOAN, F. J., AND BALDWIN, F. B., JR.: *Jour. Dairy Sci.* XIX. 225. 1936.
12. MACK, M. J.: *Mass. Agr. Expt. Sta. Bul.* 268. 1930.
13. DOAN, F. J.: *Ice Cream Rev.* 13. p. 40. 1930.
14. DAHLE, C. D., AND PYENSON, H.: *Jour. Dairy Sci.* XXI. p. 407. 1938.
15. DOAN, F. J.: *Nat. Butter and Cheese Jour.* 28. p. 24. 1937.
16. OPENLANDER, H. F., AND ERB, J. H.: 38th Ann. Conv. Internat. Asso. Ice Cream Mfgs. 1938.
17. REIGHART, E. L., AND CORLEY, R. T.: *Jour. Dairy Sci.* XXI. 109. 1938.
18. WINN, H. H.: Quoted by Crowe and Deane, *Jour. Dairy Sci.* XXIII. 919. 1940.
19. DOAN, F. J., AND LEEDER, J. G.: *Food Industries* p. 532. July 1944.

## CHAPTER XXVIII

### MANUFACTURE OF SEMI-SOLID BUTTERMILK AND CONCENTRATED SOUR SKIMMILK

#### SEMI-SOLID OR CONDENSED BUTTERMILK

**Definition.**—This product, known by the trade name “Semi-Solid Buttermilk,” is creamery buttermilk, condensed at the ratio of approximately 3 to 1.

**Supply and Composition of Fluid Buttermilk.**—The value of buttermilk as a part of the feed ration for chickens, laying hens, pigs and hogs has long been recognized and its use for feeding purposes is increasing. Buttermilk not only contains protein and carbohydrates of high quality and great digestibility, but it has biological properties that stimulate growth and gain in weight, and it exerts a physiological action that makes for a healthy condition of the intestines, because of its lactic acid content.

Chicken feeders have found it invaluable in their efforts to accomplish maximum growth and gain in weight of the growing chicks, and because of the superior quality of the meat of buttermilk-fed fowl. Extensive experiments with laying hens have conclusively demonstrated that buttermilk makes for increased egg production.

For similar reasons buttermilk, when properly balanced with other feed, is a most valuable hog feed. In fact it is the foundation of a good hog and is becoming a more and more indispensable part of the ration for growing pigs and fattening hogs.

Buttermilk, in fresh, condensed, or dried form, has been found suitable also for rearing calves. The practice of feeding buttermilk to calves is not uncommon in some countries. Hanly,<sup>6</sup> reported that in Ireland calves are raised successfully on buttermilk. Hill<sup>7</sup> found that Guernsey calves (on the Isle of Guernsey) are fed on “the milk from the churn” from a few days after birth until they are able to subsist on coarser feeds. Otis<sup>8</sup> (Kansas) also reported successful experimental results with buttermilk for calves. Eckles and Gullickson<sup>9</sup> experimented with the rearing of calves on condensed and dried buttermilk. Ten calves were used. These investigators reported that all calves made excellent growth while on the buttermilk ration. They further observed that, while on buttermilk, the calves were unusually free from sickness or indigestion. Scours were never present. The calves were never off-feed. They readily took to buttermilk and seemed to prefer it to whole milk. They appeared to have more vigor and vitality than when on the skim milk ration. The buttermilk calves were sleek-coated and thrifty, and appeared equal in size and condition to calves raised on typical farms.

Since the great bulk of butter is manufactured during the summer season, the main supply of buttermilk is confined to the summer months. In

summer the output of buttermilk far exceeds the demand for this product and much of it goes to waste for lack of a suitable market. In winter the output of buttermilk is at ebb and often insufficient to supply the demand. In order to stop this waste of buttermilk in summer, to utilize it economically and profitably, and to equalize the supply throughout the year, some of the large creameries of the country have found it practicable and profitable to condense the surplus buttermilk.

**Manufacture.**—There are several methods whereby buttermilk can be commercially reduced in volume, namely, by removal of water (whey) from the buttermilk by gravity, by removal of whey by centrifugal separation, and by removal of water by evaporation either under atmospheric pressure or in vacuo. Today condensing under vacuum is practically the only method used.

**Equipment Necessary to Condense from 5,000 to 6,000 Pounds of Buttermilk per Hour:**

2 wooden buttermilk storage tanks, capacity 10,000 pounds each, for ripening the buttermilk;

1 6-foot vacuum pan with condenser;

1 vacuum pump, vacuum cylinder 18-inch diameter and 20 inches long; if steam driven, steam cylinder 12-inch diameter and 12-inch stroke;

2 hot wells, 5-foot diameter and 5 feet deep, with 3-inch outlet in bottom, equipped with device for steam injection.

Boiler capacity, 150 H.P.

Water requirements, 125 gallons per minute.

**Ripening the Buttermilk.**—The buttermilk should be ripened to a relatively high acidity for the following reasons:

1. To produce a good body, smooth texture, and prevent wheying-off in the finished product.

2. To give the semi-solid buttermilk dependable keeping quality. High acidity inhibits the activity of germ life.

3. To keep fowl, pig and hog in healthy condition. High acidity purifies the digestive tract, stimulates thirst for more water, and appetite for more feed.

A reasonably satisfactory condensed buttermilk must contain a minimum of 4.5 per cent acid calculated as lactic acidity, but a somewhat higher acidity is preferred. Much of the product now made contains between five and six per cent acid.

Where no attempt is made to attain maximum acidity by artificial ripening, it is common practice to allow the buttermilk to sour naturally, leaving a remnant of about 100 gallons of soured buttermilk of the previous batch in each storage tank to act as a starter for the next batch. In such case the batch is usually warmed to about 85 to 95° F. and held in the storage tank for about 24 hours.

For a product of superior quality, however, the fluid buttermilk is ripened to an acidity of 1.5 to 2.0 per cent acid, calculated as lactic acid.

This is especially desirable in case some surplus skimmilk has been mixed with the buttermilk, in order to prevent a rough, curdy coagulation in the finished product.

In order to attain this high acidity, there is need of inoculating the buttermilk with a mixed culture of *Bacillus bulgaricus* and a mycoderm organism. This may be obtained from the Research Laboratories of the U. S. Bureau of Dairy Industry, Washington, D. C. The optimum ripening temperature of the buttermilk containing this culture is 105 to 110° F. Directions for making the starter from this culture are given under "Concentrated Sour Skimmilk" later in this chapter.

The storage tanks in which the buttermilk is soured are usually also provided with an air supply pipe for the purpose of agitating the buttermilk before it is pumped into the forewarmer. A portion of the curd tends to settle to the bottom during the ripening period and there is a tendency for the buttermilk to whey off. By blowing air through the buttermilk before transferring it to the forewarmer, the product is mixed and made reasonably homogeneous, thus equalizing the composition of the batches and facilitating their handling in the pan.

It occasionally happens in the routine of manufacture that acid development is slower than normal. This is usually due to the starter having lost its vigor, or too small an amount of starter having been used, or the temperature of the buttermilk having dropped below the optimum for proper ripening, etc. These factors can usually be adjusted to insure normal ripening of succeeding batches and the acidity of any low-acid batches may be developed to the desired point by adding more starter if available, or by raising the temperature and prolonging the ripening process.

**Addition of Organic Acids.**—However, when the time set for forewarming and condensing has arrived, the factory routine does not always permit of extending the period of ripening. The tanks may be needed for new buttermilk and must be emptied. In such situations the objectionable consequences of forewarming and condensing insufficiently ripened buttermilk may be avoided by the addition of enough acid to the buttermilk to bring the acid test up to the desired point. For this purpose commercial lactic acid or other organic acids, such as acetic, citric, or tartaric acid, may be used. Mineral acids, such as hydrochloric or sulphuric should not be used. The added acid should be well mixed with the buttermilk in the tank by means of vigorous agitation. The buttermilk is then ready for forewarming and condensing in the normal manner.

The acid content of the condensed buttermilk has a marked effect on its viscosity. Hence, in order to maintain a standard procedure of manufacture, as well as to insure a product of uniform body and viscosity between batches, it is important to have the final acidity of the buttermilk before condensing conform to the acid standard adopted. In case

the acidity at the end of the ripening period happens to be below standard, it thus appears good practice to make up the deficiency by the addition of the correct amount of organic acid.

**Forewarming the Buttermilk.**—From the storage tanks the ripened buttermilk is transferred to the hot wells, where it is heated to near the boiling point. The heating is generally done in plain forewarmers by turning live steam into the buttermilk. As explained in Chapter IX, this system of forewarming is uneconomical as to steam, water and time required, because it adds steam condensate that must be evaporated, in-

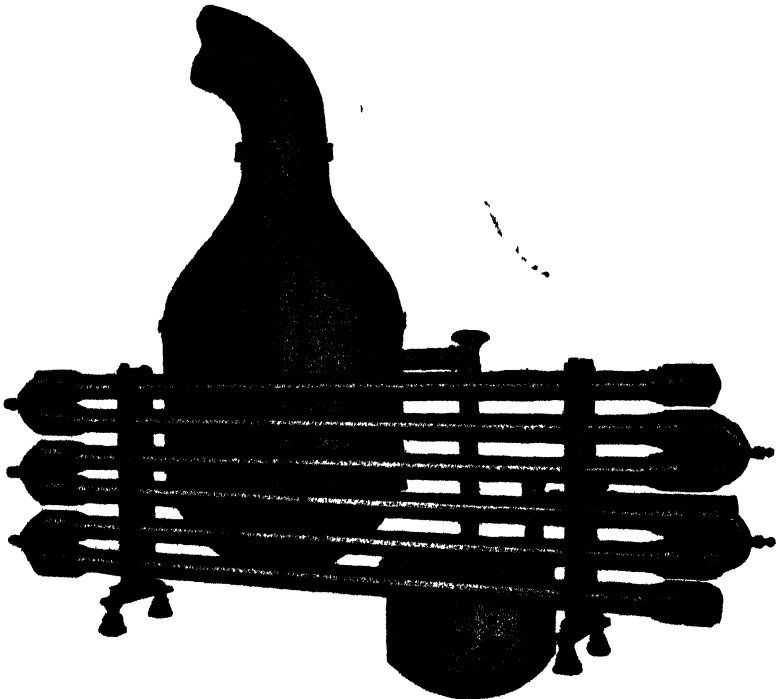

Fig. 78. Recirculating unit for forewarming buttermilk  
Courtesy of Jensen Machinery Co.

creases the volume of vapors that must be condensed and prolongs the period of milk condensing.

However, to heat the buttermilk with live steam has the advantage of keeping it well agitated, thereby preventing the copious settling of the curd and assuring the feeding of the pan with a product of reasonably uniform composition. This is further facilitated by keeping the steam valve at the forewarmer slightly open while the heated buttermilk is drawn into the pan.

**Condensing the Buttermilk.**—The hot buttermilk is drawn into the vacuum pan. The operation of the pan is similar to that described in Chapter VIII.

During the early stages of the condensing process the buttermilk boils and behaves in the pan in a manner similar to milk. As the process continues and the buttermilk increases in density, it becomes more sluggish and does not circulate as rapidly, nor boil as vigorously. The buttermilk is condensed to a concentration of approximately 27 to 28 per cent total solids.

**Testing for Density.**—To determine the point when the buttermilk has been condensed to the desired per cent of total solids is somewhat difficult. This is partly due to the variable composition of the original buttermilk and to the viscosity of the condensed product when it approaches the desired degree of concentration. It is too thick and viscous to readily respond to the Baumé hydrometer.

Ordinarily, however, the determination of the proper degree of concentration is left to the experienced eye and judgment of the pan oper-

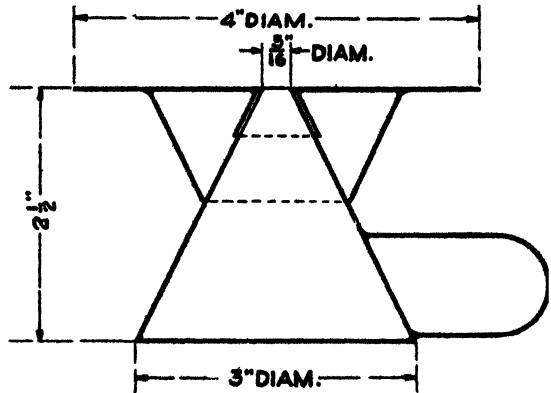

Fig. 79. Density tester for semi-solid buttermilk

ator. If he condenses batches of uniform size, the height of the surface of the condensed buttermilk in the pan furnishes an approximate guide. The behavior of the boiling buttermilk, when the proper degree of concentration is approached, is also noted. And samples taken from the pan and examined for thickness, standing-up properties and relative opaqueness, as described for sweetened condensed milk, Chapter XV, enable the operator to accomplish a fairly uniform density of the finished product from batch to batch.

When condensed at the ratio of 3:1 the buttermilk at the temperature of the pan, or about 120° F., is thick enough so that when a sample is taken into a cup and a portion of it is picked up with a spoon or stick and is allowed to drop back into the cup from a height of about six inches, it does not readily diffuse, but "piles up" on the surface of the sample in the cup.

For greater accuracy the picnometer method is generally preferred. This determines the density by weighing a measured volume of the product

at a given temperature. For this viscous, semi-fluid product, the cone-shaped picnometer cup designed by Dahlberg and Evans<sup>1</sup> shown in Fig. 79, has been found highly serviceable.

**Packing Semi-Solid Buttermilk.**—The bulk of the condensed buttermilk is packed in wooden barrels, holding approximately 58 gallons or about 520 pounds of semi-solid buttermilk. Buttermilk intended for bakers, confectioners, and other manufacturers of prepared foods for human consumption is filled into new barrels. These barrels require no treatment by the user as they are generally vacuum-cleaned and paraffined in the cooperage. Much of the product intended for animal feed is packed into second hand barrels.

A limited amount of condensed buttermilk is also packed in hermetically sealed tins for household purposes. The tins vary in size from 16 ounces to one gallon. Condensed buttermilk so put up keeps well and has been found very useful for diverse culinary purposes. It contains all the valuable food elements of milk except butter fat and its high content of lactic acid adds to its wholesomeness.

**Storage.**—The barrels and tins of condensed buttermilk are stored at ordinary temperature. If made from properly soured buttermilk, condensed at the ratio of 3:1 or higher, and if the package is filled full and sealed tightly, this product will keep. It must contain not less than 4.5 per cent and preferably as high as 6 per cent of acid, calculated as lactic acid. This high acidity is necessary to prevent deterioration and molding.

In remnant barrels or in barrels from which a portion of the contents has been removed, the buttermilk molds rapidly on the surface and spoils, because of exposure to air. This can be largely prevented by "slapping" a piece of heavy paper (wrapping paper), large enough to cover the entire exposed surface, on the top of the remaining contents. The condensed buttermilk being of a pasty consistency forms a tight seal with the paper, shutting out the air, and retarding molding and decomposition.

**Lime Deposits in Semi-Solid Buttermilk.**—Barrels in which the semi-solid buttermilk has been stored, often show large quantities of lime compounds, shaped similar to stalactite cones. These deposits are usually most noticeable in the case of buttermilk made from high-acid cream that was neutralized with lime. So far no satisfactory means has been found for preventing this, except that of eliminating lime as a cream neutralizer for buttermaking.

**Markets of Semi-Solid Buttermilk.**—Limited amounts of condensed buttermilk pass into channels of human consumption, through the medium of bakeries, confectioneries and grocery stores. The basic commercial market for this product, however, is for stock feed.

The great bulk of its annual output goes to stockfeed mills, and to feeders of pigs, hogs and poultry. Its use for these purposes has demon-

strated its value as a stock feed. It is highly relished and readily digested. It is nutritious and its high acid content acts as a tonic and assists in keeping animal and fowl in healthy condition. It accelerates the power of assimilation of other feeds in the ration, thereby augmenting their digestibility and their economy as feeds, and giving the animal greater capacity for the consumption of feed and water.

The price of semi-solid buttermilk varies with season, locality, supply and demand, ranging in normal times approximately from 3 to 5 cents per pound for stock feeding purposes.

TABLE 50. ANNUAL PRODUCTION OF SEMI-SOLID BUTTERMILK IN THE UNITED STATES\*

Year	Annual Production of Semi-Solid Buttermilk	Year	Annual Production of Semi-Solid Buttermilk	Year	Annual Production of Semi-Solid Buttermilk
	pounds		pounds		pounds
1918	6,534,023	1927	99,180,000	1936	89,585,000
1919	22,535,580	1928	102,452,000	1937	87,855,000
1920	32,539,000	1929	107,283,000	1938	89,481,000
1921	29,314,000	1930	96,431,000	1939	104,288,000
1922	44,343,000	1931	64,619,000	1940	111,842,000
1923	54,833,000	1932	52,167,000	1941	128,183,000
1924	66,837,000	1933	50,175,000	1942	169,999,000
1925	77,079,000	1934	65,659,000	1943	167,338,000
1926	86,687,000	1935	70,543,000	1944	156,769,000

CONCENTRATED SOUR SKIMMILK

**Definition.**—This is skimmilk ripened by use of artificial cultures to a high acidity, concentrated at a ratio of about 3 : 1, packed in barrels and sold for animal feed. It is similar in character, properties and uses to semi-solid buttermilk.

**Development of Process.**—The process for the commercial manufacture of concentrated sour skimmilk was developed and patented by Rogers<sup>2</sup> in 1923. He generously dedicated it to the public, thus making it available to the dairy industry free of all restrictions. In a later publication Rogers, Johnson and Albery<sup>3</sup> described the process of manufacture in detail. It is briefly, as follows:

**Culture Used.**—A mixed culture of *Bacillus bulgaricus* and a mycoderm is used. Propagate the culture at a temperature range of 105 to 110° F. Inoculate a quart jar of sterilized milk with a teaspoonful of this culture. When inoculated late in the afternoon and held overnight at the above temperature the mother culture in the jar usually is curdled with a high acidity by the following morning. This mother starter is now ready for inoculation of the "big" starter, which later is to be added to the skimmilk to be soured and concentrated.

\*U.S.D.A. Yearbooks.



**"Big" Starter.**—The big starter is prepared as follows: Use enough skimmilk for the big starter to have available a quantity of starter equal to 1 to 2% of the skimmilk to be soured and concentrated. Heat the starter skimmilk to 180° F. or above, for at least a half hour, care being taken that all the milk reaches this temperature. Use an ordinary starter can or vat for this purpose. Then cool to 115° F., add the mother starter from the quart jar and agitate for 5 to 10 minutes. Hold the starter at a temperature of 100 to 110° F. and time the inoculation so that the starter is still in the actively growing stage when it is added to the batch of skimmilk. An old starter will be slow in starting the fermentation. The starter is in most active condition at the time of curdling.

**Souring the Batch.**—Pasteurize the skimmilk, either by flash process at 180° F. or by vat process preferably at 150 to 160° F. for 30 minutes. High temperature pasteurization is desirable not only to destroy objectionable bacteria but also because these high temperatures tend to yield a smoother texture in the finished product.

Ripening vats or tanks should be provided with agitators and facilities for heating and cooling. Metal surfaces should be avoided. Even tin will discolor and corrode when exposed to the combined action of high acid and high temperature. Glass-lined tanks and cypress vats are recommended.

Cool the pasteurized milk to 115° F., add 2% of starter. The starter should be added slowly and while the milk is being agitated, otherwise lumps will form due to intense localized curdling action.

Adjust the ripening conditions so as to allow a drop in temperature of not more than 10° F. in 18 hours. At the end of this period the acidity of the milk should be between 1.7% and 2.0%. For operation of the acid test see Chapter XLVI.

**Condensing the Sour Skimmilk.**—Break up the curd as thoroughly as is possible with ordinary coils or other mechanical agitators. Do not pre-heat. Draw the sour skimmilk into the vacuum pan at the temperature at which it was held in the vat. Forewarming hardens the lumps of curd and makes a rough texture in the finished product. If the acidity of the milk before concentrating is high enough (1.7% to 2.0%) there is no difficulty from lumping in the pan or burning onto the pan coils.

For dependable keeping quality the acidity in the finished product should be not less than 5% and preferably 6%. The acidity in the finished product depends, aside from the acidity in the uncondensed milk, on the concentration of the milk solids.

**"Striking."**—This product has a very thick, sluggish body. Its degree of concentration or density cannot be determined by the use of hydrometers such as the Baumé type.

A simple and reasonably accurate method is that of titrating for acidity.

The acidity increases very nearly in direct relation to the concentration. The acidity may be conveniently tested as follows:

Transfer 9 grams of the finished product into a tared white titrating dish on scales. Add from 20 to 30 cc. of distilled water, and 5 drops of phenolphthalein indicator. From burette run  $\frac{N}{10}$  sodium hydroxide solution into the titrating dish while constantly stirring the sample. When the sample takes on a permanent, light pink color enough alkali solution has been added. The number of cc. alkali solution required as shown by the burette divided by 10 represents the per cent acid in the sample. The per cent acid of the finished product divided by the per cent acid of the uncondensed soured skimmilk gives the ratio of concentration. The per cent solids of the uncondensed skimmilk multiplied by the ratio of concentration gives the per cent solids of the finished product.

**EXAMPLE:**

The uncondensed skimmilk contains 9.2% solids and 2% acid. The concentrated skimmilk tests 6% acid. What is the ratio of concentration? What is the per cent milk solids in the finished product?

**ANSWER:**

Ratio of concentration is  $\frac{6}{2} = 3:1$ .

Per cent solids in finished product is  $9.2 \times 3 = 27.6$ .

If it is desired to attain a definite per cent solids in the finished product, the condensing process should be continued until the acidity has reached the desired concentration.

To determine the acidity required that corresponds to the desired per cent solids in the finished product, divide the per cent solids desired in the condensed milk by the per cent solids in the unconcentrated milk and multiply with the per cent acid in the unconcentrated milk. This gives the acidity required in the finished product.

**EXAMPLE:**

Solids desired in finished product	28 %
Solids contained in fluid skimmilk	9 %
Acid in fluid skimmilk	1.9%

What is the correct acidity of the finished product?

**ANSWER:**

$\frac{28 \times 1.9}{9} = 5.9\%$  acid needed in finished product to bring solids up to 28%.

The concentration may be determined also by the picnometer method, illustrated and described under "Semi-Solid Buttermilk." This method gives the weight of a 100 cc. sample as compared with the weight of the same volume of water. The chief objection to this method lies in

the difficulty of filling the flask quickly without incorporating air which interferes with the accuracy of the weight.

Still another method recommended is the determination of the refractive index. The refractive index of the serum varies directly with the concentration of the soluble solids and the relation of these constituents to the total solids has been found to be nearly constant. While the refractometer required is somewhat expensive, its operation is simple, and determinations can be made quickly. A little clear serum is obtained by pressing a small sample of the milk in a fine mesh cloth. A few drops of this serum are placed between the prisms of the refractometer and the refractive index is read. If the correct refractive index for a batch with the required per cent of solids is known, it is then only necessary to continue evaporation until the refractive index coincides with that of the standard batch. (See also Refractometer Test Chapter XLVI.)

Rogers recommends that the concentration be carried to about 28% solids. At this point the finished product flows freely from the pan, and has a thick pasty consistency when cold.

**Packaging Concentrated Sour Skimmilk.**—It is filled into barrels direct from the pan without cooling. The barrels used are usually similar to glucose barrels, made of oak or fir and with a capacity slightly over 500 pounds. The barrels should be airtight. Leaks are objectionable, not only because of loss of contents but they admit air and invite damaging mold growth. They are preferably paraffined or coated with sodium silicate. This is especially desirable in case of second-hand barrels.

The Rogers' process, as described above, was later subjected to extensive experimental study by Mohr<sup>4</sup> and Mohr and Schulz<sup>5</sup> whose results fully confirm the findings of Rogers et al. Mohr used cultures of *Thermobacterium* Yogurt for ripening the skimmilk to the high acidity required. He, too, found it necessary to develop an acidity in the uncondensed milk of approximately 2% calculated as lactic acid. He emphasizes the advantages of high-temperature pasteurization for optimum smoothness and consistency of the finished product, and secured the best results when heating for 10 minutes at 100° C. (212° F.). He likewise found that forewarming before condensing is not necessary nor desirable.

Mohr further studied the effect of homogenizing the soured uncondensed product and reports that homogenization of the soured skimmilk caused the concentrated product to be grainy. At an acidity of 1% or below in the fluid milk the grain in the finished product was coarse; an acidity of 2% also yielded a grainy product but the grain was finer. Homogenization is obviously not needed nor helpful in the manufacture of this product.

**Keeping Quality of Concentrated Sour Skimmilk.**—Rogers showed that, when properly made, and when the finished product has an acidity above 5% (preferably 6% or slightly over) the sour concentrated milk

will keep indefinitely without appreciable change. No abnormal fermentations will develop even at summer temperatures so long as the surface is not exposed to air. When the surface is exposed to air molds will develop, as in the case of semi-solid buttermilk held under similar conditions. Concentrated sour skimmilk does not freeze at ordinary winter temperatures.

Mohr and Schulz endeavored to improve the product and its keeping quality by the addition of freshly slaked lime ( $\text{Ca}[\text{OH}]_2$ ), chalk ( $\text{CaCO}_3$ ), salt ( $\text{NaCl}$ ), and sodium citrate ( $2\text{Na}_3\text{C}_6\text{H}_5\text{O}_7 \cdot 11 \text{H}_2\text{O}$ ), respectively. These additions, however, failed to improve the keeping quality and the finished product containing these added chemicals showed a greater tendency toward wheying-off. It is not improbable that, in the case of using lime or chalk, prolonged holding of the finished product in the above experiments would have developed large stalactite cone-like deposits of lime compounds, such as frequently form in semi-solid buttermilk, made from the fluid buttermilk of high-acid, lime-neutralized cream.

Experiments by Mohr and Schulz<sup>5</sup> in which the surface of the finished product held in open containers was covered with layers of lactic acid (9% solution), acetic acid (6% solution), and paraffin, respectively, showed the following results:

Lactic acid failed to prevent mold formation.

Acetic acid prevented mold formation.

Paraffin prevented mold formation.

The exposed surface of concentrated sour skimmilk molded more when kept in the dark than when exposed to daylight.

The above results are interesting in that they confirm the experience over a prolonged period of time in the commercial manufacture in the United States of both semi-solid buttermilk and concentrated sour skimmilk. This experience has amply demonstrated that it is the surface of the product in broken or remnant containers only, that is subject to mold formation. When the containers—the barrels or tins—are completely filled and sealed in accordance with the usual commercial practice, the exclusion of air is sufficient to avoid all danger of spoilage. Sealing the surface with a layer of acid or paraffin would be of added protection only in cases of broken or remnant packages, if practicable. Under commercial conditions the simplest, most effective and most economical means of protecting remnant packages against mold development is to completely cover the exposed surface with a piece of heavy packing paper, pressing the paper well into the surface layer of the concentrated product, so as to make intimate contact between paper and milk product and to thus exclude the air.

**Markets.**—Experimental feeding trials as well as experience in commercial feeding have demonstrated the value of concentrated sour skimmilk as a feed for hogs and poultry. This product makes for high quality

of meat, cheaper gain in weight, and economy in egg production. Like semi-solid buttermilk, the concentrated sour skimmilk also improves the physical condition of fowl and swine and is effective in combating disease.

**Cost of Manufacture and Price to Trade.**—In normal times the market price of barrelled goods in car lots has been about three cents per pound at the factory and up to four cents in small packages, such as in friction top tin cans. The cost has been estimated at 1½ cents and the package, in the case of barrels, should not exceed ¼ cent per pound.

One hundred pounds of average skimmilk will yield about 33 pounds of concentrated sour skimmilk containing 28 per cent solids. Placing the manufacturing cost at two cents inclusive of package, and the sales price f.o.b. factory at three cents per pound, the net returns would be approximately 33 cents per 100 pounds of fluid skimmilk.

**Annual Production of Concentrated Sour Skimmilk.**—The annual production in the United States over a period of 12 years is shown in Table 51. As compared with that of semi-solid buttermilk, it is not large. It has averaged approximately 14 million pounds per year. Absence of a consistently progressive increase may be due in large measure to the definitely growing trend of utilizing a large proportion of our milk solids surplus in the form of food commodities for the human family.

TABLE 51. ANNUAL PRODUCTION OF CONCENTRATED SOUR SKIMMILK FOR ANIMAL FEED IN THE UNITED STATES<sup>1</sup>

Year	Production pounds	Year	Production pounds
1932	11,400,000	1938	13,253,000
1933	17,217,000	1939	11,686,000
1934	12,532,000	1940	14,891,000
1935	18,093,000	1941	19,450,000
1936	12,554,000	1942	13,211,000
1937	10,060,000	1943	14,964,000
		1944	20,489,000

<sup>1</sup>U.S.D.A. Yearbooks.

#### REFERENCES

1. EVANS, F. R.: *Jour. Dairy Sci.* VIII. 37. 1925.
2. ROGERS, L. A.: U. S. Patent No. 1,477,153: 1923.
3. ROGERS, L. A., JOHNSON, W. T., JR., AND ALBERY, H. G.: U. S. Dept. Agr. Circ. 404. 1926.
4. MOHR, W.: *Intern. Dairy Congr. Sect. 3.* London. 1928.
5. MOHR, W., AND SCHULZ, M. E.: *Milchw. Forsch.* 12. 4 and 5. 1931.
6. HANLY, J.: *Journal Dept. Agr. and Tech. Instr. Ireland.* XVIII. No. 3,306. 1918.
7. HILL, C. L.: *The Guernsey Breed.* Fred L. Kimball Co. Waterloo, Ia. p. 29. 1917.
8. OTIS, D. H.: *Kans. Agr. Expt. Sta. Bul.* 126. 1904.
9. ECKLES, C. H., AND GULLICKSON, T. W.: *Jour. Dairy Sci.* VII. 213. 1924.

## CHAPTER XXIX

### MANUFACTURE OF STERILIZED SWEET MILK AND STERILIZED SWEET CREAM

#### STERILIZED SWEET MILK

In the United States there is practically no market for this product even in regions where fresh milk is not produced and not available. In its place are used the nationally available canned milks in concentrated form, such as evaporated milk, sweetened condensed milk, whole milk powder and diverse special canned milk products.

The limited volume of sterilized sweet milk produced in this country is intended largely only for certain export markets located outside of the World's dairy belt, where a safe quality of fresh milk is unobtainable. And here its distribution is confined largely to that limited group of consumers who insist on using the bulky canned fluid milk in preference to the available concentrated product.

The canning of sterilized sweet milk is somewhat more popular in European countries, but even in their case the bulk of the annual output is exported.

**Quality of Fresh Milk.**—The major justification for consumer demand of sterilized fluid milk lies in the consumer's desire for a milk product that is more nearly like that of a good quality of fresh milk in composition and properties, than any other form of milk product available to him. It is essential, therefore, that the fresh milk used in the canning of sterilized sweet milk be of superior quality and freshness. This is necessary not only because of the fact that the finished product in the tin, can be no better than the quality of the fresh milk that goes into that can, but also because a good quality of fresh milk will have the best possible chance to pass through the process of manufacture without serious injury to its flavor, texture, color and keeping quality.

**Method of Manufacture.**—The procedure is relatively simple. Standardizing to any specific composition is preferably omitted in order to process the milk as nearly as possible in its unchanged, natural condition.

The milk is preheated at the low temperature of 150° F. in order to preserve its viscosity and freedom from cooked flavor. Since this uncondensed milk is lacking in viscosity and body, the danger of objectionable fat separation is ever-present. In order to lessen this tendency, efficient homogenization is important. The fat globules must be reduced to a relatively uniform diameter of less than two microns. Experience with this product has shown that in order to accomplish such efficiency of homogenization, the milk must be pumped through two homogenizers connected in tandem, using 2500 pounds pressure in each.

The homogenizer pumps the milk over the surface cooler or through an internal tube cooler. It should be cooled to about 60° F., and canned and sterilized immediately. The sterilizing routine is similar to that of evaporated milk, but with either a slightly shorter holding period or a somewhat lower temperature, in order to lessen the tendency toward cooked flavor and discoloration. For tall size cans it is heated to 241° F. and held for 12 minutes. The operation of the sterilizer for heating and cooling is the same as described in Chapter XXIII. Sample cans are incubated and inspected also, as discussed in the above chapter.

#### STERILIZED SWEET CREAM

The universal consumer preference for sweet table cream provides a marketing opportunity fully recognized by the dairy industry. Nichols<sup>21</sup> reported that the total output of sterilized sweet cream in Great Britain for 1936 was 135,000 cwt. (British hundred weight), or approximately 15 million pounds.

Unlike canned sweet milk, the bulkiness of which renders its cost of handling, packaging and transportation uneconomically high per food unit, sterilized sweet cream is not a problem of excessive bulkiness. In fact, cream of average fat content usually contains as much total solids and as little water as evaporated milk.

A definite process of manufacture of sterilized sweet cream, covered by U. S. Patent, was devised by Webb<sup>1,2,3</sup> who made an extensive experimental study of the factors affecting the heat coagulation, viscosity, fat separation, color and keeping quality of sweet cream. This process is a modification of the methods employed in the manufacture of evaporated milk. Its development was greatly assisted by the results of diverse other investigations on related factors, such as the factors affecting fat clumping and the viscosity of milk, cream and ice cream mixes as studied by Doan,<sup>4,5,6</sup> Troy and Sharp,<sup>7</sup> Tracy and Ruehe,<sup>8</sup> Reid and Skinner,<sup>9</sup> Hening and Dahlberg,<sup>10</sup> Dahlberg and Marquardt,<sup>11</sup> Hening,<sup>12</sup> Babcock,<sup>13</sup> the effect of homogenizing on feathering and heat stability, by Burgwald<sup>14</sup> and Doan,<sup>15</sup> the effect of two-stage and double homogenization on fat clumping, viscosity and heat stability, by Martin and D...e,<sup>16</sup> Tracy and Ruehe,<sup>8</sup> Doan and Minster,<sup>17</sup> the effect of forewarming temperatures and homogenization, by Webb and Holm,<sup>18</sup> factors affecting whipping cream, by Babcock,<sup>19</sup> and the color of evaporated milk, by Webb and Holm.<sup>20</sup>

**Process of Manufacture.**—The results of extensive work by Webb show that sterilized sweet cream made in accordance with the following formula is free from noticeable darkening in color or change in viscosity due to manufacture or storage; that its cooked flavor is so slight that it is not objectionable; that it will keep indefinitely without serious objectionable change in flavor, although upon prolonged storage there is a tendency

for the appearance of a slight "milk powder" or "old cream flavor"; and that, while a considerable period of storage diminishes the uniformity of fat dispersion somewhat, the cream plug is of loose texture, it readily disintegrates and emulsifies in the contents upon slight shaking:

1. Use fresh, sweet cream only, with a titratable acidity of .15 per cent or less, calculated as lactic acid.

2. Standardize this cream to 20% fat.

3. Preheat at 176° F. without holding.

4. Double homogenize at 176° F., either by the use of the two-stage valve or by re-homogenization, using 2,500 to 3,000 pounds pressure for the first stage and 500 pounds pressure for the second stage or for re-homogenizing. For re-homogenizing bring the temperature of the cream back to 176° F.

5. Cool to 60° F. immediately after homogenizing, preferably by running the cream over a brine cooled surface cooler.

6. Pack into air-tight containers, such as plain tins, lacquered tins, or glass bottles of the soda water type.

7. Sterilize in batch sterilizer, same as is used for evaporated milk, using 15 minutes for coming up and for cooling. Hold at a sterilizing temperature of 118° C. (244.4° F.) for from 12 to 15 minutes, depending on the size of the container.

**Butter Fat Content and Preheating Temperatures.**—A good quality of cream containing 20 per cent butter fat, when preheated to the proper temperature (176° F.) before homogenizing, permits of efficient sterilization without coagulation. Unfortunately the finished product made from 20 per cent cream is not a satisfactory whipping cream. It does not whip easily and the whip is of small volume. This is due to the combined effect of low fat content and high homogenizing pressure which is necessary to prevent fat separation in storage.

An increase in fat content lowers the heat stability of the homogenized cream and increases the tendency toward fat separation. Sterilized sweet cream with a higher per cent fat can be made, however, and the whipping properties improved. Webb<sup>2</sup> suggests as optimum conditions for the preparation of a sterile whipping cream a 30 per cent cream, preheated to 176° F., homogenized at 2,500 pounds pressure and sterilized at 244.4° F. (118° C.) for 12 minutes. His later work<sup>3</sup> that shows the advantages of two-stage or double homogenization, suggests that two-stage or double homogenization at 2,500 to 3,000, and 500 pounds pressure, respectively, would be preferable in the case of the 30 per cent whipping cream. No experimental results are available, however, to substantiate this assumption.

The sterilized sweet cream made by the above formula for 30 per cent cream whipped well at 50° F., but the increase in volume was small. The finished product, however, showed noticeable fat separation and an



old cream flavor after one year of storage, although the cream retained its whipping property.

Howat and Nichols<sup>23</sup> report that their analysis shows that the British canned cream may vary approximately from 18.5 to 28 per cent in milk fat, averaging about 23 per cent. The solids-not-fat varied from 6.5 to 9.5 per cent, averaging approximately 8 per cent.

The work of Webb and Holm<sup>18</sup> shows that, at every pressure of homogenization and for any per cent of fat within the range of 15 to 30 per cent, the maximum heat stability was attained by preheating to 176° F. For cream of less than 15 per cent fat, preheating to 194° F. and homogenizing at low pressures increased the heat stability. A preheating temperature of 140° F., which is considered the lowest practical temperature for homogenization, was found to produce the minimum heat stability of all creams, except those of very low fat content (less than 15 per cent), for which the minimum heat stability curve sometimes reached its lowest point at 158° F.

Howat and Nichols<sup>23</sup> recommend standardization of all cream for heat stability by the addition of a chemical stabilizer, for the purpose of accomplishing a more uniform viscosity between batches. They give preference to the use of sodium bicarbonate. They state that in practice it has been found that the addition of bicarbonate results in a relatively thick cream, phosphate produces a medium thickness, and citrate causes the cream to remain thin even after aging. These observations, however, may be predominatingly of local significance and may, therefore, not be applicable for general guidance.

**Homogenization.**—The effect of homogenization on subdivision of the fat globules, on breaking up of fat clusters, on viscosity and on heat stability, was discussed in Chapters XXIV and XXV. The influence of homogenization on sterilized sweet cream is similar in nature to that observed on evaporated milk.

In the case of cream, because of the high ratio of fat to solids-not-fat, freedom from fat separation requires maximum efficiency of homogenization. It was shown by Webb<sup>2,3</sup> that single-stage homogenization at a pressure as high as 4,000 pounds does not entirely prevent fat separation in sterilized sweet cream upon prolonged storage. Fat subdivision must be exceedingly fine, if possible reducing the fat globules to an average diameter of one micron. The microscopic field should show consistent uniformity of size and complete absence of large globules.

Because of its high ratio of fat to solids-not-fat, cream has inherently a low heat coagulation point. It follows, therefore, that homogenization at high pressures decreases the heat stability of the cream severely. The correctness of this assumption has, in fact, been conclusively demonstrated by the work of Webb.

Webb found that rehomogenization at 500 pounds decreased the vis-

cosity and increased the heat stability over single homogenization at 1,000, 2,000, and 3,000 pounds. Increases above 500 pounds in the pressure used on the second stage increased the viscosity and decreased the heat coagulation point. As the result of further study, Webb recommended double or two-stage homogenization of cream at 2,500 to 3,000 pounds, and at 500 pounds pressure, respectively.

**Packaging.**—The homogenized cream is cooled promptly to about 60° F., preferably by flash cooling, using the surface cooler or the internal tube cooler. It is then ready for filling into the consumer package.

Either glass containers or tin cans may be used. Webb<sup>8</sup> found 250 cc. white glass bottles similar to the soda-water bottle, with cap lined with parchment or special cardboard (composition cork blackened the surface of the cream), most practicable. There was no breakage in sterilization or loss of tops. Webb further pointed out that the color observed in the canned creams had a greenish tinge, similar to that noted in evaporated milk after prolonged storage, suggesting its dependence upon the presence of the tin.

Jackson, Howat and Hoar<sup>24</sup> studied the discoloration and corrosion in canned cream. As a result of their observations they suggest the following precautions to minimize or prevent these defects: Eliminate milk with abnormal protein phase such as milk from mastitis-infected udders and milk abnormal because too soon after calving, use tins of superior quality only, avoid excessive use of stabilizer especially phosphates and citrates and avoid excessive heat treatment in sterilization.

**Sterilization.**—The same equipment, the batch sterilizer with revolving cage, and similar manipulation in sterilizing and cooling, as described under "Manufacture of Evaporated Milk," Chapter XXIII, are applicable in manufacture of sterilized, sweet cream.

The sterilizing temperature<sup>2</sup> found most satisfactory is 118° C. (244° F.) for 12 to 14 minutes; using 15 minutes for bringing the temperature up and for cooling to room temperature after sterilization. This time schedule applies to one-half pint containers. For larger unit packages somewhat more time must be allowed for raising the temperature and for cooling.

See also manufacturing procedure used in the production of "Avoset" Stabilized Cream, described in succeeding paragraphs.

#### AVOSET STABILIZED CREAM

Avoset stabilized cream is a most convincing example of the commercial practicability of the successful manufacture and marketing of sterilized sweet cream. This cream is bacteriologically sterile. It has retained the light, raw-cream color and is relatively free from objectionable cooked flavor, similar to properly pasteurized cream. These important attributes, together with its proven emulsion stability and keeping quality,

have established ready consumer acceptance and growing consumer demand for this product.

This sterilized sweet cream has been successfully manufactured in commercial quantities by Avoset Incorporated of San Francisco, California, since February 1941.<sup>25</sup> The Avoset management reports that under restrictions made necessary by the war emergency, production is largely limited to a table grade of cream of 18 per cent milk fat, but previously a table grade of 20 per cent milk fat and a whipping cream grade of 30 per cent milk fat were produced in approximately equal proportions. These grades will again become available as soon as restrictions are removed. All grades are marketed in hermetically sealed half-pint bottles, pint tins, and gallon bottles.

#### MANUFACTURING PROCEDURE

**Quality of Cream.**—High quality, fresh, sweet cream is essential. The acidity should be below 0.15 per cent for table grades and below 0.14 per cent for whipping grades.

**Addition of Vegetable Stabilizer.**—A small amount of vegetable stabilizer (0.10 to 0.25%) is added before processing. The stabilizer jell commonly used is sodium alginate, a hydrophilic colloid used widely in ice cream and ice cream mix.<sup>28, 29</sup> Its function is to give the cream emulsion stability, keeping the milk solids from separating out on prolonged storage. It also assists in preventing fat separation, appears to impede spontaneous breakdown of the fat, and retards some of the chemical changes that occur in cream without added vegetable stabilizer. However, under present Federal regulations the product containing the added stabilizing agent cannot be sold as cream, but must be sold under a trade name. This restriction appears not to have interfered with the sale of the product.

**Processing.**—The mixture is preheated and then sterilized in a continuous-flow heating unit first developed, described and patented by Grindrod.<sup>26, 27</sup> The process is essentially a method for quickly heating the liquid to a high preheating and a high sterilizing temperature. This is done in continuous flow, by direct application of high-pressure steam (injection of jets of "live steam"). In preheating, the cream is heated quickly from room temperature to a range of 212-230° F. The sterilizing temperatures used may vary within the range of 260 and 280° F., depending upon capacity of machine and time interval necessary to dependably provide both safe sterilizing time and satisfactory heat stability. The high-short preheating and time interval helps to provide satisfactory heat stability. The time interval may vary but does usually not exceed four minutes. The sterilizing temperature is generally maintained for a period of about 30 seconds.

**Homogenizing.**—The cream is homogenized after sterilizing. Aseptic homogenization is accomplished by sealing the packing glands and the

homogenization is successfully done in a condition of complete sterility. The manufacturer of Avoset has found low-pressure, two-stage homogenization helpful in improving the stability of the fat emulsion. In order to guard against excessive viscosity, pressures below 2,000 pounds on the first stage and 500 pounds on the second stage are recommended. A homogenizing temperature above 150° F. is preferred.

**Packaging.**—The homogenized cream is then cooled and stored in sterile, closed holding tanks, much as is done in accumulating the day's run of evaporated milk. In the case of the cream, however, the product is maintained in a condition of complete sterility. This is accomplished by the use of protective bacterial air filters that eliminate contamination from in-going air. From these holding tanks the cream is filled under aseptic conditions into previously sterilized containers. The packaging room must be maintained as nearly sterile as possible, and the filling and sealing must necessarily be done under a succession of sanitary precautions and a plan of sanitary inspection that practically precludes the possibility of the presence of contaminating micro-organisms.

The aseptic filling is accomplished by means of a filler covered by a steam dome. The entire machine is completely sterilized under pressure before use. The sealing is done by means of the White Cap sealer, which applies caps to bottles and cans in a steam atmosphere. When tin cans are used they are pre-sterilized by a continuous, rotary machine, synchronized with the filler. Bottles are usually batch sterilized in a retort.

**Storage and Transportation.**—Avoset, being sterile, is not subject to bacterial deterioration and spoilage. Its keeping period is limited only by the time required for physical and chemical changes that impair its marketable properties. These changes appear only very gradually, and their damaging progress is further retarded by low storage temperature (just high enough to prevent freezing).

It has been observed that undesirable flavor changes are of especially slow development, samples over two years old still being satisfactory from a flavor standpoint. Cream plug formation has been observed to take place in nine months to one year. It, too, is much delayed by low temperature and can be prevented entirely by occasionally inverting the cases. Under normal transportation conditions, the stabilized cream is reported to travel long distances without churning trouble. For table cream ordinary cars are used, but the 30 per cent butter fat whipping grade, which is most susceptible to churning, is shipped in refrigerated cars. Avoset sterilized, stabilized sweet cream is reported to be successfully transported to lands of every clime, such as Hawaii, Panama, South America, Arabia, and Alaska.

#### REFERENCES

1. WEBB, B. H.: U. S. Patent No. 1,646,671. 1927.
2. WEBB, B. H.: Jour. Dairy Sci. XIII. 159. 1930.

3. WEBB, B. H.: Jour. Dairy Sci. XIV. 508. 1931.
4. DOAN, F. J.: Jour. Dairy Sci. X. 501. 1927.
5. DOAN, F. J.: Jour. Dairy Sci. XII. 211. 1929.
6. DOAN, F. J.: Ice Cream Rev. XIII. 1930.
7. TROY, H. C., AND SHARP, P. F.: Jour. Dairy Sci. XI. 189. 1928.
8. TRACY, P. H., AND RUEHE, H. A.: Illinois Agr. Expt. Sta. Bul. 352. 1929.
9. REID, W. H. E., AND SKINNER, G. R.: Missouri Agr. Expt. Sta. Res. Bul. 127. 1929.
10. HENING, J. C., AND DAHLBERG, A. C.: Jour. Dairy Sci. XII. 129. 1929.
11. DAHLBERG, A. C., AND MARGUARDT, J. C.: N. Y. (Geneva) Agr. Expt. Sta. Tech. Bul. 157. 1929.
12. HENING, J. C.: Jour. Dairy Sci. XIV. 84. 1931.
13. BABCOCK, C. J.: U. S. Dept. Agr. Bul. 249. 1931.
14. BURGWALD, L. H.: Jour. Agr. Res. XXVI. 11. 1923.
15. DOAN, F. J.: Am. Cry & Poultry Rev. LXXI. 374. 1930.
16. MARTIN, W. H., AND DAHLE, C. D.: Penn. Agr. Expt. Sta. 38th Ann. Rept. 23. 1925.
17. DOAN, F. J., AND MINSTER, C. H.: Penn. Agr. Expt. Sta. Bul. 258. 1930.
18. WEBB, B. H. AND HOLM, G. E.: Jour. Dairy Sci. XI. 243. 1928.
19. BABCOCK, C. J.: U. S. Dept. Agr. Bul. 1075. 1922.
20. WEBB, B. H., AND HOLM, G. E.: Jour. Dairy Sci. XIII. 25. 1930.
21. NICHOLS, A. A.: Hannah Dairy Res. Inst. H.D.R.I. Reprint 75.
22. NICHOLS, A. A., HOWAT, G. R., AND JACKSON, C. J.: Jour. Dairy Research. VIII. 331. 1937.
23. HOWAT, G. R., AND NICHOLS, A. A.: Hannah Dairy Res. Inst. H.D.R.I. No. 79.
24. JACKSON, C. J., HOWAT, G. R., AND HOAR, T. P.: Jour. Dairy Res. VII. 282. 1936, and VIII. 324. 1937.
25. JORDAN, M. K., Vice President Avoset Incorporated. Information by correspondence, November 29, 1944, by courtesy of Mr. Jordan.
26. GRINDROD, GEORGE: United States Patents Nos. Re. 19,193, 1934; (Orig. 1,714,597, 1929); 2,019,491, 1935; 2,170,195, 1939.
27. GRINDROD, GEORGE: Information by correspondence. January 19 and 24, 1945.
28. GREEN ET AL.: U. S. Patent 2,097,225. 1937. Owned by Kelco Company.
29. LUCAS: U. S. Patent No. 2,097,228. 1937. Owned by Kelco Company.

## CHAPTER XXX

### CONDENSED MILK MARKETS

#### PREPARATION FOR MARKET

**Stamping Package for Identification.**—The importance of systematic marking of the consumers' package is obvious. The identification mark is needed as an integral part of the manufacturing record; it facilitates the orderly rotation of stocks; it is indispensable for the successful tracing of defects and it expedites the prevention of their recurrence.

A simple, readily legible identification mark is needed on bulk packages as well as on tins. The simplest system appears to be to give each batch a consecutive number and to stamp the respective batch number on the package. Some factories prefer to use a code of letters or figures, or both. The code usually designates the factory, date of manufacture and consecutive number of batch of the day's run. The code has the advantage of withholding information from competitors.

The stamping of the tins is usually done on one end, using small interchangeable rubber letters or figures and waterproof stamping ink containing a drier. In factories with large volume, an automatic stamping device is generally attached to the filling, sealing, or labelling machine. Instead of stamping the cans the labels may be perforated with batch or code number.

**Labelling the Tins.**—The cans roll into the labelling machine by gravity, where they are picked up by a pair of motor-driven, endless belts which draw them through the machine. They first pass over revolving metal discs that touch each can with a trace of "pick-up" cement. From here they roll over the label table which is loaded with a stack of labels face down. The touch of "pick-up" cement on the can causes each can to pick up one label which automatically wraps itself around the rolling can.

A short endless belt moving through the paste box applies a narrow strip of paste on the lap of the label. A curling rod stretches the label taut and gives its lap an inward curl to make it conform to the shape of the can, thus insuring a tight and perfect fit. The label table is equipped with an automatic feeding arrangement which pushes the stack of labels up as fast as they are being used.

Additional refinements of the modern labelling machines consist of automatic glue feed, non-stop label pack feeder, mechanical inspector which removes and returns through the machine cans that escape without label. These labelling machines with mechanical drive will average from 60,000 to 70,000 cans per 10-hour day.

**Packing the Tins into Cases.**—The labelled cans are packed into cases holding six gallon-size cans, 48 tall-size cans (15, 16 or 20-ounce), or 72 to 96 baby-size cans (6-ounce). For domestic use pasteboard and fibre

boxes are mostly used. They have proven highly serviceable and effect an appreciable saving in the cost of package. For export purposes, wire-bound wooden boxes are used.

Mechanical can casers, adjusted to synchronize with the speed of the labelling machine are available. They make the work of packing the cans easier, accelerate its speed and eliminate one person per machine. The can caser does a neater job and it eliminates the possibility of deranging of labels. There is no smearing of the labels from dirty fingers. The neat appearance of the label is preserved.

**Marking the Cases.**—On one end of the case is stencilled the batch or code number. Over the other end is pasted a case label consisting of an enlarged replica of the label or brand on the cans within. In the place of the case label, a replica of the brand may be printed on, or if wooden boxes are used the brand design may be burned into the box ends by the lumber mill. The sides are commonly marked with the name of the goods and the precaution "Keep in cool, dry place."

This precaution is important. Storing in a warm place, such as against a boiler room, et cetera, for any considerable period of time, causes sweetened condensed milk to darken in color, thicken, show mold buttons and develop a stale flavor. Evaporated milk will also darken, its flavor will suffer, the tendency to objectionable fat separation will increase, a sediment of precipitated mineral salts may accumulate in the bottom of the tin, the milk will become thinner and it may gel.

**Packing for Export.**—The United States Government requires condensed milk case goods packed for its armed forces to be supplied in tins that are dipped into a solution of lacquer before they are labelled. Or the empty tins may be bought by the manufacturer already lacquered.

In normal times, in the case of shipments for export, the tins are wrapped in heavy, soft paper with the brand printed on it. This wrapping paper takes up the slack between the tins in the case and protects the cans against damage due to rough handling in transit. This wrapping is commonly done by the labeler or by hand. Cases for export are usually wooden boxes reinforced with a band of strap iron at each end.

During the war the wrapping of the cans in paper had to be discontinued. These paper jackets caused large scale spoilage and loss of canner's milk due to intense rusting of the tins, leading to leakage. The paper becoming damp in humid atmosphere, and water-soaked from tropical rains or sea water, induced rapid corrosion that destroyed the can.

**Incubation and Inspection.**—The newer knowledge of milk technology and the systematic standardization of process and handling has made unduly extended incubation and laborious manual inspection less necessary. Thus the present-day general practice is to do the labeling and casing of the tins immediately after manufacture. A certain number of sample tins (about 12 to 48) are usually taken from each batch, or from each day's

run in the case of the continuous system of condensing and sterilizing. One or more cans may be used for bacteriological, chemical and physical analysis. The remainder of the sample tins are incubated at temperatures ranging from 85 to 120° F., and examined at bi-monthly or monthly intervals by inspection of the contents.

The batches themselves are not held at incubating temperature so as to protect the goods from high temperature exposure that would weaken their resistance to the development of age defects. In fact, in factories with refrigeration facilities the goods may even be held at cool room temperatures, such as a few degrees above 32° F.

The weakest link in the chain of factors that controls the marketable properties of canned milk is the can. This is especially true of evaporated milk, partly because the can is subjected to the rigors of the sterilizing process and to much added handling, and partly because the milk must remain sterile in order to keep. Even the most minute imperfection in seal or seams introduces the means of contamination resulting in spoilage.

Final routine inspection of the stock of milk on hand is confined to noting the condition of the sealed cases of labeled tins at the time they are loaded for shipment. If a case contains a single can of spoiled milk (evaporated milk) due to leaky can, the case will be wet and the inside will be "a mess"

### STORAGE

**Temperature of Storage.**--The optimum temperature of storage is determined to some extent by the kind of concentrated product and the type of package. Generally speaking, however, low temperatures (60° F. or below) are preferable to high temperatures (room temperature or above). This is especially true when prolonged storage is contemplated.

Plain condensed milk, which is not sterile and contains no sucrose to preserve it, is highly perishable. It is usually intended for quick consumption. Even for short storage, (a few weeks) it should be held at low temperature (32-45° F.). If intended to be stored for four weeks or longer it should be held at temperatures of commercial cold storage (0° F. or below). For effect of prolonged cold storage of plain and superheated condensed milk, see Chapter XXVII.

Evaporated milk, if properly made is sterile. Bacteriologically, it will keep indefinitely provided that the tins are and remain airtight. It is subject, however, to certain physical and chemical changes which are hastened and intensified at higher storage temperatures. The more important of these changes are listed below:

1. Gradual increase in titratable acidity.
2. Progressive action on can leading to metallic flavor.
3. Decrease of viscosity, loss of body.
4. Darkening of color.
5. Deposit of calcium citrate crystals.



6. Less homogeneity of fat-in-skimmilk emulsion.
7. Gelation of contents of can.

The above changes tend to occur in evaporated milk during prolonged storage at room temperature and above. They are less pronounced below room temperature. At 45° F. or below the development of the majority of these defects becomes noticeable only during long storage, if at all. If held in a frozen state for a considerable period, upon thawing, the tendency to fat separation is increased somewhat. In such milk, the casein tends to form a grainy precipitate that appears to be irreversible, probably due to the earlier denaturation suffered in the heat treatment of sterilization. Frozen plain condensed milk (which is never subjected to sterilizing heat) normally does not show a grainy structure upon thawing out. Evaporated milk, therefore, should not be stored at temperatures sufficiently low to cause it to freeze.

Sweetened condensed milk, though preserved by the presence of sucrose, also suffers appreciable deterioration in prolonged storage at a relatively high temperature. The more important changes are listed below:

1. Development of stale flavor.
2. Gradual increase in titratable acidity.
3. Increase in number of bacteria.
4. Appearance of mold buttons.
5. Progressive age-thickening.
6. Darkening of color.

Development of the above defects of sweetened condensed milk in high-temperature storage may be appreciably minimized, if not prevented, by proper adjustment of the process of manufacture. The majority of these storage defects are practically prevented by holding the storage temperature down to 45° F. or below, but even temperatures around 60° F. are far more favorable to the preservation of the marketable properties than 70° F. and higher.

Sweetened condensed milk conforming to the minimum standard of fat and solids of 28 per cent, and containing approximately 43 per cent added sucrose, has a freezing point of approximately 5° F.<sup>1</sup> Except in the very coldest of winter weather, therefore, sweetened condensed will not suffer freezing.

However, when packed into cans with solderless seal, such as the friction cap of the McDonald seal, or the burr cap of the Gebee seal, unexpected difficulties may arise. These seals are not airtight. A low storage temperature causes the milk and air in the can to contract sufficiently to create a partial vacuum which draws air into the tin. When the cans are moved into a warmer atmosphere, the milk and air expand. But the surplus air finds no exit because the microscopic openings of the imperfect seal, through which the air entered, are closed by the viscous milk on the

inside. The resulting pressure causes the cans to bulge, giving the impression of spoils, which may cause their rejection on the market.

Semi-solid buttermilk and concentrated sour skimmilk do not require low temperature storage. Their high acid concentration preserves their marketable properties, provided their containers (barrels) are filled and sealed in a manner to exclude air. These products likewise are not adversely affected by temperatures below the freezing point of water.

#### MARKETS

Since the year 1925 the consumption of sweetened condensed milk (case goods) in the United States has been steadily declining from 131 million pounds in 1925 to 35 million pounds in 1938.<sup>2</sup> This decrease in consumption of sweetened condensed milk in the consumer's package, the tin, has been accompanied, however, by an increase in bulk sweetened condensed whole milk from 23 million pounds in 1920 to 54 million pounds in 1939. In addition, there has been an increase, also, in the utilization of bulk sweetened condensed skimmilk, used in prepared food factories, from 72 million pounds in 1920 to 152 million pounds in 1939.

In sharp contrast to the steady decline of domestic consumption of sweetened condensed whole milk in case goods stands the tremendous increase of the domestic consumption of evaporated milk (case goods). Its uniform high quality, economy of price, convenience, proven wholesomeness, and dependable keeping quality in the sealed tin, render its utility marvelously versatile. It competes successfully with cream and with cooking milk, and it provides an acceptable, all around substitute for fresh milk.

The annual civilian consumption and annual per capita civilian consumption of sweetened condensed and evaporated milks, are shown in Table 52. The combined condensed and evaporated milk civilian consumption, and per capita civilian consumption, for the year 1943, was 2 billion, 450 million pounds, and 18.9 pounds, respectively.<sup>3</sup> To this record-breaking increase in consumption of evaporated milk (case goods) should be added the increase of plain condensed whole milk (bulk goods) of from 72 million pounds in 1920 to 128 million pounds in 1940, and of plain condensed skimmilk of from 64 million pounds in 1920 to 246 million pounds in 1940.

In normal times, large volumes of canned condensed milk, both evaporated milk and sweetened condensed milk, also supply localities, territories and countries where the dairy industry either is as yet in its infancy or where geographic and climatic conditions bar the profitable husbandry of the dairy cow.

The concentrated product, in many instances, has become as great a necessity as fresh milk is to the consumer in regions and countries within the dairy belt of the temperate zone.

TABLE 52. ANNUAL CONSUMPTION IN UNITED STATES OF SWEETENED CONDENSED AND EVAPORATED MILK, PER CAPITA CONSUMPTION OF ALL DAIRY PRODUCTS

Year	Volume of Consumption <sup>1</sup>		Per Capita Consumption <sup>2</sup>						
	Sweetened Condensed Milk (case goods)	Evaporated Milk (case goods)	Sweetened Condensed	Evaporated	Butter	Cheese	Ice Cream	Dried Whole Milk	Dried Skim Milk
	1000 pounds	1000 pounds	pounds	pounds	pounds	pounds	pounds	pounds	pounds
1925	131,434	1,063,667	1 1	9 3	17 7	4 7	9 2		
1930	97,869	1,884,895	2 3	11 3	17 3	4 6	9 2	0 096	
1935	49,444	1,866,902	1 5	14 7	17 2	5 3	7 4	0 148	1 6
1936	46,325	1,810,545	1 8	14 1	16 5	5 4	8 9	0 150	1 8
1937	43,078	1,830,195	1 7	15 0	16 5	5 5	10 2	0 108	1 9
1938	35,375	2,038,776	1 6	15 6	16 5	5 8	10 2	0 123	2 1
1939		2,327,000	1 5	16 3	17 4	5 9	10 9	0 131	2 2
1940		2,551,000	1 8	17 5	17 0	6 0	11 3	0 156	2 2
1941		2,421,000	1 7	17 2	16 0	6 0	13 7	0 175	2 5
1942		2,495,000	2 0	17 2	15 7	6 4	16 0	0 161	2 4
1943 <sup>3</sup>		2,450,000	1 8	17 1	11 9	5 1	12 6	0 380	1 8

Since the beginning of the European War in 1939, and throughout its expansion into a Global conflict after Pearl Harbor, the increasingly urgent demand for enormous quantities of sweetened condensed and evaporated milks for our armed forces and for those of our Allies, and for the civilian needs of the reconquered, enemy-occupied areas, our production, especially of evaporated milk, has been stepped up to a volume of undreamed of magnitude. In the year 1942 we manufactured in the United States 3,518,504,000 pounds of canned evaporated whole milk. Our total volume of all fluid concentrated milk for human food, sweetened condensed and evaporated, case goods and bulk goods, made from whole milk and made from skimmilk produced during the same year, amounted to 4,330,171,000 pounds.

**Market Price of Condensed Milk.**—The market price of condensed milk is governed by such factors as demand and supply in domestic and export markets, condition of international rate of exchange, duty on imports, the price situation of market milk, butter and cheese, and the brand, whether known brand (premium brand) or miscellaneous brands.

Within the span of the past 20 years condensed milk prices in this country have fluctuated widely, partly on account of removal and later reinstatement of the tariff on imported goods and partly because of the extraordinary upheaval of monetary, economic, industrial and market conditions during and following World War I.

During the above period sweetened condensed milk sold at prices ranging anywhere from \$2.50 to \$9.25 per case of 48—14 ounce cans;

<sup>1</sup>1920-38 U. S. Dept. Agr. Tech. Bul. 722, 1940

<sup>2</sup>Figures for 1925 U. S. D. A. Yearbook 1941; for 1930-42 U. S. D. A. Yearbook 1943, for 1925 case goods only; for 1930-48 case goods, bulk goods, also plain condensed milk, and all unskimmed; for 1943 U. S. D. A. Yearbook 1944.

<sup>3</sup>Preliminary.

and evaporated milk prices ranged from \$1.90 to \$6.50 per case of 48—16 ounce cans.

In 1913, the United States, by Act of Congress, removed the import tariff, placing condensed milk on the free list. This Act became effective in the fall of the same year. Its immediate effect was a rapid increase in the importation of European condensed milk, which was offered for sale at relatively low prices, decreased the sale of domestic goods, and caused the holdings of condensed milk to accumulate in large quantities. Condensed milk prices depreciated rapidly throughout 1914 and reached the bottom in the fall of that year when financial limitations compelled many concerns to move their goods at any price. At that time the bottom prices of condensed milk were approximately as follows:

Sweetened condensed milk per case.....\$2.50

Evaporated milk per case..... 1.90

The losses suffered by this slump in the condensed milk market, caused by the influx of cheap foreign goods in the absence of a protective tariff, were large and caused bankruptcy of several of the financially limited concerns. The outlook for the future of the industry seemed very uninviting at best, but the situation was saved and market conditions reversed by the urgent food requirements of the Allied nations in the European war, and after the entrance of the United States into the war, by large orders for the American army and navy.

The extraordinary and very urgent demand for condensed milk by the U. S. Government and by its allies during World War I and the enormous demand for exports to Europe after the armistice, boosted the prices of this product to a level not attained since the Civil War. While Government regulations tended to hold price advances within reasonable bounds and while lack of shipping facilities and other factors caused temporary fluctuations downward, the price advance in general continued until the spring of 1919, and reached the following maximum figures per case:

Sweetened condensed milk per case.....\$9.25

Evaporated milk per case..... 6.50

From 1920 on, prices began to decline rapidly as the result of a speedy decrease in the export demand and the simultaneous continuance of the tremendous volume of war-time production. This situation caused a rapid accumulation of stocks in this country. During the war period the industry had grown with leaps and bounds. In 1919 this country exported more concentrated milks than was represented by the entire output of 1914. With the export market suddenly shut off (in 1920) the greatly increased production caused the accumulation of a large surplus which the domestic market was not prepared to absorb. The situation was further aggravated by the arrival of some imports attracted by the favorable rate of exchange and the absence of an import tariff.

This combination of conditions had a depressing effect on domestic

market prices. With the gradual readjustment of the rate of exchange and of the general economic conditions and the reinstatement of the tariff on imported goods, encouraging exports and discouraging imports, together with a marked improvement in business conditions domestically, this surplus was gradually absorbed so that by 1924 market prices returned to normal. In 1925, summer, sweetened condensed milk sold at from \$5.75 to \$6.00 per case of 48—14 ounce cans, and evaporated milk at from \$3.75 to \$4.40 per case of 48—16 ounce cans.

The rise in prices continued through the years of the unprecedented business expansion and in 1929 premium brands of sweetened condensed milk were quoted at \$6.30 to \$6.35 per case of 48—14 oz. cans, and of evaporated milk at \$4.70 per case of 48—16 oz. cans. The business paralysis that followed the business boom reversed the price trend and during 1933 the price of sweetened condensed milk per case of 48—14 oz. cans dropped to \$4.70. The price of evaporated milk reached the low figure of \$2.08 per case of 48—14½ oz. cans.

Maximum, minimum, and average prices per case of sweetened condensed milk and evaporated milk for the period 1934 to 1944 are shown in Table 53.

TABLE 53. AVERAGE WHOLESALE SELLING PRICES OF SWEETENED CONDENSED MILK AND EVAPORATED MILK IN THE UNITED STATES\*  
(CASE GOODS)

Year	Sweetened Condensed Milk Price per case of 48—14-oz. cans			Evaporated Milk Price per case of 48—14½-oz. cans		
	average	maximum	minimum	average	maximum	minimum
5-year average						
1934-38 .....	\$4.82	\$4.85	\$4.80	\$2.84	\$2.87	\$2.81
1938 .....	4.84	4.86	4.79	2.82	3.06	2.68
1939 .....	4.82	4.86	4.80	2.75	2.94	2.67
1940 .....	4.80	4.80	4.80	2.87	2.98	2.77
1941 .....	5.15	5.64	4.80	3.33	3.67	2.95
1942 .....	5.72	5.83	5.64	3.62	3.85	3.49
1943 .....	5.84	5.84	5.84	4.15	4.15	4.15
1944 .....	6.20	6.33	5.84	4.15	4.15	4.15

\*U. S. D. A. Publication on Farm Production, Disposition, and Income from Milk, 1943-44.

#### INTERNATIONAL TRADE IN CONDENSED AND EVAPORATED MILK

The principal countries exporting and importing concentrated milks are shown in Tables 54 and 55.

**Exports.**—The fundamental conditions favoring exports of concentrated milks are: Dairy development sufficient to provide a plentiful supply of fluid milk, a balance of feed, land and labor cost that makes possible relatively low cost of production, and close proximity to favorable

export markets. The majority of these factors appear to apply particularly to such countries as the Netherlands, United States, Switzerland, Denmark, Canada and Australia. These countries, in the order named, were in fact in normal times the leading exporting countries of concentrated canned milks. Their annual exports are given in Table 54.

As shown in Table 55, the volume of sweetened condensed milk and evaporated milk exported by the United States prior to World War I was small, supplying largely only countries of the North American Continent and Panama. Limited quantities were exported also to Oceania and Asia and only small quantities to South America, Africa and Europe. The great bulk of concentrated milk that entered international commerce consisted of exports from European countries.

TABLE 54. EXPORTS OF CONDENSED AND EVAPORATED MILK\*  
PRINCIPAL EXPORTING COUNTRIES

Country Exporting	Average 1925-29	Average 1930-34	1937	1938	1939
	1,000 pounds	1,000 pounds	1,000 pounds	1,000 pounds	1,000 pounds
Netherlands . . . . .	319,831	385,907	367,873	335,371	317,006
United States . . . . .	118,215	59,921	30,847	29,125	29,766
Switzerland . . . . .	76,691	39,800	12,777	14,407	13,686
Denmark . . . . .	55,666	51,973	37,524	38,633	38,142
Canada . . . . .	32,287	20,031	28,972	29,698	26,148
Australia <sup>1</sup> . . . . .	20,852	14,702	23,899	14,246	17,218
Norway . . . . .	18,462	8,087	5,086	6,281	4,532
Italy . . . . .	9,804	5,059	4,037	1,526	.....
France . . . . .	8,910	12,115	10,966	13,186	.....
Ireland . . . . .	8,658	10,615	13,703	13,705	.....
Belgium . . . . .	2,582 <sup>2</sup>	7,093 <sup>2</sup>	1,877	1,253	2,150
New Zealand <sup>2</sup> . . . . .	1,494	2,235	8,588	5,418	6,365

\*U. S. Dept. Agr. Yearbook 1941.

<sup>1</sup>International Yearbook of Agricultural Statistics.

<sup>2</sup>Includes powdered milk.

World War I completely changed this movement of canned milk in international trade. The killing of dairy cattle for meat and the shortage and high cost of cattle feed in Europe brought about a sweeping reduction in the milk production of the majority of the European dairy countries. The shortage of sugar and tinsplate further complicated the problems of their milk condensing factories, decreasing the volume and increasing the unit cost of manufacture. The growing food shortage in the Allied countries and their need of concentrated milk products for armies, navies and civilian population called for large imports into Europe. In addition, the war deprived noncombatant countries in South America, Asia and Africa of their usual imports from Europe and opened up vast markets for this commodity in those countries.

These conditions shifted the exporting of condensed and evaporated milk to the United States, Canada, Australia, and New Zealand, causing an unprecedented expansion of the export trade of the countries of the New World. The exports continued to increase even after the Armistice. This was due partly to the economic exhaustion of Europe and the inability of some of the countries to return immediately to productive enterprises, partly because of the liberal credit extended by the American Government to Allied Governments for the purchase of American products, and partly because of intensive relief activities on the part of the United States in Belgium, Russia and the Balkans.

TABLE 55. UNITED STATES EXPORTS OF SWEETENED CONDENSED AND EVAPORATED MILK\*

Year	Sweetened Condensed Milk	Evaporated Milk	Year	Sweetened Condensed Milk	Evaporated Milk
	1,000 pounds	1,000 pounds		1,000 pounds	1,000 pounds
1909-14 Average	16,209		1928	38,762	76,789
1915	37,235		1929	41,242	68,942
1916	159,577		1930	29,648	60,811
1917	259,102		1931	19,324	55,761
1918	553,439		1932	11,502	39,305
1919	852,275		1933	4,725	32,365
1920	277,132	133,946	1934	8,202	37,363
1921	93,896	195,829	1935	4,890	32,227
1922	56,804	130,693	1936	2,370	23,561
1923	57,378	136,886	1937	7,972	22,874
1924	64,026	142,254	1938	5,427	23,698
1925	42,707	105,056	1939	2,269	27,496
1926	38,711	75,838	1940	27,384	118,747
1927	34,981	68,047			

\*U. S. Dept. Commerce & Labor, Bur. Stat. for 1911-24, U. S. Dept. Agr. Bur. Agr. Econ. Dept. F.S. 42 for 1925-26; U. S. Dept. Commerce, Bur. Foreign & Domestic Commerce for 1927-33. U. S. Dept. Agr. Tech. Bul. 722, 1940, for 1934-38. U. S. Dept. Agr. Markt. Service Statistics of Dairy Production for 1939-40.

Toward the close of the year 1919, conditions abroad began to change, and from 1920 on, the volume of our exports to Europe declined rapidly. The principal factors involved in this change had to do with the fact that European countries had accumulated large stocks of our concentrated milks in 1919 and 1920 and it required several years to consume this surplus. The increasingly unfavorable rate of exchange of foreign moneys discouraged importation by European countries. The growing revival of dairy production in Europe, and the increasing protective tariffs on imports "over there" further curtailed American exports. The world economic and political unrest during the thirties, with its paralyzing effect on international trade, caused an accelerated falling off of our exports until they had dwindled down to less than 30 million pounds per

year. Our exports continued at this low level until 1939 when the increasing food requirements incident to the advent of World War II compelled an immediate increase in both production and exports of concentrated milk products. This increase developed rapidly and soon assumed gigantic proportions.

**Imports.**—The annual imports of condensed and evaporated milk by the World's principal importing countries are given in Table 56.

The fundamental essentials that make a country a large importer of concentrated milks are: Large population with milk-minded food habits, a country with sparse cow population and limited production of fresh milk, and absence of excessive import tariff. As shown in Table 56, the leading importing countries to which the above factors largely apply are: United Kingdom, British Malaya, Cuba, Netherlands Indies, Philippine Islands, British India, Burma, Siam. Within recent years, Cuba's dairy

TABLE 56. IMPORTS OF CONDENSED AND EVAPORATED MILK\*  
COUNTRIES IMPORTING 10,000,000 POUNDS OR MORE.

Country Importing	Average 1925-29	Average 1930-34	1937	1938	1939
	1,000 pounds	1,000 pounds	1,000 pounds	1,000 pounds	1,000 pounds
United Kingdom . . . . .	280,504	284,857	193,510	188,696	161,978
British Malaya . . . . .	51,885	41,497	92,322 <sup>1</sup>	88,184 <sup>1</sup>	85,064 <sup>1</sup>
Cuba . . . . .	47,460	14,868	4,325	5,655	.....
Netherlands Indies . . . . .	27,265	27,702	39,770	37,793	39,215 <sup>1</sup>
Philippine Islands . . . . .	25,810	31,304	42,477	49,008	46,929 <sup>1</sup>
British India . . . . .	22,365	21,421	11,380	6,441	8,000 <sup>1</sup>
Burma <sup>1</sup> . . . . .	.....	.....	17,178 <sup>1</sup>	19,945 <sup>1</sup>	22,110 <sup>1</sup>
Germany <sup>2</sup> . . . . .	16,962	3,732	3,821	2,637	.....
China . . . . .	12,227	9,876	7,161	5,041	3,585
Union of South Africa . . . . .	11,305	2,443	5,768	2,836	661
Peru <sup>2</sup> . . . . .	8,593	5,507	9,318	11,344	10,806
Siam . . . . .	7,076	11,788	25,269	23,723	.....
Indo-China . . . . .	6,275	6,316	9,994	11,091	10,758 <sup>1</sup>
Jamaica . . . . .	4,198	5,830	9,053	10,012	10,106 <sup>2</sup>

\*U.S.D.A. Yearbook 1941.

<sup>1</sup>International Yearbook of Agr. Statistics.

<sup>2</sup>Includes Powdered Milk.

industry has developed to where it now supports several condensed milk factories on the Island, hence, its requirements of imports of this commodity have greatly declined.

Other countries with considerable, though lesser, capacity as importers of concentrated milk are: Germany, China, Union of South Africa, Peru, Indo-China, Jamaica.

Imports of condensed and evaporated milk into the United States have never reached a large volume. From 1909 to 1913 the imports were negligible, amounting to less than one million pounds annually. At that



time foreign concentrated milk entering the United States paid an import tariff of two cents per pound, or \$1.00 per case.

In the Fall of 1913 all foreign milk products were placed on the "free list." This resulted in an immediate and rapidly growing influx of sweetened condensed and evaporated milk from European countries, particularly from Switzerland, Denmark, Holland, Sweden, Norway, Germany and England. In 1921 foreign concentrated milk was again taken off the "free list." This brought about an immediate, progressive decline of imported milks. The imports down to the year 1937 fluctuated between one and ten million pounds annually. From 1938 on they were below one million pounds. In 1940 they had dropped to 3,900 pounds.

#### REFERENCES

1. LEIGHTON, ALAN: Fundamentals of Dairy Science. Associates of L. A. Rogers. Sec. Ed. 254. 1935.
2. VIAL, E. E.: U. S. Dept. Agr. Tech. Bul. 722. 1940.
3. U. S. Dept. Agr. Yearbook. 1944. (Preliminary).
4. U. S. Dept. Agr.: Farm Production, Disposition, and Income from Milk, 1943-44. B.A.E. 1945.

## CHAPTER XXXI

### COMPOSITION, MICRO-ORGANISMS AND ENZYMES OF CONCENTRATED MILK PRODUCTS

#### COMPOSITION

The chemical composition of the several concentrated milk products is given in Table 56-A. Obviously the composition of the same kind of concentrated milk varies considerably with different lots. In the case of canned milk, such as case goods of sweetened condensed and evaporated milk, the composition varies chiefly with the legal standards that prevail in the country of manufacture and, in the case of exports, the legal standard of the importing country. The legal standard usually refers to the minimum limit of percentage of fat or milk solids, or both, that is permissible; and the pressure of commercial competition commonly causes the industry to adopt this minimum percentage permissible as the standard of composition for case goods.

**TABLE 56-A—COMPOSITION OF CONDENSED AND EVAPORATED MILKS.**

Milk Products	Total Solids	Water	Milk Solids	Fat	Protein	Lactose	Ash	Sucrose
	%	%	%	%	%	%	%	%
<b>SWEETENED CONDENSED</b>								
U. S. standard*								
(8 5% fat, 28% MS).....	72.0	28.0	28.0	8.5	7.5	10.5	1.5	44.0
Overstandard.....	75.5	24.5	28.5	9.5	8.9	13.1	2.0	42.0
Dehydrated.....	97.0	3.0	62.0	13.5	17.5	27.0	4.0	35.0
British standard*								
(9% fat, 31% MS).....	74.0	26.0	31.5	9.0	8.5	12.2	1.8	42.5
<b>EVAPORATED</b>								
U. S. standard*								
(7.9% fat, 18% TS)	25.9	74.1	25.9	7.9	6.7	10.0	1.4	0.0
High solids	32.5	67.5	32.5	9.5	8.7	12.4	1.9	0.0
British standard*								
(9% fat, 31% TS)	31.0	69.0	31.0	9.0	8.3	12.0	1.7	0.0
<b>PLAIN CONDENSED MILK</b>								
	30.0	70.0	30.0	8.5	7.8	11.9	1.8	0.0
<b>SKIM CONDENSED</b>								
Sweetened U. S. standard**								
(24% MS)	71.5	28.5	24.0	0.5	8.8	12.7	2.0	47.5
Sweetened British standard								
(26% MS)**	71.0	29.0	26.0	0.5	9.3	14.0	2.2	45.0
Plain U. S. standard**								
	20.0	80.0	20.0	0.3	7.3	10.8	1.6	0.0
Plain British standard**								
	20.0	80.0	20.0	0.3	7.3	10.8	1.6	0.0
<b>CONDENSED BUTTERMILK</b>								
	28.9	71.1	28.9	1.95	10.61	13.01a	3.83	0.0
<b>CONCENTRATED SOUR SKIMMILK<sup>30</sup></b>								
	28.0	72.0	28.0	1.17	10.19	15.51b	2.13	0.0

\*The prescribed standard is confined to minimum percentage of fat and total solids. Figures for other constituents based on averages of analyses and calculations.

\*\*The prescribed standard refers to minimum percentage of total milk solids. Figures for other constituents based on averages of analyses and calculations.

a Includes 5.11% acid. b includes 6.08% acid (calculated as lactic acid).

With bulk goods the situation is somewhat different. The composition of the goods desired is generally specified by the buyer. The baker, or other buyer, usually prefers a product higher in milk solids than the U. S. stand-

ard calls for. He prefers more milk solids and less sugar. Thus, in the case of sweetened condensed skimmilk with a minimum content of 24% of milk solids permitted, the trade usually specifies 28 or 30% milk solids.

In the case of products with a permissible minimum limit of fat and/or milk solids specified by law, the complete percentage composition of all constituents shown in Table 56-A is the result of chemical analyses, and in some instances, of calculation on basis of minimum permissible fat and milk solids content. In the case of products of which the minimum permissible percentage of fat and/or milk solids is not specified by law, the percentage composition given in the table refers to the average of analyses of the product of commerce.

#### MICRO-ORGANISMS

**Freedom from Pathogenic Bacteria.**—The food sanitation literature appears to be devoid of recorded epidemics of consumer illness traced to any form of concentrated milk, or to the recovery of disease germs from such milks. This is as might be expected for, in every form of concentrated milk, the temperature-time ratio of forewarming appears ample to destroy any micro-organisms of milk-borne diseases, should such germ life be present in the fresh milk received by the condensery.

**The Bacteria Count.**—Manufacturing milk, received at the condensery, does not have to satisfy Grade A fluid milk requirements. This places the responsibility of control of bacterial count and quality of the fresh milk directly on the factory management. In some states the State Sanitary Department provides a crew of factory milk inspectors whose efficient enforcement of the state sanitary regulations is of definite assistance to the factory's efforts on quality improvement. In the absence of such assistance the bacterial status of the fresh milk supply obviously varies widely with the quality-consciousness of the factory management.

**Standards of Milk Quality and Factory Sanitation.**—In general, the milk supply of the well established milk condensery, located in a highly developed dairy section that has had the benefit of the factory's consistent efforts in quality improvement over a period of years, may be expected to be of a uniformly high standard of quality. Factories critical as to quality of their fresh milk supply inevitably also maintain an efficiency of plant operating supervision that makes for a high standard of factory sanitation. This combination of effort is the best guaranty to optimum bacterial purity, wholesomeness and keeping quality of the finished product. This high order of quality is characteristic of much of the canned milk, both sweetened condensed and unsweetened (evaporated) milks.

**Quality Where Manufacture of Condensed Milk is a Side Line.**—A considerable portion of the annual production of concentrated milk, however, is not made in the bona fide condensery. It is the product of plants of

variable volume, where the manufacture of concentrated milk is only a side line. Not infrequently it is limited to the utilization of surplus milk. Concordant with these conditions, attention to sanitation and to precautions against quality-jeopardizing contamination in manufacture and handling is less dependable and the finished product may show a relatively high bacterial count. This grade of product is confined mostly to bulk goods, the storage conditions of which are more easily controlled and the market requirements less exacting. Some of the bulk goods manufactured, however, are of recognized high quality.

PLAIN CONDENSED BULK MILK

Ellenberger<sup>1</sup>, in a study of the bacterial content of ice cream showed that the plain condensed milk used ranged in bacterial count from a minimum of 31,500 to a maximum of 59,800,000 per cc.

Ruehe<sup>2</sup> reported the maximum, minimum and average counts in superheated condensed milk as given in Table 57.

TABLE 57.—PLAIN CONDENSED MILK  
BACTERIA COUNT AT EACH STEP IN MANUFACTURE  
RUEHE<sup>2</sup>

	Raw Milk	After Heating to 150° F.		Held for 10 Minutes at 150° F.		After Concentrating		After Superheating at 180 to 186° F. for 5 to 15 minutes	
	Bacteria per cc.	Bacteria per cc.	Per-cent Decrease	Bacteria per cc.	Per-cent Decrease	Bacteria per cc.	Per-cent Decrease	Bacteria per cc.	Per-cent Decrease
Maximum	136,000,000	380,000	99.870	70,500	99.974	145,000	99.997	36,400	99.998
Minimum	1,150,000	17,500	96.000	7,800	98.383	2,200	95.738	1,020	99.897
Average	52,209,000	146,200	99.183	31,900	99.745	27,100	99.898	6,548	99.972

**Importance of Sanitary Condition of Vacuum Pan.**—Contamination sufficient to cause a high bacterial count due to a non-sterile vacuum pan may happen at the very end of the process when the vacuum pump is started again to bring the temperature in the pan down before dropping the batch. The mounting vacuum causes the milk to foam profusely and to rise until it practically fills the pan. The start of violent boiling causes the foam to collapse. This action brings the milk in contact with new surface and unless the pan was clean and efficiently steamed before use, it becomes a source of contamination of the milk which at this stage of the process is no longer hot. This fact was experimentally demonstrated by Ruehe<sup>2</sup> by the use of a washed but not steamed pan. In spite of the heat treatment of forewarming and superheating the bacterial count of the finished product had increased to such an extent that it was nearly eight times as great as the count of the original raw milk. (See also Chapter X, under "Vacuum Pan Sanitation.")

**Bacterial Spoilage in Unsweetened Bulk Goods.**—Unsweetened condensed bulk milk, plain or superheated, is relatively perishable and is destined to sour or ferment otherwise if held at ordinary temperature.

It is preferably utilized while fresh. If it must be held for more than an hour or two it should be stored under refrigeration.

### SWEETENED CONDENSED MILK

This product is not sterile. Its germ content is similar to that of plain condensed bulk milk. Under average commercial conditions fresh normal sweetened condensed milk usually averages approximately 5000 to 50,000 micro-organisms per cc.

**Effect of High Sucrose Concentration.**—Sweetened condensed milk has better keeping quality than plain condensed bulk milk, because the high sucrose concentration retards quality damaging bacterial development. The bacterial count has been found to increase with age in some cases and decrease in others. In normal milk these changes are very gradual, depending considerably on the temperature of storage. In the case of heavy contamination leading to definite bacterial defects, however, the rate of increase of the causative organisms is greatly expedited. The chief bacterial defects observed in sweetened condensed milk are mold buttons, age thickening and bloats.

**Mold Buttons.**—These are lumps of variable size, cheesy consistency, and whitish-yellow to reddish-brown color. They constitute firm, self contained units that do not reemulsify into the body of the milk. The

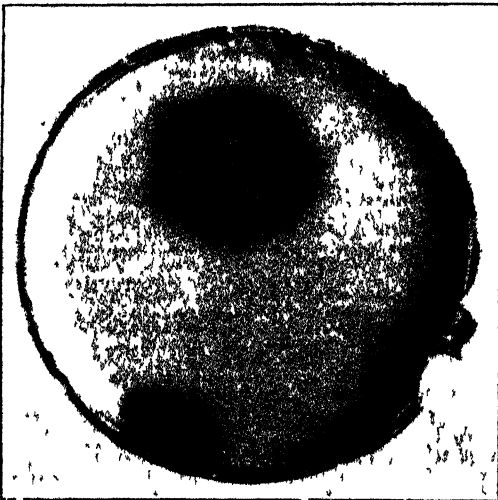

Fig. 80. Mold buttons in growing state  
Courtesy of L. A. Rogers

buttons themselves have a stale cheesy taste and they develop in the milk a stale odor. They are entirely absent in freshly made sweetened condensed milk. Their appearance and size depends, aside from the causative contamination, on the age of the milk and the temperature at which it is held. At ordinary temperature (70° F. and above) they grow comparatively rapidly.

**Growth Requirements of Mold Buttons.**—Rogers, Dahlberg and Evans<sup>8</sup>

found that these buttons are caused by the mold *Aspergillus repens*, and possibly by other molds; that the development of the mold colony is restricted by exhaustion of the oxygen in the can or barrel; and that the button itself is probably due to enzyme action which is continued after the death of the mold. Thom and Ayres<sup>4</sup> reported that the spores of *Asper-*

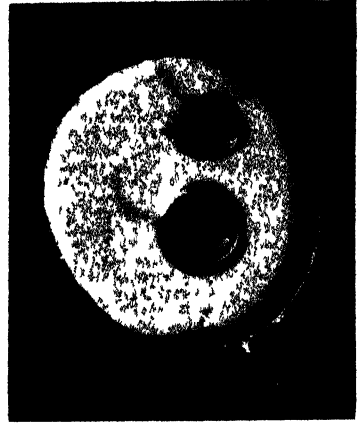

Fig 81. Buttons from which mold  
has disappeared  
Courtesy of L. A. Rogers

*gillus repens*, as well as those of most of the other common molds, are destroyed in 30 minutes at 140° F. They therefore do not survive the customary range of forewarming temperatures used. The appearance of buttons is thus due to contamination after forewarming. Rogers et al found that this mold grows very poorly, if at all, at 68° F. or below. Hunziker<sup>5</sup> was unable to prevent the appearance of mold buttons in commercial manufacture at 68° F., and recommends storage at 60° F. or below.

**Prevention of Mold Buttons.**—The development of buttons can be prevented by:

1. A system of sanitation in all operations of manufacture and packaging that will prevent contamination with the causative mold.
2. Holding the temperature of storage at 60° F. or below.
3. Vacuumizing the milk and sealing the containers under vacuum. Rogers et al<sup>8</sup> found that sealing under a vacuum of 20 inches prevented button formation.

According to Knudsen<sup>6</sup>, in Europe buttons in sweetened condensed milk have also been traced to the molds *Aspergillus glaucus* and *Catenularia fuliginea*.

**Bacterial Thickening of Sweetened Condensed Milk.**—A very common defect to which sweetened condensed milk is subject, is progressive thickening with age, particularly when stored at room temperature or above. This age thickening is usually due to a spontaneous physico-chemical change (see Chapter XXXII), but it can also be the result of bacterial activity.

Bacterial thickening of sweetened condensed milk is usually accompanied by a high germ count, a disagreeable stale and often cheesy odor and taste, and often by increase in acidity. When the thickened milk is diluted with water and heated, the curd separates.

**Experimental Results on Bacterial Thickening.**—Andrews<sup>7</sup> found large numbers (from 100,000 to 1,000,000 per gram) of *S. pyogenes* and *Staph. aureus* and *albus* in sweetened condensed skimmilk that had thickened. Cooksey<sup>8</sup> isolated staphylococci, *B. subtilis*, *B. mesentericus* and yeasts from such milk. Greig-Smith<sup>9</sup> found large numbers of cocci in sweetened condensed milk that had curdled, and Cooksey, and Dugardin<sup>10</sup> reported high acidity in the thickened product. Rice and Downs<sup>11</sup> traced the cause to a coccus capable of inverting and destroying sucrose and producing acid. It grows within a wide range of sucrose concentrations but is inhibited in sucrose-in-water concentrations of 64.5%. It is most active at temperatures above ordinary room temperature. It is destroyed in 10 minutes at 64° C. (147.2° F.). As the result of further study Downs<sup>12</sup> concluded that the acidity factor was non-important and that the thickening is due to the production, by the causative coccus, of a rennin-like enzyme. Rice and Downs<sup>11</sup> isolated the organism from factory equipment.

**Prevention of Bacterial Thickening.**—Our present knowledge of this defect points to inadequate sanitary supervision as the fundamental cause of bacterial age thickening. For prevention the following precautions are suggested:

1. Elimination of source of contamination by more thorough cleaning and sterilizing of equipment.
2. Raising the sucrose-in-water concentration, but not to exceed a 64.5% concentration which would invite objectionable sucrose crystallization.
3. Storing the milk below room temperature.

**Bloats of Sweetened Condensed Milk.**—Gaseous fermentation resulting in the appearance of bloats of sweetened condensed milk is one of the most disastrous defects of this product, as the goods so fermented are commercially worthless, except possibly for use as hog feed. In the case of canned milk, the resulting pressure causes the ends of the tins to bulge and in extreme cases to burst open at the seams. In the case of bulk goods it may blow out the barrel head.

**Characteristics of Causative Germ.**—In the majority of characteristic bloats of sweetened condensed milk, the responsible organism is a virulent species of yeast of the type to which Hammer<sup>13</sup> assigned the name *Torula lactis condensis*. The reported observations by Pethybridge<sup>40</sup>, Savage and Hunwicke<sup>15</sup>, Hammer<sup>13</sup>, Cordes<sup>16</sup>, and Hunziker<sup>14</sup> indicate that each investigator found the causative micro-organism to be a budding yeast capable of fermenting sucrose in saturated solution.

The descriptions of the contents of the bulged cans also show much similarity. Hunziker<sup>14</sup> reported a case of bloats caused by an insanitary sugar chute. The inside of the chute was coated with a crust of sugar dampened by the vapors arising from the boiling milk below, and contaminated from contact with bees. The sugar had become fermented and sour. The cans bulged intensely and some opened at the body seams. The contents contained considerable acid and some lumps, grew thinner with age, and had a yeasty, sour odor and flavor. Microscopic examination revealed a practically pure culture of a yeast resembling *Torula lactis condensis*. In sucrose bouillon it caused violent gas formation, emptying the

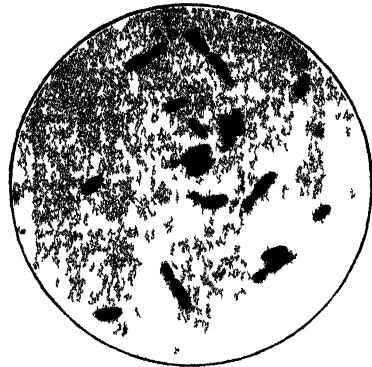
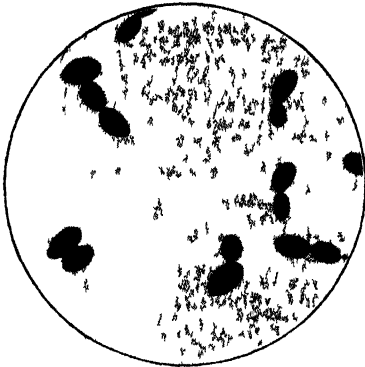

Fig 82 *Torula lactis condensis* from gassy sweetened condensed milk in barrels      Fig 83 *Torula lactis condensis* from stock cultures after many transfers

Courtesy of B. W. Himmer

closed arm of the incubated fermentation tube in about 12 hours. The closing of the sugar chute stopped the defect.

Rogers and Clemmer<sup>17</sup> reported a case of gassy sweetened condensed milk containing 40 to 45 per cent sucrose in which an aerogenes type bacterium caused vigorous gas production.

**Gaseous Fermentation due to Heavy Contamination.**—The above data indicate that gaseous fermentation of sweetened condensed milk is predominantly due to heavy contamination of the product with invigorated strains of yeast cells that are capable of fermenting saturated or near-saturated solutions of sucrose. The development of the defect is hastened by warmth, hence the occurrence of bloats of sweetened condensed milk is confined largely to the summer months.

One of the principal reasons for the above limitations lies in the fact that sucrose is not fermentable directly by yeast. It must first be inverted by the enzyme invertase which is contained in the yeast. In the inversion of sucrose (or saccharose), the molecule of sucrose takes on one molecule of water and breaks down into two molecules of monosaccharide. The monosaccharides (in this case fructose and glucose) are readily fermentable.

But yeast cells must have oxygen for their metabolism. The contamina-



tion (inoculation with vigorous yeast cells), therefore, must be sufficiently heavy to exploit the air contained in the can before this limited oxygen supply is exhausted by the activity of germ life other than yeast. It must be sufficiently heavy to incite the resulting invertase to initiate inversion at once. When once started, inversion and fermentation proceed rapidly at or above room temperature.

**Prevention of Gaseous Fermentation of Sweetened Condensed Milk.**—The most likely and the most direct cause of bloats of sweetened condensed

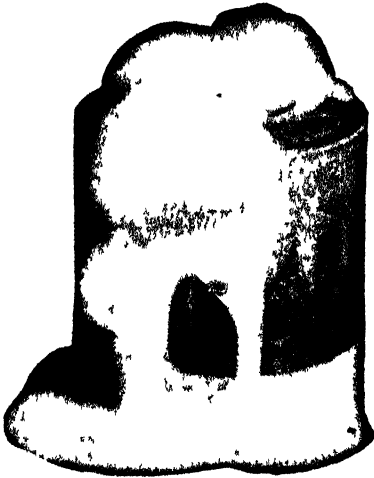

Fig 84 Gassy fermentation in sweetened condensed milk

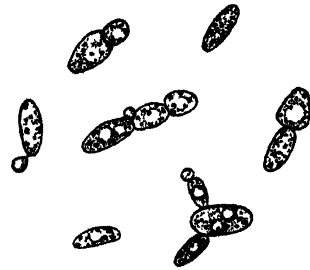

Fig 85 Yeast cells causing gassy fermentation

milk is contaminated sugar. Keep the sugar sealed in its original package until needed. Use barrels in preference to sacks. Keep it protected from dampness, and insects such as bees, wasps, flies, cockroaches. Insects plus dampness cause inversion and fermentation. Cleanse all sugar conveyors such as chutes, et cetera, after each day's use. Adding the sugar to the milk in the pan in the form of a concentrated syrup in boiling hot water (about 65% sugar in water) is a dependable safeguard.

Sanitation of all equipment, from hot wells to filling machines, and protecting the condensed milk from prolonged exposure to air, by filling into the final container as soon as possible after manufacture, are important additional precautions. Containers should be filled as full as reasonable allowance for heat expansion will permit. For bloats due to causes other than fermentation by micro-organisms, see Chapter XXXII.

### EVAPORATED MILK

Normal evaporated milk is sterile. Deming and Davis<sup>43</sup> conducted an extensive bacteriological study for the purpose of determining whether evaporated milk, as purchased in the local market, is sufficiently free from

viable micro-organisms to be bacteriologically a safe food for infants. Their conclusions were as follows:

"1. It appears that evaporated milk, as purchased in the local market, is not only free from pathogenic micro-organisms, but may, for all practical purposes, be considered sterile.

"2 From the bacteriological standpoint, evaporated milk may be considered a safe food for use in infant feeding."

Only in rare cases are bacteria found in a can of the apparently normal product. Evaporated milk that is defective because of bacterial contamination and fermentation, does occur occasionally, however. The more com-



Fig 86 Gassy fermentation in evaporated milk

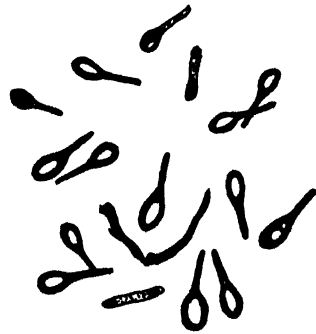

Fig 87. *Plectridium foetidum* responsible for evaporated milk bloats

mon bacterial defects of evaporated milk are: Bloats caused by gaseous fermentation, bacterial coagulation, and off-flavors due to bacterial causes, of which bitter flavor appears to be the most frequently encountered.

**Bloats of Evaporated Milk.**—Bloats caused by gaseous fermentation are commercially the most serious bacterial defect of evaporated milk. The responsible organism is usually, though not always, a spore-forming anaerobe. Savage and Hunwicke<sup>15</sup> reported bloats from which they isolated several aerobic species of the *B. coli* group which they reported to have caused gas production upon inoculation into sound tins. Hammer<sup>18</sup> isolated a streptococcus from a bloat of evaporated milk. It produced gas upon inoculation into evaporated milk. However, this organism failed to survive 15 minutes at 60° C.

The above cases appear to refer to isolated instances of gaseous fermentation caused by organisms incapable of surviving the standard process used in the sterilization of evaporated milk. Their description suggests contamination after sterilization due to cans that have become defective in or following the sterilizing process.

**Characteristic Organisms Causing Bloats.**—Characteristic epidemics of bloats in the commercial manufacture of evaporated milk, that involve

the great majority of serious outbreaks of bloats, are caused by microorganisms of superior heat resistance. Such fermentations are usually due to anaerobic bacteria belonging to the butyric acid group, and in most cases, though not always, the putrefactive types prevail. Hunziker and Wright<sup>19</sup> investigated a severe epidemic of this type of evaporated milk bloats. Gas formation was most vigorous and was accompanied by a very foul odor that suggested intense putrefactive changes.

The responsible organism answered Weigmann's<sup>20</sup> description of *Plectridium foetidum*. It is an exclusively obligatory anaerobe. It has flagella, is spore bearing and motile. It resembles a kettle-drumstick similar to *B. tetani*. Under strictly anaerobic conditions and incubated at 90° F., it ferments milk in four days. The milk first curdles, the curd gradually digests, leaving a clear yellow liquid similar in appearance to butter oil. The fermentation is accompanied by the evolution of a penetrating, foul putrefactive odor suggesting hydrogen sulfide. The organism survives 15 minutes at 245° F. Its thermal death lies between 245 and 250° F.

**Source of Organism and Prevention of Defect.**—*Plectridium foetidum* belongs to a group of butyric acid bacilli found abundantly in cultivated soil, on field crops and on small grain. According to Weigmann<sup>20</sup>, these organisms are more prominent in milk from stable-fed cows than in milk from cows on pasture. They are found in cow manure. Prevention of the defect thus involves improved sanitation in the production of milk on the farm, or such adjustment of the temperature-time ratio of heat sterilization of the evaporated milk as will destroy these germs if present in the milk. Similar anerobic spore-bearing bacilli found in bloats were reported also by Esty and Stevenson<sup>44</sup>, and Savage and Hunwicke<sup>21</sup>. (For discussion of bloats in evaporated milk due to causes other than bacterial fermentation see Chapter XXXII.)

**Coagulated Evaporated Milk.**—Bacterial coagulation is probably the most common bacterial defect occurring in evaporated milk. The coagulum found in different outbreaks has varied from the sweet curdling type to a sour curd and an intensely bitter curd. Thus, Hammer and Hussong<sup>22</sup> reported a case where the coagulum appeared normal to taste, the acidity had not increased, the curd was of varying firmness and there was complete absence of wheying-off. The causative organism was identified as *Bacillus cereus*.

Esty and Stevenson<sup>44</sup>, and Cameron and Esty<sup>45</sup> reported the study of spoils with "flat sour" coagulum due mainly to thermophilic, spore-forming bacteria. Hunziker and Cordes<sup>23</sup>, Hammer<sup>24</sup>, Sarles and Hammer<sup>25</sup>, and Kelly<sup>41</sup> separately reported coagulated milk outbreaks in which a sour curd and separation of whey occurred. In each case the organism responsible for the defect was identified as *Bacillus coagulans* (Hammer). In the case investigated by Hunziker and Cordes the organism was not destroyed by a 10-minute exposure to 176° F., but failed to survive 234° F.

**Bitter Evaporated Milk.**—Many instances of bacterial coagulum showed intense bitterness, suggesting protein breakdown and the formation of peptone and other protein decomposition products of known bitter flavor. Hunziker and Wright<sup>26</sup> investigated a case of coagulated evaporated milk with gall-like bitterness. The coagulum was firm and of striking whiteness. The contents had wheyed-off. The whey was practically clear. The acidity was normal (0.35 to 0.4%). Inoculation into sterile milk

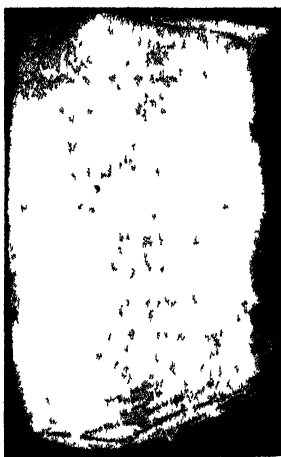

Fig 88 Sour curd in evaporated milk

Fig 89 *Bacillus coagulans*

Courtesy of B W Hammer

yielded a pure culture of very small rods. There was no apparent spore formation. The organism was a facultative anaerobe with an optimum incubating temperature of 90° F. It failed to survive exposure to 212° F. for 15 minutes.

**Prevention of Defect.**—The extreme whiteness of the contents of defective cans suggested insufficient heat treatment in sterilization as the cause of the defect. The fact that only a portion of these cans in the batch showed the defect, further indicated lack of uniformity of heat distribution in the sterilizer as the specific cause.

**Other Outbreaks of Bitter Evaporated Milk.**—Hammer<sup>27</sup> reported a similar bitter flavor outbreak and assigned the name *Bacillus amarus* to the organism responsible for the defect. In another occurrence of bitter coagulated evaporated milk Spitzer and Epple<sup>28</sup> found *Bacillus panis* to be the causative organism. This is a rapidly growing, spore-bearing rod with intense peptonizing power. It is highly heat-resistant, requiring an eight to 10 minute exposure of 250° F. for destruction.

**Fishy Flavor in Evaporated Milk.**—A can of coagulated evaporated milk with fishy flavor was reported by Hammer<sup>42</sup>. The causative organism, designated *Proteus ichthyosmius*, developed fishiness in milk, cream and evaporated milk.

## ENZYMES

**Definition.**—Enzymes are chemical substances produced by living plant and animal cells. They are known by their action on substance or substrate. They are capable of accelerating chemical changes already in progress without being themselves altered or becoming a part of the products formed. Their chemical structure is as yet unknown.

Unlike micro-organisms, enzymes do not reproduce themselves, nor increase, nor become invigorated. In their functions they do not depend upon food, moisture and air supply. Enzymes are colloidal in nature, non-dialyzable, and they do not form a true solution. Their action is independent of the living cells, but is influenced by the chemical reaction of the medium and by temperature. They are inactivated when the temperature rises above that for optimum activity. It is held by some of the leading authorities on the science of enzymes that most of the changes that are attributed to the direct action of micro-organisms are the result of enzymes secreted by them.

**Source of Enzymes.**—According to origin, the enzymes found in milk divide themselves into two groups, namely, those that are inherent in milk, and which are present at the time the milk is drawn; and those that are the result of bacterial secretion or that are a product of the catabolism of the bacterial cell. The majority of the enzymes found in milk may come from either source.

**Kinds of Enzymes.**—Enzymes are commonly named according to their functions. In milk work, the enzymes that have received the foremost attention are: lipase, protease, peroxidase and catalase. Some of the other enzymes reported to have been found in milk are lactase, diastase, salolase, aldehydease.

**Lipase.**—It has been fairly definitely established that some strains of the enzyme lipase are inherent in milk<sup>28</sup>. In addition, certain species of lipolytic micro-organisms also have been found as shown by Kirchner<sup>29</sup>, and Orla-Jensen.<sup>30</sup> To these fat-hydrolysing agencies belong the molds *Oidium lactis*, *Cladosporium butyricum*, *Actinomyces odorifera*, *Penicillium glaucum*, *Penicillium roqueforti*, several yeasts and such bacterial species as *Bacterium fluorescens liquefaciens*, *Bacillus prodigiosus*, *Bacillus mesentericus*. Some of these microbic species are commonly found in polluted water which, at least in one case of rancid sweetened condensed milk investigated by the author, proved to be the direct cause of the defect.

The enzyme lipase and rancidity-producing micro-organisms hydrolyze the fat contained in milk and milk products. Hydrolysis splits the fats (fatty glycerides) into their component parts, i.e., glycerol and free fatty acids. The resulting free fatty acids impart to the milk product the objectionable bitter flavor and the pungent, sharp, unpleasant, rancid aroma that are characteristic of such volatile free fatty acids as butyric, caproic and caprylic.

**Effect of Lipase on Sweetened Condensed Milk.**—Among concentrated milks, rancidity in sweetened condensed milk is occasionally causing serious trouble and loss. The defect can be prevented with certainty by using forewarming temperatures sufficiently high to destroy the lipase and such species of lipolytic micro-organisms as may be present. Rogers, Berg and Davis<sup>33</sup> reported that, under the conditions of their experiment, heating the milk to 66° C. (150.8° F.) greatly weakened the enzyme activity, and 80° C. (176° F.) destroyed it. Krukovsky and Herrington<sup>31</sup> pasteurized cream at 110, 125, 140, 155, 170 and 180° F. They observed that the rate of lipolysis was still measurable after an exposure of 15 minutes to 140° F., but not after 35 minutes. At 155° F. flash, lipolysis was scarcely noticeable. Rice<sup>32</sup> cautioned that when considerable sugar or old sweetened condensed milk was added to the hot well even 180° F. is only a "border-line" temperature.

Since it is common practice in American condenseries to add the sugar to the hot well, and condensed milk of a previous batch may be rerun at any time, dependable prevention of rancidity in the finished product makes necessary the use of forewarming temperatures of 180° F. or above.

**Protease.**—Proteases are enzymes belonging to the group of proteolytic enzymes which attack the proteins. To this group belongs the enzyme galactase, first reported by Babcock and Russell<sup>34</sup>. Proteolytic enzymes other than galactase which is believed to be inherent in milk, are produced by proteolytic micro-organisms.

It is the function of proteolytic micro-organisms to ferment protein compounds, such as the casein of milk, splitting these protein substances into simpler compounds. However, this function is not performed by the bacteria direct. As in the case of the bacterial breaking down of other organic substances, the splitting of the casein is the work of a succession of three enzymes produced by the proteolytic bacteria present in milk. The breaking down of the casein is initiated by a rennin or curdling type of enzyme which coagulates the casein forming insoluble paracasein and a soluble whey protein (albuminoid). The second bacterial proteolytic enzyme is a trypsin-like enzyme which has been given the name casease. It splits the paracasein into water-soluble albumoses and peptones. The third enzyme, which is known by the name erepsin, then reduces the decomposition products formed to still simpler protein compounds, such as amino acids and even ammonia.

Protease is especially active at the temperature of the animal body (98.6° F.). Its activity is somewhat less at ordinary temperature (70° F.). At the low temperatures of butter cold storage, (—10 to —20° F.) its activity is practically completely inhibited.

It appears that protease is highly resistant to heat. Rogers et al<sup>33</sup> found that it was not destroyed at 93° C. (199° F.), but they found it much weakened at 159 to 170.6° F.

**Peroxidase.**—Peroxidase belongs to the group of oxidases. It liberates oxygen from peroxides. It has the property of oxidizing readily oxidizable substances by transferring the thus liberated oxygen to them. It is a natural milk enzyme. It is largely associated with the cell elements (leucocytes) and is present, therefore, in much greater concentration in the separator slime than in the skimmilk or cream. Gillett<sup>35</sup> reported its optimal temperature to be 40 to 50° C. (104 to 122° F.).

Spitzer and Taylor<sup>36</sup> observed that heating to 62.5° C. (144.5° F.) for 20 minutes had no noticeable effect on the peroxidase in milk, but that flash pasteurization at 85° C. (185° F.) inactivated the greater part of it. Rogers, Berg and Davis<sup>33</sup> reported that flash pasteurization at 77 — 79° C. (170.6 — 174.2° F.) destroyed the enzyme, but that at 165° F. it was always present.

The peroxidase provides a dependable basis for ascertaining whether milk (or milk products) has been heated to relatively high temperatures (70° C. or above), and if so, to what temperature. In this test the presence or absence of peroxide is established by means of a color indicator, such as guaiaconic acid, which assumes a characteristic blue color as a result of its absorption of the oxygen so transferred. Thus, the peroxidase liberates active oxygen from hydrogen peroxide. It is by this reaction that the presence of peroxidase is demonstrated, the indicator guaiaconic acid being oxidized to a blue color by the liberated active oxygen.

Peroxidase is not believed to have any considerable influence upon the quality deterioration of dairy products. Its oxidizing power is limited as shown by Elliott<sup>38</sup>.

**Catalase.**—The enzyme catalase is inherent in milk. It is also produced in relatively large quantity by certain species of bacteria, as for instance, by *Bacterium acidi propionici* d (Sherman)<sup>20</sup>. The concentration of catalase is much greater in colostrum and in milk toward the end of the lactation period than in normal milk. The catalase content is increased when the cows are on green feed. Its content is especially large in milk with large numbers of leucocytes, dead and disintegrating milk cells, colostrum bodies, red and white blood corpuscles, pus cells such as are often present in milk of cows ready to become dry, oestrus milk, milk from irritated, inflamed and diseased udders. High catalase content is usually also accompanied by relatively high bacterial count. For these reasons the catalase test indicating the concentration of catalase present in the milk is looked upon and used especially in European milk plants as an index of the quality of milk and for the detection of diseased udders. The test has also proved highly valuable in the determination of the suitability of milk for cheese making. The test consists of measuring the volume of gas (oxygen) that is liberated by the milk catalase from a sufficient amount of H<sub>2</sub>O<sub>2</sub>. The more gas formed, the greater the amount of catalase in the milk and

the more suspicious its quality. The optimum temperature for the reaction is 20 to 25° C. The enzyme is inactivated by an exposure of 30 minutes to 68° C.

## REFERENCES

1. ELLENBERGER, H. B.: New York (Cornell) Agr. Expt. Sta. Mem. 18. 331. 1919.
2. RUEHE, H. A.: New York (Cornell) Agr. Expt. Sta. Mem. 76. 1924.
3. ROGERS, L. A., DAHLBERG, O. A., AND EVANS, A. C.: Jour. Dairy Sci. III. 2. 1920.
4. THOM, C., AND AYRES, S. H.: Jour. Agr. Res. VI. (1916).
5. HUNZIKER, O. F.: Condensed Milk and Milk Powder 3rd ed. pp. 237-241. 1920.
6. KNUDSEN, QUOTING HAMMER: Dairy Bacteriology, 2nd ed. 1938.
7. ANDREWS, F. W.: Jour. Path. and Bact. XVIII. 169. 1913.
8. COOKSEY, THOS.: Med. Jour. Australia II. 271. 1916.
9. GREIG-SMITH, R.: Proc. Linn. Soc. New South Wales XXXIV. 107. 1909.
10. DUGARDIN, M.: Ann. Chim. Analyst. XXIII. 83. 1918.
11. RICE, F. E., AND DOWNS, P. A.: Jour. Dairy Sci. VI. 6. 1923.
12. DOWNS, P. A.: Jour. Dairy Sci. VIII. 4. 1925.
13. HAMMER, B. W.: Iowa Agr. Expt. Sta. Res. Bul. 54. 1919.
14. HUNZIKER, O. F.: Factory Investigations of Cause of Sweetend Condensed Milk Bloats. 1903-1916.
15. SAVAGE, W. G., AND HUNWICKE, R. F.: Food Insp. Bd. London Spec. Rept. 13. 1923.
16. CORDES, W. A.: Libby, McNeill & Libby Res. Labs. 1922.
17. ROGERS, L. A., AND CLEMMER, P. W.: Abstr. of Bact. II. 6. 1918.
18. HAMMER, B. W.: Iowa State Coll. Jour. Sci. II. 1-7. 1927.
19. Cond. Milk and Milk Powder. 3rd ed. 1920.
20. WEIGMANN, H.: Pilzkunde der Milch. 2nd ed. 1924.
21. SAVAGE, W. G., AND HUNWICKE, R. F.: Food Insp. Bd. London. Spec. Rept. 13. (1923).
22. HAMMER, B. W., AND HUSSONG, R. V.: Jour. Dairy Sci. XV. 220. 1932.
23. HUNZIKER, O. F., AND CORDES, W. A.: Blue Valley Creamery Co. Res. Labs. 1923.
24. HAMMER, B. W.: Iowa Agr. Expt. Sta. Res. Bul. 19. 1915.
25. SARLES, W. B., AND HAMMER, B. W.: Jour. Bact. XXIII. 301. 1933.
26. HUNZIKER, O. F., AND WRIGHT, W. R.: Purdue Agr. Expt. Sta. Ann. Rept. 1910.
27. HAMMER, B. W.: Iowa Agr. Expt. Sta. Res. Bul. 52. 1919.
28. SPITZER, G., AND EPPLE, W. F.: Jour. Dairy Sci. III. 1920.
29. KIRCHNER, W.: Botan. Gesell. 101. 1888.
30. ORLA-JENSEN, S.: Landw. Jahrb. d. Schweiz. 1901.
31. KRUKOVSKY, N., AND HERRINGTON, B. L.: Jour. Dairy Sci. XXV. 231. 1942.
32. RICE, F. E.: Jour. Dairy Sci. IX. 293. 1926.
33. ROGERS, L. A., BERG, W. N., AND DAVIS, B. J.: U.S. Dept. Agr. B.A.I. Circ. 89. 1912.
34. BABCOCK, S. M., AND RUSSELL, H. L.: 14th Ann. Rept. Wisconsin Agr. Sta. p. 77. 1897-98.
35. GILLET: Quoted by Grimmer. Chemie und Physiologie der Milch. 1910.
36. SPITZER, GEO., AND TAYLOR, M. C.: Jour. Dairy Sci. VII. 234. 1924.
37. PALMER, L. S., AND MILLER, M. M.: Jour. Dairy Sci. IX. 272. 1926.
38. ELLIOTT: Quoted by Hammer. Dairy Bacteriology 2nd ed. 265. 1938.
39. ASSOCIATES OF ROGERS: Fundamentals of Dairy Science 2nd ed. 1935.
40. PETHYBRIDGE, G. H.: The Econ. Proc. Royal Dublin Soc. I. 1906.
41. KELLY, C. D.: Tran. Roy. Soc. Can. Sec. V. 387. 1926.
42. HAMMER, B. W.: Iowa Agr. Expt. Sta. Res. Bul. 38. 1917.
43. DEMING, JEAN, AND DAVIS, HILDA: Archives of Pediatrics. XLVIII. p. 42. 1931.
44. ESTY, J. R., AND STEVENSON, A. E.: Jour. Infec. Dis. XXXVI. 486. 1925.
45. CAMERON, E. J., AND ESTY, J. R.: Jour. Infec. Dis. XXXIX. 89. 1926.



## CHAPTER XXXII

### CONCENTRATED MILK DEFECTS

Defects due to micro-organisms and enzymes, their causes and prevention, are discussed in detail in Chapter XXXI. The present chapter deals with the physical and chemical defects of concentrated milks.

#### SWEETENED CONDENSED MILK

The major defects that are characteristic of unmarketable sweetened condensed milk are as follows: sandiness, sugar sediment, age thickening, mold buttons, bloats, curdiness, rancid flavor, metallic flavor, tallowy flavor, brown discoloration, and fat separation.

#### SANDINESS

The relative smoothness of texture of sweetened condensed milk is determined mainly by the size of the lactose crystals it contains. Sandiness is due to the presence of relatively large, coarse crystals. In milk of the desired smooth, velvety texture the crystals average 10 microns in length or less (see Table 34, Chapter XVI).

**Control of Crystal Size.**—The size of the lactose crystals is controlled

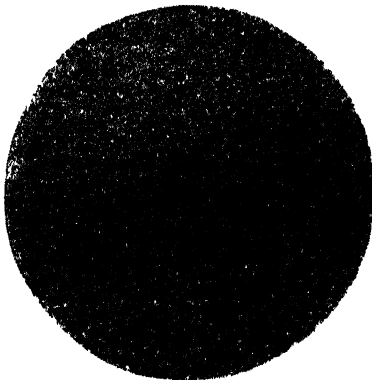

Fig. 90. Lactose crystals in smooth sweetened condensed milk



Fig. 91. Lactose crystals in sandy sweetened condensed milk

Microphotographs, Mag. x 130

by the method and management of cooling the condensed milk. The process of cooling must accomplish mass crystallization. This is done by shock cooling, liberal seeding with fine lactose dust, and vigorous agitation, as fully discussed in Chapter XVI, on "Cooling Sweetened Condensed Milk."

**Sandiness Due to Sucrose.**—When the sucrose-in-water ratio of the finished product exceeds 64.0 per cent, it approaches the status of a saturated solution of sucrose. When such condensed milk is subjected to low

temperature, such as in cold storage, or otherwise on its journey from factory to consumer, some of the sucrose that is present in excess of saturation will crystallize. The sucrose crystals so formed are of relatively large size. They give the condensed milk a coarse, sandy texture. Table 58 shows that at 32° F. water will dissolve 64.18 per cent sucrose. The presence of undissolved sucrose crystals in the fresh milk at the time it enters the pan has also been found to be a contributing factor of sandiness

TABLE 58.—SATURATION OF SUCROSE IN WATER  
AT DIFFERENT TEMPERATURES  
(Browne<sup>12</sup>)

Temperature		Sucrose Saturation percent	Temperature		Sucrose Saturation percent
° C.	° F.		° C.	° F.	
0	32	64 18	30	86	68 70
10	50	65 58	35	95	69 55
15	59	66 30	40	104	70 42
20	68	67 09	45	113	71 32
25	77	67 89	50	122	72 25

**Sandiness due to Rewarming too Cold Condensed Milk.**—When sweetened condensed milk that has been allowed to become too cold for packaging is rewarmed in the presence of agitation, the development of sandiness is almost unavoidable. Vigorous agitation while warming tends to cause the smaller lactose crystals to redissolve. This increases supersaturation and promotes diffusion of the dissolved lactose. The number of crystals is thus much reduced, so that the remaining crystals have relatively much dissolved lactose on which to grow, forming sufficiently large aggregates to give the milk an objectionable sandy character.

These findings are supported also by the "Heat Shocking Theory" discussed by Dahle<sup>1</sup> and by the findings of Zoller and Williams<sup>2</sup> to the effect that heat-shocked ice cream (allowed to soften by exposure to warmer air, and immediately frozen again) causes greater and more rapid growth of lactose crystals in ice cream. In the case of sweetened condensed milk, if the milk warms without agitation, the tendency of solution and diffusion is diminished and the danger of causing sandiness is largely eliminated.

### SUGAR SEDIMENT

Deposits of sugar sediment on the bottom of can or barrel of sweetened condensed milk are not an uncommon occurrence. Microscopic examination as well as chemical analysis show such sediment to consist predominantly of lactose crystals. The fundamental cause of such deposits obviously lies in the difference in specific gravity between the crystallized lactose and the remainder of the condensed milk.

The specific gravity at 15.5° C. (59.9° F.) of alpha lactose hydrate (which

is the form of lactose contained in sweetened condensed milk) is 1.5453. The average specific gravity of sweetened condensed milk is about 1.3085. It varies considerably with composition and concentration. The specific gravity of sweetened condensed skim milk varies from about 1.3400 to 1.4100.

**Effect of Crystal Size on Sugar Sediment.**—In harmony with the fundamental principle of Stokes' Law on the fall of a small sphere in a viscous liquid, the tendency of sugar sediment in sweetened condensed milk of a given viscosity increases or decreases, respectively, with an increase or decrease of the crystal size. Condensed milk of normal viscosity in which the lactose crystals do not exceed 10 microns in length, generally remains free from objectionable sugar sediment. The solution of the prevention of sugar sediment is, therefore, largely a problem of crystal size and viscosity. The control of the crystal size was discussed under "Prevention of Sandiness", earlier in this chapter.

**Effect of Viscosity on Sugar Sediment.**—Other factors being the same, the greater the viscosity, the greater the resistance to the force of gravity, hence the less the ability of the lactose crystals to drop to the bottom. One of the important factors that influences the viscosity of the sweetened condensed milk is the concentration. Other things being equal, the greater the concentration, the more pronounced the viscosity. In many cases of sediment trouble, the finished product is definitely too thin to hold the crystals in permanent suspension. In such cases a reasonable increase in concentration may avoid sediment provided that the crystal size is dependably controlled. For factors that influence viscosity see "Effect of Initial Viscosity" under "Age Thickening" later in this chapter.

**Effect of Turning the Cases During Storage.**—Turning the cases at specified intervals during prolonged storage tends to minimize the amount of sugar sediment. It also makes the sugar deposit that does occur somewhat less compact, softer, and more readily re-emulsifiable into the contents of the container. However, turning the cases is not a preventive of lactose crystal deposit. In the case of milk with excessive crystal size or sub-normal viscosity, a sugar deposit will occur in spite of the turning precaution.

### AGE THICKENING

Progressive thickening is a common defect of sweetened condensed milk. It is due to either bacterial activity or physico-chemical reactions. Bacterial thickening is fundamentally caused by bacterial contamination such as results from lack of efficient sanitary supervision in manufacture. It is readily prevented by proper factory sanitation and efficiently controlled forewarming treatment. In the presence of the causative contamination, bacterial age thickening can be checked by raising the sucrose-in-water ratio to near 64.5 per cent. It can be retarded by storage at low tempera-

ture (below room temperature). For details see Chapter XXXI, under "Micro-organisms."

**Age Thickening Due to Physico-Chemical Changes.**—The exact nature of the reactions that are involved in age thickening of sweetened condensed milk due to physico-chemical causes has not as yet been fully explained. It appears evident, however, that the immediate cause of the viscosity of sweetened condensed milk and of the tendency of the product to thicken progressively with age has to do with the phenomenon of colloidal swelling or hydration of the proteins (principally the casein). That the milk proteins are involved was convincingly demonstrated by the early work of Rogers, Deysher and Evans<sup>4</sup>. These investigators showed experimentally that removal of the protein, especially the casein, from the product eliminated all tendency to thicken.

**Effect of Season on Age Thickening.**—The influence of season on age thickening is very marked. Within the dairy belt of the Northern Hemisphere, sweetened condensed milk made from approximately the middle of April through May, June and into early July is least stable and shows the greatest tendency to suffer objectionable progressive thickening. In some regions this tendency extends throughout July and August and even into early September. In general, however, the milk processed in May and early June is the most vulnerable and from middle of July on it becomes increasingly stable. The stability extends throughout fall, winter and early spring. The milk produced during midwinter may even exhibit a definite tendency to age thinning.

Available experimental data on the exact cause of seasonal age thickening are lacking. It has been attributed by some to the supposed freshening of the majority of cows, and by others to the change from dry winter feed to green pasture. In fact, this unstable milk is often designated "grass milk". These assumed causes may play an important part in the occurrence of the defect. There is no lack of evidence that seasonal age thickening is a fact, but there appears to be no available information on the mechanism of the responsible changes.

Stebnitz and Sommer<sup>8</sup> reported that in the region of Madison, Wisconsin, the unstable period for sweetened condensed milk begins very abruptly, sometime between the middle of April and May. The return to stable milk occurs more slowly, usually during the latter part of June and July. They hold that there is no direct correlation between the time of these changes in stability and the freshening of the cows or their change from winter feed to green pasture.

**Effect of Forewarming Temperature.**—The forewarming temperature is one of the major controlling factors of the storage stability of sweetened condensed milk. Its proper adjustment will prevent age thickening. Full directions for the prevention of age thickening, as related to forewarming temperature, are given in Chapter XIV, on "Forewarming."

**Effect of Sucrose Content on Age Thickening.**—The sucrose content of sweetened condensed milk plays an important part in the control of age thickening due to physico-chemical causes. Hunziker<sup>3</sup> observed in commercial manufacture that an increase of the sucrose-in-water ratio decreased the tendency to age-thickening at the height of grass milk instability. Leighton and Deysher<sup>5</sup> found experimentally that the viscosity curves of sweetened condensed milk, as affected by different forewarming temperatures of the fresh milk, are practically the complete reverse of those of evaporated milk. These investigators therefore concluded that the sucrose of sweetened condensed milk modifies the effects of forewarming. They suggest that sucrose may affect the salt equilibrium by reacting with the metals or by dissolving some otherwise insoluble calcium or magnesium salts.

Because an increase in the sucrose content definitely tends to stabilize the product it has been found helpful to adjust the sucrose-in-water content according to the seasonal stability or instability of the finished product. During late spring and early summer the sucrose content is therefore preferably increased, and during late fall and winter it may be correspondingly decreased. It is good practice to keep the sucrose-in-water content at all times within the range of 61.5 and 64 per cent.

**Effect of Time of Adding the Sucrose.**—The time in the process when the sucrose is added to the batch has a considerable effect on the fluidity stability of the finished product. Results of experiments by Stebnitz and Sommer<sup>6</sup> show that the presence of the sucrose in the milk during forewarming is most conducive to age thickening. Adding the sugar in the form of a concentrated syrup near the end of the condensing period tends to cause age thinning even to the extent of giving rise to objectionable fat separation. Forewarming the milk and sugar syrup separately, cooling to pan temperature (approximately 130° F.), then mixing the milk and sugar syrup and drawing the mixture into the pan, yielded satisfactory protection against age thickening. It decreased the viscosity in terms of poises, but gave the milk a more syrupy viscosity that prevented fat separation. These results are graphically illustrated in Fig. 45. See also Chapter XIV, under "Addition of Sugar".

**Effect of Pan Temperature.**—Condensing the milk at a relatively high pan temperature tends to unstabilize the finished product and increase the tendency to age thickening. Lowering the pan temperature toward the end of the condensing period is especially effective in lessening the viscosity at the pan and diminishing the tendency to age thickening. This fact has been taken advantage of increasingly during recent years in commercial manufacture by starting the cooling process before dropping the milk from the pan. The steam to jacket and coils is shut off about five minutes before the end of the condensing period, while the operation of the vacuum pump and the water supply to the condenser are continued.

In this manner the batch is usually finished at a temperature of approximately 110° F.

**Effect of Solids-Not-Fat on Age Thickening.**—It was shown earlier in this chapter that the constituents of milk that are responsible for age thickening of sweetened condensed milk are mainly the proteins, and that their removal eliminates the ability of the product to thicken after manufacture. It may be reasonably expected, therefore, that, other conditions being the same, the thickening tendency will increase or decrease with the amount or proportion of proteins present.

This is, in fact, the case. The proteins are the major solid constituents of the solids-not-fat. Experience in manufacture, as well as experimental evidence, shows that an increase in the percentage of solids-not-fat, and especially also in the ratio of SNF-in-water, increases the tendency to age thickening. During late spring and early summer, and particularly in the case of condensed milk intended for the tropics, a suitable reduction of the SNF-in-water concentration is helpful in lessening the seasonal thickening tendency. During the winter months a suitable increase in the SNF-in-water ratio will assist in maintaining a body sufficiently heavy to prevent objectionable fat separation. Gressly<sup>14</sup> holds that the SNF-in-water ratio should be confined within the range of 44 to 48 per cent.

**Effect of Ratio of Fat to Solids-Not-Fat.**—The tendency to age thicken is more pronounced in the case of sweetened condensed skimmilk than with sweetened condensed whole milk. The ratio of fat-to-SNF alone does not prevent age thickening. Yet, a reasonable ratio such as is provided by the U.S. standard for fat and total solids, i.e., 8.5% fat and 28% total solids, or a ratio of SNF to fat of  $\frac{8.5}{(28-8.5)}$  or 1 SNF: 0.436 fat, has a

tendency to ameliorate the effect of the influences that cause colloidal swelling of the proteins. The fat lessens the intensity of the reaction. It acts as a softener and diluent of the protein suspension, yielding a product that has, and is capable of retaining, a more syrupy, more pliant and more velvety texture than the product made from skimmilk.

**Effect of Concentration.**—In general, sweetened condensed milk of high concentration has a high initial viscosity and tends to hasten age thickening. It has, therefore, been found helpful during the season of unstable milk, to finish the batch at a somewhat lower concentration than during the season of naturally stable milk. Too low a concentration, however, may cause fat separation and sugar deposit.

**Effect of Acid Reaction.**—The reaction of the milk has a very marked influence on the thickening tendency of sweetened condensed. It has long been known to the commercial manufacturer that the fresher and sweeter the fresh milk, the better the chances for satisfactory stability and keeping quality of the condensed milk. These experiences are sup-

ported by the work of Stebnitz and Sommer<sup>10</sup> who found that even small changes in the acid reaction of the fresh milk definitely influence the tendency to age thickening.

The age thickening effect of a drop in the pH of the raw milk occurs in both seasonally unstable and seasonally stable milk, but it is much more intense in the unstable milk. These findings indicate the dominating importance of efficient platform inspection with especial emphasis upon the quality of late spring and early summer milk. Stebnitz and Sommer further showed that reduction of the acidity by the addition of an alkali improved the storage stability of the finished product. They suggest that the addition of approximately 2 to 4 ounces of sodium bicarbonate per 1000 pounds of raw milk is sufficient to stabilize milk that is unstable toward age thickening.

**Effect of Initial Viscosity.**—By initial viscosity is meant the viscosity of the condensed milk at the pan at the end of the condensing period. The initial viscosity is an important factor in the combination of conditions that determine the permanency of the fluidity of sweetened condensed milk. It reflects reactions that appear to hold the key to the extent of colloidal swelling of the proteins, such as are caused by the heat treatment of forewarming and of condensation as modified by the presence of sucrose. Because of this fact it is not uncommon that different batches of the same composition and the same specific gravity yield different initial viscosities. It is helpful to determine the initial viscosity of the batch both at the pan (without cooling) and again the next day.

**Effect of Storage Temperature.**—The storage temperature has a very marked effect on age thickening. In the case of seasonally unstable milk, the thickening tendency increases with the storage temperature. At or below 45° F. the product retains its initial viscosity practically permanently, but even at 60° F. there is definite retarding of age thickening. At room temperature (about 70° F.) there is a very gradual but persistent increase in viscosity. As the temperature rises above 70° F., this increase becomes more rapid. In summer heat (85 to 100° F.) such milk usually becomes solid within 30 days or less after manufacture.

Stable milk, such as is characteristic of milk produced in late fall and winter, or the manufacturing procedure of which is adjusted for maximum resistance to the unstabilizing influence of high storage temperatures, (milk intended for the tropics) will retain its initial fluidity for several years.

The few published experimental data<sup>4, 7</sup> on the relation of storage temperature to age thickening support the above facts in a general way. Some of the foremost manufacturers of sweetened condensed milk for the tropics, where sustained exposure to tropical temperatures is unavoidable, have succeeded in supplying those markets with a product that is practically age thickening-proof under the most adverse temperature conditions.

They have accomplished this achievement by the diligent application, in the process of manufacture, of a carefully considered combination of the stabilizing factors discussed in the foregoing paragraphs. Profound study and long experience have enabled them to develop a process sufficiently versatile for ready adjustment to seasonal changes and for dependable assurance of permanent storage fluidity consistent with a commercially satisfactory viscosity.

#### OTHER DEFECTS OF SWEETENED CONDENSED MILK

**Bloats Due to Causes Other than Gassy Fermentation.**—For bloats caused by bacteria and yeasts see Chapter XXXI under "Micro-organisms". The present discussion deals with bloats due to thermal contraction and expansion of the contents of the tins. Bloats of this character are possible only in the case of cans the seal of which is not entirely hermetical. This has been found to be the case with the Gebee-type of burr cap seal and the McDonald type of friction cap seal, as explained in Chapter XXX under "Storage".

An instance of this type of bloats was brought to the attention of the author. A condensery packaging its sweetened condensed milk in tins with the Gebee-type seal, stored its goods during the winter months in a storage shed where it was exposed to low temperature. The milk happened to reach the market during warm weather. Soon complaints reached the factory that the milk was spoiled, the cans showing bulged ends. Tins sent to the author for examination looked like typical bloats but upon opening, the milk was found sound and normal.

In order to definitely determine the cause, sweetened condensed milk of a batch of local manufacture was filled into an equal number of tins with the Gebee-seal and tins with the solder-seal. In addition, six Gebee-seal tins and six solder-seal tins were purchased at random from grocery stores. All tins were placed in the cooler at 40° F. At the end of three days all tins were transferred to a top shelf in the office where the temperature averaged approximately 80° F.

After three days at this temperature, every Gebee-seal tin had developed bulged ends characteristic of bloats of spoiled milk. Every tin with the solder seal was normal. Upon opening, the contents of all tins, regardless of type of seal, were found perfectly normal. It is evident from these experimental results that, in the case of tins with non-hermetical seal, successive exposure to low and high atmospheric temperatures may cause the appearance of bulged ends identical to those of bloats of spoiled milk.

**Rancid Flavor.**—Rancidity is not a frequent defect of sweetened condensed milk. Its cause was discussed in Chapter XXXI under "Enzymes". Rancidity in sweetened condensed milk is readily prevented by the following precautions:

1. Forewarm the<sup>d</sup> fresh milk at temperatures above 150° F.



2. Avoid leaks of raw milk into the batch during forewarming and between forewarmer and vacuum pan.

3. Do not add sugar, nor remnants and rinsings of condensed milk to the fresh milk before or during the forewarming process.

4. Use unpolluted water in the condensery and keep condenser, vacuum pan and other milk-handling equipment in sanitary condition.

**Metallic Flavor.**—Sweetened condensed milk may be pregnant with a pronounced, disagreeable metallic flavor suggesting the puckery, coppery taste of copper salts.

This flavor defect is usually confined to the use of copper equipment, such as copper forewarmers and copper vacuum pans, the milk-side of which is not in sanitary condition. It is a particularly characteristic defect of milk condensed in a copper pan with neglected dome or vapor belt and goose neck. See "Importance of Vacuum Pan Sanitation", Chapter X.

**Tallowy Flavor.**—Tallowiness is due to autoxidation of the milk fat. This flavor defect has practically been eliminated from the calendar of sweetened condensed milk defects. To be sure it can still happen, if the finished product is exposed for a considerable period of time to air and light, and in plants that are still using copper vacuum pans and copper forewarmers. But where stainless steel equipment is used, tallowy flavor in sweetened condensed milk is no longer a problem. In the case of copper equipment, its sanitary care, as recommended under "Metallic Flavor", also will prove a dependable preventive of the development of tallowy flavor.

**Fat Separation.**—Fat separation in sweetened condensed milk occurs infrequently. It is the result of abnormally low viscosity and thin body. In such milk at rest, there is a definite tendency of some of the fat to rise to the surface forming a layer that has a considerably deeper and clearer yellow color than the body of the milk. In transportation the motion and jolts cause partial remixing that gives the contents of the container a mottled-like appearance.

Fat separation may be expected to be caused by the several factors that cause the finished product to be abnormally thin and it is readily prevented by the factors that are known to increase body and viscosity.

Thus, in late fall and winter when the product has maximum natural storage stability, the milk has a tendency toward the type of thinness that invites fat separation. This is readily prevented by any one or more of the following changes:

1. slightly increase the SNF-in-water ratio;
2. increase the ratio of concentration;
3. forewarm within a temperature range of 185 to 212° F.;
4. slightly decrease the sucrose-in-water ratio.

**Dark Color.**—The causes of the browning of concentrated milk were discussed in Chapter II under "Color". The immediate causes of the

discoloration are the intense heat treatment of forewarming, and high storage temperature.

**Effect of Forewarming on Color.**—The influence of the time factor of forewarming is more pronounced than the temperature factor. Heating to the higher temperature, even as high as 250° F. by the flash method or holding for only a very few minutes, causes less development of color than heating to much lower temperatures (such as to near the boiling point) for a longer time (such as 30 minutes).

Heating by means of metal heating surfaces, such as with a tubular heater, to an abnormally high temperature (300° F., for instance) causes a very brown color. This can be prevented by finishing the heating (about the top 30° F.) with live steam under pressure. In the presence of an alkaline condition, discoloration is hastened at any temperature.

**Effect of Cut-Opens on Color.**—The presence of cut-opens and remnants of sweetened condensed milk of previous batches increases the color of the new batch. The larger the proportion of these additions the more noticeable the effect on the color of the fresh batch. It appears that the condensed milk is more sensitive to the second heat treatment and less resistant to the reactions responsible for the resulting discoloration. Redissolving a car of age thickened milk returned to the factory, in water and re-running it with fresh milk yielded a chocolate brown color in the new batches. This browned milk then went to a certain mining region. Its pronounced caramel flavor appeared to be relished in spite of the brown color, for the same market demanded repeat shipments of sweetened condensed milk with brown color. The average consumer, however, objects to browned condensed milk, and insists on a natural, creamy, light color.

**Effect of Storage Temperature on Color.**—In storage at favorable temperatures the color increases progressively. At a low storage temperature (40 to 45° F.) the color is not noticeably affected by aging. The milk does not turn darker. As the storage temperature rises to room temperature (about 70° F.) a slight darkening becomes evident in the course of two to three months. At summer heat the rate of darkening is accelerated. Even within 30 days the color will be distinctly darker, depending somewhat on the intensity, and especially the duration, of the heat treatment of forewarming the raw milk of the respective batch.

#### EVAPORATED MILK

Evaporated milk, in order to be marketable, must be free from symptoms of biological fermentation. It must be sterile. In addition, it must have certain physically important properties, such as a fullness of body that symbolizes richness and prevents objectionable fat-separation; a smooth and homogeneous texture; a pleasing natural milk flavor; and a light, creamy color.

Thanks to the ingenuity and ceaseless effort on the part of the com-

mercial manufacturer, the evaporated milk industry has attained a high level of processing perfection. These efforts have been materially assisted by the cooperation of the equipment engineer in providing much improved condensery equipment, and by the results of scientific research on processing reactions on the part of Federal and several of the State Agricultural Experiment Stations

Due to these accomplishments some of the former defects have been eliminated, the recurrence of the remaining defects has been materially reduced, and the "general run" of the goods that reach the consumer may justly be said to be of uniformly high quality. Thus, the defects due to bacterial causes have simmered down to occasional cans of coagulated milk that may contain a sweet, sour, or bitter curd, and of bloats due to gassy fermentation. These defects are discussed in detail in Chapter XXXI under "Micro-organisms".

### DEFECTS DUE TO PHYSICAL CAUSES

To this group belong such defects as: curdiness due to heat coagulation; fat separation; mineral deposit; browning; bloats due to freezing, to change in altitude, and to chemical action by milk acids upon base metal of container.

**Curdiness due to Heat Coagulation.**—It was shown in Chapter XXV, under "Viscosity", that dependable prevention of curdiness and other physical defects that dissipate the marketable properties of the finished product, necessitates efficient control of the viscosity of the evaporated milk. The causes and prevention of curdiness due to heat coagulation are briefly summarized as follows:

1. Curdy evaporated milk is due to too low heat stability in the presence of the heat treatment used for sterilization.

2. The standard commercial sterilizing process of holding at 240° F. for 20 minutes, or other temperature-time ratios with equal lethal effect, represents the minimum temperature-time ratio that will insure a sterile finished product.

3. When the cooking time (minutes held at full sterilizing temperature) approaches the heat stability\* time, there is danger of permanent curdiness in the finished product.

4. U.S. standard Evaporated milk that is to come out of the sterilizer with a nice, smooth texture (free from visible curd), consistent with a good, full body, should have a heat stability within the range of 30 to 40 minutes.

5. Such milk on the day sterilized may be expected to have a viscosity of approximately 100° retardation at 86° F. (MacMichael), or 150° retardation at 75° F. (Mojonnier-Doolittle), or about 7000 centipoises.

\*Heat stability time here refers to the time (minutes) necessary to initiate visible coagulation.

6. If the heat stability of the evaporated milk is too low to insure freedom from curdiness, it may be increased, and curdiness prevented, by the use of higher forewarming temperatures (see Chapter XIX on "Forewarming"), or by the proper use of a casein stabilizer (see Chapter XXVI on "Control of Heat Coagulation").

7. Too old or otherwise inferior raw milk, as well as holding the evaporated milk too long, or at too high a temperature before sterilization, are not infrequent causes of curdy evaporated milk.

8. High homogenizing pressure, such as pressures between 3000 and 4000 pounds, lowers the heat stability and increases the tendency to curdiness. In the presence of raw milk of inferior quality, or evaporated milk held improperly before sterilizing, homogenizing pressures in excess of 2500 pounds greatly increase the tendency to a curdy finished product.

**Fat Separation.**—It was pointed out in Chapter XXI that the adoption of homogenization as an integral function of the manufacture of evaporated milk eliminated the defect of fat separation as a serious problem. Yet, even in the homogenized product, the distribution of the fat globules is not permanently uniform. The work of Webb and Holm<sup>15</sup> shows that the milk in the top third of the tin becomes increasingly richer in milk fat with progressive storage.

If objectionable intensity of fat separation is to be avoided, therefore, it is necessary, in addition to efficient homogenization (such as reduces the fat globules uniformly to a diameter of 2 microns or less), to aim not for maximum heat stability but for a stability sufficiently moderate to give the evaporated milk a full body and a viscosity adequate to definitely retard fat separation in storage. To accomplish this the processor aims at a concentrate that possesses a heat stability a few minutes longer than about twice that of the sterilizing period<sup>16</sup>. Then, by varying the sterilizing temperature-time ratio he is able to adjust the heat stability to that which will yield the optimum viscosity for maximum fat emulsion stability.

In addition, the cream layer formed by the longer time of heating to a lower temperature of the standard commercial sterilizing process used, is less objectionable than that resulting from the use of a high-temperature, short-time, sterilizing process. Thus, Bell, Curran and Evans<sup>16</sup> demonstrated that the low-temperature, long-time process not only provides better opportunity for control of viscosity, but it also decreases the firmness of the cream layer and increases the ease with which the fat in the layer can be redistributed in the product.

**Mineral Deposit.**—Under certain conditions there is a tendency for a whitish gritty deposit to appear on the milk side of the bottom of the container. This deposit consists chiefly of tricalcium citrate. For details see Chapter XXV. The causes and prevention are briefly summarized as follows:

1. Citric acid is believed to be present in milk combined with the calcium and magnesium. The citric acid content of milk has been found to be greatest when the cows are on green pasture. The citrates may, therefore, be expected to be highest in late spring and early summer.

2. The higher the concentration of the evaporated milk, the greater the tendency for the appearance of a mineral deposit during storage.

3. The temperature of storage is a controlling factor. The higher the temperature, the larger the amount of deposit. At 45° F. or below there is no precipitation of mineral salts.

**Browning of Evaporated Milk.**—The causes and prevention of discoloration of evaporated milk are briefly summarized as follows:

1. The darkening of color is due to a reaction, in the presence of sterilizing heat, between the sugar of milk and certain amino acids (protein compounds) which causes discoloration of the proteins.

2. The browning effect is much less intense in the case of high-temperature, short-time heat treatment than with long-time, low-temperature exposure.

3. The color of evaporated milk darkens with age. The rate of darkening increases with the storage temperature. At 41° F. or below there is no change of color during storage.

For detailed discussion see Chapter XXV.

**Bloats of Evaporated Milk due to Causes other than Micro-Organisms.**

—For discussion of bloats caused by bacterial fermentation, see Chapter XXXI under "Micro-organisms". The present discussion deals with bloats due to freezing, to change in altitude, and to chemical action. Bloats resulting from these causes are infrequent.

When **Freezing**, the contents expand sufficiently to cause the cans to bulge at their ends, giving the impression of bloats. When subsequently transferred to temperatures at which the milk melts, the bulging ends almost invariably "flip" back to normal.

**Change to High Altitude** may cause the tins to bulge. This will result especially when the cans are sealed at a low altitude and are then transferred to regions of high altitudes. The danger in such cases is intensified if the evaporated milk happens to be cold at the time of filling and the atmosphere at the higher altitude happens to be warmer, causing the air and milk in the can to expand. The pressure difference between inside and outside of tin thus causes the can ends to bulge out. One specific case in which an entire shipment of bloats of this nature was condemned was investigated by the author. Inspection of the contents showed the milk to be perfectly sound.

**Chemical Action** of the milk acid upon the base metal of the container is capable of evolution of gas sufficient to cause the appearance of bloats. This fact was experimentally demonstrated by Hunziker and Wright<sup>17</sup>. Similar results were reported also by Dodge<sup>18</sup>.

## REFERENCES

1. DAHLE, C. D.: Proc. World's Dairy Cong., Washington, D. C., I. 1923.
2. ZOLLER, H. F., AND WILLIAMS, O. E.: Jour. Agr. Res. XXI. 1921.
3. HUNZIKER, O. F.: Condensed Milk and Milk Powder. 1st ed. pp. 148-152. 1914.
4. ROGERS, L. A., DEYSHER, E. F., AND EVANS, F. R.: Jour. Dairy Sci. III. 468. 1920.
5. LEIGHTON, A., AND DEYSHER, E. F.: Proc. World's Dairy Cong. Washington, D. C. II. 1276. 1923.
6. MIYAWAKI, A.: Proc. World's Dairy Cong. II. 1233. 1923.
7. STEBNITZ, V. C., AND SOMMER, H. H.: Abstracts 27th Ann. Meet. Am. Dairy Sci. Assn., Lexington, Kentucky. p. 48. 1932.
8. STEBNITZ, V. C., AND SOMMER, H. H.: Jour. Dairy Sci. XVIII. 757. 1935.
9. STEBNITZ, V. C., AND SOMMER, H. H.: Jour. Dairy Sci. XVIII. 805. 1935.
10. STEBNITZ, V. C., AND SOMMER, H. H.: Jour. Dairy Sci. XIX. 55. 1936.
11. STEBNITZ, V. C., AND SOMMER, H. H.: Jour. Dairy Sci. XIX. 101. 1936.
12. BROWNE, C. A.: Handbook of Sugar Analysis. p. 649. 1912.
13. DODGE, C. W.: Jour. Inf. Diseases. Supple. 1. 1905.
14. GRESSLY, K. E.: Techn. Dir. Berner Alpen Milchgesellschaft. 1941.
15. WEBB, B. H., AND HOLM, G. E.: Jour. Dairy Sci. XXII. 363. 1939.
16. BELL, R. W., CURRAN, H. R., AND EVANS, F. R.: Jour. Dairy Sci. XXVII. 913. 1944.
17. HUNZIKER, O. F., AND WRIGHT, W. R.: Purdue Agr. Expt. Sta. 1911 Results not published.

## CHAPTER XXXIII

### THE DRIED MILK INDUSTRY

#### HISTORY AND DEVELOPMENT

Dried milks, similar to condensed milks, are forms of concentrated milk. The fundamental difference between milk powder and condensed milk is mainly one of degree of concentration. The objectives striven for are basically the same, i. e., optimum conservation of the natural properties that are characteristic of fresh milk, dependable keeping quality of the finished product, reduction to minimum bulk to facilitate economical transportation to all parts of the world.



Fig. 92. A modern milk drying factory  
Courtesy of F. H. Douthitt

References to milk powder date back to medieval history. To Marco Polo<sup>1</sup> (1254-1324), the celebrated Venetian traveler, is attributed the description of a dried milk made by the Tartars during the 13th century. In China he found Kublai Khan, 1216-1294, a Mongol Emperor, grandson of Genghis Khan, conqueror and founder of the Mongol dynasty. Kublai Khan reigned from 1259 to 1294 as ruler of China and large portions of western and central Asia and Russia. Marco Polo rose rapidly in the emperor's favor and was employed in important missions in various parts of the empire. Upon his return to Venice in 1295, he reported that the soldiers of Genghis Khan were said to have carried dried milk as part of their ration.

Next we hear of dried milk in tablet form made in 1810 by the French scientist Nicolas Appert,<sup>2</sup> from milk concentrated slowly to a dough-like consistency in a current of dry air. The first process that was utilized for manufacture on a commercial scale was that invented by Grimwade,

to whom was issued a British patent in 1855. The perfection of milk drying processes for commercial use dates back to about the same period, the last half of the 19th Century, as that of commercially practicable processes of milk condensing. In most cases the inventors of processes for the one product were not unmindful of the possibilities of the other.

In the United States the first successful dried milk manufactured on a commercial scale was malted milk, the process having been invented in 1883, and the product first placed upon the market in 1887. This product contains, in addition to milk solids, the extract resulting from the enzymation of barley malt and wheat flour paste. Its advent constituted an important step in the development of milk drying. For details on Malted Milk see Chapter XL.

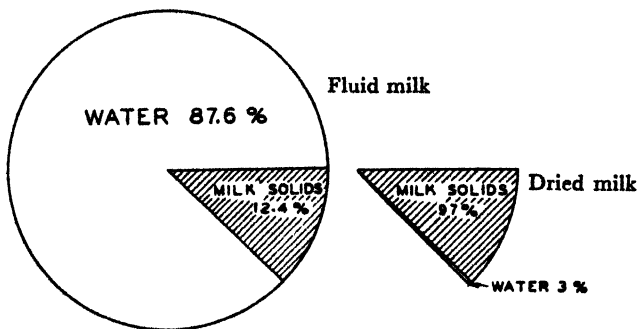

Fig. 93. Showing reduction in volume

**Kinds of Dried Milks.**—Every form of fluid milk product and fluid milk by-product lends itself to conversion to the powder form. Thus we have today dried whole milk, dried cream, dried skimmilk, dried buttermilk, dried whey, dried ice cream mix, dried malted milk.

In most dairy countries volume production of milk powder began with the drying not of whole milk, but of skimmilk. This has been true especially of countries that convert a large portion of their milk production to butter and sweet market cream, thus being confronted with the problem of finding a profitable market for large volumes of surplus skimmilk. The reason for volume production of dried skimmilk is obviously an economic one.

**Utilizing Skimmilk Solids for Human Nutrition.**—The market of the bulky fresh factory skimmilk for the feeding of farm animals and fowl within economically practicable hauling distance is limited and entirely inadequate for the utilization of the enormous skimmilk surplus. Because of this unabsorbed surplus, the returns per gallon are far below the true nutritional value of skimmilk solids. The same is true also of the returns from skimmilk marketed in the form of industrial casein.

There appears to be only one answer to the problem of profitable exploi-



tation of the creamery skimmilk and that is to market it in suitable form for human consumption. The usual skimmilk dairy products, such as skim cheese (hard cheese), cottage cheese, skim condensed milk both sweetened and unsweetened, have been absorbing a considerable portion of the skimmilk surplus.

**Skimmilk Solids Needed in Prepared Food Industries.**—With the advent of dried skimmilk, supplied not only as such to the kitchen of the consumer, but especially also to prepared food factories, such as for the manufacture of ice cream mix, candy, confections, milk chocolate, for bread making, as a constituent of sausage, in prepared soups and the like, hundreds of millions of pounds of surplus fluid skimmilk are annually diverted from channels of complete waste and financial loss and turned into channels of human nutrition, profitable returns, and promotion of consumer health.

**Definition and Change in Name of Dried Skimmilk.**—The name of the dried product resulting from the removal of the bulk of the water contained in the fluid skimmilk was changed by Act of Congress approved by the President of the United States March 2, 1944, from "Dried Skimmilk" to the designation "nonfat dry milk solids" or "defatted milk solid". The Act reads as follows:

"An Act to fix a reasonable definition and standard of identity of certain dry milk solids.

"Be it enacted by the Senate and House of Representatives of the United States of America in Congress Assembled, That for the purposes of the Federal Pure Food, Drug and Cosmetic Act of June 26, 1938 (ch. 675, sec. 1, 52 Stat. 1040), nonfat dry milk solids or defatted milk solids is the product resulting from the removal of fat and water from milk, and contains the lactose, milk proteins, and milk minerals in the same relative proportions as in the fresh milk from which made. It contains not over 5 per centum by weight of moisture. The fat content is not over 1½ per centum by weight unless otherwise indicated. "Approved March 2, 1944."

The term "milk", when used herein, means sweet milk of cows.

It does not lie within the province of this treatise to comment upon the merits of the new nomenclature quoted above. However, for clarity's sake and to avoid confusion, the designation used throughout this volume, for the product resulting from the drying of skimmilk, will continue to be "dried skimmilk."

**Annual Production of Dried Milks in the United States.**—According to Government statistics for 1943,<sup>3</sup> a total of 11,023,000,000 pounds of factory separated skimmilk was utilized for manufacturing purposes during that year. Over one-half of that volume (53.3%) of surplus skimmilk was dried. The annual production in the United States of all forms of dried milk products for the years 1916-1944 inclusive, is given in Table 59.

Table 59 shows that the annual production of dried skimmilk exceeds that of all other dried milk products combined. The figures further indicate that for the period 1932 to 1942 inclusive, for every pound of whole milk powder made there was produced approximately 15 pounds of skim-

milk powder. In 1944 the ratio had dropped to approximately 3.4 pounds of dried skim milk for each pound of dried whole milk.

TABLE 59.—ANNUAL PRODUCTION OF DRIED MILKS IN THE UNITED STATES\*

Year	Dried Whole Milk	Dried Skim-Milk <sup>1</sup>	Dried Cream	Dried Butter-milk	Dried Whey	Dried Malted Milk
	1000 pounds	1000 pounds	1000 pounds	1000 pounds	1000 pounds	1000 pounds
1916	2,123	16,463		342		11,654
1917	3,138	22,624		2,557		13,852
1918	4,164	25,432	654	4,341		15,623
1919	8,660	33,076	592	5,278		17,436
1920	10,334	41,893	309	5,585		19,725
1921	4,242	38,545	129	7,708		15,651
1922	5,599	41,217	118	9,007		13,659
1923	6,569	62,254	328	13,032		15,331
1924	7,887	69,219	330	18,058		15,899
1925	8,931	73,300	339	22,772		18,050
1926	10,768	91,718	331	31,378		20,673
1927	11,464	118,123	338	38,435		22,116
1928	9,605	147,990	673	45,502		21,128
1929	13,202	207,579	294	54,215		22,850
1930	15,440	260,675	400	64,601		22,691
1931	12,627	261,938	161	50,535		19,197
1932	11,983	270,194	80	48,712		13,215
1933	13,026	288,114	154	53,141		12,430
1934	15,809	294,935	65	53,636		13,569
1935	19,432	297,506	44	49,823		15,485
1936	18,180	349,550	178	50,781		18,495
1937	13,676	372,203	79	53,141	66,582	19,785
1938	21,496	449,291	40	63,910	47,384	15,394
1939	24,472	408,380	49	62,187	56,341	19,744
1940	29,409	481,805	54	67,931	90,996	20,021
1941	45,627	476,497	43	75,614	111,316	23,242
1942	62,167	626,562	54	69,637	124,479	34,679
1943	137,766	533,899	216	60,995	110,158	49,435
1944	177,877	598,861	193	56,573	141,553	38,655

\*From Agricultural Statistics, U. S. Department Agriculture Yearbooks.  
<sup>1</sup>Includes Spray and Drum powder; for human food and for animal feed.

**Production of Dried Whole Milk Retarded by Uncertainty of Keeping Quality.**—In sharp contrast to the phenomenal production of dried skim-milk, the annual output of dried whole milk has been limited, and prior to World War II it appeared relatively static. Foremost among the volume-retarding factors has been the problem of dependable keeping quality. Dried whole milk is subject to autoxidation of its milk fat, accompanied by quality-destroying tallowy flavor. Dried skim milk is practically free from this danger.

Extensive experimental research was necessary, therefore, to establish means of preventing costly age spoilage of dried whole milk, sufficiently

dependable to justify embarkation upon large scale production of this important food product. Due to the food urgency of World War II, these efforts in the interest of quality improvement were redoubled. This has resulted in improved methods of manufacture and packaging, methods that are proving effective in delaying or preventing damaging fat oxidation. These accomplishments have definitely diminished the risk of storage and increased the volume of manufacture of dried whole milk. Thus, in the year 1944 the production of dried whole milk in the United States has jumped to 177,877,000 pounds.

In the presence of the marked development that has been made within recent years, in volume of production, and in the perfection of flavor, keeping quality and solubility of dried whole milk, and in the properties of its reconstituted product, it is interesting here to note the early verdict of the eminent German dairy scientist, Dr. Fleischmann<sup>4</sup>, of the University of Göttingen, on the future possibilities of whole milk powder. This investigator commented upon the poor keeping quality, unpalatability, insolubility, and denatured condition of the proteins, of dried whole milk made in the latter half of the nineteenth century by the firm Dalson, Blatchford and Harris, in their factory near New York City.

As a result of this failure, Fleischmann<sup>4</sup> reached the following conclusion: (Translated from the German by the author.)

"As the result of this failure, the question whether it is possible to produce a marketable product worthy of the name milk, by dehydrating milk and reconstituting the dried mass, is thus answered conclusively and finally for all time."

TABLE 60.—ANNUAL PRODUCTION OF DRIED MILK  
IN DIFFERENT COUNTRIES\*

Country	1928-31 Annual Average	1932-35 Annual Average	1936-39 Annual Average	1940-41 Annual Average
	1,000 pounds	1,000 pounds	1,000 pounds	1,000 pounds
Australia.....	48,151 <sup>1</sup>	12,967 <sup>2</sup>	20,040 <sup>2</sup>	.....
Canada <sup>3</sup> .....	15,457	16,689	27,316	34,148
Great Britain.....	15,008 <sup>3</sup>	26,096 <sup>4</sup>	39,200 <sup>4</sup>	.....
Netherlands <sup>5</sup> .....	20,924	39,682	68,948	.....
New Zealand.....	14,750 <sup>3</sup>	.....	.....	.....
Switzerland.....	95,122 <sup>3</sup>	.....	.....	.....
United States <sup>6</sup> .....	232,646	302,764	414,312	516,717

\*Summarized from Figures of Div. Statist. and Histor. Res., Bur. Agr. Economics.

1. Includes condensed milks.

2. Dried milk, year beginning July 1.

3. Dried milk and dried skim milk.

4. Same as "3" plus sweetened.

5. Dried milk.

6. Dried whole milk, dried skim milk, dried whey.

Table 60 gives available figures of annual production of dried milk in some of the principal dairy countries other than the United States.

#### REFERENCES

1. *The Book of Ser Marco Polo*: Vol. I. 1903.
2. APPERT, NICOLAS: *L'Art de Conserver, Pendant Plusieurs Années, Toutes les Substances Animales et Végétales*. English Translation of Second Edition. 1812.
3. Bureau Agricultural Economics: *Production of Manufactured Dairy Products in 1943*. U. S. Dept. Agr. 1945.
4. FLEISCHMANN, W.: *Lehrbuch der Milchwirtschaft*. 3rd ed. 386. 1901.

## CHAPTER XXXIV

### MILK DRYING SYSTEMS

The systems and processes of milk drying are listed in the following classification:

Drying by	Cold	Freezing out water and centrifuging	
		Freezing milk and sublimation	
	Heat	Dough or Paste Drying	
		Film Drying	{ Atmospheric drum Drum in vacuum chamber
		Flake Drying	{ Atmospheric flake drying Vacuum band drying
Spray Drying	{ Compressed air Pressure spray Centrifugal spray		

This chapter deals with the drying of milk by the application of cold, and the application of heat by means of the film- or drum-drying system (roller process), and the atmospheric-flake and the vacuum band drying system, respectively.

#### DRYING MILK BY APPLICATION OF COLD

The commercial development of the manufacture of milk powder has been builded, practically exclusively, upon evaporation of the water contained in the milk by the utilization of heat. Numerous attempts, however, have been made to dry milk by the use of cold. The basic principles upon which the drying of milk by the use of cold has been worked out are: 1. Drying by freezing out the water and separating the ice crystals from the milk solids by centrifuging, and 2. Drying by freezing the milk and evaporating the water from the frozen product by sublimation

**Drying Milk by Freezing Out the Water.**—This system was proposed by Byron F. McIntyre,<sup>1</sup> of East Orange, New Jersey, who in 1894 was granted a German patent. Skimmilk placed in shallow trays is allowed to freeze from the top down. The crust of milk ice so formed is broken up by stirring sufficiently often until the entire contents of the container constitute a snow-like mass of crystals. The crystals proper consist almost exclusively of frozen water. They are surrounded by a pasty layer of milk solids in unfrozen condition. The entire mass is then centrifuged at high speed while playing a steam jet upon the crystal mass. This treatment removes the semi-fluid milk solids from the ice crystals. The ice crystals remain in the centrifuge, while the paste of milk solids is allowed to freeze solid in a thin layer upon a rotating refrigerated disc. The frozen milk solids are scraped off the revolving disc in the form of flakes which

are then dried in a vacuum at moderate heat. Prior to, or during the drying an amount of sterilized cream sufficient to standardize to the composition desired in the finished product is added to the flaky milk solids.

**Drying by Freezing the Milk and Evaporation by Sublimation.**—The basic principle involved in this system of drying is to subject the product to a high vacuum. The vacuum must be sufficiently high to cool the milk to its eutectic temperature, which is the temperature at which all the constituents of the product freeze. In the case of milk this temperature is lower than the freezing point of water.

Thus, if whole milk is subjected to a very low pressure, such as 1/50 of one inch absolute, the water is frozen out of the product in the form of very small ice crystals, and the milk solids are left practically a bone dry matrix that separates the small ice crystals. If the high vacuum is sustained and heat is applied to the product the ice will sublime, i.e., it will change from the solid ice to water vapor without going through the liquid stage (water) and the milk solids are left practically bone dry.

Basically the above is the principle of drying milk from the frozen state. The successful practical application of this principle involves, in addition, the solution of the engineering problem of dissipating the tremendous volume of water vapor that results in the presence of the greatly reduced pressure. Water vapor is a very elastic material and, as the pressure is decreased, the specific volume of vapor increases. Thus, at atmospheric pressure one pound of water vapor occupies approximately 13 cu. ft. Under the conditions of high vacuum (1/50" absolute pressure) as given in the above example, each pound of water driven off from the product by sublimation, occupies approximately 30,000 cu. ft. Therefore, this tremendous volume of water vapor must be removed as fast as it is formed, in order to sustain the very high vacuum that is indispensable for the success of the process.

Numerous attempts have been made to dry organic substances by the use of this principle. Experimental results of many investigators have demonstrated the superiority of drying food products from the frozen state. In 1906 d'Arsonval and Bordas<sup>9, 10</sup> described the vacuum desiccation for the drying of frozen organic material. In 1907 U. S. Patent No. 864978 was issued to Morel.<sup>11</sup> Shackell<sup>12, 13</sup> in 1909 also dried organic substances from the frozen state and found that by this method of desiccation, utilizing vacuum and a chemical desiccant, organic substances retained their physical condition better than when they were dried from their natural state. In 1935 Elser, Thomas, and Steffen<sup>14</sup> proposed certain changes and modifications in apparatus and equipment for drying from the frozen state. In 1942 a U. S. patent was granted to James C. Irwin, Jr.,<sup>3</sup> Kansas City, on a batch process of dehydrating frozen milk, using silica gel as desiccant for the resulting water vapor.

In spite of the many advantages inherent in drying from the frozen

state, no commercial installations have been made. This appears to be due to the fact that the engineering problems incidental to drying from the frozen state have so far proved insurmountable to the many researchers who have attempted to arrive at a satisfactory solution. The latest process resulting from efforts to provide a commercially practicable, continuous method of food drying by taking advantage of the principle of drying from the frozen state, is the Freeze Drying Process, developed by the Research Engineering Staff of the Chain Belt Company,<sup>8</sup> Milwaukee, Wisconsin.

**The Freeze Drying Process.**—This process and equipment, with patents pending, is designed for continuous operation. It represents the latest improvements of equipment and method for drying milk and fluid milk products from the frozen state. The entire drying cycle from entrance of the fluid milk into the drying chamber to the resulting powder in the hermetically sealed consumer package occurs in the practically complete absence of oxygen and the process has the ability of reducing the moisture content to extremely low values. In addition, the low temperatures used in the drying process preclude the possibility of heat damage to protein stability, flavor, solubility and color of the finished product. The operation of the pilot plant is yielding a beautiful product of undeniably fine quality.

The equipment designed and the process developed by the Chain Belt Company are as follows:<sup>8</sup>

**Equipment for Freeze Drying Process:**

1. A vacuum drying chamber designed and constructed to be operated under almost perfect vacuum conditions.
2. A suitable mechanical vacuum pump for initially removing practically all of the air from the vacuum chamber.
3. A series of heating platens, consisting of metal plates machined smooth on the top side, having cored spaces within the plates whereby heating medium, such as hot water, can be circulated. The platens are built to present a continuous surface having a long radius vertical curve.
4. A stainless steel belt approximately the width of the platens, and approximately 0.015" thick. This belt slides in continuous contact with the top surface of the platens and passes over a head and tail pulley.
5. Refrigeration equipment for refrigerating an aqueous solution of lithium chloride.
6. Lithium chloride regenerator for boiling off absorbed water from lithium chloride solution.

**Operation of Freeze Drying Process.**—The vacuum pump is used to exhaust the vacuum chamber down to an approximate pressure of .5 mm. (1/50") absolute. This represents a barometric vacuum of approximately 29.98 inches and is equivalent to a water vapor temperature of approximately—27° C. (—17° F.), and a specific volume of 27,500 cu. ft. of vapor per lb. of water. The product to be dried is sprayed in the form of a very

thin film of uniform thickness upon the top side of the flexible metal belt, the sprays being located at the first of the series of platens. The belt is mechanically driven so that it moves at a uniform rate over the heating platens. This heats the belt which, in turn, supplies the latent heat of vaporization to the thin film of product which is on the upper surface of the belt. The water vapor generated by sublimation of the ice crystals from the product is condensed by means of the refrigerated lithium chloride solution, which is sprayed into a separate condenser compartment, having free communication with the drying chamber.

The refrigerated lithium chloride solution condenses the water vapor but is also diluted by the amount of water vapor condensed, and its temperature is increased by the equivalent heat of vaporization given up by the water vapor being condensed. The lithium chloride solution is pumped out of the vacuum chamber through a brine cooler, whereby its temperature is lowered to the initial temperature and the brine is continuously recirculated in this closed circuit. A small percentage of the lithium chloride brine that is being circulated is passed through a regenerator whereby water is boiled off from the solution and the concentrated lithium chloride brine is returned to the circuit. This procedure permits the lithium chloride brine to be continuously circulated at constant strength.

The steam produced by the regeneration of the lithium chloride supplies heat to a tubular heat exchanger whereby water is heated and circulated through the cored passages of the platens. By the time the belt carrying the product has traversed the length of the platens, all of the water in the product has been driven off by the process of sublimation of the ice crystals and the product is practically bone dry when it reaches the far end of the platens and is removed as a dry powder by a doctor blade.

The dry product is passed through an air lock and is accumulated in batches. When a hopper is filled with the product, the vacuum is broken within the hopper by dry nitrogen in order to completely saturate the cell walls of the powder particles with a non-oxidizing gas. The process thus is continuous. The drying time is approximately one-half minute. As compared with drying by the use of heat, the operating cost of the freeze drying process is obviously very low, and, according to the estimate of the Chain Belt Company, the capacity of a commercial machine would be comparable to the largest spray drying installations in current use.

The fluid milk is dried in an essentially near perfect vacuum and the finished powder is removed from the drying chamber without ever having become exposed to the deteriorating effect of atmospheric air. The problem of desorption is, therefore, automatically eliminated. The cells within the freshly dried powder particle are, in fact, minute vacuum chambers. There is no oxygen to desorb. The only gas that is present in the sealed can is an inert gas, such as nitrogen or carbon dioxide, or a mixture of the two. The gas status in the sealed can is thus confined to equalization



of the inert gas between the head space and the interior of the powder particles.

Since practically no oxygen is present in the can, the danger of oxidation due to the presence of free oxygen in any part of the can is non-existent. In addition, the powder dried in this manner has a very low moisture content (about 1% or less), precluding the possibility of bacterial activity. Hence, with the milk side of all major equipment constructed of stainless steel and kept in sanitary condition, and with fluid milk of good quality preheated at a time-temperature ratio adequate to inactivate all milk enzymes, the freeze drying process gives promise of yielding a powder of optimum keeping quality. The fresh powder made in the pilot plant in the presence of the author is free from cooked flavor. It has a fine flavor, light color and perfect solubility.

#### DRYING MILK BY APPLICATION OF HEAT

**Dough- or Paste-Drying Process.**—This manner of drying belongs to the earlier and more primitive methods. Grimwade (England, 1855) condensed the milk in an open kettle to a dough, added sugar, pressed the mixture into ribbons, and dried it further. Wimmer (Denmark, 1901) concentrated the milk in a vacuum pan with agitator to about 18% water, and finished drying by spreading in the open air. Campbell (U.S.A., 1901), by blowing heated air through milk in an open vat, condensed it to a dough which was shredded and dried in trays at low heat to prevent coagulation of lactalbumin.

#### FILM, OR DRUM-DRYING SYSTEM (ROLLER PROCESS)

**Principle.**—The milk is applied in a thin film upon the smooth surface of a continuously rotating, steam heated metal drum, and the film of dried milk is continuously scraped off by a stationary knife located opposite the point of application of the milk. By reason of its relatively low initial cost, space-saving compactness, and simplicity and economy of operation, the drum dryer, with its ever-ready drying surface, has distinct advantages as a milk dryer.

**Drum Dryers and Their Operation.**—The drum dryers used in commercial manufacture of dried milk consist of either a single drying drum, double drying drums, or a combination of single drying drum and a film-applying drum. In practically every case the drums are heated by steam under pressure. They are equipped with suitable arrangement for steam intake and condensate outlet, preferably with compressor attachment that provides for the continuous return of the steam back to the boilers. An air vent provides exit for the air and gasses entrained in the drum. In the double-drum units the drums revolve in opposite directions, turning downward toward each other. Each drum is equipped with a stationary knife, scraper or "doctor". Above the drums there is installed a hood

which collects and carries off the vapors that arise from the drying milk. The hood usually exhausts to the outside. The removal is facilitated by forced ventilation provided by a suction-blower fan. See also Chapter XXXVIII, under "Prevention of Foul Odor Nuisance."



Fig 94 Drum dryer in action<sup>1c</sup>  
Courtesy of Ben M. Zakariasen,  
Land O'Lakes Creameries, Inc

**Steam Pressure and Speed of Drying Drum.**—The drying period is limited to the journey of the milk film on the revolving drum between milk feed and scraper. This usually represents about three-quarters of one complete revolution of the drum. The steam pressure in the drum is the predominating factor that determines the rate of evaporation. The drying of the milk film must be completed as the film approaches the scraper. The accomplishment of this requires a certain definite relation of drum speed to steam pressure for a given diameter of drum.

According to Scott,<sup>6</sup> Reavell using the Just-Hatmaker type of double-drum dryer, reported a speed of 12 R.P.M. for 40 pounds, and of 20 R.P.M. for 20 pounds steam pressure. The drum size is not given. Combs and Hubbard,<sup>8</sup> using the Buflovak double-drum dryer, size 24" x 36", found a drum speed of 24 R.P.M. for 50 to 60 pounds, and a drum speed of 36 R.P.M. for 85 pounds steam pressure satisfactory combinations. For uniformity of drying it is important to maintain a uniform drum steam pressure. This is facilitated by carrying the boiler pressure at least 20 pounds or preferably more above the pressure in the drying drums.

**Feeding the Milk Upon the Drying Drum.**—In the Just-Hatmaker type of double-drum dryer, the drums are sufficiently close together (clearance approximately 0.02 inch), to form a trough for the milk supply on top between drums. The milk level in this trough has a marked effect on the drying capacity of the drums; the higher the level the greater the volume of milk dried per hour.

In case of dryers with single drum, there may be a reservoir containing the milk under the drying drum extending over its entire length, with the milk carried at a level sufficiently high to cause the drum at its lowest side to dip into it. Or, the milk may be applied to the surface of the

drying drum by contacting a small auxiliary drum which revolves in the pre-concentrated milk contained in the supply trough, or by spraying the milk upon the revolving drying drum.

**Uniformity of Film Thickness.**—Other factors being the same, the thinner the film the less moisture it contains when scraped off. Therefore, uniformity of moisture content of all portions of the day's run necessitates maintenance of a film of uniform thickness. Lack of such uniformity also has an unfavorable effect on solubility, flavor and color of the finished product.

The thickness of the film is affected by the uniformity of the clearance between drums over their entire length, uniformity of level of milk in the trough, and degree of concentration of milk. In the double-drum dryer, the drum alignment must be such that drum wear is even throughout, and drums run true. The milk must be fed into the supply trough at a uniform rate and a uniform level must be maintained in the trough.

In the case of most of the single drum units, the drums of which are serviced with milk by dipping, spraying or contact with milk-dipped auxiliary drum, it is necessary to precondense the milk to a considerable concentration, such as from 3 to 5: 1, in order to cover the drying drum with a film of satisfactory thickness.

**Factors Affecting Capacity of Drum Dryer.**—An increase in steam pressure that permits of a greater drum speed consistent with satisfactory

TABLE 61.—EFFECT OF STEAM PRESSURE, DRUM SPEED AND TEMPERATURE OF MILK ON CAPACITY OF DRYER  
COMBS AND HUBBARD<sup>3</sup>

Temperature of Milk Degrees F.	Steam Pressure Pounds	Drum Speed R.P.M.	Dried Milk per Hour Pounds
50 to 60	60	24	53 0
50 to 60	85	36	64 0
155	60	24	58 0
155	85	36	72 5
185	60	24	69 0
185	85	36	85 0

completeness of drying, increases the capacity of the dryer. Other factors are temperature of fluid milk, level of milk in the trough, and concentration of the fluid milk.

A study of the figures given in Table 61 shows that preheating the fresh milk to 185° F. increased the capacity of the dryer approximately 31 per cent over that when using unheated milk at 50 to 60° F. Furthermore, regardless of temperature of fresh milk, an increase of steam pres-

sure from 60 to 85 pounds, and of drum speed from 24 to 36 R.P.M. increased the capacity of the dryer about 23 per cent. The same authors<sup>3</sup> found experimentally that a trough with an abnormally low milk level reduced the capacity of the dryer approximately 23 per cent below that of a normal level, while a high milk level (ready<sup>a</sup> to overflow) increased the capacity about 30 per cent above that of the normal level.

**Fluid vs. Precondensed Milk.**—It was shown in previous paragraphs that precondensing is practically indispensable when using single-drum dryers, as the fluid sweet milk, because of its relatively low viscosity, will not provide a satisfactory film thickness. In case of double drums, the milk in the trough on top between drums is in direct contact with the heated drum surface. Here it boils and is subjected to some evaporation. If the milk is fed into the trough at a uniform rate and maintains a uniform level, a constant concentration is assured and this favors uniform thickness of film.

**Effect of Temperature and Time of Film Drying.**—The heat-unstable milk constituents are most subject to heat damage in the presence of moisture. Available data suggest that it is the time of heat and the concentration more than the exact temperature used that are the determining factors. Reavell found that, for a given drum size, the moisture content of the powder decreases with increased steam pressure, and increases with higher drum speed. There also appears to be a certain drum speed above which the moisture content increases rapidly.

Since an increase in steam pressure hastens the drying, it makes possible the use of more rapid drum speed and thereby shortens the period of heat exposure. The results of Combs and Hubbard<sup>3</sup> showed that the higher steam pressure (85 lbs., 316.3° F.) accompanied by the increased drum speed (36 R.P.M.) did not change the percentage of protein insolubility nor the moisture content. The results of Wright<sup>4</sup> established the fact that it is that phase of the milk film on the drying drum that has become highly concentrated and before it reaches the dry stage that suffers the greatest decrease of solubility for a given time-temperature factor. See also "Solubility of Film-Dried Powder", Chapter XLI.

**Removal of Dried Milk Film from Drum.**—The usual arrangement consists of a stationary adjustable knife that extends over the entire length of the drum. The position of the knife or scraper is at an elevation on the drum corresponding to approximately three-fourths of a drum revolution from the start of the milk film. The pressure that holds the knife edge against the drum surface is provided by weights attached to suitable levers, or by springs or jack-screws. Efficient film removal requires a fine adjustment of the knife edge. Reavell<sup>6</sup> pointed out the difficulty of uniformly complete removal at each revolution with one single knife. This is due to the tendency of the scraper to warp, due to uneven expansion resulting from temperature differences according to proximity of

different parts of the scraper. This permits portions of the film to remain on the drum for more than one revolution, inviting discoloration, insolubility and damage to flavor.

Knock<sup>5</sup> found that dried milk scraped off during the first revolution of the drum is invariably of superior quality, and that the solubility diminishes with increasing number of revolutions. Scott<sup>6</sup> points out the advantage of the Kestner drum dryer, in which the long one-piece knife is substituted, with a series of independent short knives arranged in staggered position, for effective coverage of all parts of the drum over its entire length. This also suggests the possibilities of a single, motile scraper which slides horizontally back and forth across the revolving drum, for efficient removal of the film of dried milk. Excessive pressure of the knife on the drum surface, however, increases the tendency of shaving particles of metal from the drum surface, jeopardizing the quality of the finished product.

**Homogenizing Milk for Drum Drying.**—The film drying action does not homogenize the milk. If not homogenized before drying, there is danger of the milk, when reconstituted with hot water, to objectionably oil-off with a tendency to develop a tallowy flavor due to oxidation. This condition is avoided by homogenization of the milk before drying, using precautions similar to those listed for "Homogenization of Evaporated Milk", Chapter XXI.

It was also shown in Chapter XXI, that homogenization of evaporated milk has a tendency to distabilize the casein. This tendency increases with an increase in concentration. Casein distabilization tends to diminish the solubility of the milk powder. If the milk is precondensed to a high concentration, such as 3 : 1 or higher, it should be homogenized before condensing in order to protect the solubility of the finished product. From the standpoint of operating efficiency it is obviously preferable to homogenize the condensed milk because of lesser bulkiness.

**Film Drying Under Atmospheric Pressure or in Vacuo.**—Vacuum drum-dried powder is and remains more soluble than atmospheric drum-dried powder. This is due partly to the lower moisture content of the former, as well as to the lower drying temperature and the shorter drying period. In the vacuum dryer the temperature difference between milk and steam is greater. Hence, heat transmission is more rapid and the rate of evaporation is faster. The greater freedom from air of the interior of the powder particles and the lower moisture content also tend to make a better keeping powder. The vacuum drum-dried powder is, in fact, a product of splendid quality.

The drawbacks of the vacuum drum dryer are the high initial cost of the dryer unit and the somewhat higher operating cost. Scott<sup>6</sup> suggests the wisdom of precondensing to a concentration of not less than 40 per cent milk solids because the initial and the operating costs of a

vacuum pan are less than those of a vacuum film dryer of similar evaporative capacity.

The above facts suggest that the vacuum drum dryer would be of no tangible advantage in the case of dried milk products intended for stock feed or other purposes where high solubility or superior flavor are relatively unimportant, such as dried buttermilk and such portion of dried separated milk as would be used as animal feed. However, the vacuum drum dryer is admirably suited for drying milk and milk products intended for human consumption, and for other purposes where ready solubility and high quality are of prime importance, as is the case with whole milk and cream powders and much of the dried separated milk.

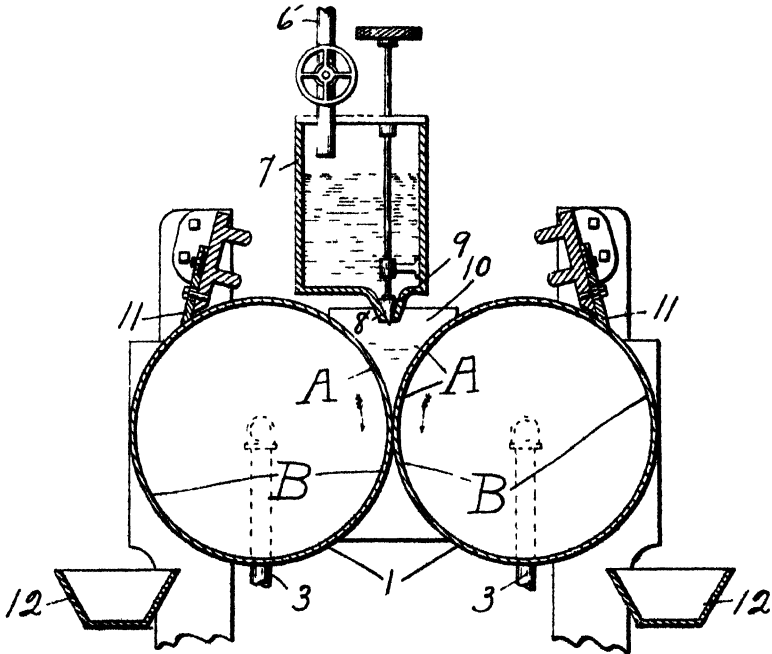

Fig. 95. The Just drum dryer

**Film-Drying Inventions and Processes.**—The film or drum dryers that have been found commercially practicable fundamentally fall into two main groups, namely, those that operate under atmospheric pressure and those that operate under reduced pressure. For the sake of clarity the brief discussion that follows classifies them according to the above grouping, making mention of a few of the more outstanding American and overseas inventions and patents of equipment and processes in each group.

#### ATMOSPHERIC DRUM DRYERS

**The Just Process.**—This process appears to have been the first attempt at drying milk by the use of the atmospheric drum, that proved successful,

and the basic principle of which has found wide application in milk drying. It was invented and patented by John A. Just, Syracuse, New York. The United States patent was granted in 1902.

As shown in the Patent drawing, Fig. 95, the Just dryer consists essentially of twin metal drums (B), installed sufficiently close together to form a trough on top between the drums. This trough serves as a reservoir for the fluid milk that reaches it by controlled flow via gravity from an elevated tank or via pump action. The reservoir automatically feeds the milk onto the drum surface. Being exposed to the surface of the steam-heated drums, the milk in this reservoir is subjected to some evaporation. It therefore, reaches the exposed drum surface in somewhat concentrated form.

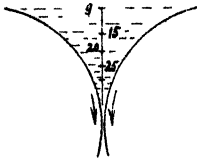

Fig. 96. Milk in trough between double drums. Numerals indicate approximate increase in per cent solids concentration of the milk from surface to bottom of trough

Each drum is equipped with a stationary knife (11) for removing the film of dried milk which then drops into conveyor trough below (12). According to the original patent, the temperature of the steam-heated drums is above 212° F. and below 270° F., and the speed from 6 to 7 R.P.M. The speed has since been increased to 15 to 20 R.P.M., in order to shorten the solubility-jeopardizing period of exposure to drum heat.

The original patent claims also provide treatment of the milk with an alkali such as lime and calcium chloride to reduce the acidity, and hypochlorites to preserve the milk fat.

**The Just-Hatmaker Process.**—James R. Hatmaker of London, England, purchased the Just patent, improved the process, and later secured a patent of his own. The resulting modification of the Just process is known as the Just-Hatmaker process, which is today the most widely used drum process in the United States. (See Fig. 94.)



Fig. 97. The Buffalo double-drum dryer  
Courtesy of Buffalo Foundry  
& Machine Co.

**The Buffovak Atmospheric Double-Drum Dryer.**—This is a typical representative of the latest improved design of atmospheric drum dryer, embodying the Just-Hatmaker principle. It is a complete drying unit, consisting of metal drums with suitable end boards that form a trough on top between drums for the float-controlled fresh milk supply, adjustable knife scrapers, closed screw conveyors for the dried milk, with elevator to flaker or grinder, and screening device, adjustable speed transmission, drum clearance adjustment, vapor hood, spur gear driving mechanism and necessary accessories.

**The James Bell Milk Dryer.**—This dryer was developed and is manufactured by James Bell Machinery Pty., Ltd., Australia. It is in extensive use in Australia for drying milk by the roller process. It is a twin-drum dryer of the Just-Hatmaker type. Its outstanding distinctive feature is its steam compressor attachment that eliminates the need for steam traps. It consists of a gear-driven pump unit that returns the high-pressure steam from the drums back to the boilers. Its ability to remove steam under pressure and to do so continuously, is claimed to insure greater uniformity of drum temperature and to effect a considerable saving in fuel.

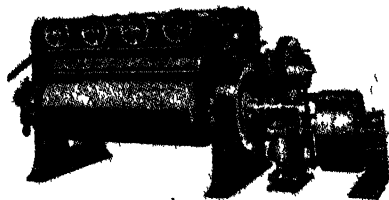

Fig. 98. The James Bell milk dryer  
Courtesy of James Bell Machinery Pty., Ltd.

**The Mignot-Plumcy Process.**—This process is in use in some of the milk powder factories in France. The machine has a single drying roll. In addition there is an unheated auxiliary drum, of smaller diameter, which dips into the fluid milk contained in a milk supply trough and conveys a film of milk upon the surface of the drying drum. This process requires the use of pre-concentrated milk. The temperature of the drying drum is held below the boiling point of water, i.e., 90-94° C. (194-201.2° F.).

A similar design, i.e., single drying drum and auxiliary film transfer, applies also to the dryers and processes of Gabler-Saliter and of Kunick.

**The Schroeder Thin-Film Dryer.**—This appears to be the latest and most improved design of the single-drum, atmospheric type of dryer. It is manufactured by the Schroeder Company, Luebeck, Germany.

In addition to the drying drum there are two auxiliary drums. The first one is made of rubberized material. It revolves in the milk supply trough of the machine and transfers a milk film upon the surface of the drying drum. The second auxiliary drum rolls out this milk film to a very thin layer of uniform depth that dries quickly and evenly, even at



a low milk temperature (cold). The fluid milk must be precondensed to a concentration of 5 : 1, and is to be applied as cool as possible. It is claimed that the Schroeder process is capable of milk powder with 100 per cent solubility.

#### VACUUM DRUM DRYERS

The vacuum drum dryer is identical in principal to the atmospheric drum dryer. It differs from the latter in that the drying drums are enclosed and operate in a vacuum chamber. The earlier designs are the Ekenberg single-drum vacuum dryer, invented by Martin Ekenberg of Stockholm, Sweden in 1899, the Passburg single-drum vacuum dryer invented by Emil Passburg of Berlin, Germany and patented in the United States in 1903, and the Govers double-drum vacuum dryer invented by Francis X. Govers of Oswego, New York, who was granted a U. S. A. patent in 1909. In the Ekenberg process the milk is dried at a temperature of approximately 100° F., in the Passburg process at about 110 to 130° F., and in the Govers process at approximately 170° F., the heating medium in the drums being water heated to a temperature below 212° F.

**The Buffovak Double-Drum Dryer.**—The latest design of vacuum drum dryer used in the United States appears to be the new Buffovak double-drum vacuum dryer illustrated in Figure 99. This dryer is equipped

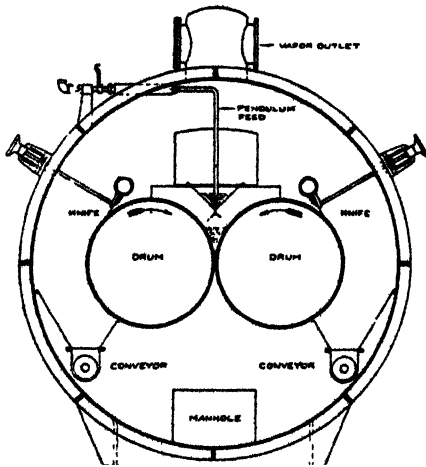

Fig. 99. The Buffovak Double-drum vacuum dryer  
Courtesy of Buffalo Foundry & Machine Co.

with a pendulum feed to facilitate even distribution of highly concentrated viscous milk. This is economically important, for the initial cost of the double-drum vacuum unit is relatively high. It involves a financial outlay about treble that of the atmospheric drum unit. For financially successful operation, therefore, operating management of the vacuum unit that will give it maximum capacity is called for. This is made possible by precondensing the milk to a high concentration. Vacuum pans or evaporators are purchasable at much lower cost than vacuum drying units. In addition,

evaporation by speedy circulation of the uncondensed milk over steam-heated metal surfaces is more rapid and the use of fuel more efficient, than by placing a static film of uncondensed milk on slowly rotating drums.

It is customary, therefore, to precondense the milk at the high ratio of about 4 : 1. With so high a concentration the product is too viscous, however, for even distribution over the entire length of the trough between drums, without mechanical assistance. Therefore the pendulum feed which places the concentrate into the trough evenly from end to end. (See also "Lavett Two-Stage Drum-Drying Process for Whey" in Chapter XXXIX.)

The knife of each roller drops the dried milk into a receiver trough with screw conveyor, which empties alternately into one of two discharge compartments. By this arrangement the discharge of the finished product from the dryer is continuous without interrupting or breaking the vacuum.

By reason of the relative rapidity of evaporation (short heat exposure) and low drying temperature, made possible by drum drying under vacuum as compared with the atmospheric roller process, the milk proteins of vacuum roller powder suffer no appreciable heat damage and the solubility of these dried milks is relatively high.

#### FLAKE FILM DRYERS

The principle of this type of film dryer consists of the use of precondensed milk of high concentration, which is spread upon a continuous wire mesh belt. The belt travels through a heated chamber or tunnel in which the drying is accomplished by heated air and without contact of the milk product with hot metal surfaces. The dried milk is removed from the belt by mechanical fingers or brushes. The finished product is in the form of fine flakes.

The available literature divulges two types of flake film dryers, namely, one designed and patented by the Borden Co., U.S.A., and the other by George Scott & Son, Ltd., London, England. In the Borden process the drying is done under atmospheric pressure; the Scott process operates under vacuum.

**The Borden Flake Film-Drying Process.**—The guiding aim of the design of equipment and method of operation of this process is to produce a powder of high solubility, and particularly, one that is capable of dissolving with maximum rapidity. This is accomplished by conducting the drying process in such a manner as to produce a highly porous, flake-shaped grain that offers maximum surface area of contact with the solvent—the water.

To this end the milk is first condensed to a high degree of concentration, reducing it to approximately one-fourth of its original volume. The concentrated milk is then cooled and whipped to a light, fluffy con-

sistency. The fluffing is accomplished in a horizontal rectangular container equipped with a horizontal, revolving shaft that carries a wooden dasher similar to the revolving dasher in the old horizontal barrel dash churn, in which the barrel is stationary and the dasher revolves. The dasher moves slowly through the thick milk, causing the dasher boards or sticks to tear the semi-solid milk into loosely hanging films and shreds. Simultaneously, heated air is blown through the mass, which intensifies the swelling. This treatment and the flow of milk through the rectangular container is made continuous by the presence of partitions which divide the container into several compartments. The partitions are equipped with a port hole with shutter, allowing the milk to pass through each compartment, and allowing untreated condensed milk to enter the first compartment as soon as the latter has discharged its treated contents into the second compartment. The whipping and air incorporating treatment is continued in each succeeding compartment, so that when the milk reaches the last compartment it has become swelled to approximately double its original volume.

This fluffy, porous milk is then fed on to a continuous wire mesh belt which travels through an air-heated tunnel, where the drying is completed. Hot air passes both over the drying milk and under the belt, enhancing the drying of the porous milk coating. By the time the milk reaches the end of the tunnel it has surrendered all of its removable moisture, and the dried milk is removed from the belt by mechanical fingers, in the form of fine milk flakes.

This product, because of its porosity, dissolves rapidly, and because of absence of contact with high-temperature metallic heating surfaces, possesses a high degree of solubility. On account of its profuse air incorporation, however, this process is not suitable for drying milk containing any considerable percentage of butterfat, such as part-skimmilk, whole milk, or cream, as the fat yields readily to the oxidizing action of the air and causes the development of tallowy flavor. This process is particularly suited to the manufacture of a high quality, readily soluble skimmilk powder.

It has the added advantage of inducing copious crystallization of lactose in dried skimmilk as reported by Troy and Sharp.<sup>7</sup> It thus improves the moisture stability of such milk products as dried skimmilk and dried whey, retarding absorption of moisture from the air and prolonging freedom from stickiness and caking.

**Scott Continuous Vacuum Band Dryer.**—This dryer was developed by George Scott & Son, Limited, Leven, Scotland. Its latest improved design, British Patent No. 345,302 is shown in Figure 100. It consists essentially of a large, horizontal, metal cylinder which constitutes the drying chamber. The interior contains numerous endless woven wire bands which travel from end to end of the chamber. During the upper

run each band extends and travels over steam- or hot water-heated hot plate containing numerous sections with independent inlets for the heating medium. This makes possible application of varying degrees of heat at different stages of the drying process. Combined with varying speeds, the unit thus gives flexibility of control to suit different milk products. In addition, the unit provides a hopper for grinding and one for sifting, both operating under vacuum.

In operation the milk is precondensed to approximately 50-55 per cent solids and, after flash cooling, is delivered upon the bands by a special rotary pump. The product spreads across the width of each band in a manner which causes it to coalesce into an unbroken sheet covering the width of the band. Upon arrival at the discharge end, the milk is in the form of a light, dry cake which separates readily from the bands, is

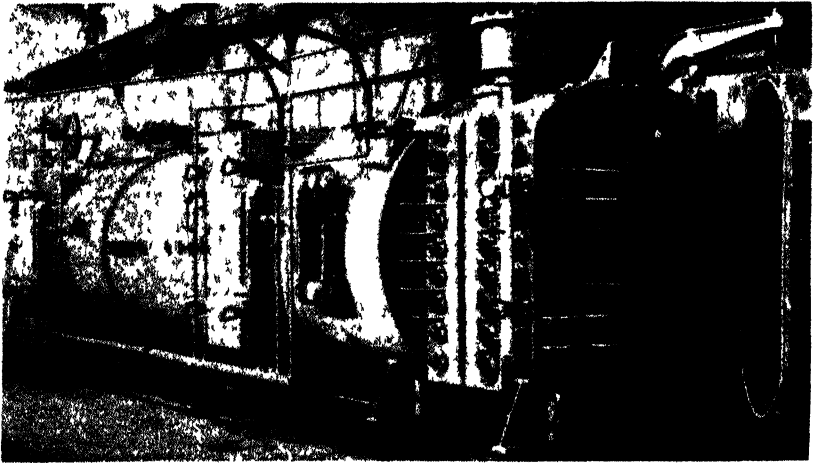

Fig 100 Scott continuous vacuum band dryer  
Courtesy of Geo Scott & Son (London) Ltd

broken up and passes through a discharge gate into the grinding hopper. Mechanical scrapers are provided to complete the removal of the dried milk from the band. The powder is then discharged intermittently through the sifter hopper without disturbing the high vacuum (about 29") in the drying chamber. This permits of continuous operation and ensures low temperature in the material. The dried milk can be packaged under vacuum before the container reaches the atmosphere.

This process differs in one main factor from the Borden Flake-Film process in that it operates under a high vacuum and thus eliminates air instead of incorporating it. The dried material has an open texture because the high vacuum expands and bursts the occluded air bubbles, facilitating efficient evacuation in packaging, and promoting keeping quality of whole milk powder. As in the Borden process, complete absence

of contact of the drying milk with high-temperature heating surfaces makes for high solubility of finished product. In the Scott process this is further enhanced by the low drying temperature due to the vacuum. This process also improves the moisture stability of the milk powder making it less hygroscopic and less prone to cake than drum-dried powders.

#### REFERENCES

1. McINTYRE, B. F.: Quoted by C. Knoch in *Handbuch der neuzeitlichen Milchverwertung*. 406. 1926.
2. IRWIN, JR., J. C.: *Dehydration Process* U. S. Patent No. 2,292,447. 1942.
3. COMBS, W. B., AND HUBBARD, E. F.: *Jour. Dairy Sci.* XV. 147. 1932.
4. WRIGHT, N. C.: *Jour. Dairy Res.* IV. 122. 1932.
5. KNOCH, C.: See reference (1).
6. SCOTT, A. W.: *The Engineering Aspects of the Condensing and Drying of Milk*. 1932.
7. TROY, H. C., AND SHARP, P. F.: *Jour. Dairy Sci.* XIII. 140. 1930.
8. Chain Belt Company, Milwaukee, Wisconsin: Information by courtesy of Horace L. Smith, Jr., Chief Research Engineer. 1945.
9. D'ARSONVAL, A.: *L'air Liquide, Compt. Rend. Acad. d. Sc.* 126. 1683. 1898.
10. D'ARSONVAL, A., AND BORDAS, F.: *Les Bases Temperatures et l'analyse Chimique, Compt. Rend. Acad. d. Sc.* 142. 1058. 1906.
11. MOREL: U. S. Patent No. 864978. 1907.
12. SHACKELL, L. F.: *Am. J. Physiol.* 24. 325. 1909.
13. HARRIS, D. L., AND SHACKELL, L. F.: *Am. J. Pub. Health.* 1. 52. 1911.
14. ELSEY, W. J., THOMAS, R. A., AND STEFFEN, G. I.: *Jour. Immunol.* 28. 433. 1935.

## CHAPTER XXXV

### THE SPRAY-DRYING SYSTEM

**Principle.**—The basic principle of spray drying milk is reducing the milk to a fog-like mist in the presence of a current of heated air. The minute particle size so produced presents a tremendous milk area of evaporating surface. The milk thus quickly surrenders its moisture to the hot air, dropping to the bottom of the drying chamber in the form of small grains and aggregates of grains, and the spent air is discharged to the outside.

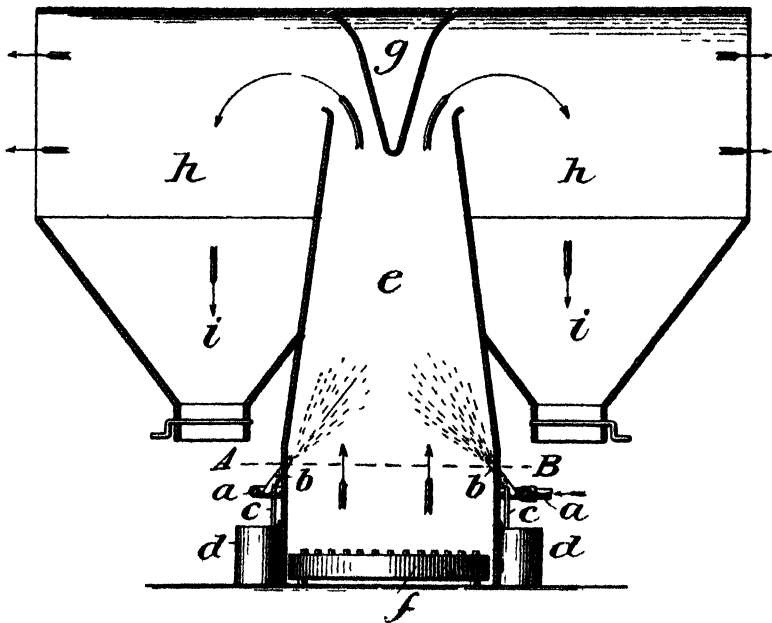

Fig. 101. The Stauf spray dryer

**Development of the Process.**—The spray-drying system, similar to the film-drying system, did not originate with the milk drying industry. The advent of dehydrating fluid substances by atomizing them into an atmosphere of heated air currents dates back to the year 1872, but it was not until 1901 that it was specifically applied to the drying of milk. From that time on, however, its possibilities as a means of converting milk into powder form received extensive experimental study. This brought forth the invention of equipment and processes suitable for commercial manufacture. Today the annual production of spray process, dried milk products in the United States alone is approximately 500,000,000 pounds.

## SPRAY-DRYING INVENTIONS

**The Percy Process.**—The process of spray drying fluid or solid substances was invented by Samuel R. Percy of New York City. United States Patent No. 125,406 was granted to the inventor April 9, 1872.

**The Stauf Process.**—The Stauf process constitutes the first commercially successful application of the Percy process to the drying of milk. It was developed and patented by Robert Stauf of Posen, Germany, United States Patent No. 666,711, January 29, 1901. Fig. 101 illustrates the patent drawing of the Stauf dryer. Its operation is briefly as follows:

The milk, atomized under pump pressure, enters through jets (b) into drying chamber (c) where it mingles with the heated air entering at (f). The milk vapors and dried milk particles are carried upward by the current of heated air in the collecting chambers (h). Here the dried milk particles drop into hoppers (i) while the moisture-laden air or gas escapes through the mill gauze, woolen fabric, or like pervious material that covers the open sides of the collecting chamber (h). (See arrows).

**The McLachlan Process.**—This process is a modification of the Stauf process. It is covered by United States Patents Nos. 806,747 and 1,038,773, granted to John C. McLachlan of Chicago, Illinois, in 1905 and 1912, respectively.

The milk enters through a perforated coil at the top of a tall cylindrical drying chamber. The resulting spray drops through an atmosphere of heated air. In passing downward through the hot air the milk particles surrender their moisture and fall to the bottom of the drying chamber. In the 1912 modification, the hot air is blown into the drying chamber through a rotating discharge head located in the center of the drying chamber. The dried milk is discharged from the floor of the chamber by conveyor belt and screw conveyor. The moisture-laden air escapes through perforations in the top of the chamber.

**The Merrell-Merrell-Gere Process.**—The Merrell-Soule Company of

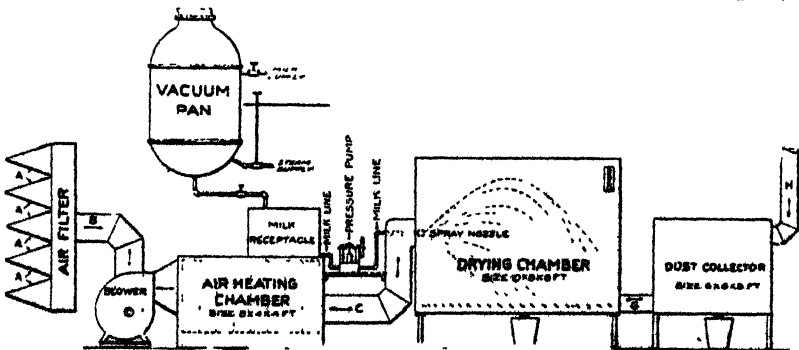

Fig. 102. The Merrell-Soule spray dryer

Syracuse, New York, in 1905, purchased the Stauf patent. In 1907, the assignees of the patent to the company, L. C. Merrell, I. S. Merrell, and

W. B. Gere, all of Syracuse, secured a new United States patent (No. 860,929) on a modification of the Stauf process, covering a drying unit as shown in Fig. 102. The basic feature in which the new patent differs from the Stauf patent lies in the claim of concentrating the milk before spraying.

To the inventors of the Merrell-Merrell-Gere process belongs the credit of developing the spray drying of milk into a commercially highly successful enterprise. They were the pioneers of the industry of spray drying milk. It is their early efforts that made the process practicable and that gave impetus to the manufacture of quality milk powder.

**The Krause Process.**—This process was invented by Dr. George A. Krause of Munich, Bavaria. It was first patented in Germany in 1912, Patent No. 297,388. Its distinctive feature is that Krause uses a disc centrifugal atomizer, depending upon centrifugal force as determined by the peripheral speed of the disc, for optimum subdivision and dispersion of the milk particles. See also "Atomizers", Chapter XXXVI.

**The Douthitt Gray-Jensen Process.**—Basic U. S. patents Nos. 1,078,848 and 1,107,784 were granted to the inventors, Chester Earl Gray, Eureka, California and Aage Jensen, Oakland California, in 1913 and 1914, respectively. Supplementary patents followed in 1915 and 1918 (Gray) and in 1921 (California Central Creameries). Later developments and improvements were made by the Douthitt Corporation, Chicago, Illinois.

The Douthitt Gray-Jensen drying unit is shown in Fig. 103. The Milk passes through the "Heater" into the "Processing Tank" where it is held at 180° F. for 30 minutes. From here it is pumped by "Recirculating Pump" through tubular "Heater" into the "Concentrator" in which it is sprayed into the current of spent air entering the concentrator from the "Drying Chamber". This treatment concentrates the milk to approximately 30 per cent solids. The condensed milk at a temperature of about 130° F. reaches the spray nozzle of the drying chamber via "Drop Tank", booster pump and "Hydraulic pump".

Milk and drying air pass through the drying chamber in counter-current direction. The filtered heated air from the heating vault enters the drying chamber peripherally near its top at a temperature of about 240° F. It sets up a cyclonic current in centripetal direction, discharging the spent air at the center through the top. Before exhausting to the atmosphere it passes through the continued spray of incoming fresh milk in the concentrator which thus serves as a collector for the recovery of the entrained milk dust. The air from the drying chamber enters the concentrator at approximately 160° F. and leaves it at about 120° F. It thus surrenders a considerable portion of its remaining heat units and becomes more completely moisture-saturated, economizing fuel and eliminating the necessity of providing equipment and labor for precondensing outside of the spray drying unit.



At their exit from the spray nozzle located in the center in the upper part of the drying chamber, the atomized milk particles partake of the rotary movement of the cyclonic air current, travelling outward and downward. Thus, the hottest and driest air strikes the milk particles at the point in the chamber where they are driest (near periphery). The less hot and partially saturated air (near center) contacts the milk near the spray nozzle where it is highest in moisture. The milk powder that deposits on the sloping walls of the cone-shaped drying chamber is continuously removed by a merry-go-round chain attached to a rotating vane (not shown in Fig. 103). The slant of the vane causes air eddies that further assist in sweeping the powder from the walls of the chamber.

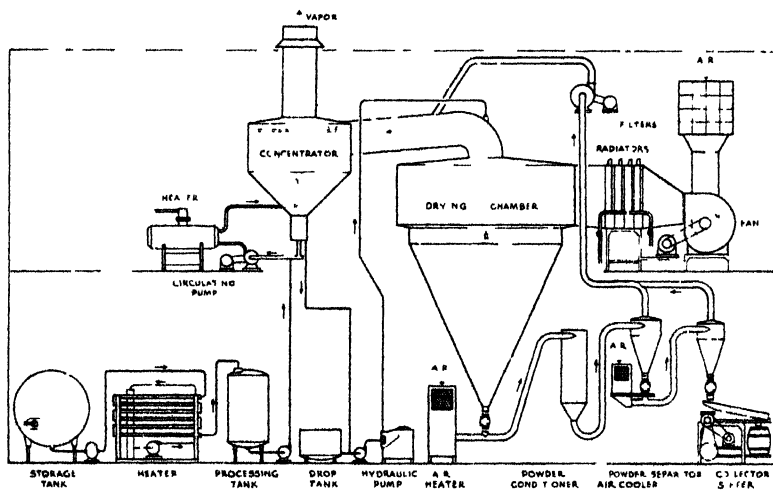

Fig. 103. The Douthitt Gray-Jensen spray process flow diagram

Courtesy of F. H. Douthitt

In the manufacture of whole milk powder by this process, the drying operation is not entirely completed in the drying chamber. The powder in the bottom of the chamber still contains about 5 per cent moisture. From here it is continuously discharged through a star valve. The "Air Heater" fans a blast of hot air through the powder on its way to the "Powder Conditioner" in which the drying is completed at a temperature of about 170° F.

The moisture of the dried milk leaving the powder conditioner has now been reduced to about 2 per cent or slightly lower. On its way to the "Powder Separator" the product is cooled to 85° F. by means of a current of dry refrigerated air from the "Air Cooler". The powder then reaches the "Collector", and the "Sifter" which discharges it for packaging.

**The Rogers Process.**—Two basic United States Patents, Nos 1,226,001 and 1,243,878, were granted to the late inventor, Charles E Rogers of Detroit, Michigan, in 1917. The original design and process have undergone many changes and improvements within the past score of years. The most recent design of the Rogers spray drying unit is illustrated in Fig 104.

The drying chamber consists of a horizontal rectangular vault (D), with multiple pressure atomizing jets (B) and air inlets (G) at one end. Milk and drying air enter the chamber at the same point and in concurrent direction. The milk is pushed by pump (A) through inlet pipe (X) to the heater. It is atomized into the drying chamber at an approximate temperature of 130° F or higher, according to type of product made, or Government requirements in case of Government orders. The pressure on spray nozzles for non-fat products is 1800 to 2000 pounds and for whole milk 2300 to 2400 pounds.

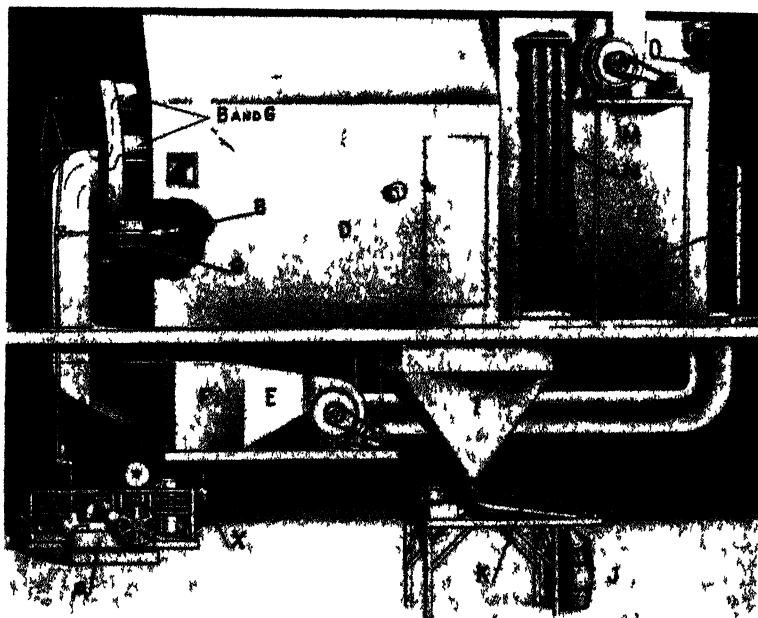

Fig 104 The Rogers spray dryer  
(Courtesy of C. F. Rogers Company)

The air enters the heating vault through air filters (C) and the heated air is blown into the drying chamber by fan (E). The air enters the chamber at an approximate temperature of 310° F. The spent air enters the cloth bag dust collectors (N) from which it is exhausted to the outside by fan (M). Blower fan (E) and suction fan (M) are synchronized in a manner that causes the drying chamber to be operated under a slight vacuum. This in turn tends to facilitate control of air circulation in the

chamber and to expedite the rate of evaporation. The filter bags (N) are shaken by an automatically controlled shaking device (O).

Rogers dryers are built in both the batch type and the continuous type. In the batch type no conveyor is provided. The powder is removed from the chamber manually at the end of the day's operation. Normally it is pushed through a trap door into the hopper which is located directly below the spray dryer. In the continuous discharge type a drag conveyor removes the powder and discharges it, at the option of the purchaser, direct to the sifter, followed by packaging, or into the hopper for sifting and packaging later. Where the powder is taken from the drying chamber continuously and conveyed direct to the sifter, a star valve is used to insure proper control of the outlet and to prevent infiltration of air.

**The Scott Spray Dryer.**—This dryer has been developed during recent years by the firm of George Scott and Son, (London) Limited, of Leven, Fife, Scotland.



Fig 105 The Scott spray dryer  
Courtesy of Geo Scott & Son (London) Ltd

As shown in Fig. 105, milk and drying air enter through the top of the drying chamber and travel in parallel current. The atomizer is mounted directly upon the shaft of a special high-speed motor, thus eliminating troublesome gear boxes. The chamber walls being vertical, the powder drops to the floor where a system of stainless steel sweepers takes care of its continuous discharge. For recovery of entrained milk dust a textile filter with automatic discharge is provided.

The inventors claim as the major advantages, low steam requirements (8 lbs. steam per 10 lbs. fresh milk), large capacity (15,000 lbs. fluid milk per hour), and high solubility of powder (99.8%). For maximum thermal economy, high preconcentration by use of the Scott forced circulation, thermo-compression evaporator see (Fig. 32) is recommended.

**Mojonnier Process.**—This process was developed by Mojonnier Bros. Company, of Chicago, Illinois. The present process and the design of its equipment are of comparatively recent origin. (See Fig. 107.)

The drying chamber is cone shape. The milk enters through a spray gun located in the center of the chamber near the top. The milk is sprayed into the center of the chamber with a wide angle spray. The air also

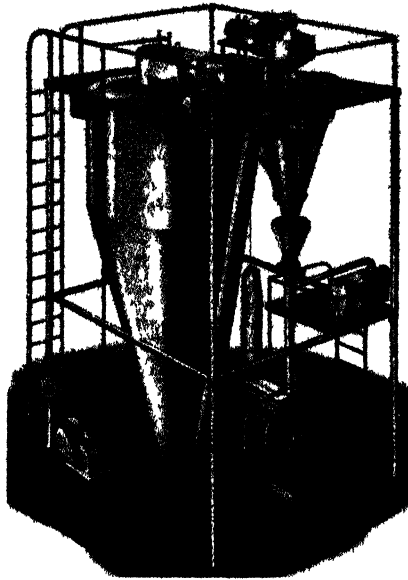

Fig 107 Mojonnier vacuum spray dehydrator

Courtesy of Mojonnier Bros Co

enters in the center of the chamber near the top. Milk fog and heated air travel concurrently. The air distributor is made with straightening vanes to insure a fixed travel of all parts of the heated air. In addition, a secondary stream of air enters through a patented device causing the mixture of air and spray to rotate at high velocity.

At the bottom of the cone-shaped drying chamber all the drying air is brought together with the particles of dried milk. The mixture is boosted through a U tube and through the primary cyclone, thus continuing the drying effect during the prolonged travel of the mixture. Recovery of

entrained milk dust from the outgoing air is accomplished in the centrifugal powder collector.

**The Dick Process.**—Dr. S. M. Dick, the inventor, of Minneapolis, Minnesota, received two United States patents, Nos. 1,298,470 and 1,374,555, on his process in 1919 and 1921, respectively. As in the Krause spray dryer, the milk is atomized by the use of a disc centrifugal device operating in a cylindrical drying chamber. It passes through four zones, as follows:

The milk enters the spraying and evaporating zone, then passes through a dead air zone into the dehydrating or finishing zone from where the dried milk particles drop into the cooling and receiving zone. A portion of the heated air enters the top zone where it mixes with milk spray, causing initial evaporation. The remainder enters the third or dehydrating zone where the drying is completed. The temperature of the heated air is relatively low, ranging from 150 to 168° F.

**The Drying and Concentrating Process.**—This process was developed by the Drying and Concentrating Company of Chicago. It is covered by several U. S. patents owned by this company, dating from 1938 on. The drying unit uses a unique centrifugal type of spray head and is composed essentially of a concentrator, drying chamber, air heating units, air filters, air supply fans, powder cooler and variable speed sanitary pumps for handling the milk to be dried.

As shown in Fig. 106, the drying chamber is supplied with filtered air, heated by heater B. The concentrator is supplied with exhaust air from

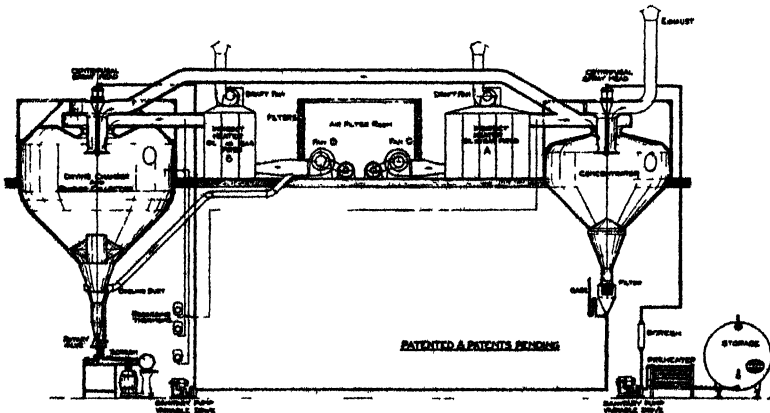

Fig. 106. Drying & Concentrating process spray dryer  
Courtesy of Drying & Concentrating Company

the drying chamber and heated air from heater A. The powder cooler mixes cold air with the powder at its discharge from the collector.

The fluid milk is pumped from the supply tank or preheater to the concentrator spray head. The air from heater A mixes with the partially

saturated air from the drying chamber as it enters the concentrator at high velocity. The centrifugal spray head disperses the fluid milk into the whirling stream of incoming air, causing almost instantaneous concentration to the desired degree, usually to about 40 to 45 per cent solids. The concentrated milk is pumped from the bottom of the concentrator to the spray head in the drying chamber, which discharges it into the whirling incoming air from heater B, facilitating quick, uniform drying. The spiral motion of the air throws the resulting powder to the wall of the chamber and to the bottom of the collector where it is cooled by a blast of cold filtered air which enters the powder zone in revolving motion. From here the outlet valve feeds the cooled powder upon the vibrating screen which discharges it direct into the barrel or other shipping container.

This unit is a complete drying plant for which the inventors make the following claims: This drying unit will handle up to approximately 6,000 pounds of fluid milk per hour without the use of vacuum pan or evaporator for precondensing the milk. If the milk is precondensed to 35 per cent solids, the unit is capable of handling up to approximately 20,000 pounds of fluid milk per hour. In this case the air heater for heating additional air for the Concentrator is eliminated, and the precondensed milk is further reduced in the Concentrator to approximately 45 per cent solids through the sole medium of the exhaust air from the drying chamber.

## CHAPTER XXXVI

### THERMODYNAMICS AND ENGINEERING ASPECTS OF COMMERCIAL SPRAY DRYING OF MILK

This chapter deals with some of the thermodynamic and engineering aspects relevant to commercial milk drying in general, and to spray drying in particular, with especial emphasis on dried skimmilk and dried whole milk. Special problems of manufacture and packaging dealing with control of marketable properties of finished product, that are peculiar to dried whole milk, dried buttermilk, dried whey and dried malted milk, are discussed in Chapters XXXVII, XXXVIII, XXXIX, and XL, respectively. For spray drying by application of cold see Chapter XXXIV, under "Freeze Drying Process."

#### HEATED AIR REQUIREMENTS IN SPRAY-DRYING SYSTEM

The volume and temperature of the heated air, that will evaporate a given amount of water or that will dry a given amount of milk, vary with the temperature and humidity of the atmospheric air, the temperature and concentration of the milk to be dried and the temperature and degree of saturation of the moisture-laden air exhausting from the drying chamber.

**Temperature of Heated Air.**—Other things being equal, the consumption of heat in spray drying decreases with the rise of temperature of the heated air. With air only slightly heated the expenditure of heat is very great, and large volumes of air, necessitating large drying chambers, must be used. Hausbrand<sup>1</sup> shows that with slightly heated air the expenditure of heat may be two or three times as great to evaporate a given weight of water as the theoretically needed calories. It is economically advantageous, therefore, to use the highest temperature of heated air that the liquid to be dried will stand without injury to its quality.

The maximum temperature of the heated air that the particles of milk will stand without injury to quality depends primarily on the rapidity of evaporation. Damaging overheating, therefore, is avoided by providing conditions that make for maximum rapidity of evaporation, such as is made possible by accomplishing the mixing of milk particles with the air in the presence of violent turbulence. This violent mixing brings the milk particles in contact with the air that contains but little moisture, causes almost instantaneous evaporation of the milk spray, and removes the moisture-laden air quickly from the chamber. For average conditions of milk and air dispersion, the air entering the drying chamber usually has a temperature of about 130°C. (266°F.). The increased rate of mixing air and milk spray in the Kestner process permits, according to Reavell,<sup>2</sup> air inlet temperatures as high as 200°C. (392°F.).

**Effect of Atmospheric Conditions on Volume of Air Required.**—The

temperature of the heated air being the same, the weight of air required increases with the atmospheric temperature. Less air is required in cold weather than in hot weather. But the smaller quantity of cold air requires more calories to heat than the larger quantity of warmer air, in order to be raised to the same temperature. For economic operation, therefore, the heating surface in the hot air furnace or vault and the size of the equipment for circulating the air should be of such flexibility as to adjust operation to seasonal and weather conditions. The heating surface should be sufficient for maximum temperature of heated air on coldest days, and the air circulating system should be of sufficient size to carry 'the large quantity of air required on the hottest days.

It is obvious that, with the above flexibility provided, the blowing apparatus, while adequate when run at full capacity during the warm season, will be too large to run at full capacity in cold weather and, therefore, should be run below capacity at that time. On the other hand, the heating surface, while ample when run at full capacity during cold weather, is oversize in warm weather and only a portion of it should be used.

**Velocity of Air.**—For economical and proper heating of the air and satisfactory performance in the drying chamber, the air should have the proper velocity. The amount of heat, taken up increases with the velocity of the air current over the heating surface. High velocity, however, greatly increases the friction in the air conduits, requiring more power and decreasing the efficiency of the blowers; it reduces the water-absorption power of the heated air in the drying chamber and increases entrainment losses. According to Scott,<sup>8</sup> in the conduits to and from the heating vault the velocity of the air should not exceed 10 feet per second, and in the heating vault and drying chamber it should be limited to about 20 feet or less per second. In order to control the velocity of the air circulation throughout the drying unit properly, there must be proper correlation of dimensions of all air flues, conduits, and blower fan, from intake of cold air to exit of drying chamber.

**Location of Air Intake Fan.**—For mechanical circulation of air, as is used in the spray drying of milk, it is easier to move small volumes than large. From the standpoint of mechanical conveyance of the air, therefore, it is preferable to install the blower fan at the intake of the cold air to the heating vault, and this is, in fact, done in many installations. The next best location for the fan is at the exit of the drying chamber. In this case the fan creates a slight vacuum in the drying chamber. This makes for evaporative efficiency and economic expenditure of heat. The most unfavorable position is between heating vault and drying chamber.

**Effect of Barometric Pressure.**—Variations in the atmospheric or barometric pressure also influence the amount of air and heat required to some extent. Other conditions, such as humidity of air, being the same,



an increase in barometric pressure decreases the amount of air required and enhances the economy of drying. The lower the barometric pressure, other conditions being the same, the more air and heat are required to dry a given amount of milk. This effect occurs only when the barometric pressure in the drying chamber is the same as that of the outside air, which in most instances of spray drying of milk is the case. The effect, however, is slight, but its presence may explain some of the fluctuations in operating results that are encountered in commercial drying.

**Effect of Humidity of Atmospheric Air.**—The humidity of the atmospheric air also has a considerable effect on the drying efficiency and economy of the air. Atmospheric air always contains moisture. It is seldom, if ever, completely saturated, but the humidity of the air varies within wide limits. It usually increases with a rise in temperature. Since the chief duty of the air in the spray-drying system lies in evaporating water from the milk and absorbing this water, it is clear that the evaporative efficiency of the heated air decreases with an increase in the humidity of the atmospheric air.

**Temperature and Saturation of Air Discharge.**—Finally, the temperature and degree of saturation of the air discharged from the drying chamber influence the quantity of air and heat required for drying a given quantity of milk. As previously stated, the higher the temperature, the higher is the point of saturation and the more moisture the air is capable of absorbing and holding. While heat is given off and the air escapes from the drying chamber at a temperature lower than that at which it entered, it must be sufficiently hot at its exit from the drying chamber to be capable of holding the water evaporated from milk, together with the original moisture, without being in a state of supersaturation. In commercial practice the air leaves the milk drying chamber at temperatures ranging from 120 to 200°F.

#### AIR-HEATING VAULTS

The air-heating vault is a heavily insulated room equipped to heat the air for the drying chamber. The air may be heated direct, such as by the furnace flame, or semi-direct, such as by means of a furnace with hot air flues, or by indirect means whereby the air passes over banks of fin-type steam coils.

**The Direct and Semi-Direct Systems.**—These systems of heating the air have the advantage of greater thermal efficiency provided the escape of the furnace gases at uneconomically high temperatures is prevented. They also attain higher temperatures than are possible with the indirect heating system. The direct system has the further advantage in that it consumes much of the oxygen that is contained in the air and to that extent lessens the tendency to autoxidation of the milk fat and development of tallowy flavor in the milk powder.

One of the most serious draw-backs of these two systems lies in the danger of black specks in the powder due to the presence of particles of extraneous material, such as entrained furnace soot and dust, and scales and rust breaking loose from the flues. This could obviously be avoided by switching the air filter from the usual point of fresh air intake to the point of heated air discharge from the heating vault. Unfortunately this shift is not practicable when using the standard air filter with oil as filtering element. The hot air would destroy the oil filter. However, changing to another type of air filter, such as an asbestos fabric filter, etc., might solve this problem (see also "Air Filters" later). Other draw-backs of these systems are: less efficient temperature control and a greater fire hazard, and in case of the semi-direct system there is need of frequent replacement of flues due to relatively rapid deterioration. Neither the direct nor the semi-direct system is used to any appreciable extent in American milk powder plants.

**Indirect Air Heating System.**—This is the system commonly used in the spray drying of milk. The incoming currents of fresh air pass over banks of fin-type steam coils installed in the heating vault. Heat control is facilitated by a separate control valve for each coil section. Fuel is saved by using exhaust steam in the first coil sections and high-pressure steam in subsequent sections.

Other media that may be used for heating the air in the spray drying system are hot oil, and electric current.

**Heat Insulation of Vault and Heated Air Flues.**—It is advantageous to so locate the heating vault as to obviate long flues at its fresh air intake and between heating vault and drying chamber. It is important, also, to protect the entire system, including heating vault, hot air flues and drying chamber against avoidable thermal loss due to heat radiation, by proper heat insulation.

#### AIR SUPPLY

In the spray drying of milk fresh air from the outside atmosphere only is used. With the exception of the partial utilization of the heat contained in the spent air from the drying chamber for preheating and precondensing, as exemplified by the Douthitt Gray-Jensen system, the air from the drying chamber is not re-used. It is exhausted direct to the outside. The air supply to the heating vault consists exclusively of fresh, new air from the outside atmosphere.

It is important that this air supply be pure, free from visible extraneous material, dust, soot, and objectionable odors. The plant obviously should be located away from sanitarily undesirable surroundings, plowed fields and dusty gravel roads, and the air intake should be established either on top or on the leeward side of the building. Even in the most favorable location, the intake needs to be equipped with an efficient air filter.

**Air Filters.**—Different types of air filters may be used. Close weave filters are unsuitable because of the heavy, extra load which their resistance places upon the suction fan. In some plants the incoming air is washed by drawing it through a spray of water, or through a series of screens of wire mesh or gauze over which a film of water trickles. The water spray or film is limited in its efficiency as an air filter. It removes the coarser mechanical impurities, but it fails to purify the air from the greasy turbidity of the city atmosphere.

The filter most commonly used is the type in which oil is used as filtering element. It embodies the adhesive impingement principle of removing dust from the air. This type filter consists of multiple cells filled with expanded metal. The cells are dipped in an oil which coats the entire grill with an adhesive film consisting of an odorless oil that is sufficiently heavy to prevent being blown off. A plant with an average capacity of

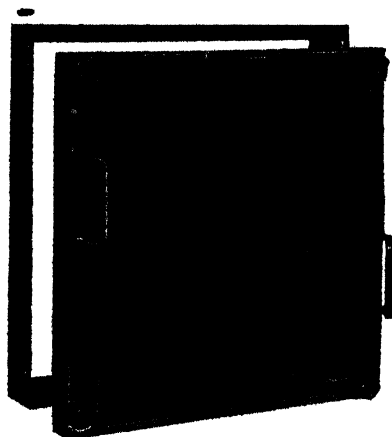

Fig. 108. Oil air filter

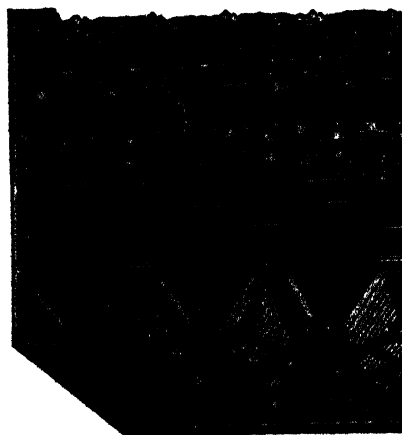

Fig. 109. Metal Baffles

Courtesy of American Air Filter Company, Inc.

approximately 650 pounds of dried skim milk per hour requires about 24,000 cubic feet of air per minute. Such a plant needs a battery of 28 filter cells, and preferably two to four additional cells for use as spares during cleaning.

In the presence of air of average purity, it is good practice to wash the cells at least every two weeks. In order to maintain a satisfactory average condition of the filter, the rotation system of cleaning is generally preferred. Thus, by replacing two dirty cells by two clean spares each day, the entire 28 cells are replaced by clean and recharged cells every two weeks. The washing is done by soaking the cells overnight in hot water containing an alkaline cleaning compound, followed by blowing live steam through the cells for a period of 15 to 30 minutes. The clean cells are then "recharged"

by dipping them in the oil and allowing them to drain 12 hours longer. The cells are now ready to replace the same number of dirty cells in the system.

**Drying Chamber.**—The drying chambers vary in size and shape. Some are rectangular, others cylindrical. Some have straight vertical sides, others are cone shape sloping downward. Some of the latter are equipped with merry-go-round link chain that “rattles down” the dry milk deposited on the sloping sides. In the continuous discharge chambers, a screw or drag conveyor is usually provided that removes the powder from the drying heat as fast as it forms.

Some of the drying chambers are constructed of hollow tile; some are lined with glazed tile. Metal walls and ceilings are usually covered with sheet asbestos on the outside. The inside lining, and the joints with hot air flue and with hopper, should be tight to prevent leaks of wash water that would foul the insulation. Also observation windows, shutters and doors should fit tightly to avoid infiltration of air. For suitable metal lining, see also Chapter V.

**Position of Milk Inlet and Air Inlet and Discharge.**—For reasons of economic efficiency the relationship of position of milk inlet into the drying chamber, and air inlet and discharge, should be such as to accomplish maximum saturation of drying air and maximum utilization of the heat contained therein. For best preservation of important marketable properties of the resulting powder (quality and solubility), milk inlet and air inlet and discharge should be so located as to accomplish maximum rapidity of evaporation and uniformly low moisture content of the finished product.

**Counter-Current versus Parallel-Current Flow.**—In general, the milk and air either enter at opposite sides (or top and bottom, respectively) and flow in counter-current toward each other, or they both enter in the same region mingling together in parallel or concurrent flow.

In the counter-current principle, the points of inlet and direction of flow are so organized as to cause the incoming air (which is driest and hottest at this point) to meet the milk particles at the point of their lowest humidity, and to cause the outgoing air (which is most nearly saturated) to leave the drying chamber at the point where the milk is wettest (which is near the atomizer). It would appear, therefore, that a higher degree of saturation and of efficiency of heat utilization is attained by this arrangement than with the concurrent flow principle. Similarly, contact of the milk particles at a point in the chamber where they are driest, with the driest and hottest incoming air, suggests that the finished product so dried should be lowest in moisture content.

In the parallel-flow principle, the milk and air enter in the same region and travel concurrently. Here the tendency is for a somewhat lower degree of saturation and the utilization of the heat contained in the drying air

may be somewhat less efficient, if the desired degree of low moisture content is to be achieved. Published results of comparable experiments on this point are lacking. Our present knowledge of the comparative merits of the two principles regarding degree and uniformity of dryness and speed of drying attained appears to be limited largely, as yet, to theoretical conjecture.

**Effect of Parallel Flow on Uniformity of Particle Size.**—The seeming logic of the counter-current principle, in which the drying milk passes successively through zones of increasingly dry air and finishes in the incoming air which is hottest and driest at that point, suggests maximum dryness of finished product. It is conceivable, however, that the head-on collision between air currents and milk fog causes countless numbers of atomized milk particles to collide and fuse, forming larger droplets, dissipating uniformity of particle size and impeding the speed of drying. In the parallel-flow principle, milk fog and air currents move in the same direction, eliminating the danger of violent collision between milk particles, and preserving the uniform fineness of particle size.

**Effect of Parallel Flow on Rapidity of Drying.**—Again, it appears not improbable that the parallel flow of milk fog and air currents makes for maximum rapidity of drying. The set-up here is based on the theory that the high temperature and very low humidity of the incoming heated air, in the presence of the high moisture content and tremendous surface area of the freshly atomized milk particles, cause maximum rapidity of evaporation. The dry, hot air at this point is at its maximum capacity for instantaneous absorption of the vapors released by the vast surface area of the drying milk. Simultaneously, the dried milk particles drop to the bottom while the saturated air currents exhaust through the top of the chamber.

It is of interest to point out here that the tendency of the newer designs of air drying chambers, is in the direction of the parallel-flow intake of milk and air currents. This is especially noticeable in the case of whole milk dryers. Maximum rapidity of drying (because of minimum duration of exposure to the drying heat) favors high solubility and keeping quality of finished product.

#### ATOMIZERS

The objective of atomizing is to reduce the milk to a particle size so small that, due to the tremendously increased surface of evaporation, the resulting mist of milk projected into the current of heated air, surrenders its moisture nearly instantly. The minute particles of milk are dry before they reach the side walls or floor of the drying chamber.

The average particle size of the milk fog provided by efficient atomization has a diameter of approximately 50 microns (0.002 inch). It is estimated that one pint of milk so atomized contains approximately 6,893,415,000

particles, which represent a surface area of about 300,780 square feet, or 6.9 acres. There are principally three types of atomizers used in milk work, namely, compressed air atomizers, pressure spray nozzles, and disc centrifugal atomizers.

**Compressed Air Atomizer.**—A jet of compressed air issues horizontally from a nozzle and impinges against a vertical jet of the milk, dispersing the milk into a fine spray. This type was used in the early days of spray drying milk. It has been superseded by the more modern designs of atomizers, such as the pressure spray nozzle and the centrifugal atomizer, that have proven superior as to uniformity and fineness of spray.

**Pressure Spray Nozzles.**—Atomizers belonging to this group are extensively used in American milk drying factories. The milk is forced under high pressure (usually about 2500 to 3000 lbs.) through a small orifice. One of the most widely used pressure spray nozzles contains, behind the spray orifice, a so-called "whizzer." This may consist of a soft metal plug with a spirally grooved periphery. The grooves give the stream of milk

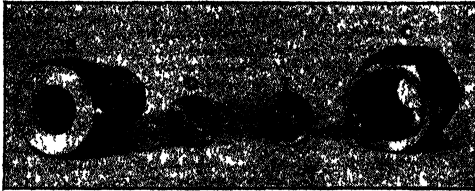

Fig. 110. Monarch pressure spray nozzle  
B—Body, C—Cap, D—Disc, T—Tip



Fig. 111. Complete nozzle assembly

Courtesy of Monarch Mfg. Co., Inc

a rotating twist, causing the milk mist to assume a swirling action at the orifice. Or the whizzer may consist of a cup-shaped disc with multiple slanting holes near the periphery. The purpose of the swirling motion is to widen the angle of the milk fog and intensify the atomizing action. The higher the pressure or the smaller the orifice, the finer the particle size of the mist. Low pressure and a large spray orifice, respectively, yield coarseness of particle size.

For satisfactory control and uniformity of moisture content of the spray powder, the orifice must be of the right size and shape and its edges must be smooth and free from nicks. On the other hand, the high velocity of the milk stream under high pressure causes rapid wear of the spray discs due to intense abrasive action by the milk solids. This necessitates frequent renewal of the spray nozzle, and it emphasizes the importance of daily inspection.

The life of these nozzles has been much prolonged within the past decade by the efforts of the manufacturer to provide spray discs of harder and more nearly wear-proof metal. One manufacturer whose spray nozzles have been used for years by many plants throughout the country, reports that while the early cold rolled steel nozzles gave 10 to 12 hours service, the new alloy he is now using is of diamond-like hardness and gives 400 hours of service. (See Figs. 110 & 111.)

**Pressure Spray Pumps.**—Uniform fineness of spray and maximum efficiency of desiccation demand uniform pressure of the milk. This requires a special type of pump. Experience has shown that pumps best suited for this purpose are three-cylinder pumps with large, heavy valves, and with extra deep stuffing boxes that can be packed with one-half inch packing rings; and special, heavily bolted glands that can be readily adjusted while the pump is running.

**Centrifugal Spray Atomizers.**—The atomizing device here consists of a disc or slotted basket that revolves at a velocity (about 5,000 to 20,000 R.P.M.) depending upon the diameter of the rotating device.

The milk is fed from above either upon the top of the saucer-like disc (Krause system), or on the underside of the bell-shaped disc (Kestner system). The centrifugal force of the rapidly rotating disc causes the milk to spread in a film of uniform thickness toward the periphery where it is thrown off in the form of a thin veil resembling a fog. The atomizing efficiency depends primarily upon the peripheral speed of the atomizer. The centrifugal atomizer has the advantage of absence of small orifices that are subject to clogging. It thus permits of the spray drying of highly concentrated milk (containing as high as 50% solids), and no pump pressure is required. It is capable of continuous operation over prolonged periods without special attention. It is free from abrasive action, but involves the necessity of up-keep of high speed bearings.

#### RECOVERY OF DRIED MILK

It has been shown that the particle size of spray-dried milk is influenced by numerous factors. Yet, regardless of type of spray dryer in the product of each day's run, a certain proportion of the powder is much finer than the remainder. It has been estimated that the grain size in any spray-dried milk may range from less than 10 to over 100 microns.

Because of these variations, each drying milk particle floating in the drying chamber is subject to one or the other of two physical forces. The relatively coarser particles, which may constitute approximately 80 per cent or more of the yield, respond to the force of gravity and deposit on the sides or drop to the floor of the chamber. The milk dust which constitutes the smallest particle size, becomes entrained in the air currents and is swept by them to the exit of the drying chamber where it is more or less completely recovered by mechanical means.

**Removal of Product from Drying Chamber.**—The majority of drying units now in operation provide for the continuous removal of the finished product from the drying chamber by mechanical means, such as the screw conveyor. In addition, some units provide for cooling the powder by subjecting it to a blast of cold air at its exit from the chamber.

**Recovery of Milk Dust.**—There are principally four types of devices in use for the separation and recovery of the exceedingly fine milk dust that is entrained in the strong currents of outgoing air. These consist of the filter bag dust collectors and supplementary screens, the cyclonic separator, the electrical dust collector, and the liquid dust collector.

**Filter Bag Dust Collectors.**—The most common type of dust collector used consists of a series of filter bags equipped with mechanical shakers. The filter bags are usually made of cotton or linen of very fine weave. They are about 6 to 10 feet high and approximately 8 to 10 inches wide.

The entire series of bags presents a large screening surface not infrequently amounting to several thousand square feet. The air is drawn through these bags, and deposits the entrained milk particles in their meshes. As the milk dust builds up on the inside of the bags they are subjected to intermittent mechanical shaking which drops the powder to the bottom of the vault in which the bags are suspended.

**Supplementary Dust Collectors.**—In some factories these filter bags are supplemented by preliminary recovery equipment that reclaims a portion of the entrained milk dust before the outgoing air reaches the filter bags. This equipment commonly consists of a progressive series of large cloth screens suspended in a vault, or one or more cyclonic dust collectors.

**The Centrifugal Milk Dust Separator or Cyclone.**—This is commonly a cylindrical container with cone-shaped bottom. The air leaving the drying chamber at a high velocity enters the cyclone tangentially. It thus assumes a rotary motion forming a cyclonic vortex. Centrifugal force throws the solids to the peripheral wall of the cylinder, along which the material then works down into the hopper.

According to the theory of centrifugal collection, the separating efficiency of the cyclone varies inversely with the radius and directly with the square of the tangential velocity of the gas, as expressed by the following formula:

$$F = \frac{MV^2}{R},$$

in which F is the centrifugal force, M the mass of the particle,

V the velocity in feet per second and R the radius of the cylinder.

Thus, a comparison between a 6 inch diameter cyclone tube and a 12 foot diameter cyclone cylinder shows that the separation of particles of the fineness of milk dust entrained in the air discharging from the spray-drying chamber (particle size ranging from less than 1 to about 5 microns), requires

$\frac{12}{0.5}$  or 24 times as much velocity in the 12 foot diameter cylinder as in the



6 inch diameter tube. In the past, the cyclonic dust collectors used for the recovery of milk dust have been almost exclusively of the large-diameter type, the diameter ranging approximately from 5 to 20 feet. These large cyclones have commonly been used supplemental to the filter bags, preceding the latter as do the series of cloth filters previously described.

Within recent years the **Multiclone Dust Collector** has become available. As shown in Fig. 112, the dust separating element of the Multiclone consists of a battery of small-diameter tubes, commonly ranging from 6 to 9 inches in diameter. Because of the greater dust recovery efficiency of the small-diameter cyclone tube, the Multiclone is being installed in some of the milk powder plants, not supplemental to, but in the place of other systems of milk dust recovery.



Fig. 112. Multiclone dust collector  
(Courtesy of Western Precipitation Company)



Fig. 113. Buell powder recovery system  
(Courtesy of Buell Engineering Co., Inc.)

Still another type of cyclonic milk dust separator unit embraces the **Buell Powder Recovery System** shown in Fig. 113, which consists of the van Tongeren design of cyclone. This recovery separator provides a patented dust "shave-off," consisting of a slot located near the top of the cyclone, through which the finest milk dust borne by the upward eddies is conveyed. This device liberates the fine milk particles and drops them through a specially designed by-pass dust channel into the downward eddies of the lower zone. The recovered powder is then discharged through the bottom of the cyclone. The outstanding advantage claimed for this system is that it separates even the finest milk particles and prevents their re-entrainment by directing them down through the by-pass channel into the zone

of the downward eddies, practically eliminating the escape of milk dust with outgoing air.

**The Electrical Dust Collector.**—Recovery by means of electrical precipitation of the entrained milk dust, such as by the use of the Cottrell precipitator, has also been found practicable. In this system the spent air discharging from the drying chamber passes upward through a battery of vertical metal tubes. From a high-tension bus-bar above the top of the tubes are suspended as many chains as there are tubes. These chains extend down through the center of the tubes. The bus-bar and the chains are maintained at a high voltage. This causes the dried milk particles in the air to become electrically charged and to be attracted to the chains and tube walls, from which they are readily dislodged by automatic rapping device. It is claimed that electrical precipitation, in the presence of adequate voltage, makes a very satisfactory recovery of milk dust.

In its present status of development the electrical dust collector, as applied to recovery of milk dust, has the following draw-backs:

1. The initial cost is far above that of other dust recovery systems which do a very creditable job.
2. The present set-up of the Cottrell calls for a voltage ranging from 7,500 to 100,000 volts which, it is believed, will affect the keeping qualities of the milk product. However, units of lower voltage can be and have been successfully used.
3. It has been reported that the reclaimed powder tends to show a considerable increase in moisture content.

**The Liquid Dust Collector.**—This device refers to the ingenious system of milk dust recovery used in the Douthitt Gray-Jensen process (see Chapter XXXV). The air exhausting from the drying chamber passes through a spray of incoming milk in the liquid milk collector. By this method the milk dust entrained in the outgoing air is deposited in the fluid milk to be dried. It thus accomplishes highly efficient recovery, utilizes the bulk of the heat units contained in the spent air, and preconcentrates the fluid milk.

In the case of products for the spray drying of which the liquid dust collector is feasible, such as with skimmilk, buttermilk and whey, the use of the liquid dust collector provides maximum efficiency in the recovery of practically all of the entrained material, as well as in the utilization of heat contained in the drying air. The liquid dust collector appears less suitable for drying whole milk, by reason of the oxygen and other gases which the exhausting air from the drying chamber contains.

**Cooling the Milk Powder.**—As previously shown, prolonged exposure of the dried milk to high temperature jeopardizes its flavor and keeping quality. At the time of drying, the dried product appears to constitute an emulsion of fat in milk solids, in which the milk solids are the continuous phase covering and protecting the fat against oxidizing influences of

the air. If the powder is promptly cooled, it will retain this phase of emulsion.

Prolonged exposure of the powder to heat, such as that of the drying chamber, on the other hand, has a tendency of reversing the phase of the emulsion. The fat melts, oils off, and saturates the milk particles. The fat thus becomes the continuous phase. Some of it covers the surface of the dried milk particles and, being no longer protected by the milk solids, is exposed to air and light and becomes subject to oxidation. Experimental trials have shown that if the powder is packed while hot, such as spray powder direct from the drying chamber without cooling, it will retain its heat in the bulk package, the barrel, for several days. Temperature tests of barrelled spray-dried milk 24 to 48 hours after packing showed temperatures as high as 135 to 145° F. For cooling, the powder is usually treated near its exit from the drying chamber, with a blast of refrigerated air.

It will be shown, however, in Chapter XXXVII, under "Temperature at Time of Packaging", that cooled powder does not respond as readily to vacuumizing and gassing. Experimental evidence indicates that powder gas-packed while hot retains less oxygen than cooled powder and, therefore, should be less susceptible to autoxidation.

#### PREPARATION FOR MARKET

**Grinding, Bolting and Sifting.**—The milk powder made by spray drying requires no grinding. It is of a fine, floury grain, and after bolting and sifting it is ready to be packed in bulk or in the consumer package. The film-dried milk comes from the drying drum in crinkly sheets and shreds, which break up into a relatively coarse and uneven size grain in the conveyor. This material is ground to a fine powder, bolted and sifted.

**Compressing Milk Powder.**—The need of saving cargo space created by the war emergency has led to the consideration of compressing foods for shipment overseas. In fact, dehydration and compression were considered as effective steps taken to get rid of two space-wasting "stow-aways" in ships carrying food abroad, one stowaway being water and the other air.<sup>4</sup> "Nutritional Ammunition" stamped out in presses to save cargo space was thus shipped overseas in vast quantities and dried milk has played a part in this movement.

Earlier experiments with film-dried milk in Germany had demonstrated the practicability of compressing dried milk into blocks to the extent of one-half or one-third of its original volume.<sup>5, 6</sup> Mohr and Ritterhoff<sup>6</sup> found further that a pressure of 60 kg./sq.cm. was sufficient and that if the pressure did not exceed 200 kg./sq.cm., compression had no effect on quality as related to moisture content, solubility and fat dispersion. At higher pressures, however, there was a tendency to cause leakage of butter oil. In addition, they discovered that the pressure must be applied gradually, as sudden pressure causes rapid closing of the surface pores

of the powder which makes further escape of air contained in the powder impossible.

More recently Webb and Hufnagel<sup>7</sup> experimented with the compression of spray-dried milk. Their results are given in Table 62.

TABLE 62.—THE EFFECT OF COMPRESSION ON THE DENSITY OF SPRAY SKIM AND WHOLE MILK\*

Pressure (lb. per sq. in.)	Dry Skimmilk			Dry Whole Milk		
	Density	Space saved (%)	Properties of cake	Density	Space saved (%)	Properties of cake
0	0.60			0.55		
200	0.78	23.1	no cake	0.73	24.6	no cake
400	0.81	25.9	no cake	0.75	26.7	no cake
800	0.84	28.6	no cake	0.79	30.4	crumbles
1,200	0.87	31.0	no cake	0.82	32.9	fragile
1,600	0.89	32.6	crumbles	0.86	36.0	weak
2,400	0.93	35.4	weak	0.93	40.8	firm
3,200	0.97	38.1	firm	1.01	45.5	hard

\*The values are averages from duplicate and triplicate determinations made on several different milks. Samples at zero pressure were loose and unpacked.

$$\text{Space saved (\%)} = \frac{\text{final density} - \text{initial density}}{\text{final density}} \times 100$$

Table 62 shows that dried skimmilk did not compress into cake form as well, nor did it save as much space as dried whole milk. These experimenters report that "a few preliminary observations did not indicate that compression of dried whole milk increases its keeping quality." Their findings agree essentially with those of Mohr and Ritterhoff who worked with drum-dried whole milk.

Hunziker<sup>8</sup> stored similar samples of dried whole milk taken before and after compressing. The samples were furnished by a manufacturer. They were kept in ordinary glass containers without hermetical seal and were held at room temperature. Repeated inspection of these samples showed that the compressed cake turned stale and tallowy more quickly than the corresponding loose, dried whole milk. It is possible that the pressure was not applied sufficiently gradually to ensure optimum escape of the air and its replacement by nitrogen gas.

**Packaging Precautions.**—In freshly prepared dried milk, either spray dried or drum dried, the lactose is present in the glass state. In this state the powder is very hygroscopic.<sup>9</sup> If packed in a humid atmosphere, or in non-hermetical, non-moisture proof containers, it will absorb moisture rapidly, become sticky and will cake in storage. In order to keep the powder free-flowing in the glass state it must be handled in a dry atmosphere between dryer and sealed package, and it must be packaged promptly into an hermetical, moisture-proof package. This applies both to dried whole milk and dried milk by-products.

**Packing Dried Skimmilk.**—Webb and Hufnagel<sup>7</sup> found the paraffin-lined, tight oak barrel a highly suitable package for dried skimmilk, especially for export shipment. They report that the moisture pick-up after four-months' storage at 110° F. and 80 per cent relative humidity was only one per cent, and the powder was not caked, but in excellent condition. The rectangular fiber box proved the best shaped container for saving space, but it lacked strength and moisture tightness.

**Packing Dried Whole Milk**<sup>10,11</sup>—U. S. Federal requirements of package are that the dried whole milk shall be vacuum packed with inert gas in hermetically sealed tin containers. Commercial packages of whole milk powder range in net weight from one pound to 50 pounds. For details see Chapter XXXVII.

#### REFERENCES

1. HAUSBRAND, E.: *Das Trocknen mit Luft and Dampf*. 1920.
2. REAVELL: *Trans. Inst. Chem. Eng.* VI. 115. 1928. Quoted by Scott.<sup>3</sup>
3. SCOTT, A. W.: *The Engineering Aspects of the Condensing and Drying of Milk*. 1932.
4. *Compressed Food Wrapped in Cellophane Saves Cargo Space*. *Scientific American*. p. 265. June, 1943.
5. KELLNER, E.: *Proceed. XI. World's Dairy Cong. Berlin II*. 245. 1937.
6. MOHR, W., AND RITTERHOFF: *Proceed. XI World's Dairy Cong. II*. 249. 1937.
7. WEBB, B. H., AND HUFNAGEL, C. F.: *Food Industries*, September 1943.
8. HUNZIKER, O. F.: *Keeping Quality of Compressed and Loose Whole Milk Powder in Storage at Room Temperature*. Results not published, 1943-44.
9. TROY, H. C., AND SHARP, P. F.: *Jour. Dairy Sci.* XIII. 140. 1930.
10. *Dry Milk Solids. Federal Specifications for Package and Packing*. C-M-351b.
11. *Dry Whole Milk. Federal Specifications for Package and Packing*. C-M-351b.

## CHAPTER XXXVII

### MANUFACTURE OF DRIED WHOLE MILK

The relation of the problems of thermodynamics and engineering of spray drying to the quality of dried skimmilk, referred to in Chapter XXXVI, apply to dried whole milk as well. In addition, whole milk powder, because of its relatively high fat content (U. S. standard whole milk powder must contain not less than 26 per cent milk fat) automatically reflects some of the properties of the milk fat. As shown in Chapter III, milk fat is relatively unstable. It is subject to hydrolysis brought about by lipolytically active bacteria and enzymes that cause rancidity due to the liberation of free fatty acids. It is subject to autoxidation causing intense tallowy flavor in the presence of oxidizing and catalyzing agencies, such as air, light and heat, acidity, alkalinity, certain metals, especially copper and iron and their salts, and certain pro-oxidant substances that are inherent in milk.

In order to protect whole milk powder against the development of rancid flavor and tallowy flavor, the manufacture and packaging of the powder must be adjusted and controlled in a manner that will eliminate, destroy, or otherwise inactivate the agencies responsible for fat spoilage. Much progress has been made within recent years in efforts to discover the specific causes and to provide effective methods for the prevention of these quality-damaging, fat-borne flavor defects of whole milk powder.

**Quality Control of Dried Whole Milk.**—The present chapter deals with some of the steps and conditions, between cow and the consumer, that are known to affect keeping quality of whole milk powder, such as: Freshness of fluid milk, sanitation in factory, type of metal on milk side of equipment, centrifuging the fluid milk, manner of homogenization, preheating temperature and time, extent of precondensing, promptness of removal of powder from drying chamber, temperature of powder at time of packaging, manner of packaging the powder, and age and temperature of storage.

**Quality of Fresh Milk.**—High quality of fluid milk is indispensable to keeping quality of whole milk powder. There is need, therefore, of efficient daily inspection of the farmers' milk upon its arrival at the factory, such as by the senses of smell and taste, supplemented by the sediment test and the methylene blue reduction test at suitable intervals. The acid test and direct microscopic count will also prove helpful for frequent checks. (See also Chapter XII.)

The milk must be fresh and it must be sweet. Without these fundamentals, efforts at dependable keeping quality are hopeless. It has been common experience, both in experimental work and in commercial operation, that whole milk powder made from Monday milk is of more uncer-

tain and of relatively poorer keeping quality than that made from milk received on other days of the week. Again, it has been observed in commercial manufacture that farmers' milk delivered twice daily yields better keeping powder than farmers' milk delivered once only per day.

Freshness of milk means absence of time necessary for the activity of lipolytic enzymes and bacteria which cause the liberation of free fatty acids and the appearance of rancidity. In addition, fat hydrolysis may become a precursor of autoxidation since the free fatty acids are more susceptible to oxidation than the fats (glycerides) themselves. Freshness of milk likewise means that the status of the fat in the newly-made powder represents the earliest possible stage of the induction period, thus giving promise of maximum stability of the milk fat and maximum deferment of the appearance of tallowy flavor. Furthermore, freshness means absence of a milk protein break-down. It appears to be the growing belief on the part of the student of the chemistry of milk that the break-down of the milk fat is initiated by the products of protein decomposition.

**Acidity of Fresh Milk.**—The milk must be sweet. Acidity hastens and intensifies the reactions that lead to tallowy flavor. Even exceedingly small additions of acids, barely perceptible to titration, materially increase the susceptibility of the fat to oxidation. It is especially the fatty acids that act as catalyzers in the reaction. They play a dominant role in the relative resistance of the fat to oxidation. Holm and Greenbank<sup>1</sup> demonstrated experimentally that partial removal of the fatty acids by washing improved the keeping quality of the fat, and that steam distillation was still more effective in retarding fat oxidation. Similarly, low acidity of the fluid milk minimizes the tendency to fat oxidation and tallowiness in whole milk powder. In addition, low acidity of fluid milk is essential to high solubility of dried milk. Government contracts limit the permissible acidity to 0.15 per cent.

**Metals on Milk Side of Equipment.**—Metals that are active oxidizers and catalyzers must be eliminated from the milk side of all equipment. The most damaging of these metals is copper and its organic salts. Being an active oxygen carrier, copper readily takes up oxygen from substances and gives it off to other substances such as milk fat, inciting oxidation. Even when present in exceedingly small amount, (less than 1 p.p.m.) copper salts accelerate the development of tallowy flavor. Alloys containing copper, such as the "white metals", have a similar effect, but their action appears somewhat less intense. Iron also incites fat oxidation but its action is slower than that of copper.

Copper, copper alloys and iron on the milk side of equipment jeopardize the keeping quality of whole milk powder. They are unsuitable and should not be used. The safest metals are: stainless steel 18-8, Inconel (a nickel-chrome alloy), glass-enamel, and aluminum. Coatings of tin,

nickel or chromium on copper and iron render the base metal harmless as long as the coating remains intact. However, such coatings have not proven sufficiently permanent to justify their use on the milk side of equipment used in the manufacture of whole milk powder.

**Factory Sanitation.**—Not infrequently the cause of rapid deterioration lies in contamination within the factory due to absence of systematic sanitary supervision of equipment. All equipment that comes in contact with the milk, from receiving platform to packaging room, needs thorough cleansing and sterilizing at the close of each day's operations. Its sanitary status should be controlled and approved by rigid daily sanitary inspection. In addition to insistence on scrupulous cleanliness of all equipment, special attention need be given to the possibility of leaky seams, welds and joints in insulated equipment, such as the drying chamber, and all other equipment that might foul the powder. The air filter also needs constant attention, see "Air Filter" in Chapter XXXVI.

A further ever-present threat of high bacterial counts and damage to keeping quality lies in long uninterrupted runs of plant operation, that cause increasingly heavy deposits of milk solids in preheaters (especially in the case of high preheating temperatures), and in evaporators. A long, continuous milk flow through plant equipment also invites the protracted entrapping of varying quantities of concentrated milk in and between evaporator and atomizer feed tanks, at near optimal temperatures for maximum bacterial multiplication. Referring to commercial observations Crossley<sup>28</sup> reported that, with a preheating temperature of 190° F., the bacterial count per gram of powder for different operating periods was as follows: Runs not exceeding 8 hours 86% below 20,000, 81% below 10,000, 20% below 1,000. The critical period was reached from 10 hours upward. Counts exceeding 1,000,000 per gram were all obtained between 16 and 18 hours.

The above observations emphasize the need, in the case of long runs, to provide means for a cleaning break at intervals of not more than about 9 hours. In some plants it may be feasible to install a double line of processing equipment with suitable by-pass connection. In this case the milk flow is switched to the clean line after say a 9-hour run, and the used line is washed without interrupting the milk flow. Where this is not financially practicable, the duplication of equipment may have to be confined to the less expensive pieces, such as the atomizer feed tank, and the milk flow must be interrupted long enough to permit of proper cleaning of such equipment as preheater and evaporator.

**Centrifuging the Fluid Milk.**—Clarifying the fluid milk by centrifugal force improves the keeping quality of whole milk powder. The beneficial effect of centrifuging depends on the promptness of this treatment after milking. Holm, Greenbank and Deysher<sup>3</sup> demonstrated experimentally that this improvement is due to the removal of the slime that deposits



in the bowl. They further found that improvement is greatest when the centrifuging is done as soon as possible after the milk is drawn. Dahle and Josephson<sup>4</sup> concluded that the partial elimination of the lecithin, and perhaps other oxidants, from milk by centrifuging, retards fat oxidation and improves the keeping quality of the whole milk powder.

Results by different investigators on the benefits of centrifugal clarification are somewhat at variance, however. Thus Lea, Findlay and Smith<sup>28</sup> reported that removal of separator slime by use of the centrifugal clarifier did not significantly increase the storage life of the powders.

**Separating All the Milk Upon Arrival at Factory.**—If the fluid milk is separated such as is the practice when homogenizing the cream only, the cream separator performs the centrifuging function and may eliminate the need of the clarifier. This practice has the further advantage of permitting the centrifuging immediately upon arrival of the milk at the factory. The cream so separated should be relatively low in milk fat (18 to 25% fat). High-fat cream (such as 45% fat) is difficult to manage due to tendency to churn and oil-off. Also, too rich cream lacks the volume of non-fat solids necessary to properly protect the much increased fat surface of the homogenized product from agencies of quality-damaging oxidation.

**Manner of Homogenizing.**—Homogenization is necessary in order to accomplish uniform distribution of the fat in the whole milk powder and to facilitate reconstitution to fluid milk. Some manufacturers homogenize the cream only, then cool it and return it to the cooled skim milk in the fluid milk storage tank. This practice appears to stabilize the emulsion of fat-in-skim milk quite as efficiently as homogenizing the whole milk. Its chief advantage lies in its reduction in volume that must be homogenized, thereby economizing power and time, and permitting the use of a smaller capacity homogenizer.

It has the further advantage that homogenization at the beginning of the process eliminates the danger of fat separation from the very start of the process and thus makes unnecessary the use of costly, and often objectionable, mechanical agitators. Agitation tends to promote bacterial activity. The cream is best homogenized at a temperature of about 145° F. using a single-stage homogenizer at 3,000 pounds pressure.

**Temperature of Preheating.**—It is common practice in milk powder plants to preheat the fresh milk at temperatures ranging approximately from 165 to 185° F., for 30 minutes. If higher temperatures are used, it becomes necessary to shorten the time of heat exposure in order to guard against objectionable cooked flavor and to protect the solubility (protein stability) of the finished product. Within recent years increasing attention has been given to the use of preheating temperatures near or above the boiling point. There is a growing acceptance, on the part of the industry, of the theory that the higher temperatures assist in retard-

ing fat oxidation and in prolonging the shelf-life of the powder. In fact, some manufacturers of dried whole milk have adopted the practice of preheating within the approximate range of 220 to 250° F.

Published results of properly controlled experiments showing the comparative merits of high and low preheating temperatures as regards keeping quality of whole milk powder are limited. On different levels of preheating below the boiling point, comparative experimental results are reported by Holm, Greenbank and Deysher<sup>3</sup> (spray process powder), Hollender and Tracy<sup>11</sup> (spray process powder), Jack and Henderson<sup>17</sup> (atmospheric roller process powder), and Lea, Findlay and Smith<sup>23</sup> (spray process powder). The results are summarized in Table 62-A.

TABLE 62-A.—EFFECT OF PREHEATING TEMPERATURES BELOW THE BOILING POINT UPON KEEPING QUALITY OF MILK POWDER

Investigators	Number of Samples at Each Temp.	Preheating Temperatures Used	Time Held	Temperature That Produced Best Keeping Quality	Time Powder Maintained Satisfactory Flavor
			min.	° F.	mos.
Holm et al. . . . .	1	°C. 63, 73, 83, 93 °F. 145.4, 163.4, 181.4, 199.4	30	181.4	(a)
Hollender & Tracy.	2	°C. 65.5, 76.7, 84 °F. 150, 170, 190	30	170	Not given
Jack & Henderson..	1	°C. 61.1 (30 min.), 79.4 (15 min.) °F. 142. 175	.....	175	24
Lea et al. ....	5	°C. 73.8, 87.7 °F. 165, 190	3 to 5*	190	24

\*Preheating time for each temperature was 20 seconds, followed by 3 to 5 minutes at a slight drop in temperature in holding tank.

(a) After two months storage, the powder made from milk preheated at 63° C. had dissipated the induction period approximately 20% more than that made from milk preheated at 83° C.

**Effect of Heat Treatment on Production of Antioxigenic Reducing Substances.**—Normal milk contains antioxidants, such as ascorbic acid (vitamin C), tocopherols (members of the vitamin E group), and an as yet undetermined number of vitagens\* with distinct antioxidant properties. These antioxidants are active reducing agents. However, most of them are readily oxidized upon prolonged exposure to heat in the presence of air. Coulter<sup>7</sup> points out that reducing substances that are definitely antioxigenic may be produced in milk by heat treatment. It is now recognized that high heat treatment (especially preheating at temperatures near, and even above the boiling point) is capable of retarding fat oxidation through the formation of compounds belonging to the sul-

\*Vitagens, similar to vitamins, are required for normal growth and maintenance of animal life. They are also essential for the transformation of energy and for the regulation of the metabolism of structural units. They differ from the vitamins in that the vitagens, in addition, act as suppliers of energy, or as structural building units.

phydryl group. Being active antioxidants, these compounds, if present in the milk powder, are in position to neutralize the oxygen contained in the can before the oxygen combines with the milk fat present.

As indicated in Chapter III under "Substances Associated with the Milk Fat," Bordas and de Raczkowski<sup>12</sup> reported that temperatures within the range of 203 to 230° F. destroyed as high as 28 per cent of the lecithin content of milk. Greenbank and co-workers<sup>13</sup>, in a more recent experimental study of the effect of heat treatment of fluid milk, likewise found that "heating reduces the oxidation-reduction potential, that is, forms reducing substances (probably antioxidants)." These investigators studied the effect of temperatures up to 95° C. (203° F.). They observed that heating at 90° C. (194° F.) for 5 minutes causes the greatest decrease in the oxidation-reduction potential.

Greenbank et al found that within the temperature-time heat treatments used (up to 203° F., 5 minutes), a temperature-time exposure of 194° F. for 5 minutes yielded maximum production of reducing substances in the fluid milk. These findings support the results of Lea et al which showed that preheating at 190° F. for 3 to 5 minutes greatly increased the storage life of whole milk powder over that made from milk preheated at 165° F. They attribute the marked protective effect of the higher temperature (190° F.) to (a) the production in the milk of antioxidant-active sulphhydryl compounds formed by the action of heat upon the proteins, and possibly to (b) the more complete destruction of oxidizing enzymes present in the milk.

The sulphhydryl compounds were readily detectable in the dried milk preheated at 190° F. but not in that preheated at 165° F. These findings support the hypothesis of the sulphhydryl production as a major cause of the improvement at the higher preheating temperature.

The phosphatase test showed that preheating at 165° F. for 20 seconds and holding near that temperature for 3 to 5 minutes was insufficient to destroy the oxidizing enzymes present. In addition, both Holm<sup>20</sup> and Lea et al<sup>23</sup> observed that the higher preheating temperature produced greater improvement in the keeping properties of the powder made from milk of poor quality than of that made from milk of good quality. These facts support the hypothesis of more efficient destruction of the oxidizing enzymes at 190° F. than at 165° F.

**Effect of Preheating Temperature on Shelf-Life of Powder.**—The experimental results cited<sup>4</sup> in Table 62-A, together with the above discussion of their merits, emphasize the preheating temperature as an important potential factor in the control of keeping quality of whole milk powder. They thus suggest the urgency of further experimental study of the temperature-time ratio of preheating most favorable to protect the flavor of whole milk powder from age deterioration due to autoxidation of its fat constituent.

The findings of the several investigators given in the above table are not in close agreement. It was pointed out in earlier paragraphs in this chapter that results vary considerably with different systems of drying.<sup>20</sup> In addition, in most of the trials cited the number of runs made and samples tested was far too limited to be conclusive. Yet, on the basis of the available data and the discussion of their merits, the conclusion appears inevitable that for preheating temperatures below the boiling point, flash heating to a temperature range of 190 to 194° F., followed by a short holding period (3 to 5 minutes), retards flavor deterioration and prolongs the shelf-life of dried whole milk as compared with powder made from milk preheated at lower temperatures.

Thompson and Kon<sup>26</sup> emphasized that preheating of the milk at 190°<sup>23</sup> produced a spray powder that was perfectly palatable even after 12 months storage in air pack.

**Effect of Preheating Temperature on Flavor of Milk Powder.**—As explained in Chapter II, the cooked flavor of milk is now generally attributed to the liberation of the sulphides of milk by heat. Lea et al suggest that it may be impossible to stabilize milk by heating without introducing the cooked flavor. The cooked flavor, while noticeable, was not considered objectionable. It has been experimentally demonstrated<sup>24, 25</sup> and should be emphasized here, that it is the time factor of the temperature-time ratio of heat treatment that jeopardizes the flavor most. Thus milk can be heated to a comparatively high temperature without objectionably pronounced cooked flavor provided that the coming up period is practically instantaneous (a few seconds only), and the holding period is very short (a few minutes only).

**Effect of Preheating Temperature on Solubility of Powder.**—The solubility of milk powder is controlled principally by the stability of the proteins. Factors that denature the proteins jeopardize the solubility of the powder. High preheating temperatures tend to promote protein denaturation, and such distabilization increases with the intensity of the heat treatment. As in the case of effect of preheating on flavor, so also in the case of effect on solubility, the time factor of the heat treatment is of predominating importance. Within practicable limits short-high temperature preheating is less damaging to solubility than the long-low temperature process. Lea et al<sup>28</sup> report that preheating to 190° F. for 20 seconds, followed by 3 to 5 minutes at a slight temperature drop in the holding tank did not appreciably reduce the solubility of the powder. See also Chapter XLI on "Solubility of Milk Powders". These investigators concluded that damage done to solubility and flavor by the above temperature-time ratio of preheating was relatively negligible and that it was far outweighed by the benefits derived from the much improved keeping quality.

**Merits of Addition of Antioxidants.**—Considerable experimental study

has been made in efforts to determine the beneficial effect of added antioxidants on the flavor stability of milk powder. A variety of antioxidant substances, mostly of vegetable origin, have been used in these investigations.

Hollender and Tracy<sup>11</sup> experimented with ascorbic acid, Avenex, butyl ester of tyrosine, culture of *S. lactis*, gum guaiac, hydroquinone, sodium citrate and wheat germ oil. They found gum guaiac and hydroquinone\* most effective in prolonging the shelf-life of the powder.

Findlay, Smith and Lea<sup>27</sup> worked with ascorbic acid, citric acid, cysteine, gallic acid and its esters, gelatinhydrolysate, haemotoxylin, hydroxy-tetonic and dihydroxy-maleic acids, sodium hypophosphite, sodium pyrophosphate and creatinine, potassium metabisulphite and tocopherol concentrates and a synthetic chroman. They reported that ethyl gallate and ascorbic acid proved most promising. Both of these substances materially increased the resistance of the powder to the development of tallowiness without producing any flavor foreign to milk. The activity of both of these chemicals was confirmed in factory-made spray powder. Ethyl gallate was the more powerful of the two. At a concentration of 0.07% it increased the storage life of milk powder in the accelerated tests 2½ to 3 fold.

The addition of antioxidant substances foreign to the composition of normal milk, to prevent flavor deterioration due to autoxidation of the fat in whole milk powder, can obviously not be considered the final answer to the problem of insuring commercially satisfactory keeping quality of this valuable food product. Nor does such practice appear ethically desirable.

**Effect of Precondensing.**—The economic advantages of precondensing were pointed out in Chapter XXXVI. In addition, the early work of Holm, Greenbank and Deysher<sup>5</sup> has shown that dried milk made from precondensed fresh milk has better keeping quality than that made from uncondensed milk. These investigators concluded that precondensing under vacuum facilitates removal of some of the volatile substances which may include also substances that act as catalysts for oxidation. As a result of later and as yet unpublished work, Holm<sup>20</sup> reported that dried milk made from milk of low concentration retains more air and oxygen when subjected to vacuum treatment during packaging than does dried milk made from milks of higher concentrations. Similar findings have been reported also by Hetrick and Tracy<sup>8</sup> and by Gane.<sup>22</sup>

It has long been observed that an increase in concentration of the fresh milk is accompanied by an increase in particle size of the resulting spray powder. The spray drying of uncondensed milk not only is prohibitively

\*The use of hydroquinone in the form of Nitardi, as an antioxidant in fat-soluble vitamin concentration, has not been approved by the American Medical Association, because of its toxic effect.

uneconomical due to excessive steam requirements, low capacity of equipment and prolonged drying time, but it yields a powder of such small particle size that entrainment losses are high, it is difficult to handle, and recovery, miscibility and resistance to early flavor deterioration is relatively low. In fact, one of the pivotal claims of the early Merrell-Soule patents covered the discovery by the inventors that precondensing of the fresh milk to a relatively high solids content is essential to the economically successful manufacture of a marketable spray process milk powder.

It was also shown in Chapter XXXVI, under "Pressure Spray Nozzles" that the larger the nozzle orifice and the lower the pressure, the coarser will be the particle size of the powder. In addition, Hetrick and Tracy<sup>8</sup> found that when the method of spray drying was altered, use of a smaller

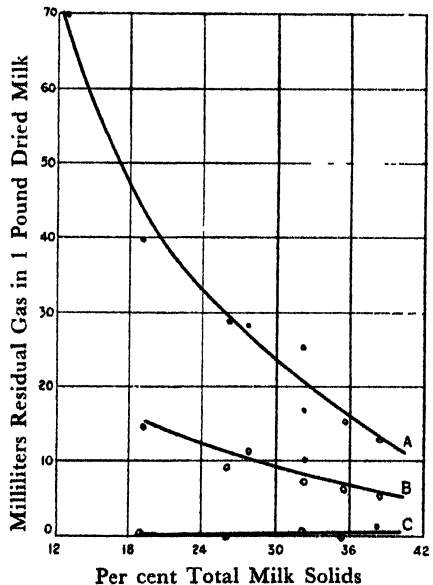

Fig. 114. Effect of solids content of milk before drying on residual gas of dried product

A.—Total gas      B.—Oxygen content  
C.—Carbon dioxide content

Courtesy of George E. Holm<sup>20</sup>

orifice and higher pressure yielded a powder with a higher oxygen content per gram than did the use of a larger orifice and lower pressure. It is interesting here to note that an increase in particle size of the powder was accompanied by a decrease in the ratio of oxygen retained in the vacuumized product. This was the case when the increased particle size was due to higher concentration of the milk and also when it was due to larger spray orifice and lower pressure.

The above observations suggest particle size as one of the factors influencing the volume of oxygen retained in the vacuumized powder. The mechanism responsible for the phenomenon that powder of coarse particle size retains less oxygen than powder of fine particle size, has not as yet been fully explained. Two hypotheses have been advanced, namely,

(1) The smaller surface area per unit volume of powder with large particle size exposes less surface to oxygen adsorption, and (2) large air cells offer less resistance to pressure differences between interior and exterior of powder particle; they may be expected, therefore, to collapse more readily and release the contained oxygen more completely during gas-packing. Hypothesis (1) is inadequate because adsorption of oxygen to the surface of the powder particles is believed to represent only a relatively small portion of the retained oxygen.<sup>21</sup> Hypothesis (2) fails to satisfactorily explain why powders of similar particle size, but dried by different spray processes, show a wide range of oxygen retention, as reported by Holm and co-workers.<sup>20</sup>

**Promptness of Removal of Powder from Hot Drying Chamber.**—Whole milk powder is preferably removed from the drying chamber continuously during operation. Allowing the powder to accumulate in the hot drying chamber until the end of the day's run, tends to shorten the induction period of the fat, accelerating and intensifying susceptibility to early autoxidation accompanied by the appearance of the quality-damaging, tallowy flavor. Jeopardy to keeping quality then is further augmented by the fact that prolonged exposure to the drying heat invites oiling-off. This causes some of the fat to lose the protective protein covering.

**Temperature of Powder at Time of Packaging.**—When packed direct into the bulk package—the paper-lined barrel—the hot-packed powder sealed in the paper-lined barrel retains its drying heat for several days. This condition jeopardizes both solubility and keeping quality. It tends to distabilize the proteins, lowering the solubility of the powder. In addition, the prolonged heat exposure initiates oiling off of the fat causing the fat to become the continuous phase. This exposes the fat that reaches the surface of the powder particles to the oxidizing influence of the surrounding atmosphere, dissipating the induction period and hastening the appearance of tallowy flavor. Efforts to protect the quality of dried milk from heat damage have suggested the advisability of providing means for cooling the powder on its way to the bulk package. Some manufacturers have adopted the practice of cooling the whole milk powder to about 85° F. before packaging.

The use of a much smaller container, of metal construction, such as the one-pound or five-pound tin can, in the place of the large wooden barrel, has largely eliminated the danger of prolonged exposure to high temperature in the barrel after packing. Furthermore, the hot whole milk powder from the drying chamber, vacuumized and gassed without cooling, was found to release the retained oxygen more readily and more completely than the cooled powder. Hetrick and Tracy<sup>8</sup> demonstrated experimentally that dried whole milk packed from the dryer at approximately 120 to 125° F., contained less oxygen than portions of the same powder cooled to 60° F. before packaging.

Published experimental data showing the effect of hot versus cold packaging on keeping quality, appear to be lacking. Yet the results on oxygen content cited above suggest the probability of better keeping quality of whole milk powder that is vacuumized and gassed while hot, than of the same powder that has been cooled before packaging.

#### THE PACKAGING OF WHOLE MILK POWDER

**Importance of Elimination of the Oxygen from the Package.**—It is shown under "The Dried Milk Particle", in Chapter XLI, that the major part of the oxygen retained in the milk spray dried in the presence of heated air is that entrapped in the air cells of the milk powder particles. The secret of successful packaging of whole milk powder involves the use of a commercially practicable procedure that will release this entrapped air and thus reduce the oxygen concentration to as low a level as possible. This may be accomplished by vacuumizing, and gas-packing in an inert gas, and it may also be done by holding under vacuum continuously. These methods of packaging cause the oxygen to permeate the walls of the air cells and to diffuse from them until equilibrium is attained between interior of air cells and head gas space in the can.

As shown in Chapter XLII under "Prevention of Tallowy Flavor", this diffusion of gas through the walls of the air cells is relatively slow and it varies with different powders. Attainment of equilibrium in the gas packed cans is reached in about 5 to 7 days. The findings and conclusions of the leading research workers in this field are in general agreement that a decrease, especially below 5%, in oxygen content improves the keeping quality of the powder, and that for a commercial pack of satisfactorily dependable keeping quality the oxygen concentration in the free gas space of the can seven days after gas-packing should not exceed 3% per gram of powder. These findings,<sup>20, 29</sup> supplied the basis for the recommendation to the U. S. Army and the Industry to limit the permissible oxygen content after the 7-day desorption period to 3%.

**History of Gas-Packing.**—Mutschler,<sup>14</sup> reported the development of gas-packing of foods in chronological order. The data show that packing perishable foods in an atmosphere of low oxygen content is not new. The first U. S. patent on vacuum packing was granted A. T. Twing and Ebenezer Wood of Louisburg, and William Elderhost of Troy, New York in 1860.<sup>18</sup> The patent reads as follows:

"The object of the invention is to remove the air from the interior of a fruit can without heating the contents, and to seal the same up perfectly tight and with an easy manipulation without giving the air a chance to find its way back to the interior of the can."

In short, the patent covers vacuumizing the can of fruit by means of an air pump including an arrangement in the top of the can to seal it hermetically after exhausting.



In 1865, Francis Stabler of Baltimore, Maryland, was granted a U. S. patent on his process of preserving food products by extracting water from such products by means of salting or sugar, followed by sealing in air-tight cans, from which the air is expelled by means of carbonic acid gas. The patent reads as follows:

"Wholly or partially desiccated animal or vegetable substance is preserved by sealing in air-tight cans and expelling the air by substitution of gas that will not support combustion." In 1866, the same inventor received a U. S. patent covering an apparatus designed for gas-packing by the Stabler process above described. Process and apparatus are essentially the same in principle as those used in the batch system of gas-packing whole milk powder today.

It appears from available records that the first installation of commercial gas-packing machinery was made in 1921. This equipment was

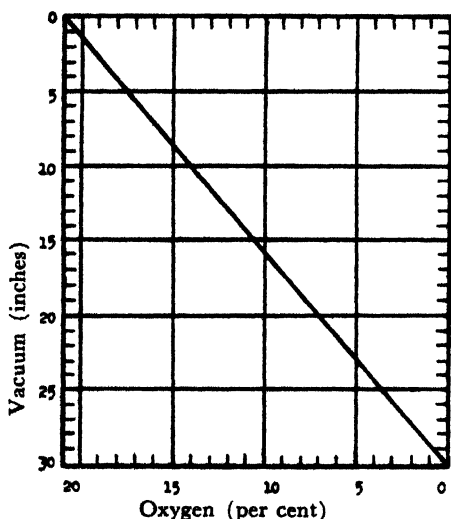

Fig. 115. Relation of vacuum to oxygen equivalent  
Courtesy of Wm. J. Mutschler<sup>14</sup>

used for gas-packing shredded cocoanut. Whole milk powder was first gas-packed in 1924 by the Merrell-Soule Company, who marketed their product under the familiar trade name "Klim". The Borden Company in 1927-28 purchased the Merrell-Soule interests and continued the output of Klim. Numerous U. S. patents on packaging procedures have been granted since 1924, one of the most recent of which is the one granted to Shipstead and Brant<sup>15</sup> of the Borden Company, on "Packaging Spray-Dried Whole Milk Powder".

**Vacuum Packing.**—It will be shown in Chapter XLII under "Prevention of Tallowy Flavor", that for a satisfactory pack of whole milk powder, the air must be evacuated sufficiently to have the oxygen content in the head space of the can on the seventh day after vacuumizing, 3%

or less. This means a vacuum of about  $28\frac{1}{2}$  inches on a 30-inch barometer at the time of vacuumizing. See also Fig. 115, which shows relation between vacuum and oxygen equivalent. A permanent vacuum pack for milk powder, however, has not proven commercially satisfactory because of the following drawbacks:

1. Large cans are unable to withstand so high a vacuum. They are

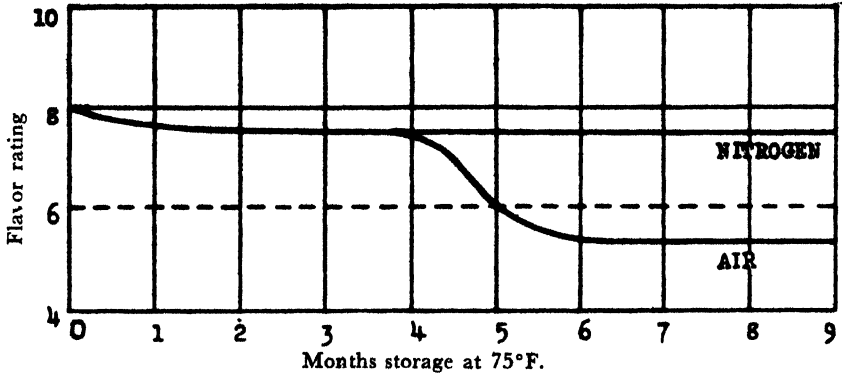

Fig. 116. Effect of nitrogen packing on storage life of whole milk powder  
Courtesy of Wm. J. Mutschler<sup>14</sup>

prone to panel and even collapse. Thus it has been found impractical to pack cans larger than the one pound can under vacuum.

2. Vacuumizing at high speed powders of very fine particle size, such as spray-dried whole milk, tends to cause fine milk dust to be drawn

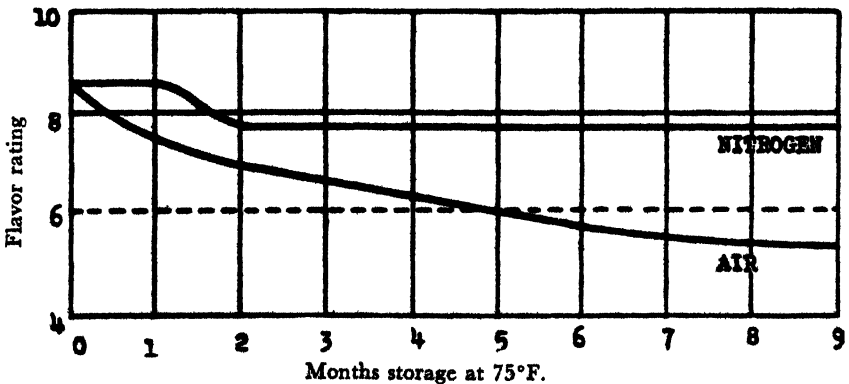

Fig. 117. Effect of nitrogen packing on storage life of dried ice cream mix  
Courtesy of Wm. J. Mutschler<sup>14</sup>

from the can, inviting seaming difficulties accompanied by high maintenance cost.

Experimental results of Mutschler,<sup>14</sup> graphically illustrated in Figures 116 and 117, show the superior keeping quality of nitrogen-packed over

air-packed dried whole milk and dried ice cream mix, held in storage at 75° F. The keeping quality is expressed in terms of flavor ratings. The flavor rating of 6 which is indicated by the broken line, is the minimum acceptable flavor. The graphs show that, in each case, the nitrogen-packed powders uniformly maintained a flavor rating close to 8 for the entire storage period (9 months). The air-packed whole milk powder suffered a break in flavor rating at the end of the fourth month. This may represent the end of the induction period of the milk fat. In both of the air-packed powders the flavor rating dropped below 6 between the fifth and sixth months of storage.

**Nitrogen Packing after Vacuumizing.**—Packing in an inert gas has proved to be a very satisfactory method of packaging whole milk powder. It consists of drawing a high vacuum on the cans of dried whole milk (within  $\frac{1}{4}$  inch of the barometer), then dissipating the vacuum with an inert gas such as nitrogen or carbon dioxide, and sealing the cans.

Carbon dioxide has the advantage of being cheaper and containing less oxygen than bottled nitrogen. According to Mutschler<sup>14</sup> the rate of gas per 1000 one-pound cans is \$.46 for CO<sub>2</sub> and \$.70 for nitrogen. The average oxygen content of carbon dioxide is less than 0.1% and that of water pumped nitrogen is 0.2% or less. On the other hand, carbon dioxide is soluble in milk fat and may thus cause off-flavors in the powder. Experimental evidence on this point, however, is lacking. Furthermore, when whole milk powder or other products containing fats are packed in an atmosphere of carbon dioxide, a vacuum develops in the can. It is thus not possible to use 100% carbon dioxide in cans larger than the one-pound size, due to panelling. Carbon dioxide alone is now rarely used. Most manufacturers of dried whole milk appear to consider nitrogen the most suitable gas to use. One large manufacturer is reported to use a mixture of 20% carbon dioxide and 80% nitrogen.

**Transfer from Drying Unit to Packaging Room.**—It is seldom feasible to synchronize the routine of packaging with the rate of drying. It is, therefore, customary to collect the whole milk powder that is continuously discharging from the sifter of the drying unit into temporary bulk containers. Double-lined barrels are commonly used for this purpose. The filled barrels are removed to the packaging room where the powder is packed into tin cans of the desired size. The cans are then vacuumized, filled with nitrogen, and hermetically sealed as fast as the factory routine permits. See also "Double Vacuumizing" later.

**Size of Cans.**—The family size cans most commonly used are the 1-pound, 2½-pound and 5-pound can. There is also a 4½-ounce can. The milk powder contained in this can represents the total milk solids equivalent to one quart of whole milk of average composition. Then there are the large size cans which are mainly intended for institutional

use. Of these, the 50-pound can is the most common size. A limited number of 25-pound and 100-pound cans is also used.

**Filling the Cans.**—In order to fill containers with a light, fluffy material, such as whole milk powder, to exact weight and reasonable uniformity of fulness between cans, there is need of a definite system of packag-

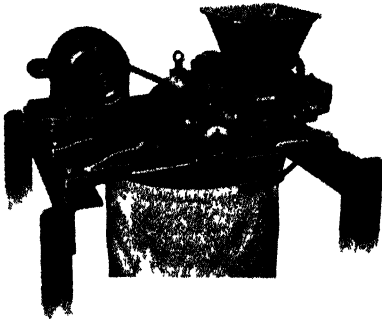

Fig. 118. Filler with gravity feed and vibrating hopper.

Courtesy of Pulverizing Machinery Co.

ing. Automatic filling machines, designed specifically for the satisfactory packaging of whole milk powder and other materials of similar physical properties, have only recently become available. They supply a long-felt want in the now rapidly expanding field of the whole milk

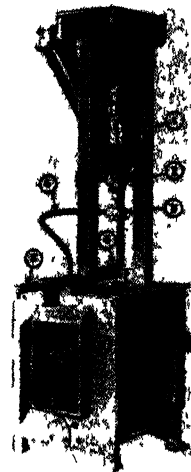
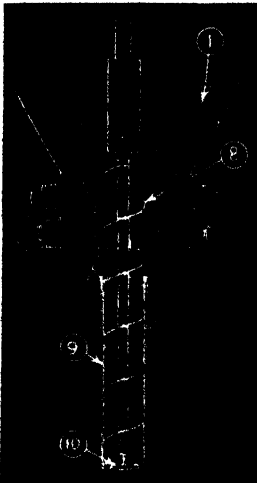

Fig. 118A. Combination Auger and vacuum feed filler

Courtesy of Stokes & Smith Co.

powder branch of the dairy industry. Some of these machines operate with gravity feed and vibrating hopper as illustrated in Fig. 118. The latest model is a combination of Auger and vacuum feed as illustrated in Fig. 118A. This filler combines the advantages of the Auger feed for speed and accuracy with the compact, clean and dustless packaging of the

vacuum method. It consists essentially of an Auger (8) that extends from hopper (1) through the Auger tube (10) terminating in vacuum-auger head (3); a rubber cap that is held by the lip of the vacuum head (3) and seals the top of the can for evacuation.

**Vacuumizing and Nitrogen Packing.**—Equipment for semi-automatic and automatic packaging of whole milk powder has been developed by leading can manufacturing companies.<sup>9, 10</sup> These vacuumizing and nitrogen packing units handle cans up to and including the 5-pound size. In the semi-automatic units the gassing box is the pivot of the packaging operation. Into this box are placed the trays of cans that have been filled with the dried whole milk. The cans either have one or more vent holes in the cover, or the cover is only loosely fastened by a "clinching" operation.

The entire gassing box containing the filled cans is vacuumized and then filled with nitrogen. A vacuum within about  $\frac{1}{4}$ -inch of the barometer is drawn on the box. The nitrogen is built up to a pressure of one

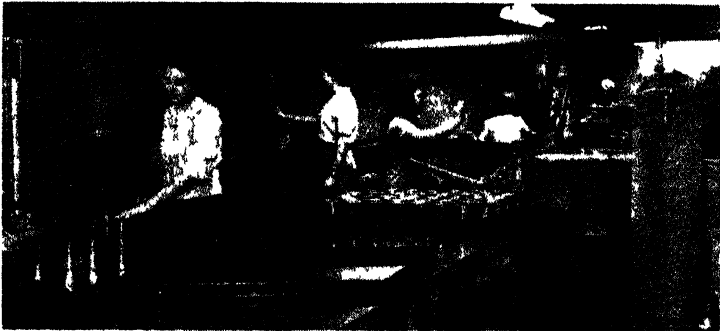

Fig. 119. Whole milk powder packaging room, showing vacuumizing and gassing machines

Courtesy of Central Dairy, Inc., Ft. Wayne, Indiana

to three pounds. The entire operation of vacuumizing and gassing occupies approximately one minute, the exact time depending on size of can, vacuum pump and powder particle. The gassed cans are then removed into the atmosphere immediately for final sealing. The cans with vent holes are tipped with solder. The cans with clinched tops are sealed by a double seaming operation on an automatic closing machine. In either case, the sealing is completed immediately in order to prevent increase of oxygen content due to entrance of air. It is for this reason that the number of cans per gassing unit of these semi-automatic machines is limited. More cans per unit would expose the last cans sealed for too long a time to the atmosphere, causing excessive infiltration of air back into the gassed can before sealing. The gassing box assemblies in present use have a maximum capacity of 32 one-pound cans per minute. The

loose top can system is somewhat more automatic and slightly more speedy than the vent hole top system, see Fig. 119.

The present completely automatic packaging unit consists of 21 bell-type chambers arranged radially. Their vacuumizing and gassing operation is controlled by a centrally located rotary valve. The entire unit is synchronized with the clincher and the closing machine. Speeds up to 40 one-pound cans per minute are attained. Newer machines will handle up to 120 one-pound cans per minute. These machines will also accommodate larger cans at lower speed.

**Packaging in Large Containers.**—The large size cans (25 to 100 pounds of powder), intended mostly for institutional use, are expected to be reopened more times than the smaller, family size cans (4½ ounces to 5 pounds). The opening of the can is, therefore, made large enough to admit a metal scoop for removal of the powder, and the can is provided with a tight reclosure. The 50-pound can, for instance, is a round can, fitted in the center of the top with a single friction opening 7¾ inches in diameter. The vacuum and gassing is usually done in a special gassing chamber holding one can. Some large manufacturers of whole milk powder now use a multiple-can vacuumizing and gassing cabinet for the large cans. The large cans require longer vacuumizing and gassing times than the family size cans. It is claimed, however, that even with the 50-pound can, treated in a single can gassing box, a speed of one can per minute can be attained with the proper size vacuum pump.

**Double Vacuumizing.**—Some manufacturers double vacuumize the powder before "gassing". In this case the dried milk is transferred from the sifter to large drums (usual capacity about 300 pounds). The filled drums are immediately vacuumized. This temporary form of package is held for several hours, or overnight, or even as long as 48 hours. After the holding period, the powder is then transferred to the final containers in which it is again vacuumized, followed by gassing and sealing as previously described.

The purpose of double vacuumizing with intervening holding period is to accomplish more nearly complete removal of the air from the air cells before final sealing. It is usually resorted to where efforts are made to reduce the final oxygen concentration to less than 3%. Liberation of the air occluded in the powder particles is not instantaneous. It is gradual and is assisted by holding under vacuum. Double vacuumizing makes for more complete elimination of the oxygen and thus favors maximum shelf life of the dried milk. The improved keeping quality of whole milk powder so packed may prove to justify the somewhat higher cost of packaging.

To this group of packaging procedure also belongs the method recently developed by Shipstead and Brant<sup>15</sup> previously referred to in this chapter. This method is covered by U. S. patent. It has to do with

prevacuumizing the milk powder in bulk (in large tanks) and holding it under a vacuum of 20 inches or higher for a number of hours (such as 10 to 20 hours, or longer or shorter according to magnitude of vacuum). After the vacuum holding period the vacuum of the tank is then broken and the powder is packed and sealed in consumer cans (preferably in an atmosphere of an inert gas), as soon as possible after releasing the vacuum of the bulk tank. Shipstead and Brant report that their procedure prolongs the keeping quality of the milk powder and simplifies the operation, economizes labor and lowers the cost of packaging.

Some manufacturers accomplish the preliminary vacuumizing by placing solid carbon dioxide (dry ice) in the freshly filled milk powder drum, and keeping the container sealed until ready to pack into consumer cans for the final vacuumizing, gassing and sealing. A procedure covering

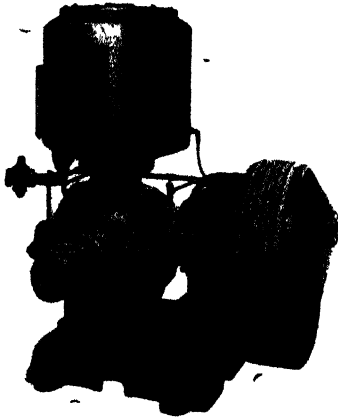

Fig. 120. Rotary-piston high vacuum pump

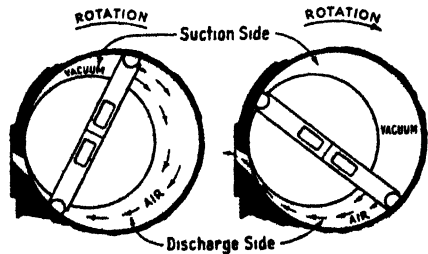

Fig. 121. Rotor showing slide valve with inlet and discharge ports

Courtesy of Beach-Russ Company

this method was invented by Carl H. Hansen<sup>16</sup> who was granted a U. S. patent in 1936. Another method using the solid carbon dioxide was developed by the Western Regional Laboratory of the United States Department of Agriculture.

**Vacuumizing Pumps.**—The pump that is suitable for vacuumizing the cans filled with whole milk powder must be a quick action pump, capable of drawing a very high vacuum (29¾ inches or better), and it must do so in a short time, especially when used with automatic machinery. Attainment of such high vacua requires the direct, positive rotary motion type of pump. All working surfaces must be machined, ground and fitted to close tolerances. Contact between cylinder and slide valve of rotor must be sufficiently close to provide a completely dependable oil seal in the cylinder and a vacuum seal of high efficiency. A pump embodying these principles is illustrated in Figs. 120 and 121.

**Nitrogen Supply.**—Nitrogen gas is available on the open market, in high pressure cylinders containing 200 cubic feet of gas, at a price ranging from \$1.00 to \$2.00 per 100 cubic feet, depending upon the annual volume of gas used. Only water-pumped nitrogen is suitable. It has a higher purity than the oil-pumped gas.

There is available also equipment whereby the large manufacturer of whole milk powder may produce his own supply of nitrogen at considerably lower cost.

**Packaging Powder Spray Dried in Absence of Atmospheric Air.**—It may reasonably be expected that the gas contained in the air cells within the spray-dried milk particle is similar in nature to the atmosphere of the drying chamber. It follows, therefore, that using a vacuum, or any suitable heated inert gas in the drying chamber in the place of heated air, would eliminate the problem of removing the occluded oxygen. Thus in the Freeze Drying System (see Chapter XXXIV), the operation of drying is done in an essentially complete vacuum. This should yield particle cells or cores free from air. In this system the powder is collected in a receptacle under vacuum. The vacuum is then dissipated by gassing, and the final containers are filled direct from the gassed receptacle. Therefore, the entire drying and gassing operation, from the time the concentrated fluid milk enters the vacuumized drying chamber until the resulting gassed powder is hermetically sealed in the final package, is done in an atmosphere almost completely devoid of oxygen.

Hence, the problem of gas-packing by this system does not involve desorption of oxygen. It is solely concerned with equilibrium of inert gas between interior of powder particles and air space of can. This suggests that whole milk powder so made should keep for an almost unlimited period, provided that, prior to drying, the fluid milk is preheated to a temperature sufficiently high to destroy or inactivate all enzymes present, as explained under "Preheating" earlier in this chapter, and in Chapter XLII, under "Rancid Flavor and Odor".

**Cost of Canning Whole Milk Powder\*<sup>9</sup>**

July 15, 1944

Can size, 5 lb., height 8 in., diameter 6 3/16 in.

Can cost \$70.59 per 1,000 f.o.b. Chicago

Can cost per pound of powder .....	\$0.01411
Carton cost per pound of powder.....	0.01333
Labor cost per pound of powder.....	0.002
Gas cost per pound of powder.....	0.0005
Strap .....	0.001
<b>Total packaging cost per pound of powder.....</b>	<b>\$0.03094</b>
<b>Labor at \$0.75 per hour</b>	

\*Town girls get \$0.55-.60 per hour.



## REFERENCES

1. HOLM, G. E., AND GREENBANK, G. R.: *Pro. World's Dairy Congr. Washington, D. C. II.* 1253. 1923.
2. Chicago Quartermaster Corps. No. 1664. April 8, 1944.
3. HOLM, G. E., GREENBANK, G. R., AND DEYSHER, E. F.: *Jour. Dairy Sci.* IX. 512. 1926.
4. DAHLE, C. D., AND JOSEPHSON, D. V.: *Milk Plant Monthly* 32. p. 28. 1943.
5. HOLM, G. E., GREENBANK, G. R., AND DEYSHER, E. F.: *Jour. Dairy Sci.* VIII. 515. 1925.
6. HOLM, G. E.: Information by courtesy of personal interview. 1944.
7. COULTER, S. T.: *Jour. Dairy Sci.* XXVII. 607. 1944.
8. HETRICK, J. H., AND TRACY, P. H.: *Jour. Dairy Sci.* XXVII. 685. 1944.
9. Continental Can Company: Research Dept. Information by courtesy of personal interview. Chicago. 1944-45.
10. American Can Company: Research Dept. Information by courtesy of personal interview. Chicago. 1945.
11. HOLLENDER, H. A., AND TRACY, P. H.: *Jour. Dairy Sci.* XXV. 249. 1942.
12. BORDAS, F., AND DE RACZKOWSKI, SIG.: *Ann. Chim. Analyst.* 7. 372. 1902.
13. GREENBANK, G. R.: Dairy Res. Laboratories, U. S. Dept. Agr. Information by correspondence. 1945
14. MUTSCHLER, WM. J.: Continental Can Company, Chicago: Gas Packing of Canned Foods. *Ann. Proc. Instit. Food Technologist*, 1945.
15. SHIPSTEAD, H., AND BRANT, A. P.: U. S. Patent 2,363,445. 1944.
16. HANSEN, C. H.: U. S. Patent No. 2,027,429. 1936.
17. JACK, E. L., AND HENDERSON, J. L.: *Food Industries.* XIV. p. 50 1942
18. TWING, A. T., WOOD, EBENEZER, AND ELDERHOST, WM.: U. S. Patent No. 28, 424. May 22, 1860.
19. STABLER, FRANCIS: U. S. Patents Nos. 50,965 (1865), and 53,355 (1866).
20. HOLM, G. E., AND Co-Workers: Unpublished information by correspondence. October 1945.
21. COULTER, S. T., AND JENNESS, R.: *Minnesota Tech. Bul.* 167. 1945.
22. GANE, R.: Unpublished results reported by Lea et al. *Jour. Dairy Res.* 13. 162. 1943.
23. LEA, C. H., FINDLAY, J. D., AND SMITH, J. A. B.: *Jour. Dairy Res.* 14. Nos. 1 and 2. 1945.
24. BELL, R. W., AND WEBB, B. H.: *Jour. Dairy Sci.* XXVI. 579. 1943.
25. BELL, R. W., CURRAN, H. R., AND EVANS, F. R.: *Jour. Dairy Sci.* XXVII. 913. 1944.
26. THOMPSON, S. Y., AND KON, S. K.: *Jour. Dairy Res.* 14. Nos. 1 and 2. 1945.
27. FINDLAY, J. D., SMITH, J. A. B., AND LEA, C. H.: *Jour. Dairy Res.* 14. Nos. 1 and 2. p. 165. 1945
28. CROSSLEY, E. L.: *Jour. Dairy Res.* 14. Nos. 1 and 2. 1945.
29. GREENBANK, G. R., WRIGHT, P. A., DEYSHER, E. F., AND HOLM, G. E.: *Proc. 39th Ann. Meet. Am. Dairy Sci. Asso.* 1944.

## CHAPTER XXXVIII

### MANUFACTURE OF DRIED BUTTERMILK

**Development of Buttermilk Drying.**—The drying of buttermilk as a commercial industry is essentially a child of World War I. While small quantities of dried buttermilk were made earlier, it was the feed shortage and high prices of all farm products, caused by the ravages of that war, and the growing need of high quality animal feed in concentrated form, that emphasized the economic value and clarified the conception of the commercial possibilities of drying buttermilk.

The momentum of production gained during World War I, however, did not stop with the cessation of hostilities. The feeding results and economy of dried buttermilk had spoken for themselves. Its merits had gained recognition on the part of the hog, poultry, and calf feeder, causing a continuously increasing demand for the product. World War II has given further impetus to production. Thus, from the modest beginning of 342,000 pounds of dried buttermilk in 1916 the annual production has increased to over 75,000,000 pounds in 1941. Of the total volume of 2¾ billion pounds of fluid creamery buttermilk produced in the United States in that year, approximately 30 per cent was utilized in the manufacture of dried buttermilk. The annual production by years is shown in Table 59, in Chapter XXXIII.

**War Emergency Use of Dried Buttermilk For Human Consumption.**—Prior to World War II the volume of sweet-cream buttermilk available for the manufacture of buttermilk powder in the United States was comparatively limited. At that time the great bulk of dried buttermilk production was confined to sour-cream buttermilk which is almost exclusively used for animal and poultry feed. The unprecedented global food emergency of World War II has emphasized anew the importance of the high quality proteins, carbohydrates, and minerals, and the indispensable water-soluble vitamins contained in such milk by-products as skimmilk, buttermilk and whey for human nutrition. This has brought about reconversion on the part of an appreciable number of creameries from the gathered cream creamery receiving sour cream, to the whole milk creamery receiving sweet milk. This change has made available millions of gallons of sweet skimmilk for the manufacture of products of human nutrition, which in the days of the farm cream separator was kept on the farms as feed for farm animals. It likewise provided factory-skimmed sweet cream for churning purposes, yielding sweet-cream buttermilk suitable for human consumption. This evolution has increased the volume of nutritionally valuable milk solids for the human family, and the resulting greater market value of the creamery by-products has thus enabled the creamery to increase its returns to the farmer.

**Drying Sweet-Cream Buttermilk.**—In the United States a limited but growing volume of dried buttermilk is made from sweet-cream buttermilk. The finished product in this case is almost exclusively intended for human consumption. High solubility is therefore one of the important marketable properties insisted upon.

In general, the behavior of sweet-cream buttermilk during and after drying is similar to that of skimmilk. Davis<sup>16</sup> found the dried sweet-cream buttermilk slightly more hygroscopic than dried skimmilk. It is much less hygroscopic, however, than the powder made from sour-cream buttermilk and from neutralized sour-cream buttermilk. Davis further reported that dried sweet-cream buttermilk was much superior to sour-cream buttermilk as to keeping quality. It was more soluble and held its original fresh flavor and color better than the sour, or sour-neutralized product. Thomas and Combs<sup>14</sup> reported that drum-dried, sweet-cream buttermilk improved the whipping properties of ice cream mix and yielded ice cream superior to drum-dried skimmilk in appearance, consistency, richness of flavor and absence of cooked taste.

**Drying Sour-Cream Buttermilk.**—A large portion of the dried buttermilk made annually in the United States is still manufactured from sour-cream buttermilk intended for animal and poultry feeding. The question of solubility of finished product in this case is, therefore, not involved. Likewise the margin of profit is limited by competition with other farm-grown feeds. Hence, the drying of practically all of the sour-cream buttermilk is done by the use of the atmospheric drum dryer which requires minimum initial financial outlay and the operation of which is relatively simple.

#### **DRYING DIFFICULTIES PECULIAR TO SOUR-CREAM BUTTERMILK**

**Effect of Acidity.**—The manufacture of a marketable powder from sour-cream buttermilk is more difficult than that from sweet-cream buttermilk or skimmilk. The major difficulties are due to the following peculiarities of behavior and properties: (1) tendency to form unmanageable smear on the drying drum; (2) tendency to become sticky followed by caking; (3) tendency to browning.

The above difficulties can be minimized by neutralizing the sour buttermilk to about 0.2 per cent titratable acidity or lower, using calcium hydrate as neutralizer. However, the high lactic acidity of the powder made from sour-cream buttermilk is one of the nutritionally important factors of this product. Moreover, the feeder depends upon the wholesomeness and tonic effect of the dried sour-cream buttermilk to keep animal and fowl in vigorous, thrifty and healthy condition. In fact, rather than lowering the acidity by addition of a neutralizer, the general practice is to standardize the acid level upward by the use of a good starter. There are, however, other means of overcoming the drying difficulties referred to above.

**Effect of Lactose.**—Most dried milk products contain a relatively high

percentage of lactose as shown in Table 63. It is not surprising, therefore, that products with such high lactose concentrations reflect some of the physical properties of the lactose.

TABLE 63.—APPROXIMATE LACTOSE CONTENT OF  
DRIED MILK PRODUCTS

Dried whole milk .....	35%	Dried buttermilk.....	40%
Dried skimmilk. . . . .	50%	Dried whey .....	70%

Schmoeger<sup>1</sup> found that a pure lactose solution, if dried very rapidly, yielded a non-crystalline glass which took up moisture readily, became sticky and then crystallized, forming a hard mass of alpha lactose hydrate. Holm and Greenbank<sup>2</sup>, Hauser<sup>3</sup>, Hauser and Hering<sup>4</sup>, Supplee<sup>5</sup>, Troy and Sharp<sup>6</sup>, Capstick<sup>7</sup>, and Sharp and Doob<sup>8</sup> studied the physical properties of milk powders as related to humidity, moisture absorption, stickiness and caking.

**Smear on Drying Rolls.**—In fluid sour-cream buttermilk at rest there is a constant tendency for the product to whey-off, dropping its curd to the bottom of the container. The tendency to whey-off is intensified when the buttermilk is heated preparatory to drying. When it thus reaches the hot drying drum without the curd, it refuses to yield a normal film. It forms an unmanageable, semi-solid, yellowish film which sticks tenaciously to the knife. When cold it usually consists of a non-crystalline, hard glass.

The logical prevention of this abnormal behavior of the buttermilk upon the drying drum obviously lies in preventing the wheying-off by agitation sufficiently vigorous to insure uniform distribution of the precipitated curd particles throughout the body of the buttermilk at the time it reaches the drying drums.

**Stickiness and Caking of Powder.**—The physical instability of buttermilk powders is primarily due to absence of lactose crystallization, the lactose in the freshly dried milk being present in the form of a highly concentrated, non-crystalline syrup or glass which has hygroscopic properties.

The work of Troy and Sharp<sup>6</sup> suggests that the caking of milk powder is the result of the following succession of reactions: (1) Absorption of moisture by the concentrated syrup, (2) Adherence of milk particles to one another causing stickiness, and (3) Solidification of the mass due to crystallization of some of the lactose alpha hydrate, causing caking. These investigators further found that skimmilk powder dried by the pressure and centrifugal spray process and by the atmospheric and vacuum drum-drying process, contained its lactose in the form of a non-crystalline mixture of alpha and beta lactose, while during drying by the flake process

a considerable amount of alpha lactose hydrate was found to have crystallized in the skim milk.

**Lactic Acidity Intensifies Tendency to Stickiness and Caking.**—In the case of buttermilk powder made from sour-cream buttermilk, the hygroscopicity of the dried product is much intensified and the defect of stickiness and caking vastly aggravated. This is believed to be due to the presence, in relatively high concentration, of lactic acidity. As pointed out by Sharp and Doob<sup>8</sup>, in the conversion by fermentation one molecule of osmotically active lactose yields four molecules of osmotically active lactic acid. This fact is probably responsible for the greater hygroscopicity of sour-cream buttermilk powder, with its somewhat lower lactose content, as compared with sweet-cream buttermilk powder and dried skim milk.

This defect may be prevented by procedures based on one or the other of the following two fundamental principles: (1) Permanent maintenance of glass stage of lactose in the powder, or (2) Copious lactose crystallization before the powder is packed.

**Prevention of Permanent Glass Stage of Lactose.**—It was explained in the foregoing paragraphs that the freshly-dried milk of the spray-drying processes (pressure spray or centrifugal), and the drum-drying processes (atmospheric or vacuum) contains its lactose in the non-crystalline (glass) form. It was further pointed out that in this form the lactose and the resulting milk powder are highly hygroscopic. In the presence of moisture or humid air, therefore, it absorbs moisture rapidly, becomes damp and sticky, and when enough moisture has been absorbed to permit crystallization, the lactose crystallizes as alpha lactose hydrate. This causes the powder to cake.

This change can be prevented by drying to a low moisture content (below 5 per cent and preferably below 3 per cent), bolting, flaking or grinding and packaging it in an atmosphere of a low relative humidity, and sealing it in an air-tight and moisture-proof container, such as an hermetically sealed tin can, or a barrel (preferably of tight tongue-and-grooved white oak) lined with moisture-proof double liner. In case the package is not air-tight, it should be stored in an atmosphere of low relative humidity (below 40%) and at low temperature (preferably below 70° F.). Milk powder made and stored in this manner does not cake readily. In addition, other factors being equal, it is not subject to rapid loss of its original solubility. These attributes constitute important marketable properties of milk powders intended for human consumption.

**Prevention of Caking by Lactose Crystallization Before Packaging.**—In the case of sour-cream buttermilk powder intended for animal feeding purposes, however, the limited margin of profit does not justify the high cost of package indicated above. This product is usually packed in burlap sacks lined with a double layer of crinkled paper. This package is neither air-tight nor moisture proof. Under ordinary atmospheric conditions, hygro-

scopic powder so packed will absorb moisture rapidly. The powder will become damp and sticky followed by caking.

But in order to be marketable, the buttermilk powder must be and must remain dry and free-flowing for satisfactory compounding with other feed stuffs in the commercial feed mill. To this end the process of manufacture and handling must be adjusted and controlled in a manner that insures copious crystallization of the lactose between dryer and grinder or sifter. This then stabilizes the moisture content before the finished product reaches the grinder and the final package. Milk powder containing its lactose in the form of alpha lactose hydrate crystals is non-hygroscopic.

**Methods of Causing Lactose Crystallization Before Packaging.**—It was explained earlier that the lactose in the freshly dried powder is in the non-crystalline glass form. This is due to the fact that evaporation of moisture during early drying proceeds at so rapid a rate (fraction of a second) that in the absence of seeding the point of concentration most conducive to lactose crystallization is passed before crystallization has occurred. A state of supersaturation is then reached, that bars the formation of lactose hydrate crystals, and the lactose remains in the non-crystalline stage until re-absorption of moisture has caused sufficient dilution to induce crystallization.

**The Collis Buttermilk Dryer.**—As a practical and successful early process of buttermilk drying, embodying the principle of free-flowing powder by reason of providing for crystallization of the lactose between dryer and grinder, may be mentioned the Collis process. This dryer and its inventor, the late N. P. Collis of St. Paul, Minnesota, played a leading part in the development of buttermilk drying in the days when the great multitude of local creameries of the Northwest lacked the volume and the financial resources that would justify installation of dryers of their own. Mr. Collis was granted U. S. patents Nos. 1,317,777 (1919), and 1,356,340 (1920) on his process. He established and personally operated a large commercial buttermilk drying plant.

The Collis dryer is a single drum unit. Its basic features are a spray pipe with pump and supply tank, and a battery of buttermilk storage tanks so connected with pump as to provide continuous agitation of the fluid buttermilk. The pump used for agitation in the storage tanks also services the supply tank underneath the drying drum. Another pump feeds the spray pipe from the supply tank, directing the spray tangentially against the side of the drum in the direction of its rotation. A considerable portion of the fluid buttermilk thus sprayed onto the revolving drying drum drops back into supply pan and in this manner helps to agitate the milk contained in the pan and to forewarm it, making possible the maintenance of a temperature of about 150 to 160° F.

The roll has a speed of about 2 R.P.M. By the time the milk film approaches the scraper its temperature is approximately 200° F. It is then

sufficiently dry to be scraped off. At this point its moisture content is about 10 to 15 per cent. From the scraper the dried product falls into a "cut flight" conveyor which moves it toward one end of the machine and drops it into another conveyor on which it travels to a dried milk receptacle. On its journey from drying drum to dried milk receptacle the scraped-off film cools, disintegrates somewhat and surrenders the remainder of its removable moisture, reducing the moisture content to about five per cent, and after the lactose in it is completely crystallized the product is ready for milling. It is then packed in sacks or barrels or tin containers.

**Other Methods to Insure Physical Stability of Buttermilk Powders.**—In some drying plants the dried buttermilk is held in a bin or other convenient storage place until it has become definitely caked. It is then ground and packed in sacks with moisture-proof liner. While conversion to lactose hydrate crystals causes the milk powder to give up some of the moisture that it had taken up while in the glass state, the finished powder handled in the manner here described may still be too high in moisture. In such case its moisture content may be reduced before grinding by exposure to a blast of low heat hot air (about 130 to 150° F.).

**The Atmospheric, Double-Drum Dryer.**—In the United States the type of dryer used for drying sour-cream buttermilk is now predominatingly the double-drum dryer of the Just-Hatmaker type. The general buttermilk drying assembly usually consists of the following equipment:

One or more double-drum drying units with end boards, buttermilk pump and perforated pipe feed, variable speed transmission, self aligning main bearings, scraper knife with adjustable knife angle, vapor-hood, steam condensate pump return to boiler, screw conveyor and flaker-sifter.

Two or more buttermilk storage tanks with agitators and tempering device.

Flash heating equipment to preheat buttermilk to about 165° F.

For drying sour-cream buttermilk it is not customary to provide a separate precondensing unit such as vacuum pan or evaporator, with condenser and vacuum pump. For precondensing, the trough between rolls is depended upon.

It is obvious from discussions in previous paragraphs that conveyance of the dried film scraped from the drums, direct from drum to flaker-sifter where the powder is immediately sacked, fails to provide the opportunity necessary for satisfactory crystallization of the lactose.

The finished product is therefore in the glass form, in which form it takes up moisture rapidly from the atmosphere, becomes sticky and cakes. Stickiness and caking under these conditions can be retarded by so adjusting the steam pressure, drum speed, film thickness-ratio, as to secure a low-moisture powder (3% or lower), packing at a low relative humidity

into sacks with moisture-proof lining, storing at a low relative humidity and at a reasonably low temperature.

**Prompt Disposition of Powder.**—This ideal ratio, however, seldom occurs; hence buttermilk powder sacked direct from the dryer generally lacks moisture stability in storage. In order to avoid complaints from the feed mill due to objectionable caking and to prevent unprofitably low financial returns, it is good practice to arrange for outlets of the finished product that will insure prompt disposition, preferably every two weeks or oftener.

The safer, and in the long run, the more profitable procedure obviously is to produce a moisture-stable buttermilk powder by treatment, between dryer and finished package, that will insure copious crystallization of the lactose as lactose hydrate, on the basis described under "The Collis Buttermilk Dryer."

**Prevention of Discoloration of Sour-Cream Buttermilk Powder.**—Buttermilk powders are more subject to browning than skimmilk powder. Sour-cream dried buttermilk discolors more intensely than sweet-cream dried buttermilk. The usual causes of discoloration are: Incomplete removal of film due to maladjustment of scraper knives; excessive steam pressure in drums (over 90 pounds pressure); too slow drum speed; high storage temperature (especially above room temperature [70°F.]). The knife edge must be kept in condition and adjustment to scrape the drum closely and evenly over the entire length of the drum.

**Yield of Dried Buttermilk.**—For summary of yield of dried milk products and by-products, see Table 66, Chapter XLI. The yield of dried buttermilk per 100 pounds of fluid buttermilk depends largely on the per cent solids in the fluid buttermilk, per cent moisture of the dried product, and ratio of recovery.

In genuine buttermilk, which is free from additions of extraneous water between cow and churn, the total solids range approximately between 9 and 10.5 per cent, as shown by Miller<sup>9</sup> who made 58 experimental churnings free from dilution with extraneous water. Similar results were obtained by Anderson<sup>10</sup> who reported a range of 10.16 to 10.55 per cent total solids in a series of 29 experimental churnings free from dilution with extraneous water. With the moisture content of the powder limited to 5 per cent and placing recovery of the total solids at an average of 98 per cent, it becomes evident that the yield of buttermilk powder from buttermilk that contains no extraneous water would fall within the approximate range of 9.5 to 11 pounds of powder per 100 pounds of fluid buttermilk.

In commercial manufacture, however, this high yield is seldom attained because the bulk of creamery buttermilk available for drying contains varying amounts of extraneous water. This dilution includes the flushings of the cream separator on the farm, and of steam condensate from the cans inverted over weigh can or forewarmer, vat rinsings, etc., in the creamery. In case of the cream station system there may be a transfer



of cream from farmers' cans to creamery cans which adds more rinsings. Cream improvement processes at the creamery that involve injection of live steam or reseparation of cream cause further marked addition of water or extraction of solids.

**Solids Content Higher in Sweet-Cream Buttermilk.**—The solids content of sweet-cream buttermilk is usually higher than that of sour-cream buttermilk. If the latter is the result of ripening cream that arrives at the creamery sweet, the decrease in per cent solids, if any, is only slight. If the sour-cream buttermilk is the product of centralizer sour-cream, then the total solids content is usually definitely lower. This is in part at least due to unavoidable dilution with variable amounts of water. Sweet cream commonly suffers less dilution; generally it passes through fewer hands, and being of better quality, it is less in need of cream improvement treatment in the factory. Miller's<sup>9</sup> survey of Minnesota local creameries shows an average solids content of 9.111 per cent for sweet-cream buttermilk and of 8.717 per cent for sour- (ripened) cream buttermilk. These compositions suggest an approximate yield range of 9 to 9¾ pounds of powder for sweet-cream buttermilk and 8.5 to 9 pounds of powder for ripened cream buttermilk per 100 pounds of fluid buttermilk manufactured under commercial conditions.

TABLE 64.—ANALYSIS OF CENTRALIZER SOUR-CREAM BUTTERMILK  
FOR PERCENTAGE OF TOTAL SOLIDS<sup>11</sup>  
BY MOJONNIER METHOD

Location of Creamery	Total Solids Percent	Location of Creamery	Total Solids Percent
Cedar Rapids, Ia.....	7.94	Kansas City, Mo.....	6.34*
Chicago, Ill.....	7.71	Louisville, Ky.....	6.80*
Cleveland, Ohio.....	7.75	Milwaukee, Wis.....	7.50
Columbus, Ohio.....	7.54	St. Louis, Mo., I Grade..	6.97*
Detroit, Mich.....	8.28	St. Louis, Mo., II Grade..	5.31*
Indianapolis, Ind.....	7.80	Sioux City, Ia.....	7.31

\*Cream improvement treatment with injection of "live" steam.

Table 64 provides a convincing illustration of sour-cream buttermilk with low solids content due to water dilution. It also shows the lowering effect of steam injection treatment of cream on percentage of solids of buttermilk. The average of total solids in Centralizer sour-cream buttermilk thus falls within the approximate range of 7 and 7.75 per cent, with a yield of dried buttermilk more often below 8 pounds per 100 pounds of fluid buttermilk than above. Combs<sup>12</sup> also reports that the results of a recent survey of the composition of the buttermilk in Minnesota centralizer plants indicates an average of near 7.5 per cent total solids.

**Preparation for Market.**—Sweet-cream buttermilk powder is intended predominately for human consumption. It should therefore be packed

in containers similar to those approved by the American Dry Milk Institute for non-fat, dry milk solids (dried skim milk), such as "substantial metal cans or drums having tight-fitting friction plugs or covers, and high-grade tongue-and-grooved barrels, paraffined and with adequate liners, until further studies reveal necessary specifications."

Sour-cream buttermilk powder intended for animal feed is usually packed in burlap sacks lined with one paraffined and one plain crinkly paper liner. Unless the powder is handled in a manner to insure copious crystallization of the lactose before packaging, as explained earlier in this chapter, the dried buttermilk made from sour-cream buttermilk is intensely hygroscopic, and will absorb moisture rapidly from an atmosphere with relative humidity above 30 per cent, causing it to become sticky followed by caking. In this condition it handles with difficulty and is objected to by the commercial feed mill.

Unless and until the operator has hurdled the fundamentals of the manufacture of sour-cream buttermilk powder that will stay sufficiently dry, when stored, to avoid stickiness and caking, he will find it good practice to dispose of his product reasonably promptly (within a few weeks of manufacture), even at times when a rising market suggests the advantage of holding. For "Markets of Dried Buttermilk" see Chapter XLIII.

#### PREVENTION OF FOUL ODOR NUISANCE

The vapors that escape from the stack over the hood of the drum dryer when drying sour-cream buttermilk, usually contain obnoxious odors that may become a serious nuisance in the case of a drying plant operated within or in the neighborhood of a residential section.

**Cooperation of Local Health Authorities.**—When contemplating the installation of a buttermilk dryer unit, the local health department should be consulted for its consideration, advice, approval and cooperation. In cases where there has been no permanently organized system of utilization of the factory buttermilk, and much of the daily buttermilk has been "dumped" into the town or city sewer, the chances are that the municipal authorities will welcome the creamery's efforts to establish a permanent means of buttermilk utilization. The sanitary engineer, experienced in the problems of the purification of sewage that contains refuse from dairy products plants, fully recognizes the shock to the municipal sewage system caused by the influx of milk constituents such as the protein part of creamery buttermilk. He naturally is interested in cooperating in every consistent effort by the factory to eliminate the buttermilk disposal problem from the municipal sewage system.

**Location of Buttermilk Dryer.**—In most cases consideration of installing buttermilk drying equipment refers to a factory already established, such as a creamery, and the problem is no longer one of choice of location. In the establishment of a new plant for the drying of buttermilk, however,

attention to choice of location may save the management much grief in future operation. In most towns the local zoning ordinance regulates the location of such factories. The location should obviously be as far away as practicable from the residential section and where the prevailing winds will blow the escaping vapors into the open country.

**Height of Vapor Stack.**—Height of vapor stack assists in dispersing the vapors and aids in dilution of the vapor odors. The height of stack minimizes the intensity of the odors and improves the effectiveness of treating the vapors within the plant.

**Conducting the Vapors Through Fire Box in Boiler.**—In some factories the vapors that arise from the drying drums are blown into the fire box of the boiler. The products responsible for the odors are thus burned and destroyed. This method has the further advantage of increasing the available heat units and thus saving fuel.

**Filtering the Vapors Through Wet Coke.**—This method is recommended by the Buffalo Foundry and Machine Co., of Buffalo, New York. An enlarged section, about four feet square, is built into the stack above the dryer hood. The stack is usually 30 inches square. The enlarged section is built in shelves or trays, one on top of the other, 18 inches apart, and provided with slats standing on edge, each 1" x 1½" x 4' long. Each tray or shelf is filled about two inches deep with coke. A water spray on the top tray passes two to three gallons of water per minute successively through all the trays, wetting each layer of coke. The bottom of the entire assembly terminates in a canopy centrally located over the opening from dryer hood, so this excess water will not run back into the dryer. The entire assembly is constructed of wood as the acid vapors would quickly corrode galvanized iron or similar cheap metal that might be considered for construction of the assembly.

#### REFERENCES

1. SCHMOEGER, M.: Über Wasserfreien Milchzucker. Ber. XIV. p. 2121. 1881.
2. HOLM, G. E., AND GREENBANK, G. R.: Proc. World's Dairy Congress II. p. 1253. 1923.
3. HAUSER, E. A.: Proc. World's Dairy Congress II p. 1154. 1923.
4. HAUSER, E. A. ET HERING, H.: Le Lait IV p. 388. 1924.
5. SUPPLEE, G. C.: Jour. Dairy Sci. IX. 50. 1926.
6. TROY, H. C., AND SHARP, P. F.: Jour. Dairy Sci. XIII. 140, 1930.
7. CAPSTICK, E.: Proc. XI World's Dairy Cong. II, p. 261. 1937.
8. SHARP, P. F., AND DOOB, HUGO, JR.: Jour. Dairy Sci. XXIV. 679. 1941.
9. MILLER, A. T.: Thesis, Deg. of M.S., University of Minnesota. 1931.
10. ANDERSON, A. E.: Thesis, Deg. of M.S., University of Minnesota. 1932.
11. HUNZIKER, O. F., AND CORDES, W. A.: Check-up on Total Solids Content of Sour-Cream Buttermilk. Blue Valley Res. Lab., Chicago, 1933. (Results not published.)
12. COMBS, W. B.: Information by Correspondence, 1944.
13. CORDES, W. A., AND NISSEN, B. H.: Analysis of Dried Buttermilk, Blue Valley Res. Lab. 1925. (Results not published.)
14. THOMAS, E. L., AND COMBS, W. B.: Jour. Dairy Sci. XXVI. 770. 1943.
15. HAUSER, G. F.: Information by Correspondence. 1925.
16. DAVIS, R. N.: Jour. Dairy Sci. XXII. 179. 1939.
17. AMERICAN DRY MILK INSTITUTE: Bul. 906. p. 19. 1944.

## CHAPTER XXXIX

### MANUFACTURE OF DRIED WHEY

It was shown in Table 63, Chapter XXXVIII, that dried whey contains approximately 70 per cent of lactose. When drying whey by the methods of spray drying or drum drying that are commonly used in the drying of milk products, the lactose contained in the freshly dried whey is present in the anhydrous form consisting of a syrup or an amorphous glass. With the lactose in this form the whey powder, because of its very high lactose content, is intensely hygroscopic. It absorbs moisture rapidly from the air and, even at ordinary relative humidities, becomes unmanageably sticky. The lactose then gradually crystallizes. Crystallization dilutes the syrup further by reason of the separation of solids, decreasing the osmotic pressure, increasing the vapor pressure and causing some loss of moisture. Crystallization of lactose causes the humid whey powder to cake and harden progressively.<sup>6</sup>

The physical instability of the dried product is further accentuated, in the case of sour cheese whey, in which conversion of lactose to lactic acid by fermentation increases the osmotically active molecules present four-fold, as indicated by the theory of Sharp and Doob.<sup>1</sup> (See Chapter XXXVIII.) In order to make whey powder moisture-stable and permanently free-flowing at ordinary relative humidities, the method of manufacture must be so modified as to cause copious lactose crystallization before the dried whey is ground preparatory to packaging.

**The Peebles and Manning Spray-Drying Process.**—According to Chuck<sup>10</sup>, Peebles and Manning<sup>11</sup> were the first to discover that the caking of milk powder is due to lactose in the anhydrous form. These inventors adapted the spray-drying process to the commercial production of a non-hygroscopic, free-flowing whey powder. Their process is briefly as follows:

The whey is precondensed to a concentration of 45 to 60 per cent solids, preferably using multi-effect tubular evaporators. The condensed whey is spray dried in Gray-Jensen type, cone shape drying chambers where it is dried to an approximate moisture content of 12 to 14 per cent. It is aimed to so control the temperatures of this primary drying operation as to cause conversion of the lactose to the monohydrate form, and crystallization to take place simultaneously with the removal of moisture from the atomized particles. Upon removal from the drying chamber, the partially dried material may then be supplied to the finishing dryer. This may be the conventional heated tunnel type, at low heat (about 145° F.), or a revolving drum-dryer through which the drying air passes, or a chamber in which the material is placed in suspension in a drying gas. A blower then delivers it to a separator of the cyclone or bag type.

The inventors point out that the optimum inflow and outflow tempera-

ture of the air currents in the drying chamber will depend upon the solids content and character of the concentrate. They further found that the drying range within which the desired results may be obtained is wider for higher concentrations and they give preference to concentrations of solids near 60 per cent. With such a whey concentrate they report good results (a stable powder) with an inflow drying air temperature of about 310° F. and an outflow air temperature of about 130° F.

In some installations the second drying is preceded by introducing the mixed product into a rotating drum, together with a little moisture in the form of steam, to induce lactose crystallization as lactose hydrate. The drying is then completed by air.

**Effect of Uncoagulated Whey Proteins on Stability of Whey Powders.**—Later Peebles and Manning<sup>12</sup> pointed out that irrespective of process used, difficulties are at times experienced in producing a satisfactory, non-caking powder from certain wheys. They reported such difficulties to be due to the presence of uncoagulated whey proteins (lactalbumin and lactoglobulin) causing an increase in the hygroscopicity of the powder. They discovered that uncoagulated whey proteins, when mixed with lactose, lactic acid and water, form a very sticky mass which is difficult to dry and handle. They believe this to be due to the fact that the presence of uncoagulated whey proteins, during at least the initial part of the lactose crystallizing period, serves to retard the setting and the rate of crystal growth. They further found that the whey proteins of anhydrous powder produced by prior processes are substantially uncoagulated.

These investigators then developed a process whereby they coagulate the major part of the whey proteins prior to crystallization of lactose. This they accomplish by suitable heat treatment of the raw whey or of the concentrated whey to which has been added mineral acid such as sulphuric or hydrochloric acid.

Thus, with raw whey difficult to handle by prior processes, and containing a relatively high percentage of lactic acid, the addition of mineral acid to adjust the hydrogen ion concentration to below pH 4.8, and heating the whey to approximately 200° F. for a period of about 10 minutes is recommended. Or, with a whey having a mineral acid content which, when the whey is concentrated to 40 per cent solids will yield a pH value of less than 4.8, they recommend heating momentarily to about 220° F. to insure good protein coagulation and a dependably non-hygroscopic, free-flowing powder. This process is covered by U. S. patent.<sup>12</sup>

**The Lavett Two-Stage Drum-Drying Process for Whey.**—Efforts to dry whey by the ordinary atmospheric drum or roller process usually yield an unmanageable mass. However, a non-hygroscopic, non-caking, drum-dried whey is being obtained by the use of a two-stage, double-drum dryer, such as is illustrated in Fig. 122. In this dryer and process, developed and patented by Lavett<sup>2</sup>, the crystals formed are predominately beta lactose.

This drum dryer consists of an upper set of double drums (first stage), and a lower set of double drums (second stage) installed directly under the first stage drums. The upper drums rotate outward from the pinch and the knives are placed on the underside of the drums. The lower drums rotate inward toward each other and the knives are located near the top of the drums. The upper drums are equipped with a vertical pendulum feed pipe that swings back and forth lengthwise, feeding the viscous whey concentrate evenly into the trough between drums from end to end. A feed pressure pump supplies the whey product to the pendulum feed header. In the trough between the lower drums, distribution of

Fig. 122. The Lavett two-stage double-drum dryer

Courtesy of Buffalo Foundry & Machine Co.

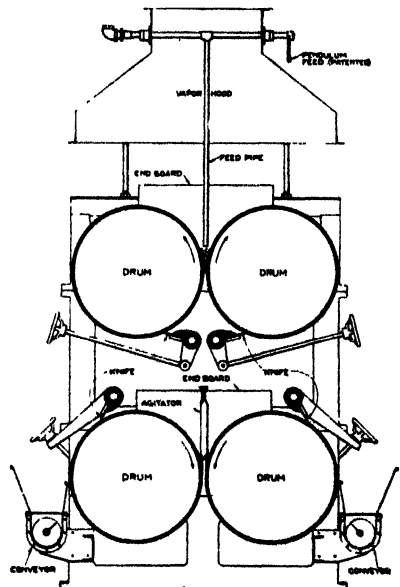

the near-dry whey is facilitated by a plow or leveler (see "agitator" in Fig. 122). This is a stout vertical rod running back and forth lengthwise and terminating near the bottom of the trough. The plow operates on the counter thread of a horizontal bar.

In commercial operation the whey is precondensed to about 40 per cent solids and then fed into the trough between the upper drums. These drums carry about 50 to 60 pounds of steam pressure. The knives on the underside drop the partially dried milk in the form of chunks into the trough between the lower drums. At this point the solids content of the taffy-like mass ranges from 80 to 90 per cent. The steam pressure maintained in the second stage drums is approximately 30 pounds. These drums turning inward toward the pinch facilitate close contact of the product with the drum surface. The whey film is thus continually seeded with crystals that adhere to the drum surface. According to Sharp and Doob,

Jr.<sup>1</sup> these crystals are the beta lactose type, and the dried whey comes off the second stage drums in flake form and is easily pulverized. Its lactose is present largely in the form of beta lactose crystals. The second stage drums complete the drying, yielding a whey powder with about 97.5% solids.

**Spellacy's Method of Drum Drying.**—Spellacy<sup>3</sup> found that the addition to whey of skimmilk solids, either in liquid or dry form, preferably in dry form, greatly improves its drying properties when using the atmospheric drum dryer. He was granted a U. S. patent on his improved process of drum-drying whey. His process consists of first neutralizing the whey with an alkali such as lime, sodium carbonate, sodium hydroxide, or other known alkali. He then adds skimmilk powder or buttermilk powder in sufficient amount to form with the whey a thickened mass. The ratio he concluded must be not less than 8 pounds of milk powder to 100 pounds of whey. This thick mixture is then applied to the surface of the drum dryer. The patent claims that by the use of this process it is possible to build up self-sustaining sheets, of substantial thickness and cohesiveness, capable of being dried completely, yielding a dry, powdery, non-sticky and non-caking whey powder of high protein content.

Spellacy appears to attribute the improvement of the whey film on the drum, as well as the non-caking properties of the resulting whey powder, to the increase of the protein content and relative decrease of the lactose content of the finished product. It appears reasonable to assume that the addition of milk powder to the whey causes profuse seeding of the whey with lactose crystals which, in turn, incite copious lactose crystallization in the drying whey. In the light of our present knowledge, the non-hygroscopic properties of the crystallized lactose are an important contributing, if not the basic, cause of the resulting free-flowing whey powder.

Jack and Wasson<sup>4</sup> report that in the case of sweet whey, the addition of cereal products, when used in the ratio of one part of cereal to two parts of whey solids improved the drum-drying properties of whey somewhat. The cereals found usable were: wheat flour, cornstarch, ground oats (sifted), and ground barley (sifted). The proportion of cereals required to produce the desired improvement was not affected appreciably by different concentrations of acidity in the whey. Their experiments with additions of milk solids to the whey yielded results similar to those reported earlier by Spellacy. The addition of casein to the whey was of no benefit.

Waite<sup>5</sup> summarized his results on drum drying neutralized sour whey as follows:

1. Sodium and potassium salts cannot be used successfully for this purpose. They cause very bad drying properties, make the product unpalatable, and in most cases of poor color.

2. In the case of sour cheese whey, neutralization with calcium hydroxide, in the form of a suspension of finely ground slaked lime, yielded a satisfactory product. The drying properties, appearance and palatability were as good as when made from freshly drawn whey of low acidity. This held for acidities reduced from 0.3 to 0.02 per cent. Here again incitement of copious crystallization of the lactose in the whey powder may have entered into the combination of conditions responsible for the improvement of the powder. In this case, the finely ground suspension of the slaked lime may have supplied the seed nuclei. Over-neutralization with lime, however, yielded unsatisfactory drying properties, an unpalatable product and dark color.

3. In the case of hydrochloric acid whey, the unneutralized product cannot be successfully dried by the atmospheric drum process. Reduction of the acidity from 0.48 to 0.18 per cent with calcium hydroxide allowed successful drying and made a reasonably satisfactory product, but it was unpalatable.

4. Acetic acid whey was dried successfully without the addition of any acid reducer. Atmospheric drum drying of this whey did not cause drying difficulties and it yielded an excellent and palatable product.

**Vacuum Drum Drying of the Whey.**—This process is described by Sharp and Doob<sup>1</sup> as follows:

"Whey is concentrated to 60 per cent solids and is then agitated in a crystallizing vat, preferably with seeding from a previous lot. After a considerable amount of lactose has crystallized and the material has thickened to a very considerable extent, drying and crystallization are completed on rolls in a vacuum; the rolls are maintained at an interior temperature between 140 and 170° F. In this way, with the completely seeded mass applied to the roll and the temperature maintained well below the so-called inversion point\* of lactose, drying accompanied by crystallization of the lactose as alpha hydrate is accomplished."

**The Simmons Process.**—The compelling purpose that motivated the development of the Simmons process of drying whey<sup>13</sup> was to provide an economical and successful method of making a stable whey powder on a small scale as well as by volume production. It was the inventor's plan to accomplish this by the use of equipment more simple and more nearly within reach of the individual with limited finances.

The whey is precondensed under vacuum to a very high concentration, near 70 per cent solids. The whey concentrate is dropped into crystallizing vats where it is cooled and may be seeded with alpha hydrate crystals by mixing with a part of a previous batch of crystallized concentrate or with dried whey. This mixture is given sufficient time to set and to crystallize a considerable portion of its lactose in the form of alpha lactose

\*Meaning point of alpha-beta equilibrium (see Chapter III).



hydrate. This may take some hours. The material is then broken up into a sugary mush of small particle size and drying is completed by exposure to low heat, hot air currents. The temperature of the heated air should be sufficiently low to prevent loss of the water of crystallization (well below 268° F), and preferably at the lowest temperature that permits of satisfactory economy of operation.

**Flake-Drying the Whey.**—It was shown by Troy and Sharp<sup>6</sup> that when dried by the flake process, freshly dried skimmilk contained a considerable portion of its lactose in crystallized condition and the crystals are predominatingly of the alpha lactose form. Similar results have been observed also when drying whey by the flake process. It appears that the crystallization in the flake-dried product is initiated by the continuous seeding of the concentrated milk product as it enters the dryer by reason of the mechanics of the system of drying. These results refer to whey powder made by the Borden Atmospheric flake film dryer, described in Chapter XXXIV.

The above observations are supported also by Capstick<sup>7</sup> who reported results with the Continuous Vacuum Band Dryer described in Chapter XXXIV. A later communication by Capstick<sup>14</sup> concludes with the following statement:

“My experience is that all whey powder is hygroscopic and will cake if exposed to the atmosphere a sufficient length of time, the only exception to this being whey powder made from whey from which the albumin has been almost completely removed. Whey powder produced by the vacuum band method does, however, cake less rapidly than powder produced on the Hatmaker rollers.”

**Moisture Stability of Whey Powder at Different Relative Humidities.**—The water-holding capacity of dried whey at 25° C. at relative humidities ranging from 0 to 80% was studied by Sharp and Doob, Jr.<sup>1</sup> They emphasize in part that:

1. When in equilibrium with an atmosphere of constant relative humidity below 65 per cent, dried wheys in which crystalline beta lactose is present as a solid phase contain less water than do dried wheys in which alpha hydrate is the solid phase. The difference is largely accounted for by the molecule of water of crystallization contained in the alpha lactose hydrate crystals.

2. Stabilized dried wheys do not absorb excessive moisture until the relative humidity exceeds 40-50 per cent.

3. The equilibrium moisture is attained more rapidly at the higher temperatures.

4. At relative humidities of 65 per cent and above, the crystalline beta lactose in dried wheys is converted to crystalline alpha hydrate.

**Discoloration of Dried Whey.**—Doob, Willmann and Sharp<sup>8</sup> studied the

cause of browning of dried whey. They hold that reaction between reducing sugars, such as lactose and certain amino acids of the whey proteins, is responsible for the browning of dried whey. For details of lactose-amino acid complexes, see Chapter XXV, under "Color". Doob and co-workers found dried whey held in storage darkened more rapidly and more intensely than dried milk. The tendency to darken with age was increased with high osmotically held moisture, and with an increase of the relative humidity of the storage atmosphere and of the storage temperature, respectively. At 25° C. browning was inhibited at a relative humidity between 20 and 30 per cent. Above 30 per cent the browning increased, a maximum extractable color being obtained at 55 to 60 per cent relative humidity. Increasing the storage temperature above 30° C. accelerated the discoloration. Other factors that intensified the browning to a lesser extent were rise in titratable acidity and drop in pH.

**Composition of Dried Whey.**—The composition of the whey powder varies with that of the raw whey which may fluctuate considerably. It depends on the composition of the original milk, the kind of cheese made, the skill of the cheese maker in controlling leakage of fat and casein from cheese curd into whey, or whether made from rennet or acid-casein whey. The approximate composition of cheese whey and acid-casein whey is given in Table 4, Chapter 1. For composition of whey powder made from cheese whey and from acid-casein whey, respectively, see Table 67, Chapter XLI.

**Uses of Whey Powder.**—See Chapter XLIII, "Markets".

#### REFERENCES

1. SHARP, P. F., AND DOOB, H., JR.: *Jour. Dairy Sci.* XXIV. 679. 1941.
2. LAVETT, C. D.: U. S. Patent Nos. 2,143,019 (1939), and 2,188,907. (1940).
3. SPELLACY, JOHN R.: U. S. Patent No. 2,163,331. (1939).
4. JACK, E. L., AND WASSON, A. J.: *Jour. Dairy Sci.* XXIV. 85. 1941.
5. SHARP, P. F.: U. S. Patent No. 1,810,682. (1931).
6. TROY, H. C., AND SHARP, P. F.: *Jour. Dairy Sci.* XIII. 140. 1930.
7. CAPSTICK, E.: *Proc. World's Dairy Congr.* II p. 261. 1937.
8. DOOB, H., JR., WILLMANN, A., AND SHARP, P. F.: *Jour. Ind. Eng. Chem.* 34. p. 1460. 1942.
9. WAITE, R.: *Jour. Dairy Res.* XII. 1. p. 71. 1941.
10. CHUCK, FAW YAP: U. S. Patent 2,016,592. (1935).
11. PEBBLES, D. D., AND MANNING, P. D. V.: U. S. Patent Nos. 1,928,135 (1933) and 2,088,606. (1937).
12. PEBBLES, D. D., AND MANNING, P. D. V.: U. S. Patent No. 2,181,146. (1939).
13. SIMMONS, N. L.: U. S. Patent No. 1,763,633. (1930).
14. CAPSTICK, E.: Information by correspondence. *British Dairy Inst. Reading, England.* 1944.

## CHAPTER XL

### MANUFACTURE OF MALTED MILK AND DRIED ICE CREAM MIX

#### MALTED MILK

**Definition.**—The prepared food known as malted milk is the product made by combining whole milk with the liquid separated from a mash of ground barley malt and wheat flour in such a manner as to secure full enzymic action of the malt extract, and reducing the mixture to dryness by desiccation. It may also contain added sodium chloride, sodium bicarbonate and potassium bicarbonate. The U. S. Federal standard provides that malted milk shall contain not less than 7.5 per cent milk fat and not more than 3.5 per cent moisture. Each pound of malted milk contains the total solids of approximately 2.2 pounds of whole milk.

**History of Malted Milk Industry.**—The process of the manufacture of malted milk was invented by Mr. William Horlick, of Racine, Wis., in the year 1883 and the product was first placed on the market in 1887.

The convenience, nutritive value and digestibility of this product attracted favorable attention on the part of the medical profession, and its palatability appealed to the public. The industry grew rapidly; its prosperity attracted other manufacturers of dairy products, so that today malted milk is made by several firms. Its annual production is given in Table 59, Chapter XXXIII.

**Manufacture.**—The manufacture of malted milk divides itself chiefly into two phases, namely:

1. The malting of the barley grain, which has to do with the cleaning, steeping and germinating of the barley, and the drying of the malted barley grain; and

2. The manufacture proper of the malted milk which consists of the crushing and steeping of the malted barley, preparation of the wheat flour paste, mashing or enzymation of the malt-flour mixture, separation of the husk from the wort and washing and draining the insoluble residue of the mash, mixing the malt-extract mixture with whole milk, forewarming and condensing the mixture, drying the malted milk syrup, and preparing the resulting dry malted milk for the market.

**Use of Barley Malt.**—It is now common practice on the part of manufacturers of malted milk to purchase their barley requirements in the form of prepared, dried malted barley from a bonafide malt house. Hence, it appears superfluous to present in the present edition a detailed discussion of the commercial procedure of malting the barley grain. For information on the composition of barley malt and on the several steps involved in its preparation, the reader is referred to the fourth and fifth editions of this

book. The present discussion deals exclusively with the manufacture of malted milk products direct from barley malt.

**Processing the Malted Milk.**—The first step in the manufacture of malted milk is the preparation of the mash of barley malt and wheat flour. The purpose of the mashing process is to complete the conversion of the insoluble starch and protein into soluble carbohydrates and protein derivatives.

**Steeping the Crushed Barley Malt.**—The barley malt is the foundation of the mash. It supplies the malt flavor that is relished by the consumer, contains the diastatic potency capable of complete conversion of the starch into sugar, and is said to contribute certain desirable compounds to the finished malted milk. It is because of the latter properties that the medical profession demands, and the Federal Standard requires, the use of barley malt in the manufacture of malted milk.

Before mixing it with the flour, the barley malt is crushed and steeped in water. For crushing, the dry barley malt is run through a malt mill of the roller type. The purpose of crushing is to make the diastase readily accessible to the starch. The grain should not be reduced to a powder, as this would hinder the subsequent separation of the hulls from the malt liquid. The more mellow the malt the less fine need the crushed material be.

The crushed barley malt is then steeped in a separate kettle in about six to seven times its weight of water at 90° F. The purpose of steeping is to put the enzymes in solution. This requires about 30 minutes.

**Preparing the Wheat Flour.**—The barley malt contains considerably more diastase than is necessary to convert the starch contained in the barley grain. It is claimed that 10 per cent barley malt contains sufficient diastatic potency to invert all the starch in the wheat flour. It has, therefore, become customary to use another grain, in addition to barley, as a source for the desired quantity of starch. For this purpose wheat flour is used in the manufacture of malted milk.

Whole wheat has the added advantage that it is rich in protein content and thus adds valuable nitrogenous compounds to the malted milk. In addition, its purchase price is lower than that of barley malt. It is given preference over corn because of the greater amount of protein and mineral salts contained in the wheat. Furthermore, the starch cells of the wheat are more easily disintegrated by the heat than those of corn. Hence the temperature required in preparation of the wheat flour paste for the mashing need not be as high.

The wheat flour is prepared for the mash in a separate kettle. It is mixed with approximately 1.3 times its weight of water. The mixture is cooked at 200° F. for about two hours. This reduces the flour to an opalescent paste.

The proportion of wheat flour to barley malt varies somewhat with different manufacturers. The general commercial practice is to use about

2.5 times as much dry barley malt as wheat flour, or to use 0.4 pound of wheat flour per pound of barley malt.

**The Enzymation Process.**—The barley malt and its steeping water and the cooled flour paste are then transferred to the large mash kettle where they are mixed. The reactions and end products resulting from the process of enzymation or mashing, that are most desired, are complete conversion of the starch into relatively high maltose- and low dextrin-content, together with reduction of the original grain proteins into simpler and more readily digestible compounds. This is accomplished by holding the barley malt-wheat flour mixture at a temperature of 113° F. for 30 minutes in order to break down the cereal proteins. The temperature is then gradually raised to 158° F., using a coming-up time of about 30 minutes. The mixture is held at 158° F. for two hours in order to complete the conversion of the starch to sugars.

It was shown by Rogers<sup>3</sup> that the peptonizing enzyme peptase is most active at 100 to 120° F., diastase at about 140 to 154° F., and that at temperatures above 170° F. diastase action becomes very weak.

Martin<sup>4</sup> points out that the starch molecule is very complex, the intermediate transition products between starch and maltose are many, and their number and exact nature are still more or less uncertain. He suggests that the vegetable diastase is a mixture of several distinct enzymes, some of which dissolve and hydrolyze the starch to dextrins when their action stops. Others hydrolyze the dextrins to maltose. The malt contains, in addition to diastase, other enzymes such as maltase, invertase and proteolytic enzymes.

**Separating the Wort from the Husks.**—During the mashing process the pleasant flavor, characteristic of the flavor and aroma of barley malt, is conveyed to the liquid extract from the husk. The malt flavor is understood to be derived from empyreumatic oil generated in the barley husk during the process of malting the barley grain.

The mashing of the mixture of barley malt and wheat flour paste is complete when all the starch has been converted into maltose and dextrin. When this has been accomplished the husks are allowed to settle and the liquid portion of the mash is discharged into a hot well. The residue in the enzymation kettle is washed with two rinsings of water which are also added to the wort in the hot well. The total amount of water used for the two washings is approximately equal to the weight of the original dry barley malt. The residue is allowed to drain into the hot well for about one and one-half hours.

**Addition of Milk, Forewarming, Condensing.**—The wort entering the hot well contains approximately 11 per cent cereal solids. To this wort is added whole milk equal in amount and in fat and solids content to cause the finished malted milk to meet the minimum Federal requirement of 7.5 per cent milk fat, and to make the milk-equivalent of malted milk not

less than 2.2 pounds of fluid whole milk of average composition, per pound of dry malted milk. To the above malt-flour-milk mixture is added a small amount of common salt (about 0.75 pound per 100 pounds of dry barley malt and wheat flour), and enough soda to standardize to the desired acidity.

This mixture is then forewarmed to 150° F. and is condensed in a standard vacuum pan to an approximate total solids content of 68 to 70 per cent. To reach this high concentration requires a condensing period of four to five hours.

**Drying the Concentrated Wort-Whole Milk Syrup.**—The condensing pan discharges the now highly concentrated malted milk syrup into the drier. The drying may be done in a special vacuum pan, or by means of

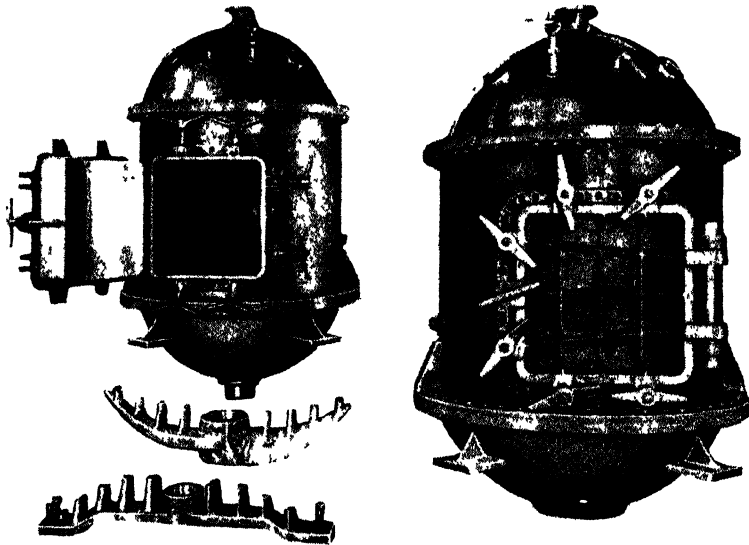

Fig 123 Malted milk drying vacuum pan, showing mechanical agitator  
Courtesy of Arthur Harris & Co

a drum dryer, or a spray dryer. In the commercial manufacture of malted milk, drying in the vacuum pan has been given preference. It is claimed that the pan drying method preserves the relative solubility of the malted milk product better than the other systems.

**The Malted Milk Drying Pan.**—This vacuum pan is of special construction. It has a dished bottom that is provided with a steam jacket. The interior of the pan contains a revolving vertical shaft with shaft extension through the center of the pan bottom. The shaft engages a heavy agitator located in the lower part of the pan. The agitator consists of a stationary upper rake with teeth pointing downward, and a rotating lower rake with teeth pointing upward. The lower rake is closely sweeping the jacketed bottom. On one side there is a large door (25 inches square) in the wall

of the pan, through which the finished product is scooped out. The standard malted milk drying pan is a 4½-foot diameter pan. (See Fig. 123.)

**Operating the Pan.**—For operation the pan is filled with the malted milk syrup sufficiently to cover the steam-jacketed portion. The surface of the syrup just touches the upper rake of the revolving agitator. The operating capacity of the pan is limited to approximately 400 pounds of finished product per batch. Since the batch of syrup is made up in much larger volume, the malted milk factory is usually operating a battery of multiple (4 or more) drying pans.

The vacuum maintained during drying ranges from about 15 to 27½ inches. Until near the finish it is held at about 25 to 26 inches. When drying has reached the desired point, air is admitted through the vacuum break, dropping the vacuum to about 15 inches. The continued action of the revolving agitator works this air into the semi-solid product and disperses it throughout the mass. This mechanical air incorporation under

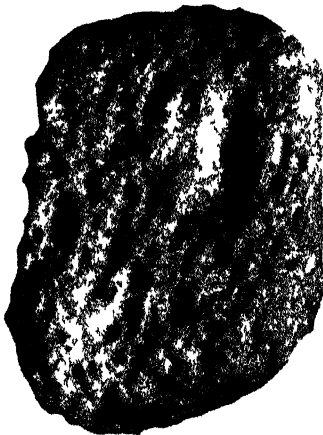

Fig 124 Malted milk as it comes from the pan showing porous character (actual size)

low vacuum may occupy about 30 minutes. Then the vacuum is suddenly raised to about 27½ inches. This sudden change (lowering) of pressure in the pan causes the air entrained in the nearly solid mass of malted milk to expand. The mass becomes impregnated with air bubbles. It swells and rises with wave-like, trembling convolvulaceous movements, filling the pan to near the top and changing the product to a solid block of dried malted milk. The finished product now is brittle and porous and has a honeycomb-like make up. (See Fig. 124.)

The successful accomplishment of the light, porous structure of the dried malted milk depends largely upon the suddenness of the change from low to high vacuum. At the end of the period of air incorporation under low vacuum, the steam to jacket is shut off, the agitator is stopped, the air intake is closed. The vacuum "shocking" is then performed by opening connections with a tank in which a high vacuum has already been stored

up. This, together with the continued operation of the vacuum pump, provides the shock of change in pressure that suddenly expands the entrained air into countless air bubbles, and the inevitable sudden drop in temperature brings about immediate rigidity (solidification) that prevents the collapse of the air bubbles and preserves the porosity of the finished product.

**Preparation for Market.**—The manner of unloading the drying pan depends somewhat on the intended disposition of the malted milk. If the product is to be disposed of in powdered form, it is “cracked” in the pan by the rotating agitator, and the broken down product is then scooped into an enclosed hopper from which it travels by enclosed mechanical conveyor to the milling and packing room. For the sake of brevity and clarity, this room is hereinafter referred to as the “Malted Milk Room”.

If intended for diverse confections, such as Bunte’s “Malteser” and similar products with a dry malted milk base, the agitator is kept at rest and the solid mass of product located above the agitator is sawed into blocks through the open door. These blocks are transferred in covered hand trucks to the malted milk room, where they are sawed into bars of the desired sizes and packed for market. The agitator is then started to crack the remainder of the product in the pan, which is then transferred to the grinding and packing room.

The freshly dried malted milk is highly hygroscopic. It absorbs moisture so rapidly that, if handled and packed in the ordinary atmosphere, it inevitably becomes moist, soft, sticky and unmanageable. The grinding and preparation for market must be done, therefore, in an atmosphere of controlled, low humidity. This means that the air in the malted milk room must be artificially dehydrated. This is commonly done by passing the air supply, before it enters the malted milk room, over banks of ammonia expansion coils, causing the humidity to precipitate. Similar coils are installed also in the malted milk room itself. In the transfer of the dry malted milk from pan to grinding and packing room, the product must also be protected from exposure to humid air.

**Composition of Malted Milk.**—The composition of malted milk is of complex nature. It involves both vegetable and milk proteins, and several sugars and dextrin. Chemical analysis carried to the point of determining the percentage of each individual ingredient is, at best, difficult, and accuracy of results is somewhat uncertain. For these reasons the proteins are usually given as total proteins, and the sugars and dextrans as nitrogen-free extract. For percentage composition of malted milk see Table 67, Chapter XLI.

**Keeping Quality of Malted Milk.**—Those who have given the manufacture, properties and marketing of malted milk careful study, appear to agree that the dependable keeping quality of malted milk is in all probability due to a film or layer of gluten, sugars and salts, that protects the



surface of the fat globules against the quality-deteriorating influence of contact with air.

The use of whole wheat flour, while originally a survival of "The Horlick's Food", from which malted milk was developed, may also be responsible, in part at least, for the good keeping quality of malted milk. The large amount of gluten provided by the wheat may assist in furnishing an effective coating for the protection of the fat globules. Experiments made with flour of other cereals gave results that did not warrant their use in the place of wheat flour.

Again, it was experimentally found that malted milks made by the mere mixing of the required ingredients, become stale and tallowy. It was noted that the only product that has permanent keeping quality is that, in the manufacture of which scientific use is made of the action of enzymes and similar ferments.

#### DRIED ICE CREAM MIX

During the years of World War II some of the manufacturers of dehydrated foods, especially those making dried milk products, have been using their drying equipment also for the drying of ice cream mix. The original aim of this venture appears to have been to provide the powdered mix for use by our men in service on every front. This attempt has proven successful and it has suggested to others the opportunity of a new outlet for surplus milk solids, and a means to extend the profitable operation of war-time drying plants into the post-war period.

The most promising markets for dried ice cream mix obviously are those territories and countries that are located outside of the world's dairy belt, where geographic and climatic conditions bar the profitable husbandry of the dairy cow and which lack availability of milk constituents of suitable quality, and other ingredients that are part and parcel of good ice cream.

It is reported<sup>5</sup> that Seattle is the shipping point of dried ice cream mix to all parts of Alaska and that large quantities are sold direct to the Quartermaster Corps for use at the large Army installations.

This branch of the dried milk industry is as yet young, and accurate official production figures appear to be lacking. However, according to rough estimates by the Dairy and Poultry Division of the U. S. Marketing Service,<sup>6</sup> the total production of dried ice cream mix in the United States was 5 to 8 million pounds in 1943 and within the limit of 40 million pounds in 1944. For 1945 a production of 150 million pounds is forecast.

**Formulas for Dried Ice Cream Mix.**—The following general formula complies with Army Quartermaster Corps specifications of minimum percentage of fat, solids-not-fat and sugar required, and maximum percentage of stabilizer and moisture permissible, in dried ice cream mix:

Not less than	27 % milk fat
Not less than	27.5 % SNF
Not less than	39.5 % sugar
Not more than	1.0 % stabilizer
Not more than	2.25% moisture
Unspecified	2.75%
Total	100.00%

The following formula to make up 80 pounds of liquid mix has been suggested<sup>7</sup> for a dry mix that meets Army Quartermaster Corps specifications:

- 14 lbs. of 40% cream
- 35.7 " of 3.5% milk
- 13.8 " of plain condensed skim (30% SNF)
- 10.3 " of sucrose
- 2.5 " of corn syrup
- 0.3 " of stabilizer

TABLE 65.—COMPOSITION OF DRIED AND OF RECONSTITUTED ICE CREAM MIX MEETING SPECIFICATIONS OF ARMY QUARTERMASTER CORPS  
ALAN LEIGHTON<sup>8</sup>

Ingredients of ice cream mix	Composition of Mix	
	After drying to 2% moisture	After reconstitution for freezing
	per cent	per cent
Milk fat.....	27 85	10 3
Solids-not-fat.....	27 65	10 2
Sucrose.....	34 8	12.85
Corn syrup solids.....	6.7	2 47
Stabilizer.....	1 0	0 38
Moisture.....	2 0	63.8

Table 65 shows the composition of the mix made by the above formula when dried to 2% moisture; and when reconstituted for freezing according to customary directions, i.e., 7.3 pounds of water is added to 4.25 pounds of dry mix (or 1.717 pounds of water per pound of dry mix).

**Precautions in Manufacture.**—To insure keeping quality of the dried product, the liquid mix, before drying, should be preheated at a relatively high temperature similar to that used for whole milk powder. A high-short temperature, such as 190° F. for five minutes is preferred. In addition, gas-packing is essential unless the mix is made for immediate use.

When all the sugar is added before drying, the dried product tends to

show an objectionable caramel flavor. This can be avoided by adding only about 25 per cent of the total sugar to the liquid mix and mixing the balance of the required sugar into the dried mix. Up to one-fourth of the total sugar may be replaced by corn sugar or by corn syrup solids.

Whole eggs and egg yolk—fresh, frozen, or powdered—may be used in normal amounts.<sup>8</sup> To obtain approximately one per cent whole egg in the finished ice cream 10.2 pounds liquid whole egg, or 2.7 pounds powdered whole egg, are added. To obtain approximately 0.5 per cent egg yolk in the finished ice cream, 3.11 pounds of liquid egg yolk, or 1.38 pounds powdered egg yolk, are added. The dried mix is readily reconstituted by addition of cold water. It has been found<sup>9</sup> that the reconstituted mix can be frozen, without aging, to 100 per cent overrun. The viscosity produced by the stabilizer limits the concentration of the liquid mix before drying. Excessive viscosity interferes with ease of handling and jeopardizes quality due to high oxygen content caused by excessive incorporation of air.

#### REFERENCES

1. HORLICKS MALTED MILK Co.: Information by correspondence. March 8, 1918 and 1925.
2. THOMPSON'S MALTED FOOD Co.: Information by correspondence. 1925.
3. ROGERS, A.: Industrial Chemistry. 1920.
4. MARTIN, G.: Industrial and Manufacturing Chemistry. 5th Ed. I. 1919.
5. NATIONAL BUTTER AND CHEESE JOUR. p. 40. November 1945.
6. DE VRIES, P. H.: Information by correspondence. Bur. Agr. Econ., U.S.D.A. May 1945.
7. LEIGHTON, A.: Bur. Dairy Ind., B.D.I.M.-Inf. 11. Revised August 1945.
8. LEIGHTON, A.: Information by correspondence. April 1944.
9. TRACY, P. H.: Ice Cream Trade Jour. 41. No. 4. April 1945.

## CHAPTER XLI

### YIELD, COMPOSITION AND PROPERTIES OF DRIED MILKS

This chapter deals with yield, chemical composition, physical properties and bacteria of dried milks.

#### YIELD

The approximate average yield and the high and low of yield for dried whole milk, dried skimmilk, dried buttermilk and dried whey are shown in Table 66.

TABLE 66.—YIELD OF DRIED MILKS PER 100 LBS.  
OF FLUID MILK PRODUCT

Kind of Dried Milk	Yield per 100 lbs. of Fluid Milk Product		Lbs. Fluid Milk Product Required to Make 1 lb. Dried Product	
	Range pounds	Average pounds	Range pounds	Average pounds
Dried Whole Milk.....	11.5 to 13.0	12.0	8.7 to 7.7	8.3
Dried Skimmilk.....	8.2 to 9.0	8.6	12.2 to 11.1	11.6 ✓
Dried Buttermilk (sweet) <sup>1</sup> ....	8.7 to 9.6	9.3	11.5 to 10.4	10.7
Dried Buttermilk (sour) <sup>2</sup> .....	7.0 to 8.2	7.7	14.3 to 12.2	13.0
Dried Whey.....	5.0 to 6.0	5.6	20.0 to 16.7	17.9

<sup>1</sup>Made from sweet-cream buttermilk.

<sup>2</sup>Made from Centralizer sour-cream buttermilk.

The yield of milk powder depends principally upon the percentage of solids in the fluid milk product, the percentage of water in the dried product and the entrainment losses in manufacture.

**Solids in Fluid Milk Product.**—In the case of whole milk, variations in per cent solids are almost exclusively due to causes beyond control of the factory, such as breed, period of lactation and season. These variations fluctuate within wide limits (below 11% to above 14%) in the case of individual cows, but even in mixed herd milk they are considerable.

In the case of by-products, such as skimmilk, buttermilk and whey, fluctuations in solids content are largely determined by dilution with extraneous water due to production and handling. Buttermilk provides a convincing example. As pointed out in Chapter XXXVIII, buttermilk which has suffered no dilution with water at any time may be expected to contain slightly over 10 per cent solids, while the solids content of sour gathered cream buttermilk may drop to 6 per cent or even lower due to dilutions with many rinsings, etc.

**Moisture in Dried Milk Products.**—Every per cent moisture contained in the dried product increases the yield to that extent. In the case of powders intended for human nutrition, the moisture content is automati-

cally limited by the quality-depreciating influences of high moisture. In the case of dried milk products for animal feed, solubility and keeping quality are not deciding factors. Hence these powders contain somewhat more moisture, causing an increase in yield. (See chemical composition of dried milks below.)

**Entrainment Losses and Recovery.**—A certain portion of each dried milk product is in a state of division so fine that it refuses to respond to the law of gravity. In the spray-drying process it is in danger of escaping with the outgoing hot air currents. In the drum-drying process, some milk dust also escapes but the major losses appear to be spills of milk when carrying the milk level too high, and leaks due to poorly fitting end boards.

Much progress has been made in the recovery of entrained milk dust, as shown in Chapter XXXVI, under "Recovery of Dried Milk". The loss of milk solids ranges from a small fraction of a per cent to about 2 per cent, averaging about one per cent. In their effect on the yield, these losses are more than offset by the gains resulting from the moisture content of the powder.

#### CHEMICAL COMPOSITION

The approximate average percentage composition of dried whole milk, dried cream, dried skim milk, dried buttermilk, dried whey and dried malted milk is shown in Table 67. The figures given are averages assembled from dried milks produced under a wide range of conditions.

TABLE 67.—CHEMICAL COMPOSITION OF MILK POWDERS

Milk Constituents	(1) Dried Whole Milk	(2) Dried Cream	(3) Dried Skimmilk	(4) Dried Buttermilk		(5) Dried Whey		(6) Dried Malted Milk
				from sweet cream	from centralizer sour cream	cheese whey	casein whey	
	%	%	%	%	%	%	%	%
Water . . . .	2 00	0.66	3 23	3 90	5 00	6.10	6 35	3.29
Fat . . . .	27 00	65.15	0 88	4 68	5 55	0.90	0.65	7.55
Protein . . . .	26 50	13.42	36 89	35 88	34.85	12 50	13 25	13.19
Lactose . . . .	38.00	17.86	50 52	47 84	39.10	72 25	68 90	72.40 (7)
Ash . . . .	6 05	2.91	8 15	7 80	8 40	8 90	10.50	3.66
Lactic acid . . . . .			1.40	1.55	8.62			

(1) Half/Half+ : American Dry Milk Inst. Bul. 905. 1944.

(2) Merrell-Soule Products p. 100. 1919.

(3) See (1), Averages of 291 samples representing all sections of the United States and all seasons of the year.

(4) Samples from products manufactured and analyzed under supervision of author.

(5) Averages of Analyses provided by courtesy of American Dry Milk Institute, 1945.

(6) Averages of analyses of five different brands.

(7) Includes lactose, maltose and dextrin.

**Dried Whole Milk.**—The Federal Standard places the minimum fat content at 26 per cent and the maximum moisture content permissible at 5 per cent. Because of a multitude of variables that jeopardize the accuracy

of standardizing calculations, the industry has adopted the practice of aiming at a slightly higher fat content than minimum requirements, such as 26.5 to 27 per cent. If 27 per cent fat is adopted as the goal, for instance, then the fresh milk is standardized to the per cent fat that is calculated to yield the desired 27 per cent fat in the dried milk. It was shown in Table 66 that the production of one pound of whole milk powder requires approximately 8.3 pounds of fresh milk. The fresh milk, therefore, must be standardized to contain  $\frac{27}{8.3}$  or 3.25 per cent fat.

The moisture content largely controls such important marketable properties of whole milk powder as free-flowing property, solubility and keeping quality. In the whole milk product these factors are of paramount importance commercially. Hence the moisture content must be limited to a figure sufficiently low to eliminate moisture as a quality-jeopardizing factor. That optimum figure appears to be 2 per cent moisture or less.

**Dried Cream.**—The composition of cream powder is regulated according to the demand of the trade for fat content. It is provided principally in three richnesses, containing approximately 50, 65, or 72 per cent fat, respectively. Its moisture content is held below one per cent and is lowered with increasing fat content.

**Dried Skimmilk.**—This product is made of grades suitable for human nutrition as well as in the form of animal feed. Dried skimmilk for channels of human consumption is made of high quality, sweet skimmilk. It should be dried to a relatively low moisture content to preserve its free-flowing property, solubility and fresh flavor. It averages approximately 3 per cent moisture. The Federal standard limits the permissible moisture content to a maximum of 5 per cent, and the fat content to 1.25 per cent.

Dried skimmilk intended for animal feed usually contains considerably more moisture than that produced for human consumption. It averages approximately between 5 and 6 per cent. The aim obviously is to increase the yield. The Association of American Feed Officials<sup>26</sup> places the maximum moisture content permissible in dried skimmilk for animal feed at 8 per cent.

**Dried Buttermilk.**—The dried product made from sweet-cream buttermilk goes largely into channels of human nutrition. It averages approximately 4 per cent moisture. Sour-cream dried buttermilk, made from centralizer sour-cream buttermilk is practically exclusively used for animal feed. It contains about 5 per cent moisture. It is subject to the same standard (moisture limit 8 per cent)<sup>26</sup> as dried skimmilk, for animal feed.

**Dried Whey.**—The composition of this product consists over two-thirds of lactose. The Association of American Feed Control Officials<sup>26</sup> specifies that dried whey must contain at least 65 per cent lactose. The moisture content of the finished product varies considerably with pro

cess of manufacture. The figures in Table 67 show an average of about 6 per cent moisture. Cheese whey averages slightly higher in lactose and somewhat lower in protein content than casein whey. Casein whey is higher in percentage of ash. This is generally attributed to the common practice of neutralization of the acid casein whey.

**Dried Malted Milk.**—As shown in Chapter XL on the “Manufacture of Malted Milk”, this product consists of a mixture resulting from combining whole milk with the liquid separated from a mash of ground barley malt and wheat flour, the mash having been subjected to enzymic action. The above mixture is reduced to dryness by evaporation of moisture in the presence of heat. The U. S. Federal standard provides that malted milk shall contain not less than 7.5 per cent milk fat, and not more than 3.5 per cent moisture.

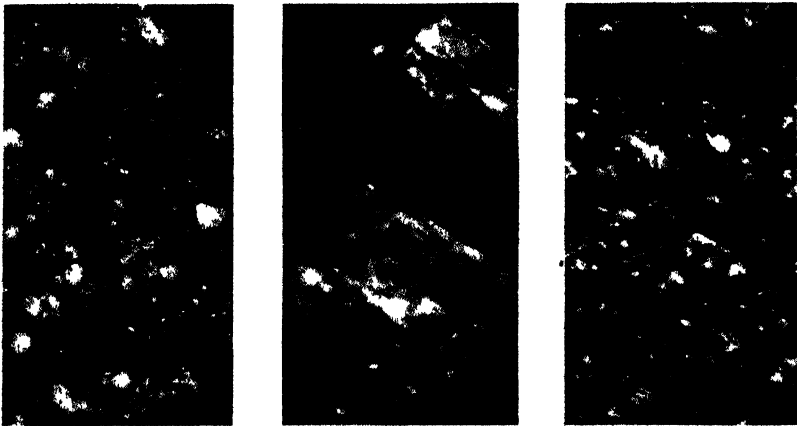

Fig. 125. Dried milk particles  
 Pressure spray                      Atmospheric roller                      Vacuum roller  
 Courtesy of American Dry Milk Institute

#### THE DRIED MILK PARTICLE

**Grain in Roller-Process Powder.**—In drum drying, the dried milk is scraped from the drum surface by the knife in large thin sheets. These sheets are broken into small pieces automatically by the usual screw conveyor that removes the dried material from the dryer unit. In some cases the particles are further broken up by the use of a flaker or grinder before final packaging. The particles are of irregular size and shape. They consist of amorphous flakes with rough and broken edges, varying in size. These flakes are devoid of air cells and contain no entrapped air. They are ground to whatever fineness or coarseness the buyer may desire.

**Grain in Spray-Process Powder.**—In spray-dried powders, the particles usually consist of minute spherical grains of varying size. According to Palmer and Dahle<sup>1</sup> each grain contains one or more air cores. These

authors point to the possible important bearing of the presence of air cells on the susceptibility of spray powders to oxidative deterioration (tallowiness). These air cells appear to be closely related to the relatively slow response of spray powders to vacuumizing. Miyawaki<sup>2</sup> reported the diameter of the air cores to range from 10 to 37.5 microns. Coulter and Jenness<sup>29</sup> observed that all spray-dried milks contain some powder grains which have no air cells.

**Period of Oxygen "Desorption".**—Lea, Moran and Smith<sup>4</sup> demonstrated, in an experimental study of gas-packing of dried whole milk, that the oxygen content of the gas in the sealed can increases for a period of approximately 5 to 7 days. They adopted the designation "desorption" for this phenomenon. These observations of oxygen desorption are supported by the work of Holm,<sup>27</sup> of the Continental Can Company,<sup>28</sup> of the American Can Company,<sup>31</sup> and of Coulter and Jenness.<sup>29</sup>

Knowledge of the mechanism of air retention by whole milk powder and of desorption of oxygen appears to be incomplete as yet. It is generally held that the desorption of oxygen from dried whole milk, after gas-packing, is the result of gradual diffusion of oxygen from the entrapped air cells. In addition, desorption of oxygen absorbed to the surface of the powder particle may also be involved. Coulter and Jenness<sup>29</sup> established experimentally that the oxygen level in cans of spray-dried egg does not increase after evacuation and gassing. They suggest the possibility that the lactose, which is present as a highly concentrated syrup and probably constitutes the continuous phase, may diminish the permeability to gases of the milk powder particle.

**Effect of Different Systems of Atomizing on Amount of Air Entrapped.**—Data of experimental comparisons of volume of entrapped air between the powders from different spray dryers appear to be too limited to justify final conclusions.

The results of Coulter and Jenness<sup>29</sup> indicate that centrifugal powders contain considerable entrapped air. They further show the smallest volume of oxygen retained when using the Minnesota compressed air atomizer. The results of Lea et al<sup>4</sup> indicate that centrifugal-spray powder retained more oxygen than pressure-spray powder.

**Effect of Grinding on Amount of Retained Oxygen.**—Grinding decreases the entrapped oxygen. Coulter and Jenness<sup>29</sup> ground different lots of whole milk powder in a ball mill for 4 hours. Seven days after gas-packing, the oxygen content of the ground samples averaged 0.66 ml./100g., while that of the control samples averaged 1.83 ml./100g. These results suggest that the mutilation of the powder particles due to grinding disrupts the air cells. This facilitates release of the entrapped air in subsequent vacuumizing. The decisive reduction in the oxygen content of the ground powder strongly supports the theory that the air entrapped in the powder particles is the major cause of the oxygen content of the powder and of



oxygen desorption after gas-packing. The subdivision of the powder particles caused by grinding vastly increases the surface area. Therefore, if surface adsorption were the major source of the oxygen desorbed after gas-packing, grinding might reasonably be expected to increase the amount of oxygen desorbed.

**Effect of Age of Powder on Amount of Oxygen Retained.**—Hetrick and Tracy<sup>30</sup> reported that powder immediately packed after drying showed a lower oxygen content per gram than powder aged 18 to 24 hours before packing. There appears to be no additional evidence to the same effect that would justify the conclusion that holding before final gas-packing increases the oxygen retained by the powder.

In the above experiment the temperature, when the powder was packed immediately after drying, was 120 to 125° F., while the temperature of the powder that was held for 18 to 24 hours before packing had dropped to 60° F. It is conceivable that the decisive factor responsible for the increase in oxygen content was not the aging, but the drop in temperature.

As shown under "Temperature of Powder at the Time of Packing" in Chapter XXXVII, it has been observed in commercial manufacture, that desorption of oxygen is less complete when vacuumizing and gassing cold powder. Some manufacturers have adopted 85° F. as the minimum temperature suitable for packaging whole milk powder. This suggests that cooling the powder to temperatures low enough to cause the fat to solidify, may decrease the permeability of the powder particles. This in turn would increase the per cent oxygen retained.

Experimental results<sup>20, 30</sup> as well as commercial experience have demonstrated, however, that the oxygen content of gas-packed powder is lowest when the powder is vacuumized and gas-packed without cooling, as it comes from the drying unit. It would appear, therefore, that for gas-packed powder vacuumizing and gassing of the uncooled powder makes for optimum keeping quality, and this practice is, in fact, gaining in preference for commercial manufacture.

Similarly, if the presence of lactose in the highly viscous, non-crystalline form decreases the permeability of the powder particle, as suggested by Coulter and Jenness<sup>29</sup>, this effect also may be expected to be aggravated in the cooled powder.

For details on vacuumizing and gassing, see "Manufacture of Dried Whole Milk", Chapter XXXVII.

**Density of Milk Powders.**—Spray powders vary considerably in density as shown by Stamberg and Bailey<sup>8</sup>. These variations appear to be due mainly to the numerous variable factors that control the fineness (particle size) and the air cells of the powder, such as size of spray orifice, pressure on milk, degree of preconcentration, etc.

Drum powders, because of flake-shape, crinkly structure, unyielding texture and ragged contour do not pack as closely, are less dense and re-

quire more space per unit weight than do spray powders. The particles of spray powders are of spherical shape and more yielding texture, their density is noticeably greater than that of the drum powders. The relative density of the two powders was reported by Lea, Moran and Smith<sup>4</sup> as follows:

Uncompressed drum powder, about 0.3 to 0.5 g./ml.

Uncompressed pressure spray powder, about 0.5 to 0.6 g./ml.

Compressed drum and spray powder, about 1.1 to 1.2 g./ml.

Dried whole milk, "air-free", about 1.31 to 1.32 g./ml.

Dried skim milk, "air-free" about 1.44 g./ml.

#### FREE-FLOWING PROPERTY

One of the important marketable requisites of the physical character of milk powder is that it must be free-flowing, similar to dry sand. It must be free from stickiness and caking.

**Effect of Form of Lactose.**—The relative free-flowing property of all milk powders depends primarily upon the physical state of the lactose which they contain<sup>5, 6, 7, 8</sup>. The lactose in the powder is present either in the non-crystalline or glass state (as anhydride), or it is present in the crystallized state, usually as lactose hydrate crystals. In the non-crystalline (anhydride) state, lactose is very hygroscopic and absorbs moisture readily from the air. In the hydrate crystal state it is relatively moisture-stable and non-hygroscopic.

In both the roller process and the spray-drying process, evaporation proceeds so rapidly that the optimum range of concentration for lactose crystallization is passed before conversion to lactose hydrate crystals takes place. Therefore, barring special modifications of the process of drying, the lactose in the freshly spray-dried powder and the freshly drum-dried powder is present in the non-crystalline form.<sup>5, 7, 17</sup>

**Hygroscopicity of Freshly-Made Powders.**—By reason of the high lactose content of milk powders, the dried milk assumes some of the physical properties of the lactose. Powders containing non-crystalline lactose, when exposed to air of high, or even average relative humidity, absorb moisture rapidly and become damp. In this condition the protein particles tend to stick together, making the powder objectionably sticky. When this stage has been reached the dilution due to humidity absorbed from the atmosphere usually has been sufficient to make possible and expedite crystallization of lactose hydrate. This change to crystal form is accompanied by some loss of moisture.

**Prevention of Caking.**—From the standpoint of free-flowing properties acceptable to the trade, then, two alternative methods of manufacture and handling suggest themselves, namely:

**Method 1.** So manage the making and handling of the powder as to maintain the lactose it contains in the permanently non-crystalline, an-

hydride form. This is accomplished by drying the milk to a relatively low moisture content (below 2 per cent for spray powder and below 3 per cent for drum powder), removing it promptly to a room with low relative humidity for handling and packaging, packing it and sealing it in a moisture-proof, air-tight container, such as hermetically sealed tin cans, or metal drums, or tongue-and-grooved barrels with heavily paraffined double liners. The powder is preferably stored at or below room temperature. Whole milk powder should be gas-packed.

Method 2. Allow sufficient time between dryer and sacking to enable copious lactose crystallization. If this is not feasible and the powder must be sacked immediately, store it at low relative humidity. Keep temperature a few degrees above that of outside atmosphere by use of a steam radiator (that does not leak). Under these conditions, with lactose in non-crystalline form and exposed to atmosphere, depreciation of market value due to caking, may be avoided by disposing of the powder promptly, preferably weekly. (See also "Manufacture of Dried Buttermilk" and "Manufacture of Dried Whey", Chapters XXXVIII and XXXIX, respectively.)

**Choice of Method Depends on Intended Use of Powder.**—Method 1 applies to powder intended for human consumption. In the case of Method 2, the absorption of moisture that is necessary to induce lactose crystallization diminishes the solubility of the powder. This depreciates its usefulness for human nutrition (see "Solubility" later). In powders intended for animal feed, such as undergrade dried skim milk, sour-cream buttermilk powder and much of the whey powder production, high solubility is not a deciding factor. The essential requisite here is that the powder be sufficiently free-flowing to ensure ease of handling in the feed mill. Likewise, limitations in the margin of profit, in the case of animal feed, do not justify the cost of a dependable, air-tight, moisture-proof package. Hence for feed mill purposes Method 2, that contains the lactose in non-hygroscopic and non-caking form, is preferred (see also Chapters XXXVIII and XXXIX).

Milk powders intended for animal feed are sacked; in fact, the feed mill does not want the powder in barrels. Its operating routine is organized for handling sacks and not barrels. In the powder store room of the factory the filled sacks are often piled from 10 to 20 high. The resulting pressure on the sacked powder aggravates, hastens and intensifies the caking.

#### SOLUBILITY OF MILK POWDERS

A soluble milk powder implies a product that is capable, when mixed with water in proportion approximately equal to that contained in normal fluid milk, of returning to a solution, suspension and emulsion that will simulate the physical characteristics of normal milk. Milk powder solu-

bility means casein suspension stability, rather than true molecular solubility.

**Relative Importance of Factor of Solubility.**—The degree of solubility of dried milks is important where the powder is intended for purposes of reconstitution, such as for table milk. Here the solubility must be sufficiently complete to leave no residual sediment. This is one of the important prerequisites of consumer acceptance. In the manufacture of some of the prepared foods from part milk powder, high solubility is likewise insisted upon.

**Factors that Influence Solubility.**—The major factors that control or influence solubility are: system of drying, quality of milk, heat treatment prior to drying, drying temperature, moisture content of powder, age, and temperature of storage.

**Effect of System of Drying on Solubility.**—Lea and co-workers<sup>4</sup>, as a result of their most recent extensive studies of the properties of milk powder, reconfirm the generally recognized fact that spray-dried milk is practically completely soluble in cold water. In the case of atmospheric drum-dried powder they found the solubility in cold water to range from 70-85 per cent, and in hot water from 80 to 95 per cent. Hunziker<sup>9</sup> reported the solubility in hot water of vacuum drum powder to be 97 per cent. Dried milks of solubilities ranging from 98 to 100 per cent by the use of the thin film atmospheric single-drum dryer (Schroeder) and the conventional atmospheric double-drum dryer, were reported by Clausen<sup>10</sup> and by Mohr and Ritterhoff<sup>11</sup>, but important details of procedure are lacking. Drying milk by refrigeration does not jeopardize protein stability and, therefore, yields, a completely soluble powder as far as the effect of the system of drying on solubility is concerned. (See Chapter XXXIV under "Drying Milk by Application of Cold.")

**Effect of Quality of Fresh Milk on Solubility.**—It was briefly pointed out in Chapter XXXVII that fluid milk which is not fresh or is otherwise of inferior quality jeopardizes the solubility of the resulting dried milk. Developed acidity or the presence of coagulating enzymes tends to dissipate protein stability and lessen solubility. The action of the acid is intensified by concentration of product and processing heat. The potential damage of poor quality accepted at the receiving platform is augmented by continuance of rapid acid development in such milk at the factory, unless cooled low or heat-processed immediately.

**Effect of Heat Treatment on Solubility.**—The effect of heat treatment involves both the temperature-time factor of preheating and the temperature-time-concentration factor of drying. Many angles of the complex problems in solubility of milk powders still are awaiting satisfactory solution. Yet the research of the past score of years has provided valuable facts and helpful suggestions. On the basis of our present knowledge, the similarity of cause and effect between solubility of milk powders and

heat stability of evaporated milk becomes increasingly apparent. In both products the milk proteins are primarily involved.

**Effect of Temperature-Time-Concentration Factor on Solubility of Drum-Dried Powder.**—Holm, Deysher and Evans<sup>12</sup>, in their early work on the factors controlling heat coagulation in evaporated milk, demonstrated the existence of a logarithmic relationship between temperature and time of forewarming. In addition, they showed that increasing the concentration of milk solids decreased the heat stability (i.e., lowered the heat coagulation temperature) of evaporated milk. Wright<sup>13</sup> studied the factors that caused insolubility in drum-dried milk powder. He demonstrated that for a given temperature the higher the concentration of milk solids the more easily is the protein rendered insoluble, and that for a given time of heating, an increase of one per cent in concentration of solids lowers the temperature required to produce a given degree of insolubility about 1° C.

Wright concluded that there are three stages of evaporation (concentration of film of milk solids) in the process of drum drying, namely:

1. First Stage: The film is still in liquid condition, the concentration is still relatively low (below 60 per cent solids), overheating by denaturation of proteins causing insolubility is improbable.

2. Second Stage: This is the critical concentration period, ranging from approximately 60 to 90 per cent solids. At temperatures approximating 100° C., insolubility may be induced during periods varying from a few seconds to a fraction of a second. It is the status of this period that emphasizes the difficulty of producing atmospheric drum powders of a high degree of solubility.

3. Third Stage: This comprises the dry state in the presence of overheating. Wright suggests that this stage may account for the differential solubility (more soluble in hot than in cold water) observed in drum-dried powder. The increased insolubility in cold water, resulting from heating in the dry state is believed to be confined to a reversible physical change in the casein, hot water having the effect of restoring the solubility of the protein.

**High Solubility of Spray-Dried Milk.**—In spray drying conversion from the fluid milk (fresh or precondensed) to the dried powder is almost instantaneous. By reason of the minute particle size and consequent immense surface area of the milk fog and the intense turbulence of the heated air currents, evaporation is so rapid as to actually have a cooling effect. Danger of heat damage and loss of protein solubility during spray drying, therefore, is practically nonexistent. Holding the dried product in the hot drying chamber until the end of the operating day may be expected to cause slight overheating. Experimental evidence that such overheating is accompanied by noticeable loss of solubility appears to be lacking; but prolonged heat exposure of the dried product, in the case of whole milk powder

and cream powder, does jeopardize flavor as will be shown in later paragraphs.

However, the production of a completely soluble milk powder is possible only provided the milk, before it reaches the dryer, has not already been subject to heat treatment sufficiently severe to induce denaturation of the proteins. For this reason the conventional method of preheating at temperatures ranging approximately from 165 to 180° F. is not believed to noticeably affect the solubility of atmospheric drum-dried milk when operated at the conventionally used gauge steam pressure of about 50 to 80 pounds, which represents drum-drying temperatures of about 297 to 324° F.

In spray drying the severity of heat treatment is somewhat reversed. The definite cooling effect created by the high rate of evaporation lowers the drying heat of the milk particles definitely below the boiling point. It is probably not above 160° F. and may be considerably lower. A preheating range of 165 to 180° F. appears not to noticeably affect the solubility of the spray-process powder.

**Relation of Heat Stability to Solubility Stability.**—It was pointed out in Chapter XXXVII that autoxidation of milk fat in dried whole milk may be retarded and flavor, color and keeping quality improved, by preheating at temperatures far above those necessary to insure keeping quality in skimmilk powder, provided that the high-temperature short-time method of preheating is used. Thus, in the place of preheating at 180° F. for 30 minutes, the temperature is instantly raised to say 240° F., held only momentarily, and the milk quickly cooled. It was likewise shown in Chapter XIX that the high-temperature, short-time method of preheating greatly improved the heat stability of evaporated milk. In addition, the apparent similarity of reaction between that which controls heat stability in evaporated milk and the reaction that controls solubility in milk powder suggests that the high-temperature, short-time method of preheating may also be useful in stabilizing the solubility of dried milk. The potential possibilities of high-temperature, short-time preheating in the drying of milk has not as yet been experimentally exploited in terms of published confirmation. However, further research relevant to this subject may reveal new facts of tangible assistance to the industry.

**Effect of Moisture Content, Age, and Temperature of Storage on Solubility.**—The general tendency is for the solubility of dried milk to diminish with age. Loss of solubility is greatly retarded by low moisture content and relatively low storage temperature. Gas packing is a further protection of solubility, largely because it eliminates the relative humidity of the air contained in the can and prevents progressive moisture absorption from the atmosphere.

The solubility-dissipating influence of high moisture is attributed to physico-chemical changes in the milk proteins (chiefly the casein), which

proceed more rapidly in moist powders and at high storage temperatures. Fonassieu<sup>14</sup> holds that an increase in moisture content accelerates the rate at which the lactic acid renders casein insoluble.

Supplee and Bellis<sup>15</sup> increased the moisture content of dried milk from 2 to 11 per cent by circulating moist air (relative humidity 70 to 75%) through it. The protein in the powder became progressively insoluble, and in 52 days the casein had lost its power of suspension entirely. Moisture-free air, circulated through dried milk in the same manner, caused no change in solubility of the proteins. These investigators concluded that, at a moisture content below 3 per cent, the original solubility of the casein present can be maintained for a year or more. When maintaining the moisture content within the limits of about 3 to 5 per cent the solubility had shown but slight change during one year, but raising the moisture content to 6.5-7.0 per cent caused almost complete insolubility within a few days.

Lca, Moran and Smith<sup>4</sup> reported the results of their most recent comprehensive experimental study of the effect of moisture content, age and storage temperature on the solubility of gas-packed dried milk. According to their findings and conclusions spray-dried whole milk with a moisture content ranging from 1.3 to 1.9 per cent keeps sufficiently well at 37° C. (98° F.) to withstand tropical temperatures without serious deterioration and without appreciable loss of solubility. Spray-dried powder with a moisture content up to 2.5% was found satisfactory for long periods under temperate climatic conditions, and 3 per cent moisture appeared not too high for moderate temperatures and periods of storage.

Experiments with roller-process dried whole milk, containing as high as 3.7 per cent moisture, indicated satisfactory storage and no loss of solubility for 3½ years at a constant temperature of 15° C. (59° F.). However, when stored for long periods at 37° C., powders with as little as 2.4 per cent moisture suffered considerable loss of solubility, and powders containing 3.7 per cent moisture had become completely insoluble.

The above results are in general agreement with average commercial experience. At ordinary, temperate zone temperature, gas-packed whole milk spray powder at or below 2.5 per cent moisture, and gas-packed whole milk roller powder at or below 3.5 per cent moisture stand up satisfactorily in quality and solubility for any reasonable storage period. For warmer climes, however, the moisture content of whole milk spray powder should be below 2 per cent and that of whole milk roller powder below 2.5 per cent in order to stand storage without serious depreciation in quality, appreciable loss of solubility and objectionable discoloration.

#### COLOR

Whole milk, skimmilk and sweet-cream buttermilk, dried without overheating to a relatively low moisture content, yield a light, creamy-white powder. Dried sour-cream buttermilk properly neutralized, and dried

they tend to be a shade darker but not objectionably so. Overneutralization causes objectionable browning. Age tends to darken the color. This change is accelerated and intensified by high moisture content and high storage temperature. Dried milk exposed to the atmosphere in storage suffers more rapid discoloration than gas-packed powder and powder otherwise held in air-tight moisture-proof containers. Doob, Willmann and Sharp<sup>16</sup> found that in an atmosphere with a relative humidity of 20 to 30 per cent, browning is practically inhibited, but at relative humidities above 30 per cent and up to 55-60 per cent the color increased progressively. The same investigators further reported that samples of dried whey and dried skim milk held in storage at 77° F. showed no change in color, but above 86° F. they browned rapidly.

**Reaction Responsible for Browning.**—It is believed that the browning of dried milk is due to reaction between the reducing sugar (lactose) and certain amino acids of the milk protein (principally of the casein) in the presence of heat. This is the same reaction as has been shown to be responsible for the browning of evaporated milk. (See "Color" in Chapter XXV.) It is accelerated at high temperature and greatly intensified by alkalinity. It is for this reason that overneutralization of sour-cream buttermilk, or otherwise careless neutralization that produces general or localized alkalinity, causes severe browning of the dried milk product. Sour-cream buttermilk or other high-acid fluid milk product should not be neutralized to a point lower than 0.15 per cent titratable acidity, calculated as lactic acid. The high acidity of sour-cream buttermilk, however, increases the difficulty of handling because the acid makes the powder more hygroscopic and increases the tendency to stickiness and caking.

**Conditions in Manufacture that Cause Browning.**—In manufacture, aside from overneutralization and high moisture in the powder, excessive temperature and long exposure to heat are the chief causes of browning. In drum drying, in order to provide conditions that will insure low moisture content on the one hand and maximum solubility and freedom from browning on the other, consistent with optimum capacity of dryer, there must be a proper relationship between drying temperature (gauge steam pressure in drums) peripheral speed and thickness of film. The milk must be carried at maximum level in the trough between the drums short of overflowing, the clearance between drums must be such as to permit the proper thickness of film (average clearance is about 0.02 inch), and the knife must be sharp-edged and so adjusted that its pressure on the drum is uniform over the entire length.

In spray drying the danger of browning, as a result of the drying process, is negligible. Excessive temperatures or time in preheating, and holding the dried product in the hot drying chamber until the end of the day's drying operation may, under certain combinations of conditions, cause a slight increase in color. Otherwise any darkening of spray-dried powder



may be expected to be confined to conditions of storage, such as high moisture content of powder, high relative humidity of air, high temperature of storage, and age.

### BACTERIOLOGY OF DRIED MILK PRODUCTS

When dried milk is properly manufactured and stored, action of its germ life appears insignificant. the moisture content of milk powder of standard quality is far below the requirements for bacterial development in the finished product. This fact precludes quality-damaging bacterial activity after manufacture.

**Number of Bacteria in Milk Powder.**—While the plate count of milk powders, as given in Tables 68 and 69, shows a wide range in the number of bacteria that may be present in freshly dried milk, the figures in Table 70 show unmistakably that the bacterial count decreases progressively with age, and some species have been found to die out entirely.

TABLE 68.—BACTERIAL PLATE COUNT OF DRIED MILK  
NUMBER OF COLONIES PER GRAM

Author	Roller Process		Spray Process	
	Range	Average	Range	Average
Supplee and Bixby <sup>18</sup> . . . . .	161—1,482	540*	24,000— 175,000	75,800
Macy <sup>19</sup> . . . . .	40—7,900	2,595	4,400—5,500,000	2,152,450
Higginbottom <sup>20**</sup> . . . . .	All below 1,000	700***	500,000—2,500,000	1,500,000
Average . . . . .	.....	1,278	.....	1,242,750

\*Represent averages of samples taken daily from commercial production for seven years.

\*\*Represent averages of 400 samples of roller-dried and spray-dried milk products from total plants throughout Great Britain.

\*\*\*Estimated.

TABLE 69.—PLATE COUNT OF SPRAY-DRIED WHOLE MILK,  
SKIMMILK AND WHEY (CROSSLEY AND JOHNSON<sup>21</sup>)  
NUMBER OF COLONIES PER GRAM

Kind of Product	Number of Samples	Minimum per gram	Maximum per gram	Average per gram
Dried whole milk . . . . .	80	2050	6,455,000	290,350
Dried skimmilk . . . . .	561	5900	12,350,000	127,900
Dried whey . . . . .	30	3500	600,000	29,683

Supplee and Ashbaugh<sup>23</sup> concluded that a high count does not produce any detectable effect upon the keeping quality of dried milk with a moisture content that makes the powder acceptable commercially. Crossley and Johnson<sup>21</sup> concluded that the plate count of milk powders is not directly related to the raw milk counts, and Constance Higginbottom<sup>20</sup>

reported that no co-relation could be found between plate counts and titratable acidity or pH of either roller- or spray-dried whey, nor between keeping quality and plate count of reconstituted roller-dried milks.

TABLE 70.—PER CENT REDUCTION OF PLATE COUNT  
AFTER PROGRESSIVE STORAGE

Drying System	After Storage at Room Temperature						
	3 mos.	6 mos.	12 mos.	2 years	3 years	4 years	5 years
Drum process <sup>19</sup> . . . . .	.....	60.0	96.0	97.6	97.9	97.9	.....
Spray process <sup>19</sup> . . . . .	.....	56.3	90.7	93.9	97.4	99.2	99.9
Spray process <sup>21</sup> . . . . .	74.1	97.2	99.8	.....	.....	.....	.....

**Importance of Bacterial Cleanliness in Plant Operation.**—Because of the germicidal efficiency of either preheating or of drying, or both, the plate count of the finished powder may not reflect sanitary neglect in manufacture. Yet, such neglect, if permitted, is destined to lower the resistance of the powder to quality-damaging reactions. Among the more common changes in the milk, that are likely to accompany such neglect, are increase of acidity, development of flavor-damaging enzyme activity, and oxidative reactions that shorten the induction period of the fat and hasten the appearance of tallowy flavor.

**Increase of Count between Dryer and Final Package.**—Plate counts of the powder at different steps in the process of manufacture show a definite increase in number of bacteria between dryer and after packing. This increase is more noticeable in drum powder than in spray powder, probably chiefly because of the much lower original count of drum-dried milk. Jephcott, Hunwicke and Ratcliff<sup>22</sup> concluded that the most likely source of contamination, causing increase in count after drying, has to do with the transfer of the powder from drum dryer to bulk packing operation, followed by only slight increase due to distribution into small containers. Constance Higginbottom<sup>20</sup> also reported much lower counts in samples taken direct from drums than in samples after packing. In some cases the increase in count, due to grinding, sifting and bagging, was as high as from an original of 100 colonies to 50,000 colonies per gram in the final package. Supplee and Ashbaugh<sup>23</sup> concluded that over 1,000 bacteria per gram of milk powder made by the Just process is an indication, in the majority of cases, of recontamination after drying.

**Types of Bacteria in Dried Milks.**—The general character of the bacterial flora of dried milk is determined principally by the system of drying. Crossley and Johnson<sup>24</sup>, as a result of work with the Kestner centrifugal spray process, concluded that spray drying itself could not be depended upon to destroy pathogens. In defense of the bacteriological efficiency of

the spray process it appears pertinent here to point out, however, that in commercial manufacture the system of spray drying embraces the preheating of the fresh milk, using a temperature-time factor that is ample to destroy all milk-borne pathogens that might be present in the milk. The conventional process preheats the milk within a temperature range of 165 to 180° F. for 30 minutes. For drying whole milk, some manufacturers are preheating to temperatures as high as 235° F. and even higher. Macy<sup>19</sup> and others<sup>20, 22</sup> found that most spray powders show a predominance of acid-producing types of bacteria. Prolonged preheating of the fresh milk prior to drying, as occasionally happens in the spray-drying system, may lead to high thermophilic counts<sup>20</sup>.

Agnes Nichols<sup>25</sup> studied the bacteriology of over 400 samples of spray-dried milk from eight factories in England and Scotland. At 37° C. (98° F.) her plate counts varied from 1400 to 149,000,000 per gram, and her methylene blue reduction tests from 3 to 14 hours. In the case of reconstituted milk stored at 60° F., over 90% of the samples remained sweet for 2½ to 3½ days. The predominating flora of reconstituted milk at 37° C. rendered it acid in reaction and clotted it.

In drum-dried powder the acid bacteria have largely disappeared. Among the remaining species the more heat-resistant peptonizing and sporing groups predominate as shown by Macy<sup>19</sup>, Supplee and Ashbaugh<sup>23</sup>, Hunziker and Jephcott<sup>24</sup>. The above results refer to the use of the Just-Hatmaker type of double drum dryer, which has demonstrated its ability to destroy all non-sporing micro-organisms. They do not cover the germ-killing efficiency of single roll drum-dryers such as the Kunick dryer, the Schroeder dryer and others which are operated at a definitely lower drum temperature.

#### REFERENCES

1. PALMER, L. S., AND DAHLE, C. D.: *Jour. Dairy Sci.* V. 240. 1922.
2. MIYAWAKI, A.: *Proc. World's Dairy Congr.* 370. London. 1928.
3. STAMBERG, O. E., AND BAILY, C. H.: *Jour. Food Res.* V. 3. 1940.
4. LEA, C. H., MORAN, T., AND SMITH, J. A. B.: *Jour. Dairy Res.* XIII. 200. 1943.
5. TROY, H. C., AND SHARP, P. F.: *Jour. Dairy Sci.* XIII. 140. 1930.
6. LAMPITT, L. H., AND BUSHILL, J. H.: *Jour. Soc. Chem. Industry.* L. p. 45. 1931.
7. HERRINGTON, B. L.: *Jour. Dairy Sci.* XVII. 501. 1934.
8. SHARP, P. F., AND DOOB, H., JR.: *Jour. Dairy Sci.* XXIV. 679. 1941.
9. HUNZIKER, O. F.: *Condensed Milk and Milk Powder* IV ed. p. 486. 1926.
10. CLAUSEN, P.: *World's Dairy Congr.* II. 233. 1937.
11. MOHR, W., AND RITTERHOFF: *World's Dairy Congr.* II. 249. 1937.
12. HOLM, G. E., DEYSHER, E. F., AND EVANS, F. R.: *Jour. Dairy Sci.* VI. 556. 1923.
13. WRIGHT, N. C.: *Jour. Dairy Res.* IV. 122. 1932.
14. FONASSIEU, M.: *Bul. Soc. Chem. Biol.* V. 1923.
15. SUPPLEE, G. C., AND BELLIS, B.: *Jour. Dairy Sci.*, VIII. 39. 1925.
16. DOOB, H., JR., WILLMANN, AND SHARP, P. F.: *Ind. and Eng. Chem. Indust. Edition* 34. 1461. 1942.
17. TUCKEY, S. L., RUEHE, H. A., AND CLARK, G. L.: *Jour. Dairy Sci.* XVII. 587. 1934.
18. SUPPLEE, G. C., AND BEXBY, E. M.: *Am. Jour. Dis. of Children.* 37. 1016. 1929.
19. MACY, H.: *Jour. Dairy Sci.* XI. 516. 1928.
20. HIGGINBOTTOM, C.: *Jour. Dairy Res.* XIII. 308. 1944.
21. CROSSLEY, E. L., AND JOHNSON, W. A.: *Jour. Dairy Res.* XIII. p. 5. 1942.

22. JEPHOTT, H., HUNWICKE, R. F., AND RATCLIFFE, N.: Proc. World's Dairy Congr., Washington, D. C., II. 1248. 1923.
23. SUPPLEE, G. C., AND ASHBAUGH, V. J.: Jour. Dairy Sci. V. 216. 1922.
24. HUNWICKE, R. F., AND JEPHOTT, H.: Jour. Dairy Sci. VIII. 206. 1925.
25. NICHOLS, A. A.: Jour. Dairy Res. X. 202. 1939.
26. Association of American Feed Officials Incorporated: Official Publication p. 25. 1945.
27. HOLM, GEO. E.: Information by courtesy of personal interview. 1944.
28. Continental Can Company, Research Department: Information by courtesy of personal interview. 1944.
29. COULTER, S. T., AND JENNESS, R.: Minnesota Agr. Expt. Sta. Tech. Bul. 167. 1945.
30. HETRICK, J. H., AND TRACEY, P. H.: Jour. Dairy Sci. XXVII. 685. 1944.
31. American Can Company, Research Department: Information by courtesy of personal interview. Chicago. 1945.

## CHAPTER XLII

### THE KEEPING QUALITY OF DRIED MILK PRODUCTS

Keeping quality refers to freedom from deterioration with age. The dried milk industry, assisted by the helping hand of science and impelled by the food emergency of two gigantic world wars within a quarter of a century, has made tremendous strides in the art of preserving the palatability and prolonging the shelf life of dried milk products. This accomplishment, in turn, has made possible the record-breaking increase in annual production of whole milk powder in the United States, from 13 million pounds in 1937 to 177 million pounds in 1944.

The effect of age on the physical properties of the powder, such as free-flowing character, solubility, and color of dried milks, was discussed in Chapter XLI. The present chapter deals with the effect of age on palatability and flavor. The major aspects of the factors of flavor deterioration have already been pointed out in the chapters on manufacture of the different kinds of milk powder (see especially Chapter XXXVII). The present discussion is limited to a brief summary of the causes and prevention of individual flavor defects.

**Palatability.**—Freshly dried milk has a flavor character that is definitely attractive to the palate of normal man. Loss of palatability is usually associated with progressive disappearance of the original, pleasing fresh flavor and the gradual development of an increasingly less pleasing flavor character that is commonly recognized as stale flavor. This general decline of palatability with age is believed to be due to physico-chemical changes of the protein constituents. Our understanding of the specific reactions involved is as yet somewhat incomplete. Some of the factors most essential to the prevention of stale flavor and the preservation of the original palatability of dried milk held in storage are listed below:

1. High quality, perfectly fresh, sweet milk.
2. Approved plant sanitation (see "Plant Sanitation", Chapter XXXVII).
3. Low moisture content, preferably below 3%.
4. Air-tight moisture-proof package.
5. Low storage temperature. Room temperature or below, preferably not above 60° F.

**Rancid Flavor and Odor.**—Rancidity in milk powder resembles the sour, irritating flavor and pungent, rasping odor of butyric acid. It is the result of fat hydrolysis causing liberation of the volatile fatty acids of which butyric acid is the most prominent. Hydrolysis, producing rancidity, is due to the presence of the fat-splitting enzyme lipase. This enzyme is inherent in milk.

In addition, there are numerous micro-organisms that are capable of

secreting lipolytic enzymes in the milk. The bacterial origin of such enzymes suggests the importance of freshness, high sanitary quality and low bacterial count of the patrons' milk as a potential safeguard against the development of rancidity in milk powder. Fleming and Nair<sup>1</sup> further emphasize, on the basis of long experience, that high-acid milk taken in at the receiving platform continues to develop acidity so rapidly that milk powder dried from it has a peculiarly disagreeable acid flavor. (See also Chapter XXXI.)

Rancidity in milk powder is readily and dependably prevented by heat treatment in the process of manufacture, that will destroy or permanently inactivate the enzyme lipase. In the roller process, using the Just-Hatmaker double-drum atmospheric dryer, the heat treatment provided by the steam heated drying drums is usually ample to ensure complete destruction of the lipase present in the milk. In the case of certain single-drum, low temperature roller dryers and of the spray-drying process, the heat treatment of the drying process alone, is generally inadequate to prevent rancidity in the finished product. When using these relatively low-temperature drying systems, therefore, the heat treatment of the preheating process must be depended upon to permanently inactivate the lipase. In such case, rancidity in the milk powder is prevented with certainty by preheating at a temperature not lower than 63 to 64.5° C. (145.4 to 148.1° F.) for at least 30 minutes<sup>2</sup>, or other temperature-time combination with equal lethal effectiveness. These temperatures are not sufficiently high to insure destruction of the oxidizing enzymes that may be present in milk and that lead to tallowy flavor. (See "Tallowy Flavor" later in this chapter.) Successful prevention of rancidity by the use of suitable preheating treatment makes imperative the complete absence of leaks of raw milk into the line between preheater and dryer.

**Fishy Flavor.**—Fishy flavor is a relatively uncommon defect of dried milk. When it does occur it is usually associated with high moisture. It appears to be of somewhat variable stability. Instances have been observed of definite fishiness one day, and absence of the defect in the same sample a few days later. The specific reaction involved is not entirely clear. Lecithin hydrolysis appears the most likely cause. It was demonstrated by Supplee<sup>3</sup>, Cusick<sup>4</sup> and Sommer<sup>5</sup> that fishy flavor is the result of hydrolysis of lecithin. Sommer and Smit<sup>6</sup> showed that oxidation of the choline, which is one of the products of lecithin hydrolysis, hastens the reaction. Such oxidation is accelerated by the presence of metals (especially the salts of copper and iron), acidity, and moisture. Oxidation of the unsaturated fats in the presence of moisture and of protein substances has also been suggested as a probable cause. Reduction of the moisture content to below 3.5 per cent prevents the development of fishy flavor in dried milk.

**Tallowy Flavor.**—Tallowy milk powder has a distinct flavor that definitely suggests spoiled tallow. Tallowiness is a flavor defect of milk powder

containing milk fat. It is by far the most serious and most common flavor defect to which whole milk powder is susceptible. Its prevention during prolonged storage of the powder is, in fact, a major problem.

**Reactions that Cause Development of Tallowy Flavor.**—Tallowiness is frequently confused with rancidity. With the exception that both defects involve changes in the milk fat, the two defects are due to separate and distinctly different reactions. Rancidity deals with the presence of free fatty acids which are volatile and are the result of hydrolysis of the glycerides (fats). Tallowiness is the product of autoxidation of the fat; it is usually accompanied by bleaching. The tallowy flavor is not volatile; in steam distillation it remains in the residue.<sup>8</sup>

The development of tallowiness in milk fat was studied by Holm and Greenbank<sup>9, 10</sup>, Supplee<sup>11</sup>, Hunziker and Hosman<sup>8</sup>, Holm, Wright and Greenbank<sup>12</sup>. The results of these investigations indicate that it is especially the fatty acid radicals of the unsaturated fats, such as the oleic acid, that are involved. When oleic acid takes up oxygen, a tallowy flavor results. The absorption of exceedingly small amounts of oxygen, too small to noticeably affect the iodine absorption number, is capable of producing intense tallowiness, and there appears to be little difference in degree of tallowy taste between slightly and highly oxidized fats.

**Induction Period.**—Milk fat, when in contact with oxygen or air, passes through an initial period during which oxygen absorption, while not entirely absent, is very slow and practically imperceptible. This is called the induction period. During this period the fat remains free from tallowy flavor. As the induction period advances, the resistance of the fat to oxidation diminishes. It is believed that the induction period is accompanied by a slight absorption of oxygen and by the formation of compounds of increased oxidizing intensity. The induction period is usually followed by rapid oxygen absorption and the appearance of an intense tallowy flavor.

**Effect of Ascorbic Acid in Milk on Tallowy Flavor.**—According to Krukovsky and Guthrie,<sup>18</sup> quick complete oxidation of ascorbic acid inhibits reactions that produce tallowy flavor. Such reactions can be induced again by addition of ascorbic acid. Tallowy flavor was not promoted by added copper (0.1 p.p.m.) in the milk which was wholly depleted of its vitamin C content. Pasteurization of milk prior to forced and complete oxidation of ascorbic acid, or pasteurization after such oxidation, results either in complete destruction of the vitamin C content or in retention of dehydroascorbic acid only. Promotion of tallowy flavor due to added copper (0.1 p.p.m.) in the presence of dehydroascorbic acid is much less effective as compared with that in milk containing ascorbic acid. Partial oxidation of ascorbic acid in milk, prior to storage in the dark, stimulates the development of tallowy flavor; its complete oxidation prevents the development.

**Prevention of Tallowy Flavor.**—The major factors that are involved in the prevention of tallowy flavor in whole milk powder were discussed in Chapter XXXVII. Because of their importance they are briefly summarized in the present chapter.

1. **Use Fresh, Sweet Milk Only.** Use perfectly fresh, sweet milk of high quality as determined by rigid platform inspection and suitable platform tests. Developed acidity renders the fluid milk unfit for drying purposes.

Holm and Greenbank<sup>10</sup> concluded from their study of butter fat, that acidity perhaps plays a greater part in oxidation than any other one factor. They hold that the resistance of a powder to oxidation increases with the ability of the process to remove acids, and suggest that herein may lie the fundamental reason for the greater resistance to oxidation of drum dried powder.

2. **Avoid Contact of Milk with Copper or Iron.** Eliminate copper, iron, and copper alloys such as white metal, Ambrac and other alloys containing copper, from the milk side of all equipment throughout the factory. Presence of these metals induces fat oxidation accompanied by tallowy flavor.

3. **Keep Equipment In Sanitary Condition.** Maintain the milk side of all equipment in sanitary condition by scrupulous cleaning and sterilizing after each day's work. In continuous operation (around the clock), equipment should be shut down for a thorough cleaning at least every 9 hours.

4. **Centrifuge the Milk.** Centrifugal clarification of the fresh milk improves the keeping quality of milk powder. This is attributed to removal of some of the lecithin and perhaps other pro-oxidant substances that are contained in the "slime" of the centrifuge bowl. For best results clarification should occur as soon as possible upon arrival of the milk at the factory.

5. **Preheat Preferably by High-Short Heat Treatment.** Use of the high-temperature, short-time method of preheating has proven helpful in minimizing the tendency to oxidation and tallowiness. Quick heating, short holding at temperatures sufficiently high to destroy all oxidizing enzymes, followed by quick cooling, appears to assist in the destruction of pro-oxidant substances and to promote the development and activity of protective antioxidants. The results of Greenbank et al<sup>16</sup> and those of Lea et al<sup>13</sup> suggest that, for preheating temperatures below the boiling point, a range of 190 to 194° F. and from 3 to 5 minutes, is the most effective temperature-time ratio to retard tallowiness without causing objectionably pronounced cooked flavor, or seriously jeopardizing color and solubility. (See Chapter XXXVII.)

6. **Precondense to Concentration of 4:1.** Precondensing of a milk definitely improves the keeping quality of whole milk powder. Holm et al<sup>14</sup> suggest that this improvement may be due to the extra heat treatment causing the removal of the volatile substances, and perhaps of substances



which act as catalyzers of the oxidation. There may also be involved a purely physical effect relative to the fact that precondensing, especially to the high concentration commonly used (about 4:1), yields a larger particle size. This reduces the surface area per unit of powder that is available to absorption of oxygen, and it may facilitate the collapse of the air cells during vacuumizing, causing them to surrender more readily their occluded oxygen.

**7. Remove Powder From Drying Chamber Promptly.** Prompt removal of finished product from hot drying chamber assists in retarding appearance of tallowy flavor. Prolonged exposure of the finished powder to the heated air currents encourages oiling-off. The fat thus becomes the continuous phase. In this phase it covers the surface of the dried milk particles. This exposes it to the intense oxidizing influences of air and light. However, cooling to low temperatures should be avoided because cold powder has been found to retain more oxygen in gas-packing than uncooled powder. See Chapter XXXVII, under "Packaging of Whole Milk Powder."

**8. Gas-Packing Helps to Prevent Tallowiness.** According to Holm,<sup>17</sup> preliminary results indicate that the rate of autoxidation of the fat is inversely proportional to the oxygen concentration. Vacuumizing and gas-packing to the extent of reducing the oxygen content of the air space in the can to 3 per cent or less per gram of powder greatly improves the keeping quality of dried whole milk in storage. Lea, Moran and Smith<sup>18</sup> studied the effect of different concentrations of oxygen in vacuumized, gas-packed cans on the development of tallowy flavor in whole milk powder stored at different temperatures. They reported that in powder containing 0.01 ml/g of oxygen (means 1% of oxygen in the free-space gas of the can per gram of powder after completion of desorption) of spray-process powder of average density, or 0.005 ml/g of oxygen (means 0.5% of oxygen in the free-space gas of the can per gram) of roller-process powder of average density, tallowiness was never definitely detected in storage. Powder containing 2% oxygen weathered storage at 59° F. just as well, and it stayed good in storage at 98° F., but it showed a distinguishable change in character. .

Lea et al considered gas-packing of spray-process powder at 3% oxygen satisfactory for commercial pack. They concluded that it should be possible to store whole milk powder under these conditions for several years at 59° F., but that lower concentrations of oxygen were desirable at higher storage temperatures. Additional tests by the same investigators, in which whole milk powders were stored in nitrogen containing various concentrations of oxygen at 37 and 47° C. (98 and 116° F.), confirmed their previous findings that an inert gas containing not more than 0.5 to 1.0% of oxygen per gram powder, should prevent the development of recognizable tallowy flavor for an indefinite time, while nitrogen containing as much

as 3 to 6% oxygen should still have a marked effect in retarding the development of tallowiness.

Preliminary results by Holm<sup>17</sup> also demonstrated that infinite keeping quality is reached before the oxygen concentration has dropped to zero. For one particular milk used this was about 1.33%. Holm pointed out that this occurrence (infinite keeping quality in the presence of oxygen) means that a certain amount of oxygen is taken up by the skim milk solids and is not available for oxidation of the fat.

**9. Low Moisture Content Is Essential.** There is an optimum moisture content for maximum resistance to oxidation and tallowy flavor. Holm and Greenbank<sup>9</sup> demonstrated that, insofar as this defect is controlled by the factor of humidity, there is an optimum content of moisture for preventing tallowiness. They further found that the point of optimum percentage of moisture varies with the process of drying, and that it is approximately 1.88 per cent for spray powder and approximately 3 per cent for drum-dried powder.

**10. Freeze Drying Process Eliminates Oxygen.**—As indicated in Chapter XXXIV on "Milk Drying Systems," milk powder made by use of the Freeze Drying Process is practically devoid of any oxygen and, therefore, promises to resist oxidation almost indefinitely. Because the development of this process is of very recent date, results as to the keeping quality of the powder during long storage are not as yet available.

**Effect of Addition of Sucrose on Keeping Quality.**—Sucrose improves quality of milk powder. Vacuum roller process powder, containing 13.7 per cent fat and 14.24 per cent sucrose, did not show the slightest manifestation of tallowiness or other flavor defect when kept by the author in a tin for three years. The seal had been broken for sampling at the beginning of the storage period and the sample was kept at room temperature (ranging from 45 to 95° F.) for three years.

Samples of spray-dried milk powder, designated dehydrated sweetened condensed milk, containing 15 per cent milk fat, 57 per cent MSNF, and 25 per cent sucrose, which have now been held for 18 months, are retaining their fresh flavor perfectly. These samples are being held in glass jars with screw top cap, without protection from air, light, and summer heat. The jars have been opened so often for sampling that they are now only half full. The powder has therefore been exposed to an increasingly deep air space in the top of the jars.

**Effect of Storage Temperature on Keeping Quality.**—High storage temperatures are detrimental to keeping quality. They tend to promote, hasten and intensify the development of every type of flavor defect discussed in this chapter. The flavor deteriorating effect of high temperature storage is most effectively minimized by low oxygen concentration, see preceding paragraph (8), "Gas-Packing Helps to Prevent Tallowiness."

## REFERENCES

1. FLEMING, R. S., AND NAIR, J. H.: Jour. Dairy Sci. IV. 2. 1921.
2. NAIR, J. H.: Ind. and Eng. Chem. XXII. 42. 1930.
3. SUPPLEE, G. C.: Cornell Univ. Agr. Expt. Sta. Memoir 29. 1919.
4. CUSICK, J. T.: Cornell Univ. Agr. Expt. Sta. Memoir 30. 1920.
5. SOMMER, H. H.: Proc. World's Dairy Cong. Washington, D. C. II. 974. 1923.
6. SOMMER, H. H., AND SMIT, B. J.: Wis. Agr. Expt. Sta. Res. Bul. 57. 1923.
7. DAVIES, W. L., AND GILL, E.: Jour. Soc. Chem. Ind. London 55. 141 T. 1936.
8. HUNZIKER, O. F., AND HOSMAN, D. FAY: Jour. Dairy Sci. I. 320. 1917.
9. HOLM, G. E., AND GREENBANK, G. R.: Proc. World's Dairy Cong. II. 1253. 1923.
10. HOLM, G. E., AND GREENBANK, G. R.: Associates of Rogers. Fundamentals of Dairy Sci. 2nd ed. III. 71. 1935.
11. SUPPLE, G. C.: Proc. World's Dairy Cong. II. 1248, 1923.
12. HOLM, G. E., WRIGHT, P. A., AND GREENBANK, G. R.: Jour. Dairy Sci. X. 33. 1927.
13. LEA, C. H., MORAN, T., AND SMITH, J. A. B.: Jour. Dairy Res. XIII. 162. 1943.
14. HOLM, G. E., GREENBANK, G. R., AND DEYSHER, E. F.: Jour. Dairy Sci. VIII. 515. 1925.
15. HOLM, G. E., GREENBANK, G. R., AND DEYSHER, E. F.: Jour. Dairy Sci. IX. 512. 1926.
16. GREENBANK, G. R., WRIGHT, P. A., DEYSHER, E. F., AND HOLM, G. E.: Proc. 39th Ann. Meet. Am. Dairy Sci. Asso. 1944.
17. HOLM, G. E.: Unpublished data by correspondence. October 1945.
18. KRUKOVSKY, V. N., AND GUTHRIE, E. S.: Jour. Dairy Sci. XXVIII. 565. 1945.

## CHAPTER XLIII

### MARKETS

#### USES OF DRIED MILK PRODUCTS

Dried milk is intended to serve every purpose for which fluid milk is used. The purpose of drying milk and milk by-products is to preserve the valuable food nutrients they contain in as nearly an unchanged and natural condition as possible, and to make them available, at all seasons of the year and in all parts of the world, without damaging depreciation of their food value and marketable properties, and at minimum cost of transportation and storage.

It is, in short, to better economize, more efficiently utilize, and more widely distribute the product of the dairy cow, so as to increase the returns to the producer, make production and manufacture more profitable, provide the consumer with low-cost, high-quality food nutrients, and improve the diet habit and physical well being of the human family.

**Dried Whole Milk.**—It was shown in Chapter XXXIII that up to about a decade ago the annual production of whole milk powder was relatively small and had assumed a more or less static status. Similarly, the market for the product was limited. This static condition of both supply and demand was largely the result of the uncertain keeping quality of dried whole milk. Some of the product that reached the market had failed to hold up, causing lack of confidence in its keeping quality on the part of the trade.

Necessity, the mother of invention, born of the food emergency of World War II, provided the incentive for renewed effort to make keeping quality of whole milk powder a commercial reality. The efforts of scientific research of the past decade have provided improvements in heat treatment of fluid milk, drying operations, control of composition, and in packaging of the finished product, that make possible the economically practicable manufacture of whole milk powder that will keep for several years without damaging flavor deterioration, and without objectionable discoloration and loss of solubility, even under tropical conditions of storage. These whole milk powders are readily reconverted to a palatable table milk by the addition of water at ordinary temperature.

This accomplishment means that the babies and growing children, as well as the adult population, in every region of this urban planet may have access to high quality fresh whole milk in the form of properly reconstituted whole milk powder. The medical profession recognizes the superiority of dried whole milk as a substitute for fluid milk, when the latter is unavailable, or as a supplement to the diet, for use as infant food, and in hospitals and sanitariums, particularly in tropical countries and other regions.

In addition, whole milk powder is an ever ready convenience in the household of the family for all culinary purposes where milk is needed. There is room for large quantities of whole milk powder also in the manufacture of milk chocolate, the milk fat being an essential component upon which milk chocolate depends for its smoothness of texture and superior flavor. The market of dried whole milk extends also to all other prepared foods in which milk fat and milk solids are desired. The potential markets for whole milk powder that will keep, thus are practically unlimited.

**Dried Skimmilk.**—It is estimated that the manufacture of creamery butter in the United States yields annually approximately 20 billion pounds of fluid skimmilk. Formerly the chief channel of disposition consisted of its return to the farm as feed for the young stock and poultry. This market of the bulky skimmilk, within economically practicable hauling distance, was limited and inadequate, resulting annually in a large surplus, and the returns were far below the true nutritional value of skimmilk solids. The same was true also of the returns from the limited volume of skimmilk utilized for industrial casein.

**Utilization of Dried Skimmilk for Human Nutrition.**—The high quality food nutrients represented by the milk proteins, carbohydrates (milk sugar), milk minerals and milk vitamins are needed for human nutrition. Their natural mission is to improve the diet of the human family.

In pre-milk powder days, a small fraction only of the skimmilk surplus reached the table of the consumer. Its use in the form of human food items was confined mainly to skimmilk cheese (cured), cottage cheese, and condensed skimmilk (sweetened and unsweetened). All of these outlets combined, including use for human consumption, animal feed and industrial purposes, still left annually a vast surplus, much of which was wasted or totally lost. The advent of milk drying has made possible the profitable utilization of this surplus of valuable milk nutrients. As shown in the "Introduction," over 12 billion pounds of factory separated skimmilk was utilized in the manufacture of skimmilk products in the United States in 1944. It has brought skimmilk into its own. Its accessibility in dry form brings it within reach of the consumer everywhere, and all surplus over and above requirements of the human family is readily converted into animal feed and marketed through the feed mill.

**Dried Skimmilk in the Baking Industry.**—By far, the largest single user of dried skimmilk is the baker of bread. He has found the use of dried milk in bread, to the extent of six pounds of dried skimmilk for every 100 pounds of flour, desirable and advantageous. The use of dried skimmilk supplements the nutritive elements of wheat flour, by high-quality and highly digestible milk solids containing the muscle building proteins, the energy creating milk sugar, and the invaluable lime, phosphorus and other essential food minerals contained in milk. It also increases the vitamin content of bread.

Aside from actually making the "Staff of Life" more nutritious, more wholesome and a more completely balanced food, dried skimmilk, when added to the flour at the rate of about six per cent, increases the weight of the loaf about six per cent and the size of the loaf about 12 to 15 per cent. It augments the water holding and retaining ability of the loaf and thereby keeps it fresh longer. It improves the appearance and palatability of the loaf, and thus stimulates consumption.

Marx and McDuffee,<sup>15</sup> in charge of the Bakery Division of the American Dry Milk Institute, made a comprehensive study of the actual and potential consumption of dried skimmilk in the Baking Industry of the United States. Using the census figures of pounds of bread made and of the dollar value of the same for 1939, they determined the price per pound, which was about 7 cents. From the census figures on pies, doughnuts, cakes, cookies and pastries, they found the price of this type of bakery goods to be about 25 cents per pound. From these computations they were able to estimate the poundage of the two groups of bakery goods to be approximately  $\frac{7}{8}$  and  $\frac{1}{8}$  for bread and for pastry goods, respectively. Estimating the increase in the volume of dried skimmilk used in the baking industry in 1941 yielded in round figures a total of 200,000,000 pounds which, divided on the basis of  $\frac{7}{8}$  and  $\frac{1}{8}$ , respectively, yielded roughly 175,000,000 pounds of dried skimmilk for bread and 25,000,000 pounds for pastry goods, used in the baking industry in 1941.

The figures for potential volume of consumption of dried skimmilk in the baking industry were estimated on the products basis. This yielded the following dried skimmilk potential:

in Bread .....	420,000,000 lbs.
“ Cakes .....	30,502,219 “
“ Cookies .....	4,479,456 “
“ Doughnuts .....	10,582,586 “
Total potential consumption of dried skimmilk in bakery goods .....	465,564,261 lbs.

The summary comparison between actual and potential consumption of dried skimmilk in the baking industry given in Table 70-A suggests that the potential capacity of bakery goods for utilizing dried skimmilk is of a magnitude capable of more than doubling its present annual consumption without danger of excessive proportion of milk constituents in bakery goods.

**Federal Definition and Standard for Milk Bread.**—The Definitions and Standards of the U.S. Federal Food and Drug Administration<sup>1</sup> make the use of milk or milk product optional for such breads as white bread, whole wheat bread, graham bread, raisin bread and Boston brown bread. For "milk bread" the Federal Definition and Standard is as follows:

"4. Milk Bread. The product in the form of loaves or smaller units,

obtained by baking a leavened and kneaded mixture of flour, salt, yeast, and milk or its equivalent (milk solids and water in the proportion normal to milk) with or without edible fat or oil, sugar and/or other fermentable carbohydrate substance. It may also contain diastatic and/or proteolytic ferments and such minute amounts of unobjectionable salts as serve solely as yeast nutrients. The flour ingredient may include not more than 3 per cent of other edible farinaceous substance. Milk bread contains, one hour or more after baking, not more than 38 per cent of moisture."

TABLE 70-A—VOLUME OF DRIED SKIMMILK ACTUALLY USED IN BAKERY GOODS IN THE UNITED STATES IN 1941 AND POTENTIAL CONSUMPTION OF DRIED SKIMMILK IN THE BAKING INDUSTRY IN 1942. ESTIMATED BY MARX AND MCDUFFEE<sup>15</sup>

Class of Products	Dried Skimmilk in Bakery Goods in 1941	
	Estimated Actual Volume Used	Potential Annual Volume
In bread**	pounds 175,000,000	pounds 420,000,000
In pastry***	25,000,000	45,000,000
Total	200,000,000	465,000,000

\*\*Includes white bread, whole wheat bread and rye bread.

\*\*\*Includes cakes, cookies and doughnuts.

**Other Prepared Foods Containing Dried Skimmilk.**—Dried skimmilk reaches the table of the consumer in the form of a great variety of prepared foods other than milk bread. Some of the food factories that are absorbing sizable quantities of dried skimmilk in their products are: the cake bakery, confectionery, the milk chocolate factory, plants making ice cream, ice milk, candy and caramels, plants making puddings, custards, wafers, waffles, pancakes, muffins and Danish pastry, also factories engaged in the preparation and packing of soups, sausages and meat loaves.

**Dried Buttermilk.**—Buttermilk powder, like skimmilk powder, is made in form for human consumption as well as for animal feed. The product utilized for human nutrition is largely all made from sweet-cream buttermilk and from buttermilk derived from sweet cream that was ripened usually by the use of mixed butter cultures made up of lactic acid bacteria and aroma bacteria. The product marketed as animal feed is largely that made from the buttermilk of cream that arrived at the creamery in sour condition.

Dried buttermilk, whether made for human consumption or for animal feed, is nutritionally even more valuable than dried skimmilk. It contains more milk fat than dried skimmilk. (Dried buttermilk contains about 5.0 and dried skimmilk about 1.0 per cent of fat.) This in itself adds a highly valuable food nutrient and makes the dried buttermilk a

better balanced food. Also, the lecithin and other important nitrogenous substances associated with the surface layer of the fat globules pass into the buttermilk during the churning process and are, therefore, contained in the buttermilk powder.

By reason of the appreciable fat content of dried buttermilk, this product also contains the nutritionally important fat-soluble vitamins, such as vitamins A, D, E, and K; the water-soluble vitamin choline, which is a product of lecithin hydrolysis. Dried buttermilk has also been found to be about twice as rich in the water-soluble vitamin B<sub>2</sub> (riboflavin).<sup>2</sup> In the case of ripened sweet-cream and of sour-cream buttermilk, the high lactic acid concentration is nutritionally advantageous as a tonic, and yields products of superior quality in baking.

**Dried Buttermilk for Human Nutrition.**—When reconstituted to normal fluid concentration, both ripened and sweet-cream buttermilk powder provide a highly palatable, refreshing, nutritious and easily digested milk drink. In the home kitchen, dried buttermilk lends itself advantageously to griddle cakes and buckwheat cakes. In the baking industry its baking properties in bread and crackers are superior. Dried buttermilk made from sweet-cream buttermilk has recently been reported by Thomas and Combs<sup>3</sup> as an excellent source of non-fat milk solids for ice cream.

Due to the increasing appreciation of the superior nutritive value of buttermilk and the apparent gradual trend back to the whole milk creamery, a definite increase may be expected in the future production in this country of dried buttermilk for channels of human nutrition.

**Dried Buttermilk for Animal Feed.**—The dried-buttermilk made in this country from buttermilk churned from cream that arrives at the creamery in sour condition (centralizer cream) is used almost exclusively for animal feed. Some of it is returned direct to the farms where it becomes a part of the feed ration for pigs, hogs, young chicks and laying hens. The bulk of dried sour-cream buttermilk, however, goes to the stock feed mill.

Dried sour-cream buttermilk appears to be relished by beast and fowl. It is readily digested and its lactic acidity acts as a tonic, purging the colon of toxic products and keeping the livestock in healthy condition. It accelerates the animal's power of digestion and assimilation of other feeds in the ration. It thus augments the economy of these feeds and stimulates the animal's capacity for the consumption of feed and water. Heuser<sup>4</sup> reports: "We have used the skimmilk powder and the buttermilk powder for laying hens and for chick feeding but not for fattening. In both the young and the mature stock, we have obtained better results from the buttermilk product."

**Dried Whey.**—Dried whey contains many of the important food nutrients of milk. While deficient in milk fat (less than 1.0%), it is high in lactose (about 70%), and in milk ash (about 9.0%). Its protein content (about 13.0%) consists principally of lactalbumin which contains the



essential amino acids in proper proportion to sustain normal growth. It is water-soluble and not coagulated by rennet. According to Price, Bohstedt and Rupel,<sup>5</sup> the high lactose content of dried whey aids in the assimilation of calcium. By reason of its very low fat content, whey powder is deficient in fat-soluble vitamins, although it has been reported to contain small amounts of vitamins A, D, and E. It appears to contain vitamin B<sub>1</sub> and B<sub>2</sub> in considerable amounts. It is also reported to contain small amounts of the grass juice factor.<sup>6</sup>

During the early days of whey drying practically all of the whey powder produced was converted into stockfeed disposed of via feed mill. Being rich in readily digestible carbohydrates (milk sugar), as well as the valuable minerals and water-soluble vitamins of milk, whey powder lends itself admirably for milling with protein-rich concentrates such as distillery slops, fish meal, wheat bran and the like.

**Animal Feeding Experiments with Dried Whey.**—Thus Hathaway<sup>7</sup> and co-workers conducted feeding experiments in which dried whey constituted a part of the ration fed to 50 Grade Holstein calves. The authors concluded that healthy, vigorous dairy calves can be satisfactorily raised from three weeks to six months of age on as little as 50 pounds of skim-milk if it is properly supplemented with dried whey, blood meal, alfalfa hay, a grain mixture and a vitamin concentrate. They point out that dried whey with blood meal can thus be utilized as a means of diverting milk used for calf feeding to human food and other uses.

Nevens and Kuhlman<sup>8</sup> mixed whey powder with alfalfa at the time of ensiling at the ratios of 1, 2, 3, 4 and 5 per cent, respectively, of the weights of alfalfa. They report that the whey powder caused an increase of acid in the silage over alfalfa alone. In most cases the larger amounts of whey powder produced more acid in the silage. The whey powder proved to be the most effective of the preservatives used in causing an increase in the acid content. Price et al<sup>6</sup> likewise recommend the use of whey solids as a substitute for mineral acids or molasses in making grass silage.

The results of extensive trials with fattening pigs and growing dairy heifers by Büniger<sup>9</sup> et al, indicate that small quantities of dried whey (not over 0.5 kilo per head daily), mixed with other concentrates constitute a satisfactory feed for these classes of livestock. The feeding of dried whey resulted in increased water consumption. The carcasses of pigs that had been fed dried whey were normal. The nutritive effect proved similar to that of the feed grains, i.e., barley.

**Dried Whey for Human Nutrition.**—Whey powder is also increasingly used as human food. It has definite merit for medicinal purposes and in baby foods. Its use in other dairy products and in prepared foods is increasing. Templeton and Sommer<sup>10, 11</sup> found the use of whey powder

in cheese spread satisfactory. They suggest the addition of a minimum of 10 parts of dry whey to 90 parts of cheese spread of prescribed composition. They point out that the whey powder tends to give a weaker body to cheese spread, but it also imparts a rather distinctive sweetness pleasing to some consumers.

Webb and Ramsdell<sup>12</sup> urge the utilization of the unique properties of whey solids. They point out that the lack of casein is a deficiency which has proved a distinct advantage in the preparation of certain types of food products. Whey powder has been successfully used in canned soups; there is less difficulty with coagulation than is the case with skim milk solids. It assists in retaining the natural color of the soup better and imparts a characteristic milk flavor. On account of only slight coagulation, whey powder is also well suited in combination with acid foods. In a further report<sup>13</sup> these investigators recommend the use of whey powder in cream soups, tomato juice, fruit cream whips and ice cream mix. Specific formula are given for the making of these products made up with whey powder.

Webb<sup>14</sup> calls attention to the promising outlet for whey powder in the candy industry; the whey protein being valuable in candy as an improver of body and flavor, and the lactose being a desirable substitute for sucrose, as it pleasantly decreases the sweetness of the ordinary confection.

**Annual Production of Dried Whey in the United States.**—Official statistical records of the annual production of dried whey in the United States started with the year 1937, although a limited volume of this product had been manufactured for several years prior. The production for that year was 66 million pounds, and by 1942 the annual production had doubled. For detailed figures of annual production see Table 59, in Chapter XXXIII.

**Malted Milk.**—Malted milk is placed upon the market in several forms. The original form in which the great bulk of malted milk reaches the market is the powdered malted milk packed in containers of different sizes from one pound upward. In this form it is packed for family use, soda fountain service, hospitals and diverse confectioner purposes. In the powder form it is very hygroscopic. Unless kept in a closed container it will absorb moisture from the air rapidly and become moist and sticky.

Later, malted milk tablets appeared on the market, further extending the use of this product. Their compressed and more compact character makes the product somewhat less hygroscopic. The tablet form thus lends itself for use under conditions where exposure to the atmosphere is unavoidable. They are not completely immune to atmospheric humidity, however, and are preferably kept under cover too.

Another malted milk product that has become very popular is the chocolate-coated malted milk bar, such as Bunte's "Malteser". Aside from a variety of similar confections with malted milk as the base, choco-

essential amino acids in proper proportion to sustain normal growth. It is water-soluble and not coagulated by rennet. According to Price, Bohstedt and Rupel,<sup>5</sup> the high lactose content of dried whey aids in the assimilation of calcium. By reason of its very low fat content, whey powder is deficient in fat-soluble vitamins, although it has been reported to contain small amounts of vitamins A, D, and E. It appears to contain vitamin B<sub>1</sub> and B<sub>2</sub> in considerable amounts. It is also reported to contain small amounts of the grass juice factor.<sup>6</sup>

During the early days of whey drying practically all of the whey powder produced was converted into stockfeed disposed of via feed mill. Being rich in readily digestible carbohydrates (milk sugar), as well as the valuable minerals and water-soluble vitamins of milk, whey powder lends itself admirably for milling with protein-rich concentrates such as distillery slops, fish meal, wheat bran and the like.

**Animal Feeding Experiments with Dried Whey.**—Thus Hathaway<sup>7</sup> and co-workers conducted feeding experiments in which dried whey constituted a part of the ration fed to 50 Grade Holstein calves. The authors concluded that healthy, vigorous dairy calves can be satisfactorily raised from three weeks to six months of age on as little as 50 pounds of skim-milk if it is properly supplemented with dried whey, blood meal, alfalfa hay, a grain mixture and a vitamin concentrate. They point out that dried whey with blood meal can thus be utilized as a means of diverting milk used for calf feeding to human food and other uses.

Nevens and Kuhlman<sup>8</sup> mixed whey powder with alfalfa at the time of ensiling at the ratios of 1, 2, 3, 4 and 5 per cent, respectively, of the weights of alfalfa. They report that the whey powder caused an increase of acid in the silage over alfalfa alone. In most cases the larger amounts of whey powder produced more acid in the silage. The whey powder proved to be the most effective of the preservatives used in causing an increase in the acid content. Price et al<sup>6</sup> likewise recommend the use of whey solids as a substitute for mineral acids or molasses in making grass silage.

The results of extensive trials with fattening pigs and growing dairy heifers by Büniger<sup>9</sup> et al, indicate that small quantities of dried whey (not over 0.5 kilo per head daily), mixed with other concentrates constitute a satisfactory feed for these classes of livestock. The feeding of dried whey resulted in increased water consumption. The carcasses of pigs that had been fed dried whey were normal. The nutritive effect proved similar to that of the feed grains, i.e., barley.

**Dried Whey for Human Nutrition.**—Whey powder is also increasingly used as human food. It has definite merit for medicinal purposes and in baby foods. Its use in other dairy products and in prepared foods is increasing. Templeton and Sommer<sup>10, 11</sup> found the use of whey powder

in cheese spread satisfactory. They suggest the addition of a minimum of 10 parts of dry whey to 90 parts of cheese spread of prescribed composition. They point out that the whey powder tends to give a weaker body to cheese spread, but it also imparts a rather distinctive sweetness pleasing to some consumers.

Webb and Ramsdell<sup>12</sup> urge the utilization of the unique properties of whey solids. They point out that the lack of casein is a deficiency which has proved a distinct advantage in the preparation of certain types of food products. Whey powder has been successfully used in canned soups; there is less difficulty with coagulation than is the case with skim milk solids. It assists in retaining the natural color of the soup better and imparts a characteristic milk flavor. On account of only slight coagulation, whey powder is also well suited in combination with acid foods. In a further report<sup>13</sup> these investigators recommend the use of whey powder in cream soups, tomato juice, fruit cream whips and ice cream mix. Specific formula are given for the making of these products made up with whey powder.

Webb<sup>14</sup> calls attention to the promising outlet for whey powder in the candy industry; the whey protein being valuable in candy as an improver of body and flavor, and the lactose being a desirable substitute for sucrose, as it pleasantly decreases the sweetness of the ordinary confection.

**Annual Production of Dried Whey in the United States.**—Official statistical records of the annual production of dried whey in the United States started with the year 1937, although a limited volume of this product had been manufactured for several years prior. The production for that year was 66 million pounds, and by 1942 the annual production had doubled. For detailed figures of annual production see Table 59, in Chapter XXXIII.

**Malted Milk.**—Malted milk is placed upon the market in several forms. The original form in which the great bulk of malted milk reaches the market is the powdered malted milk packed in containers of different sizes from one pound upward. In this form it is packed for family use, soda fountain service, hospitals and diverse confectioner purposes. In the powder form it is very hygroscopic. Unless kept in a closed container it will absorb moisture from the air rapidly and become moist and sticky.

Later, malted milk tablets appeared on the market, further extending the use of this product. Their compressed and more compact character makes the product somewhat less hygroscopic. The tablet form thus lends itself for use under conditions where exposure to the atmosphere is unavoidable. They are not completely immune to atmospheric humidity, however, and are preferably kept under cover too.

Another malted milk product that has become very popular is the chocolate-coated malted milk bar, such as Bunte's "Malteser". Aside from a variety of similar confections with malted milk as the base, choco-

late malted milk, as such, has become a popular malted milk derivative. This is made by adding chocolate to the malted milk syrup in the drying pan, at the approximate ratio of one pound of chocolate to 31 pounds of malted milk syrup. The mixture is then dried as described in Chapter XL. Malted milk has also been found useful in bread making.

Its ready digestibility, high nutritive value, dietetic virtues, health-protective properties, and outstanding palatability render it most valuable as a wholesome food for infants and invalids, and its compactness and dependable keeping quality facilitate its transportation to all parts of the globe.

**Annual Production of Malted Milk.**—The annual production of malted milk is given in Table 59, Chapter XXXIII. The table shows that during the period 1916-1940 the annual output stayed fairly uniform within the approximate range of 11 and 22 million pounds, averaging about 18 million pounds per year. Beginning with 1941, it started to climb, and in 1943 it had increased to 49 million pounds.

**Market Price of Dried Milk Products.**—Table 70-B shows the manufacturers' wholesale selling price of the major dried milk products in the

TABLE 70-B.—MANUFACTURERS' WHOLESALE SELLING PRICES OF  
DRIED MILKS IN THE UNITED STATES  
ANNUAL AVERAGE PRICES PER POUND 1934-1944 INCLUSIVE \*

Year	Dried Whole Milk	Dried Skimmilk		Dried Buttermilk
		Human Consumption	Animal Feed	
	cents	cents	cents	cents
1934	14 30	**	**	4 28
1935	15 69	6 65	4 47	4 64
1936	18 23	8 73	7 14	7 05
1937	17 98	7 65	5 12	5 37
1938	15.57	5 47	3 74	4 16
1939	15 10	6 12	4 94	5 34
1940	16 04	6 87	4 58	5 38
1941	19.86	9 00	6 17	6 76
1942	26 00	12 94	8 10	9 63
1943	32 76	13 81	8 74	10 86
1944	36 48	14 26	8 62	11 21

\*Farm Production, Disposition and Income from Milk, 1943-44. U. S. Dept. Agr. 1945.

\*\*Figures not available.

United States from 1934 to 1944, inclusive. The figures represent the twelve months' average for each calendar year given.

#### REFERENCES

1. Definitions and Standards for Food Products. Federal Pure Food and Drug Administration, U. S. Dept. Agr. F. D. No. 2. 1936.
2. SHARP, P. F., AND HAND, D. B.: Proc. 1st Food Confer. Inst. Food Tech. p. 139. 1940.
3. THOMAS, E. L., AND COMBS, W. B.: Jour. Dairy Sci. XXVII, 419. 1944.

4. HEUSER, G. F.: Information by correspondence. 1925.
5. PRICE, W. V., BOHSTEDT, G., AND RUPEL, I. W.: *Nat. Butter & Cheese Jour.* 66. June 1943.
6. RANDALL, S. B., SOBER, H. A., AND KOHLER, G. O.: *Jour. Nutr.* 20. 459 1940.
7. HATHAWAY, I. L., TRIMBERGER, G. W., AND DAVIS, H. P.: *Nebr. Agr. Expt. Sta. Res. Bul.* 132 1943.
8. NEVENS, W. B., AND KUHLMAN, A. F.: *Jour. Dairy Sci.* XIX. 611. 1936.
9. BUNGER: *Proc. XI. World's Dairy Cong.* I. 258. 1937.
10. TEMPLETON, H. L., AND SOMMER, H. H.: *Jour. Dairy Sci.* XV. 147. 1932.
11. TEMPLETON, H. L., AND SOMMER, H. H.: *Jour. Dairy Sci.* XVII. 373. 1934.
12. WEBB, B. H., AND RAMSDELL, G. A.: *Jour. Dairy Sci.* XIX. 502. 1936.
13. WEBB, B. H., AND RAMSDELL, G. A.: *Bur. Dairy Ind. U. S. Dept. Agr. Report.* October 1936.
14. WEBB, B. H.: *Jour. Dairy Sci.* XXI. 156. 1938.
15. MARX, V. E., AND McDUFFEE, C. A.: *Bakery Division, American Dry Milk Institute.* December 16, 1942

## CHAPTER XLIV

### VITAMINS IN MILK AND MILK PRODUCTS

**Importance.**—Extensive feeding experiments have shown that food rations containing, in proper proportion, adequate amounts of proteins, carbohydrates, fats and mineral constituents, fail to sustain life very long. It is now known that before complete growth can occur in the young, for prolonged maintenance, for the prevention of certain diseases, and for the enjoyment of “buoyant” or “vibrant” good health, the diet must also contain certain accessory substances now commonly known as vitamins.<sup>3</sup> The present discussion of vitamins is limited primarily to vitamins that are associated with milk and milk products.

**Definition.**—Rosenberg<sup>1</sup> defines vitamins as follows:

“Vitamins are organic compounds which are required for the normal growth and maintenance of life of animals, including man, who, as a rule, are unable to synthesize these compounds by anabolic processes that are independent of environment other than air, and which compounds are effective in small amounts, do not furnish energy and are not utilized as building units for the structure of the organism, but are essential for the transformation of energy and for the regulation of the metabolism of structural units.”

**Discovery of Vitamins.**—A brief history of the discovery of vitamins is listed in chronological order in Rosenberg’s “Chemistry and Physiology of the Vitamins”. Certain pathological conditions, such as night blindness, and the diseases of rickets in children, scurvy, beriberi, had been traced to nutritional deficiencies as far back as the physicians of ancient Greece, Rome, the Arabs, and even to the Egyptians and the Chinese<sup>2</sup> many centuries before the Christian era. But systematic research that has revealed the need and the sources of these important accessory substances commenced as late as the first decade of the present century. It is interesting here to note the discovery by Hopkins (1906-1912) of milk as a source of what he designated accessory substances. He experimented with rats which were fed a diet of purified proteins, carbohydrates, fats, minerals and water. The rats failed to thrive but the addition to the ration of even exceedingly small amounts of milk resulted in growth.

**Determination of Vitamin Values of Foods.**—In the past the only reasonably accurate means of evaluating the vitamin potency of different foods has been the bio-assay method. This has proven an essentially cumbersome, time consuming and expensive method. The rapidly increasing knowledge of the chemistry of vitamins, and the perfection of methods for their isolation in pure form, are paving the way to the establishment of dependable chemical and physical tests for the determination of the vitamin potency of food substances and diets.

**Classification of Vitamins.**—Since the early days of McCollum and Davis, and Osborne and Mendel the vitamins have been divided into two general groups, namely, (1) those that are fat-soluble, and (2) those that are water-soluble. The fat-soluble group embraces vitamins A, D, E, and K. The remainder of the identified vitamins belong to the water-soluble vitamins. The major identified vitamins are listed in Table 71. For daily vitamin requirements for different age groups see Table 71-A.

TABLE 71.—LIST OF IDENTIFIED VITAMINS ASSEMBLED FROM DATA BY ROSENBERG<sup>1</sup> AND U.S.D.A. YEARBOOK FOR 1939<sup>2</sup>

Vitamin	Name	Relative Amount Present in Milk*
Vitamins A	Axerophthols	XX
Vitamin B Complex		
Vitamin B <sub>1</sub>	Thiamin	XX
Vitamin B <sub>2</sub> or G	Riboflavin	XXX
Vitamin B <sub>6</sub>	Pyridoxin	X
Vitamin B <sub>3</sub>	Nicotinic acid	X
Vitamin B <sub>5</sub>	Pantothenic acid	X
Vitamin C	Ascorbic acid	X
Vitamins D	Viosterol, calciferol	XX
Vitamins E	Tocopherols	X
Vitamin H	Biotin	XX
Vitamins K	Antihemorrhagic factor	X
Vitamin P	Citrin	O

\*Amount present in milk. O = none; X = small; XX = fair; XXX = large. (Inserted by Hunziker.)

TABLE 71-A.—DAILY VITAMIN REQUIREMENTS

	Minimum for Prevention of Disease <sup>a</sup>			Recommended for Good Health <sup>b</sup>		
	Less than 6 years	Over 6 years	Adult	Less than 6 years	6 to 19 years	Adult
A, U. S. P. units	1500	3000	4000	4500	4500-6000	6000
B <sub>1</sub> , U. S. P. units	83	167	333	200	250-600	500
B <sub>2</sub> , milligrams	0.5	.....	2.0	450	450-600	600
C, U. S. P. units	200	400	600	1000	1000-1800	1500
D, U. S. P. units	400	400	400	400	400	400 <sup>d</sup>

<sup>a</sup>Federal Register VI, 227.

<sup>b</sup>U. S. Dept. Agr. Yearbook 1939.

<sup>c</sup>Except B<sub>2</sub> where good daily allowance is given in Sherman Units.

<sup>d</sup>Rosenberg.

**Vitamin A.**—Vitamin A is essential for normal growth in the young and to promote health in individuals of all ages. Sherman<sup>3</sup> suggests that addition of vitamin A in excess of the amount necessary further accelerates growth, health, and spirits, and that such abundance of vitamin A contributes to the establishment of "buoyant" rather than just "passable" health. Its function is to stimulate metabolism with anabolism, the building of new cells.



Vitamin A deficiency in the diet slackens anabolism, stunts growth and diminishes resistance to disease. According to Rosenberg<sup>1</sup> it causes atrophy (withering) of the epithelium of the mucous membranes, attacking the respiratory tract first. It corrupts the lesions of the eyes, causing short sightedness, night-blindness, and it may develop softening of the cornea, leading to the nutritional eye disease of xerophthalmia and total blindness. The Technical Commission for the Study of Nutrition of the League of Nations established<sup>1</sup> the optimum vitamin A requirement for an average adult at about 5000 International Units of vitamin A or 15,000 International Units of carotene. The International Unit of vitamin A is 0.0006 milligram of pure beta carotene.<sup>2</sup>

**Vitamin A in Milk and Milk Products.**—Milk is a good source of vitamin A. Being fat-soluble, it is contained principally in the fat fraction. Sherman<sup>3</sup> observed that milk and milk products are the most important sources of the essential fat-soluble A in the American and European diet. In the milk fat it is especially the unsaturated fat fraction that is rich in carotene and vitamin A. The vitamin A content of 100 grams of milk (3.9% fat) is approximately 180 International Units (I.U.).<sup>31</sup>

Vitamin A is derived from its precursor provitamin A, or carotene. The vitamin A activity of cow's milk is influenced to a considerable extent by the vitamin A potency (carotene content) of the feed. The principal sources of carotene for cow feed are green pasture grasses, and green and carefully cured legumes, root crops such as carrots, beets, etc., and molasses silage. Milk from cows with rations high in cottonseed products is low in vitamin A content. Summer milk, in general, averages higher in vitamin A content than winter milk.

Vitamin A is not appreciably affected by processing temperatures, such as are used in forewarming in the manufacture of concentrated and dried milks, and in the sterilization of evaporated milk.<sup>4, 5</sup> There is no noticeable loss of vitamin A nor of its provitamin carotene in the manufacture of sweetened condensed, evaporated or dried milk.<sup>4, 5, 17</sup>

**Vitamin B<sub>1</sub> (Thiamin).**—Vitamin B<sub>1</sub> is essential in the metabolism of foods, especially carbohydrates, that provide energy for the body functions and its physiological processes. It stimulates appetite and is needed for normal growth. Recent research has revealed that this vitamin acts in combination with phosphoric acid as a co-enzyme designated cocarboxylase.<sup>2</sup> Vitamin B<sub>1</sub> protects the body from the disease of beriberi, a nutrition deficiency disease that has to do with neuritic ailments, nerve disorder, and general paralysis.

**Distribution in Dairy Products.**—Milk is just a fair source of vitamin B<sub>1</sub>. It contains about 0.15 mg. of B<sub>1</sub> per pound.<sup>18</sup> Being water-soluble, this vitamin is contained mainly in the skim milk fraction of milk products. Vitamin B<sub>1</sub> is vulnerable to high temperature. It is destroyed to the extent of 10 per cent by commercial pasteurization and of 50 per cent by com-

mercial sterilization of milk.<sup>22</sup> Published experimental data on the vitamin B<sub>1</sub> potency of concentrated and dried milks are too meager to warrant conclusions. Kathleen Henry et al<sup>17</sup> found that commercial processing caused a loss of vitamin B<sub>1</sub> of 3.5 per cent in the case of sweetened condensed milk, and of 27 per cent in the case of evaporated milk.

**Vitamin B<sub>2</sub> or G (Riboflavin).**—In America vitamin B<sub>2</sub> is also called vitamin G, in honor of Dr. Joseph Goldberger of the U. S. Department of Public Health Service, who discovered independently in this country that vitamin B embraces both B<sub>1</sub> and B<sub>2</sub>. An adequate supply of Riboflavin in the diet plays an important role, promoting good health in man and preventing skin disease and progressive corneal opacity. It also is an important factor in the prevention or cure of the disease of pellagra (characterized by nervous symptoms such as nervousness, headaches, melancholia, mental disorder, peripheral paralysis).

**Distribution in Dairy Products.**—Milk is recognized as one of the richest sources of riboflavin. It has been found to contain from about 0.72 to 1.36 mg./lb., averaging approximately 0.95 mg./lb.<sup>18, 26, 27</sup> The vitamin withstands commercial pasteurization and sterilization without loss.<sup>22</sup> Its potency is diminished and gradually destroyed by light. High temperatures in the presence of alkalis are detrimental to it. It is water-soluble, but the flavoprotein is associated with the surface of the fat globules.<sup>10</sup> Hence, much of the riboflavin of the milk is contained in the cream and the buttermilk. Dried buttermilk has been found twice as rich in riboflavin as dried skimmilk.<sup>20</sup>

**Vitamin B<sub>6</sub> (Pyridoxin).**—According to Rosenberg, vitamin B<sub>6</sub> appears to be concerned in the metabolism of the amino-acids. Persons afflicted with muscular paralysis are reported to have responded to vitamin B<sub>6</sub> treatment. In rats, pyridoxin deficiency causes inflammation of the skin, accompanied by dropsy, affecting especially the extremities such as paws, mouth, nose, ears, and tail. But little appears to be known as yet of the physiological behavior of this vitamin in man.

**Distribution in Dairy Products.**—Milk contains only small amounts of this vitamin.<sup>1</sup> Hodson<sup>21</sup> reported the following pyridoxin content of milk products: Fresh whole milk 0.67 mg./l., pasteurized milk 0.65 mg./l., irradiated evaporated milk 1.46 mg./l., dried whole milk 5.0 mg./kg., dried skimmilk 6.8 mg./kg. These figures show no noticeable losses of this vitamin due to concentration or drying. Vitamin B<sub>6</sub> is water-soluble. It has been found stable to heat, but is destroyed by light.<sup>1</sup>

**Vitamin C (Ascorbic Acid).**—Vitamin C is the only naturally occurring antiscorbutic substance. Its adequate availability in the diet prevents scurvy. Its deficiency causes scurvy and similar skin diseases, also pyorrhea and stomach ulcers. According to McCollum et al,<sup>7</sup> such diseases as rheumatic fever, pulmonary tuberculosis, diphtheria and pneumonia are listed as infectious diseases in the prevention of which vitamin C may play an im-

portant part. It is further suggested<sup>2</sup> that the failure of intercellular substances to set to a jell in the absence of sufficient vitamin C accounts for lowered resistance to infections. Rosenberg<sup>1</sup> points out that one function of vitamin C consists of its participation in the formation of colloidal intercellular substances, such as cartilage, dentine, and matrical bone. Krukovsky and Guthrie<sup>32</sup> demonstrated experimentally that partial oxidation of the vitamin C in milk stimulates the development of tallowy flavor, while complete quick oxidation of this vitamin inhibits reactions that produce tallowy flavor. See also "Tallowy Flavor" in Chapter XLII.

**Distribution in Dairy Products.**—Cow's milk contains only small quantities of vitamin C and, being water-soluble this vitamin is contained in the skim milk fraction. Vitamin C is sensitive to heat and to oxidizing agencies such as air, sunlight, and metallic salts (especially the salts of copper<sup>8</sup> and of iron). Sommer<sup>9</sup> found that pasteurization of milk by the holding process destroyed 60 per cent of this vitamin. Hess and Fish<sup>10</sup> and Hess<sup>11</sup> reported a milk outbreak of infantile scurvy on a diet of milk pasteurized at 145° F. for 30 minutes. Upon substitution of raw milk in the place of pasteurized milk, the scorbutic symptoms disappeared. Hart, Steenbock and Smith<sup>12</sup> stated that milk sterilized at 248° F. for 10 minutes had lost its antiscorbutic properties.

Kathleen Henry and co-workers<sup>23</sup> reported a loss of 30 per cent of the original vitamin C content in evaporated milk and of 20 per cent in dried milk. There was practically no difference between spray-dried and drum-dried milk. Josephson and Doan<sup>29</sup> found that "commercially manufactured evaporated milk contains nutritionally unimportant quantities of ascorbic acid after two months of storage." They further suggest that "Fortification of vitamin D evaporated milk with 50 to 100 milligrams per liter of ascorbic acid (reconstituted basis) is a commercially feasible and economically sound proposal if the cans are sealed under vacuum. Such fortification would correct one of the most obvious nutritional deficiencies of this otherwise rather complete food."

**Vitamin D (Viosterol).**—Vitamin D is essential for normal growth and health. It functions as the sentinel for the sound development and for the safeguarding of the integrity of the bony structure of the animal body. Its presence in the diet makes for maximum retention and optimum utilization of the calcium and phosphorus in the diet, which are the minerals so essential to the normal building up of a strong skeletal structure. It is the means of preventing decalcification and crystallization of the bone substance, that causes brittleness.

Absence or deficiency of vitamin D in the daily diet leads to the disease of rickets. Rickets is essentially a disease of infancy and early childhood. Among the early symptoms of vitamin D deficiency is delayed ossification of the fontanelles in babies. Later, the weakness of the bony structure develops enlargement of the ends of the long bones due to excessive carti-

lage formation, and their bending due to lack of resistance to the body weight. Some of the more common outward symptoms are bow legs, knock knees, enlarged joints, malformation of skull and jaws, defective teeth that are subject to caries, general weakness of the entire body, and subnormal vitality.

**Distribution in Dairy Products.**—Vitamin D is fat-soluble. Hence in milk it appears in the fat fraction. It is stable toward heat and oxidation. According to Sommer,<sup>9</sup> neither pasteurization, nor sterilization of milk at 240° F. for 15 minutes or longer, diminished the vitamin D potency. This indicates that when reconstituted, evaporated and dried milk may be expected to contain the approximate vitamin D potency of the fresh milk from which they are made. Milk has other virtues that make it a desirable carrier of vitamin D. The effective prophylactic control of rickets necessitates the presence of calcium and phosphorus and depends on the ability of vitamin D to efficiently utilize these important minerals in the food metabolism. In addition, McCollum<sup>13</sup> et al made the important discovery that the ratio between calcium and phosphorus may be more important than the absolute amount of these minerals contained in the diet. Their ratio in average milk appears to be in the right direction. It is approximately 1.3 : 1.

Average, normal milk is not rich in vitamin D. Holm<sup>21</sup> reported a range of 10-50 I. U. of vitamin D in 100 grams of whole milk (3.9% fat). The vitamin D potency of milk is often not sufficient to prevent rickets in babies. In addition, its vitamin D content is not constant. It varies considerably with the feed of the cow and her access to sunshine. In general, green feeds and carefully cured leafy feeds, and an abundance of sunshine make for a relatively high vitamin D content. Dry feeds (promiscuously dried) and the stabling of cows depreciates the vitamin D potency of milk, as demonstrated experimentally by Steenbock et al,<sup>14</sup> Bechtel and Hoppert,<sup>15</sup> and Wallis.<sup>16</sup>

Thus, under our present artificial mode of life, the vitamin D content of our available natural foods is inadequate. This deficiency, where it exists, makes necessary the use of vitamin D supplements for the normal development and health of our babies and growing children and for the health and vitality of the adult. Milk, by virtue of the excellence of its calcium-phosphorus set-up and because of its natural place as the basic food for the young and its indispensability in the daily diet of the family, is the logical choice of vehicle for the vitamin D supplement.

By reason of the fact that evaporated milk takes the place of fluid milk as food for babies and growing children of a large proportion of the population, it is essential that the vitamin D content of evaporated milk meet their nutritional vitamin D requirements. Since the natural vitamin D content of milk is variable and activation of the provitamin D by ultra-violet radiation from the sun is uncertain, several methods have been de-

veloped to ensure officially recognized adequate vitamin strength of the evaporated milk of commerce. This is done by the manufacture of (1) metabolized vitamin D milk, (2) fortified vitamin D milk, or (3) irradiated vitamin D milk:

1. **Metabolized Vitamin D Milk:** The cows are fed a highly potent vitamin D substance, such as irradiated yeast. The vitamin D factor is thus transmitted to the milk physiologically. Unfortunately the nature and the magnitude of the problem of dependable farm supervision of the feeding of irradiated yeast to cows supplying manufacturing milk virtually precludes the practicability of producing metabolized vitamin D evaporated milk.

2. **Fortified Vitamin D Evaporated Milk:** A vitamin D-rich substance is added to the evaporated milk. Several concentrated vitamin D preparations are on the market. The majority of them consist of products foreign to the natural composition of milk. Examples of these are fish liver oil, or irradiated yeast concentrated and emulsified in a vegetable oil such as cottonseed oil. One organization provides irradiated ergosterol concentrate in a carrier of butter oil, prepared from fresh, sweet-cream butter, of Grade A milk rating. This vitamin D product, as far as the carrier is concerned, is made up entirely of dairy products. The vitamin D concentrate is ergosterol, extracted from yeast. It is in pure crystalline form, subjected to irradiation, and then emulsified in the butter oil. This butter oil is assayed and standardized. It is then ready to be used. It is added to the evaporated milk at the rate of 10 cc. per 100 quarts of evaporated milk. This gives the finished product a vitamin potency of 400 I. U. per quart.<sup>6</sup>

3. **Irradiated Vitamin D Evaporated Milk:** The evaporated milk is irradiated after condensing. This exposes the provitamin inherent in the milk to the ultra-violet rays of the carbon arc or the quartz lamp. The resulting activation transforms the provitamins to vitamin D.

This method has the advantage that no foreign substance is added to the milk. This process was developed and patented by Dr. Harry Steenbock in 1928.<sup>30</sup> The patent was assigned to the Wisconsin Alumni Research Foundation which licenses the users of the process. (For "Irradiation of Evaporated Milk", see Chapter XXI.)

**Vitamins E (Tocopherols).**—The tocopherols are known as the anti-sterility vitamins. Information on the effect of vitamin E deficiency on man is meager. Some evidence is reported of the beneficial effect of the administration of vitamin E in cases of habitual abortion, toxemia in pregnancy and the treatment of certain diseases.<sup>1</sup> Rosenberg further reported observations of successful treatment of sterility and early abortion in beef cattle and dairy cows. Administration of vitamin E proved of value also in the treatment of infectious abortion in cows, caused by *Bacillus abortus* (Bang).

**Distribution in Dairy Products.**—Milk contains small amounts of vitamin

E. This vitamin is fat-soluble. It is contained in the fat fraction of milk. It is heat-stable in the absence of oxygen, but is destroyed by oxidation and by ultra-violet light.<sup>1</sup>

#### OCCURRENCE OF OTHER MORE RECENTLY IDENTIFIED VITAMINS

**Nicotinic Acid (Niacin).**—This vitamin is water-soluble and is believed by some investigators to be identified with vitamin B<sub>6</sub>. It is known as the Pellagra Preventive Factor.<sup>2</sup> The niacin content of milk is variously reported to range from 0.81 micrograms/ml. to 1.46 micrograms/ml.<sup>18, 24, 25</sup>

**Pantothenic Acid.**—This vitamin is water-soluble. It is related to growth. Its deficiency usually occurs along with pellagra. Pantothenic acid is reported to be present in milk to the extent of about 3.1 mg./l.<sup>25</sup>

**Vitamin H (Biotin).**—This vitamin is water-soluble. Its deficiency causes skin disease. Milk contains about 47 micrograms/l.<sup>25</sup>

**Vitamin K.**—This vitamin is fat-soluble. Its deficiency causes occurrence of hemorrhages and prolongs bleeding time. Vitamin K is essentially heat stable. Its requirements in the human diet are not known.

**Choline.**—This is a compound that appears to function both as a vitagen, being utilized as a building unit in the animal organism, and as a member of the vitamin B complex essential for growth and fat metabolism. Deficiency of choline in the diet impairs liver and kidney function causing deposition of the fat in the liver, leading to hemorrhagic kidney condition. Milk contains approximately 149 microg./l, of choline.<sup>25</sup> This essential lipotropic factor is water-soluble and appears to be fairly heat-stable.

**Grass Juice Factor.**—This factor, classified with the non-identified vitamins, has been studied by Randle, Kohler and co-workers<sup>28</sup>, and others. The grass juice factor is water-soluble. It is destroyed by heat and oxidation. Experimentally it appears to be readily absorbed by animals and secreted into their milk. Randle et al found it present in small amounts in dried whey.

#### REFERENCES

1. ROSENBERG, H. R.: *Chemistry and Physiology of the Vitamins*. 1942.
2. BOOHER, L. E., AND CALLISON, E. C.: *U. S. Dept. Agr. Yearbook*. 1939.
3. SHERMAN, H. C.: *Chemistry of Food and Nutrition*. 5th ed. 1937.
4. OSBORNE, T. B., AND MENDEL, L. B.: *Jour. Biol. Chem.* XX. 379. 1915.
5. STEENBOCK, H., AND BOUTWELL, P. W.: *Jour. Biol. Chem.* p. 163. 1920.
6. KARRER, P.: *Inst. Internat. de Chim. Solvay 16ième Conseil de Chimie. Paris. 1938. Quoted by Rosenberg.*<sup>1</sup>
7. MCCOLLUM, E. V., ORIENT-KEILES, E., AND DAY, H. G.: *The Newer Knowledge of Nutrition*. 5th ed. 701. 1939.
8. HESS, A. F., AND WEINSTOCK, M.: *Jour. Am. Med. Asso.* 82. March 22, 1924.
9. SOMMER, H. H.: *Market Milk and Related Products*. 1938.
10. HESS, A. F., AND FISH, M.: *Am. Jour. Dis. Child.* VIII. 1914.
11. HESS, A. F.: *Am. Jour. Dis. Child.* XII. 1916.
12. HART, E. B., STEENBOCK, H., AND SMITH, D. W.: *Jour. Biol. Chem.* XXXVIII. 2. 1919.
13. MCCOLLUM, E. V., SIMMONDS, N., SHIPLEY, P. G., AND PARK, E. A.: *Proc. Soc. Exper. Biol. and Med.* XVIII. 75. 1921., *Am. Jour. Hyg.* I. 492. 1921., *Jour. Biol. Chem.* XLVII. 507. 1921.
14. STEENBOCK, H., HART, E. B., RUISSING, E. M., HOPPERT, C. A., BASHEROV, S., AND HUMPHREY, G. C.: *Jour. Biol. Chem.* 87. 103. 1930.

15. BRECHTEL, H. E., AND HOPPERT, C. A.: Jour. Nutrit. II. 537. 1936.
16. WALLIS, G. C.: So. Dak. Agr. Expt. Sta. Bul. 372. 1944.
17. HENRY, K. M., HOUSTON, J., KON, S. K., AND THOMPSON, S. Y.: Jour. Dairy Res. XIII. 329. 1944.
18. American Dry Milk Institute: Half/Half.+ Bul. 905. 1944.
19. SHARP, P. F., AND HAND, D. B.: Proc. 1st Food Confer. Inst. Food Tech. P. 139. 1940.
20. KON, S. K.: Jour. Dairy Res. XI. 196. 1940.
21. HODSON, A. Z.: Jour. Nutrition XXVII. 415. 1944.
22. HOUSTON, J., KON, S. K., AND THOMPSON, S. Y.: Jour Dairy Res. XI. 67. 1940.
23. HENRY, K. M., HOUSTON, J., KON, S. K., AND OSBORNE, L. W.: Jour. Dairy Res. X. 272. 1939.
24. BAILEY, E. A., JR., DANN, W. J., SATTERFIELD, G. H., AND GRINNELLS, D.: Jour. Dairy Sci. XXIV. 1047. 1941.
25. HODSON, A. Z.: Jour. Nutrition XXIX. 137. 1945.
26. KRAMER, M. M., DICKMAN, R. M., HILDRETH, M. D., KUNERTH, B. L., AND RIDDELL, W. H.: Jour. Dairy Sci. XXII. 753. 1939.
27. EULER, H., VON, AND ADLER, E.: Arkh. Kemi, Mineral Geol. 11B. 28. 6. 1934.
28. RANDLE, S. B., SOBER, H. A., AND KOHLER, G. O.: Jour. Nutrition. XX. 459. 1940.
29. JOSEPHSON, D. V., AND DOAN, F. J.: Penn. Agr. Expt. Sta. Bul. 473. 1945.
30. STEENBOCK, HARRY: U.S.A. Patent No. 1,680,818. 1928.
31. HOLM, G. E.: U. S. Dept. Agr. B.D.I.M.-Inf.-25. 1945.
32. KRUKOVSKY, V. N., AND GUTHRIE, E. S.: Jour. Dairy Sci. XXVIII. 565. 1945.

## CHAPTER XLV

### MANUFACTURE OF MILK SUGAR OF COMMERCE

**History and Development.**—According to Whittier's<sup>1</sup> comprehensive review of "Lactose and Its Utilization," sugar of milk was first mentioned in the technical literature by Fabritius Bartoletus,<sup>2</sup> philosopher and physician of Mantua, Italy, in 1633. The work of Albertus Haller<sup>3</sup> (1744) shows that lactose was made on a commercial scale during the first half of the eighteenth century. Andrea's<sup>4</sup> publication (1765) indicates that the sugar of milk became a recognized article of commerce in the second half of that century.

Until about 1880, lactose of commerce was produced only in the Canton Luzern, Switzerland. But a few years later milk sugar factories were established also in other European countries and in the United States. Some milk sugar is made in Australia.

The source of milk sugar of commerce is whey. According to statistical calculations by Whittier, during the war year 1942 the quantity of lactose in unprocessed whey of the United States was over 400 million pounds. While there are diverse industrial uses for lactose (listed in later paragraphs), the lactose extracted from milk via whey, and refined, is utilized almost exclusively for human consumption, such as in infant foods, modified milks, other prepared foods, and in pharmaceutical preparations. Until recent years these outlets for refined lactose have averaged approximately five million pounds. The advent of penicillin (referred to later in this chapter) has more than doubled the market requirements of lactose.

In past years, lactose of commerce was almost entirely made from acid casein whey. The increased demand due to the rapidly growing penicillin industry, and the present higher market price offered for lactose of commerce, has aroused growing interest in cheese whey as an added source for the manufacture of lactose.

The profitable manufacture of lactose requires the availability of a large volume of whey. At best the factory producing the whey generally confines its activities with lactose to the manufacture of the crude milk sugar, which is then sold to the bona fide sugar refinery which does the final refining. In case the cheese factory engages in the manufacture of crude lactose, there is usually need of added boiler capacity and the installation of several major pieces of equipment, such as vacuum pan unit, filter press, and sugar centrifuge.

#### **PROCESS OF MANUFACTURE OF CRUDE MILK SUGAR FROM CASEIN WHEY**

Average whey contains about 6.6 per cent milk solids, of which about 5% is lactose, 1.6% is protein plus ash, and a trace of fat. In casein whey the protein content is usually about 0.85% and the ash about 0.75%, while rennet cheese whey contains about 1.1% protein and 0.5% ash. The



difference in ash content is attributed mainly to the presence in casein of appreciable quantities of calcium phosphate, while rennet whey contains negligible quantities only.

**Crude Sugar From Acid-Casein Whey.**—The bulk of milk sugar manufactured in the United States is made from acid-casein whey (grained-curd casein whey). This whey is the by-product of casein manufacture in which the casein is precipitated by mixing dilute hydrochloric acid with skimmilk at the rate of approximately 2.6 quarts of concentrated commercial hydrochloric acid per 1,000 pounds of skimmilk. The concentrated acid is diluted on the basis of 8 quarts of water to one part of concentrated acid, before adding to the skimmilk. This yields a whey with a pH of approximately 4.2.

**Heating and Neutralizing the Whey.**—The whey is run into large iron tanks where it is heated with direct steam and neutralized with milk of lime that is added gradually until the whey shows a pH of 6.2. Excess of lime darkens the product, while insufficient neutralization causes trouble-

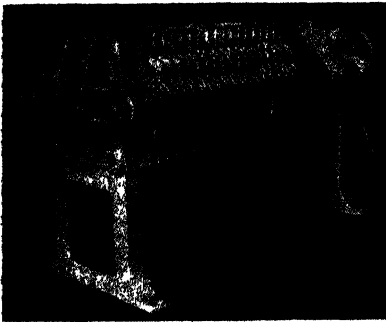

Fig. 126. Filter press used in manufacture of lactose from whey

Courtesy of D. R. Sperry & Co.

some foaming during the early stages of subsequent evaporation. The heating is continued to near the boiling point. This treatment coagulates much of the albumin which forms a compact layer on the surface when the boiling ceases. The clear whey is drawn from the bottom and the precipitated albumin is held over for later pressing.

**Evaporating and Filtering.**—The neutralized, clear whey is now drawn into the vacuum pan and condensed to a concentration of 20° Baumé. The condensing is preferably done in double-effect pan units. In case of excessive foaming in the first pan the foaming may be minimized by neutralizing to a slightly higher pH. The tendency toward excessive foaming appears to be greatest in the spring of the year, which suggests the presence of more non-coagulable albumin as the most likely cause. The thin syrup is then run through a filter, after which the protein sludge is also filtered in the same manner and its filtrate is added to the remainder of the syrup.

**Second Evaporation, Graining and Crystallizing.**—The filtered whey is then further condensed in a single-effect vacuum pan. The pan is filled

with the thin sugar syrup in such a manner that lactose crystals which have formed will serve as nuclei for expediting and obtaining suitable crystal growth. The last part of the condensing process (graining process) is carried on slowly to insure proper crystal formation (large crystals).

When concentrated to about 40° Baumé the contents of the pan are dropped into large crystallizing vats in which the mass is slowly agitated for one or more hours while cooling gradually to 70° F. In some plants the crystallizing period at room temperature is extended to several days for the purpose of securing satisfactory crystallization.

**Centrifuging, Washing and Drying.**—When, in the judgment of the operator, crystallization is complete, the sugar crystals are then separated by running the mush of crystals and liquid through a sugar centrifugal. The sugar crystals are washed in the centrifugal with cold water, adding the washings to the next batch of whey. The sugar now is quite pure, containing 85 to 90 per cent lactose. If not produced at the refinery it must be dried to prevent spoilage. The drying is usually done on trays in a hot air tunnel. The yield of crude sugar per 100 pounds of whey does not exceed 3.75 pounds.

The mother liquor from the centrifuge may be subjected to a second crystallization. This is usually done by concentrating, and allowing it to crystallize in wooden boxes. The mother liquor from this second crop is high in salts and is discarded. In the place of reconcentrating and recrystallizing the mother liquor from the first crop, it may be dried for use with other hog or poultry feed.

**Crude Sugar From Rennet-Casein Whey.**—When using rennet whey, the whey is evaporated to a thin syrup (18° Bé.) before it is limed, and allowed to settle out the albuminous matter. This method is, in fact, preferred, because neutralization after condensing tends to accomplish a more complete settling of the whey. According to Nabenhauer,<sup>5</sup> this procedure is not suitable, however, when using acid casein whey because of the presence of phosphate ions in acid whey.

#### CRUDE SUGAR FROM CHEESE WHEY

**Reaction of Whey.**—Sweet whey only is suitable, because the reduction of the lactose content proceeds rapidly when whey is allowed to sour, making the manufacture of milk sugar unprofitable. The sweet whey is run through a centrifugal separator to remove the fat it may contain. The separated whey is then ready for the routine of milk sugar, the manufacture which is briefly as follows:

**Removal of Albumin.**—If desired, the albumin may be removed before condensing. In this case it is precipitated by the addition of acetic acid and by heating to near the boiling point. The usual practice, however, is to condense the whey first and remove the albumin and milk salts from

the liquor of the heavily concentrated whey after the bulk of milk sugar has been extracted.

**Condensing the Whey.**—The whey is condensed in double-effect vacuum pans at a temperature of from 60 to 70° C. to a concentration of 30 to 32° Baumé at which it contains approximately 60 per cent solids.

**Crystallization of the Syrup.**—When the above concentration has been attained the contents of the pan are dropped into the crystallizing vats, which usually consist of jacketed iron containers holding about 174 gallons. Cold water is circulated through the jackets and the mass is allowed to cool. The gradually thickening mass is gently agitated at intervals and after about 24 hours it has become a thick, coarse-grained, yellow mush.

**Centrifuging the Mush.**—The thick mush of crystallized syrup is now run through a sugar centrifuge. As soon as the separator bowl is filled with sugar crystals from which the liquor has been centrifuged out, the crystals are washed by running cold water into the revolving bowl. The centrifuge is then stopped and the wet crude sugar is removed. The yield of wet crude sugar is approximately 3.8 per cent of the original whey, and it contains about 88 per cent lactose.

The mother liquor has a concentration of about 15° Baumé. It contains approximately one-third of the original lactose and most of the albumin and milk salts. These impurities are removed by boiling the mother liquor with "live" steam, allowing the coagulated mass to come to the surface and drawing off the clear liquid. The liquid is recondensed and recrystallized, and this second crop of mush is centrifuged as before. This second crop of crystals increases the total yield to about 4.3 per cent of wet crude sugar of the original weight of the whey. The second mother liquor is either discarded or utilized for fertilizer. The sludge of precipitated albumin and salts is utilized for hog and poultry feed.

#### REFINING THE CRUDE SUGAR

The crude sugar of milk obtained from acid casein whey, rennet casein whey and cheese whey has a yellow color and still contains considerable impurities, particularly albumin not coagulated by heat. The purpose of refining is to bleach the sugar and remove these impurities, and to thus produce the white pure lactose of commerce.

**Removal of Impurities.**—To this end the crude sugar is redissolved in enough water at 50° C. to make a solution testing 13 to 15° Baumé, and containing approximately 24 to 27 per cent lactose. The purifying treatment used varies somewhat in detail with different manufacturers but is essentially as follows:

To the thin sugar syrup are added bone black and acetic acid. The mixture is then heated to the boiling point and a small quantity of magnesium sulphate is added. The boiling is continued until the liquid is decolorized. This treatment yields a flocculent precipitate of protein and phosphates. This precipitate is removed, filterpressed, and washed,

and treated with sulphuric acid to produce a fertilizer high in nitrogen and soluble phosphoric acid. The filtrate consisting of all of the sugar syrup that has thus been freed from the precipitated impurities, is evaporated in vacuo to 35° Baumé which is equivalent to approximately 65 per cent solids. It is then crystallized in the usual manner, centrifuged and washed.

According to Whittier,<sup>1</sup> two more crops of crystals are obtained from the liquors by further crystallization, and the refining process is repeated until the desired quality of lactose is obtained. The purified product is dried in a rotating air dryer until the particles will not cohere when pressed between hands. The dried sugar is then ground in an edge-runner mill and sifted to such a fineness that the particles cannot be felt between the fingers.

**Yield of Refined Milk Sugar of Commerce.**—The yield of refined lactose averages about 2.5 per cent, or one-half of the amount contained in the original whey. The low yield of lactose is attributed to the cumulative effect of a variety of causes, the most important of which appear to be lactic acid fermentation, inversion of lactose, incomplete crystallization due to the presence of other constituents of the whey, faulty evaporation, difficulties in washing, mechanical losses of syrup due to leaky fittings and accidental spills.

#### MODIFICATIONS IN MANUFACTURE OF CRUDE AND TECHNICAL SUGAR

**Simplified Process for Crude Sugar from Cheese Whey.**—Webb and Ramsdell,<sup>6</sup> as a result of an experimental study to simplify the handling of cheese whey, suggest the elimination of the removal of the protein from the whey before condensing and recommend the following procedure:

Separate the whey from the cheese vats and run direct into the vacuum pan. Concentrate to 55-60% solids and drop the syrup into a crystallizing tank. When the lactose has crystallized, remove the sugar by centrifuging. Wash the lactose in the centrifuge, then dry it in an air tunnel. The resulting product is relatively high in milk solids. The wet cake from the centrifuge may vary widely in composition. An average sample contains approximately 86% lactose (hydrate), 5% protein plus ash, and 9% water. Precaution: If the concentrate from the pan is slimy and the crystals small, do not condense to such high solids content. Allow crystals to develop slowly at a low temperature with only occasional agitation. This will increase crystal size, prevent over-heating during crystallization, and facilitate separation.

**Process for Crude Lactose and Soluble Albumin.**—This modification was developed by Bell, Peter, and Johnson.<sup>7</sup> It differs from the usual commercial procedure in that it eliminates the boiling and filter pressing, reduces evaporation to one condensing operation, increases the yield, and permits of recovery of the by-product in soluble and powdered form suitable for channels of human nutrition. The procedure is as follows:

Sweet whey, titratable acidity 0.2%, is neutralized with sodium hydroxide to 0.04% acidity (pH. 7.3). It is then pre-heated to not over 140° F. and condensed to 32° Baumé at 50° C. (122° F.). This corresponds to a total solids content of 63%. For satisfactory crystal growth there is need of proper "graining" in the pan. The sugary concentrate is then dropped into crystallizing vats where it is held, without agitation, preferably at 32° F., for at least 18 hours to complete the crystallization. The crystallized whey is then centrifuged and the crystals washed. At this point the resulting crude sugar contains about 91% lactose, 3 per cent protein plus ash, and 6% water. The mother liquor from the centrifuge averages approximately 4.6% ash, 12.6% protein, and 20.8% lactose. When dried by either the spray or the vacuum drum process, it yields a slightly yellow powder, the appearance and solubility of which is largely controlled by the heat treatment in drying.

The crude sugar yield is about 4 per cent, and the yield of the by-product about 1.5 per cent, making a total yield of approximately 5.5 per cent. The richness of the by-product in bone-building ash constituents, readily digested lactalbumin, energy-producing lactose, and probably also a relatively high riboflavin content, should make this dried mother liquor valuable as an ingredient of modified milk for human nutrition.

**Technical Process Recommended by Webb and Ramsdell<sup>6</sup>.**—The whey is heated to boiling and then acidified to pH 5.0. The resulting flocks of curd are allowed to gather. Or, calcium chloride at the ratio of 4½ ounces and 30 ounces per 100 lbs. of uncondensed and condensed whey, respectively, may be used, followed by milk of lime to bring the reaction to pH 5.84. The clear whey is then syphoned off, or filtered, before evaporation. It is concentrated to 20° Baumé, which corresponds to approximately 30% lactose. For securing a white sugar a decolorizing carbon is added, followed by heating to boiling. Stringer<sup>8</sup> uses a carbon paste consisting of a mixture of three parts of bone black, one part activated carbon, and one part hydrochloric acid, with enough water to form a paste. Use one pound of paste per 100 pounds of lactose. If convenient, allow mixture to stand overnight at this point. Next add milk of lime to the hot syrup to neutralize to pH 6.3. Do not overneutralize. Boil mixture again and concentrate to 38 to 40° Baumé. The lactose begins to crystallize during the final stages of evaporation of the whey and crystallization is continued for a short time. The mushy syrup is centrifuged and the crystals are washed and dried. Webb and Ramsdell advise that the product should give a clear whey or only slightly turbid solution in water, and is suitable for most food uses.

**Manufacture of High Grade Technical Lactose by the Use of Trypsin.**—This process was developed by Webb, Rogers, Johnson and Ramsdell.<sup>9</sup> Its purpose is to so modify the present method as to obtain a good grade

of crude or technical lactose from acid-casein whey, substantially free from protein and other impurities, without the necessity of a second crystallization (refining) with its inevitable expense and loss of yield. They recommend the following method:

"Lime the whey to obtain a reaction of pH 6.2 to 6.3; boil and decant or filter off the clear whey. Adjust the temperature to 56-58° C., add trypsin at the rate of 1 part in 10,000 and hold the temperature between the above limits for one hour, or until digestion has been shown to be complete by the trichloro-acetic acid test. Evaporate the whey to 18 to 20° Baumé and filter, using approximately 1/10 per cent of decolorizing carbon by weight of the lactose present in the raw whey. The amount of carbon to be used will, of course, depend upon its activity in removing the milk pigment. Condense the whey to 40° Baumé, graining the product in the pan. Remove from the pan and allow to crystallize. The sugar may now be centrifuged and washed. The resulting product should be very low in protein, give a clear solution in water, and very little or no foam on boiling."

#### THE MANUFACTURE OF QUICKLY SOLUBLE LACTOSE (BETA-ANHYDRIDE)

**Solubility and Sweetness of Alpha and Beta Lactose.**—Milk sugar exists in two forms, the alpha and beta lactose, as explained in Chapter III under "The Sugar of Milk." The alpha lactose is of two kinds, the hydrate and the anhydride. The milk sugar of commerce consists of the alpha hydrate form, which has but slight sweetness and is of relatively low solubility. These attributes greatly limit its usefulness for various medicinal and dietary purposes, for which it would otherwise be highly desirable.

Beta lactose, on the other hand, is readily soluble and, probably because of its greater solubility, has the desired sweetness to taste. It follows, therefore, that a modification in the process of manufacture that would yield beta lactose instead of alpha lactose would greatly assist in increasing the usefulness and extending the available markets for lactose.

**The Alpha-Beta Equilibrium.**—It was explained in Chapter III that when milk sugar of commerce (alpha-hydrate) is dissolved in water a certain portion of it will readily change to beta lactose, the proportion and rapidity of such conversion depending upon the temperature of the solution. Likewise, beta lactose will change to alpha lactose. When the conversion has been completed the lactose solution is in equilibrium, that is, it contains such proportion of alpha lactose and beta lactose as is normal for that particular temperature. Thus, according to Rahn and Sharp<sup>10</sup>, the beta-alpha ratio for different temperatures is as follows. at 25° C., 1.58:1; at 50° C., 1.51:1; at 70° C., 1.45:1; at 90° C., 1.40:1; at 100° C., 1.33:1.

Under normal conditions alpha lactose, because of its lower solubility, will crystallize out at lower temperatures, and beta lactose, because of its higher solubility, will crystallize out at higher temperatures. The temperature below which the alpha form and above which the beta form

will crystallize out is spoken of as the transition point. This temperature is approximately 93.5° C. (200.3° F.). In other words, alpha hydrate is the stable solid form below 93.5° C. At the temperature of the transition point, the proportion of alpha to beta lactose is approximately 1 to 1.38. At higher temperatures the solution becomes supersaturated with respect to beta lactose.

**Conversion of Alpha to Beta Lactose.**—Sharp,<sup>11</sup> however, discovered that in the presence of a large quantity of beta crystals and in the absence of any considerable proportion of alpha crystals, beta crystals may be formed by heating a saturated solution of lactose at a much lower temperature than 93° C. (as low as 83 and even 78° C.).

Sharp further reports that beta crystals may be produced in commercial quantities without substantial admixture of alpha crystals, by crystallization from lactose solutions containing undissolved alpha crystals, by maintaining the temperature of the solution above the transition point, by providing conditions that prevent evaporation of the solvent, and by subsequent removal of the mother liquor from the crystals under conditions that will not permit the formation of appreciable quantities of alpha crystals. Sharp found that in solutions supersaturated with beta lactose at temperatures above the transition point and containing an excess of alpha lactose, such excess will go into solution, and beta lactose will go out of solution in the form of beta crystals. This crystallizing-out of beta lactose disturbs the equilibrium of the solution, but it is immediately restored by the conversion of more of the dissolved alpha lactose into beta lactose. The latter continues to crystallize out causing more alpha to go in solution until all the excess alpha lactose has dissolved.

When this point is reached there is then present the magma beta crystals, and the mother liquor composed of a solution of alpha and beta lactose in equilibrium. If the crystals present are now separated from the liquor under conditions unfavorable to the formation of alpha lactose crystals, i.e., in a heated centrifuge, the crop of crystals will consist of beta crystals only.

**Trials in Commercial Manufacture of Beta Anhydride Lactose.**—Methods of preparing beta anhydride lactose had been published by Erdmann<sup>14</sup> and by Hudson and Brown<sup>15</sup> prior to the work of Sharp, but it is the application of these findings by Sharp<sup>11</sup> and by Bell<sup>12</sup> that resulted in methods suitable for commercial manufacture.

Bell<sup>12</sup> used 10 and 20 per cent solutions of commercial milk sugar, and after forewarming at 60 to 100° C. dried them by the Gray-Jensen spray process. The resulting powder was highly soluble due to the porosity of the sugar grain. The dried sugar, however, proved to be a mixture of alpha and beta lactose in the ratio in which they occur in an equilibrated solution. This was attributed to the fact that the water was evaporated so quickly that the alpha form did not have time to change to the beta

form as the solute was precipitated from solution. Bell further reports that "there was no indication in any of the trials with the spray drying units that the ratio of solid beta to solid alpha lactose could be increased in favor of the beta form." On the other hand, trials with drum dryers showed that nearly pure beta lactose can be made by desiccating equilibrated milk sugar solutions on either the vacuum drum or the atmospheric drum dryers.

**A Practical Procedure for Beta Lactose.**—Bell<sup>12</sup> suggested the following procedure as a satisfactory, practical method of commercial manufacture of beta lactose:

Preheat an 80 per cent solution of refined lactose (such as lactose of commerce) to near 92° C. (197° F.) for one-half hour. Apply the solution to an atmospheric drum dryer, and conduct the drying in such a manner as to yield a powder of crystalline structure. This is done by proper adjustment of ratio of steam pressure to speed of drums. A steam pressure (gauge pressure) on drums of 65 to 75 pounds and a drum speed of 5 to 7 R.P.M. is recommended. The film thickness should be adjusted to secure a dry product of very low moisture, preferably as low as 1.0 per cent. While less hygroscopic than the spray-dried product, the drum-dried beta lactose is not immune to moisture absorption from the air. It should, therefore, be packed in an atmosphere of low humidity into containers that are air-tight and moisture-proof.

In later patents, Sharp and Hand<sup>13</sup> suggested a procedure whereby dry lactose of commerce (alpha lactose hydrate) is heated in a closed container to 120° to 130° C. (248 to 266° F.). This vaporizes the water of crystallization of the lactose hydrate crystals. In the presence of this water vapor, a solution of alpha lactose forms on the surface of the crystals, and beta lactose crystallizes from this solution. At a desired state of completeness of the conversion to beta lactose, the pressure is released, permitting the water vapors to escape.

#### USES OF SUGAR OF MILK

The average annual production of milk sugar of commerce in the United States for the period 1921-31 was approximately five million pounds. This amount is far below the lactose that was contained in the unused whey during that period. Since 1931, issuance of production statistics of milk sugar has been discontinued. The manufacture of lactose of commerce is limited basically by the relatively few uses of this nutritionally important constituent of milk. Lactose constitutes the highest quality of carbohydrate that nature provides. According to the findings of French and Cowgill,<sup>16</sup> lactose definitely promotes the utilization of calcium and phosphorus in the young; Bergeim,<sup>17</sup> and Kline and co-workers<sup>18</sup> reported a marked increase of calcium assimilation in rats and in chicks, respectively, resulting from an increase in the lactose content of the feed ration.



The ready conversion of lactose to lactic acid by bacterial fermentation assists in keeping the intestines in healthy condition. It exerts a bacteria-selective influence promoting the activity of lactic acid bacteria, such as *Lactobacillus acidophilus* and *Lactobacillus bulgaricus*, to the exclusion or partial exclusion of protein fermentations which tend to cause digestion-impeding gases and health-jeopardizing, mildly toxic substances. The therapeutic value of lactose is further augmented by the ability of the sugar of milk to pass the ileocaecal valve (formed by a double fold of the mucous membrane that guards the passage between small and large intestine).

The major general use of lactose thus has to do with infant feeding, proprietary and prepared infant foods, and prepared dry cultures of lactic acid bacteria. It is also used in the preparation of pharmaceutical products, largely as a suitable vehicle of medicine in powder and in tablet form. Lactic acid and riboflavin are produced by fermentation of lactose. In the course of the development of the commercial production of penicillin relatively large quantities of lactose (5 to 10 million pounds per year) were utilized, due to the discovery by the Regional Penicillin Research Laboratories,<sup>19</sup> that the presence of lactose in the culture medium of the mold used (*Penicillium notatum*), promoted the growth of the mold and caused a large increase in the yield of penicillin. However, the most recent research<sup>20</sup> now reveals other and more suitable means for the production of maximum yield of penicillin. Therefore, this channel of lactose utilization is expected to be discontinued in the near future.

## REFERENCES

1. WHITTIER, E. O.: *Jour. Dairy Sci.* XXVII. 505. 1944.
2. BARTOLETTUS, FABRITIUS: *Methodus in Dyspnoeam seu de Respirationibus, Libri V. p. 400. Bononiae 1633.*
3. HALLER, ALBERTUS: *Tome 4. pars. II. No. 689. p. 430. Goettingae. 1744.*
4. ANDREA: *Hannoversches Magazin. Stuck 93. p. 1473. 1765.*
5. NABENHAUER, F. P.: *Ind. and Eng. Chem.* XXII. 54. 1930.
6. WEBB, B. H., AND RAMSDELL, G. A.: *Nat. Butter and Cheese Jour.* July-August 1944.
7. BELL, R. W., PETER, P. N., AND JOHNSON, W. T., JR.: *Jour. Dairy Sci.* XI. 163. 1928.
8. STRINGER, W. E.: *Food Industries* XI. 72 and 262. 1939.
9. WEBB, B. H., ROGERS, L. A., JOHNSON, W. T., JR., AND RAMSDELL, G. A.: *The Manufacture of High Grade Technical Lactose. Unpublished manuscript 1934.*
10. RAHN, O., AND SHARP, P. F.: *Physik der Milchwirtschaft.* 1928.
11. SHARP, P. F.: *Method of Preparing Lactose. U. S. Patent 1,810,682. 1931.*
12. BELL, R. W.: *Ind. Eng. Chem.* XX. 51. 1930.
13. SHARP, P. F., AND HAND, D. B.: *U. S. Patents 2,182,618 and 2,182,619. 1939.*
14. ERDMANN (Quoted by Belf<sup>20</sup>).
15. HUDSON, C. S., AND BROWN, F. C.: *Jour. Am. Chem. Soc.* XXX. 960. 1908.
16. FRENCH, R. B., AND COWGILL, G. R.: *Jour. Nutrition* 14. 383. 1937.
17. BERGEM, O.: *Jour. Biol. Chem.* 103. 135. 1926.
18. KLINE, O. L., KEENAN, J. A., ELVERJEM, C. A., AND HART, E. B.: *Jour. Biol. Chem.* 98. 121. 1932.
19. COGHELL, R. D.: *Address Ann. Meeting Am. Chem. Soc. April 1944.*
20. ELDER, A. L.: *Formerly Coordinator of Penicillin Research, now Chief of Research, Corn Products Refining Co. Information by personal interview. October 1945.*

## CHAPTER XLVI

### FACTORY TESTS

#### PLATFORM TESTS

The purpose of these tests is to determine the suitability of fresh milk received at the factory for the manufacture of condensed, evaporated and dried milks. The relative merits of the several factory tests used for this purpose are discussed in Chapter XII on "Control of Quality of Milk Supply." The technique employed in the use of these tests is briefly described in the following paragraphs.

**Acid Tests (Titratable Acidity).**—Apparatus needed is a 50 cc. burette, graduated to 0.1 cc., with stand and connections, supply of sodium hydroxide solution in bottle, pinch cock, titrating cup with stirring rod, and 17.6 cc. pipette. The needed reagents are tenth normal solution of sodium hydroxide in bottle provided with soda-lime tube to protect the alkali solution against carbon dioxide, and phenolphthalein indicator, made up by dissolving one-half gram of dry phenolphthalein powder in 50 cc. of alcohol, and when dissolved, diluting the solution to 100 cc. with distilled water.

Measure 17.6 cc. of the milk into titrating cup and add 4 to 5 drops of the indicator. Run alkali solution slowly from burette while constantly stirring the sample, until the milk in the cup turns a faint pink throughout. If end point is in doubt, add another drop of indicator. This should turn pink when it strikes the milk, if the end point has been reached. The number of cc. of alkali used as shown on the burette, divided by 20, gives the per cent acid.

**Rapid Acid Test for Daily Use.**—Dilute 200 cc. of the tenth normal alkali solution with 790 cc. of distilled water and add 10 cc. of indicator. This makes a one-fiftieth normal alkaline solution, each cc. of which neutralizes .01 per cent lactic acid. 18 cc. of this solution therefore neutralizes 0.18 per cent acid in the milk, when a 17.6 cc. (18 gram) pipette is used for measuring the milk. The one-fiftieth normal alkali solution should be made fresh each day.

With the Babcock pipette, measure 17.6 cc. into a white cup. With a small dipper, holding exactly 18 cc., pour 18 cc. of the above N/50 solution into the cup; stir or shake. If the mixture remains faintly pink, it contains less than .18 per cent acid; if it turns white, it contains more than .18 per cent acid. An acidity in excess of .18 per cent suggests the presence of considerable developed acidity.

**The Alcohol Coagulation Test.**—Mix equal parts, by volume, of 70 to 75 per cent alcohol and milk, and examine the mixture for presence or absence of coagulation. For commercial work use a block of wood similar to that used for Babcock test bottles, but with smaller diameter

holes to hold small size test tubes such as are used in the chemical laboratory. Use not less than 2 cc. each, of milk and alcohol. Measure the milk and alcohol into the test tube with two pipettes or two small size dippers of equal capacity. When using dippers keep the alcohol in a wide-mouth bottle to facilitate removal of reagent. Before examining, invert each test tube once or twice, while holding finger over top, so as to insure complete mixture.

If no coagulation takes place, the mixture recedes from the glass leaving the sides clear. In case of a fine precipitate, the walls of the glass tubes are cloudy. Intense coagulation shows small lumps. This test is very simple, it is easily and quickly made, and the reaction is sharp. If coagulation occurs in the mixture the milk may reasonably be expected to be unsafe from the standpoint that it may not stand the necessary heat in the sterilizer without becoming objectionably curdy. The alcohol should be added rapidly each time, because slow additions invite alcohol denaturation<sup>3</sup> that interferes with the accuracy of the results.

**The Phosphate Test.**—This test was developed by Ramsdell, Johnson and Evans<sup>1</sup> who determined the relationship of heat coagulation and the coagulation of milk in the presence of mono-basic potassium phosphate ( $\text{KH}_2\text{PO}_4$ ). It consists of adding to the milk sample a definite amount of a dilute solution of  $\text{KH}_2\text{PO}_4$ .

Dissolve 68.1 grams of mono-basic potassium phosphate in water and dilute the solution to 1 liter. This represents the phosphate solution to use for the test. Measure 10 cc. of the milk sample into a test tube, using a 10 cc. dipper. Add 1 cc. of the phosphate solution, preferably from 25 cc. burette. Mix the contents of the tube thoroughly and then immerse in boiling hot water for five minutes. The water bath should reach above the contents of the tube to insure the required heating. After five minutes remove the tube from the bath, cool, and examine the contents for presence of curd. Visible coagulation indicates low heat stability of the evaporated milk in the sterilizer. Ramsdell et al suggest that when grading out milk, on the basis of the 1 cc. of phosphate solution per 10 cc. of milk, fails to produce increased stability in the remaining batch, the use of a smaller proportion of phosphate solution may prove helpful.

This test is not intended for use as a quality test of sanitary milk. Its chief aim is to aid in picking out those milks that impair the heat stability of the total composite during the seasons when sterilizing difficulties are encountered.

**The Brom-Thymol Blue Test.**—This test determines the hydrogen ion concentration colorimetrically. Its pH range is pH 6.0 to 7.6. Its color at different hydrogen ion concentrations may be described as follows:

At pH 6.00 yellow

At pH 6.58 light olive green

At pH 6.65 dark olive green

At pH 6.80 light grass green

At pH 7.00 bluish green

At pH 7.60 blue

According to Benton and Albery,<sup>2</sup> within the pH range of 6.58 and 6.65 the influence of the hydrogen ion concentration on heat coagulation is slight, being overshadowed by the salt balance. Above and below this pH range, on the other hand, changes in pH produce a marked effect on heat stability. It would appear, therefore, that the colors of the brom-thymol blue test that coincide with a pH below 6.58 or above 6.65 suggest probable heat coagulation difficulties. The use of this test with milk has its drawbacks because of the turbidity of milk which detracts from the sharpness of the color reaction.

The brom-thymol blue test is recommended particularly for the determination of the suitability of the water used for dissolving corn sugar in the manufacture of sweetened condensed milk in which dextrose is used. Such water should be free from alkali and should show a pH below 7.0, preferably pH 6.8.

The apparatus needed consists of test tubes and test rack and one of the following color standards for comparison:

1. Set of test tube color standards covering the b.t.b. range (pH 6.0 to 7.6), or
2. A single tube of solution at pH 6.8 colored with b.t.b., or
3. A color chart covering the b.t.b. range.

The color standards recommended in No. 1 are preferred because of maximum accuracy. No. 2 is equally accurate for comparison at pH 6.8, but fails to provide direct comparisons at any other pH. No. 3 is the least dependable, as printed color charts are seldom as accurate as they should be and usually change with age.

For making the test a solution containing 0.04 per cent brom-thymol blue dye in water is used. Place 10 cc. of the fluid to be tested in a test tube and add 0.5 cc. of the brom-thymol blue solution. Compare with the color standard. For correcting alkalinity of water used in dissolving dextrose (see Chapter XIV and Chapter XVII, under "Addition of Sugar"), add dilute acid to change the reaction to pH 6.8, at which the brom-thymol blue test shows a light grass green color.

**Direct Microscopic Count.**—The method recommended for microscopic examination of milk is the Breed Method.<sup>4</sup> This is a simple and accurate method for direct examination under the microscope. It consists of transferring, with a capillary pipette, .01 cc. of the milk to a clean glass slide and spreading it uniformly over an area one square centimeter by means of a stiff needle. The film of milk is then dried by putting the slide in a place sufficiently warm to accomplish the drying in five minutes. The slide with the dried film is then dipped into a fat solvent, such as xylol, to remove the fat, then drained and dried again. It is

next immersed in 90 per cent grain alcohol and then placed in a solution of methylene blue, leaving it in until overstained. The slide is then rinsed in water, decolorized in alcohol and, after drying, it is ready for examination under the microscope.

In place of the above technique involving three operations, the one-solution procedure of Newman<sup>5</sup> may be used. The fat solvent, fixative and methylene blue stain are combined in one solution, facilitating the handling of a large number of samples. This solution, known as Newman-Lampert Formula No. 2, may be obtained from dairy and chemical supply companies.

The microscope is standardized by means of the stage micrometer, to a definite area of field, from which the number of fields in 1 square cm. may be calculated. From the number of bacteria per field (usually representing the average of a number of fields) the total number of bacteria per cc. of milk is obtained. In order to secure dependable results the numerous details of technique must be correctly performed. The test requires considerable skill in preparing the slide, and training in the standardization and proper manipulation of the microscope. Detailed directions for the Breed method of direct microscopic examination of milk are given in "Standard Methods for the Examination of Dairy Products,"<sup>6</sup> and a complete atlas of the microscopic appearance of market milk and cream has been prepared by Breed.<sup>7</sup>

**The Sediment Test of Fresh Milk.**—The sediment test consists of filtering a specified amount of the fluid milk through a special cotton or lintine filter disc. The bottom can method of sediment testing of producers' milk, adopted by the Evaporated Milk Association, is recommended. In this method the sample is taken from the bottom of one can of each shipper. The sample consists of approximately a pint taken from the bottom of the producer's shipping can prior to agitation or dumping of the milk. The entire pint of milk is allowed to pass through the sediment disc in the tester. The testing is done by the use of the Langsenkamp-Wheeler Sediment Tester, or other tester adjusted to yield comparable results.

The discs are then graded by comparing with the Standard Sediment Chart for Bottom Can Samples. The coloration and amount of extraneous material on the sediment disc reflect the standard of sanitation observed on the farm and thus enable the factory to locate the farms that need immediate attention by the fieldman. (See Chapter XII, under "Quality Control.") If the samples tested are not in compliance with the accepted standards for health and sanitation, the producer's milk is returned.

**The Methylene Blue Reduction Test.**—Use methylene blue tablets certified by the Commission on Standardization of Biological Stains, such as may be secured from supply houses. Dissolve methylene blue tablets in

the proportion of one tablet per 200 cc. of sterile water. Store the solution in the dark and prepare a fresh solution weekly. Use freshly steamed or boiled test tubes and arrange them in the rack in numerical order, the numbers to correspond with the patrons' numbers on the sample bottles. With a sterile pipette transfer 10 cc. of the milk to the respective test tubes. To insure thorough mixing, invert the sample bottles just before use. For each succeeding transfer of milk thoroughly rinse the pipette, first in cold and then in very hot water.

When the tray of test tubes has been filled, add 1 cc. of methylene blue solution to each tube. Mix well by inverting the tubes. Set tray in water bath at 98.6° F. Maintain uniform temperature by means of burner. For operation of a large number of tests daily, thermostatic temperature control is advisable. Where an incubator is available, the rack may be placed in it without water bath after the temperature of the test tubes has been raised to 98.6° F. in the bath.

The following classes of milk are recognized in "Standard Methods for the Examination of Dairy Products".<sup>6</sup>

Class I. Excellent, not decolorized in 8 hours.

Class II. Good, decolorized in less than 8 hours, but not less than 6 hours.

Class III. Fair, decolorized in less than 6 hours, but not less than 2 hours.

Class IV. Decolorized in less than 2 hours."

**Viscosity Tests.**—To the viscosity tests commonly used in connection with sweetened condensed and evaporated milk belong the well known viscosimeters which operate on the Torsion principle, the viscosity flow meters that operate on the principle of the time required for the product to flow through a certain orifice or to fill a certain measure, and the viscosimeters that operate on the falling sphere principle. Their use is generally not intended for viscosity tests at the pan, but for check tests in the laboratory.

**Torsion Viscosimeters.**—To these belong the Mojonnier-Doolittle viscosimeter and the MacMichael viscosimeter. Both instruments measure the viscosity by the use of a Torsion wire. In the MacMichael viscosimeter the container of the sample revolves. The pressure exerted by the contents of the rotating container upon the plunger attached to the bottom of a vertically suspended Torsion wire gives the wire a twist. The magnitude of this twist indicates the relative viscosity. In the Mojonnier-Doolittle viscosimeter the container of the sample is stationary. The wire is given a twist of one complete convolution, and the distance traveled on the rebound indicates the relative viscosity.

Both instruments register the viscosity in the form of graduations on a turning dial, and express it in terms of degrees retardation. The results are relative, and are comparable only for each type of instrument.

To compare results between viscosimeters, a conversion factor that will express degrees of retardation in terms of centipoises\* may be used; however, the manufacturers of these viscosimeters do not supply the conversion factors. In order to make different viscosity tests with the same instrument comparable, the same size plunger, the same gauge wire, and a standard temperature of the product tested must be used.

**Viscosity Flow Meters.**—One method that is used by a large manufacturer of sweetened condensed milk, is as follows: Use a 100 mm. transfer pipette with an orifice at the large end of 58 mm. inside diameter. The length of the tube from orifice to bulb is  $7\frac{1}{2}$  inches. This pipette is filled to the mark, inverted so that the condensed milk has a good sized opening for flow, and the time in seconds required for the pipette to empty is used as the viscosity index.

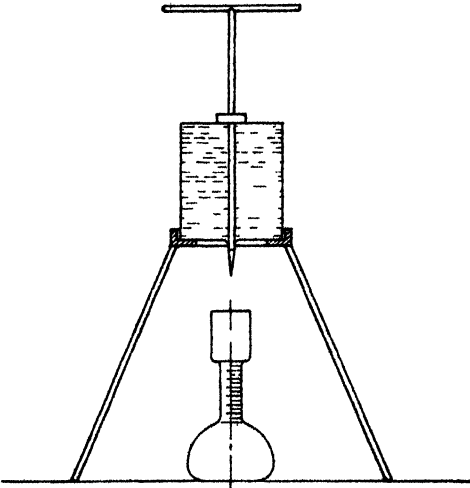

Fig 127 Viscosity flow meter for  
canned milk  
(courtesy of A W Baumann)

Another type of viscosity flow meter is illustrated in Fig. 127. This tester is used on canned milk, both sweetened condensed and evaporated. The can is placed on a suitable stand the base of which houses a 100 cc. flask with graduated neck. An 8-inch metal spike,  $\frac{3}{16}$  inch in diameter, with handhold at top and sharp point at bottom is used to perforate the can. The spike carries a baffle shield near the center that controls distance of penetration.

The spike is rammed through the center of the can to a depth that causes the baffle shield to rest on the can top. It is then withdrawn and the seconds required to fill the flask to the 100 cc. graduation are recorded. For uniform results the cans should be tempered to a uniform standard temperature. For new sweetened condensed milk, not over 10 days old and tempered to  $70^{\circ}$  F., a range of viscosity of 50 to 70 seconds has been found satisfactory and normal.

\*1 centipoise = 0.01 poise, 1 poise = the power of 1 gram per centimeter per second.

**The Falling Sphere Viscosimeter.**—This test measures the relative viscosity of sweetened condensed milk by means of a falling metal sphere. It has been found a highly suitable, simple test for ordinary control work. Glass tubes, 17 inches long with an inside diameter of 20 mm. are used. The spheres are steel ball bearings, 0.375 inches in diameter and weighing  $3\frac{1}{2}$  grams. The distance of fall of the sphere for which the time is recorded is  $11\frac{1}{2}$  inches, with the upper mark about 5 inches below the top of the tube and the lower mark about 2 inches above the bottom. The relative viscosity is expressed in terms of seconds required for the ball to drop from the upper to the lower mark. For comparable results, a standard temperature must be adopted and used for all tests, and the temperature must be the same for milk, tube, and sphere at the time of testing.

**Refractometer Test.**—This optical test is an accurate and rapid means of determining the percentage of total solids in sweetened condensed milk. An Abbé or Zeiss refractometer is used. The available instruments are equipped with a scale of suitable range graduated directly in indices of refraction for a spectrum of sodium light. For using white light, special compensating prisms (Amici prisms) are provided. These prisms achromatize the spectrum that is produced by refraction of white light. An eye lense focusable in spiral mount, facilitates the setting of the instrument by providing a sharp, enlarged image of the dividing line and cross hair. Water jackets around the base prism and the illuminating prism, with suitable water-circulating unit, assist in temperature control.

Fig. 128. Spencer Refractometer  
Courtesy of American Optical Company

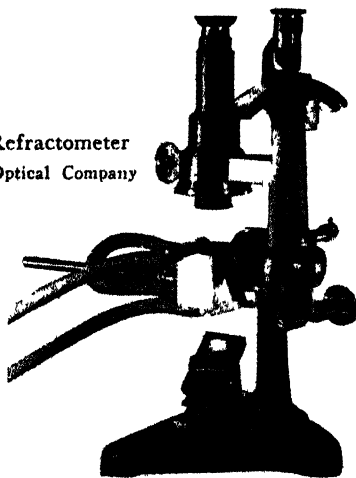

**Conversion of Refractive Index to Per Cent Total Solids.**—Rice & Miscall<sup>8</sup> studied the adaptation of the refractometer for use with sweetened condensed milk. They established that for this product refraction is an additive property, that its refractive power follows the general law



of true solutions, and that the estimation of total solids from the refractive index readings is scientifically sound. They assembled the following formula for conversion of refractive index to per cent total solids;

For sweetened condensed whole milk:

$$T = 70 + 444 (N - 1.4658)$$

For sweetened condensed skim milk:

$$T = 70 + 393 (N - 1.4698)$$

Where T = total solids, and N = refractive index.

**EXAMPLE:**

Assuming that the refractive index of a sample of sweetened condensed whole milk is 1.4750, what is the per cent total solids?

**ANSWER:**

$$70 + 444 (1.475 - 1.4658) = 74.0\% \text{ total solids.}$$

**Suitability of Refractometer Test for Sweetened Condensed Milk.—**

From the above formula, tables or charts may be assembled that give the per cent total solids for every range of refractive index of commercial sweetened condensed milk. It should be pointed out that, unless the refractive index of the suspended substance is very near that of the suspending medium, there is danger of such a dispersion of light that the shadowy edge in the refractometer is diffused to an extent that renders satisfactory reading practically impossible. In this respect, sweetened condensed milk offers exceptionally favorable conditions for good readings, as indicated in succeeding paragraphs.

**Comparison of Refractive Constants.—**Available experimental data on refraction suggest that the refractive power of a solution is equal to the sum of the refractive powers of its constituents. For comparison of refractive powers, the refractive constant is generally determined by the formula

$\frac{N^2 - 1}{(N^2 + 2)d}$ , where (n) is the refractive index and (d) is the density of the substance. Thus, a sample of commercial sweetened condensed whole milk showed a refractive index of 1.4750 and density of 1.3050. Its refractive

constant therefore is  $\frac{1.475^2 - 1}{(1.475^2 + 2) \times 1.305}$ , or 0.2158. Similarly, commercial sweetened condensed skim milk testing 45.7% sucrose, 27.8%

water, 1.4777 refractive index and 1.347 density, has a refractive constant

of  $\frac{1.4777^2 - 1}{(1.4777^2 + 2) \times 1.347}$  or, 0.2100. Comparing these constants with that

of sucrose which is 0.20614<sup>11</sup>, it is apparent that the difference in constants between sucrose and the condensed milk is not large. By reason of this fact, it is obvious that even considerable variations in sucrose content have no appreciable effect on the accuracy of the refractometer test. On the other hand, the refractive constant of milk fat (0.2868)<sup>8</sup> is much greater than that of the condensed milks. Hence the percentage of fat

contained in the sample must be close to that for which the conversion formula or table of index of refraction to per cent total solids was prepared.

**Temperature of Sample for Refractometer Test.**—The standard temperature at which the index of refraction is determined appears to be 20°C. (68°F.). For work with sweetened condensed milk a temperature of 68°F. appears somewhat unfortunate, especially for use at the vacuum pan. Cooling from pan temperature (about 130°F.) to 68°F. delays operation at a time when minutes are precious. In addition, cooling increases supersaturation of the lactose in the sample and invites copious lactose crystallization. When these crystals are allowed to grow to their usual maximum size, low readings of the refractive index result. These objections are eliminated by adopting a standard batch-finishing temperature (such as 130°F.) for the refractometer. When the temperature at the time of the test, is higher than the temperature on the basis of which the conversion factor was computed, a predetermined temperature correction factor must be added to the percent total solids.

**Operation of Refractometer.**—First start the water circulation through the prism jackets for adjustment to the desired temperature. Then introduce a drop of the sample and lock the prisms together. The source of light and the mirror are then adjusted for optimum brightness of illumination, and the knob of the Amici compensator is turned until the dividing line between halves of the field is sharp and free from obstructing color. After moving the arm that supports the telescope until the dividing line cuts the intersection of the cross hairs, the refractive index and the compensator scale are read.

Several different drops of the same sample are commonly examined and the results averaged. The individual readings of the different drops should check. With sweetened condensed milk of the standard composition for which the conversion factor has been computed, the refractometer test provides an easy, speedy and accurate method for determination, by the pan operator, of the desired end point of concentration of the batch. If the composition is altered, the conversion factor must be computed on the basis of the new composition. The exceedingly small amount of sample used renders this test very sensitive. This necessitates the development and use of a standard technique the merits of which have been carefully established, and which must be followed precisely in every detail. Observance of this precaution is indispensable for dependable, consistently accurate results. This test is not suitable for use with plain condensed and evaporated milk nor with condensed ice cream mix.

**Other Tests and Analyses.**—For detailed directions for other physical, chemical, and bacteriological tests and analyses of fresh milk, concentrated milks, and dried milks, the reader is referred to the following authoritative treatises on these subjects:

For Chemical Analysis: "Official and Tentative Methods of Chemical Analysis", American Association of Official Agricultural Chemists.

For Bacteriological Analysis: "Standard Methods for the Examination of Dairy Products." American Public Health Association, 7th edition, New York, 1939.

For Dried Milk Tests: Including preparation of representative samples, titratable acidity, solubility index, sediment tests, moisture tests, and plate counts: "The Grading of Dry Milk Solids." American Dry Milk Institute, Chicago. Bul. 906, second edition. 1944.

For Butter Fat Tests of Dried Milk: Mojonnier Modification of Roesse-Gottlieb Method.

For Determination of Oxygen in Dried Milk: Orsat Method. "Standard Methods of Chemical Analysis" by Scott. 5th edition. Vol. II.

For Determination of Iron in Dried Milk: Method described by American Association of Cereal Chemists in "Cereal Laboratory Methods," Fourth edition. Section 22-b, p. 47. 1941.

For Determination of Copper, Leakers and Keeping Quality of Dried Milks: Directions of Quartermaster Corps Subsistence Research and Development Laboratory. Chicago Quartermaster Depot, Chicago 9.

#### REFERENCES

1. RAMSDELL, G. A., JOHNSON, W. T., JR., AND EVANS, F. R.: Jour Dairy Sci. XIV. 93. 1931.
2. BENTON, A. G., AND ALBERY, H. G.: Jour. Biol. Chem. LXVIII. 251. 1926.
3. ASSOCIATES OF ROGERS: Fundamentals of Dairy Science. 2nd ed. p. 213. 1935.
4. BREED, R. S., AND BREW, J. D.: N. Y. (Geneva) Agr. Expt. Sta. Tech. Bul. 49. 1916 and Circ. 58. 1918.
5. NEWMAN, R. W.: Calif. Dept. Agr. Monthly Bul. 16. 1. 1927.
6. Standard Methods for the Examination of Dairy Products: Am. Pub. Health Assn. 7th ed. New York. 1939.
7. BREED, R. S.: N. Y. (Geneva) Agr. Expt. Sta. Tech. Bul. 120. 1926.
8. RICE, F. E., and MISCALL, JACK: Jour. Dairy Sci. IX. 140. 1926.
9. HODGMAN, C. D.: Handbook of Chem. and Phys. 26th Ed. 1944.
10. GIBB, T. R. P.: Optical Method of Chem. Analysis, 1942.
11. BROWNE, C. A. and ZERBAN, F. W.: Physical and Chemical Methods of Sugar Analysis, 3rd Ed. 1941.

## CHAPTER XLVII

### DEFINITIONS AND STANDARDS

#### U. S. FEDERAL STANDARDS FOR FRESH MILK, CONCENTRATED MILK AND DRIED MILK PRODUCTS IN FORCE JANUARY 1, 1946<sup>1,2,3</sup>

##### MILKS

**Milk.**<sup>1</sup> "The whole, fresh lacteal secretion obtained by the complete milking of one or more healthy cows, excluding that obtained within 15 days before and 5 days after calving, or such longer period as may be necessary to render the milk practically colostrum-free. The name 'milk' unqualified means cow's milk."

**Pasteurized Milk.**<sup>1</sup> "Milk every particle of which has been subjected to a temperature not lower than 142° F. for not less than 30 minutes and then promptly cooled to 50° F. or lower."

**Homogenized Milk.**<sup>1</sup> "Milk that has been mechanically treated in such a manner as to alter its physical properties, with particular reference to the condition and appearance of the fat globules."

**Evaporated Milk.**<sup>2</sup> (Quoted in part.) "(a) Evaporated milk is the liquid food made by evaporating sweet milk to such point that it contains not less than 7.9 per cent of milk fat and not less than 25.9 per cent of total milk solids. It may contain one or both of the following optional ingredients:

(1) Disodium phosphate or sodium citrate or both, or calcium chloride, added in a total quantity of not more than 0.1 per cent by weight of the finished evaporated milk.

(2) Vitamin D in such quantity as increases the total vitamin D content to not less than 7.5 U.S.P. units per avoirdupois ounce of finished evaporated milk.

It may be homogenized. It is sealed in a container and so processed by heat as to prevent spoilage.

"(b) When optional ingredient (2) is present, the label shall bear the statement 'With Increased Vitamin D Content' or 'Vitamin D Content Increased'. Such statement shall immediately and conspicuously precede or follow the name 'Evaporated Milk', without intervening written, printed, or graphic matter, wherever such name appears on the label so conspicuously as to be easily seen under customary conditions of purchase.

"(c) For the purpose of this section—

(1) The word 'milk' means cows' milk.

(4) Vitamin D content may be increased by the application of radiant energy or by the addition of a concentrate of vitamin D (with any accompanying vitamin A when such vitamin D in such concentrate is obtained from natural sources) dissolved in a food oil; but if such oil is not milk fat

the quantity thereof added is not more than 0.01 per cent of the weight of the finished evaporated milk."

**Plain Condensed Milk.**<sup>2</sup> "Concentrated milk, plain condensed milk, conforms to the definition and standard of identity, and is subject to the requirements for label statement of optional ingredients, prescribed for evaporated milk . . . except that:

- (1) It is not processed by heat;
- (2) Its container may be unsealed; and
- (3) Optional ingredient (1) is not used."

**Sweetened Condensed Milk.**<sup>2</sup> "(a) Sweetened Condensed Milk is the liquid or semi-liquid food made by evaporating a mixture of sweet milk and refined sugar (sucrose) or any combination of refined sugar (sucrose) and refined corn sugar (dextrose) to such point that the finished sweetened condensed milk contains not less than 28.0 per cent of total milk solids and not less than 8.5 per cent of milk fat. The quantity of refined sugar (sucrose) or combination of such sugar and refined corn sugar (dextrose) used is sufficient to prevent spoilage.

"(b) For the purpose of this section—

- (1) The word 'milk' means cows' milk."

**Condensed with Corn Syrup.**<sup>2</sup> "(a) Condensed milks with corn sirup are the foods each of which conforms to the definition and standard of identity prescribed for sweetened condensed milk . . . except that corn sirup or a mixture of corn sirup and sugar is used instead of sugar or a mixture of sugar and dextrose. For the purpose of this section the term 'corn sirup' means a clarified and concentrated aqueous solution of the products obtained by the incomplete hydrolysis of cornstarch, and includes dried corn sirup; the solids of such corn sirup contain not less than 40 per cent by weight of reducing sugars, calculated as anhydrous dextrose.

"(b) The name of each such food is:

- (1) 'corn sirup condensed milk,' if corn sirup alone is used; or
- (2) '—% Corn sirup solids —% sugar condensed milk,' if a mixture of corn sirup and sugar is used, the blanks being filled in with the whole numbers nearest the actual percentages of corn sirup solids and sugar in such food."

**Dried Milk.**<sup>1</sup> "The product resulting from the removal of water from milk. It contains not less than 26 per cent of milk fat and not more than 5 per cent of moisture."

**Malted Milk.**<sup>1</sup> "The product made by combining whole milk with the liquid separated from a mash of ground barley malt and wheat flour, with or without the addition of sodium chloride, sodium bicarbonate, and potassium bicarbonate, in such a manner as to secure the full enzymic action of the malt extract, and by removing water. The resulting product contains not less than 7.5 per cent of butterfat and not more than 3.5 per cent of moisture."

**Goat's Milk and Ewe's Milk.**<sup>1</sup> "The whole, fresh lacteal secretions free from colostrum obtained by the complete milking of the healthy animals. The milk conforms in name to the species of animal from which it is obtained."

#### SKIMMILKS

**Skimmilk, Skimmed Milk.**<sup>1</sup> "That portion of milk which remains after removal of the cream in whole or in part."

**Evaporated Skimmed Milk.**<sup>1</sup> "The product resulting from the evaporation of a considerable portion of the water from skimmed milk. It contains not less than 20 per cent of milk solids." (Refers to plain condensed skimmilk.)

**Sweetened Condensed Skimmed Milk.**<sup>1</sup> "The product resulting from the evaporation of a considerable portion of the water from skimmed milk to which sugar and/or dextrose has been added. It contains not less than 24 per cent of milk solids."

**Dried Skimmed Milk.**<sup>3</sup> "Definition . . . promulgated in July, 1940 under the Food, Drug and Cosmetic Act of 1938<sup>2</sup> has been superseded by an Act of Congress of March 2, 1944 which reads as follows:

"That for the purposes of the Federal Food, Drug, and Cosmetic Act of June 26, 1938 (ct. 675, sec. 1, 52 Stat. 1040), non-fat dry milk solids or defatted milk solids is the product resulting from the removal of fat and water from milk, and contains the lactose, milk proteins, and milk minerals in the same relative proportions as in the fresh milk from which made. It contains not over 5 per centum by weight of moisture. The fat content is not over 1½ per centum by weight unless otherwise specified. The term "milk," when used herein, means sweet milk of cows."

**Buttermilk.**<sup>1</sup> "The product that remains when fat is removed from milk or cream, sweet or sour, in the process of churning. It contains not less than 8.5 per cent of milk solids not fat."

**Cultured Buttermilk.**<sup>1</sup> "The product obtained by souring pasteurized skimmed or partially skimmed milk by means of a suitable culture of lactic bacteria. It contains not less than 8.5 per cent of milk solids not fat."

#### CREAM

**Cream, Sweet Cream.**<sup>2</sup> "The sweet fatty liquid or semi-liquid separated from cows' milk and containing not less than 18 per cent of milk fat constitutes a class of food commonly known as 'cream'."

Cream containing less than 30 per cent milk fat is commonly termed "coffee cream" or "table cream".

Cream containing not less than 30 per cent of milk fat is commonly termed "whipping cream".

**UNITED STATES ARMY QUALITY STANDARDS FOR DRIED MILKS<sup>4</sup>**

The following material, quoted verbatim in part, and summarized in part, has been taken from standards issued by the Quartermaster Corps Subsistence Research and Development Laboratory.<sup>4</sup>

**TYPES, CLASSES AND GRADES**

- Type I Dried Whole Milk**  
Grades—Premium and Extra.
- Type II Dried Skimmilk**  
Grades—Premium and Extra.
- Class 1—Spray Process**
- Class 2—Vacuum Drum Process**
- Class 3—Atmospheric Roller Process**

**GENERAL REQUIREMENTS**

D-1. Unless otherwise specified, all deliveries shall conform to provisions of the Federal Food, Drug and Cosmetic Act, and regulations promulgated thereunder.

D-3. The finished products shall be reasonably uniform in composition, free from lumps that do not fall apart under light pressure, and practically free from all brown or black specks. The color shall be reasonably uniform, white or light cream, and free from any off-color typical of overheated or old stock. The flavor and odor of the powder and of the reconstituted milk shall be sweet, clean and free from rancid, tallowy, fishy, cheesy, soapy, scorched, or other equally objectionable flavors or odors.

D-4. The addition of antioxidants to any of the whole milk products covered in this specification shall be preceded by a formal request to, and the approval of, the Quartermaster Corps Subsistence Research and Development Laboratory.

**TYPE I WHOLE MILK POWDER**

E-1a. The product shall be prepared by the drying of whole fresh sweet milk or standardized milk (to which no preservative, alkali, or other chemical has been added except as provided for in paragraph D-4), which has been pasteurized by heating to a temperature of not less than 143° F. and held at such temperature for not less than 30 minutes, or any other means of pasteurization which yield equivalent bacterial destruction.

E-1a. (1). Standardizing milk for the purposes of this specification shall mean milk which has been standardized by any of the following means:

(a) Milk as delivered to the plant, that has been altered by the removal of cream by plant separation or by the addition of either sweet freshly plant-separated cream or separated milk.

(b) Concentrated milk or whole milk to which has been added sweet cream or concentrated separated milk which has been prepared from milk.

of a quality equivalent to that required for the production of premium or extra grade powder.

(c) Concentrated milk to which has been added sweet cream which has been separated from milk in accordance with (b) above.

(d) The addition of nonfat dry milk solids conforming to all the requirements for premium or extra grade nonfat dry milk solids as defined in this specification which is identical to the grade of the whole milk powder produced.

E-1a (2). The product shall meet the requirements of the keeping quality test. Note: Dried whole milk will be released for shipment without waiting for the outcome of the keeping quality test, provided that the product meets all the other requirements of this specification.

E-1b. **Class I, Spray Process.** The oxygen content of the gases in the sealed container shall not exceed 3 per cent (calculated to atmospheric pressure) after at least one week from the time of gas packing.

E-1b (1) **Premium Grade.** The finished product shall meet the following requirements:

\*Standard bacterial plate count not to exceed 6,000 per ml. of reconstituted milk.

Butterfat not less than 26%.

Moisture not to exceed 2.25%.

Titratable acidity (reconstituted basis) not to exceed 0.15% (calculated as lactic acid).

Solubility index not to exceed 0.5 cc.

Sediment not to exceed disc No. 2.

Copper content of product not to exceed 1.5 p.p.m.

Iron content of product not to exceed 10.0 p.p.m.

E-1b (2). **Extra Grade.** The finished product shall meet the following requirements:

\*Standard bacterial plate count not to exceed 6,000 per ml. of reconstituted milk.

Butterfat not less than 26%.

Moisture not to exceed 2.5%.

Titratable acidity (reconstituted basis) not to exceed 0.15% (calculated as lactic acid).

Solubility index not to exceed 0.5 cc.

Sediment not to exceed disc No. 3.

E-1-c. **Class 2, Vacuum Drum Process.** The product shall meet all requirements for **Class 1 Spray Process, Extra Grade**, in paragraphs E-1a, E-1a(2), E-1b, and E-1b(2), except that the solubility index shall not exceed 2.0 cc.

E-1d. **Class 3, Atmospheric Roller Process.** The product shall meet all

\*Based on 12 grams dry whole milk per 100 cc. distilled water.



requirements prescribed for Class 1, Spray Process, Extra Grade, in paragraphs E-1a, E-1a(2), E-1b, E-1b(2), except that the solubility index shall not exceed 15.0 cc. and the moisture shall not exceed 3.0%

#### TYPE II DRY NONFAT SOLIDS

E-2. The product shall result from the removal of fat and water from fresh sweet milk, to which no preservative, alkali, or other chemical has been added and which has been pasteurized by heating to a temperature of not less than 143° F. for not less than 30 minutes, or any other means of pasteurization which yields equivalent bacterial destruction.

E-2a. **Premium Grade.** The finished product shall meet the following requirements:

\*\*Standard bacterial plate count shall not exceed 15,000 per ml. of reconstituted milk.

Butterfat shall not exceed 1.25%.

Moisture shall not exceed 3.0%.

Titratable acidity (reconstituted basis) shall not exceed 0.15% (calculated as lactic acid).

Solubility index shall not exceed 1.25 cc.

Sediment shall not exceed disc No. 2.

Copper content shall not exceed 2.0 p.p.m.

Iron content shall not exceed 12.5 p.p.m.

E-2a(1). The milk supply plant and equipment, personnel, operations, transportation, and receiving platform tests shall meet the requirements of the May 1, 1942 issue of the "Sanitary and Quality Standards for the Dry Milk Industry".

E-2a(2). **Extra Grade.** The finished product shall meet the following requirements:

\*Standard bacterial plate count shall not exceed 15,000 per ml. of milk.

Butter fat shall not exceed 1.25%.

Moisture shall not exceed 4%.

Titratable acidity (reconstituted basis) shall not exceed 0.15% (calculated as lactic acid).

Solubility index shall not exceed 1.25 cc.

Sediment shall not exceed disc No. 3.

E-2b. **Class 2, Vacuum Drum Process.** The product shall meet the requirements prescribed for Class 1, Spray Process, Extra Grade, in paragraphs E-2, E-2a, and E-2a(2), except that the solubility index shall not exceed 2.0 cc.

E-2c. **Class 3, Atmospheric Roller Process.** The product shall meet all requirements prescribed for Class 1, Spray Process, Extra Grade in paragraphs E-2, E-2a, E-2a(2), except that the solubility index shall not exceed 15.0 cc.

\*Based on 18 grams dry whole milk per 100 cc. distilled water.

\*\*Based on 10 grams bonifat dry milk solids per 100 cc. sterile distilled water.

**STANDARDS FOR CONCENTRATED AND DRIED MILK PRODUCTS  
USED AS ANIMAL FEED<sup>1</sup>**

The following paragraphs are quoted from the official publication of the Association of American Feed Control Officials Incorporated:

**"93. Dried Buttermilk (Feeding)** is the dried product resulting from the removal of water from clean, sound buttermilk derived from natural cream to which no foreign substances have been added, excepting such as are necessary and permitted in the manufacture of butter. It contains not more than 8% of moisture, not more than 13% of mineral matter (ash), and not less than 5% of butterfat, as determined by the Roesse-Gottlieb method. (Adopted 1932.)

**"94. Evaporated Buttermilk, Concentrated Buttermilk or Condensed Buttermilk** is the product resulting from the removal of a considerable portion of water from clean, sound buttermilk derived from natural cream to which no foreign substances have been added, excepting such as are permitted and necessary in the manufacture of butter. It contains not less than 27% total solids, and not less than 0.055% of butterfat for each per cent of solids and not more than 0.14% of ash for each per cent of solids. (Adopted prior to 1928). (Amended 1944.)

**"95. Dried Skimmed Milk (Feeding)** is the product resulting from the removal of water from clean, sound skimmed milk. It contains not more than 8% of moisture. (Adopted 1930.)

**"96. Condensed Skimmed Milk** is the product resulting from the removal of a considerable portion of water from clean, sound skimmed milk. It contains not less than 27% of total solids. (Adopted 1930.)

**"97. Dried Soured Skimmed Milk** is the product resulting from the removal of water from clean, sound skimmed milk which has been soured by a suitable culture of lactic bacteria. It contains not more than 8% of moisture. (Adopted 1932.)

**"98. Evaporated Soured Skimmed Milk, Concentrated Soured Skimmed Milk or Condensed Soured Skimmed Milk** is the product resulting from the removal of a considerable portion of water from clean, sound, skimmed milk which has been soured by a suitable culture of lactic bacteria. It contains not less than 27% of total solids. (Adopted 1932.)

**"99. Condensed Whey** is the product resulting from the removal of a considerable portion of water from clean, sound cheese or casein whey, either or both. It must not contain less than 62% of total whey solids. When this product contains less than 62% of total whey solids it shall be designated 'condensed whey, —% solids'. (Adopted 1944.)

**"100. Condensed Whey Solubles** is the product resulting from the removal of albumin and the partial removal of milk sugar from clean, sound whey, to which no foreign substances have been added except such as are necessary in the manufacture of milk sugar. (Adopted 1944.)

**"101. Dried Whey Solubles** is the dried product resulting from the re-

removal of albumin and the partial removal of milk sugar from clean, sound whey, to which no foreign substances have been added except such as are necessary in the manufacture of milk sugar. (Adopted 1944.)

"102. **Dried Whey** is the by-product from the manufacture of cheese or casein, either or both. This product shall contain at least 65% of lactose (milk sugar). (Adopted 1934.)

"103. **Cheese Rind** is cooked, partially defatted cheese rind. (Adopted 1935.)"

#### REFERENCES

1. **FOOD AND DRUG ADMINISTRATION:** U. S. Dept. Agr. S.R.A., F.D. No. 2, Rev. 5. 1936.
2. **FEDERAL REGISTER:** Washington, D. C. Evaporated milk, plain condensed milk, sweetened condensed milk, cream, sweet cream, V. 128. 1940. Condensed milk with corn syrup, Aug. 13, 1943. Dried Skimmilk, V. 135. 1940.
3. **DEFINITION OF NONFAT DRY MILK SOLIDS APPROVED BY ACT OF CONGRESS MARCH 2, 1944.**
4. **QUARTERMASTER CORPS SUBSISTENCE RESEARCH AND DEVELOPMENT LABORATORY:** Chicago Quartermaster Depot, Chicago 9.
5. **ASSO. OF AM. FEED CONTROL OFFICIALS, INC.:** Official Pub. p. 24. 1945.

# INDEX

- Abbe refractometer, 483  
 Acid dairy cleaners, 109, 113  
 Acidity, 5, 6, 27, 239, 241, 244, 380  
 Acidity tests, 124, 125, 477  
 Actinomyces odorifera, 314  
 Age thickening, 143, 144, 307, 320, 321  
 Air heating systems, 364  
 Albumin (see Lactalbumin)  
 Alcohol coagulation test, 127, 193, 477  
 Aldehyde, 314  
 Alpha-beta conversion, 24, 474  
 Alpha-beta equilibrium, 24, 473  
 Alpha lactose anhydride, 23, 473  
 Alpha lactose hydrate, 23, 473  
 Altitude, effect of  
     on barometric reading, 59  
     on vacuum gauge reading, 59  
     of cities in U. S. A., 60  
     relation to atmospheric pressure, 60  
 Aluminum, 50  
 Amici prisms, 483  
 Anderson-Barngrover continuous sterilizer, 234  
 Annual consumption in U. S. of concentrated milks, 296  
 Annual production in specified countries, 42, 336  
     evaporated milk, 41  
     plain condensed milk, 41  
     sweetened condensed milk, 41  
 Antihemorrhagic factor, 459, 465  
 Antioxidants in milk, 382, 383  
     addition of, 385  
 Apparent acidity (see natural acidity)  
 Appert, Nicolas, 34, 332  
 Ascorbic acid, 444, 459, 461  
 Ash, composition of, 4, 27, 28  
     effect on heat coagulation, 28  
     influence of lactation and feed on, 29  
 Aspergillus repens, 306, 307  
 Atomizers, 370-372  
 Avoset stabilized cream  
     definition, 287  
     manufacturing, 288  
     packaging, 289  
     storage, 289  
 Axerophthols, 459  
 Ayrshire milk, 2, 3, 8, 10, 12, 18  
  
 Bacillus amarus, 313  
 Bacillus bulgaricus, 273  
 Bacillus mesentericus, 314  
 Bacillus panis, 313  
 Bacillus prodigiosus, 314  
 Bacteria count in  
     dried milk, 438-440  
     plain condensed, 305  
     sweetened condensed, 304  
 Bacterium fluorescens liquefaciens, 314  
 Barley Malt, 417  
 Barrels, reconditioning, 186  
 Batch samplers, 68  
  
 Baumann steam distribution nozzle for pan coils, 103  
     exhaust steam connections for pan, 102  
     multi-velocity single-pass preheater, 147  
 Baumé hydrometer, 157  
 Beri beri, 460  
 Beta lactose anhydride, 23, 473  
     commercial manufacture, 474  
     solubility of, 473  
     sweetness of, 473  
 Biotin, 459, 465  
 Bitter flavor, 313  
 Bloats of exaporated milk, 311, 325, 330  
     of sweetened condensed milk, 308, 325  
 Boiling points of fluid milk products, 9  
 Bolting dried milk, 376  
 Borden flake film drying process, 351  
 Borden Gail, 34, 35  
 Brom-thymol blue test, 478  
 Brown-Boveri mechanical vapor compression evaporator, 106  
 Browning of milk due to lactose-amino acid reaction, 11, 326, 327, 330  
 Brown Swiss milk, 2, 3  
 Brucella abortus, 464  
 Buell milk dust recovery, 374  
 Buffalo milk, 2  
 Buflovak atmospheric drum dryer, 349  
     vacuum driver, 350  
 Buttermilk, composition, 5  
     solids content, 406  
  
 Caking of dried milk, prevention of, 401, 402, 431  
 Calciferol, 459  
 Calcium caseinate, 17  
 Calcium content of colostrum, 29  
     stripper milk, 29  
 Campbell process, 342  
 Can washing, 112-114  
 Canning evaporated milk, 224  
     size of cans, 225  
 Carbon dioxide, 1, 6  
 Caries, 463  
 Carotene, 1, 10, 460  
 Casein, 4, 17, 18, 19, 240, 241, 248  
 Casing canned milk, 291  
 Catalase, 1, 316  
 Central Dairy, Inc., gas packing room, 394  
 Centrifugal clarifier, 130  
 Centrifugal emulsor, 217  
 Centrifuging milk, 445  
 Cephalin, 1, 16  
 Chain Belt Company, 340  
 Chapman continuous pressure process sterilizer, 235  
 Chemical action on can causing bloats, 330  
 Chemical reaction, 5  
 Chemical sterilizers, 111

- Cherry-Burrell round process batch cooler, 173
- Cherry-Burrell split-flo viscolizer valve, 209
- Chester Ste-vac high-temperature heater, 196
- Cholesterol, 1, 205, 207
- Choline, 465
- Chrome-nickel alloy, 49
- Citrates, 6, 242
- Citric-acid content, 29
- Citrin, 459
- Cladosporium butyricum, 314
- Cleaning condensery equipment, 109-112
  - Air ventilation for idle equipment, 112
  - Vacuum pan sanitation, 110
- Cloth screen dust collectors, 373
- Coagulation on boiling, 4
- Collis buttermilk dryer, 403
- Color of dried milks, 436-438
  - evaporated milk, 11, 252, 330
  - fresh milk, 10
  - dried whey, 414
  - causes of browning, 10, 326, 437
- Colostrum, 3, 4, 122
- Composition of concentrated milks, 303
  - dried milks, 426
  - fresh milk products, 1, 5
- Compressed dried milk, 377
- Concentrated milk defects, 294, 295, 318
- Concentrated sour skimmilk
  - annual production, 282
  - keeping quality, 280, 281
  - markets, 281
  - manufacture, 277-280
- Condensed buttermilk (see semi-solid)
- Condensed milk markets, 291-301
- Condenser, barometric, 77
  - counter-current, 75, 76
  - inside of pan, 75, 77
  - parallel-flow, 75
  - surface, 75
- Condenser water pump, 82
  - with automatic flow control, 80
- Continuous density tester, 203
- Continuous pan discharge system, equipment for, 202
- Continuous samplers, 68
- Cooked flavor, reaction involved, 11, 253, 255, 385
- Cooling dried whole milk, 376, 388
- Cooling evaporated milk, 221
- Cooling sweetened condensed milk, 164-179
  - equipment for, 171
  - forced crystallization curve, 166
  - labile area, 25, 167
  - metastable area, 25, 167
- C. P. multi-flo homogenizer valve, 209
- Copper, copper alloys, 47
- Copper in dried milk, 445
- Cost of canning dried milk, 397
- Cream composition, 5
  - specific gravity of, 9
  - weight per gallon, 7
- Crude milk sugar
  - manufacture of, 467-470
  - refining of, 470-472
- Cryoscope, 9, 10
- Curdy evaporated milk, 312, 328
- Cyclone dust collectors, 373
- Dairy cleaners, 108, 109
- Definitions and Standards Federal Food, Drug and Cosmetic Act, 487, 489
- Defatted milk solids (see dried skimmilk, 334)
- De Laval air-tight milk clarifier, 131
  - centrifugal emulsor, 218
- Density of dried milks, 430
- Density tests, 157
- Developed acidity, 6
- Dextrose, 149, 154
- Diastase, 1, 314
- Dick process, 362
- Dickerson evaporated milk filler and tipper, 225
- Direct microscopic count, 127, 479
- Double vacuumizing, 395
- Dough or paste dryers, 342
- Douthitt-Gray-Jensen spray dryer, 357
- Dried buttermilk, composition, 426
  - Collis dryer, 403
  - foul odor nuisance, prevention of, 407, 408
  - manufacture, 399-408
  - from sour-cream buttermilk, 400-406
  - from sweet-cream buttermilk, 400
  - markets, 333, 453
  - packaging, 406
  - prevention of stickiness and caking, 401
  - yield, 405, 425, 427
- Dried cream, composition, 427
- Dried ice cream mix, 422
  - composition, 423
  - formula for manufacture, 424
- Dried milk industry, 332
- Dried milk particles, 428
- Dried milks
  - annual production, 335
  - chemical composition, 426
- Dried skimmilk, composition, 426
  - markets, 449, 450
  - need of for human nutrition, 333
  - yield, 425
- Dried whey, composition, 426
  - discoloration of, 414
  - flake-drying of, 44
  - Lavett two-stage double-drum dryer, 410, 411
  - manufacture, 409-414
  - markets, 455
  - Peebles Manning Process, 409, 410
  - Sharp and Doob vacuum process, 413
  - Simmons process, 413
  - Spellacy process, 412
  - yield, 425
- Dried whole milk, composition, 426
  - annual production, 333
  - manufacture, 379-389

- markets, 449
- packaging, 389-398
- yield, 425
- Dropsy, 461
- Drum dryers, atmospheric, 347, 349
- operation, 342
- vacuum, 350
- Drying and Contrating Company spray dryer, 362
- Drying by use of cold, 338-341, 397, 447
- Drying by use of heat, 338, 342
- Drying chamber, 369
- air and milk inlet, 369
- counter-current, 369
- parallel-current, 374
- Drying in absence of air, 338-341, 397, 447
- Dust collectors, 373-376
  
- Electric arc, 205
- Entrainment losses in pan, 90
- Entrainment of milk dust recovery systems, 372-376
- Entrainment separators, 73, 75, 90
- Enzymes, 1, 303, 314-317
- Epithelial cells, 1
- Ergosterol, 207
- Evaporated milk
- freezing point, 10
- specified gravity, 9
- Evaporated milk cans, 224
- filling, 225
- Evaporated milk color, 252, 253
- Evaporated milk defects, 294, 311, 327
- Evaporated milk formula for calculating correct Bé reading
- for desired concentration, 201
- standardizing over-condensed milk, 223
- standardizing ratio of fat to S N F, 194, 222, 223
- temperature correction of Bé reading, 200
- Evaporated milk manufacture, 191
- canning, fullness of, 227
- inspection for leakers, 227
- pro-coating Army cans, 228
- Evaporated milk sterilizers
- batch, 229-233
- continuous, 229, 233-237
- detection of leakers, 234, 235
- detection of underweights, 235
- temperature-time schedule, 231
- uniformity of heat distribution, 230
- Evaporated milk storage tanks, 221
- Evaporative capacity of pan, 64-66
- Evaporators
- conventional vacuum pan, 63
- mechanical vapor compressor, 73, 105, 106
- multi-effect evaporator, 71, 104
- thermo-compression evaporator, 72, 105
- tubular evaporators, 69, 71
- Ewe milk, 2
- Exhaust steam, 55, 92
- utilization in pan operation, 101, 102
- Exporting countries, 299
- Exports, 298-300
- Extraneous matter in milk
- removal by centrifuging, 130
- removal by filters or strainers, 129
  
- Factory sanitation, 108, 304, 381, 439, 442, 445
- Factory tests, 477
- Falling sphere viscosimeter, 483
- Fat constants, 15
- Fat globule membrane, 11, 13, 14
- Fat globules, 13
- Fat-in-skim milk emulsion, 14
- Fat separation in evaporated milk, 251, 329
- in sweetened condensed milk, 326
- Fatty acids, 14
- Federal Food Drug and Cosmetics Administration definitions and standards of dairy products, 487-489
- Filling machine for,
- dried milk, 393
- evaporated milk, 225
- fullness of cans, 227
- in barrels, 183, 187
- sweetened condensed milk, 188
- Film Drving (see Roller process)
- Financial resources, 44
- Fishy flavor, in dried milk, 443
- in evaporated milk, 313
- Flake film atmospheric dryer, 351
- Flipping of filled cans, 226
- Fluid milk dust collectors, 375
- Fontanelles, 462
- Forewarming, 142, 143, 145, 148, 194, 274, 321
- equipment, 145, 147, 196
- temperature, high-short, 143, 195, 445
- two-stage forewarming, 197
- effect on age thickening of sweetened condensed milk, 143
- effect on heat stability of evaporated milk, 244
- effect on viscosity of plain condensed milk, 265
- effect on superheated milk, 265
- Formula for
- calculating Bé for desired concentration, 158, 201
- calculating S N F in skim milk, 137
- in cream, 139
- correcting fat shortage, 139
- correcting fat surplus, 140
- Foul odor nuisance, 407, 408
- Free-flowing dried milk, 431
- Freeze-drying Process, 340, 397, 447
- Freezing point of milk, 9, 10
- Frozen plain condensed milk, 268
- for consumer, 269
- for ice cream, 269
- for superheated, 266

- Galactase, 1, 315  
 Gaseous fermentation in evaporated milk, 330  
   in sweetened condensed milk, 309  
 Gases in pan, non-condensable, 78, 81, 82  
 Gas packing, 392, 446  
   cost of, 397  
   history of, 389  
   modern gas packing room, 394  
 Gel formation in stored evaporated milk, 251  
 Glass enamel steel, 50  
 Glycerides, 14  
 Glycerol, 14  
 Goat milk, 2  
 Grass juice factor, 465  
 Grimwade process, 332, 342  
 Grinding dried milk, 376  
 Guernsey milk, 2, 3
- Hanrahan-Webb helical groove milk heater, 196**  
**Harris counter-current condenser, 63**  
   'deflector type entrainment separator, 63, 74  
   internal tube cooler, 174  
   submerged coil cooler, 174  
   vacuum pan, 63  
**Hatmaker process, 348**  
 Health of cows, effect on milk, 122  
 Heat coagulation of casein, 17  
 Heat, sensible, 52  
   external latent, 53, 54  
   internal latent, 53  
   thermal energy expended by vacuum pump, 54  
 Heat stability, definition, 238  
   factors controlling, 238-247  
   optimum, 239  
 Heat units required, in forewarming, 93  
   in condensing, 96  
 Heated air requirements, 364  
   heated air filters, 368  
   intake, 365  
   supply, 367  
   temperature, 364  
   vaults, 366  
   velocity, 365  
   volume, 364  
 Heating platens, 340  
 Holstein milk, 2, 3  
 Homogenizer valve, 209  
   breaker ring, 211  
   two-stage valve, 210  
 Homogenizing for dried milk, 346, 382  
 Homogenizing evaporated milk, 207  
   effect on fat globule size, 213  
     on heat coagulation, 214  
     on viscosity, 213, 246  
   care of homogenizer, 216  
   non-piston homogenizers, 217  
**Horlick, William, 416**  
 Hot wells, 145
- Humidity of air, 404, 409, 412, 414  
   effect on malted milk, 421  
     on dried milk, 404, 409, 412, 431, 432, 436  
 Hydrogen ion concentrator, 5  
 Hygroscopicity of dried milk, 431  
   effect of lactic acidity, 27  
   of lactose glass, 26  
 Husks, separation from mash, 418
- Imports of concentrated milks, 301, 302  
   countries importing, 301  
 Inconel, 49  
 Incubation of sample cans, 236, 292  
 Index of refraction, 483  
 Induction period, 444  
 Infectious abortion, 464  
 Inspection of concentrated milks, 292  
 Internal latent heat, 52  
 Introduction, ix-xiii  
   annual cow population  
   annual production of milk and its products  
   average annual production for four pre-war years  
   for four war years  
   whole milk products  
   milk equivalents  
   skimmilk products  
   skimmilk equivalents  
 Inversion of starch, 417  
   of sucrose, 309  
 Invertase, 309  
 Iron, 49  
 Irradiation of evaporated milk, 205
- Jacket, in forewarmer, 145**  
   in pan, 64  
**James Bell double-drum dryer, 349**  
**Jensen buttermilk forewarming unit, 274**  
   Jensen condensed milk batch cooler, 172  
 Jersey milk, 2, 3  
**Just-Hatmaker process, 348**  
**Just process, 347**
- Keeping quality of**  
   evaporated milk, 310, 313, 327-330  
   dried milks, 442-447  
     when packed in air, 391  
     when packed in nitrogen, 391-392  
   plain condensed milk, 305  
   sweetened condensed milk, 306-310, 318-327  
**Kestner tubular evaporator, 70**  
**Khan, Genghis, 332**  
**Khan, Kublai, 332**  
**Krause centrifugal spray dryer, 387**  
**Kunick single drum dryer, 349**
- Labelling, 291**  
**Laboratory tests and analyzes, 486\***

- Lactalbumin, 1-4, 6, 17-20, 240, 241, 410, 460  
 Lactase, 314  
 Lactochrome, 1, 10  
 Lactoglobulin, 1, 17, 20  
 Lactose content of dried milk products, 399  
 Lactose content of milk, 4, 20  
   effect of breed and lactation, 21  
 Lactose crystal structure, 21, 22  
 Lactose crystallization in dried milks, 26  
   in sweetened condensed milk, 21  
 Lactose crystals, size, 20, 26  
   rate of crystallization, 166  
 Lactose glass, 26  
 Lactose modifications, 23, 24  
   solubility, 24, 25  
   specific gravity, 8  
 Leakers, inspection for, 227  
 Leaky can detectors, 234, 235  
 Lecithin, 1, 14, 16  
 Leucocytes, 1  
 Lime deposits in semisolid buttermilk, 276  
 Lipase, 1, 314  
 Lithium chloride, 340  
 Litmus, 5
- Malted milk, 333, 416-422  
   definition, history, manufacture, 416-420  
 Malted milk, drying pan, 419  
   drying operations, 419  
   composition, 421  
   keeping quality, 422  
   preparation for market, 421  
   uses, 455  
 Mammalian milks, 2  
 Market price, of  
   concentrated milks, 296-298  
   dried milks, 456  
 Markets of  
   concentrated milks, 295-302  
   dried milks, 449  
 Marking cans and cases, 291, 302  
 Metallic flavor, 326  
 Metals on milk side of condensing and drying equipment, 45-50, 380  
 Methylene blue reduction test, 126, 480  
 Meyenberg, John B., 37, 38, 229  
 Meyenberg, sterilizer, 39  
 Microorganisms  
   in concentrated milks, 304  
   in dried milks, 438  
 Mignot-Plumey process, 349  
 Milk ash, 1-4, 27-30  
 Milk condensery, establishment of, 43-45  
 Milk constituents, 1, 12-30  
 Milk drying systems, 338  
 Milk dust recovery systems, 372-375  
 Milk fat, 1, 2, 3, 4, 14, 15  
 Milk flavor, 11  
 Milk intake at pan, 67  
 Milk, minor organic substances in, 30
- Milk, physical properties, 7  
 Milk proteins, 1-4, 16  
 Milk sampling, 119, 136  
 Milkstone, 108  
 Milk sugar, 20  
   content in milk, 1-4  
   crystals, 21-24  
   effect on sweetened condensed milk, 21  
   effect on dried milk, 26  
   quickly soluble lactose, 473  
   solubility, 24  
 Milk sugar of commerce, 467  
   manufacture of  
     from acid casein whey, 468  
     from rennet casein whey, 469  
     from cheese whey, 469  
   refining crude sugar, 470-471  
   technical sugar, 471, 472  
   uses of, 475, 476  
   yield of crude sugar, 468, 470, 472  
   yield of refined sugar, 471  
 Milk supply, basis of buying, 115  
   composite samples, 120  
   care of samples, 120  
 Evaporated Milk Association price code, 116-118  
   factory prices, 115  
   preparing samples for fat test, 119  
   temperature of milk and acid, 120  
   transportation to factory, 118  
 Milk supply, 43, 122  
   fundamentals of quality control, 122  
   platform inspection and tests, 122, 123, 477  
   follow-up by field man, 128  
 Milk trough between double drums, 348  
   concentration, 348  
 Mineral sediment in evaporated milk, 254, 255, 329, 330  
 Moisture in dried milk, 447  
 Mojonner, evaporated milk cooler, 222  
   sweetened condensed milk batch cooler, 173  
   tubular evaporator, 70  
   vacuum spray dehydrator, 361  
 Mold buttons, 306 307  
 Monarch pressure spray nozzle, 371  
 Multiclone dust collector, 374  
 Multi-effect evaporators, 71, 104  
 Mycoderm, 273
- Nash, combination water and dry vacuum pump, 83  
   water-sealed rotary vacuum pump, 81  
 Natural acidity, 6  
 Niacin, 1, 459, 465  
 Nickel, 47  
 Nicotinic acid, 459, 465  
 Nitrogen content of milk, 1  
 Nitrogen supply, 397  
 Non-fat dry milk solids (see dried skim-milk)



- Odor of milk, inspection of, 123  
 Oidium lactis, 314  
 Oxidants in milk, removal by centrifuging, 130, 131, 381  
   destruction by heat treatment, 383, 384  
 Oxidation-reduction potential, 384  
 Oxygen, 1, 389, 428-430, 444-447  
 Oxygen content of dried milk, effect of concentration of T. S. before drying, 387  
 Oxygen desorption, period of, 341, 429, 430  
 Oxygen entrapped in air cells, 389
- Packaging dried whole milk, 378, 388, 389, 397**  
   dried skimmilk, 378  
   evaporated milk, 227, 291  
   sweetened condensed milk, 186-190  
**Packaging dried whole milk made by Freeze drying, 397**  
 Palatability of dried milk, 442  
 Pantothenic acid, 1, 459, 465  
 Pathogens in concentrated milks, 304, 306  
 Pellagra, 461, 465  
 Pendulum feed pipe, 411  
 Penicillin, 467, 476  
 Penicillium glaucum, 314  
 Penicillium notatum, 476  
 Penicillium roqueforti, 314  
 Peripheral paralysis, 461  
 Peroxidase, 1, 316  
 pH determination, 125, 478  
 pH value, 5, 6  
 Phenolphthalein, 5  
 Phosphatase, 1  
 Phosphates, 6  
   test, 127, 478  
 Phosphatide content of milk products, 15  
 Phospholipid protein, 15  
 Phospholipids, 1, 14  
 Physical properties of milk, 7  
 Pycnometer test, 157, 275  
 Pigments of milk, 1  
 Pilot sterilizer, 257  
 Plain condensed milk  
   definition, 265  
   manufacture, 265-268  
   defects, 293  
 Plane of nutrition, 12  
 Plant sanitation (see factory sanitation)  
 Platform tests, 477-485  
 Plectridium foetidum, 311, 312  
 Polo, Marco, 332  
 Pre-condensing at receiving stations, 204  
 Pre-condensing, effect on keeping quality of dried milk, 386  
 Preface, v  
 Preheating effect on keeping quality of dried milk, 382-384  
 Pro-Coating of cans, 228  
 Protease, 315  
 Proteins, 16, 240, 241, 248
- Proteus ichthiosmius, 313  
 Provitamin A, 1, 460  
 Provitamin D, 1, 205, 463  
 Pseudoxin, 459, 461
- Rancid flavor, in dried milk, 442**  
   in sweetened condensed milk, 143, 315, 325  
**Ratio of fat to S N F in milk, by breeds, 3**  
   effect on age thickening, 323  
   standardizing of, 139, 222  
**Raymond pulverizer for seed lactose, 169**  
 Reductase, 1  
 Refractive constants, 484  
 Refractometer, 280, 483  
   test of sweetened condensed milk, 483-485  
 Riboflavin, 459, 461  
 Rickets, 206, 462  
 Rogers spray dryer, 359  
   vacuum pan, 63  
 Roller process of drying milk  
   atmospheric, 343  
   vacuum, 350  
   single drum, 349  
   double drum, 343  
   two-stage, 411  
 Rotary-piston high vacuum pump, 396
- Salolase, 314  
 Salt balance, effect on heat stability, 242  
 Sandiness, 318  
 Saturated steam, 92, 93  
   table of, 53  
 Schroeder thin film dryer, 349  
 Scott, continuous vacuum band dryer, 352-354  
   forced circulation evaporator, 69  
   high vacuum cooler, 178  
   spray dryer, 360  
   thermo-compression evaporator, 105  
 Sediment test, 125, 480  
 Seed material, 168  
 Seeding sweetened condensed milk, 168  
 Semi-solid buttermilk, annual production, 277  
   barrels for, 176  
   feeding value, 171  
   manufacture, 272-276  
   markets, 276  
   lime deposits in, 276  
 Sensible heat, 52  
 Separator slime, 5, 131, 381, 382  
 Sewage disposal, 44  
 Shaking, 232  
 Shorthorn milk, 2, 3  
 Sifting dried milk, 376  
 Sixmmenthaler milk, 2, 3  
 Skimmilk, composition of, 5  
**Solubility of**  
   alpha lactose, 25  
   beta lactose, 25  
   sucrose, 25

- Solubility of dried milks, 432-436  
   effect of preheating temperature, 385  
 Soluble albumin, manufacture of, 471  
 Sonic oscillator, 218  
 Soxhlet-Henkel, conversion to % lactic acid, 4  
 Specific gravity, 4, 7, 8, 9, 10  
 Specific gravity formula, 158, 159  
 Specific heat of milk products, 8, 9  
 Sperry filter press, 468  
 Spray drying in complete absence of air, 397  
 Spray drying processes, 355-363  
 Stabilizers for evaporated milk, preparation and use, 257, 258  
 Stainless steel, 48  
 Stainless steel belt, 340  
 Stale flavor, 442  
 Standardization of ratio of fat to S N F, 137, 140, 162, 194  
   correcting fat shortage, 139  
   fat surplus, 140  
 Standards for milk products  
   Association of American Feed Officials, 493-494  
   Federal Food, Drug and Cosmetics Administration, 487-489  
   Quartermaster Corps, U. S. Army, 490-493  
 Steam  
   relation of gauge pressure to temperature, 99  
   relation of boiler pressure to steam pressure used in pan, 98  
   requirements for forewarming by live steam injection, 93, 94  
   forewarming by steam heated metal surfaces, 94  
   condensing, 96  
 Steam distribution nozzles for pan coils, 103  
 Steam purifiers, 95, 96  
   traps, 103  
 Sterilization of equipment  
   place of chemical sterilizers, 110  
   proper strength of, 111  
   steam sterilization, 110  
 Sterilization of evaporated milk, 229  
   effect on bacterial sterility, 238  
   color, 252  
   cooked flavor, 253  
   heat stability, 238  
   viscosity, 248  
 Sterilized sweet cream, butter-fat content, 285  
   manufacture, 284-287  
   Avoset stabilized cream, 287-289  
   manufacture, 288  
   packaging, 289  
 Sterilized sweet milk, manufacture, 283  
 Stickiness and caking; causes and prevention, 401-408, 409-414, 431-432  
 Storage of, dried milks, 447  
   evaporated, plain and sweetened condensed milk, 250, 293-295  
   Storage temperatures, 324, 393, 447  
   Strainers, in milk line, 129, 130  
     on weigh cans, 129  
   Striking the batch, 156, 200  
   Sublimation of milk ice, 339  
   Submarine Signal Sonic oscillator, 219  
   Sucrose crystals, 22  
   Sucrose in dried milks, 26, 447  
   Sugar in sweetened condensed milk, 21  
     amount to use, 151  
     dissolving, 148, 149, 153  
     effect on age thickening, 154  
     formula for calculating amount to use, 152  
     quality and care of, 150  
     refined liquid sugar, 155  
     time of adding, 154  
   Sugar of milk (see lactose and milk sugar)  
   Sugar-protein complex, 11, 252, 253, 437  
   Sugar sediment, 319  
   Sulphvdryl, 254, 384  
   Superheated condensed, 265  
     procedure, 266-268  
   Superheated steam, 92  
     conversion to saturated steam, 101  
   Sweetened condensed milk  
     defects, 294, 306-313, 318-321, 325-327  
     manufacture, 133  
     specific gravity, 9  
   Sweetened condensed skimmilk, manufacture of, 180  
   Sweetened condensed whey, 184  
   Tallowy flavor, in dried whole milk, 379, 443-447  
     in milk, 462  
     in sweetened condensed milk, 326  
   Technical control of evaporated milk, 257, 260  
   Technical lactose, manufacture of, 471-473  
   Thermal inactivation of enzymes, 315  
   Thermodynamic aspects of  
     condensing milk in vacuo, 52-62  
     drying milk, 364  
   Thiamin, 459  
   Titratable, acidity, 477  
     effect on heat coagulation, 6  
   Tocopherol, 383, 459, 464  
   Torsion viscosimeters, 481  
   Torula lactis condensis, 309  
   Total solids, 4  
   Toxemia, 464  
   Tracifyer steam purifier, 96  
   Transportation facilities, 44  
   Tricalcum citrate, 254  
   Trypsin use of, for high grade technical lactose, 472  
   Tubular evaporators, 69, 70  
   Uncoagulated whey protein, effect on stickiness, 410  
   Underweight can detector, 235

- Vacuum break, 66, 89  
 Vacuum cooler, for sweetened condensed milk, 176  
 Vacuum drum dryers, 350  
 Vacuum, effect on rapidity of evaporation, 56  
 Vacuum gauge fluctuations, 58  
 Vacuum pan unit  
   description of, 63-83  
   operation of, 84-91  
   mechanical care, 91  
   sanitary care, 84, 110  
 Vacuum pump, dry, 81  
   wet, 80  
 Vacuumizing and gas packing, 392, 394  
 Vacuumizing cans, drums and tanks, 390, 395  
 Vacuumizing pump, 396  
 Vapor space, 66  
 Viosterol, 462-464  
 Viscolizer, 210  
 Viscosimeters, 260, 481, 483  
 Viscosity flow meters, 482  
 Viscosity of evaporated milk  
   influenced by, 248-252  
   technical control of, 257-264  
 Viscosity of sweetened condensed milk, 307, 308, 320-325  
   initial viscosity, 324  
 Viscosity tests, 260, 481  
 Vitagens, 383, 465  
 Vitamin D, evaporated milk, 205-207, 464  
 Vitamins, 1, 458-466  
   classification of, 459  
   distribution in milk products and in nature, 461-465  
   functions in nutrition, 461-465  
   requirements for different ages, 459  
   resistance to processing, 460-465  
 Washing compounds, 108  
 Washing factory equipment, 109  
 Washing milk cans, 112  
 Water, in milk, 1  
   in sterilizer, 231  
 Water leg of barometric condenser, 77  
 Water supply, 43  
   amount required in condenser, 78  
 Water vapor, 341  
 Wet steam, 92  
 Wet vacuum pump, 80  
 Wetting agents, 108  
 Wheat flour paste in barley mash, 417  
 Whey, composition of, 4, 5  
 Whey powder, from acid casein whey, 426, 468  
   cheese whey, 426, 469  
   rennet casein whey, 469  
 Whittier, 20, 467  
 Wimmer process, 342  
 Whipping properties of sterilized cream, 285, 288  
 White metals, 47  
 Whole milk powder, manufacture of, 379  
   cost of canning, 397  
 Woman's milk, 2  
 Xerophthalmia, 1, 460  
 Yeast contamination causing bloats in sweetened condensed milk, 308-310  
 Yield of dried milks, 425  
 Zarembo recompression evaporator, 105

## LIST OF ADVERTISERS

Allegheny Ludlum Steel Corporation.....	505
Anderson-Barngrover Div., Food Machinery Corporation.....	506, 507
Bausch & Lomb Optical Company.....	508
Beach-Russ Company .....	550
James Bell Machinery Pty. Ltd.....	509
Berlin Chapman Company.....	508
Blaw-Knox Company .....	510
Buell Engineering Company, Inc.....	511
Bufllovak Equipment Div. Blaw-Knox Company.....	514
Cherry-Burrell Corporation .....	512, 513
Chester Dairy Supply Company.....	559
Creamery Package Manufacturing Company.....	516, 517
DeLaval Separator Company .....	515
Diamond Crystal Salt Company, Inc.....	528
Dickerson, The F. G., Company .....	518
The Diversey Corporation.....	519
C. Doering & Son, Inc. ....	522, 523, 524
Drying & Concentrating Company .....	520
General Dairy Equipment Company.....	521
Golden Churn Laboratories.....	525
Chr. Hansen's Laboratory.....	528
Arthur Harris & Company .....	526, 527
Henszey Company .....	556, 557
Inland Sugar Company .....	538
International Nickel Company.....	529
Jensen Machinery Company .....	530, 531
Kalamazoo Vegetable Parchment Company.....	532
Kimble Glass Company.....	533
Lithgow Corporation .....	538
Illinois Creamery Supply Company.....	534
Mathieson Alkali Works.....	542
Meyenberg Milk Products Company.....	535
Mojonnier Bros. Company .....	536, 537
Monarch Manufacturing Works .....	539
Nash Engineering Company.....	540

Oakite Products, Inc.....	542
Pfautler Company, The .....	541
Pennsylvania Salt Manufacturing Company.....	543
Pulverizer Machinery Company.....	560
Raymond Pulverizer Div., Combustion Engineering Company.....	544
Rice and Adams Corporation.....	544
Rogers Company, C. E.....	545
George Scott & Son (London) Limited.....	546
Solvay Sales Corporation.....	550
Sperry & Company, D. R.....	550
Stokes & Smith Company .....	550
Stoelting Bros. Company.....	552
Submarine Signal Company.....	552
Taylor Instrument Companies .....	547
Toledo Scale Company .....	551
Tri-Clover Machine Company.....	548, 549
Waukesha Foundry Company.....	554
Western Precipitation Corporation.....	553
Whiting Corporation, Swenson Evaporator Div.....	555
Wyandotte Chemical Corporation .....	554
Zaremba Company .....	558

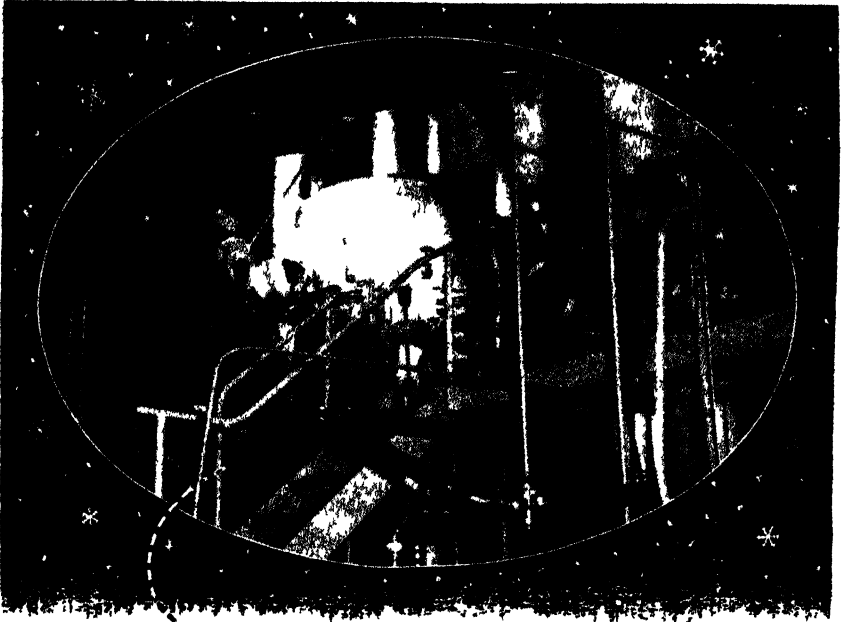

## ALLEGHENY METAL

*keeps powdered and condensed milk  
as pure and clean as driven snow*

**C**LEANLINESS and purity are essential in the milk industry. *Allegheny Metal*, the time-tested stainless steel, assures both. The heart of the condensery and milk powder plant is the vacuum pan, whether it be the conventional type, depending on helical coils for its heating surfaces, or the more modern recirculating tubular evaporator, like the one shown above. Every part of the pan must present a

contamination free surface to the milk, and experience indicates stainless steel.

Allegheny Metal has proven its value through many years of successful service in every phase of production, processing, storage and transportation of milk and milk products. It is recommended and used by leading fabricators of dairy machinery and equipment.

*Allegheny Metal*



THE PIONEER STAINLESS STEEL

*Allegheny Ludlum*

STEEL CORPORATION

BRACKENRIDGE, PA.

Branches in Principal Cities

ALSO AVAILABLE IN ALL JOSEPH T. RYERSON & SON, INC. WAREHOUSES

# ANDERSON-BARNGROVER FOR EVAPO

## No Labor from Filling

### Continuous Sterilizers

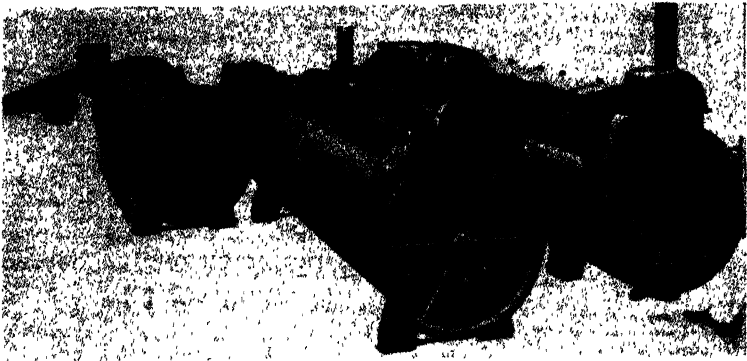

Cuts costs, eliminates swells and leaks, produces better and more uniform quality, allows direct labeling, economizes steam, saves floor space and reduces labor.

## FOOD MACHI Anderson - Barn

San Jose, California

New York, N. Y.

Portland, Oregon

Los Angeles, California

Factory at

# PROCESSING EQUIPMENT RATED MILK

## Machine to Packing Case

### High-Velocity Heaters

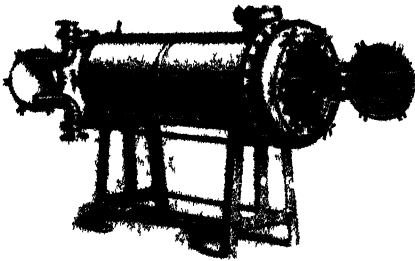

Heats to any temperature up to 300° F. without objectionable coating of tubes. Capacity 4,000 to 60,000 lbs. per hour.

### Fillers

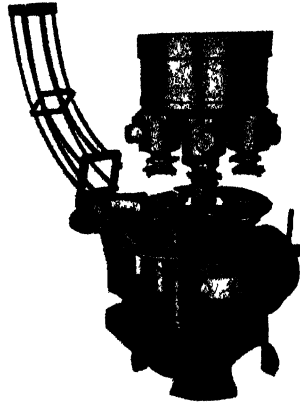

No foaming, accurate measure, sanitary construction, labor saving.

**NERY CORP.**  
grover Division.

Chicago, Illinois

Washington, D. C.

San Francisco, California

San Jose, California



# COUNTING BACTERIA

*rapidly and accurately*

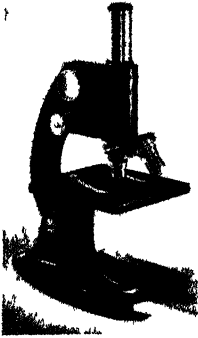

Many dairies are making milk examinations more quickly and more accurately by using the Breed and other officially approved methods which involve the counting of bacteria rather than colonies.

The Bausch & Lomb BA Microscope is ideally adapted to this type of work. An extra large stage and smoothly operating mechanical stage aid in the systematic examination of large slides. Accessories for the various counting methods are available.

## STONE COLONY COUNTER

For convenience in counting colonies of bacteria, Bausch & Lomb offer a Stone Colony Counter mounted on an adjustable stand.

Further information on either of these instruments can be obtained from the Bausch & Lomb Optical Company, 685 St. Paul St., Rochester 2, N. Y.

# Bausch & Lomb

## REVOLVING AGITATING

The Berlin Chapman Sterilizer is used for processing milk and other foods which require agitating cage. Usually set-up in a battery of 4 to 5 for one line of food at 120 cans per min. Completely equipped with thermometer, combined pressure and vacuum gauge, tight and loose pulley, interior piping or valves, one cage, one cage truck and 96 trays.

## 30 CASE STERLIZER

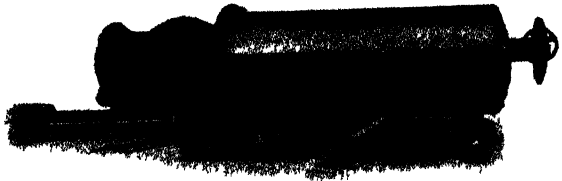

*Used Extensively by America's Largest Packers*

These Sterilizers were originally designed as a standard machine for Evaporated Milk and have been giving satisfactory service for over 20 years.

# Berlin Chapman

CANNING MACHINERY FOR ALL FOOD PRODUCTS

WATCH FOR  
BERLIN  
CHAPMAN'S  
NEW  
DEVELOPMENTS

# Put An End to Waste

and recover with profit that which  
today is not being put to best use  
such as

## Buttermilk and Whey

This simple TWIN ROLLER DRYER  
provides the means for doing so  
at a low production cost  
and a minimum capital outlay.

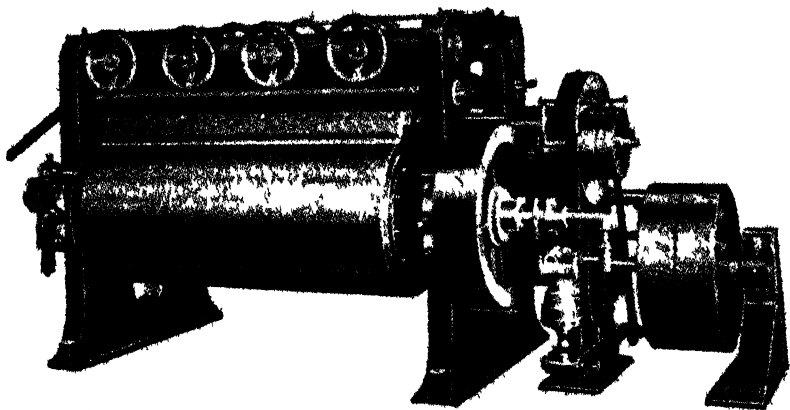

We have this and other modern equipment  
to serve in the manufacture  
of the products of the cow,  
and invite you to contact with us.

**James Bell Machinery Pty. Ltd.**

200 King Street, MELBOURNE:

and at —

108 Roma Street, BRISBANE.

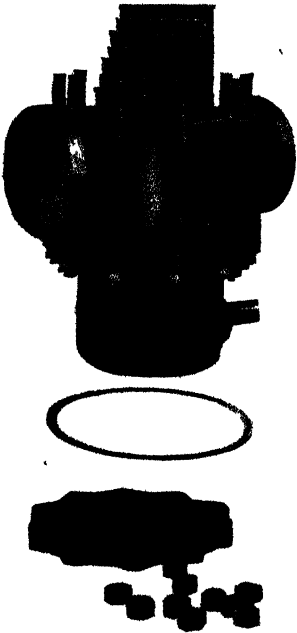

When used as direct heating medium, ordinary steam contaminates and endangers the uniformity and quality of your product.

The Blaw-Knox Tracyfier insures clean-dry steam, 100% free from moisture, scale, rust, oil or other impurities.

The original cost is moderate and up-keep is held to a minimum by the use of high quality material including *stainless steel* baffles. Construction of the unit is such that access is convenient without removing the unit from the steam line.

Repeat orders from the Drug, Pharmaceutical and Chemical industries are an indication that Blaw-Knox Tracyfiers have established themselves as an economical means of continuously providing clean, dry steam.

For more details write for Bulletins Nos. 1565 and 1929.

**BLAW-KNOX DIVISION OF BLAW-KNOX COMPANY**  
Farmers Bank Building - - - Pittsburgh, Pa.



# BUELL COLLECTORS *for* POWDERED MILK

● Diagram to the right shows the effect of the "double eddy current" on dust travel within Buell (van Tongeren) cyclone. See page 169 for article on Buell Powder Collectors..

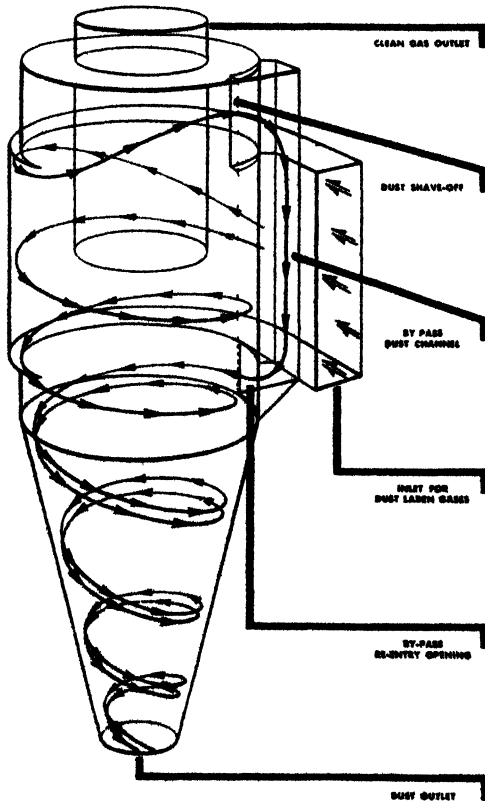

→ Pattern of dust stream (principally the finer particles) following upper half of double eddy current

→ Pattern of dust stream following path of lower half of double eddy current



**BUELL ENGINEERING COMPANY, INC.**

70 Pine Street, New York 5, N. Y.

*Sales Representatives in Principal Cities*

**DESIGNED TO DO A JOB, NOT JUST TO MEET A "SPEC"**



## **COMPLETE EQUIPMENT *for***

★ Cherry-Burrell builds a full line of modern, plant-tested equipment for dairy products plants. Each size or type is designed to coordinate with associated equipment in your plant, whether you need one machine or complete equipment for an entire plant. You can be sure of getting the right machines for

# **CHERRY-BURRELL**

*427 West Randolph Street*

**ENGINEERS AND MANUFACTURERS OF**

# DAIRY PRODUCTS PLANTS

your individual requirements.

The services of our experienced sales engineers and dairy plant specialists are available to help you with your problems.

Cherry-Burrell equipment is backed by a world-wide sales and service organization. You will find Cherry-Burrell equipment in the better plants wherever you go.

## CORPORATION

*Chicago 6, Illinois*

DAIRY PRODUCTS PLANT EQUIPMENT

# *Buflovak*

## MILK DRYERS and EVAPORATORS

In the Dairy Industry, the name BUFLOVAK stands for equipment that produces high quality dry and evaporated milk products, at the lowest production costs . . . Top quality products that demand peak market prices give larger profits.

BUFLOVAK has pioneered in the development of Roller Process Milk Dryers of both the Atmospheric and Vacuum types.

Double Effect Milk Evaporators, that cut steam and cooling water directly in half, is another BUFLOVAK development.

BUFLOVAK Milk Dryers and Evaporators are described in this Edition of Dr. Hunziker's book.

For complete information, send for these two interesting bulletins . . . they will show you how to get larger profits from your processed milk products.

Milk Dryer Bulletin No. 327

Milk Evaporator Bulletin No. 329

**BUFLOVAK EQUIPMENT**  
**Division of Blaw-Knox Company**

**49 Winchester Avenue**

**Buffalo 11, New York**

# Why Clarify Milk?

The De Laval "Air-Tight" Milk Clarifier is today being used in outstanding milk plants to insure the removal of sediment from milk for the following reasons:

## Improved Sanitation

The "Air-Tight" Clarifier removes sediment — doesn't just dissolve or scatter it—and does its work in a sanitary manner.

## Better Flavor

Operating with milk at low temperature, the "Air-Tight" removes impurities before they affect the flavor of the product.

## Greater Economy

The "Air-Tight" Clarifier completes long runs without cleaning and operates with minimum upkeep and without cost for supplies.

## Indispensable

In the case of homogenized milk, the "Air-Tight" Clarifier is the only available means of appreciably reducing the excessive number of cells which cause sediment or "cloud" to appear. It is equally necessary with short-time pasteurizing systems and in the production of whole milk powder or the manufacture of high-score cheese.

Regardless of the size of your plant or the type of your equipment, there is a De Laval "Air-Tight" Milk Clarifier which will further improve your product. Write for details.

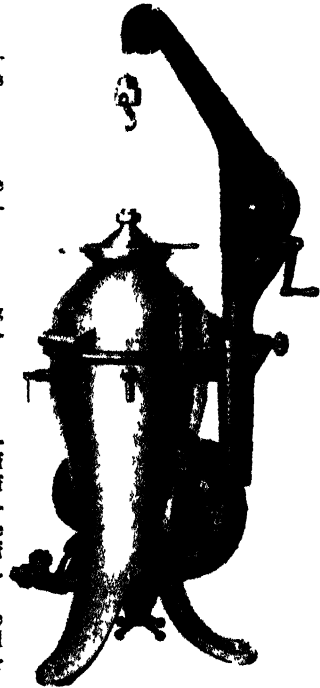

## THE DE LAVAL SEPARATOR COMPANY

165 Broadway, New York

427 Randolph St., Chicago

DE LAVAL PACIFIC COMPANY, 61 Beale St., San Francisco

THE DE LAVAL COMPANY, Limited

MONTREAL

PETERBOROUGH

WINNIPEG

VANCOUVER

# DE LAVAL

Also manufacturers of the  
"Air-Tight" Separator

**AIR-TIGHT MILK CLARIFIER**





# QUALITY EQUIPMENT FOR THE DAIRY INDUSTRY

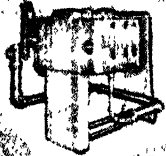
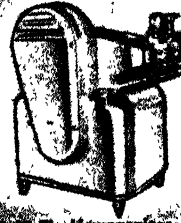
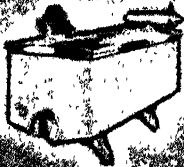

Plate Heat Exchanger



Homogenizer



Storage Tank

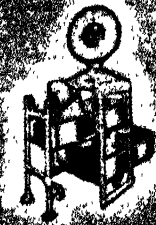

Can Washer

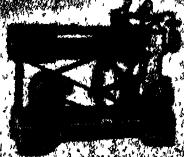

Canning Machine

For nearly 60 years Creamery Package has made dairy machinery and has gained a world-wide reputation for building quality equipment. Whether you need a Plate Heat Exchanger, Homogenizer, Storage Tanks or Refrigeration—CP makes it. . . Sanitary Economical—Efficient—Dependable.

\*\*\*\*\*

Have other CP equipment for the Dairy Industry

- BOVINE AND CAN WASHERS
- PASTEURIZERS
- MILK PROCESS TANKS
- GLASS AND CAPPER
- CONDENSERS
- CHILLERS
- STERILIZERS
- MILK CANNERS

**THE CREAMERY PACKAGE MFG. COMPANY**

2000 WASHINGTON ST. N. MINNEAPOLIS, MINN.  
 1245 W. WASHINGTON ST. CHICAGO, ILL.  
 LONDON, ENGLAND



# SUPPLY HEADQUARTERS FOR THE DAIRY INDUSTRY

Creamery Package maintains a complete line of supplies for each phase of dairy products processing. Supplies or equipment—all available from one source. Coast to coast service from CP Branches located at Atlanta, Boston, Buffalo, Chicago, Dallas, Denver, Kansas City, Los Angeles, Minneapolis, Nashville, New York, Omaha, Philadelphia, Portland, Salt Lake City, San Francisco, Seattle, Toledo and Waterloo.

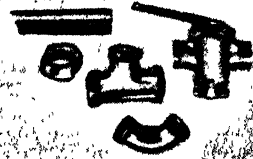

Sanitary Fittings



Roller Seal Pump

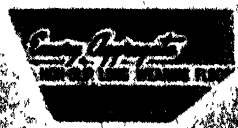

Roller Seal Pump

See other CP Supply Items

- PAINTS
- METAL SPONGES
- FILTER PAPER
- PLASTIC TUBING
- GLASSWARE
- MEASURING AND DISPENSING
- LABORATORY EQUIPMENT

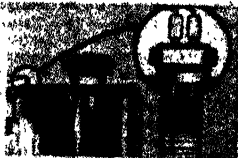

**THE CREAMERY PACKAGE MFG. COMPANY**

Sales Branches in 19 Principal Cities  
 General Offices: 1243 W. Washington Blvd., Chicago 7, Ill.  
 Toronto, Canada • London, England

# **DICKERSON**

## **VENT FILLERS AND SEALERS**

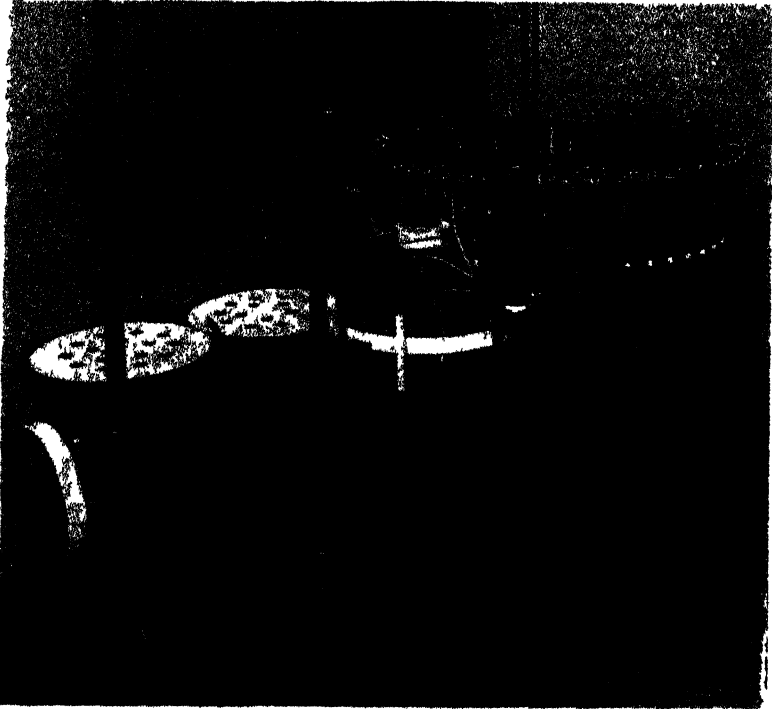

**THE ACCEPTED STANDARD OF  
THE EVAPORATED MILK INDUSTRY  
FOR THIRTY-THREE YEARS**

*Manufactured and Sold by*

**THE F. G. DICKERSON COMPANY**

**312 N. LAVERGNE AVE.**

**CHICAGO 44, ILL.**



## The Problem

In condenseries, general cleaning methods have proved inadequate in removing heavy milkstone deposits from vacuum pans, tubular evaporators, tubular heat exchangers and coolers. How to clean this type of equipment is the problem.



## The Answer

Use Diversey specialized products and sanitation methods! The research laboratories of the Diversey Corporation have developed a simple and effective method for removing these stubborn milk deposits . . . the difficult task becomes an easy and economical one, requiring little or no manual labor. Complete cleaning, and increased operating efficiency of the plant equipment is insured.

To secure information about this procedure call in a Diversey D-Man. He is a specialist in condensery plant sanitation . . . at your service, without obligation. He will show you why Diversey's approved cleaning and sanitation methods have been adopted by some of the largest condenseries in the country.

Write for details.

**THE DIVERSEY CORPORATION**

53 WEST JACKSON BLVD. CHICAGO 4, ILLINOIS

---

*Improved Process*  
**Centrifugal Spray Dryer  
and Concentrator**

**T**HE Drying and Concentrating Company Spray Drying Plant (described and illustrated on pages 362-363 is the ideal complete plant for producing the highest quality spray dried milk products at the lowest operating cost.

You are invited to send for descriptive booklet.

**DRYING AND CONCENTRATING COMPANY**

332 South Michigan Blvd.

Chicago, Illinois

## EFFICIENT EQUIPMENT for the PROGRESSIVE CREAMERY!

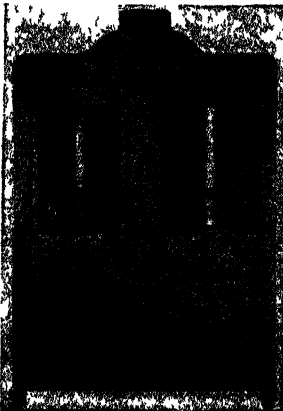
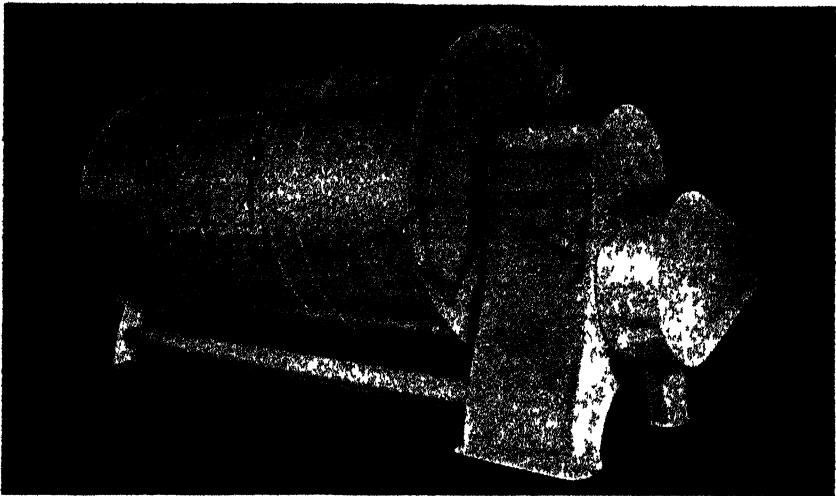

**ECONOMY CAN WASHER**—Most compact on the market. Requires only 33x48" floor space. Automatically cleans, sterilizes, and dries cans and covers in one operation. Economical, long-lasting, and easy-to-use!

**RED HOOK BOX CAN TRUCK**—Saves time and money—labor—wear and tear on equipment. Will handle a 90 pound butter box on one side and 5, 8 and 10 gallon cans on the other.

**VANE CHURN**—Unqualified choice of hundreds of satisfied users. Criss-Cross working principle insures more butter from same amount of cream; butter with finer, waxier body, and better keeping quality.

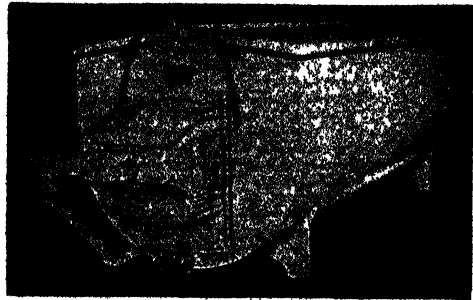

**OVL-KOIL PASTEURIZER**—Many new and exclusive features, including the oval shaped coil which provides faster heating and cooling. Full opening cover with no center board, totally enclosed drive, easy-to-pack glands and battleship construction.

**LINCOLN BUTTER BOX**—Galvanized or stainless steel corner irons, the best lumber, expertly fitted—Made to fit all types of box printers.

### GENERAL DAIRY EQUIPMENT CO.

MINNEAPOLIS, MINNESOTA

## C. DOERING & SON, INC.

1375 West Lake Street

Chicago 7, Illinois

Butter Cutting and Printing Machines  
 Tub and Cube Cutters  
 Butter Patty Cutting and Embossing Machines

### DOERING BUTTER PRINT MACHINE (Large Size)

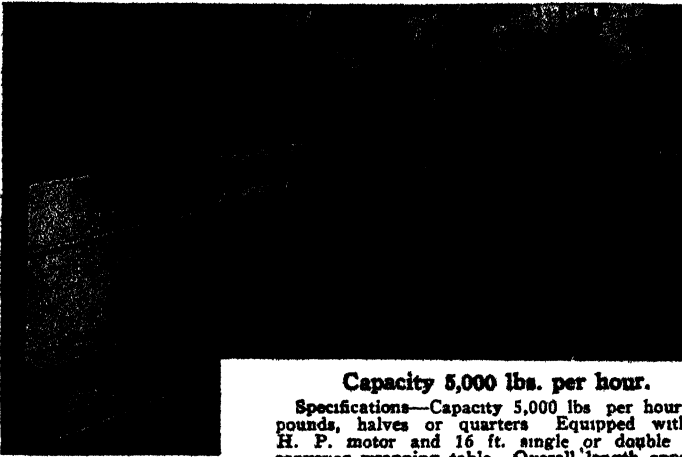

Capacity 5,000 lbs. per hour.

Specifications—Capacity 5,000 lbs per hour, in pounds, halves or quarters. Equipped with 5 H. P. motor and 16 ft. single or double belt conveyor wrapping table. Overall length approximately 28'. Floor space 28'x3'2".

This machine can be furnished without table for direct connection to the automatic wrapping machine, in which event the length of the machine is approximately 10' long.

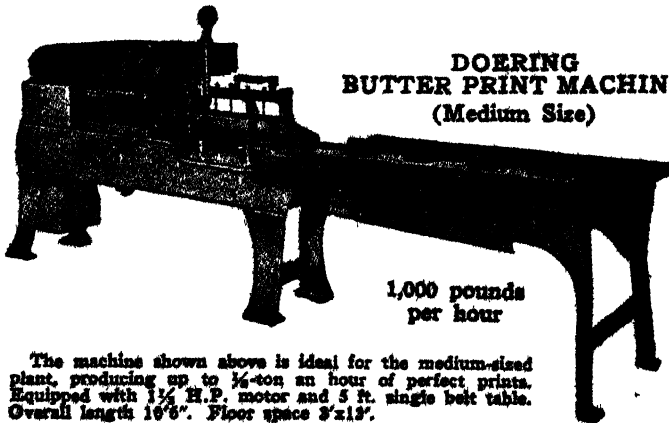

DOERING  
 BUTTER PRINT MACHINE  
 (Medium Size)

1,000 pounds  
 per hour

The machine shown above is ideal for the medium-sized plant, producing up to  $\frac{1}{4}$ -ton an hour of perfect prints. Equipped with  $1\frac{1}{2}$  H.P. motor and 5 ft. single belt table. Overall length 16'6". Floor space 8'x13'.

**LOW IN OPERATIONAL EXPENSE**

## war time conservation required no changes in DOERING BUTTER PRINTERS

DOERING  
BUTTER PRINT MACHINE  
(Small Size)

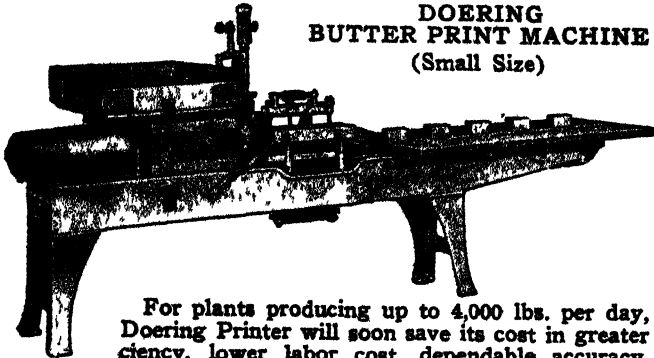

For plants producing up to 4,000 lbs. per day, this Doering Printer will soon save its cost in greater efficiency, lower labor cost, dependable accuracy and production speed.

Specifications—Capacity 500 lbs per hour, in pounds, halves or quarters. Equipped with  $\frac{3}{4}$  H. P. motor and 5 ft single belt table. Overall length 10'. Floor space 3'x11 $\frac{1}{2}$ '.

### DOERING POWER TUB CUTTER

Equipped with  $\frac{3}{4}$  H. P. motor is rigidly constructed, and has ample power to cut the hardest storage butter. The operation is very simple. The pressing of a lever, raises a platform on which the butter, stripped of its parchment, is carried up through a rigid cutting frame and delivered into the hopper of the print machine. Hands need not touch the butter. This machine is a great labor saver where storage butter is printed in volume. Floor space 5'x2 $\frac{3}{4}$ '.

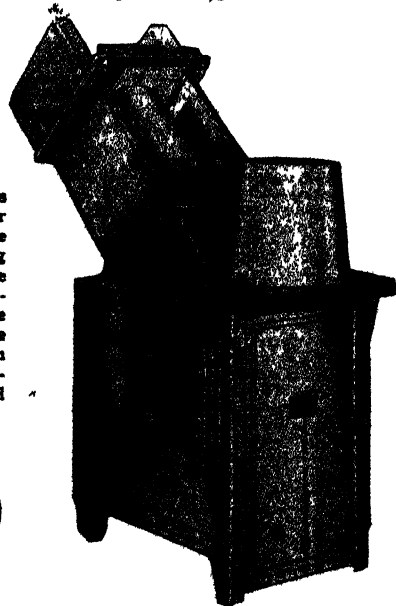

## HIGH IN PRODUCTION EFFICIENCY



# C. DOERING & SON, INC.

1375 West Lake Street

Chicago 7, Illinois

Butter Patty  
and Embossing  
Machines

No. 86 Automatic Butter Patty Cut-  
ting and Embossing Machine.



Doering manufactures  
two models — AUTO-  
MATIC and SEMI-AUTO-  
MATIC — to serve every  
size of plant.

Special dies made for  
monograms, trade  
names or designs.

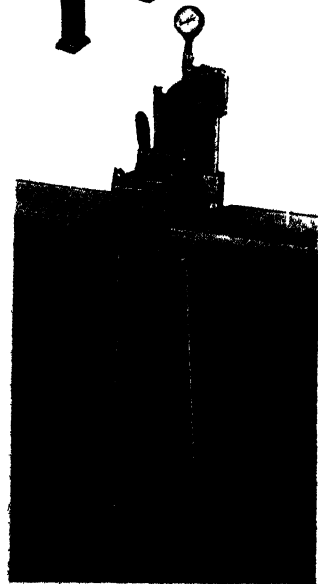

DOERING No. 79 Semi-Automatic But-  
ter Patty and Embossing Machine.

**MAKES BUTTER EXCLUSIVE**

# ACKNOWLEDGMENT

Golden Churn Laboratories acknowledges this debt of gratitude to Prof. O. F. Hunziker for his early experiments and co-operation in standardizing for actual butter making practice a new kind of Butter Color.

GOLDEN CHURN BRAND BUTTER COLOR was developed in 1920 by Leon Adler, at the suggestion of Prof. Hunziker.

GOLDEN CHURN BRAND BUTTER COLOR was the answer to his search for a Butter Color that remains free of sludge; that does not settle out; that has better keeping qualities; and that colors butter a natural golden June shade.

GOLDEN CHURN BRAND BUTTER COLOR was then adopted by the many creameries of Blue Valley Creamery Company, and used by them from 1922 to 1939 when the company was dissolved.

You will be using a tried and proven Butter Color, and following wise leadership, if you use GOLDEN CHURN.



**GOLDEN CHURN LABORATORIES**  
**SAINT LOUIS, MISSOURI**

*“Back to Nature with GOLDEN CHURN”*



Modern, sanitary installations of Harris stainless steel vacuum pan in milk condensing plants.



### Vacuum Pans—Evaporators For Condensing Milk Products

Batch and continuous system.

Single and multiple effect.

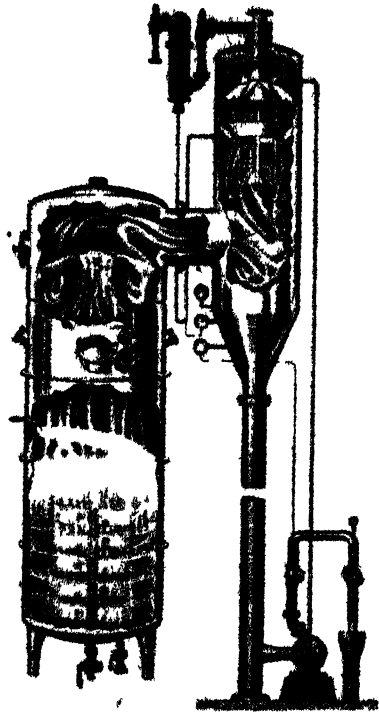

Harris patented stainless steel vacuum pan with entrainment separation chamber for complete recovery of milk losses.

Free flowing counter current condenser.

Stream lined coils.

**ARTHUR HARRIS & COMPANY, Chicago**  
Vacuum pans, Evaporators, Heat exchanging equipment.



### Entrainment Separator Chamber

Milk losses from vapor carry over into condenser, vary from  $\frac{1}{2}$  to  $2\frac{1}{2}$ % of total solids determined by biological oxygen demand method.

Harris patented entrainment separator for complete recovery of milk solids in existing vacuum pan installation.

### Coolers for Sweetened Condensed Milk Products

*Evaporation type cooler.*

*Vacuum vat cooler.*

*Tubular counter current cooler.*

High pressure stainless steel cooler illustrated:

Single tube flow.

Counter current type.

Sanitary removable return bends.



### Milk Preheaters

*Re-circulation type and single pass stainless steel tubular milk heaters complete with hot wells and milk pumps for pre-heating skim and whole milk ahead of evaporators and dryers.*

## ARTHUR HARRIS & COMPANY

Engineers—Designers—Builders of Milk Condensing Equipment  
212 N. ABERDEEN STREET CHICAGO 7, ILLINOIS



Ever look through a microscope at Butter Salt showing greater specific surface? Not unless it was another sample of **DIAMOND CRYSTAL!** Salt like this dissolves rapidly. The sample illustrated dissolved completely in 9.2 seconds at 65° F—really fast as butter salts go, but just average for **DIAMOND CRYSTAL.** Try it and see for yourself.

## YOUR STAR SALESMEN



### "HANSEN'S" ANNATTO BUTTER COLOR

Gives a uniformly natural, rich, yellow hue to butterfat. A pure vegetable product made from choice grade Annatto Seed.



### "HANSEN'S" CERTIFIED BUTTER COLOR

For maximum coloring power at minimum cost. Pure vegetable oil base. Every batch certified by U.S. Government. Unexcelled in keeping quality.



### "HANSEN'S" STARTER DISTILLATE

Ideal for standardizing the flavor and aroma of butter. Produced under strict laboratory control—always of standard high quality.



DR. HANSEN'S LABORATORY, Inc., Milwaukee, Wisconsin

## Recommended Materials of Construction in Evaporated or Sweetened Condensed Milk Equipment

(See Chapter "METALS IN DAIRY EQUIPMENT")

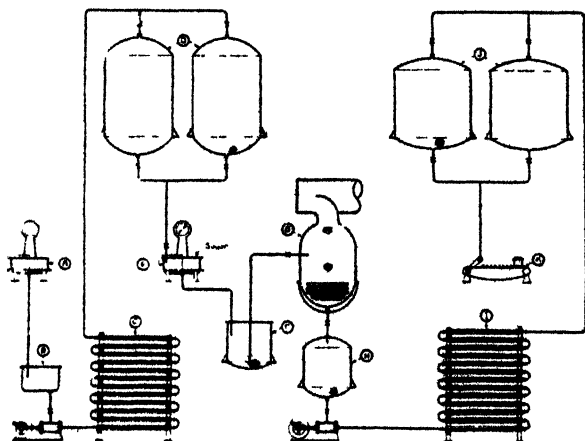

- |  |  |
|--|--|
| A. Weigh Tank .....                                    | Inconel or Pure Nickel   |
| B. Pump Reservoir .....                                | Inconel or Pure Nickel   |
| C. Fluid Milk Storage.....                             | Nickel or Inconel Tubes  |
| D. Fluid Milk Storage.....                             | { Pure Nickel or Inconel<br>Nickel-Clad Steel or Inconel-Clad Steel                |
| E. Weigh Tank .....                                    | Inconel or Pure Nickel   |
| F. Hot Well .....                                      | Inconel or Inconel-clad Steel  |
| G. Evaporator .....                                    | { Body—Inconel-Clad Steel or Nickel-Clad<br>Steel Coils or Tubes—Nickel or Inconel |
| H. Drop Tank .....                                     | { Pure Nickel or Inconel<br>Nickel-Clad Steel or Inconel-Clad Steel                |
| I. Condensed or Evaporated Milk<br>Cooler .....        | { Nickel for Condensed Milk<br>Inconel Tubes for either product                    |
| J. Condensed or Evaporated Milk<br>Storage Tanks ..... | Nickel-Clad Steel or Inconel-Clad Steel  |
| K. Filling Machine .....                               | Nickel or Inconel parts  |
| Sanitary Piping .....                                  | { Pure Nickel, except between F and G.<br>Inconel may be used for all piping.      |

*Available publications sent on request:—*

- Bulletin T-5—"Engineering Properties of Monel"**  
**Bulletin T-7—"Engineering Properties of Inconel"**  
**Bulletin T-15—"Engineering Properties of Nickel"**

**THE INTERNATIONAL NICKEL COMPANY, INC.**  
**57 Wall Street, New York 5, N. Y.**

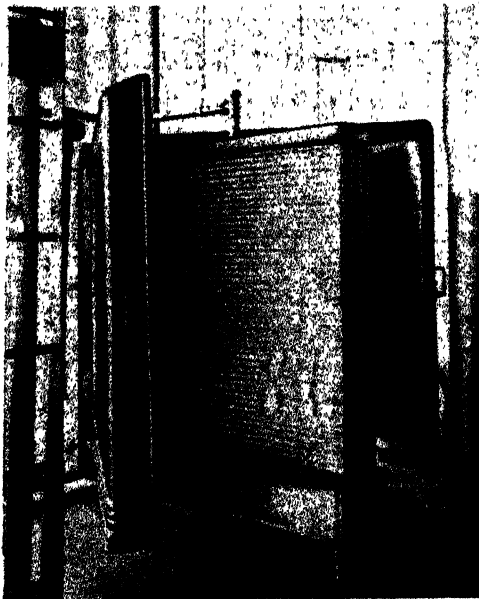

*Evaporated milk cooler in actual operation*

### **Jensen Fan Cooler**

It's the patented "short gas flow" feature that makes the Jensen Fan Cooler more efficient. You can use higher back pressures—yet cool to lower temperatures which saves money. Made of glistening stainless steel, the wings swing widely apart for easy cleaning. *Ideal to use when your compressor is under-capacity!*

**Designed for**

*Efficiency!*

The chief aim of Jensen engineers is to design easy-to-clean equipment for prolonged service — equipment to produce a *better product at less cost!* Listed are "special" features of each machine.

### **Jensen Square Vertical Coil Machine**

Here's a perfect cooler for condensed and evaporated milk. It eliminates crystallization, furnishes the correct amount of agitation to produce a smooth product, *removes air*, and prevents contamination because there are no stuffing boxes in contact with the product.

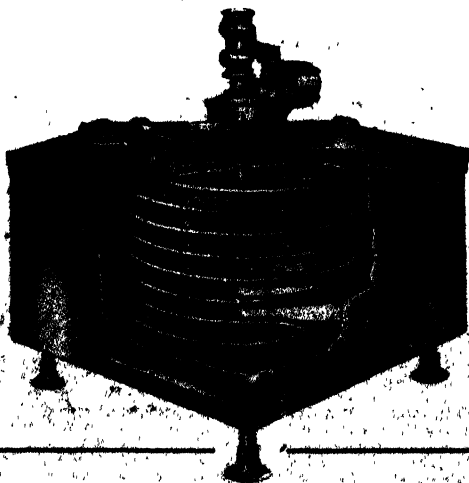

*Cutaway view showing air-removing feature*

### Jensen All-Metal Churn

*Positively Sanitary!* The Jensen All-Metal Churn can be sterilized with live steam or boiling water. (It can't warp, splinter, or develop unsanitary cracks). The kneading action produces firm, waxy-bodied, high-scoring butter. Tests show a minimum moisture variation. Because the churn is made of *special* aluminum alloy, butter does not stick.



2,000-lb. Jensen All-Metal Churn

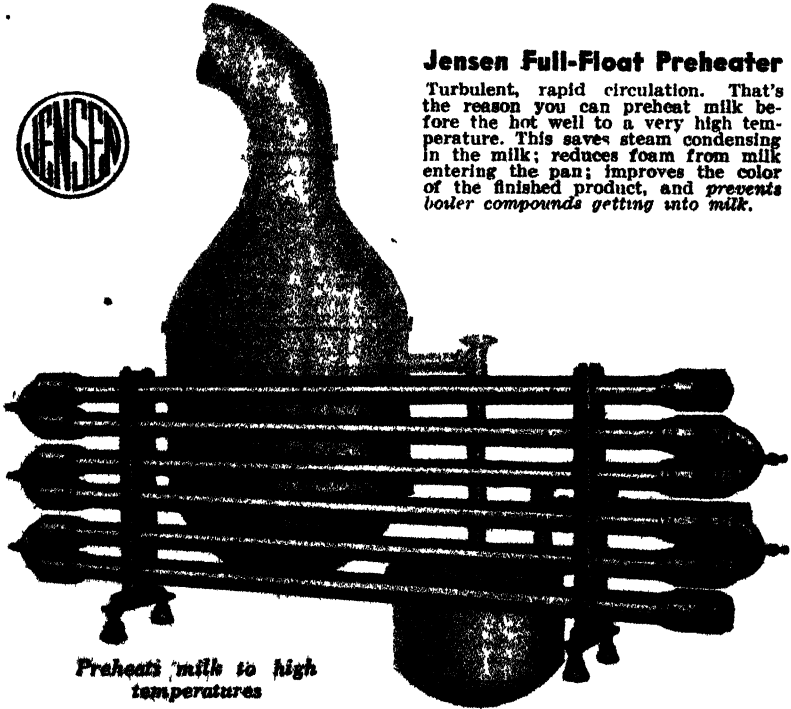

### Jensen Full-Float Preheater

Turbulent, rapid circulation. That's the reason you can preheat milk before the hot well to a very high temperature. This saves steam condensing in the milk; reduces foam from milk entering the pan; improves the color of the finished product, and *prevents boiler compounds getting into milk.*

*Preheats milk to high temperatures*

**JENSEN MACHINERY COMPANY, INC.**

*Specialists in Individually Engineered Food Equipment*

Bloomfield, N. J.

Oakland, Calif.



# KVP

**papers for  
industries**



THE WORLD'S MODEL PAPER MILL

**KALAMAZOO VEGETABLE  
PARCHMENT • KALAMAZOO**

BUTTER WRAPPERS  
TUB LINERS  
BUTTER BOX LINERS  
MILK CAN TOPS  
MILK BOTTLE HOODS  
ICE CREAM CAN SQUARES  
ICE CREAM BRICK  
AND  
SLICE WRAPPERS  
CHEESE WRAPPERS

**dairy**

ROLLS  
AND  
SHEETS

PRINTED  
OR  
PLAIN



**PARCHMENT CO.**  
KALAMAZOO, MICHIGAN

Acid Measuring glassware  
 Acidometers  
 Automatic Tests  
   Acidity  
   Caustic  
   Chlorine  
   Reductase  
   Salt  
 Babcock test bottles—  
   Paley bottles  
 Beakers  
 Burettes  
 Calipers  
 Color comparison rods  
 Color standards  
 Condensers  
 Cylinders  
 Dividers, reading  
 Droppers  
 Extraction tubes  
 Flasks—Erlenmeyer, extraction,  
   volumetric  
 Funnels  
 Glycol  
 Graduates  
 Hydrometers  
 Lactometers  
 Methylene Blue tablets  
 Microscopic plates  
 Minnesota Babcock reagent  
 Petri dishes  
 Pipettes  
 Rod  
 Stains  
 Syphons  
 Test Tubes  
 Thermometers  
 Tubing

**KIMBLE  BRAND**  
*For Assurance*  
**LABORATORY GLASSWARE**  
*for the*  
**DAIRY INDUSTRY**

Correct design and fabrication and superior materials assured by the skill and experience of Kimble technicians and craftsmen—Accuracy assured by Kimble precise calibration methods and testing—Sturdiness assured by scientific annealing—Ease of reading assured by durable fused-in colored markings—Retested—Ingeniously packed for protection in transit—Completely ready for immediate use and long service.

**Test—Control—Analysis—  
 Research**

*The Kimble line includes glassware apparatus for every need of laboratories in the dairy industries.*



Distributed by leading Dairy Supply Dealers throughout the United States and Canada.

**KIMBLE GLASS COMPANY**  
**VINELAND, NEW JERSEY**

# THE MALLORIZER

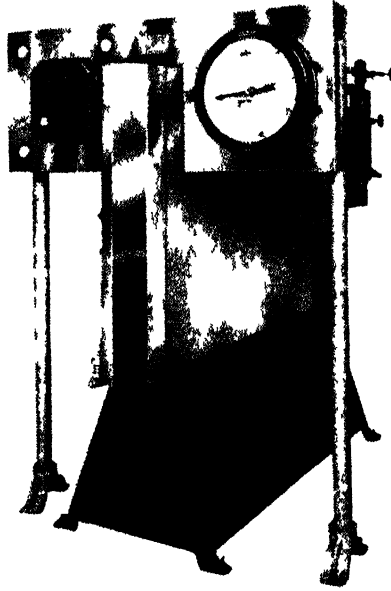

## Heat Exchanger

for

*Evaporated Milk*

*Sweetened Condensed Milk*

*Whole Milk Powder*

## THE MALLORIZER MAKES POSSIBLE

*Attainment of high prewarming temperature*

*Better control of HEAT STABILITY, BODY, COLOR AND FLAVOR of evaporated milk*

*Prevention of AGE-THICKENING of sweetened condensed milk, and*

*Longer SHELF LIFE of whole milk powder*

**Illinois Creamery Supply Co.**

715-719 South Damen Avenue

Chicago 12, Illinois



John B. Meyenberg  
*Inventor Evaporated Milk*



# MEYENBERG Milk Products Co.

*Manufacturers*

of

## Evaporated and Condensed Milk

for

### Domestic and Export Trade

***General Office:***

511 South Main St.  
Salinas, California

***Factories:***

Soledad, California  
Ripon, California  
Paso Robles, California

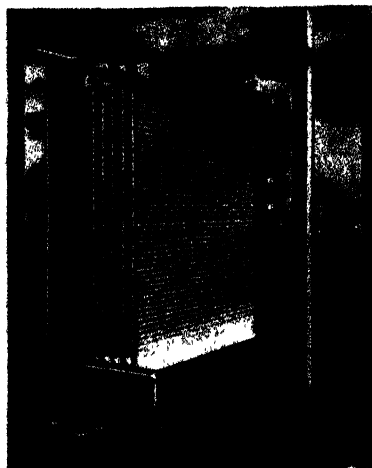
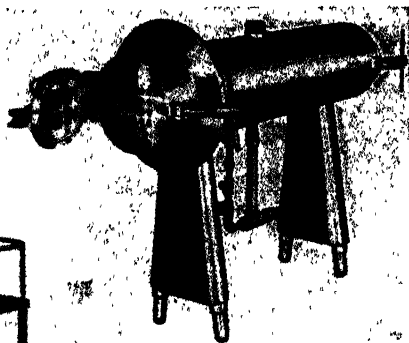
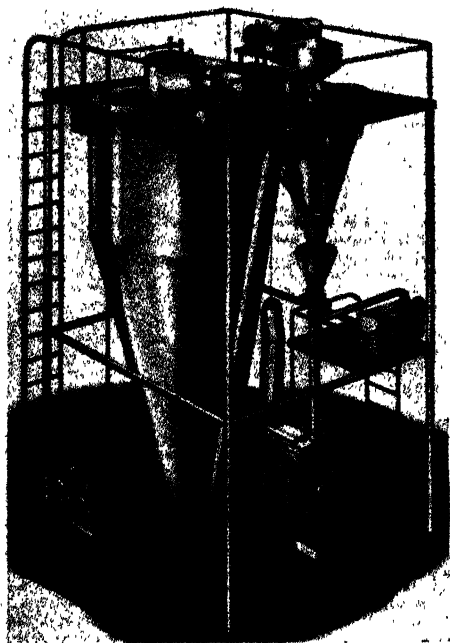

# mojonnier STAINLESS FOR CONDENSING

## NO. 1. SWEETENED CONDENSED MILK COOLER

All welded stainless steel construction, with water ways in the jacket of the vat and scraper type agitator with plastic paddles to gently but thoroughly keep the product in motion, to insure the smallest possible milk crystals in the finished product.

## NO. 2. TUBULAR HEAT EXCHANGER

For heating liquid products in any range up to 210° F. Of stainless steel construction. Easy to clean with only two (2) sanitary round rubber gaskets to remove for cleaning.

## NO. 3. EVAPORATED MILK COOLER

For cooling evaporated milk direct from the evaporator to 34° F. All stainless steel surface type cooler, using flooded ammonia as the refrigerant.

**MOJONNIER BROS. CO., 4601 WEST**

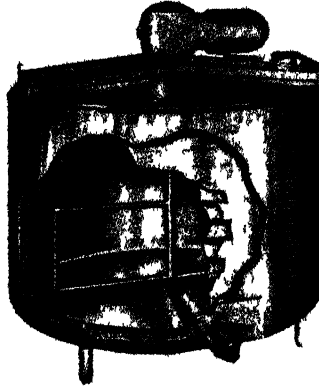
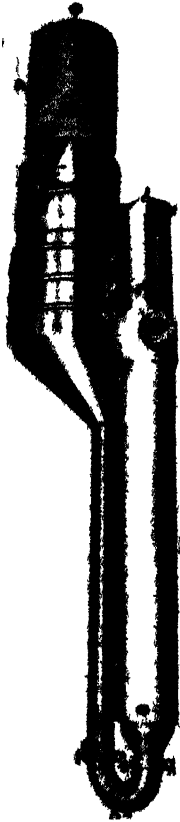

MOJONNIER

ENGINEERED  
QUALITY

# STEEL EQUIPMENT AND DRYING

## NO. 4. MOJONNIER TUBULAR EVAPORATOR

For continuous evaporation and greater concentration. Made in single, double and triple effects. Rapid circulation of product, good vapor separation, and a high rate of heat transfer are some of the built-in features.

## NO. 5. MOJONNIER VACUUM SPRAY DRYER

For drying skim, whole milk and ice cream mix. Stainless steel construction. Made in various capacities.

## NO. 6. MOJONNIER MILK TESTER

For standardizing milk for fats and solids.

**OHIO STREET, CHICAGO 44, ILLINOIS**

# INLAND SUGAR COMPANY

*Refiners  
of  
Liquid Cane Sugar*

**Milwaukee, Wisconsin**

730 West Oregon Street

Phone Broadway 3250

# LITHCOTE LINING

Glass  
Lined

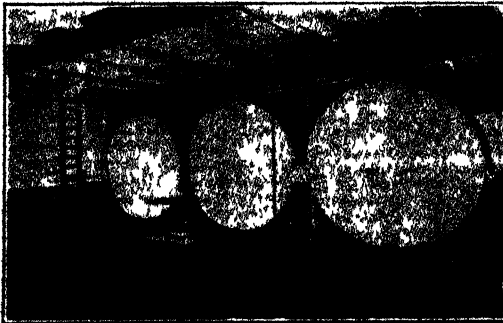

Tanks  
Reclaimed

Lithcote lining will not crack, chip or separate from the foundation metal.

Lithcote lining will not impart any trace of odor or taste to sensitive products whose purity must be unquestionable.

**Lithgow Corp., 333 W. 40th Place, Chicago 9, Ill.**

# MONARCH MILK POWDERING SPRAYS



Because they produce uniformly fine powder over a long period of time Monarch nozzles have been standard equipment in milk powdering Plants throughout the Country for many years.

Two types of nozzles are available, the fig. 621-MP and the fig. H-466 and each consists of four parts, the body "B", cap "C", tip "T" and disc "D". The bodies and caps are always made of stainless steel while the "Tips" and "Discs" (the only parts subject to wear) are made of special abrasive resistant materials and are easily renewable. Fig. 621-MP tips are stocked in eight different capacity sizes and Fig. H-466 in three sizes.

The fig. 621-MP nozzle is used by most Plants as replacement parts are very inexpensive. The "Tips" of these nozzles will usually give about 500 hours' service on milk with 2500 lbs. operating pressure.

The fig. H-466 nozzles have tips and discs made of very special material and will last about 2500 hours at 2500 lbs. operating pressure on milk. Initial cost is considerably higher than the fig. 621-MP nozzles but this is more than offset by the long life and uniformly fine quality powder obtained over a long period of time.

Write for Catalog

**MONARCH MFG. WORKS, Inc.**  
2725 E. Westmoreland Street  
PHILADELPHIA 34, PA.





## ***Nash—the Non-pulsating Vacuum Pump for Milk Evaporators without barometric leg.***

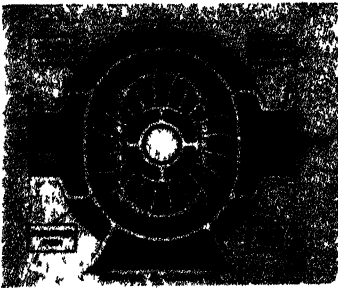

### **How the Nash Pump Operates**

A single moving element, a round rotor, with shrouded blades, forming a series of buckets, revolves freely in an elliptical casing containing water. The liquid, carried with the rotor, follows the elliptical contour of the casing.

The moving liquid therefore recedes from the rotor buckets, which, as they approach the wide part of the ellipse, fill with air from the stationary inlet ports. As the liquid continues to recede, non-pulsating vacuum is produced.

Nash Vacuum Removal Pumps are designed to handle a liquid and a vapor simultaneously, with efficiency, and without danger to the pump structure.

Nash Pumps produce constant vacuum without pulsation, which insures a uniform operating condition at all times, and hence, a uniform product.

Nash Pumps have a secondary condensing effect, supplementing that of the condensers, an advantage produced by the liquid compressant, which contracts and condenses hot vapors.

Nash Pumps have but a single moving element, rotating without wearing metallic contact with the pump casing, assuring long life and freedom from operating troubles.

Nash Pumps are compact, and may be installed in any convenient place. They operate at suitable speeds for direct connection to electric motors or steam turbines. A nation-wide Nash Service organization insures the satisfactory performance of every Nash Pump.

# **NASH ENGINEERING COMPANY**

## **281 WILSON ROAD, SOUTH NORWALK, CONNECTICUT**

# CONDENSED MILK AND MILK POWDER

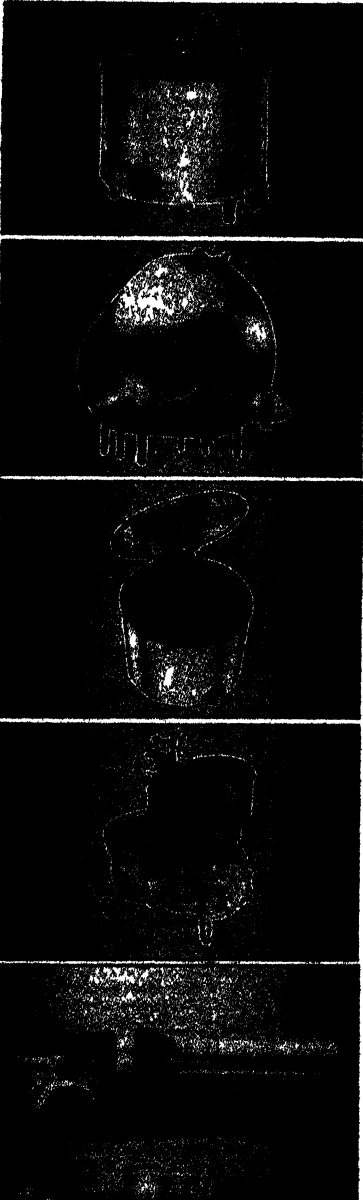

## PFAUDLER "LO-VAT" PASTEURIZERS — GLASS-LINED OR STAINLESS STEEL

These streamlined pasteurizers, the last word in "easy to clean" construction, are equipped with a scientifically designed three blade agitator powered by a two-speed motor drive which provides proper agitation for a variety of milk products. Flush valve, cover detail and over-all design meets all Board of Health requirements. Sizes—150, 200, 300 and 500 gals. Free Bulletin on request.

## PFAUDLER MILK PRODUCTS STORAGE TANKS — GLASS-LINED OR STAINLESS STEEL

Pfaudler Tanks are built to last longer than most and do because of sturdy, sanitary design which meets requirements of strictest codes. Exclusive "streamflo" removable agitator with sanitary rotary seal and motor drive provides thorough mixing action without creating foam. Available from 500 to 7,000 gals. Send for Bulletin.

## PFAUDLER "DX" FLASH-FLOOD COOLERS (PATENTED) FOR VATS OR TANKS

Most efficient unit available for cooling or holding milk products at low temperatures. Built of heavy stainless steel tubing. Available in vat type (Fig. 3) and horizontal type for storage tanks (not shown). Sanitary and easy to clean. Operate on any standard refrigerant. Precooled mix increases (as high as 100%) capacity of ice cream freezer.

## PFAUDLER "KING" FILLERS AND CAPPERS

Available in two standard models—the D-5, 25 quarts per minute, the D-10, 50 quarts per minute. Each machine handles one-half gallons, quarts, pints, and half-pints, with a minimum of adjustment. All moving parts fully enclosed and protected from milk and wash water. Double lifter rods and rollers; no-drip valves. Write for details.

## PFAUDLER TRUCK AND TRAILER TANKS

Two types of truck tank construction, straight frame and frameless, either of which provides greatest pay load per given weight of any other known make. Available in stainless steel construction in round or oval design for gravity or pressure loading and unloading. Capacities to meet maximum permitted in any state. Further details on request.



# PFAUDLER

THE PFAUDLER CO.

ROCHESTER 4, N. Y.



# LO-BAX *Helps Keep* BACTERIA COUNTS DOWN!

**Fast-Killing Chlorine Bactericide**  
For Use Wherever Milk is Handled

Lo-Bax is a chlorine bactericide especially made for dairymen. It is a winner wherever milk is handled, noted for its high speed sanitizing whether rinse or immersion method is used.

**QUICK FACTS about LO-BAX**

1. Kills bacteria almost instantly.
2. Dissolves quickly in hard or soft water — hot or cold.
3. Makes clear solutions for rinsing or immersing dairy equipment and utensils.
4. Contains 50% available chlorine.
5. Retains its full strength.
6. Economical — dairy rinse solution made from Lo-Bax averages in cost 1/8 of a cent per gallon.

**LO-BAX**  
50% Available Chlorine  
**LO-BAX SPECIAL** — a superior chlorine bactericide in granular form — packed in 2 1/2-lb. bottles, 1/4 oz. to the case; and in 1/4-oz. bot. 1 doz. to the case.  
**LO-BAX POWDER** — a highly efficient chlorine bactericide packed in 28-oz. bot., 1 doz. to the case.

**ANOTHER BACTERIA KILLER**  
**HTH-15**, the ALL-PURPOSE bactericide, germicide, disinfectant and deodorant is the ORIGINAL dry chlorine compound.  
**HTH-15**  
contains 75% available chlorine and makes true SODIUM hypochlorite solutions. Combines quickly-killing with low corrosive effect on dairy metals. Safe and dependable for Dairy Products Plants, for Milk Producers and for many Farm and Home uses.



**FULL INFORMATION FREE ON REQUEST**

**SANITATION Helps the Nation** 438

**THE MATHIESON ALKALI WORKS Inc.**

40 East 42nd Street New York 17, N. Y.

## To Protect Your Product Quality Use OAKITE DAIRY CLEANING AND GERMICIDAL MATERIALS

Dairies and milk processing plants the Nation over find Oakite Dairy Cleaning and Germicidal Materials make it easy to maintain high sanitary standards at low cost.

Scientifically designed to meet an unusually wide range of sanitation requirements, these specialized Oakite materials provide (1) consistently dependable results and (2) savings in time, effort and money.

Write for FREE booklets describing these time-tested materials for successfully increasing sanitation efficiency.

**OAKITE PRODUCTS, INC., 22 Thayer St., NEW YORK 8, N. Y.**  
*Technical Service Representatives Conveniently Located in All Principal Cities of the United States and Canada*

**SEND FOR FREE BROOKETS ON OAKITE METHODS FOR**

- Cleaning Vats, Tanks, Can Washing
- Conditioning and Brightening Cans
- Removing Milkstone Deposits
- Bottle Washing
- Germicidal Treatment of Equipment, Etc.
- Removal of Lime-Scale and Rust
- Lubricating Conveyor Chains
- Steam-Drum Cleaning

**OAKITE CLEANING**

# Help Produce Quality Milk For Condensing Plants The Beekay Way

B-K Powder is a dairy utensil and plant equipment bactericide containing 50% active available chlorine. The B-K Powder solutions used for sanitizing are fast-acting bactericides.

General Manual Kleanser, formerly B-K General Cleaner, is a soapless washing powder containing a wetting agent and a polyphosphate. It is free-flowing and quickly soluble. It emulsifies milk solids, wets surfaces, and is inexpensive to use.

Authorities agree that about 85% of the bacteria found in raw milk is the result of the bacterial contamination present on the surfaces of farm dairy utensils. Milk of satisfactory quality for evaporating and condensing must be produced in clean, sanitized utensils and cooled promptly and properly.

Farm dairy utensils immediately after each use must be rinsed with cold water, brushed with hot water containing a soapless washing powder, rinsed with hot water and stacked to drain and dry. Then just before use sanitized with a fast acting chlorine solution containing 100 parts per million of chlorine prepared from B-K Powder.

As a bactericide for plant equipment B-K Powder is used in solution containing 100 parts per million of chlorine for flowing over and through equipment and in 200 parts per million of chlorine for spraying surfaces of large equipment such as holding tanks.

B-K Powder is widely accepted by milk sanitarians, milk control officials and the dairy industry as an efficient fast-acting chlorine bactericide. It is available through dairy supply jobbers situated at strategic distributing points throughout the United States.

Our technical staff is always available for consultation on your production and plant cleaning and sanitizing problems. We will be pleased to be of service.



**B-K DIVISION**

**PENNSYLVANIA SALT**  
MANUFACTURING COMPANY  
*Chemicals*

1000 WIDENER BUILDING, PHILADELPHIA 7

# RAYMOND



## PULVERIZERS SEPARATORS FLASH DRYERS

For extremely fine grinding and the removal of moisture from materials while pulverizing.

### RAYMOND PULVERIZER DIVISION

COMBUSTION ENGINEERING COMPANY, Inc.

1310 North Branch Street

Chicago 22, Illinois

Sales Offices in Principal Cities

Canada: Combustion Engineering Corp., Ltd., Montreal

# R&A

CAN WASHERS ARE AVAILABLE IN SIZES

To meet all capacity and Receiving Room conditions.

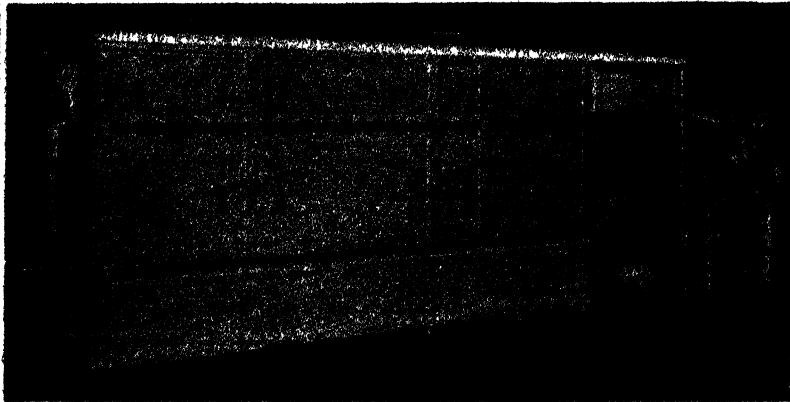

R&A Straightline Model No. 200 is illustrated above. Equipped with Automatic Unloader and Recoverer; Heat Exchanger; Thermostatically Controlled Sterile Rinse; Rising Wash Jets; Rising Rinse Jets; Rising Air Jets; 4 Tanks; 3 Pumps; Unit Wiring; Renewable Air Filter and Automatic Watchdog. Capacity 14 Cans Per Minute.

**RICE & ADAMS CORPORATION**  
BUFFALO, NEW YORK

**EQUIPMENT FOR THE  
MILK CONDENSING**  
*and*  
**SPRAY DRYING  
INDUSTRY**

**SPRAY PROCESS DRIERS**

**VACUUM PANS**

(With Efficient Entrainment Separators)

**HOTWELLS and AUXILIARY  
EQUIPMENT**

**CREAM PASTEURIZERS  
and DEODORIZERS**

---

**C. E. ROGERS CO.**

**8731 WITT ST.**

**DETROIT 9, MICH.**

*Since 1883*

# SCOTT

## MILK PROCESSING PLANT



**COMPLETE  
EQUIPMENT**

for

**CONDENSED  
EVAPORATED**

and

**DRIED MILK  
FACTORIES.**

Forced Circulation Thermo-Compression Condensing  
Plant in Stainless Steel.

**FOR ALL MILK PRODUCTS.**

"SCOTT" Patent Forced Circulation Condenser.

"SCOTT" Patent High Vacuum Condensed Milk  
Cooler.

"SCOTT" Patent High Vacuum Band Dryer  
Milk Superheaters      Sugar Pans      etc., etc.

**GEORGE SCOTT & SON (LONDON) LIMITED**

Head Office: Levenbank, Leven, Fife, Scotland.  
London Office: Artillery House, Artillery Row,  
London S. W. 1, England.

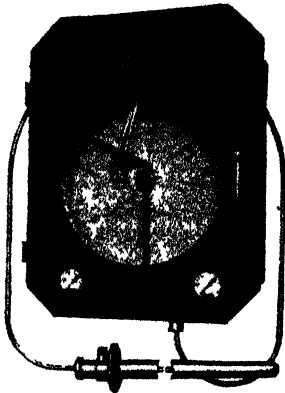
**PROTECT EACH PROCESSING STEP***with Taylor Instruments for***INDICATING RECORDING  
CONTROLLING****Temperature - Pressure - Density**

In close cooperation with Sanitarians and Milk Processing Technologists, Taylor Instrument Companies have designed a line of instruments for the Milk Industry which have gained a reputation for accuracy and dependability.

"Taylor-Equipped-as-Usual" becomes one of the specifications, when new equipment is ordered. This precaution assures maximum efficiency of equipment for producing uniform, quality milk products.

When assistance is needed, Taylor Field Engineers are ready to offer you the benefit of years of training and experience in the Milk Industry.

*Taylor Instrument Companies*

Rochester | New York

Branch Offices in All Principal Cities

**TAYLOR INSTRUMENTS MEAN ACCURACY FIRST**



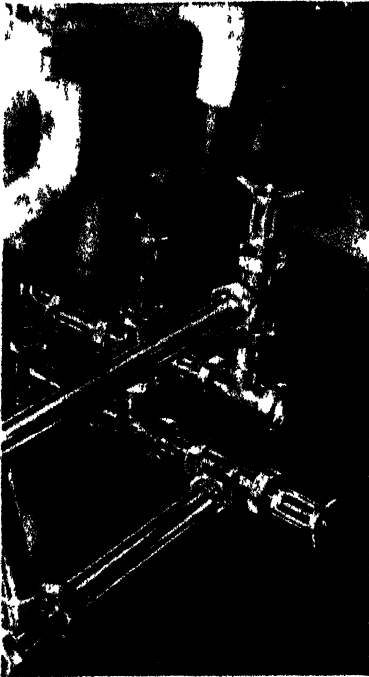

*The* **COMPLETE**  
*Always a step*

TRI-CLOVER SANITARY FITTINGS, in Stainless Steel (18-8) and Trialloy, are made flush throughout, with glass-like finishes—no threads or shoulders — every interior surface easily reached by cleaning solutions and brushes. These were the specifications of TRI-CLOVER engineers in constructing the special equipment that makes Tri-Clover Sanitary Fittings, Valves and Tubing true to one-thousandth of an inch, and the choice of the best sanitation engineers in dairies and food processing plants all over America.



**THE**  
*Complete Line*

1. Trialloy (Cupro Nickel) Sanitary Fittings
2. Fabricated Stainless Steel Sanitary Fittings
3. Pumps (Centrifugal—non-agitating) Trialloy and Stainless Steel
4. Custom Fabrication
5. Sediment Testers
6. Line Filters

Standardized Accuracy  
and Interchangeability are  
**YOUR Tri-Clover Guarantee**



Write for information on any of the products listed at right.

*No Pockets for Bacteria—  
No Threaded Inside Joints—*

# TRI-CLOVER LINE . . . .

## *ahead of Sanitary Regulations*

The TRI-CLOVER Pump, with its non-agitating, gentle propelling push, is made to handle 100 to 42,000 gallons per hour. Every part meets all sanitary regulations, handling liquids even containing semi-solids.

*Pump Catalog on request.*

POSITIVE WATER  
SEAL ON  
TRI-CLOVER  
PUMPS.

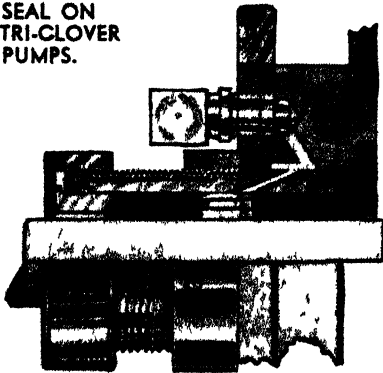

All TRI-CLOVER Valves are engineered to make cleaning and sterilizing easy and thorough.



**SANITARY  
FITTINGS**  
VALVES *and* PUMPS



**TRI-CLOVER MACHINE CO.**

2814 60th Street  
KENOSHA, WISCONSIN

## HIGH VACUUM PUMPS

*For Vacuum Packing Whole Milk Powder  
and Other Products*

Beach-Russ Type RP Pumps Assure the High Vacuum Required for Quality. Used by leading processors and canning machinery manufacturers.

**BEACH-RUSS COMPANY**

50 CHURCH ST.

NEW YORK 7, N. Y., U. S. A.



## For General Dairy Cleaning

SOLVAY Cleanser No. 600 contains a special wetting agent that "gets under" all types of soil. Fast, thorough action eliminates need for scouring or scrubbing. No. 600 does not spot, is an effective water softener, and is safe for hands. Available in commercial quantities, also in 5 lb. packages for resale to producer farmers.

SOLVAY SALES CORPORATION, 40 Rector St., New York 6, N. Y.

## FOR LACTOSE PRODUCTION FROM CHEESE WHEY

### ... USE SPERRY FILTER PRESSES

Recent developments in commercial production of lactose from cheese whey opens a new and profitable field for cheese producers. Of the several methods employed it has been found that filter presses produce the purest results and the highest yield. Sperry engineers are ready to serve you at any time, analyzing your needs and offering unbiased suggestions . . . all without obligation. Write Sperry today and take advantage of this complete service.

**D. R. SPERRY & COMPANY BATAVIA, ILLINOIS**

## FILLING & PACKAGING MACHINES

FOR

**POWDERED MILK & OTHER PRODUCTS  
SEMI AUTOMATIC & FULLY AUTOMATIC**

**STOKES & SMITH CO.**

**PHILADELPHIA (24), U.S.A.**

# FOR MODERN DAIRIES AND MILK PLANTS

Toledo Receiving Scales

●  
Toledo Butter Scales

●  
Toledo Portable  
and Floor Scales

●  
Toledo Net Weight  
Packing Scales

●  
Toledo Retail Scales  
for Dairy Stores

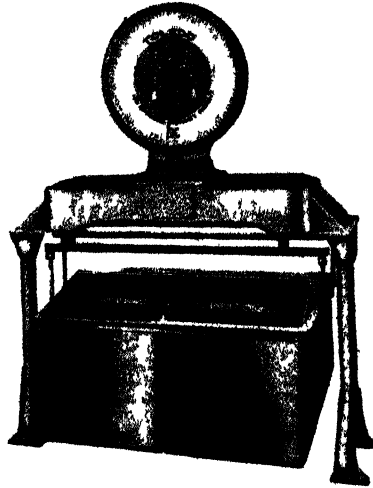

TOLEDO MILK SCALE

## ACCURACY . . . SPEED . . . DEPENDABILITY

For the Dairy Industry Toledo builds every modern type of scale—from heavy-duty Motor Truck Scales to compact, accurate Butter Print Scales. The year-after-year satisfactory performance of these Toledos under rigorous operating conditions has made them first choice in leading creameries and dairies everywhere. Vital working parts of Toledo Scales are designed and built to resist corrosion.

For the installation and regular inspection of Toledo Scales, and the efficient repair of scales of ALL makes, Toledo factory-trained Service Men are conveniently located in 181 cities of the United States and Canada. Whatever your weighing problem, it will pay to call a Toledo Scale man, *first*. Write for newest literature.

## TOLEDO SCALE COMPANY

1003 Telegraph Rd.

TOLEDO, OHIO

Canadian Toledo Scale Company, Limited  
Toronto, Ontario, Canada

# SONIC (Soft Curd) MILK

SONIC  
OSCILLATOR

in operating  
position

SECURE MAXIMUM DIGESTIBILITY  
FOR YOUR MILK WITH THE  
SONIC OSCILLATOR



The operation of the Sonic Oscillator is extremely simple—yet its results are amazing. By subjecting pasteurized milk (250 gallons per hour) to intense high-frequency vibrations (360 per second) as it passes through the Oscillator, the butter fat particles in the milk are broken up, producing a smooth, rich, natural-taste milk that forms fine soft curds in the stomach, and secures maximum uniform digestibility. Nothing is added—nothing is taken away. No sediment is created. The milk comes in contact with only two smooth, highly polished, stainless steel surfaces.

*Send today for bulletin containing complete details on Sonic Process.*

**SUBMARINE SIGNAL CO., 160 State St., Boston, Mass.**

## THE NEW STOELTING CHEESE VAT

*"This New Vat Tops Them All"*

**A Lifetime of Service . . . and Easy Cleaning**

All metal  
Round end  
Self draining  
Rust-proofed  
New design

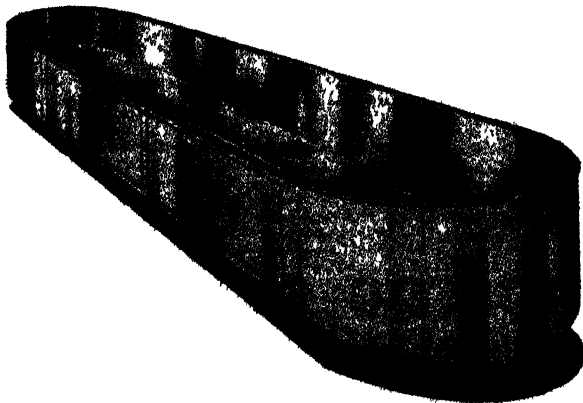

**STOELTING BROS. COMPANY**  
KIEL, WISCONSIN

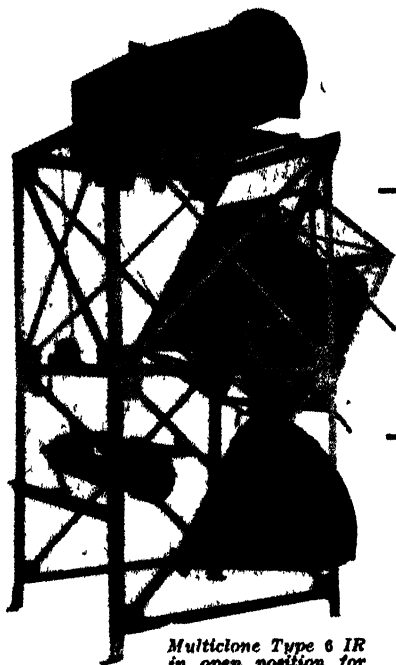

*Multiclone Type 6 IR  
in open position for  
easy sterilisation.*

# 6

## of MULTICLONE'S Many Vital Savings IN RECOVERING DRIED MILK SOLIDS!

More and more operators of dried milk plants are standardizing on MULTICLONE recovery equipment because it offers so many important advantages in sanitation, operating efficiency and low maintenance. Here are SIX savings that are typical of the many you make in installing MULTICLONE equipment . . .

**1. Unusually High Recovery:** The exclusive MULTICLONE design permits the use of many small collecting tubes compacted into one efficient unit. The higher centrifugal forces generated by small tubes insures more complete recovery of suspended materials, whether coarse or extremely fine. For example, at the same flow velocity, a 6 inch MULTICLONE tube generates 24 times the separation forces of a 12 ft. cyclone chamber.

**2. Greater Sanitation:** MULTICLONE'S smooth all-metal surfaces can be completely sterilized in a fraction of the time required for other types of recovery equipment. There are no fabrics in which solids can become enmeshed . . . no hard-to-reach surfaces on which particles can become trapped. If desired, the MULTICLONE can be made completely of stainless metal for the ultimate in sanitation.

**3. Better Product:** In the MULTICLONE the separated material is immediately and completely removed from the gas flow, thus minimizing contact time with the air and greatly reducing oxidation effects. This results in a better, more uniform product.

**4. No Contamination:** The material recovered in a MULTICLONE is completely

clean and pure. It contains no lint or other undesirable contamination.

**5. Uniform Dryer Operation:** MULTICLONE'S continuous removal of the separated product from the gas stream assures uniform draft loss at all times. Nothing to clog or choke the air flow, no variable back pressure to reduce dryer efficiency.

**6. No Maintenance Costs:** You can install a MULTICLONE and forget about it. No bags or filters to maintain or replace, nothing to require frequent servicing or repair. The first cost is the last cost!

There are still many other vital advantages you get by installing a MULTICLONE. Let our trained engineers consult with you and show you the multiple savings MULTICLONE equipment can make for you. A wire, letter or call to our nearest office places this information at your service without obligation. Or write direct.

Send for the MULTICLONE booklet!

**WESTERN PRECIPITATION  
CORPORATION**  
MAIN OFFICE: 1828 W. NINTH STREET  
LOS ANGELES 18, CALIFORNIA

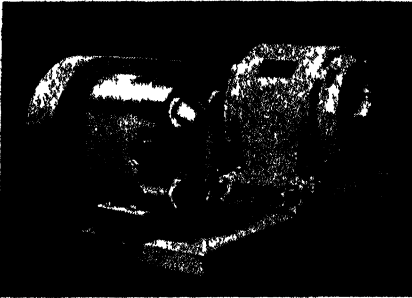

**STEP UP YOUR  
PUMPING EFFICIENCY**

**With this "WAUKESHA"  
100% Sanitary Pump**

Pat. No. 2,270 186

- ★ Twin-Blade Impellers deliver 4 full loads of product at every complete turn—assuring smooth, even flow.
- ★ Non-Agitating. Non-Aerating.
- ★ Positive, slow-speed rotary action.
- ★ Variable Speed Drive with speed ration as high as 7 to 1.
- ★ Precision-engineered.
- ★ Friction-Free Ball Bearing operation.
- ★ Requires Minimum Repairs and Parts Replacements.
- ★ Handles Heavy Viscous Products. Available in capacities of from 50 lbs. to 60,000 lbs. per hour.

Ask for Complete Illustrated Catalog.

**WAUKESHA FOUNDRY COMPANY, Waukesha, Wisconsin**

DEPENDABLE PRODUCT OF A RELIABLE MANUFACTURER

## The Wyandotte Line—

Cleaner and Cleanser — for general plant cleaning in soft water.

G. L. X.—Equipment cleaning in hard water.

C. A. S.—Acidity standardizer.

C. W.—Can washing

Steri-Chlor—A germicide.

S. R.-10—Milk stone solvent

Seneca Flakes—Condensing pan cleaner.

*Offices and Representatives in 88 North American Cities*

**WYANDOTTE CHEMICALS CORPORATION**

JERFORD DIVISION

WYANDOTTE, MICHIGAN

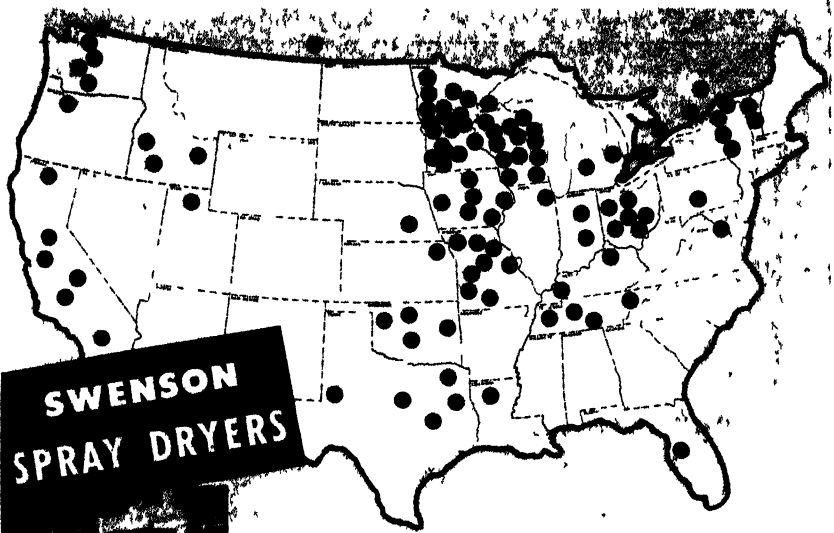

**SWENSON  
SPRAY DRYERS**

*in FOOD Production*

Sifting and packaging

The drying chamber

Auxiliary equipment

Dots on the map indicate cities where Swenson (Gray-Jensen Type) Spray Dryers are in operation. Some cities have more than one plant, and some plants have multiple spray drying units. Altogether they represent about half of the entire U. S. capacity for producing spray dried foods.

Swenson Gray-Jensen Equipment is widely used because of these important advantages:

- 1** THREE STAGE DRYING—giving full control of moisture content in the finished product.
- 2** COMPLETE SANITATION—all parts easily cleaned and sterilized at the close of each operating cycle.
- 3** TOTAL RECOVERY OF SOLIDS—no waste or fly material from the Liquid Collector.

*Swenson Gray-Jensen Spray Dryers are fully described and illustrated in Bulletin D-100, which we will gladly send you on request.*





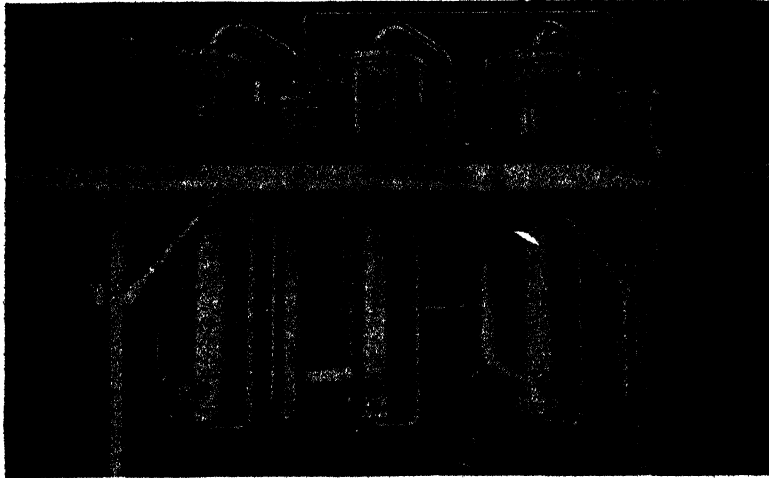

## HENSZEY Triple Effect EVAPORATORS

**Save 70% of the steam.**

**Save 72% of the water.**

*They use the following Henszey developments:*

1. Preheating of milk by means of vapor from the milk.
2. Two-stage absolutely complete centrifugal separation of milk from the vapor.
3. The complete preassembled and protected pan with its heaters and auxiliaries.
4. Automatic control of milk levels.
5. Recompression and re-use of waste vapor. (Where high pressure steam is used.)

*These result in—*

1. Very low total first cost. (Boilers, wells, buildings, pans).
2. Very low steam and water consumption.
3. Small space requirement.
4. Reliability and simplicity.
5. Pan completely open for cleaning from the outside.

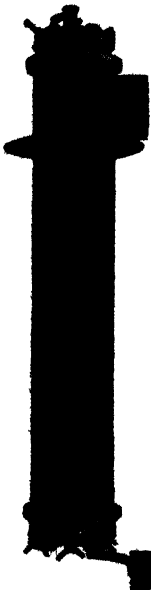

VERTICAL

## HENSZEY MILK

Henszey Milk Preheaters, either vertical or horizontal, are built in five different diameters and different lengths up to 10 feet. They are made with 1" tubes for reheat-

# HENSZEY

## SINGLE EFFECT

# EVAPORATORS

We have increased the efficiency of this type of pan to as great an extent as possible using high, narrow coils, giving less interference with circulation and easier cleaning. The usual innermost set of coils is omitted and replaced by a steam jacket around the waist or shell. All of these features give more rapid circulation of steam and liquid, improve the heat transfer and reduce cleaning time. They are built in sizes from 30" to 7' in diameter.



# HENSZEY

## HENSZEY COMPANY, Watertown, Wisconsin

*Also Power Plant Specialties Including:*

CONTINUOUS BLOWDOWN • FEED WATER METERS • HEAT EXCHANGERS  
FLOW INDICATORS • BOILER FEED REGULATORS • PROPORTIONING VALVES

# PREHEATERS

ating heaters and 1 1/2" tubes for non-recirculating heaters, for use with low pressure steam or vapor and in any capacity and temperature range desired.



HORIZONTAL

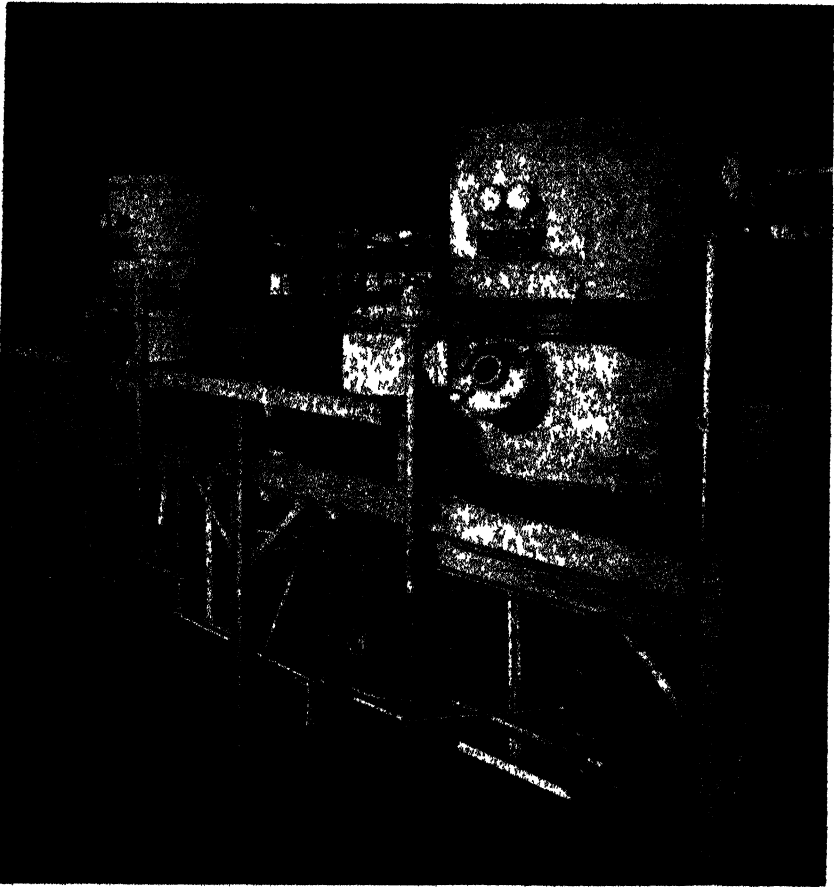

Zarembo polished stainless steel sanitary milk evaporator. Capacity 16,000 pounds per hour. Sanitary automatic level controls. Steamchest covers hinged and counterpoised for ready access to tubes.

## **ZAREMBO COMPANY**

(Incorporated 1908)

506 CROSBY BUILDING

BUFFALO, NEW YORK

# CHESTER STE-VAC HEATER

The Chester Ste-Vac Heater will heat milk or skimmilk from 40 degrees to 190 degrees continuously without burn on.

When used in a two-stage operation using two heaters the Ste-Vac will heat to 235 degrees without burn on.

There is no limit to the length of the run without cleaning.

These machines are installed in plants all over America.

Bulletins and list of nearby installations furnished on request.

*Manufactured by*

**CHESTER DAIRY SUPPLY COMPANY**

**CHESTER, PENNSYLVANIA**

## **MIKRO - PULVERIZERS**

are used extensively on various dried milk products. Our completely equipped test grinding laboratory is placed at the disposal of all accredited companies for conducting confidential test work. Write for complete forty page catalog and free test grinding data forms.

**PULVERIZING MACHINERY  
COMPANY**

**Summit, New Jersey**





