

# Birla Central Library

PILANI (Jaipur State)

( Engg College Branch )

Class No :- 620'136 .

Book No :- T1904 - V1

Accession No :- 33957.

## REQUEST

IT IS EARNESTLY DES'ED THAT THE BOOK  
HANDLED WITH CARE AND BE NOT MARKED,  
UNDERLINED OR DISFIGURED IN ANY OTHER WAY.  
OTHERWISE IT WILL HAVE TO BE REPLACED OR  
PAID FOR BY THE BORROWER IN THE INTEREST OF  
THE LIBRARY.

LIBRARIAN.





**CONCRETE**  
**PLAIN AND REINFORCED**

**CONCRETE  
PLAIN AND REINFORCED**

BY

**The late Frederick W. Taylor; Sanford E.  
Thompson; and the late Edward Smulski**

**Volume I. Theory and Design of Concrete and  
Reinforced Structures**

With a chapter by HENRY C. ROBBINS.

Fourth edition. 969 pages, 311 figures, 42 tables.  
Cloth, 6 x 9.

**Volume II. Theory and Design of Continuous  
Beams, Frames, Building Frames and Arches.**

688 pages, 224 figures and 31 diagrams, 83 tables.  
Cloth, 6 x 9.

---

**REINFORCED-CONCRETE BRIDGES,  
EXCEPT ARCHES**

BY

**The late Frederick W. Taylor; Sanford E.  
Thompson; and the late Edward Smulski**

With Formulas Applicable to Structural Steel  
and Concrete.

456 pages, 187 figures. Cloth, 6 x 9.

# CONCRETE

## PLAIN AND REINFORCED

VOL. I.  
THEORY AND DESIGN OF CONCRETE  
AND REINFORCED STRUCTURES

BY  
THE LATE FREDERICK W. TAYLOR,  
SANFORD E. THOMPSON, S.B.  
AND  
THE LATE EDWARD SMULSKI, C.E.

With a Chapter by  
HENRY C. ROBBINS

FOURTH EDITION

NEW YORK  
JOHN WILEY & SONS, INC.  
LONDON: CHAPMAN & HALL, LIMITED

~~1~~  
COPYRIGHT, 1925, 1931, BY  
EDWARD W. CLARK 3RD  
AND  
SANFORD E. THOMPSON  

---

Copyrighted in Great Britain

FOURTH EDITION  
7th Printing March, 1948  
MA 13.6

PRINTED IN U. S. A.

## PREFACE TO FOURTH EDITION

---

THIS treatise is adapted for use both by the practical engineer and as a text-book for students of engineering. As a text-book it provides the student with material that is an essential part of his equipment for any line of professional engineering work.

The authors, in preparing the work, have drawn upon their long and varied experience and practice as engineers. Because of this practical experience, they can speak with authority and can make specific recommendations with confidence.

Reference to the Table of Contents indicates the breadth and scope of the treatment. The numerous illustrations are selected, not as pictures, but each with the definite purpose of conveying information on a particular point. The diagrams indicate the action of stresses. The line drawings show construction details based on the experience of the authors, to indicate the best way of attaining a required result. The photographs have been selected to show typical structures or structural details. The treatment of flat slabs, which the engineer—even one having broad experience in other types of construction—finds so difficult to design properly, is particularly comprehensive and practical. Not only are the theory and methods of the main design presented in simple and usable form, but all of the supplementary features, such as column heads, wall panels, openings, and beams, are taken up in practical fashion and with numerous illustrations. The treatment of column design includes the various types and adaptation to special uses and various City Building Codes. The portions dealing with foundations, footings, and piles cover all conditions.

The treatment of building construction is particularly comprehensive, covering not merely general structural features but also intimate consideration of various types of design, with special chapters on Wall Bearing Construction, Basement Walls, Roofs, Stair-



ways, Fire Exits and Elevator Shafts, Steel Window Sash, Structural Plans, Different Types of Buildings, and Chimneys. Two particularly interesting and novel chapters are those on the construction in concrete of Theaters and Auditoriums and the Architectural Treatment of Exterior and Interior of Reinforced Concrete Buildings the latter chapter prepared by Mr. Henry C. Robbins.

NEW YORK, June, 1925.

SANFORD E. THOMPSON,  
EDWARD SMULSKI.

---

#### NOTE TO THIRD PRINTING OF FOURTH EDITION

---

The assistance given by Mr. Miles N. Clair of the Thompson & Lichtner Co., Inc., in the correction of errata in the first printing of this edition is gratefully acknowledged.

BOSTON, January, 1931.

SANFORD E. THOMPSON,  
EDWARD SMULSKI.

# CONTENTS

## CHAPTER I

### MATERIALS AND METHODS FOR MAKING CONCRETE

	PAGE
Essentials.....	1
Cement.....	2
Fine Aggregates.....	2
Coarse Aggregates.....	3
Proportions.....	4
Mixing and Placing.....	5
Strength and Other Characteristics.....	6

## CHAPTER II

### REINFORCEMENT

Quality of Reinforcing Steel.....	7
Selection of Grade of Steel for Reinforcement.....	8
Shapes for Reinforcement.....	10

## CHAPTER III

### TESTS OF REINFORCED CONCRETE

Tests of T-Beams.....	35
Tests of Beams to Determine Effect of Diagonal Tension.....	38
Behavior of Beam Failing by Diagonal Tension.....	46
Beams without Shear Reinforcement.....	46
Beams Reinforced for Tension and Compression.....	48
Tests of Bond between Concrete and Steel.....	51
Pull-out Tests.....	51
Bond Stresses in Beams.....	56
Splices of Tensile Reinforcement at Points of Maximum Stress.....	61
Deflection.....	61
Tests of Continuous Beams.....	64

	PAGE
Distribution of Concentrated Load on Wide Slabs.....	69
Tests to Determine Distribution of Load by Slab to Joists.....	74
Tests of Plain Concrete Columns.....	76
Tests of Columns Reinforced with Vertical Steel.....	78
Tests of Spiral Columns.....	82
Tests of Square Columns with Rectangular Bands.....	88
Tests of Columns with Structural Steel Reinforcement.....	88
Tests of Long Columns.....	93
Torsional Resistance of Concrete and Reinforced Concrete.....	94
Tests of Flat Slab Construction.....	98
Test of Flat Slab—Two-way System.....	99
Test of Flat Slab—Smulski System.....	104
Tests of Reinforced Concrete Buildings under Load.....	113
Tests of Octagonal Cantilever Flat Slabs.....	116

## CHAPTER IV

### THEORY OF REINFORCED CONCRETE

General Principles of Reinforced Concrete Beams.....	123
Assumptions.....	126
Analysis of Rectangular Beams.....	126
Notation.....	128
Formulas for T-Beams.....	133
Reinforced Concrete Beams with Steel in Top and Bottom.....	137
Wedge-shaped Beams.....	140
T-Beams with Unsymmetrical Flange.....	142
Shearing Stresses in a Beam or Slab.....	143
Diagonal Tension.....	147
Column Formulas.....	158
Members Subjected to Direct Tension.....	162
Notation.....	167
Plain Concrete Section under Direct Stress and Bending.....	169
Reinforced Concrete Section under Direct Stress and Flexure.....	173
Rectangular Section with Symmetrical Reinforcement.....	174
How to Combine Thrust with Bending Moment.....	187
Members Subjected to Direct Tension and Bending.....	189
Flat Slab Theory.....	194

## CHAPTER V

### REINFORCED CONCRETE DESIGN

Ratio of Moduli of Elasticity.....	201
Formulas for Design of Rectangular Beams.....	203
Design of Slabs.....	208
Design of T-Beams.....	215

	PAGE
T-Beam with Compression Reinforcement.....	230
Rectangular Beam with Compression Reinforcement.....	232
Examples of Beams with Steel in Top and Bottom.....	240
Diagonal Tension.....	241
Formulas for Diagonal Tension.....	247
Semi-graphical Method of Spacing Stirrups.....	252
Diagonal Tension for Moving Loads.....	258
Bond of Steel to Concrete.....	260
Anchorage and Splicing of Reinforcement.....	265
Bearing Stresses.....	270
Protective Covering for Reinforcement.....	272
Clear Distance between Parallel Bars in a Beam.....	273
Bending Moments for Use in Design of Beams.....	275
Notation.....	277
Formulas for Single Span Beams.....	278
Continuous Beams of Equal Spans.....	278
Continuous Beams of Equal Spans Running into Columns.....	279
Continuous Beams of Unequal Spans or with Non-uniform Loading.....	280
Effect of Varying Moments of Inertia on Bending Moment.....	281
Details of Continuous Beams.....	281
Process of Designing Continuous Beams.....	285
Points at which Horizontal Reinforcement Should be Bent.....	290
Reinforcement for Temperature and Shrinkage Stresses.....	298

## CHAPTER VI

## DESIGN OF FLAT SLAB STRUCTURES

Columns in Flat Slab Construction.....	305
Interior Columns for Symmetrical Arrangement of Panels.....	307
Exterior Columns.....	312
Column Heads.....	319
Drop Panels.....	322
Thickness of Slabs.....	325
Bending Moments in Flat Slabs.....	328
Bending Moments in Interior Panels in Flat Slabs.....	331
Wall Panels.....	333
Formulas for Slab Thickness.....	336
Thickness of Slab as Determined by Positive Bending Moment.....	340
Compression Stresses in Concrete in Flat Slabs.....	341
Shearing Stresses in Flat Slabs.....	346
Reinforcement in Flat Slabs.....	351
Flat Slab Systems.....	358
Four-way System.....	358
Two-way System.....	362
Circumferential or Smulski (S. M. I.) System.....	367

	PAGE
Explanation of Action of the Smulski System.....	369
Three-way System.....	374
Openings in Flat Slab.....	375
Design of Beams in Flat Slab Construction.....	377
Wall Beams.....	379
General Remarks.....	385
Problems in Designing Flat Slab Construction.....	389
Example of Flat Slab Design.....	390
Chicago and New York City Flat Slab Regulations.....	396
Bending Moment Coefficients.....	398

## CHAPTER VII

## CONCRETE AND REINFORCED CONCRETE COLUMNS

Plain Concrete Columns and Piers.....	403
Reinforced Concrete Columns.....	404
Columns with Longitudinal Bars.....	405
Spiral Columns.....	419
Octagonal Spiral Columns.....	429
Square Spiral Columns.....	429
Oblong Spiral Columns.....	430
Details of Spiral Columns.....	431
Long Columns.....	434
Structural Steel Columns Imbedded in Concrete.....	435
Rules for Structural Steel and Cast-iron Columns.....	435
Rules for Structural Steel of Various Building Codes.....	437
Details of Design of Steel Section.....	440
Economies in Column Design.....	445
Reduction of Live Loads in Buildings.....	452
Design of Columns in a Building Several Stories High.....	456
Columns Subjected to Bending.....	458

## CHAPTER VIII

## FOUNDATIONS AND FOOTINGS

Determination of Carrying Capacity of Soil.....	469
Bearing Power of Soils.....	470
General Rules of Design.....	472
Plain Concrete Footings.....	480
Reinforced Concrete Footings.....	481
Independent Column Footings.....	485
Design of Independent Footings.....	491
Simple Slab Footing.....	503
Sloped and Stepped Footings.....	506

CONTENTS

xi

	PAGE
Rectangular Footings.....	510
Corner Column Footings.....	514
Independent Footings with Piles.....	516
Continuous Wall Column Footings.....	518
Combined Footings.....	522
Strap Beams to Connect Footings.....	533
Raft Footings.....	538

CHAPTER IX

PILES

Wood Piles.....	543
Concrete Piles.....	546

CHAPTER X

BUILDING CONSTRUCTION

Relative Cost of Buildings of Different Materials.....	564
Actual Cost of Reinforced Concrete Buildings.....	567
Floor Loads.....	569
General Description.....	572
Beam and Girder Design of Floors.....	575
Example of Beam and Girder Design.....	578
Flat Slab Floor Construction.....	587
Light-weight Floor Construction.....	588
Reinforced Concrete Hollow Tile Floor Construction.....	589
Example of Hollow Tile Floor.....	598
Steel Tile Floor.....	602
Combination of Structural Steel and Concrete.....	611
Basement and Ground Floor Slabs.....	618
Floor Surfaces.....	620

CHAPTER XI

WALL-BEARING CONSTRUCTION

Brickwork.....	629
Concrete Walls.....	634

CHAPTER XII

BASEMENT WALLS

Method of Construction.....	637
Earth Pressure.....	638

	PAGE
Wall Supported at Top and Bottom.....	638
Wall Supported by Columns.....	643
Example of Basement Wall Supported by Column.....	645

## CHAPTER XIII

## ROOF CONSTRUCTION

Loading.....	648
Drainage.....	649
Insulation.....	650
Roof Coverings.....	654
Roof Design.....	659
Long Span Roof Construction.....	661
Concrete Arches for Long-span Roofs.....	668
Long-span Roof Construction.....	671
Sawtooth Roofs.....	675
Pre-cast Concrete Roof Trusses.....	677
Auxiliary Structures above Roof.....	678

## CHAPTER XIV

## STAIRWAYS, FIRE EXITS, AND ELEVATOR SHAFTS

Fire Exits.....	682
Layout of Stairs.....	686
Structural Design of Stairs.....	690
Special Design of Stairs.....	695
Elevator Shafts.....	695

## CHAPTER XV

## STEEL WINDOW SASH

Standards of Window Sash.....	699
Erection of Sash.....	702
Sizes of Sash.....	705
Underwriters' Pivoted Sash.....	706

## CHAPTER XVI

## STRUCTURAL PLANS FOR BUILDINGS

General Structural Plans.....	707
Complete General Structural Plans.....	710
Method of Showing Details.....	716
Working Plans.....	720

## CHAPTER XVII

ARCHITECTURAL TREATMENT OF EXTERIOR AND INTERIOR OF REINFORCED  
CONCRETE BUILDINGS

By Henry C. Robbins

	PAGE
Exterior Work . . . . .	729
Concrete in Combination with Brick, Tile or Other Masonry . . . . .	739
Brick Exterior . . . . .	747
Stone or Terra Cotta Exterior . . . . .	753
Interior Finish . . . . .	755

## CHAPTER XVIII

## CONCRETE IN CONSTRUCTION OF THEATERS AND AUDITORIUMS

Orchestra Floor . . . . .	762
Balcony Design . . . . .	763
Fulcrum Girders . . . . .	765
Balcony Cantilevers . . . . .	772
Balcony Floor Construction . . . . .	778
Theater at Winston-Salem . . . . .	778

## CHAPTER XIX

## REINFORCED CONCRETE IN DIFFERENT TYPES OF BUILDINGS

Warehouse Construction . . . . .	785
Cold-storage Warehouses . . . . .	792
Manufacturing Buildings . . . . .	792
Automobile Buildings and Garages . . . . .	795
Office Buildings . . . . .	803
Hotels, Apartment Houses and Hospitals . . . . .	805
School Buildings . . . . .	808

## CHAPTER XX

## REINFORCED CONCRETE CHIMNEYS

Notation . . . . .	812
Theory and Formulas . . . . .	813
Design of Hollow Circular Beams . . . . .	822
Design of Reinforced Concrete Chimneys . . . . .	822
Examples of Chimney Design . . . . .	829



## CHAPTER XXI

## RETAINING WALLS

	PAGE
Weight of Earth.....	833
Earth Pressure.....	835
Design of Retaining Walls of Gravity Section.....	839
Cantilever Walls.....	849
Example of T-shaped Retaining Wall .....	856
Wall with Counterforts.....	863
Special Designs of Retaining Walls.....	869

## CHAPTER XXII

## TABLES AND DIAGRAMS

General.....	879
Constants for Rectangular Beams and Slabs.....	880
Safe Loading for Rectangular Beams.....	884
Safe Loading for Slabs .....	886
Design of T-Beams.....	894
Design of Stirrups.....	899
Beams with Steel in Top and Bottom.....	904
Flat Slab Design.....	911
Column Design.....	915
Members Subjected to Direct Loading and Bending.....	934
General Data.....	942
Index.....	947

# CONCRETE

## PLAIN AND REINFORCED

---

### CHAPTER I

#### MATERIALS AND METHODS FOR MAKING CONCRETE

In this chapter are treated the materials used in concrete and certain fundamental principles relating to concrete. The properties of concrete are fully discussed in Volume III of this treatise, which covers selection and testing of materials, proportioning, strength, water-tightness, resistance to sea water, fire resistance, effect of impurities, and the various other characteristics, as well as discussion and advice on mixing and placing concrete, form construction, architectural treatment of surfaces, and the laying of floors, roads, and pavements. In this chapter, only such facts and conclusions are given as are necessary for the understanding of the subject matter of this volume.

#### ESSENTIALS OF GOOD CONCRETE

Concrete consists of hard particles of inorganic material, called aggregates, such as sand, gravel, crushed stone, slag, or cinders, cemented together with Portland cement and water. When all the aggregate is fine, like sand, the mixture is termed mortar.

In making durable concrete, the prime essentials are as follows:

- Hard, durable aggregates;
- Aggregates graded, or stepped, in size, from fine to coarse;
- Aggregates clean, that is, entirely free from organic impurities;
- Cement sufficient in quantity to give the required strength or water-tightness;
- Water clean and free from organic matter or deleterious minerals;
- Quantity of water to produce the consistency needed for the work, always avoiding a wet, sloppy mix;

## 2 MATERIALS AND METHODS FOR MAKING CONCRETE

- Mixing of the mass thoroughly to insure homogeneity and also properly to work the cement;
- Transporting and placing in such a way as to avoid separation of aggregates;
- Ramming or puddling so that the concrete will fill every part of the forms;
- Temperature of concrete maintained appreciably above freezing until it is thoroughly hard, to avoid retarded hardening.

### CEMENT

Portland cement is used universally for reinforced concrete and also for plain concrete, except where abnormal conditions necessitate a special cement.

Cement should be tested, except for very small and unimportant jobs, and should pass the requirements of the American Society for Testing Materials for tensile strength in 1 : 3 mortar; fineness; setting time; and soundness. Samples of cement, except for small jobs, are preferably taken at the mill before shipment. If this is impracticable, about 20 bags out of a carload of, say, 200 barrels (800 bags) are opened, and a small quantity taken from each and mixed together to make a single sample of about 2 quarts.

Cement that is unsound, that is, cement that checks or warps when steaming, should not be used. Sometimes the unsoundness disappears if the cement is held for a period.

A particularly dangerous characteristic in cement is a "flash set," which is evidenced in practice by the concrete setting so quickly as to harden in the mixer or in ordinary transportation to place. Concrete thus prematurely hardened is practically worthless and must not be reworked.

### FINE AGGREGATES

Poor sand is the most common cause of defective concrete. The presence of organic matter, such as vegetable loam, is the most objectionable characteristic, as such matter, even when present in very small quantities, prevents the concrete from hardening satisfactorily. Concrete containing organic matter may remain soft and friable for months and never attain full strength or resistance to abrasion.

**Sand, Therefore, Should Always be Tested.**—It is more necessary to test the sand than the cement, as the quality of sand cannot be determined by inspection. With the exception of the presence of organic matter, the quality of a sand that is most detrimental to concrete is excessive fineness. Not only must an excess of fine particles of dust be avoided, but the average size of the grains should be coarse.

Sand, for most uses, is preferably graded from fine to coarse, with not more than 30 per cent passing through a 50-mesh sieve and not less than 85 per cent passing through a No. 4 sieve.

The most important test of sand is for organic matter. The Abrams-Harder test is described in Volume III of this treatise.

Crushed stone screenings may be used as a substitute for sand or may be mixed with sand, provided they do not contain an excess of dust, which tends to come to the surface of the concrete and reduce its durability. Limestone screenings, for this reason, make a very poor material for roads and sidewalks.

#### COARSE AGGREGATES

Coarse aggregate should consist of crushed stone, gravel, or other approved inert materials with similar characteristics, or combinations thereof, having clean, hard, strong, durable, uncoated particles free from injurious amounts of soft, friable, thin, elongated or laminated pieces, alkali, organic or other deleterious matter.

Coarse aggregate should range in size from fine to coarse within the limits given in table below.

The following table indicates desirable gradings for coarse aggregates of certain nominal maximum sizes:

Nominal Maximum Size of Aggregate, in.	Percentage by Weight Passing through Standard Sieves with Square Openings						Percentage Passing, not More than	
	3 in.	2 in.	1½ in.	1 in.	¾ in.	½ in.	No. 4 Sieve	No. 8 Sieve
3	95	.....	40-75	.....	.....	.....	10	5
2	.....	95	.....	40-75	.....	.....	10	5
1½	.....	.....	95	.....	40-75	.....	10	5
1	.....	.....	.....	95	.....	.....	10	5
¾	.....	.....	.....	.....	95	.....	10	5
½	.....	.....	.....	.....	.....	95	10	5

The test for size and grading of aggregate should be made in accordance with the Standard Method of Test for Sieve Analysis of Aggregates for Concrete. (A. S. T. M. C 41-24).

### PROPORTIONS OF CONCRETE

The amount of cement to use in concrete, that is, its proportion to the aggregates, depends upon the nature of the structure and the strength or water-tightness required.

The concrete mixture is generally proportioned or designed for a particular condition by one of the following methods:

1. Arbitrary proportions of cement to aggregate based on experience and common practice, such as 1 part cement, 2 parts sand, 4 parts stone (written 1 : 2 : 4), with sufficient water to give the consistency required.

2. Proportions based on the results of tests of trial mixtures using the particular job materials. The water-cement ratio \* strength relation established by such tests is used as the major control factor, the proportion of cement, fine and coarse aggregate with a given water-cement ratio being allowed to vary within reasonable limits, provided a workable mix of proper consistency is obtained.

3. Proportions based on average curves relating the fineness modulus † of aggregate with the strength and consistency of the resulting concrete for a given water-cement ratio.

4. Proportions determined on the basis of the voids in the aggregate or by the use of the mechanical analysis curves so as to give the least voids and thus concrete of the maximum density for a given water and cement content.

The authors recommend the use on all important work of methods No. 2 or No. 4 based on tests of the material to be employed in the concrete. When there is no time for the necessary tests and for the purpose of preliminary estimates of proportions method No. 3 should be employed. Method No. 1 should be employed only for unimportant work.

A bag (94 lb.) of cement is always assumed to be 1 cubic foot. A 1 : 2 : 4 mix, therefore, means 1 bag cement, 2 cubic feet fine

\* Other factors being constant and the mixture workable, the strength of concrete depends on the ratio of the volume of water to the volume of cement in the mixture. The greater the water-cement ratio the less the strength of the concrete.

† The fineness modulus is defined as the sum of the percentages, divided by 100, of the aggregate coarser than each of the set of U. S. Standard square mesh sieves of sizes No. 100, No. 50, No. 30, No. 16, No. 8, No. 4,  $\frac{3}{8}$  in.,  $\frac{1}{2}$  in,  $1\frac{1}{2}$  in.

aggregate, and 4 cubic feet coarse aggregate. Proportions in practice are apt to run from 1 : 1 : 2, often used in columns, to 1 : 4 : 7 for mass concrete employing specially graded aggregates. The usual proportions for reinforced concrete are 1 : 2 : 4.

For concrete in large masses, such as dams, a great deal of money can be saved by making extensive tests, so as to obtain the maximum density and the minimum of cement.

### MIXING AND PLACING

Concrete mixers, driven by power, are used almost universally for all kinds of concreting. The size and type of machine must be adapted to the structure and to the quantity of concrete to be placed in a day. For ordinary work, a revolving drum with interior blades is used.

The time of mixing is an important element. The authors advise mixing a batch of concrete not less than  $\frac{3}{4}$  minute after the dry materials and water are in the mixer. The concrete should be placed in the forms within one hour after the original mixing. The use of partly hardened concrete or retempering with water should not be allowed.

The most important element in making good concrete is the control of the water-cement ratio. The quantity of water should be corrected for the average moisture content of the materials. When the average quantity has been fixed, the amount to be added may be changed slightly to allow for difference in the moisture content of the aggregates. The water for every batch should be measured.

Concrete is often seriously injured by the use of an excess of water in mixing. The strength is reduced by excess water, the wearing qualities are lessened, danger of checking or crazing of the surface is increased and laitance, a whitish, nearly inert substance, rises to the surface. For reinforced concrete, the best consistency is that which will flow very sluggishly without flattening out and without separation of the fine and coarse material. If the concrete is deposited through a sloping chute, the slope should not be flatter than one vertical to three horizontal. For many mixtures, a 1 to 2 slope should be maintained.

While the greatest danger in mixing concrete is that of having the mix too wet, excessive dryness also must be avoided. In reinforced concrete, the mix must be soft enough to thoroughly imbed the steel and fill all parts of the forms. In mass concrete, a drier mixture can be used than in reinforced concrete.

When, for small pieces of work, concrete is mixed by hand, the same precautions must be taken as in machine-mixed concrete. Materials must be carefully measured, a bag of cement being assumed

to be one cubic foot; the materials must be spread out in uniform layers; they must be thoroughly mixed dry by turning two or three times with a square-pointed shovel; water must be added to obtain the required consistency; the mass must be turned about four times wet, and the mixture taken to place without delay.

In important construction, specimens of the concrete should be taken at intervals, molded in 6 in. by 12-in. cylinders to be crushed at the age of 7, 14, or 28 days.

#### STRENGTH AND OTHER CHARACTERISTICS

For reinforced concrete structures, a compressive strength of the concrete of 2 000 lb. per sq. in. at the age of 28 days is a common requirement. The strength is determined by testing cylinders 6 in. in diameter by 12 in. high.

For concrete in large masses under low stress, and for such structures as cellar walls, a strength of 1 500 lb. per sq. in. at 28 days is satisfactory; while for columns, where small dimensions are preferred, 3 000 lb. per sq. in. may be specified. The variations in strength to accord with any requirements are obtained by use of the proper water-cement ratio and proportions of cement and aggregate.

For water-tight work, concrete 2 000 lb. per sq. in. at 28 days is usually required. In work of this kind, the size of the voids, as well as the density of the concrete, is important; therefore, a finer sand may sometimes be advantageously used to make the concrete flow smoothly and to avoid stone pockets due to separation of materials.

Concrete laid in sea water, or in alkali waters, requires special precautions, as discussed in Volume III.

For fire resistance, reinforced concrete is the best all-round building material. Aggregates like trap are better than gravel, which has a large coefficient of expansion, or limestone, which is liable to be affected chemically by the heat.

For the purpose of design, the following strengths of 6 by 12 cylinders at 28 days are assumed for various proportions of concrete:

Strength of Cylinder at 28 days. Lb. per sq. in.

Mix	1 : 1 : 2	1 : 1½ : 3	1 : 2 : 4	1 : 2½ : 5
Water-cement ratio . . .	0.75	0.85	0.95	1.05
Strength at 28 days, <i>fc'</i>	3 000	2 500	2 000	1 600
<i>n</i>	10	12	15	15

*n* = ratio of moduli of elasticity.

## CHAPTER II

### REINFORCEMENT

Reinforcement for concrete may consist of any kind of ductile metal, the prime factors being strength, reliability, and economy. In the United States, steel is used practically exclusively, while in Europe wrought iron is used to a great extent.

#### QUALITY OF REINFORCING STEEL

The Specifications of the American Society for Testing Materials (A15-30), endorsed by the authors, require the following properties for reinforcement.

**Chemical Properties.**—The steel shall conform to the following requirements as to chemical composition:

Phosphorus { Bessemer not over 0.10 per cent.  
Open-hearth not over 0.05 per cent.

**Physical Properties.**—The bars shall conform to the requirements as to tensile properties given in the table below.

**Tensile Properties of Concrete Reinforcement Bars**

Properties Considered	Plain Bars			Deformed Bars			Cold-twisted Bars
	Structural steel grade	Inter-mediate grade	Hard grade	Structural steel grade	Inter-mediate grade	Hard grade	
Tensile strength, lb. per sq. in. . .	55 000 to 70 000	70 000 to 90 000	80 000 min.	55 000 to 70 000	70 000 to 90 000	80 000 min	Recorded only
Yield point, min., lb. per sq. in. . .	33 000	40 000	50 000	33 000	40 000	50 000	55 000
Elongation in 8 in., min., per cent. . .	1 400 000*	1 300 000*	1 200 000*	1 250 000*	1 125 000*	1 000 000*	5
	Tens. str.	Tens str	Tens. str	Tens str	Tens. str.	Tens. str	

\* Deduct 1 per cent for each increase of  $\frac{1}{16}$ -inch above  $\frac{1}{4}$ -inch diameter, or for each decrease of  $\frac{1}{16}$ -inch below  $\frac{1}{4}$ -inch diameter.



**Bend-test Requirements.**—The test specimen shall bend cold around a pin without cracking on the outside of the bent portion, as follows:

Bend-Test Requirements

Thickness or Diameter of Bar	Plain Bars			Deformed Bars			Cold-twisted Bars
	Structural steel grade	Intermediate grade	Hard grade	Structural steel grade	Intermediate grade	Hard grade	
Under $\frac{1}{4}$ in. . . . .	180 deg. $d = t$	180 deg. $d = 2t$	180 deg. $d = 3t$	180 deg. $d = t$	180 deg. $d = 3t$	180 deg. $d = 4t$	180 deg. $d = 2t$
$\frac{1}{4}$ in. or over . . . . .	180 deg. $d = t$	90 deg. $d = 2t$	90 deg. $d = 3t$	90 deg. $d = 2t$	90 deg. $d = 3t$	90 deg. $d = 4t$	180 deg. $d = 3t$

**EXPLANATORY NOTE:**  $d$  = the diameter of pin about which the specimen is bent;  
 $t$  = the thickness or diameter of the specimen.

The bending test is the most important test in the specification, and no steel which fails in this test should be used under any circumstances.

Steel with high elastic limit, whether due to high carbon or to manipulation in manufacture, should be purchased with these reservations even if the working stress is to be no higher than is used with structural grade steel, say, 16 000 lb. per sq. in., because it is liable to be brittle. In case a lot of steel has been delivered without previous test by the purchaser, one bar selected at random in every 100 should be subjected to this test; and if it fails to pass, the portion from which it is taken should be rejected. On small jobs, where it is impossible to get proper tests of steel, it is of importance to purchase material from a reliable dealer having direct connection with reliable mills. Otherwise there is a likelihood that material rejected on some other job may be furnished.

#### SELECTION OF GRADE OF STEEL FOR REINFORCEMENT

**Steel of Structural-steel Grade** was universally accepted in the past as the most satisfactory material for reinforcement. It was manufactured under such standard conditions that, for unimportant structures, it could be used without other test than the bending test given above. The allowable stress for this grade should not exceed

16 000 lb. per sq. in. This gives a factor of safety of a little over 2, for the live and dead load. The factor of safety for the live load alone will depend upon the ratio of the live to dead load. For structures subjected to severe weather conditions or to locomotive smoke, it may be advisable to reduce the stresses so as to prevent formation of open cracks.

**Intermediate Grade Steel** has the advantage over structural-steel grade in its higher elastic limit. It is possible to use a stress in steel of 18 000 lb. and still have a somewhat higher factor of safety than for the structural-steel grade. Since there is no appreciable difference in cost between the two grades, the intermediate grade steel has become the standard for billet-steel reinforcement and other grades are not available commercially in the United States. In some cases, intermediate grade is specified even if the allowable stress in steel is only 16 000 lb. per sq. in. The factor of safety is thereby increased considerably by the additional strength of intermediate steel, without any appreciable extra cost. Intermediate grade steel should be properly tested.

The only disadvantage in using intermediate grade steel with 18 000-lb. stress is that the cracking of the concrete at working loads is larger, because the stretch in the steel, being proportional to the stress, is larger. Under ordinary conditions for ordinary building construction work, this objection is not important. Tests made in Europe (see Vol. III) have proved conclusively that the cement protects the steel from ordinary corrosive action until the elastic limit of steel is nearly reached. Where it is desirable, however, for any reason, to avoid cracking, the stress in steel should be kept as low as for structural grade steel.

For temperature reinforcement, a steel of high elastic limit is particularly valuable.

**Hard Grade Steel.**—If properly tested as required by the previously given specifications, hard grade steel may be safely used for reinforced concrete. Although hard grade steel has a higher elastic limit than the intermediate grade, the allowable stress should not be larger than 18 000 lb. per sq. in. because an accidental increase in loading would produce excessive cracking. With a stress of 18 000 lb. per sq. in., the factor of safety for hard grade steel is larger than for either of the two previously described grades. What has been said as to the economy of using intermediate grade steel applies also to the use of hard grade steel.

Many engineers do not approve of the use of hard grade steel because of its brittleness when of poor quality, and because it is prohibited in ordinary structural steel work. Brittleness in reinforcing steel, however, is less dangerous in reinforced concrete than in many classes of structural steel work because the concrete protects the steel from shock, and also because smaller sections of steel are used in concrete beams than in steel beams. Concrete reinforcement bars rolled from rail-steel and meeting the requirements of the American Society for Testing Materials specification A16-14 may be safely used in place of hard grade new billet steel.

#### SHAPES USED FOR REINFORCEMENT

**Small Angles.**—Small angles are sometimes used as reinforcement, mostly in columns or in Melan arches.

**Reinforcing Bars.**—The most common shapes used for reinforcement are round and square bars, and to a much smaller extent, flat bars. The bars may be either plain or deformed. The common types of deformed bars are shown in Fig. 1, p. 11.

**Plain vs. Deformed Bars.**—Steel bars used in reinforced concrete may be either plain or deformed.

Plain bars are round, square, or flat bars passed through regular rolls.

Deformed bars are bars provided with irregularities of the surface, formed either in the process of rolling or by twisting after rolling. When the area of cross section of deformed bars is not constant, its effective area is equal to the minimum cross section.

The purpose of the deformations of the surface is to increase the bond between the bars and the concrete, by adding to the surface bond of the plain bars the mechanical bond of the projecting deformations. Tests show that deformed bars of proper design have a considerably larger bond resistance than plain bars, so that larger unit bond stresses are allowable. (See p. 54.)

Either plain or deformed bars may be used with safety, provided the unit bond stresses are kept within the limits set for the two types of bars. In ordinary beams and slabs, the bond stresses are likely to be low, so that there is no difficulty in keeping the bond stresses within working limits of plain bars. In such cases, there is no special advantage in using deformed bars. In footings and short beams carrying heavy loads, on the other hand, it is often impos-



Cold Twisted Square Bar

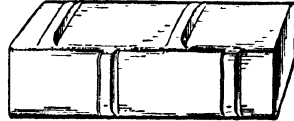
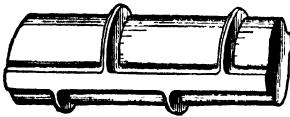

Corrugated Bars

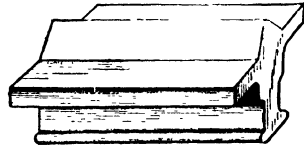
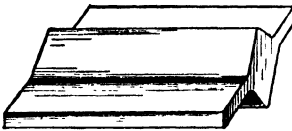

Kahn Wing Bars

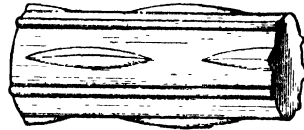
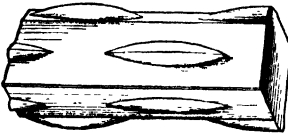

Havemeyer Bars

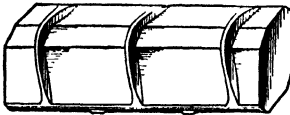

New Rib Bar

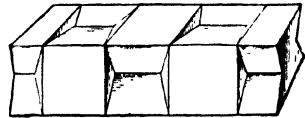

Elcannes Bar



Herringbone Bar

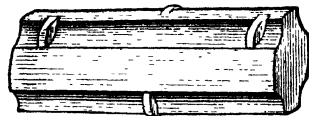

Monotype Bar

FIG. 1.—Types of Deformed Reinforcing Bars. (See p. 10.)

sible to utilize the full working value of the steel in tension, owing to the difficulty of providing sufficient bond. The use of deformed bars in such members is therefore advantageous and economical. They are also useful for temperature reinforcement, as the distribution of cracks depends upon the bond between the bars and the concrete. In road construction, deformed bars are useful for the same reason.

As a general proposition, where deformed bars are easily obtainable and their cost is not appreciably higher than that of plain bars, they are recommended in preference to plain bars because the factor of safety against actual collapse is larger for deformed bars than for plain bars. The use of deformed bars is particularly recommended for structures subjected to dynamic loads.

**Properties of Bars Used as Reinforcement.**—The table below gives the sizes of plain bars used in practice, their areas, weights, and perimeters.

#### Round and Square Bars

Areas, Weight and Perimeters

Size, inches	Round Bars			Square Bars		
	Area, sq. in.	Weight per foot, lb.	Perimeter, in.	Area, sq. in.	Weight per foot, lb.	Perimeter, in.
1/4	0.049	0.17	0.78	0.062	0.21	1.00
5/16	0.077	0.26	0.98	0.098	0.33	1.25
3/8	0.110	0.38	1.18	0.141	0.48	1.50
7/16	0.150	0.51	1.37	0.191	0.65	1.75
1/2	0.196	0.67	1.57	0.250	0.85	2.00
9/16	0.248	0.84	1.77	0.316	1.08	2.25
5/8	0.307	1.04	1.96	0.391	1.33	2.50
11/16	0.371	1.26	2.16	0.473	1.61	2.75
3/4	0.442	1.50	2.36	0.563	1.91	3.00
13/16	0.518	1.76	2.55	0.660	2.24	3.25
7/8	0.601	2.04	2.75	0.766	2.60	3.50
15/16	0.690	2.35	2.95	0.879	2.99	3.75
1	0.785	2.67	3.19	1.000	3.40	4.00
1 1/8	0.994	3.38	3.53	1.266	4.30	4.25
1 1/4	1.227	4.17	3.93	1.563	5.31	4.50

In the table the sizes set in bold type have been adapted as standard by the Division of Simplified Practice of the U. S. Department of Commerce. Other sizes are not available commercially in the United States.

*Cold Twisted Bars* have the same dimensions and weight as the corresponding square bars.

*Corrugated Bars*, round and square, have the same dimensions as the corresponding round or square plain bars. Their weight is somewhat greater, however, on account of the projections, which are not included in the effective area.

*Kahn Trussed Bars* have special dimensions as given in table below.

Type. (See Fig. 2)	Dimensions, in.		Weight per Lineal Foot, lb.	Area, sq. in.
	<i>D</i>	<i>B</i>		
Type 1 . . . . .	$\frac{1}{2}$	$1\frac{1}{2}$	1 4	0 41
Type 1 . . . . .	$\frac{3}{4}$	$2\frac{3}{16}$	2.7	0 79
Type 2 . . . . .	$1\frac{1}{2}$	$2\frac{1}{4}$	4.8	1 41
Type 2 . . . . .	$1\frac{3}{4}$	$2\frac{3}{4}$	6 8	2 00
Type 2 . . . . .	2	$3\frac{1}{2}$	10 2	3 00

If *trussed* bars are used as beam reinforcement, the wings are sheared near the ends and bent up to serve as diagonal tension reinforcement.

*Kahn New Rib Bars*.—Same remarks as for corrugated bars.

*Havemeyer Bars*.—Round and square Havemeyer bars have the same properties as the corresponding round and square plain bars. Since the projections form a part of the effective area, the weight of these bars is the same as that of plain bars.

Havemeyer flats are of the dimensions given below.

Size, in.	$1 \times \frac{1}{4}$	$1 \times \frac{3}{8}$	$1\frac{1}{4} \times \frac{3}{8}$	$1\frac{1}{2} \times \frac{5}{16}$	$1\frac{1}{2} \times \frac{3}{8}$	$1\frac{1}{2} \times \frac{1}{2}$	$1\frac{3}{4} \times \frac{3}{8}$	$1\frac{3}{4} \times \frac{7}{16}$	$1\frac{3}{4} \times \frac{1}{2}$
Area, sq. in.	0.2500	0.3750	0.4690	0.4688	0.5625	0.7500	0.6563	0.7656	0.8750
Weight per foot, lb..	0.850	1.280	1.590	1.590	1.913	2.550	2.230	2.600	2.980

*Elcannes Bars.*—These are rolled in sizes from  $\frac{3}{8}$  in. to  $1\frac{1}{4}$  in. with a variation of  $\frac{1}{8}$  in. The bars correspond in area and weight to square bars.

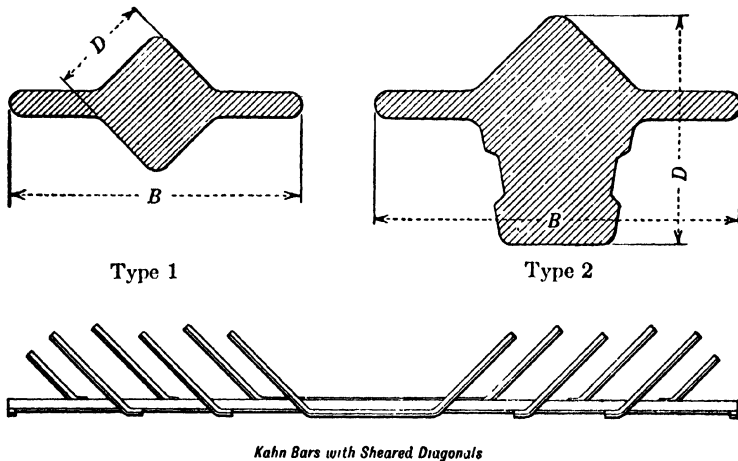

FIG. 2.—Sections of Kahn Trussed Bars. (See p. 13.)

*Herringbone Bar.*—The sizes and weights of the Herringbone bars are as follows:

Size, inches	$1\frac{1}{2}$	$1\frac{1}{4}$	1	$\frac{7}{8}$	$\frac{3}{4}$	$\frac{5}{8}$
Weight per foot, lb. . .	5.13	3.62	2.38	1.72	1.28	0.91

*Monotype Bars.*—These bars are rolled in one type only. The size, however, is arranged so that it is possible to get bars equivalent to standard sizes of round and square bars. The weight of bars is slightly higher than for plain bars because of the additional weight of lugs.

**Wire Used as Reinforcement.**—The wire used for spirals in spiral columns, is cold-drawn from rods which are hot-rolled from billets. The cold drawing causes the wire to attain tensile strength from 80 000 to 100 000 lb. per sq. in. It is usually designated by gage numbers. The sizes of wire are given below.

Gage Number	Equivalent Diameter, in.	Area, sq. in.	Gage Number	Equivalent Diameter, in.	Area, sq. in.
7-0	0.4900	0.189	5	0.2070	0.034
6-0	0.4615	0.167	6	0.1920	0.029
5-0	0.4305	0.146	7	0.1770	0.025
4-0	0.3938	0.122	8	0.1620	0.021
3-0	0.3625	0.103	9	0.1483	0.017
2-0	0.3310	0.086	10	0.1350	0.014
0	0.3065	0.074	11	0.1205	0.011
1	0.2830	0.063	12	0.1055	0.009
2	0.2625	0.054	13	0.0915	0.007
3	0.2437	0.047	14	0.0800	0.005
4	0.2253	0.040			

The U. S. Department of Commerce adopted as standard for spiral reinforcement round wire of following diameters:  $\frac{1}{4}$ ,  $\frac{3}{8}$ ,  $\frac{1}{2}$  and  $\frac{5}{8}$  in.

### SPECIAL REINFORCEMENT

**Expanded Metal**, shown in Fig. 3, p. 15, is produced by special machines from soft open-hearth steel plates. These plates are slit and expanded by a cold drawing process in such a way that

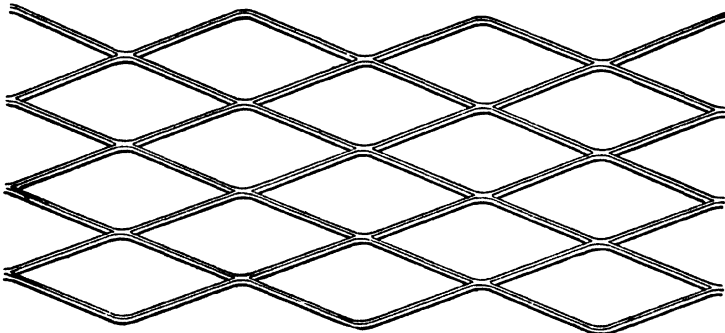

FIG. 3.—Expanded Metal. (See p. 15.)

in the final state the strands form diamond-shaped meshes. The cold drawing raises the elastic limit of the steel to around 55 000 lb. per sq. in.

The standard sizes of expanded metal are given in the table on page 16.



## Standard Sizes of Expanded Metal Adaptable to Concrete Reinforcing

Designation	Sectional Area, sq. in. per ft. Width	Weight, lb. per sq. ft.	Width of Standard Sheet	Number of Sheets in a Standard Bundle
*3-13-075	0.075	0.27	6' 0"	10
*3-13-10	0.10	0.37	6' 9"	7
*3-13-125	0.125	0.46	5' 3"	7
*3-9-15	0.15	0.55	7' 0"	5
*3-9-175	0.175	0.64	6' 0"	5
*3-9-20	0.20	0.73	5' 3"	5
*3-9-25	0.25	0.92	4' 0"	5
*3-9-30	0.30	1.10	7' 0"	2
*3-9-35	0.35	1.28	6' 0"	2
3-6-40	0.40	1.46	7' 0"	2
3-6-45	0.45	1.65	6' 3"	2
3-6-50	0.50	1.83	5' 9"	2
3-6-55	0.55	2.01	5' 3"	2
3-6-60	0.60	2.19	4' 9"	2
*3-1-75	0.75	2.74	5' 9"	1
*3-1-100	1.00	3.63	4' 3"	1

All of the above have a diamond-shaped opening, 3 by 8 in.

All items listed above are furnished in 8, 12 and 16-ft. lengths. Items marked thus \* are also furnished in 10-ft. lengths.

\*3-1-75 and 3-1-100 are manufactured to order only.

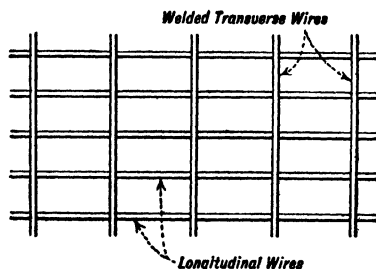

FIG. 4.—Welded Wire Fabric. (See p. 17.)

**Welded Wire Fabric** consists of two sets of parallel cold-drawn wires placed at right angles to each other and electrically welded at the intersections. The wires are galvanized before welding.

**Welded Wire Fabric**

Transverse Wires		Longitudinal Wires			Area in Longitudinal Wires Only, per Foot of Width, sq. in.				
Gage	Spacing, in.	Gage	Diameter of wire, in.	Area of wire, sq. in.	Spacing of Longitudinal Wires				
					2 in.	3 in.	4 in.	5 in.	6 in.
6	12	0	0 307	0 074	0 443	0 295	0 221	0 177	0 148
6	12	1	0 283	0 063	0 377	0 252	0 189	0 151	0 126
8	12	2	0 263	0 054	0 325	0 217	0 162	0 130	0 108
8	12	3	0 244	0 047	0 280	0 187	0 140	0 112	0 093
9	12	4	0 225	0 040	0 239	0 160	0 120	0 096	0 080
9	12	5	0 207	0 034	0 202	0 135	0 101	0 081	0 067
10	12	6	0 192	0 029	0 174	0 116	0 087	0 069	0 058
10	12	7	0 177	0 025	0 148	0 098	0 074	0 059	0 049
10	12	8	0 162	0 021	0 124	0 082	0 062	0 049	0 041
12	12	9	0 148	0 017	0 104	0 069	0 052	0 041	0 035
12	12	10	0 135	0 014	0 086	0 057	0 043	0 034	0 029

**Triangle Mesh.**—Triangle Mesh woven wire reinforcement for concrete is made with either solid or stranded longitudinal members, properly spaced by means of diagonal cross wires, so arranged as to form a series of triangles between the longitudinal or tension members; the longitudinal members are spaced 4 in., the cross wires either 2 or 4 in. as desired, providing either a 2- or 4-in. mesh. The sizes of both longitudinal and cross wires are varied in order to provide the cross-sectional areas of steel required to meet the conditions.

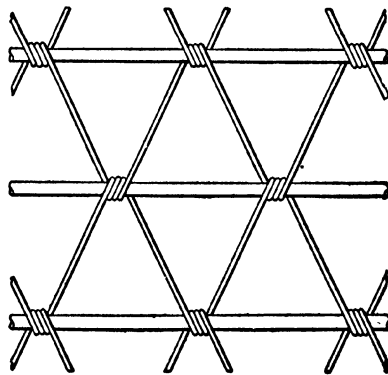

FIG. 5.—Triangle Mesh Wire Fabric.  
(See p. 17.)

Information about triangle mesh may be taken from table below:

**Triangle-mesh Wire Fabric**

Number and Gage of Wires, Areas per Foot Width and Weights per 100 Square Feet.

Longitudinals Spaced 4 Inches. Cross Wires Number 14 Gage Spaced 4 Inches.

Style Number	Number and Gage of Wires, each Longitudinal	Sectional Area Longitudinals square inches per foot width	Total Effective Longitudinal Sectional Area square inches per foot width	Approximate Weight lbs. per 100 square feet
032	1—No. 12 gage	.026	.032	22
040	1— “ 11 “	.034	.040	25
049	1— “ 10 “	.043	.049	28
058	1— “ 9 “	.052	.058	32
068	1— “ 8 “	.062	.068	35
080	1— “ 7 “	.074	.080	40
093	1— “ 6 “	.087	.093	45
107	1— “ 5 “	.101	.107	50
126	1— “ 4 “	.120	.126	57
146	1— “ 3 “	.140	.146	65
153	1— ¼ inch	.147	.153	68
168	1—No. 2 gage	.162	.168	74
180	2— “ 6 “	.174	.180	78
208	2— “ 5 “	.202	.208	89
245	2— “ 4 “	.239	.245	103
267	3— “ 6 “	.261	.267	111
287	3— “ 5½ “	.281	.287	119
309	3— “ 5 “	.303	.309	128
336	3— “ 4½ “	.330	.336	138
365	3— “ 4 “	.359	.365	149
395	3— “ 3½ “	.389	.395	160

Length of Rolls: 150-foot, 200-foot and 300-foot.

Widths: Approximately 16-in., 20-in., 24-in., 28-in., 32-in., 36-in., 40-in., 44-in., 48-in., 52-in. and 56-in.

NOTE.—Material may be furnished either plain or galvanized. Unless otherwise specified, shipments will be made of material not galvanized.

**Expanded Metal Lath.**—Expanded metal may be used as lath for plaster or stucco. Two kinds of metal lath are obtainable, one painted black, and the other cut from galvanized sheet. The weights given in the table below are for painted lath. Galvanized lath weighs 0.4 lb. per sq. yd. more than painted lath.

Expanded Metal Lath

Designation	Weight per sq. yd. in Bundle, lb.	Size of Sheet, in.	Sheets in Bundle	Sq. Yd. in Bundle	Weight per Bundle, lb.
22-P	4.37	24 × 96	10	17.77	77.65
24-F	3.40	24 × 96	15	26.66	90.67
25-F	3.00	24 × 96	15	26.66	80.00
26-F	2.55	24 × 96	15	26.66	68.00
27-F	2.33	24 × 96	15	26.66	62.22
24-H	2.90	28 × 96	14	29.00	84.10
26-H	2.20	28 × 96	14	29.00	63.80

**Rib Lath.**—There are several types of expanded metal lath on the market which are provided with stiffening ribs running longitudinally with the lath. Rib lath is used for suspended ceilings, for partitions, and for other purposes. The function of the ribs is to stiffen the lath, so that the furring strips or other supports may be spaced farther apart.

Figure 6, p. 19, shows two types of Rib Lath, which are marketed under the trade name of Hy-rib. The ribs of the lath are  $\frac{3}{4}$  in. and  $\frac{3}{8}$  in. deep respectively. The  $\frac{3}{8}$ -in. Rib Lath is used where greater rigidity and strength are required.

 $\frac{3}{4}$ -inch Hy-rib Lath $\frac{3}{8}$ -inch Hy-rib Lath

FIG. 6.—Special Type of Rib Lath. (See p. 19.)

## CHAPTER III

### TESTS OF REINFORCED CONCRETE\*

The selected tests presented in this chapter were originally carried out to determine the principles of the theory and design of reinforced concrete. They are given here to illustrate the principles and conclusions presented in the following chapters.

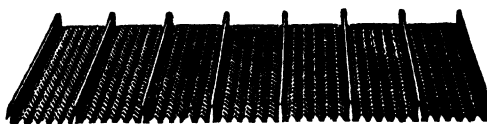
The following data are obtained by tests:

Stress at which first cracks appear and corresponding stretch in concrete;

Location of neutral axis;

Relation between ultimate compressive fiber stress and strength of concrete in compression;

Distribution of stresses over a section;

Relation between bending moment and moment of resistance based on stresses in steel;

Effect of the percentage of reinforcement;

Effect of mix of concrete and age.

The results and conclusions are given on the following pages. Formulas for design based on the tests may be found in Chapter V, pp. 201 to 302.

**Behavior of Rectangular Beams During Loading.**—When a reinforced concrete beam is subjected to a loading test its behavior is not the same throughout the progress of loading. Three stages can be distinguished: first stage, before the appearance of the first crack; second stage, after first crack is developed, but before either of the materials passes its elastic limit; third stage, after the elastic limit of steel or concrete has been passed.

\* To avoid breaking the continuity of treatment of theory and design this chapter on Tests is placed to precede the Theory instead of following it in regular sequence. When using the book as text book this Tests chapter may be taken up subsequently to the chapter on Theory preferably using it merely as supplementary material. Notation used in this chapter is explained in Chapter IV.

*First Stage.*—Before the appearance of the first crack, a reinforced concrete beam behaves like a homogeneous beam. Compression is resisted by concrete, and tension is resisted by concrete and steel in proportion to their moduli of elasticity. The position of the neutral axis nearly coincides with the center of gravity of a section obtained by replacing the steel by an area of concrete equal to the area of steel multiplied by the ratio of moduli of elasticity. This is called the first stage. It lasts until, at an elongation or stretch of concrete equal to the ultimate stretch of plain concrete, the first cracks appear in the beam.

*Second Stage.*—This stage begins when the concrete cracks. At first, the cracks are not visible to the naked eye and do not extend up to the reinforcement. At increased loads, the number of cracks increases. They widen and move up toward the center of the beam. The neutral axis moves up. The larger the amount of reinforcement, the larger the number of cracks and the smaller their width, as illustrated in Fig. 7, p. 23. In this stage, tension is resisted by steel and by the portion of concrete above the crack and below the neutral axis.

The cracks never extend all the way up to the neutral axis (which rises as the cracks develop). The stretch is zero at the neutral axis and increases in a straight line to its maximum at the level of the steel. There must be, therefore, a portion of concrete below the axis where the deformation is smaller than the ultimate stretch for the concrete, and there must be a fiber which is just at the point of breaking. Above it, the concrete is intact and is carrying tensile stresses.

The ratio of the tensile stresses carried by the concrete to the total amount of tension decreases with the increase in the load. For equal intensity of loading, the amount of stresses carried by concrete is larger for smaller percentages of steel. For large loads and percentages of steel, commonly used in design, the amount of the stresses resisted by concrete is negligible. The assumption made in the design formulas, given in the chapters on Theory and Design, that steel resists all tension stresses and concrete in tension is disregarded, is, therefore, accurate enough for practical purposes. This assumption is still further justified by the fact that the tensile strength of concrete may be totally destroyed by shrinkage or temperature contraction cracks and by construction joints. In analyzing tests, however, it is necessary to take the tension in concrete into account, since its existence explains why the moment of resistance, based on the

stress in steel and figured by formula  $M = A_s f_s j d$ , is smaller than the bending moment, and why the actual stresses in steel obtained from deformations are smaller than the theoretical stresses. (See Fig. 9, p. 29.) The amount of tension carried by the concrete may be estimated by comparing the moment of resistance, based on the actual stresses in steel, with the bending moment.

*Third Stage. Beams Failing by Tension in Steel.*—When the steel reaches its elastic limit, one or two of the cracks, which have been small up to this point, begin to widen and extend toward the top. This is shown by the loads underlined in Fig. 7, p. 23. The deflection increases appreciably as the cracks widen and extend toward the top (the neutral axis rising), the compressive area becomes smaller, and finally the beam fails by the total destruction of the compressive area. This condition is brought about by a small addition to the load at which the steel passes the elastic limit. Thus, the passing of the elastic limit of steel marks the failure of the beam. Ultimate strength of steel is never reached, and is, therefore, of no consequence in reinforced concrete design.

*Beams Failing by Compression.*—For beams failing by crushing of concrete, the third stage is marked by cracks in the top of the beam, which appear after the elastic limit of the concrete in compression has been reached. At increased load, wedge-shaped pieces of concrete spall off and the beam fails.

**Appearance of First Crack and Corresponding Stretch in Concrete.**—Numerous tests prove that the appearance of the first cracks in reinforced concrete corresponds to about the same stretch as in plain concrete. This stretch may be taken approximately as 0.00012 of its length (corresponding to 3 600 lb. per sq. in. in the steel) for 1 : 2 : 4 stone concrete, and 0.00018 (corresponding to 5 400 lb. per sq. in. in the steel) for cinder concrete.<sup>1</sup> At this stretch, however, as discussed below, the cracks are very minute and not visible to the naked eye.

The early conclusion of Mr. Considère in France, as the result of his tests, that the stretch of concrete when reinforced was 0.002 of its length, or about twenty times the stretch of concrete without reinforcement, has been disproved by further experiments. Professor Turneure,<sup>2</sup> in testing moist beams, observed, at about the same stretch at which the first cracks developed in plain concrete beams,

<sup>1</sup> Technologic Paper No. 2, U. S. Bureau of Standards, 1912, p. 39.

<sup>2</sup> Proceedings, American Society for Testing Materials, 1904, p. 498.



Fig 7 —Variation in Position of Cracks with Variation in Percentage of Reinforcement, Granite Concrete, Age Four Weeks \*  
 (See p 26 )

\* U S Bureau of Standards Technologic Paper No 2 1912, p 97 Tests by Messrs Richard L Humphrey and Louis H Losee



dark marks which he called watermarks. Part of these watermarks developed later into actual cracks. Professor Bach<sup>3</sup> investigated the subject further and came to the conclusion that watermarks are places where adhesion between particles of concrete becomes weakened just previous to the formation of cracks. In plain concrete, each watermark develops into a crack. In reinforced concrete, on the other hand, only a part of the watermarks actually open, because the steel strengthens these weakened spots and either retards the appearance of actual cracks or prevents their formation altogether.

**Professor Bach's Tests.**—Professor Bach's tests<sup>3</sup> in Stuttgart, summarized below, give the relation between actual and computed tensile stresses in concrete and steel just before the first crack, in beams with different mixes of concrete, different percentages of steel, and various conditions of storage. All of the values are high, as Bach evidently obtained a stronger concrete than the same proportions give ordinarily. It must be noted further, as has been emphasized elsewhere, that the actual stresses in steel at this stage are much smaller than the computed stresses. This does not affect the accuracy of the ordinary formulas for practical design, as it does not increase the factor of safety nor the load at elastic limit.

*The Influence of Mix of Concrete.*—The table on p. 25 gives the tensile stresses in concrete at first crack, the actual stresses in steel and the stresses computed by formula  $f_s = \frac{M}{A_s j d}$ . As would be expected, the richer concretes resist larger stresses before cracking than the leaner concretes. The difference between computed and actual stresses in steel is also larger for rich concretes than for lean concrete. It is interesting, however, to note that the ratio between the computed stresses in steel and the actual stresses equals  $3\frac{1}{2}$  for all mixes of concrete.

*Influence of Storage.*—The tensile stress in concrete,  $f_c$ , was smaller for beams stored dry than for beams kept wet, the difference amounting on an average to about 20 per cent. Concrete stored dry tends to shrink, causing initial tensile stresses in concrete because free movement of concrete is prevented by the adhesion of concrete to steel. Concrete kept wet, on the other hand, tends to expand, which, prevented by the steel, causes initial compressive stresses in concrete. When loaded, the initial tensile stresses increase tension

<sup>3</sup> Bach. Spannungen unmittelbar vor der Rissbildung. Deutscher Ausschuss, Heft 24, 1913.

on the section while initial compressive stresses decrease it. To concrete in building construction the values for dry storage are applicable because, even if the concrete is kept wet during construction, in course of time it will dry out and the ultimate amount of shrinkage will be substantially the same as if it were held in dry storage.

**Actual and Computed Stresses at First Crack for Different Proportions of Concrete.**  
(See p. 24)

Age of beams at test, 45 days; aggregates, Rhine sand and gravel; ratio of steel,  $p = 0.0056$ . Wet storage.

Compiled from tests by C. BACH.

Proportions	Strength of Plain Concrete Lb. per sq. in.		Tensile Stresses at First Crack Lb. per sq. in.		
	Compressive	Tensile	In concrete	In steel	
			$f_t$	Actual stresses $f_s$	Computed by formula $f_s = \frac{M}{A_s j d}$
1 : 3 : 4	2 100	198	290	3 900	13 400
1 : 2 : 3	3 750	270	380	5 150	17 200
1 : 1 5 : 2	4 400	330	485	6 600	23 000

Tensile stresses,  $f_t$ , and actual stresses,  $f_s$ , are figured by formulas on page 207, in which the tensile stresses in concrete are taken into account. The stresses computed by formula,  $f_s = \frac{M}{A_s j d}$ , on the other hand, are figured neglecting the tensile value of concrete.

*Influence of Percentage of Steel.*—Professor Bach's tests<sup>4</sup> show that in concrete beams of the same proportions the actual unit stresses in concrete and steel at first crack are constant, irrespective of the percentage of steel in the beam. The theoretical stresses in steel at the first crack, however, figured by the ordinary formulas neglecting the tensile resistance of concrete, vary with the percentage of steel. Similar results, as shown in the table below, were obtained in the tests by the Bureau of Standards carried on by Mr. Richard L. Humphrey and Mr. Louis H. Losse.<sup>5</sup>

<sup>4</sup> Bach. Spannungen unmittelbar vor der Rissbildung. Deutscher Ausschuss, Heft 24, 1913.

<sup>5</sup> Technologic Paper No. 2, U. S. Bureau of Standards, p. 39.

**Actual and Computed Stresses with Different Percentages of Steel. (See p. 25).**

Experimenters	Proportions of Concrete	Age Days	Tensile Stresses in Steel at First Crack Lb. per sq. in.			
			Actual stress lb. per sq. in.	Computed by ordinary formula		
				$p = .005$	$p = .01$	$p = .02$
Bach.....	1 : 1.5 : 2	45	6 600	25 000	13 000	8 000
Bureau of Standards.	1 : 2 : 4	28	4 200	25 000	13 000	8 000

*Influence of Consistency.*—A wet consistency reduces the strength. At an age of forty-five days for 1 : 2 : 3 concrete,  $p = 0.0056$ , and for percentages of water by weight, varying between 6.8 and 10.0 per cent, the tensile stress,  $f_t$ , at first crack ranged from 395 lb. to 310 lb. per sq. in., while the compressive strength of the same concrete ranged from 3 800 lb. to 2 360 lb. per sq. in., and the tensile strength in direct pull, from 485 lb. to 245 lb. per sq. in.

*Influence of Age.*—Increase in strength with age, as determined by Bach, is shown in the table below.

**Actual and Computed Stresses at Different Ages. (See p. 26)**Proportions of concrete, 1 : 2 : 3. Ratio of steel,  $p = 0.0056$ 

Compiled from tests by C. BACH \*

	Stresses at First Crack Lb. per sq. in.			
	Age	Age	Age	Age
	28 days	45 days	6 months	1 year
$f_c$ Actual stresses in concrete....	360	380	466	495
$f_s$ Actual stresses in steel.....	4 900	5 100	6 300	6 700
$f_s$ Computed stresses in steel....	16 400	17 500	21 700	23 000

The computed stresses,  $f_s$ , are the stresses in steel figured by Formula (7), p. 207.

\* Bach. Spannungen unmittelbar vor der Rissbildung. Deutscher Ausschuss, Heft 24, 1913.

**Position of Neutral Axis.**—The position of the neutral axis in reinforced concrete beams varies with the percentage of steel and the strength of concrete and also with the intensity of the loading. For beams with large percentages of steel, the initial position of the neutral axis is lower than for beams with smaller percentages of steel. With the same steel and stronger concrete, the neutral axis is higher than with a weaker concrete.

In any beam, the neutral axis at the beginning of the loading nearly coincides with the center of gravity of a section in which the steel is considered as replaced by an area of concrete equal to the area of steel times the ratio of the moduli of elasticity. With the progress of the loading, it moves upward. Figure 8. p. 27, illus-

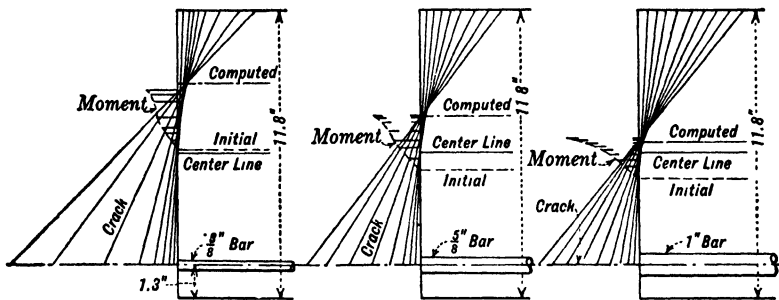

FIG. 8.—Change in Position of Neutral Axis During Loading for Different Percentages of Steel.<sup>6</sup> (See p. 27.)

trates the typical movement of the neutral axis during loading for beams with different percentages of steel. As is evident from the figure, the position of the neutral axis for different loadings was determined by plotting at proper levels the deformation of the upper concrete fiber and the deformation of steel. The intersection of the line obtained by connecting the two points and the vertical section of the beam gives the position of the neutral axis. For usual percentages of steel, the distance from the compressive side of the beam under working loads is three-tenths to four-tenths of the depth. The formula for location of neutral axis is given on p. 129.

**Stresses in Steel for Varying Intensity of Load.**—Figure 9, p. 29, gives the typical deformation of steel and of the upper fiber of concrete in inches per inch of length in beams with different percentages of steel, based on the tests of Messrs. Humphrey and Losse.<sup>7</sup>

<sup>6</sup> Bach "Biegeversuche mit Eisenbetonbalken," Berlin, 1907, pages 7 and 8.

<sup>7</sup> Technologic Paper No. 2, U. S. Bureau of Standards, 1912, p. 39.

The deformation curve for steel is not a straight line, but a composite curve, the shape of which varies with the percentage of reinforcement. The deformation and, therefore, the stresses in steel at the first stage of the loading, that is, before the first crack, are comparatively small and proportional to the load, so that the deformation curve for this stage is almost a straight line. At deformation equal to the ultimate deformation in plain concrete beams, cracks appear in the concrete, and the tensile stresses borne by it are transferred to the steel, causing an abrupt change in the steel deformation curve. As is evident from the change in deformation, as shown in the diagram, the change in the direction of the curve is much larger for smaller percentages of steel, because the amount of tensile stress, constant for beams of equal cross sections, which is transferred from the concrete to the steel, is distributed over a smaller amount of steel, and the increase in the unit stress in steel is therefore larger.

On the deformation diagram, the load at first crack is marked by the change in deformation from a straight line to a curve.

After the first crack, a large proportion of the total tensile stresses is carried by the steel. The concrete, however, still carries a small proportion of tensile stresses, dependent in amount upon the percentage of reinforcement in the beam. Because of these stresses carried by the concrete, the deformation in steel at different intensities of loading does not vary proportionally to the load.

It is absolutely necessary that this be taken into account in analyzing results from tests not carried to the breaking point, for instance, in tests of completed buildings.

The actual stresses in steel corresponding to the deformation are smaller, for reasons indicated above, than the stresses computed by formula  $f_s = \frac{M}{jdA_s}$  for the same load. In beams with small percentages of steel, concrete carries a considerable portion of the stresses up to the breaking point of the beam. (This is shown by the deformation curve for beam with 0.49 per cent of reinforcement.) For larger percentages of steel, the dash line on the diagrams, which indicates the theoretical deformation of the steel obtained from Formula (9), p. 131, strikes the actual deformation curve at the deformation corresponding to a stress of 39 000 lb. to 43 000 lb. per sq. in. This indicates that, near the elastic limit, the actual stresses agree very well with the theoretical stresses.

The fact that at design load the actual stresses in steel are much

lower than those obtained from formulas may create a wrong impression as to the actual capacity of the beam. To get the right idea,

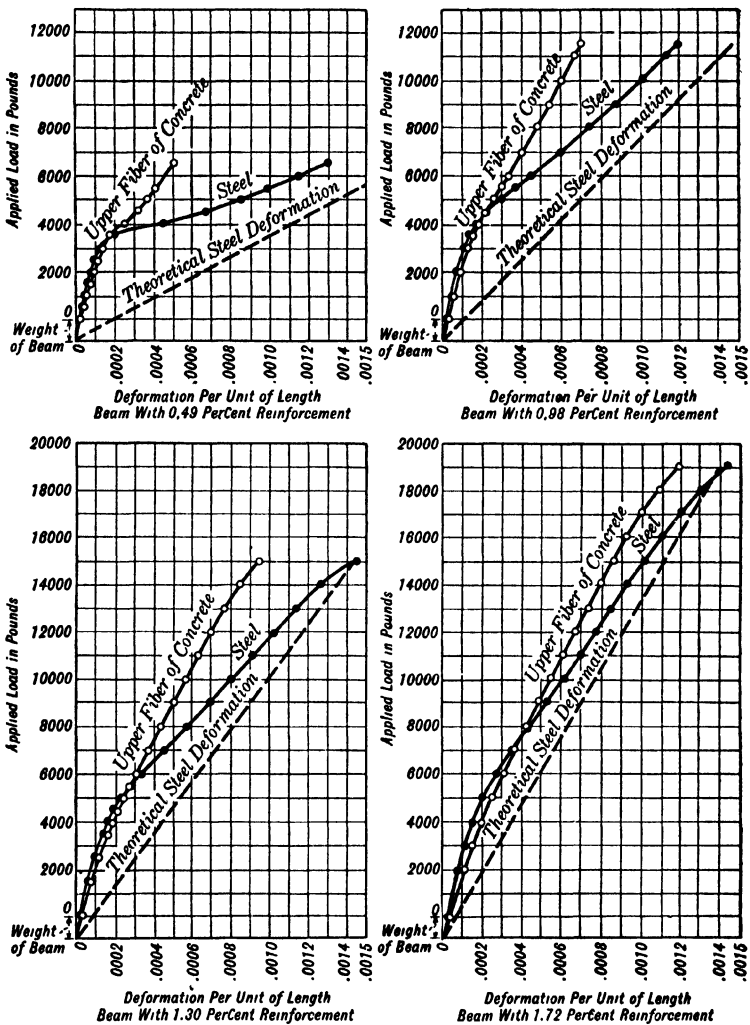

FIG. 9.—Deformations in Steel and Concrete Due to Loading.\* (See p. 27.)

it must be remembered that the conditions at the elastic limit, and not those at the intermediate loads, govern the strength. It is

\* Technologic Paper No. 2, U. S. Bureau of Standards, 1912, p. 39.

desirable to get a certain factor of safety. This means that it is required to build the beam so that it will not fail under a smaller load than the design load multiplied by the factor of safety. When the distribution of stresses in a beam varies, i.e., when the distribution at the design load is different from the distribution at the elastic limit, two methods of procedure are possible. The first method is to multiply the design load by the factor of safety and then use the distribution and magnitude of stresses at the elastic limit. The second method is to use the design load in computations with unit stresses equal to the elastic limit divided by the factor of safety. However, the distribution of stresses used in this method is the same as exists at the elastic limit. The second method is commonly used, with the understanding that the stresses used in design indicate only the factor of safety and not the actual stress.

The formulas on p. 131, therefore, although they do not represent the actual conditions of stresses at the design load, give the required factor of safety and are recommended for use in design.

The behavior of a beam reinforced with steel in two layers is substantially the same as that of a beam with one layer. The only difference is that the steel is not as effective as if all the bars were placed in one layer. The bars in the second layer are nearer the neutral axis. Their moment arm is, therefore, smaller than that of the bars in the first layer. Also, their unit stress is smaller because it varies with the distance from the neutral axis.

The method used in design where the depth of the beam is taken as the distance from the center of gravity of the bars to the top, is not exact, because it does not take into account the difference in stresses between the two layers. It is, however, exact enough for practical purposes.

**Tests of Beams Failing by Compression.**—From tests of beams failing by compression, the following conclusions may be drawn:

The computed compression stresses in the extreme fiber in concrete, at the load causing failure, are much larger than the strength of concrete in compression obtained from control cylinders of standard dimensions (8 × 16 in.) made of the same material as the beams, cured in the same way, and tested at the same time. As would be expected, the difference is much greater for the stresses obtained from formulas based on straight-line distribution of stresses than from formulas based on parabolic distribution.

The difference between the fiber at failure and the strength of

control cylinders may be explained as follows: In a beam, only the extreme fibers are exposed to the maximum stresses. The adjoining fibers, being nearer the neutral axis, are subjected to smaller stresses. If any weakness should develop in the extreme fibers in any part of the beam, causing them to reach the point of crushing, actual crushing would not take place, because the less heavily stressed adjoining fibers would come to the assistance of the heavily stressed fibers and would assume a part of the excess stress without exceeding their ultimate strength. A series of such adjustments of stresses is likely to take place before final failure.

In a cylinder, on the other hand, all the concrete is subjected to the same stresses at the same time, so that weak particles in a cylinder cannot be assisted by the adjoining particles without increasing their unit stresses. The compressive stresses are not evenly distributed over the whole area because the material is not perfectly homogeneous. Deformation readings on opposite sides of a cylinder often show that the compression on one side is different from the compression on the opposite side. This uneven distribution of stresses not only increases the stresses of some particles of the cylinder over the average stresses, but also produces harmful shearing stresses in the cylinder, which often cause final failure.

From the above description of the conditions in a beam and cylinder at failure, it follows that some difference between the actual fiber stresses at failure and actual unit strength of cylinders is to be expected. The difference is not as large, however, as it is shown to be by computations. The large difference between maximum compression strength in the cylinder and in a beam is largely due to the inexactness of formulas for computing fiber stresses. The stresses depend largely upon the magnitude of the modulus of elasticity, which varies not only for different concretes, but also for different intensities of stresses in the same material. The straight-line formula especially, being based upon the assumption of constant modulus of elasticity, gives much larger stresses than are actually developed in a beam. This is compensated by accepting larger unit stresses with straight-line formulas than would be permitted for formulas with varying modulus of elasticity, such as the parabolic formulas.

Details of tests of beams failing by compression are given in a paper by Messrs. W. A. Slater and R. R. Zipprode.<sup>8</sup> The tables on pp. 32 to 34 are taken from this paper.

<sup>8</sup> Compressive strength of concrete in flexure by W. A. Slater and R. R. Zipprode: Proceedings, Am. Con. Ins., 1920. Vol. XVI, p. 120.



TESTS OF REINFORCED CONCRETE

Data of Beams of Series 21A Tested by the United States Geological Survey at St. Louis in 1908  
Proportions of Concrete 1 : 3 : 6

Beam No.	Made by	Forms	Aggregate	Mixing	Storage	Age, Weeks	Maxi- mum Load, lb.	Cylinder Strength, lb. per sq. in.	Computed stress				Ratio $f_c$ to Cylinder Strength		Ratio Secant to Initial Modulus	Unit Deforma- tion at Maxi- mum Load	
									Tension		Compression		Para- straight line	Para- bolic		Steel	Concrete
									Straight line	Straight line	Straight line	Para- bolic					
779	Co. A	Wood	Gravel	Hand	Outside	4	16 310	833	21 900	2 190	1 580	2.63	1.90	0.30	0.00130	0.00220	
780	" A	"	"	"	"	4	12 920	789	17 300	1 740	1 250	2.20	1.58	0.58	0.00115	0.00280	
800	" A	Steel	"	"	Inside	13	19 000	660	25 400	2 550	1 840	3.86	2.79	0.38	0.00120	0.00327	
791	" A	"	"	Machine	"	4	14 500	885	19 350	1 950	1 400	2.20	1.58	0.41	0.00092	0.00215	
792	" A	"	"	"	"	4	11 610	650	15 500	1 560	1 120	2.40	1.72	0.49	0.00078	0.00254	
795	" A	"	"	"	"	13	16 700	1 470	22 300	2 240	1 620	1.52	1.10	0.50	0.00110	0.00200	
811	" B	Wood	Limestone	Hand	Outside	13	10 560	584	14 100	1 420	1 020	2.43	1.75	0.43	0.00083	0.00243	
856	" B	Steel	Gravel	"	Inside	4	10 750	537	14 350	1 440	1 040	2.68	1.94	0.44	0.00076	0.00174	
858	" B	"	"	"	"	4	8 400	672	11 200	1 130	810	1.68	1.21	0.46	0.00068	0.00268	
822	" C	Wood	Limestone	Hand	Outside	4	9 700	507	10 900	1 100	790	1.91	1.37	0.24	0.00049	0.00213	
827	" C	"	"	"	"	13	8 000	1 280	12 900	1 300	940	2.56	1.85	0.22	0.00042	0.00194	
829	" C	"	"	"	"	13	10 300	636	13 750	1 380	1 070	2.75	0.78	0.58	0.00059	0.00265	
830	" C	Steel	Gravel	Machine	Inside	4	9 450	725	12 600	1 270	915	2.17	1.57	0.56	0.00058	0.00286	
838	" C	"	"	"	"	4	8 200	689	10 900	1 100	790	1.60	1.15	0.54	0.00058	0.00286	
839	" C	"	"	"	"	4	9 360	623	12 500	1 260	910	2.02	1.46	0.23	0.00058	0.00286	
841	" C	"	"	"	"	13	18 030	956	24 100	2 760	1 980	2.53	1.83	0.44	0.00058	0.00286	
842	" C	"	"	"	"	13	20 500	1 243	27 400	2 600	1 950	2.22	1.59	0.52	0.00058	0.00286	
843	" C	"	"	"	"	13	18 560	1 214	24 800	2 480	1 790	2.05	1.47	0.30	0.00058	0.00286	
807	S.M.T.L.	"	"	"	Outside	4	13 150	789	20 200	2 030	1 470	2.38	1.86	0.27	0.00068	0.00182	
804	"	"	"	"	"	13	19 150	658	22 400	2 300	1 620	3.02	2.37	0.25	0.00082	0.00201	
853	"	"	"	"	"	13	15 000	1 210	22 000	2 370	1 450	1.90	1.31	0.69	0.00073	0.00185	
863	"	"	Limestone Gravel	"	"	4	16 700	1 091	22 300	2 240	1 620	2.33	1.69	0.43	0.00093	0.00239	
864	"	"	"	"	Inside	4	13 000	1 074	17 350	1 740	1 260	1.62	1.17	0.59	0.00065	0.00198	

Data of Beams of Series 21A Tested by the United States Geological Survey at St. Louis in 1908

Proportions of Concrete 1 : 2 : 4

Beam No.	Made by	Forms	Aggregate	Mixing	Storage	Age, Weeks	Maximum Load, lb.	Cylinder Strength, lb. per sq. in.	Computed stress				Ratio $f_c$ to Cylinder Strength		Ratio of Servant to Initial Modulus	Unit Deformation at Maximum Load			
									Tension		Compression		Straight line	Parabolic		Straight line	Parabolic	Steel	Concrete
									Straight line	Parabolic	Straight line	Parabolic							
1095	Co. A	Wood	Gravel	Machine	Outside	4	15 400	1 285	20 600	2 070	1 490	1 61	1 16	0.43	0.00104	0.00147			
1096	" A	"	"	"	"	4	18 500	1 250	23 100	2 520	1 820	2.00	1.14	0.41	0.00106	0.00175			
1097	" A	"	"	"	"	4	18 500	1 250	23 100	2 520	1 820	2.00	1.14	0.41	0.00106	0.00175			
1098	" A	"	"	"	"	13	21 500	1 750	26 400	3 400	2 410	1.98	1.43	0.45	0.00130	0.00211			
1099	" A	"	"	"	"	13	21 500	1 750	26 400	3 400	2 410	1.98	1.43	0.45	0.00130	0.00211			
1100	" A	"	"	"	"	13	25 000	1 870	33 400	3 360	2 420	2.01	1.45	0.47	0.00117	0.00223			
1101	" A	Steel	"	"	Inside	4	27 750	1 633	30 400	3 060	2 300	2.63	1.89	0.36	0.00115	0.00174			
1102	" A	"	"	"	"	4	19 900	1 526	26 600	2 670	1 920	1.78	1.28	0.52	0.00103	0.00163			
1103	" A	"	"	"	"	4	21 950	1 659	29 300	2 950	2 120	1.78	1.28	0.52	0.00116	0.00145			
1107	" B	Wood	"	"	Outside	4	20 750	1 750	27 700	2 790	2 010	1.60	1.15	0.50	0.00098	0.00145			
1110	" B	"	"	"	"	13	23 950	2 100	37 000	3 210	2 320	1.51	1.09	0.50	0.00129	0.00148			
1112	" B	"	"	"	"	13	28 240	2 100	37 000	3 790	2 730	1.80	1.30	0.45	0.00127	0.00148			
1113	" B	"	"	"	"	13	19 920	1 935	26 600	2 680	1 930	1.39	1.00	0.45	0.00089	0.00127			
1114	" B	Steel	"	"	Inside	4	19 410	1 757	25 900	2 810	1 880	1.49	1.07	0.45	0.00089	0.00127			
1115	" B	"	"	"	"	4	20 960	1 700	28 000	2 610	2 030	1.65	1.20	0.49	0.00092	0.00179			
1116	" B	"	"	"	"	13	30 750	2 600	41 000	4 130	2 970	1.59	1.14	0.62	0.00139	0.00179			
1119	" C	Wood	"	"	Outside	4	21 750	2 388	29 000	2 910	2 100	1.22	0.88	0.48	0.00108	0.00182			
1120	" C	"	"	"	"	4	20 750	2 282	27 700	2 780	2 010	1.22	0.88	0.41	0.00115	0.00164			
1121	" C	"	"	"	"	4	18 340	1 998	24 500	2 460	1 780	1.23	0.89	0.42	0.00091	0.00168			
1123	" C	"	"	"	"	13	24 500	2 150	32 700	3 270	2 370	1.53	1.10	0.58	0.00118	0.00177			
1125	" C	Steel	"	"	Inside	4	22 880	1 917	30 600	3 070	2 210	1.60	1.15	0.41	0.00117	0.00177			
1126	" C	"	"	"	"	4	20 900	1 966	27 900	2 810	2 020	1.43	1.03	0.50	0.00092	0.00180			
1127	" C	"	"	"	"	4	17 950	1 624	24 000	2 410	1 740	1.48	1.07	0.38	0.00088	0.00158			
1128	" C	"	"	"	"	13	26 970	2 230	37 000	3 710	2 680	1.66	1.20	0.42	0.00143	0.00234			
1129	" C	"	"	"	"	13	26 900	2 400	35 900	3 610	2 500	1.50	1.08	0.60	0.00144	0.00213			
1130	" C	"	"	"	"	13	25 790	2 330	34 400	3 460	2 590	1.49	1.11	0.48	0.00139	0.00216			
1131	" C	"	"	"	Outside	4	22 610	2 600	30 200	3 040	2 190	1.17	0.84	0.54	0.00106	0.00157			
1132	" C	"	"	"	"	4	23 770	2 330	31 700	3 180	2 300	1.24	0.90	0.50	0.00113	0.00165			
1133	" C	"	"	"	"	4	24 050	2 583	32 100	3 220	2 330	1.25	0.90	0.57	0.00108	0.00190			
1134	" C	"	"	"	"	13	28 490	2 698	38 000	3 820	2 760	1.42	1.02	0.52	0.00144	0.00200			
1135	" C	"	"	"	"	13	26 710	2 648	35 600	3 580	2 580	1.35	0.97	0.51	0.00131	0.00200			
1136	" C	"	"	"	"	13	24 900	2 712	33 300	3 350	2 420	1.24	0.80	0.68	0.00123	0.00168			
1137	" C	"	"	"	Inside	4	24 560	2 371	32 800	3 300	2 320	1.29	0.90	0.64	0.00127	0.00220			
1138	" C	"	"	"	"	4	24 000	2 500	32 800	3 300	2 380	1.39	1.00	0.67	0.00139	0.00196			
1139	" C	"	"	"	"	4	24 000	2 100	32 800	3 220	2 320	1.53	1.11	0.47	0.00122	0.00206			
1140	" C	"	"	"	"	13	32 000	2 950	42 700	4 300	3 100	1.48	1.09	0.52	0.00156	0.00202			
1141	" C	"	"	"	"	13	31 000	2 750	41 000	4 160	3 000	1.51	1.09	0.60	0.00152	0.00203			
1142	" C	"	"	"	"	18	32 980	2 808	44 000	4 420	3 190	1.57	1.57	0.54	0.00138	0.00203			

S.M.T.L.

## Data of Beams Tested at Lafayette College and at Lehigh University

(All stresses are given in pounds per square inch.)

Beam Number	Maximum Load, lb.	Cylinder Strength, lb. per sq. in.	Computed Stress				Ratio $f_c$ to Cylinder Strength		Ratio of Modulus to Initial Modulus	Unit Deformation at Maximum Load	
			Tension		Compression		Straight line	Parabolic		Steel	Concrete
			Straight line	Parabolic line	Straight line	Parabolic line					
<i>Tests at Lafayette College</i>											
1A.....	40 980	1 321	33 000	3 840	2 780	2 90	2.10				
1B.....	41 950	1 480	33 800	3 930	2 840	2.64	1.91				
2A.....	47 770	2 060	38 500	4 460	3 240	2.16	1.57				
2B.....	44 200	1 890	35 700	4 140	3 000	2.19	1.59				
<i>Bureau of Standards' Tests at Lehigh University</i>											
14AA11.....	91 200	3 280	33 600	6 250	4 560	1.91	1.39	0.79	0.00146	0.00316	
14AA12.....	87 750	3 200	32 300	6 000	4 390	1.82	1.33	0.79	0.00120	0.00260	
14AB21.....	79 060	2 480	27 700	4 690	3 450	1.88	1.39	0.81	0.00111	0.00284	
14AB22.....	74 400	2 410	26 000	4 380	3 240	1.82	1.35	0.46	0.00106	0.00238	

## TESTS OF T-BEAMS

The discussion of the phenomena of loading and the movement of the neutral axis, given for rectangular beams, and the results given in connection with the appearance of first cracks, on p. 22, apply also to T-beams. The initial position of the neutral axis, however, will not be the same in a T-beam as in a rectangular beam and will depend upon the relative dimensions of the flange and the stem and the percentage of reinforcement.

It must be remembered, in applying to T-beams the discussion of influence of percentage of steel upon the appearance of first crack given for rectangular beams, that the percentage of steel must be figured for the width of beam equal to the width of the stem.

T-beams may fail by tension in steel, compression in concrete, diagonal tension, or bond. The tests discussed below are grouped according to the cause of failure.

**Tensile Failures of T-Beams.**—Professor Talbot's test of T-beams<sup>9</sup> consisted of nine beams. *Dimensions:* total length, 11 ft.; test span, 10 ft.; depth to steel,  $d = 10$  in.; height,  $h = 12$  in.; thickness of slab,  $t = 3\frac{1}{4}$  in.; breadth of stem,  $b' = 8$  in.; width of flange,  $b = 16, 24,$  and  $32$  in. (three beams of each width). *Concrete,* 1 : 2 : 4 by volume. *Steel:* the amount of reinforcement varied from 0.92 per cent to 1.1 per cent of the area of enclosing rectangle,  $bd$ . Longitudinal reinforcement:  $\frac{3}{4}$ -inch plain round bars with yield point of 38 300 lb. per sq. in., and  $\frac{3}{4}$ -inch corrugated square bars with yield point of 53 800 lb. per sq. in., with  $\frac{1}{2}$  in. U-shaped stirrups (corrugated square) spaced 6 in. apart in the outside thirds of beam.

All beams failed by tension. Stresses in steel at maximum load, figured by Professor Talbot by formula,  $f_s = \frac{M}{0.86A_s d}$ , agree well with stresses at yield point of the steel. Calculated stresses ranged, for plain bars, from 37 600 to 41 500 lb. per sq. in., with an average of 39 800 lb., and for corrugated bars, from 55 700 lb. to 64 300 lb., with an average of 55 700 lb. per sq. in.

No beam failed by diagonal tension, although the maximum shearing unit stress from formula,  $v = \frac{V}{b'jd}$ , reached the value of 605 lb. per sq. in. The web reinforcement, therefore, proved to be adequate. The total diagonal tension, considered as resisted by the

<sup>9</sup> University of Illinois Bulletin No. 12, February 1, 1907.

stirrups only, would produce a theoretical stress in stirrups of 55 500 lb. per sq. in., or higher than the elastic limit of stirrup steel. Judging from the size of the diagonal cracks, the actual stress in stirrups was much below the elastic limit, which indicates that a part of the diagonal tension is carried by concrete, justifying the recommendation on p. 246 allowing part of the total diagonal tension to be considered as resisted by concrete with the remainder carried by the steel.

#### Tests of T-Beams to Determine the Effective Width of Flange.—

The following test was made at the testing laboratory in Stuttgart,<sup>10</sup> with a number of beams of the same span, cross section, and amount of steel, but varying widths of flange. Three beams of each type were tested. Loads were applied at one-third points.

#### T-Beam Tests to Determine Effect of Width of Flange. (See p. 36.)

Compiled from tests by C. BACH<sup>10</sup>

Proportions of concrete, 1 : 3 : 4 by volume, with 9½ per cent of water by weight. Elastic limit of steel, 48 000 lb. per sq. in. Age of test, 45 days.

*Common dimensions:* Total length, 10.89 ft.; testing span, 9.84 ft.; breadth of stem  $b' = 7.08$  in.; total depth,  $h = 9.84$  in.; depth of steel,  $d = 8.66$  in.; thickness of flange,  $t = 2.36$  sq. in.; 2.36 in. fillets at juncture of slab and stem.

*Steel:* 4-1.17 in. round bars; area of steel  $A_s = 4.38$  sq. in.; ¼-in. round U stirrups spaced 3 in. on centers in outside thirds.

Beams 3, 4, and 5 were provided in outside thirds of beam with ¼-in. round cross bars spaced 6 inches on centers. Beam 5a had no cross bars.

No. of Beam	Width of Flange in.	Ratio of Projections of Flange to Thickness of Slab	Maximum Load Lb.	Stresses at Maximum Load Lb. per sq. in.		Strength of Cubes Lb. per sq. in.	Ratio of Compressive Fiber Stress to Strength of Cubes †
				$f_s$ *	$f_c$ *		
2	7.1	0.0	16 900	10 050	2 200	1 580	1.39
3	20.0	5.0	31 500	18 700	1 900	1 580	1.20
4	29.1	9.5	47 200	28 100	2 200	1 750	1.26
5	39.4	13.6	56 800	33 750	2 140	1 800	1.19
5a	39.4	13.6	35 300	21 000	1 340	1 620	0.83

\* Based on Formulas (9) and (11), p. 131.

† Ratios would have been still larger if oblong cylinders had been tested instead of cubes.

<sup>10</sup> C. Bach. Mitteilungen über Forschungsarbeiten aus dem Gebiete des Ingenieurwesens, Hefte 90 and 91.

Beams 2, 3, and 4 failed by crushing of concrete in the flange. The failure in concrete occurred as in cubes, by splitting of wedge-shaped pieces of concrete. The shortening of the flanges of Beam 3 was uniform throughout the width of the flange during the whole progress of the test. For Beam 4, there was a difference in shortening of only 8 per cent at loads near the crushing strength of concrete.

Beams 5 and 5a were of the same design except that cross bars, spaced about 6 in. apart, were used in Beam 5 while 5a had no cross bars. Beams of both designs failed by the shearing off of the flanges; but there was great difference in action and in maximum load between the two beams, which is attributable entirely to the effect of the cross bars. In Beam 5, with cross bars, the stresses and the shortening of the flange were uniform over the whole width of the flange up to a load of about 44 000 lb., at which point the first longitudinal crack appeared at the junction of the slab and the stem. This crack was followed by a number of similar cracks, which finally caused failure at a load of 56 800 lb. After the first longitudinal crack, the shortening at the edges, as compared with that at the stem, decreased. At the maximum load, the shortening at the edges amounted only to half of the shortening at the stem. Both edges of the flange of the T-beam bent down along the entire length of beam. The maximum downward movement of the edge was in the center of the beam, where the edge of the flange was 0.012 in. below the level at the stem.

Beam 5a, without cross bars, failed from the same causes as Beam 5, except that the first crack occurred at a smaller load, and failure, caused by the separation of the stem and the flanges, followed closely the appearance of the first crack. This proved conclusively that it is advisable to place reinforcement across every beam that is expected to act as a T-beam so as to insure it against the separation of the flange and the stem.

The compressive stresses in the flange, which must be transferred to the stem, cause shearing stresses along the juncture of the stem and the flange. The magnitude of the unit shearing stress is proportional to the amount of compression carried by the flange and inversely proportional to the thickness of the flange. For method of determining the shearing stresses, see p. 143.

The following conclusions can be drawn from the tests:

- (a) Maximum load is increased materially by introduction of cross bars.

- (b) Maximum load can be still further increased by fillets. Beams with fillets, making a  $30^\circ$  angle with the horizontal and having a depth of three-fourths of the depth of slab, withstood a 20 per cent larger load than beams without fillets. The effectiveness of the fillet did not increase with the increase in size of the fillet.
- (c) No appreciable difference is shown in deformation in flange at the edge and at the stem for 39.4-in. flange (projections 13.6 times depth of slab).
- (d) Maximum load for beams with 60-in. flange (projections twenty-one times depth of slab) is only 5 per cent larger than for 39.4-in. flange (projections 13.6 times depth of slab).

From the above conclusions, it is evident that:

- (1) In computing effective strength, the use of a width of flange equal to six times the thickness of the slab on each side of the stem is conservative.
- (2) In ordinary cases, no fillets are required.
- (3) Crossbars on the top of T-beams are required to insure T-beam action.

#### TESTS OF REINFORCED CONCRETE BEAMS TO DETERMINE EFFECT OF DIAGONAL TENSION

Very comprehensive diagonal tension tests, illustrated and described below, were made by Professor Bach in 1908 and 1912.<sup>11</sup> They comprise sixty-four sets of beams divided into two groups. In Group I (see Fig. 10, p. 41), the load is applied to the one-third points, and in Group II (see Fig. 11, p. 43), at eight points, uniformly spaced. Both groups include beams with no web reinforcement, with stirrups, with bent bars, and with stirrups and bent bars. The span of beams in Group I is 9.8 ft., and in Group II 13.1 ft. Other dimensions are (using notation on page 215)  $h = 15.7$  in.;  $d = 13.9$  in.;  $b' = 7.9$  in. (except as noted);  $t = 3.9$  in. for both groups. The width of flange is  $b = 19.7$  in. in Group I, and  $b = 23.6$  in. in Group II. The amount of longitudinal steel is practically the same in all the beams (see summary), the only variable being the arrangement of web reinforcement.

<sup>11</sup> Deutscher Ausschuss für Eisenbeton, Hefte X, XII, XX.

*Concrete.*—1 : 2 : 3 by volume; 9 per cent of water by weight. *Aggregates:* Rhine sand and gravel. Age of specimens, forty-five days. Average strength of cubes, 3 440 lb. per sq. in. Steel yield point varied from 45 400 lb. to 51 000 lb. per sq. in. for Group I, and from 44 000 lb. to 63 000 lb. per sq. in. for Group II.

In both groups there are:

- (a) Beams without stirrups, with widths of stem,  $b'$ , 5.9 in., 7.9 in., and 11.8 in.
- (b) Beams with U-shaped 0.275-in. round stirrups, spaced 3.8 in. apart, and with widths of stem varying as in the previous case.
- (c) Beams without stirrups, horizontal steel provided with hooks at ends.
- (d) Beams with U-shaped stirrups varying in diameter from 0.2 in. to 0.39 in. and spacing varying from 2 in. to 7.9 in.
- (e) Beams with bent bars of different arrangement, with and without stirrups.

In Group II, the web reinforcement was designed by Formula (66), p. 155, for loads producing in tensile steel a stress of 14 200 lb. per sq. in.

The figures on pp. 41 and 43 give the amount and arrangement of reinforcement, for selected beams from Groups I and II, respectively. The tables on pp. 42 and 44 give maximum loads carried by the beam; cross section of horizontal steel; cross section of bent-up bars; maximum shearing unit stress,  $v$ ; stress in steel at maximum load,  $f_s$ ; stress in stirrups figured with assumption that stirrups take the total amount of diagonal tension.

The following conclusions can be drawn:

*General.*—(1) Tests show conclusively that it is possible to provide sufficient web reinforcement, in the shape of stirrups, bent bars, or a combination of the two, to develop the maximum carrying capacity of the beam, whether governed by horizontal steel or by crushing strength of concrete.

(2) For beams with and without stirrups, failing by diagonal tension, the maximum load increases in direct ratio with the width of the stem (Group I (a) and (b)). With same arrangement of stirrups, the wider beams failed by diagonal tension at higher loads than the narrower beams. This proves that diagonal tension is



resisted partly by concrete and partly by reinforcement; otherwise, in beams with stirrups failing by diagonal tension, the width of stem would be of no influence on the maximum load.

(3) The stresses in web reinforcement are smaller than those obtained by assuming the total diagonal tension from Formula (62), p. 149, to be resisted by steel only. The two above conclusions justify the recommendation that, in designing, part of the diagonal tension be considered as resisted by concrete. (See also p. 36.)

(4) Hooks at ends of horizontal bars increase the strength of beams by preventing slipping of bars. (See also p. 60). The increase is dependent upon the ratio of the horizontal bars to total reinforcement. In case of Beams 1 and 7 (Group I) and Beams 51 and 54 (Group II), where all bars were either straight or hooked at ends, the increase caused by hooking amounted to from 40 to 50 per cent of the load carried without hooks. In other cases, where only a small amount of steel was affected, the increase varied from 5 to 22 per cent.

*Stirrups.*—(5) Stirrups increase the capacity of the beam, as is evident from comparison of Beam 7 and Beam 16, on p. 42. For equal spacing, the ultimate load increases with the increase in the diameter of the stirrup; and for equal diameters of stirrups, it increases with the decrease in space between stirrups.

(6) Stirrups of small diameter, spaced closely, are more effective than those of large diameter with correspondingly larger spacing. Stirrups in tests were most effective with a spacing equal to one-third of the depth of the beam; i.e., for this spacing, the increase in ultimate load per pound of steel in stirrups was a maximum.

(7) Only about one-third of the total depth may be counted upon in developing bond in stirrups, because with the progress of the diagonal cracks, which may reach to about one-third of the depth of the beam from the top, only the portion of concrete above the crack is effective. Slip, in stirrups under load, was largest, by actual measurement, for the stirrups intersected by the crack near the top of the beam. It is advisable, therefore, to hook the ends of the stirrups.

(8) The stirrups influence the bond of the horizontal steel. The bond increases with the increase in the number of stirrups.

*Bent Bars.*—(9) Bars bent at one point only are more effective when bent at about  $45^\circ$  than if bent flatter at about  $18^\circ$  with the horizontal. Beam 29, on p. 42, resisted 20 per cent larger load than

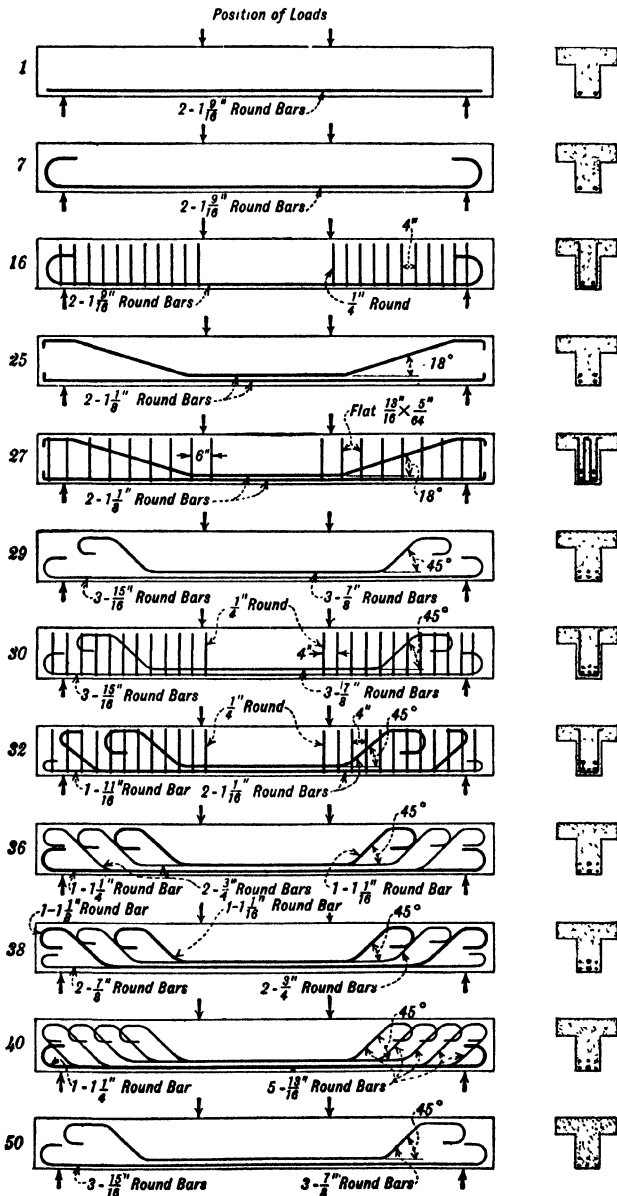

FIG. 10.—Effect of Diagonal Tension. Design and Loading of Test Beams. Selected Beams from Group I. (See p. 38.)

Beam 25, although the area of bars bent at 45° was 1.8 sq. in. against 1.98 sq. in. bent at 18° in Beam 25. No marked difference was found in strength for beams with bars bent at 30°, 40°, and 45° respectively.

**Tests of Beams to Determine the Efficiency of Web Reinforcement. (See p. 38.)**

Compiled from Tests by C. BACH \*

Number of Beam	Area of Cross Section of Bars †		Maximum	Stresses at Maximum Load			Increase in Maximum Load by Hooking of Horizontal Bars	Deflection		Cause of Failure (See note)
	Horizontal (total)	Bent		lb. per sq. in.				Maximum load	Half maximum load	
				$f_c$	$f_s$	$v$				
	sq. in.	sq. in.						Per cent	in.	

**Beams Loaded at Two Points**

1	3.91	.....	35 900	990	14 630	185	.....	0.09	0.03	D
7	3.91	.....	54 300	1 580	22 580	286	51	0.19	0.06	D
16	3.91	.....	88 000	2 430	36 130	451	.....	0.35	0.11	D
25	3.83	1.92	75 900	2 210	32 980	407	22	0.28	0.09	D
27	3.83	1.92	98 600	2 860	42 760	528	20	0.45	0.14	D
29	3.91	1.78	92 400	2 680	39 500	501	19	0.33	0.13	D
30	3.91	1.78	106 900	3 090	45 480	567	.....	0.47	0.15	T
32	3.91	3.57	98 600	2 940	42 350	529	.....	0.41	0.14	D
36	3.91	2.64	101 200	2 940	42 960	535	12	0.42	0.15	D
38	3.91	2.73	108 900	3 160	45 830	573	11	0.47	0.16	T
40	3.95	2.71	100 100	2 880	41 690	529	5	0.41	0.14	D
50	3.87	1.77	81 800	2 440	35 340	438	.....	0.36	0.11	D

NOTE: D = diagonal tension failure  
 B = bond failure  
 B = bond failure  
 T = tension failure

\* Deutscher Ausschuss für Eisenbeton, Hefte X, XII, XX, 1908 and 1912.

† Areas of bars are converted directly from the metric dimensions. Diameters in Fig. 10 are approximate to nearest sixteenth inch.

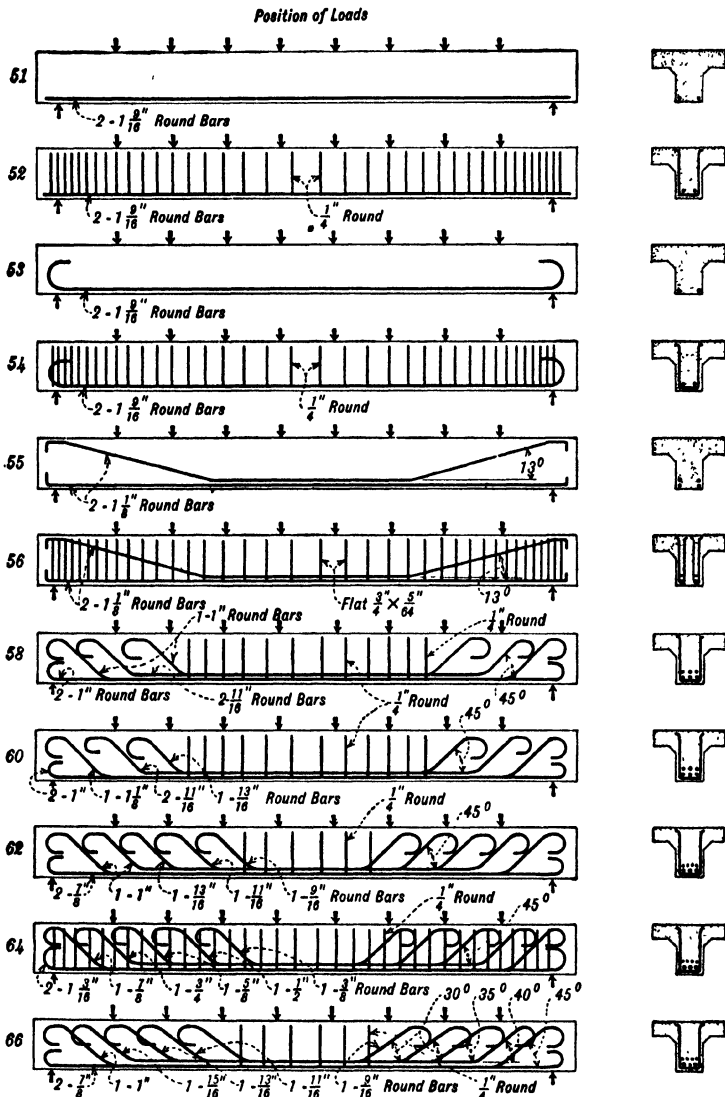

FIG. 11.—Effect of Diagonal Tension. Design and Loading of Test Beam. Selected Beams from Group II. (See p. 38.)

(10) Bent bars, as well as stirrups, are effective reinforcement for diagonal tension. Compare Beams 30 and 38, p. 42, both of which failed by tension in steel.

(11) The strength of beams with bars having sharp bends was smaller than for beams with a circular bend with a radius equal to about 12 diameters.

(12) It is evident from comparison of the stresses at maximum loads with the elastic limit of steel that almost all the beams with bent bars failed by tension in longitudinal steel.

**Tests of Beams to Determine the Efficiency of Web Reinforcement. (See p. 38.)**

Compiled from Tests by C. BACH \*

Number of Beam	Area of Cross Section of Bars †		Maximum Load lb.	Stresses at Maximum Load lb. per sq. in.			Increase at Maximum Load by Hooking of Horizontal Bars Per cent	Deflection		Cause of Failure (See note)
	Horizontal (total) sq. in.	Bent sq. in.		$f_c$	$f_s$	$v$		Maximum load in.	Half maximum load in.	
	lb.									
<b>Beams Loaded at Eight Points</b>										
51	3.91	.....	46 900	1 310	22 420	252	.....	0.22	0.10	DB
52	3.89	.....	67 300	1 870	32 020	360	.....	0.37	0.15	DB
53	3.91	.....	51 300	1 420	24 390	273	.....	0.24	0.09	D
54	3.97	.....	93 900	2 552	43 250	492	.....	0.73	0.22	
55	3.81	1.91	73 300	2 150	36 890	404	.....	0.50	0.20	D
56	3.80	1.91	100 300	2 920	50 300	549	.....	1.01	0.27	T
58	3.86	2.32	95 300	2 750	46 690	516	6	0.74	0.25	T
60	3.91	2.37	95 300	2 760	46 220	518	11	0.64	0.24	T
62	3.94	2.74	99 400	2 860	48 010	539	17	0.88	0.26	T
64	3.89	1.70	106 200	2 950	50 450	566	18	0.88	0.26	T
66	3.91	2.73	101 900	2 900	49 180	552	.....	0.75	0.26	T

NOTE: D = diagonal tension failure

B = bond failure

T = tension failure

DB = diagonal tension and bond failure

\* Deutscher Ausschuss für Eisenbeton, Hefte X, XII, XX, 1908 and 1912.

† Areas of bars are converted directly from the metric dimension. Diameters in Fig. 11 are approximate to nearest sixteenth inch.

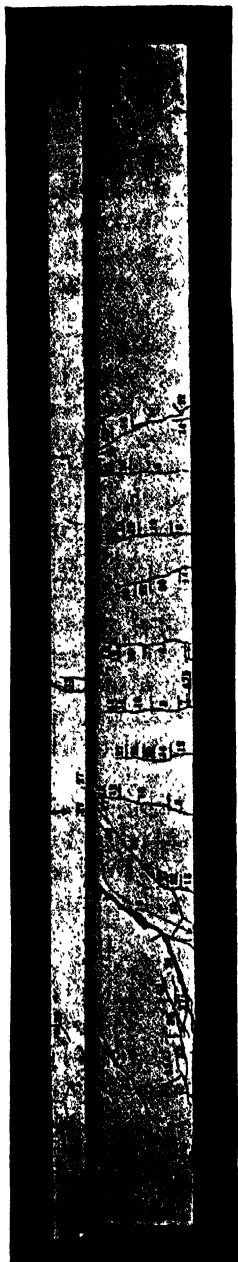

FIG. 12.—Typical Diagonal Tension Failure. (See p. 46.)  
Tests by PROF. BACH

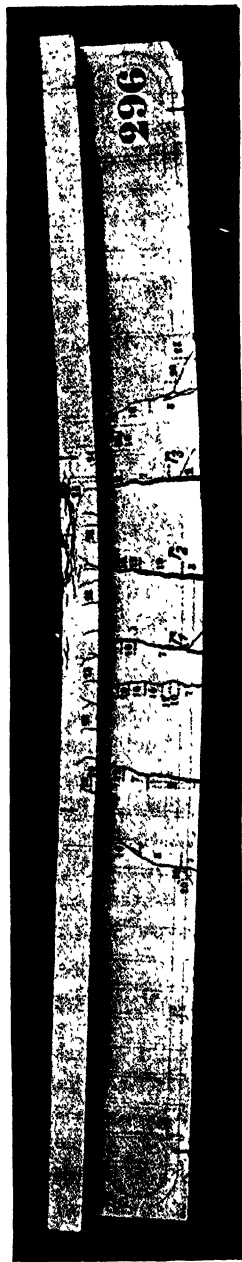

FIG. 13.—Typical Tension Failure. (See p. 46.)  
Tests by PROF. BACH

**BEHAVIOR OF REINFORCED CONCRETE BEAM FAILING BY DIAGONAL TENSION UNDER LOAD**

The difference between the intensity of loading at first diagonal crack and the ultimate loading, for beams without web reinforcement, depends upon the strength of the concrete. Lean, or green, concrete beams fail with little or no warning, so that the load at first diagonal crack coincides with the breaking load; whereas in richer and stronger concrete beams, diagonal cracks are visible for some time before final failure occurs.

Figure 12, p. 45, shows a photograph of a beam of 1 : 2 : 3 concrete, forty-five days old, with no stirrups, after failure by diagonal tension and slipping of the bar. The beam was loaded at one-third points. At a load of 14 700 lb., the first crack developed in the middle portion of the beam. At 17 640 lb., a diagonal tension crack developed in the outside third, just beyond the load. This crack increased with the load and extended diagonally upward. At 22 000 lb., the crack extended almost to the bottom of the flange. The diagonal tension cracks were much larger than the tension crack in the middle portion. At 22 000 lb., small horizontal cracks developed at the level of the horizontal bar. At further loading, additional horizontal cracks appeared. At failure, which took place at the loading of 28 600 lb., all previous horizontal cracks combined and formed a continuous crack extending from the support to the load, as is shown in the figure.

For comparison, Fig. 13, p. 45, shows a typical tension failure of a beam of similar dimensions, as shown in Fig. 12, p. 45, but provided with stirrups. All cracks are tension cracks and are confined to the center of the beam. These two beams were selected from the series made by Bach.

**BEAMS WITHOUT SHEAR REINFORCEMENT**

The maximum unit shearing stress at which beams without web reinforcement fail by diagonal tension depends primarily upon the richness of the concrete and the age, and in smaller degree upon the percentage of steel and the ratio of depth to length of span. The last two items can be neglected in ordinary design. Since diagonal tension failure in beams without web reinforcement is sudden, a large factor of safety is necessary. (See p. 244.) In all cases quoted

below, unit shearing stresses were computed by Formula (63), p. 149.

**Effect of Age upon Web Resistance.**—The effect of age is of great importance in determining the time for removal of forms and the age at which concrete can be loaded. It is illustrated in Fig. 14, p. 47, taken from tests made by Professor Talbot at the University of Illinois.<sup>12</sup>

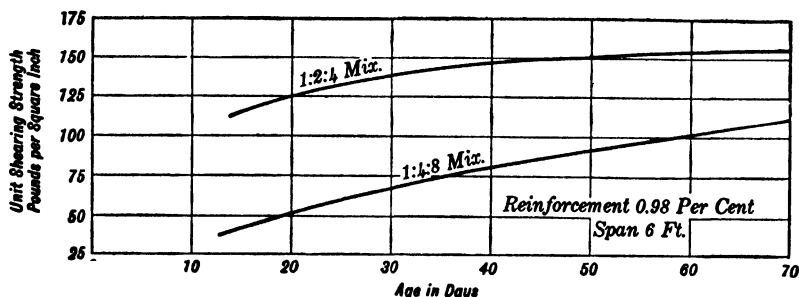

FIG. 14.—Effect of Age upon Web Resistance. (See p. 47.)

Tests by PROF. TALBOT

**Effect of Richness of Mixture of Concrete upon Web Resistance.**—Figure 15, p. 47, taken from Professor Talbot's tests, shows the increase of web resistance with the amount of cement in concrete. The increase is quite marked although somewhat less than the increase in compressive strength.

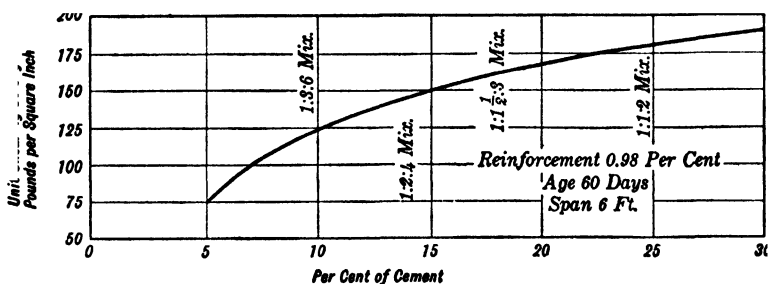

FIG. 15.—Effect of Proportion of Concrete upon Web Resistance. (See p. 47.)

Tests by PROF. TALBOT

**Effect of Percentage of Horizontal Steel upon Web Resistance.**—As is evident from Fig. 16, p. 48, the percentage of steel has a

<sup>12</sup> Bulletin No. 29, January 4, 1900.



marked effect on web resistance, which can be attributed to two causes. First, for smaller percentages of steel, the deflection is larger with consequently increased tendency of concrete to crack. Second, with larger percentages of steel, the tensile stresses developed near the support are smaller, consequently the appearance of the tension cracks which later develop into diagonal tension cracks is retarded.

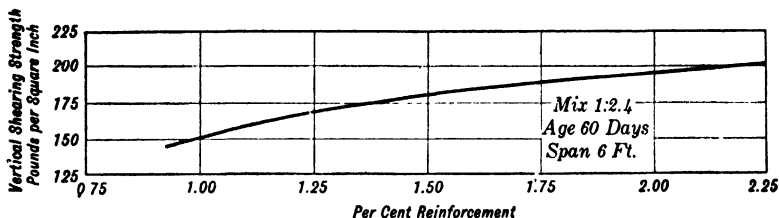

FIG. 16.—Effect of Percentage of Horizontal Steel upon Web Resistance.  
(See p. 47.)

Tests by PROF. TALBOT

**Ratio of Maximum Shearing Unit Stress Involving Diagonal Tension to the Modulus of Rupture of a Plain Beam and to the Compressive Strength.**—In beams without web reinforcement, from tests by Professor Talbot,<sup>13</sup> the ratio of maximum vertical shearing unit stress in beams failing by diagonal tension to modulus of rupture averages 0.5, and to the compressive strength, of 8 by 16-in. cylinders<sup>14</sup> averages 0.09.

#### BEAMS REINFORCED FOR TENSION AND COMPRESSION

Tests prove conclusively the effectiveness of steel as compression reinforcement.

**Professor M. O. Withey's Tests.**<sup>15</sup>—The series of 1906 consisted of eight beams, 12 ft. long; breadth = 8 in.; height = 11 in.; depth to steel =  $9\frac{3}{4}$  in., with 2.9 per cent tensile reinforcement and varying amounts of compressive reinforcement. The web reinforcement consisted of three bars bent up in two different places at a very flat angle.

<sup>13</sup> University of Illinois, Bulletin No. 29, January 4, 1909.

<sup>14</sup> In determining this ratio the authors have converted the results found in cubes to a cylinder basis.

<sup>15</sup> Bulletins of the University of Wisconsin, Nos. 175 and 197, Series of 1906 and 1907.

The results of the tests, although interesting, do not bring out fully the value of steel as compressive reinforcement, because all beams failed by diagonal tension, with the exception of the beam without compressive reinforcement, which failed in compression. Notwithstanding this, however, the maximum load of the beam without compression steel was 22 000 lb., while the maximum load for the beam with compressive reinforcement was 29 000 lb.

The series of 1907 consisted of four beams, similar in design to the beams previously described, except that they were provided at each end with  $10\frac{1}{4}$ -in. round stirrups. All the beams failed in tension at an average load of 34 000 lb., showing an increase of 55 per

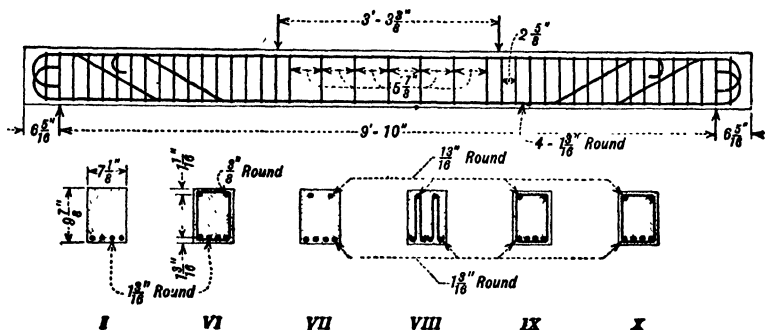

FIG. 17.—Dimensions of Beams, Stuttgart Tests. (See p. 49.)

By PROF. C. BACH

cent over the beam without compression reinforcement. Still, because of the tension failure, the full value of compression reinforcement was not demonstrated.

**Bach's Stuttgart Tests.**<sup>16</sup>—Bach's tests of beams with compressive steel consisted of six types of beams, the dimensions and arrangement of reinforcement of which are shown in Fig. 17. The results of the tests are given on p. 50. The reinforcement of Beams VII, VIII, and IX is alike except that Beam VII in the middle portion has no stirrups while Beams VIII and IX have stirrups of the shapes shown in the drawing. The amount of the compressive reinforcement in Beam X is the same as in Beams VII and VIII, but the steel is of higher elastic limit.

<sup>16</sup> Mitteilungen über Forschungsarbeiten aus dem Gebiete des Ingenieurwesen, Hefte 90 and 91.

## Test of Beams with Compression Reinforcement. (See p. 49.)

Concrete: 1 : 3 : 4 by volume. Aggregates: Rhine sand up to 0.27 in. diameter, and Rhine gravel up to 0.79 in. diameter; 9.5 per cent of water by weight. Age of test, 45 days.

Compiled from Tests by C. BACH

Specimens	Maximum Load lb.	Computed Unit Stresses in Steel and Concrete at Maximum Load Based on $n = 15$			Compressive Strength of Cubes lb. per sq. in.	Ratio Computed Unit Fiber Stress to Strength of Cubes
		Unit tensile stress in steel $f_s$ lb. per sq. in.	Unit compressive stress in steel $f'_s$ lb. per sq. in.	Unit stress in concrete $f_c$ lb. per sq. in.		
I.....	16 860	11 220	.....	2 220	1 590	1.40
VI.....	20 650	14 390	28 680	2 390	1 490	1.60
VII.....	27 500	17 750	29 200	2 500	1 480	1.69
VIII.....	29 000	18 720	29 800	2 670	1 610	1.66
IX.....	28 600	18 480	31 620	2 590	1 520	1.70
X.....	36 000	23 200	36 800	3 240	1 590	2.04

Beams VI, VII, VIII, and IX failed by compression. Beam X, in which the bond strength of the compressive steel was exceeded, failed at a considerably higher load than Beams IX, which had the same amount of reinforcement, because the compression steel in Beam X was of higher elastic limit. The table on p. 50 gives the maximum loads, the stresses in steel and concrete at the load under the assumption of  $n = 15$ , the strength of maximum cubes, and ratio of strength of cubes to figured stress in concrete in the beam. In Beams VII to IX, the compression steel reached its elastic limit first, and for further loading kept the same stress till the elastic limit of concrete was reached. In Beam X, on the other hand, the elastic limit in the concrete was reached first, and after this, stresses due to the additional loading were carried by the steel only until both materials reached the elastic limit. This points to the adjustment between compressive stresses in steel and concrete after one of the

materials passes its elastic limit. The same phenomenon was observed in the test of reinforced concrete columns.

From inspection of the table, it is evident that for beams with compression steel, the theoretical unit stresses in extreme fiber in the concrete itself, computed for the maximum test load by formulas on p. 140 and on the basis of  $n = 15$ , are much larger than similar unit stresses at which the beams without compression reinforcement failed. Since the same concrete was used in all cases, it is rational to assume that this extra strength must be attributed to compressive steel. This shows that the compressive steel carries larger stresses, and that its actual effect is greater, than would be expected from the formulas. It is especially noticeable in Beam X, for which the computed maximum fiber stress in concrete was 3 240 lb. per sq. in. while the crushing strength of the concrete was 1 590 lb. per sq. in.

The above tests prove conclusively that compressive steel may be relied upon to strengthen the compressive zone of a beam, and that its effect is even larger than would be expected from the formulas.

#### TESTS OF BOND BETWEEN CONCRETE AND STEEL

Bond between concrete and steel, or the resistance to withdrawal of steel imbedded in concrete, may be divided into two elements: (1) grip caused by shrinkage of concrete; (2) frictional resistance caused by the unevenness of the surface of the bar. Both elements act together until the bar begins to slip. Then the grip is destroyed and frictional resistance alone resists the pull.

In deformed bars, the grip and frictional resistance are aided by the bearing of the projections on the concrete, but this does not come into play until after the first slip.

The pull-out tests are treated separately from the bond tests in beams, because the action of bond stresses is different in the two cases.

#### PULL-OUT TESTS

Pull-out test specimens consist of bars imbedded in blocks. The load is applied at the free end of the bar and is resisted by the resistance to withdrawal of the steel imbedded in the block.

In practice, similar conditions occur in end anchors for fixed or cantilever beams where the concrete at the support corresponds to the block in the pull-out tests. The maximum stress in steel at

the edge of the support, which is transferred to the support by bond, corresponds to the applied force in pull-out tests.

In computation, the bond stresses are considered as uniformly distributed over the whole surface of contact between steel and concrete. (See Formula 54, p. 268.) Actually, however, the bond stresses vary from a maximum at the edge of the support to a minimum within the support. In many cases, in fact, the bar begins to slip at the place of application of the force before the bond resistance of the whole bar comes into play. Therefore, ordinarily the portion of the bar near the point of support offers frictional resistance only, while the farther end of the bar offers grip and frictional resistance. The variation in magnitude of bond stresses along the length of imbedded bar depends upon the length of imbedment. Hence, in basing allowable unit stresses on the tests, the effect of the ratio of the imbedded length to the diameter of bar must be taken into account.

When a bar imbedded in concrete slips, the movement of the free end is somewhat greater than that of the imbedded end, the difference being equal to the deformation of the imbedded portion of the bar under stress.

**Effect on Bond Strength of the Ratio of Length of Imbedment to Diameter of Bar.**—The average bond resistance, considered as distributed uniformly over the total surface area of imbedment, is smaller for long imbedments than for short imbedments. At the University of Illinois,<sup>17</sup> in tests by Mr. Duff A. Abrams for 1¼-in. plain round bars imbedded in 1 : 2 : 4 concrete, seventy-four days old, the average bond resistance for 6-in. imbedment (4.8 diameter of the bars) was 420 lb. per sq. in., while for 24-in. imbedment (19.2 diameters), it was 328 lb. per sq. in. Similar results were obtained by Prof. C. Bach.<sup>18</sup>

**Method of Determining Bond Resistance.**—In computing the bond resistance of a bar, the ratio of the length of imbedment to diameter of bar, and not the length of imbedment, is the determining item. The required length of imbedment increases in direct ratio with the increase of the diameter of bar. Thus a 25-in. imbedment is sufficient for a ½-in. bar because the ratio of the length to diameter is 50. It would not be large enough for a 1-in. bar because the ratio then is only 25. (See p. 268.)

<sup>17</sup> University of Illinois Bulletin No. 71, December 8, 1913, p. 39.

<sup>18</sup> C. Bach. *Zeitschrift des Vereines Deutscher Ingenieure*, 1911, S. 859.

**Bond Resistance for Different Slips.**—Figure 18, p. 53, shows the relation between the bond stresses and slips for plain and deformed bars during the progress of loading. As is evident from this diagram, for plain bars initial slip occurred at 260 lb. per sq. in., or at about 60 per cent of the maximum bond resistance. After the maximum

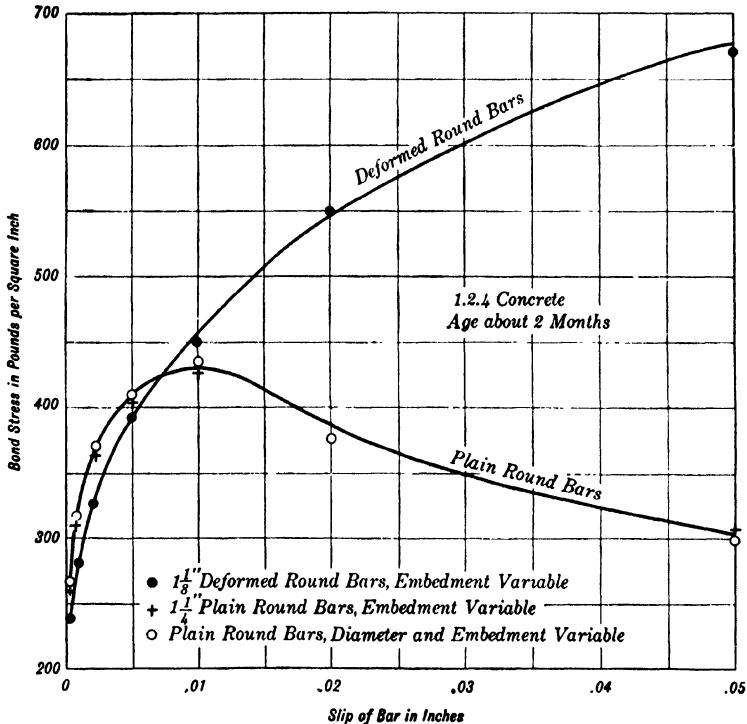

FIG. 18.—Relation of Bond Stress to Slip of Bar During Progress of Loading.<sup>19</sup> (See p. 53.)

bond resistance, which corresponds to a slip of 0.01 in. was reached, the resistance to withdrawal decreased. After a slip equal to five times the slip at maximum resistance has taken place, only 70 per cent of the maximum load is required to produce further slipping. The curves for the deformed bars are discussed on p. 54.

**Effect of Surface Condition and Shape of Bars.**—The following conclusions may be drawn from Abrams' tests:

<sup>19</sup> University of Illinois Bulletin No. 71, December 8, 1913, p. 29.

The bond resistance of square bars is only 75 per cent of the bond resistance of plain round bars.

Rusted bars (with no scale) give bond resistance 15 per cent higher than similar bars with ordinary milled surface.

The bond resistance of T-bars per unit of area decreases with the increase in size. For 1 : 2 : 4 concrete, imbedment 8 in., and age 70 days,<sup>20</sup> the maximum bond resistance of 1-in. round plain bar was 370 lb. per sq. in.; of 1-in. T-bar, 310 lb. per sq. in.; and 2-in. T-bar, 220 lb. per sq. in.

**Influence of Age and Mix.**—The table on p. 58 gives the effect of age and mix on bond of  $\frac{3}{4}$ -in. plain round bars and of  $\frac{3}{4}$ -in. corrugated square bars.

**Influence of Freezing.**—In Abrams' tests, specimens made outdoors in freezing weather, where they probably froze and thawed several times during the period of setting and hardening, were almost devoid of bond strength.

**Ratio of Compressive Strength to Bond Resistance.**—The ratio of bond strength at first slip to compressive strength, of 8 by 16-in. cylinder, is about 0.13, and of the maximum bond strength, 0.19.

These ratios were determined by Mr. Abrams from tests on specimens varying in age from two days to 2½ years, and proportions from 1 : 1 : 2 to 1 : 5 : 10. These values agree very well with the results obtained by other experimenters.

**Deformed Bars.**—Results of pull-out tests with deformed bars are given<sup>21</sup> on pp. 53, 55, and 57. The first slip for the deformed bars occurs at about the same stress as for plain bars.

After the first slip, the projections help to resist further slipping. Considering all the bond stresses except those resisted by frictional resistance taken by the projections, the bearing stresses on concrete for some types of deformed bars at large slips are very large, reaching in some cases 14 000 lb. per sq. in. of the area in contact. This high compressive stress on concrete explains the splitting of the blocks in pull-out tests. Since the allowable working stresses are only a fraction of the ultimate bond stress the bearing stresses on projections always are within safe working limits.

The maximum bond stresses, being accompanied by large slips, cannot be utilized in construction, where only a very small slip is permissible; consequently, the working bond stresses must be based

<sup>20</sup> University of Illinois Bulletin No. 71, December 8, 1913, p. 49.

<sup>21</sup> University of Illinois Bulletin No. 71, December 8, 1913.

**Maximum Bond Stress and Bond Stress at 0.001 Inch Slip for Varying Proportions and Ages.\* (See p. 53.)**

By D. A. ABRAMS

Size of Bar	Age	Stress in Pounds per Square Inch of Surface of Bar									
		Proportions									
		1 : 1 : 2 †		1 : 1½ : 3		1 : 2 : 4		1 : 3 : 6		1 : 4 : 8	
		Maximum	At 0.001-inch slip	Maximum	At 0.001-inch slip	Maximum	At 0.001-inch slip	Maximum	At 0.001-inch slip	Maximum	At 0.001-inch slip
¾-inch plain round	2 days	141	107	159	123	123	89	53	32	27	17
	4 days	197	156	231	195	153	110	77	43	49	32
	7 days	246	202	300	250	226	158	165	112	54	32
	28 days to 32 days	393	300	546	457	404	288	241	130	149	120
	60 days to 65 days	530	399	554	492	452	363	311	227	190	135
	120 days to 132 days	666	470	667	538	603	469	536	398	210	172
	16 months	779	656	896 †	875	841 †	800	372	333	373	253
	2 days	231	96	205	92	219	97	157	44	64	13
	4 days	368	176	258	115	305	129	239	74	110	23
	7 days	419	171	330	140	459	187	286	104	133	35
¾-inch corrugated square	28 days to 32 days	828	344	560	281	641	306	462	179	273	97
	60 days to 65 days	1 132	498	1 053 †	536	854	434	623	280	391	139
	120 days to 132 days	1 153	599	1 070	564	1 079	576	746	326	470	159
	16 months	1 535	892	..	..	..	..	..	..	728	322

\* University of Illinois Bulletin No. 71, December 8, 1913, pp. 82-83

† The reason for relatively low strength of 1 : 1 : 2 concrete and ¾-in bars is unexplained and may be an erratic result

‡ Bars stressed to or beyond yield point.



on stresses at a slip not exceeding 0.01 in. rather than on ultimate bond strength. The factor of safety for deformed bars based on this slip, however, may be made smaller than for plain bars, since the high ultimate bond strength and the existence of mechanical bond reduce the danger of actual bond failure. This is of special importance during construction, when comparatively green concrete may be called upon to support a considerable construction load.

**Allowable Working Stresses.**—Allowable working unit stresses based on the tests are given on p. 263.

### BOND STRESSES IN BEAMS

The method of computing bond stresses in reinforced concrete beams is given on p. 262. Although the formulas do not represent the actual conditions in a beam, they form, as explained below, a proper basis for design with values for working stresses based on tests and figured for the same assumptions.

The computed maximum bond stresses in a beam occur at points of maximum shear. With uniform loading, this is at the supports and decreases uniformly to zero at the center of the beam. In beams loaded at one-third points, maximum bond stresses act in the outside thirds and are zero in the central portion of the beam.

**Phenomena of Bond Tests.**—The bond stresses in beams are caused by the change from point to point, i.e., the increase, in the stresses in the longitudinal steel. This increase in stress in steel as computed is proportional to the amount of increase in the bending moment, and therefore equal to the vertical shear. Actually, however, the change in stress in steel is affected by the presence of tensile stresses in concrete, the amount and the proportion of which to the total tensile stresses is different in different parts of the beam. The effect is smaller near the point of maximum tensile stresses (where the concrete is cracked), and larger near the support where concrete may carry stresses even at maximum load. The increment of stresses in steel is not proportional to the shear; the bond stresses which are caused by that increment are, therefore, not proportional to the shear.

The table on p. 57 gives observed bond stresses and computed bond stresses for varying intensities of loading for a beam loaded at one-third points. Since the shear between the support and the point of application of the load is constant, the computed bond stresses

**Distribution of Bond Stress in Reinforced Concrete Beams. (See p. 56.)**

Beams 8 by 12 in. in section and 10 in. deep to center of reinforcing bar. Loaded at the one-third points of a 10-ft. span.

All beams failed by excessive tensile stress in the reinforcing bars.

Compiled from Tests by DUFF A. ABRAMS \*

Beam No.	Size and Kind of Bar	Age at Test	Applied Load on Beam lb.	Average Computed bond stress lb. per sq. in.	Observed Bond Stress	
					Over region just outside of load points † lb. per sq. in.	Near ends of beam ‡ lb. per sq. in.
1055.6	One 1-in. Plain Round	2 yr.	2 000	38	100	16
			4 000	76	125	34
			6 000	114	191	36
			8 000	152	226	64
			10 000	190	201	117
			11 700	222	165	238
1055.3	One 1-in. Plain Round	2 yr.	2 000	38	48	15
			4 000	76	75	54
			6 000	114	155	95
			8 000	152	141	100
			10 000	190	200	130
			10 700	203	140	156
			2 000	34	80	20
			4 000	68	137	45
1049.3	One 1½ in. Corrugated Round	13 mo.	6 000	102	226	95
			8 000	135	285	135
			10 000	170	250	150
			12 000	204	315	150
			14 000	236	350	225
			16 000	270	385	260
			18 000	306	400	290
			20 000	338	450	315
			21 000	355	200	360
			21 900	370	...	390

\* University of Illinois Bulletin No 71, December 8, 1913, p 193

† These stresses are, in general, the average bond stresses developed over a length of about 12 in in the portion of the beam about 4 to 16 in outside the load points

‡ The average observed stress over a length of 9 to 15 in at the ends of the beam.

are constant. The observed bond stresses, however, near the support are smaller than just outside of the points of application of the load until the steel reaches the elastic limit, after which a readjustment takes place and the bond stresses become equalized. From the table, it is evident, that in beams 1049.3, for example, the observed bond stress just outside of load points for a load of 16 000 lb. is larger than the average computed bond stress for the ultimate load, i.e., 21 900 lb. This explains why, for beams failing by bond, the average computed bond stress at the ultimate load based on Formula (50), p. 262, is smaller than the maximum bond strength in pull-out tests.

The bond stresses given in subsequent discussion are those obtained by Formula (50), p. 262.

**Effect of the Distance of the Load from the Support on the Bond Resistance.**—As may be inferred from the discussion of the phenomena of the bond stresses, the average bond resistance is larger as the load is placed nearer the support. Prof. C. Bach,<sup>22</sup> in tests of beams of 1 : 2 : 3 concrete at age of forty-five days, finds values of ultimate bond strength for distances 9.8 in., 19.7 in., and 29.5 in. from the support to average 507, 325 and 308 lb. respectively.

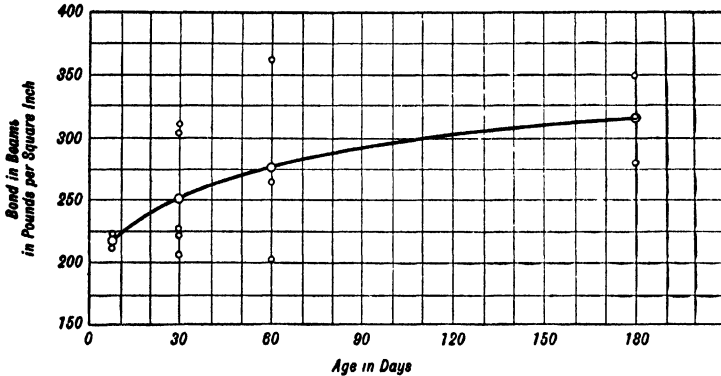

FIG. 19.—Effect of Age on Bond in Beams 1 : 2 : 4 Concrete. (See p. 58.)  
Tests by PROF. WITHEY

**Effect of Age on Bond.**— Figure 19 on p. 58, from Professor Withey's tests at the University of Wisconsin<sup>23</sup> shows the increase of bond strength with age, for 1 : 2 : 4 concrete.

<sup>22</sup> Widerstand Einbetonierten Eisens Gegen Gleiten. Einfluss der Haken, von C. Bach and O. Graf, p. 18.

<sup>23</sup> University of Wisconsin Bulletin No. 321, October, 1909, p. 27.

Professor Bach found for 1 : 2 : 3 concrete the following bond strength:

Age.. . . . .	28 days	45 days	6 months	One year
Beams kept moist, lb. per sq. in. . . . .	278	308	393	435
“ “ dry, “ “ . . . . .	271	319	356	363

He suggests the following formula for increase in bond strength with age:

$$u = 745 \left( 1 - \sqrt[6]{\frac{1}{15A + 1}} \right)$$

Where *u* = unit bond strength in lb. per sq. in;  
*A* = age in months.

**Effect of Mix of Concrete.**—From tests, it is evident that the richness of mortar in concrete affects the bond strength considerably. The quality of stone is of little effect, provided pockets around the reinforcement are prevented. The table below gives values for bond strength for concrete of different proportions.

**Bond Strength in Beams for Different Proportions of Concrete. (See p. 59.)**

Beams, 5 in. by 5 in. by 5 ft. 6 in. long. Reinforcement, 3-<sup>5</sup>/<sub>8</sub>-in. round bars. Lower bars imbedded in concrete for length of 10 inches at both supports. Beams tested on 5-foot span. Compressive tests on separate specimens.

Compiled from Tests by MORTON O. WITHEY \*

Mix	Age, Days	Coarse Aggregate	Average Bond lb. per sq. in.	Compressive Strength lb. per sq. in.
1 : 2 : 4	60	Limestone	276	1 790
1 : 2 : 4	60	Gravel	275	2 200
1 : 3 : 6	60	Limestone	216	830
1 : 2½	60	.....	267	1 600

\* University of Wisconsin Bulletin No 321, October 1909, p 27.

**Hooks as End Anchorage.**—The requirements of a properly constructed hook are: (1) it should permit the stressing of the steel to its elastic limit without appreciable movement; (2) the bearing stresses on the concrete must be within a safe limit. Since the allowable bearing stresses on concrete depend upon the properties of the con-

crete, the factor of safety against crushing must be the same as that used in determining the allowable fiber stresses in concrete. Tests show that the crushing strength of concrete, when confined, is much larger than the crushing strength of cubes or cylinders. Hence, the safe bearing stress of the hook on the concrete should be based on the crushing strength of confined concrete. In comparing, therefore, the relative efficiency of hooks, their bearing area is of first importance.

When used for end anchorage, hooks which allow stressing the steel to elastic limit, but which at the same time split or crush the concrete, have not the required factor of safety as far as concrete is concerned, because at working stresses the concrete would have only a factor of safety of 2, instead of 3 as required by rational design.

Tests<sup>24</sup> made for the Eastern Concrete Construction Company at the Massachusetts Institute of Technology determined the capacity of the hook, but did not determine the load at which the first movement of the hook took place.

In all the tests,  $\frac{3}{4}$ -in. round bars were imbedded in blocks 12 in. square and 15 in. long to a depth of 12 in.; with additional bends of different lengths. Right-angle bends and semicircular bends on a 3-in. diameter were tested. Several specimens of each type were tested, and the results were extremely uniform.

The following conclusions may be drawn from the tests:

(1) A 4-in. right-angle bend in a  $\frac{3}{4}$ -in. round bar (5 diameters) combined with 12-in. imbedment (16 diameters) is sufficient to stress the steel to its elastic limit. This hook, however, crushed the concrete and split the block; therefore it does not give the required factor of safety against crushing of concrete. A longer bend does not increase the security because the bearing stress is not appreciably reduced.

(2) A semicircular bend with a diameter four times the diameter of the bar is more effective than the square bend and is preferable because the bearing stresses on concrete can be kept within working limits.

**Action of Hooks in Beams.**—Beams in which longitudinal steel is provided with hooks show a much larger load-carrying capacity than similar beams with ends of bars straight. Tests at age of forty-five days, by Professor Bach, on beams of 1 : 2 : 3 concrete, 12 in. square and 6-ft. span, reinforced with one 0.98-in. diameter

<sup>24</sup> Concrete, Plain and Reinforced, Second Edition, p. 466.

round bar provided with three different kinds of hooks, gave the carrying capacity of the beam without hooks as 14 330 lb.; with right-angle hook, 24 250 lb.; with 45° hook, 25 800 lb.; and with circular hook, 28 060 lb. The beam with rectangular hooks failed by straightening the hook.

**SPLICES OF TENSILE REINFORCEMENT IN BEAMS AT POINTS OF MAXIMUM STRESS**

Tests have been made by H. Scheit and O. Wawrziniok<sup>25</sup> to determine the effectiveness of different methods of splicing steel at the point of maximum stress. The beams were 12 in. square, of spans 6½ ft. and 10 ft., reinforced with 1-in. bar. They were tested with two symmetrical loads spaced 3 ft. 3 in. apart for the shorter beams, and 5 ft. apart for the longer beams.

Straight splices were made with a lap of 10, 20, and 30 diameters respectively for the short beams, and 40, 50, 60, 70, and 80 diameters for the long beams; in hooked splices, the hooks consisted of a semi-circle with an inside diameter of 5 diameters of the bar and an extra length of 6 diameters of the bar parallel to the bar, and the bars were lapped 10 in, 20 in., and 30 in. respectively.

**Results.**—For straight splices, the best results were obtained with a splice of 50 diameters, with which the elastic limit of steel was reached.

Hooked splices proved very effective. Even a 10-diameter lap (the smallest lap used) in combination with a hook, as described above, was sufficient to provide the same carrying capacity as the beam without the splice.

**DEFLECTION**

The deflection in reinforced concrete depends primarily upon the ratio of the depth of the beam, or slab, to the span. It also depends upon the percentage of tension and compression reinforcement, and in T-beams, upon the width of the flange.

**Influence of Percentage of Steel upon Deflection.**—For equal depths and widths, the deflection of beams increases with the decrease in the percentage of tensile steel. Figure 20, p. 62, shows the

<sup>25</sup> Deutscher Ausschuss für Eisenbeton, Heft 14, 1912.

deflections of beams 13 ft. long, 8 by 11 in. in cross section, tested on a 12-ft. span, by two equal loads applied at one-third points. The test was made by Messrs. Richard L. Humphrey and L. H. Losse.<sup>26</sup> The deformations in steel and concrete for the same beams are shown on p. 29.

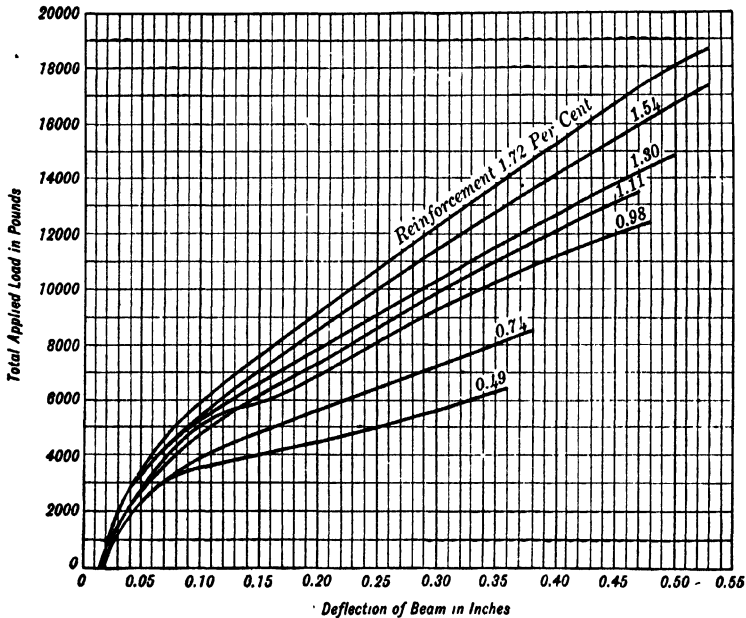

FIG. 20.—Deflection of Beams with varying Percentage of Steel (See p. 61.)  
Tests by RICHARD L. HUMPHREY and L. H. LOSSE

**Influence of Width of Flange upon Deflection.**—In Bach's tests<sup>27</sup> to determine the effect of width of the flange, the results given in the table on p. 63 were obtained. It will be seen that although the percentage of steel based on the area of the stem is the same in all cases, the deflection for equal loads is smaller for beams with larger widths of flange.

<sup>26</sup> Technologic Paper No. 2, U. S. Bureau of Standards, June 27, 1911.

<sup>27</sup> Mitteilungen über Forschungsarbeiten aus dem Gebiete des Ingenieurwesen, Hefte 90 and 91.

**Deflection of T-Beam with Varying Widths of Flanges.** (See p. 62.)

Span of beams, 9.84 feet; reinforcement, four  $1\frac{3}{8}$ -in. round bars; load applied at one-third points.

By C. BACH \*

Total Load		Deflection in Inches			
		Rectangular Beam 7.1 × 9.84 in.	T-Beam, depth 9.84 in.; width of stem, 7.1 in.		
			Width of flange in inches		
		18 9	29.5	39.4	
lb.	in.	in.	in.	in.	
8 800	0.106	0 071	0 047	0 042	
17 600	0.376	0 177	0 110	0 097	
26 500	.....	0 368	0 188	0 161	
35 300	.....	.....	0 290	0 235	
44 100	.....	.....	0 467	0 351	
52 900	.....	.....	.....	0 544	

\* Mitteilungen über Forschungsarbeiten aus dem Gebiete des Ingenieurwesens, Hefte 90 and 91.

**Influence of Compressive Steel upon Deflection.**—The table on p. 64 gives deflection of beams without compressive reinforcement and with different percentages of compressive reinforcement. From the figures, it is evident that for equal percentage of tensile reinforcement the deflection decreases with the increase of compression reinforcement.



**Deflection of Beams with Compression Steel. (See p. 63.)**

All beams,  $7.1 \times 9.8$  inches; span, 9.84 feet; tensile reinforcement, four  $1\frac{1}{4}$ -in. round bars; load applied at one-third points.

By C. BACH \*

Total Load	Deflection in Inches			
	Compression steel, per cent			
	0	0.4	1.58	1.58 †
lb.	in.	in.	in.	in.
4 400	0.046	0.042	0 038	0.037
8 800	0.119	0.102	0.086	0.084
13 200	0.256	0.184	0 143	0.139
17 600	.....	0.298	0 210	0.203
22 000	.....	.....	0.287	0.276

\* Mitteilungen über Forschungsarbeiten aus dem Gebiete des Ingenieurwesens, Hefte 90 and 91.

† High elastic limit steel used.

**TESTS OF CONTINUOUS BEAMS**

Since in concrete construction beams are usually continuous over several supports, it is of the greatest importance to determine by tests whether this continuity can be relied upon.

**Tests of Continuous Beams by Prof. H. Scheit and Dr. Ing. E. Probst.**<sup>28</sup>—These tests included the concrete beams shown in Figs. 21 to 23, pp. 66 to 68. Two beams of each type were tested to destruction.

The spans and the reinforcement for the loaded spans were the same for all beams. The complete series included beams as follows:  
Type 1, simply supported beams.

Type 2, continuous beams over two spans.

Type 3, continuous beams over three spans, end spans loaded.

Type 3a, beams similar to Type 3, but supported by columns; loading same as Type 3.

Type 4, beams of five spans, alternate spans loaded.

<sup>28</sup> "Untersuchungen an durchlaufenden Eisenbetonkonstruktionen," Berlin, 1912.

Figs. 21 to 23 show the cracks, and Fig. 22, Type 3, the deflection at different loads. Results of tests are discussed below:

**Comparison of Theoretical Deflection with Actual Deflection.**—To determine the efficiency of continuous beams, the ratios of deflections of continuous beams to those of simple beams obtained from tests were compared with theoretical ratios for homogeneous beams.

For continuous beams of two spans, Type 2, the observed ratio of deflections was between 0.42 and 0.45, while the theoretical ratio was 0.40. For beams continuous over three spans with end spans only loaded, the observed ratio was 0.69 against the theoretical ratio of 0.74.

For beams of Type 3 of the same design as the one above but in which the ends were connected with columns, the ratio varied from 0.34 to 0.37. From the theoretical figures, it appears that as far as deflection is concerned, this type is almost midway between a beam fixed at one end, for which the ratio is 0.40, and a beam fixed at both ends, for which the ratio is 0.20.

*Type 2.*—The beams continuous over two spans failed at the support at an average load of 14 240 lb. per lin. ft. The theoretical negative bending moment at the support is  $-\frac{wl^2}{8}$ . The stress in steel at the support for the maximum load, figured on the basis of the above bending moment, is about 64 000 lb. per sq. in. It is evident that this stress is much higher than the elastic limit of the steel used in the test, which shows that the assumed theoretical bending moment coefficient is too large. Based on the moment of resistance for the yield point of steel, we get a bending moment coefficient of 10 instead of the theoretical 8. The point of inflection was found to coincide with the theoretical point of inflection. (See Fig. 21, p. 66.)

*Type 3.*—In the beams continuous over three spans, the first cracks appeared at the bottom of the beam in the central portion of the loaded span at a load of 2 565 lb. per lin. ft. In the unloaded span, the first crack appeared at the top of the beam at a load of 5 600 lb. per lin. ft. The sequence of other cracks and the loads at which they appeared is evident from the illustration. The failure at a load of 12 600 lb. per lin. ft. was caused by passing of the elastic limit of steel in the loaded spans.

The deflection diagram, Fig. 22, p. 67, gives a positive proof of the continuous action of the beam. As is evident from the diagram,

the deflection in the end span is positive, while in the center span it is negative. The computed stresses and bending moments at the different loads agree quite closely with the measured stresses.

The measured compressive stress for the maximum load in the middle span (which was not loaded) was found to be 1 500 lb. per sq. in., which is almost identical with the theoretical stress. The cracks in the unloaded span, which are uniformly distributed over its whole length, furnish a conclusive proof of continuous action. If no pro-

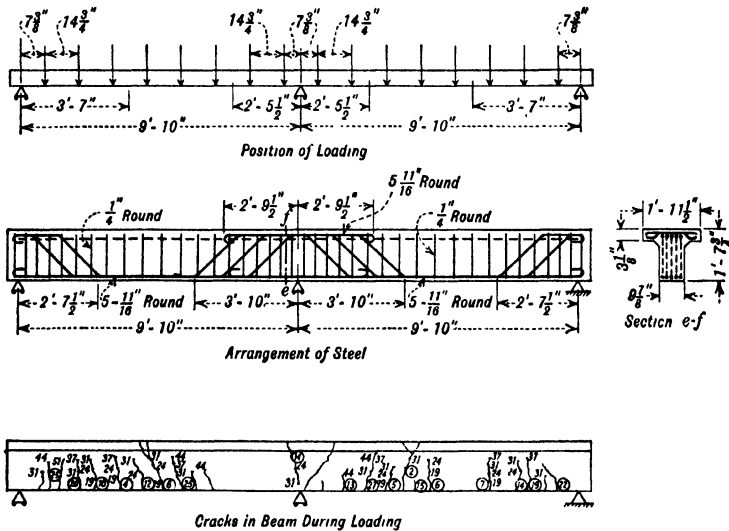

FIG. 21.—Continuous Beam of Two Spans; Type 2. (See p. 65.)

vision had been made for the negative bending moment in the unloaded span, failure would have been certain.

*Type 3a.*—In the beam continuous over three spans and monolithic with columns, as shown by Fig. 23, p. 68, the connection between beams and columns was not rigid, as would be the case with rigid frames, but was built as in ordinary building construction. The beams were of exactly the same design as in Type 3. The comparison, therefore, gives the effect of the connection of the beam with the column. The first cracks in the loaded span appeared at a load of 4 590 lb per lin. ft., and in the unloaded span, at a load of 10 935 lb. per lin. ft. The corresponding figures in Type 3 were 3 565 lb. per lin. ft. and 5 670 lb. per lin. ft. At a load of 13 905 lb. per lin. ft.,

the first cracks appeared at the top of the end column; and at 16 740 lb. per lin. ft., a crack appeared at the top of the middle column. The beam failed at 17 620 lb. per lin. ft. by steel passing the elastic limit. At the time of failure, cracks were observed in the compressive part of the interior column.

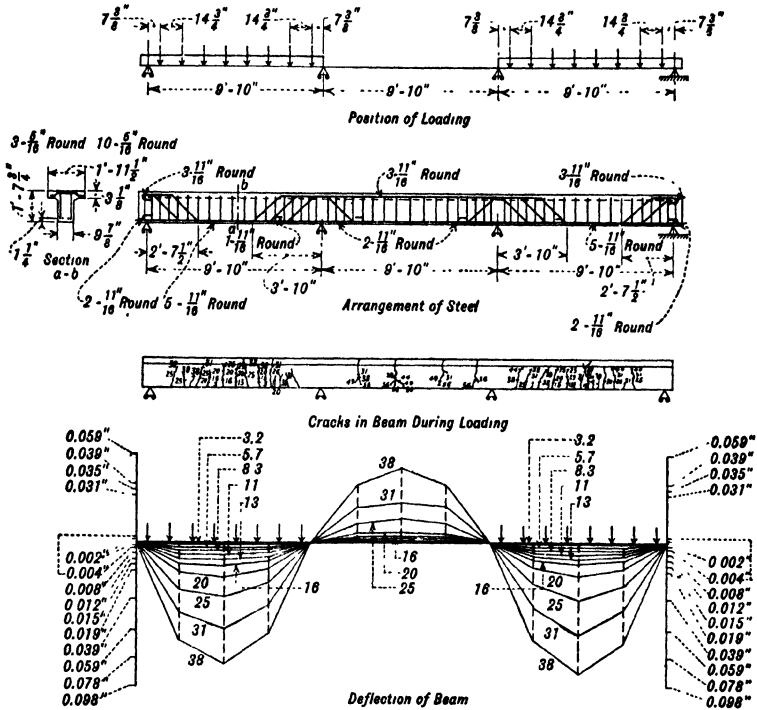

FIG. 22.—Continuous Beam of Three Spans; Type 3. (See p. 65.)

After the tests, cracks were found at the bottom of the columns, located in reverse position to the cracks at the top. During test, not only the beams, but also the columns deflected, which shows that the whole construction acted as a unit. The deflection in the beams was smaller than in Type 3, as explained before.

As was expected, the moment of resistance at the ultimate load does not agree with the bending moments for continuous beams based on the assumption of free ends. The construction must be considered as a frame. Dr. Probst finds that the positive bending

moment coefficient in the loaded span was 12.02, which agrees very closely with the bending moment coefficient computed by him by the rigid-frame method.

*Type 4.*—The cracks in the T-beams continuous over five spans indicate clearly that the beams acted as continuous. From the

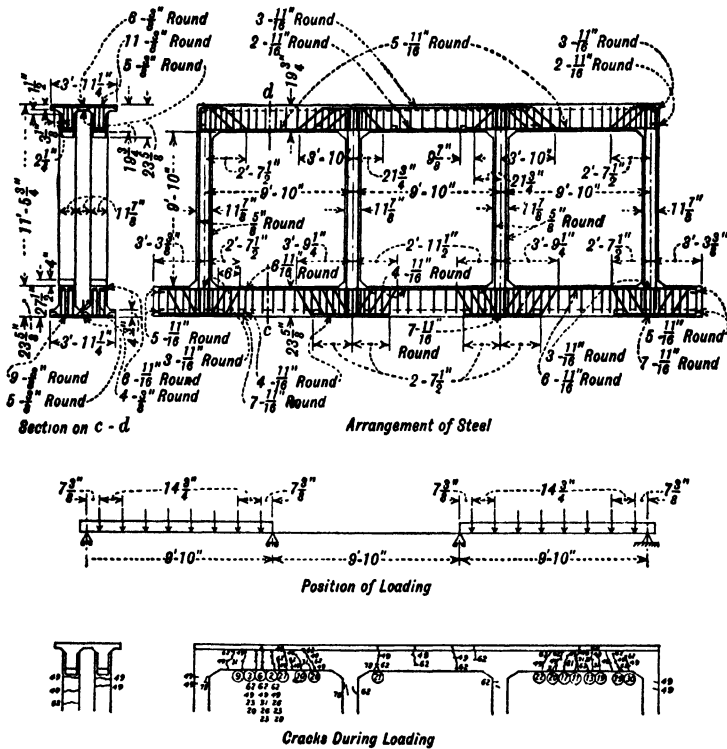

FIG. 23.—Continuous Beams of Three Spans; Type 3a. (See p. 66.)

comparison of the moment of resistance of the beam at the maximum load, with the theoretical bending moment obtained from ordinary continuous beam formulas, we find a very close agreement, which proves that even for five spans a continuous beam acts as continuous.

**DISTRIBUTION OF CONCENTRATED LOAD ON WIDE SLABS**

A concentrated load placed on a wide slab is carried not by the portion of the slab immediately below the load but by a considerable width of the slab. Experiments described below, conducted on slabs where the maximum width was equal to double the span length, show that within these limits the whole width of the slabs is affected by a concentrated load placed centrally, and, therefore, assists in larger or smaller degree in carrying the load. Thus, in a 32-ft. slab tested on a 16-ft. span, the whole slab was affected by the load. This condition is brought about by the shearing resistance of concrete and not by any distributing reinforcement.

**Distribution of Stresses and Deflections.**—The stresses and deflections in the center of the span are largest in the section of slab directly under the load. For sections away from the load, the center stresses and deflections decrease rapidly at first and then more slowly, until for wide slabs they become insignificant near the edges of the slab.

**Definition of Effective Width of Slab.**—As explained above, in a wide slab under a concentrated load, along the width of the slab, there is considerable variation in stresses in the center of the span. The ordinary slab formulas assume uniform distribution of stresses along the whole width; therefore they cannot be used directly without some assumption. In order to be able to use ordinary slab formulas for the design of wide slabs loaded by concentrated loads, it is necessary to determine the width of slab of same depth which, stressed uniformly along its whole width, would have the same strength as the wide slab with its varying distribution of stresses, and for which the moment of resistance, based on an accepted maximum unit stress, would be equal to the moment of resistance of the whole width of slab with a varying distribution of stress and with largest stress equal to the maximum accepted stress. This width is called effective width. It is less than the total width of the slab; and the ratio of effective width to total width depends upon the ratio of the total width to the span.

**Effective Width from Tests for Central Load.**—From the tests made by the Office of Public Roads and reported by A. T. Goldbeck,<sup>29</sup> the ratio of the effective width of slab to the span depends upon the

<sup>29</sup> A. T. Goldbeck. The Influence of Total Width on the Effective Width of Reinforced Concrete Slabs Subjected to Central Concentrated Loading. Proceedings, Am. Concrete Institute, 1917. Vol. XIII, pp. 78 to 88.

ratio of the total width of the slab to the span. The ratio may be found from the table below.

Effective Width of Slab for Concentrated Load

Total Width of Slab	Effective Width of Slab	Ratio Effective Width to Total Width	Total Width of Slab	Effective Width of Slab	Ratio Effective Width to Total Width
0.1 <i>l</i>	0.1 <i>l</i>	1	1.1 <i>l</i>	0.67 <i>l</i>	0.61
0.2 <i>l</i>	0.2 <i>l</i>	1	1.2 <i>l</i>	0.68 <i>l</i>	0.57
0.3 <i>l</i>	0.28 <i>l</i>	0.93	1.3 <i>l</i>	0.70 <i>l</i>	0.54
0.4 <i>l</i>	0.37 <i>l</i>	0.93	1.4 <i>l</i>	0.71 <i>l</i>	0.51
0.5 <i>l</i>	0.44 <i>l</i>	0.88	1.5 <i>l</i>	0.72 <i>l</i>	0.48
0.6 <i>l</i>	0.50 <i>l</i>	0.83	1.6 <i>l</i>	0.72 <i>l</i>	0.45
0.7 <i>l</i>	0.55 <i>l</i>	0.79	1.7 <i>l</i>	0.72 <i>l</i>	0.42
0.8 <i>l</i>	0.58 <i>l</i>	0.72	1.8 <i>l</i>	0.72 <i>l</i>	0.40
0.9 <i>l</i>	0.62 <i>l</i>	0.69	1.9 <i>l</i>	0.72 <i>l</i>	0.38
1.0 <i>l</i>	0.65 <i>l</i>	0.65	2.0 <i>l</i>	0.72 <i>l</i>	0.36

*l* = span of the slab.

From the above table it is evident that, where the width of the slab is equal to 0.4 of the span, practically the whole width is effective. When the width of span equals 1.5 *l*, the effective width attains its maximum value, namely 0.72 *l*. In such cases, about one-half of the total width is effective. The increase of the total width beyond 1½ times the span has no effect on the effective width, as in all cases the effective width equals 0.72 *l*.

From the tests made by Professor C. T. Morris, the effective width equals 0.6 times span plus 1.7 ft. for a width equal to 1.35 *l* + 4 ft. This checks closely enough the value in the table.

**Effective Width from Tests with Eccentric Load.**—When the load is not applied in the center of the width of the slab, the following rule may be used.<sup>30</sup>

If the distance from the load to the nearer edge of the slab is greater than one-half the effective width of the slab, considered as

<sup>30</sup> See: Tests of Large Sized Reinforced Concrete Slab Subjected to Eccentric Concentrated Loads, by A. T. GOLDBECK and H. S. FAIRBANK. Journal of Agricultural Research. Vol. XI, No. 10, December 3, 1917.

centrally loaded, the effective width may be assumed to be same as for centrally loaded slab.

If the distance from the load to the nearer edge of the slab is less than one-half the effective width of centrally loaded slab, the effective width may be taken as one-half the effective width for centrally loaded slab plus the distance of the load to the nearer edge.

**Example 1:** Find effective width for a slab 20 ft. wide with a 14-ft. span, when the concentrated load is placed 3 ft. from the edge.

**Solution:** The ratio of total width to span is  $\frac{20}{14} = 1.43$ . For a slab loaded with a concentrated load placed centrally, the effective width, from table on p. 70, is  $0.71l = 0.71 \times 14 = 10$  ft. The distance of the concentrated load from the nearest edge is less than one-half of this width; therefore the effective width for eccentric load is

$$\frac{10}{2} + 3 = 8 \text{ ft.}$$

**Description of Tests.**—Tests were made by the Office of Public Roads and Rural Engineering on the following slabs:

Num-ber	Span ft.	Width ft.	Total Depth in.	Effective Depth in.	Reinforcement		Percent- age
					Size bars	Spacing in.	
835	16	32	12	10½	$\frac{3}{4}$ in. sq.	10	0.75
930	16	32	10	8½	$\frac{3}{4}$ " "	8.87	0.75
934	16	32	7	6	$\frac{1}{2}$ " "	5.56	0.75
A19	6	12	7	6	$\frac{1}{2}$ " "	5.55	0.75
A20	6	12	4	3	$\frac{3}{8}$ " "	6.26	0.75
A21	6	12	5	4	$\frac{1}{2}$ " "	8.33	0.75
A22	6	32	16	15	$\frac{3}{4}$ " "	5	0.75
A23	6	12	6	5	$\frac{1}{2}$ " "	6.66	0.75

The mix of concrete in all slabs was 1 : 2 : 4. No cross reinforcement was used.

All slabs were tested with their original width. Slab A25, after being tested with its original width, was gradually reduced in width by having successive sections split off one side.

**Method of Test.**—Concentrated loads were applied in the center of the slab. Additional tests were made with two and four concentrated loads. In some slabs the loading was carried to destruction; while in slabs tested with different widths up to the working



loads, deformation of concrete and deflection readings were taken at all widths. The deformation readings on concrete were made perpendicularly to the support at regular intervals along the whole width of the slab. In several cases, deformations were also taken longitudinally with the span. Steel deformations were also measured in some slabs.

Concrete deformations were found to be a most satisfactory measure of distribution of stresses in the slab. In interpreting the results, however, it was necessary to take into account the flow of concrete under sustained loads:

Steel deformations were less satisfactory, because the readings at points where cracks occurred were different from readings at adjoining points without cracks.

**Deformation of Slab and Effective Width.**—Figure 24 shows the deformations of steel in Slab A19 when tested with different widths. The effective width is marked by dash lines.

**Results of Tests.**—Figure 25, p. 73, shows the

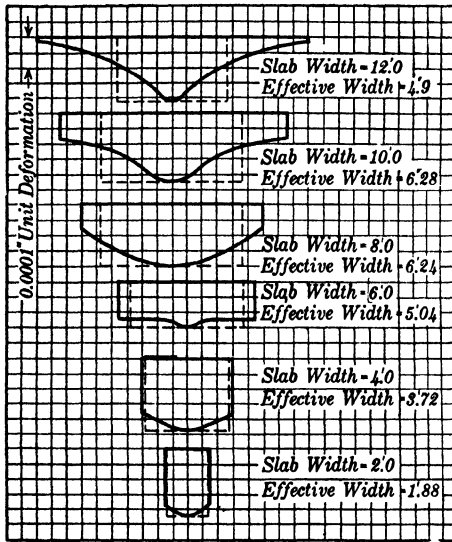

Span 6'. Effective Depth 6". Steel 0.75 per cent

FIG. 24.—Steel Deformations and Effective Width Slab A19. (See p. 72.)

results of all tests. In the figure, the ratios of total width to span are plotted as abscissas and the ratios of effective width to span as ordinates. The curve represents the values given in the table on p. 70 and suggested for use. To be on the safe side, the curve is made to coincide with the lowest values obtained in the tests.

**Breaking Loads of Slabs.**—Slabs 835, 930, and 934 were loaded to destruction. The results are given on p. 73.

Breaking Loads of Slabs. (See p. 72.)

Number	Effective Depth	Reinforcement			Breaking Load lb.
		$p$	Size	Spacing	
835	10½	0.0075	¾ in. sq.	10.5 in.	119 000
930	8½	0.0075	¾ " "	8.87 " "	80 000
934	6	0.0075	½ " "	5.56 " "	40 000

All slabs were 32 ft. wide and 16 ft. span.

Influence of Total Width on Effective Width of Reinforced Concrete Slabs Subjected to Concentrated Loading.

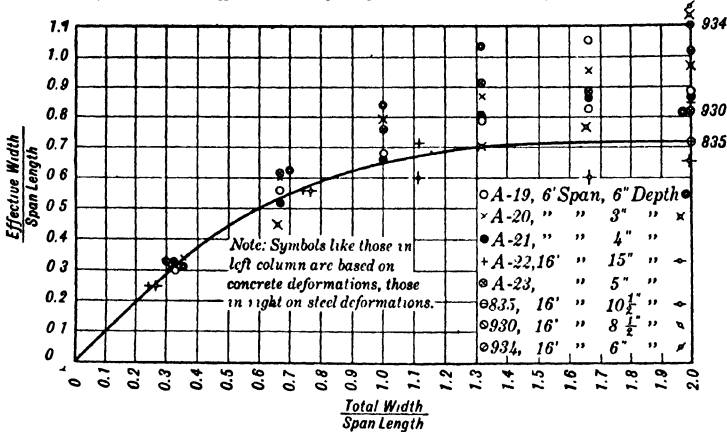

FIG. 25.—Influence of Total Width on Effective Width of Reinforced Concrete Slabs Subjected to Concentrated Loads. (See p. 72.)

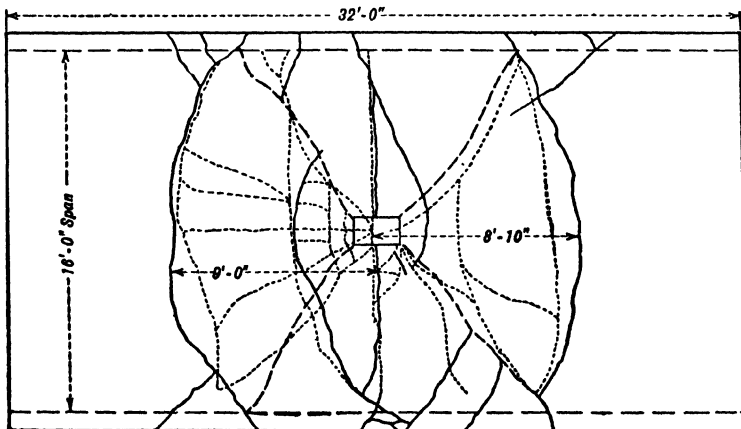

FIG. 26.—Top of Slab 930 after Failure. (See p. 74.)

It will be noticed that the breaking loads for different effective depths of the slabs are in the same relation as the squares of the depths of the slabs. This indicates that the effective width for all depths was practically the same.

Fig. 26, p. 73, shows the manner of failure of a slab under a concentrated load.

### TESTS TO DETERMINE DISTRIBUTION OF LOAD BY SLAB TO JOISTS

The tests show that if a continuous concrete slab is supported by several parallel joists of any material, and a concentrated load is placed directly above one joist, the load is distributed by the rigidity of the slab to several joists (see Fig. 27). The distribution depends upon the ratio of the thickness of the slab to the span.

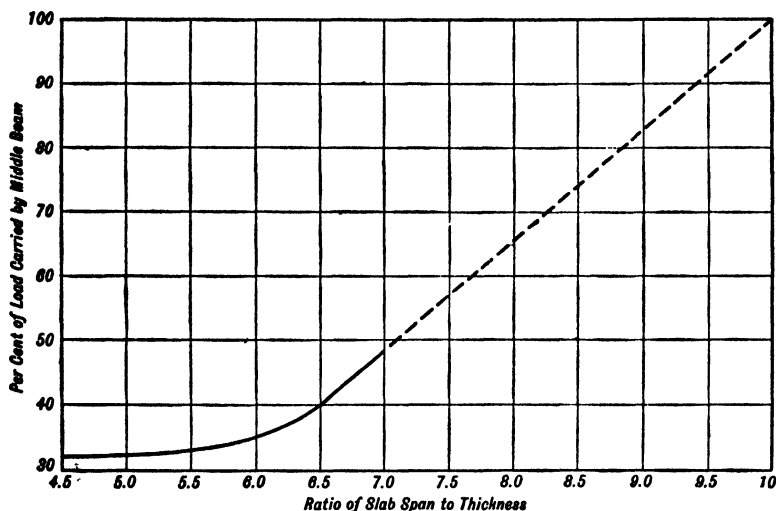

FIG. 27.—Distribution of Slab Load to Three Parallel Supporting Joists.  
(See p. 74.)

### TESTS BY PROF. C. T. MORRIS

The laboratory test made by Professor C. T. Morris consisted of slabs, 6, 7, and 8 in. thick respectively, supported on three lines of 10-in., 25-lb. I-beams spaced 3 ft. 6 in. on centers. The span of the joists was 12 ft., and they were supported on other I-beams, which in turn rested on concrete pedestals, as in bridge construction. The load was placed directly over the middle joist at its center.

In distributing the load, the slab acts as a cantilever supported

at the point of application of the load and loaded by the reaction on the side.

The following conclusions may be drawn from the tests:

(1) The percentage of reinforcement in the slab has little or no effect upon the load distribution to the joists, so long as safe loads on the slab are not exceeded.

(2) If the span is ten times the thickness of the slab, or more, total load must be considered as carried by the joist under the load. The amount of load distributed by the slab to other joists than the one immediately under the load increases with the thickness of the slab.

(3) The outside joists should be designed for the same total live load as the intermediate joists.

(4) The axle load of a truck may be considered as distributed uniformly over a 12-ft. width of roadway.

Fig. 28, p. 75, shows the elongation in extreme fiber of the steel beam and deflection for the middle beam and for outside beams.

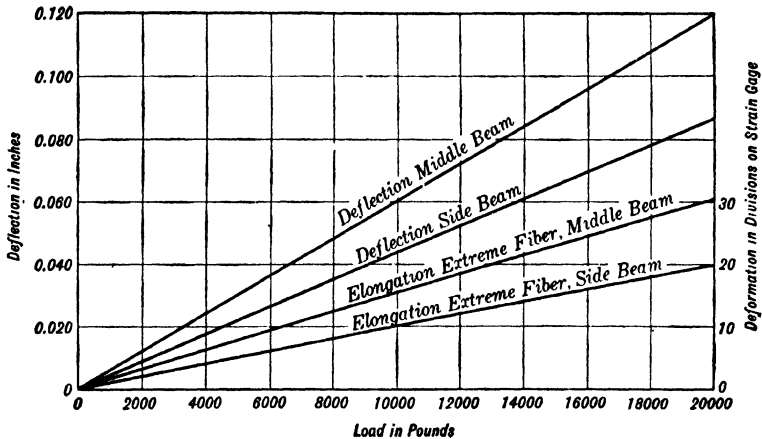

FIG. 28.—Elongation in Extreme Fiber of the Steel Beam and Deflection of the Middle Beam and of Outside Beams. (See p. 75.)

Value of One Division on the Strain Gage is 0.00019 in.

Similar results would be obtained with concrete joists.

The conclusions apply only to cases in which ratio of span to thickness of slab does not exceed 10. The largest ratio used was 7, but the results may be extrapolated.

## TESTS OF PLAIN CONCRETE COLUMNS

Professor Talbot<sup>31</sup> made a very comprehensive series of tests, the results of which are given in the table below. Conclusions, confirmed also by experimenters abroad, are as follows:

(1) **Manner of Failure.**—Plain columns fail either by shearing at a diagonal plane of fracture, or by crushing, when the material is shattered and cracked longitudinally. The diagonal shearing failure almost always occurs suddenly and with little or no warning, while the compressive failure is more gradual.

## Tests of Plain Concrete Columns. (See p. 76.)

Materials: Portland cement, Wabash River sand, crushed limestone. Columns, 12 in. diameter, round, 10 ft. long.

By PROF. ARTHUR N. TALBOT

Number of Specimens Tested	Proportions of Concrete	Average Age days	Average	Maximum	Variation in Per Cent from Average %	Minimum	Variation in Per Cent from Average %
			Ultimate Unit Strength lb. per sq. in.	Ultimate Unit Strength lb. per sq. in.		Ultimate Unit Strength lb. per sq. in.	
2	1 : 1½ : 3	64	2 300	2 480	8	2 120	- 8
7	1 : 2 : 4	65	1 740	2 210	27	1 165	- 33
2	1 : 3 : 6	61½	1 033	1 110	7	955	- 7
2	1 : 4 : 8	63	575	575	.....	575	
6	1 : 2 : 4	192	2 025	2 680	32	1 770	- 13
2	1 : 2 : 3½	14 mo.	2 710	2 770	2	2 650	- 2

(2) **Effect of Richness of Concrete.**—The strength of columns increases in nearly the same proportion, i.e., almost as a straight line, with the increase in the proportion of cement to total dry material used. (See Volume III.)

(3) **Modulus of Elasticity and Poisson's Ratio.**—The modulus of elasticity of the columns is almost constant for the first third of the strength of the concrete. Beyond this point the modulus decreases till it reaches at the ultimate load about one-half of its initial value.

<sup>31</sup> University of Illinois Bulletin No. 20, 1908.

The Poisson's ratio, or the ratio of the lateral to the longitudinal deformation (see Vol. III) was found for 1 : 2 : 4 concrete to be between 0.10 and 0.17 up to a load of about one-half the ultimate. It increases with the load, reaching probably 0.25 at the ultimate load.

(4) **Effect of Repetition.**—Repetition has no effect on deformation for loads up to one-half of the breaking strength of the column. For higher loads, the deformation increases after repeated applications of the load. After ten repetitions of a load equal to three-fourths the normal breaking strength, for example, the deformation was increased by 25 per cent.

It must be noted, moreover, that the suddenness of failure of plain concrete is increased by the length of the column. This absolutely excludes plain concrete columns from structures where they are apt to be exposed to shock or to secondary stresses due to bending, as in building construction.

**Concrete vs. Brick Columns.**—Tests carried out by the U. S. Bureau of Standards on columns of common, hard, and vitrified brick laid with lime and cement mortar, indicate that the strength varies with quality of brick and mortar, while large and small columns show about the same unit strength.

A series showing the strength of piers of common, hard, and vitrified brick, laid with different mortars, is given in the following table. The lime mortar specimens showed an almost entire lack of carbonation on the interior. Three piers of each kind of brick and mortar were made, with headers every other course, every fourth course, and every seventh course, but this variable appeared to have no effect. Bricks were laid flat.

Two large-size columns 48 in. square and 12 ft. high, of common, hard-burned brick, one laid in 1 : 1 cement mortar and one in 1 : 3 lime mortar, were tested by the Bureau and crushed at 2 920 and 760 lb. per sq. in. respectively.<sup>32</sup>

Tests made at the Watertown Arsenal and quoted by the Committee of the American Society of Civil Engineers, on the Compressive Strength of Cement,<sup>33</sup> give the ultimate strength of common brick piers about eighteen months old as ranging from 800 to 2 400 lb. per sq. in., the results for brick laid with lime mortar averaging nearer

<sup>32</sup> James E. Howard, *Engineering Record*, March 22, 1913, p. 332.

<sup>33</sup> Transactions, American Society of Civil Engineers, Vol. XV, p. 717, and Vol. XVIII, p. 264.

the lower figure, and those for 1 : 2 Portland cement mortar nearer the higher figure.

### Compressive Strength of Brick Piers \*

Tests by the U. S. Bureau of Standards. (See p. 77.)

Dimensions 30 inches square by 10 ft. high

Kind of Brick	Mortar	Age, Months	Compressive Strength, lb. per sq. in.
Common.....	1 : 3 lime	4	170
	1 : 3 cement	1	575
	1 : 6 lime	4	910
Hard.....	1 : 3 (15% lime 85% cement)	1	1465
	1 : 3 cement	1	1650
	1 : 6 lime	4	1360
Vitrified.....	1 : 3 (15% lime 85% cement)	1	2900
	1 : 3 cement	1	2780

\* *Engineering News*, August 5, 1915, p. 242.

The unit stresses allowed by the New York Borough of Manhattan Building Code, 1916, for brickwork are,

Brickwork in:	lb. per sq. in.
Portland cement mortar.....	250
Natural cement mortar.....	210
Lime cement mortar.....	160
Lime mortar.....	110

The first value is but little more than one-half that recommended for good 1 : 2 : 4 Portland cement concrete.

### TESTS OF COLUMNS REINFORCED WITH VERTICAL STEEL

Tests prove positively that in reinforced concrete columns, steel and concrete are effective in resisting the load carried by the columns. As explained in the chapter on the Theory of Reinforced Concrete, p. 159, the stress in steel equals the stress in concrete multiplied by the ratio of their respective moduli of elasticity. This fact also is borne out by the tests.

Mr. Spitzer,<sup>34</sup> in Austria, and Professor Withey,<sup>35</sup> at the University of Wisconsin, observed that, near the ultimate load, adjustment between stresses in steel and concrete takes place, so that finally the failure occurs by both of the materials passing the elastic limit simultaneously. This adjustment may be explained as follows:

Suppose that one of the two materials reaches its elastic limit, but there still exists bond between them. If the load on the column is increased, there is a tendency for the increase to be distributed over both materials. However, any increase in stress, in material which had passed the elastic limit, would produce very large deformations, which the other material, being still within the elastic limit, could not undergo. Since both of them must deform by the same amount, this other material takes all the stresses due to any increase of the load, till it finally reaches its elastic limit, and the column fails. The table on p. 81 gives results of tests of full-sized columns made at the Watertown Arsenal.

**Manner of Failure.**—Contrary to expectations, in most cases failure in columns occurs near the top or bottom instead of at the center. This has been explained as probably due to greater porosity of concrete at ends.

In most columns, hair cracks appeared at 85 to 90 per cent of the maximum load. In some cases, however, the failures were sudden. In a number of cases, concrete split at the column reinforcement after its elastic limit was reached. The splitting effect is caused by the lateral deformation of steel, which exerts sufficient pressure on the concrete to break it. The steel, therefore, should be placed at a sufficient distance, say at least 1 in. from the face of the concrete. With proper protection, there is no danger of buckling till after the elastic limit of the steel is reached.

From Spitzer's tests, it would appear that columns with steel placed well within the cross section of the column are somewhat stronger than those with steel placed near the surface. In practice, however, columns are apt to be subjected to eccentric loading; therefore, the placing of steel in abnormal positions must be discouraged.

**Factor of Safety.**—A column with vertical steel only is liable to fail without notice when its ultimate strength is reached. The ultimate

<sup>34</sup> Mitteilungen Über-Versuche ausgeführt vom Eisenbeton-Ausschuss des österreichischen Ingenieur und Architekten-Vereins, "Versuche mit Eisenbetonsäulen," Heft 3.

<sup>35</sup> University of Wisconsin Bulletin No. 466, December, 1911.



strength of concrete columns, even if built under the same conditions, is more variable than that of steel columns. Therefore, the commonly accepted factor of safety is larger than that used in steel columns. When designed according to formulas given on p. 406 with allowable unit stresses on p. 407, columns with vertical steel only are very reliable.

**Modulus of Elasticity for Reinforced Columns.**—The modulus of elasticity varies for different intensities of loading and for different mixes of concrete. In selecting the ratio of moduli of elasticity to be used in design, it is proper to be guided more by the required factor of safety than by the actual modulus of elasticity at any particular stage of the loading. From the tests thus far made, the moduli of elasticity given on p. 407, with the suggested working stresses, give the required factor of safety.

**Rich Versus Lean Mix.**—As is evident from the table on p. 81, cement is very good reinforcement for the column, as the increase in strength is much larger than the cost of additional cement.

**Influence of Bands.**—In tests made by Mr. Spitzer,<sup>36</sup> of columns having different spacing of bands, those in which the spacing was equal to, or smaller than, the diameter of the column gave somewhat greater strength than columns in which the spacing exceeded the diameter of column.

**Influence of Percentage of Steel.**—The tests show clearly that the effect of reinforcement in columns is the same whether the percentage is large or small. In all cases the steel takes a stress equal to the stress in concrete times the ratio of moduli of elasticity.

**Watertown Arsenal Tests.**—The table on page 81, from test by Mr. James E. Howard at the Watertown Arsenal, gives the relation of actual tests to theoretical computations based on a ratio of elasticity of 15. It is noticeable that the actual strength is almost always more than the theoretical, and this is especially the case with the leaner mixtures because the modulus of elasticity of the leaner concrete is lower, and therefore the ratio of 15 is very conservative.

An excellent analytical treatment of columns reinforced with vertical steel is given by Professor Talbot in one of his University Bulletins.<sup>37</sup> The problem is discussed briefly by one of the authors in a paper before the Boston Society of Civil Engineers.<sup>38</sup>

<sup>36</sup> See footnote on page 79.

<sup>37</sup> University of Illinois Bulletin No. 12, Feb. 1, 1907.

<sup>38</sup> Sanford E. Thompson, in Journal Association Engineering Societies, June, 1907, p. 316.

Many of the tests at the Watertown Arsenal, for example, were made with vertical bars imbedded in columns 12 in. square and 8 ft. long, with absolutely no bands or horizontal steel of any kind placed around these vertical bars to hold them in place; that is, the bars 8 ft. in length were placed in the four corners of the column—in some tests only 2 in. from the surface—and simply held in place by the 2 in. of concrete.<sup>39</sup> There was no sign whatever of buckling until the compression was so great that the elastic limit of the steel was passed.

**Strength of Plain Concrete and Mortar Columns vs. Vertically Reinforced Concrete**

Columns 12" × 12". Height 8 feet. Age of Mortar and Concrete 6 months. Watertown Arsenal. (See p. 80.)

Proportions			Plain Concrete or Mortar Columns Actual Strength lb. per sq. in.	Reinforced Columns			Computed strength based on column (4) and a ratio of $n = 15$ lb. per sq. in.	Reference to "Tests of Metals" U. S. A.
				Reinforcement	Actual strength lb. per sq. in.	Ratio area steel to area column		
Cement	Sand	Stone	Description					
(1)	(2)	(3)	(4)	(5)	(6)	(7)	(8)	(9)
1	2	0	3070	8- $\frac{3}{4}$ " round bars	0.029	4 200	4 290	1905, p. 377
1	3	0	2380	8- $\frac{3}{4}$ " round bars	0.029	3 840	3 320	1905, p. 377
1	4	0	1520	8- $\frac{3}{4}$ " round bars	0.029	3 380	2 120	1905, p. 377
1	5	0	1080	8- $\frac{3}{4}$ " round bars	0.029	2 810	1 510	1905, p. 377
1	5	0	1080	13- $\frac{3}{4}$ " round bars	0.046	3 900	1 780	1905, p. 377
1	1	2*	1720	4- $\frac{1}{2}$ " twisted bars	0.014	2 890	2 060	1904, p. 386
1	2	3*	1769	4- $\frac{1}{2}$ " twisted bars	0.014	2 010	2 100	1904, p. 386
1	2	4	1413	4-0.74" × 0.74" trussed bars	0.014	1 900	1 689	1906, p. 538
1	2	4*	1710	4- $\frac{3}{4}$ " twisted bars	0.014	1 990	2 050	1904, p. 386
1	2	4†	2400	8- $\frac{3}{4}$ " twisted bars	0.029	3 700	3 360	1907, p. 242
1	3	6	1450	8- $\frac{5}{8}$ " corr. bars	0.019	2 290	1 840	1904, p. 379 1906, p. 535

\*  $\frac{1}{2}$ -in. to  $1\frac{1}{4}$ -in. pebbles.

† Age 17 months 22 days.

<sup>39</sup> Test of Metals, U. S. A., 1905, p. 344.

## TESTS OF SPIRAL COLUMNS

In analyzing results from tests of spiral columns, it is necessary to examine not only the strength, but also the shortening of the column. In building construction, because of the dependence of the different members upon each other, it is advisable to permit a shortening, or

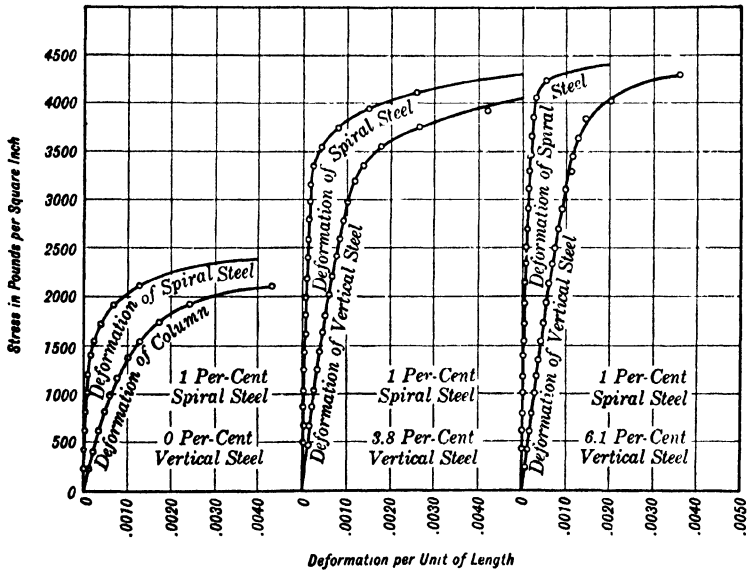

FIG. 29.—Deformation Curves for Spiral Columns with Varying Amount of Vertical Steel.<sup>40</sup> (See p. 82.)

Concrete 1 : 2 : 3½; 1% Spiral High Carbon Steel; 0% Vertical Mild Steel.

Concrete 1 : 2 : 3½; 1% Spiral High Carbon Steel; 3.8% Vertical Mild Steel.

Concrete 1 : 2 : 3½; 1% Spiral High Carbon Steel; 6.1% Vertical Mild Steel.

deformation, of not more than 0.007 of the length of the column. The factor of safety, therefore, must be based on the load causing a certain deformation rather than on ultimate strength. Although the strength of column beyond the yield point is not available in ordinary construction, the greater ultimate strength, ductility, and uniformity in strength of spiral columns reduces the danger of sudden failure,

<sup>40</sup> University of Wisconsin Bulletin No. 466, December, 1911, pp. 92, 93, 94. By MORTON O. WITHEY.\*

and larger unit stresses may be allowed. In practice, it is more rational to increase working unit stress in concrete than to compute the stress by a formula which takes into account the steel in the spiral. (See p. 421.)

Early European tests of spiral columns were made on short columns and without deformation diagrams; and as a result, very high working stresses based on the ultimate strength were recommended. More recent tests, notably by Talbot and Withey in the United States, showed excessive deformations of spiral columns at high stresses.

**Column Tests by Prof. M. O. Withey.**—The tests at the University of Wisconsin, Series of 1910, consisted of four series, two of which will be considered below; namely, series 1, columns with varying percentage of longitudinal and lateral reinforcement, and series 2, columns with varying proportions of concrete. The table on p. 84 gives the general results of the tests.

The following general conclusions may be drawn from the tests:

1. The cheapest way of increasing the strength of a column is by using a rich mix.

2. Spiral reinforcement greatly increases toughness and ultimate strength of a column, but does not raise the yield point. (See columns M and O, p. 84.) The strength beyond the yield point cannot be utilized in building construction; hence, the amount of steel for spirals should be made only large enough to produce required ductility and raise the factor of safety against failure. In practice, 1 per cent of spiral reinforcement seems to be sufficient.

3. Longitudinal steel increases the stiffness of the column and raises the yield point.

4. Stress in steel at the yield point of columns is practically the same for all mixes of concrete and only a little below the yield point of the vertical steel. (See table, p. 85.) This phenomenon may be explained by the fact that for leaner concrete the ultimate strength is smaller, but the deformation at the yield point larger than for rich mixes. For rich concrete, the stress in concrete at the yield point is larger, but the ratio of the moduli of steel to concrete decreases. Since the stress depends upon the product of stress in concrete times the ratio of the moduli of elasticity, the two values evidently adjust themselves so that the product is the same in all cases.

5. Columns loaded eccentrically give results which agree closely with the formula given on p. 175, as is evident from Fig. 30, p. 86,

## Tests to Determine the Effects of Varying the Percentage of Vertical

By MORTON

Average values given. Columns C-1, 2, 3, 4, D-1, 2, 3, 4, 120 inches long; all others

Column Number	Mix	Age, Days	Ratio Length of Column to Diameter		Area of Core A sq. in.	Reinforcement			Per Cent Reinforcement		Maximum Load P lb.	Ultimate Strength P / A lb. per sq. in.
						Vertical bars, round	Spiral		Vertical	Spiral		
							Wire	Pitch				

## Series I.

W-1-3	1 : 2 : 4	52	8.2	86.6	0	0	0	0	225 500	2 600		
H-1, 2	1 : 2 : 3½	57	8.5	78.5	...	No. 7	2"	0	0.50	175 500	2 235	
G-1, 2	1 : 2 : 3½	53½	8.5	78.5	8	½"	No. 7	2"	2 00	0.50	259 500	3 300
I-1, 2	1 : 2 : 3½	57	8.5	78.5	8	½"	No. 7	2"	3 78	0.50	327 000	4 160
J-1, 2	1 : 2 : 3½	58	8.5	78.5	8	½"	No. 7	2"	6 11	0.50	402 750	5 120
L-1, 2	1 : 2 : 3½	57½	8.5	78.5	0	No. 7	1"	0	1 00	0	207 450	2 640
K-1, 2	1 : 2 : 3½	57	8.5	78.5	8	½"	No. 7	1"	2 00	1 00	306 750	3 905
N-1, 2	1 : 2 : 3½	57½	8.5	78.5	8	½"	No. 7	1"	3 78	1 00	329 250	4 195
M-1, 2	1 : 2 : 3½	57½	8.5	78.5	8	½"	No. 7	1"	6 11	1 00	368 250	4 685
P-1, 2	1 : 2 : 4	58½	8.5	78.5	8	1"	No. 7	1"	8 00	1 00	543 900	6 925
O-1, 2	1 : 2 : 4	57	8.5	78.5	8	½"	½"	1"	6 11	1.96	516 750	6 580
R-1, 2	1 : 2 : 4	53	8.5	78.5	8	1"	½"	1"	8 00	1.96	547 500	6 965
Q-1, 2	1 : 2 : 4	53	8.5	78.5	8	1½"	½"	1"	10 12	1.96	556 500	7 090
C-1-4	1 : 2 : 4	63½	10.0	78.5		½"	1"	0	2 00		316 750	4 030
D-1-4	1 : 2 : 4	60½	10.0	78.5	9	½"	½"	1"	3 50	2 00	373 250	4 750

## Series II.

Z-1, 2	1 : 3 : 5	48½	8.3	82.6	8	1"	No. 7	1"	5 83	1 00	443 500	5 370
X-1, 2	1 : 1½ : 3½	56½	8.3	83.6	0	No. 7	1"	0	0	1 00	...	...
Y-1, 2	1 : 1½ : 3½	61	8.3	83.6	8	½"	No. 7	1"	5 75	1 00	...	...
S-1, 2	1 : 1 : 2	57	8.5	78.5	0	No. 7	1"	0	1 00	1.00	460 500	5 855
T-1, 2	1 : 1 : 2	56½	8.5	78.5	8	½"	No. 7	1"	6.11	1.00	513 000	7 290
V-1, 2	1 : 1.29	56½	8.5	78.5	0	No. 7	1"	0	1 00	4.00	420 000	5 340
U-1, 2	1 : 1.29	56½	8.5	78.5	8	½"	No. 7	1"	6 11	1.00	640 500	8 150
AA-1, 2	1 : 1.33	57	8.3	84.6	8	½"	No. 7	1"	1 86	0.99	617 500	7 300†
AB-1, 2	1 : 1.33	59	8.3	83.6	8	½"	No. 7	1"	3.55	1.00	617 500	7 390†
AC-1, 2	1 : 1.33	53½	8.3	84.6	8	½"	No. 7	1"	5 69	0.90	617 500	7 480†
AD-1, 2	1 : 1.33	195	8.2	85.0	8	½"	No. 7	1"	5.62	0.98	...	...

\* University of Wisconsin Bulletin No. 466, Engineering Series, Vol. 7, No. 1.

and Spiral Reinforcement in Reinforced Concrete Columns. (See p. 83.)

O. WITHEY\*

102 inches.

Load at Yield Point	Ratio of Stress at Yield Point to Ultimate Strength	Stresses at Yield Point				Compressive Strength of Cylinders	Ratio Strength of Cylinders to Strength in Concrete at Yield Point	Elastic Properties			
		In core	In steel		In concrete			Modulus of Elasticity at $\frac{1}{2}$ Ultimate Strength	Poisson's ratio at $\frac{1}{2}$ ultimate strength	Poisson's ratio at $\frac{1}{2}$ ultimate strength	
			Vertical	Spiral							
											$\frac{P_1}{A}$
$P_1$ lb.	$\frac{P_1}{P}$	lb. per sq. in.	lb. per sq. in.	lb. per sq. in.	lb. per sq. in.	$\frac{f_c}{f_c}$	lb. per sq. in.	$\frac{E_s}{E}$ = n at $\frac{1}{2}$ ultimate strength	$\frac{E_s}{E}$ = n at yield point	Poisson's ratio at $\frac{1}{2}$ ultimate strength	

145 500	0 83	1 855	..	10 050	1 855	1 750	0 94	3 500 000	8.6	..	0 114
213 000	0.83	2 710	40 500	12 000	7 940	1 760	0 91	3 350 000	11 0	27 0	0 127
273 000	0 84	3 470	42 000	6 450	1 960	2 180	0 13	3 400 000	13 0	22 0	0 110
333 000	0.83	4 240	40 650	6 150	1 860	2 055	1.11	4 350 000	11.5	22 0	0.088
108 000	0 52	1 370	..	4 800	1 370	1 770	1.29	2 100 000	14 5	19 5	0.146
205 500	0 67	2 615	39 450	7 050	1 865	1 995	1 07	2 800 030	13 5	21 5	0 123
265 500	0.81	3 375	38 700	6 900	1 985	1 800	0 90	3 800 000	11.0	20 0	0 130
295 500	0.80	3 760	37 650	6 450	1 565	1 685	1.09	3 425 000	18 5	24.0	0.101
445 500	0.82	5 660	39 150	8 100	2 750	2 365	0 86	5 300 000	9 6	14.5	0 121
348 000	0 68	4 430	36 900	8 400	2 310	2 480	1.08	4 650 000	9.9	16.0	0.131
408 000	0.74	5 190	37 500	8 250	2 385	2 390	1.005	5 250 000	9.7	16.0	0 125
453 000	0.82	5 765	37 200	6 750	2 230	2 305	1.03	5 500 000	10.8	17.5	0 094
180 500	0 58	2 333	..	..	2 333	2 200	0.95	..	..	..	..
280 500	0 75	3 575	40 500	..	2 223	2 252	1 02	..	..	..	..

264 500	0.60	3 200	36 900	8 250	1 115	1 770	1 59	3 950 000	12 80	..	0.085
338 000	..	4 100	..	8 400	4 100	4 760	1 16	5 050 000	5 95	..	0.175
470 000	..	5 700	30 600	6 300	4 160	4 120	0.99	6 700 000	5.70	..	0.190
318 000	0.69	4 050	..	7 350	4 050	4 070	1.01	4 125 000	7.30	..	0.124
453 000	0.79	5 760	37 050	7 350	3 725	4 400	1.18	5 175 000	8 45	..	0.140
280 500	0.67	3 570	..	6 750	3 570	4 880	1.37	3 400 000	8.80	..	0.135
468 000	0 73	5 950	36 450	6 750	3 970	4 555	1.15	5 250 000	8 40	..	0.125
489 000	..	5 780	34 750	7 050	5 185	6 787	1.30	5 625 000	5.90	..	0.190
514 000	..	6 150	35 250	7 700	5 090	6 387	1.25	5 950 000	5.95	..	0.185
542 000	..	6 590	36 000	6 600	4 760	6 075	1.28	5 150 000	6.40	..	0.180
..	..	..	..	..	..	..	..	5 450 000	7.55	..	0.135

† Column did not fail.

in which the straight lines represent figured stresses in steel and concrete by Formulas on pp. 175 and 176, while the dots and circles show the actual stresses obtained from deformation.

**Action of Columns under Test.**—Up to the point of breaking strength of plain concrete, the action of the columns with spirals was the same as for columns with vertical steel only. The observed stress in spirals was from 6 000 to 8 000 lb. per sq. in. For spiral columns with vertical steel, the deformation curve continues as a practically straight line to the yield point of the column. The yielding is indicated by the scaling off of the protective shell and by an

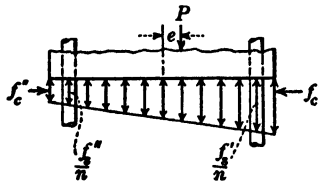
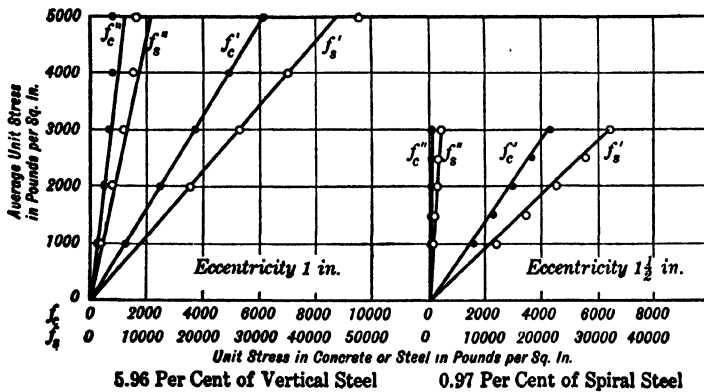

FIG. 30.—Comparison of Theoretical and Actual Stresses for Eccentric Loading.<sup>41</sup>  
(See p. 85.)

increase in ratio of lateral and longitudinal deformation to the applied load. The yield point is more marked for columns with large percentage of reinforcement (see Fig. 29, p. 82). For spiral columns without vertical steel, the deformation diagram is a curve without a marked yield point, so that the yield point is only distinguishable by scaling of the shell.

After the yield point has been passed, the disintegration of the

<sup>41</sup> University of Wisconsin Bulletin No. 466, December, 1911, p. 71.

shell progresses very rapidly. The ratio of shortening due to the applied load becomes larger and final failure takes place by buckling of the column, or, in columns with a small amount of lateral steel, by breaking of the spirals.

**Stresses in Steel and Concrete.**—The table on p. 84 gives the stresses in steel and concrete at yield point and at maximum load. The stresses in vertical steel were obtained from the deformation by using a modulus of elasticity of 30 000 000. The remainder of the load assumed as carried by the concrete, and divided by the area of the core, gave the unit stress in the concrete. In figuring the stress in concrete, the area of the core was used in preference to the total area of the column, because at yield point and at maximum load, either a part or the whole of the outside shell is destroyed and is then ineffective for carrying the load.

The stress in spirals obtained from lateral deformation is very small at the yield point of the column, which corroborates the statement that up to yield point<sup>42</sup> the spirals do not affect the column appreciably.

The table is of interest in giving a comparison of the stresses in steel with the stresses in concrete for different mixes and also in giving the values of the ratio of moduli,  $n$ . Although the value of this ratio was variable, the stress in steel at the yield point of the column was about the same for all columns, which seems to show that in a column under load an adjustment of stresses takes place. From the table, also, it is evident that the stress in concrete at the yield point was the same irrespective of the amount of vertical reinforcement.

An interesting experiment was tried in connection with tests by Wayss and Freytag.<sup>43</sup> The columns, after reaching the maximum stress, were again loaded after nine months and after one year, and showed a large increase of strength over the original maximum strength, in some cases reaching 50 per cent increase. After these two loadings, the column spirals were removed and the core tested again. In no case was the core, upon removal of the spirals, found to be disintegrated; in fact, each core showed a considerable strength, which tends to disprove a contention previously held by several authorities that the concrete in hooped columns becomes disintegrated after a certain point in loading is reached and is simply prevented from flowing by the hoops.

<sup>42</sup> See also Professor Talbot's Bulletin No. 20, University of Illinois.

<sup>43</sup> Mörsch, 4th edition, p. 117.



### TESTS OF SQUARE COLUMN WITH RECTANGULAR BANDS

Tests were made by Wayss and Freytag<sup>43</sup> on eleven types of 12-in. columns, square and rectangular in cross section with closely spaced hoops and bands. These tests prove that the bands in square columns are not very effective and can not be compared as to efficiency with spirals in round columns. The outside shell started breaking off as soon as the concrete reached its maximum crushing strength.

### TESTS OF COLUMNS WITH STRUCTURAL STEEL REINFORCEMENT

The size of column can be reduced by the use of structural shapes, rigid enough to serve as a structural steel column,

imbedded in concrete. Below are given results from tests of columns with two types of structural steel. The results must not be considered as applying to all steel sections and must be used with caution where the structural members differ materially from those in the tests.

**Talbot-Lord Tests of Columns.**<sup>45</sup>—The Talbot-Lord tests consisted of thirty-two columns divided into four groups:

1. Plain steel columns.
2. Core-type columns, i.e., columns in which the portion within the structural steel members was filled with concrete.
3. Fireproofed columns, i.e., core-type columns having a 2-in. protective covering.

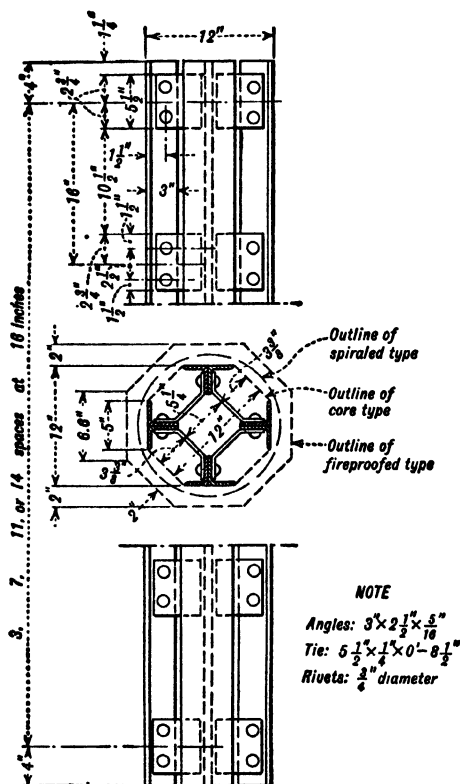

FIG. 31.—Dimensions of Test Columns.<sup>44</sup>  
 (See p. 88.)

<sup>43</sup> Mörsh, 4th Edition, p. 117.

<sup>44</sup> University of Illinois Bulletin No. 56, Fig. 1, p. 4.

<sup>45</sup> University of Illinois Bulletin No. 56.

4. Spiraled columns, i.e.; core-type columns enclosed in close-fitting spiral and filled with concrete to outer surface of spiral.

The cross section of the structural steel, which is shown in Fig. 31, p. 88, was the same for all columns. Ratio of length to minimum radius of gyration varied from 6.1 to 59.5. The results of the tests are given on p. 90.

**Plain Steel Columns.**—No bending was visible to the eye at the maximum load. After the maximum load was passed, bending developed very gradually. The average deformations per unit of length are shown in Fig. 32, below.

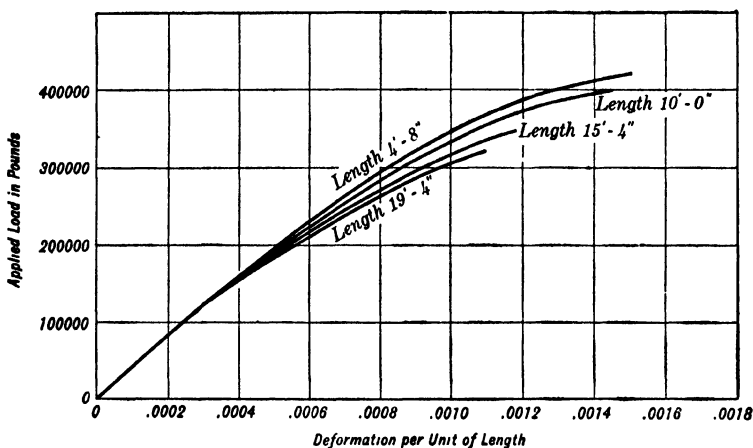

FIG. 32.—Average Deformations of Plain Steel Columns.<sup>46</sup> (See p. 89.)

The effect of the length of the column was more marked at high than at low loads. According to Professor Talbot, the ultimate stress in column for different ratios of  $\frac{l}{r}$  may be represented by a straight line formula,  $\frac{P}{A} = 36\,500 - 155 \frac{l}{r}$ .

**Core-type Columns.**—The columns of core type were very tough and failure was slow. For short columns, the failure was caused in most cases by crushing of the concrete; for longer columns, by bending and crushing of concrete. No bending visible to the eye was observed until maximum load was reached. The effect of mixture

<sup>46</sup> University of Illinois Bulletin No. 56, 1912, p. 19.

## Tests of Steel Columns, Reinforced with Concrete

By TALBOT and LORD.\* (See Fig. 31, p. 88.)

Age of concrete, 59 to 61 days.

P. S. = Plain steel column of 8 - 3" X 2½" X ¼" angles with no concrete core.

C. T. = Core-type column of 8 - 3" angles with concrete core.

F. = Fireproofed column same as core type with 2" of extra concrete outside of structural steel. No spiral.

S. = Spiraled column same as core type with spiral steel and concrete core filled out to conform with diameter of spiral.

Column Number	Type of Column.	Area of Cross Section sq. in.	Mix of Concrete	Length of Column ft. in.	Ratio of Length of Column to Least Radius of Gyration $\frac{l}{r}$	Total Load in lb.			Stresses in lb. per sq. in.	
						Column load	Load considered carried by steel	Load considered carried by concrete	In steel	In concrete
8 902	P.S.	13	none	2-0	6.1	487 300	.....	.....	37 500	.....
8 905-6	P.S.	13	none	4-8	14.4	444 600	.....	.....	34 200	.....
8 907-8	C.T.	120	1 : 2 : 4	4-8	.....	589 500	444 600	144 900	34 200	1 355
8 910-11-14	P.S.	13	none	10-0	30.8	420 000	.....	.....	32 400	.....
8 912-13	C.T.	120	1 : 2 : 4	10-0	.....	547 350	418 000	129 350	32 150	1 210
8 915-16	P.S.	13	none	15-4	47.2	372 000	.....	.....	28 600	.....
8 917-18	C.T.	120	1 : 2 : 4	15-4	.....	500 350	372 000	128 350	28 600	1 200
8 920-21	P.S.	13	none	19-4	59.5	359 600	.....	.....	27 650	.....
8 922-23	C.T.	120	1 : 2 : 4	19-4	.....	493 450	359 600	133 850	27 650	1 250
8 925-26	C.T.	120	1 : 1 : 2	10-0	.....	645 500	418 000	227 500	32 150	2 125
8 927-28	C.T.	120	1 : 3 : 6	10-0	.....	523 250	418 000	105 250	32 150	985
8 930-31	F.	213	1 : 2 : 4	10-0	.....	633 200	418 000	215 200	32 150	1 075
8 933	S.†	153	1 : 2 : 4	10-0	.....	600 000	Applied 5 times; not broken.			
8 934	S.†	153	1 : 2 : 4	10-0	.....	856 000	Not broken; near ultimate.			
8 935	S.†	153	1 : 2 : 4	10-0	.....	600 000	Applied 3 times; not broken.			
.....	.....	.....	.....	.....	.....	830 000	Second test; near ultimate.			
8 936	S.†	153	1 : 2 : 4	10-0	.....	625 000	Not broken.			
8 937	S.‡	153	1 : 2 : 4	10-0	.....	830 000	Second test with spiral and outside concrete removed.			
.....	.....	.....	.....	.....	714 000					

\* University of Illinois Bulletin No. 56, 1912, pp. 14 and 15.

† 0.75% of spiral reinforcement.

‡ 1.00% of spiral reinforcement.

of concrete on the strength was small, because the strength of the column was governed by the steel rather than by the concrete.

In Fig. 33, p. 92, are shown deformations per unit of length of core-type column. Deformations of plain steel columns are also shown for comparison. (See also Fig. 32.)

The relative loads carried by the concrete and by the steel, respectively, are given in the table on p. 90. The amounts were determined by assuming that for equal deformations the structural shapes in the core-type column carried the same load as a similar plain steel column and the balance was carried by the concrete.

**Fireproofed Columns.**—The behavior of fireproofed columns of the core type was about the same as that of the column without fireproofing. The concrete shell outside of the structural shapes, however, remained intact until the ultimate deformation of the column was nearly reached, but its effective unit strength was lower than the unit strength of the concrete core, probably because the shell failed before the maximum stress in steel and concrete core was reached.

Even if the protective covering is not relied upon as adding to the strength of the column, it is advisable to tie it by means of hoops or spirals of large pitch so as to prevent spalling in case of fire.

**Spiraled Columns with Structural Steel.**—The core-type column with surface spirally reinforced exhibited larger strength and toughness than similar columns without spiral. The thin protective cover remained intact. The strength of the columns exceeded the capacity of the Illinois and Lehigh University testing machines, which is 830 000 lb.

Because of the large deformation, the increase in strength afforded by the spiral is not available in ordinary building construction; hence a large percentage of spiral is not justifiable. One per cent of spiral reinforcement, however, makes the column tougher and safer and also prevents the outer shell from spalling. Since the danger of sudden failure is removed, such columns may be designed with somewhat higher working loads than are allowed for the fireproofed type.

**Tests by Professor Withey.**<sup>47</sup>—The structural steel reinforcement consisted of four angles  $2 \times 2 \times \frac{3}{16}$  in. placed in the four corners of a square column. The out-to-out dimensions of the steel core were 8 in. square. The result of this test agrees with the tests previously described.

<sup>47</sup> University of Wisconsin Bulletin No. 300, "Tests of Plain and Reinforced Concrete Columns."

## TESTS OF REINFORCED CONCRETE

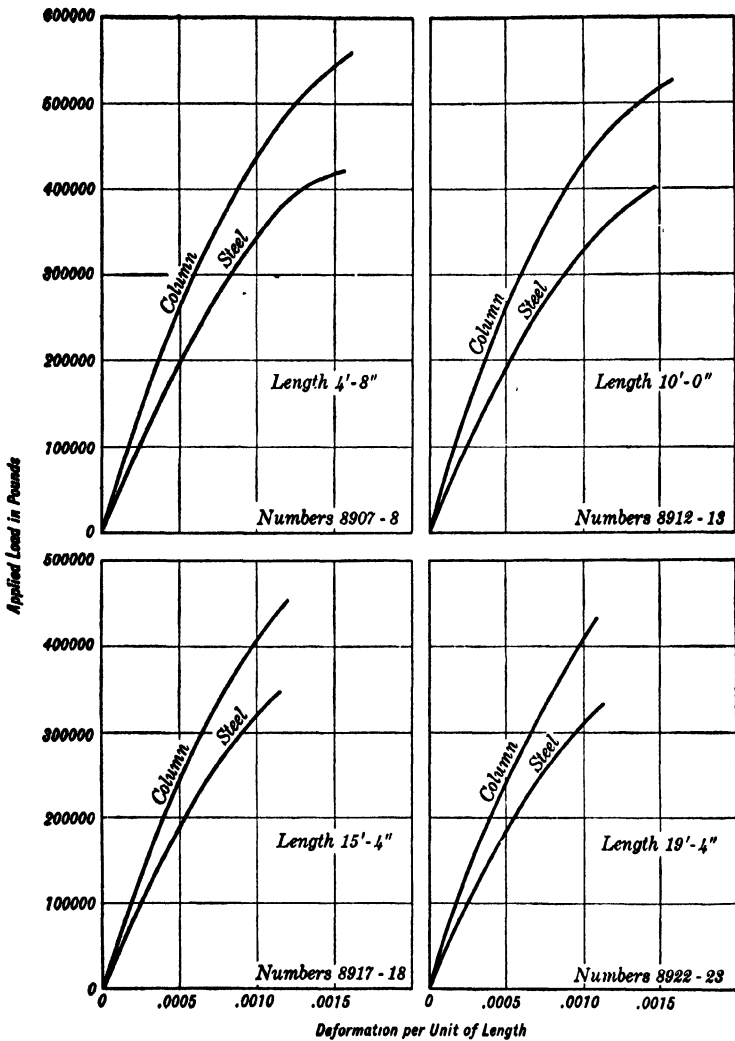

FIG. 33.—Load Deformation Diagrams for Plain Steel Columns and Corresponding Core-type Columns.<sup>48</sup> (See p. 91.)

NOTE.—Curves labeled *Column* refer to core type; those labeled *Steel* refer to plain steel type. See also Fig. 89.

<sup>48</sup> University of Illinois Bulletin No. 56, March, 1912, p. 24.

**Recommendations for Design of Core-Type Columns.**—As a result of this test, the ultimate strength of the core-type column may be considered as consisting of the strength of the plain steel column plus the strength of the concrete core figured with a unit stress equal to the strength of concrete in cylinders.

**Recommendations for the Design of Fireproofed Columns.**—Tests by Professor Talbot and Professor Withey show that in columns with structural steel the protective cover does not fail until the column reaches its maximum load. In practice, the protective cover is not considered as adding to the strength of the column. Therefore, in designing this type of column, the recommendations given in connection with core-type columns may be used. Similar results were obtained by Emperger and Spitzer.<sup>49</sup>

#### TESTS OF LONG COLUMNS

Tests by Spitzer on columns, 9.8 by 9.8 in. cross section, 9.9 ft., 14.8 ft., and 23 ft. long respectively, with ratio of length to the last diameter of 12, 18, and 28, show no appreciable difference in strength and no buckling in any of the columns.

To determine the effect of slenderness, Professor Bach<sup>50</sup> compared the strength of 4 ft. column (ratio of slenderness 4.3) with that of a 29.5 ft. column (ratio of slenderness 32), and found the strength of the longer column to be 0.75 of the strength of the short column.

As a result of this test, Professor Bach suggests the following formula for the strength of a long column in terms of the strength of a short column, which in turn may be assumed equivalent to the strength of 8 × 16-in. cylinders.

$$f_{c_1} = f_c \frac{1}{1 + 0.0072 \frac{Al^2}{I}} \quad (1)$$

$f_{c_1}$  = allowable working unit stress, lb. per sq. in., for long columns.

<sup>49</sup> Mitteilungen über-Versuche ausgeführt vom Eisenbeton-Ausschuss des österreichischen Ingenieur-und Architekten-Vereins, "Versuche mit Eisenbetonsäulen," Heft 3.

<sup>50</sup> Knickungsversuche mit Eisenbetonsäulen Zeitschrift des Vereins Deutscher Ingenieure, Prof. C. Bach, 1913, p. 1969.

Where  $f_c$  = allowable working unit stress, lb. per sq. in., for short columns;

$A$  = cross section of column, sq. in.;

$l$  = length of column in feet;

$I$  = moment of inertia inch units of the cross section of the column.

#### TORSIONAL RESISTANCE OF CONCRETE AND REINFORCED CONCRETE

**Character of Stresses Due to Torsion.**—Torsion is caused by moments of opposite signs applied at ends of a member and acting in planes normal to its axis. This produces a tendency of two adjoining normal planes to slide upon each other, which results in shearing stresses in the normal planes. The magnitude of the shearing stresses is zero in the centroid and increases according to a straight line to a maximum at the periphery. In members with circular sections the maximum shearing stress is uniform over the circumference of the section. In square and rectangular cross sections, the shearing stresses along the periphery are not uniformly distributed, but vary from a maximum in the center of the sides to zero in the corners. In rectangular sections the shearing stress in the middle of the long sides is larger than in short sides where the failure of rectangular sections starts.

An additional effect of torsion is elongation of the sides and particularly of the edges which produces tension. In concrete specimens, the tension takes place along the surface at approximately  $45^\circ$  to the axis.

This tension (and not the larger shearing stresses) is the immediate cause of failure because concrete is weaker in tension than in shear. There are no formulas for computing the tensile stresses, therefore the torsional stresses as given below may be used as their measure.

**Ultimate Torsional Stresses.**—The ultimate torsional stresses in homogeneous beams may be computed from the following formulas:

Let  $f_t$  = ultimate torsional unit stress in concrete, lb. per sq. in.;

$M_t$  = the torsional moment in inch-pounds;

$b$  = the short side of the section in inches;

$h$  = the long side of the section in inches;

$d$  = diameter of circular section.

For rectangular and square sections,

$$f_r = \left( 3 + \frac{2.6}{0.45 + \frac{h}{b}} \right) \frac{M_r}{b^2 h} \cdot \cdot \cdot \cdot \cdot \cdot \quad (2)$$

For circular sections

$$f_r = \frac{16 M_r}{\pi d^3} \cdot \cdot \cdot \cdot \cdot \cdot \cdot \cdot \quad (3)$$

Bach's tests,<sup>51</sup> made by C. Bach and O. Graf in Stuttgart, Germany, to determine the resistance of concrete and reinforced concrete to torsion, consisted of two groups of specimens: (1) plain concrete with square, rectangular, circular, and circular ring cross sections respectively; and (2) square and rectangular reinforced concrete with varied amounts and dispositions of reinforcement. The length of all specimens was 6.4 ft. and the cross section was 11.8 in. square, 8.3 by 16.6 in. rectangular, and 15.8 in. diameter for circular specimens.

**Method of Testing.**—The specimens were tested by applying torsional moments at the ends. An initial moment of 21 670 in.-lb. was applied first and the instrument read. The moment was then increased, by successive increments of 21 670 in.-lb., until failure.

**Torsional Resistance of Plain Concrete.**—The failure occurred in the center of the specimens by cracking at 45°. Failure always followed closely the appearance of the first crack. In specimens with rectangular cross sections, the first crack started on the wide face.

The ultimate torsional unit stresses, figured by the formulas for homogeneous beams, are given in the table on p. 96.

<sup>51</sup> "Versuche über die Widerstandsfähigkeit von Beton und Eisenbeton gegen Verdrehung," by C. Bach and O. Graf, Berlin, 1912, Heft 16.



**Ultimate Torsional Unit Stresses.** (See p. 96.)

Concrete, 1 : 2 : 3 by volume. Aggregates, Rhine sand from 0 to  $\frac{1}{4}$ -in. diameter and Rhine gravel from  $\frac{1}{4}$ -in. to  $\frac{1}{2}$ -in. Average compressive strength of 12-in. cubes at 45 days, 3 540 lb. per sq. in. Age of specimens at test, 45 days.

Compiled from Tests by C. BACH and O. GRAF

Cross Section	Ultimate Torsional Unit Stress		
	Lb. per sq. in.	In terms of tensile strength	In terms of compressive strength
Square.....	432	1.62	0.12
Rectangular.....	462	1.75	0.13
Circular.....	364	1.38	0.10
Circular Rings.....	243	0.92	0.07

**Torsional Resistance of Reinforced Concrete Specimens.**—Longitudinal reinforcement had very small influence on torsional resistance. For specimens reinforced with 1.13 per cent and 2.26 per cent of straight bars, the increase of torsional resistance was only 9 per cent and 14 per cent, respectively. More marked was the influence of inclined bars. For specimens with 1.13 per cent of bars at  $12^\circ$ , the ultimate resistance was increased by 27 per cent over that of plain concrete specimens.

Stirrups were much more effective in resisting twisting. For specimens with 2.26 per cent of longitudinal bars and 0.267 in. diameter, stirrups spaced 3.93 in. on centers, the torsional moment at first crack was 31 per cent larger and at failure 66 per cent larger than for plain concrete specimens.

The most effective reinforcement consisted of stirrups the legs of which were in planes parallel to the sides, but were inclined at  $45^\circ$  to the axis of the specimen. Evidently, the stirrups resisted directly the tension acting at  $45^\circ$  to the axis. Specimens reinforced with 2.26 per cent longitudinal bars and stirrups 0.276 in. in diameter, spaced 3.7 in. on centers inclined at  $45^\circ$ , showed an increase in resistance of 55 per cent at first crack and 134 per cent at failure over plain specimens.

**Toronto Tests.**—Tests made at the University of Toronto by C. R. Young, W. L. Sagar, and C. A. Hughes<sup>52</sup> gave the following results:

**Ultimate Torsional Unit Stresses—Toronto Tests**

Concrete, 1 : 2 : 4. Strength of 6 by 12 cylinders at 28 days, 1 700 lb. per sq. in. Age of specimens at test, 28 days.

Compiled from tests by C. R. YOUNG, W. L. SAGAR, and C. A. HUGHES

Specimen Number	Actual Cross Section	Longitudinal Reinforcement	Spiral Reinforcement	Ultimate Torsion Unit Stress lb. per sq. in	Ratio to Average Torsional Strength of Plain Concrete Specimens
A1	4 98×5	None	None	539	
A2	5.0 ×7.5	"	"	467	
A3	5.0 ×10.09	"	"	602	
				Average 536	
B1	5.06×5 0	4 rods $\frac{1}{2}$ in. diameter	"	532	0 99
B2	5.06×7 59	4 " $\frac{1}{4}$ " "	"	506	0.95
B3	5 0 ×10.19	4 " $\frac{1}{2}$ " "	"	584	1.09
				Average 541	Average 1 01
C1	5.13×5 19	4 " $\frac{1}{2}$ " "	4-5 deg spirals of $\frac{1}{4}$ -in iron wire	668	1 25
C2	5 13×7 68	4 " $\frac{1}{4}$ " "	"	621	1.16
C3	5.18×10.31	4 " $\frac{1}{2}$ " "	"	530	0 99
				Average 645	Average 1 21
				Omitting C3	Omitting C3
D1	5.19×5 31	4 " $\frac{1}{2}$ " "	8-45 deg. spirals of $\frac{1}{4}$ -in. iron wire	838	1.56
D2	5 19×7 81	4 " $\frac{1}{4}$ " "	"	740	1.38
D3	5.13×10.38	4 " $\frac{1}{2}$ " "	"	790	1.47
				Average 789	Average 1 47

If the excess of torsional moment over that for corresponding plain concrete specimens is assumed to be resisted by the steel

<sup>52</sup> Torsional Strength of Rectangular Sections of Concrete, Plain and Reinforced, by C. R. Young, W. L. Sagar and C. A. Hughes. University of Toronto Bulletin No. 3, 1922.

spirals, the computed stresses in reinforcement will be as given in table below.

Stresses in Spiraling at Failure of Specimens—Toronto Test

Specimen Number	Excess of Torsional Moment over that for Corresponding Plain Concrete Specimen, in.-lb.	Stress in Spiraling, lb. per sq. in.
C1	5 100	18 000
C2	8 800	31 000
C3	Unreliable	.....
D1	11 100	19 500
D2	15 800	27 900
D3	16 000	28 200

In the above computations, the excess of torsional moment is assumed to be resisted by tension in the spiral, cut by a normal plane and equal part by compression in concrete acting at right angles to the direction of the reinforcement.

### TESTS OF FLAT SLAB CONSTRUCTION

Numerous tests have been made of flat slab construction, most of which, however, were on completed buildings, where of necessity the tests were restricted to loadings well within the elastic limit of the materials. While the results of these tests are of interest, as demonstrating the strength of the construction, they may be misleading when an attempt is made to estimate from the stresses in steel the ultimate strength of the slab. The measured steel stresses in all these tests were comparatively low. This fact has caused considerable misunderstanding. The final strength of the slab has been often based upon this low steel, with the consequence that the strength so estimated was greatly in excess of the actual strength.

The low steel stresses found in tests on completed buildings are due to the fact that the slab is still in the stage where a large proportion of the tensile stresses is resisted by the concrete. A small increase in loading is often sufficient to overcome the tensile strength of concrete, when the bulk of the tensile stresses is thrown upon the steel and a considerable jump in tensile stresses takes place. To eliminate

the uncertainty, it is necessary to carry the test of the slabs to a point where the concrete cracks sufficiently to transmit all the tensile stresses to the steel. The two tests described in the following pages were conducted practically to destruction on specially built panels. They are much more instructive than the tests conducted on complete buildings. Both of the tests were made by Professor W. K. Hatt at Purdue University, one for the Corrugated Bar Company and the other for Mr. Edward Smulski.

In both tests stresses in steel and concrete were measured as described on p. 113 in connection with tests of reinforced concrete buildings.

#### TESTS OF FLAT SLAB—TWO-WAY SYSTEM

Professor Hatt conducted several tests for the Corrugated Bar Company, one of which is reported in the *Proceedings of the American Concrete Institute*, 1918, p. 177. The information given below is taken from this report.

The test slab consisted of four panels 16 ft. square with 6 ft. overhang on three sides and a wall beam on the fourth side. The object of the overhang was to balance the load at the column and produce in the adjoining panel the same conditions as in interior panels in a building. The 6 ft. proved to be greater than necessary for the purpose. A 4 ft. 6 in. overhang used in an earlier test for Mr. Smulski, described later, proved too small. The dimensions are shown in Fig. 34.

The reinforcement is shown in Fig. 35. The steel was disposed according to the arrangement of the Corr-Plate floor, as designed by the Corrugated Bar Company, and the amount of steel was that necessary to meet the requirements of the moment coefficients recommended in the Joint Committee report of 1916. (These coefficients are considerably larger than recommended by Joint Committee report of 1924.)

The design load was 150 lb. per sq. ft.

The steel was hard grade steel with a yield point of 55 600 lb. per sq. in. The concrete had a compression strength of 2 300 lb. per sq. in. at the age of twenty-eight days, and 2 586 lb. per sq. in. at ninety-five days.

The slab was tested at the age of sixty-six days.

**Loading.**—The slab was loaded with brick. Loads of 150 lb., 300 lb., 450 lb., 600 lb., and 803 lb. per sq. ft. were applied successively.

**Steel Stresses** were measured with the 10-in. Berry Extensometer. The results are given in Table on p. 102.

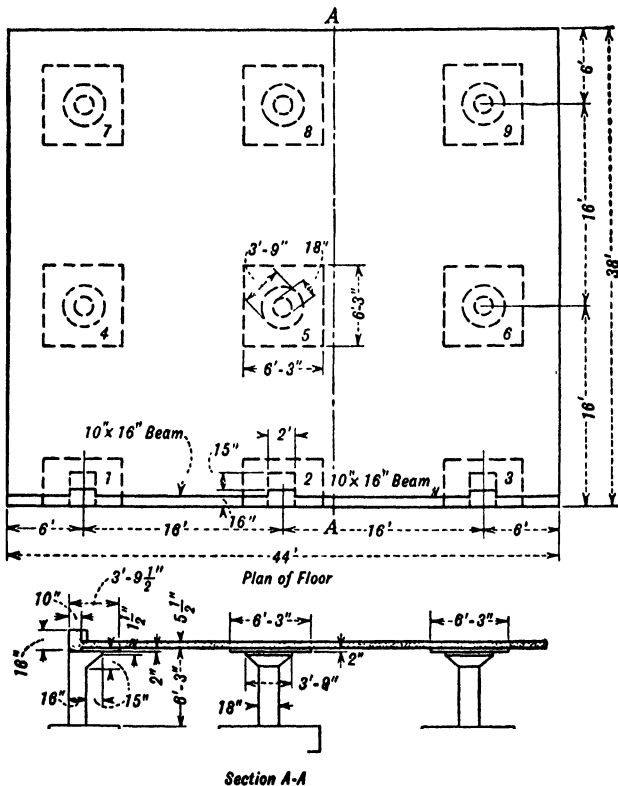

FIG. 34.—Concrete Dimensions, Slab J. (See p. 99.)

**Maximum Load.**—The maximum uniform load was 595 lb. per sq. ft. over the whole slab. After this was entirely removed, the brick were piled to a load of 803 lb. per sq. ft. over one panel, the overhang, and parts of the adjoining panels.

When the load of 600 lb. was taken off the slab, the large cracks closed, as they would be expected to do, since the steel had not reached its yield point and there was no compression failure in the concrete.

The effect of the load of 803 lb. was to dish down the panel and crush the slab at the column heads. The failure of the slab at these column caps began with a feathering of the concrete in the drop at the edge of the column cap, followed by a diagonal failure in the drop around the head of the column. The punching shear at this stage was computed to be 198 lb. per sq. in.

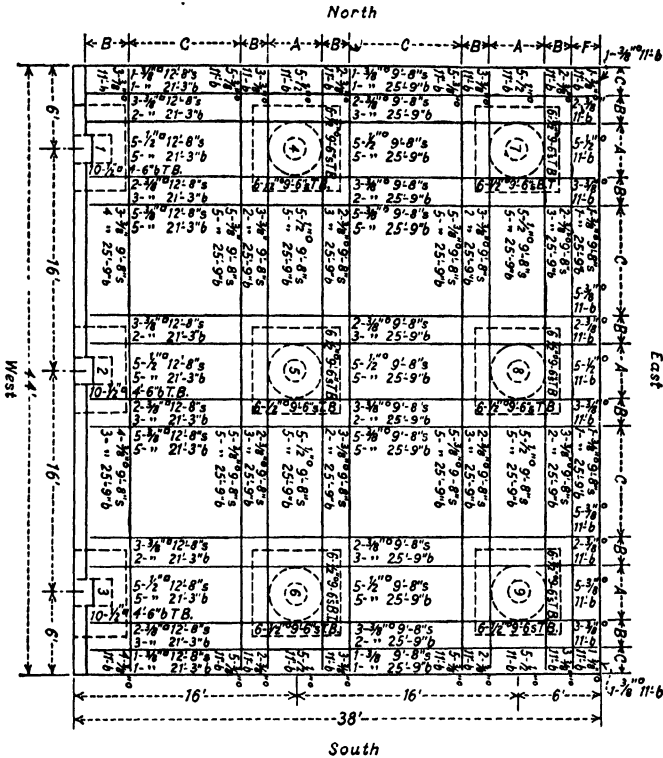

FIG. 35.—Steel Layout, Slab J. (See p. 99.)

- At load of 600 lb. per sq. ft. the stresses were:
- Average stress in band that was stressed to the greatest degree, 56 000 lb. per sq. in.
- Maximum compressive stress, 1 800 lb. per sq. in.
- Ratio of yield point of steel to stress, 1.40.
- With poorer concrete, the compressive strength of the concrete and the yield point of the steel would have been reached earlier.

## Steel Stress and Moment Coefficients in Slab J—Interior Panel—Live Load

 $m$  = moment coefficient

Band		150 lb.		300 lb.		450 lb.		600 lb.	
		Stress	$m$	Stress	$m$	Stress	$m$	Stress	$m$
A	Positive N-S.	1 470		5 820		15 580		28 780	
	Positive E-W.	3 110		9 620		16 040		30 650	
	Average....	2 290	0.0100	7 720	0.0166	15 810	0.0225	29 715	0.0315
B	Positive N-S.	1 340		6 000		16 450		32 940	
	Positive E-W.	2 510		10 590		20 490		36 740	
	Average....	1 925	0.0048	8 295	0.0106	18 470	0.0154	34 840	0.0220
C	Positive N-S.	1 970		5 600		15 650		31 820	
	Positive E-W.	1 890		10 190		18 870		33 420	
	Average....	1 930	0.0024	7 895	0.0048	17 260	0.0070	32 620	0.0100
Positive, Whole Av.		2 048	0.0048	7 970	0.0095	17 180	0.0130	32 390	0.0184
A	Negative N-S.	2 660		8 617		20 880		35 040	
	Negative E-W.	3 590		10 495		21 775		33 020	
	Average....	3 125	0.0228	9 556	0.0349	21 328	0.0515	34 030	0.0655
B	Negative N-S.	2 375		8 275		24 320		45 740	
	Negative E-W.	3 680		11 450		29 675		55 810	
	Average....	3 028		9 863		26 748		50 028	0.0480
C	Negative N-S.	2 170		7 170		33 890		56 290	
	Negative E-W.	3 110		8 010		29 370		55 500	
	Average....	2 640	0.0027	7 590	0.0041	31 630	0.0114	55 895	0.0150
Negative, Whole Av.		2 931	0.0100	9 000	0.0151	26 570	0.0270	46 650	0.0355
Entire.....		2 478	0.0148	8 480	0.0246	21 870	0.0400	39 500	0.0539

*Distribution of Stress.*—The ratio of negative to positive stress is as follows:

Band	Load 450	Load 600
A.....	1.35	1.14
B.....	1.45	1.43
C.....	1.86	1.72

Evidently, the negative steel may well be increased, especially in the margins or mid-section.

The uniformity of stress is shown in the following, where the average = 100.

Range of minimum to maximum band stress:

	Load 450	Load 600
Positive..	92-107	92-107
Negative..	82-120	73-120

*Deflections as a Fraction of the Direct Span (16 ft.)—*

Load	Direct Span	Diagonal Span
150 ..	1/3800	1/1920
300 ..	1/1370	1/735
450 ..	1/580	1/315
600...	1/375	1/194

*Distribution of Moment Coefficients.*—The total coefficient is divided in per cent.

		Slab J	
Positive	450 lb.	600 lb.	
A.....	43.0	43.2	
B.....	29.7	29.6	
C.....	27.3	27.2	
	<hr/>	<hr/>	
	100 0	32.3	100.0 34.0
Negative			
A.....	47.5	45.2	
B.....	31.9	34.1	
C.....	20 6	20.7	
	<hr/>	<hr/>	
	100.0	67.7	100.0 66.0

**Load Carried by Lintel Beam.**—The steel stresses at the center and at the support of the lintel beam allow computation of the total moment of resistance of this beam. This may be equated to  $\frac{1}{2}Wl$ , and the value of  $W$ , the load causing the flexure of the beam, may be computed. In Slab J, at 600 lb. per sq. ft. loaded on the panel, the indicated load on the lintel beam was 0.121 of the total panel



load. Another slab, with more highly developed steel stresses, yielded a fraction of 0.16.

The moment in the wall column was  $0.02 Wl$  where  $W$ =load on panel and  $l$ =panel length.

**Comparison of Wall and Interior Panel.**—The ratio of positive stress in wall and positive stress in interior panel was:

	Loading	
	450 lb.	600 lb.
A.....	0.75	0.73
B.....	0.91	0.82
C.....	1.01	0.93
Average.....	0.89	0.83

The 20 per cent additional steel in the wall panel positive sections is evidently sufficient.

The stresses in the negative steel running into the wall beam, 2 680 lb. per sq. in., and into the head of the wall column 10 230, are, at 600 lb. load, low compared to the negative stresses in the interior panel. Of course, this is only an expression of the yielding of the wall beam and wall column.

Measurements on the web of the lintel beam gave consistent indications of torsion.

The distribution of compressive stresses over the drop panel shows approximately that the concrete compressive stress at the edge of the drop is only about 25 per cent of the stress at the edge of the head of the column. In considering the allowable unit stress computed as an average over the drop panel, the maximum that fixes the strength of the slab must be considered.

Various diagrams are reproduced, showing distribution of steel and concrete stresses and photographs of the slabs.

#### TEST OF FLAT SLAB—SMULSKI SYSTEM

The test was made by Professor Hatt for Mr. Edward Smulski and was reported in the *Proceedings of the American Concrete Institute*, 1918, p. 206. The information given below is taken from this report. The test slab consisted of four panels 16 ft. square with overhang on three sides and a wall beam on the fourth side. The dimensions of the panel are shown in Fig. 36, p. 105.

The overhang was intended to balance the bending moment at the column and thereby reproduce in the panels the conditions that

exist in interior panels. Test showed that the 4 ft. 6 in. overhang was not sufficient. In a subsequent test made by the Corrugated Bar Co., and described on p. 99, an overhang of 6 ft. was used.

The reinforcement is shown in Fig. 37. For fuller description of the system see p. 367.

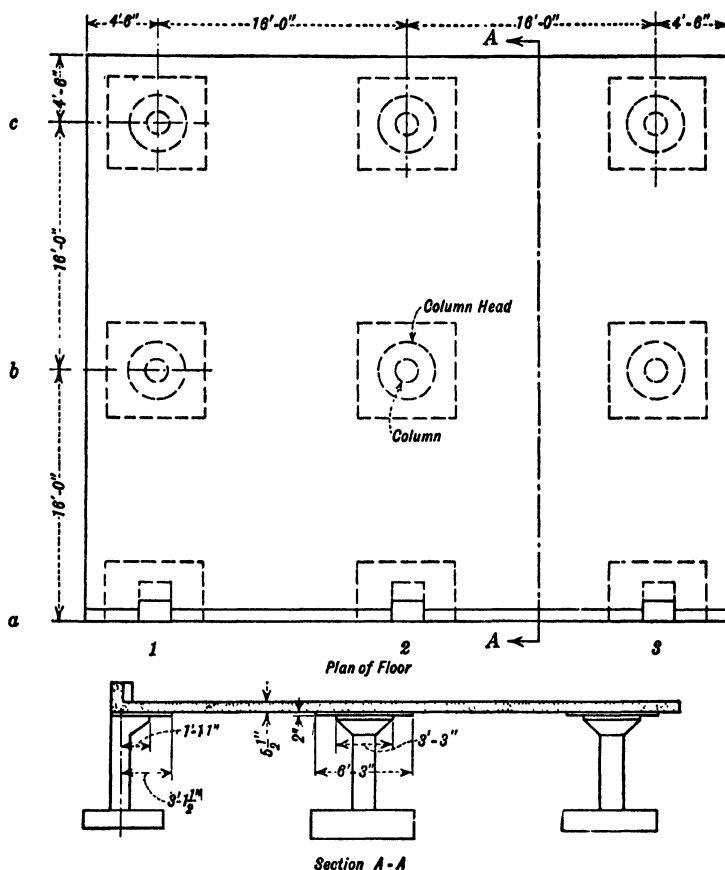

FIG. 36.—General Dimensions of Smulski Test Slab. (See p. 104.)

The design load was 150 lb. per sq. in. and the amount of steel was that necessary to meet the requirements of the moment coefficients recommended in the Joint Committee report, 1916. The two panels adjoining the overhang were treated as interior panels.

Steel of structural grade was ordered. From test coupons it was found that a large part of the steel was of intermediate grade with

elastic limit of 42,200 lb. Slab was built Nov. 30, 1916. The test began Jan. 29, 1917 and extended over a period of forty-six days.

**Loading.**—The slab was loaded with brick. The load was applied in the following increments:

	Load, lb. per sq. ft.								
East panel.....	150	300	450	450	375	475		475	700
West panel.....	150	300	450	625	700	700	to 950	700	700

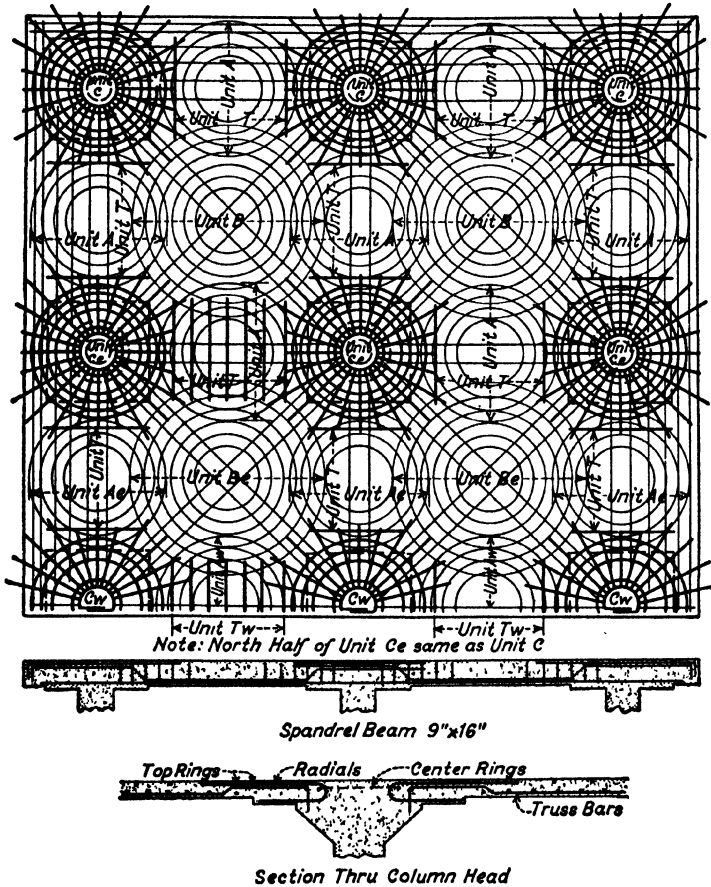

FIG. 37.—Arrangement of Reinforcement in Test Slab. (See p. 105.)

The loads in the fourth to seventh increments were unbalanced and were much more severe on the two west panels than would have been the case with uniform loading.

Steel stresses were measured with 10-in. Berry Extensometer. The results are given in the tables on p. 107 and 108.

Summary of Steel Stresses, Top of Slab, in Lb. per Sq. In.  
(Zero at 150 Lb. per Sq. Ft.)

Columns	Position of Gage Lines		Loading of Panels, lb. per sq. ft.				
	Quadrant	Between rings	West 300 East 300	450 450	625 450	700 950 475	700 700
Radials, Unit C							
Center column..	Northwest...	1-2	3 360	5 760	8 980	33 000	42 800
		2-3	2 460	3 060	7 180	26 400	42 700
		3-4	2 460	.....	.....	13 200	35 700
		4-5	2 100	.....	.....	.....	16 800
	Southwest...	1-2	3 480	.....	8 080	34 200	41 100
		2-3	2 640	2 280	7 240	26 400	31 500
		3-4	1 440	900	3 220	14 400	21 900
		4-5	1 260	.....	2 980	.....	12 600
North column...	Southwest...	1-2	4 860	5 040	10 880	39 600	42 600
		2-3	5 580	6 900	9 700	22 200	48 300
		3-4	3 960	2 400	7 360	24 000	42 600
		4-5	4 240	3 420	7 780	19 800	21 600
	Southeast....	1-2	7 260	8 580	6 520	17 400	44 700
		2-3	7 800	7 680	6 460	19 200	40 800
		3-4	4 620	11 340	6 700	19 800	31 800
		4-5	.....	5 400	9 280	12 000	36 000
Rings, Unit C							
Center column..	Northwest...	2-5	5 460	.....	8 110	24 600	40 600
	Southwest...	...	7 000	.....	8 040	27 320	38 400
	Southeast....	..	4 900	5 280	5 920	16 140	33 300
	Northeast....	...	5 700	4 800	6 640	21 500	41 940
North column...	Southwest..	...	5 300	6 120	8 980	18 780	34 000
	Southeast...	...	4 380	5 600	5 380	13 200	34 000
South column...	Northwest...	...	3 480	.....	7 560	14 340	28 700

**Summary of Stresses, Bottom Reinforcement, in Lb. per Sq. In.**  
(Zero at 150 Lb. per Sq. Ft.)

Unit	Position of Gage Lines		Loading of Panels, Lb. per Sq. ft.				
	Ring Number	Quadrant or Panel	West 300	450	625	700	700
			East 300	450	450	950	700
Unit A	1 to 4.....	Northwest.....	3 240	6 080	..	14 040	49 800
		Southwest.....	3 000	5 340	..	43 680	49 800
		Southeast..	4 860	..	..	12 580	23 640
Unit Aw	.....	West panel.....	2 640	..	..	26 240	34 620
		East panel . . .	4 200	..	..	..	18 840
Units B	3 to 6	(East panels) Wall panel.....	3 480	..	..	..	22 500
		Intermediate panel.	5 580	..	7 300	..	34 740
		(West panels) Wall panel.....	3 960	6 380	7 420	30 540	36 720
		Intermediate panel	3 900	5 400	6 070	42 120	49 800
1 to 2	(East) . . . .	Wall panel.....	2 820	..	..	..	10 440
		Intermediate panel	3 420	..	..	..	30 000
		(West) . . . .	1 680	2 640	6 220	14 280	16 450
		Intermediate panel	3 120	..	7 180	26 580	36 360

Note that at final load the west panels, which were subjected to the heavy unbalanced load, show much higher stresses than the east panels. This is due to yielding of columns under unbalanced load.

### Analysis of Steel Stresses.

*Design Load of 150 lb. per Sq. Ft.*—The steel deformations for this load were often so small as not to be apparent on the Berry Extensometer, in which one division on the dial indicated about 600 lb. per sq. in. In the rings, in a number of cases, small compression stresses were observed at low loads. These stresses, which were probably due to uncorrected temperature effects, later changed to tensile stresses. The tensile stresses, when indicated, were 1 000 to 3 000 lb. per sq. in. The stresses are therefore quoted in tables as from zero at 150 lb. per sq. in.

*At Time of Yielding of Columns.*—At a load of about 625 lb. per sq. ft. on west panels and 450 lb. on two east panels, the outside columns of the more heavily loaded panels began to yield, and cracks began to open on the under side of column heads and brackets. This load may be considered as the end of the first phase. At this time

there were none but fine cracks in the slab and the measured stresses were as follows:

Stresses at 625 lb. on West Panels and 450 lb. on East Panels.  
(Zero at 150 lb. per sq. ft. load.)

Unit B. Bottom of Slab.

Rings 1-2.....	6180 interior panel	6220 wall panel
“ 3-6.....	6680 “ “	7420 “ “
Truss rods.....	7000 “ “	7000 “ “

Unit C..... 7230 all panels

Radials.....	8440 inner gage lines	6680 outer gage lines
--------------	-----------------------	-----------------------

The above stresses were observed in the more heavily loaded panels.

*Stresses at Greatest Applied Loads.*—At the final readings of steel deformations, the slab was in the second phase.

In analyzing the stresses at higher loads, it must be remembered that after the load exceeded 625 lb. per sq. ft. because of cracking of columns the slab entered the second phase, in which, by gradual opening of the cracks under the brackets and column heads of the outside columns, the restraint of the slab was gradually removed. This caused gradual increase in bending moments, both in the center of the slab and at the column, and explained why, under maximum load, the stresses and deflections increased gradually until they reached their maximum after twelve days.

The stresses at the maximum applied load include, besides the stresses due to bending moments, (a) stresses caused by plastic deformations under the heavy load standing on the slab for a long time; (b) stresses caused by the change from a slab restrained at wall columns and continuous in all other directions (as contemplated in design) to a slab nearly freely supported at the outside columns.

The maximum measured stresses in lb. per sq. in. were as follows  
(Zero at 150 lb. per sq. in.):

Unit A.....	49 800 west panel	23 640 east panel
Unit B—Rings 1-2.....	33 180 interior panel	13 490 wall panel
“ 3-6.....	42 840 “ “	29 600 “ “
Unit C—Rings.....	35 800	
Radials.....	42 840 inner gage lines to	21 750 outer gage lines
Unit T.....	46 250	

**Points of Inflection.**—The distance of the points of inflection are given in the table below.

Rectangular direction..... Span = 16 ft. 0 in. Clear span = 12 ft. 3 in.  
 Diagonal direction..... Span = 22 ft. 6 in. Clear span = 19 ft. 0 in.

Position	Direction	Distance of Points of Inflection					
		From Center of Column			From Edge of column head		
		Ft.	In.	In terms of span	Ft.	In.	In terms of clear span
Center column.....	North.....	3	10	0.24	1	10	0.15
	Northwest...	5	2	0.23	3	2	0.16
	South.....	4	2	0.21	2	4	0.20
	Southwest...	5	8	0.26	3	10	0.20
West center column....	East.....	4	10	0.30	4	0	0.24*
	Northeast...	5	3	0.25	3	5	0.18
Northwest column....	Southeast....	5	0	0.22	3	2	0.17
Center wall column....	North.....	4	1	0.26	2	0	0.17
	Northwest...	5	6	0.25	4	3	0.22
Southeast wall column.	Northwest...	5	3	0.24	4	0	0.21

\* Doubtful.

**Distribution of Stresses in Rings.**—The distribution of stresses in rings is evident from Fig. 38, p. 111, and Fig. 39, p. 112. The figures were drawn by plotting in the center of each gage line the observed stresses.

**Comparison of the Two Flat Slab Tests.**—The two tests described above were made by the same experimenter and the general dimensions of the test specimens were practically the same. The results are, therefore, comparable.

Before making comparison, a proper allowance should be made for following differences in design and testing.

(1) The projections in the two-way system slab were larger than in the Smulski System. The larger projection increased the restraint

of the slab at the columns thereby reducing the stresses in the positive reinforcement of the adjoining panels.

(2) The wall columns were evidently made stronger in the Two-way System test because the cracking below the bracket, observed

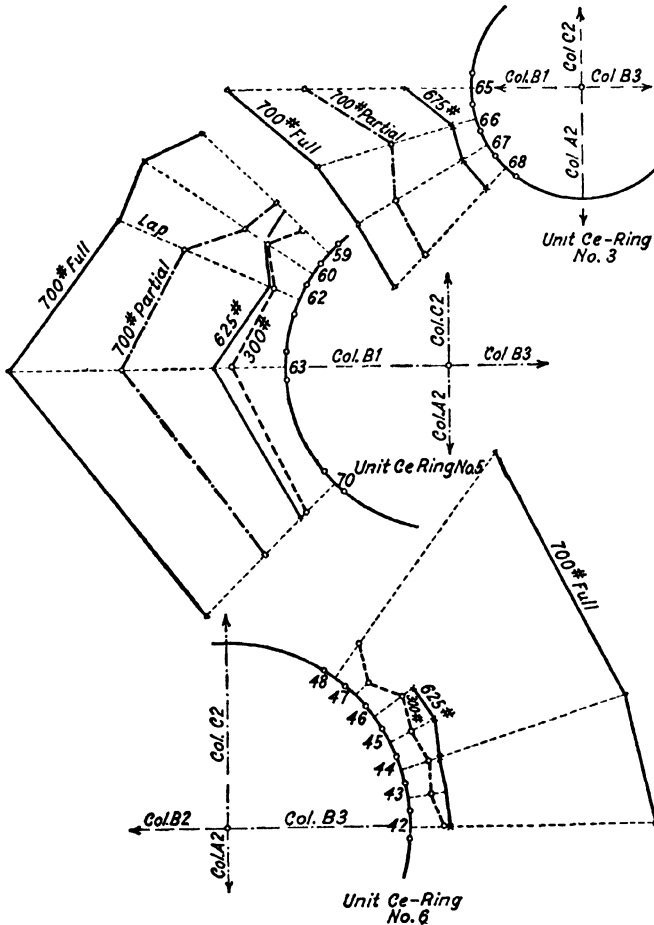

FIG. 38.—Distribution of Stress in Rings of Column Head Unit C. (See p. 110.)

in earlier test, did not take place. Therefore, the results of the two tests are comparable only for the loads prior to those producing cracking of wall columns in the Smulski System.

(3) As evident from compressive tests of cylinder, the concrete



in the Two-way System was of better quality, presumably because it was cured under more advantageous conditions. (Smulski slab was built in winter while the Two-way slab was built in the summer.)

(4) The distribution of test load as adapted by Prof. Hatt for the two tests differs to some extent.

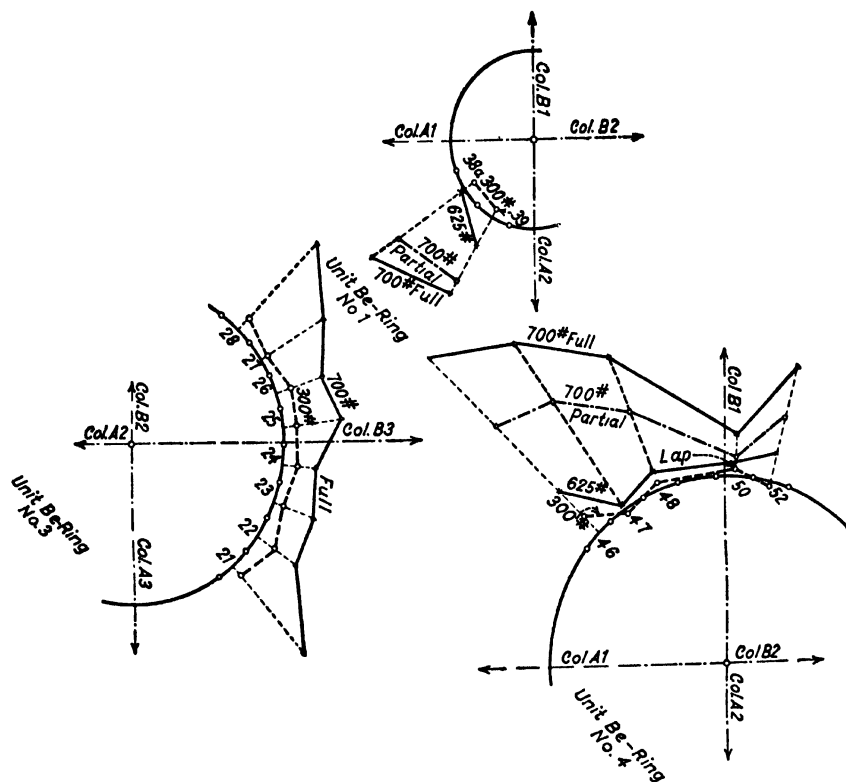

FIG. 39.—Distribution of Stress in Rings of Unit Be. (See p. 110.)

In the earlier (Smulski) test, open spaces were left at two columns for observation purposes, and extra brick was placed in the central portion of the slab to compensate for the omitted load and to produce same bending moment as would have been produced by a full uniform load.

In the second (Two-way) test practically the whole area was loaded and observations were made in tunnels.

Due to this difference in loading, for equal unit load in the two

tests, the Two-way slab was subjected to larger external shears, although the difference in bending moments was not appreciable.

Keeping these differences in mind, the stresses as given in table on p. 102 may be compared with the stresses for equal loading as given in table on pp. 107 and 108.

The stresses for the Smulski test are given more in detail while for the Two-way System as averages for whole bands.

### TESTS OF REINFORCED CONCRETE BUILDINGS UNDER LOAD

One of the most important developments in testing within the last few years is the testing of complete structures under load. It has been customary to make deflection tests of engineering structures to determine whether the structure can safely carry the load for which it has been built. Such tests, however, are of little scientific use as they do not give the stresses in the structure. Sometimes they are actually misleading, because with small deflection there may exist in certain parts of the structure stresses that are much higher than allowable. Moreover, such tests do not determine weakness of details or the effect of continuity.

The recent tests on completed structures are much superior to the old deflection tests, as they measure not only deflection of the structure, but also the stresses in various parts of the members. These tests were inaugurated by Prof. Arthur N. Talbot of the University of Illinois, with the assistance of Messrs. A. R. Lord and W. A. Slater. The first building tested in this way was the Deere and Webber building in Minneapolis, in October and November, 1910. Following this test, several other tests were made under the auspices of the Reinforced Concrete Committee of the American Concrete Institute.

The instruments used in such tests are (1) extensometer for measuring the stretch or compression of the materials, (2) deflectometer, for measuring deflection.

The extensometer consists of a framework (which in the best instruments is made of invar steel to prevent appreciable changes in length due to the changes of temperature), two movable legs attached to the framework and provided with sharp points, and a device for measuring accurately any changes in distance between the points. In order to find the stretch in steel, the bar to be tested is uncovered in two places a few inches apart, and small holes, called gage holes

(0.055 in. in diameter) are drilled. An observation on the gage line is taken before the structure is loaded and again at each increment of the load. The difference between the original reading and the reading at any load gives the stretch of the steel due to that load. The stress is then found from the known relation between the deformation and the stress.

The compression in concrete is measured by making small holes in the concrete, inserting metal plugs, and then marking the gage holes in these plugs as was done for the steel. Readings and stresses are obtained in the same way as for steel. Since concrete flows gradually under heavy loads, the readings must be made immediately after each loading.

For measuring deflections, a rigid scaffold is built directly under the members to be tested. In the place in which a deflection reading is desired, a steel plate is fastened by plaster of Paris to the under side of the beam or slab. On a vertical line below this steel plate, a steel rod is fastened to the scaffold. Before the test is begun and at different stages of loading, the deflectometer is placed between the plate and the rod below, readings are taken, and the difference between the original reading and the readings under the load give the deflection.

For loading the panels, there may be used: (a) brick, (b) cement in sacks, (c) loose sand in boxes or in sacks, and (d) pig iron. In making tests, care always must be taken that the material does not arch. The whole floor cannot be covered with the load, because places must be left uncovered for the taking of measurements, and aisles must be left to make the points accessible.

It is important that the test load should cover a sufficient floor space to insure that certain parts of the floor resist nearly the full load which, in the calculations, they are considered to take.

**Wenalden Building Test.**<sup>53</sup>—The floor panels in this building are 15 ft. by 20 ft. The slab is  $3\frac{3}{8}$  in. thick; the girders, placed between columns in the short direction,  $7\frac{1}{2}$  in. by  $20\frac{1}{8}$  in., reinforced with four  $\frac{7}{8}$ -in. square bars in the middle. The longitudinal beams, 5 ft., apart on centers, are  $6\frac{1}{2}$  in. by  $18\frac{7}{8}$  in., reinforced with four  $\frac{3}{4}$ -in. square bars in the middle. Half as much steel was used over the supports as in the center.

The floor was designed for a live load of 200 lb. per sq. ft., and the total test load was made 400 lb. per sq. ft. and placed in layers of

<sup>53</sup> University of Illinois Bulletin No. 64, January 13, 1913.

80 lb. per sq. ft. A set of observations was taken after every additional loading.

The measurements were taken in steel at the support and at the center of the span; also measurements of stresses in concrete at the support and at the center of the span.

This test proved conclusively that the beams and the girders act as continuous ones. While the stresses in steel in the center and at the support were not excessive, the highest stress being 17 000 lb. for the total test load, the stresses in concrete at the supports of the beams were high and in some places even reached a stress of 2 200 lb. per sq. in. Even under the working load, stress in concrete was 1 150 lb. per sq. in. The compressive stresses in the center of the beam were low, and it appeared from the test that the total slab acted as a compressive flange of the T-beams. It must be noted that in this case the overhang of the flange was seven times the thickness of the slab, while in practical design, we consider only an overhang of six times the thickness of the slab as effective in taking compression. The total compression in a beam, figured with the assumption of a straight line distribution of stress and no tension in concrete, was much larger than the total tension, showing that either arch action existed in the beam or considerable tension was carried by concrete. The difference was especially large at the supports, where the tension must have distributed itself over the entire slab.

*Test Cracks.*—Tensile cracks were observed in the middle portion of the bottom of the beams. They formed at the same stress in steel as is usually found in the laboratory. Diagonal cracks developed in the girder which carried a very large shear ( $V = 40\,000$  lb. and  $v = 360$  lb.), just outside the junction with intermediate beams. The cracks were inclined at about  $45^\circ$ . They did not close entirely after removal of the load. It is supposed that the restraint at the ends prevented fuller development of the cracks. (See also p. 66 on formation of cracks in continuous T-beams.)

*Deflections.*—The deflections offered further proof of the continuity of the beams, being much larger, in the middle panel, for one panel loaded than for three panels loaded, as would be expected from a continuous beam. With three spans loaded, deflection of intermediate beam was 0.09 in., and for one span loaded 0.15 in.

**Turner-Carter Building Test.**—The panels in this building are 17 ft. 4 in. by 19 ft. 6 in. The girders are placed in the short direction and their dimensions are 10 by 24 in., with two 1-in. square and three

$\frac{7}{8}$ -in. square bars at the middle, and two 1-in. square bars over the support. Beams, 7 by 18 in., reinforced with one 1-in. square bar and two  $\frac{7}{8}$ -in. square bars at the middle, and one 1-in. square bar (plus ten  $\frac{3}{8}$ -in. round bars in the slab) over the support, are placed between the columns and at one-third points of the girder. The thickness of slab is 4 in.

The structure was designed for a live load of 150 lb. per sq. ft. and the beams and girders were figured as simply supported, but reinforcement was supplied for continuity. The test load was 300 lb. per sq. ft. or double the designed load.

*Results of Test.*—The beams and girders acted as continuous. The stresses in steel in the beams were comparatively low, the maximum observed for the test load being 11 000 lb. The stresses in concrete, however, at the end of the beam reached 1 100 lb. per sq. in. At the middle the compression in concrete reached only 350 lb. per sq. in., which shows that the compression there must have distributed itself over a large portion of the slab. In the girders the tensile stresses at the middle reached only 8 000 lb. per sq. in. At the supports no measurements were taken because the steel was not accessible. The compressive stress at the end of the beam in the bottom was 900 lb. per sq. in. and was very low at the center in the top surface.

In both beams and girders, the total compression was much larger than the total tension, a condition that was found in the previous test. As far as observation shows, the entire slab acted as compression flange of the T-beam.

**General Conclusions.**—In drawing conclusions from tests on completed structures, it must be remembered that low stresses in the steel do not indicate a large factor of safety. The conditions are the same as were explained in connection with laboratory beam tests (see p. 27) in which the stresses at half the maximum load were small, while the maximum load stressed the steel to the elastic limit. The results of such tests must be used with caution.

#### TESTS OF OCTAGONAL CANTILEVER FLAT SLABS

An interesting test of cantilever flat slabs supported on a central column, as shown in Fig. 40, p. 118, was made in the year 1914 by Mr. Edward Smulski under the supervision of Sanford E. Thompson.

Eight specimen slabs were made octagonal in shape, 6 ft. 6 in. in

small diameter, and with an octagonal column head in the center built monolithic with the slab and having an inside diameter of 2 ft. The slab was 4 in. thick. The reinforcement of Specimens 1 to 4, arranged as shown in Fig. 40, differed in the diameter of bars used for the five outside rings, as shown in the table on p. 120. Specimens 5 and 6 were similar to 3, except that 10 and 5 radials respectively were used instead of 20. Specimen 7 was reinforced by four layers of bars running in four directions, each layer consisting of nine  $\frac{5}{16}$ -in. round bars. Specimen 8 was reinforced with steel in top and bottom; the tensile reinforcement consisted to two layers placed at right angles, with twelve  $\frac{3}{8}$ -in. round bars per layer, and the compressive reinforcement consisted of two layers with eight  $\frac{3}{8}$ -in. round bars per layer.<sup>54</sup>

**Purpose of Test.**—The behavior of a circumferential cantilever is similar to the behavior of a flat slab floor system at the support. The purpose of the test was to compare the effectiveness of circumferential reinforcement with that of band reinforcement and to determine the most effective distribution of steel between rings and radials. The results of the test are directly applicable to flat slab construction.

**Materials of Construction.**—Concrete in the proportion of 1 : 2 : 4 was used. The compressive strength of 6-in. cubes, tested at fifty-two days, was 1 100 lb. per sq. in. Reduced to eight 16-in. cylinders and to twenty-eight days, the strength of the concrete was about 1 400 lb. per sq. in., or lower than that of first-class 1 : 2 : 4 concrete.

Plain round bars with an average elastic limit of 35 000 lb. per sq. in. were used.

**Method of Testing.**—In testing, the slabs were placed on a wooden column resting upon a base which distributed the load to the soil. The load, consisting of pig iron averaging 56 lb. per pig, was placed on swings arranged along the circumference of the cantilevers as shown in Fig. 40, p. 118. By this method the point of application of the load, and therefore the moment arm, was positively fixed.

**Deformation Readings.**—Deformations in steel, due to the loading,

<sup>54</sup> Design of specimens 1 to 6 were Smulski system, specimen 7, four-way system, and specimen 8, two-way system. Specimens 5 and 6 were of preliminary type. Their results are not given because they are not comparable with other specimens.

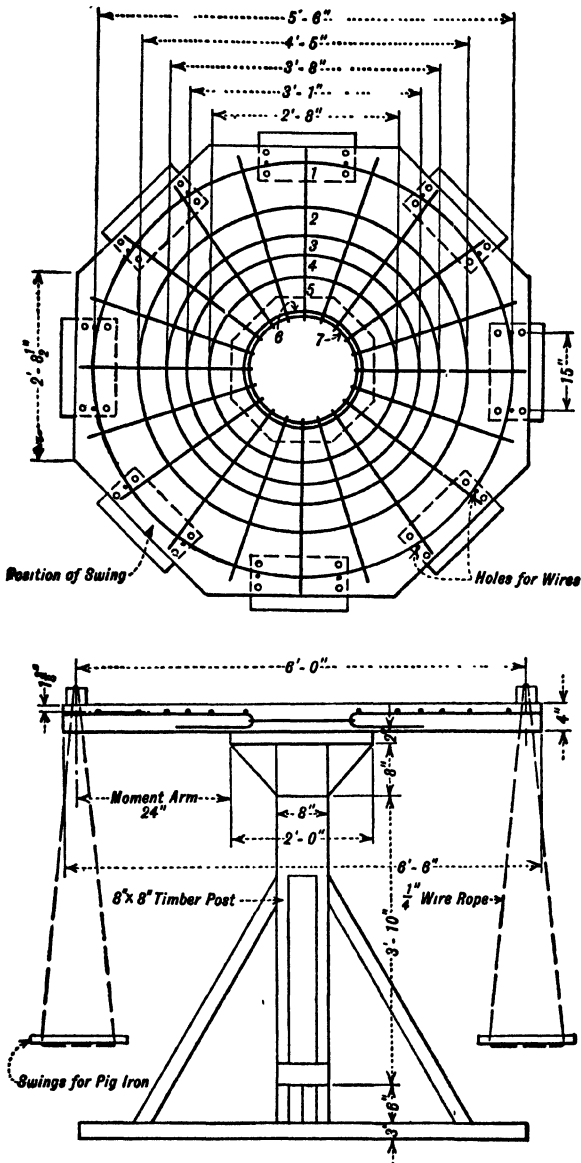

FIG. 40.—Cantilever Slab and Loading Platform. (See p. 116.)

were measured by a Berry Extensometer on 8-in. gage lines. For this purpose, gage holes about  $\frac{1}{2}$ -in. diameter were drilled in the steel. Each ring and each bar was provided with at least four gage lines to eliminate the possibility of erratic results. Average stresses were plotted on a deformation diagram. Fig. 41, p. 119, shows the deformations at different loadings for Specimens 1 and 2, and Fig. 42, p. 120, for Specimen 7. The curves for Specimen 8 are substantially like those for Specimen 7.

**Results of the Tests.**

—The results of the tests are shown in the table on p. 120, which gives the dimension of specimens, total loads, and load per pound of tensile steel. The measured stress and the load at first visible crack also are given in the table, from which it is evident that the first visible cracks occurred at about two-thirds of the load at the elastic limit. Judging from the stress diagrams, hair cracks invisible to the eye must have appeared at a

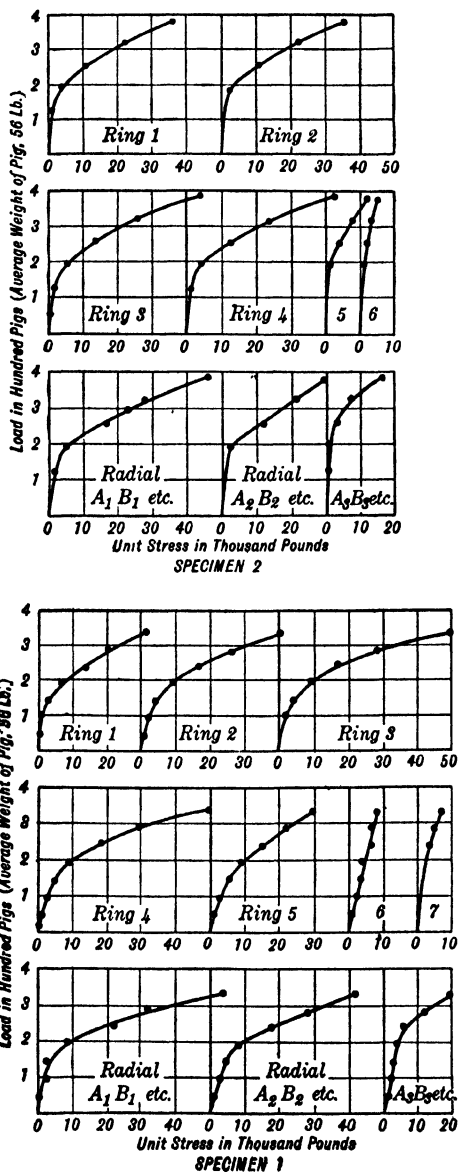

FIG. 41.—Deformation Diagrams for Slab Specimens 1 and 2. (See p. 119.)



smaller load corresponding to the break in the deformation curve.

### Summary of Results of Tests of Octagonal Cantilever Flat Slabs

Octagonal slab 6 ft. 6 in. inside diameter; column head 2 ft. diameter; 1 : 2 : 4 concrete; mild steel. Specimens 1 to 4 Radial; Specimen 7, 4-way; Specimen 8, 2-way. All slabs 4 inches thick.

Specimen Number	Age, Days	Weight of tensile steel, lb.	Number and Diameter of Round Bars in Inches			Area of radial or straight bars around circumference, sq. in.	Area of effective rings, sq. in.	Average effective depth, in.	Total load at elastic limit, lb.	Load per pound of tensile steel Col. 10 ÷ Col. 3, lb.	Load at first visible crack, lb.	Measured stress in steel at first visible crack, lb. per sq. in.
			Radial bars	Outside rings	Straight bars							
1	47	42.6	20 - #	5 - #	2.2	0.368†	2.56	18 800	442	12 400	14 000	
2	44	50.2	20 - #	5 - #	2.2	0.484†	2.62	22 500	448	15 000	15 000	
3	42	71.7	20 - #	5 - #	2.2	0.901†	2.60	32 000*	447	21 200	16 000	
4	35	101.2	20 - #	5 - #	2.2	1.38	2.50	42 500†	210	26 600	15 000	
7	51	60.0	.....	.....	36 - #	5.5	2.25	12 600	421	8 950	15 000	
8	50	56.0	{ Tension Compression	{ 24 - # 16 - #	{ 5.3	{	{ 2.25	{ 12 600	{ 225	{ 8 900	{ 15 000	

\* Estimated from stress diagram. Broken by accident at 29 500 lb., before elastic limit was reached.

† Estimated from stress diagram. Elastic limit not reached at maximum applied load.

‡ Only part of the area of Ring 5 was considered as effective because it was placed too near the column head and therefore carried smaller stress than the other rings.

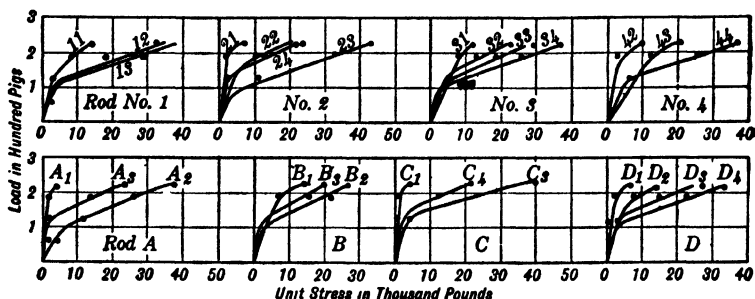

FIG. 42.—Deformation Diagrams for Slab Specimen 7. (See p. 119.)

The first crack, at first hardly noticeable, extended all the way around the circumference of the column head, several inches from its edge. Upon additional loading, this crack opened slowly and other circumferential and radial cracks appeared. The test was

discontinued after the steel had reached the elastic limit with the exception of Specimen 4, in which the elastic limit of the slab was not reached on account of the difficulty of applying further loading. No cracks developed within the column head although the radials were stressed to elastic limit and the hooked portions did not bear against the center ring. Of interest is the fact that the cracks in Specimens 7 and 8, reinforced with bands of bars, were also radial and circumferential.

From the stress diagrams, it is noticeable that the outside Rings, 1 to 4 in Specimens 1 to 3, and Rings 1 to 3 in Specimen 4 were equally effective in resisting the bending moment, the stresses at different loads being almost equal. The stress in Ring 5 was smaller than in the other rings, which can be accounted for by the fact that the ring was placed too near the column head. The stresses in Rings 6 and 7 within the column head were very small, showing that very little stress is transferred by the radials to the center rings. Evidently, most of it is transferred to concrete by bearing.

**Splicing of Rings.**—All rings were spliced with a 50-diameter lap. During testing, special attention was paid to the behavior of the steel at the splices and it was found that the elastic limit was reached without any movement being observed at the splices.

**Conclusions.**<sup>55</sup>—(1) First crack occurred at substantially the same measured stresses in the steel, irrespective of the arrangement and amount of reinforcement. The load at first crack increased with the increase of reinforcement.

(2) The actual load sustained in all specimens was larger than would be expected from ordinary methods of computation, proving the effect of Poisson's ratio. The reduction of bending moment coefficients suggested for flat slabs on p. 331 is justified.

(3) The relative effectiveness of the various arrangements of steel can be obtained by comparing the load per pound of tensile steel, which for Specimens 1 to 4 varied between 420 lb. and 450 lb. and for Specimens 7 to 8 between 210 and 225 lb.

(4) In specimens reinforced by rings, the stresses were uniformly distributed over all rings. (See stress diagrams, p. 120.)

(5) The lap of 50 diameters of a plain bar was sufficient to develop the elastic limit of the rings.

<sup>55</sup> Taken from report by Sanford E. Thompson.

## CHAPTER IV

### THEORY OF REINFORCED CONCRETE

Reinforced concrete is concrete in which steel or other reinforcing metal is imbedded to increase its strength. The reinforcement in general consists of bars of small diameter connected with the concrete by bond. Since the reinforcement has little stiffness in itself, in compression members it relies upon the concrete and the ties for lateral support. When properly designed the reinforcing bars are capable of developing full tensile or compressive resistance. Sometimes rigid structural shapes are used as reinforcement.

Not all construction consisting of steel and concrete may be classed as reinforced concrete. The function of the two materials in a completed structure determines whether it is a reinforced concrete structure or a steel structure fireproofed with concrete.

An arch of the Melan type, for example, consisting of rigid metal ribs capable of carrying some of the load unassisted, but depending largely for its stiffness and ultimate strength upon the concrete, (see Vol. II) may be considered a reinforced concrete structure. A similar arch, consisting of metal ribs connected laterally by metal bracing and strong enough to carry the entire load, although encased in concrete, cannot be considered as a reinforced concrete structure, because the concrete does not serve the purpose of resisting stresses, but only the auxiliary purpose of protecting the steel against corrosion and giving the arch the appearance of a masonry structure. Any increase in strength of the structure due to the concrete is only incidental. Similarly, concrete columns and other members with structural steel shapes may be considered as reinforced concrete when the concrete serves to increase the strength of the member. When, however, as in steel frame structures fireproofed with concrete, the steel is self-supporting and designed to resist the whole of the stresses while the concrete serves chiefly for protection, the member is not reinforced concrete.

The theory of the design of reinforced concrete is definitely estab-

lished. The action of the combination of steel and concrete in tension, compression, and shear is well understood, so that a thoroughly rational treatment is possible. In practice, in beam design, the straight-line theory, as it is termed (see p. 127), which was selected and adopted by the authors for the First Edition of this treatise, in 1905, has since that time been accepted universally as affording the simplest method of computation and as giving results which may be used in design with safety and economy.

In this chapter is presented the analysis of this straight-line theory of stresses for rectangular beams (p. 129), followed by the application of the same theory to T-beams (p. 133). The analysis of a beam with steel in top and bottom is given on p. 137. Wedge-shaped beams are treated on p. 140 and unsymmetrical T-beams on p. 140. The analysis of shear and diagonal tension will be found on p. 143.

The theory of columns of concrete reinforced with vertical steel bars is treated on p. 159, and that of columns reinforced with vertical steel bars and spirals on p. 160. Analyses and formulas are presented for the distribution of stresses in reinforced concrete under combined thrust and bending moment (p. 164) for use in arch design and in the design of columns and beams with eccentric load or thrust.

The theory of members subjected to direct tension or pull, p. 162, and also to pull and bending moment is given on p. 189. The theory of reinforced concrete chimney design is treated in Chapter XX.

Formulas for use in practical design, with illustrations of methods of treatment, will be found in Chapter V. Tests of reinforced concrete, covering all usual features of design, are taken up in Chapter III.

### GENERAL PRINCIPLES OF REINFORCED CONCRETE BEAMS

Concrete is very strong in compression, but is brittle and unreliable in pull or tension. Therefore, it cannot be used safely nor economically where tensile stresses have to be resisted. Steel, on the other hand, being a comparatively ductile material, is well adapted for resisting pull, but is more costly than concrete for resisting compression. The economy in the use of reinforced concrete is obtained by placing concrete where compressive stresses are to be resisted, and steel where tensile stresses are to be resisted. The bond and shearing resistance of concrete holds the steel and concrete together so that they act as a unit.

**Requirement for Formulas for Reinforced Concrete Beams.—**

The behavior of reinforced concrete beams under load, as discussed on p. 20, is different from that of homogeneous beams. The location of the neutral axis for varying intensities of loading is not constant. The sum of compression stresses in the concrete is nearly proportional to the load, but the tensile stresses in the steel are not proportional to the load because of the variable proportion of tension resisted by concrete (see p. 27). It is impossible to make formulas which would represent actual stress conditions for all loads within elastic limit. This, however, is not the purpose of formulas used for design. Their purpose is to supply a construction to carry a load equal to the design load multiplied by the factor of safety, without either steel or concrete exceeding the elastic limit. This being the case, the design formulas must be based on conditions existing at the elastic limit. In practice, instead of multiplying the design load by the factor of safety and working with stresses at elastic limit, the work is simplified by establishing working stresses equal to the stresses at elastic limit divided by the factor of safety, and using them with bending moments for design load only. It is important to keep the purpose and the origin of the formulas constantly in mind, to avoid using them for purposes for which they are not intended.

Formulas for reinforced concrete beams must satisfy the following requirements:

- (1) The compressive stresses in concrete for working loads must not exceed the allowable unit stress;
- (2) The beam must have the required factor of safety based on the elastic limit of steel.

The first requirement fixes the unit stresses for concrete.

To satisfy the second requirement, it is necessary in the analysis to eliminate the variable amount of tensile stress carried by the concrete (see p. 30), by assuming that all the tensile stresses are resisted by the steel. Analysis based on this assumption will not represent the actual conditions in a beam under working loads because the actual stresses in steel will be less than the computation would show, but it will give the required factor of safety and, therefore, be correct for design. On p. 27 is given a comparison between actual stresses and stresses computed by the accepted formulas for beams with different ratios of steel to concrete. It is seen that,

for earlier stages of loading, the actual stress is much less than the computed. This difference, which is due to the tensile resistance of concrete, decreases with the increase of the load. At the elastic limit of steel, the stage upon which the factor of safety would be based, the computed stresses agree fairly well with the actual stresses. The action is shown by the tests, illustrated in Fig. 9, p. 29, which give the deformations of concrete and steel at various loads. Stresses, of course, are proportional to the deformations.

**Factor of Safety.**—By the factor of safety is understood the ratio between the load at which the construction would fail and the load which it is intended to carry. The words “fail” and “failure” do not mean actual collapse, but a state where the structure ceases to be useful. If the material of which the construction is composed is equally strong in tension and in compression, the factor of safety is the same against both tensile and compression failure. In a structure of a composite material, such as reinforced concrete, the factor of safety against compression failure may be different from the factor of safety against tensile failure. The factor of safety of the structure as a whole is governed by the smaller factor.

In reinforced concrete construction, steel is considered as the more reliable of the two materials, because it is manufactured under standardized and uniform conditions and the variation in its elastic limit and ultimate strength is, therefore, small. The manufacture of concrete, on the other hand, as well as the strength and characteristics of the materials composing it, varies from job to job so that the ultimate strength of the concrete in different constructions may vary to a great extent. Also, during construction, concrete may be called upon to resist considerable stresses before its full strength has been attained. The allowable unit stresses in compression are so selected that the construction has a larger factor of safety against compression failure than against tensile failure. The structure is, therefore, governed by the factor of safety of the tensile steel.

The factor of safety, governed by the reinforcement, is based upon the elastic limit of the steel and not upon its tensile strength, because failure of the beam follows closely after stresses in steel reach the elastic limit. The ultimate strength of steel in tension is of no significance as far as the strength of reinforced concrete is concerned.

**Formulas Considering Tensile Strength of Concrete.**—In analyzing the results of the tests in the early stages of the loading, it is

sometimes necessary to consider the tensile stresses in concrete. Formulas for such a case are seldom used.

### ASSUMPTIONS

In the analysis of beams, the following assumptions will be made:

- (1) A section that is plane before bending remains plane after bending. (See p. 127.)
- (2) Modulus of elasticity of concrete is constant. (See p. 201.)
- (3) Tension is borne entirely by the steel. (See p. 124.)
- (4) Adhesion of concrete to steel is perfect within the elastic limit of the steel.
- (5) There are no initial stresses in the steel.

Reasons for selecting these assumptions are as follows:

- (a) Beams designed by formulas based on them have the required factor of safety.
- (b) The method of design based on them is the simplest.
- (c) They have been adopted by the highest authorities in America and Europe.

Assumption (2) is not actually correct. The modulus of elasticity varies with the variation in intensity of the stresses; but the allowable compression stresses and the modulus of elasticity have been selected in such a fashion that the results obtained by the simple formulas give the same dimensions as would be obtained with the more complicated formulas using the variable modulus of elasticity. The maximum fiber stress obtained by formulas is larger than the actual stresses. In the selection of the working stresses, this has been taken into account.

Working stresses recommended in this book should not be used with other than "straight-line" formulas.

### ANALYSIS OF RECTANGULAR BEAMS

**Bending Moment and Moment of Resistance.**—In a beam subjected to bending, the bending moment due to the external forces, or loads, is resisted by the moment of the internal resisting forces, which will be called stresses. Since, by the simple mechanical laws of equilibrium, the bending moment must be equal to the resisting

moment of the internal forces or stresses, the unknown stresses in the materials may be found by equating the known external bending moment to the internal resisting moment.

**Straight-Line Formula.**—The stresses cause deformation in the material and the consequent deflection of the beam. At any vertical section through the beam, the compressive stresses above the neutral axis cause shortening of the fibers, and the tensile stresses below the neutral axis cause lengthening of the fibers. According to the first assumption above, a section that is plane before bending remains plane after bending. This means that when the beam is bent, a plane section through the beam simply swings into a new position, without warping.

In Fig. 43, p. 127, for example, section  $AB$  after bending assumed the position  $A'B'$  by turning around point  $O$  at the neutral axis. Therefore, the deformation, or change in length, in any fiber is proportional to its distance from the neutral axis and the variation of deformation of different fibers may be represented by a straight line.

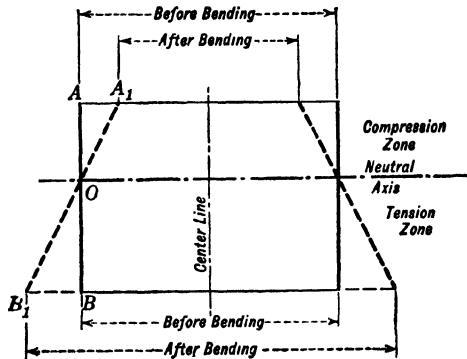

FIG. 43.—Plane Section before and after Bending. (See p. 127.)

According to the second assumption, the modulus of elasticity is constant for all intensities of stresses. With a constant modulus of elasticity (see p. 126), the ratio of the deformation to the stress is constant. Therefore, the variation of the resisting stresses from the neutral axis upward can be represented by a straight line, in the same manner as the variation in deformations. The compressive stresses then form a triangle having for its base the stress in the extreme fiber,  $f_c$ , and for its height the distance from the extreme fiber to the neutral axis,  $kd$ . The total compression may be considered as concentrated at the center of gravity of the triangle, which is distant  $\frac{1}{3}kd$  from the extreme fiber. (See Fig. 44, p. 129.)

According to the third assumption, all tensile stresses are resisted by the steel. They may be considered as acting in the center of gravity of the steel, which is at the center of the bar if there is only



one layer of bars, and at the center of gravity of the set of bars, if there is more than one layer.

For equilibrium, the sum of all forces must equal zero; that is, the total compression must be equal to the total pull. The total tension and the total compression, which are equal and act in opposite directions, form a couple with a moment arm equal to the distance between the center of steel and the center of gravity of the triangle of compressive stresses. The moment caused by this couple is the resisting moment. For equilibrium this must equal the bending moment due to exterior forces.

The discrepancy between the actual conditions in a beam and the assumption of straight-line distribution of stresses is discussed on p. 142.

#### NOTATION

For this and succeeding analyses, let

$h$  = total depth of beam;

$t$  = thickness of T-beam flange, i.e., thickness of slab;

$b$  = breadth of rectangular beam or breadth of flange of T-beam;

$b'$  = breadth of web of T-beam;

$A_s$  = area of cross section of steel =  $pbd$ ;

$p$  = ratio of steel in tension to area of beam,  $\frac{A_s}{bd}$ ;

$p_m$  = maximum ratio of steel in T-beams,  $\frac{A_s}{bd}$ , for which compression stress in concrete equals maximum allowable stress.

In beams with steel in top and bottom:

$p_1$  = ratio of tensile steel to area of beam,  $bd$ ;

$p'$  = ratio of compressive steel to area of beam,  $bd$ ;

$f_c$  = compressive unit stress in outside fiber of concrete;

$f_t$  = tensile unit stress in outside fiber of concrete;

$f_s$  = tensile unit stress, or pull, in steel;

$f'_s$  = compressive unit stress in steel;

$E_c$  = modulus of elasticity of concrete;

$E_s$  = modulus of elasticity of steel;

$n = \frac{E_s}{E_c}$  = ratio of moduli of elasticity;

$d$  = depth from outside compressive fiber to center of gravity of steel;

$\alpha$  = ratio of depth of compressive steel to depth,  $d$ , of beam;  
 $k$  = ratio of depth of neutral axis to effective depth of beam,  $d$ ;  
 $Z$  = total amount of shearing stresses in distance,  $s$ , and width  $b$  in any horizontal plane below neutral axis.

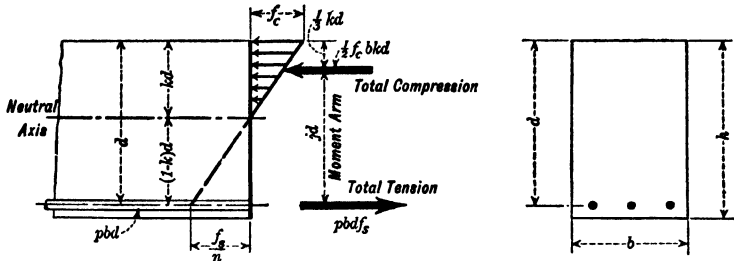

FIG. 44.—Resisting Forces in a Reinforced Concrete Beam. (See p. 129.)

$kd$  = depth of neutral axis below the compressive surface in a beam;  
 $j$  = ratio of lever arm of resisting couple to depth  $d$ ;  
 $jd$  = moment arm, i.e., distance between centers of tension and compression;  
 $M$  = moment of resistance, or bending moment in general;  
 $C$  = constant in Tables, pp. 880 and 881.

Since it is assumed that a section which is plane before bending remains plane after bending, we have the proportion

$$\frac{\text{stretch in steel}}{\text{deformation in outside compressive concrete fibers}} = \frac{d(1 - k)}{kd}$$

and since unit stretch in steel =  $\frac{\text{stress per square inch}}{\text{modulus of elasticity}} = \frac{f_s}{E_s}$  and unit

deformation in concrete =  $\frac{\text{stress per square inch}}{\text{modulus of elasticity}} = \frac{f_c}{E_c}$ , we have

$$\frac{\frac{f_s}{E_s}}{\frac{f_c}{E_c}} = \frac{d(1 - k)}{kd} \quad \text{or since} \quad \frac{E_s}{E_c} = n$$

$$\frac{f_s}{nf_c} = \frac{1 - k}{k} \quad (1) \quad \text{and} \quad k = \frac{1}{1 + \frac{f_s}{nf_c}} \dots \dots \dots (2)$$

Solving Formula (1) for  $f_c$

$$f_c = f_s \frac{k}{n(1-k)} \dots \dots \dots (3)$$

Now, as stated above, for equilibrium the total tension in the steel must be equal and opposite to the total compression in the concrete. The total tension in the steel is its unit stress,  $f_s$ , multiplied by the area of the steel,  $pbd$ , and the total compression in the concrete is represented by the area of the pressure triangle,  $\frac{1}{2}f_c k c'$ , times the breadth of the beam,  $b$ . Equating these two forces and canceling out the  $bd$  which occurs in both,

$$p f_s = \frac{f_c k}{2} \dots \dots \dots (4)$$

If the value of  $k$  in Formula (2) be substituted for the  $k$  in Formula (4) we have

$$p = \frac{1}{2 \frac{f_s}{f_c} \left(1 + \frac{f_s}{n f_c}\right)} \dots \dots \dots (5)$$

For any given percentage of steel the values of  $f_s$  and  $f_c$  cannot be assumed independently, as they bear a constant ratio to each other.

Substituting the value of  $f_c$  in Formula (3) for  $f_c$  in Formula (4) we have

$$p = \frac{k}{2} \frac{k}{(1-k)n} \dots \dots \dots (6)$$

Solving this quadratic equation and adopting the positive sign before the square root,

$$k = -np + \sqrt{2np + (np)^2} \dots \dots \dots (7)$$

From Formula (7) the location of the neutral axis may be determined for any percentage of steel,  $p$ , and any assumed ratio of moduli of elasticity,  $n$ . Values for  $k$  are given in Tables, pp. 880 and 881.

The center of gravity of the compressive stresses is distant  $\frac{1}{3}kd$  from the top of the beam, so that  $jd = d - \frac{1}{3}kd = (1 - \frac{1}{3}k)d$ .

Since the total compression equals the total tension, the moment of resistance of the beam may be obtained by multiplying either the

total tension,  $pbd f_s = A_s f_s$ , or the total compression,  $\frac{1}{2} f_c b k d$ , by the moment arm  $j d$ .

$$M = A_s f_s j d \quad . \quad . \quad (8) \quad \text{and} \quad f_s = \frac{M}{A_s j d} \quad . \quad . \quad (9)$$

$$M = \frac{f_c k j b d^2}{2} \quad . \quad (10) \quad \text{and} \quad f_c = \frac{2M}{k j b d^2} \quad . \quad . \quad (11)$$

For a given quality of concrete and steel, the values of  $f_s$ ,  $f_c$ ,  $p$ ,  $k$ , and  $j$ , are constant, so that we may consider the terms  $p f_s j = \frac{1}{2} f_c k j$  equal to a constant  $\frac{1}{C^2}$ . This changes Formulas (8) and (10) to

$$M = \frac{b d^2}{C^2} \quad . \quad . \quad (12) \quad \text{and} \quad d = C \sqrt{\frac{M}{b}} \quad . \quad . \quad (13)$$

The constant values in Formulas (8) and (10) may also be called  $\frac{1}{2} f_c k j = p f_s j = R$ . The formula for depth of beam may be also expressed by

$$d = \sqrt{\frac{M}{b R}} \quad . \quad . \quad . \quad . \quad . \quad (14)$$

The area of steel may be obtained by solving Formula (8) for  $A_s$ . It is

$$A_s = \frac{M}{f_s j d} \quad . \quad . \quad . \quad . \quad . \quad (15)$$

For balanced design the area of steel equals

$$A_s = p b d, \quad . \quad . \quad . \quad . \quad . \quad (16)$$

where  $p$  is the ratio of steel corresponding to the allowable stresses in steel and concrete and  $d$  is the depth computed on the basis of the same stresses.

To obtain the total depth of beam,  $h$ , a value  $e$  must be added to the theoretical depth,  $d$ . Then,  $h = d + e$ .

For the use of these formulas in design, see pp. 203 to 214.

Values of constants  $j$ ,  $k$ , and  $p$  are given on pp. 880 and 881.

Values of constants  $C$  and  $R$  are given on pp. 880 and 881.

**Balanced Design of Rectangular Beam.**—As is evident from Formulas (9) and (11), the stresses of  $f_c$  and  $f_s$  are practically independent of each other. The stress in concrete depends upon the depth and breadth of beam, while the stress in steel depends upon depth of beam and the amount of reinforcement.

A balanced design of a rectangular beam is one in which the stress in steel and the stress in concrete reach their maximum allowable values at the same time. The moment of resistance of concrete, figured by Formula (10), is equal to the moment of resistance of steel, figured by Formula (8). In a balanced design for fixed stresses  $f_s$ ,  $f_c$ , and  $n$ , there is a fixed relation between the area of steel and area of concrete. Thus, for a stress in steel,  $f_s = 16\,000$ , and stress in concrete,  $f_c = 650$ , the ratio of steel for a balanced design is  $p = 0.0077$ .

**Unbalanced Design of Rectangular Beam.**—An unbalanced design of a rectangular beam is one in which either the amount of steel or the amount of concrete is larger than required by the stresses. In such a case, the moments of resistance figured for the two materials, based on their respective working stresses, will not be equal. The available strength of the beam will then be governed by the material giving the smaller moment of resistance.

Thus, if the amount of steel is larger than that obtained from the formula  $A_s = pbd$ , where  $p$  is the ratio of steel for a balanced design corresponding to the selected unit stresses, the design has more steel than is required by tensile stresses. Therefore, the bending moment must be based upon the compressive strength of the concrete, and the steel cannot be stressed to its full working value. For a bending moment based on the full working value of steel, the concrete stresses would be excessive. If such a condition should occur in a design, the amount of steel should be reduced, *unless the increase in the amount of steel was necessitated by bond stresses.* (See p. 264.)

On the other hand, if for any reason an amount of steel smaller than  $A_s = pbd$  is used ( $p$  being the ratio for a balanced design), the moment of resistance must be based on the reinforcement. The stresses in concrete will be smaller than the allowable fiber stresses. To stress the concrete to its working value would over-stress the steel.

FORMULAS FOR T-BEAMS

If a reinforced concrete beam is built monolithic with the slab, the beam may be considered as a T-beam in which a portion of the slab acts as a flange. (See Fig. 45, p. 133.)

The formulas for T-beams given below are based on the same assumptions as those for rectangular beams. Tension is considered as taken entirely by the steel, and the variation of stresses in concrete is according to a straight-line. Unless the slab is very thick, the neutral axis is located below the flange.

For notation, see p. 128.

Case I.—Neutral Axis below Flange,  $kd > t$ .

**Formulas Neglecting Compression below Flange.**—In ordinary T-beams, the amount of compression stresses resisted by stem below the flange is insignificant and may be neglected. This simplifies the formulas without causing any appreciable error.

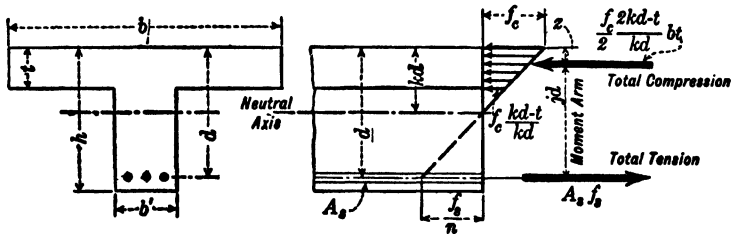

FIG. 45.—Resisting Forces in T-shaped Section of Beam. (See p. 133.)

The location of the neutral axis is determined in the same manner as for rectangular beams. The ratio  $k$  may be expressed by

$$k = \frac{1}{1 + \frac{f_s}{nf_c}} \dots \dots \dots (17)$$

The total tension is equal to the unit stress in steel,  $f_s$ , multiplied by the area of steel,  $A_s$ . The total compression in the concrete is represented by a trapezoid, the sides of which are  $f_c$  and  $f_c \frac{kd - t}{kd}$ ;

and the depth is equal to  $t$ . The total compression, therefore, equals

$$f_c \frac{2kd - t}{2kd} bt, \text{ also } f_c \frac{2k - \frac{t}{d}}{2k} bt.$$

By equating total tension to total compression acting on the section

$$A_s f_s = f_c \frac{2kd - t}{2kd} bt. \quad \dots \quad (18)$$

Solving the two above equations for  $kd$  and eliminating  $f_c$  and  $f_s$ , we get

*Position of neutral axis*

$$kd = \frac{2nd A_s + bt^2}{2n A_s + 2bt}. \quad \dots \quad (19)$$

The distance of the center of compression from upper surface of beam

$$z = \frac{3kd - 2t}{2kd - t} \left( \frac{t}{3} \right). \quad \dots \quad (20)$$

*Arm of resisting couple*

$$jd = d - z$$

*Moment of resistance*

$$M = A_s j d f_s. \quad \dots \quad (21) \quad \text{and} \quad M = \frac{2kd - t}{2kd} bt j d f_c. \quad (21a)$$

*Fiber stresses*

$$f_s = \frac{M}{A_s j d}. \quad \dots \quad (22)$$

$$f_c = \frac{Mkd}{bt(kd - \frac{1}{2}t)jd} = \left( \frac{f_s}{n} \right) \frac{k}{1 - k}. \quad \dots \quad (23)$$

*Area of steel*

$$A_s = \frac{M}{f_s j d}. \quad \dots \quad (24)$$

The form of this equation is the same as for rectangular beams (Formula (15) p. 131). The difference is in the value of  $j$ . As in the case of rectangular beams, the moment of resistance of a T-beam may be governed either by the allowable tensile stresses in the reinforcement or by the allowable compressive stresses in concrete, whichever gives the smaller value. For a T-beam of fixed dimen-

sions there is one value of  $p$  for which the stresses in steel and concrete reach their allowable stresses simultaneously. This is the maximum ratio of steel that can be fully utilized without overstressing the concrete. Its value is given in the diagram, p. 894, for different unit stresses and different dimensions of the beam.

**Minimum Depth of T-Beam.**—In a T-beam design, the depth of slab to be used for the flange is designed first. This fixes the value  $t$ . The width of the flange depends largely upon the thickness (see p. 217), so that for fixed  $t$ , the value  $b$  is practically fixed. Since the area of compression flange is fixed, for specified working stress in concrete,  $f_c$ , the available compression is practically fixed. The moment of resistance being equal to total compression multiplied by moment arm  $jd$ , it is clear that with total compression practically fixed there corresponds to each moment  $M$ , a definite value  $d$ , for which the stresses in the flange are equal to the maximum working stresses. This depth is called minimum depth. The formula for minimum depth is

$$\text{Minimum } d = \frac{M}{bt} \frac{2k}{\left(2k - \frac{t}{d}\right) j f_c}$$

Calling  $C_a = \frac{\left(2k - \frac{t}{d}\right) j f_c}{2k}$ , the formula becomes

*Minimum depth*

$$\text{Minimum } d = \frac{M}{C_a b t} \dots \dots \dots (25)$$

Values of  $C_a$  depend upon the ratio  $\frac{t}{d}$ , and upon,  $k, j$  and  $f_c$ , which are functions of the allowable working stresses. The diagram on p. 894 gives values of  $C_a$  for various assumptions.

**Maximum Area of Steel in T-Beam Permitted by Compression.**—In a T-beam of definite design, the compression area is fixed as explained above. For a definite depth  $d$  and working stresses  $f_c, f_s$

and  $n$ , this fixes the available total compression, which is  $f_c \frac{2k - \frac{t}{d}}{2k} b t$ .

The total tension available equals  $A_s f_s$ , in which only  $f_s$  is fixed. The available moment of resistance of the beam equals either total tension or total compression multiplied by the moment arm, which-



ever gives the smaller value. If the total available tension,  $A_s f_s$ , is smaller than the total available compression in the flange, then the tension governs the bending moment and it is  $M = A_s f_s j d$ . When the total available tension,  $A_s f_s$ , is larger than the available total compression in the flange, the compression governs the bending and the area of steel is not fully utilized. It follows that, in a rational design, such an area of steel should be used that the total tension is smaller than, or equal to, the total compression.

The maximum area of steel which can be used economically is that for which the total tension equals the total compression,

$$\text{Maximum } A_s f_s = f_c \frac{2k - \frac{t}{d}}{2k} b t.$$

Calling Maximum  $A_s = p_m b d$  in substituting in the above equation, we have

$$p_m b d f_s = f_c \frac{2k - \frac{t}{d}}{2k} b t,$$

or finally

*Maximum ratio of steel*

$$p_m = \frac{2k - \frac{t}{d}}{2k} \frac{t}{d} \frac{f_c}{f_s} \dots \dots \dots (26)$$

and

*Maximum area of steel*

$$\text{Maximum } A_s = p_m b d. \dots \dots \dots (27)$$

The ratio  $p_m$  depends upon the values  $k$ ,  $f_s$  and  $f_c$ , all of which depend upon the working stresses and the ratio  $\frac{t}{d}$ . The diagram on p. 894 gives values of  $p_m$  for various assumptions.

**Maximum Moment of Resistance of T-beam.**—In a T-beam of definite concrete dimensions, the maximum moment of resistance is the one for which the compression stresses in the extreme fiber in concrete reach the maximum working value.

$$\text{Maximum } M = \frac{2k - \frac{t}{d}}{2k} j f_c b t d.$$

Calling, as on p. 135,  $C_s = \frac{(2k - \frac{t}{d}) j f_c}{2k}$ , the formula becomes

$$\text{Maximum } M = d C_s b t. \dots \dots \dots (28)$$

The diagram on p. 894 gives values of  $C_s$  for various assumptions.

**Formulas Considering Compression below Flange.**—For large beams where the stem forms a large part of the compression area, the above formulas do not give results accurate enough for practical purposes. For such cases, formulas given below may be used, which take into account the compressive stresses in the stem as well as in the flange. The following formulas are derived by the same principles used in derivation of formulas in the previous analysis.

Depth to neutral axis

$$kd = \sqrt{\frac{2ndA_s + (b - b')t^2}{b'} + \left(\frac{nA_s + (b - b')t}{b'}\right)^2} - \frac{nA_s + (b - b')t}{b'} \quad (29)$$

$$z = \frac{(kdt^2 - \frac{3}{8}t^3)b + [(kd - t)^2(t + \frac{1}{4}(kd - t))]b'}{t(2kd - t)b + (kd - t)^2b} \quad (30)$$

Arm of resisting couple

$$jd = d - z. \quad (31)$$

Moment of resistance

$$M = A_s j d f_s. \quad (32) \quad M = \frac{f_c}{2kd} [(2kd - t)bt + (kd - t)^2 b'] j d. \quad (33)$$

Fiber stresses

$$f_s = \frac{M}{A_s j d}. \quad (34) \quad \text{and} \quad f_c = \frac{2Mkd}{[(2kd - t)bt + (kd - t)^2 b'] j d}. \quad (35)$$

A simplified method is given on p. 224. This can be used in design for determining dimensions of the beam for known stresses in steel and concrete. It cannot be used for computing stresses, however.

Case II.—Neutral Axis in Flange or at Underside of Flange,  $kd < t$ .

In this case, which occurs only with slabs very thick in proportion to the depth of the beam, use the rectangular beam formula, considering the T-beam as a rectangular beam of the same depth, the breadth of which is the breadth of the flange. The percentage is then based on the total area,  $bd$ .

**REINFORCED CONCRETE BEAMS WITH STEEL IN TOP AND BOTTOM**

In beams reinforced with steel placed both in the compressive and tensile portions of the beam, the steel in the compressive portion, as in reinforced concrete columns (p. 159), may be considered as resisting compression stresses equal to the stresses in the concrete

which it replaces, multiplied by the ratio of moduli of elasticity,  $n$ . Same assumptions are made as for simple rectangular beams (p. 126).

The tension in concrete may be neglected, as in beams without compressive steel, and all the tension may be considered as resisted by the bottom steel. Referring to Fig. 46, p. 138, the total compression consists of the compressive stresses in concrete represented by a triangle and the compressive stress in steel. The compressive unit stress in steel equals the unit stress in concrete at the same level, multiplied by the ratio of their moduli of elasticity.

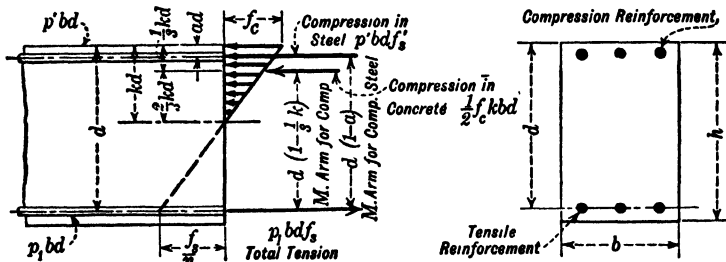

FIG. 46.—Resisting Forces with Steel in Top and Bottom of Beam. (See p. 138.)

The sum of all the horizontal stresses acting on a cross section must equal zero;<sup>1</sup> therefore, the total tension in steel must be equal to the compression in concrete plus the compression in the top steel. The resisting moment, that is, the moment of the internal stresses, may be obtained either by multiplying the total tension or compression by the distance between center of tension and center of compression, or by taking moments about the center of tension steel, the center of compression in concrete, or the center of compression in steel. The moments of resistance obtained by either of the four methods must be equal. To find the stresses for a certain loading, the moment of resistance taken in any one of these ways is equated to the known bending moment.

**Formulas.**—Deformations, as usual, are assumed to vary directly as distance from neutral axis, hence from Fig. 46, using notation on p. 138,

$$\frac{\frac{f_s}{E_s}}{\frac{f_c}{E_c}} = \frac{d(1-k)}{dk} = \frac{1-k}{k}. \quad \text{Whence } k = \frac{1}{1 + \frac{f_s}{n f_c}}. \quad (36)$$

<sup>1</sup> This is a law of simple statics. Otherwise there would be a movement in the beam.

By comparing the above equation for  $k$  with that given for simple beams, p. 129, it is evident that for any ratio of  $\frac{f_s}{nf_c}$ , the position of the neutral axis is the same irrespective of whether the beam is provided with compressive steel or not.

By similarity of triangles in Fig. 46, p. 138, the following relations between the unit stresses may be obtained:

$$f'_s = f_s \frac{k - a}{1 - k} \quad \dots (37) \quad \text{and} \quad f'_s = nf_c \frac{k - a}{k} \quad \dots (38)$$

$$f_s = nf_c \frac{1 - k}{k} \quad \dots (39) \quad \text{and} \quad f_c = \frac{f_s}{n} \frac{k}{1 - k} \quad \dots (40)$$

The total tension in steel equals  $bdp_1f_s$ , and the total compression in steel and concrete is

$$bd \frac{f_c k}{2} + bdp'f'_s = bd \left( \frac{1}{2} f_c k + p'f'_s \right).$$

Since the sum of all the stresses must equal zero, the total compression acting on the cross section of the beam equals the total tension, or

$$bd \left( \frac{f_c k}{2} + p'f'_s \right) = bdp_1f_s.$$

Whence

$$p_1 = \frac{1}{f_s} \left( \frac{f_c k}{2} + p'f'_s \right) = \frac{1}{f_s} \left( \frac{f_s}{2n} \frac{k^2}{1 - k} + p'f_s \frac{k - a}{1 - k} \right)$$

Hence

$$p_1 = \frac{k^2}{2n(1 - k)} + p' \frac{k - a}{1 - k} \quad \dots \dots (41)$$

Solving equation (41) for  $k$ ,

$$k = \sqrt{2n(p_1 + p'a) + n^2(p_1 + p')^2} - n(p_1 + p') \quad \dots (42)$$

Taking moments about the center of compressive stress in the steel, we have

$$M = bd^2 \left[ f_s p_1 (1 - a) - \frac{f_c k}{2} \left( \frac{k}{3} - a \right) \right]$$

or by eliminating  $f_c$

$$M = f_s bd^2 \left[ \frac{p_1 (1 - a) 2n(1 - k) - k^2 \left( \frac{k}{3} - a \right)}{2n(1 - k)} \right] \dots (43)$$

From which

$$f_s = \frac{M}{bd^2} \frac{6n(1 - k)}{6np_1(1 - k)(1 - a) - k^2(k - 3a)} \quad \dots (44)$$

By substituting this value of  $f_c$  in equations for  $f_c$  and  $f'_c$ , respectively, we get

$$f_c = \frac{M}{bd^2} \frac{6k}{6np_1(1-k)(1-a) - k^2(k-3a)}, \quad \dots \quad (45)$$

and

$$f'_c = \frac{M}{bd^2} \frac{6n(k-a)}{6np_1(1-k)(1-a) - k^2(k-3a)}, \quad \dots \quad (46)$$

It may be noted that the denominator in the three above equations is the same. A simplified method for designing beams with steel in top and bottom is given in the chapter on Design. Tables of constants are given on pp. 904 to 910.

#### WEDGE SHAPED RECTANGULAR BEAMS

Under this heading come beams in which one or both faces are not at right angles to the section of bending moments. They are found in retaining walls, footings, dams and also at the support of beams provided with haunches.

When the angle of inclination of the faces with the horizontal does not exceed 10 degrees, ordinary formulas may be used. For larger angles the following formulas suggested by Professor William Cain<sup>1a</sup> will give closer results. These formulas are approximate. The number of experiments made on wedge shaped beams is very small so that it is not possible to check the accuracy of the formulas.

Figure 47 represents part of a wedge shaped beam, both faces of which are sloping. The stresses produced by a bending moment acting on section  $AB$  will not be perpendicular to the section. In the steel they act in the direction of the reinforcement, while in concrete they are parallel to the compression surface. The direction of stresses is marked in the figure. To get a moment of resistance acting on section  $AB$  it is necessary to take components of compression and tension at right angles to the section. Following formulas are based on condition represented in Fig. 47, p. 141.

**Notation.**—See pp. 128, 246 and 262.

**Both Faces Inclined.**

$$k = \frac{\cos \beta}{\cos^2 \alpha} \left[ -np + \sqrt{2np \frac{\cos^2 \alpha}{\cos \beta} + (np)^2} \right] \quad \dots \quad (47)$$

<sup>1a</sup> See Professor William Cain "Earth Pressure, Retaining Walls and Bins."

$$j = 1 - \frac{1}{3}k \quad \dots \dots \dots (48)$$

$$f_s = \frac{M}{A_s \cos \beta j d} \quad \dots \dots \dots (49)$$

$$f_c = \frac{2M}{k j b d^2 \cos^2 \alpha} \quad \dots \dots \dots (50)$$

$$p = \frac{1}{2} k \frac{f_c}{f_s} \frac{\cos^2 \alpha}{\cos \beta} \quad \dots \dots \dots (51)$$

$$v = \frac{V}{b j d} - \frac{M(\tan \alpha + \tan \beta)}{b j d^2} \quad \dots \dots \dots (52)$$

$$u = \frac{V}{\Sigma o j d} - \frac{M(\tan \alpha + \tan \beta)}{\Sigma o j d^2} \quad \dots \dots \dots (53)$$

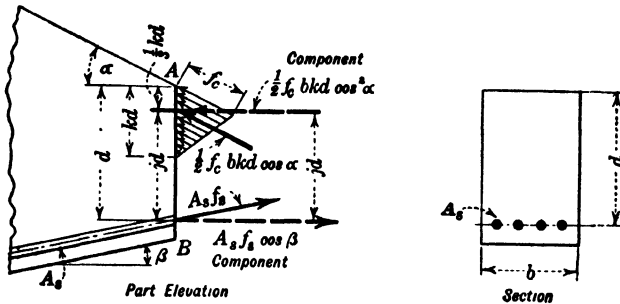

FIG. 47.—Resisting Forces in Wedge Shaped Beam. (See p. 140.)

**Compression Face Inclined. Steel at Right Angles to Section.—**  
 $\beta = 0^\circ$ .

$$k = \frac{1}{\cos^2 \alpha} (-np + \sqrt{2np \cos^2 \alpha + (np)^2}) \quad \dots (54)$$

$$f_s = \frac{M}{A_s j d} \quad \dots \dots \dots (55)$$

$$f_c = \frac{2M}{k j b d^2 \cos^2 \alpha} \quad \dots \dots \dots (56)$$

$$p = \frac{1}{2} k \frac{f_c}{f_s} \cos^2 \alpha \quad \dots \dots \dots (57)$$

$$v = \frac{V}{b j d} - \frac{M \tan \alpha}{b j d^2} \quad \dots \dots \dots (58)$$

$$u = \frac{V}{\Sigma o j d} - \frac{M \tan \alpha}{\Sigma o j d^2} \quad \dots \dots \dots (59)$$

**T-BEAMS WITH FLANGES ON ONE SIDE ONLY**

T-beams with flange on one side only are found where the slab extends only on one side of the beam as at the wall and at openings in the floor. It is common practice to treat these beams in the same manner as symmetrical T-beams, assuming that the neutral axis will be parallel to the compression flange and that the distribution of stresses will be the same as accepted for symmetrical T-beams. Tests by Professor Bach on Unsymmetrical Beams prove that the neutral axis, instead of being parallel to the flange, slopes upward toward the side provided with the flange and may even intersect the flange. The maximum stresses in concrete occur at the rectangular corners. The stresses in steel are not affected much by the unsymmetrical arrangement of the flange.

While formulas have been proposed for this condition,<sup>1b</sup> there are not sufficient data to warrant their adaptation. Until additional information is obtained the stresses should be figured in the same manner as for symmetrical beams, except that the allowable working stresses in compression should be reduced by about 30 per cent.

**COMPARISON OF STRAIGHT-LINE FORMULAS WITH ACTUAL CONDITIONS**

Tests prove that the assumption (2) on p. 126, that the modulus of elasticity of concrete is constant for all stresses, is not correct. Actually the modulus of elasticity is a maximum for small stresses and decreases with the increase of the intensity of the stresses. (See Volume II.)

If a plane section before bending remains plane after bending, the deformations vary according to a straight line, as shown in Fig. 48a. The unit stresses are equal the deformation multiplied by the modulus of elasticity. For constant modulus the variation of stresses will be the same as the variation of deformations. This gives the "straight-line" formula, Fig. 48b.

Actually the variation in stresses is different from the straight-line variation, because, to get the stresses, the deformations must be multiplied not by a constant modulus of elasticity but a varying modulus of elasticity, which is a maximum for small stresses near

<sup>1b</sup> See Karl Hager "Vorlesungen über Theorie des Eisenbetons."





shear. This depends only upon the magnitude and character of the loading and is independent of the dimensions of the beam. These terms are used in the discussion below.

In a beam, shearing stresses are developed in two principal directions. It is, therefore, necessary to study

- (1) vertical shearing stresses,
- (2) horizontal shearing stresses.

**Vertical and Horizontal Shearing Stresses.**—Vertical and horizontal shearing stresses are equal. They may be computed from formulas on page 149. The resistance of concrete to direct shear is large. (See Vol. III.) It is safe to use a working shearing stress of at least 200 lb. per sq. in. Therefore, a concrete girder, beam, or slab will always have sufficient area of section to withstand this direct shearing stress. However, since the direct shearing stress is a measure of the diagonal tension (see p. 148), which may be excessive when the direct shearing stress is comparatively low, it must always be computed in a beam or girder for use in the designing of web reinforcement.

**Magnitude of External Shear.**—The external shear is a maximum at the support, where it is equal to the reaction. For simply supported beams, the external shear may be determined by statics. In continuous beams, the actual external shears differ from the static shears, as is evident from the formulas given in the section on continuous beams. While, with uniform or symmetrical loading, the reaction, and therefore the maximum shear, in simply supported beams is one-half the total load upon the beam, it will be noticed from the diagrams that in the end spans of continuous beams with free ends the external shear at the first support away from the end may be 25 per cent greater than the static shear, and should be specially provided for in cases where the full live load is likely to be constantly maintained. For complete treatment of external shears in continuous beams see Volume II of this treatise.

**Longitudinal Shear in T-beam.**—The projections of the flange of a T-beam on each side of the stem are subject to compressive stresses. These are zero at the support or at the point of inflection and increase with the increase in bending moment. The increase in compression stresses in the projections of the flange must be transferred from section to section by the resistance to shear at the junction of the flange projections and the stem. These shear sections are marked  $AB$  and  $A_1B_1$  in Fig. 49, p. 145. When the shearing stresses are larger than

the resistance to shear, the flanges become separated from the stem, the compression area becomes reduced, and the beam fails by crushing of the stem. Such failures are described in the chapter on Tests, p. 36. An analogy may be found between the shearing stresses along the flanges of a T-beam and the shear in the rivets of a built-up steel beam, which connect the flange angles to the steel web plate.

The magnitude of the shearing stresses may be found in the following manner: Consider two vertical cross sections of a beam, one inch apart. Let  $M_1$  be the moment at the section nearer the support,  $M_2$  the moment at the other section, and  $V$  the external shear, and assume for the sake of simplicity that there is no loading between

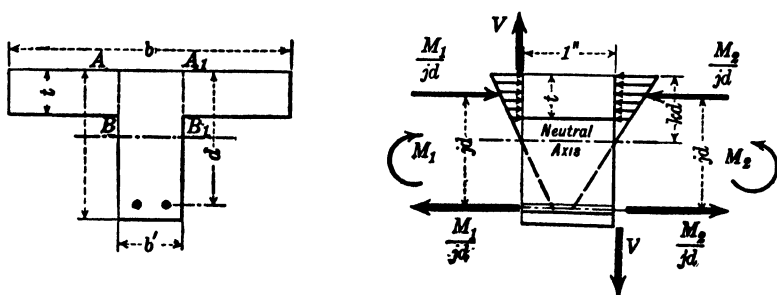

FIG. 49.—Longitudinal Shear in T-beam. (See p. 144.)

the two sections. Then, from simple laws of statics, the moment  $M_2 = M_1 + V \times 1$ . The total amount of compression stresses produced at each of the two sections is  $\frac{M_1}{jd}$  and  $\frac{M_2}{jd} = \frac{M_1}{jd} + \frac{V}{jd}$ . If the part of the beam between the two vertical sections is detached from the beam, the compression stresses act in opposite direction, as shown in the figure. Since the amount of compression on the two sections is not equal, only a part of the compression stresses will balance. The unbalanced difference between the compression stresses at the two vertical sections produces shear in the beam.

This difference is  $\frac{M_2}{jd} - \frac{M_1}{jd} = \frac{V}{jd}$ . This increment of compression stresses acts on the whole flange. To get the amount of compression on the projections only, it is necessary to multiply the total increment by the ratio of the width of the projections  $b - b'$  to the width of flange,  $b$ . Thus the amount of compression stresses producing

longitudinal shear at the juncture of the flange projections and the stem equals  $\frac{V}{jd} \frac{(b - b')}{b}$ .

The intensity of the compression stresses on the flange is not uniform, but is a maximum at the extreme fiber and a minimum at the bottom of the flange. The unit increment producing shear is proportional to the compression unit stresses; therefore, the longitudinal shear will be a maximum at the top and a minimum at the bottom of the flange. If the shearing stress at the top is called  $v_h$ , the minimum shearing stress at the bottom is  $v_h \frac{kd - t}{kd}$ . The total shear on two sections  $AB$  and  $A_1 B_1$ , for a depth of flange equal

to  $t$  is  $\frac{1}{2} \left( v_h + v_h \frac{kd - t}{kd} \right) 2t = v_h t \frac{2k - t}{k}$ . By equating this to the stresses producing shear, found above,

$$v_h t \frac{2k - t}{k} = \frac{V}{jd} \frac{(b - b')}{b},$$

from which maximum longitudinal shearing stress in flange

$$v_h = \frac{V}{tjd} \frac{(b - b')}{b} \frac{k}{2k - t} \dots \dots \dots (60)$$

From this formula it is evident that the shearing stresses increase with the ratio of the projections to the total width of flange.

Ordinarily, the shearing stresses are so small that the concrete alone can resist them. Excessive longitudinal shear may be developed only in short beams with heavy loads.

As evident from the chapter on Tests, the strength of a T-beam is increased by fillets at the junction of the slab and the stem. Also, cross bars placed across the beam near the top of the slab increase the strength of the T-beam. Where the tensile reinforcement in a slab is placed across the beam, it strengthens the connection between the stem and the flange. Where the slab reinforcement is parallel to the beam, special short bars should be placed across the beam. These serve two purposes: first, they strengthen the connection between the stem and the flange; second, they resist negative bending moment stresses which are developed by the load

in the slab. Without the tensile bars, tensile cracks often form at the junction of the flange and the stem and materially reduce the effectiveness of the flanges.

### DIAGONAL TENSION

In any beam, besides direct horizontal tension and compression and direct horizontal and vertical shearing stresses, there exist also stresses acting in diagonal directions. The maximum diagonal stress composed of the tension and the shearing stresses is called diagonal tension.

In steel and other homogeneous beams, diagonal stresses need no attention. In reinforced concrete, however, it has been shown in beams tested to destruction that, beside tensile cracks at the points of maximum moment, diagonal cracks, caused by diagonal tension, develop near the supports. (See tests on pp. 38 to 46.) These cracks have often been the cause of failure, frequently without warning, especially in beams reinforced with straight bars only or provided with insufficient web reinforcement. The need of effective web reinforcement is discussed in the paragraphs which follow.

**Diagonal Tension in Homogeneous Beams.**—The magnitude and inclination of the diagonal tension in homogeneous beams may be found from the following formula:

Let  $f_d$  = diagonal tensile unit stress;  
 $f_t$  = horizontal tensile unit stress;  
 $v$  = horizontal or vertical shearing unit stress.

Then <sup>2</sup>

$$f_d = \frac{1}{2}f_t + \sqrt{\frac{1}{4}f_t^2 + v^2}. \quad \dots \quad (61)$$

The direction of this diagonal tension makes an angle with the horizontal equal to one-half the angle whose cotangent is  $\frac{1}{2} \frac{f_t}{v}$ .

As is evident from the formula, the value of diagonal tension depends upon the values of  $f_t$  and  $v$ . Since the values in  $f_t$  and  $v$  vary in different parts of the cross section of the beam, the value of the diagonal tension and its angle of inclination also vary. At the bottom of the section, where  $v$  equals 0,  $f_d$  equals  $f_t$  and acts horizontally. At the neutral axis, the direct tension,  $f_t$ , equals 0,

<sup>2</sup> For derivation, see Merriman's "Mechanics of Materials," 1905 edition, p. 265.

which reduces the formula to  $f_s = v$  and the angle of inclination to  $45^\circ$ .

**Measure of Diagonal Tension for Reinforced Concrete Beams.**—In homogeneous beams, the diagonal stresses can be determined easily by means of Formula 63, p. 149. In reinforced concrete, however, the diagonal stresses cannot be computed with exactness because, as may be seen from the formula, they depend upon the horizontal tensile stresses in concrete,  $f_t$ . The action of concrete in tension cannot be computed. It varies for different stages of loading. For heavier loadings, concrete cracks, thus decreasing the tensile stresses carried by it. The tensile strength of concrete, which may be disregarded in figuring the moment of resistance of the beam, affects the magnitude of the diagonal tension to a great extent, especially near the ends of simply supported beams, where the stresses due to the bending moment are low and the tensile stresses in concrete may not exceed its breaking strength in tension. While the exact determination of diagonal tension is impossible, tests show that the shearing unit stress, figured as given on p. 149, may be accepted as a convenient measure of diagonal tension; that is, the diagonal tension may be assumed as proportional to the direct shearing stress. Therefore, by adopting proper working stresses based on tests producing diagonal tension failures, formulas for shearing stresses may be used for diagonal tension. This measure has been universally accepted and, in subsequent discussion, diagonal tension is expressed in terms of shearing stresses.

**Formulas for Shearing Stresses and Diagonal Tension.**—A convenient and safe method of determining the diagonal tension is by accepting for its measure the unit shearing stress as discussed above.

Let  $V$  = total external shear at section considered. (Reaction minus the loads between the support and the section.)

$v$  = horizontal (or vertical) shearing unit stress at section considered;

$b$  = breadth of beam;

$b'$  = breadth of web of T-beam;

$jd$  = moment arm or distance between center of compression and center of tension (approximately, in a T-beam, distance between center of slab and steel).

$Z$  = total shearing stress or diagonal tension in a given length of beam,  $s$ .

The following general principles and formulas are discussed in the paragraphs which follow:

(1) Vertical shearing unit stress is equal to the horizontal shearing unit stress, and acts at right angles to the plane of horizontal shearing stress. The distribution of vertical shearing stress over a vertical section is shown in Fig. 50, p. 150.

(2) Horizontal (or vertical) shearing stress is zero at the top of the section and changes according to a parabola till it reaches its maximum at the neutral axis. (See Fig. 50.)

(3) If tension in concrete is neglected, the horizontal (or vertical) shearing stress is constant below the neutral axis.

(4) The total amount, then, of horizontal (or vertical) shearing stresses developed below the neutral axis at any horizontal plane in a distance,  $s$ , and width,  $b$  is

$$Z = \frac{V_s}{jd} \dots \dots \dots (62)$$

(5) Shearing unit stress, the measure of diagonal tension, is total horizontal shearing stress,  $Z$ , divided by the horizontal area,  $b \times s$ , that is  $v = \frac{V_s}{jd} \div bs$ .

Hence

$$v = \frac{V}{bjd} \dots (63) \quad \text{For T-beams, } v = \frac{V}{b'jd} \dots (64)$$

If the external shear,  $V$ , changes in the distance,  $s$ , the same formulas may be used except that  $V$  in the formula is the average shear in that distance.

(6) Diagonal tension may be expressed in terms of the shearing stress and the above formulas may be accepted as its measure.

(7) If the width of the section below the neutral axis is not constant, the shearing unit stress will vary with the width,  $b$ . The smallest  $b$  must be taken in figuring maximum shearing unit stress and the maximum diagonal tension.

(8) In continuous T-beams near the support, the maximum shearing unit stress will be in the stem directly under the flange. The shearing stress and diagonal tension in the plane of tension steel (at top of beam) is small, because the width,  $b$ , being the total width of the flange, is large.

The action of horizontal shearing stresses is illustrated in Fig. 50, in which is shown a section of a beam between two vertical sections spaced a distance  $s$  apart. If the bending moment at the left is  $M_1$ , the external shear  $V$ , and the distance between the sections under consideration  $s$ , then, from the principles of mechanics, the bending moment at the right is  $M_r = M_1 + Vs$ .

Since the bending moment at the right is larger than the bending moment at the left, the unit compressive and tensile stresses at the right section are larger than at the left. Consider an arbitrary longitudinal plane,  $ef$ , above the neutral axis. The compressive stresses above this plane are represented by the shaded portions of the triangles. They act in opposite directions. At the left they are

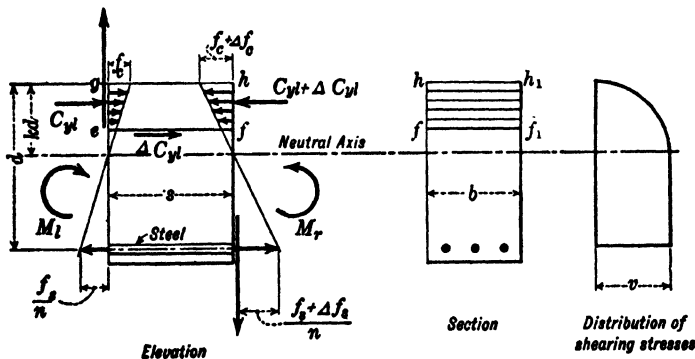

FIG. 50.—Horizontal and Vertical Shearing Stresses in Beam. (See p. 150.)

equal to  $C_{yl}$ , and at the right to  $C_{yr} = C_{yl} + \Delta C_{yl}$ . The difference between  $C_{yl}$  and  $C_{yr}$ , which act in opposite directions, is  $\Delta C_{yl}$ . This tends to move the upper portion of the beam along the plane  $eff_1e_1$ , but is kept in equilibrium by the horizontal shearing resistance in the beam on that plane. The shearing unit stress produced by the force  $\Delta C_{yl}$  is equal to the force  $\Delta C_{yl}$  divided by the area,  $bs$ , of the plane,  $eff_1e_1$ .

At the top of the beam, the value of  $\Delta C_{yl}$  and also the total shearing stress is zero; it increases steadily according to a parabola till it reaches its maximum at the neutral axis. There its value equals the difference between the total compression on the right and the total compression on the left. From the ordinary beam formulas, p. 130, we know that the total compression may be found by dividing the

bending moment by the moment arm: thus, at the left, the total compression is  $C_l = \frac{M}{jd}$ ; and at the right,  $C_r = \frac{M_r}{jd} = \frac{M_l}{jd} + \frac{Vs}{jd}$ . The difference between  $C_l$  and  $C_r$  is  $\frac{Vs}{jd}$ . Therefore, the total amount of horizontal shearing stress at the neutral axis for the length,  $s$ , and width,  $b$ , is  $Z = \frac{Vs}{jd}$ . This has to be resisted by the horizontal plane of the beam,  $bs$ , so that the shearing unit stress,  $v$ , equals  $Z$  divided by  $bs$ . It is

*Shearing Unit Stress*

$$v = \frac{V}{bjd} \dots \dots \dots (65)$$

If there is no tension in concrete, the difference between the stresses acting above any plane located below the neutral axis is the same as the difference at the neutral axis. Consequently, the sum of horizontal shearing stresses is uniform at all planes below the neutral axis. As the shearing unit stress depends upon the width,  $b$ , it is constant for rectangular sections, but various for sections with variable widths,  $b$ .

At the plane of reinforcement, the stresses in steel at the left are  $T_l = \frac{M}{jd}$ ; and at the right,  $T_r = \frac{M_r}{jd} = \frac{M_l}{jd} + \frac{Vs}{jd}$ , and the difference,  $T_l - T_r = \frac{Vs}{jd}$ . This shows that the total horizontal shear, or the tendency to move the upper portion of the beam, is the same at the plane of the bars as at the neutral axis.

If there is tension in concrete, the total horizontal shearing stress,  $Z$ , on any plane below the neutral axis will be decreased by the difference in tension at the two vertical sections above that plane.

**Bond Stresses.**—The increase in the stress in steel, equal to  $\frac{Vs}{jd}$ , between the two sections considered, must be transferred from the beam to the steel. Therefore, bond must exist between steel and concrete, or else the beam will slide on the steel instead of increasing its stress. Tests of bond, or resistance to slipping of bars, are treated on p. 56. Discussion of bond stresses and their importance is given on p. 260.



**Diagonal Tension Acting on an Element of a Beam.**—Figure 51 represents the stresses to which any element of a beam is subjected. In Fig. 51 is shown a rectangular element of the beam, the sides of which are  $dx$  and  $dy$ . This element is kept in equilibrium by six forces: two forces,  $f_1 dy$ , acting in opposite directions and being either direct tension or compression; and four shearing stresses,  $v dx$  and  $v dy$ , respectively, caused by the increment of the bending moment, as explained in the preceding paragraphs. The two horizontal shearing stresses,  $v dx$ , form a couple,  $v dx \times dy$ , which is resisted by a vertical couple,  $v dy \times dx$ . The moments of the two couples are

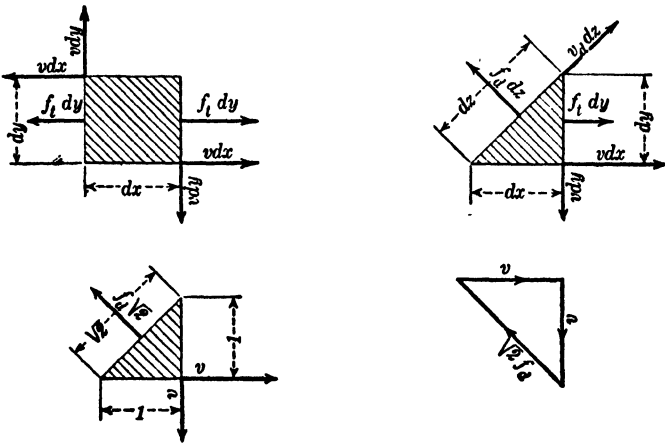

FIG. 51.—Stresses Acting on an Element of Beam. (See p. 152.)

equal; therefore, the horizontal shearing unit stress must be equal to the vertical shearing unit stress.

**Illustration of Action of Web Reinforcement.**—Figure 52, p. 153, illustrates the action of vertical stirrups in a simply supported beam. Stirrups do not act until minute cracks open. After a crack forms, as in the figure, the reaction and the shear,  $V$ , tend to widen the crack and cause failure of the beam. This tendency is resisted by the stirrups, acting in tension. Figure 52 also represents what would happen if there were no web reinforcement. Figure 53 represents the action of stirrups in a continuous beam. It may be noticed that the stirrup gets its stress at the top instead of at the bottom.

**Distribution of Diagonal Tension to Concrete and Stirrups.**—Tests prove that in beams with web reinforcement, the diagonal

tension found by Formula (65), p. 151, is resisted by both concrete and steel. The relative proportion of stress taken by the concrete

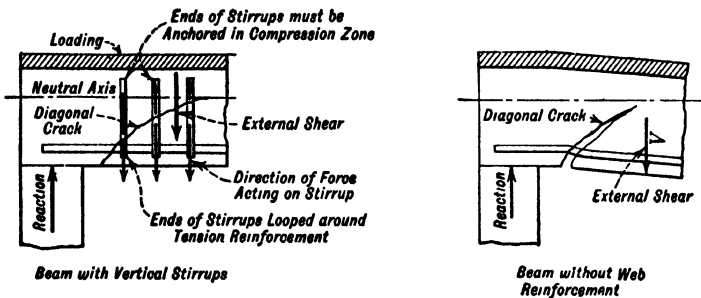

FIG. 52.—Action of Vertical Stirrups in Simply Supported Beams. (See p. 152.)

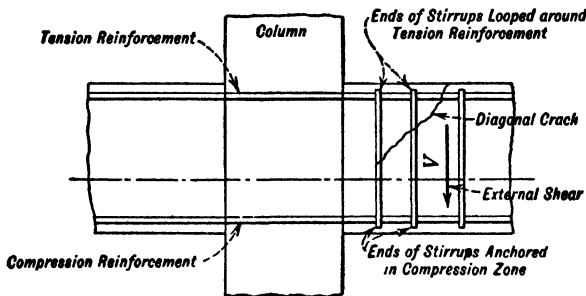

FIG. 53.—Action of Stirrups in Continuous Beams. (See p. 152.)

and steel cannot be determined by computation. Assumptions variously made are:

- (1) Web reinforcement takes all the diagonal tension with no reliance on concrete. The web reinforcement therefore resists, in the length  $s$ , a total amount of shear equal to  $\frac{V_s}{j'd}$ .
- (2) Web reinforcement takes two-thirds of the diagonal tension and the concrete the remainder. Web reinforcement resists in the length,  $s$ , the force  $\frac{2}{3} \frac{V_s}{j'd}$ .

Where the shearing unit stress does not exceed the allowable unit for plain concrete,  $v'$ , all stress is taken by the concrete.

- (3) Concrete resists a certain definite unit stress per square inch,  $v'$ , the whole length of the beam, and the stirrups resist the remainder. Then, in a length,  $s$ , the concrete resists  $v'bs$ , and the web reinforcement resists,

$$Z_1 = Z - v'bs = \frac{V_s}{jd} - v'bs = \frac{V - v'bjd}{jd} s.$$

The first assumption corresponds to that made in ordinary beam design, where the tensile strength of the concrete is disregarded. Tests have shown, however, that the actual stresses in the stirrups are less than would be obtained with this assumption. (See p. 40.)

The second and third assumptions are most commonly used in practice. Either of them will give satisfactory results, especially if the rule about maximum allowable spacing is followed. The Joint Committee on Concrete and Reinforced Concrete, 1916, recommended the second assumption, while in the later, 1924, recommendations the third assumption is accepted. The authors recommend the use of the third assumption.

**Area and Spacing of Vertical Stirrups.**—The area of steel and the spacing of stirrups may be found by making the force to be resisted, as given above, equal to the working strength of the stirrups in tension.

Let  $V$  = total vertical shear in pounds at section  $x$  feet from left support;

$v$  = total shearing unit stress at section in pounds per square inch;

$v'$  = allowable shearing unit stress (or diagonal tension) on concrete alone;

$A_s$  = cross-sectional area of all legs of a vertical stirrup in square inches. (In a U-stirrup this is the sum of the area of the two legs);

$f_s$  = allowable unit stress in stirrups in pounds per square inch.

$jd$  = moment arm or distance in inches from center of compression to center of horizontal reinforcement. (In a T-beam, this may be taken as distance between center of slab and steel; in a rectangular beam, as 0.87 of the total depth to steel);

$b$  = breadth of beam in inches;

$b'$  = breadth of web in T-beam in inches;

- $s$  = spacing of stirrups in inches at a place  $x$  feet from left support;
- $x$  = distance in feet from left support to point at which required spacing is desired;
- $x_1$  = distance in feet from left support to point beyond which stirrups are necessary;
- $l$  = span of beam in feet;
- $w$  = uniform load in pounds per foot.

Since  $A_s$  is the area of a stirrup resisting diagonal tension in a distance,  $s$ , and  $f_s$  is the tensile strength of steel, the strength of the stirrup in pull is  $A_s f_s$ . The area of stirrups and the spacing for different assumptions of distribution of diagonal tension between stirrups and concrete may be found as follows:

(1) *Area and spacing if stirrups take all the diagonal tension.*

The diagonal tension to be resisted is  $\frac{V_s}{jd}$ . Hence  $A_s f_s = \frac{V_s}{jd}$ , and

$$A_s = \frac{V}{jdf_s} s. \quad (66) \quad \text{and} \quad s = \frac{f_s jd}{V} A_s. \quad (67)$$

(2) *Area and spacing if stirrups take two-thirds of the diagonal tension.*

Diagonal tension to be resisted is  $\frac{2}{3} \frac{V_s}{jd}$ . Hence  $A_s f_s = \frac{2}{3} \frac{V_s}{jd}$ , and we get by solving for  $A_s$  and  $s$ ,

$$A_s = \frac{2}{3} \frac{V}{f_s jd} s. \quad (68) \quad \text{and} \quad s = \frac{3}{2} \frac{f_s jd}{V} A_s. \quad (69)$$

(3) *Area and spacing if concrete takes a definite amount of shear,  $v'$ , and the stirrups, the remainder.*

The stress resisted by concrete in the distance,  $s$ , equals  $v'bs$ . As the total stress is  $Z = \frac{V_s}{jd}$ , the stirrups must carry the difference,

$$\frac{V_s}{jd} - v'bs, \quad \text{or} \quad \frac{V - v'bjd}{jd} s.$$

Equating this to the resistance of the stirrup,  $A_s f_s$ , and solving for  $A_s$  and  $s$ , we get

$$A_s = \frac{(V - v'bjd)}{f_s jd} s. \quad (70) \quad \text{and} \quad s = \frac{f_s jd}{(V - v'bjd)} A_s. \quad (71)$$

In T-beams, use width of web,  $b'$ , in place of  $b$ .

**Area and Spacing of Bent Bars.**—The spacing of bent bars,  $s$ , (or the distance in which they are effective) is usually measured along the neutral axis of the beam. The diagonal tension stresses to be resisted by the bent bars may be taken, as equal to the stresses to be resisted by the stirrups, multiplied by the sine of the angle of inclination of the bent bars with the horizontal. Since, however, tests indicate that there is practically no difference in effectiveness between bars bent at angles between 25 and 50°, it is near enough to accept a constant value of 0.7 for the sine for these inclinations. Using same derivation as for the stirrups, the formulas for required area of bent bars and spacing become as follows:

(1) *Area and spacing if bent bars take all the diagonal tension.*

$$A_s = 0.7 \frac{V}{jdf_s} s \quad \dots \quad (72) \quad \text{and} \quad s = 1.43 \frac{f_s j d}{V} A_s \quad \dots \quad (73)$$

(2) *Area and spacing if bent bars take two-thirds of the diagonal tension.*

$$A_s = 0.47 \frac{V}{j_s j d} s, \quad \dots \quad (74) \quad \text{and} \quad s = 2.13 \frac{f_s j d}{V} A_s \quad \dots \quad (75)$$

(3) *Area and spacing if concrete takes a definite amount of shear,  $v'$ , and the bent bars, the remainder.*

$$A_s = 0.7 \frac{(V - v' b j d)}{f_s j d} s \quad \dots \quad (76) \quad \text{and} \quad s = 1.43 \frac{f_s j d}{(V - v' b j d)} A_s \quad (77)$$

**Uniformly Distributed Loading.**—The distance from the support to the point where no stirrups are required, for uniform loading, is<sup>3</sup>

$$x_1 = \frac{l}{2} \left( 1 - \frac{v'}{v} \right) \quad \dots \quad (78)$$

**Maximum Spacing of Stirrups.**—Tests tend to prove not only that a sufficient amount of web reinforcement should be provided but also that the maximum spacing of stirrups or bent bars should be limited.

<sup>3</sup> The diagram of shearing unit stresses is a triangle from which the distance  $x_1$  may be obtained by the known rule  $\frac{l}{2} \div \left( \frac{l}{2} - x_1 \right) = v + v'$ .

This equation solved for  $x_1$  gives formula (76), above.

If the spacing is too large, cracks may develop between the stirrups. A recommendation for maximum spacing is given on p. 250.

**Usefulness of Web Reinforcement.**—Numerous tests have demonstrated that a beam properly reinforced with stirrups or bent bars sustains three or four times as much load as the same beam without web reinforcement. The same tests, however, show that the web reinforcement retards the appearance of first diagonal cracks very little, and that the web reinforcement does not get any stress until the first crack appears. It has been noticed<sup>4</sup> also that under working loads (that is, before the diagonal tension exceeds the tensile strength of the concrete) the beam acts like a homogeneous beam, and as would be expected, the stress in the stirrups is sometimes compressive instead of tensile.

This is, nevertheless, no argument against the use of web reinforcement, because in beams without stirrups, final failure follows closely the appearance of the first crack, while with beams having web reinforcement, stirrups and bent bars represent a factor of safety which allows stressing of concrete in diagonal tension nearly to its ultimate strength without any danger to the stability of the structure. Under working loads the stirrups may not act; but in case of overstressing, due to faulty construction or to occasional excessive loading, although the concrete cracks, the stirrups not only prevent the failure of the beam, but enable it to develop its full strength. The minute cracks that may develop are not dangerous and in many cases are hardly visible. After the excess load is removed, the cracks close up. Tests showing conclusively the value of stirrups are shown on p. 38.

**Web Reinforcement for Continuous Beams.**—The formulas given above are based upon results of tests of simply supported beams. Their use for continuous beams allows a margin of safety.

In continuous beams, several conditions tend to prevent, or at least to retard, the formation of diagonal cracks. The compressive force, due to the reaction, tends to close the developed cracks. There exists also, almost invariably, some arch action, which decreases the direct and diagonal tension. In continuous T-beams, the horizontal shearing unit stress is zero at the bottom and increases till it reaches a maximum at the neutral axis. From there it is constant till it reaches the bottom of the flange. As the width of the flange is much greater than the width of the stem, the shear-

<sup>4</sup> University of Illinois, Bulletin No. 64, January 13, 1913.

ing unit stress in the flange is much smaller than in the stem. Diagonal cracks, therefore, tend to develop in the portion between the neutral axis and the bottom of the flange, and larger unit stress is required to open them than in simply supported beams. This is offset by the fact that at the support of continuous beams, both the tensile stresses and the diagonal tension stresses are a maximum. As there have been comparatively few tests on continuous beams, the formulas for web reinforcement given above should be used.

**Web Reinforcement for Cantilevers.**—The conditions affecting web reinforcement are the same for cantilevers as at the supports of continuous beams. In cantilevers supporting vertical loads, vertical stirrups must, therefore, be attached to the tension steel (at the top) and the free ends hooked in the compressive portion of the beam (at the bottom). In cantilevers carrying loads acting in other directions, the stirrups must be placed parallel to the direction of the force and attached in the manner suggested above.

#### COLUMN FORMULAS

For reinforced concrete columns centrally loaded, the following formulas may be developed:

Let  $f$  = average compressive unit stress upon the reinforced column, equal to the total load divided by the effective area;

$f_c$  = compressive unit stress upon the concrete of the column.

$f'_c$  = ultimate strength of concrete cylinders.

$f_s$  = tensile unit stress in spiral, New York Code.

$f'_s$  = compressive unit stress upon the vertical steel in the column;

$n = \frac{E_s}{E_c}$  = ratio of modulus of elasticity of steel to modulus of elasticity of concrete;

$P$  = load to be sustained by the column;

$A$  = area of total effective cross section of column (see pp. 272 and 406);

$A_c$  = area of concrete in effective cross section, equal to  $A - A_s$ ;

$A_s$  = area of steel in cross section;

$p = \frac{A_s}{A}$  = ratio of area of steel to total effective area of column.

$p'$  = ratio of volume of spiral to volume of enclosed concrete

Since, as is evident from tests, a reinforced concrete column under load acts as a unit, the deformation or shortening of steel in the column is the same as the deformation or shortening of the concrete.

From mechanics,  $\frac{\text{stress per square inch}}{\text{modulus of elasticity}} = \text{unit deformation}$ , hence

$$\frac{f'_s}{E_s} = \text{unit deformation of steel and } \frac{f_c}{E_c} = \text{unit deformation of concrete.}$$

The deformation of steel in a reinforced column is the same as the deformation of concrete, and since  $\frac{E_s}{E_c} = n$ , we have:

$$\frac{f'_s}{E_s} = \frac{f_c}{E_c} \quad \text{and} \quad f'_s = nf_c.$$

The stress in steel is therefore equal to the stress in concrete multiplied by the ratio of the moduli of elasticity,  $n$ .

If a column sustains a load  $P$ , stresses in steel and in concrete must be equal to the load. Hence:  $P = f_c A_c + f'_s A_s$ , or  $P = f_c A_c + nf_c A_s$ . Since  $A_c = A - A_s$ , we have  $P = f_c [(A - A_s) + nA_s]$ . Finally,

$$P = f_c [A + (n - 1)A_s] \quad (79) \quad \text{and} \quad f_c = \frac{P}{A + (n - 1)A_s}. \quad (80)$$

The area of steel,  $A_s$ , may be expressed in terms of  $A$ , by substituting  $A_s = pA$ , which changes the above formulas to

$$P = f_c A [1 + (n - 1)p] \quad (81) \quad \text{and} \quad f_c = \frac{P}{A [1 + (n - 1)p]}. \quad (82)$$

Knowing the stress,  $f_c$ , and the steel ratio,  $p$ , we may find the required area from

$$A = \frac{P}{f_c [1 + (n - 1)p]}. \quad \dots \quad (83)$$

Knowing the stress,  $f_c$ , and the total area, we may find the required area of steel,  $A_s$ , and the percentage from

$$A_s = \frac{P - f_c A}{f_c (n - 1)}. \quad (84) \quad \text{and} \quad p = \frac{P - f_c A}{f_c (n - 1) A}. \quad (85)$$

The average unit stress, which is the total force,  $P$ , divided by the effective area,  $A$ ,

$$f = \frac{P}{A} \quad \text{and} \quad A = \frac{P}{f}.$$



The relation between  $f$  and  $f_c$  may be found by substituting for  $P$  in the above equation its value from Formula (81), giving

$$f = f_c[1 + (n - 1)p]. \quad \dots \quad (86)$$

Values of  $f$  for different percentages of steel are given on p. 916.

**Columns with Spiral Reinforcement.**—The ultimate strength of a column with spiral reinforcement depends upon (1) the amount of vertical steel, and (2) the amount of spirals. Therefore, in formulas for the breaking strength of a spiral column, the amount of spirals must be considered. In design, however, the elastic limit and not the breaking strength of the column is the determining value, as explained on p. 82.

There are differences of opinion as to the proper formulas for spiral columns. Practical design is treated on p. 419.

The following formulas are in use:

(1) Columns with spiral limited to 1 per cent of the volume of concrete within the spiral, and variable amount of vertical steel.

Same formulas are used as for columns with vertical steel only. To allow for the effect of the spiral, the unit stresses in concrete and vertical steel are increased.

This method is specified by the Codes of Boston, Cleveland, and, with some modification, Philadelphia. It was recommended by the Joint Committee in 1916. Although it does not fully represent the actual conditions, the authors consider this method as the most reasonable thus far developed.

(2) Columns with spiral varying from one-half to 2 per cent of the volume of concrete ( $p' = 0.005$  to  $0.02$ ) and variable amount of vertical steel.

Formula for strength of column (Building Code of New York).

$$P = A_c f_c + n A_s f_c + 2 p' A_s f_s.$$

In this formula, the stress in concrete and vertical steel is assumed to be the same as for columns with vertical steel only. The spiral is assumed to increase the strength of the column by its strength in tension. (Any section cuts the spiral at two places, which explains the value 2 in the term  $2 p' A_s f_s$ .)

(3) Columns with spiral from  $\frac{1}{2}$  to  $1\frac{1}{2}$  per cent of the core ( $p' = 0.005$  to  $0.015$ ) and variable percentage of vertical steel, but not to exceed the percentage of spirals.

Formula for strength of column (Building Code of Chicago).

$$P = Af_c[1 + (n - 1)p + 2\frac{1}{2}(n - 1)p']. \quad \dots \quad (87)$$

In this formula, the effect of spiral is considered as two and one-half times as large as the effect of same amount of vertical reinforcement. In addition, the allowable stress,  $f_e$ , is larger than for columns with vertical bars only.

(4) Joint Committee 1924 formula. Percentage of spiral shall not be less than one-fourth the percentage of vertical steel. Vertical steel shall be from 1 to 6 per cent of the core.

The formula for strength of column is of the same form as that for columns with vertical steel only; the difference is in the allowable unit stress in concrete, which is a function of the ultimate strength and of the steel ratio,  $p$ .

$$P = Af_c[1 + (n - 1)p]. \quad \dots \quad (88)$$

Where the allowable stress is

$$f_e = 300 + (0.10 + 4p)f'_c. \quad \dots \quad (89)$$

The value of  $f'_c$  is the ultimate compressive strength of concrete at age of twenty-eight days, based on 6 by 12 in. or 8 by 16 in. cylinders.

In this formula, an attempt is made to take into account the stresses in steel due to shrinkage and yield of concrete, in accordance with the ideas advanced by Mr. Franklin R. McMillan in his paper, "Study of Column Test Data."<sup>5</sup>

The authors consider that the refinements and the change from present practice required by these new formulas are not yet warranted by our present knowledge of the subject. The formulas are not well adapted for use without tables, because a change in percentage of steel not only affects the amount of total load carried by steel, but also the unit stress in concrete. For instance, to find the amount of steel for an accepted size of column (a very common problem) requires solution of two simultaneous equations, one of which is a second-degree equation. Moreover, the cost of columns required by these formulas is larger than by the formula of the previous Joint Committee recommendation, while there is not yet sufficient proof that the previous formula did not give safe results to warrant the increase in cost of construction.

<sup>5</sup> Proceedings, American Concrete Institute. Vol. XVII, 1921, p. 150.

## MEMBERS SUBJECTED TO DIRECT TENSION

In concrete construction, there very often occur members subjected to direct tension, as for instance, stair hangers, floor hangers in arch bridges, tie-rods in arches, walls in circular tanks, conical hoppers in bins. Such members are subjected to direct tension only. Any bending in the direction of the tensile stress is only incidental.

Members like the bottom chord in concrete trusses, particularly when the truss is without diagonals as in Vierendeel trusses, are subjected to tension and a bending moment. The same is true of the sides of square or rectangular reservoirs.

The stress conditions are discussed below.

**Members under Direct Tension Only.**—When a member is subjected to direct tension only, all stresses must be resisted by steel and no allowance should be made for the strength of concrete.

The required area of steel is

$$A_s = \frac{T}{f_s}, \dots \dots \dots (90)$$

where  $T$  is the total tensile stress and  $f_s$  the allowable unit stress in steel.

The unit stress,  $f_s$ , for which the reinforcement is to be designed, depends upon conditions. Where the stretch due to the stress is not harmful, a stress in steel of 16 000 lb. per sq. in. may be used. In circular tanks designed to contain fluids, the stresses in the rings must be limited to from 10 000 to 12 000 lb. per sq. in. to limit the stretch as much as possible and thus avoid open cracks in concrete and the consequent leakage. Also, deformed bars are recommended to properly distribute any cracks. The hair cracks which may occur for these recommended stresses are not likely to extend the full thickness of the wall and therefore would not affect its water-tightness.

In designing arches with tie-bars, their stretch must be considered (See Arch Design, Volume II).

**Composition of Tension Members.**—When a tension member is not likely to be subjected to secondary bending, it may consist of a single bar. When imbedded in concrete as a protection against rust and fire, the bar is placed in the center of the concrete section.

In a tension member likely to be subjected to secondary bending, as, for instance, the hanger for floor beams in arches which may be

struck by a vehicle, the reinforcement should consist of four bars placed in the corners of the concrete section. The member is then able to resist any such bending moment. Since the stresses due to bending moment increase the tensile stresses due to direct tension, it is necessary to use a larger area of steel than would be required for direct tension alone. Sometimes the bars for direct tension are placed in the center of the member and small bars are added in the corners of the concrete section for bending.

**Details of Tension Members.**—It is important to keep the tension members straight. It is obvious that a member with an accidental curvature would straighten under tension, and the movement due to this straightening would be injurious to the rest of the construction. A sag in horizontal ties also should be avoided. For these reasons, in arches, the tie is provided with a turnbuckle for the purpose of tightening it after installation. The tie-bar is also supported by suspenders at proper intervals so as to prevent sagging under its weight.

If the tension member consists of a number of bars, they should be held properly in place by ties or hoops in the same manner as column reinforcement.

The bars composing the tensile reinforcement must be anchored at the ends, so as to develop their full strength. The anchorage may consist of straight imbedment, of straight imbedment with a hook, or of a screw thread at the end with a nut and a plate. In circular tanks, the rings are usually spliced by lapping. It is important that the splices of the rings be staggered.

With straight imbedment only, the bar must be extended into the anchoring member a sufficient distance to develop by bond the strength of the bar. (See p. 268.)

With straight imbedment and hook, the straight imbedment may be made shorter because of the effect of the hook. In important members, the straight imbedment is made long enough to satisfy bond requirement and the hook is added as an additional factor of safety. The bearing stresses of the hook in the concrete are high, although with properly designed shape of hook (see p. 269) they are not excessive. To relieve the stresses, the hook may engage a cross bar; this distributes the compression stresses and also tends to prevent any tendency to splitting. The plate method is illustrated in Fig. 218, p. 670. In this method the bars are threaded at the end, a plate of proper dimensions is placed at the end, and this is kept

in place by nuts, one for each bar in front, and the other back of the plate. When imbedded in concrete, the plate distributes the tensile stresses on the concrete. The area of the plate is determined by dividing the total tension in the bar by the allowable bearing stress on concrete. If more than one bar is used in the member, each bar may be provided with a separate plate or one plate may be used for all bars. The thickness of the plate should be determined by considering it supported by the bars and loaded uniformly over its whole surface by the reaction of the concrete. When a plate is used for a single bar, it should be treated as a cantilever. When one plate is used for two bars, it may be considered as a simply supported plate uniformly loaded. The plate must be imbedded far enough beyond the end of the tensile member to prevent shearing of the concrete.

**Thickness of Concrete in Tension Members.**—In fireproof construction, the tensile members should be imbedded in concrete to protect them from fire and rust. If subjected to tension only, the required concrete section is governed mainly by the required thickness of the protective cover.

Where lateral stiffness of the member is desirable on account of the possibility of accidental stresses, the dimensions should be adopted accordingly. In circular tanks, the thickness of concrete should be sufficient to make them watertight.

#### MEMBERS UNDER FLEXURE AND DIRECT STRESS

The formulas given below apply when any member of a structure is subjected to compression (or tension) due to a central force and to bending or flexure. This takes place when the member is subjected:

- (1) Simultaneously to a bending moment and a central force or thrust;
- (2) To an eccentrically applied force or thrust.

The first condition occurs in columns carrying the column load and in addition—particularly in wall columns—subjected to a bending moment caused by rigid connection between beam and column.

Another instance is that of columns with brackets for crane runways. The crane load produces a bending moment in the column in addition to the central force. All members in rigid frames, particularly the vertical members, are subjected to central force and bending. In trusses, the compression members must resist, in addition to the central force, a bending moment, which in trusses

with diagonals is produced by the rigidity of connection at the joints, and in trusses without diagonals by the shear, as explained in Volume II of this treatise.

The second condition occurs in arches and dams when the line of pressure intersects the normal section at a distance from the arch axis, in other words, when the thrust is applied eccentrically. The thrust may be normal to the section or, as is usually the case, it may be inclined to the section. Before determining the stresses, the inclined thrust,  $R$ , is resolved into a component normal to the section,  $N$ , and a component parallel to the section,  $V$ . The normal component produces both direct stresses on the section and bending, while the parallel component produces only shearing stresses which are usually small and do not need to be considered in design.

An eccentrically applied force is found also at the base of retaining walls where the resultant pressure is composed of the horizontal earth pressure and the vertical weight of the structure. In this case, the formulas below are used to find the distribution of pressure over the foundation.

**Sign of the Thrust.**—The thrust is either positive, when it produces compressive stresses on the section, or negative, when it produces tensile stresses. Usually, the positive thrust is called “thrust,” and the negative thrust, “pull,” although the designations “positive and negative thrust” are often used.

**Relation between Bending Moment and Eccentrically Applied Thrust.**—The stresses produced by a combination of a central thrust and a bending moment are the same as those produced by an eccentrically applied thrust. Thus, a central thrust,  $N$ , and a bending moment,  $M$ , may be replaced by an eccentric thrust,  $N$ , acting at a distance from the axis of the section equal to  $e = \frac{M}{N}$ . In turn, the eccentric thrust may be replaced by a central load of the same intensity and a bending moment equal to the thrust multiplied by the eccentricity.<sup>6</sup> Therefore, both cases can be solved by the same

<sup>6</sup> *Proof of the above statement.* Assume that a section is submitted to an eccentric thrust  $N$  acting at a distance  $e$  from the axis. The stress conditions will not be altered if in the center of the section are added two equal forces, but acting in opposite directions, such as  $+N$  and  $-N$ . The section is then exposed to three forces, namely  $+N$  at a distance  $e$  from center of section and  $-N$  and  $+N$  in the center of the section. The eccentric force with the negative central force forms a couple,  $Ne$ , and may be replaced by a bending moment  $M = Ne$ . There remains in the center a positive force  $N$ . Thus the eccentric thrust is replaced by a central force,  $N$ , and a bending moment  $M = Ne$ .

formulas. The case of an eccentrically applied thrust gives simpler formulas.

**Relation between Position of Eccentric Thrust and the Sign of Bending Moment.**—A positive bending moment, producing in a horizontal member,<sup>7</sup> compressive stresses at the top of the section and tensile stresses at the bottom, may be replaced by a positive thrust acting above the axis.

A negative bending moment, producing compressive stresses at the bottom of the section and tensile stresses on the top, may be replaced by a positive thrust acting below the axis.

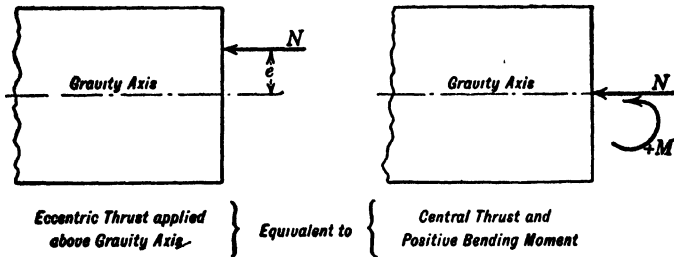

FIG. 54.—Positive Bending Moment and Central Thrust. (See p. 166.)

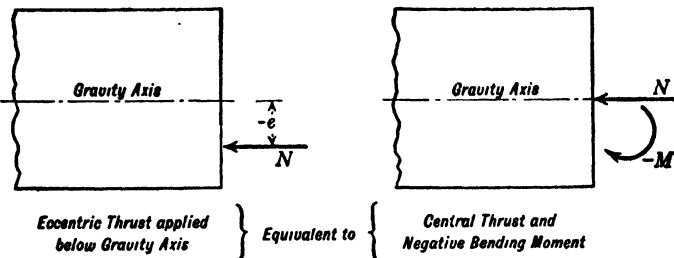

FIG. 55.—Negative Bending Moment and Central Thrust. (See p. 166.)

Conversely, a positive thrust acting above the axis produces maximum compression at the top and minimum stresses at the bottom. A positive thrust acting below the axis produces reverse results.

**Negative Thrust, or Pull.**—In the discussion, that follows  $N$  is assumed as a positive thrust, i.e., a thrust producing compression, and therefore the maximum stresses are compressive. If  $N$  is a negative thrust, or pull, as in arch design with the thrust due to

<sup>7</sup> Similar action, of course, is true in a vertical or inclined member.

rib shortening or to fall of temperature, it will produce tension over the section. A negative thrust, applied below the gravity axis, produces positive bending moment, while, if applied above the axis, it produces a negative bending moment. Conversely, positive bending moment and pull can be replaced by an eccentric pull acting below the gravity axis. The reverse is true of negative bending moment and pull.

Negative thrust (or pull) combined with positive bending moment (or negative thrust acting below axis) produces maximum tension at extreme fiber below the axis and minimum tension (or small compression) at the extreme fiber above the axis. Pull combined with negative bending moment (or negative thrust acting above the axis) produces reverse results. The formulas given in subsequent pages may be used for negative thrust (or pull) by substituting  $-N$  for  $N$ . This changes the compression unit stresses due to the thrust to tensile unit stresses and reverses the position of bending stress in the section.

A question arises as to whether, with negative thrust, it is permissible to use the formulas given below for materials such as concrete, which is not capable of resisting tensile stresses. If the negative thrust and bending moment act alone, then, of course, the formulas are not applicable and the formulas on p. 189 to 194 should be used. When, however, the tensile stresses due to the negative thrust are counteracted to a great extent by a positive thrust, the formulas in this section, after the sign is changed before  $N$ , are applicable. For instance, in arch design, the negative thrust due to fall of temperature is counteracted by the positive thrust due to dead load. In such a case, the stresses due to both thrusts are computed by the same formulas separately and the results added.

#### NOTATION

- Let**  $R$  = inclined thrust acting on a section;  
 $N$  = normal thrust, a component of thrust  $R$  normal to the section; also a central load;  
 $V$  = external shear, the component of  $R$  parallel to the section;  
 $T$  = normal pull, in members subjected to direct tension or tension and bending;  
 $b$  = breadth of rectangular cross section;



- $h$  = height of rectangular cross section;  
 $e$  = eccentricity, that is, the distance from axis of gravity of the section to the point of application of the thrust;  
 $e_0$  = value of eccentricity which produces zero stress in concrete at outer edge of rectangular section;  
 $M$  = bending moment on the section;  
 $y$  = perpendicular distance to any point in the section from gravity axis of section;  
 $I$  = moment of inertia of cross section of concrete about the gravity axis;  
 $I_s$  = moment of inertia of cross section of steel about the horizontal gravity axis;  
 $I_t$  = moment of inertia of transformed section;  
 $A$  = total effective area of cross section of concrete;  
 $A_s$  = total area of section of steel;  
 $A_t$  = area of transformed reinforced concrete section;  
 $y_1$  = perpendicular distance from outside fiber to gravity axis of unsymmetrical section having maximum compression;  
 $y_2$  = perpendicular distance from center of gravity of unsymmetrical section to outside fiber having maximum tension or minimum compression;  
 $f_c$  = maximum unit compression in concrete;  
 $f_t$  = maximum unit tension in concrete, or minimum compression;  
 $f'_s$  = maximum unit compression in steel;  
 $f_s$  = maximum unit tension or minimum unit compression in steel;  
 $p$  = ratio of steel to total area of section;  
 $n = \frac{E_s}{E_c}$  = ratio of moduli of elasticity of steel and concrete;  
 $k$  = ratio of depth of neutral axis to depth  $d$ ;  
 $kd$  = distance from outside compressive surface to neutral axis;  
 $d'$  = depth of steel in compression;  
 $d$  = depth of steel in tension;  
 $a$  = distance from center of gravity of symmetrical section to steel;  
 $C_s, C_c$  = constants.

**PLAIN CONCRETE SECTION UNDER DIRECT STRESS AND BENDING MOMENT**

**General Formula.**—For members of any cross section subjected to a central load,  $N$ , and a bending moment (or to an eccentric thrust), the stresses may be obtained by computing separately the stresses caused by the central load and by the bending moment. The sum of the results then gives the actual stresses.

The unit stresses produced by a central load,  $N$ , obtained by dividing the load by the effective area of the section, are equal to  $\frac{N}{A}$ .

The unit stresses produced by the bending moment,  $M$ , at any point at a distance,  $y$ , from gravity axis, from simple mechanics, are equal to  $\pm \frac{My}{I}$ . The sign  $+$  is used for points above the axis, and  $-$  for points below the axis.

The combined stresses, therefore, at any distance,  $y$ , from the axis of gravity, are equal to the sum of the two above expressions.

*Stresses at any point.*

$$f_c = \frac{N}{A} \pm \frac{My}{I} \dots \dots \dots (91)$$

The second term of this expression, depending upon the value  $y$  varies with the position of the point in relation to the axis of gravity, therefore, the intensity of stresses varies from a maximum at one edge of the section to a minimum at the opposite edge.

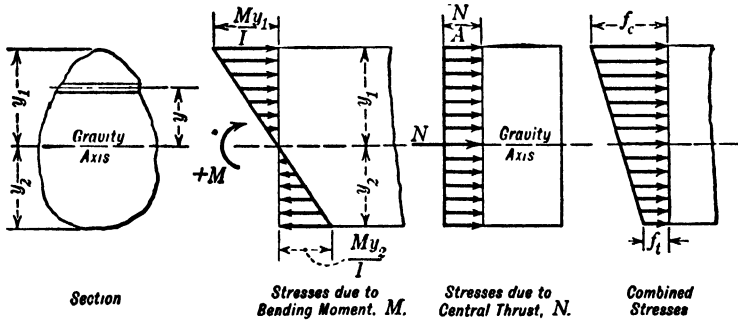

FIG. 56.—Section Subjected to Direct Stress and Bending. (See p. 169.)

Usually, only the maximum and minimum stresses in the extreme fibers are of interest. If, as given in Fig. 56,  $y_1$  is the distance of

the extreme fiber above the axis and  $y_2$  below the axis, the combined stresses are:

*Maximum Stresses,*

$$f_c = \frac{N}{A} + \frac{My_1}{I}. \quad \dots \quad (92)$$

*Minimum Stresses,*

$$f_t = \frac{N}{A} - \frac{My_2}{I}. \quad \dots \quad (93)$$

This condition exists for a positive bending moment, or when the eccentric thrust is applied above the axis.

For negative bending moment or a thrust acting below the axis, the sign before the second term in the formulas changes. The maximum stress acts below the axis and the minimum stress above the axis.

**Formulas for Rectangular Plain Sections.**—In a rectangular section with breadth,  $b$ , and height,  $h$ , the area  $A = bh$ , the moment of inertia  $I = \frac{bh^3}{12}$ , and the distance from axis to extreme fibers,

$y_1 = y_2 = \frac{h}{2}$ . These values substituted in the general equation give the following expressions for rectangular section:

*Maximum Compressive Stress,*

$$f_c = \frac{N}{bh} + \frac{6M}{bh^2}. \quad \dots \quad (94)$$

*Minimum Stress,*

$$f_t = \frac{N}{bh} - \frac{6M}{bh^2}. \quad \dots \quad (95)$$

If the bending moment  $M$  is replaced by  $Ne$  the above formulas change to:

*Maximum Compressive Stress,*

$$f_c = \frac{N}{bh} \left( 1 + \frac{6e}{h} \right). \quad \dots \quad (96)$$

*Minimum Stress,*

$$f_t = \frac{N}{bh} \left( 1 - \frac{6e}{h} \right). \quad \dots \quad (97)$$

For positive bending moment (or thrust applied above the axis), maximum stresses act above the axis. The position of maximum stresses is reversed with negative bending moment or with thrust below the axis. When  $b$ ,  $h$  and  $e$  are in inches and  $M$  is in inch-pounds, and  $N$  in pounds, the unit stresses are in pounds per square inch. For  $M$  in foot-pounds, multiply the second term by 12.

To get the stresses in pounds per square foot, as is customary in dam design, the dimensions  $b$  and  $h$  must be in feet and  $M$  in foot-pounds.

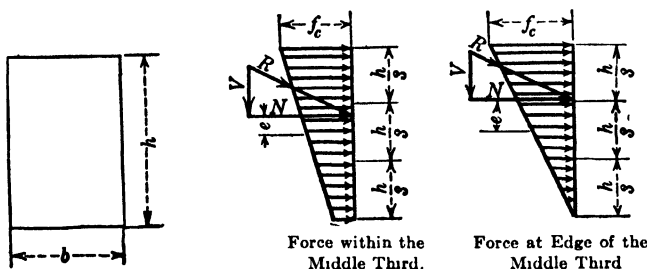

FIG. 57.—Stresses Caused by Eccentrically Applied Thrust. (See p. 171.)

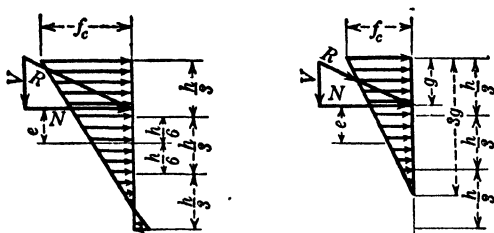

FIG. 58.—Stresses Caused by a Force Acting Outside the Middle Third of Plain Concrete Section. (See p. 172.)

For positive thrust, the maximum stress is always compression. The minimum stress from Formula (97) is compression when  $\frac{6e}{h}$  is smaller than unity, that is, when the eccentricity,  $e$ , is smaller than  $\frac{h}{6}$ . When the force acts at the edge of the middle third of the section, the minimum stress equals zero, and the maximum stress equals double the stress caused by a central load of equal intensity. (See Fig. 57, p. 171.)

When  $e$  is larger than  $\frac{h}{6}$ , and the load acts outside of the middle third, the minimum stress is negative, and the section is subjected to tension. In such cases, this formula can be applied only when the material is capable of resisting tensile stresses.

If the material cannot resist tension, as in masonry, or in concrete where tension exceeds the allowable stress, it is necessary to assume that the pressure is distributed only over a section equal to three times the distance of the point of application of the load from the nearest edge. (See Fig. 58). If that distance is  $g$ , the total effective depth of the section is  $3g$ . Substituting in Formula (96),  $e = \frac{g}{2}$ , and  $h = 3g$ , we get for plain concrete and masonry.

*Maximum Compression,*

$$f_c = \frac{2N}{3bg} \dots \dots \dots (98)$$

**Plain Circular Sections.**—For circular sections where  $d$  is diameter of circle, the area of moment of inertia is  $I = \frac{\pi d^4}{64}$  and the section is  $A = \frac{\pi d^2}{4} = 0.785d^2$ , and the distance to extreme fiber  $y_1 = y_2 = \frac{d}{2}$ . These values substituted in equations 92 and 93 give

*Maximum Compression in Concrete,*

$$f_c = \frac{N}{0.785d^2} + \frac{10.2M}{d^3} \dots \dots \dots (99)$$

*Minimum Stress,*

$$f_t = \frac{N}{0.785d^2} - \frac{10.2M}{d^3} \dots \dots \dots (100)$$

Substituting

$$M = Ne.$$

*Maximum Compression Stress,*

$$f_c = \frac{N}{d^2} \left( 1.275 + \frac{10.2e}{d} \right) \dots \dots \dots (101)$$

*Minimum Stress,*

$$f_t = \frac{N}{d^2} \left( 1.275 - \frac{10.2e}{d} \right) \dots \dots \dots (102)$$

The stresses at one extreme edge become zero for  $e = 0.125d$ . For larger eccentricity, tensile stresses will be developed.

**REINFORCED CONCRETE SECTION SUBJECTED TO DIRECT STRESS  
AND FLEXURE**

**General Formulas.**—The stresses in a reinforced concrete section subjected to direct stress and flexure may be obtained by replacing the reinforcement by an equivalent area of concrete and then applying to the transformed section the general Formulas (92) and (93) developed for plain concrete sections. To get the equivalent area of concrete, the area of reinforcement is multiplied by the ratio of moduli of elasticity of steel and concrete,  $n$ . The area of the transformed section is  $A_t = A + (n - 1)A_s$ . The moment of inertia of the transformed section about the axis of gravity equals the moment of inertia of the concrete section plus the moment of inertia of the concrete replacing the steel. The substitute area must be placed at the same distance from the axis as the steel area, so that the moment of inertia of the substitute area equals  $(n - 1)$  times the moment of inertia of the steel area about the gravity axis of the section. The total moment of inertia,  $I_t = I + (n - 1)I_s$ . The value of  $(n - 1)$  is used in the formulas instead of  $n$  because, in taking the concrete area, one  $A$  is already included. Substituting these values in Formulas (92) and (93), the formulas for maximum and minimum stress become

*Maximum Compressive Stress,*

$$f_c = \frac{N}{A + (n - 1)A_s} + \frac{My_1}{I + (n - 1)I_s} \cdot \cdot \cdot \quad (103)$$

*Minimum Stress,*

$$f_t = \frac{N}{A + (n - 1)A_s} - \frac{My_2}{I + (n - 1)I_s} \cdot \cdot \cdot \quad (104)$$

The stress in steel equals the stress in the adjoining concrete multiplied by  $n$ . As evident from the formulas, for positive bending moment, maximum stresses act above the neutral axis while minimum stresses act below the neutral axis. For negative bending moment, the sign before the second term of the equation changes, and the maximum stresses act below the neutral axis while minimum stresses act above the neutral axis.

## RECTANGULAR SECTION WITH SYMMETRICAL REINFORCEMENT

The formulas for a rectangular section subjected to direct load and bending moment depend upon the arrangement of reinforcement. The bars may be placed in the section as shown in Fig. 59(a) or as shown in Fig. 59(b).

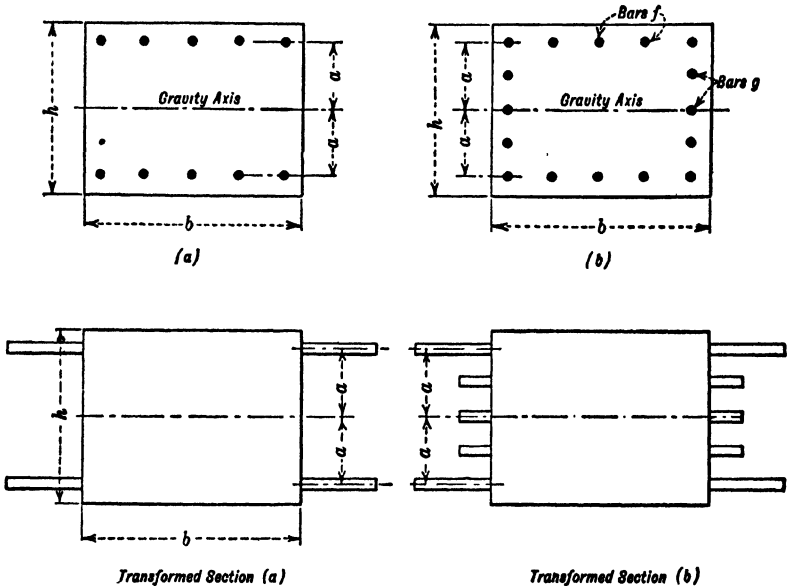

FIG. 59.—Arrangement of Bars in Rectangular Section. (See p. 174.)

In Fig. 59 (a), the area of concrete is  $A = bh$ , the area of steel,

$$A_s = pbh, \text{ and the transformed area,}$$

$$A_t = A + (n - 1)A_s = bh[1 + (n - 1)p].$$

The moment of inertia of the concrete section is  $I_c = \frac{bh^3}{12}$ . Since all the bars are at the same distance from the gravity axis, their moment of inertia is obtained by multiplying their area by the square of the distance,  $a$ . The moment of inertia of steel is  $I_s = A_s a^2$ , and the moment of inertia of concrete replacing the steel is  $(n - 1)A_s a^2$ . The total moment of inertia is therefore

$$\begin{aligned}
 I &= I_c + (n - 1)A_s a^2 = \frac{bh^3}{12} + (n - 1)pbha^2 \\
 &= bh \left[ \frac{h^2}{12} + (n - 1)pa^2 \right]. \dots \dots \dots (105)
 \end{aligned}$$

The value of  $(n - 1)$  is used in the formulas instead of  $n$ , because in taking  $bh$  for concrete area one  $A_s$ , is already included.

For the arrangement of steel shown in Fig. 59 (b), the transformed area may be found in the same manner as before. It is  $A_s = bh[1 + (n - 1)p]$ . The formula for the moment of inertia of concrete is the same as before, but the formula for the moment of inertia of steel is different because the distance of the side bars,  $g$ , from the gravity axis is different from the distance of bars  $f$ . A formula taking the bars,  $g$ , into consideration would be too complicated. Since their effect on bending stresses is comparatively small, they may be disregarded and the same formulas used as for case (a). The value of  $p$  to be used in the formulas should be based on bars  $f$  only, or else a small allowance may be made for the effect of bars,  $g$ , by using, in figuring  $p$ , an area of steel somewhat larger than in bars  $f$ .

Thus, in both cases the transformed area is  $bh[1 + (n - 1)p]$  and the moment of inertia  $I_t = bh \left[ \frac{h^2}{12} + (n - 1)pa^2 \right]$ . Substituting these values in the general Formula (91) and making  $M = Ne$ , we get

*Stresses at any distance,  $y$ , from gravity axis*

$$f_c = \frac{N}{bh} \left[ \frac{1}{1 + (n - 1)p} \pm \frac{12ye}{h^2 + 12(n - 1)pa^2} \right]. \dots (106)$$

The maximum and minimum stresses in concrete are at the edges of the section for  $y = \frac{h}{2}$ .

*Maximum Compression Stress in Concrete,*

$$f_c = \frac{N}{bh} \left[ \frac{1}{1 + (n - 1)p} + \frac{6he}{h^2 + 12(n - 1)pa^2} \right]. \dots (107)$$

*Minimum Stress in Concrete,*

$$f_c = \frac{N}{bh} \left[ \frac{1}{1 + (n - 1)p} - \frac{6he}{h^2 + 12(n - 1)pa^2} \right]. \dots (108)$$

The stresses in steel equal  $n$  times the stresses in concrete at a distance  $a$  from the axis. Thus,



*Maximum Compression Stress in Steel,*

$$f_s = n \frac{N}{bh} \left[ \frac{1}{1 + (n - 1)p} + \frac{12ae}{h^2 + 12(n - 1)pa^2} \right]. \quad (109)$$

In the limits within which these formulas are applicable, the minimum stress in steel has no significance and does not need to be computed.

In the above formulas, if  $N$  is in pounds and  $b$ ,  $h$ , and  $e$  in inches, the resulting stress is in pounds per square inch. The value  $e$  is obtained by dividing bending moment,  $M$ , in inch-pounds, by the thrust,  $N$ , in pounds.

To get stresses in pounds per square foot, the values  $b$ ,  $h$ ,  $a$ , and  $e$  must be in feet. The value of  $e$  is obtained by dividing  $M$  in foot-pounds by the thrust in pounds.

For positive bending moment, the eccentric thrust is applied above the axis and the maximum compression stresses are at the upper edge of the section.

For negative bending moment, the eccentric thrust is applied below the axis and the maximum compression stresses are at the lower edge of the section.

The resulting stresses are shown in Fig. 60, p. 176.

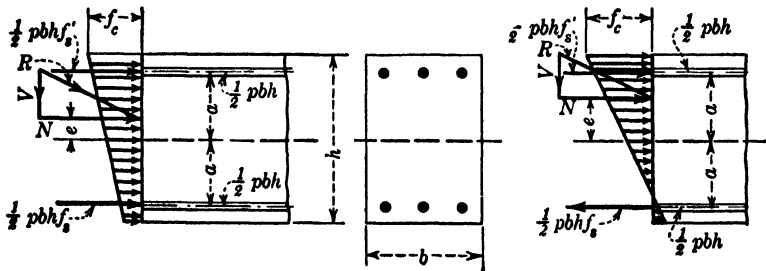

Force Producing Compression upon the Whole Reinforced Section.

Force Acting at a Distance Larger than  $e_0$  from the Axis of Gravity of Reinforced Section.

FIG. 60.—Stresses in Reinforced Concrete Section Subjected to Eccentrically Applied Thrust. (See p. 176.)

**Solving Formula (107) by Diagram.**—In Formula (107), the expression  $C_s = \left( \frac{1}{1 + (n - 1)p} + \frac{6he}{h^2 + 12(n - 1)pa^2} \right)$  is a constant for constant values of  $p$ ,  $\frac{e}{h}$  and  $\frac{a}{h}$ . The formula changes to

*Maximum Compression Stress in Concrete,*

$$f_c = C_c \frac{N}{bh} \dots \dots \dots (110)$$

The value of  $C_c$  is given in diagrams on pp. 934 to 937. Separate diagrams are drawn for  $a = 0.5h$ ,  $a = 0.45h$ ,  $a = 0.4h$  and  $a = 0.35h$ .

The variables in each diagram are  $\frac{e}{h}$  and  $p$ .

For the purpose of making a diagram the constant is written in the following form:

$$C_c = \frac{1}{1 + (n - 1)p} + \frac{6 \frac{e}{h}}{1 + 12(n - 1)p \left(\frac{a}{h}\right)^2} \dots \dots (111)$$

The use of the diagrams may be seen from the example below.

**Example 1.**—Determine stresses in concrete column when  $b = 12$  in.,  $h = 24$  in.; the reinforcement consists of six  $\frac{3}{8}$ -in. round bars; fireproofing 2 in. and the section is subjected to a normal thrust,  $N = 73\ 000$  lb. and a bending moment  $M = 365\ 000$  in.-lb. Consider total area as effective.

*Solution.*—The area of concrete is  $bh = 12 \times 24 = 288$  sq. in. Since the area of a  $\frac{3}{8}$ -in. round bar is 0.6 sq. in., the area of steel is  $6 \times 0.6 = 3.6$  sq. in. The steel ratio,  $p = \frac{3.6}{288} = 0.0125$ . Since the fireproofing to outside face of bars is 2 in. and the bar is  $\frac{3}{8}$  in., the distance to center of bar,  $d'$ , is  $2 + \frac{7}{8} = 2\frac{7}{8}$  in. The value of  $a$  is  $a = \frac{3}{4} - 2\frac{7}{8} = 9\frac{9}{16}$  in. The ratio  $\frac{a}{h}$  is  $\frac{9\frac{9}{16}}{24} = 0.40$ .

The eccentricity,  $e$ , found from  $\frac{M}{N}$ , is  $e = \frac{365\ 000}{73\ 000} = 5$  in. and the ratio  $\frac{e}{h} = \frac{5}{24} = 0.208$ . The value of  $C_c$  is now found for  $a = 0.4h$ ,  $p = 0.0125$  and  $\frac{e}{h} = 0.208$ .

Use the diagram marked  $2a = 0.8h$ . Find the intersection of a vertical line corresponding to  $\frac{e}{h} = 0.208$  with a curve for  $p = 0.0125$  (interpolate between  $p = 0.012$  and  $p = 0.014$ ). Read at the left the value of  $C_c = 1.79$ .

The maximum compression then is

$$f_c = 1.79 \times \frac{73\ 000}{12 \times 24} = 454 \text{ lb. per sq. in.}$$

**Effect of Eccentricity.**—As in plain concrete sections, the location of the center of thrust determines the distribution of the stress. If

the thrust acts at the center of gravity, there is uniform compression over the whole section. As the center of thrust moves from the gravity axis, the compression at the opposite surface decreases until it finally becomes zero, and then changes to tension.

When the first term in the brackets of Equation (108), p. 175, is greater than the second, the minimum stress in the concrete is compression. When the two terms are equal, the stress is zero at the outer edge of the concrete on the opposite side to that on which the thrust acts. When the second term is greater than the first the result is negative and the minimum stress is tension.

If the tension, determined by the above formula, exceeds the allowable tension on concrete, the above formulas are not applicable and the formulas given on p. 180 should be employed.

**Thrust Applied so that the Compression at One Surface Becomes Zero.**—The eccentricity for which this occurs may be determined by substituting zero for  $f_c$  in Formula (108) and solving the resulting equation for  $e$ .

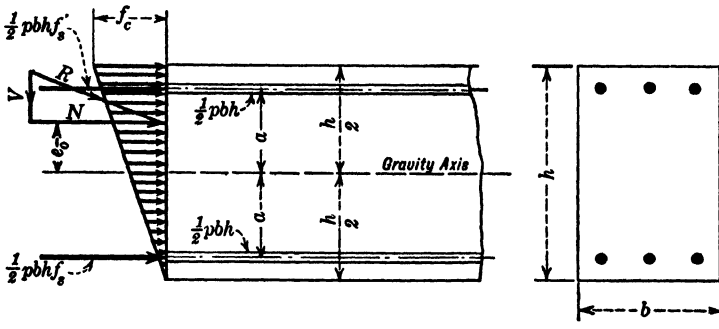

FIG. 61.—Stresses Caused by a Force Acting at a Distance equal to  $e_0$  from the Axis of Gravity of Reinforced Section. (See p. 178.)

Using previous notation and also letting  $e_0 =$  value of  $e$ , for which the minimum stress is zero, then

*Limiting Eccentricity,*

$$e_0 = \frac{1 + 12(n - 1)p \left(\frac{a}{h}\right)^2}{6[1 + (n - 1)p]} h. \quad \dots \quad (112)$$

In the above case, the formulas on p. 175 change to

*Maximum Unit Compression in Concrete,*

$$f_c = \frac{2N}{bh[1 + (n - 1)p]} \dots \dots \dots (113)$$

*Maximum Unit Compression in Steel,*

$$f'_s = \frac{nN}{bh[1 + (n - 1)p]} \left(1 + \frac{2a}{h}\right), \dots \dots (114)$$

also

$$f'_s = n f_c \frac{h + 2a}{2h} \dots \dots \dots (115)$$

*Minimum Compression in Concrete = 0.*

Minimum compression in steel is very small and does not need to be determined.

In the diagrams on pp. 934 to 937, the dash curve indicates the limiting values of  $\frac{e}{h}$  for which compression at one surface becomes zero. If it is desirable to avoid tensile stresses, the dimensions of the section should be so selected that the  $\frac{e}{h}$  is smaller than, or equal to, the limiting value  $\frac{e_0}{h}$ .

**Effective Section.**—Some building codes require that the outside protective cover of concrete be disregarded in computing combined stresses, in the same manner as recommended for centrally loaded columns. Then the values of  $b$  and  $h$  in the formulas are the dimensions within the fireproofing. For instance, if  $1\frac{1}{2}$  in. fireproofing is required, a 12-in. by 18-in. section becomes 9 in. by 15 in., because  $(12 - 2 \times 1.5) = 9$  and  $(18 - 2 \times 1.5) = 15$ .

**Circular Reinforced Section.**—In a circular section, the reinforcement is evenly distributed along the circumference. It may be replaced by a ring. The area of the section equals the area of concrete,  $A$ , plus  $(n - 1)A$ . The area of the circle is  $0.785d^2$ . If  $p$  is the ratio of steel,

$$A_s = 0.785d^2[1 + (n - 1)p].$$

The moment of inertia of the concrete section,  $I_c = \frac{\pi d^4}{64}$ . The moment of inertia of the steel ring the area of which is  $A_s$  and the radius,  $a$ , is  $I_s = \frac{A_s a^2}{2}$ .

Since  $A_s = pA = 0.785pd^2$ , the moment of inertia becomes  $I_s = pA \frac{a^2}{2} = 0.393pd^2a^2$ . The total moment of inertia, of transformed section,

$$I_t = \frac{\pi d^4}{64} + (n - 1)0.393pd^2a^2$$

Finally

$$I_t = d^4 \left[ \frac{1}{20.4} + 0.393(n - 1)p \left( \frac{a}{d} \right)^2 \right]$$

The values of  $A_t$  and  $I_t$ , substituted in Equations (103) and (104), give

*Maximum Compression Stress, Circular Reinforced Section,*

$$f_c = \frac{N}{0.785d^2[1 + (n - 1)p]} + \frac{M}{2d^3 \left[ \frac{1}{20.4} + 0.393(n - 1)p \left( \frac{a}{d} \right)^2 \right]} \quad (116)$$

*Minimum Stress, Circular Reinforced Section,*

$$f_t = \frac{N}{0.785d^2[1 + (n - 1)p]} - \frac{M}{2d^3 \left[ \frac{1}{20.4} + 0.393(n - 1)p \left( \frac{a}{d} \right)^2 \right]} \quad (117)$$

**Distribution of Stress in Rectangular Section When One Surface is in Tension.**—When the thrust is applied at a distance from the gravity axis greater than the eccentricity,  $e_0$  (from Formula (112), p. 178), and the concrete is assumed to be unable to carry any tension, then Formulas (107) and (108), p. 175, are no longer applicable. The following method may be used in determining the conditions under which the steel on the side opposite the thrust is assumed to resist all tension stresses. Referring to Fig. 62, p. 181, and making the same assumptions as given in connection with simple flexure on p. 126, the following relation is found between the stresses in steel and in concrete. If  $f_c$  is compression in extreme fiber, then

*Unit compressive stress in the upper steel is,*

$$f'_s = nf_c \left( 1 - \frac{d'}{kd} \right), \dots \dots \dots (118)$$

and

*Unit tension in the lower steel is,*

$$f_s = nf_c \frac{d - kd}{kd} = nf_c \frac{1 - k}{k} \dots \dots \dots (119)$$

The magnitude of the stress,  $f_c$ , may be determined from the principle that for equilibrium the sum of the stresses acting on a section must equal the thrust, and the principle that the bending moment of the external forces (which is the thrust multiplied by the eccentricity) equals the moment of resistance of the internal stresses.

In this case, it is more rational to use the depth to steel,  $d$ , as a basis instead of the total depth,  $h$ , as used in previous formulas. The steel ratio,  $p$ , equals  $\frac{A_s}{bd}$  where  $A_s$  is the total area of steel in the section. For symmetrical arrangement of bars, the areas of tensile and compressive reinforcement are equal to each other and amount to  $\frac{1}{2}pbd$ .

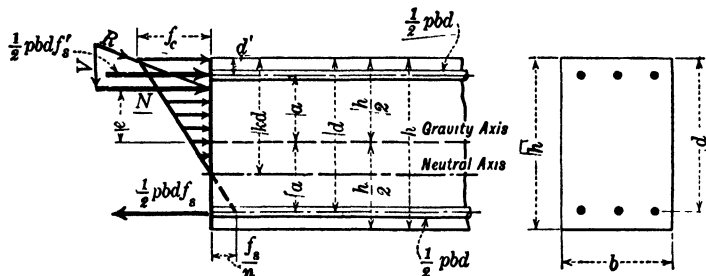

FIG. 62.—Stresses Caused by a Force Producing Compression and Tension upon a Reinforced Section, Tensile Strength of Concrete Neglected. (See p. 180.)

From the first principles, we have

$$N = \frac{f'_c pbd}{2} + \frac{f_c bkd}{2} - \frac{f_s pbd}{2} \dots \dots \dots (120)$$

Substituting the values for  $f'_c$  and  $f_s$  from formulas (118) and (119),

$$N = \frac{f_c b d}{2} \frac{k^2 + 2npk - np \frac{h}{d}}{k} \dots \dots \dots (121)$$

The moment of the stresses about the gravity axis, obtained by taking the sum of the moments of all the stresses about the gravity axis, after eliminating  $f'_c$  and  $f_s$  by the use of Equations (118) and (119), is

$$M = f_c b d^2 \left[ \frac{np}{k} \left( \frac{a}{d} \right)^2 + \frac{k}{4} \left( \frac{h}{d} \right) - \frac{k^2}{6} \right] \dots \dots \dots (122)$$

By equating the expressions in Formulas (121) and (122) to the known thrust and known bending moment, we get two equations from which the unknown values of  $k$  and  $f_c$  may be determined. This would mean, however, solving third power equations. In practice, the use of the curves given on pp. 938 and 939 will be found convenient.

Calling the quantity in brackets in Formula (122)

$$C_a = \left[ \frac{np}{k} \left( \frac{a}{d} \right)^2 + \frac{k}{4} \left( \frac{h}{d} \right) - \frac{k^2}{6} \right], \dots \dots \dots (123)$$

we may write

$$M = C_a f_c b d^2, \dots \dots \dots (124)$$

from which

*Maximum Compression Stresses in Concrete,*

$$f_c = \frac{M}{C_a b d^2}, \dots \dots \dots (125)$$

and

*Maximum Tensile Stresses in Steel,*

$$f_s = n f_c \frac{1 - k}{k}. \dots \dots \dots (126)$$

Compression stresses in steel do not need to be computed, because for satisfactory  $f_c$  they are always lower than the allowable stresses.

The values of  $C_a$  and  $k$  in the above formulas depend upon known dimensions of the section and known eccentricity. They may be taken from the diagrams on pp. 938 and 939.

For positive bending moment, the eccentric thrust is applied above the axis and the maximum compression stresses are at the upper edge of the section.

For negative bending moment, the eccentric thrust is applied below the axis and the maximum compression stresses are at the lower edge of the section.

If the bending moment,  $M$ , is in inch-pounds and  $b$  and  $h$  in inches, the stresses are in pounds per square inch.

To get stresses in pounds per square foot, the bending moment,  $M$ , must be in foot-pounds and  $b$  and  $h$  in feet.

**General Formula for  $k$ .**—The value of the constant  $C_a$  in Formula (124) depends upon the known values of  $n$ ,  $h$  and  $p$  and the unknown value of  $k$ .

The value of  $k$  may be determined from the requirement that the bending moment,  $M$ , as expressed in Formula (122), be equal to

Ne where  $N$  is given in Formula (121). Multiplying the Equation (121) by  $e$  and equating it to Equation (122), we have

$$\frac{f_c b d}{2} \frac{k^2 + 2npk - np \frac{h}{d}}{k} e = f_c b d^2 \left[ \frac{np}{k} \left( \frac{a}{d} \right)^2 + \frac{k}{4} \left( \frac{h}{d} \right) - \frac{k^2}{6} \right].$$

After simplification, the equation changes to

$$k^3 + 3 \left( \frac{e}{d} - \frac{1}{2} \frac{h}{d} \right) k^2 + 6npk \frac{e}{d} = 3np \frac{e}{d} \frac{h}{d} + 6np \left( \frac{a}{d} \right)^2. \quad (127)$$

This third degree equation may be solved by substituting

$$k = z - \left( \frac{e}{d} - \frac{1}{2} \frac{h}{d} \right),$$

whereupon the final equation will assume the form

$$z^3 + C_1 z + C_2 = 0,$$

where  $C_1$  and  $C_2$  are constants depending upon  $e$ ,  $h$ ,  $n$  and  $p$ . The solution of this equation by Cardan's formula is

$$z = \sqrt[3]{-\frac{1}{2}C_2 + \sqrt{\left(\frac{1}{2}C_2\right)^2 + \left(\frac{1}{3}C_1\right)^3}} + \sqrt[3]{-\frac{1}{2}C_2 - \sqrt{\left(\frac{1}{2}C_2\right)^2 + \left(\frac{1}{3}C_1\right)^3}}.$$

Finally

$$k = z - \left( \frac{e}{d} - \frac{1}{2} \frac{h}{d} \right).$$

The solution of the equation as outlined above requires considerable time and is not adaptable for practice. To simplify the work, the values of  $k$  are given in the diagram on p. 938 for different values of  $p$  and  $\frac{e}{d}$ , but for a fixed value of  $a$ , namely,  $a = \frac{2}{5} d$ . The value of  $k$  may also be found by trial as described below.

**Curves for  $k$ .**—If it is desired to prepare a diagram for different values of  $a$ , the following simplified method may be used. The Equation (127) is solved for  $\frac{e}{d}$ , giving the following formula:

$$\frac{e}{d} = \frac{-k^3 + 1.5k^2 \frac{h}{d} + 6np \left( \frac{a}{d} \right)^2}{3k^2 + 6npk - 3np \frac{h}{d}}. \quad (128)$$

With this formula, instead of assuming values of  $\frac{e}{d}$  and determining the corresponding  $k$  by the elaborate method, the work is reversed.



For each value of  $p$ , the value of  $k$  is assumed successively and the corresponding value of  $\frac{e}{d}$  computed from the simpler Equation (128). The curves may then be plotted and used for determining the values of  $k$ .

**Curves for  $C_a$ .**—The values of  $C_a$  may be taken from the diagram on p. 939. The diagram is also based on  $a = \frac{3}{8}d$ .

**Use of Diagrams for  $k$  and  $C_a$ .**—For the solution of any problem both diagrams are necessary. The value of  $k$  is found from one diagram, and for this value and the known ratio of steel,  $p$ , the value of  $C_a$  is found from the other diagram. This value of  $C_a$ , inserted in Formula (124), gives the required unit stresses in concrete.

The following problem is very common in practice:

Given the dimensions of the member,  $b$ ,  $h$ , and  $d$  and the area of steel,  $A_s$ ; the ratio of elasticity,  $n$ ; the thrust,  $N$ ; and the bending moment,  $M$ .

Required the compressive stresses in concrete,  $f_c$ , and tensile stresses in steel,  $f_s$ .

The solution of the problem is as follows:

Find value of  $p = \frac{A_s}{bd}$ . The percentage of steel =  $100p$ . Find value of  $e$  from  $e = \frac{M}{N}$ . Determine the ratio  $\frac{e}{d}$ . Locate on diagram for  $k$  the line corresponding to the determined value  $\frac{e}{d}$ . The intersection of this line with the curve marked with proper percentage of steel gives the value of  $k$ . Use, in diagram (23), the determined value of  $k$  and the known percentage of steel for determining the value of  $C_a$ , which with Formula (124) gives the stress in concrete.

The stresses in steel may be obtained from Formula (126), p. 182.

**Determining  $k$  without Curves.**—The value of  $k$  for any condition not covered by the diagram, for instance for different  $\frac{a}{d}$ , may be found by trial from Formula (128). This work is simpler than solving the third degree equation. A value of  $k$  is assumed first, and then checked by substituting it in formula. If the resulting value of  $\frac{e}{d}$  is substantially equal to the actual value of  $\frac{e}{d}$ , the assumed  $k$  is satisfactory. If not, another value should be assumed and the work

repeated. Usually, two trials will give a close agreement. In assuming the first value of  $k$ , the diagram on p. 938 will be found useful, as in most cases the actual conditions will not be very different from those assumed in preparing the diagram.

**Steel in Tension Face Only.**—The formulas given in preceding pages apply to members reinforced with steel in tension and compression placed symmetrically in respect to the axis. Often, members are reinforced for tension only, in which case the formulas given below may be used. The section is shown in Fig. 63, p. 185. As in the previous case, the sum of all stresses must equal the thrust. Since the area of tension reinforcement is  $pbd$  and there is no compression reinforcement, the sum of all stresses is

$$N = \frac{1}{2}f_c bkd - f_s pbd.$$

The relation between  $f_c$  and  $f_s$  is the same as given on p. 180.

$$f_s = nf_c \frac{d - kd}{kd} = nf_c \frac{1 - k}{k}.$$

Substituting this value in the above equation,

$$N = f_c b d \frac{k^2 - 2np(1 - k)}{2k}. \quad \dots \quad (129)$$

Since all the reinforcement is near one face, the center of gravity of the combined section will not coincide with the center of the concrete section.

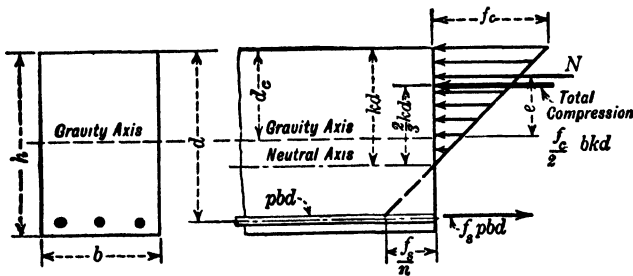

FIG. 63.—Section with Steel in Tension Face Only. (See p. 185.)

Referring to Fig. 63 and assuming that the effect of the reinforcement equals  $n$  times the effect of concrete, the area of the combined section is  $bh + (n - 1)pbd$ . The distance of the center of gravity from the top of the section is equal to the moment of the combined

section about the top edge divided by the total area. After the equation has been simplified the final formula for the distance of the center of gravity of the section from the top edge is

$$d_c = \frac{h}{2} \frac{1 + 2(n-1)p \left(\frac{d}{h}\right)^2}{1 + (n-1)p \left(\frac{d}{h}\right)},$$

or

$$\frac{d_c}{d} = \frac{1}{2} \frac{1 + 2(n-1)p \left(\frac{d}{h}\right)^2}{1 + (n-1)p \left(\frac{d}{h}\right)} \quad \dots \quad (130)$$

Values of  $\frac{d_c}{d}$  may be found from Table 37, p. 940, for different ratios of steel,  $p$ . The moment,  $M$ , about this center of gravity may be found by multiplying the total compression by  $(d_c - \frac{1}{3}kd)$  and the total tension by  $(d - d_c)$ .

$$M = \frac{1}{2} f_c b k d (d_c - \frac{1}{3} k d) + p b d f_s (d - d_c).$$

Expressing  $f_s$  in terms of  $f_c$ , the formula changes to

$$M = f_c b d^2 \left[ \frac{k}{2} \left( \frac{d_c}{d} - \frac{1}{3} k \right) + p n \frac{1-k}{k} \left( 1 - \frac{d_c}{d} \right) \right] \quad \dots \quad (131)$$

This value must equal the thrust,  $N$ , from Formula (129) multiplied by  $e$ . Thus,

$$f_c b d \frac{k^2 - 2np(1-k)}{2k} e = f_c b d^2 \left[ \frac{k}{2} \left( \frac{d_c}{d} - \frac{1}{3} k \right) + p n \frac{1-k}{k} \left( 1 - \frac{d_c}{d} \right) \right],$$

from which

$$\frac{e}{d} = \frac{k^2 \left( \frac{d_c}{d} - \frac{1}{3} k \right) + 2pn(1-k) \left( 1 - \frac{d_c}{d} \right)}{k^2 - 2np(1-k)} \quad \dots \quad (132)$$

This equation may be used for preparing a diagram for  $k$  for different values of  $p$ . Also, the value of  $k$  may be found by trial, as explained on p. 184 in connection with members with steel in tension and compression.

The stresses may be obtained by solving Equation (131) for  $f_c$ .

$$f_c = \frac{M}{b d^2 \left[ \frac{k}{2} \left( \frac{d_c}{d} - \frac{1}{3} k \right) + p n \frac{1-k}{k} \left( 1 - \frac{d_c}{d} \right) \right]}.$$

By substituting  $C_b = \frac{k}{2} \left( \frac{d_c}{d} - \frac{1}{3} k \right) + pn \frac{1-k}{k} \left( 1 - \frac{d_c}{d} \right)$ , the formula changes to

*Maximum Compression Stresses in Concrete,*

$$f_c = \frac{M}{C_b b d^2} \dots \dots \dots (133)$$

*Maximum Tensile Stresses in Steel,*

$$f_s = n f_c \frac{1-k}{k} \dots \dots \dots (134)$$

The value of  $C_b$  and  $k$  may be taken from diagrams, pp. 940 and 941.

**HOW TO COMBINE THRUST WITH BENDING MOMENT**

In most cases where the formulas for direct stress and flexure are applicable, the bulk of the thrust is produced by one kind of loading and the bending moment by another kind of loading. For instance, in arches, the dead load produces very small bending but comparatively large thrust. The live load, on the other hand, produces small thrust but large bending moment. The thrust and the bending moment are therefore produced by two different agencies independent of each other. When the live load producing the bulk of the bending moment increases, the thrust and the bending moment do not increase in the same ratio.

The same condition is found in column design. The column load is produced by the load on all stories above the column, while the bending moment is produced mainly by the floors connected with the column. Here again, an increase in bending moment can take place, due to overloading of one panel, without corresponding increase in the thrust. Again, the thrust depends upon the loading of the floors above. It is a maximum when all floors are loaded and the thrust consists of the sum of all the live and dead loads above the floor. It is a minimum when the load consists of dead load only. It is possible that a condition producing maximum bending moment will take place simultaneously with a minimum thrust.

From the above, it is obvious that, to get the worst stress condition, it is not permissible to combine the maximum thrust with the maximum bending moment, since they do not always occur simultaneously. On the contrary, it is necessary to find a type of loading which will give the required factor of safety.

In every design problem, the object is to produce a member with a certain factor of safety, that is, a member in which, for a load equal to the design load multiplied by the factor of safety, the stresses are equal to or smaller than the elastic limit of the material.

In simple members, such as beams subjected to simple flexure, the computed stresses due to dead load are of the same character as those due to live load, and their magnitude is in direct proportion to the intensity of the loading. Also, the computed stresses for twice the design load, for instance, are twice as large as for the design load. Therefore, instead of multiplying the loads by the factor of safety and then working with stresses at elastic limit, designers use the simple expedient of establishing working stresses by dividing the stresses at elastic limit by the factor of safety. The problem is then solved by computing the bending moments for design load and determining the dimensions so that the stresses do not exceed the working stresses. This method simplifies the work, but it creates the wrong impression that the stress conditions at the design load are the determining factor. This is particularly misleading in reinforced concrete, where the *actual* stress conditions at the design load are no indication of the actual stresses at the load equal to design load times the factor of safety, even in simple structures. This is still more the case where it is necessary to combine stresses due to different types of loadings.

In structures subjected to combined action, this simplification is not permissible without first making an adjustment between the load producing the bending moment and the load producing the thrust. As explained above, it is impossible to get a common multiplier for the two types of loading. The examples will make the matter clear.

Suppose that, in an arch, a certain cross section, normal to the axis, is 12 in. wide and 18 in. deep and that the normal thrust due to the dead load is  $N_d = 35\,000$  lb. and acts at the center of the section. At the same section the thrust due to live load is  $N_l = 15\,000$  lb. and the bending moment  $M_l = 160\,000$  in.-lb.

If the thrust and bending moments due to live and dead load were added, the resultant thrust would be  $N = 15\,000 + 35\,000 = 50\,000$  lb. and the bending moment  $M = 160\,000 + 0 = 160\,000$  in.-lb. From Formulas (94) and (95), p. 170, the stresses would then be

$$f_c = \frac{50\,000}{12 \times 18} \pm \frac{160\,000 \times 6}{12 \times 18^2} = 232 \pm 248 \text{ lb. per sq. in.}$$

The maximum stress would figure  $f_c = 480$  lb. per sq. in. and minimum stresses  $f_t = -16$  lb. per sq. in.

Since compression is not excessive and there is no appreciable tension in the section, the design would appear to be satisfactory. However, this is not the case, as there is no factor of safety. Suppose that a factor of safety of 2.5 is required, i.e., that the structure must stand 2.5 times the design live load before failure. Let us apply this to this example. Taking 2.5 times the live load, the thrust and the bending moment due to the live load given above must be multiplied by 2.5. Thus,  $N_l = 37\,500$  lb. and  $M_l = 400\,000$  in.-lb. The thrust due to the dead load, on the other hand, can never be exceeded and remains 35 000 lb.

Thus, the sum of thrusts for live and dead load is  $N = 37\,500 + 35\,000 = 72\,500$  lb., and the bending moment is  $M_t = 400\,000 + 0 = 400\,000$  in.-lb. The stress is

$$f_c = \frac{72\,500}{12 \times 18} \pm \frac{6 \times 400\,000}{12 \times 18^2} = 336 \pm 617 \text{ lb. per sq. in.}$$

The maximum stress is  $f_c = 953$  lb. per sq. in., and the minimum stress is  $f_t = -281$  lb. per sq. in.

For a live load equal to 2.5 times the design live load, therefore, instead of a tensile stress of  $16 \times 2.5 = 40$  lb., we actually get the excessive tensile stress of 281 lb. per sq. in. It is evident that, for this condition, the tensile stresses actually developed are considerably greater than the first method would have indicated.

From the above illustration, it is evident that, to get a proper idea of the stress condition to be expected in case of overloading, it is necessary to investigate the stresses for dead load plus the live load multiplied by a factor of safety. For such a condition, instead of using working stresses as the requirement, the stresses must not exceed the elastic limit in materials. This is more fully explained in the "Arch Chapter," in Volume II.

The method to be employed in designing columns subjected to bending is discussed on p. 458.

#### MEMBERS SUBJECTED TO DIRECT TENSION AND BENDING

Members are subjected to direct tension and bending when they receive simultaneously a central pull,  $T$ , and a bending moment,  $M$ , or when the pull,  $T$ , acts eccentrically. These two conditions are

interchangeable, as explained with relation to members subjected to positive thrust and bending, since they produce the same stresses. The central pull,  $T$ , and bending moment,  $M$ , may be replaced by an eccentric pull,  $T$ , acting at an eccentricity equal to  $\frac{M}{T}$ . The reverse is also true.

A positive bending moment, i.e., a bending moment producing tension at the bottom and compression in the top, may be replaced by a pull acting below the axis. A negative bending moment may be replaced by a pull above the axis.

Two conditions are considered below: first, the whole section is under tensile stresses; second, part of the section is under compression.

For Notation see p. 167.

**Whole Section under Tension.**—Assume that a rectangular section, with bars arranged as in Fig. 64, is subjected to a tensile force,  $T$ , and a bending moment,  $M$ . The eccentricity is  $e = \frac{M}{T}$ . Assume that the eccentricity is such that the whole section is under

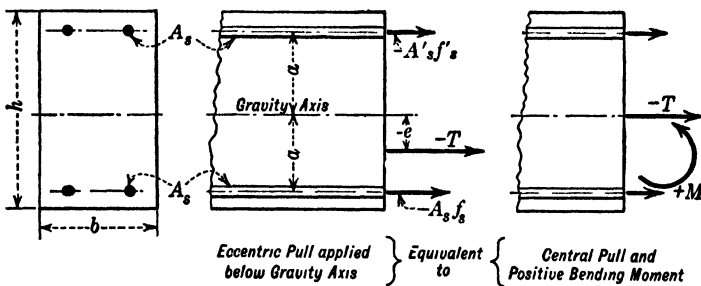

FIG. 64.—Section Subjected to Direct Tension and Bending. (See p. 190.)

tension. Since concrete cannot resist any tension, all stresses must be resisted by the steel. For equilibrium, the sum of all the stresses must equal  $T$ . Therefore,

$$-T = -(A'_s f'_s + A_s f_s). \quad \dots \quad (135)$$

From the figure, it is found that the stress in the reinforcement nearest the force,  $T$ , equals

$$A_s f_s = T \frac{a + e}{2a}. \quad \dots \quad (136)$$

The stress in the reinforcement away from  $T$  is

$$A'_s f'_s = T \frac{a - e}{2a}. \quad \dots \dots \dots (137)$$

The two equations are sufficient to determine the stresses carried by the respective tensile members. Since in each equation two values, namely,  $A_s$  and  $f_s$ , are unknown, it is necessary to make some assumption. Either the area of steel is assumed and the stress determined, or the stresses are accepted and the areas computed.

If  $A_s = A'_s$ , the required area of steel is obtained from the following equation,

$$A_s = \frac{T}{f_s} \frac{a + e}{2a}, \quad \dots \dots \dots (138)$$

in which  $f_s$  is the maximum allowable tensile stress in steel. The stress in the other section is  $f'_s = f_s \frac{a - e}{a + e}$ . It is smaller than the allowable stress.

If it is desired to use the same unit stress in both rows of bars, i.e.,  $f_s = f'_s$ , the area next to  $T$  is found from Equation (136) and the area away from  $T$  from equation

$$A'_s = \frac{T}{f_s} \frac{a - e}{2a} = A_s \frac{a - e}{a + e}. \quad \dots \dots (139)$$

The stresses in the set of bars next to the thrust are always tension. From Equation (137) it follows that in the other set of bars the stresses are tensile for  $e$  smaller than  $a$ . For  $e = a$ , i.e., when force  $T$  acts in the center of gravity of the one row of bars, the stresses in the upper row are zero. For  $e$  larger than  $a$ , compression stresses will be developed in the section and the formulas are not applicable.

**Part of Section under Compression.**—When the eccentricity,  $e$ , is larger than  $a$ , part of the section is under compression.

Referring to Fig. 65, p. 192, and making the same assumption as given in connection with simple flexure on p. 126, the relation between the stresses in steel and concrete is as follows:

*Unit Compression Stress in Upper Steel,*

$$f'_s = n f_c \left( 1 - \frac{d'}{kd} \right). \quad \dots \dots \dots (140)$$



*Unit Tensile Stress in Lower Steel,*

$$f_s = n f_c \frac{1 - k}{k} \dots \dots \dots (141)$$

The stresses may be determined from the principle that for equilibrium the sum of the stresses acting on the section must equal the pull,  $T$ . The stresses resisted by the concrete are  $\frac{f_c b k d}{2}$ . The stresses resisted by the compression steel are  $A'_s f'_s = A'_s n f_c \left(1 - \frac{d'}{k d}\right)$ .

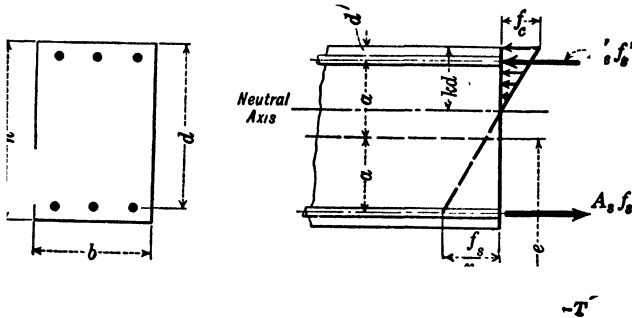

FIG. 65.—Direct Tension and Bending Moment. Part of Section in Compression. (See p. 191.)

The stresses resisted by the tensile steel are  $A_s f_s = A_s n f_c \frac{1 - k}{k}$ .

Adding these, we have

$$- T = \frac{f_c b k d}{2} + A'_s n f_c \left(1 - \frac{d'}{k d}\right) - A_s n f_c \frac{1 - k}{k} \dots \dots \dots (142)$$

The sign before  $T$  is minus because the force is a pull.

Assume that  $A'_s = A_s = \frac{p}{2} b d$ , we have

$$- T = \frac{f_c b d}{2} \frac{k^2 + 2 n p k - n p \frac{h}{d}}{k} \dots \dots \dots (143)$$

This equation is the same for positive thrust and moment, except that  $T$  is negative instead of positive.

The second requirement is that the bending moment of all external forces about the center of gravity must be equal to the bending moment of all internal forces about the same axis. Taking

the moment of all stresses about the gravity axis and expressing  $f_s$  and  $f'_s$  in terms of  $f_c$ , the equation of the moment of internal forces is

$$M = f_c b d^2 \left[ \frac{np}{k} \left( \frac{a}{d} \right)^2 + \frac{k}{4} \frac{h}{d} - \frac{k^2}{6} \right]. \quad (144)$$

This equation is identical with Equation (122) for positive thrust and bending moment. For equal  $M$ , the stresses, however, will be different because the value of  $k$  is smaller for pull and bending moment than for positive thrust and bending moment.

The value in square brackets may be called  $C_a$ , and the equation changes to  $M = f_c b d^2 C_a$ , from which

*Maximum Compression Stress,*

$$f_c = \frac{M}{C_a b d^2}. \quad (145)$$

*Maximum Tensile Stress,*

$$f_s = n f_c \frac{1 - k}{k}. \quad (146)$$

**Value of  $k$ .**—In the above equation, the value of  $C_a$  depends upon the value of  $k$ . This can be determined by equating the value of  $M$  from Equation (144) to the value of  $T_e$  obtained by multiplying Equation (143) by  $-e$ .

Solving the equation for  $\frac{e}{d}$ , we have

$$\frac{e}{d} = \frac{-k^3 + 1.5k^2 \frac{h}{d} + 6np \left( \frac{a}{d} \right)^2}{-3k^2 - 6npk + 3np \frac{h}{d}}. \quad (147)$$

This equation is similar to the Equation (128) for positive thrust and moment. *The difference is in signs.*

The direct equation is an equation of the third degree. It is easier to find  $k$  by trial, as explained on p. 184. In assuming the first value of  $k$ , it must be remembered that it is much smaller than the  $k$  in ordinary beams.

**Use of Formulas.**—In practice, the problem usually is to determine the stresses in steel and concrete for known dimensions and given values of  $T$  and  $M$ .

In solving the problem, the value of  $e$  is found first, from  $e = \frac{M}{T}$ .

Next, the value of  $k$  is found by trial from Formula (147) for the known value of  $\frac{e}{d}$ . Finally, the value of  $k$  is substituted in the formula for  $C_a$  and the values of  $f_c$  and  $f_s$  are computed.

If dimensions  $b$  and  $d$  are in inches and  $M$  in inch-pounds, the stresses are in pounds per square inch.

### FLAT SLAB THEORY

Flat slab construction is statically indeterminate, i.e., the static equations of equilibrium are not sufficient to determine external shears and bending moments in the various parts of the slab. The problem can be solved only by consideration of the deflection of the slab and the relation between the deformations and the stresses. This makes the bending moments dependent not only upon the loads, as in statically determinate structures, but also upon the elastic properties of the slab and the relative stiffness of the different parts. The purely mathematical problem is made difficult because the material composing the slab is not homogeneous. It is also complicated by the fact that the slab deflects in two directions and that the equations for deflection are functions of three variables,  $x$ ,  $y$ ,  $z$ , instead of two variables as is the case with continuous beams. The solution of the equations cannot be obtained by integration but by approximate summation. The actual solution is still further complicated by the uncertainty of the application to concrete construction of the formulas based on the assumption of homogeneous slab, and also by the uncertainty of the value of Poisson's ratio. Furthermore, it has been observed that, in a slab under load, a readjustment of stresses takes place for which it is not possible to make any allowance in the analysis.

**Statical Limitations.**—It is well known that, in continuous beams or slabs, for uniformly distributed load, the numerical sum of the positive bending moment in the center and the average of the negative bending moments at the two supports is equal to the maximum positive bending moment (which is at the center) for the beam or slab if considered as simply supported. If  $-M_a$  and  $-M_b$  are negative moments at the supports  $a$  and  $b$ , and  $M_c$  is the positive moment at the center of the span, then

$$\frac{M_a + M_b}{2} + M_c = \frac{1}{8}wl^2.$$

Applying the same rule to flat slab construction, Mr. Nichols<sup>8</sup> demonstrated that in an interior flat slab panel, shown in Fig. 66, p. 195, the sum of the negative bending moment along section 1-1 and the positive bending moment along section 2-2 equals static

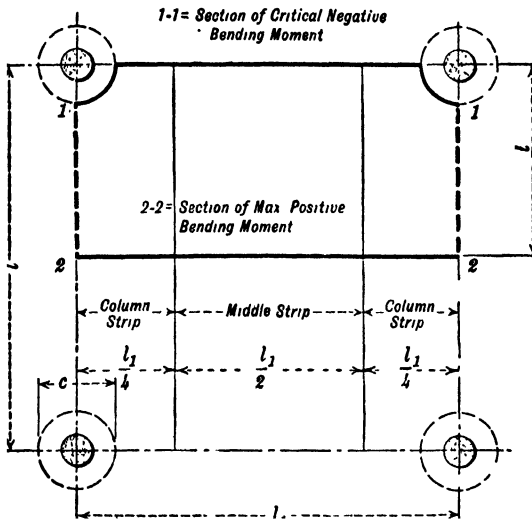

Bending Moments act at right angles to Sections  
 $l$  = Length of span in the direction of Bending Moments  
 $l_1$  = Length of span at right angles to  $l$   
 Note that the designation of  $l$  and  $l_1$  depends upon the direction of Bending Moment and not upon relative length of spans.

FIG. 66.—Moment Sections in Flat Slab Panel. (See p. 195.)

bending moment in the center of a freely supported slab with a span equal to  $l\left(1 - \frac{2c}{3l}\right)$ . This is expressed by the following equation:

- Let  $w$  = unit live and dead load;
- $l$  = side of a square panel;
- $c$  = diameter of the column capital;
- $M_1$  = negative bending moment along the edge of the panel, section 1-1.
- $M_2$  = positive bending moment along the center of panel, section 2-2.

<sup>8</sup> "Statistical Limitations upon the Steel Requirement in Reinforced Concrete Flat Slab Floors," by John R. Nichols, Trans., Am. Soc. C. E., Vol. 77.

Then

*Sum of Bending Moments,*

$$M_1 + M_2 = \frac{1}{8}wl^3 \left(1 - \frac{2c}{3l}\right)^2 \dots \dots \dots (148)$$

**Distribution of Moments.**—The above formula does not show how to distribute the bending moments between the positive and negative bending moment. The distribution can be determined only by means of equations taking into account the deformation of the slab. This problem was treated by Mr. Westergaard.<sup>9</sup> In his analysis, Mr. Westergaard used the results obtained by N. J. Nielsen for uniformly loaded square panels extending indefinitely in all directions and supported upon point supports. These results were obtained by dividing each panel into one hundred elementary squares and computing the deflection of each corner of each elementary square. The moments then were determined from deflections by the summation method. Since Nielsen's results were not directly applicable to flat slabs supported along a column capital, they were modified by Mr. Westgaard by the introduction at the column head of the so-called ring loads, consisting of a combination of an upward load uniformly distributed along the circumference of the column head, with an equally large downward load applied at the center of the column head. The two loads balance, but produce a bending moment at the column head. A ring load of the proper intensity at each point support, combined with a certain uniformly distributed bending moment applied at the edge of the whole slab (which includes many panels), and combined with the original uniformly distributed load and the reactions at the point support, will make the slab deflect in such a way that at circles marking the column capitals it will become horizontal and tangential to the deflection curve.

The sum of the positive and negative moments is the same as found by Mr. Nichols, since both theories start with the same general assumption. The distribution of the moments along the various design sections is given in the table. The design sections referred to in the table are those shown in Fig. 66, p. 195.

**Application of the Theoretical Moments.**—The above bending moments and their distribution are only of theoretical significance.

<sup>9</sup> Moments and Stresses in Slabs, by H. M. Westergaard and W. A. Slater. Proceedings, American Concrete Institute, p. 415, Vol. XVII, 1921.

In actual construction, the stresses in steel are much smaller than would be obtained from the above formulas. The reasons are:

1. The Poisson's ratio in the formulas was assumed as equal to zero. This is not the case in an actual slab.

**Percentages of Sum of Positive and Negative Moments Resisted in Sections Shown in Fig. 66**

Computed by H M Westergaard

Results of analysis of a square interior panel of a uniformly loaded homogeneous flat slab.

The sum of positive and negative moments is approximately equal to

$$M_0 = \frac{1}{8} Wl \left( 1 - \frac{2}{3} \frac{c}{l} \right)^2$$

$c$  = diameter of column capital;  $l$  = span;  $W$  = total panel load; Poisson's ratio = 0.

Description of Moments		$\frac{c}{l}$				Average	
		0.15	0.20	0.25	0.30		
Negative Moments...	Column Strips. {	Across edge of capital.	31.8	37.1	40.2	42.7	$20 + 80 \frac{c}{l}$
		Outside capital . . . . .	16.5	11.3	8.1	5.7	$28 - 80 \frac{c}{l}$
	Total . . . . .		48.3	48.4	48.3	48.4	48
	Middle Strip. . . . .	17.0	16.7	16.6	16.3	17	
Total Negative Moment..		65.3	65.1	64.9	64.7	65	
Positive Moments...	Column Strip. . . . .	20.9	20.9	20.8	20.7	21	
	Middle Strip. . . . .	13.8	14.0	14.3	14.6	14	
	Total Positive Moment....	34.7	34.9	35.1	35.3	35	

2. A considerable amount of tension is carried by the concrete. Since this happens in every test and since, because of this, flat slab construction is able to carry, without signs of distress, loads under which it should have failed according to the theoretical formulas, it is clear that advantage should be taken of these factors.

3. Considerable arch action takes place, which increases the total compression, but reduces the total tension in the slab.

Since the theoretical formulas are not in close accord with the practical results, they were modified for practice, and thus brought into closer agreement with the results from the tests.

**Action of Flat Slabs.**—To get an understanding of the action of a flat slab, consider its deflection under load. Figure 67 shows, by

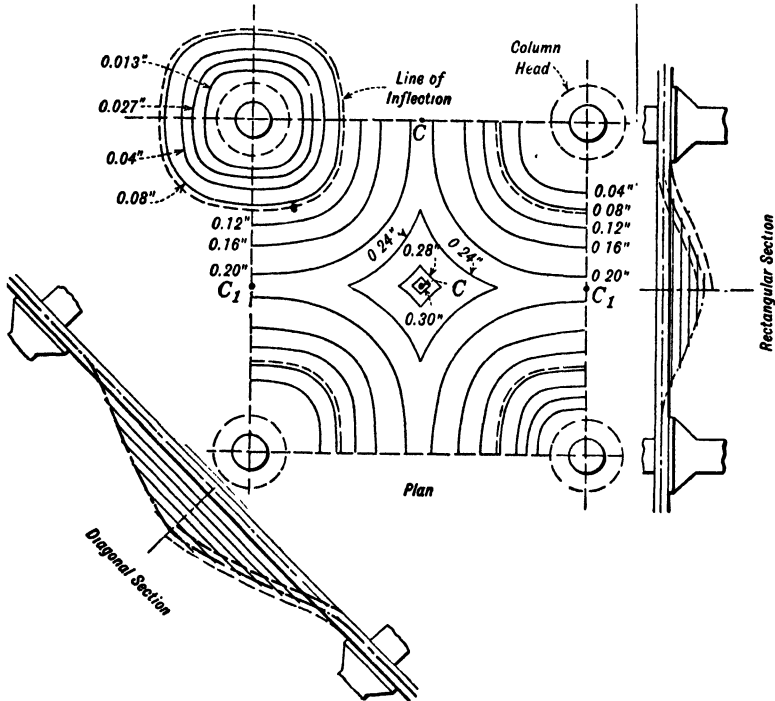

FIG. 67.—Contour Lines for Flat Slab. (See p. 198.)

means of contour lines, the deflection of one panel taken from a continuous floor, where it and the surrounding panels were uniformly loaded. The contour lines are curves connecting points of equal deflection, i.e., points which, after loading, deflect an equal distance below the original level of the slab. The points were obtained by drawing cross sections along the edge of the panel and along a diagonal section, and plotting their deflection curves. This curve of deflection, just as for continuous beams, is determined by the requirements that the tangents at the support and at the center of the

span shall be horizontal and that the points of inflection shall be at about one-fifth of the net span. After the deflection curves have been drawn the contour lines were plotted from the deflection curves. From the contour lines it is evident that a flat slab, after deflection, assumes the shape of an umbrella at the column head, of a trough between the columns, and of a saucer in the central portion.

**Points of Inflection.**—Since the bending moments change from negative at the column head to positive at the center of the slab, there must be a line of zero moment, or a line of points of inflection surrounding each column. This line of points of inflection divides the slab into circumferential cantilevers concentric with the columns and firmly clamped to them, slabs extending between adjacent columns and supported on both ends, and square or rectangular panels supported on four edges.

**Stresses at Column Head.**—It is evident from the contour lines and lines of deflection that the portion of the slab at the column head, which acts as a circumferential cantilever, is subjected to a negative bending moment causing tensile stresses at the top and compressive stresses at the bottom. Assuming the umbrella shape, the slab undergoes deformation in two directions, namely, in the direction of the radius of any circle drawn on the slab around the column, and also along the circumference of the circle, because both the radius and the circumference are increased by the deflection. The particles, therefore, are subjected to two stresses, radial and circumferential, acting at right angles to each other. The reinforcement at the column head, therefore, must be placed in two directions, preferably radial and circumferential.

As explained in text books on mechanics, when a particle is subjected to forces acting at right angles to each other, its actual deformation in any direction is smaller than if the force in this direction acted separately, because the longitudinal deformation due to one force is decreased by the lateral deformation produced by the force acting at right angles. The ratio of decrease, called Poisson's ratio,<sup>10</sup> is taken into account in fixing the constants recommended in the Chapter VI on Design of Flat Slab Structures.

<sup>10</sup> If a particle is subjected to compression, it shortens in the direction of the force, but at the same time it extends laterally. The ratio between the longitudinal shortening and the lateral extension is called Poisson's ratio. It varies for different materials. If the particle is subjected to stress in one direction only, the Poisson's ratio has no significance. It is important only when the particle is subjected to stresses at right angles to each other.



**Stresses in Central Portion.**—The central portion of the slab between the points of inflection is subjected to positive bending moment, causing tension below and compression above. The portion of the slab between adjacent columns develops stresses in one direction only, since the contour lines are practically perpendicular to the center line through the columns. The portion in the middle of the panel, on the other hand, is stressed in two directions, since the conditions there are somewhat similar to those at the column head, except that they are reversed.

In the first case, the steel must be placed in one direction only, while in the other case, it must be circular or placed in two directions.

The bending moments recommended for design are given in Chapter VI.

## CHAPTER V

### REINFORCED CONCRETE DESIGN

In this chapter are given the definite principles and rules used in the design of reinforced concrete structures. The matter is based on the two preceding chapters, one of these goes much more fully than the present chapter into the fundamental theory of reinforced concrete, giving formulas and their derivations for rectangular beams, T-beams, beams with steel in top and bottom, columns, and members under direct compression and flexure; while the other chapter describes the tests which verify both theory and rules for design. The working formulas which are necessary in actual design are taken up in the present chapter. Before using these final formulas, the designer should become acquainted with the derivations already given so as to have a thorough understanding of the subject.

#### RATIO OF MODULI OF ELASTICITY

As given in Volume III of this treatise, the value of the modulus of elasticity of concrete depends upon the quality of the aggregates used, the consistency, and the age. It varies also for different intensities of the stresses, but may be considered constant within working limits. The modulus of elasticity of steel being practically constant (see p. 203), the ratio of the modulus of steel to that of concrete changes in direct proportion to the change in the modulus of concrete. This ratio is designated by the letter  $n$ .

In computations, it is advisable to vary the ratio according to the ultimate strength of the concrete. The ratios,  $n$ , recommended<sup>1</sup> for use are:

- (a) For concrete having a crushing strength of 2 200 lb. per sq. in. or less, a value of 15.

<sup>1</sup> These values agree with the recommendations of the Joint Committee, 1924.

- (b) For concrete having a crushing strength between 2 200 and 2 900 lb. per sq. in., a value of 12.
- (c) For concrete having a crushing strength exceeding 2 900 lb. per sq. in., a value of 10.

The value of 15 has been adopted in the British, German, and Austrian rules up to 1916. The French rules for 1907 authorize a range from 8 to 15 according to conditions. For determining deflection of beams when using formulas which do not take into account the tensile strength developed in the concrete, a ratio of 8 may be used.

The effect of the ratio of moduli on the stresses in beams may be seen from the formulas and also from the tables. For a given beam with a definite amount of steel, the use of a higher ratio of moduli lowers the position of the theoretical neutral axis, and for a given bending moment decreases the stresses in concrete and increases the stresses in steel, the latter, however, in much smaller proportion. For the same unit stresses and bending moments, but different ratios of moduli, the beam designed for the larger ratio will have a smaller depth, but at the same time a larger amount of steel. Therefore, in beam design, if a concrete richer than ordinary is used, the question of economy must be carefully considered.

**Modulus of Elasticity in Tension.**—But few tests of modulus of elasticity of concrete in tension have been made, but these indicate that the value is probably the same as the modulus in compression.

**Significance of Yield Point of Steel in Reinforced Concrete.**—In reinforced concrete construction, the yield point of steel marks the failure of the structure. The ultimate tensile strength of steel is important only as far as it indicates the quality of the material. It can never be reached in reinforced concrete structures, as all concrete construction fails by compression soon after the yield point of steel is exceeded. Tests show that when the yield point of steel in the beam reinforcement is reached, the beam sags, and the cracks widen and extend upward into the compression zone. Any small increase in loading beyond the load producing yield point increases the width of the cracks considerably and extends them up into the compression zone. When the load is still further increased, the compression zone becomes finally reduced to such an extent that the beam fails by crushing of the concrete. This type of failure takes place even if the beam is very strong in compression. As the

failure always follows closely the yield point in steel, the strength of the beam is based upon the yield point of the reinforcement, and not upon its ultimate strength.

**Modulus of Elasticity of Steel.**—The modulus of elasticity of all grades of steel is substantially the same, namely, 30 000 000 lb. per sq. in. It does not vary with the strength of steel, as is the case with concrete. This is unfortunate, as steel with high modulus of elasticity would be particularly serviceable for reinforced concrete, because the higher the elastic limit, the smaller is the deformation under any given loading.

### FORMULAS FOR DESIGN OF RECTANGULAR BEAMS

Reinforced concrete beams must have breadth and depth sufficient to keep the compression stresses within working limits, and enough tensile reinforcement to take all the pull without exceeding the working stress of the steel. Rules for this are given in the simple formulas which follow. The bond stresses must be investigated (see p. 260), and also inclined or vertical reinforcement may be required, as stated in connection with diagonal tension, pp. 241 to 260. Continuous beams also require tensile reinforcement over the supports, as described on pp. 285 to 290.

For derivation of formulas, see chapter on "Theory of Reinforced Concrete."

**Balanced Design of Rectangular Beam.**—The design of a rectangular beam is balanced if its concrete dimensions are determined by Formula (1), (1a) or (2); and the amount of steel by Formula (3), using constants corresponding to the specified unit stresses. In such beams unit stresses in both materials reach their maximum working value simultaneously.

**Unbalanced Design of Rectangular Beam.**—The design is not balanced, if the depth is larger than required by Formula (1), or the amount of steel larger than required by Formula (3). See also p. 206.

Let  $d$  = effective depth of beam;

$b$  = breadth of rectangular beam;

$A_s$  = area of steel in tension;

$p$  = steel ratio,  $\frac{A_s}{bd}$ ;

$M$  = bending moment or moment of resistance;



the working stresses in steel and concrete and to their ratio of elasticity.

The following table gives the values of constants for selected stresses:

Constants in Beam and Slab Design \*

For use in beam formulas  $d = C\sqrt{\frac{M}{b}}$  and  $d = \sqrt{\frac{M}{bR}}$  and in slab formula  $d = C_1\sqrt{M}$ . (See pp. 204 and 208.) For additional values, see table on p. 880.

Proportion	Ultimate Strength	n	Allowable Unit Stresses, Lb. per Sq. In.		k	j	p	C	C <sub>1</sub>	R
			Steel f <sub>s</sub>	Concrete f <sub>c</sub>						
1 : 1 : 2	3 000	10	16 000	1 200	0 429	0 857	0 0161	0 067	0 019	221
1 : 1½ : 3	2 500	12		1 000	0 429	0 857	0 0134	0 074	0 021	184
1 : 2 : 4	2 000	15		800	0 429	0 857	0 0107	0 083	0 024	147
1 : 2½ : 5	1 600	15		640	0 375	0 875	0 0075	0 098	0 028	105
1 : 3 : 6	1 300	15		520	0 328	0 891	0 0053	0 115	0 033	76
1 : 1 : 2	3 000	10	18 000	1 200	0 400	0 867	0 0133	0 070	0 020	208
1 : 1½ : 3	2 500	12		1 000	0 400	0 867	0 0111	0 076	0 022	173
1 : 2 : 4	2 000	15		800	0 400	0 867	0 0089	0 085	0 024	139
1 : 2½ : 5	1 600	15		640	0 348	0 885	0 0062	0 101	0 029	99
1 : 3 : 6	1 300	15		520	0 302	0 899	0 0044	0 118	0 034	70

**IMPORTANT NOTE:** The values in the above table can be used only when special care is taken to produce concrete of strengths assumed in the table and when the strength is checked by field tests. If no field tests are made, use in design the constants for the next lower mixture. Thus for 1 : 2 : 4 concrete use constant corresponding to 1 : 2½ : 5 concrete.

**Example 1.**—What depth of beam and what area of steel are required for a freely supported beam having a span of 18 ft. and supporting a load of 600 lb. per running foot. 2 000 lb. concrete and structural grade steel are used. The stresses are  $f_c = 800$ ,  $f_s = 16 000$ ,  $n = 15$ .

$$* k = \frac{1}{1 + \frac{f_s}{nf_c}}, j = 1 - \frac{1}{3}k, p = \frac{f_c}{2f_s}k, C = \frac{1}{\sqrt{pf_sj}}, C_1 = \frac{1}{\sqrt{12}}C, R = pf_sj.$$

*Solution.*—Bending moment,  $M = \frac{wl^2}{8} \times 12 = \frac{600 \times 18 \times 18 \times 12}{8} = 291\,600$  in.-lb. From table above, for specified working stresses, the constants are  $C = 0.083$  and  $p = 0.0107$ . Assuming a breadth  $b = 8$  in. and using Formula (1),

$$d = 0.083 \sqrt{\frac{291\,600}{8}} = 15.8 \text{ in.}$$

With 2 in. of concrete below the center of steel, the total depth of beam is thus 17.8 in. In practice, a depth in even inches should be adopted.

The area of steel, from Formula (3), is  $A = 0.0107 \times 8 \times 15.6 = 1.34$  sq. in., thus requiring three  $\frac{3}{4}$ -inch round bars, or their equivalent.

**Value of  $f_s$ ,  $f_c$ , and  $p$  are Interdependent.**—The stresses,  $f_s$  and  $f_c$ , and the ratio,  $p$ , are interdependent. To any pair of values of  $f_s$  and  $f_c$ , there corresponds only one value of  $p$ . With  $f_s$  and  $f_c$  given, the corresponding ratio,  $p$ , must never be exceeded, else, if the stress in the steel  $f_s$ , were maintained, the stress in the concrete would be increased beyond the allowable working stress,  $f_c$ .

If, for resisting the bending moment, it is necessary to use a larger ratio of steel than the value  $p$  corresponding to the adopted working stresses, and at the same time maintain the stress in steel,  $f_s$ , and stress in concrete,  $f_c$ , the excess tensile steel must be balanced by compression steel, as discussed on p. 232, or else concrete of richer mix should be used.

Sometimes the ratio,  $p$ , is increased to reduce bond stresses. In such a case, however, the stress in steel is reduced correspondingly, so that the compression stresses are not affected.

**Example 2.**—To the stresses  $f_s = 16\,000$  and  $f_c = 650$ , specified by the New York Code, corresponds a ratio of steel  $p = 0.0077$ . If a ratio of  $p = 0.01$  were used and the steel were stressed to 16 000 lb. per sq. in., the corresponding stress in concrete would be 770 lb., instead of 650 lb., per sq. in. To maintain, with a ratio  $p = 0.01$ , the stress in concrete  $f_c = 650$  lb. per sq. in., without adding compression steel, it would be necessary to limit the stress in steel to 13 000 lb. per sq. in. This shows that, with too large a ratio of steel and no provision for additional compression, the full working value of steel cannot be utilized and therefore the beam is not economical.

**Formulas to Review Rectangular Beams Already Designed.**—The following formulas, the derivation of which is given on p. 130, may be used to review a beam already designed.

$f_c$  = compressive unit stress in concrete, in pounds per square inch;

$f_s$  = tensile unit stress in steel, in pounds per square inch;

- $b$  = breadth of beam in inches;
- $d$  = effective depth of beam in inches;
- $k$  = ratio of depth of neutral axis to depth of beam,  $d$ ;
- $j$  = ratio of distance between the centers of compression and tension to depth of beam,  $d$ ;
- $jd = d\left(1 - \frac{k}{3}\right)$  = moment arm, or distance between the centers of compression and tension;
- $A_s$  = area of cross section of steel in square inches;
- $p$  = steel ratio =  $A_s \div bd$ ;
- $M$  = bending moment in inch-pounds;
- $n$  = ratio of modulus of elasticity of steel to that of concrete.

Then

$$p = \frac{A_s}{bd} \quad (4) \quad k = \sqrt{2np + (np)^2} - np \quad (5) \quad j = 1 - \frac{k}{3} \quad (6)$$

*Stresses in Steel and Concrete,*

$$f_s = \frac{M}{A_s jd} \quad (7) \quad f_c = \frac{2M}{bd^2 jk} \quad (8)$$

The value of  $p$  is figured first, then  $k$  and  $j$  are computed or taken from the table on p. 205, and substituted in Equations (7) and (8).

**Neither the allowable tension in steel nor the allowable compression in concrete should be exceeded.** For explanation see p. 206.

**Approximate Formulas.**—For rectangular beams designed with the stresses ordinarily used, the moment arm,  $jd$ , is about  $\frac{7}{8}d$  and the above formulas may be expressed as

*Stresses in Steel and Concrete,*

$$f_s = \frac{M}{0.87A_s d} \quad (9) \quad f_c = \frac{6M}{bd^2} \quad (10)$$

**Tables and Examples.**

Tables for determining the dimensions and loading of rectangular beams are given on pp. 884 and 885, and the methods of practical computation and details of design are illustrated in Example 1, p. 578. T-beams are treated on p. 215.

The selection of bending moments for use in design of continuous beams is treated on p. 275.

**Factor of Safety.**—Full explanation of the factor of safety is given on p. 125.



## DESIGN OF SLABS

A slab, so far as computation is concerned, is a rectangular beam. The dimensions and stresses, therefore, can be obtained by the formulas given for rectangular beams.

The bending moment is usually figured for a 1-ft. width of slab. The formula for depth of slab can be simplified by combining the selected value of  $b = 12$  in. with the constants given for rectangular beams, changing formulas as given below. In the formula for required area of steel,  $A_s$ , it is most convenient to assume a width of slab,  $b = 1$  in. The formula then gives the area of steel per inch of width of the slab, and the spacing of the bars can be readily determined by dividing the cross-sectional area of a bar by the determined area per inch of width of slab.

Using notation on p. 203, and making

$M$  = bending moment in inch-pounds per foot of width of slab;

$A_s$  = area of steel in square inches per inch of width;

$C_1$  = constant based on these units;

the Formulas (1) and (3), change to

*Depth of Slab,*

$$d = 0.29C\sqrt{M} = C_1\sqrt{M} \text{ (inches)}. \quad \dots (11)$$

*Area of Steel,*

$$A_s = pd \text{ (per inch of width)}. \quad \dots (12)$$

The table on p. 205 gives the values of constants,  $C_1$  and  $p$ , for concrete of selected proportions. If larger depth of slab is used than required by this formula, the area of steel may be found from

$$A_s = \frac{M}{12jdf_s} \text{ (per inch of width)}. \quad \dots (13)$$

The use of these formulas is illustrated in Example 1, p. 579.

**Tables and Examples.**—Tables for determining dimensions and loading of slabs can be found on pp. 888 to 893. Table 6, on p. 886, gives dimensions and reinforcement for slabs for different live loads based on stress in concrete,  $f_c = 800$ , stress in steel,  $f_s = 16\,000$  and  $18\,000$  respectively, and ratio of elasticity,  $n = 15$ . Examples and details of design are given on pp. 210 to 579.

**Continuous Slabs.**—In slabs continuous over two or more supports, provision should be made for negative and positive bending

moments. For substantially equal spans and uniform loading, the following bending moments should be used:

Maximum positive bending moment near the center and negative bending moment at the support should be  $M = \frac{wl^2}{12}$  for interior spans and  $M = \frac{wl^2}{10}$  for exterior spans. The negative bending moment at the end support should be not less than  $M = \frac{wl^2}{16}$ . The span length in the formulas is the span between the edges of the supports. If in the above formulas  $w$  is in pounds per square foot and  $l$  is in feet, the moments are in foot-pounds. To change the moments to inch-pounds, multiply by 12.

**Reinforcement at Supports.**—To provide proper negative bending moment reinforcement at the supports, some of the bars (from one-half to five-eighths of the total area of bars) may be bent up and extended over the support into the next span. There they may terminate at the top about 6 in. beyond the point of inflection in this next span, or, if of 2-span length they may be bent down there and serve as positive bending moment reinforcement in the next span. Since the required area of steel at the support is equal to the required area in the center, and not all of the bars are bent up, the balance of the required area must be made up either by bent-up bars extended from the adjoining span or by extra short bars. Several arrangements of slab reinforcement are shown in Fig. 69, p. 210.

**Points of Bending Slab Steel.**—The point of bending should be selected so as to satisfy best the positive and negative bending moments. The authors recommend bending up the bars at a distance from the support equal to one-fifth of the net span,  $l$ , plus one-half the depth of the slab. For thick slabs, the point may be moved somewhat farther from the support.

The bend in the bars should be made around a pin of a diameter at least three times the diameter of the bar. Sharp bends may be injurious to the concrete. The bent portion should make, with the horizontal, an angle of from  $30^\circ$  to  $45^\circ$ , depending upon the ratio of the thickness of the slab to the span. The lower value should be used for thin slabs and the upper value for thick slabs. In exceptional cases, for very thick slabs, the angle of the bend may be made larger.

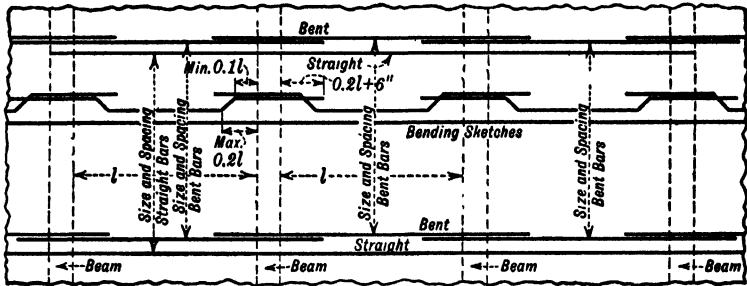

Scheme 1: Combination of Alternating Straight and Bent Bars.

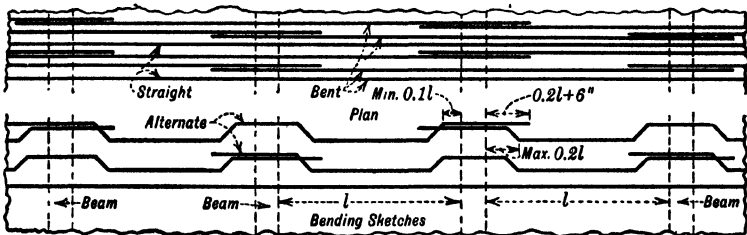

Scheme 2: Combination of One Straight and Two Bent Bars with Four Double Bends.

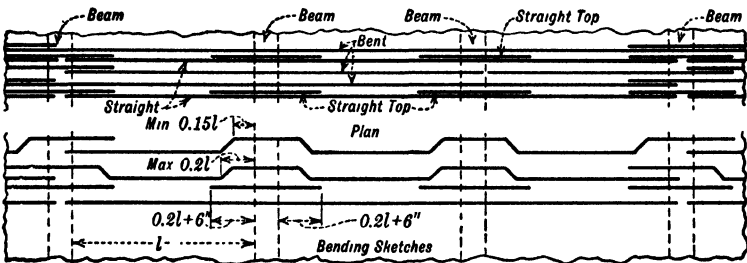

Scheme 3: Combination of One Straight, Two Bent Bars, and Straight Bars on Top.

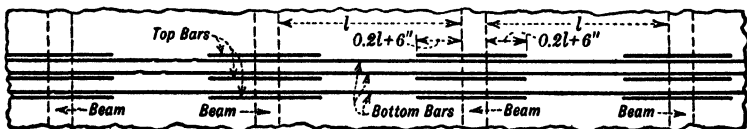

Scheme 4: Long Straight Bars on Bottom Short Straight Bars on Top.

Fig. 69.—Arrangement of Slab Reinforcement in Continuous Slabs.

(See p. 209.)

**Cross Reinforcement of Slabs.**—Cross reinforcement, that is, bars at right angles to the principal reinforcement, is customarily used to prevent shrinkage and temperature cracks. The amount of steel to use for this is usually selected somewhat arbitrarily, a cross-sectional area of bars equivalent to 0.2 per cent to 0.3 per cent ( $p = 0.002$  to  $0.003$ ) of the cross section of the slab being usual in practice.

**Reinforcement over Girders.**—If a girder is parallel to the principal reinforcement of the slab, short bars should be placed at the girder transversely, near the top of the slab, not only to stiffen the T-beam (see p. 38), but also to provide for the secondary negative bending moment produced by the bending of the slab next to the girder. This reinforcement is necessary even when the beam is simply a small stiffener. (See p. 223.)

The authors recommend that the amount of such reinforcement should not be less than 0.3 per cent of the effective area of the slab. The bars should be placed near the top of the slab, not farther apart than 18 in. Their length should not be less than two-thirds of the total effective width of the flange as given on p. 218. This recommendation agrees substantially with the 1924 Joint Committee recommendation.

**Bar Spacers.**—To keep the bars in place and a proper distance above the forms, the use of proper spacers is recommended. There are numerous types of spacers on the market, which serve not only to keep the bars in place, but also to keep them a proper distance above the forms. If no spacers are used, the bars should be securely tied to the transverse reinforcement.

**Computing Ratio of Steel in Slab.**—The ratio of steel in a slab may be found by dividing the cross section of one bar by the area between two bars, this area being the spacing of the bars times the depth of steel below top of slab. For example, a slab with steel 4 in. below the top and  $\frac{1}{2}$ -in. round bars spaced 6 in. apart has a ratio,

$$p = \frac{0.196}{4 \times 6} = 0.0082, \text{ or } 0.82 \text{ per cent steel.}$$

**Square and Oblong Slabs Supported by Four Beams.**—When a slab is supported by four beams and its length does not exceed  $1\frac{1}{2}$  times its width, the loads will be carried by the slab to all four beams, and therefore the slab must be reinforced in two directions, as shown below.

The load carried in either direction can be determined from the following formulas:

Let  $w$  = total unit load;  
 $w_B$  = unit load carried by the short span;  
 $w_L$  = unit load carried by the long span;  
 $L$  = length of slab;  
 $B$  = width of slab;

Then

$$w_B = \left( \frac{L}{B} - 0.5 \right) w, \quad (14)$$

and

$$w_L = \left( 1.5 - \frac{L}{B} \right) w. \quad (15)$$

The following table gives the ratio of the unit load,  $w_B$ , carried by the short span for different ratios of  $\frac{L}{B}$ :

Load Carried by the Shorter Span. (See p. 212.)

Ratio of Length to Breadth of Slab $\frac{L}{B}$	Load Carried by the Shorter Span, $w_B$	Ratio of Length to Breadth of Slab $\frac{L}{B}$	Load Carried by the Shorter Span, $w_B$
1.00	0.50w	1.30	0.80w
1.05	0.55w	1.35	0.85w
1.10	0.60w	1.40	0.90w
1.15	0.65w	1.45	0.95w
1.20	0.70w	1.50	1.00w
1.25	0.75w		

More thorough treatment of slabs reinforced in two directions is given in Volume IV in connection with the design of slabs for girder bridges.

After the proportion of the load is determined, the bending moments are found as for slabs reinforced in one direction, and the dimensions or stresses are found by the ordinary formulas. The thickness of the slab, of course, is governed by the larger bending moment of the two.

The above proportion is based on the assumption that the conditions of restraint on all four sides are the same. It does not apply if the slab is continuous in one direction and simply supported in the other direction; in this case the slab in the continuous direc-

tion will resist a much larger proportion of the load, because it takes a larger load to deflect a continuous slab an amount equal to the deflection of a simply supported slab.

**Most Economical Design of Rectangular Beam.**—To get the most economical design, the ratio of width of beam to depth should be as large as practicable. For any given width of beam best economy is obtained by the use of the balanced design of beam (see p. 203). No economy results from using a larger depth than required by Formula (1), p. 204, because the cost of additional concrete is larger than the saving in the cost of steel.

**Economy of Rich Mix of Concrete in Slabs.**—Under ordinary conditions no economy in the cost of the slab alone results from the use of concrete of richer mix than the leanest permissible in reinforced concrete, for the reasons given below. (See p. 4 for permissible mix.)

The use of richer mix of concrete results in smaller depth of slab with consequent reduction in the amount of concrete, but it requires a larger amount of reinforcement than necessary for the leaner mix. While the amount of concrete in cost for rich mix is smaller than for lean concrete, the difference in cost due to higher unit cost of rich mix, is small. The saving in cost of concrete is more than offset by the extra cost of steel.

As an illustration, compare the cost of slab required by  $M = 40\,000$  in.-lb. using  $1 : 2 : 4$  and  $1 : 1\frac{1}{2} : 3$  concretes with the unit stresses given in table on page 205. Following unit prices<sup>2</sup> should be used:  $1 : 1\frac{1}{2} : 3$  concrete—49 cents per cubic foot;  $1 : 2 : 4$  concrete—45 cents per cubic foot; steel—5 cents a pound.

The concrete dimensions and the required area of steel are found from Formulas (11) and (3).

Mix	Effective Depth	Total Depth	Area of Steel
$1 : 1\frac{1}{2} : 3$	$d = 0.021\sqrt{40\,000} = 4.2$ in.	$h = 4.2 + 1 = 5.2$ in.	$A_s = 0.0134 \times 4.2 \times 12 = 0.675$ sq. in.
$1 : 2 : 4$	$d = 0.024\sqrt{40\,000} = 4.8$ in.	$h = 4.8 + 1 = 5.8$ in.	$A_s = 0.0107 \times 4.8 \times 12 = 0.615$ sq. in.

Volume and cost of concrete:

Mix	Volume $\times$ Unit Cost = Cost per sq. ft. of floor
$1 : 1\frac{1}{2} : 3$	$\frac{5.2 \times 12}{144} = 0.43$ cu. ft. $\times 49 = 21$ cents
$1 : 2 : 4$	$\frac{5.8 \times 12}{144} = 0.48$ cu. ft. $\times 45 = 21.6$ cents
	Saving due to rich mix = 0.6 cents per sq. ft.

<sup>2</sup> Prices prevailing in year 1925.

## Weight and cost of steel:

Mix	Area of Steel	Weight of Steel × Unit Cost = Cost of steel per sq. ft. of floor
1 : 1½ : 3	0.675 sq. in.	2.3 lb. × 5 = 11.5 cents
1 : 2 : 4	0.615 sq. in.	2.1 lb. × 5 = 10.5 cents
Extra cost of steel = 1 cent per sq. ft.		

Since there is a saving in concrete due to rich mix of 0.6 cent and an extra cost of steel of 1.0 cent, the difference is 0.4 cent per sq. ft. in favor of leaner mix. Hence rich mix not economical.

**Economy of Rich Mix of Concrete in Rectangular Beams.**—Under some conditions the use of rich mix in beams is economical. It is particularly advantageous for very long spans or where heavy loads are to be carried with limited headroom. Often, the reduction in dead load resulting from the use of rich concrete is of advantage.

Rich mix of concrete permits reduction of the concrete dimensions of a beam. Either the depth may be reduced, keeping the width same as for leaner mix, or the depth may be used same as for leaner mix and the width reduced.

In the first case the conditions are identical with those explained in connection with slabs and no economy would result. In the second case distinct economy may result from the use of rich mixture as evident from example below.

As an illustration compare the cost of beams designed for 1 : 1½ : 3 and 1 : 2 : 4 mixes for a bending moment  $M = 720\,000$  in.-lb. when the depth of beam is limited to  $h = 22$  in. using stresses and constants in the table on p. 205.

Since the total depth is  $h = 22$  in., the effective depth  $d = 22 - 3.5 = 18.5$  in. This allows for 2 in. fire proofing and two layers of steel. Since the depth is fixed, the width of beam will be obtained from Formula (3).

Mix	Width of Beam	Volume of Concrete per lin. ft.
1 : 1½ : 3	$b = \frac{720\,000}{184 \times 18.5^2} = 11.4$ in.	$\frac{11.4 \times 22}{144} = 1.74$ cu. ft.
1 : 2 : 4	$b = \frac{720\,000}{147 \times 18.5^2} = 14.3$ in.	$\frac{14.3 \times 22}{144} = 2.18$ cu. ft.

## Comparison of cost:

Mix	Volume of Concrete × Unit Cost = Cost per lin. ft.
1 : 1½ : 3	1.74 cu. ft. × 49 cents = 85.3 cents
1 : 2 : 4	2.18 cu. ft. × 45 cents = 98.0 cents

The saving in favor of rich mix is  $98.0 - 85.5 = 12.5$  cents per lineal foot. The amount of steel is the same in both cases. An additional saving will be due to the reduction in dead load which amounts to  $(2.18 - 1.74) \times 150 = 66$  lb. per lin. ft.

### DESIGN OF T-BEAM

The formulas given below are sufficient to design or review a T-beam for any given span and loading. The derivation of the formulas is given on p. 134. Formulas for bond stresses and for diagonal tension are given in subsequent pages, and the design at supports for negative bending moment is also treated.

**How T-Beams are Obtained.**—If a beam is built at one pouring with the slab, and precautions are taken to prevent separation of the slab and beam, the portion of the slab near the beam may be considered as part of the beam. The beam then assumes the shape of the letter T and is called a T-beam.

Figure 70 shows a cross section through a floor. The section of the slab considered as part of the T-beam is indicated.

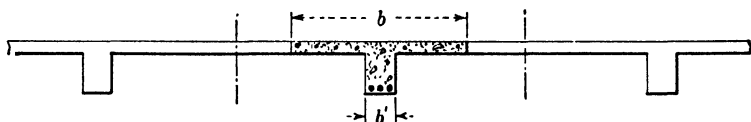

FIG. 70.—Section Showing T-Beam in Floor. (See p. 215.)

### NOTATION

- Let  $b$  = breadth of flange of T-beam in inches;  
 $b'$  = breadth of web of T-beam in inches;  
 $d$  = effective depth of T-beam in inches;  
 $jd$  = moment arm in inches;  
 $t$  = thickness of flange in inches;  
 $r$  = ratio of cost of steel to that of concrete;  
 $f_c$  = compressive unit stress in concrete, pounds per square inch;  
 $f_s$  = tensile unit stress in steel, pounds per square inch;  
 $n$  = ratio of modulus of elasticity of steel to that of concrete;  
 $A_s$  = area of tensile steel in square inches;



$p_m$  = ratio of steel,  $\frac{A_s}{bd}$ , in T-beam for which stresses in steel and concrete simultaneously reach their maximum working value;

$C_d$  = constant for figuring minimum depth.

**Formulas used in Design of T-beams.—**

*Area of Web required by Diagonal Tension,*

$$b' \left( d - \frac{t}{2} \right) \text{ equal or larger than } \frac{V}{v} \quad (16)$$

*Minimum Depth Required by Compression,*

$$d = \frac{M}{C_d b t'} \quad (17)$$

where  $C_d$  is constant on p. 894 for  $f_c, f_s$  and  $\frac{t}{d}$ .

For explanation see p. 219.

*Economical Depth,*

$$d = \sqrt{\frac{rM}{f_s b'}} + \frac{t}{2} \quad (18)$$

where  $r$  is cost ratio of steel and concrete.

*Area of Steel,*

$$A_s = \frac{M}{j d f_s} \quad (19)$$

where  $j$  is as given on pp. 221 and 897.

This area of steel must not exceed the value found from the formula below, else compression stresses will be exceeded.

*Maximum Area of Steel Permitted by Working Compression Stress,  $f_c$ ,*

$$\text{max. } A_s = p_m b d, \quad (19a)$$

where  $p_m$  is constant on p. 895 for  $f_c, f_s, n$  and  $\frac{t}{d}$ .

For explanation see p. 136.

Area of steel used in design must not be larger than the above value, else compression stresses will be exceeded.

*Maximum Moment of Resistance of Beam Based on Working Stress in Concrete,  $f_c$ ,*

$$M = d C_d b t, \quad (20)$$

where  $C_d$  is constant on p. 894 for  $f_c, f_s$  and  $\frac{t}{d}$ .

For explanation see p. 136.

The maximum area of steel given in the formula just above corresponds to this maximum moment of resistance.

The uses of the above formulas are explained below under proper headings.

**To Design a T-beam.**—Design the slab.

Determine bending moments and end shears in beam.

Determine width of flange (see p. 217). If headroom is not limited, determine most economical depth (see p. 220). (In designing a number of similar beams, the economical depth needs to be figured only for one beam, and estimated for the remainder.)

Before selecting final depth of beam and breadth of stem,  $b'$ , see that the compression in concrete in the center and at the support and the shearing unit stresses do not exceed the allowable working stress (pp. 244 and 879). For continuous T-beam, the depth required at the support, where the T-beam becomes a beam with steel in top and bottom, may be the governing depth.

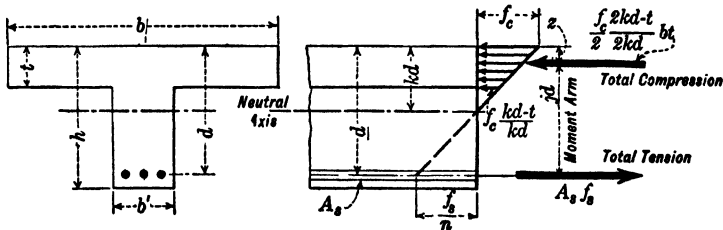

FIG. 71.—Section of T-Beam. (See p. 216.)

Figure amount of tension steel by Formula (19), p. 216.

Design web reinforcement.

For large T-beams, a saving in concrete may be effected by using the more exact formulas, which take into account the compression in stem below the flange. In such cases, preliminary  $A_s$  for  $k$  and  $z$  may be found from Formula (19), and final  $A_s$  from Formulas (19) to (24), p. 134. The problem is more easily solved by the authors' simplified method given on p. 224, which gives exact results and requires much less work.

**Width of Flange.**—The width of the slab,  $b$ , to use for the flange of the T-beam is selected by judgment on the basis of results from tests. In no case, of course, can it be greater than the distance between beams. The Joint Committee has recommended the

following rules, which are approved by the authors, for the effective width of flange:

- (a) The effective width shall not exceed one-fourth of the span length of the beam;
- (b) Its overhanging width, on either side of the web, shall not exceed eight times the thickness of the slab, nor one-half the clear distance to the next beam.

“For beams having a flange on one side only, the effective flange width to be used in design shall not exceed one-tenth ( $\frac{1}{10}$ ) of the span length of the beam, and its overhanging width from the face of the web shall not exceed six (6) times the thickness of the slab nor one-half ( $\frac{1}{2}$ ) the clear distance of the next beam.”

This practice is conservative. (See tests, pp. 36 to 38.)

Isolated beams in which the T-form is used only for the purpose of providing additional compression area of concrete should preferably have a width of flange not more than four times the width of the stem and a thickness of flange not less than one-half the width of the web of the beam.

**Width of Flange Required by Different Building Codes.**—In large cities the Building Codes must be followed. The dimensions of the flange required by the Codes of the Cities of Boston, Chicago, Cleveland, New York, and Philadelphia are given in Fig. 72, p. 219.

**Cross Section of Web as Determined by the Diagonal Tension.**—The width of the web of a T-beam is governed by the shearing stress (see p. 244) and by the layout of the tension bars (see p. 273).

The area of the web required for shear involving diagonal tension, using notation on p. 215 and letting  $V$  = total external shear, and  $v$  = shearing unit stress, may be found from the formula (see also Formula (37), p. 247).

*Area of Web Required by Diagonal Tension.*—

$$b' \left( d - \frac{t}{2} \right) \geq \frac{V}{v} \text{ (approx.),} \quad \dots \quad (21)$$

or

$$b'jd \geq \frac{V}{v}. \quad \dots \quad (22)$$

This means that the area of web at any point in the beam (considering this up to the middle of the slab) must not be less than the

total shear divided by the maximum allowable unit shear for the reinforced beam.

The vertical unit shearing stress,  $v$  (used as measure of diagonal tension), in a beam effectively reinforced with bent bars or stirrups, or both, should be limited to 120 lb. per sq. in. for ordinary concrete having a compressive strength (in cylinders) of 2 000 lb. per sq. in. at twenty-eight days.

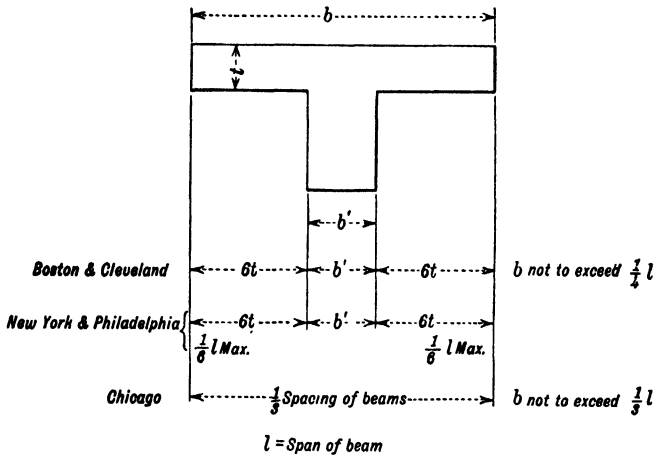

FIG. 72.—Width of Flange Required by Building Codes. (See p. 218.)

**Minimum Depth of T-Beam at Center of Span.**—A minimum depth is the depth at which concrete and steel are stressed simultaneously to their working limits. It is governed by the law that **the compression in the flange must not exceed the working compressive stress in the concrete.** Greater depth than the minimum, with proportionally decreased amount of steel, is generally used for economy. A smaller depth would give excessive compressive stresses.

To find the minimum depth, the rectangular beam formula (1) p. 204, may be used where the depth of the beam is not greater than four times the thickness of the slab, the breadth of the flange of the T-beam being used in this formula for the breadth of the rectangular beam. For ratios of depth of T-beam to thickness of slab larger than four, the rectangular beam formula gives unsafe results and the following formula should be used:

*Minimum Depth of T-beam at Center of Span,*

$$d = \frac{M}{C_a b t} \dots \dots \dots (23)$$

In the above formula,  $C_a$  is a constant from pp. 894 and 895, depending upon the stresses  $f_s$  and  $f_c$  and the ratio  $\frac{t}{d}$ . Since the depth of beam,  $d$ , is not yet known, the depth required by shear may be taken as a close approximation, in computing the ratio of  $\frac{t}{d}$ . The use of the formula is illustrated in the example on p. 896.

**Economical Depth for T-beam.**—For T-beams, a depth greater than the minimum depth required by compression stresses will usually be found economical. By increasing the depth of the stem, the area of the tensile reinforcement is decreased, with a consequent reduction in cost of steel. The volume of concrete in the web, and as a consequence the cost of concrete, is increased; but, up to a certain point, the reduction in the cost of steel is larger than the increase in the cost of concrete, and the cost of the beam as a whole is therefore reduced. The most economical depth is the depth for which the increase in cost of steel is equal to the decrease in cost of concrete, but beyond which any further increase in the depth would cause an increase in cost of concrete larger than reduction in cost of steel.

The following convenient formula for the economical depth of the beam was developed by Professors Turneure and Maurer.<sup>3</sup>

Using the notation given p. 215 and

$r$  = ratio of cost of cubic foot of steel in place to cost of cubic foot of concrete in place.

*Economical Depth of Beam,*

$$d = \sqrt{\frac{rM}{f_s b'}} + \frac{t}{2} \dots \dots \dots (24)$$

From this formula the economical depth for different widths of stem may be computed, and the most suitable combination of depth of beam and width of stem may then be selected.

The value of the ratio  $r$  ranges from 35 to 75. It is computed

<sup>3</sup> Turneure and Maurer, "Principles of the Reinforced Concrete Construction, Second Edition, p. 238.

as follows: If concrete in place costs 40 cents per cubic foot and steel in place 4 cents per pound or  $4 \times 490 = 1960$  cents per cubic foot, the ratio is  $r = \frac{1960}{40} = 49$ .

In continuous beams add from 25 to 40 per cent to the unit cost of steel to allow for the overlapping of bars at the supports.

**Value  $r$  as Affected by Cost of Formwork.**—In computing the value  $r$  above, only cost of materials was considered because the actual cost of formwork is little affected by small changes in depth of beam. The supports for the forms and the number of joints remain the same and the labor of making, erecting and stripping the form also is little affected by changes of depth of beam. The only effect caused by changes in depth is a small difference in cost of lumber for the sides, which is negligible, specially when forms are reused several times.

Often, however, in practice the cost of formwork is computed by multiplying the area of the bottom and the sides of the beam by a certain unit cost. In such case the computed cost of formwork is affected appreciably by changes in depth of beam. The economical depth of beam, when estimated on that basis, may be obtained by Formula (24), p. 220, in which value of  $r$  is found as follows: Compute volume and cost of concrete for a section of beam, 1 ft. long and 1 ft. deep with width of stem equal to  $b'$ . Add to this the cost of 2 sq. ft. of formwork based on the units used in estimating. Divide this total cost by the volume of concrete previously computed. Substitute this new unit cost for the cost per cubic foot of concrete in figuring the value  $r$ .

**Area of Steel in a T-beam.**—The area of cross section of steel in tension may be obtained very closely by the following formula:

*Required Area of Steel,*

$$A_s = \frac{M}{jdf_s} \dots \dots \dots (25)$$

The value of  $j$  may be taken from the following table:

**Value of  $j$  for Different Ratios of Depth of Beam to Thickness of Slab,  $\frac{t}{d}$ .**

$\frac{t}{d}$ .....	0.10	0.12	0.14	0.16	0.18	0.20	0.22	0.24	0.26	0.28	0.30
$j$ .....	0.95	0.94	0.93	0.93	0.92	0.91	0.90	0.90	0.89	0.88	0.88

Sometimes  $jd$  is assumed to equal  $\frac{7}{8}d$ , or  $d - \frac{t}{2}$ , but the error is larger than in the above table.

More exact values of  $j$  may be found from the table on p. 897, or by the use of formulas on p. 134.

**Minimum Depth at Support in Continuous Beams.**—At the support of a continuous beam, owing to the change of the bending moment from positive to negative, the compression flange of the T-beam is in the tensile zone and is therefore ineffective. The compression zone consists only of the width of the stem, and the T-beam changes into a rectangular beam with a depth equal to the depth of the beam and a width equal to the width of the stem. The compression stresses, therefore, are much larger than in the center and may require special provision.

In all cases, some of the reinforcement used in the center for positive bending moment is carried straight at the bottom, throughout the full length of the beam. This reinforcement, if carried a sufficient distance into the column to develop the required compression stresses, may be utilized as compression reinforcement. The beam then becomes a rectangular beam with steel in top and bottom.

On account of the great reduction in the compressive area, the compression stresses at the support may be excessive and the condition at the support may determine the depth of the beam. The required depth at the support will depend upon the amount of compression reinforcement used. Usually, about one-half of the bottom steel is available as compression reinforcement. When the required area of tensile steel is the same at the support as in the center and one-half is bent up and carried over the support, the ratio of the available compression steel to the tensile steel at the support is  $\frac{1}{2}$ . This is the most desirable ratio to use. If this ratio is not sufficient, additional compression steel may be obtained by extending the bottom steel from the adjoining span a sufficient length to make it available as compression reinforcement in the span under consideration. With such design the ratio of compression steel to tensile steel may be increased to one. Larger ratios than *one* can be obtained only by introducing additional short bars at the bottom.

After the ratio of the area of compressive steel to the area of tensile steel is selected, the required minimum depth of beam may be found from the following formula:

*Minimum Depth at Support,*

$$d = 1.05 \sqrt{\frac{M}{bp_1 f_s}} \quad \dots \dots \dots (26)$$

In this formula,  $M$  is bending moment at support,  $b$  and  $d$  are dimensions of rectangular beam,  $f_s$  is tensile stress in steel, and  $p_1$  is the tensile steel ratio,  $\frac{A_s}{bd}$ , the magnitude of which depends upon the accepted compression stresses in concrete and also upon the ratio of the area of the compression steel to that of the tensile steel. The value of  $p_1$  may be taken from pp. 904 to 907. The use of the formula is illustrated by the example given below. The allowable compression stress in concrete at the support is larger than in the center of the beam, as explained on p. 282.

**Example 3.**—Given the bending moment at support,  $M = 1\,200\,000$  in.-lb.; allowable working stresses,  $f_c = 750$ ,  $f_s = 16\,000$ ,  $n = 15$ ; width of stem,  $b = 12$  in.

Find minimum depth if it is desired to limit the area of compression steel to one-half the area of tensile steel, so that  $\frac{p'}{p_1} = 0.5$ .

*Solution.*—Assume the ratio of depth of compression steel to depth of beam,  $a = 0.1$ . From Diagram, p. 904, in the section for  $f_c = 750$  and  $f_s = 16\,000$ , and in the column for  $a = 0.1$ , we find by interpolation that a value of  $p' = 0.006$  corresponds to a value of  $p_1 = 0.013$ . This gives substantially the desired ratio between the compression steel and the tensile steel. The value of  $p_1 = 0.013$  will be used in Formula (26), p. 222.

Thus, minimum depth

$$d = 1.05\sqrt{\frac{M}{bp_1f_s}} = 1.05\sqrt{\frac{1\,200\,000}{12 \times 0.013 \times 16\,000}} = 1.05\sqrt{480} = 23 \text{ in.}$$

**Details of Design.**—In designing T-beams, diagonal tension must be investigated and web reinforcement provided where necessary (see p. 247). Bond stresses must be computed (see p. 262). In continuous beams, negative reinforcement must be provided (see p. 281).

To insure proper T-beam action and prevent cracks through the slab adjacent to the stem, reinforcement at right angles to the beam or girder is necessary. When the principal slab reinforcement is parallel to the girder, short bars should be placed at the top of the slab, transversely over the girder and extending on both sides well into the slab. The ratio of the area of this reinforcement to the cross section of the slab should be at least 0.003.

The example on p. 578 illustrates the use of the formulas and principles of design. The selection of bending moments is treated on p. 275.



**To Find Stresses  $f_c$  and  $f_s$  in T-beam.**—If the dimensions of beam, the amount of steel and the bending moment are known, the stresses may be found as follows:

Find  $k$  and  $j$  from Formulas (19) and (20), p. 134.

Find  $f_c$  and  $f_s$  from Formulas (22) and (23), p. 134.

The work may be simplified by use of the table on p. 896, giving values of  $k$ ,  $j$  and  $C_T$ . Compute ratios  $\frac{nA_s}{bt}$  and  $\frac{t}{d}$ . For these find  $k$  from the Table of  $k$ . Knowing  $k$  and  $\frac{t}{d}$ , find value of  $j$  from the Table of  $j$ . The stress in steel is then found from

$$f_s = \frac{M}{A_s j d}$$

The stress in concrete is found from

$$f_c = \frac{f_s}{n} \frac{k}{1 - k} = C_T f_s, \quad \dots \quad (27)$$

where  $C_T$  may be taken from table on page 896.

**T-beam Design Considering Compression below Flange.**—In a large T-beam, it is often desirable to take advantage of the compression stresses in the web below the flange, especially when the compression stresses, as computed by the approximate formulas, are excessive and it would be necessary to increase the compression area. Computed by the formulas that take account of the compression below the flange, the compression stresses are smaller. In instances where the thickness of the flange depends upon compression stresses in the T-beam, the use of these formulas reduces the amount of concrete in the flange and thereby the dead load.

The formulas on p. 137 are too complicated and may be replaced by the following simple method, which gives equally exact results.

**Simplified Method.**<sup>4</sup>—This method, which gives exact results, need be used only when the compression stresses in the beam are practically equal to the maximum allowable stress. Where the compression area is in excess, the approximate formulas on p. 134 give satisfactory results. The simplified method is most useful in large T-beams, in isolated T-beams, and for girders in joist-constructed floors. Its use frequently saves appreciable amount of concrete.

Consider a T-beam section, as shown in Fig. 73, p. 225. If the stress in concrete in such a beam equals the maximum allowable,  $f_c$ ,

<sup>4</sup> This method was devised by Edward Smulski.

and the stress in steel is  $f_s$ , the position of the neutral axis of the T-beam is located in the same place as in a rectangular beam of the same depth and with the same unit stresses.

The T-beam may be considered as consisting of two parts: (1) a rectangular beam with a width equal to the width of stem,  $b'$ , and a depth equal to the depth,  $d$ , of the original beam; and (2) an auxiliary T-beam, the width of flange of which is equal to the sum of the projections of the T-beam and the depth equal to the depth of the original T-beam. The dimensions of each part and the area of steel required for each may be determined separately and the results added. The rectangular beam may be designed by

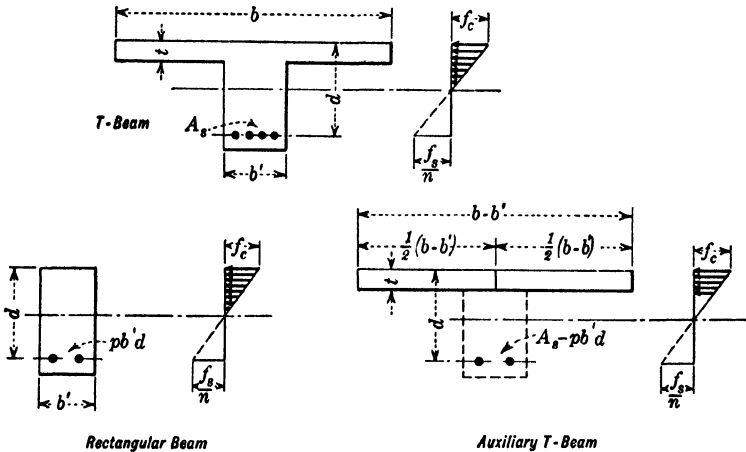

FIG. 73.—Illustration of Simplified Method of T-Beam Design. (See p. 224.)

rectangular beam formulas. In the auxiliary T-beam there is no concrete below the flange; therefore, the formulas on p. 216 give exact results.

This method is particularly advantageous if it is necessary to provide compression reinforcement in the T-beam, as may be the case in theater construction, where not only the depth of the beam but also the width of the flange is limited. In such cases, the T-beam is considered as composed of a rectangular beam with double reinforcement and an auxiliary T-beam without concrete below the flange, and the results are combined.

**Case 1.**—The procedure with ordinary beam and slab may be seen from the following examples:

**Example 4.**—Design a T-beam for an external shear,  $V = 134\,000$  lb. and a bending moment  $M = 17\,500\,000$  in.-lb., when the depth is limited to 60 in. and the thickness of slab is 5 in. The allowable stresses are  $f_c = 650$ ,  $f_s = 16\,000$ ,  $v = 120$ .

**Solution.**—The required width of stem for shear will be determined first. Since  $h = 60$  in.,  $d = 60 - 5 = 55$  in., and  $v = 120$  and, assuming  $j = 0.9$ , the required width of stem is

$$b' = \frac{134\,000}{0.9 \times 55 \times 120} = 22.6 \text{ in. Use } b' = 23 \text{ in.}$$

This value of  $b'$  is accepted and the cross section of the T-beam is then as shown in Fig. 74, below.

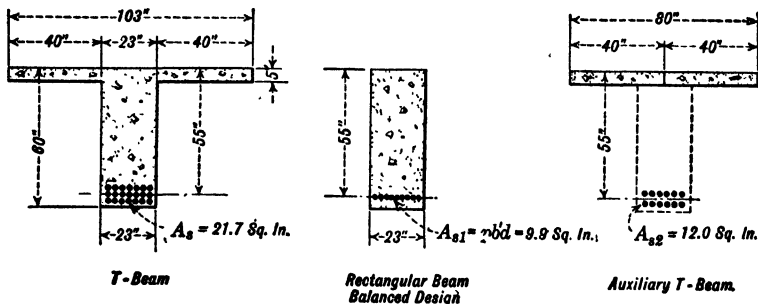

FIG. 74.—Cross Section of T-Beam and Auxiliary Beams. (See p. 226.)

Divided into two parts, the beam consists of a rectangular beam with  $b = 23$  in.,  $h = 60$  in.,  $d = 55$  in., and an auxiliary T-beam with  $b = 80$  in.,  $t = 5$  in., and  $d = 55$  in.

For the specified stresses, for rectangular beam, the ratio of steel is  $p = 0.0077$ , and  $j = 0.874$ . The corresponding area of steel is

$$A_{s1} = 0.0077 \times 23 \times 55 = 9.7 \text{ sq. in.}$$

The moment of resistance of the rectangular beam, from formula  $M = jdA_s f_s$ , is

$$M = 0.874 \times 55 \times 9.7 \times 16\,000 = 7\,462\,000 \text{ in.-lb.}$$

The auxiliary T-beam must resist the difference between the total bending moment and the moment resisted by the rectangular beam, or

$$17\,500\,000 - 7\,462\,000 = 10\,038\,000 \text{ in.-lb.}$$

For  $d = 55$  in.,  $t = 5$  in., the ratio of thickness of slab to depth is

$$\frac{t}{d} = \frac{5}{55} = 0.09,$$

for which, from table on p. 221,  $j = 0.95$ . The required area of steel, from formula  $A_s = \frac{M}{jdf_s}$ , is

$$A_s = \frac{10\,038\,000}{0.95 \times 55 \times 16\,000} = 12.0 \text{ sq. in.}$$

To determine whether compression stresses are satisfactory, compare the area of steel, just computed, with the limiting area of steel. The limiting area of steel corresponding to the allowable working stresses, from Formula (19a), p. 216, is

$$A_s = bdp_m = 80 \times 55 \times 0.0032 = 14.1 \text{ sq. in.},$$

where  $p_m$  is taken from diagram, p. 894, corresponding to the stresses  $f_c = 650$ ,  $f_s = 16\,000$ ,  $n = 15$ , and  $\frac{t}{d} = 0.09$ . This is larger than the value found above; therefore, the design is satisfactory, as far as compression stresses are concerned.

The total area of steel in the T-beam is

$$A_s = A_{s1} + A_{s2} = 9.7 + 12.0 = 21.7 \text{ sq. in.}$$

**Comparison of Result of Exact Formula and Approximate Formula.**—To get a comparison between the areas of steel and compression stresses computed in the previous example by the exact (simplified) method and by the approximate method, it is now necessary to compute the steel areas and compression stresses by the approximate method.

*Steel Areas.*—If the compression stresses below the flange are not considered, the area of steel, from Formula (19), p. 216, would be

$$A_s = \frac{17\,500\,000}{0.95 \times 55 \times 16\,000} = 20.9 \text{ sq. in.}$$

It will be noticed that this area of tension reinforcement is smaller than the area  $A_s = 21.7$  sq. in., obtained previously by the exact (simplified) formula. This is easily explained by the fact that in the approximate formula the moment arm,  $jd = 0.95d$  was used for the total bending moment, while in the exact formula the moment arm  $jd = 0.95d$  was used for the T-beam part and  $jd = 0.874d$  for the rectangular beam part of the T-beam.

*Compression Stresses.*—The compression stresses, for the case where compression in the stem below flange is not considered, will be found from formula  $f_c = C_T f_s$ . The value of  $C_T$  will be taken from Table 13, p. 896, for corresponding  $\frac{nA_s}{bt}$ . In the present case,  $\frac{nA_s}{bt} = \frac{15 \times 20.9}{103 \times 5} = 0.6$  and  $\frac{t}{d} = \frac{5}{55} = 0.09$ , for which  $k = 0.4$  and  $C_T = 0.044$ .

The figured stress in concrete, therefore, would be  $f_c = 0.044 \times 16\,000 = 704$  lb. per sq. in. This stress is about 8 per cent larger than the allowable stress,  $f_c = 650$ , and to reduce the stresses to the

allowable working stress it would be necessary either to increase the depth of the slab (since the depth of beam is limited) or to add compression reinforcement. By the use of the exact formula, however, which correctly utilizes the compressive resistance below the flange, this necessity is avoided and an appreciable saving made in materials.

**Case 2.**—Another use for this (simplified) method is for determining the required flange area for a beam where the flange is provided solely to increase the compression area of the beam. Such is the case in beams carrying joist construction, where the floor is thickened on both sides of the beam, and in isolated beams with projecting flanges. This method is not restricted to cases where the flanges are of uniform thickness, but may also be used with unusual flanges, as shown in Fig. 75, below.

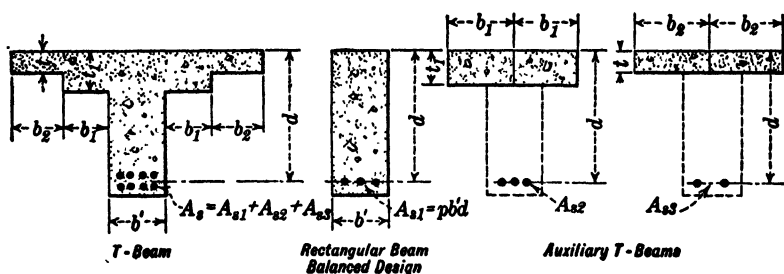

FIG. 75.—T-Beam with Unusual Flange. (See p. 228.)

In such cases, the T-beam is replaced by a rectangular beam and two T-beams, one of which has the thicker flange and the other the thinner flange. The beams are shown in Fig. 75.

**Example 5.**—Design a beam to support joist construction consisting of joists 8 in. deep, for which external shear,  $V = 100\,000$  lb., and bending moment,  $M = 15\,000\,000$  in.-lb. The total depth of beam is limited to 54 in. The allowable stresses are  $f_c = 650$ ,  $f_s = 16\,000$ ,  $n = 15$ ,  $v = 120$ .

**Solution.**—Total depth of beam,  $h = 54$  in., allowing 2 in. for fire proofing and assuming three layers of one-inch bars with one-inch separators between layers. The distance from bottom to center of steel is  $2 + 2.5 = 4.5$  in. The effective depth of beam is  $d = 54 - 4.5 = 49.5$  in.

For  $V = 100\,000$  lb., the width of beam required for shear is

$$b = \frac{V}{jdv} = \frac{100\,000}{0.874 \times 49.5 \times 120} = 19.2 \text{ in. Use } 20 \text{ in.}$$

For  $M = 15\,000\,000$  in.-lb. and the depth  $d = 49.5$  in., the required width of a rectangular beam, from Formula 2, p. 204, is

$$b = \frac{M}{Rd^2} = \frac{15\,000\,000}{107.5 \times 49.5^2} = 57 \text{ in.}$$

This width required by bending moment is much larger than the width required by shear. A rectangular beam would be too expensive and too heavy. It will be cheaper to use a T-shaped beam in which the width of the stem is equal to the width required by shear and compression is supplied by a flange.

The required dimensions of this T-beam will be found by considering the compression below the flange. The simplified method will be used, assuming the T-beam replaced by a rectangular beam and an auxiliary T-beam consisting of the two projecting flanges on each side of the stem only.

The dimensions of the rectangular beam are already known. They are:  $b = 20$  in.,  $d = 49.5$  in. ( $b$  of rectangular beam becomes  $b'$ ). For  $f_c = 650$ ,  $f_s = 16\,000$ , the ratio of steel is  $p = 0.0077$  and  $j = 0.874$  (see table, p. 205). The area of steel for the balanced rectangular beam, from formula  $A_s = pbd$ , is

$$A_{s1} = 0.0077 \times 49.5 \times 20 = 7.6 \text{ sq. in.}$$

The moment of resistance of the beam, from  $M = A_s j d f_s$ , is

$$M_1 = 7.6 \times 0.874 \times 49.5 \times 16\,000 = 5\,260\,000 \text{ in.-lb.}$$

The bending moment to be resisted by the auxiliary T-beam is obtained by subtracting from the total bending moment the moment of resistance of the rectangular beam,

$$M_2 = 15\,000\,000 - 5\,260\,000 = 9\,740\,000 \text{ in.-lb.}$$

It is now necessary to decide upon the thickness and the width of the flange. To simplify the formwork, a thickness of flange equal to the depth of the joist will be accepted. Therefore,  $t = 8$  in. The width ( $b - b'$ ) will be computed.

For  $d = 49.5$  in. and  $t = 8$  in., the ratio  $\frac{t}{d} = 0.16$ , for which, from table on p 221,  $j = 0.93$ . The area of steel, from  $A_s = \frac{M}{j d f_s}$ , is

$$A_{s2} = \frac{9\,740\,000}{0.93 \times 49.5 \times 16\,000} = 13.2 \text{ sq. in.}$$

The width of flanges of the auxiliary T-beam is obtained from the fact that the above area of steel is equal to the maximum allowable steel area permitted by compression stresses.

The equation for maximum allowable steel area in a T-beam is  $A_{s2} = b d p_m$ , in which  $p_m$  is a constant obtained from diagram, p. 894, for known  $f_c$ ,  $f_s$ , and  $\frac{t}{d}$ . In this case,  $p_m = 0.0051$  and the steel area  $A_{s2} = (b - b') \times 49.5 \times 0.0051$ .

Equating this to the steel area computed above,  $13.2 = (b - b') \times 49.5 \times 0.005$ , from which

$$b - b' = \frac{13.2}{0.253} = 52 \text{ in.}$$

To get the total width of flange, it is necessary to add to the above value the width of stem  $b' = 20$  in. Hence  $b = 52 + 20 = 72$  in.

*Final Design,*

Concrete dimensions,  $b = 72$  in.;  
 $b' = 20$  in.;  
 $d = 49.5$  in.;  
 $h = 54$ .

Area of steel  $A = A_{s1} + A_{s2} = 7.6 + 12.9 = 20.5$  sq. in.

### T-BEAM WITH COMPRESSION REINFORCEMENT

**Use of Compression Reinforcement in T-beams.**—Compression stresses are seldom a controlling factor in T-beam design. Occasionally, however, the stresses may be larger than can be taken care of by the concrete, and compression reinforcement may then be advantageous.

Compression reinforcement is required when not only the depth of the beam but also the available width for the flange is limited. One such case is that of beams supporting balconies in theater construction.

Compression steel may be useful also in a series of T-beams of similar design, of which one beam carries a larger load than the others. If the compression stresses in all but the heavy beam are satisfactory, it is cheaper to add compression steel rather than to change the concrete dimensions.

**Formulas to Use.**—In designing T-beams requiring compression reinforcement, formulas taking into consideration the compression in the stem below the flange should be used. The simplified method, in which the T-beam is considered as a combination of a rectangular beam and an auxiliary T-beam, may be used to advantage. The rectangular beam will be one with compression reinforcement.

**Problem to be Solved.**—The problem in this connection usually is: Given the depth of beam,  $d$ , and the width and thickness of flange,  $b$  and  $t$ , and the width of stem,  $b'$ . Determine the required tensile and compression reinforcement for a given bending moment,  $M$ , and specified unit stresses,  $f_s$  and  $f_c$ . (See Fig. 76, p. 231.)

The problem is solved by computing the moments of resistance,  $M_1$ , of a balanced rectangular beam without compression rein-

forcement. For the specified stresses, the steel ratio,  $p$ , is taken from the table on p. 880.

Then the area of tensile reinforcement equals  $A_{s1} = pb'd$ , and the moment of resistance is  $M_1 = A_{s1}jdf_s$ .

Next, the moment of resistance,  $M_2$ , is computed for the auxiliary T-beam. The tensile area is

$$A_{s2} = p_m b'd,$$

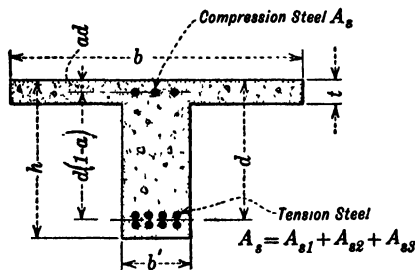

T-Beam with Compression Reinforcement

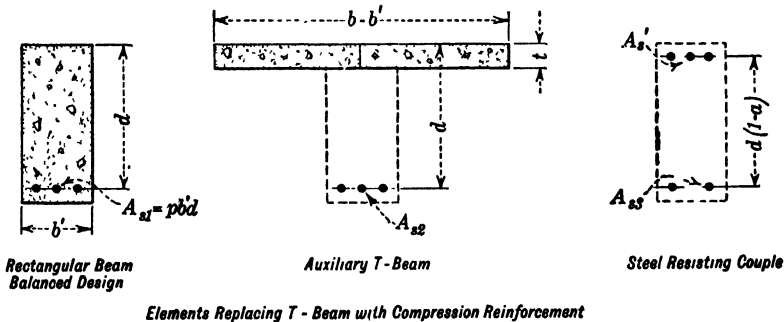

Elements Replacing T-Beam with Compression Reinforcement

FIG. 76.—T-Beam with Compression Reinforcement. (See p. 230.)

where  $p_m$  is taken from diagrams 3 or 5 for the specified stresses and the proper value of  $\frac{t}{d}$ . The moment of resistance is  $M_2 = A_{s2}j_1df_c$ , where  $j_1$  is value from Table 13, p. 896.

Finally, the bending moment to be resisted by the compression steel is equal to the difference between the total bending moment to be resisted,  $M$ , and the sum of the bending moments,  $M_1$  and  $M_2$ , resisted by the rectangular beam, and the auxiliary T-beam, respectively. It is, therefore,  $M_3 = M - (M_1 + M_2)$ .



This bending moment may be considered as resisted by a couple, composed of compression resisted by compression steel and tension resisted by tensile steel. The moment of this couple is

$$M_3 = A_{s3}d(1 - a), \text{ where } d(1 - a) \text{ is the moment arm.}$$

From this

$$A_{s3} = \frac{M_3}{d(1 - a)} = \frac{M - (M_1 + M_2)}{d(1 - a)} \dots \dots \dots (28)$$

The total amount of tensile steel is

$$A_s = A_{s1} + A_{s2} + A_{s3} \dots \dots \dots (29)$$

The compression reinforcement may be found from formula

$$A'_s = A_{s3} \frac{1 - k}{k - a}, \dots \dots \dots (30)$$

where  $k$  is the ratio of neutral axis and  $a$  the ratio of depth of compression steel.

### RECTANGULAR BEAM WITH COMPRESSION REINFORCEMENT

**Use of Compression Reinforcement.**—When, in a beam of fixed concrete dimensions, the compression stresses in the extreme fiber are larger than the allowable unit stresses, the beam may be strengthened by the introduction of reinforcement in the compression zone. This compression reinforcement resists fifteen times the stresses (for  $n = 15$ ) which were resisted by the replaced concrete and thus reduces the stresses in concrete. To be effective, the bars composing the compression reinforcement must be straight and they must extend a sufficient distance beyond the support to transmit the stresses from the bar to the support.

### PROBLEMS IN CONNECTION WITH COMPRESSION REINFORCEMENT

The following problems may occur:

**Problem 1.**—Concrete cross section fixed. Determine area of tension and compression reinforcement for given bending moment and specified working stresses.

**Problem 2.**—Ratio of area of compression steel to area of tension steel fixed. Find required dimensions of beam for given bending moment and specified working stresses.

**Problem 3.**—Concrete dimensions and areas of steel given. Find stresses in steel and concrete for any given bending moment.

**Problem 4.**—Concrete dimensions and areas of steel given. Find moment of resistance of beam, and from this the load the beam is capable of carrying for specified working stresses.

**Solution of the Problems.**—All these problems may be solved by using formulas given in the section on theory (see p. 137). These formulas, however, are too complicated.

**Easier Solutions are Provided by Two Simplified Methods, Devised by Mr. Edward Smulski and Given Below.**—These methods give exact results, require less work, and are easier to understand and to remember than the elaborate formulas.

By the first method, the required areas of compression steel may be obtained directly. Problem 1 above may be easily solved by this method. The method is especially valuable when handbooks (such as this volume) with tables of constants are not available.

The second method, a modification of the first method, gives the required ratio of compression steel,  $p'$ , when the computed ratio of tensile steel,  $p_1$ , exceeds the value,  $p$ , permissible for a simple beam; i.e., when the area of concrete is too small to resist safely all of the compression. This method may be used for solving Problems 1 and 2, either directly or in conjunction with diagrams, p. 904. It is particularly useful for determining compression steel needed for negative moment in a continuous beam.

Problems 3 and 4 are best solved by using the diagrams, pp. 908 and 909, as explained on p. 238 and illustrated by examples opposite each diagram.

Let  $A_s$  = area of cross section of tensile steel in beam under consideration;

$A_{s1} = pbd$  = area<sup>5</sup> of tensile steel in balanced simple beam in which steel and concrete are stressed to specified allowable unit stresses,  $f_s$  and  $f_c$ ;

$p$  = steel ratio for balanced design of beam with tensile steel only;

$p_1$  = ratio, in beams with steel in top and bottom, of total cross section of steel in tension to cross section of beam,  $bd$ ;

<sup>5</sup> The limiting value for which no compression steel is required.

- $p'$  = ratio of cross section of steel in compression to cross section of beam,  $bd$ ;  
 $k$  = ratio of depth of neutral axis to depth of beam,  $d$ ;  
 $a$  = ratio of depth of compressive steel to depth of beam;  
 $A_{s2} = A_s - A_{s1}$  = extra tensile steel, in beam with steel in top and bottom, to be balanced by compression steel;  
 $A'_s$  = area of compression steel required to balance extra tensile steel =  $p'bd$ ;  
 $M$  = moment of resistance or bending moment for beam with steel in top and bottom;  
 $M_1$  = moment of resistance of beam without compressive reinforcement.

**First Method. Simplified Method of Design of Beam with Steel in Top and Bottom.**—As evident from Fig. 77, the position of the neutral axis for a beam with steel in top and bottom is the same as for a rectangular beam of the same dimensions and subjected to the same stresses,  $f_c$  and  $f_s$ . The beam with steel in top and bottom may, therefore, be considered as a combination of (1) a rectangular beam without compression steel and (2) a couple of equal forces, one of which forces is the compression resisted by the compression steel and is equal to  $A'_s f'_s$ , while the other force is the tension resisted by tensile steel and is equal to  $A_{s2} f_s$ .

The moment of resistance,  $M$ , of a beam with steel in top and bottom may therefore be separated into two moments: (1) the moment of resistance,  $M_1$ , of a rectangular section of balanced design with bottom reinforcement only, and (2)  $M_2$ , the moment of resistance of the couple of forces. By a beam of balanced design is understood a beam with an area of tensile reinforcement,  $A_s = pbd$ , such that both the maximum tensile and the maximum compression stresses are reached at the same time.

The moment of resistance of a simple beam of balanced design is

$$M_1 = f_s A_{s1} j d \text{ in which } A_{s1} = pbd.$$

The value,  $p$ , is a definite ratio depending upon the specified values of  $f_s$ ,  $f_c$ , and  $n$ .

The moment of resistance of the couple of forces is obtained by multiplying the tensile force,  $A_{s2} f_s$ , by the moment arm  $d(1 - a)$ ,

$$M_2 = A_{s2} f_s d(1 - a).$$

The value of  $M_1$  is fixed for any size of beam and specified stresses by the strength of the concrete. The value of  $A_{s1}$  is also fixed.

The value of  $M_2$  depends only upon the tensile area  $A_{s2}$  and the corresponding compression area  $A'_s$ . Within practical limits it may be made of any magnitude.

The moment of resistance of a beam with steel in top and bottom is  $M = M_1 + M_2$ .

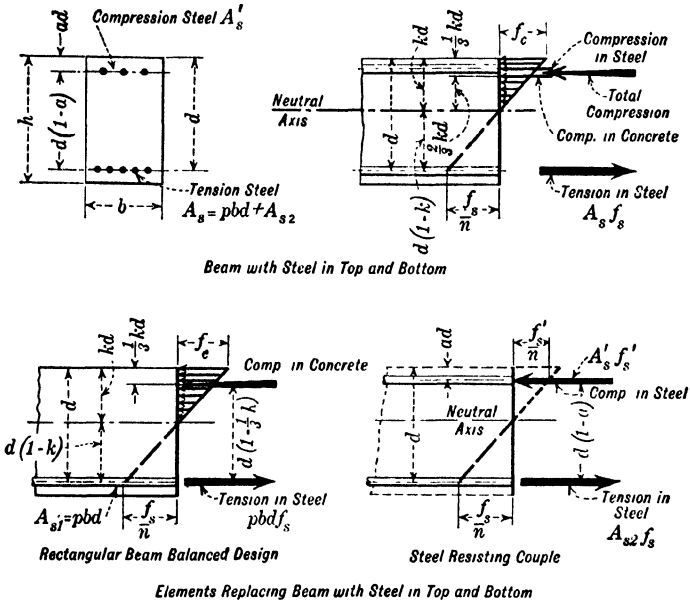

FIG. 77.—Beam with Steel in Top and Bottom. (See p. 234.)

The above relation may be used for solving Problem 1, in which the dimensions,  $b$  and  $d$ , are given and it is desired to find the areas of tensile and compression reinforcement to resist a bending moment,  $M$ , with specified stresses  $f_s$ ,  $f_c$ , and  $n$ .

The ratio of steel,  $p$ , corresponding to the specified stresses, is found first, either from table on p. 880 or from Formula (5), p. 130. (For instance, for  $f_s = 16\,000$ ,  $f_c = 800$ ,  $n = 15$ , the steel ratio is  $p = 0.0107$ .) The area of steel is  $A_{s1} = pbd$  and the moment of resistance of a balanced rectangular beam without compression reinforcement is

$$M_1 = jdA_{s1}f_s = jdpbdf_s.$$

Subtract this value from  $M$ . The remainder,  $M - M_1$ , must be resisted by the steel couple whose moment of resistance is

$$M_2 = A_{s2}f_s d(1 - a).$$

Thus,  $A_{s2}f_s d(1 - a) = M - M_1$  and

$$A_{s2} = \frac{M - M_1}{f_s d(1 - a)}. \quad (31)$$

The total area of tensile steel is

$$A_s = A_{s1} + A_{s2} = pbd + \frac{M - M_1}{f_s d(1 - a)}. \quad (32)$$

The area of compression steel is

$$A'_s = A_{s2} \frac{1 - k}{k - a}. * \quad (33)$$

This method is exact. It does not require any tables. The values of  $p$  and  $k$  corresponding to the specified stresses are the only constants required.

**Second Method. Determining Ratio of Compression Steel,  $p'$ .**—The method given below may be used for determining the required ratio of compression steel,  $p'$ , if the ratio of tensile steel,  $p_1$ , is larger than the allowable ratio,  $p$ , for a balanced simple beam. This is a modification of the previous method. It is particularly useful in continuous beams at the support.

For any accepted stresses,  $f_c$  and  $f_s$ , and the ratio  $n$ , the location of the neutral axis is the same for beams with compression reinforcement as for simple beams.

The formula for tensile steel ratio for beam with compression reinforcement is (see Formula 41, p. 139).

$$p_1 = \frac{k^2}{2n(1 - k)} + p' \frac{k - a}{1 - k}.$$

The first term in this formula,  $\frac{k^2}{2n(1 - k)}$ , is identical with Formula 6, p. 130,  $p = \frac{k^2}{2n(1 - k)}$ , in which  $p$  is the ratio of tensile

\* The formula for the area of compression steel is obtained from the requirement that the total tensile stresses in the couple of forces (see Fig. 77) must be equal to total compression stresses. The ratio of unit stresses in tension and compression is equal to the ratio of their distance from neutral axis.

steel for a balanced simple beam. This may be substituted in the above equation and

$$p_1 = p + p' \frac{k - a}{1 - k}$$

From this:

*Required ratio of compression steel,*

$$p' = (p_1 - p) \frac{1 - k}{k - a} \dots \dots \dots (34)$$

This formula gives the ratio of required compression steel if the ratio of tensile steel,  $p_1$ , necessary to resist a bending moment, is larger than the value of  $p$  corresponding to the specified stresses in a balanced beam without compression steel.

For instance, assume that the computed ratio of tensile steel to resist bending moment is  $p_1 = 0.0125$ . If the allowable stresses are  $f_c = 750$ ,  $f_s = 16\ 000$ , and  $n = 15$ , the allowable ratio without compression reinforcement is  $p = 0.0097$ , and value of  $k = 0.414$ . The required ratio of compression steel is then

$$p' = (0.0125 - 0.0097) \frac{1 - 0.414}{0.414 - a}$$

The value of  $a$  is the ratio of the distance of the center of compression steel from the surface to depth of beam.

The amount of tensile steel (and from this the value  $p_1$ ) is found from formula  $A_s = \frac{M}{jdf_s}$ , in which  $j$  is assumed as 0.9. This value of  $j$  is near enough for practical purposes. If desired, after computing the ratio of compression reinforcement, the correct ratio of  $j$  may be taken from the diagram on p. 910 and the values of  $p_1$  and  $p'$  revised accordingly.

**Solving Problems 1 to 4 (p. 232) by Means of Diagrams.**—Formula (34) for the required compression steel was used in preparing Diagrams, p. 904. From these the required ratio of compression steel may be taken directly for any ratio of tensile steel and different allowable stresses,  $f_c$  and  $f_s$ .

Problem 1 may be solved by using Diagrams as follows: In this problem it is required to find the amount of tensile and compression steel for given moment and stresses. For the given bending moment, the area of tensile steel is computed by formula  $A_s = \frac{M}{0.9df_s}$  (assuming

$j = 0.9$ ). From this  $p_1$  is found. The value  $a$  is estimated. Then the required ratio of compression steel is taken directly from the diagram corresponding to the specified stresses,  $f_s$  and  $f_c$ , and to the value  $a$ . Diagrams, p. 908, may also be used to solve the problem.

Problem 2 also may be solved by means of diagrams. In this problem, dimensions of beam are required, with the ratio of  $\frac{p'}{p_1}$  fixed and stresses  $f_c$  and  $f_s$  specified. In solving, the value of  $a$  is estimated first. Then reference is made to the section for the specified stresses and the column for the nearest value of  $a$ . From this, a value of  $p'$  is found which has the required relation to  $p_1$ . For instance, if for  $f_s = 16\ 000$ ,  $f_c = 750$ ,  $n = 15$ , it is required to get a design in which ratio of  $\frac{p'}{p} = 1$ , when  $a = 0.08$ . In the section for the specified  $f_s$  and  $f_c$  and on the curve for  $a = 0.08$ , it is found by inspection that a value of  $p' = 0.016$  corresponds to  $p_1 = 0.016$ . These values satisfy our requirement and may be used in design. (See example, p. 903.)

For solving Problems 3 and 4, with given concrete dimensions and steel areas, where the relation between the stresses  $f_c$  and  $f_s$  is not known, the diagrams on p. 904 cannot be used advantageously. For this purpose, the diagrams on pp. 908 and 909 were prepared; from these the relation between the steel ratios,  $p_1$  and  $p'$ , may be found for any ratio of unit stresses of  $\frac{f_s}{15f_c}$  and any value of  $a$ , and conversely the ratio of stresses  $\frac{f_s}{15f_c}$  may be found for any combination of steel ratios,  $p_1$  and  $p'$ , and any value of  $a$ .

In solving Problem 3, where it is required to determine the stresses for known dimensions of beam and known areas of steel, the values of  $p_1$ ,  $p'$ , and  $a$  are computed first. The tensile stresses may then be computed from the formula  $f_s = \frac{M}{0.9dA_s}$  (assuming  $j = 0.9$ ).

The ratio of unit stresses,  $\frac{f_s}{15f_c}$ , is found from the diagram for nearest value of  $a$  and for the known values of  $p_1$  and  $p'$ . The tensile stress,  $f_s$ , and the ratio,  $\frac{f_s}{15f_c}$ , being known, the compression stress is easily found by dividing the stress  $f_s$  by 15 times the determined value for  $\frac{f_s}{15f_c}$ .

Problem 4, in which moment of resistance is required for known dimensions and specified unit stresses, may be solved as follows: The moment of resistance may be governed either by the steel stresses or by the concrete stresses, whichever are smaller. The simplest method is to determine the moment of resistance governed by steel stresses and then find whether the compression stresses for this moment are within the specified working limits. The moment of resistance governed by steel may be found directly from formula  $M = 0.9dA_s f_s$ , in which all values are known. (The value of moment arm is assumed  $j = 0.9$ .) To find compression stresses corresponding to this moment, compute, from known areas of steel and concrete, the steel ratios  $p_1$  and  $p'$  and ratio  $a$ . From the diagram for value of  $a$  nearest to the computed value, find the ratio  $\frac{f_s}{15f_c}$  corresponding to the steel ratios,  $p_1$  and  $p'$ . The compression stress in concrete may now be found by dividing the stress in steel,  $f_s$ , by 15 times the ratio  $\frac{f_s}{15f_c}$ , which was found from the diagram. If this compression stress is smaller than the specified stress, the moment of resistance of the beam, as determined by tensile steel, is satisfactory. If the compression stress in concrete is larger than the allowable stress, it signifies that the moment of resistance of the beam is governed by compression stresses; hence the moment of resistance determined from tensile steel is too large, and the load the beam is able to carry is lighter than would follow from this moment of resistance.

If the beam is already built, the moment of resistance governed by the concrete is computed, and from this is found the load the beam is able to carry. For this moment of resistance, the stress in steel is smaller than the maximum allowable. The value  $\frac{f_s}{15f_c}$  is already known. The reduced stress in steel may be computed by multiplying the allowable stress in concrete by  $n$  and by the ratio  $\frac{f_s}{15f_c}$ . The moment of resistance based on this reduced stress in steel is the moment of resistance as governed by compression stresses.

If the beam is not built, the moment of resistance as governed by concrete should be increased by adding compression steel. Or, if the moment of resistance is sufficient, the amount of steel should be reduced. The tensile stress may be found from the diagram  $\frac{f_s}{15f_c}$ , by



substituting the value of  $f_c$ . The value of the reduced  $f_s$  then follows, and this will give the required moment of resistance.

**Moment Arm.**—The magnitude of the moment arm for a beam with compression steel is different from the magnitude of the moment arm for a simple beam. Its exact value is

*Moment arm, Beam with Steel Top and Bottom,*

$$j = \left(1 - \frac{k}{3}\right) + \frac{p'}{p_1} \left(\frac{k}{3} - a\right) \frac{k - a}{1 - k} \quad \dots \quad (35)$$

This value may be obtained from the diagram on p. 910 for different ratios of stresses,  $\frac{f_s}{nf_c}$ , and ratios of  $\frac{p'}{p_1}$ . In practice,  $j = 0.9$  may be accepted. After  $p'$  and  $p_1$  are computed, the value may be corrected by referring to the diagram.

#### EXAMPLES OF BEAMS WITH STEEL IN TOP AND BOTTOM

**Example 6.**—Given size of beam,  $b = 10$  in. and  $d = 18$  in. as determined by architectural requirements; bending moment,  $M = 500\,000$  in.-lb.; allowable unit stresses,  $f_s = 16\,000$  lb. per sq. in.,  $f_c = 750$  lb. per sq. in.,  $n = 15$ . Find required amount of tensile and compressive steel.

*Solution.* For  $f_s = 16\,000$  lb.;  $f_c = 750$  lb.; from table on p. 880,  $k = 0.414$ ;  $j = 0.862$ ; and  $p = 0.0097$ . The area of steel in a beam without compression steel is  $A_{s1} = 10 \times 18 \times 0.0097 = 1.75$  sq. in., and the moment of resistance is  $M_1 = jdA_{s1}f_s = 0.862 \times 18 \times 1.75 \times 16\,000 = 435\,000$  in.-lb. By comparing this moment with the bending moment of  $500\,000$  in.-lb., we find a difference of  $M - M_1 = 500\,000 - 435\,000 = 65\,000$  in.-lb. This must be provided for by extra tensile steel and by the corresponding amount of compressive steel. Since center of compression steel is distant  $ad = 2.25$  in. from the top of beam  $a = 0.125$  and distance between tensile steel and compressive steel is

$$d(1 - a) = 18 \times 0.875 = 15.75 \text{ in.}$$

This is moment arm of couple composed of compression stress in steel and tensile stress of extra amount of tensile steel. Required extra amount of tensile steel,  $A_{s2}$ , will be found by dividing extra bending moment,  $M - M_1$ , by  $d(1 - a)f_s$ ;

hence  $A_{s2} = \frac{65\,000}{15.75 \times 16\,000} = 0.26$  sq. in. The total tensile steel therefore equals

$$A_s = A_{s1} + A_{s2} = 1.75 + 0.26 = 2.0 \text{ sq. in.}$$

From Formula (33), required amount of compression steel is

$$A'_s = A_{s2} \frac{1 - k}{k - a} = 0.26 \left( \frac{1 - 0.414}{0.414 - 0.125} \right) = 0.53 \text{ sq. in.}$$

**Example 7.**—Find required amount of compression steel for a T-beam at the support, where  $b' = 12$  in.,  $d = 22$  in.,  $A_s = 4.0$  sq. in. and the specified stresses are  $f_s = 18\,000$  and  $f_c = 900$ ,  $n = 15$ . Distance from top of beam to center of compression steel,  $d_1 = 2\frac{1}{4}$  in. and  $a = \frac{2\,25}{22} = 0.102$ .

*Solution.*—At the support, the T-beam changes into a rectangular beam (see p. 282). By dividing area of steel by  $b'd$ , ratio of tensile steel,

$$p_1 = \frac{4.0}{12 \times 22} = 0.0152.$$

From table on p. 880, the ratio of steel for beams without compression steel, for stresses,  $f_s = 18\,000$ , and  $f_c = 900$ , is  $p = 0.0107$  and  $k = 0.429$ . Since ratio  $p_1 = 0.0152$  is larger than  $p$ , compression steel is required.

Ratio of required compression steel, from Formula (34), p. 237.

$$p' = (0.0152 - 0.0107) \frac{1 - 0.429}{0.429 - 0.102} = 0.0045 \times \frac{0.571}{0.327} = 0.0079.$$

Therefore, an area of compression steel  $A'_s = 0.0079 \times 12 \times 22 = 2.1$  sq. in., is required to keep compressive stress in concrete within working limits of 900 lb. per sq. in., when the stress in steel is 18 000 lb. per sq. in.

## DIAGONAL TENSION

**Diagonal Tension Stresses.**—In reinforced concrete members subjected to bending, diagonal tension stresses must always be computed, and if they exceed the allowable unit stresses for plain concrete, web reinforcement must be provided.

All members subjected to bending develop, in addition to the tension and compression stresses due to the bending moment, tension stresses in the web acting at an inclined plane and mainly caused by shear. In homogeneous beams, these stresses do not require any special attention. In reinforced concrete, on the other hand, they assume considerable importance. Full discussion of diagonal tension is given in the chapter on Theory, with which the designer should familiarize himself thoroughly.

Formulas to be used in design and recommendations for their practical application are given below.

**Vertical Shearing Stresses as Measure of Diagonal Tension.**—Concrete is strong in direct shear and capable of withstanding (in 2000-lb. concrete) a working shearing stress of at least 200 lb. per sq. in. Concrete beams or slabs, therefore, always have sufficient area to withstand direct shear.

However, since shearing stresses have been accepted as a measure of diagonal tension stresses, and the resistance of concrete to diagonal tension is small, the unit shearing stresses must always be computed. If the stresses exceed the values for plain concrete, web reinforcement must be provided to take care of the excessive diagonal tension stresses.

**Usefulness of Web Reinforcement.**—Numerous tests have demonstrated that a beam properly reinforced with stirrups or bent bars sustains three or four times as much load as the same beam without web reinforcement.

This effectiveness in increasing the strength of the beam is unquestionable. There is a peculiarity in the action of the web reinforcement, however, particularly of the stirrups, which has sometimes created confusion and doubt—not as to their effectiveness for high load, but as to their usefulness in beams designed for ordinary working conditions. Tests show that, until diagonal cracks appear, a reinforced concrete beam acts like a homogeneous beam. Moreover, the measured stresses in web reinforcement are small, and in some cases compression stresses, instead of tensile stresses, have been found in stirrups. The stirrups do not come into action, in fact, until after diagonal cracks develop. Since the allowable unit stress for diagonal tension is usually somewhat lower than the tensile strength of concrete, it can easily happen that the stresses in a beam will never be sufficient to crack the concrete and bring the stirrup into action.

This fact, then raises a question as to whether there is any object in providing web reinforcement which may never be called upon to carry stresses. The answer is obvious. Reinforced concrete beams are not designed for the condition at working loads, but for the condition at working loads multiplied by the factor of safety. (See also p. 125.) Web reinforcement should always be used, therefore, when unit stresses exceed the allowable stresses for plain concrete, irrespective of whether or not diagonal cracks are likely to occur under working loads. In beams without stirrups, final failure closely follows the appearance of the first crack; while with beams having web reinforcement, stirrups and bent bars represent a factor of safety which allows stressing of concrete in diagonal tension up to its ultimate strength. Under working loads, the stirrups may not act; but in case of overstressing, due to faulty construction or to occasional excessive loading, the stirrups prevent the failure of the

beam. The minute cracks that may develop are not dangerous and in many cases are hardly visible. They close after the excessive load is removed.

**Description of Web Reinforcement.**—Web reinforcement may consist of (a) vertical or inclined stirrups; (b) bent-up tension bars; (c) a combination of stirrups and bent-up bars.

Stirrups are steel members, usually U-shaped, made of bars of comparatively small diameter and independent of the main reinforcement, extending from the tensile zone into the compression zone and anchored at both ends. Fig. 78, p. 243, shows different types of stirrups.

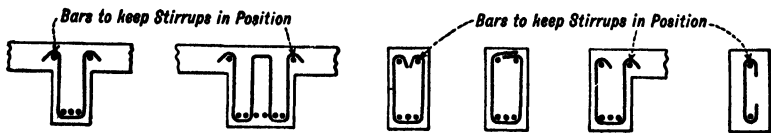

FIG. 78.—Types of Stirrups. (See p. 243.)

**Vertical Stirrups.**—Vertical stirrups are most commonly used. Although not placed in the theoretical direction of diagonal tension, they resist the stresses effectively. They are secure against slipping in a horizontal direction and are easy to keep in position during construction. As contrasted with bent-up bars, the number and spacing of stirrups can be varied to suit conditions.

**Inclined Stirrups.**—Theoretically, the most appropriate reinforcement to resist diagonal tension stresses would consist of inclined stirrups placed in the direction of the stress. The inclination of diagonal tension varies in different parts of the beam, being steepest near the end of the beam and flattening out toward the center of the beam, so that to follow the direction of the stress the inclination of the stirrups would have to be varied throughout the beam. This is impracticable. If used at all, the inclined stirrup should be inclined about  $40^\circ$  with the horizontal. The objection to inclined stirrups is that they are difficult to attach to the tensile reinforcement and to keep in place. Therefore, in spite of the superiority resulting from a closer coincidence between the direction of the stress and the direction of the bar, for practical reasons they are seldom used.

**Bent-up Bars.**—Bent-up bars, if properly distributed and inclined, form excellent web reinforcement. Like inclined stirrups they have the advantage resulting from closer coincidence with the direction

of the diagonal tension stresses, and in addition they have the advantage of being rigidly connected with the main reinforcement.

When bent horizontally at the top of the incline, and extended into the adjoining span or into the support, the bent bars have sufficient anchorage, so far as their function as web reinforcement is concerned. If not so extended, they must be provided in the compressive zone with hooks of proper dimensions to develop their tensile strength. The only disadvantage of bent-up bars lies in the fact that their number in a beam is small and that the points of bending up may be governed by the bending moment requirements which, in turn, do not coincide with the requirements of diagonal tension reinforcement.

*Stirrups and Bent-up Bars.*—The most effective diagonal tension reinforcement consists of a combination of bent-up bars and properly placed vertical stirrups.

**Anchorage of Web Reinforcement.**—In the tensile zone of the beam, the web reinforcement must be continuous with the tensile reinforcement, as in bent-up bars; or, if stirrups are used, it is necessary to anchor them to the tensile bars by bending the stirrup around the lowest layer of tensile reinforcement in such a way as to develop the tensile value of the stirrup at the level of the tensile reinforcement. In the compression zone, the web reinforcement should be brought as near the compressed surface as possible. It should be provided with hooks of sufficient dimensions to develop, in connection with straight imbedment, the full tensile value of the bar in a distance  $0.3d$  from the compression face of the beam. A semi-circular hook with a radius not less than four times the diameter of the bar will be found satisfactory.

In continuous beams at the support, the tensile zone is at the top and the compression zone at the bottom of the beam.

**Allowable Unit Stresses for Diagonal Tension.**—The following unit stresses are recommended for concrete testing 2 000 lb. per sq. in. at the age of twenty-eight days. This strength corresponds to the 1 : 2 : 4 mix used in general practice.

(a) In beams without web reinforcement, the maximum unit shearing stress (being measure of diagonal tension) computed from Formulas (36) and (37) must not exceed 40 lb. per sq. in.

(b) In beams provided with web reinforcement, the maximum unit shearing stress (being measure of diagonal tension) computed as before must not exceed 120 lb. per sq. in. Not more than 40 lb.

per sq. in. of this stress may be considered as resisted by concrete, the balance being considered as resisted by web reinforcement.

(c) In beams without web reinforcement, but where tensile reinforcement is anchored at the ends,<sup>6</sup> the maximum unit shearing stress, computed as before, may be 60 lb. per sq. in.

(d) In beams with web reinforcement, where at least 50 per cent of tensile reinforcement extends the full length of the tensile zone and is anchored at the ends,<sup>6</sup> the maximum unit shearing stress may be increased to 180 lb. per sq. in. Not more than 60 lb. of this stress may be considered as resisted by concrete, and for the rest web reinforcement must be provided. The increased unit stress must not be used where too thin members would result.

In continuous beams in the region of negative bending moment the top reinforcement must be anchored by extending beyond the point of inflection, to permit the increased unit stresses under (c) and (d).

The 1924 Joint Committee allows a unit shearing stress of 240 lb. per sq. in. for beams with end anchorage. This stress is considered by the authors as excessive, because it is likely to give thin members so filled with reinforcement as to interfere with proper placing of concrete. Moreover, such members would be particularly vulnerable in case of fire.

The allowable unit stresses recommended above may be expressed in terms of the ultimate compressive strength of concrete,<sup>7</sup>  $f'_c$ , as follows: 40 lb. =  $0.02 f'_c$ ; 60 lb. =  $0.03 f'_c$ ; 120 lb. =  $0.06 f'_c$ ; 180 lb. =  $0.09 f'_c$ ; and 240 lb. =  $0.12 f'_c$ . Thus, for concrete of greater compressive strength,  $f'_c$ , than 2 000 lb. per sq. in., the allowable stresses may be increased proportionally by using the corresponding ratios.

The allowable unit shearing stresses should be used in determining the smallest allowable area of a beam. In beams of large proportions carrying considerable load, also in beams subjected to dynamic loads, such as those in bridges, the whole length of the beam should be provided with web reinforcement even if not required by unit stresses.

**Distribution of Diagonal Tension between Concrete and Web Reinforcement.**—Tests indicate that diagonal tension is resisted

<sup>6</sup> Required anchorage is same as specified under "Working Stresses, Bars with Anchored Ends," p. 263.

<sup>7</sup> Cylinder strength of concrete at 28 days.

by the concrete in the web and by the web reinforcement. The proportion resisted by each material is not definitely known; therefore, in determining the amount of web reinforcement, part of the stresses to be carried by the steel must be assumed as discussed in the chapter on Theory of Reinforced Concrete. Two methods of distributing the stresses are in common use, namely:

*Method 1.*—Concrete takes all stresses when the unit stresses are equal to or less than the working unit stress specified for plain concrete (same as in method 2). Where the working unit stress for plain concrete is exceeded, the concrete is assumed to resist an amount of shearing stresses equal to the allowable stresses for plain concrete, and the steel is assumed to resist the balance.

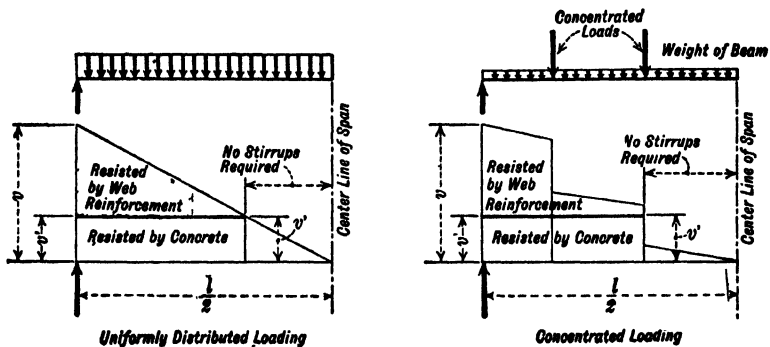

FIG. 79.—First Method. Distribution of Diagonal Tension between Concrete and Web Reinforcement. (See p. 246.)

*Method 2.*—Concrete takes all stresses when unit stresses are equal to or less than the working unit stress specified for plain concrete. For sections where this working unit stress for concrete is exceeded, the concrete resists one-third and the steel two-thirds of the diagonal tension.

The first method requires somewhat less web reinforcement than the second method. The required spacing of stirrups at the points of maximum shear is fairly alike in both methods, since here the stresses attributed to concrete are about the same in each case. The difference is more noticeable at points of small shear, where the first method would permit larger spacing of stirrup; but here it is apt to be offset by the rule which limits the maximum spacing of stirrups.

Either method may be used with satisfaction. The first method is recommended by the authors. The 1916 Joint Committee recommended the second method, while the 1924 Joint Committee recommends the first method.

FORMULAS FOR DIAGONAL TENSION

NOTATION

- $V$  = total external shear, in pounds, at section considered;
- $v$  = total unit shearing stress at section, lb. per sq. in.
- $v'$  = allowable unit shearing stress (or diagonal tension) on concrete alone, lb. per sq. in.;

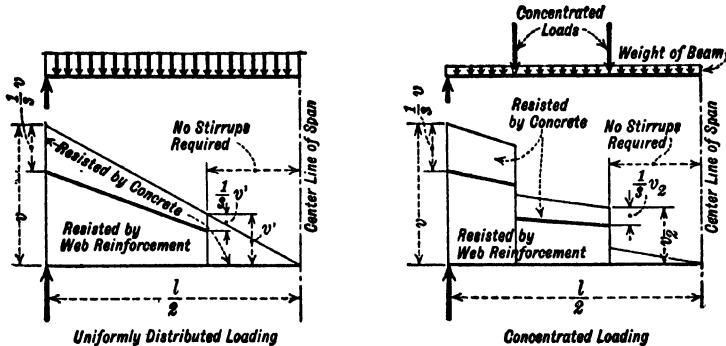

FIG. 80.—Second Method. Distribution of Diagonal Tension between Concrete and Web Reinforcement. (See p. 246.)

- $f'_c$  = ultimate unit compression stress of cylinder of same concrete at 28 days;
- $f_s$  = allowable unit stress in stirrups, lb. per sq. in.;
- $A_s$  = cross-sectional area of all legs of a vertical stirrup in square inches. (In a U-stirrup this is the sum of the area of the two legs);
- $jd$  = moment arm, or distance in inches from center of compression to center of horizontal reinforcement. (In a T-beam, this may be taken, for diagonal tension computation, as distance between center of slab and steel; in a rectangular beam, as 0.87 of the total depth of steel);
- $b$  = breadth of beam in inches;



$b'$  = breadth of web in T-beam in inches.

$s$  = spacing of stirrups, in inches, at section considered (Figs. 81 and 82).

**Unit Stresses.**—The unit shearing stresses at any point, where the external shear is  $V$ , may be found by formulas given below. These values should not exceed the allowable stresses given in preceding paragraph.

*Shearing Unit Stress in Rectangular Beam,*

$$v = \frac{V}{bjd} \quad \dots \dots \dots (36)$$

Value of  $jd$  may be ordinarily taken as  $\frac{3}{8}d$ .

*Shearing Unit Stress in T-beams,*

$$v = \frac{V}{b'jd} \quad \dots \dots \dots (37)$$

Value of  $jd$  may be taken as  $d - \frac{t}{2}$  but not less than  $\frac{3}{8}d$ .

In irregular sections, for  $b$  and  $b'$  in above formulas, the smallest dimensions should be used.

**Area and Spacing of Web Reinforcement.**—Formulas are given below for area of cross section and maximum spacing of web members at any point in the beam where the external shear is  $V$ . Two alternate assumptions are given as to the distribution of the diagonal tension between the concrete and the web reinforcement. In both cases the external shear,  $V$ , is the average value in the length of beam equal to the spacing of stirrups.

1. Concrete assumed to resist a definite amount of diagonal tension,  $v'$ , and the web reinforcement the rest. (See Fig. 79, p. 246.)

*Required Area of Web Reinforcement in a Distance  $s$ ,*

$$A_s = \frac{\frac{V}{jd} - v'b}{f_s} s \text{ for vertical stirrups.} \quad \dots \dots \dots (38)$$

$$A_s = 0.7 \frac{\frac{V}{jd} - v'b}{f_s} s \text{ for inclined members.} \quad \dots \dots \dots (39)$$

*Spacing of Web Reinforcement having a Cross Section,  $A_s$ ,*

$$s = \frac{A_s f_s}{\frac{V}{jd} - v'b} \text{ for vertical stirrups. . . . . (40)}$$

$$s = 1.43 \frac{A_s f_s}{\frac{V}{jd} - v'b} \text{ for inclined members. . . . . (41)}$$

**2. Concrete assumed to resist one-third of the diagonal tension and the web reinforcement the rest. (See Fig. 80, p. 247.)**

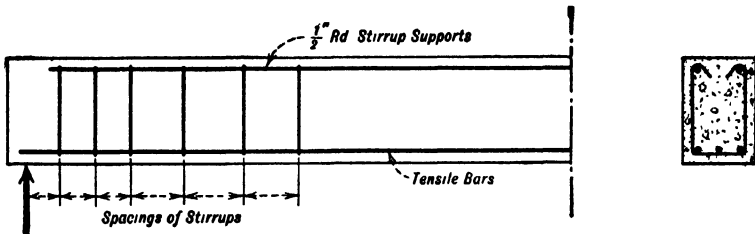

FIG. 81.—Spacing of Stirrup. (See p. 248.)

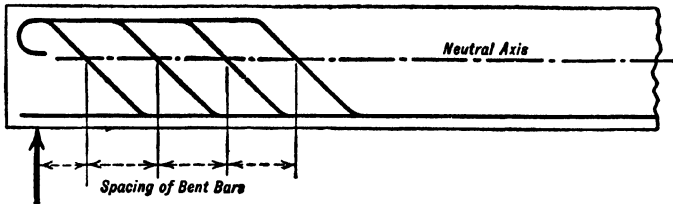

FIG. 82.—Spacing of Bent Bars. (See p. 248.)

*Required Area of Web Reinforcement in a Distance,  $s$ ,*

$$A_s = \frac{2}{3} \frac{jd}{f_s} s \text{ for vertical stirrups. . . . . (42)}$$

$$A_s = 0.47 \frac{jd}{f_s} s \text{ for inclined members. . . . . (43)}$$

*Spacing of Web Reinforcement having a Cross Section,  $A_s$ ,*

$$s = \frac{1.5 A_s f_s}{\frac{V}{jd}} \text{ for vertical stirrups. . . . . (44)}$$

$$s = \frac{2.13 A_s f_s}{\frac{V}{jd}} \text{ for inclined members. . . . . (45)}$$

The area of reinforcement,  $A_s$ , in these formulas is the sum of the areas of all prongs of the stirrup or all bars bent up at one place.

The above formulas may be used for angles of inclination of the bar with the beam axis of from 25 to 50°. For larger angles use formulas for vertical stirrups. Tests discussed on p. 42 prove that there is no difference in effectiveness between bars bent at different angles within this limit. The 1924 Joint Committee recommends more elaborate formulas based on the use of actual angles. Different formulas are used for small and large angles. This refinement is hardly warranted.

**Limiting Spacing of Stirrups.**—In the section of the beam where the unit shearing stresses exceed 60 per cent of the maximum allowable unit stress, the spacing of stirrups should not exceed  $\frac{1}{2}d$ . Elsewhere the spacing should not exceed  $\frac{3}{4}d$ .

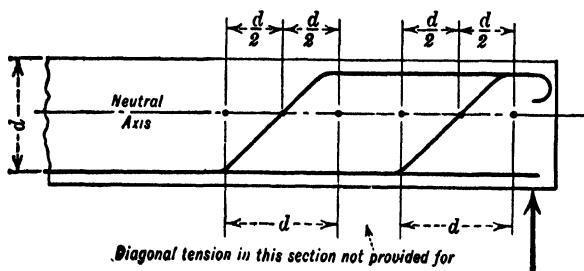

FIG. 83.—Limiting Spacing of Bent Bars. (See p. 250.)

**Limiting Spacing of Bent-up Bars.**—To make the bent bars fully effective as diagonal tension reinforcement, the spacing of the bars, measured along the axis of the beam, should not be larger than the effective depth of the beam. For larger spacing, or where only one bar in a beam is bent up, the region of effectiveness of the bent bar as diagonal tension reinforcement extends, on both sides, from the point of intersection of the bar with the neutral axis for a distance along the beam equal to one-half of the depth of the beam.

The effect of the bent bar in resisting diagonal tension cannot exceed the amount of shearing stresses to be resisted within the spacing specified above, irrespective of the strength of the bar.

A bar bent up at a flat angle (around 15° with the horizontal) may be considered as effective for a distance equal to twice the distance given above.

**Procedure in Designing Web Reinforcement.**—Determine the maximum total shear,  $V$ , and from this the unit shearing stress,  $v$ . See that  $v$  does not exceed the maximum allowable stress.

*Vertical or Inclined Stirrups.*—If vertical or inclined stirrups only are used, select the diameter and shape of the stirrup so that the minimum spacing is not too small (preferably not less than 4 in.), and the total number of stirrups in a beam not too large. Remember that the maximum spacing of stirrups in the part of beam where stirrups are required must not exceed three-quarters of the depth of beam. Use the same size of stirrup and the same design for the whole length of the beam and, if possible, for all similar beams in the entire structure, as a variety of designs may lead to errors and confusion.

Common types of stirrup consist of  $\frac{1}{4}$ -in.,  $\frac{3}{8}$ -in.,  $\frac{7}{16}$ -in., or  $\frac{1}{2}$ -in. diameter round bars in the shape of a U with the free ends hooked.

For uniformly loaded beams, the number and the spacing of stirrups for different conditions may be taken from the table on p. 900.

For concentrated loads, a semi-graphical method of determining the spacing of stirrups is the most satisfactory. (See p. 252.)

*Vertical Stirrups and Bent-up Bars.*—Determine the maximum total shear,  $V$ , and shearing unit stress,  $v$ , as in previous case.

Determine the number of bars to be bent and the places where the bends can be made. (See p. 287.)

Mark the distances within which the bent bars may be considered as effective as web reinforcement. Compute the shear to be resisted in these regions and also the available strength of bent bars. If the strength of bars is equal to or larger than the shear to be resisted, no stirrups are required in these regions.

Select proper diameter of stirrup, as suggested in previous case.

Provide stirrups where stresses are not resisted by bent bars.

If bent-up bars are bent in places where they cannot resist diagonal tension or are bent in one or two places only, their full value as web reinforcement may not be available. Bent-up bars may be considered as effective web reinforcement for a distance equal the depth of the beam.

**SEMI-GRAPHICAL METHOD OF SPACING STIRRUPS**

The semi-graphical method suggested below is well adapted for practice. The diagrams may be drawn free-hand on computation sheets, which, to simplify the work, should consist of cross-section paper with squares of about  $\frac{1}{4}$ -in. diameter. In drawing the diagram, each horizontal division may be taken to represent 1 ft. of the span and each vertical division 10 lb. of the unit shearing stress. The fractions of a foot may be gaged by the eye, so that no additional scale is necessary.

**Method of Procedure.**—Lay out length of beam to a convenient scale. When beam is loaded by concentrated loads, indicate points of application of load; for uniform or symmetrical loading, only one-half of beam needs to be considered.

Compute unit shearing stresses (to be considered as measure of diagonal tension) at points of maximum shear and, in case of concentrated loads, also at points of concentration.

Plot the unit shearing stresses as ordinates, to scale, at points of maximum shear and also at points of concentration, if any. The resulting diagram will be similar to the external shear diagram.

Mark off the portion of diagonal tension resisted by concrete. If concrete is assumed to resist at all sections a definite amount of diagonal tension (say 40 lb. per sq. in.), draw a horizontal line at a vertical distance from the bottom equal to 40 lb. Then the upper part of the diagram represents the shear to be provided for by stirrups. If concrete is assumed to resist a percentage of total shear (say one-third of the shear) mark off, starting from the top, the portion resisted by the concrete. The lower part of the diagram will represent shear to be provided for by stirrups.

Decide on diameter of bar for stirrup and on the number of legs.

Find spacing of stirrups as follows: From the sketch, scale at the support the shear to be resisted by stirrup. From the table on p. 899 for proper width of beam, read the spacing corresponding to the selected diameter of stirrup and the scaled shear. Mark this length on the sketch, starting from edge of support. This is the first division. Next, scale the shear at the end of this first division<sup>8</sup> and proceed in the same manner until all diagonal tension to be resisted by web reinforcement is taken care of. The stirrups should then be placed in the center of each division.

<sup>8</sup> Actually, the shear should be scaled at the center of each division. The error of the recommended procedure is slight and on the safe side.

In practice, the first spacing is repeated several times, then the next spacing is duplicated, so that actually only three or four spacings need to be determined by reference to the table.

When bent-up bars are used, mark on the sketch their position and the distance in which they are effective. Compare the available tensile strength of bent bars with the amount of diagonal tension to be resisted in the distance in which the bars are effective. Tensile strength of bar is area multiplied by unit stress in steel,  $f_s$ , and by 1.43. The amount of diagonal tension equals shear scaled at point of application of the bar multiplied by width of beam and by the distance in which bent bar is effective. If the tensile strength is equal to or greater than the amount of diagonal tension to be resisted, no stirrups are then required; otherwise, the diagonal tension not taken care of by the bent bars should be provided for by stirrups. Elsewhere the same method should be used as when no bent bars are used. (For example, see p. 582.)

**Spacing of Stirrups for Uniformly Distributed Loading.**—For uniformly distributed load, the shear is a maximum at the support and zero in the center. The shear diagram to be used in determining the spacing of stirrups for one-half of the beam is a triangle, as shown in Fig. 253. The required spacing of stirrups obtained in the manner described above is also shown.

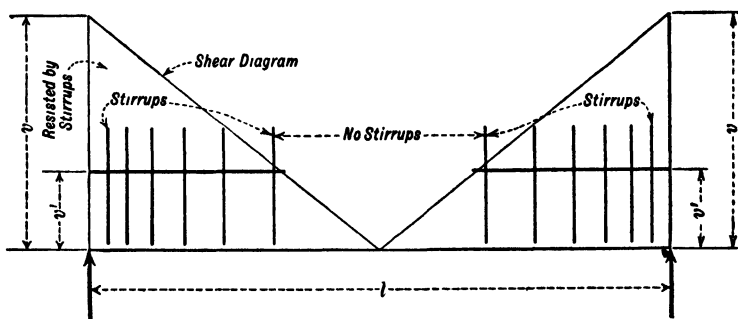

FIG. 84.—Spacing of Stirrups for Uniformly Distributed Load. (See p. 253.)

**Spacing of Stirrups.**—For concentrated loads, such, for instance, as are produced by beams running into a girder, the shear diagram used for determining the spacing of stirrups will not always be a regular figure, as it depends upon the number of concentrated loads and their position. For symmetrical position of concentrated loads, the spacing of stirrups is symmetrical at both sides, and one-

half of the diagram is sufficient. For unsymmetrical position of concentrated loads, the spacing will be different at both ends.

Particular attention is called to the fact that for two beams of equal length, equal concrete dimensions, and same maximum shear at the supports, but one of which is uniformly loaded and the other loaded with concentrated loads, the spacing of stirrups throughout the beams will be different. This is evident from a comparison of Figs. 84, 85, and 86, giving spacing for different position of concentrated loads.

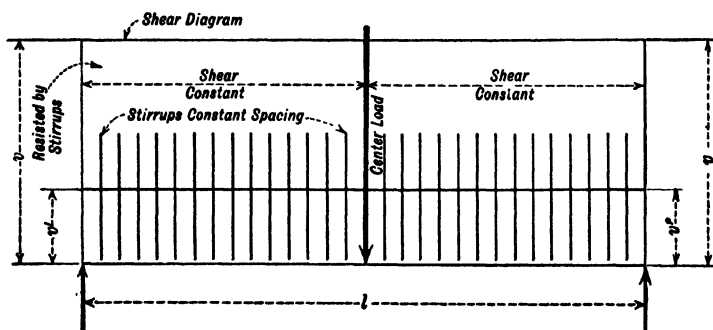

FIG. 85.—Spacing of Stirrups for Load Concentrated in the Center of Beam.  
(See p. 254.)

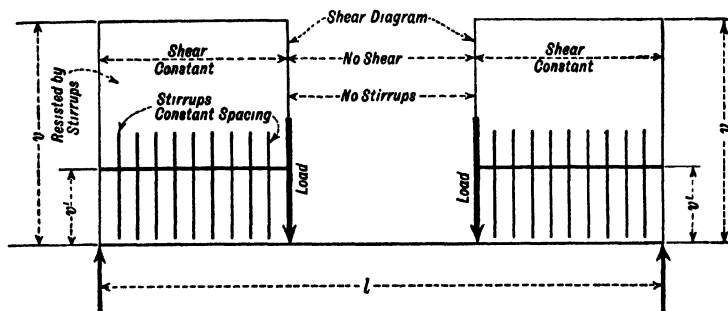

FIG. 86.—Spacing of Stirrups for Loads Concentrated at Third Points.  
(See p. 254.)

*One Load Concentrated in the Center.*—In this case, the shear will be uniform for the whole length of the beam (except for the small difference caused by varying shear due to dead load of the beam). After computing the shearing unit stress and selecting the kind of

web reinforcement, determine the spacing by dividing the tensile value of one stirrup by the shearing unit stress to be resisted by the stirrup times the width of the beam. The spacing of stirrups will then be uniform throughout the beam.

*Loads Concentrated at Third Points.*—The shear due to concentrated loads is constant between the supports and the loads. The spacing of stirrups there is uniform. No stirrups are theoretically necessary in the middle third of the beam. For important beams, stirrups are placed at intervals throughout the whole length of the beam.

**Concentrated Loads, Irregularly Spaced with Uniform Load.**—Lay out the span and, at points of concentration, mark off to scale

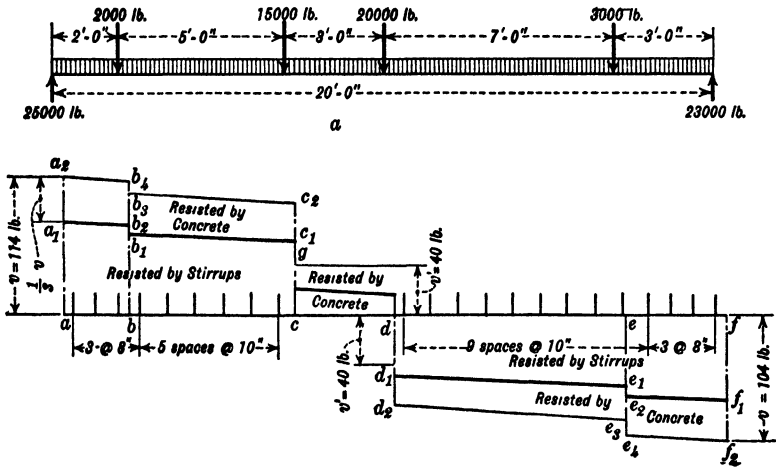

FIG. 87—Spacing of Stirrups for Concentrated Loads. (See p. 255.)

the unit shearing stresses (as the measure of diagonal tension). Mark off the amount of shearing stresses to be resisted by the concrete. Then, starting at the support, determine and mark off the area that can be resisted by one stirrup, and place the first stirrup in the center of gravity of that area. Next, mark off the area for the second stirrup and place the stirrup and proceed thus until the total area of the diagram is provided for. Where the shear does not change radically, the same spacing may be repeated several times.

Table 14 on p. 899 will be found useful in determining the spacing of stirrups.



To illustrate the method more clearly, detailed computations are given below for determining the number and the spacing of stirrups for a beam 20 ft. long, the dimensions of which are  $b = 10$  in.,  $d = 25$  in.,  $jd = 22$  in., and the loading as shown in Fig. 87.

The reaction is found first. Then the external shears are computed at points  $a$ ,  $b$ ,  $c$ , and  $d$ . The external shears divided by  $bjd$ , which in this case is  $10 \times 22 = 220$ , give the unit shearing stresses at the respective points, as follows:

Points	External Shear		Shearing Unit Stress	
	Left	Right	Left	Right
$a$	.....	25 000	.....	114
$b$	24 200	22 000	110	100
$c$	20 200	5 200	92	23
$d$	4 000	-16 000	18	-73
$e$	-18 800	-21 800	-86	-99
$f$	-23 000	.....	-104	

The shearing unit stresses are plotted as shown in Fig. 87. The length of the beam is laid out first, and the location of the points of application of loads marked. The shearing unit stresses are then plotted as ordinates at the respective points. After the points are connected, an area is obtained which represents the total amount of shearing stresses acting on a beam 1 in. wide. The shearing stresses at the left are plotted above the line  $af$ , and those at the right below the line.

The section in which concrete alone can resist the total diagonal tension is found by drawing horizontal lines above and below at a distance equal, in the accepted scale, to  $v' = 40$  lb. At the left end of the beam, this line strikes the outline at point  $g$ , and at the right end at point  $d_1$ . To the right of point  $g$  and to the left of  $d_1$ , all diagonal tension is resisted by the concrete and no stirrups are necessary. The shearing stresses outside of points  $g$  and  $d_1$  must be provided for by web reinforcement.

Assume that steel resists two-thirds of the shearing stresses and concrete one-third. Then, to the left of point  $g$  and to the right of  $d_1$ , one-third of the area is resisted by concrete and two-thirds by

web reinforcement. The area resisted by concrete is marked off on the diagram. The balance of the area represents the stresses to be resisted by steel.

The total amount of diagonal tension to be resisted by steel at the left end of the beam may be found by computing the areas  $aa_1b_2b$  and  $bb_1c_1c$  and multiplying them by the width of the beam,  $b = 10$  in.

$$\begin{aligned} \text{Areas } aa_1b_2b + bb_1c_1c &= \frac{2}{3} \left( \frac{114 + 110}{2} \right) \times 24 + \frac{2}{3} \left( \frac{100 + 72}{2} \right) \times 60 \\ &= 1\,792 + 3\,440 = 5\,232 \text{ lb.} \end{aligned}$$

Multiplying by  $b = 10$ , we obtain 52 320 lb. as the total amount of diagonal tension to be resisted by the web reinforcement.

For  $\frac{1}{2}$ -in. stirrups with two legs, the area of one stirrup is  $A_s = 2 \times 0.196 = 0.392$  sq. in. and the stress resisted by one stirrup is  $A_s f_s = 0.392 \times 16\,000 = 6\,272$  lb.

Divide the total amount of diagonal tension by the stress resisted by one stirrup, to get the total number of stirrups; or,

$$N_s = \frac{52\,320}{6\,272} = 8.3.$$

Use 9 stirrups.

The spacing of stirrups may be found as follows: By trial, starting at the support, find shear areas in Fig. 87 equal to the resisting value of one stirrup divided by  $b = 10$ , or  $\frac{6\,272}{10} = 627.2$  lb. This may be done by scaling the ordinate above the line  $af$ , approximately in the middle of the first division, and dividing 627.2 lb. by it. Scaling the ordinate at a distance of 4 in. from  $a$ , we get 73 lb. as the average unit shearing stress for the first division. The length of the first division, then, is  $\frac{627.2}{73} = 8.6$  inches. Lay off this distance and place the stirrup in the middle. Next, scale the ordinate 4 inches from the end of the first division and find the next spacing.

In this example, as the effect of the uniform load is small, the matter is simplified by considering the ordinates between  $a$  and  $b$  and between  $b$  and  $c$  as constant and finding the spacings for these two constant values. Thus, we find the spacing in portion  $ab$  to be 8.5 in., and in portion  $bc$ , 10.5 inches. So we may use three spaces

at 8 in. and six spaces at 10 in., giving the required number of stirrups.

The same method may be used in determining the spacing in the right end of the beam. The shear here is somewhat smaller than at the other end, but it facilitates the erection to adopt the same spacing at both ends. Of course, the stirrups must extend to the point *d*.

Table 14 on p. 899 will be found useful in spacing stirrups.

### DIAGONAL TENSION FOR MOVING LOADS

For beams carrying moving loads, as bridges and crane runways, it is necessary to determine for every section the maximum total shear, draw the shear diagram and space the stirrups as suggested above.

For heavy moving loads, it is advisable to make allowance for impact. The magnitude of the impact depends upon the character of the structure, the loading, and the relation of the weight of the structure to the moving load.

FIG. 88.—Shear Diagram for Uniformly Distributed Moving Load. (See p. 258.)

For railroad bridges and bridges carrying electric cars,

the ordinary impact formulas may be used; for crane runways and highway bridges, from 25 to 50 per cent of the live load should be added to allow for impact.

**Shear Diagram for Uniformly Distributed Moving Load.**—Assume moving load,  $w$ , per lin. ft.; then the maximum positive shear at any section occurs when the load extends from the right support to the section under consideration and the portion between the left support and the section is unloaded. (See Fig. 88.) The

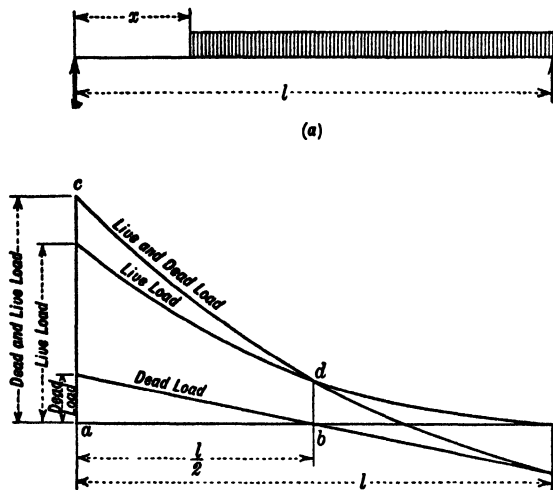

general equation for the maximum shear due to a moving load approaching from right to left then is,  $V = \frac{w(l-x)^2}{2l}$ . This is an equation of a parabola.

For  $x = 0$ ,  $V = \frac{wl}{2}$ ; for  $x = \frac{l}{2}$ ,  $V = \frac{wl}{8}$ ; for  $x = l$ ,  $V = 0$ .

To the shear due to moving loads, the shear due to fixed (dead) loads must be added. In Fig. 89, the diagrams for dead and live loads are drawn.

The first line gives the diagram for dead load only; the second line for moving load plus impact only; and third line for the sum of the dead and live load.

It will be noted that there is considerable shear at the center of the beam.

Stirrups must be provided for the sum of shears.

The diagram should be used only for half of the

span. For the other half, the moving load should be considered as the left. The spacing of stirrups must be made the same for both ends of the beam.

**Shear Diagram for Two Equal Moving Loads a Constant Distance Apart.**—This case occurs in a beam carrying cranes and in highway bridges (see Vol. IV). The maximum shear at any section is obtained by placing one load at the section considered. A general equation is:

$P$  = concentrated moving load;

$e$  = constant distance between the loads,  $P$ .

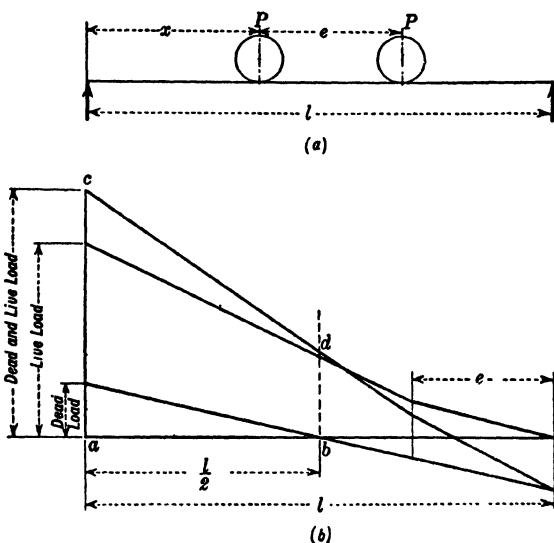

FIG. 89.—Shear Diagram for Two Moving Loads a Constant Distance Apart. (See p. 259.)

$$V = 2P \frac{l - \left(x + \frac{e}{2}\right)}{l} \quad \text{or} \quad P \frac{2(l-x) - e}{l} \quad \text{for } x < l - e, \quad (46)$$

$$V = P \frac{l-x}{l} \quad \text{for } x > l - e. \quad \dots \dots \dots (47)$$

The variation in shear is a straight line for both equations. It is therefore sufficient to determine shear at two points only, namely for  $x = 0$  and  $x = l - e$ . (See Fig. 89, p. 259.)

$$\text{Maximum shear for } x = 0, \quad V_{\max} = P \frac{2l - e}{l}, \quad (48)$$

and

$$\text{Shear for } \quad x = l - e, \quad V = P \frac{e}{l}. \quad \dots (49)$$

With these two values, the shear diagram can be drawn. To this must be added the shear due to the dead load. The shear diagram having been drawn, the spacing of web reinforcement is determined as in previous cases. The diagram is used only for one-half of the beam. The stirrups in the other half are made symmetrical.

For bridge design, the shear may be found as directed in the chapter on Bridge Design, Vol. IV. The shear diagram may then be plotted and the spacing of web reinforcement determined as explained before.

### BOND OF STEEL TO CONCRETE

**Importance of Bond Resistance.**—It is of the utmost importance to design reinforced concrete construction so that the bond stresses between the steel and the concrete will not exceed the safe bond resistance. The safe bond resistance is equal to the unit stress at which the bar begins to slip, divided by the factor of safety. If bond stresses exceed safe working values, the factor of safety is lowered and there is danger of separation of concrete and steel and a consequent failure of the construction from pulling out of the steel.

Bond stresses do not always receive proper consideration. Many designers consider them of secondary importance and often do not even compute them. As a result, one often finds designs with adequate areas of cross section of longitudinal steel, but with no means of bringing the reinforcement into action.

**Bond Stresses Should Always Be Computed.**—It is particularly important to compute the bond stresses in short beams with heavy loads, footings, and retaining walls, where they are likely to be excessive unless properly provided for. Bond stresses are often excessive also in joist construction, where, because of the narrowness of the joist, bars of large diameter are used.

The importance of proper provision for bond stresses will be realized if it is considered that, ordinarily, the bond is the agency which causes cooperation between concrete and steel, and that the resistance of steel to tension can be utilized only through the bond between concrete and steel. When the bond between steel and concrete is not sufficient, the bar will slip instead of resisting tensile stresses. The function of bond in reinforced concrete is the same as the function of rivets in built-up structural steel beams. In a structural steel beam consisting of web plates and flange angles, the angles will not act unless they are properly riveted to the plates. When the number of rivets is not large enough to hold the plates and angles together, the rivets shear off and the angles become separated from the plates. In the same way, in a reinforced concrete construction, when bond stresses are too large, the bars pull out instead of acting as tensile reinforcement, and the beam will fail even if it is provided with a sufficient amount of tensile reinforcement, because there is no medium which will bind the two materials. It would be just as illogical, in designing a reinforced concrete beam, to supply tensile reinforcement without proper bond as it would be, in steel construction, to supply plates and angles for a built-up section without a sufficient number of rivets to make the component parts act as a unit.

**Bond is a Function of External Shear.**—Consider, in a horizontal beam subjected to bending, a portion of beam between two vertical sections. Assume that the depth and the amount of steel between the two sections are constant, but that the bending moment at one section is larger than at the other section. The unit stresses in steel, being proportional to the bending moment, are larger at the section with the larger bending moment. The increase in stresses in steel between the two sections must be developed in the bar by the bond between the steel and concrete acting in the distance between the two sections. From mechanics, the increase in the bending moment between two sections is a function of the external shear. The increase in stresses in steel will also be dependent upon the magni-

tude of the external shear. Therefore, finally, the bond stresses are a function of the external shear.

#### Formulas for Design.

Let  $V$  = total external shear at section considered, in lb.;

$v$  = shearing unit stress in lb. per sq. in.;

$u$  = bond unit stress in lb. per sq. in. of surface area of tension steel;

$o$  = perimeter of one bar in inches;

$\Sigma o$  = sum of perimeters of all horizontal tension bars at section considered;

$jd$  = distance between centers of tension and compression (approximately  $\frac{7}{8}d$ );

$d$  = effective depth of beam, in inches.

Then

*Bond Unit Stress,*

$$u = \frac{V}{jd\Sigma o} \dots \dots \dots (50)$$

*Required Perimeter of Tensile Reinforcement,*

$$\Sigma o = \frac{V}{jdu} \dots \dots \dots (51)$$

If a portion of tensile reinforcement is bent up, only horizontal bars, and those bent-up bars which are not farther up than one-third of the effective depth of the beam, should be considered as resisting bond at the section under consideration.

Special attention is called to the fact that in computing bond stresses in continuous beams, in the region between the support and the point of inflection subjected to the negative bending moment, the top bars must be used in the formula. In the balance of the beam, the bottom steel must be used.

#### **Bond Stresses for Small Bars are Smaller than for Large Bars.—**

The ratio of the perimeter of a bar to its sectional area is not constant for all sizes of bars. It is larger for small bars than for large bars. This means that, for each square inch of sectional area, the sum of perimeters is larger for small bars than for large bars. When the bars are subjected to equal tension, those having larger perimeter will have smaller bond resistance than those having smaller perimeter. For this reason, where subjected to equal tensile unit stresses, the bond stresses for small bars are smaller than for large bars of the

same sectional area. This property is often utilized for reducing excessive bond stresses.

The above principle can be clearly seen from the following comparison. For instance,  $\frac{1}{2}$ -in. round bars have an area of cross section of 0.196 sq. in., and a perimeter of 1.57 in. The ratio between the perimeter and the area is  $\frac{1.57}{0.196} = 8$ . This means that for  $\frac{1}{2}$ -in. bars of an aggregate area equal to one unit (say one square inch) the total perimeter is equal to 8 units (8 in.).

For one-inch bar, on the other hand, the area of bar is 0.785 sq. in., the perimeter is 3.14 in., and the ratio of perimeter to area is  $\frac{3.14}{0.785} = 4$ . The aggregate area of one-inch bars amounting to one unit has only 4 units of perimeter. From the above figures, it is obvious that for equal area of cross section the  $\frac{1}{2}$ -in. bars have twice as large a perimeter as the one-inch bars. The tensile stresses are governed by the area, and the bond stresses by the perimeter. The larger the ratio of the perimeter to the area, the smaller are the bond stresses for equal tensile strength. Therefore, for equal tensile stresses, the bond stresses for  $\frac{1}{2}$ -in. bars would be only half as large as for one-inch bars. Conversely, the bond resistance of  $\frac{1}{2}$ -in. bars is twice as large as the bond resistance of one-inch bars.

**Working Unit Bond Stresses.**—The bond stresses computed by Formula (50), p. 262, should not exceed the following values.

For plain bars,  $u = 0.04f'_c$ , or 80 lb. for 2 000 lb. concrete.

For deformed bars,  $u = 0.05f'_c$ , or 100 lb. for 2 000 lb. concrete.

$u = 0.06f'_c$  may be allowed on specially efficient deformed bars.

**Working Stresses, Bars with Anchored Ends.**—When the ends of the bars, for which bond stresses are computed, are provided with hooks of proper proportions or are extended beyond the point of zero bending moment a sufficient length to develop one-half of the strength of the bar, the allowable bond stresses may be increased by 50 per cent. To comply with this requirement, in simply supported beams the bars must be extended the proper length beyond the support. In continuous beams, if bond stresses for the bottom reinforcement are considered, the bars must be extended beyond the points of inflection governed by the positive bending moment, as shown in Figs. 98 to 103. If bond stresses for the negative reinforcement are considered, the top bars must be extended the proper length beyond the points of inflection governed by the negative bending



moment. The bent bars which are continuous with the bottom reinforcement may be considered as fulfilling the above requirement.

In cantilever footings, to allow the increased bond stresses, all bars must be provided with hooks at their ends.

**Problems in Bond.**—In design, the following problems may have to be solved:

*Problem 1.*—To determine whether the bond stresses for the tentatively selected bars are within working limits. The external shear,  $V$ , is known. The required area of steel is found from bending moment. Bars giving the required area of steel are tentatively selected.

To solve this problem, the perimeter,  $o$ , of one bar is found and multiplied by the number of bars. This gives the value  $\Sigma o$ . If groups of different sizes are used, the perimeter of each size is found and multiplied by the number of bars in the respective group. The sum gives the value of  $\Sigma o$ . The bond unit stress is now found from Formula (50). If the bond stresses are within working limits, the selected bars are satisfactory. If the bond stresses are larger than the allowable working stresses, either of the following methods may be used.

(a) A larger number of bars of smaller diameter, giving the same area, may be substituted. This is the most economical method of reducing bond stresses. Small bars have a larger perimeter in proportion to the area than larger bars. This difference may be sufficient to bring the bond stresses within working limits. For instance, six 1-in. square bars have an area,  $A_s = 6$  sq. in. and a sum of perimeters,  $\Sigma o = 24$  in. Ten  $\frac{7}{8}$ -in. bars have the same area, but their perimeters are  $\Sigma o = 27.5$  in. The bond stresses for the  $\frac{7}{8}$ -in bars would be about 15 per cent smaller than for 1-in. bars.

(b) The depth of the beam may be increased sufficiently to reduce the bond stresses. The area of steel found for the smaller depth, of course, must be retained. This method, since it requires more concrete, should be used only when, for any reason, the first method is not possible. For example, if the bond unit stress in a beam, as found by formula, is  $u = 120$  lb. per sq. in. and the allowable bond unit stress is 100 lb. per sq. in., the necessary increase by this method in the depth of the beam would be in the ratio  $\frac{120}{100} = 1.2$ , keeping same reinforcement to reduce the bond stresses to 100 lb. per sq. in.

(c) The depth of beam and size of bars may be kept the same, but the number of bars may be increased. Thus, in the example mentioned under (b), the bond stress may be reduced by multiplying the number of bars by 1.2. This also is evidently uneconomical.

(d) A combination of (a) with either (b) or (c) may be used. In such a case the bond stresses should be decreased as far as possible by the use of bars of small diameter. After that, further reduction may be obtained by increasing either the depth or the number of bars.

*Problem 2.*—To find the bars giving bond stresses within working limits. The external shear,  $V$ , and the required area of steel are known.

In solving this problem, the smallest allowable sum of perimeters,  $o$ , is computed from Formula (51), p. 262. Bars having an aggregate area of cross section equal to the required area, and having also a sum of perimeters equal to or larger than the value,  $o$ , obtained from the formula, are then selected. The required area and the required minimum perimeters being known, the bars can be easily selected.

*Problem 3.*—To review a design already made, for known loading, to determine whether the working stresses are exceeded.

This problem is solved in the same way as Problem 1.

## ANCHORAGE AND SPLICING OF REINFORCEMENT

**Where Anchorage and Splicing is Required.**—Anchorage of reinforcement is required when the reinforcement at the face of the support is subjected to stresses which must be transmitted from the bars to the support. The stresses from the bars may be transferred either to the concrete of the support or to another set of bars within the support. As an example, we may consider the bars at the support in continuous and restrained beams and in cantilevers, because there the maximum tensile stresses in steel, produced by the bending moments, exist at the face of the support and must be transmitted to the support. Another instance of anchorage is seen in the splicing of two bars at a point where the bar to be spliced is subjected to considerable tensile stress, and it is desirable to transmit the stress to the other bar.

**Means Used for Anchoring Bars.**—The simplest means of anchoring a bar is by extending it from the beam into the concrete of the

support, for such a distance that the stresses from the bar are transferred gradually, by bond, to the concrete of the support. (See Fig. 90.)

Another method of anchoring a bar is by providing it at the end with a hook of sufficient dimensions. The hook is placed within the support.

The best method of anchorage is to extend the bar some distance into the support and also to provide it with a hook at the end. (See Fig. 90.)

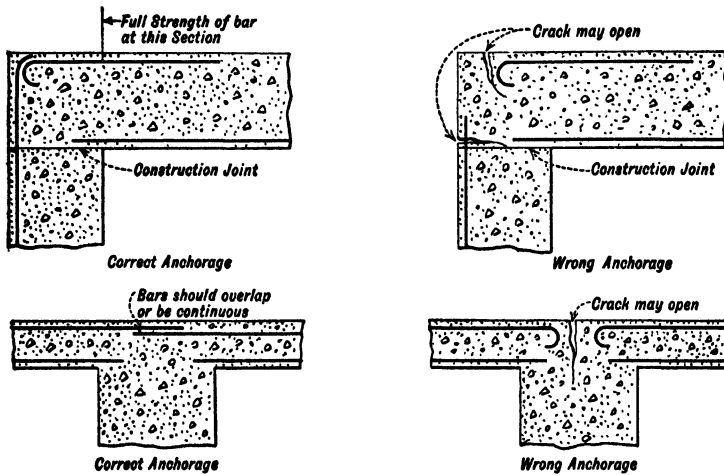

FIG. 90.—Method of Anchoring Bars. (See p. 266.)

**Method of Splicing Bars.**—The stress from one bar may be transferred to another bar by splicing. The splice may be formed by lapping the bars for a length equal to the length of imbedment,  $l_1$ , required for anchorage. A splice may also consist of a straight lap with hooks at both ends of bars. The length of the lap may then be shorter than for straight ends.

Sometimes it may be necessary to splice two bars by means of a third bar as shown in Fig. 91. The third bar must lap each bar a length sufficient to develop the strength of the bar. The length of the short bar is then equal to twice the length of imbedment,  $l_1$ , required for anchorage.

When several bars in a beam or slab are spliced, the splices

should be arranged so that not more than one bar is spliced at any one place.

SplICES at points of maximum stress, for example, in the middle of beams, should preferably be avoided. This does not mean, however, that they may not be permissible with proper staggering.

When tensile bars are spliced by lapping, the length of the lap should be based on the maximum tensile stress in steel, even if the stresses at the points of the splice are smaller.

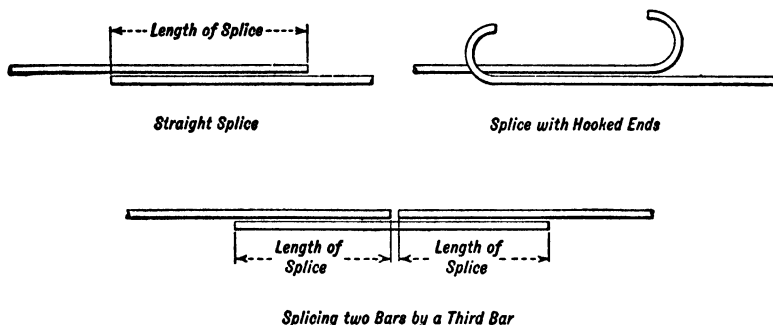

FIG. 91.—Method of Splicing Bars. (See p. 266.)

**Problems to be Solved in Connection with Anchorage.**—The following problems may have to be solved in connection with anchorage of the bar:

1. Diameter of bar and stress are given, and it is necessary to determine the means of anchoring the bar.
2. Stress, diameter of bar, and length of imbedment are given, and it is necessary to determine the bond unit stress.
3. Length of imbedment, diameter of bar, and bond unit stress are given, and it is necessary to determine the safe tensile stress to which a bar may be subjected without exceeding the allowable bond stress.
4. The length of the lap or splice for a bar may have to be determined.

These problems are solved by use of formulas and principles given below.

**Formulas for Determining Anchorage by Straight Imbedment.**—

- Let  $f_s$  = tensile or compressive stress per square inch in bar;  
 $i$  = diameter of (round or side of square) bar in inches;  
 $u$  = bond in pounds per square inch of surface;  
 $l_1$  = necessary length of imbedment of bar in inches.

Then

*Length of Imbedment of Square and Round Bars,*

$$l_1 = \frac{f_s}{4u}i. \quad . . . . . (52)$$

*Bond Unit Stress,*

$$u = \frac{f_s}{4l_1}i. \quad . . . . . (53)$$

*Allowable Tensile Stress in Bar,*

$$f_s = 4l_1 \frac{u}{i}. \quad . . . . . (54)$$

**Conditions in Beams at Support.**—At an interior column in continuous beams, the tensile bars at the support are extended from one span into the adjoining span. The extended portion acts not only as anchorage for the stresses developed in the first span, but also as tensile reinforcement in the adjoining span. The length of the extended portion of the bar is governed not by anchorage requirements, but by the moment requirements in the adjoining span. Good practice in such cases requires that the bars be extended 12 in. beyond the point of inflection of the adjoining span.

If a beam extends beyond the column, forming a cantilever, the same conditions exist.

In the end spans of continuous beams, and in restrained beams where it is not possible to extend the bars into the adjoining span, the length of imbedment is determined solely by the requirement for anchorage. It is often impossible to get sufficient length of imbedment, and the bar is provided with a hook. The support in which the bar is anchored must be strong enough to withstand the tensile stress transferred by the anchored bar. If the support is a column, provision may be required for tensile stress in the column, due to bending. The tensile reinforcement for the beam and column must be arranged so as to prevent cleavage between the two members.

**Allowable Bond Unit Stresses for Anchorage and Splices.**—The allowable bond unit stresses to be used in computing the anchorage and splices are the same as recommended on p. 263 for beams.

**Anchorage of Compression Reinforcement.**—In continuous beams at the support, bottom reinforcement is subjected to compressive stresses. If the bars are intended to serve as compressive reinforce-

ment, provision should be made for transferring the compressive stresses in the bars at the face of the support into the column. For this purpose, the bars are extended a sufficient length into the support to gradually transfer the compressive stresses, by bond, from the bar to the concrete of the column. These compressive stresses act at right angles to the main column stresses and therefore they do not affect its capacity as a column.

The necessary length of imbedment,  $l_1$ , may be found by Formula (52). The stress,  $f_s$ , to be used in computing the length, is the compressive stress in the bar, which is usually much smaller than the allowable tensile stress in the bar.

Sometimes, to increase the amount of compression reinforcement at the support of a beam, the bottom bars from the adjoining beam are extended into it. The extension then serves both as anchorage in one span and as compressive reinforcement in the other. The length in the adjoining span will be governed by the moment requirements.

**Anchorage of Column Reinforcement.**—Compression reinforcement in columns carries considerable stress. Since the bars ordinarily are only one story high, it is necessary to transmit the stresses from the bars in the column above to the bars in the column below. The requirements are treated in the column section.

**Use of Hook as Anchorage for Reinforcement.**—When it is not possible to extend the bar sufficiently into the support to develop its strength by straight imbedment, the anchorage is accomplished by a hook. The effectiveness of the hook depends upon the strength of the concrete, as the hook transfers the stress from the bars to the concrete by bearing on the concrete. The dimensions of the hook must be such that the bearing stresses do not exceed allowable working values. Where considerable stress is transmitted by a hook, it is advisable to place a cross bar of proper length inside of the hook, to distribute the bearing stresses to a large area of concrete and to prevent splitting of the concrete. It is not essential that the hook should bear perfectly on the cross bar. Even if there is no contact between the hook and the bar, the cross bar will prevent splitting of the concrete.

The conditions are still more improved if the cross bar, instead of being straight, is inclined at an angle to the direction of the bar to be anchored, as shown in Fig. 92, p. 270. Then part of the pull may be taken by the cross bar in tension and transferred gradually to the

concrete. Another instance of effective anchorage is found in the Smulski Flat Slab System at the column head, where the pull from radials is transferred partially by bearing on the concrete and partially by tension in the center ring.

When the reinforcement in another beam is at right angles to the reinforcement requiring anchorage, it may be considered as assisting in the distribution of the bearing stresses on the concrete.

The best anchorage is obtained by a combination of straight imbedment equal to 15 diameters of the bar and a semicircular hook, the inside diameter of which is at least four times the diameter of the bar. (See Fig. 92, p. 270.) With such a design, the elastic limit of the steel can be reached without causing excessive secondary

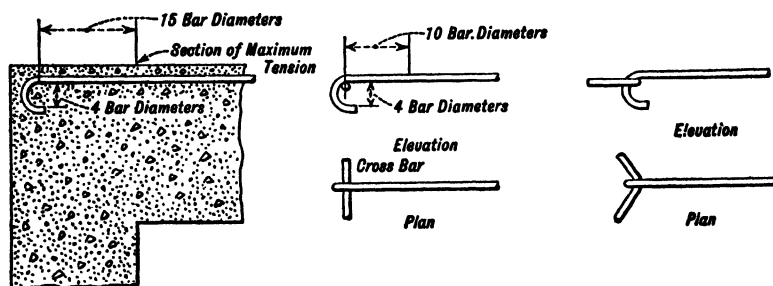

FIG. 92.—Hook Recommended for Anchorage. (See p. 269.)

stresses in the concrete. When cross bars are used, the straight imbedment may be reduced to 10 diameters of the bar.

### BEARING STRESSES

Let  $P$  = superimposed load in pounds;

$A$  = total area of pedestal or footing (subjected to limitation according to depth);

$A_1$  = bearing area, in same units as area  $A$ ;

$f_b$  = allowable bearing unit stress, lb. per sq. in.;

$f_{b1}$  = allowable bearing unit stress on wall, lb. per sq. in.;

$f'_c$  = ultimate compressive strength of cylinder, lb. per sq. in.

*Explanation of Bearing Stresses.*—Bearing stresses are produced by a supported member, resting upon a supporting member, at the surface of contact of the two members. Bearing stresses are produced under the bearing plate or base of a steel beam or column

resting on concrete. A concrete column resting upon a pedestal also produces bearing stresses in the concrete of the pedestal, the magnitude of which may be computed by dividing the column load by the gross area of the column. When the stress from vertical column reinforcement is transferred to the pedestal or footing by a plate, the stresses produced under the plate may be called bearing stresses.

The magnitude of bearing stresses equals the total superimposed load  $P$  divided by the area of contact,  $A_1$ . Therefore

$$f_b = \frac{P}{A_1} \dots \dots \dots (55)$$

**Allowable Unit Stresses.**—The allowable bearing unit stress depends not only upon the strength of the material composing the supporting member, but also upon the relation between the size of the bearing area and the total area of the top of the supporting member. If the bearing area equals the area of the top of the supporting member, the allowable working unit stress over the bearing area must not exceed  $0.25f'_c$ . For 2000 lb. concrete the allowable bearing unit stress is 500 lb. per sq. in.

If the area of the pedestal is larger than the bearing area and projects on all sides beyond the bearing area, the allowable unit stresses may be found from formula below.

*Allowable bearing unit stress*, when area  $A$  extends on four sides outside area  $A_1$ .

$$f_b = 0.25f'_c \sqrt{\frac{A}{A_1}} \dots \dots \dots (56)$$

but not more than  $0.7f'_c$ .

The thickness of the footing, pedestal or pedestal and the footing must not be less than six-tenths of the maximum projection of the area  $A$ , beyond the bearing area.

If a column rests directly on a shallow footing, the total area of the footing can not be used in the formula. Instead an imaginary area should be used, the sides of which equal the sides of the bearing area plus  $1\frac{1}{2}$  times the depth of the footing. This imaginary area must not in any place come outside of the actual area of the footing.

Formula 56 applies if the bearing area is surrounded on all sides by concrete of the pedestal or footing. If the bearing area on one or two sides coincides with the sides of the supporting area, as in



case of a bearing plate resting on a wall, only one-third of the increase in allowable bearing stresses over  $0.25 f'_c$  as given by Formula (57) may be used. The formula changes to

*Allowable bearing unit stress* when side of bearing area  $A_1$  coincides with side of supporting area  $A$ ,

$$f_{b1} = 0.25 f'_c \left( 0.67 + \frac{1}{3} \sqrt{\frac{A}{A_1}} \right), \quad . . . . (57)$$

but not more than  $0.5 f'_c$ .

### PROTECTIVE COVERING FOR REINFORCEMENT

**Purpose.**—The concrete outside of the reinforcement of concrete members serves several purposes. First, it bonds the concrete and the steel. In computing bond resistance, the whole perimeter of the bar is considered as resisting bond stresses. This is only possible where there is sufficient concrete around and below the bar. Second, it protects the reinforcement from fire. Third, it protects the reinforcement from weather and moisture and therefore from rusting. Since the amount of concrete that must be placed below the steel for protection is always sufficient for bond, only the protective purposes will be treated.

**Fire Protection.**—The thickness of concrete necessary for protection of reinforcement against fire depends upon the quality of the aggregates, and upon the severity of the possible fire to which the structure may be subjected. Aggregates having low coefficient of expansion, such as limestone and traprock, are desirable for fire protection. Gravel and granite should not be used as an aggregate where fire hazard is large, because the quartz, of which they largely consist, has a high coefficient of expansion and, under high heat, will expand and crack the concrete.

**Limestone and Traprock.**—With aggregates such as limestone or traprock, the protective concrete, measured from the surface of the concrete to the surface of the lowest bar, should be, for large fire hazard:

Slabs and walls, 1 in.

Beams, girders and columns, 2 in.

Where the fire hazard is small, the protective covering may be as follows:

Slabs and walls,  $\frac{3}{4}$  in.

Beams, girders, and columns,  $1\frac{1}{2}$  in.

*Gravel and Granite.*—When gravel or granite aggregates are used in buildings with small fire hazard, the larger protective covering recommended for the traprock should be used.

When it is absolutely necessary to use these aggregates in a building exposed to severe fire hazard, the protective cover should be 1 in. larger than recommended for traprock and should be reinforced with metal lath placed 1 in. from the surface. The openings in metal lath should not exceed 3 in.

**Moisture Protection.**—Reinforcement in footings should be protected with a minimum covering of 3 in. Where concrete is exposed to weather, the concrete covering for the reinforcement should be 2 in. thick. In all cases, the thickness of the protective covering is measured from the face exposed to moisture to the nearest surface of the bar.

#### CLEAR DISTANCE BETWEEN PARALLEL BARS IN A BEAM

Parallel bars in a beam must be placed so far apart that the amount of concrete around each bar is sufficient to provide proper bond between steel and concrete. Proper clear spacing between bars, depending upon the maximum diameter of coarse aggregates, is also required to allow the concrete to flow below the bars. The width of the stem of a T-beam is often governed by the distance required for spacing of bars.

**Spacing Recommended by the Authors.**—The minimum clear distance between parallel bars should not be less than 1 in., or less than  $1\frac{1}{2}$  times the diameter of the larger round bar and 2 times the side of a square bar.

The minimum clear distance of the bar from the side of the beam should not be less than required for protective covering, nor less than  $1\frac{1}{2}$  times the diameter of the bar. As a further requirement, the minimum spacing of the bars should be larger than the maximum diameter of the coarse aggregate. If aggregates cannot pass freely between bars, there is danger that arching of the aggregates, will produce voids in the concrete at the level of reinforcement. Such voids are dangerous because they reduce bond and also reduce the effectiveness of the protective covering.

The table on p. 274 gives the required width of the beam for different number and size of bars.

## Width of Beam Required by Different Number of Round and Square Bars

Assumptions: Fireproofing  $1\frac{1}{2}$  In. to Face of Bar. Clear Space between Bars Equal to 1.5 Diameters of Round Bars and 2 times Side of Square Bars.

Diam. Bars, In.	Width of Beam in Inches									
	Number of Bars in One Layer									
	1	2	3	4	5	6	7	8	9	10
Round Bars										
$\frac{1}{2}$	3.5	4.7	6.0	7.2	8.5	9.7	11.0	12.2	13.5	14.7
$\frac{3}{8}$	3.6	5.2	6.7	8.3	9.9	11.4	13.0	14.6	16.1	17.7
$\frac{1}{2}$	3.7	5.6	7.5	9.4	11.2	13.1	15.0	16.9	18.7	20.6
$\frac{3}{4}$	3.9	6.1	8.2	10.4	12.6	14.8	17.0	19.2	21.4	23.6
1	4.0	6.5	9.0	11.5	14.0	16.5	19.0	21.5	24.0	26.5
$1\frac{1}{8}$	4.1	6.9	9.7	12.6	15.4	18.2	21.0	23.8	26.6	29.4
$1\frac{1}{4}$	4.2	7.4	10.5	13.6	16.7	19.9	23.0	26.1	29.2	32.4
$1\frac{1}{2}$	4.5	8.2	12.0	15.7	19.5	23.2	27.0	30.7	34.5	38.2
Square Bars										
$\frac{1}{2}$	3.5	5.0	6.5	8.0	9.5	11.0	12.5	14.0	15.5	17.0
$\frac{3}{8}$	3.6	5.5	7.4	9.2	11.1	13.0	14.9	16.7	18.6	20.5
$\frac{1}{2}$	3.7	6.0	8.2	10.5	12.7	15.0	17.2	19.5	21.7	24.0
$\frac{3}{4}$	3.9	6.5	9.1	11.7	14.4	17.0	19.6	22.2	24.9	27.5
1	4.0	7.0	10.0	13.0	16.0	19.0	22.0	25.0	28.0	31.0
$1\frac{1}{8}$	4.1	7.5	10.9	14.0	17.6	21.0	24.4	27.7	31.1	34.5
$1\frac{1}{4}$	4.2	8.0	11.7	15.5	19.2	23.0	26.7	30.5	34.2	38.0
$1\frac{1}{2}$	4.5	9.0	13.5	18.0	22.5	27.0	31.5	36.0	40.5	45.0

**Vertical Spacing of Layers of Reinforcement.**—Whenever possible, bars should be placed in one layer. If more than one layer is necessary, the vertical spacing of the layers in the clear should be not less than 1 in., or less than the diameter of the largest bar.

If the design requires the extreme number of three layers of bars, the bars in the lowest layer should be properly anchored at the ends

by hooking or extending into the supporting column. At least one-half of the bars, by area, should be bent up and anchored in the compressive zone, not only to serve as diagonal tension reinforcement, but also to develop the tensile stresses by anchorage in the compressive zone and thereby to insure proper action of the reinforcement.

**Keeping Bars in Place.**—When the spacing of bars is the minimum allowable, it is important that the bars should not be even slightly misplaced during construction. For this purpose, some positive means of separating the bars, such as spacers, should be used. This is particularly important in narrow beams.

Layers of bars must be separated vertically by mechanical means. One of the accepted means consists of placing across the reinforcement short pieces of bars of proper diameter, spaced not more than 3 ft. on centers.

Bars should be kept the proper distance above the forms. Certain mechanical spacers keep the bars a proper distance above the form and a proper distance apart. Their use is recommended.

#### BENDING MOMENTS FOR USE IN DESIGN OF REINFORCED CONCRETE BEAMS

The bending moments for use in design of reinforced concrete beams depend not only upon the length and the loading of the span under consideration, but also upon whether the beam is a single span or is built continuous with a number of other spans.

In a single span, the question to be considered is whether the beam is simply supported, or restrained at the supports. The quality of the restraint is also to be considered. The beam may be fully restrained, i.e., fixed, at the support; it may be only partly restrained by a concrete column; or it may be slightly restrained by masonry.

In a continuous beam consisting of a number of spans, it is important to determine whether the spans are equal or not; whether the beams are connected with intermediate columns; whether the loading of all spans is the same; and finally, whether the ends of the beam are freely supported, restrained, or partly restrained.

**Quality of Restraint at Ends.**—When an end of a beam rests on the support and is free to turn, it should be considered as freely supported, and no provision is necessary for negative bending moment.

When an end of a beam runs into a masonry wall and is encased in it, especially when additional masonry is placed upon it, the end is not free to move as in the previous case. The masonry offers restraint to the beam, which should be considered as slightly restrained. The amount of such restraint is uncertain and unreliable, however, and it cannot be counted upon as reducing the positive bending moment. To prevent cracks at the support, some provision should be made for a possible negative bending moment by using negative bending moment reinforcement. The amount of reinforcement should be governed by the actual conditions, but should not be smaller than required by formula on p. 278. The bars must be anchored at the end, and at least one-third of the reinforcement should extend to a point distant  $0.2 l$  from the edge of the support.

When the end of a beam runs into a flexible support, such as a column, and is rigidly connected with it, the end should be considered as restrained. The magnitude of this restraint depends upon the relative ratio of stiffness of the beam and the column, as fully explained in Volume II. Such restraint is reliable and may be counted upon in determining bending moments.

When the end of a beam runs into a support of much larger stiffness and is rigidly connected with it, it may be considered as fixed at that end. A beam may be considered as connected with a column, wall, or other support, when the connection is capable of resisting the bending moment produced at the support.

#### **Difference between Continuous Beams and Building Frames.—**

When a continuous beam simply rests upon the intermediate supports—as, for instance, a continuous bridge simply resting upon the piers and not monolithically connected with them,—or when the beam is supported by small intersecting girders, full bending moment from one span is transferred directly to the adjoining span. Such a continuous beam is sensitive to unequal loading. The positive bending in such a case should be based upon the possibility of unequal loading of the adjoining spans, and the Formulas (63) to (68), under the heading "Continuous Beams of Equal Spans," should be used. Continuous beams are shown in Fig. 93, p. 277.

When a continuous beam is connected with intermediate columns, as shown in Fig. 94, the bending moment from one span is not transferred directly in full to the adjoining span, but a part of this bending moment is transferred to the columns, so that the effect of

the loading in one span upon the adjoining span is much smaller than for the continuous beams just described. Smaller provision is necessary for unequal loading and, for the positive bending moment, the Formulas (69) to (74) under "Continuous Beams of Equal Spans Running into Columns," may be used.

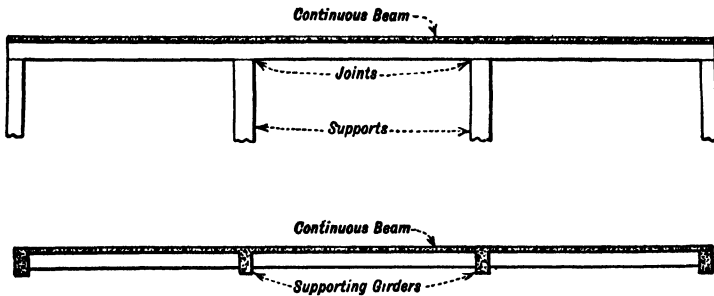

FIG. 93.—Continuous Beams. (See p. 276.)

The subject is thoroughly treated in Volume II, to which reference should be made for full explanation of the subject.

**Span Length.**—The span length for a freely supported beam or slab should be taken equal to the clear distance between the supports, plus the depth of the beam or slab.

The span length for a continuous or restrained beam should be taken as the clear distance between the faces of the support.



FIG. 94.—Building Frame. (See p. 276.)

**Use of Formulas.**—The formulas given below may be used for equal or nearly equal spans and for uniform loading. Where spans are not equal or the loads on different spans are not uniform, formulas given in Volume III should be used.

#### NOTATION

- Let  $M$  = bending moment;  
 $w$  = uniformly distributed load, lb. per lin. ft. ;  
 $l$  = span length of beam in ft., as defined above.

## FORMULAS FOR SINGLE SPAN BEAMS

**Ends Freely Supported.**—Beam free to turn at support.

*Maximum Positive Moment at the Center,*

$$M = \frac{wl^2}{8} \text{ ft.-lb.} = 1.5wl^2 \text{ in.-lb.} \quad \dots \quad (58)$$

*No Negative Reinforcement is Required,*

**Beam Slightly Restrained at Ends.**—Ends not free to turn.

*Maximum Positive Moment,*

$$M = \frac{wl^2}{8} \text{ ft.-lb.} = 1.5wl^2 \text{ in.-lb.} \quad \dots \quad (59)$$

*Negative Bending Moment at End Supports,*

not less than  $M = \frac{wl^2}{20} \text{ ft.-lb.} = 0.60wl^2 \text{ in.-lb.} \quad \dots \quad (60)$

**Beam Fixed at Ends.**

*Maximum Positive Moment at Center,*

$$M = \frac{wl^2}{12} \text{ ft.-lb.} = wl^2 \text{ in.-lb.} \quad \dots \quad (61)$$

*Negative Moment at Supports,*

$$M = -\frac{wl^2}{12} \text{ ft.-lb.} = -wl^2 \text{ in.-lb.} \quad \dots \quad (62)$$

## CONTINUOUS BEAMS OF EQUAL SPANS

These formulas are adapted to such constructions as ordinary slabs in beams and slab floors, beams supported by girders, and roof construction, as shown in Fig. 93, p. 277.

The ends may be considered as slightly restrained.

**Beams and slabs continuous for two spans only.**

*Maximum Positive Moment near Center,*

$$M = \frac{wl^2}{10} \text{ ft.-lb.} = 1.2wl^2 \text{ in.-lb.} \quad \dots \quad (63)$$

*Negative Moment over Interior Support,*

$$M = \frac{wl^2}{8} \text{ ft.-lb.} = 1.5wl^2 \text{ in.-lb.} \quad \dots \quad (64)$$

*Negative Moment at End Supports,*

$$M = \text{not less than } \frac{wl^2}{20} \text{ ft.-lb.} = 0.60wl^2 \text{ in.-lb.} \quad \dots \quad (65)$$

**Beams and slabs continuous for more than two spans.**

(a) Interior Spans

*Maximum Positive Moment near Center,  
Negative Moment at Support,*

$$M = \frac{wl^2}{12} \text{ ft.-lb.} = wl^2 \text{ in.-lb.} \quad \dots \quad (66)$$

(b) End Spans.

*Maximum Positive Moment near Centers of End Spans,  
Negative Moment at First Interior Support,*

$$M = \frac{wl^2}{10} \text{ ft.-lb.} = 1.2wl^2 \text{ in.-lb.} \quad \dots \quad (67)$$

*Negative Moment at End Supports,*

$$M = \text{not less than } \frac{wl^2}{20} \text{ ft.-lb.} = 0.60wl^2 \text{ in.-lb.} \quad (68)$$

## CONTINUOUS BEAMS OF EQUAL SPANS, RUNNING INTO COLUMNS

### (Building Frames)

Beams and slabs of equal spans built to act integrally with intermediate and end columns, walls, or other restraining supports, and assumed to carry uniformly distributed loads, as shown in Fig. 94, p. 277, should be designed for the following moments at critical sections:

(a) Interior Spans.

*Negative Moment at Interior Supports except the First,*

$$M = \frac{wl^2}{12} \text{ ft.-lb.} = wl^2 \text{ in.-lb.} \quad \dots \quad (69)$$

*Maximum Positive Moment near Centers of Interior Span,*

$$M = \frac{wl^2}{16} \text{ ft.-lb.} = 0.75wl^2 \text{ in.-lb.} \quad \dots \quad (70)$$



- (b) End spans of continuous beams for which the ratio of stiffness,  $\frac{I}{l}$ ,<sup>9</sup> is less than the sum of the ratios of stiffness for the exterior columns,  $\frac{I}{h}$ , above and below a rigidly connected beam.

*Maximum Positive Moment near Center of Span and Negative Moment at First Interior Supports.*

$$M = \frac{wl^2}{12} \text{ ft.-lb.} = wl^2 \text{ in.-lb.} \quad . . . . . (71)$$

*Negative Moment at Exterior Supports,*

$$M = \frac{wl^2}{12} \text{ ft.-lb.} = wl^2 \text{ in.-lb.} \quad . . . . . (72)$$

- (c) End spans of continuous beams for which the ratio of stiffness,  $\frac{I}{l}$ , is equal to or greater than the sum of the ratios of stiffness,  $\frac{I}{h}$ , for the exterior column above and below a rigidly connected beam.

*Maximum Positive Moment near Center of Span and Negative Moment at First Interior Support,*

$$M = \frac{wl^2}{11} \text{ ft.-lb.} = 1.1wl^2 \text{ in.-lb.} \quad . . . . . (73)$$

*Negative Moment at Exterior Support,*

$$M = \frac{wl^2}{16} \text{ ft.-lb.} = 0.75wl^2 \text{ in.-lb.} \quad . . . . . (74)$$

The formulas under (c) are adapted to ordinary floor construction where the beams run into column and concrete walls.

#### CONTINUOUS BEAMS OF UNEQUAL SPANS OR WITH NON-UNIFORM LOADING

Continuous beams with unequal spans or with non-uniformly distributed loading should be designed for actual bending moments as directed under proper headings in Volume III. With unequal spans, provision should be made for bending moment in the columns.

<sup>9</sup> Table on p. 945 gives formulas for moments of inertia,  $I$  for various cross sections.

Bending moments for concentrated loads are also fully treated in Volume II.

#### EFFECT OF VARYING MOMENT OF INERTIA UPON THE BENDING MOMENT

As the bending moment in a continuous beam depends upon its moment of inertia, it will vary with the variation in the moment of inertia. The moment of inertia is seldom constant for the whole length of a continuous reinforced concrete beam. This is especially true of T-beams and of beams provided with haunches.

However, a thorough study of different conditions, by the authors, shows that the greatest variation in moment of inertia in a beam that is possible in ordinary design causes a variation in bending moment of less than 10 per cent. Under most conditions, the variation is even smaller. Consequently, a continuous beam may be designed safely with the bending moments recommended on p. 279. The effect of varying moment of inertia is fully treated in Volume II.

#### DETAILS OF CONTINUOUS BEAMS

**Continuous Beam at the Supports.**—In the past, too little attention has been paid to the details of reinforced concrete beams at the supports, with the result that a number of reinforced concrete structures have been built with beams and girders containing insufficient steel at the top of the beam over the supports to take the pull caused by the negative bending moment, and insufficient area of concrete to take the compression.<sup>10</sup> Not only do these beams fail to have the required factor of safety, but frequently even the working loads cause cracks that are always unsightly and sometimes dangerous. Moreover, moisture is likely to penetrate the open cracks and rust the steel.

Just as much care, therefore, is necessary in designing the reinforced concrete beam at the supports as in the middle of the span. Not only the tensile stresses in the steel, but also the compressive stresses in the concrete must be computed and properly provided for.

In T-beams particularly, there is a likelihood of the concrete being overstressed at the supports. At the center of the span, the portion of the slab forming the flange is available for resisting compression.

<sup>10</sup> See p. 282.

At the supports, however, where the bending moment is negative, the flange is in the tensile part of the beam and the compressive area consists merely of the part of the stem below the neutral axis. Usually, the compression area is not sufficient and it is necessary to increase it by using compression reinforcement.

**Allowable Working Stresses at the Support.**—As is evident from the curves of bending moments, the negative bending moment decreases very rapidly, so that the extreme fibers are under maximum stress only in a very short length of the beam. It is therefore permissible, at the supports, to use a higher compressive working stress in the extreme fiber than is used in the center of a beam where the rate of decrease in bending moment is much smaller and a larger part of the beam is under high stresses. The 1924 Joint Committee recommends an allowable working stress in concrete at the support of 900 lb. per sq. in. for 2 000 lb. concrete, when the working stress in the center of the beam is 800 lb. per sq. in. The authors indorse this recommendation. If other unit stress is used in the center, it may be increased at support by 15 per cent.

For a stress in the center of 650 lb. per sq. in. as specified by most Building Codes, a stress of 750 lb. per sq. in. is allowable at the support.

Even with this allowance, it is often impossible, without special provisions, to keep the stresses within working limits.

**Compression Steel at the Support.**—Frequently, additional compressive area is provided by reinforcement in the compressive part of the beam so that the beam must be considered and computed as reinforced at the top and bottom. The effectiveness of steel in compression has sometimes been questioned, but the results of tests with reinforced concrete columns, as well as with beams with steel in top and bottom (see p. 49), have proved conclusively that compression steel not only takes its share of the stress, but also stiffens the beam.

*First Method.* (See Fig. 95).—In a reinforced concrete beam, part of the bottom steel is bent up, and the rest, usually composing one-half of the steel area, is carried horizontally to the supports. This steel may be utilized as compression reinforcement. As the bars get their maximum compression at the edge of the support, to be effective as compression reinforcement they must be extended into the support, a sufficient length beyond the edge to develop the stress by bond. (See p. 268.) A shorter length of imbedment for bond is required for compression than for tension, because the compression

stresses are smaller. This is the simplest method of providing compression reinforcement and should be used where possible. It is illustrated in Fig. 95, p. 283. The ratio of compression reinforcement,  $p'$ , equals about one-half of the ratio of the tensile reinforcement, or  $\frac{p'}{p_1} = 0.5$ .

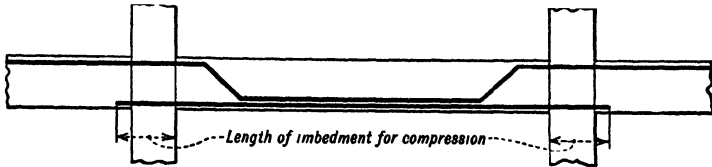

FIG. 95.—Compression Reinforcement at Support. First Method. (See p. 283.)

*Second Method.* (See Fig. 96.)—When the amount of compression reinforcement provided, as explained above, by the straight bars is not sufficient, additional reinforcement may be obtained by extending into the span under consideration the straight bars from the adjoining span. The length of the extended bar, measured from the edge of the support, will depend upon the bending moment, but

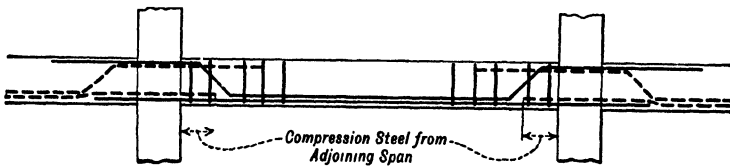

FIG. 96.—Compression Reinforcement. Second Method. (See p. 283.)

it must not be smaller than required to develop by bond, the compression stresses at the edge of the support. In turn, the straight bars from the span under consideration are extended into the adjoining span so that the compression reinforcement at both sides of the support consists of the sum of the horizontal bars in both spans. Such an arrangement is shown in Fig. 96, p. 283. The ratio of the compression reinforcement at the support,  $p'$ , is thus about equal to the ratio of tension reinforcement,  $p_1$ . Thus  $\frac{p'}{p_1} = 1$ .

Since each horizontal bar is subjected to compression stresses in the original span and also to equal compression stresses in the adjoining span, a question may be raised about the amount of com-

pression stresses carried by the bar. The answer can be had by referring to Fig. 97. From this, it is obvious that the compression stresses in one span act in the opposite direction to the compression stresses in the adjoining span. Thus, the compression stresses in the bar from the two spans are not added but balanced. The compression stress in the bar in one span acts as a reaction to the compression stress in the other span, and the stress is the same as though only one span were acting.

*Third Method.*—Sometimes the amount of compression reinforcement obtained by the second

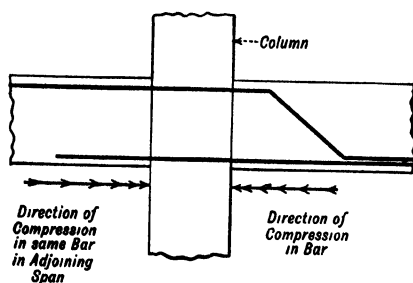

FIG. 97.—Compression Stresses in Bar at Support. (See p. 284.)

method is not sufficient. Additional reinforcement then can be supplied by short bars, placed at the support at the bottom of the beam. The length of the short bars will be governed by the bending moment, the minimum length being such that the projections beyond the column faces on each side are equal to the length of imbedment required

by bond for the expected compression stresses. The ratio of compression steel,  $p'$ , is then larger than the ratio of tension steel,  $p_1$ .

**Depth of Beam Increased by a Haunch.**—Another method of providing additional compression area is by increasing the depth of the beam at the support by a shallow haunch. Under ordinary conditions, this method is less desirable than increasing compression area by compression reinforcement. While material is saved, the excess cost of forms is apt to overbalance this saving. In many cases also, the haunch is objectionable from the architectural standpoint. A haunch is only useful, therefore, where it is desirable to avoid excessive compression reinforcement, or where more lateral stiffness is required for the structure. The required depth of haunch may be obtained by trial. A depth is assumed and then, with the aid of the diagrams on pp. 292 to 297, the stresses are computed and a new depth tried out if necessary. The depth is satisfactory if the compression stresses do not exceed the specified working stresses.

The depth of haunch may also be found from the rectangular

beam formula (Formula (1), p. 204). In this case, the effect of compression reinforcement may be neglected, because for deep haunches the bars are placed some distance from the extreme fiber. In any case, the error is on the safe side.

Under ordinary conditions, the computation need be made only for the maximum bending moment. The point at which the slope should be ended can be readily found from the following formula:

For a uniformly loaded beam, let

$M_b$  = negative bending moment next to the support;

$M_r$  = moment of resistance of the inverted T-beam without the haunch, governed by the concrete;

$x$  = length of haunch measured from face of column;

$l$  = clear span of beam.

Then

$$x = \frac{M_b - M_r}{M_b} \frac{l}{5} \text{ (approximately).}^{11} \quad . . . \quad (75)$$

This formula errs slightly on the safe side.

## PROCESS OF DESIGNING CONTINUOUS BEAM

After the floor is laid out and the spacing of beams fixed, the slab is designed first.

Next the dead and live load per lineal foot of beam is computed by multiplying the sum of dead and live load by the spacing of beams and adding the estimated dead load of the beam.

Knowing the condition of restraint at the ends, the shears and bending moments of the various spans are computed.

The depth of the beam is then decided upon. In a continuous beam of equal spans, it is desirable to use the same depth for all spans although the bending moments in the end spans are larger than in the center spans.

<sup>11</sup> This formula is based upon the fact that the point of zero moment is at approximately  $\frac{1}{5}$  of the span. The variation in the moment between the support and the  $\frac{1}{5}$  point is assumed to be a straight line. (This assumption is correct enough for the purpose.) Hence, the difference between the bending moment and the moment of resistance is in approximately the same ratio to the bending moment as is the ratio of the distance from the point where the haunch is needed to the point of zero bending moment. When the point of zero moment is not approximately at  $\frac{1}{5}$  span, the fraction may be altered accordingly.

When the beam is rectangular, the problem is simple. The depth is determined for the largest bending moment by Formula (1), p. 204, and for the largest shear by Formula (36), p. 248.

For a T-beam, the problem is solved as explained for T-beam designed on p. 217.

The selection of the proper depth for a continuous beam is somewhat more complicated than for a simple beam because the depth must be satisfactory for all spans.

Experience teaches that in most continuous beams, the depth is governed by the compression stresses at the support. The proper solution then would be to select the ratio of compression to tension steel,  $\frac{p'}{p_1}$ , and then find the required depth for the largest negative bending moment as described on p. 238. It is desirable, if possible, to arrange the reinforcement as described in "First Method" on p. 283, in which case the ratio  $\frac{p'}{p_1} = 0.5$ .

If, in a series of beams, a few beams are subjected to a disproportionately large bending moment at the support and if, in spite of this, it is desirable to retain the same depth for all beams, it will be found economical to use a large amount of compression reinforcement for these few beams. Considered by itself, such a design would not be desirable or economical. Taking the series of beams as a whole, however, the design will be more economical than if a deeper beam were used throughout.

Having tentatively decided upon the depth of beam and width of stem, diagonal tension stresses are computed to see that they do not exceed the allowable working stresses.

After the depth of beam is decided upon, the areas of reinforcement required in the different spans of the beam for negative and positive bending moment are computed, as discussed below. For main reinforcement, such bars are selected as will satisfy the positive bending moment in each span. Before these bars are finally accepted bond stresses should be investigated.

Bending of bars is then decided upon, and reinforcement for negative bending moment investigated.

After the points of bending of bars is decided upon, the required web reinforcement must be designed for beam in which the shearing unit stresses exceed those permitted for plain concrete.

**Tension Steel in Center of Span.**—The size and number of bars necessary to make up the required cross-sectional area are selected for each span independently. If possible, bars of one diameter, or of diameters that do not differ by more than  $\frac{1}{8}$  in. should be used. It is desirable to use not less than two bars in small beams and not less than four bars in larger beams. If a larger number is required, bars of the largest diameter permissible by bond should be selected, as this reduces the number of bars and therefore the cost of handling. The number of bars should be chosen, also, to permit the required proportion of bars to be bent up. When bending of one-half of the bars is contemplated, an even number of bars should be used.

Whenever possible, the bars should be placed in one layer. Often it is cheaper to widen a beam sufficiently to have all bars in one layer than to introduce two layers of bars and thereby increase the depth of beam. With two layers of bars, a strip of concrete, the width of the beam, and equal in depth to the diameter of bar plus  $\frac{1}{2}$  in., is wasted. This may be more than is required for widening the beam. In addition, with wider beam the extra concrete is used to resist shear, thus reducing the number of stirrups.

**Bending of Bars is Now Decided upon.**—The bars should be bent with due regard to the bending moments. The points of bending should be far enough from the center of the span, where the bending moment has decreased sufficiently to permit the reduction of reinforcement. The location of points of bending is not the same for uniformly distributed loads as for concentrated loads.

Diagrams, pp. 292 to 297, give the location of points of bending. Before using the diagrams, read the notes carefully.

In small beams, bars should be bent at one point only at each end. Many constructors favor bending the bars at one point only for beams of all sizes, because it reduces the number of types of bar on the job and thereby facilitates construction. The authors disagree with this practice and recommend bending bars in larger beams at several points. The disadvantage in the field is more than balanced by better distribution of reinforcement in the beam and by the increased effectiveness as diagonal tension reinforcement. If a large number of closely spaced bars are bent up at one point, they form in a beam an inclined plane which impedes the flow of concrete. This tends to form a plane of weakness, especially when the bars are not kept exactly in position. Proper distribution of the points of bending prevent such conditions.



When bending bars, there is a natural tendency to bend them symmetrically in the cross section. While symmetrical arrangement in a section is preferable, it is not absolutely necessary. Bending bars in two points with unsymmetrical arrangement in cross section is usually preferable to bending all bars at one point.

**Tension Steel at the Support.**—After the number and the size of the bars required in the center of the span are decided upon, the requirement at the supports is studied.

*If Maximum Positive and Negative Bending Moments are Equal.*—If the negative bending moment at the support and the maximum positive bending moment in the center of span are equal, and the beam consists of a number of equal spans and is of uniform depth, the arrangement of steel is simple. The positive reinforcement is designed so that it can be divided into two equal parts. Then one-half of the bars are laid straight and the other half bent up and carried across the support into the adjoining span to resist one-half of the tension there. An equal amount of steel is brought across from the adjoining span into the span under consideration. The sum of the effective bars at the support is then equal to the sum of the bars in the center. The requirement as to the amount of steel is satisfied. The only problem is to decide upon the points of bending of bars.

The condition is somewhat different at the first interior support. Assuming again that maximum positive and negative bending moments in a span are equal, the bending moment at the first interior support is equal to the positive bending moment in the center of the end span, but is 20 per cent larger than the bending moment in the center of the interior span. If the depths are equal, the required area of steel is proportional to the bending moments. When one-half of the steel in the end span and one-half of the steel in the interior span are bent up and carried across the first interior support, the available area of steel for the negative bending moment will be about 10 per cent less than required. The difference must be supplied by extra bars of proper length placed in the top of the beam at the support.

At the wall support, where negative bending moment equal to  $\frac{wl^2}{16}$  is required, those bottom bars which are bent up, and which are half the total number of bottom bars, will not give sufficient reinforcement for the negative bending moment; neither will the reinforce-

ment extend far enough from the column to take care of the tensile stresses at all points. It is necessary to add there, in the top of the beam, short bars provided with a hook at the support and extending to a point distant  $0.2l$  from the edge of the support.

*If Maximum Negative Bending Moment is Larger than Maximum Positive Moment.*—For continuous beams running into columns, where the positive bending moment is  $\frac{wl^2}{16}$  while the negative bending moment is  $\frac{wl^2}{12}$ , to supply the required amount of tension reinforcement at the support, two-thirds of the bottom steel must be bent up and carried across the support. In other respects, the condition is the same as in the previous case.

It may be found that with such an arrangement the straight bars are not sufficient to take care of the compression stresses. In such case, it is a good practice to bend up a smaller proportion of bars and supply the deficiency in tensile reinforcement at the support by extra short bars.

*If no Bars are Bent Up.*—Sometimes, it is not desirable to bend up any reinforcement, but to use only straight bars for positive and negative bending moment. This method is used in short, deep beams where bent-up bars would not reach the top at the proper place to be effective as negative bending moment reinforcement. The positive bending moment reinforcement is then made up of straight bars, some of which extend the full length of the beam while the rest extend on both ends beyond the points of inflection. It is not permissible to stop any bars short of the point of inflection, unless the bars are provided with a hook of proper dimension to develop the existing stress in bars at the point where the bar was stopped short. Otherwise there would be no means of inducing any stresses into the short bar without slipping of reinforcement.

The top reinforcement at the support consists of short bars of proper area. These should extend on both sides of an intermediate support beyond the points of inflection. At the wall column, one end should be hooked at the wall and the other should extend beyond the point of inflection.

A design in which the spans are not equal must be studied with more care. If the difference in span is large, the bending moments must be determined as explained in Volume II. In this case, it will not be possible to make up the area of tensile reinforcement at

the support by the bent-up bars, and additional top bars will be required.

**Top Bars to Hold Stirrups.**—To keep stirrups in position, two straight bars of small diameter are placed at the top, as shown in Fig. 81, p. 249. The stirrups are hooked on these bars and wired to them. With such an arrangement there is some assurance that the stirrups will not become disarranged in process of construction.

#### POINTS AT WHICH HORIZONTAL REINFORCEMENT SHOULD BE BENT

In a beam, the bending moments decrease from a maximum to zero at the points of inflection in continuous beams (and at points of support in simply supported beams); therefore, the required amount of reinforcement at intermediate points, for a beam with constant cross section, decreases proportionally. Consequently, it is permissible to bend up a part of the positive moment reinforcement at proper points and utilize it either as diagonal tension reinforcement or as negative bending moment reinforcement.

As the reduction of the required amount of steel depends upon the reduction of bending moments, the bending moment curves should be used as a guide in preparing bending sketches for the bars. To facilitate the work, bending moment diagrams for uniformly distributed loading are given on pp. 292 to 297 for different conditions of restraint at the support. Under each moment diagram, corresponding bending details are given. It should be noted that in the bending moment diagram the maximum bending moment is assumed as a unit and the intermediate bending moments are expressed as a fraction of the maximum moment. Where the positive and negative bending moments are equal, the assumed units for both cases are equal. Where the maximum positive bending moment is different from the maximum negative bending moment, the magnitudes of the units are also different.

To facilitate the use of the diagram, horizontal lines divide the maximum bending moment into ten parts. The span is also divided. In this way, the bending moment at any point may be found from the diagram in terms of the maximum moment.

In all diagrams for continuous beams, the distance between the supports was assumed as the span, in accordance with the recommendation given on p. 277. The diagrams may be used for other assumptions as to the length of the span. However, if for any

reason it is required to assume the point of support to be within the column, the distance of points of bending of negative reinforcement should be based on the net span and measured from the edge of support (and not from the theoretical point of support).

**Explanation of Max. and Min. Dimensions in Bending Diagrams.**

—In the bending diagrams for each bend, two limiting dimensions are given, one at the bottom and the other at the top. This does not mean that each bent bar will be bent at both these points. The two points are limiting points.

The bottom dimensions are given as, say, Max.  $0.25l$ . This means that the distance of the bent of the bar from the edge of the support must not exceed  $0.25l$ . As far as positive bending moment is concerned, however, the bent may be moved nearer towards the support and the distance of the bent from the support may be smaller than the allowable maximum value.

The top dimensions are given as, say, Min.  $0.15l$ . This means that the bent must not be placed nearer the support than  $0.15l$ . As far as negative bending moment is concerned the position of the top bent may be moved away from the column.

**Any bend between these points is satisfactory.** In selecting the actual points of bending, the diagonal tension should also be considered. In fixing the points of bending, it is always advisable to take into account the possibility of small inaccuracies in bending of bars and provide for it by placing the points of bending a few inches from the theoretical point. Thus, the point at the bottom should be a few inches nearer the support, and the point at the top a few inches farther from the support, than the theoretical values.

In practice, the point of bending at the bottom will be assumed, and the bar bent at an angle of  $35$  to  $45^\circ$ . The point of bending at the top is obtained automatically. If the distance from the support to this top point is equal to or larger than the minimum given in the bending diagrams, the design is satisfactory. If the point at the top comes too near the support, a steeper angle should be used. Although the angles recommended above are desirable, as then the bar is most effective as web reinforcement, angles of any steepness may be used if necessary.

The use of the diagrams is shown in Example 1, on page 578.

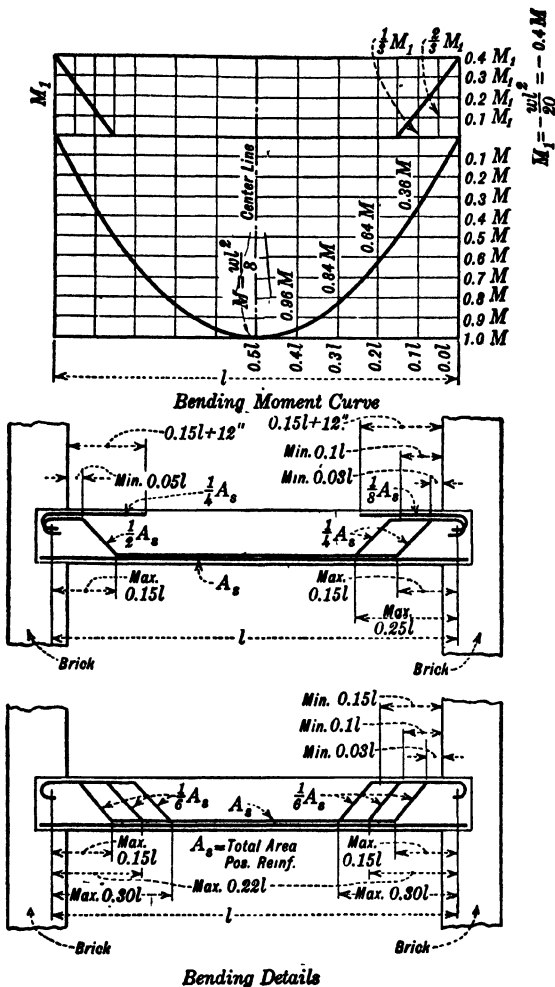

FIG. 98.—Beam Freely Supported or Slightly Restrained at Both Ends.  
(See p. 290.)

Note: For formula of bending moments see p. 278.

For explanation of terms Max. and Min. used in bending diagrams see p. 291.

The limiting dimensions for bending do not always coincide with selected points for bending of bars.

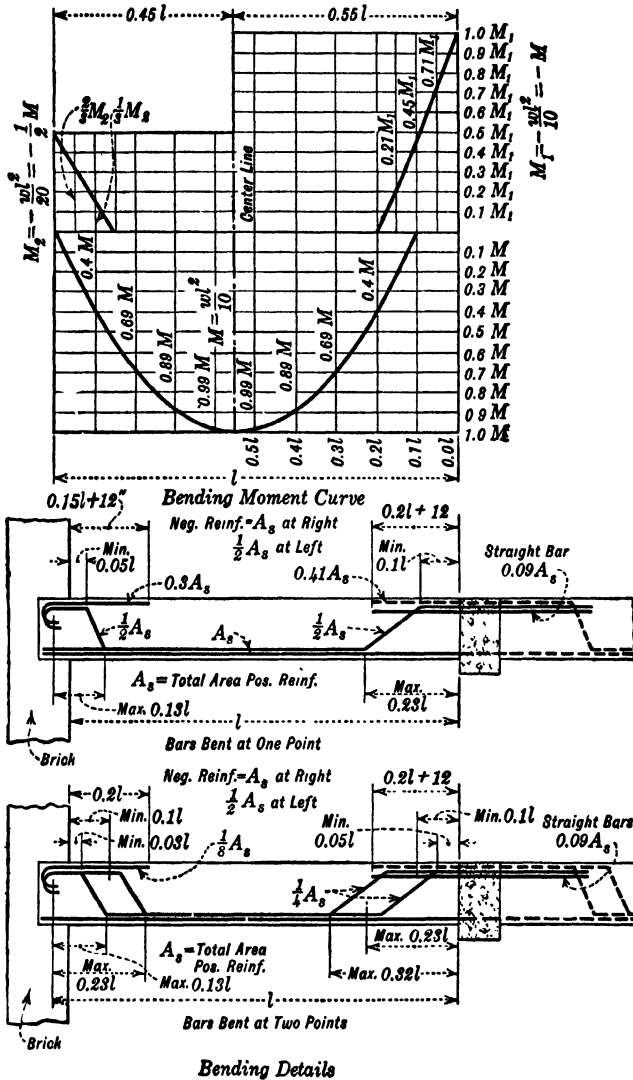

FIG. 99.—End Span of Continuous Beam, Freely Supported or Slightly Restrained at End. (See p. 290.)

Note: For formula of bending moments see p. 279.

For explanation of terms Max. and Min. used in bending diagrams see p. 291.

The limiting dimensions for bending do not always coincide with selected points for bending of bars.

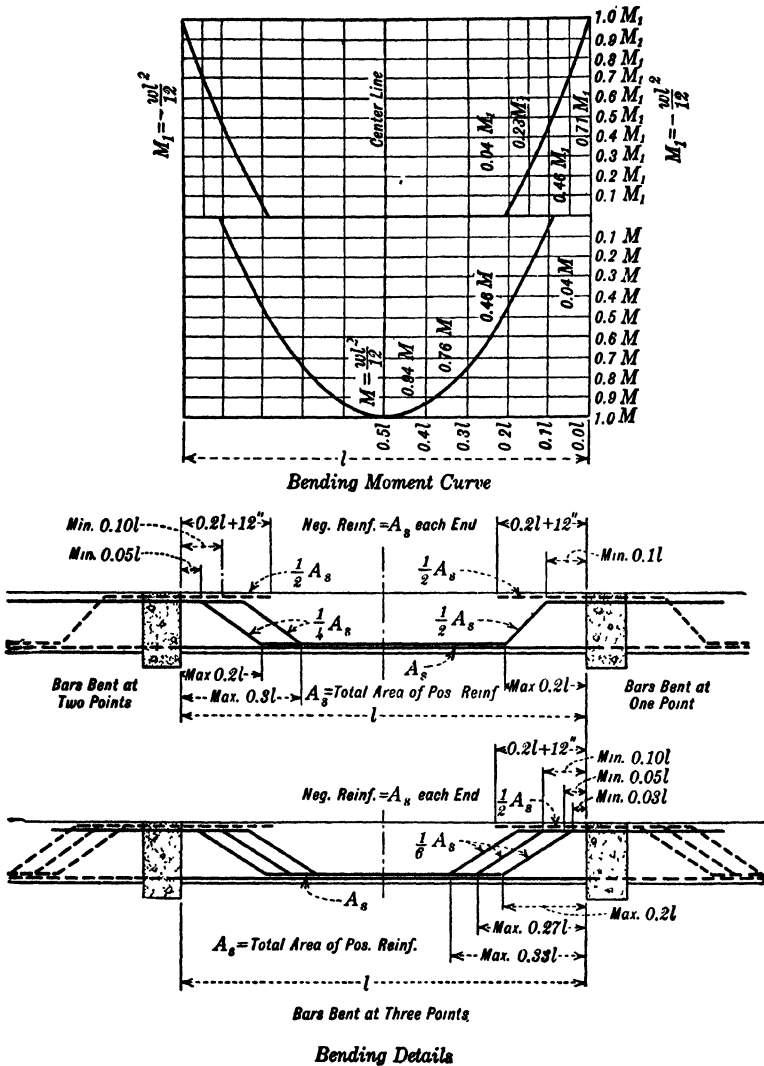

FIG. 100.—Interior Span of Beam Continuous for More than Two Spans. (See p. 290.)

Note: For formula of bending moments see p. 279.

For explanation of terms Max. and Min. used in bending diagrams see p. 291.

The limiting dimensions for bending do not always coincide with selected points for bending of bars.

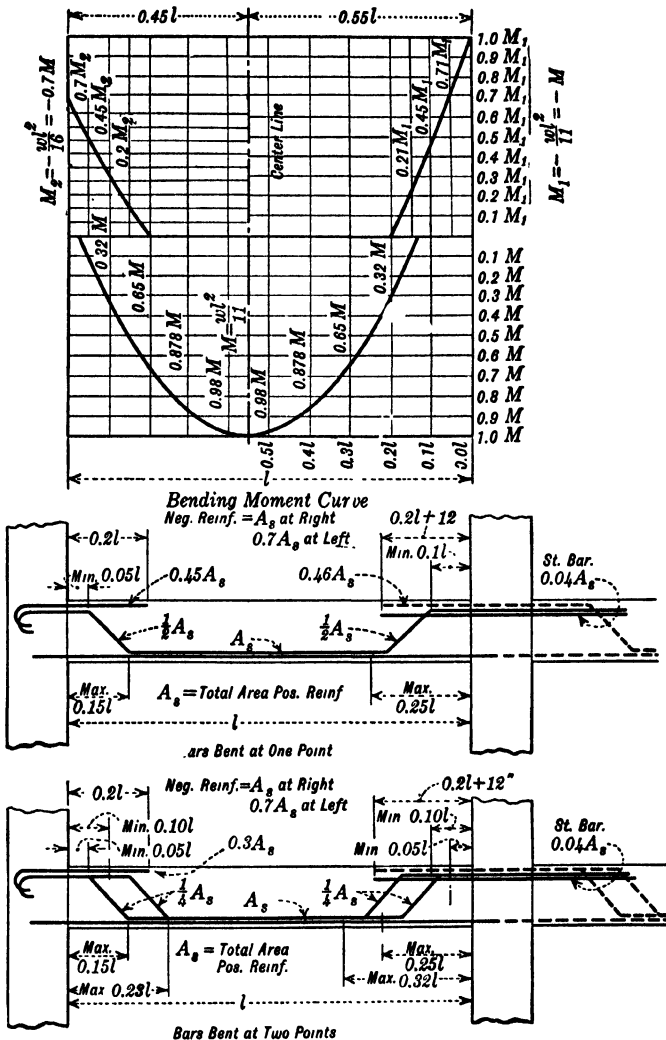

FIG. 101.—End Span of Building Frame End Partly Restrained. (See p. 290.)

Note: For formula of bending moments see p. 280.

For explanation of terms Max. and Min. used in bending diagrams see p. 291

The limiting dimensions for bending do not always coincide with selected points for bending of bars



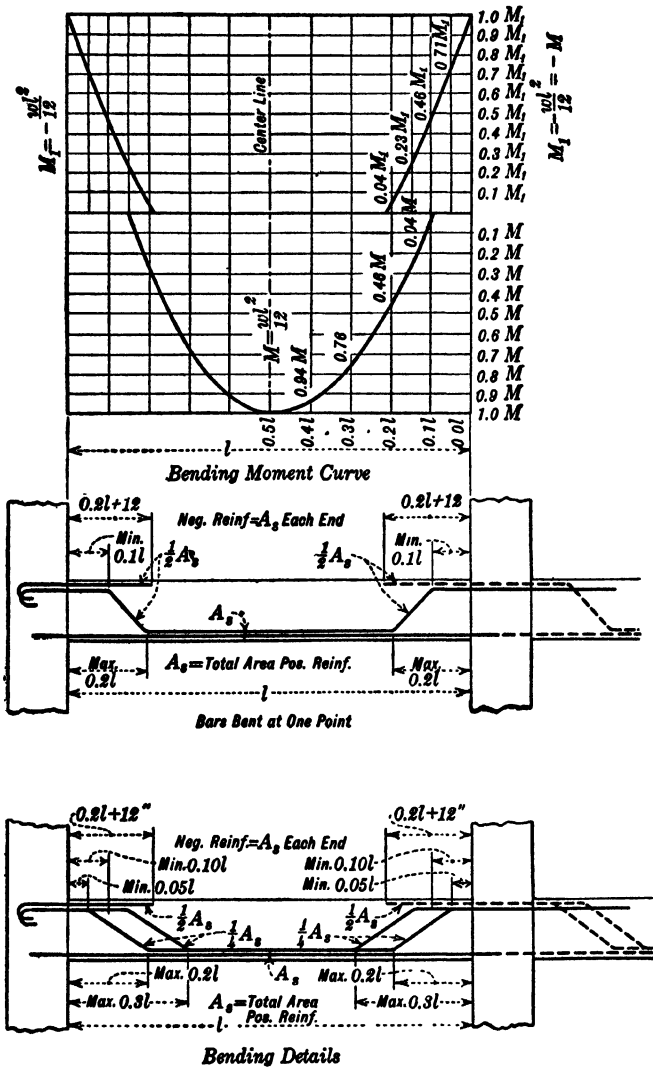

FIG. 102.—End Span of Building Frame. End Fully Restrained. (See p. 290.)

**Note:** For formula of bending moments see p. 280.  
 For explanation of terms Max. and Min. used in bending diagrams see p. 291.  
 The limiting dimensions for bending do not always coincide with selected points for bending of bars.

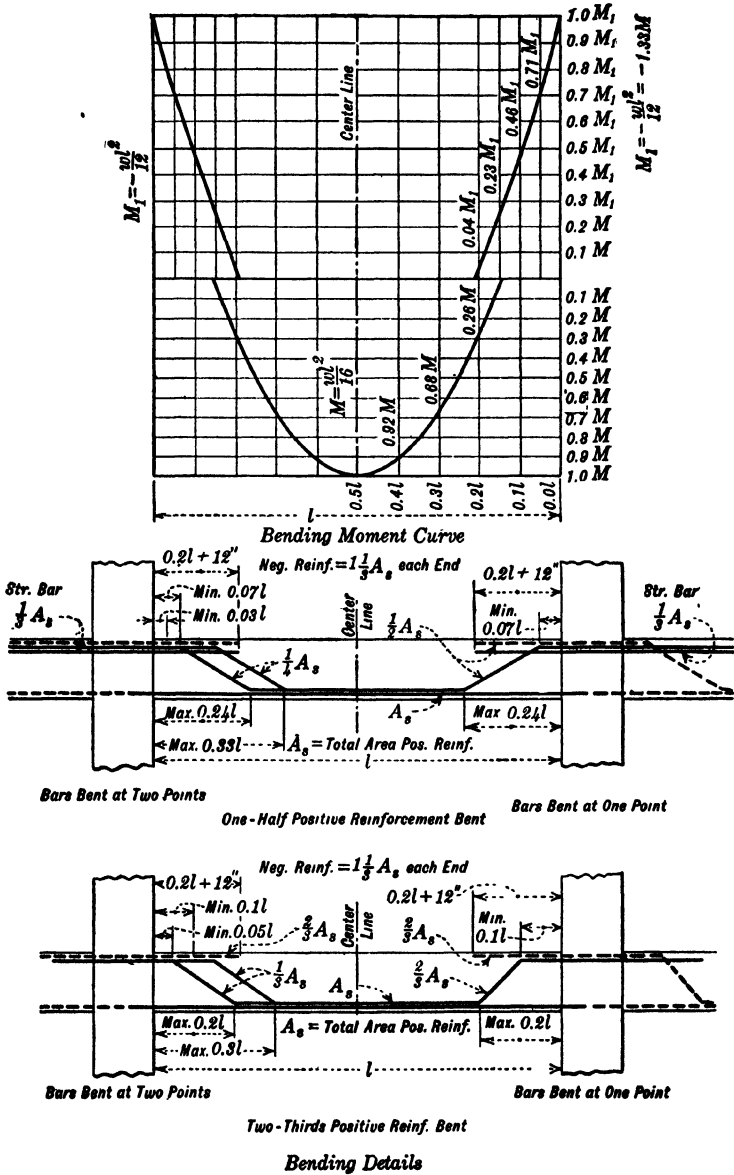

FIG. 103.—Interior Span of Building Frame. (See p. 290.)

Note: For formula of bending moments see p. 279.

For explanation of terms Max. and Min. used in bending diagrams see p. 291

The limiting dimensions for bending do not always coincide with selected points for bending of bars.

**REINFORCEMENT FOR TEMPERATURE AND SHRINKAGE STRESSES**

All masonry is subject to temperature cracks, but when they are distributed in the many joints between bricks or stones they do not show so plainly as on the smooth surface of concrete.

Expansion due to a rise in temperature rarely causes trouble except at angles where the lengthening of the surface may produce buckling or sliding of one portion of the wall past the end of the other. In a building, the walls and floors are generally so well bonded together and free to move as a unit, that no provision need be made for expansion. In a structure like a square reservoir, the effect of expansion must be taken into account in the design, to prevent failure at the corners.

Contraction is often more serious, although cracks are by no means necessarily dangerous. Temperature reinforcement is ordinarily used to prevent excessive cracking due to the shrinkage of the concrete in hardening or to the lowering of the temperature (see Volume III). Also, expansion joints are used in long structures.

Temperature reinforcement, placed in the direction of the expected contraction, does not prevent cracking entirely; but it distributes the cracks in such a way that numerous very small cracks, which are often invisible to the eye, are formed instead of a few large ones. To accomplish this purpose, the temperature reinforcement must be sufficient in quantity, and it should consist of bars of small diameter placed as close as practicable to the surfaces. Deformed bars, that is, bars with irregular surfaces which provide a mechanical bond with the concrete, are more effective in distributing cracks than smooth bars. Steel of high elastic limit also is advantageous.

The area of temperature or shrinkage reinforcement used in practice varies from 0.2 to 0.4 of 1 per cent of the cross section of the concrete ( $p = 0.002$  to  $0.004$ ).

The amount of temperature steel to be used depends upon conditions and the degree to which the cracks should be reduced. If a water-tight job is required, the higher value should be used.

The tensile strength of concrete is so low that a small change in temperature will crack it. For example, the coefficient of expansion of concrete is 0.000055 (see Volume III) and the modulus of elasticity is generally assumed as 2 000 000; therefore, the stress per degree Fahrenheit is  $0.000055 \times 2\,000\,000 = 11$  lb. per sq. in.,

and a fall in temperature of  $\frac{300}{11} = 27^\circ$  is sufficient to crack a concrete the tensile strength of which is 300 lb. per sq. in.

It is evident, and it has been proved by experience, that there is less cracking in concrete laid in cold than in warm weather.

Longitudinal reinforcement is especially necessary in conduits, which must be water-tight.

Cracks due to shrinkage in hardening of the concrete may be prevented by keeping the concrete wet. (See Volume III.)

It has been suggested by Mr. Charles M. Mills that the relation between the tensile strength of the concrete and the bond with the bars is an important factor in governing the size of the cracks; and the following analysis, based on his suggestions, gives a means of estimating the size and distance apart of the cracks, thus forming a basis for judgment as to the sizes and percentage of steel to use.

The tensile stress in the steel at a crack tends to pull out the bars from the concrete, and, referring to Fig. 104, the bond stress of the bar in the length  $ab$  must equal the tensile stress in the whole cross section of the concrete at  $b$  caused by the contraction of the concrete.

Let  $x$  = distance apart of cracks inches;

$D$  = diameter of round bar or side of square bar;

$p$  = ratio of cross section of steel to cross section of concrete.

Then,<sup>12</sup> if, as is sufficiently accurate for practical purposes, the strength of concrete in tension is assumed to be equal to the bond between plain steel bars and concrete, the distance apart of cracks is

$$x = \frac{1}{2} \frac{D}{p} \text{ for square or round bars.} \quad \dots \quad (76)$$

The distance apart is inversely proportional to the unit bond,<sup>12</sup> so that a deformed bar having twice the bond strength would space

<sup>12</sup> In addition to above notation, let

$A$ = area of section of concrete;	$u$ = unit bond between plain steel and concrete;
$A_s$ = area of section of steel;	$f_s$ = unit tensile stress in steel;
$o$ = perimeter of steel bar;	$D$ = diameter of bar.
$j_t$ = tensile stress in concrete;	

Then  $Af_t = \frac{1}{2}uox$ , or  $x = \frac{2Af_t}{uo}$ . If  $f_t = u$ ,  $x = \frac{2A}{o}$ , and since  $p = \frac{A_s}{A}$

$x = \frac{2A_s}{op}$ . Also,  $\frac{A_s}{o} = \frac{D}{4}$  for both round and square bars, hence  $x = \frac{1}{2} \frac{D}{p}$ .

the cracks one-half as far apart and allow them to be only one-half as wide.

It is evident that the distance apart of the cracks is proportional to the diameter of the reinforcing bars, and inversely proportional to the percentage of steel.

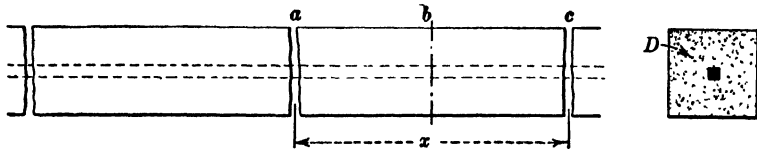

FIG. 104.—Reinforcement for Temperature Stresses. (See p. 299.)

From this formula is tabulated the estimated percentage of reinforcement for different spacing of cracks and different sizes of bars, assuming the bonding strength of the steel to the concrete to equal the tensile strength of the concrete.

#### Estimated Percentage of Reinforcement for Different Spacing of Cracks

	Distance Apart of Cracks						
	12"	18"	24"	36"	48"	60"	
Plain Bars.....	12"	18"	24"	36"	48"	60"	
Deformed Bars *.....	8"	12"	16"	24"	32"	40"	
	%	%	%	%	%	%	
Diameter of round or side of square bar.....	$\frac{1}{4}$ "	1.04	0.70	0.52	0.35	0.26	0.21
	$\frac{3}{8}$ "	1.56	1.04	0.78	0.52	0.39	0.31
	$\frac{1}{2}$ "	2.08	1.39	1.04	0.69	0.52	0.41
	$\frac{5}{8}$ "	2.60	1.74	1.30	0.87	0.65	0.52
	$\frac{3}{4}$ "	3.12	2.08	1.56	1.04	0.78	0.62
	$\frac{7}{8}$ "	3.65	2.44	1.82	1.22	0.91	0.73
	1"	4.17	2.78	2.08	1.39	1.04	0.83

NOTE: To express the steel as the ratio of area of cross section of steel to cross section of concrete, divide the percentages by 100; thus 1.04 becomes  $p = 0.0104$ .

\* Assuming the bond of deformed bars to be 50 per cent greater than plain.

The size of the crack is governed by the amount of shrinkage and for cracks due to temperature changes may be estimated as the product of the coefficient of contraction (0.000055) by the number of degrees fall in temperature by the distance between cracks.

Estimated Width of Cracks for Different Distances Apart

Change of Temperature	Distance Apart					
	12''	18''	24''	36''	48''	60''
30° Fahr.*.....	0.0020	0.0030	0.0040	0.0059	0.0079	0.0099
50° ".....	0.0033	0.0050	0.0066	0.0099	0.0132	0.0165
70° ".....	0.0046	0.0069	0.0092	0.0139	0.0185	0.0232

\* 30° corresponds to a shrinkage of 0.017 per cent; 50° to 0.028 per cent; 70° to 0.038 per cent.

From this, if it can be determined how large a crack will be allowable, the corresponding spacing can be obtained.

To avoid large cracks it may be necessary to use enough steel to prevent its passing its elastic limit. If the bars are continuous for such a length that the ends are practically immovable, as in a long retaining wall, a drop in temperature, tending to shorten them, produces a tensile stress which is independent of the distance between the restrained ends. Assuming the coefficient of expansion of steel to be the same as that of concrete and the modulus of elasticity of steel as 30 000 000, this stress is  $30\,000\,000 \times 0.0000055 = 165$  lb. per sq. in. per degree of temperature, or for 50° F. is 8 250 lb. per sq. in. This is well within the elastic limit of the steel and would not, of itself, cause the steel to take a permanent set. However, since the concrete surrounding the steel will be continuous except at certain cracks, the stretch in the steel may be unevenly distributed and largely confined to the immediate vicinity of the cracks. If cracks occur while steel is unstressed, through the concrete shrinking, the steel tends to resist the shrinkage by tension at the crack and compression at the center of the block of concrete, and the tensile stress will be equal to the compressive and each equal to one-half the tensile strength of the concrete. This may be expressed by the following formula, in which the foregoing notation is used.<sup>13</sup>

$$f'_s = \frac{1}{2p} f_t.$$

$$^{13} \frac{A f_t}{2} = A_s f'_s, \text{ or } f'_s = \frac{A}{2A_s} f_t \text{ hence } f'_s = \frac{1}{2p} f_t.$$

Since the tensile stress in the concrete is liable to be low at the time shrinkage cracks are formed, it may be assumed, for illustration, as 200 lb. per sq. in., making

$$f'_s = \frac{100}{p}.$$

This represents the stress due to local cracks, which is additional to the temperature stresses above described. The total stress is, therefore, for 50° change of temperature  $8\,250 + f'_s$  or  $8\,250 + \frac{100}{p}$ . If the elastic limit of the steel is 40 000 lb. per sq. in., and we must keep below this,

$$40\,000 = 8\,250 + \frac{100}{p} \quad \text{and} \quad p = 0.0031.$$

For steel, the elastic limit of which is 50 000 lb. per sq. in.,

$$50\,000 = 8\,250 + \frac{100}{p} \quad \text{and} \quad p = 0.0024.$$

These values of  $p$  represent the lowest theoretical ratio of area of cross section of steel to area of cross section of concrete which can be used without the steel passing its elastic limit at certain of the cracks when the ends are restrained or the length is so great that intermediate parts are practically restrained.

In view of the very slight stretch required to relieve the stress in the bars when the elastic limit is exceeded, and the probability of its distribution by the restraint to movement by the mass, it is not always essential to consider the elastic limit.

## CHAPTER VI

### DESIGN OF FLAT SLAB STRUCTURES

The aim in this chapter is to present a complete and logical treatment of the design of the flat slab. Precedent and common practice are followed when they agree with sound engineering. A number of rules of thumb, however, which have accumulated during the early stages of flat slab development have been eliminated, and rules based on logic and on accepted principles governing other types of concrete design have been substituted.

In this chapter, besides covering the general principles of flat slab design, the authors aim to treat the details in such a way as to give the engineer, and also the student, the basic information and instruction required to design a safe and economical slab adapted to any required conditions. Design of interior columns is treated on p. 305; that of exterior columns on p. 312; column heads and drop panels, p. 319; rules for thickness of slab, pp. 325 and 337; bending moments to be used in design, p. 328; formulas for compression stresses in slab, p. 341; use of compression reinforcement in flat slab design and formulas, p. 345; shearing stresses in flat slab, p. 347; method of computing tensile reinforcement and arrangement of bars in flat slab, p. 351.

For computing bending moments in flat slabs, the authors have adopted the widely accepted method based on the division of the slab into parallel strips. This permits a fairly well balanced design which, with proper tables, can be worked out without excessive labor. For a method more logical in theory and still simpler in practice, the reader who desires to investigate theory is referred to the treatment in the Second Edition of this book, which was worked out by the authors. The strip method, however, has become established by precedent and gives workable results; for the present, therefore, it is accepted by the authors in preference to introducing a different type of formulas. Further experiment and analysis will probably throw new light on the subject.



The formulas for bending moments, recommended for use, agree in general with those given by the 1924 Joint Committee, which, in turn, correspond with those now in common use. Modifications have been made by the authors, however, where necessary for uniformity of design. The formulas may be safely used for rows of equal or substantially equal panels. Unusual designs should be analyzed according to formulas given in Vol. II.

In all respects, the material in the chapter has been based upon the considerable experience of the authors in design of flat slab construction, and upon various tests, many of which were made by or for the authors.

**Advantages of Flat Slab Construction.**—In flat slab construction, concrete is used more logically than in beam and girder construction. Whereas, in beam and girder construction, the load is transmitted from the slab to the beam, then from the beam to the girder, and finally from the girder to the column, in flat slab construction the load is transmitted directly by the slab to the column. The load, irrespective of its position on the slab, is carried by the whole slab; therefore, overstressing, due to concentrations of load, is impossible.

The under side of a flat slab is practically flat. Because of the absence of exposed corners, flat slab construction is less vulnerable in case of fire than beam and girder construction.

The formwork for flat slab is simple. Forms for column heads and drop panels, usually made of metal, are adjustable and can be rented at a small cost. Ordinarily, scarcely any adjustment of forms is necessary for different floors designed for different loadings, since the change in thickness of slab does not require change in formwork. Change in thickness of drop can be readily accomplished.

**Universal Adoption of Flat Slab Construction.**—Owing to its many advantages, flat slab construction has practically superseded beam and girder construction for spans up to 30 ft. and live loads over 100 lb. per sq. ft. For smaller live loads, light-weight floors are often more economical. For more detailed discussion, see Chapter VI and also discussion of various types of buildings.

**Description of Flat Slab Construction.**—Reinforced concrete flat slab construction is distinguished from all other types of slabs by the absence of beams and girders. The slab carries the load and is supported directly by columns, which are provided ordinarily with enlarged heads, called column heads or capitals. For heavy loads, the slab is thickened at the column by drop panels or plinths. The

elements of flat slab construction are, therefore: columns, column heads, slabs, and drop panels. For light loads, the drop panels, and sometimes even the column heads, are omitted. The functions of the elements are discussed under separate headings.

Flat slab construction is illustrated by photographs in Figs. 105 and 106. In Fig. 105 is shown light flat slab construction without drop panels. The pleasing appearance of the room, which is used as an office space, is noticeable. Attention is called also to the distribution of the light. Fig. 106 shows a heavy flat slab construction with drop panels, as used in a warehouse.

Reference should also be made to the photograph of flat slab building, Fig. 185, p. 572, and also to the perspective view, Fig. 187, p. 574.

### COLUMNS IN FLAT SLAB CONSTRUCTION

In flat slab construction, distinction is made between interior and exterior columns, not only on account of their shape but also because of the difference in function.

#### INTERIOR COLUMNS.

Interior columns may be round, square, octagonal, rectangular, or oblong in cross section, as required. In most structures, the only consideration affecting the shape of the column is economy of the formwork for the column and the column head. Where metal forms are easily obtainable, round columns and round column capitals are most economical, especially with spirally reinforced columns. Octagonal or square columns are sometimes specified. Octagonal columns are considered by some architects to be more pleasing in appearance than round columns. Square and octagonal columns are also preferred, in some cases, because it is easier to fit partitions to the flat surfaces of the columns. Square and octagonal columns are also used where metal forms are not readily obtainable, since wood formwork for either square or octagonal columns and column heads is cheaper than for round columns.

Rectangular or oblong interior columns are used where it is desirable to keep the clear span in one direction as large as possible. Such may be the case in manufacturing establishments, such as shoe factories and textile mills, in which the manufacturing processes or machines run in one direction, and a strip of the building of the width



FIG. 105.—Interior of Office Building. (See p. 305.)

Densmore LeClear and Robbins, Architects. S. M. I. Engineering Co.,  
Consulting Engineers.

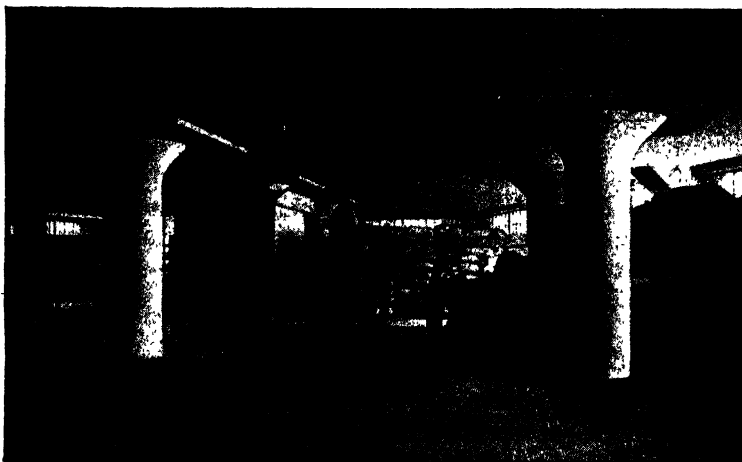

FIG. 106.—Interior of Warehouse. (See p. 305.)

Chas. H. Way, Architect. S. M. I. Engineering Co., Engineers.

of the column is unoccupied space. Rectangular columns are sometimes used in garages and in printing establishments, to make more room for the machines between the columns.

**Design Formulas.**—Formulas for design are given in the chapter on Column Design. The economy of design of the columns is also discussed there.

### INTERIOR COLUMNS FOR SYMMETRICAL ARRANGEMENTS OF PANELS

When the arrangement of panels is symmetrical about the center line of the column and the load is uniformly distributed over the whole area, the interior column is subjected to vertical load only, and no bending moment acts in it. However, in the actual use of the building, occasional unbalanced loading is unavoidable. This is caused by live load placed in panels on one side of the column line, while the opposite side is not loaded. Such loading produces bending moments in the interior columns. Ordinarily, the possibility of such bending moment is taken care of by limiting the minimum size of the interior column to a definite ratio of the span. The columns are then designed for the vertical load only.

**Limitation of Minimum Size of Interior Column.**—Most specifications and building codes require that the diameter of the interior round column should be not less than a certain fraction of the span measured center to center of columns. The requirements of various building codes are given in the table on p. 308.

**Authors' Recommendations.**—The authors recommend the following limitations of interior columns:

Design Live Loads, lb. per sq. ft.	Limitation of Outside Diameter of Interior Round Column
60 lb. and under	No limitation
70 to 100 lb.	$\frac{1}{8}$ of span
110 to 200 lb.	$\frac{1}{5}$ of span
210 to 300 lb.	$\frac{1}{2}$ of span

For higher loads, computations of bending moments should be made.

The above limitations apply when the bending moment due to unbalanced load is resisted by a column above and below the floor. The columns should be provided with vertical bars of an area equal to at least 1 per cent of the effective area of the column, but not

less than four  $\frac{3}{4}$ -in. round bars should be used in square columns nor less than six  $\frac{5}{8}$ -in. round bars evenly spaced around the circumference in round columns. If no column extends above the floor, the minimum diameter of column should be increased by 15 per cent,

### Limitation of Diameter of Interior Columns for Flat Slabs

With Symmetrical Arrangement of Panels

(In Effect in 1925)

City	Smallest Diameter in Terms of Span	Other Diameter Limitations	Provision for Unbalanced Loading
Boston.....	$\frac{1}{15}$ span in longer direction		
Chicago.....	$\frac{1}{12}$ average span	$\frac{1}{12}$ clear height	
Cleveland.....	$\frac{1}{15}$ average span for floors	Min. diameter, 14 in.	Moment of $\frac{1}{16}W_1l^*$ to be resisted by column above and below in proportion to their $\frac{I}{h}$
	$\frac{1}{15}$ average span for roof		
New York.....	$\frac{1}{15}$ average span	Min., 16 in. for round, and 14 in. for square columns	
Philadelphia.....	.....	.....	
Joint Committee, 1924.....	No special	requirement given	

\*  $W_1$  = total live load on panel in lb ;  $l$  = average span center to center of columns in feet. Moment is in ft.-lb.

or the amount of steel increased beyond one per cent, in accordance with the discussion given below.

The limitation of the column size serves the purpose of supplying sufficient rigidity for the column to take care of the bending moment

produced by occasional unbalanced loading. The limitations given are based on experience and are satisfactory with average spans and average heights of columns. In special cases, the bending moment due to unbalanced live load in the interior column should be computed in the manner given below. This should be done for unusual heights of columns, special sections, and especially heavy live loads. Stresses due to bending should be computed when the loading in the panels is not uniformly distributed, for instance, if one panel carries much heavier machinery than the adjoining panels.

The authors' recommendations are based on the following reasoning.

Since the limitation of the diameter of interior column is for the purpose of supplying in it sufficient resistance to bending caused by unbalanced loading, the required resistance should depend not only upon the span but also upon the magnitude of the live load and upon the possibility of unbalanced loading. If a column with a diameter equal to, say,  $\frac{1}{15}l$ , is rigid enough for a warehouse designed for a live load of 150 lb. per sq. ft., where it may have to resist large bending moments caused by one-sided loading of panels, a smaller diameter may be used with equal satisfaction for an office or a hotel with live loads from 40 lb. to 70 lb. per sq. ft. and where heavy unbalanced loading is practically impossible.

The limitation of the diameter of column to a fraction of the span, say  $\frac{1}{15}l$ , applies directly to round or octagonal columns provided with a minimum amount of vertical steel. An increase in the amount of steel increases appreciably the magnitude of the moment of inertia. Therefore, if it is necessary for any reason to use a column having a smaller diameter than  $\frac{l}{15}$ , the required rigidity may be obtained by using an increased amount of vertical steel, so that the moment of inertia of the column is equal to that of a column with a diameter equal to  $\frac{l}{15}$  but with the minimum amount of steel.

If square or rectangular columns are used, the limitations in the table do not apply directly. In such cases, the column selected should have a moment of inertia equal to that of a round column of a diameter equal to the required fraction of the span. The moment of inertia of a square with a side,  $d$ , is  $\frac{d^4}{12}$  or  $0.083d^4$ , while for a circle with a diameter,  $d_1$ , it is  $0.049d_1^4$ . For equal moment of inertia,

$\frac{d^4}{12} = 0.049d_1^4$ , from which  $d = 0.87d_1$ . This means that, for equal moment of inertia, the side of a square may be only 0.87 of the diameter of the round column. When the minimum diameter of round column is required to be  $\frac{1}{15}l$ , the minimum side of a square column should be  $\frac{1}{17.2}l$ .

For a wide rectangular column equivalent to a round column with a diameter equal to  $\frac{1}{15}l$ , the thickness of the column, for rigidity, may be much smaller than  $\frac{1}{15}l$ , as illustrated below.

**Example of Square and Rectangular Columns.**—For a specific example, assume a 25-ft. square panel and a limiting fraction  $\frac{1}{15}l$ . The minimum allowable diameter of a round column is  $\frac{25 \times 12}{15} = 20$  in. If a square column is used, the side of the square may be made equal to  $20 \times 0.87 = 17.4$  in. Now assume that for a special reason it is desirable to reduce the thickness of the column in one direction by using a rectangular column 30 in. wide. The moment of inertia of a rectangular column, where  $b$  is width and  $d$  thickness, is  $\frac{1}{12}bd^3$ . For  $b = 30$ , this is  $\frac{3}{2}d^3 = 2.5d^3$ . The moment of inertia of a 20-in. round column is  $0.049 \times 20^4$ . Comparing the two values,  $2.5d^3 = 0.049 \times 20^4$ , from which  $d = 14.6$  in. Thus, in this case, a 20-in. round column, a 17½-in. square column, or a 14.6 by 30-in. rectangular column may be used.

In a rectangular panel with a round or square column, the minimum diameter is based on the average span. If a rectangular or oblong column is used, the rigidity in the long direction may be made equal to that of a round column of a diameter equal to the specific fraction of the long span, and the rigidity in the short direction may be made equal to that of a round column with a diameter equal to the same fraction of the short span.

The rigidity of the column depends not only upon the moment of inertia but also upon the height of the column. Rigidity is expressed by the ratio  $\frac{I}{h}$ . The limitation given above applies to columns of ordinary height, say up to 14 feet. The rigidity decreases with the increase in height of the column. Therefore, for higher columns, the diameter of the column should be increased above  $\frac{1}{15}l$  if it is desired to make its ratio of stiffness equal to the ratio of stiffness of a 14-foot round column with a diameter  $\frac{1}{15}l$ .

**Bending Moment in Interior Columns.**—Some building codes, notably those of the cities of Philadelphia and New York, and the 1924 Joint Committee recommendations require that interior columns

be computed for the bending moment produced by the live load placed on one side of the column with adjacent panels without live load. This bending moment may be computed by the following formulas, which apply when the column extends above and below the floor under consideration.

Let  $W_l$  = total live load on the loaded panel, lb.;

$l$  = panel length, ft.;

$M_l$  = bending moment produced by unbalanced live load.

Then

*Bending Moment due to Unbalanced Live Load,*

$$M_l = \frac{1}{40} W_l l \text{ ft.-lb.} \quad \dots \dots \dots (1)$$

$$= 0.3 W_l l \text{ in.-lb.} \quad \dots \dots \dots (2)$$

This bending moment should be considered as resisted by the columns above and below the slab in proportion to their ratios of stiffness  $\frac{I_c}{h}$ . If the stiffness of the two columns is equal the moment  $M$  to be resisted by each column equals  $\frac{M_l}{2}$ . When the difference between the ratios is appreciable, the proportion of the moment resisted by each column should be computed. Usually it is near enough to assume that the lower column resists  $0.6M_l$  and the upper column  $0.4M_l$ .

The points of application of the bending moment are evident from Fig. 107, p. 311.

This bending moment is combined with the column load, and stresses are computed by formulas for direct load and moment (see p. 173).

The combined compression stresses due to the direct load and the bending moment should not exceed the stresses recommended on p. 463. Of course, the column must be strong enough to resist the maximum direct stresses without exceeding the stresses specified for columns.

If the column steel is not sufficient to resist the tensile stresses, additional bars should be added.

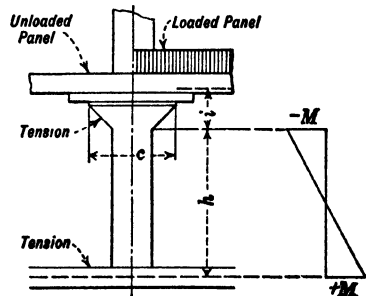

FIG. 107.—Bending Moment in Interior Columns. (See p. 311.)



Since, in a square panel, some bending moment may occur at any side of the column, the required additional reinforcement must be so placed as to be effective on all four sides of the column. It is best to place such bars in the corners, since then they may be considered as effective for bending moments acting on either of the adjacent sides. In rectangular panels, bending moments in both directions may have to be computed.

It is not necessary, in columns, to consider unbalanced live loading due to the roof load. The most unfavorable effect of the bending moment on the column will be found in the top story column, where the bending moment due to floor load is essentially the same as in other floors, but the size of the column and the amount of reinforcement is smaller than in any other story.

**Unsymmetrical Arrangement of Interior Columns.**—For unsymmetrical arrangement of interior columns, the bending moments in columns exist even for uniform loading. The required bending moments in columns and slabs should be determined as explained in Volume II.

### EXTERIOR COLUMNS.

Exterior columns are usually rectangular in shape. A rectangular column imbedded in the wall projects less into the building than a square column carrying the same load. Also, exterior columns often serve as pilasters between windows, in which case their width depends upon the width of the window sash. For this and other reasons, it is advisable to make the width of the column constant for the whole height of the building.

Some specifications (notably the Flat Slab Regulation of the City



Special Exterior Columns

FIG. 108.—Cross Sections of Exterior Columns.

(See p. 312.)

Note: Reinforcement not shown.

of Chicago) require large minimum dimensions for wall columns. In such cases, rectangular columns may not be economical. The sections shown in Fig. 108, p. 312, are often used under these conditions.

**Design of Exterior Columns.**—Exterior flat slab panels, when supported by concrete columns, are designed as partly restrained at the ends. To get this favorable condition for the slab, the exterior

columns must have sufficient rigidity to produce in the slab the required restraint. Also, they must have sufficient reinforcement to resist the bending moment transferred from the slab to the column. The fact that exterior columns are subjected to bending and that the strength of the slab in the wall panels depends upon the strength and rigidity of the exterior columns cannot be overemphasized. Outside columns of light or improper design are the most frequent cause of weakness in flat slab design.

**Required Rigidity of Exterior Column.**—The rigidity of a member depends directly upon its moment of inertia,  $I$ , and inversely upon its height,  $h$ , or length,  $l$ . It is represented by the ratio  $\frac{I_c}{h}$  for columns, and by  $\frac{I}{l}$  for beams or slabs.

Exterior columns should be made rigid enough to develop in the slab, at the wall columns, at least eight-tenths of the negative bending moment in an interior panel. By the theory of least work, the authors find that for this purpose the relation between the ratio of rigidity of the column and that of the slab is expressed in the formula below.

- Let  $I$  = moment of inertia of slab;
- $l$  = length of span perpendicular to the wall;
- $I_c$  = moment of inertia of column;
- $h$  = height of column.

Then

$$\frac{I_c}{h} = 1.5 \frac{I}{l}. \quad . . . . . (3)$$

From this relation, the required dimensions of the column may be computed as given below. The moment of inertia of the slab should be based on a thickness equal to the thickness of the slab plus one-third of depth of drop panel, and a width equal to the spacing of the exterior columns.

The minimum thickness of a rectangular wall column for a given width,  $b$ , determined by the required rigidity, may be easily found from the following equations:

- Let  $l$  = length of span of slab at right angles to the wall, from center to center of columns, ft.;
- $l_1$  = length of span of slab parallel to the wall, from center to center of columns, ft.;

$h$  = height of column from center to center of slab, ft.;

$b$  = width of column, ft.;

$d$  = depth of roof slab or top floor slab, in.;

$d_1$  = minimum thickness of column, in.;

Then

$$d_1 = 1.15 \sqrt[3]{\frac{hl_1}{bl}} d. \quad . \quad . \quad . \quad . \quad . \quad . \quad (4)$$

For slab with drop panels, the value  $d$  in the above formula equals the thickness of the slab plus one-third of the depth of the drop panel.

**Bending Moment in Slab at Wall Column.**—The magnitude of the negative bending moment in the slab at the wall column, which is transferred to the columns, depends upon the relative rigidity of the column and the slab. This bending moment should not be taken as less than eight-tenths of the negative bending moment at the column in an interior panel of the same dimensions. For this condition, the relation between the ratios of stiffness of the column and the slab should be as expressed in equations (3), p. 313.

Where the wall columns are much stiffer, negative bending moment in the slab at the wall columns should be increased.

**Bending Moments in Exterior Columns.**—The negative bending moment developed in the slab at the wall, the magnitude of which is discussed above, is transferred to the exterior columns and must be resisted by them. In the roof, the total bending moment is resisted by the column below. In lower stories, the bending moment is resisted partly by the column above and partly by the column below. The proportion of the moment resisted by the two columns depends upon their ratio of stiffness,  $\frac{I_c}{h}$ . The stiffer column will resist a proportionally larger share of the bending moment.

The bending moment in each column may be found by dividing the bending moment in the slab by the sum of the ratios of stiffness (the moment of inertia  $I_c$ , divided by the length  $h$ , of the two columns), and multiplying the result by the ratio of stiffness of the column under consideration. For practical purposes, it is accurate enough to assume that 60 per cent of the bending moment will be resisted by the lower column and 40 per cent by the upper column.

It should be noted that the bending moment in the upper end of the column below the slab is negative, i.e., it produces tensile stresses

on the outside face of the column. The bending moment in the lower end of the column above the slab is positive and produces tension on the inside face of the column.

*Points of Application of Maximum Moments in Columns.*—The maximum negative bending moment in the column, as determined in the above paragraph, may be considered as acting at the bottom of the bracket, or, when no brackets are used, at the bottom of the slab or drop panel. The maximum positive bending moment acts above the slab. Plotting the maximum negative moment at the top and the maximum positive bending moment at the bottom, and connecting the points by a straight line, the moments at intermediate points may be determined.

**Steps in Design of Exterior Columns.**—After the column load and bending moments are determined as described above, it is necessary to compute the maximum compression stresses for the combination of the concentric vertical column load and the bending moment, and to determine the amount of tensile reinforcement required to resist the tensile stresses for the most unfavorable combination of the concentric column load and the bending moment.

The first step in this process is to determine the dimensions for a column required by the concentric column load alone. This consists simply in applying the ordinary rules for column design, pp. 403 to 469.

Next, the maximum compression unit stresses in this column are computed for the combination of maximum concentric column load and the maximum bending moment, either by formulas on p. 175, or formulas on p. 182, depending upon the amount of tensile stresses developed for this condition of loading. The maximum unit stresses thus obtained should not exceed the maximum allowable stresses as recommended on p. 463. In computing the combined stresses, the full section, including the fireproofing, may be used in the same manner as in slab at the support. If the computed unit stresses in concrete exceed the allowable unit stresses, the section should be increased.

The final step is to determine the required amount of tension steel to resist the bending moment. For this purpose, that combination of the vertical column load and the bending moment which produces maximum tension should be used. This combination will be different from that used for determining maximum compression.

There is a difference of opinion as to the method of determining

the required amount of reinforcement to resist the bending moment in the column.

The following method, developed by the authors, is recommended for use.

For the top columns in a structure, where the vertical column load is small in comparison with the bending moment, the amount of tensile steel should be determined for the bending alone, the effect of the vertical load being disregarded. The amount of steel is determined from the beam formula  $A_s = \frac{M}{f_s j d}$ , where  $d$  is the distance from center of tension steel to the face of the column. If the amount of steel required by the column design is not sufficient, additional bars should be used. These do not need to extend the full length of the column, as the bending moment decreases rapidly.

For columns in lower floors, where the total dead load carried by the column is appreciable, the following method for computing tensile stresses in column is recommended by the authors.

Assume that the structure above the floor under consideration is loaded with dead load only, but that the floor under consideration is loaded by dead and live load. Under such conditions, provide sufficient tensile strength in the column to give a factor of safety of two in case of overloading of the floor (with the structure above not loaded).

For this purpose, compute the dead load on the column above the floor under consideration. Add to it double the reaction due to live and dead load from the floor.

Compute the bending moment in the column produced by the dead and live load on the floor under consideration.

Multiply this moment by two and combine it with the column load computed above. Provide such an amount of steel in the column that the tensile stresses will not exceed double the allowable tensile stresses in steel. If the amount of reinforcement required by column design is not sufficient additional bars must be added.

This method gives the same factor of safety, against cracks in the column, as is used in the floor construction.

The method will be understood from the following explanation. It may easily happen during the life of a structure, and even during construction of the structure, that the wall panels of one floor are overloaded, while no appreciable live load is placed on the floors above. With such loading, only the dead load above this floor can

be counted upon as reducing the tensile stresses produced by the bending moment. This dead load is constant. It will not increase with the overloading of the slab. When the slab is overloaded by double the design load, the column load below the slab will be increased by the reaction of the slab, but the column load above the slab will not be changed.

Some engineers and some building codes (notably that of the City of Chicago, Flat Slab Ruling) require that the amount of steel for the bending moment in the column be computed for the bending moment alone, and that the regular beam formulas and the same allowable tensile stress in steel be used here as for parts of the building subjected to bending only. The amount of steel thus obtained is required in addition to the regular column steel. The steel may be arranged as shown in Fig. 109, p. 318. This method is too wasteful.

Other specifications permit the maximum direct column loads to be combined with the bending moment, and if the resulting tensile stresses in steel do not exceed the allowable unit stresses, the column is considered satisfactory. This method is not safe. It depends upon the total dead and live load on the column to balance the tensile stresses, although it is clear that the total column load is not always there to balance these stresses. Also, in case of overloading of one floor, the bending moment in the column is increased but the column load above the floor remains the same. The method already described, on the other hand, safely provides for such contingencies.

**Anchoring of Steel Resisting Bending in Wall Column.**—The steel designed to resist bending stresses in the column should be properly anchored, else the bars may pull out instead of resisting tension.

In the top of the top story columns, the outside bars should extend, above the points of maximum bending moment, a sufficient length to develop the strength of bar in tension. If this is not possible by straight imbedment, the bars should be properly hooked at the top in the slab. The inside bars are compression reinforcement.

In intermediate stories, the outside bars at the top of any column are sufficiently developed when they are extended into the column above, the proper distance from points of maximum moment to develop the strength of the bar in tension. The inside bars of any column serve as compression reinforcement below the slab and as tension reinforcement above the slab. The length of imbedment of

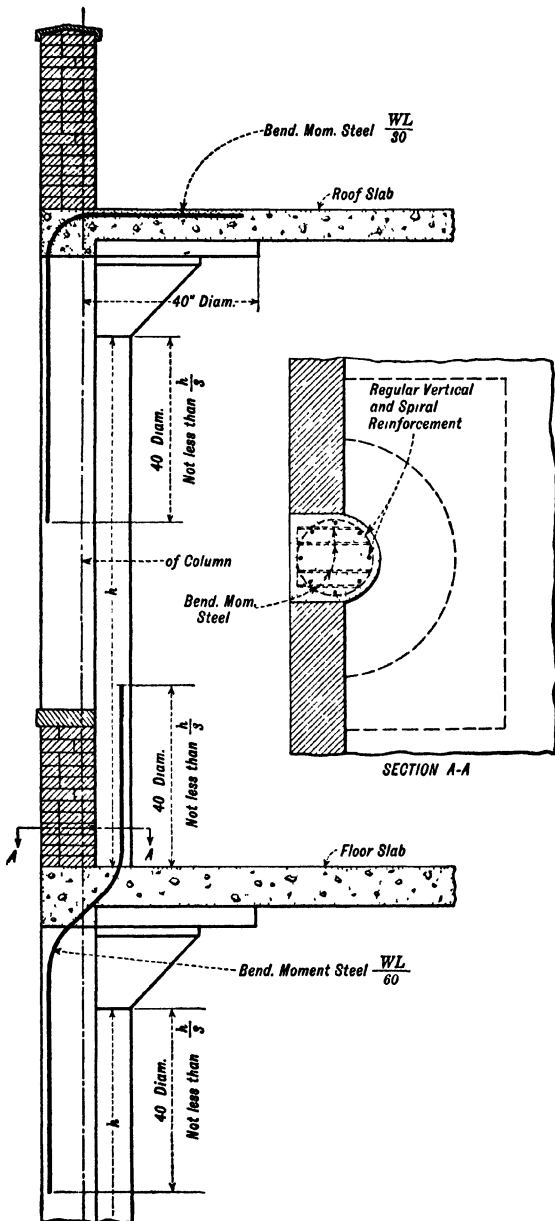

FIG. 109.—Wall Column Reinforcement, Chicago Ruling. (See p. 317.)

these bars in the column above, measured from the top of slab, should be such as to develop the full tensile strength in the bar.

In all the above cases, an imbedment equal to 40 diameters of the bar for deformed bars, and 50 diameters for plain bars, may be considered ample.

COLUMN HEADS

The column head usually has the shape of a truncated cone or a pyramid. Its cross section depends upon the cross section of the column. For round columns, the cross section of the head is also

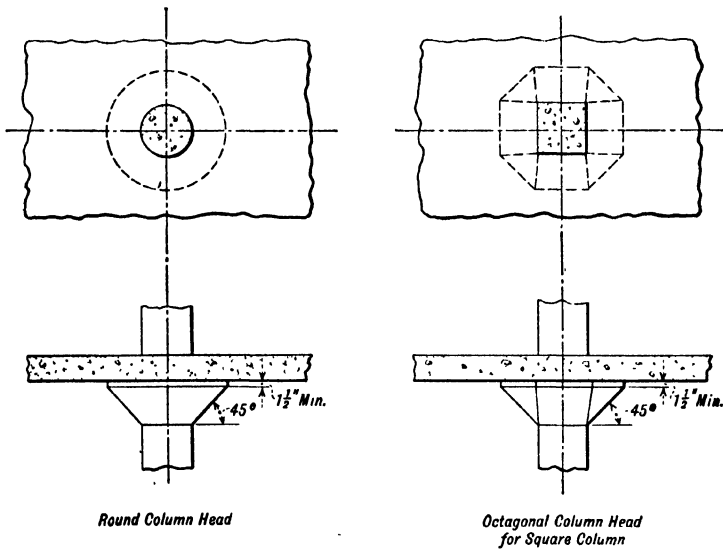

FIG. 110.—Typical Design of Column Heads. (See p. 319.)

round; for square columns, it is sometimes square. A more pleasing effect, however, is obtained by making the section octagonal, as shown in Fig. 110. Sometimes, when metal forms are available, the column heads for square columns are made circular in section. The effect is not pleasing, as the joint between the column and the head does not look neat. For octagonal columns, octagonal heads are used; for oblong columns, the heads may be as shown in Fig. 111. The forms for such heads may be made of sheet metal, the two halves of a circular column head being joined with two flat pieces of sheet metal.



The column heads may be made ornamental. Metal forms for the column head shown in Fig. 112 are readily obtainable.

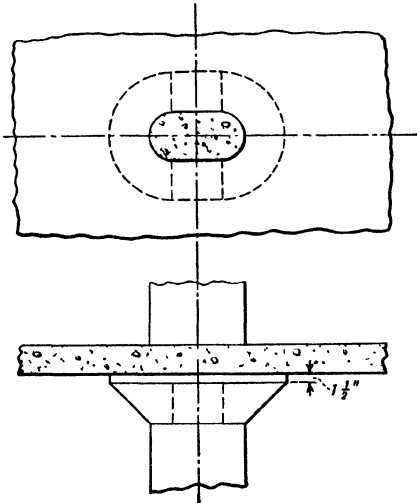

FIG. 111.—Column Head for Oblong Column.  
(See p. 319.)

form with the horizontal an angle of not less than 45 degrees. Also, the diameter of the column capital to be used in calculations should be taken where the vertical thickness of the column head is at least  $1\frac{1}{2}$  in. The theoretical shape of the column head is shown in Fig. 110. All rules are based on round column heads. When square column heads are used, they may be considered as equivalent to a round column head with a diameter 20 per cent larger than the side of the square.

If it is desirable, for architectural reasons, to use for the column head a flatter angle than 45 degrees, as shown in Fig. 114, p. 321, the effective column head is then governed by lines drawn at 45 degrees, as shown in the figure.

If a block is placed above a column, as in Fig. 115, it may be con-

At wall columns, when spandrel beams are used, brackets are substituted for column heads, as shown in Fig. 113. Some codes, however, require that a section of a regular column head be provided at the wall column.

**Design of Column Heads.**—The function of the column head is two-fold: first, to decrease the shear; second, to reduce the net span and thereby the critical bending moments. It is a well-established rule that, in order to fulfill the second function, i.e., to decrease the span, the sides of the column head should

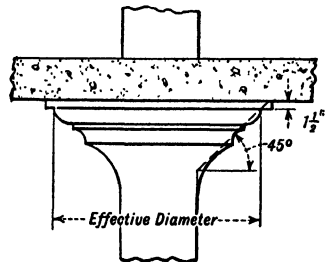

FIG. 112.—Ornamental Column Head.  
(See p. 320.)

sidered as a column head and its diameter determined as shown in the figure.

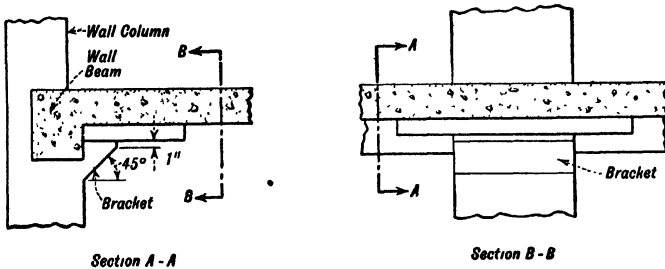

FIG. 113.—Wall Bracket. (See p. 320.)

Early rules (some of which are still in use) specified a definite relation between the span of the panel and the diameter of the

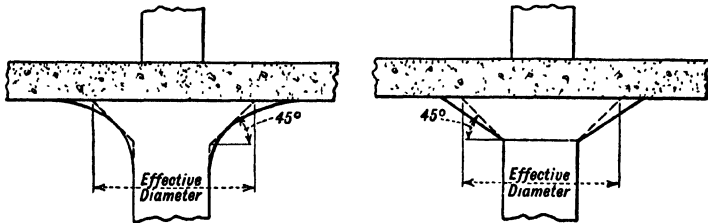

FIG. 114.—Flat Column Head. (See p. 320.)

column head, without regard to the design load. In such specifications, the bending moments were computed on the basis of the specified size of the column and were expressed as functions of the gross span and the load. Modern rules do not impose any arbitrary restrictions as to the minimum diameter of the column head. Its size is only limited by the shearing stresses in the slab. The selection of the proper size depends upon economy of design and also upon the architectural requirements. As the bending moments are functions of the net span, the increase in the diameter of the column head decreases the bending moments in the slab, and vice versa.

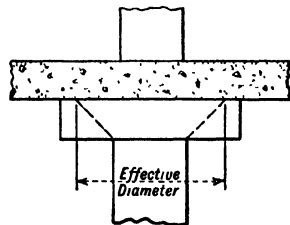

FIG. 115.—Block Serving as Column Head. (See p. 320.)

The minimum diameter of the column heads specified by the Chicago and New York City regulations equals  $0.225l$  as given on page 397. The authors recommend that the size of the column head be varied with the design load. For factories and warehouses, the diameter of the column head may be equal to  $0.225$  to  $0.25l$ , where  $l$  is the span in square panels and the average span in rectangular panels. For light manufacturing buildings,  $0.2l$  may be used.

In buildings carrying light loads, such as office buildings and apartment houses, the column head may be greatly reduced or even omitted if desirable for architectural reasons.

For the method of computing shearing stresses at column head, see p. 346, under Shearing Stresses.

#### DROP PANELS

By the term drop panel, is understood a thickening of the slab around the column. This portion is sometimes called the plinth, or simply the drop. The drop panels in square or nearly square panels are usually square. In rectangular panels, rectangular drops may be used, with a ratio of dimensions of drop equal to the ratio of the corresponding sides of the panel. Sometimes, for the sake of appearance, the drop panels are made round or octagonal. This complicates the formwork, and the effect does not warrant the departure from general practice.

**Advisability of the Use of the Drop Panels.**—In early flat-slab designs, no drop panels were used. This gave unsatisfactory results in many cases. The shearing and compression stresses at the column, in many designs, were too high and the deflection of the slab excessive. In recent years, the practice went to the other extreme of using drop panels indiscriminately even in cases where they could be omitted with economy. The designer should keep in mind that; from the standpoint of the user of the building, drop panels are not desirable. This is particularly the case where shafting is suspended from the under side of the slab. As a general proposition, then, drop panels should not be used except for economy, or when it is not possible to satisfy the stresses at the column without them. In deciding whether or not to use drop panels, comparative estimates of cost should be made of designs with and without drop panels, taking into account not only the cost of the materials but also the extra cost of formwork for the drop panels.

It will be found that for live loads over 150 lb. per sq. ft., drop panels are economical. For smaller loads, down to 100 lb. per sq. ft., drop panels are economical only for long spans and for specifications requiring bending moment coefficients in excess of those recommended by the authors (such as 1916 Joint Committee Recommendations or the Boston Code). In many cases, the use of larger column heads, with some compression reinforcement in the slab, may be found more economical than the drop panels. The cost of extra steel may be more than balanced by the saving in concrete and in the cost of formwork for the drop. For loads of 100 lb. per sq. ft. and under, drop panels are hardly ever economical.

**Dimensions of Drop Panels.**—The dimensions of the drop to be determined are the depth and the width. These are to some extent interdependent, as will be explained below.

The purpose of drop panels is to reduce the shearing unit stresses, both at the column head and at the edge of the drop panel; also to reduce the compression stresses and the amount of tensile steel at the column head. The magnitude of the shearing and compression unit stresses at the column head depend upon the depth of the drop panel. The most economical depth is one for which the compression unit stresses in the concrete are about equal to the maximum allowable unit stress. Additional depth saves steel but increases the amount of concrete in a larger ratio. Instead of adopting an arbitrary depth for the drop panel, the designer is advised to compute it by formulas on p. 339. Since it is advisable to use the same depth for all drop panels throughout the floor, the depth should be computed for the largest bending moments. Ordinarily, these will occur in end panels, i.e., at the first interior columns next to the wall. The compression stresses for interior panels will then be somewhat smaller than the maximum allowable.

The width of the drop panel depends upon three factors, the first being the compression stresses at points of maximum bending moment. As evident from the discussion on p. 341, under "Compression Stresses in Concrete," and from Formula (29), p. 344, a large part of the compression stresses is resisted by the drop panel. If the compression stresses in concrete are nearly equal to the maximum unit stresses, the width and the depth of the drop are interdependent. The width in this case cannot be reduced without overstressing the concrete in compression.

The second factor is the diagonal tension stresses at the edge of

the drop, as figured by Formula (41), p. 349. If, for a certain width of the drop panel, the shearing stresses are excessive, the width of the drop panel must be increased.

The third factor is the compression and tensile stresses at the edge of the drop panel, where the depth of the flat slab is suddenly reduced by the depth of the drop. This reduction is permissible only when the bending moment becomes so much smaller that, with the decreased depth, the compression and tensile stresses do not exceed the allowable unit stresses. The location of the section where the drop panels may be stopped will depend mainly upon the ratio of the depth of the drop panel to the total depth at the point of maximum bending moment. For larger ratios of the depth of the drop to the depth of slab, the required reduction in bending moments is larger than for smaller ratios. The points where the drop can be stopped are, therefore, farther from the edge of the column head for large ratios than for small ratios. Large ratios of the depth of the drop to depth of slab, therefore, require larger width of the drop than small ratios.

In various specifications, including that of the 1924 Joint Committee, the width of the drop is arbitrarily fixed, irrespective of its depth, and varies from one-third to three-eighths of the span. This is not consistent. The authors recommend the following relation between the width of the drop panel and the ratio of the depth of the drop panel to the depth of the slab:

Let  $d$  = effective depth of slab outside the drop panel;

$t_2$  = depth of drop below slab;

$l$  = span, center to center of columns, in the direction of the width under consideration.

Then the width of the drop will be as given in the table below.

Ratio $\frac{t_2}{d}$	Width of Drop Panel
0.1	0.28 $l$
0.2	0.30 $l$
0.4	0.33 $l$
0.6	0.36 $l$
0.75	0.38 $l$

**Drop Panels at the Wall Columns.**—If drop panels are provided at the wall columns, they should be of the same depth as the interior drop panels. The width of the drop panel, parallel to the wall, should be the same as for interior drops in the same direction. The

width at right angles to the wall, measured from the center of the column, should be equal to one-half the corresponding width of the interior drop panel.

In many instances, the shearing unit stresses at the wall columns are much smaller than at the interior column, on account of the larger circumference of the wall column, and also because part of the shear is resisted by the spandrel beam. Also, the bending moment is smaller. For these reasons, the drop panel may often be omitted at the wall column. **The required amount of negative reinforcement at the wall must then be computed on the basis of the smaller depth.** In rectangular panels, where the difference between the spans is appreciable, the drop panels at the wall in the short direction may be omitted.

### THICKNESS OF SLABS

The thickness of the slab is governed, in flat slabs without drop panels, by the shearing and compression stresses at the column head. In flat slabs with drop panels, the only limiting stresses, as far as the thickness of the slab is concerned, are the diagonal tension stresses at the edge of the drop panel and the compression stresses in the center. The thickness of slab, determined by the stresses, may not be large enough to keep the deflection within desired limits. Since there are no reliable formulas for computing the deflection, most specifications impose a number of arbitrary and unnecessary limitations on the minimum thickness of the slab, such as that (1) the slab thickness shall not be less than 6 in., or that (2) it shall not be less than  $\frac{1}{12}$  of the span for floor slabs nor less than  $\frac{1}{16}$  of the span for roof slabs.

It will be observed that the above limitations are general. They apply equally to flat slabs with and without drop panels. They apply also to all load conditions; the only distinction made is between floor slabs (irrespective of the design load) and roof slabs (also irrespective of the design roof load). All these limitations originated when little was known about flat slab construction and are being carried along from specification to specification without investigation.

The limitation of the thickness of slab to 6 in. originated when the four-way system was the only one in use and all flat slabs were built without drop panels. Under such conditions, it was not practicable to use thinner slabs and accommodate effectively the four layers of steel at the column. With the development of systems

using only two layers of steel, and also with the introduction of drop panels, the reason for this limitation has been removed. With this limitation, flat slabs cannot be used economically for small spans. There is no reason why, for small spans, a thickness of slab proportional to the span should not be used. The authors recommend that the limitation be revised to permit 4-in. thickness for slabs with drop panels and  $4\frac{1}{2}$  in. for slabs without drop panels.

The second limitation of the thickness of slab to a certain ratio of the span was made for the purpose of limiting deflection. It was based on the performance, in use, of flat slab structures, mostly built without drop panels. Since, in a floor consisting of nearly equal panels and with slabs of the same thickness throughout, the wall panels deflect most, the limitation was based on the performance of the wall panels. Assuming that the limitation is correct under such circumstances, its use would be justified for buildings in which the interior and exterior spans are about equal and the thickness of slab is uniform throughout the floor, as then the conditions in the wall panel would govern. In cases where the wall panels are smaller than the interior panels, it would not be correct to apply this limitation to the larger interior panels. The unreasonableness of the rule is evident from the comparison of the conditions in Fig. 116, *a* and *b*. Fig. 116*a* shows a building three panels wide, with exterior panels 18 ft. and interior panels 26 ft. Fig. 116*b* shows a building two

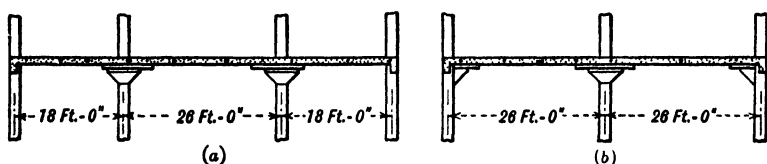

FIG. 116.—Section through Flat Slab Buildings. (See p. 326.)

panels wide, each of the panels being 26 ft. According to the limitation under discussion, the minimum allowable thickness of the slab is the same for both cases, although it is plain that the slab in the second case would deflect much more than in the first case.

Another objection to this rule is that it separates flat slab design into floors and roofs, irrespective of the loading to be carried. In many cases this leads to absurdities. For instance, in an office building, the design live load for the floors is 70 lb. per sq. ft. Actually, this load is seldom reached. The load on the roof, on the

other hand, may consist of cinder fill weighing about 60 lb. per sq. ft., roofing weighing 10 lb. per sq. ft., and live load of 40 lb. per sq. ft. The total load, exclusive of the slab load, to be carried by the roof is 110 lb. per sq. ft., of which 70 lb. is permanently on the roof. According to the rule under discussion for 20-ft. panels, the required thickness of the floor slab would be  $7\frac{1}{2}$  in. for the design load of 70 lb.; while for roof slab carrying 110 lb. per sq. ft.—of which 70 lb. is permanently on the slab—only 6 in. would be used.

**Authors' Rules Limiting Thickness of Slab.**—It is questionable whether any limitation of the thickness of the slab, other than that imposed by the stresses, is necessary. General rules, however, if made consistent, may be of assistance to designers who are not grounded in flat slab design. Therefore, the authors recommend the following rules:

Two groups are to be considered: (1) slabs carrying, in addition to the dead load of the floor slab, loads of 100 lb. per sq. ft. and under; (2) slabs carrying, in addition to the dead load of the slabs, loading of over 100 lb. per sq. ft.

The minimum thickness of the slab without drop panels, for the first group, should be  $\frac{1}{40}$  of the end span or  $\frac{1}{45}$  of the interior span; for the second group,  $\frac{1}{32}$  of the end span or  $\frac{1}{38}$  of the interior span. For slabs with drop panels, designed as recommended under proper heading, the minimum thickness given above may be reduced by  $\frac{1}{8}$  of the thickness of the drop panel.

Where the end spans are not monolithic with the wall columns, as in brick bearing jobs, the minimum thickness obtained above should be increased by 25 per cent.

**Thickness of Slab for Floors with Different Sizes of Panels.**—If the panels are nearly uniform throughout the floor, the slab should be made of uniform thickness. The minimum thickness should then be based either on outside or inside span, whichever gives larger value. If the panels in one part of the floor are materially different from those in some other part, the thickness of the slab may be different for the different parts. The floor should be made level, and the difference in thickness made up by dropping the bottom surface of the slab. Where the different thicknesses of slab meet, the underside of the slab should be sloped gradually rather than stepped.



## BENDING MOMENTS IN FLAT SLABS

**General.**—As explained in the section on theory, a flat slab is subjected to bending in two directions. For instance, at the column head and in the center of the panel, the slab bends in radial and cir-

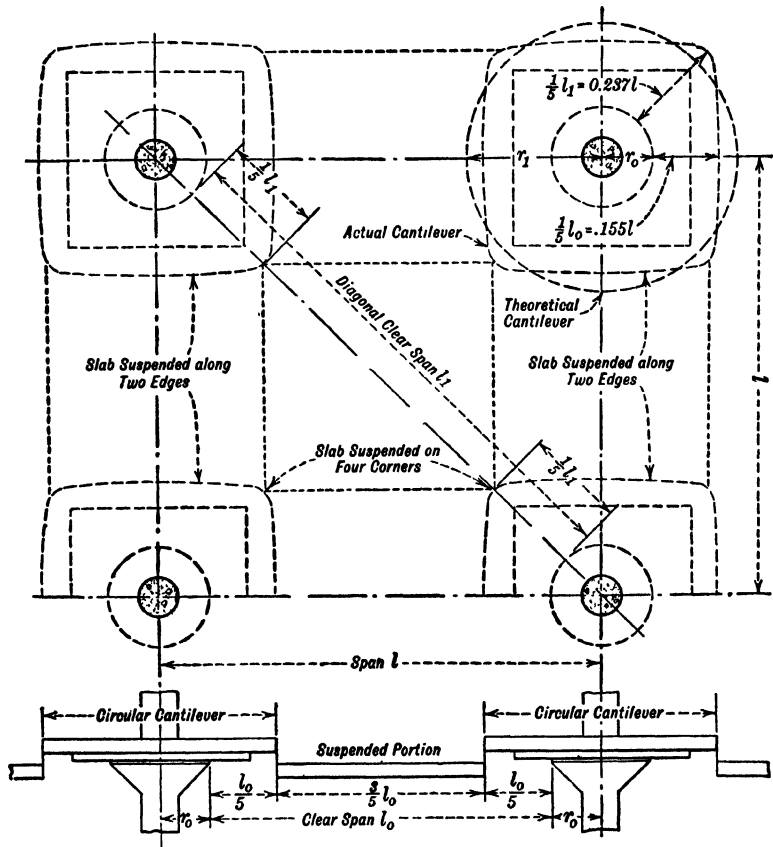

FIG. 117.—Flat Slab Divided into Simple Parts. (See p. 328.)

cumferential directions; while in the section between columns, the bending takes place in two directions at right angles to each other. The action will be better understood from Fig. 117, above, showing the flat slab divided into simple parts by cutting it along the points of inflection.

To simplify the computations, it has become established practice to resolve the bending moments to which the slab is subjected into two sets of bending moments acting at right angles to each other. Each set produces bending in one direction only. The two sets, combined, produce the actual deflection of the slab. Each set of bending moments, and the required amount of reinforcement for each, can be computed separately.

The character of bending due to each set of bending moments, when considered separately, is the same as if a continuous uniformly loaded slab were supported along two opposite panel edges. This condition produces negative bending moments at the support and positive bending moments in the central portion of the slab.

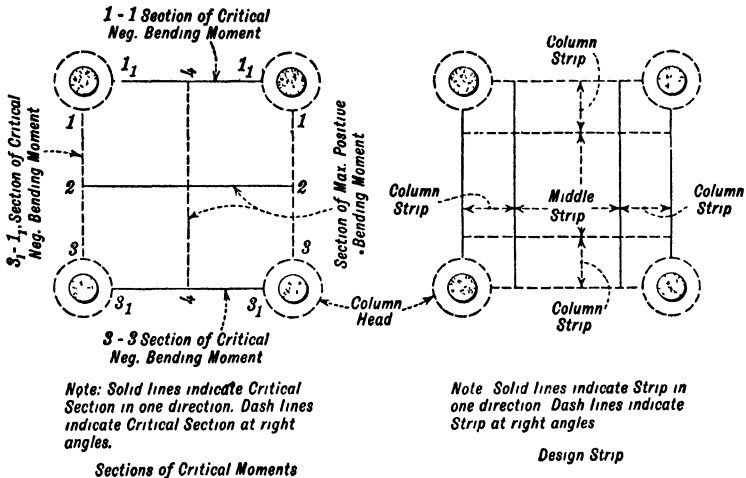

FIG. 118.—Sections of Critical Bending Moments and Design Strips. (See p. 329.)

**Sections of Maximum Bending Moments.**—Sections of maximum bending moments are shown in Fig. 118, p. 329. As there are two sets of bending moments in a slab, there are also two sets of sections of maximum moments. Both sets are shown in Fig. 118. For the sake of clearness, Fig. 119 shows the sections of maximum moment for one set only. They are as follows:

*Section of Maximum Positive Bending Moment*, coinciding with the center line of the panel. It is marked by 2-2 in Fig. 119, p. 330.

*Section of Critical Negative Bending Moment*, coinciding with the edge of the panel and the edge of the column head. It is marked by 1-1 in Fig. 119, p. 330.

**Design Strips.**—To simplify the computation of bending moments in any one direction, the panel is divided into strips running at right angles to the sections of maximum bending moments. (See Fig. 119.)

The *middle strip* is concentric with the panel and is equal in width to one-half of the width of the panel. The *column strips*, placed one on each side of the middle strip, extend to the edge of the panel, so that the width of the two column strips is equal to the width of one middle strip.

Similar strips can be drawn for the other set of bending moments.

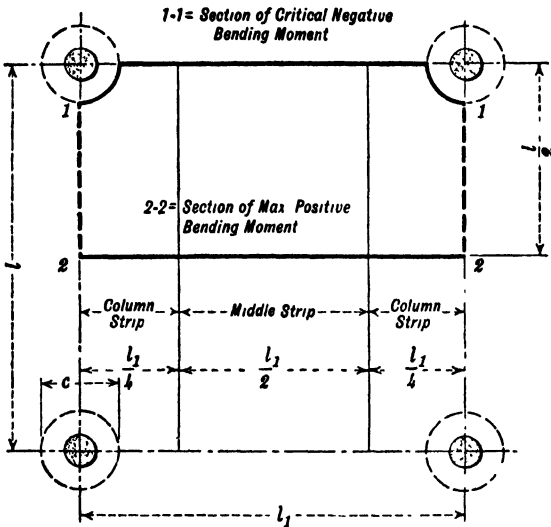

Bending Moments act at right angles to Sections  
 $l$  = Length of span in the direction of Bending Moments  
 $l_2$  = Length of span at right angles to  $l$   
 Note that the Designation of  $l$  and  $l_2$  depends upon the direction of Bending Moment and not upon relative length of spans.

FIG. 119.—Sections of Critical Moments and Design Strips in One Direction Only. (See p. 330.)

**Distribution of Maximum Bending Moments.**—The distribution of bending moments over the sections of maximum moments is not uniform. The intensity of bending moments is largest near the column and decreases towards the middle of the section. Instead of using the varying distribution of bending moments, it is accurate enough to assume a uniform distribution over the section in each strip, but to make the intensity in the middle strip smaller than in

the column strip. The difference between the intensity of bending moment in the two strips is particularly large for negative bending moment. For the purpose of design, therefore, the total negative bending moment at each section is divided into two unequal parts. The larger part is assumed to act in the two-column head sections and the smaller in the middle section. A similar assumption is made regarding the distribution of the positive bending moment.

**BENDING MOMENTS IN INTERIOR PANELS IN FLAT SLABS**

The bending moments recommended by the authors, for use in computing design, agree substantially with those recommended by the 1924 Joint Committee. They are about two-thirds of the static bending moments. The reduction in bending moments is justified because the static bending moments do not take into account several factors which reduce tensile stresses in steel in flat slab construction.

- Let  $W$  = total live and dead load per panel, lb.;
- $w$  = live and dead load, lb. per sq. ft.;
- $l$  = length of panel, center to center of columns, in the direction of computed bending moment, ft.;
- $l_1$  = width of panel, center to center of columns, ft.;
- $c$  = diameter of effective column head, ft.;
- $M$  = sum of positive and negative bending moments;
- $M_1$  = negative bending moment in two column strips;
- $M_2$  = negative bending moment in middle strip;
- $M_3$  = positive bending moment in two column strips;
- $M_4$  = positive bending moment in middle strip.

The formulas for bending moments given below apply to square and rectangular interior panels. For square panels, the bending moments in both directions are equal. For rectangular panels, the bending moments in the two directions are obtained by using, for  $l$  in the formula, the two dimensions of the panel,  $l$  and  $l_1$ , successively.

The sum of negative bending moment on section 1-1 and positive bending moment on section 2-2 is given by following formula. Sections are shown in Fig. 119, p. 330.

*Sum of Bending Moments—Interior Panel.—*

$$M = 0.09Wl \left(1 - \frac{2c}{3l}\right)^2 \text{ ft.-lb. . . . . (5)}$$

$$= 1.08Wl \left(1 - \frac{2c}{3l}\right)^2 \text{ in.-lb. . . . . (6)}$$

Values of  $\left(1 - \frac{2c}{3l}\right)^2$  and  $1.08\left(1 - \frac{2c}{3l}\right)^2$  may be taken directly from table below.

Values of  $\left(1 - \frac{2c}{3l}\right)^2$  and  $1.08\left(1 - \frac{2c}{3l}\right)^2$

	Value of $\frac{c}{l}$								
	0.1	0.125	0.15	0.175	0.20	0.225	0.25	0.275	0.30
$\left(1 - \frac{2c}{3l}\right)^2$	0.870	0.841	0.810	0.780	0.752	0.722	0.694	0.667	0.640
$1.08\left(1 - \frac{2c}{3l}\right)^2$	0.940	0.908	0.875	0.842	0.812	0.780	0.749	0.721	0.691

The above sum on bending moments,  $M$ , may be distributed as given below:

*Negative Bending Moment on Section 1-1—Interior Panels.—*

	With Drop Panel	Without Drop Panel
Two Column Strips.....	$M_1 = - 0.54M$	$M_1 = - 0.50M$
Middle Strip.....	$M_2 = - 0.08M$	$M_2 = - 0.10M$

*Positive Bending Moments Section 2-2—Interior Panels.—*

	With Drop Panel	Without Drop Panel
Two Column Strips.....	$M_3 = 0.23M$	$M_3 = 0.24M$
Middle Strips.....	$M_4 = 0.15M$	$M_4 = 0.16M$

**Permissible Variation in Distribution of Bending Moments.—**

A small variation in the distribution of bending moments, from that recommended above, is permissible. The positive bending moment in the column strips may be reduced by an amount not exceeding by  $0.02M$ , provided that the positive bending moment in the middle strip is increased by same amount. The negative bending moment in the two column strips may be either increased or reduced by an amount not exceeding  $0.03M$ . If the negative moment is increased, the other three moments, namely the two positive moments and the negative moment in the middle strip, may be reduced, the sum of reduction not to exceed the increase. If the negative moment is made smaller, the other three bending moments must be increased proportionally, the sum of increase to be at least equal to the reduction of the negative moment.

**Application of Formulas.**—The formulas apply only to flat slabs extending in each direction at least over three panels, and only where the spans are equal or nearly equal. For bending moment formulas for unequal panels, as well as for flat slabs extending over two panels only, see Volume II.

**Use of Bending Moments.**—The bending moments given above may be used directly for computing required areas of steel from the formula  $A_s = \frac{M}{j d f_s}$  or for computing stresses in steel from the formula  $f_s = \frac{M}{j d A_s}$ , where  $d$  is the effective depth of the construction at the section in consideration. Thus, in column strips, for negative bending moment the depth of the slab and drop panel,  $d_1$ , should be used. For all other bending moments, the effective depth of slab alone should be used.

For computing compressive stresses, the bending moments cannot be used directly, as it is necessary to make an allowance for factors which do not enter into the determination of the steel areas. For formulas for compression, see p. 341.

### WALL PANELS

The design of wall panels is governed by the amount of restraint to which the slab is subjected at the wall. The restraint to be considered is not only due to the wall column, but also to the wall beam, i.e., the beam at the edge of the wall panel. In practice, the following cases may occur.

Case (1). Wall panels with properly designed concrete wall columns and with wall beams capable of resisting torsion.

Case (2). Wall panels with properly designed concrete wall columns, but without wall beams capable of resisting torsion.

Case (3). Wall panels supported on brick bearing walls.

The authors' recommendations for bending moments in the three cases are given below. They differ from the requirements of the 1924 Joint Committee in that they differentiate between various conditions instead of making a general rule to cover all the dissimilar cases.

Columns should have a ratio of rigidity of at least  $\frac{I_c}{h} = 1.5 \frac{I}{l}$ .

Let, in addition to the notation given on p. 331,

$\frac{c_1}{2}$  = distance from center of column to outside of bracket at wall column.

Then

$$\left. \begin{aligned}
 M &= 0.09Wl \left[ 1 - \frac{1}{3} \left( \frac{c}{l} + \frac{c_1}{l} \right) \right]^2 \text{ ft.-lb.} \\
 \text{or} \quad &1.08Wl \left[ 1 - \frac{1}{3} \left( \frac{c}{l} + \frac{c_1}{l} \right) \right]^2 \text{ in. lb.}
 \end{aligned} \right\} \dots (7)$$

$W$  is the total load on wall panel, but does not include the spandrel load.  $l$  is the span length at right angles to the wall. If  $\frac{c_1}{2}$  is equal to  $\frac{c}{2}$ , values of  $M$  in the above formula equal the values of  $M$  for interior panel.

The moments given below are fractions of the moment represented by the above equation.

**Case (1)—Slab Restrained by Wall Columns and by Spandrel Beams.**—This design is particularly recommended for flat slabs carrying heavy loads. The wall beams should be nearly square in cross section and capable of withstanding torsional moment as on p. 336. Moments are in terms of  $M$ , from equation (7) above.

	—With Drop Panel—		—Without Drop Panel—	
	Moment	Ratio to moment in interior panel	Moment	Ratio to moment in interior panel
<i>Negative Moments at First Interior Column Line:</i>				
Column Strip, $M_1 \dots$	$0.62M$	1.15	$0.58M$	1.15
Middle Strip, $M_2 \dots$	$0.12M$	1.20	$0.10M$	1.20
<i>Negative Moments at Wall Column</i>				
Column Strip, $M_1 \dots$	$0.42M$	0.80	$0.40M$	0.80
Middle Strip, $M_2 \dots$	$0.08M$	0.80	$0.07M$	0.80
<i>Positive Bending Moment.</i>				
Column Strip, $M_3 \dots$	$0.27M$	1.18	$0.28M$	1.18
Middle Strip, $M_4 \dots$	$0.18M$	1.20	$0.19M$	1.20

**Case (2)—Slab Restrained by Wall Columns Only, Spandrel Beam not Capable of Resisting Torsion.**—This occurs when no wall beam is used, or when the thin concrete spandrel wall above the slab is utilized as a wall beam. Such design should be used only for light live loads. The recommended bending moments are the same as for Case (1), with the exception of the bending moments in the

middle strip, both positive and negative, which are larger. They are in terms of  $M$ , from equation (7), p. 334.

	—With Drop Panel—		—Without Drop Panel—	
	Moment	Ratio to moment in interior panel	Moment	Ratio to moment in interior panel
<i>Negative Moments at First Interior Column Line:</i>				
Column Strip, $M_1$ . . .	$0.62M$	1.15	$0.58M$	1.15
Middle Strip, $M_2$ . . .	$0.13M$	1.25	$0.10M$	1.25
<i>Negative Moments at Wall Column</i>				
Column Strip, $M_1$ . . .	$0.42M$	0.80	$0.40M$	0.80
Middle Strip, $M_2$ . . .	$0.08M$	0.80	$0.07M$	0.80
<i>Positive Bending Moment.</i>				
Column Strip, $M_3$ . . .	$0.27M$	1.18	$0.28M$	1.18
Middle Strip, $M_4$ . . .	$0.20M$	1.30	$0.21M$	1.30

**Case (3)—Slab Supported on Brick Bearing Wall.**—No reliable restraint at the wall. The bending moments recommended, in terms of  $M$ , given by equation (7), p. 334, are:

	—With Drop Panel—		—Without Drop Panel—	
	Moment	Ratio to moment in interior panel	Moment	Ratio to moment in interior panel
<i>Negative Moments at First Interior Column Line:</i>				
Column Strip, $M_1$ . . .	$0.75M$	1.40	$0.70M$	1.40
Middle Strip, $M_2$ . . .	$0.11M$	1.40	$0.14M$	1.40
<i>Negative Moments at the Wall</i>				
Column Strip, $M_1$ . . .	$0.20M$	....	$0.20M$	
Middle Strip, $M_2$ . . .	$0.08M$	....	$0.08M$	
<i>Positive Bending Moment.</i>				
Column Strip, $M_3$ . . .	$0.32M$	1.40	$0.34M$	1.40
Middle Strip, $M_4$ . . .	$0.21M$	1.40	$0.22M$	1.40

The negative bending moment reinforcement at wall is required to take care of any restraint caused by the brickwork above slab.

**Permissible Variations in Bending Moment.**—The variations in bending moment for the wall panels are the same as recommended for interior panels on p. 332.



**Torsional Moment in Spandrel Beam.**—In Case (1) the spandrel beam should be able to resist a torsional moment at each end equal to one-half the moment  $M_2$  at the wall. For formula for torsional stresses see p. 95.

**Explanation of the Recommendations.**—In wall panels, it has been observed that the loading produces not only appreciable bending in the wall columns but also torsion or twisting in wall beams. The torsional resistance of the beams develops an equal amount of negative bending moment in the slab along the beam. This bending moment reduces the positive bending moment in the middle strip of the wall panels. If the wall beam is properly designed to resist the twisting moment, its resistance may be utilized by reducing the bending moments in the middle strip, as in Case (1). If no torsional resistance of wall beam exists, the bending moments in the middle strip must be increased, as in Case (2).

In a number of cases, where flat slab has not been provided with proper spandrels, considerable trouble has been observed at the wall, where the brickwork above the slab or the thin concrete walls become distorted. Thin concrete spandrel beams have often bulged and cracked through torsion.

**Points of Inflection.**—Points of inflection are points in the slab where the bending moments change from negative to positive. The bending moment at the points of inflection is, therefore, zero.

For the purpose of determining the length of bars, the most unfavorable position of the points of inflection must be taken. For negative bending moment the most unfavorable condition occurs when all spans are loaded. For such case the distance of points of inflection from the edge of the column head may be assumed as equal to  $0.2l_1$ , where  $l_1$  = distance between the edges of column heads. This location of points of inflection must be used in determining the length of negative bending moment reinforcement.

For positive bending moment the most unfavorable conditions occur when the adjoining spans are not loaded. For such condition the points of inflection are nearer the support and may be assumed equal to  $0.18l_1$ . This location determines the length of positive moment reinforcement.

### FORMULAS FOR SLAB THICKNESS

The formulas for thickness of slab, given below, are not arbitrary, but are based upon bending moments specified in previous paragraphs and upon allowable compressive stresses, as explained on

**p. 341.** These formulas and the formulas for compression given on p. 341, are based on the same general formulas, which in one case were solved for the depth of slab and in the other for the unit stress. If a depth of slab obtained from the formulas below is adopted, it is not necessary to compute the stresses.

Formulas are given for thickness of slab at the column head and in the center of the column strip. If no drop is used, the required thickness at the column head governs the thickness of the slab. For slabs with drop panel, the thickness must be found both at the column and in the center.

Let  $M_1$  = negative bending moment in two column strips  
(see pp. 332 to 335);

$M_3$  = positive bending moment in two column strips  
(see pp. 332 to 335).

$t_1$  = thickness of slab and drop at the column;

$t$  = thickness of slab in center of panel;

$l$  = span length, center to center of columns, in direction in which moments are considered;

$l_1$  = span length, center to center of columns, at right angles to  $l$ ;

$c$  = diameter of column head;

$b$  = width of drop panel, in direction at right angles to span,  $l$ ;

$j, k,$  = constants for specified stresses in concrete and steel  $f_c$  and  $f_s$  (see p. 205 and table, p. 880);

$w$  = uniformly distributed dead and live load per sq. ft.;

$C_1, C_2, C_3, C_4, C_5, C_6$  = constants for different ratios  $\frac{c}{l}$  and different unit stresses (see diagrams, p. 911).

**Basis of Formulas.**—The formulas for thickness of slab are based on the same principles as formulas for depth of slab in other concrete construction. The bending moments  $M_1$  on pages 332 to 335 are recommended only for computing reinforcement. They do not take into account the increased compression stresses caused by arch action, the compression which balances the tension resisted by concrete nor the effect of the size of column head on compression stresses. To provide for these in the formulas given on p. 338 bending moments  $M_1$  were multiplied by a constant equal to  $1.5 \left( 1 - 1.2 \frac{c}{l} \right)$ . To get the thickness of slab, 1.5 inches were added to the effective depth.

**Thickness of Slab at Column Head as Determined by Negative Bending Moment.**—The thickness of the slab at the columns required by the compression stresses, should be computed from the following formulas.

**Flat Slab without Drop Panel.**

*General Formula, as Determined by Negative Bending Moment,*

$$t = 0.71 \left( 1 - \frac{2c}{3l} \right) \sqrt{\frac{M_1}{j_k l f_c}} + 1.5 \quad \dots \quad (8)$$

Thickness  $t$ , will be in in. if  $M$  is in in.-lb.,  $f_c$  in lb. per sq. in., and  $l_1$  in ft. Since, for interior panels, from formula on p. 332,

$$M_1 = 0.50M = 0.50 \left[ 1.08 w l_1 l^2 \left( 1 - \frac{2c}{3l} \right)^2 \right] \text{ in.-lb., the formula for thickness becomes:}$$

*Thickness of Slab for Interior Panels,*

$$t = \frac{0.52}{\sqrt{f_c j_k}} l \left( 1 - \frac{2c}{3l} \right)^2 \sqrt{w} + 1.5 = C_1 l \sqrt{w} + 1.5 \quad \dots \quad (9)$$

where

$$C_1 = \frac{0.52}{\sqrt{f_c j_k}} \left( 1 - \frac{2c}{3l} \right)^2 \quad \dots \quad (10)$$

In exterior panels for slabs restrained at ends, the bending moment is  $M_1 = 0.58 \left[ 1.08 w l_1 l^2 \left( 1 - \frac{2c}{3l} \right)^2 \right]$  in.-lb. For freely supported slabs, the fraction 0.58 changes to 0.70. The thickness of slab required for the two conditions is

*Thickness of Slab for Exterior Panels. Slab Restrained at End.*

$$t = \frac{0.56}{\sqrt{f_c j_k}} l \left( 1 - \frac{2c}{3l} \right)^2 \sqrt{w} + 1.5 = C_2 l \sqrt{w} + 1.5 \quad \dots \quad (11)$$

where

$$C_2 = \frac{0.56}{\sqrt{f_c j_k}} \left( 1 - \frac{2c}{3l} \right)^2 \quad \dots \quad (12)$$

*Thickness of Slab for Exterior Panels. Slab Freely Supported.*

$$t = \frac{0.61}{\sqrt{f_c j_k}} l \left( 1 - \frac{2c}{3l} \right)^2 \sqrt{w} + 1.5 = C_3 l \sqrt{w} + 1.5 \quad \dots \quad (13)$$

or where

$$C_3 = \frac{0.61}{\sqrt{f_c j_k}} \left( 1 - \frac{2c}{3l} \right)^2 \quad \dots \quad (14)$$

Constants  $C_1$ ,  $C_2$ , and  $C_3$  are given in diagram, p. 911, for different ratios of  $\frac{c}{l}$  and different unit stresses.

The thickness,  $t$ , will be in in., if  $l$  is in ft. and  $w$  in lb. per sq. ft.

**Flat Slab with Drop Panel.**

Thickness of slab and drop as determined by negative moment.

*General Formula for Thickness of Slab and Drop:*

$$t_1 = 0.50 \left( 1 - \frac{2c}{3l} \right) \sqrt{\frac{M_1}{jkbfc}} + 1.5 \dots \dots \dots (15)$$

Thickness,  $t_1$ , will be in in., if  $M_1$  is in in.-lb.,  $b$  in ft., and  $f_c$  in lb. per sq. in.

Since, for interior panels, from formula on p. 332,

$M_1 = 0.54 M = 0.54 \left[ 1.08 w l^2 \left( 1 - \frac{2c}{3l} \right)^2 \right]$  in.-lb., the formula for thickness becomes:

*Thickness of Slab and Drop for Interior Panels,*

$$t_1 = \frac{0.38}{\sqrt{f_c j k}} l \left( 1 - \frac{2c}{3l} \right)^2 \sqrt{w \frac{l_1}{b}} + 1.5 = C_4 l \sqrt{w \frac{l_1}{b}} + 1.5 \quad (16)$$

where

$$C_4 = \frac{0.38}{\sqrt{f_c j k}} \left( 1 - \frac{2c}{3l} \right)^2 \dots \dots \dots (17)$$

In exterior panels, for slabs restrained at ends, the fraction 0.54 in moment formula changes to 0.62, and for freely supported slab to 0.75. The formula for thickness changes to:

*Thickness of Slab and Drop for Exterior Panels. End Slab Restrained.*

$$t_1 = \frac{0.41}{\sqrt{f_c j k}} l \left( 1 - \frac{2c}{3l} \right)^2 \sqrt{w \frac{l_1}{b}} + 1.5 = C_5 l \sqrt{w \frac{l_1}{b}} + 1.5 \quad (18)$$

where

$$C_5 = \frac{0.41}{\sqrt{f_c j k}} \left( 1 - \frac{2c}{3l} \right)^2 \dots \dots \dots (19)$$

*Thickness of Slab and Drop for Exterior Panels. End Slab Freely Supported.*

$$t_1 = \frac{0.45l}{\sqrt{f_c j k}} \left( 1 - \frac{2c}{3l} \right)^2 \sqrt{w \frac{l_1}{b}} + 1.5 = C_6 l \sqrt{w \frac{l_1}{b}} + 1.5 \quad (20)$$

where

$$C_6 = \frac{0.45}{\sqrt{f_c j k}} \left( 1 - \frac{2c}{3l} \right)^2 \dots \dots \dots (21)$$

Constants  $C_4$ ,  $C_5$ , and  $C_6$  are given in diagram, p. 911, for different unit stresses and values of  $c$ . The thickness  $t_1$  is in in., if  $l$ ,  $l_1$ ,  $b$ , and  $c$  are in feet and  $w$  in lb. per sq. ft.

**Thickness of Slab as Determined by Positive Bending Moment.**

—The thickness of slab due to the positive bending moment should be based upon the largest value of the positive bending. This acts in the column strips and is given by formula for  $M_3$  on p. 334. The bending moments recommended on pp. 331 to 335 are for the purpose of computing the required amount of reinforcement. They do not include the bending moment resisted by tension in concrete. Since the thickness of slab, as governed by compression, must be based upon total bending moment, the value of  $M_3$  used in computing thickness of slab is multiplied by a ratio 1.5. This represents fairly well the ratio between the total compression and the amount of the tensile stresses carried by reinforcement.

*General Formula for Thickness of Slab.*

$$t = 0.7\sqrt{\frac{M_3}{f_c k l_1 j c}} + 1. \dots \dots \dots (22)$$

Thickness will be in in., if  $M_3$  is in in.-lb. and  $l_1$  in ft.

For interior panels,  $M_3 = 0.24 \left[ 1.08 w l_1 l^2 \left( 1 - \frac{2c}{3l} \right)^2 \right]$  is used for slabs with and without drop panels. Therefore

*Thickness of Slab for Interior Panels,*

$$t = \frac{0.36}{\sqrt{f_c j k}} \left( 1 - \frac{2c}{3l} \right) l \sqrt{w} + 1 = C_7 l \sqrt{w} + 1, \dots (23)$$

where

$$C_7 = \frac{0.36}{\sqrt{f_c j k}} \left( 1 - \frac{2c}{3l} \right). \dots \dots \dots (24)$$

For exterior panels, the fraction 0.24 in equation for  $M_3$  may be taken as 0.29 for slab restrained at end, and as 0.34 for freely supported slab. The formulas for thickness of slab become:

*Thickness of Slab for Exterior Panels. Slab Restrained at End.*

$$t = \frac{0.40}{\sqrt{f_c j k}} \left( 1 - \frac{2c}{3l} \right) l \sqrt{w} + 1 = C_8 l \sqrt{w} + 1 \dots (25)$$

where

$$C_8 = \frac{0.40}{\sqrt{f_c j k}} \left( 1 - \frac{2c}{3l} \right). \dots \dots \dots (26)$$

In the above formula, it was assumed that the size of the bracket,  $c_1$ , is equal to one-half the diameter of the interior column head. If no bracket is used, the depth of slab must be increased by a ratio

$$\text{of } \frac{1 - \frac{1}{3} \frac{c}{l}}{1 - \frac{2}{3} \frac{c}{l}}$$

*Thickness of Slab for Exterior Panels. Slab Freely Supported at End.*

$$t = \frac{0.43}{\sqrt{f_c j k}} \left(1 - \frac{1}{3} \frac{c}{l}\right) l \sqrt{w} + 1 = C_9 l \sqrt{w} + 1 \quad \dots (27)$$

where

$$C_9 = \frac{0.43}{\sqrt{f_c j k}} \left(1 - \frac{1}{3} \frac{c}{l}\right) \quad \dots \dots \dots (28)$$

Constants  $C_7$ ,  $C_8$ , and  $C_9$  are given in diagram, p. 911, for different ratios  $\frac{c}{l}$  and different unit stresses.

Thickness  $t$  is in in., if  $l$  is in ft. and  $w$  is in lb. per sq. ft.

**COMPRESSION STRESSES IN CONCRETE IN FLAT SLABS**

Not so much is known about the magnitude and distribution of compression stresses in flat slab construction as about tensile stresses in steel. The latter have been determined from extensometer readings in a comparatively large number of flat slab tests. Information on compression stresses from tests is much more meager. Since the modulus of elasticity of steel is known, it is possible in flat slab tests to get actual tensile stresses in steel by measuring deformations, and therefrom to get an idea of the magnitude of bending moment to be used in computing steel stresses. This, however, is not equally feasible in connection with compressive stresses, because the measured deformations are not a sure guide to the magnitude of the stresses in concrete. In the first place, the measured deformations of concrete are not due to stresses alone, but consist of stress deformations and plastic deformations caused by a prolonged application of the stress. In the second place, the actual modulus of elasticity of the concrete, the correct value for which is necessary to convert deformations into stresses, is usually unknown. While for steel the modulus of elasticity is practically constant, for concrete it varies not only for different concretes but also for different intensities of stresses in the same concrete.

**Compression Stresses in Slab at Column Head.**—Tests show that in the column head section the stresses are not uniformly distributed along the whole length of the section used for computing maximum bending moments. The stresses are much larger at and near the column head, especially at the diagonal lines where compression failures at high loads first occur. The size of the column head influences the magnitude and distribution of the compressive stresses. For equal bending moments and equal length of section, the stresses will be smaller for larger column head.

Tests indicate that the sum of measured compression stresses on a section of maximum bending moment is larger than the sum of measured tensile stresses along the same section. Theoretically, the two sums should be equal as they are produced by the same bending moment. The difference is due to arch action, which increases compression stresses and decreases tensile stresses, and also to the fact that a certain percentage of tensile stresses is resisted by concrete, so that the sum of tensile stresses based on steel alone is not the total sum of tension on the section.

The bending moments recommended on p. 332 are mainly for the purpose of determining tension reinforcement. They are based upon observations of tensile stresses in steel. Therefore, it is plain that it is not possible to use them for computing compression stresses without some modification. For this reason, in the formulas given below for determining compression stresses, the bending moments are multiplied by appropriate constants.

In flat slabs with drop panels, there is another element of uncertainty as to the width of the slab to be used in figuring compression stresses. The drop panel and the adjoining slab deform as a unit and have a common neutral axis. The extreme fiber in the drop, being much farther below the neutral axis, will shorten more than the extreme fiber of the slab. The compression stresses, therefore, in the extreme fiber of the drop are larger than for the slab just adjoining the edge of the drop. For points some distance from the edge of the drop panel, the deformation of the extreme fibers in slabs increases gradually until it reaches the same magnitude as the deformation of the extreme fibers in the drop. For instance, in the Channon test<sup>1</sup> with 20 ft.  $\frac{1}{2}$  in. square panels, 6 ft. 6 in. square drop panels, 8 in.

<sup>1</sup> Test of a Flat Slab Floor of the New Channon Building, by H. F. Gonnerman and F. E. Richart: Proceedings of the American Concrete Institute, Seventh Convention. Vol. XVII, 1921, p. 182.

slab thickness, 12 in. thickness at drop, for maximum test load the measured deformation of extreme fibers at the edge of the drop was 0.00049, while the deformation of the extreme fibers of the adjoining slab was only 0.00020. At a distance of 6 in. from the drop, the deformation of the extreme fiber of the slab increased to 0.00033, and 14 in. from the drop, to 0.00053. This last deformation was even larger than the deformation of the drop. This indicates that while the effect of the slab at the column head next to the drop is small, it becomes considerable some distance from it.

The difference between the stresses in the slab and in the drop will depend upon the ratio of the depth of the slab to the depth of the drop. For deep drops, the difference is greater and the distance is also greater from the edge of the drop to the point where the slab attains the same stresses as in the drop.

With deep drops in the column head section, the effect of the slab outside the drop on compression stresses is negligible. In such cases, Formula (29), p. 344, may be used for computing compression stresses. This formula neglects the effect of the slab.

With shallow drops, the effect of the slab outside of the drop may be considerable. In such cases, Formula (31), p. 344, will give better results.

**Formulas for Compression Stresses in Slab at Column Head.—**

Let  $M_1$  = negative bending moment in column strips, in.-lb.;

$M_c$  = bending moment resisted by concrete, in.-lb.;

$M_s$  = bending moment resisted by compression reinforcement, in.-lb.;

$l$  = span of panel, center to center of columns, in direction for which bending moment was figured, ft.;

$l_1$  = span of panel, center to center of columns, perpendicular to direction for which bending moment was figured, ft.;

$c$  = diameter of column head, ft.;

$b$  = width of drop panel measured at right angles to the span, ft.;

$d$  = effective depth of slab, in.;

$d_1$  = effective depth of slab and drop, in.;

$A_s$  = area of compression reinforcement, sq. in.;

$j, k, n$  = constants for concrete. See p. 207.

$C_{10}, C_{11}$  = constants. See Table 17, p. 912.



Then

*Compression Stresses, Drop Only Considered Effective,*

$$f_c = \frac{0.25 \left( 1 - 1.2 \frac{c}{l} \right) M_1}{j k b d_1^2} = C_{10} \frac{M_1}{b d_1^2} \text{ lb. per sq. in.,} \quad (29)$$

where

$$C_{10} = \frac{0.25 \left( 1 - 1.2 \frac{c}{l} \right)}{j k}, \quad \dots \dots \dots (30)$$

In the above formula  $b$  is in ft. and  $d_1$  in in.

Values of  $C_{10}$  for different  $\frac{c}{l}$  and  $jk$  are given in Table 17, p. 912.

*Compression Stresses, Drop and Slab Considered Effective,*

$$f_c = \frac{0.25 \left( 1 - 1.2 \frac{c}{l} \right) M_1}{j k l_1 d_1^2 C_{11}} = \frac{C_{10}}{C_{11}} \frac{M_1}{l_1 d_1^2} \text{ lb. per sq. in.} \quad (31)$$

where

$$C_{11} = \left[ \frac{b}{l_1} + \left( \frac{1}{2} - \frac{b}{l_1} \right) \left( \frac{d}{d_1} \right)^2 \left( 2.5 \frac{d}{d_1} - 1.5 \right) \right],$$

and  $C_{10}$  as given above.

In the above formula  $l_1$  is in ft. and  $d_1$  in in.

Values of  $C_{11}$  for different values of  $\frac{b}{l_1}$  and  $\frac{d}{d_1}$  are given in diagram on p. 912.

*Compression Stresses, No Drop Panel Used,*

$$f_c = \frac{0.5 \left( 1 - 1.2 \frac{c}{l} \right) M_1}{j k l_1 d^2} = C_{10} \frac{2 M_1}{l_1 d^2} \text{ lb. per sq. in.} \quad (32)$$

Values of  $C_{10}$  for different  $\frac{c}{l}$  and  $jk = 0.34$  are given in table, p. 912.  $l$  in ft.,  $d_1$  in in.

In the above formulas, if  $M_1$  is in in.-lb.,  $l$ ,  $l_1$ ,  $b$ , and  $c$  in ft. and  $d_1$  in in., then  $f_c$  is in lb. per sq. in.

Values of  $jk$ .—In solving the equation for compression stresses, the values of  $jk$  must be assumed. For this purpose the values may be taken from table below.

Values of  $jk$  for Different Ratios of Steel

$p$	0.002	0.003	0.004	0.005	0.006	0.007	0.008	0.009	0.01
$jk$	0.21	0.24	0.26	0.28	0.30	0.32	0.33	0.34	0.36

**Use of Compression Reinforcement.**—Compression reinforcement may be found useful in many instances where it is not desirable to increase the thickness of the slab. Since, with equal spans, the compression stresses at the first interior row of columns next to the wall are larger than at other interior columns, it may be economical in flat slabs without drop panels to use compression reinforcement there, instead of increasing the thickness of the whole slab. The thickness of the slab can then be determined from the moment at the interior columns and made uniform for the whole floor. Also, in many cases, odd panels are much larger than the rest of the slab. It may be more economical to use compression reinforcement in such panels, instead of changing the concrete dimensions.

**Formulas for Compression Reinforcement at the Column Head.**—Since the maximum compression stresses act at the column head, especially in the diagonal direction, the reinforcement, to be most effective, should be placed there. Using notation on p. 343.

The bending moment resisted by the compression reinforcement (see p. 234) is

$$M_c = A'_c(n - 1)f_c \frac{k - a}{k} d(1 - a). \quad \dots \quad (33)$$

When the concrete dimensions are fixed and it is necessary to introduce compression reinforcement for the purpose of keeping the compression stresses within working limits, the problem may be solved as follows:

Compute moment of resistance of slab at the column head,  $M_c$ , based on the allowable working stress in concrete. To get as large a value as possible, the moment of resistance is based on the formula which takes into account not only the compression resisted by the drop panel, but also that resisted by the slab outside the drop panel. This moment of resistance may be obtained by solving Formula (31) for  $M_1$ . Therefore,

*Moment of Resistance of Slab at the Column Head,*

$$M_c = \frac{C_{11}}{C_{10}} l_1 d_1^2 f_c. \quad \dots \quad (34)$$

The values of  $C_{10}$  and  $C_{11}$  are given on p. (912).

If  $l_1$  is in ft.,  $d_1$  in in.,  $f_c$  in lb. per sq. in.,  $M_c$  is in in.-lb.

The bending moment to be resisted by steel equals the actual moment,  $M_1$ , at the column head minus the moment of resistance,  $M_c$ , computed above.

Thus,

*Moment to be Resisted by Compression Reinforcement,*

$$M_s = M_1 - M_c, \quad \dots \quad (35)$$

and

*Required Area of Compression Reinforcement,*

$$A'_s = \frac{M_s}{(n-1)f_c d(1-a)} \frac{k}{k-a} \quad \dots \quad (36)$$

If  $M_s$  is in in.-lb.,  $f_c$  in lb. per sq. in., and  $d$  in in.,  $A'_s$  is in sq. in.  
**Compression Stresses for Positive Moments.**—The compressive stresses due either to positive bending moment or to negative bending moment in the middle strip may be computed from the formula below.

Let, in addition to notation on p. 343,

$M_n$  = bending moment in the section under consideration, in.-lb.

*Compressive Stresses for Positive Moment,*

$$f_c = \frac{0.5M_n}{jkl_1d^2} \text{ lb. per sq. in.} \quad \dots \quad (37)$$

Values of  $l_1$  are in ft. and those of  $d$  in in.

Values of  $jk$  to be used in the above formula for different ratios of steel,  $p$ , may be taken from table on p. 344.

### SHEARING STRESSES IN FLAT SLABS

There is some difference of opinion as to the method of computing shearing stresses in flat slab construction and as to the allowable unit stresses at the various sections. The available test data on ultimate shearing resistance of flat slabs are meager. The tests on circumferential cantilevers and footings, which in some respects resemble the conditions in flat slab at the support, also give little information on diagonal tension. The test specimens either failed by tension (see p. 120) or the failure was complicated.

The only reported tests on flat slabs carried to destruction are those conducted on the Western Newspaper Union Building<sup>2</sup> during its demolition, and the tests at Purdue University on specially built panels designed according to the S. M. I. System and the Cor-plate System (see p. 99). None of these tests furnish any data on the ultimate resistance of concrete to diagonal tension, as all the slabs

<sup>2</sup> Test of a Flat Slab Floor of the Western Newspaper Union Building, by Arthur N. Talbot and Harrison F. Gonnerman. University of Illinois Bulletin No. 106.

failed by tension or tension in combination with compression. In the Purdue tests, cracks were observed at the column head, running diagonally downward from the tensile steel on the top of the slab toward the edge of the column head. The inclination of the cracks caused them to be mistaken by some observers for diagonal tension cracks. Actually they were caused by the steel passing the elastic limit. The development of the tensile crack after the steel had passed the elastic limit was followed by a compression failure in concrete, a phenomenon observed in tensile failures of simple beams at points where there is no possibility of diagonal tension (see p. 22).

It is generally agreed that the critical sections are at the column head and at the edge of the drop panel. Many codes and recommendations require that punching shear be figured at the edge of the column head and drop panel respectively. According to the Boston Code, the punching shear must be figured by the formula,  $v = \frac{V}{bjd}$ , and must not exceed 132 lb. per sq. in. for 2 000-lb. concrete. The Chicago Code requires that the shear be figured by the same method, but the unit stress at the column is limited to 120 lb., and at the drop panel to 60 lb. per sq. in. for 2 000-lb. concrete. The New York flat slab regulation specifies the same stresses as the Chicago Code, the difference being that the unit stresses are computed by dividing the total shear,  $V$ , by the area  $bd$ , instead of  $bjd$ .

The modern tendency is to reduce the shearing unit stresses, especially at the column head.

The authors recommend the following rule:

**Authors' Recommendations for Shearing Stresses in Flat Slabs.**

—(1) Shearing unit stresses shall be computed at sections indicated in Fig. 120, p. 348.

(a) At the column of critical shear the section is concentric with the column head and located from its edge a distance equal to  $t_1 - 1\frac{1}{2}$  in.

(b) At the drop panel the section of critical shear is concentric with the drop panel and is located from its edge a distance equal to  $t - 1$  in.

(2) Formula  $v = \frac{V}{bjd}$  shall be used in computing the unit stresses

where  $V$  is external shear in lb. at the section considered,  $b$  is the perimeter of the section in in.,  $d$ , the effective depth in in. The resulting stress is in lb. per sq. in.

(3) The shearing unit stress shall not exceed  $0.03f'_c$ , which for 1 : 2 : 4 concrete with  $f'_c = 2000$  lb. per sq. in. equals 60 lb. per sq. in.

This rule agrees substantially with 1924 Joint Committee Specification, except that in formula for allowable unit stresses the steel ratio,  $r$ , is omitted because there does not appear any justification for the same.

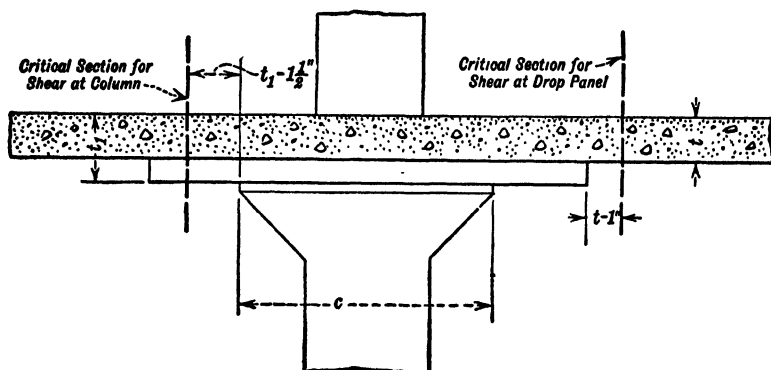

FIG. 120.—Section of Critical Shearing Stresses. (See p. 347.)

**Formulas and Constants for Computing Shearing Stresses.**—The following formulas simplify the computation of shearing stresses. These may be used for square and rectangular panels, in.

Let  $t_1$  = thickness of slab and drop panel, in.;

$t$  = thickness of slab, in.;

$c$  = diameter of circular column head, ft.;

$$c_2 = c + \frac{2(t_1 - 1\frac{1}{2}'')}{12}, \text{ ft.};$$

$b$  = side of square drop panel or long side of rectangular drop panel, ft.;

$$c_3 = b + \frac{2(t - 1'')}{12}, \text{ ft.};$$

$b_1$  = short side of rectangular drop panel, ft.;

$$c_4 = b_1 + \frac{2(t - 1'')}{12}, \text{ ft.};$$

$l$  = length of long side of panel, center to center of column, ft.;

$l_1$  = length of short side of panel, center to center of column, ft.;

- $m = \frac{l_1}{l}$  = ratio of short side to long side of panel;
- $w$  = live and dead load per sq. ft.;
- $v$  = shearing unit stress, lb. per sq. in.;
- $d$  = effective depth, in.

Then

*Shearing Unit Stress at the Column Head,*

$$v = \frac{m - 0.785\left(\frac{c_2}{l}\right)^2}{3.14\frac{c_2}{l} \times 12} \frac{1}{\frac{7}{8}d} wl \text{ lb. per sq. in.} \quad \dots \quad (38)$$

or

$$v = C_{12}w\frac{l}{d} \text{ lb. per sq. in.,} \quad \dots \quad (39)$$

where

$$C_{12} = \frac{m - 0.785\left(\frac{c_2}{l}\right)^2}{\frac{7}{8} \times 3.14\frac{c_2}{l} \times 12} = \frac{m - 0.785\left(\frac{c_2}{l}\right)^2}{33.0\frac{c_2}{l}} \quad \dots \quad (40)$$

Note that  $l$  is in feet and  $d$  in inches.

*Shearing Unit Stress at Drop Panel,*

$$v = \frac{m - \left(\frac{c_3}{l}\right)^2}{4\frac{c_3}{l} \times 12} \frac{1}{\frac{7}{8}d} wl \text{ lb. per sq. in.,} \quad \dots \quad (41)$$

or

$$v = C_{13}w\frac{l}{d} \text{ lb. per sq. in.,} \quad \dots \quad (42)$$

where

$$C_{13} = \frac{m - \left(\frac{c_3}{l}\right)^2}{42\frac{c_3}{l}} \quad \dots \quad (43)$$

Note that  $l$  is in feet and  $d$  in inches.

Values of  $C_{12}$  and  $C_{13}$  are given in tables on pp. 913 and 914 for different values of  $c_2$  and  $c_3$ , respectively, and different ratios of panel sides,  $m$ . For square panels,  $m = 1$ .

When the drop panel is rectangular, the formula for shearing stresses changes to

$$v = C_{14} w \frac{l}{d} \text{ lb. per sq. in., . . . . . (44)}$$

where

$$C_{14} = \frac{\left(m - \frac{c_3}{l} \times \frac{c_4}{l}\right)}{2l \left(\frac{c_3}{l} + \frac{c_4}{l}\right)} . . . . . (45)$$

No table is provided for  $C_{14}$ .

Note that  $l$  is in feet and  $d$  in inches.

**Diagonal Tension Reinforcement in Flat Slabs.**—The critical section, as far as diagonal tension is concerned, usually is at the column head. Generally, it is advisable to select such dimensions for the slab that the shearing unit stresses do not exceed the allowable stresses for concrete alone. If it is necessary to reduce the thickness below that required by shearing strength of concrete alone, stirrups or other diagonal tension reinforcement may be introduced, in the same manner as in any other type of concrete construction.

The diagonal tension reinforcement should be computed to resist the excess of shear, beyond that which can be resisted by concrete alone. The method of procedure is as follows:

The stirrups will be placed concentrically with the column head. Compute shearing unit stresses at the critical section. From these subtract the allowable shearing unit stresses for concrete alone. Multiply the difference by the perimeter of the section, in inches, at which shear was computed. Assume radial distance between two concentric rows of stirrups. Multiply the shear along the perimeter just found by this spacing. This gives total shear to be resisted by stirrups in the assumed spacing. Select diameter of stirrups and find the tensile strength of one leg. Divide the total shear to be resisted by the tensile strength of one leg of stirrups. This gives the number of legs of stirrups required to be placed around the column head. Next, compute shearing unit stress of a section at a distance from the critical section equal to the radial spacing of the stirrups. With this shear, proceed as before.

The stirrups must be anchored to the tensile reinforcement, which in this section is at the top of the slab, and must extend of the bottom of the slab, where they should be provided with hooks at the ends.

## BOND STRESSES

Bond stresses should be computed for the negative reinforcement at the column head by formula,

*Bond Stresses,*

$$u = \frac{V}{\Sigma o_j d}. \quad (\text{See p. 262.})$$

They should not be larger than the allowable unit bond stresses, which for plain bars are equal to  $0.04f'_c$  and for deformed bars,  $0.05f'_c$ . For 1 : 2 : 4 concrete the ultimate stress,  $f'_c = 2\,000$  lb. per sq. in.; therefore, the allowable unit bond stress for plain bars is 80 lb. per sq. in. and for deformed bars 100 lb. per sq. in.

The following values should be used in the equation:

$W$  = total dead and live load on the panel;

$V = 0.35W$  for interior panel;

$0.40W$  for exterior panel;

$\Sigma o$  = perimeter of all effective bars in two column strips used to satisfy the bending moment,  $M_1$ ;

$d$  = effective depth at column head.

The values  $0.35W$  and  $0.40W$ , respectively used for external shear  $V$ , are equivalent to the load producing the bending moment resisted by the reinforcement, the perimeter of which is used in the equation.

## REINFORCEMENT FOR FLAT SLABS

**Required Areas of Steel.**—After the bending moments for the various strips are computed and the thickness of slab and drop panel selected, the required areas of steel are determined from the formula

$$A_s = \frac{M}{jdf_s}$$

An approximate value of  $j = \frac{7}{8}$  may be used. For  $f_s = 16\,000$ , the value of  $jf_s = 14\,000$ , and for  $f_s = 18\,000$ ,  $jf_s = 15\,800$  may be used.

In the above formula,  $M$  is the bending moment for the various design strips and  $d$  the corresponding effective depth of slab from center of tension steel (which at column is in the top of slab) to surface of slab. In flat slabs with drop panels of the dimensions described on p. 323, the depth  $d$  at the column head equals the depth of the slab taken from the tension steel to the bottom surface of the drop, and the required area of negative bending moment reinforcement in



the column strips should be based on this depth. In computing the required area of steel at all other sections, the depth of slab without the drop should be used. When drop panels are omitted at wall columns, the reduced depth must be used in computing the required area of negative reinforcement in the column strips at the wall.

To get the effective depth, i.e., the distance from compression face of slab to center of tensile reinforcement, proper deduction should be made from the total depth. The distance to be deducted depends upon the number of layers of reinforcement.

The bars making up the effective reinforcement in any strip should be distributed over its whole width. They should be placed at right angles to the bending moment section and extended far enough on both sides, as explained in subsequent discussion. Conversely, all bars cut at right angles by a bending moment section, if they extend far enough on both sides of it, as described under arrangements of bars, may be considered as effective at that section.

The effect of bars in the horizontal plane, inclined at an angle other than right angle to a section of bending moment, as in the middle strip in a four-way system, may be considered as equal to the area of the bars multiplied by the sine of the angle of inclination. The same bars are also effective at a section at right angles to the above-mentioned section, and their effect is again equal to the area of bars times the sine of the angle of the bar with the second section. In square panels, the effect of diagonal bars is the same at both sections, while in rectangular panels the effect of diagonals is larger at the section parallel to the short side of the rectangle.

Bars parallel to a section must not be considered as effective at that section.

The effectiveness of rings as used in the Smulski System, in resisting tensile stresses, is explained on p. 373. Obviously, the rules given above must be extended to fit the condition.

*Two-way System.*—In the two-way system, each design section cuts, in each design strip, only one band or group of bars running at right angles to the section. The area of the bars in each band should be made at least equal to the required area of steel in the strip in which the band is located.

In computing the effective areas for negative bending moment, not only the bent bars in the panel under consideration should be used, but also the bent bars extended from the adjoining panel, if the length of extension is sufficient to make them effective.

*Four-way System.*—In the four-way system, the section of positive moment in the column strips cuts the direct band of bars at right angles, and their area must be made at least equal to the required area of steel. In the middle strip, the section of positive bending moment cuts two diagonal bands at an angle. The effect of each band equals the area of steel in the band times the sine of the angle of inclination. Therefore, the area of bars in each band required to satisfy the bending moment may be obtained by dividing the total required area by twice the sine of the angle of inclination of the bars to the section. In a square panel, the angle of inclination is 45 degrees and the sine is 0.71. If  $A_{s4}$  is the required area of positive moment reinforcement in the middle strip, the area of bars in each diagonal band equals  $\frac{A_{s4}}{2 \times 0.71} = \frac{A_{s4}}{1.42}$ .

In the column strips, the effective negative reinforcement consists of the bent bars in the band perpendicular to the section and of the vertical components of the bent bars in the diagonal bands. The components, again, equal the areas of the bars times the sine of angle of inclination. Not only the bent bars from the panel under consideration but also the bent bars extended from the adjoining span may be considered as effective, if the length of extension is sufficient for this. If the bars from the adjoining panel extend only far enough to develop their strength, they should not be counted as effective in this panel.

*Smulski (S. M. I.) System.*—In the Smulski System, the section of positive moment in the column strip cuts the trussed bars and (in square panels) all rings in Unit *A* and two or three outside rings in Unit *B*.

The positive moment section in the middle strip cuts the remaining rings of Unit *B* and the diagonal bars. The effect of the diagonal bars is equal to their areas multiplied by the sine of their angle of inclination to the section.

The negative moment section in the column strips cuts the rings of Unit *C*, the bent portion of the trussed bars of Units *A* and *B*, and the radial bars. The rings and the bars at right angles to the section are considered as fully effective, while the effect of the diagonal bars and radials is equal to their areas multiplied by the sine of their angle of inclination to the section.

In all cases, the required area of reinforcement should be distributed between the various units and the various parts of each unit.

**General Rules.**—After the required amounts of steel at the sections of maximum bending moments have been found from formula on p. 351, the problem resolves itself into providing bars of such lengths, and bent in such a fashion, that not only the bending moments at critical sections but also those at intermediate sections are provided for.

In the region of the points of inflection, the positive and negative reinforcement should overlap, to take care of the movement of the point of inflection, due to partial loading. Tests show that, with columns rigid enough to withstand the bending moments due to unbalanced live load, the possible movement of the points of inflection for different loading is small.

If slender columns are used, the amount of positive moment reinforcement should not only be increased, but should also extend much nearer to the column than required with rigid columns. This means that, for this condition, the points of inflection for the maximum positive bending moments are much nearer the column than for negative bending moment.

Proper attention should be paid to bond stresses at the column head. There the external shear is large, and the rate of increase in tensile stresses is high, with the result that large bond stresses are produced. To keep the bond stresses within working limits, the use of bars of small diameter is advisable (see p. 262).

Free ends of straight bars should extend beyond the points of inflection for a length equal at least to 20 diameters of the bar but not less than 12 in. to insure the bond needed to make them available as tensile reinforcement at the points of inflection.

**It is important to remember that, until the tensile strength of bar is developed by bond, it is not the area of the bar that determines its capacity for resisting stresses, but the length of imbedment, measured from the point where the stresses are investigated, to the end of the bar.** For instance, in a  $\frac{3}{4}$ -in. plain bar, the full tensile working stress is not attained until the length of imbedment<sup>3</sup> reaches 3 ft. 2 in. In a band of straight bars, therefore, contrary to common belief, the available area of steel is not constant throughout the bar. On the contrary, it is zero at the end and increases gradually as it is developed by bond.

<sup>3</sup> Where values governed by working stresses are given, normal concrete testing 2 000 lb. per sq. in. at 28 days is assumed.

When reinforcement consists of rings, it is not necessary to consider bond stresses except in determining the length of lap.

When reinforcement consists of bands of bars, as in the two-way and four-way systems (see p. 358), most of the bars are of such length that they serve as positive and negative bending moment reinforcement. The arrangement of the reinforcement at the support is, therefore, dependent upon the reinforcement in the center of the span. In such cases, the number of bars required by the maximum positive bending moment is determined first; next, one of the schemes of bending, described below, is adapted. This fixes the number of bars which will be bent up and extended over the support. The area of the bent bars available for negative bending moment reinforcement is compared with the total required area of negative moment reinforcement. If the bent bars are not sufficient, additional short bars at the support should be supplied.

When reinforcement consists of rings and radials (see p. 367), the various units are designed more or less independently.

**Bending of Bars.**—In band systems, a large proportion of the bars are bent up and extended over the support, as shown in Figs. 122 and 127. The best method is to bend the bars before they are placed on the forms, as this insures proper location and proper height of the bends. Another method, which is much less satisfactory, is to place straight bars on the form and then bend them by means of a tool popularly called a "hicky." Bars of small diameter can be easily bent in this way; bars  $\frac{5}{8}$  in. and larger should not be hickied. This bending method is much less desirable than bending steel before placing. Satisfactory results with the "hicky" are obtained only when thorough supervision is available. The length of time required to place the steel is increased by the time it takes to hicky the bars, and the placing of concrete is thus delayed. When the bars are bent on the ground ahead of time, this delay is obviated. The hickying of bars is particularly dangerous in rush jobs, where the concreting very closely follows the placing of steel. Under such conditions, it is obvious that exact bending of steel would be an accident rather than a certainty.

In early flat slab designs, no actual bending of bars was done. The bars were supported above the form at the column and were allowed to sag down or drape. This practice was not satisfactory, as the sagging, especially with larger bars, was gradual, so that the bars did not get down to the bottom of the slab for quite a distance.

Large sections, therefore, both at the top and at the bottom, were without effective reinforcement. As a result, cracks developed at the regions of sagging of the bars. Modern specifications prohibit draping of bars and require that bars be bent at proper definite places, and that both the positive and negative reinforcement be parallel to the surface of the concrete.

**1924 Joint Committee Rules for Arrangement of Reinforcement in Two-Way and Four-Way Systems.**—The 1924 Joint Committee provides the following rules for arrangement of steel in two-way and four-way systems :

“The design shall include adequate provision for securing the reinforcement in place so as to take not only the critical moments, but the moments at intermediate sections. Provision shall be made for possible shifting of the point of inflection, by carrying all bars in rectangular or diagonal directions, each side of a section of critical moment, either positive or negative, to points at least twenty (20) diameters beyond the point of inflection as specified in Section 151.

This recommendation is rational. It provides general principles which will give satisfactory results. Following this, however, in the same section requirements are specified for the two-way and four-way systems which depart from the sound policy of laying down principles of design upon which the details could be developed to suit the conditions. By prescribing the lengths of bars, this rule practically limits the design of flat slab two-way and four-way reinforcement to one arrangement. Several very satisfactory arrangements, both in two-way and four-way systems, described later, would be prohibited by this rule in spite of the fact that they are perfectly sound and give good results.

**Support for Flat Slab Reinforcement.**—Flat slab reinforcement should be securely tied and supported, in such a way that no displacement of the bars can take place during concreting.

The displacement of bars most to be guarded against is in the vertical direction, since the effect of both the positive and negative reinforcement depends upon its distance from the compression face of the slab. This distance must be as great as shown on the plans, while on the other hand, the bars must not be brought so near the tension surface of the concrete as to destroy the fireproofing.

With positive reinforcement, the problem is to keep the bars high enough above the forms to get proper fireproofing. The best method is to support the bars on metal chairs of proper height. There are

on the market, also, bar spacers which serve both as chairs and as spacers. Another method is to support the bars on small concrete blocks of proper height. To save the cost of such supports, in many cases, the bars are placed directly on the forms; then, during concreting, they are lifted up by a special workman just after the concrete is poured, and the concrete is allowed to flow under the bars. This method is not positive and should be prohibited, since the amount of concrete below the bars depends entirely upon the judgment and skill of the workman who lifts them.

When pipes for electric wires are imbedded in concrete, they should be placed above and not below the reinforcement; otherwise, the reinforcement would be raised more than required by the plans. A crack is likely to form along the pipe.

For negative reinforcement, supports are absolutely necessary. The bars must be kept the required distance above the form, since lowering of the bars reduces their effectiveness. In thin slabs, even small vertical misplacement may be dangerous. For instance, in an 8-in. slab without drop panel, with an effective depth of, say,  $6\frac{3}{4}$  in., an accidental lowering of bars by 1 in. would reduce the strength of the slab by about 15 per cent.

In band systems, the negative reinforcement may be kept above the forms by four heavy supporting bars, resting either on concrete blocks of proper height or on metal chairs. The supporting bars are placed a short distance from the points where the bars begin to bend down. The number of blocks should be sufficient to enable the supporting bars to keep the steel rigidly in place during construction.

The negative reinforcement in the middle strip should also be kept a proper distance above the forms. For this purpose, at least two heavy supporting bars, running at right angles to the band, should be used. These supporting bars should rest on concrete blocks or chairs. In the four-way and circumferential systems, the negative reinforcement in the middle strip consists of short bars. These are often placed after the concrete is in place but before it has attained its initial set. This method requires proper supervision.

In designing proper supports for the bars, it should be kept in mind that the reinforcement is subjected to very hard usage during concreting. Very often, even well-placed reinforcement, with supports strong enough to keep it in place, is bent completely out of shape by the workmen, when they are spading and placing concrete. This is particularly true in cases where concrete is spouted. The

adjusting of the spout requires a large number of men, who, occupied with their task, have no time to pay attention to the steel upon which they are walking. This emphasizes the absolute necessity of rigid arrangement of the negative moment reinforcement.

**Showing Reinforcement on Plans.**—The best method of showing flat slab reinforcement on plans is to designate the various bands or units by letters, and give the reinforcement for each band or unit in a schedule. To explain the schedule, a typical exterior and interior panel should be prepared, clearly showing the arrangement of steel. The length and type of bending of various bars should be shown in sections.

It is obviously insufficient to give the number of bars in a band required by the positive bending moment, without giving their length and clearly showing how the bars should be disposed, as then the arrangement of the steel at the support, which is the most heavily stressed section of the slab, is left to conjecture. This wrong method of showing flat slab reinforcement is unfortunately often found in general drawings submitted to the contractors for bids. No intelligent estimate of tonnage can be made on the basis of such plans. It leaves the field free to unsafe designs.

### FLAT SLAB SYSTEMS

As far as arrangement of steel is concerned, flat slab construction may be divided into three general groups, which, in the order of their appearance, are as follows:

The Four-way System;

The Two-way System;

The Circumferential or Smulski System.

The last-named system is also known under the abbreviated name of S. M. I. System. The three-way system may be considered as a modification of the four-way system.

### FOUR-WAY SYSTEM

The four-way system is distinguished by the use of four bands<sup>4</sup> of small bars at the column, running in four directions, namely, in two directions at right angles to each other—parallel to the center lines of the panel—and in two diagonal directions. While the Norcross patent was in force, the four-way system was exploited under

<sup>4</sup> A band is a layer of definite width of bars spaced at definite distances apart.

several trade names. The best known were: Mushroom System, Cantilever Flat Slab System, Simplex System, and Barton Spider Web System.

The Mushroom System was developed by C. A. P. Turner and used in a large number of buildings. At present it is used but little, if at all, because the features distinguishing it from ordinary four-way systems are either useless or harmful. The main reinforcement consisted of four bands of bars, running as in the modern four-way systems. At the columns, these bands rested near the top of the slab on a framework formed by "elbow bars" and two rings placed on top of them. The "elbow bars" were heavy bent bars with the vertical leg imbedded in the column and the other leg extending into the slab, not horizontally, but diagonally downward. The band of bars resting on the framework draped from the column. This left large sections of the slab, both at the top and at the bottom, without effective reinforcement. The "elbow bars" and rings did not contribute materially to the strength of the slab, because, being located

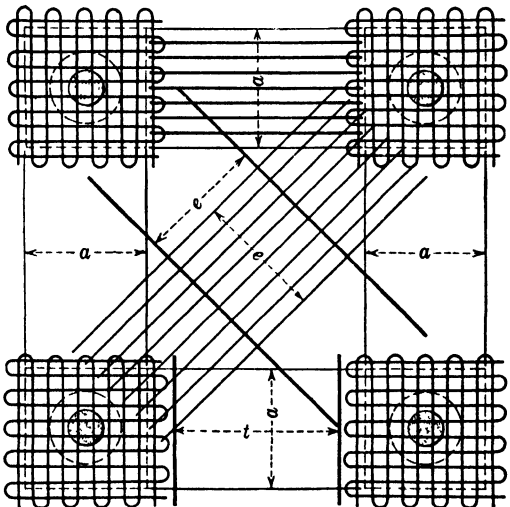

FIG. 121.—Barton Spider Web System. (See p. 359.)

under the four bands of bars, they were too near the neutral axis.

The Cantilever Flat Slab System and the Simplex System have practically the same arrangement of reinforcement. They differ only in the arrangement of chairs and spacing bars.

The Barton Spider Web System has several patented features. The bottom reinforcement consists of four bands of straight short bars, which do not reach the column but extend on each side only a short distance beyond the points of inflection. The negative reinforcement consists of two layers of bars running in two directions. This arrangement is shown in Fig. 121, p. 359, but is not recommended for use.



**Arrangement of Four-way System in Interior Panel.**—Several methods of arranging flat slab reinforcement, now in common use, will be illustrated. Any of the first three methods may be used. The fourth method, although used extensively, is not recommended.

*First Method.*—Each band, rectangular or diagonal, consists of long bent bars and short straight bars.

The long bars are bent at both ends near the points of inflection, and the bent portions are carried, near the top of the slab, across the column head beyond the points of inflection for negative reinforcement of the adjoining spans. These bars serve as positive bending moment reinforcement in one span, and as negative bending moment reinforcement in the same span and in two adjoining spans.

The short straight bars, placed at the bottom of the slab, serve as positive bending moment reinforcement only. They should extend, on both sides, at least 20 bar diameters, but not less than 12 inches, beyond the points of inflection for positive moment reinforcement as specified on page 336.

In this method, after the required areas of positive and negative reinforcement have been computed, the number of bars in the rectangular and diagonal bands are determined from the areas required by the positive bending moments. A sufficient number of bars are bent up, both in the rectangular and diagonal bands, to supply the required area of reinforcement in the column head section. Not only the bent bars in the span under consideration, but also the bars extending from the adjoining spans, should be considered as effective in the column head section. The bars in each band that are not required for negative moment are carried straight. This method is illustrated in Fig. 122, folding page.

The negative reinforcement in the midsection consists of short straight bars.

*Second Method.*—All bars in rectangular and diagonal bands are provided with one double bend, as shown in Fig. 123, folding page.

They are of such length that one end extends at the bottom beyond the point of inflection and the other end is bent up to the top of the slab and extended across the column head, beyond the point of inflection for negative reinforcement of the adjoining span. Each bar serves as positive reinforcement in one panel, and as negative reinforcement in same panel and in the adjoining panel. The bars in each band are so placed that a straight end alternates with a bent-up end.



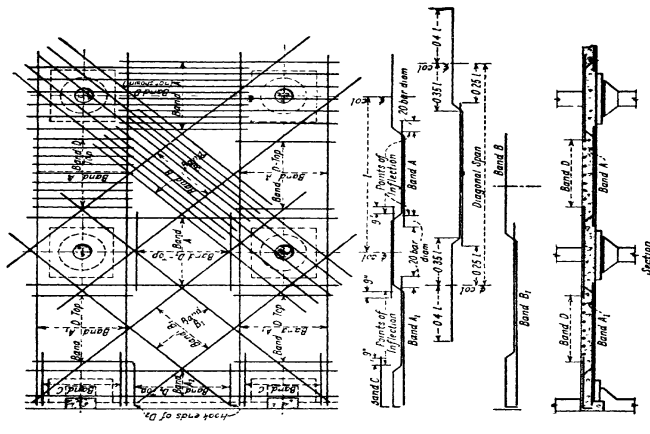

**Notes:**  
 Distance of points of inflection from edge of column head for positive and negative moment is not indicated.  
 Distance of points of inflection from edge of column head equals, for negative moment reinforcement  $0.2l_1$ , and for positive moment reinforcement  $0.18l_1$ , where  $l_1$  is the net span.  
 Distance of points of inflection from edge of column head equals, for negative moment reinforcement  $0.2l_1$ , and for positive moment reinforcement  $0.18l_1$ , where  $l_1$  is the net span.  
 Positive moment reinforcement to extend beyond points of inflection 20 bar diameters but not less than 12 in.  
 Area of straight bars at the bottom should equal at least one-quarter of the total area of reinforcement in column strips.

FIG. 123.—Four-way Reinforcement. Second Method. (See p. 360.)

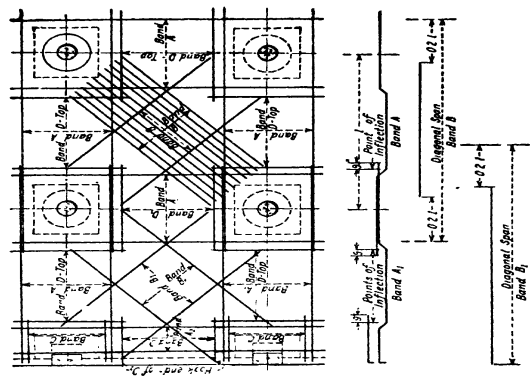

**Notes:**  
 Distance of points of inflection from edge of column head for positive and negative moment is not indicated.  
 Distance of points of inflection from edge of column head equals, for negative moment reinforcement  $0.2l_1$ , and for positive moment reinforcement  $0.18l_1$ , where  $l_1$  is the net span.  
 Positive moment reinforcement to extend beyond points of inflection 20 bar diameters but not less than 12 in.  
 Area of straight bars at the bottom should equal at least one-quarter of the total area of reinforcement in column strips.

FIG. 124.—Four-way Reinforcement. Third Method. (See p. 361.)



The number of bars in each band is determined for the positive bending moment. In the column head section, every other bar of each rectangular and diagonal band is bent up and becomes effective as negative bending moment reinforcement. Also, every other bar from the adjoining span is extended into this span and becomes effective as negative bending moment reinforcement. The area of the effective negative bending moment reinforcement is therefore equal to one-half the sum of the reinforcement at both positive sections in the span under consideration, plus one-half of the corresponding sum in the adjoining span. With proper depth of drop panel, this amount of steel may be sufficient to supply the required negative moment reinforcement in the column strips. If not, additional short bars should be provided. This happens for shallow drops or for slabs without drop panels. The short bars should extend, on both sides, 20 bar diameters,<sup>5</sup> but not less than 12 in., beyond the points of inflection for positive moment reinforcement as specified on page 336.

The negative reinforcement in the midsection consists of short straight bars.

*Third Method.*—All bars in rectangular bands are bent up and extended, at both ends, 9 in. beyond the points of inflection for negative moment reinforcement of the adjoining panels. (See folding Fig. 124.) The bars in the diagonal bands are straight and extend at each end, 20 bar diameters beyond the points of inflection for positive moment reinforcement as specified on page 336. With such an arrangement, the negative bending moment reinforcement at the column consists of two layers only. The area of the negative reinforcement is equal to twice the area of the rectangular band steel. If this is not sufficient to supply the negative bending moment reinforcement, additional straight bars should be added.

The negative moment in the midsection consists of short straight bars.

*Fourth Method.*—In this method, all four bands consist of long bars, all of which are bent up in the region of the points of inflection and extend beyond the column center. Some of the bars are extended into the adjoining panel, beyond the points of inflection, and are considered as negative reinforcement there. Other bars are lapped at the column. For comparatively short panels, some of the bars of the rectangular bands are made two panels long.

<sup>5</sup> See footnote, p. 354.

This is the earliest method of arranging flat slab reinforcement and was used in the Cantilever and Simplex Systems. It is in disfavor now, because all the bars are bent at the points of inflection, thus leaving a section of the slab, where positive moments may occur, without any positive reinforcement. This method is not recommended.

*Cross Bars.*—In each of the four methods, negative bending moment in the middle strip (as defined on p. 330) is provided for by means of short bars placed across the rectangular bands.

**Arrangement of Four-way System in Exterior Panel.**—In exterior panels, the continuous bands are arranged in the same manner as in interior panels. In discontinuous bands, the straight bars composing the band are extended to the wall column or wall beam. This applies also to the straight ends adjacent to the wall in the Second Method. **The bent bars at the wall are provided with hooks of sufficient size to develop the strength of the bars.** The hooked ends are extended to within 2 or 3 in. of the outside face of the column or wall beam. This last is an important requirement but is frequently neglected.

Usually, it will be found that at the wall column the bent bars alone are not sufficient to resist the negative bending moment. The required area of steel should be computed, and extra, short, hooked bars should be provided. The hooks should be placed in the wall beam, as near its outside face as possible, and these bars should extend into the slab beyond the point of inflection. The required number of additional bars will be particularly large when the drop panel is omitted at the wall column, in which case the required area of steel must be computed on the basis of the depth of the slab and not the depth of slab and drop panel.

In the midsection, at the wall beam, short bars should be used near the top of the slab. They should be placed at right angles to the wall beam. The hooks should be placed not more than two inches from the outside face of the wall beam.

## TWO-WAY SYSTEM

In the two-way system, the reinforcement consists of bands of small bars running in two directions. This system was originated and patented by Frank F. Sinks, and developed commercially by the Condron Company, under the trade name of the Acme System. The question of patents is not definitely settled. In one instance,

at least, the Sinks patent has been declared void by the court, but this is not necessarily a final decision. A typical arrangement of the Acme System is shown in Fig. 125, p. 363.

Another variation of the two-way system is the so-called Cor-plate, developed by the Corrugated Bar Company. Some features

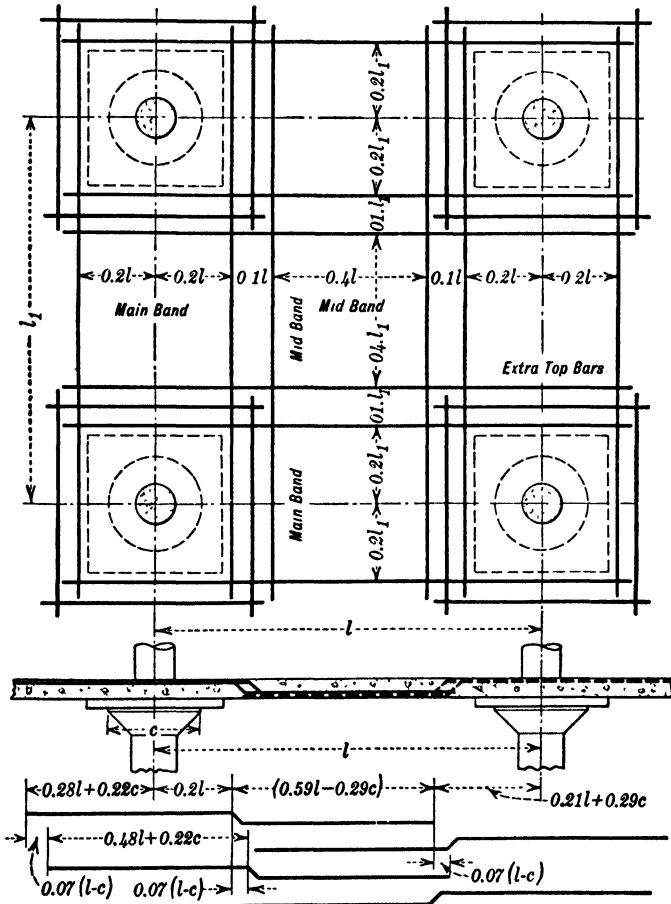
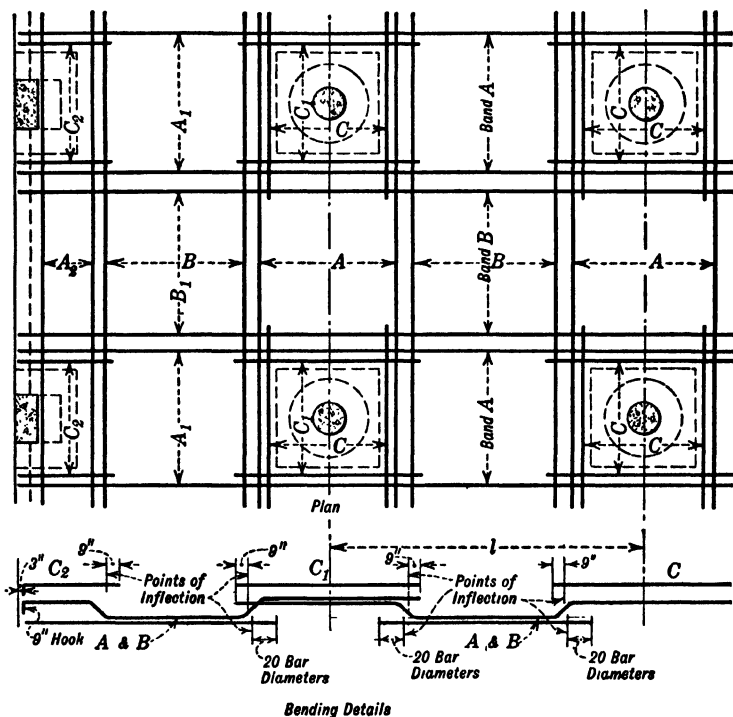

FIG. 125.—Acme System. (See p. 363.)

of this arrangement are patented. This variation differs from ordinary two-way arrangements in that the steel in the column head section is not uniformly distributed through the band, but is more concentrated near the column than near the edges of the band. With bars of equal diameter, this is accomplished by making the

spacing of the bars smaller in the middle of the band and then increasing it toward the edges of the band. This is shown in Fig. 35, p. 101.

**Arrangement of Two-way System in Interior Panel.**—Several methods of arranging reinforcement are now in common use. Three



**Notes:**

Distance of points of inflection from edge of column head for positive and negative moment is not identical

Distance of points of inflection from edge of column head equals: For negative moment reinforcement  $0.2l_1$ , and for positive moment reinforcement  $0.18l_1$ , where  $l_1$  is the net span.

Positive moment reinforcement to extend beyond points of inflection 20 bar diameters but not less than 12 in.

Area of straight bars at the bottom should equal at least one-quarter of the total area of reinforcement in column strips.

FIG. 126.—Two-way System. First Method. (See p. 364.)

methods will be described and illustrated. Either of the first two methods may be used. The third method is described because it is sometimes used, but it is not recommended.

**First Method.**—Each band consists of long bent bars and short straight bars. The long bars are bent up at both ends, and the bent



portions are carried, near the top of the slab, across the column into the adjoining spans, extending 9 in. beyond the points of inflection for negative moment reinforcement. The points at which the bars are bent should coincide with the points of inflection.

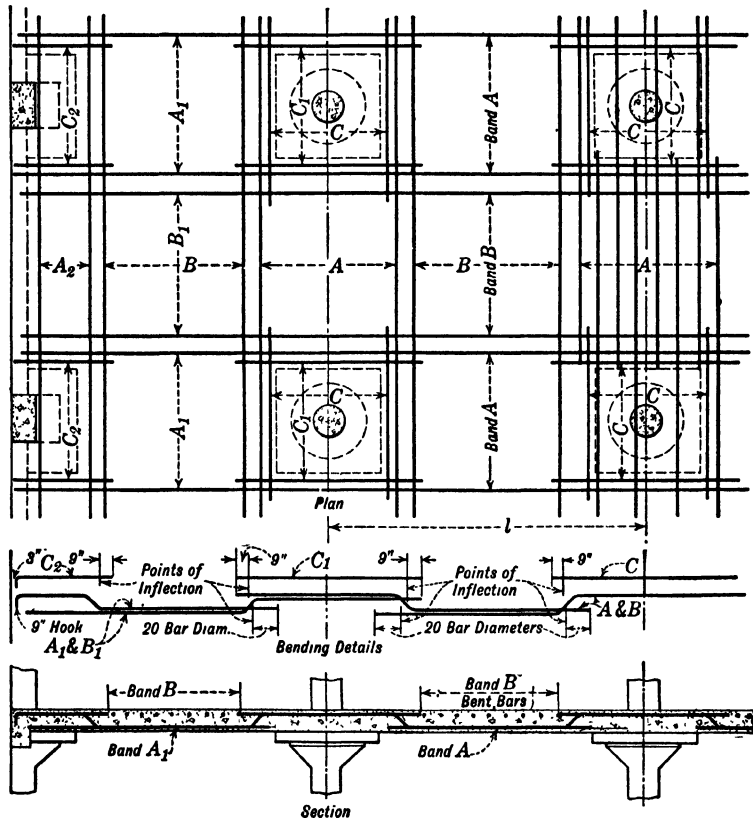

Notes:

Distance of points of inflection from edge of column head for positive and negative moment is not identical.

Distance of points of inflection from edge of column head equals: For negative moment reinforcement  $0.2l_1$ , and for positive moment reinforcement  $0.18l_1$ , where  $l_1$  is the next span.

Positive moment reinforcement to extend beyond points of inflection 20 bar diameters but not less than 12 in.

FIG. 127.—Two-way System. Second Method. (See p. 366.)

The short straight bars should extend, at each end, 20 bar diameters, but not less than 12 in., beyond the points of inflection for

positive moment reinforcement as specified on page 336. This arrangement is shown in Fig. 126, p. 364.

The number of bars in each band is determined from the positive bending moment. A sufficient number of bars should then be bent up to provide the required amount of steel for negative bending moment. With the arrangement recommended, the negative reinforcement consists not only of the bent-up bars in the panel under consideration, but also of the bars extending from the adjoining span. It is good practice to have at least one-third of the bars in a band straight. If the negative moment reinforcement is not satisfied by the number of bent bars, additional straight bars should be used. These should extend, at each end, 9 in. beyond the points of inflection for negative moment reinforcement.

*Second Method.*—All bars in each band consist of bars straight at one end and are provided with a double bend at the other end. The straight portion serves as positive reinforcement and is of such length that it extends 20 bar diameters (minimum 12 in.) beyond the points of inflection for positive moment reinforcement. The point of bending of the bar coincides with the point of inflection. The bent-up portion of the bar is carried, near the top of the slab, into the adjoining panel, extending 9 in. beyond the points of inflection for negative moment reinforcement. Each bar serves as positive bending moment reinforcement at one section of maximum bending moment, and as negative reinforcement in the same panel and also in the adjoining panel.

The bars in each band are so arranged that at each end the straight portions alternate with the bent-up portions. The total number of bars in each band is determined for the positive bending moment. The negative moment reinforcement will consist of one-half of the bars in a band in the panel under consideration, and one-half of the bars from the adjoining panel. Ordinarily, this is not sufficient in the column head section, and additional straight bars, extending, on each side, 9 in. beyond the points of inflection for negative moment reinforcement, should be used. This method is shown in Fig. 127, p. 365.

*Third Method.*—In this method, all the bars in each band are bent up at both ends and carried near the top of the slab. Such an arrangement is not recommended, because it leaves a section of the slab, where positive bending moment may occur, without any reinforcement.

**Arrangement of Two-way System in Exterior Panel.**—In exterior panels, the continuous bands are arranged in the same manner as in interior panels. In discontinuous bands, the straight bars or the straight ends of bars should extend to the column or wall beam. The bent bars at the wall column should be provided with hooks, to develop their full strength. These should be extended to within 2 or 3 in. from the outside face of the column wall beam. This requirement is important.

Usually, it will be found that, at the wall column, the bent bars alone are not sufficient to resist the negative bending moment. The required area of steel should be computed and extra, short, hooked bars should be provided. These should extend beyond the point of inflection. The required number of additional bars will be particularly large when the drop panel is omitted at the wall column.

#### CIRCUMFERENTIAL OR SMULSKI (S.M.I.) SYSTEM <sup>6</sup>

The Circumferential or S.M.I. System was developed and patented by Edward Smulski.

The reinforcement of typical interior and exterior panels is shown in Fig. 128, p. 369. A modification of the design is shown in Fig. 129, p. 370.

In general, the reinforcement consists of four types of units, which are usually designated by the letters *A*, *B*, *C*, and *T*. To distinguish between units of different panels, small letters are added. Thus, in end panels, the units become *Ae*, *Be*, *Ce*, *Te*, while at the wall *Cw* and *Aw* are used. When the steel in various floors is arranged differently, the floor is designated by a number placed before the name of the unit. Thus, 2*A* is Unit *A* in the second story, while *RA* is Unit *A* in the roof.

Units *A* and *B* are placed near the bottom of the slab and serve as positive bending moment reinforcement, while Units *C* and *T* are near the top of the slab and serve as negative bending moment reinforcement.

<sup>6</sup> Because of the business association of one of the authors, Mr. Smulski, with the Smulski Flat Slab System, we have refrained from comparing in the test the relative economy of the different Flat Slab Systems. Personal analyses of the theory made by the signer of this footnote show that, using the same principles of design and same bending moment, the Smulski System requires 20 to 24 per cent less reinforcement than the two-way or four-way systems. Tests of the system made by the signer of the footnote or witnessed by him prove the strength, reliability and permanence of the system.—Sanford E. Thompson.

**Bottom Reinforcement.**—Units *A* are placed between columns. They consist of trussed bars and of rings. The number of rings depends upon the span and the load. For spans up to 22 ft., four rings are generally used. The ends of the rings are lapped to develop their full strength. The laps are staggered, so that not more than one ring is lapped in one section.

The trussed bars are bent up at appropriate points and are carried, near the top of the slab, into the column head. In Fig. 128, they are extended into the adjoining panel and carried beyond the point of inflection. In the modification shown in Fig. 129, they are hooked on to the center ring within the column head.

Units *B* are placed in the central part of the slab. They consist of rings and diagonal bars. The rings overlap those in Units *A*, thereby forming a continuous mat of steel extending over the whole slab. As evident from Figs. 128 and 129, the whole slab, with small exception of the area immediately around the column head which needs no such reinforcement, is provided with bottom reinforcement capable of resisting stresses in any conceivable direction.

The diagonal bars are bent up and carried, near top of the slab, into the column head, where they are hooked on the center ring.

Units *Aw*, at the spandrel beam, consist of trussed bars and half rings that are provided with hooks at their ends.

**Top Reinforcement.**—Units *C* are placed at the column, near the top of the slab. They consist of rings and radial bars.

One of the rings is placed within the column head, while the remaining rings are placed outside the column head. The number of rings depends upon the size of the panel and the load. They are spliced to develop the full strength of the bar, and the splices are staggered. The rings form the top layer of steel.

The radial bars are in the shape of a hairpin, with prongs of uneven length. The longer prong is placed near the top of the slab, directly under the rings. The hook of the hairpin engages the center ring, which is placed within the column head. The free end of the longer prong extends beyond the points of inflection.

The reinforcement at the column head, in addition to Unit *C*, consists of trussed bars from Units *A* and *B*.

Units *T* are placed across the panel edge in the midsection, consisting of bars of a length equal to one-half of the panel length.

Units *Cw*, at the wall panel, consist of radial bars similar to those of Unit *C*, and of half rings placed on the top of the radial bars. The half rings are provided at their ends with hooks of proper

dimensions. To provide proper anchorage, the hooks are placed as near the outside edge of the wall beams as possible.

Units *Tw* take the place of Units *T* at the wall. They are provided on one end with a hook, which is placed as near the outside edge of the wall beam as possible.

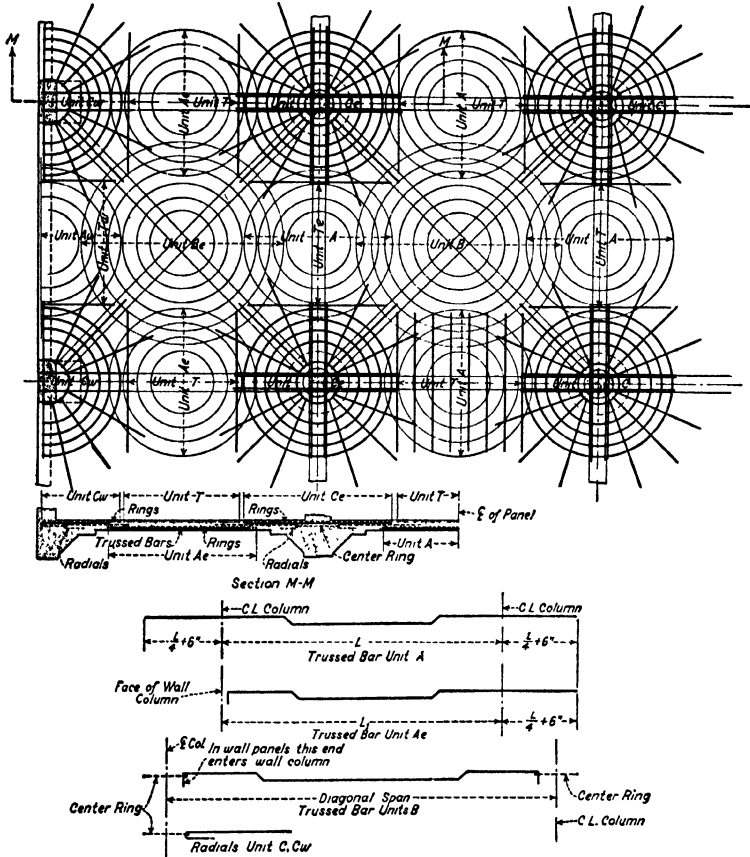

FIG. 128.—Typical Smulski Flat Slab Reinforcement for Interior and Exterior Panel. (See p. 367.)

### EXPLANATION OF ACTION OF THE SMULSKI SYSTEM

Since the reinforcement of the Smulski (S. M. I.) System is radically different from that of the Two-way and Four-way Systems, its action will be more fully explained below.

The Smulski System takes advantage of the following principles:

1. Ring reinforcement prevents any deformation of the concrete enclosed by it. Any tendency of the concrete within the ring to

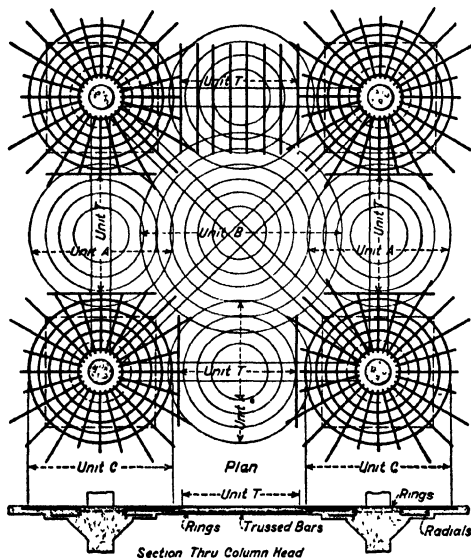

FIG. 129.—Modified Arrangement of Smulski Flat Slab Reinforcement. (See p. 367.)

spread or elongate in any direction is resisted by the steel ring. Therefore, any tensile stresses within the ring, irrespective of their direction, are resisted by the steel ring.

A properly lapped ring is a complete unit and does not depend upon bond to develop stresses in the bar, as is the case with straight bars. While the ring is not at all effective outside of its circumference, it is fully effective at all points within it.

Because of this property, a ring is a valuable reinforcement where the direction of stresses is either unknown or changeable, as in a flat slab, particularly at the column head. In test, to destruction, of the Western Newspaper Union Building,<sup>7</sup> with flat slab floor, four-way system, the stresses in diagonal direction were much larger than in rectangular directions, also at ultimate load the stresses in each band varied at an average from 18 000 lb. per sq. in. for outside bars to 50 000 lb. per sq. in. for center bars of the band. This means unequal utilization of steel, with the consequence that, to prevent excessive stresses in the bars carrying the largest stresses, a larger area of steel is required to resist the bending moment than if all bars were fully effective and equally stressed.

<sup>7</sup> Test of a Flat Slab Floor of the Western Newspaper Union Building, by Arthur N. Talbot and Harrison F. Gonnerman. Bulletin No. 106, Engineering Experiment Station, University of Illinois.

With ring reinforcement, all the stresses are resisted by all the rings at their full working value, irrespective of their position and intensity. Thus in Purdue test, for maximum load, the stresses in rings at center column varied from 33 300 to 41 900 lb. per sq. in., while in radials the variation of maximum stress was from 41 100 to 44 700 lb. (See p. 107.)

**Separating Flat Slab into Simple Parts.**—It is a well-known fact that a continuous beam or slab can be replaced by simple parts without changing the stress conditions. Thus, the beam can be cut at the points of inflection, where the bending moment is zero. It is then changed into two cantilevers and a simple beam suspended from the cantilevers. The stresses and the bending moments would not be affected by this change.

The same principle can be applied to flat slabs, which can be separated into following parts, as shown in Fig. 117, p. 328:

Circular cantilevers at the column head;

Slabs between columns;

Slabs supported at four points subjected to stresses in all directions.

In designing the reinforcement, it is permissible to treat the separate parts independently and to provide in each of them a sufficient amount of steel to resist the particular moments to which they may be subjected.

As the unit shear at the points of inflection is always low, not exceeding 40 lb. per sq. in., concrete is capable of taking care of the shearing stresses.

Since it is not advisable to rely on concrete alone, the parts of the slab subjected to positive bending moment, and reinforced by Units *A* and *B*, are tied securely to the circular cantilever at the column head by the bent portions of the trussed bars and by the overlapping of Units *A* and *C*.

The position of the points of inflection is variable for different positions of the live load. To provide for this and also to prevent secondary cracks due to temperature and shrinkage, the various units overlap, thereby tying the slab together and enabling it to act as a whole if such action is required by any contingencies.

**Column Head Section.**—At the column head the portion of the slab within the points of inflection acts like a circular cantilever, loaded uniformly over its area, and also along its circumference, by

the loads transferred to it from the rest of the slab. This portion is subjected to negative bending moments; i.e., the particles in the upper part of the slab elongate, while the particles in the lower part are compressed. After deflection, the cantilever assumes the shape of an umbrella.

The negative bending moment at the column head is larger than the positive bending moment in the center of the slab. The amount of steel required there is therefore larger than in any other part of the slab. To reduce the amount of reinforcing steel required at the column head, the depth of the slab in this section is often increased by forming the so-called drop panel.

The most unfavorable condition of loading for the column head section is that which occurs when all the spans surrounding the column are loaded. In such a case, the shape of the cantilever will be as shown in Fig. 130, p. 373. Since, after deflection, any circle increases its radius as well as its circumference, the particles must elongate in radial as well as in circumferential direction and are therefore subjected to radial and circumferential stresses. The most effective tensile reinforcement consists of rings and radial bars.

Compressive stresses act also in radial and circumferential directions. The compression acting radially composes the bulk of compressive stresses.

**Slabs between Columns.**—The principal stresses in this part act mainly in one direction, which at first is parallel to the edge of the panel and then gradually becomes inclined. In addition, negative stresses due to cross bending, and also due to shrinkage and temperature changes, act across the principal positive stresses.

The advantages of using rings in this part to resist the various stresses are as follows: (1) They intersect the lines of equal deflection more nearly at right angles than straight reinforcement. (2) They bind the Units *A* and *B*, thereby preventing secondary cracks. (3) The rings in the two units supplement each other. (4) The arrangement is economical, as the rings cover the whole surface without waste of material.

**Central Part of Slab.**—The central portion acts like a slab supported at four corners and loaded with uniform load. The bending moment is positive, so that the top is in compression and the bottom in tension. The stresses act in all directions; the reinforcement consisting of rings, therefore, is fully effective.



**Action of Rings.**—The rings resist all tensile stresses within them, irrespective of the direction in which they act.

To understand the action of the rings, it is necessary to keep in mind that tensile stresses can not act without producing a corresponding lengthening of the materials. Also, it must be remembered that the rings are filled solidly with concrete. If the shape of

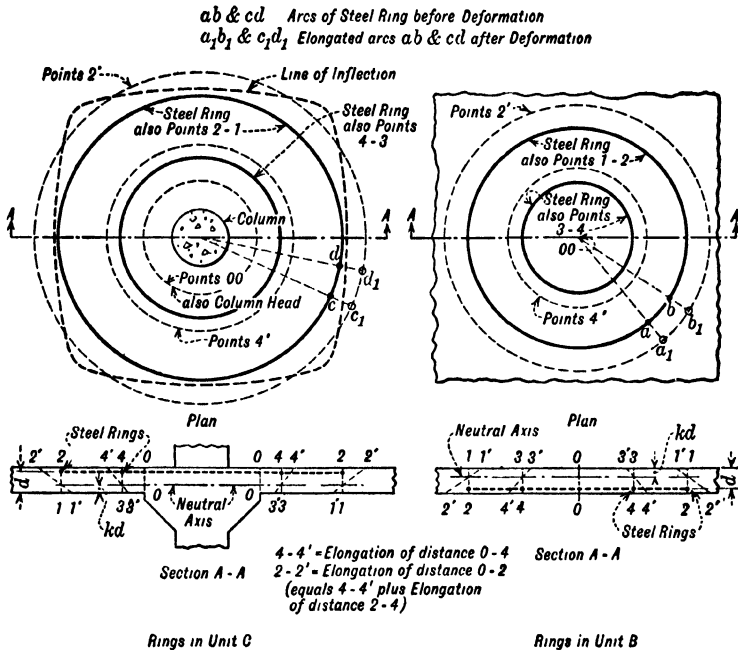

FIG. 130.—Action of Rings in Resisting Stresses. (See p. 373.)

the concrete within the ring undergoes any changes due to tensile stresses, the tight-fitting rings must undergo similar changes. When the slab is loaded and the concrete is elongated by stresses produced by the bending moments, it presses against the circumference of the enclosing ring and forces it to stretch proportionately to the magnitude of the stresses.

Parts of the slab at the column and also in the center of the slab, subjected to stresses in all directions, are shown in Fig. 130, p. 373. AA is a section in any direction. When loaded, the slab is compressed near one surface and elongated near the other surface, so that in

Fig. 130 the distance 0-3 shortens by 3-3', while 0-4 expands by 4-4'. The same is true of a section in any direction; therefore the circle 4-4 tends to assume the position 4'-4'. Before assuming the new position, the concrete must stretch the ring by which it is enclosed and increase its radius and therefore its circumference. The concrete exerts a pressure along the circumference of the ring similar to the pressure of water in a reservoir. The steel ring, by its tensile resistance, partially prevents the movement, but it stretches to some extent, causing tensile stresses in the steel.

Considering the second ring, it is evident that the movement of point 2 consists not only of the elongation of the distance 0-4 but also of the elongation of the distance 2-4. The outside ring, therefore, shares the stresses with the inside ring. Any deformation of the concrete, irrespective of its direction, is taken up at once by all the rings placed outside of the place of deformation. All rings are effective in resisting stresses.

*Forces Acting in All Directions.*—Where the forces act in all directions, as in the center of a slab and at the column head, the ring stretches uniformly along its circumference. After deformation, the shape of the ring remains substantially circular and the stresses are uniform along its circumference.

*Forces Acting Principally in One Direction.*—When the forces act principally in one direction, as in Unit A, the condition is similar to that of a solid disc of concrete with a tight-fitting steel ring around it, subjected to a force in one direction. Under the pressure of the enclosed concrete, the shape of the ring changes gradually into an oblong curve, with the concrete following and still pressing tightly on the ring. In this case the stresses in the ring are a maximum at the sections cut by a diameter perpendicular to the direction of the stress, and decrease to zero at points 90 degrees from the point of maximum stress.

From the above, it is evident that the stresses due to the principal bending moment are small in the parts of rings of Unit A which are near the column head, so that they can resist stresses in diagonal direction in places where they run almost parallel to the diagonal bars.

### THREE-WAY SYSTEM

The three-way system was developed by D. W. Morrow of Cleveland. It can be used only with a peculiar spacing of columns.

The reinforcement then consists of three bands of small bars. The number of bars in each band may be determined for positive bending moment. The arrangement of bars may be similar to that described in connection with the four-way system. The negative moment in the midsection should be provided for in the same manner as in the four-way system, and should consist of short straight bars.

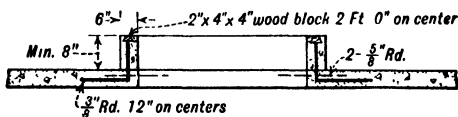
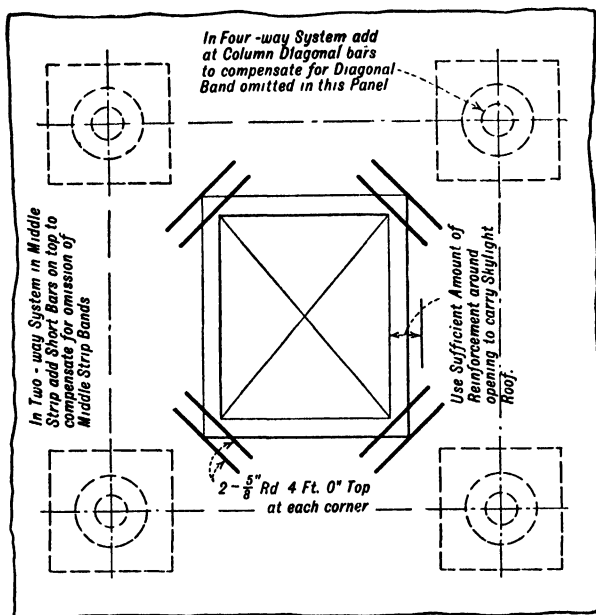

Section Through Skylight

FIG. 131.—Opening for Skylight. (See p. 376.)

OPENINGS IN FLAT SLAB

Proper design of the flat slab at openings requires considerable judgment. Openings up to one foot in diameter seldom require framing unless they occur at the columns. For large openings, it is often possible to strengthen the slab sufficiently to get along without

any beams. No general rule can be made to cover all cases. Inexperienced designers are advised to provide beams at openings.

Figure 131 shows a typical opening in the roof slab for skylight. With such an opening, the slab can be designed without any beams, the reinforcement on all four sides of the opening being made strong enough to carry the weight of the skylight. Sometimes, a curb is

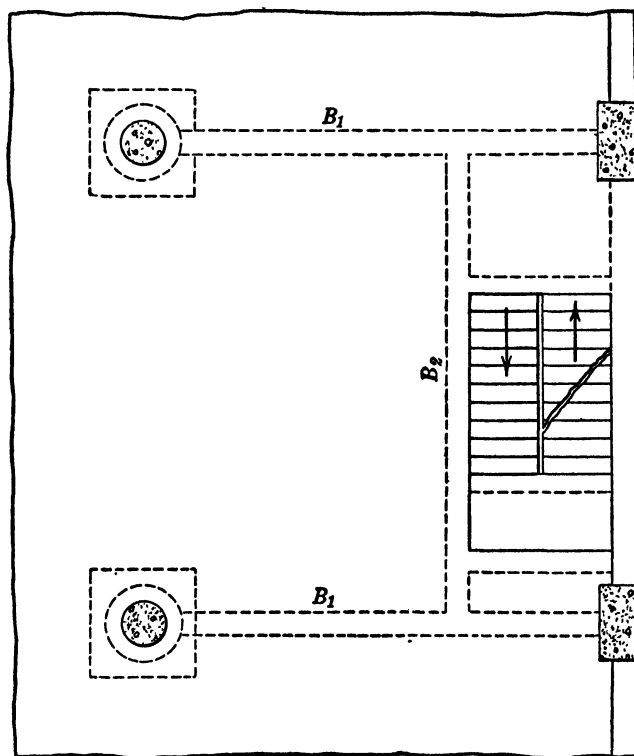

FIG. 132.—Opening for Staircase. (See p. 376.)

provided, which may be built with the slab or separately after the slab is poured. If the curb is to be built separately, dowels should be provided in the slab, and when the curb is being built, the joint between old and new concrete should be bonded with neat cement paste to avoid leakage. To prevent corner cracks, two  $\frac{5}{8}$ -in. round bars should be placed diagonally at the top of the slab at each corner of the opening.

Figure 132 represents another common type of opening, for a

staircase. A framing of beams is usually provided for such an opening.

### DESIGN OF BEAMS IN FLAT SLAB CONSTRUCTION

**When Beams are Necessary in Flat Slab Construction.**—Sometimes it is necessary to introduce interior beams in flat slab construction, to carry for instance, heavy concentrated loads, or to frame an opening. An illustration of the use of beams is given in Fig. 132, p. 376.

**Load Carried by Beam.**—An interior beam in flat slab construction should be designed for the load coming directly upon it, plus a flat slab load from a width of slab on each side of the beam equal to one-fifth of the span at right angles to the beam.

Often, in such cases, the beam is designed only for the load superimposed upon it, and the flat slab, reinforced as if no beam were used, is assumed to carry the slab load. This is obviously wrong. The beam and slab cannot act separately, the behavior of the slab being dependent upon that of the beam. Part of the slab on both sides of the beam acts as a T-flange for the beam, and, when the beam deflects, the slab deflects not as an independent slab, but as a flange of the T-beam. The position of the neutral axis is governed by the beam. The under side of the slab is in compression or, if not, the tensile stresses there are small. The effect of the slab reinforcement parallel to the beam (which would have been sufficient to carry the slab load if the beam were not there) is small; therefore, the load which would have been carried by the slab must be carried by the beam. Short bars must be placed at the top of the slab across the beam.

**Restraint of Interior Beams Framing into Columns.**—Beams in flat slab construction are usually one panel long, and the tendency is to treat them as simply supported beams. This is not correct. The beams form a monolithic part of the flat slab construction. If they frame into the columns, they are restrained there to the same degree as the rest of the flat slab. When they frame into interior columns, they may be considered as fixed at both ends. When they frame into one interior and one exterior column, they may be considered as fixed at the interior column and restrained at the wall column.

In Fig. 132, p. 376, for instance, beam  $B_1$  is only one span long. If the rules for one-span beams were followed blindly, it would be

designed for  $\frac{wl^2}{8}$  in the center, with little or no provision for bending moment at the supports. This would be not only wasteful but also unsafe. From inspection of the construction, it is evident that the beam is restrained not only by the column but also by the flat slab on the other side of the column. The beam has a restraining effect on the slab and in turn, the slab restrains the beam.

**Bending Moments in Interior Beams Framing into Columns.**—Interior beams framing into columns should be designed as follows:

The span of the beam should be taken as the distance between the faces of the column and not between the edges of the column heads.

The following bending moments should be used.

Let  $l_1$  = net span, i.e., distance between faces of columns, ft.;

$w$  = total live and dead load, lb. per lin. ft.

Then

**Interior Panels.**—

*Negative Bending Moment at Columns,*

$$M = -\frac{1}{2}wl_1^2 \text{ ft.-lb. or } -wl_1^2 \text{ in.-lb.} \quad \dots \quad (46)$$

*Positive Bending Moment in the Center,*

$$M = +\frac{1}{16}wl_1^2 \text{ ft.-lb. or } 0.75wl_1^2 \text{ in.-lb.} \quad \dots \quad (47)$$

**Exterior Panels.**—

*Negative Bending Moment at Interior Column,*

$$M = -\frac{1}{8}wl_1^2 \text{ ft.-lb. or } -1.2wl_1^2 \text{ in.-lb.} \quad \dots \quad (48)$$

*Negative Bending Moment at Wall Column,*

$$M = -\frac{1}{16}wl_1^2 \text{ ft.-lb. or } -0.75wl_1^2 \text{ in.-lb.} \quad \dots \quad (49)$$

*Positive Bending Moment in the Center,*

$$M = +\frac{1}{2}wl_1^2 \text{ ft.-lb. or } wl_1^2 \text{ in.-lb.} \quad \dots \quad (50)$$

**Interior Beams not Framing into Columns.**—Interior beams that do not frame into columns such as beam  $B_2$  in Fig. 132, p. 376, are only partly restrained at the ends. The bending moments should be assumed as  $\frac{wl^2}{10}$  in the center and  $\frac{wl^2}{16}$  at the support. The span should be taken as from center to center of the supporting beams. The negative reinforcement should not be hooked in the beam but should be extended into the slab.

## WALL BEAMS

Wall beams are beams between exterior columns, used to carry the spandrels (i.e., the walls under the windows) or curtain walls.

In flat slab construction, wall beams may be divided into two general types: (1) wall beams extending below the slab, and (2) wall beams extending above the slab.

The various designs of the wall beams are shown in Figs. 133 to 137.

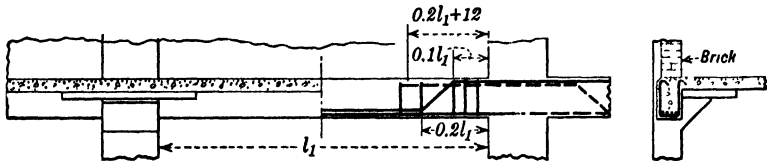

FIG. 133.—Wall Beams below Slab. (See p. 379.)

**Wall Beams Below the Slab.**—When wall beams extend below the flat slab, as in Fig. 133, they must be designed to carry not only the wall load but also a portion of the flat slab load. The reason for this is explained on p. 388, and is evident from Fig. 134, p. 381. The best practice, endorsed by the authors, requires that 20 per cent of the slab load in the wall panel be considered as carried by the wall beam. The slab load should be assumed as uniformly distributed over the whole length of the beam. For example, if the span of the slab at right angles to the beam is 20 ft., the dead and live load on a width of slab equal to 4 ft. should be considered as being carried by the beam.

The authors recommend that the bending moments be based on the net span, i.e., the distance between the faces of the columns. The following coefficients are recommended:

Let  $l_1$  = net span, i.e., distance between the faces of column, ft. ;  
 $w$  = dead and live load on wall beam, lb. per lin. ft.

For interior spans the bending moments should be as follows:

Negative bending moment,  $M = -\frac{1}{12}wl_1^2$  ft.-lb. or  $wl_1^2$  in.-lb.;

Positive bending moment,  $M = \frac{1}{16}wl_1^2$  ft.-lb. or  $0.75wl_1^2$  in.-lb.

For end spans where the width of the corner column is less than one-tenth of the span,

Negative bending moment, interior column,

$$M = -\frac{1}{8}wl_1^2 \text{ ft.-lb. or } -1.2wl_1^2 \text{ in.-lb.}$$

*Negative bending moment, corner columns,*

$$M = -\frac{1}{16}wl_1^2 \text{ ft.-lb. or } -0.75wl_1^2 \text{ in.-lb.};$$

*Positive bending moment,*

$$M = \frac{1}{12}wl_1^2 \text{ ft.-lb. or } wl_1^2 \text{ in.-lb.}$$

For end spans where the end column is more than  $1\frac{1}{2}$  times the depth of the spandrel and more than one-tenth of the span, the same bending moments may be used as for interior spans of the wall beam. At the end column, then, the same area of negative reinforcement must be used as at interior columns.

For deep beams, the bending moment must be considered as resisted by the reinforcement in the beam only, because the tensile stresses in the reinforcement of the slab strip parallel to the beam are either non-existent or negligible.

With shallow wall beams, the slab reinforcement parallel to the beam resists part of the bending moment in the wall beam. Usually, the effect of the slab reinforcement is small and is not worth considering. If desirable to consider the slab reinforcement, it should be done as in the following example:

**Example 1.**—If effective depth of beam is  $d = 15$  in. effective depth of slab,  $d_1 = 10$  in.;  $k = 0.375$ . Then the depth of neutral axis for the beam is  $kd = 5.6$  in. The depth of slab below neutral axis for the beam is  $15 - 5.6 = 9.4$  in., while for the slab it is  $10 - 5.6 = 4.4$  in. If the stress in beam reinforcement is  $f_s$ , the stress in slab reinforcement will be in proportion to its distance from the neutral axis, or  $\frac{4.4}{9.4}f_s = 0.47f_s$ . If  $A_s$  is the steel in the strip parallel to the beam, the tensile stresses resisted by it are  $0.47A_s f_s$ . To get the bending moment, this stress must be multiplied by the distance between the slab steel and the center of compression, which is  $4.4 + \frac{2}{3}kd = 4.4 + \frac{2}{3} \times 5.6 = 8.1$  in. The bending moment is  $M_1 = 0.47f_s \times 8.1 = 3.8A_s f_s$ .

The same area of steel, if placed in the beam, would resist a bending moment  $M_2 = A_s f_s \times \frac{2}{3} \times 15 = 13.2A_s f_s$ . Comparing this with the above value, it is evident that the effectiveness of the slab steel is equal only to 0.29 of the effectiveness of the same reinforcement placed in the beam.

*Requirements of Building Codes.*—The requirement adopted by the authors, as to the amount of slab load carried by the beam, is incorporated in most modern codes. Some codes, however, still permit the wall beam to be designed for the wall load only. This always gives unsafe results. The Code of the City of Boston requires that the wall beam be designed to carry the wall load and, in addition, a slab load on a width of slab equal to 20 per cent of the clear



span of the spandrel beam (irrespective of the magnitude of the span of the slab at right angles to the beam). This requirement is safe in some instances and unsafe in others. In cases where the span of the slab at right angles to the wall is small, the requirement gives absurd results.

1924 *Joint Committee Requirements*.—The 1924 Joint Committee distinguishes between a beam having (a) a depth greater than the depth of drop panel into which it frames, and one having (b) a depth equal to or smaller than the depth of drop panel. The beam (a) (deeper than drop panel) is required to be designed for all directly superimposed loads plus one-fourth of the distributed load for which the adjacent panel (or panels) is designed. Each column strip

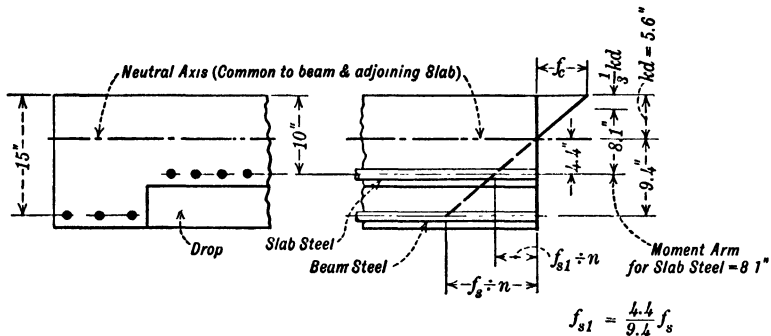

FIG. 134.—Stresses in Beam and Slab Reinforcement at Wall Beam. (See p. 380.)

adjacent to and parallel with the beam is required to be reinforced with one-half of the reinforcement which it would have required without the beam. The beam (b) (depth equal to or smaller than drop panel) is required to be designed for the load directly superimposed upon it, while the flat slab strip parallel with it is to be designed to carry all the slab load.

The requirement for beams (a) (deeper than drop panel) is logical and agrees substantially with the authors' recommendation. **The requirement for beams (b) is not correct**, as clearly explained above and on p. 388. This requirement is based on the assumption of full working stresses in slab steel. From Fig. 134, it is evident that if the slab steel were stressed to full working stresses, the stress in beam steel would have to pass the elastic limit.

**Wall Beam below Slab with Concrete Curtain Wall above.**—In many cases, the wall beam and curtain wall are built of concrete,

but, for reasons connected with construction, it may not be desired to build them at the same time or to make provision for the cooperation of the concrete wall beam below the slab with the concrete curtain wall above. In such cases, a definite joint is made between the curtain wall and the rest of the construction, at the top of the slab and at the columns. The concrete curtain wall is then built after the frame is completed. To insure weather tightness and to tie the curtain wall to the beam, dowels are provided in the beam and are then imbedded in the curtain wall. Also, recesses coated with asphalt are provided, in the column, for the walls. The curtain wall is reinforced for temperature. The amount of this reinforcement will depend upon the extent to which it is desired to avoid cracking. At least 0.25 of one per cent of longitudinal steel is recommended, particularly if the concrete in the wall is exposed. Window sills should be reinforced with two  $\frac{1}{2}$ -in. round bars. Satisfactory results have been obtained in some cases, in 8-in. curtain wall where  $\frac{3}{8}$ -in. round bars were spaced 12 in. on centers; but the small saving in reinforcement does not compensate for the unsightly appearance of the temperature and shrinkage cracks which are liable to occur.

The concrete curtain wall is not considered as a part of the beam. The method of design of the wall beam, in this case, differs from the previous case only in that the curtain wall does not need to be considered as adding to the loading of the beam.

**Wall Beam above the Slab.**—It is often desirable to bring the top of the window as close to the bottom of the slab as possible. In such cases, the wall beam is placed above the slab, as illustrated in Figs. 135 to 137.

When no drop panel is used, the bottom of the wall is flush with the bottom of the slab. When a drop panel is used, the bottom of the beam is at the same level as the bottom of the drop panel.

The design of the wall beam will depend upon the method of construction.

**Beam and Slab Built at the Same Time.**—The wall beam shown in Fig. 135 should always be built with the slab. The method of design will be the same for wall beams below the slab.

In the design of wall beams shown in Fig. 136, the slab and the wall beam, for its full depth (including the column), are built at the same time. The beam is designed as fully continuous. The temperature steel in the beam is extended into the columns, to prevent cracks at the junction of the beam and the column. When beams

are deep, no bent bars are used, and the negative reinforcement at the column consists of short bars placed near the top of the beam. In such cases, the beam is tied to the columns so that it cannot contract freely. To prevent cracks due to shrinkage and temperature, at least 0.3 per cent of longitudinal steel is needed.

This method, when the wall beam is properly designed and built, gives very satisfactory results. However, it is difficult to construct. The formwork for the wall beam is expensive, and difficult to keep in place during construction. It is difficult to prevent the concrete in the wall above the slab from running out into the slab, especially

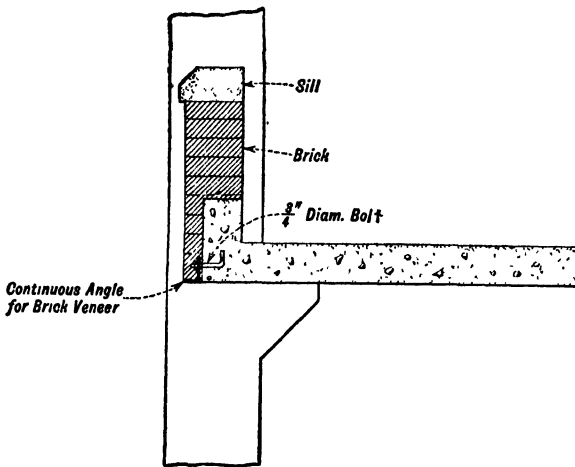

FIG. 135.—Wall Beam above Slab. (See p. 382.)

when the spandrel is so high that considerable pressure is developed. Rather dry mix should be used in such cases, and the concrete in the wall should be poured after the concrete in the slab has begun to stiffen very slightly.

The same loads and moments may be assumed as in the case of beams extending below the slab. The bars in the band parallel to the wall may be assumed as effective in resisting the positive bending moment in the beam, to the extent of 50 per cent of the required steel area in the beam.

Stirrups should be used throughout the length of the beam. They act partly to suspend the slab load from the beam.

*Beam and Slab Built Separately.*—In the design shown in Fig. 137 the portion of the beam above the slab is built after the frame is

completed. To get cooperation of the upper portion with the lower portion of the beam, sufficient stirrups are provided throughout the beam. Since no provision is made for resisting negative bending moment, the wall beam should be designed as simple supported, using the distance between faces of the column as the span. The design load should be taken as in previous cases. The reinforcement should be computed for three-quarters of the total effective depth of upper and lower portions of the beam. The fraction is used to provide for the possibility of imperfect cooperation between the two parts of the beam. With this type of design, the forms are often stripped before the upper part of the beam is built. For this reason, the lower portion of the beam must be provided with

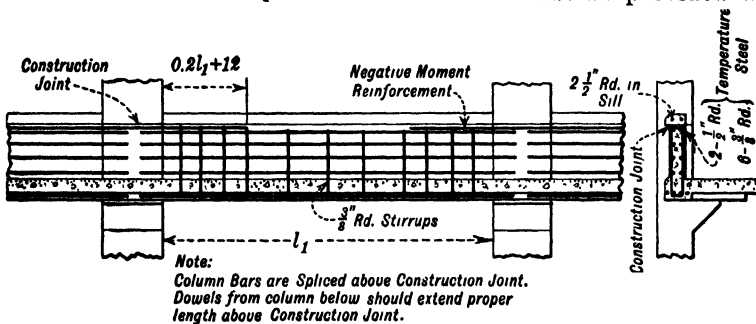

FIG. 136.—Concrete Spandrel Built Monolithic with Slab and Columns. (See p. 382.)

sufficient reinforcement to carry safely the dead load of the slab without the assistance from the upper part. It is particularly important to provide negative bending moment reinforcement in the lower part of the beam, as shown in Fig. 137.

The upper part of the beam should be provided with proper amount of temperature reinforcement. Since the beam is able to contract to some extent, the amount of temperature steel may be smaller than in previous case. The actual amount will depend upon conditions. The authors recommend one-quarter of one per cent for temperature reinforcement.

Recesses should be provided in the columns for the upper part of the beam. The joint should be water-proofed by using tar felt or similar material.

Sometimes an attempt is made to tie the separately poured upper part of beam to the column by providing in the columns horizontal

dowels and longer horizontal bars near the top of the beam, and thus provide continuity for the upper part of the beam when built. This is not desirable for construction reasons. It is necessary to drill holes in the forms for reinforcement. These must be located with care so that the hole in one face is just opposite the hole in the other face. After the holes are drilled there is always some difficulty in placing the dowels in the forms. Finally, great difficulty is experienced in stripping the forms. The sides must be moved horizontally to clear the dowels. This movement cannot be conveniently made on account of stirrups extending up from the slab. For these reasons, this method is not popular on the job and is not advocated.

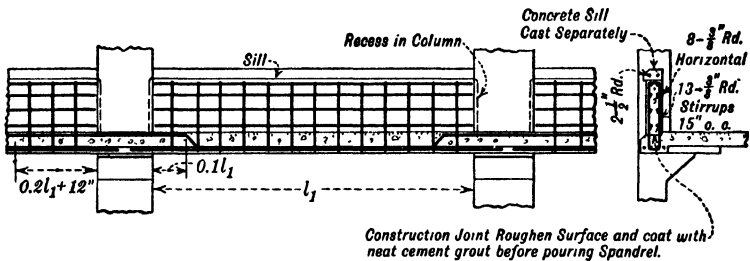

FIG. 137.—Concrete Spandrel Built Separately. (See p. 383.)

Instead of providing horizontal dowels in the columns for the wall beams, the Aberthaw Construction Co. of Boston places horizontal pipe sleeves in the column forms at the proper height. After the column forms are stripped, steel bars of proper length, extending on both sides of the column, are inserted in the pipe. When imbedded in the wall beam, they serve as negative bending moment reinforcement.

### GENERAL REMARKS

It is impossible to design flat slab construction properly without a thorough understanding of the action of continuous structures and particularly of continuous flat slabs under varying conditions of loading. Rules and formulas given in preceding paragraphs are mostly for typical panels. In actual construction, odd panels will be found, the designing of which must be left to the judgment of the designer. Sometimes, whole floors consist of an assortment of

odd panels. In all such cases, the designer should be able to judge how the various parts of the floor will deflect when loaded. Following general formulas blindly may give unsafe results.

Another perplexing point is the effect of beams on the action of the adjoining slab. This may be such as to require complete change in the amount and location of the reinforcement.

Of importance it is to study the effect of openings on flat slab action.

**Tensile Reinforcement Does Not Transfer Loads to Supports but Resists Stresses Due to Bending.**—The designer should understand the function of reinforcement which is often misunderstood. There is a notion prevalent that bands of steel bars transfer the loads from the slab to the support. This is not the case. The function of the tensile reinforcement is to resist tension due to the bending moments, while the function of transferring the load from one section to another and then to the column is performed by concrete through its resistance to shear. While this is obvious and should not require comment, in order to correct the prevalent wrong notion, full explanation is here given.

In the center, where external shear is zero and therefore there is no load transferred, tensile stresses in a band of bars are a maximum. These stresses decrease gradually until at the point of inflection they become zero. At the point of inflection, the effect of the reinforcement is practically negligible. While the stresses in the tensile reinforcement decrease from a maximum to zero, the load to be transferred to the column equal to external shear steadily increases from zero at the center until at the point of inflection, the load to be carried to support amounts to about three-quarters of the total load on the panel. Thus, the effect of the steel is largest where there is no load to be transferred to the column and is *nil* at the point of inflection where three-quarters of the load on the panel need to be taken care of. This fact proves that the bands of bars do not perform the function of transferring the load towards the column. If they did, their stresses would increase, instead of decreasing with the increase of external shear. The function of transferring the load from section to section is performed by shearing stresses in the concrete. In the center, where the load to be carried is zero, the shear is zero. With the increase in load to be transferred, the total shear increases in proportion until it reaches its maximum at the column.

**Suspension Action Impossible in Flat Slab Construction.**—

Another misconception, fairly widespread specially among advocates of the four-way arrangement of steel, is that bands of bars act as sort of suspension bars. Nothing could be farther from the truth.

Suspension action is always distinguished by the load being carried to the support entirely by tension stresses in the suspension bars. The stresses in the bars depend upon their sag. The horizontal component of the stresses equals the static bending moment divided by the area of bars and the amount of the sag. The suspension bars are under tensile stresses for their full length, the magnitude of which is such that their horizontal component is constant for the whole length of the suspension bar. A good example of suspension action is furnished by the suspension cables of a suspension bridge. The cables are anchored at each end and sag between the piers. They form the main means of carrying the load. No compression members are existing. The cables are free to elongate for their full length.

No such action takes place in flat slab construction. The stresses in each band of bars are a maximum in the center, then they decrease until they are zero at the point of inflection. Near the column, the stresses increase from zero at point of inflection to a maximum at the support. There is no continuous transference of tensile stresses as in suspension cable. The bands of bars may be continuous, but their action is not continuous. As a matter of fact, as far as tensile stresses are concerned, the bars in flat slab could be cut at the point of inflection without affecting the construction, because the tensile stress there is zero. If a cable of a suspension bridge was cut, the bridge would collapse. A further difference is that for slabs of uniform thickness the sum of tensile stresses at the support is much larger than the sum of tensile stresses in the center. In suspension structures, on the other hand, the horizontal component of the tensile stresses is constant at all sections.

If bands of bars acted as suspension bars, the strength of the slab would be only a fraction of the strength flat slabs actually have. Flat slabs action is fully explained on page 328.

**Stresses Cannot Act without Corresponding Deformation.**—It is of particular importance to remember also that stresses cannot exist without corresponding deformation of the materials and deflection of the member. Neither can deformations of materials (other than shortening or lengthening of members free to move, due to

temperature) and deflection of members exist without stresses. Reinforcement cannot be effective in resisting tension when it is placed in such a way that it is not able to elongate.

This is of importance in many cases in connection with flat slab design, particularly in connection with the design of beams in flat slab construction. In Fig. 138, page 388, for instance, the bottom of the beam is some distance below the bottom of the slab. Some building codes permit the beam to be designed only strong enough to carry its own weight and the load directly superimposed upon it. The slab is assumed to act as if there was no beam, and the slab load is assumed as being carried from column to column by the strip of slab along the beam. The tensile stresses in the slab are supposed to be resisted by the half-band of bars parallel to the

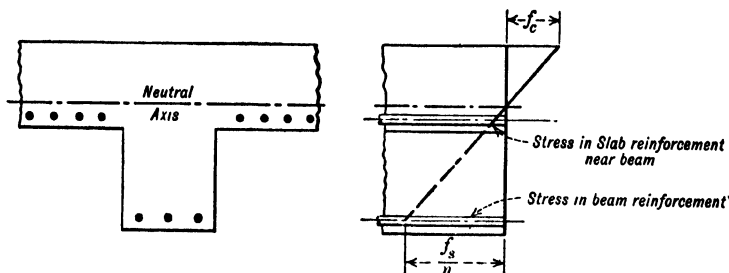

FIG. 138.—Action of Beam and Slab Reinforcement in Flat Slab Construction. (See p. 388.)

beam. It should be clear that no such action can take place. The slab and the beam must deflect as a unit. The position of the neutral axis for both the beam and the slab is governed by the beam. The slab reinforcement will be near the neutral axis so that for quite a distance from the beam the amount of tensile stresses resisted by slab steel will be negligible. Before the slab bars can come into full action, the beam would have to fail. The design has sufficient amount of reinforcement, but it is placed in such a way that it cannot perform its function. The proper method of designing is to make the beam strong enough to carry not only the brickwork but in addition 20 per cent of the slab load. (See p. 379.)



## PROBLEMS IN DESIGNING FLAT SLAB CONSTRUCTION

**Method of Designing.**—After the spacing of columns has been decided upon, the design of flat slab floors or other plane structures may proceed as follows:

1. Assume dead load of slab based on assumption of its thickness. This weight added to the live load and to the weight of floor finish gives the total loading for the flat slab.

2. Select size of column head and dimensions of drop panel. (See p. 319.)

3. Determine restraint at wall column. (See p. 313.)

4. Compute required thickness of slab and drop panel, using formulas, Nos. 8 to 28. If slab of uniform thickness throughout the floor is desired, the thickness should be computed for panels for which the expected bending moments are largest.

5. Compute shearing stresses at the column head and at the drop panel. (See p. 347.)

6. Compute bending moments at the various design sections for interior and exterior panels. (See pp. 332 to 335.)

7. Compute required areas of steel at the various design sections. (See p. 351.)

8. Select the flat slab system to be used and the desired arrangement of steel. (See pp. 360 to 369.) Select bars which will supply the required amount of positive and negative reinforcement in each strip. Decide upon the manner of bending the bars. Compute the areas of bent bars effective as negative moment reinforcement, and compare this area of reinforcement with the required area. If the bent bars are not sufficient, add short bars.

9. Check bond stresses at the column head. (See p. 351.)

10. Show on the plan, by sketches details of reinforcement for typical panels. Give a designating mark to each band of bars or reinforcing unit, and label the floor plan with these marks. In a schedule of reinforcement, give the number, length, and type of bars in each band or unit. Indicate clearly the length of the bars composing each band or unit, and show bending sketches for bent bars. If the typical panel is to be used as a general guide for panels of different sizes, express the lengths of bars and the points of bending in terms of the span.

11. Show clearly the concrete dimensions, on the floor plan and in the schedule.

12. Design wall beams. (See p. 379.)

13. Check all columns supporting the flat slab, for strength and rigidity. Supply bending moment reinforcement in the exterior columns when required. (See pp. 305 to 319.)

### EXAMPLE OF FLAT SLAB DESIGN

The use of the formulas and recommendations will be illustrated by the following example.

**Example 2.**—Design an interior and exterior panel of a floor in a flat slab building. The dimensions of the panels are 20 by 22 ft., as shown in Fig. 139, p. 391. The design live load is 150 lb. per sq. ft. The floor finish consists of 1½ in. of bonded granolithic finish (i.e., finish applied separately).

Use following stresses in lb. per sq. in.,  $f_c = 800$ ,  $f_s = 16\,000$ ,  $u = 100$ ,  $v = 60$ , and ratio  $n = 15$ .

*Solution.*—The method of solving the problem, as outlined on p. 389, will be followed. The reference numbers used in the example correspond to the numbers used there.

1. Assuming thickness of slab as 8 in., the design load is

Live load.....	150 lb.
Slab load.....	100 lb.
1½ in. finish.....	18 lb.

Total.....  $w = 268$  lb. per sq. ft.

2. The diameter of column head is made equal to 0.225 times the average span. Therefore,  $c = \frac{22 + 20}{2} \times 0.225 = 4.72$  ft. Assume 4 ft. 9 in. for the diameter of column head. A rectangular drop panel will be used, with length of sides equal to 0.35 of the sides of the rectangular panel. The dimensions of the drop panel are 7 ft. by 7 ft. 6 in., with the long side parallel to the long side of the panel.

At the wall column, a square bracket will be used, with a distance from center of column to edge,  $c_1 = 2$  ft. 5 in. Half drop panel will be used at the wall.

3. The slab is supported by concrete columns having the required rigidity. Concrete spandrels are also used. Therefore, the exterior panel may be classed as Case 1 (see p. 333).

4. It is desired to use a slab of uniform thickness throughout, and drop panels of the same depth. Therefore, the required thickness will be computed for exterior panels, which in this case require the maximum dimensions.

*Thickness of Slab and Drop Panel.* (Use Formula (18), p. 339.)

The dimensions are  $l = 22$  ft.,  $b = 7$  ft.,  $w = 268$  lb. per sq. ft. For  $\frac{c}{l} = \frac{4.75}{22} = 0.22$  and for specified stresses from diagram, p. 911, the constant  $C_s = 0.0173$ .

$$t_1 = 0.0173 \times 22 \times \sqrt{268 \times \frac{2.0}{7} + 1.5} = 10.50 + 1.5 = 12 \text{ in.}$$

Thickness of Slab in the Center. (Use Formula (25), p. 340.)

Using dimensions given above, and since for  $\frac{c}{l} = 0.22$  and for specified stresses from table, p. 911,  $C_s = 0.0198$ ,

$$t = 0.0198 \times 22\sqrt{268} + 1 = 7.1 + 1 = 8.1.$$

Use 8 in. slab.

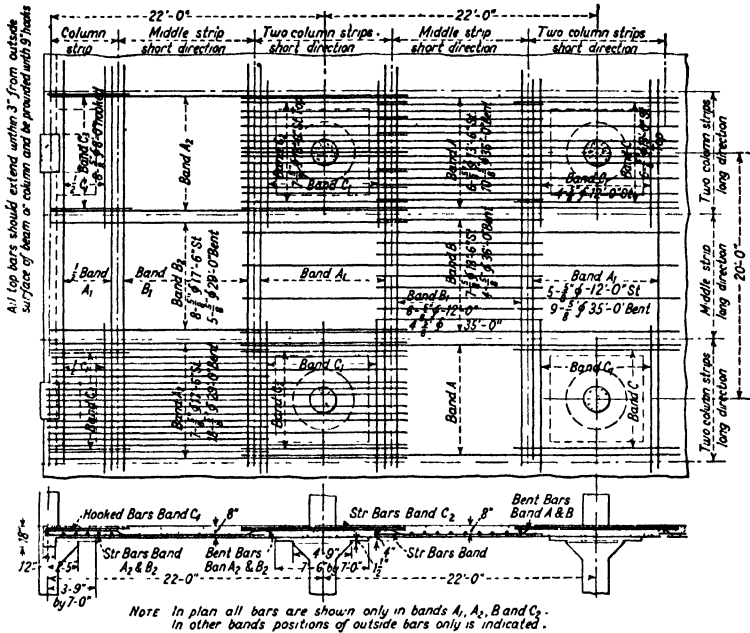

FIG. 139.—Details of Flat Slab Design. (See p. 390.)

5. The points of critical shear are distant  $t_1 - 1\frac{1}{2} = 12 - 1\frac{1}{2} = 10.5$  from column head. The diameter of critical section is

$$c + 2(t_1 - 1\frac{1}{2}) = \left( 4.75 + 2 \times \frac{10.5}{12} \right) = 6.5 \text{ ft.} = 78 \text{ in.}$$

The circumference is  $78 \times 3.14 = 245$  in.

The net area of panel outside the critical section is found as follows:

Area of panel.....  $20 \times 22 = 440$  sq. ft.

Area inside of critical section,  $\frac{6.5^2}{4} \times 3.14 = 33.3$

Net area..... 406.7 sq. ft.

Total shear at critical section equal to net area times unit load,

$$V = 406.7 \times 268 = 109\,000 \text{ lb.}$$

The weight of drop panel is neglected.

The shearing stresses are,

$$v = \frac{109\,000}{245 \times \frac{1}{3} \times 10.5} = 48.5 \text{ lb. per sq. in.}$$

The same result may be obtained by using Formula (39), p. 349. Since  $l = 22 \text{ ft.}$ ,  $l_1 = 20$ ,  $m = \frac{20}{22} = 0.91$ ,  $c_2 = 6.5 \text{ ft.}$ ,  $\frac{c_2}{l} = 0.296$ , from table, p. 913, the constant  $C_{12} = 0.85$ .

Therefore

$$v = C_{12} w_d \frac{l}{d} = 0.85 \times 268 \times \frac{22}{10.5} = 47.7 \text{ lb. per sq. in.}$$

Since the computed stress is less than the allowable stress of 60 lb. per sq. in., the thickness is satisfactory.

#### 6. Bending Moment at Various Design Sections.—

Interior Panel,  $W = 268 \times 20 \times 22 = 118\,000 \text{ lb.}$

$$\text{Long Direction, } l = 22 \text{ ft., } l_1 = 20 \text{ ft., } \frac{c}{l} = \frac{4.75}{22} = 0.22.$$

$$M = 1.08 \times 118\,000 \times 22(1 - \frac{1}{3} \times 0.22)^2 = 2\,040\,000 \text{ in.-lb.}$$

$$\text{Negative } \left\{ \begin{array}{l} M_1 = -0.54M = -1\,100\,000 \text{ in.-lb.} \\ M_2 = -0.08M = -163\,000 \text{ in.-lb.} \end{array} \right.$$

$$\text{Positive } \left\{ \begin{array}{l} M_3 = 0.23M = 469\,000 \text{ in.-lb.} \\ M_4 = 0.15M = 306\,000 \text{ in.-lb.} \end{array} \right.$$

$$\text{Short Direction, } l = 20 \text{ ft., } l_1 = 22 \text{ ft., } \frac{c}{l} = \frac{4.75}{20} = 0.24.$$

$$M = 1.08 \times 118\,000 \times 20(1 - \frac{1}{3} \times 0.24)^2 = 1\,800\,000 \text{ in.-lb.}$$

$$\text{Negative } \left\{ \begin{array}{l} M_1 = -0.54M = -972\,000 \text{ in.-lb.} \\ M_2 = -0.08M = -144\,000 \text{ in.-lb.} \end{array} \right.$$

$$\text{Positive } \left\{ \begin{array}{l} M_3 = 0.23M = 414\,000 \text{ in.-lb.} \\ M_4 = 0.15M = 270\,000 \text{ in.-lb.} \end{array} \right.$$

Exterior Panel,  $W$  same as for interior panel.

Long Direction,

$$M = \text{same as for interior panel.}$$

First interior column line,

$$\text{Negative } \left\{ \begin{array}{l} M_1 = -0.62M = -1\,265\,000 \text{ in.-lb.} \\ M_2 = -0.12M = -245\,000 \text{ in.-lb.} \end{array} \right.$$

Wall column line,

$$\text{Negative Moment } \begin{cases} M_1 = -0.42M = -857\,000 \text{ in.-lb.} \\ M_2 = -0.08M = -163\,000 \text{ in.-lb.} \end{cases}$$

$$\text{Positive Moment } \begin{cases} M_3 = 0.27M = 551\,000 \text{ in.-lb.} \\ M_4 = 0.18M = 367\,000 \text{ in.-lb.} \end{cases}$$

*Short Direction.*

Bending moments same as for interior panel because the slab is continuous in this direction.

7. **Required Areas of Reinforcement.**—The required areas of reinforcement are obtained from formula  $A_s = \frac{M}{jdf_s}$ . For  $f_s = 16\,000$ ,  $jf_s = 14\,000$ . The values of effective depth,  $d$ , are as follows: At the column head,  $d = 12 - 1.5 = 10.5$  in.; in the center of column strips,  $d = 8 - 1 = 7$  in.; and in the center of middle strips where two layers of steel are used,  $d = 8 - 1.25 = 6.75$  in.

Location	Bending Moment	Effective Depth	Required Area of Steel	Required Number and Diameter of Round Bars
<b>Interior Panel:</b>				
<i>Long Direction:</i>				
Column strips	$M_1 = -1\,100\,000$	10.5	7.5 sq. in.	26— $\frac{3}{8}$ "
Middle strips	$M_2 = -163\,000$	7.0	1.7 sq. in.	6— $\frac{3}{8}$ "
Column strips	$M_3 = 469\,000$	7.0	4.8 sq. in.	16— $\frac{3}{8}$ "
Middle strips	$M_4 = 306\,000$	6.75	3.2 sq. in.	11— $\frac{3}{8}$ "
<i>Short Direction:</i>				
Column strips	$M_1 = -972\,000$	10.5	6.6 sq. in.	22— $\frac{3}{8}$ "
Middle strips	$M_2 = -144\,000$	7.0	1.5 sq. in.	5— $\frac{3}{8}$ "
Column strips	$M_3 = 414\,000$	7.0	4.3 sq. in.	14— $\frac{3}{8}$ "
Middle strips	$M_4 = 270\,000$	6.75	2.9 sq. in.	10— $\frac{3}{8}$ "
<b>Exterior Panel:</b>				
<i>Long Direction:</i>				
First interior Column line	$\begin{cases} M_1 = 1\,265\,000 \\ M_2 = 245\,000 \end{cases}$	$\begin{cases} 10.5 \\ 7.0 \end{cases}$	$\begin{cases} 8.6 \text{ sq. in.} \\ 2.5 \text{ sq. in.} \end{cases}$	$\begin{cases} 29\text{—}\frac{3}{8}\text{"} \\ 9\text{—}\frac{3}{8}\text{"} \end{cases}$
Wall column Column line	$\begin{cases} M_1 = 857\,000 \\ M_2 = 163\,000 \end{cases}$	$\begin{cases} 10.5 \\ 7.0 \end{cases}$	$\begin{cases} 5.9 \text{ sq. in.} \\ 1.7 \text{ sq. in.} \end{cases}$	$\begin{cases} 20\text{—}\frac{3}{8}\text{"} \\ 6\text{—}\frac{3}{8}\text{"} \end{cases}$
Column strip	$M_3 = 551\,000$	7.0	5.7 sq. in.	19— $\frac{3}{8}$ "
Middle strip	$M_4 = 367\,000$	6.75	3.9 sq. in.	13— $\frac{3}{8}$ "

Reinforcement in short direction of exterior panel same as in short direction of interior panel.

8. The two-way system, with the arrangement shown in the first method, will be selected (p. 364). (The selection of this system is made for the purpose of illustration only and is not intended as a recommendation.)

*Column Strips.*—In the column strip, two bars out of three will be bent up at both ends and carried across the column into the adjoining span. In the long direction of the interior panel, where sixteen  $\frac{3}{8}$ -in. rd. bars are used for positive bending moment, 10 bars will be bent up and 6 will be carried straight. The available reinforcement at the column will consist of 10 bent up bars plus 10 bars extended from the adjoining span, making 20 bars in all. Since 26 bars are required, 6 short bars must be added. In the short direction, 9 bars out of 14 will be bent up, making 18 bars available at the column. Since 22 bars are required, 4 short bars must be added to complete the required reinforcement.

In the exterior panel, 12 bars will be bent up and 7 bars carried straight. The available reinforcement at the column head consists of 12 bent bars plus 10 bars extended from the interior panel, or 22 bars in all. Since 29 bars are required, 7 straight bars must be added. At the wall column, 20 bars are required and only 12 available. Therefore, 8 short bars, provided with a hook at the wall end, must be added.

In the short direction, the same arrangement of steel should be used as in the interior panel.

*Middle Strips.*—In the middle strip, one bar in three will be bent up at both ends and extended into the adjoining panel. The amount of negative reinforcement will then be equal to two-thirds of the amount of the positive reinforcement.

9. Bond stresses will be computed at the column head of interior panels, according to formula given on p. 351.

$$V = 0.35W = 0.35 \times 118\,000 = 41\,300 \text{ lb.}$$

The perimeter of one  $\frac{3}{8}$ -in. rd. bar is 1.96 in., therefore the perimeter of all bars effective at the column is  $\Sigma o = 1.96 \times 22 = 43.2$ .

$$u = \frac{41\,300}{43.2 \times \frac{3}{8} \times 10.5} = 104 \text{ lb. per sq. in.}$$

This is somewhat higher than the bond stress allowed for deformed bars. To reduce the bond stress to 100 lb., the number of bars would have to be multiplied by  $\frac{4}{3}$ , or bars of smaller diameter used.

10. The details of reinforcement and the length of bars are shown in Fig. 139, p. 391.

11. Concrete dimensions are given in Fig. 139, p. 391.

12. The gross span of the wall beam is 20 ft. With wall columns 3 ft. wide, the net span becomes 17 ft.

In this design, the wall beam will be placed under the slab.

The load on the beam equals:

Load from slab . . . . .	$0.2 \times 22 \times 268 =$	1 180 lb. per lin. ft.
Spandrel . . . . .	$3 \times 125 =$	375 lb. per lin. ft.
Glass and sash . . . . .		20 lb. per lin. ft.
Weight of beam below slab (assumed)		150 lb. per lin. ft.
		<hr/> 1 725 lb. per lin. ft.

The external shear equals

$$V = 1\,725 \times \frac{17.0}{2} = 14\,700 \text{ lb.}$$

The bending moment is computed as recommended on p. 379.

Negative bending moment,  $M = 1\,725 \times 17^2 = 499\,000$  in.-lb.

Positive bending moment,  $M = 0.75 \times 1\,725 \times 17^2 = 374\,000$  in.-lb.

The smallest cross section for the beam, as determined by allowable shear, is

$$bd = \frac{14\,700}{\frac{1}{8} \times 120} = 140 \text{ sq. in.}$$

The depth of the beam is usually governed by the allowable distance from the top of the window to the bottom of the slab. It is usually advisable to make the beam as shallow as possible, so as to bring the window close to the under side of the slab. In this case, assume depth of beam  $h = 18$  in. and  $d = 18 - 2 = 16$ .

**Minimum Width of Stem Governed by Shear.**—Since, as computed before, minimum  $bd = 140$ , with  $d = 16$ ,  $b = \frac{140}{16} = 8.75$  in. It is desirable to use a larger value,  $b = 12$ , to get larger resistance to torsion.

**Areas of Steel.**—Since  $d = 16$  in.,  $f_v = 16\,000$  lb. per sq. in., the areas of steel required by the previously computed bending moment are

At the column,

$$A_{s1} = \frac{499\,000}{\frac{1}{8} \times 16 \times 16\,000} = 2.2 \text{ sq. in.}$$

In the center,

$$A_{s2} = \frac{374\,000}{\frac{1}{8} \times 16 \times 16\,000} = 1.7 \text{ sq. in.}$$

Use four  $\frac{3}{8}$ -in. rd. bars for positive bending moment reinforcement, the area of which is  $4 \times 0.44 = 1.76$  sq. in. Bend two bars and extend them over the support. The available reinforcement at the column, then, equals 1.76 sq. in. Since the required area there is 2.2 sq. in., add one  $\frac{3}{8}$ -in. rd. bar. The total area then is  $1.76 + 0.44 = 2.2$  sq. in. The straight bars will be extended into the column and will be available as compression reinforcement, with an area equal to  $2 \times 0.44 = 0.88$ .

**Compression Stresses at the Support.**—The bending moment at the support is 499 000 in.-lb. The dimensions are  $b = 12$  in.,  $d = 16$  in. The area of tensile reinforcement is  $A_{s1} = 2.2$  sq. in.,  $p_1 = \frac{2.2}{12 \times 16} = 0.0115$ . The area

of compression reinforcement is  $A'_s = 0.88$  sq. in.,  $p' = \frac{0.88}{12 \times 16} = 0.0046$ .

Since, with  $f_c = 900$  and  $f_s = 16\,000$ , for a balanced design the ratio of reinforcement is  $p = 0.0129$ , which is larger than the ratio used, the compression stresses are smaller than allowable and the design is satisfactory.

**Diagonal Tension Reinforcement.**—Diagonal tension reinforcement may be computed as in ordinary design. However, the authors advocate the use of a larger number of stirrups near the ends of the beam than required by diagonal tension, because there they may assist the beam in resisting torsional stresses.

**Joint Committee, 1924, Flat Slab Specifications.**—The Joint Committee, 1924, flat slab specifications are reprinted as appendix in Vol. III of this treatise.

### CHICAGO AND NEW YORK CITY FLAT SLAB REGULATIONS

(In effect 1925)

The regulations of the two cities are given below.

#### Definitions.

*Chicago Code:* "Flat slabs as understood by this ruling are reinforced concrete slabs, supported directly on reinforced columns with or without column heads at the top, the whole construction being hingeless and monolithic without any visible beams or girders. The construction may be such as to admit the use of hollow panels in the ceiling or smooth ceiling with depressed panels in the floor."

*New York Code:* "The rules governing the design of reinforced concrete flat slabs shall apply to such floors and roofs, consisting of three or more rows of slabs, without beams or girders, supported on columns, the construction being continuous over the columns and forming with them a monolithic structure.

"For structures having a width of less than three rows of slabs or in which irregular or special panels are used and for which the rules given below do not apply, the computations and the analysis shall, when so required, be filed with the superintendent of buildings."

#### Notation.

$l$  = distance center to center of columns of the side of square panel, or average distance of the long and short sides of rectangular panel;

$w$  = dead and live unit load, lb. per sq. ft.;

$W$  = total dead and live load on panel in lb. In New York the dead load should include weight of drop panel;

$W_1$  = total live load on panel under consideration.

### COLUMNS

#### General Limitations for Interior and Exterior Columns.

*Chicago Code:* "The least dimension of any concrete column shall be not less than one-twelfth the panel length, nor one-twelfth the clear height of the column."

*New York Code:* "For columns supporting reinforced concrete flat slabs, the least dimension of any column shall be not less than one-fifteenth of the average span of any slabs supported by the columns; but in no case shall such least dimension of any interior column supporting a floor or roof be less than sixteen inches when round nor fourteen inches when square; nor shall the least dimension of any exterior column be less than fourteen inches."

#### Interior Columns.

*Chicago Code:* "The interior columns must be analyzed for the worst condition of unbalanced loading. It is the intention of this ruling to cover ordinary cases of eccentric loads on the columns by the above requirement. Where the minimum size of column therein specified is found insufficient, however, the effect of the resulting bending moment shall be properly divided between the



adjoining slab and the columns above and below according to best principles of mechanics and the columns enlarged sufficiently to carry the load safely."

*New York Code:* "Interior columns shall be designed for the bending moments developed by unequally loaded panels, eccentric loading or uneven spacing of columns. The bending moment resulting from unequally loaded panels shall be considered as  $1/40W_1L$ , and shall be resisted by the columns immediately above and below the floor line under consideration in direct proportion to the values of their ratios of  $I/h$ .

"Roof columns shall be designed to resist the total moment resulting from unequally loaded panels."

#### Wall Columns.

*Chicago Code:* "Wall columns in skeleton construction shall be designed to resist a bending moment of  $\frac{WL}{60}$  at floors and  $\frac{WL}{30}$  at roof. The amount of steel required for this moment shall be independent of that required to carry the direct load. It shall be placed as near the surfaces of the column as practicable on the tension sides, and the rods shall be continuous in crossing from one side to another. The length of rods below the base of the capital and above the floor line shall be sufficient to develop their strength through bond, but not less than forty diameters, nor less than one-third the clear height between the floor line and the base of the column capital." (See Fig. 109, p. 318.)

*New York Code:* "Wall columns shall be designed to resist bending in the same manner as interior columns, except that  $W$  shall be substituted for  $W_1$  in the formula for the moment. The moment so computed may be reduced by the counter moment of the weight of the structure which projects beyond the center line of the wall columns."

**Slab Thickness.**—The thickness of slab must not be smaller than  $\frac{1}{3}l$  for floors and  $\frac{1}{4}l$  for roofs. Absolute minimum is 6 in., except that New York allows 5 in. for roofs.

Formulas for determining thickness of slab for the loading:

Chicago  $t = \frac{1}{4}\sqrt{W}$  for all cases

New York  $t = 0.024l\sqrt{w} + 1\frac{1}{2}$  for slab without drop panels

$t = 0.02l\sqrt{w} + 1$  for slabs with drop panels.

**Effective Depth of Slab.**—The effective depth of slab is the distance from the center of gravity of the effective reinforcement to the compression face of the slab. A protective covering for the reinforcement equal to 1 in., measured from outside face of the lowest layer of steel, shall be provided.

**Column Heads.**—Effective diameter of column head is as defined and described on page 319. Its diameter must not be less than  $0.225l$  for both codes.

**Drop Panels.**—Drop panels are as defined and described on page 322. Thickness and width of the drop panel must be sufficient to resist shearing stresses at the column head and at the edge of drop panel and compression stresses at the column head. In square panels minimum length of drop must not be smaller than  $\frac{1}{2}l$ . In rectangular panels New York Code permits square drop panels with length of side equal to  $\frac{1}{2}$  average span; while Chicago requires a rectangular drop with length in each direction equal to  $\frac{1}{2}$  the span in that direction.

At wall panels drop panels should extend at right angles to the wall from center of the column a distance equal to  $\frac{1}{4}l$ .

**Shearing Stresses.**—The allowable shearing unit stresses for 2 000 lb. concrete shall not exceed following values: At the perimeter of the column head 120 lb. per sq. in. and at the perimeter of the drop panel 60 lb. per sq. in. The shearing stresses should be computed according to formula  $v = \frac{V}{bjd}$  except that according to New York Code at the column head formula  $v = \frac{V}{bd}$  may be used.

### BENDING MOMENT COEFFICIENTS

**Design Strips and Bending Moment Sections.**—The slab is divided into design strips as explained on page 330 and the sections of critical bending moment correspond to sections shown in Figs. 118 and 119.

**Chicago Code. Square or Nearly Square Interior Panels.**—This rule applies to panels in which length does not exceed breadth by more than 5 per cent.

	Two-Way System	Four-Way System
Column Strips Positive Bending Moment	$\frac{1}{80}Wl$	$\frac{1}{80}Wl$
Column Strips Negative Bending Moment	$\frac{1}{30}Wl$	$\frac{1}{30}Wl$
Middle Strip Positive Bending Moment	$\frac{1}{120}Wl$ *	$\frac{1}{120}Wl$
Middle Strip Negative Bending Moment	$\frac{1}{120}Wl$	$\frac{1}{120}Wl$

\* The reinforcement required by this moment is the area of steel in each of the two diagonal bands, and not the effective area at this section. The effective area of both diagonal bands, as customarily computed, is 42 per cent larger than the area required by this moment.

Any other system of reinforcement in which the reinforcing bars are placed in circular, concentric rings and radial bars, or systems with steel rods arranged in any manner, whatsoever, shall comply with the requirements of either the two-way or the four-way system.

#### Chicago Code: Wall Panels.

**Wall Panels in Skeleton Construction.**—In wall panels supported by wall columns and wall beams, in strips at right angles to the wall increase positive bending moment by 25 per cent.

**Wall Panels Supported on New Brick Walls.**—Where wall panels are carried on new brick walls, these shall be laid in Portland cement mortar and shall be stiffened with pilasters as follows: If a 16-inch wall is used, it shall have a 4-inch pilaster. If a 12-inch wall is used, it shall have an 8-inch pilaster. The length of pilasters shall be not less than the diameter of the column, nor less than one-eighth of the distance between pilasters. The pilasters shall be located opposite the columns as nearly as practicable, and shall be corbeled out 4 inches at the top, starting at the level of the base of the column capital. Not less than 8-inch bearing shall be provided for the slab, the full length of wall.

The coefficients of bending moments required for these panels shall be the same as those for the interior panels except as: The positive bending moments at right angles to the wall shall be increased 50 per cent.

*Wall Panels Supported on Old Brick Walls.*—Where wall panels are supported on old brick walls there shall be columns with standard drops and capitals built against the wall which shall be tied to the same in an approved manner, and at least an 8-inch bearing provided for the slab, the full length. The coefficients should be same as specified for slabs on new brick walls. Where it is impossible to utilize the old brick wall in the manner described above, wall columns and wall beams should be provided as in skeleton construction and the panel treated as provided for skeleton construction.

**Chicago Code: Rectangular Panels.**

This applies to rectangular panels where length of panel exceeds breadth by more than 5 per cent but not more than 33.3 per cent.

In columns strips of two- and four-way system use in each direction same bending moment as would be required by a square panel whose span length is equal to the length of the respective side of the rectangle. The amount of steel in the short direction, however, shall not be less than two-thirds of that required in the long direction.

In the four-way system the amount of steel in the middle strip, positive and negative, shall be the same as that required for similar strip in a square panel whose length is equal to the mean of the long and the short side of the rectangular panel.

In the two-way system the amount of steel in the middle strip, positive and negative, running in short direction, shall be equal to that required for the same strip in a square panel whose length equals the long side of the rectangular panel.

The amount of steel in the middle strip, long direction, positive and negative, shall be equal to that required for the same strip in a square panel, whose length equals the short side of the rectangular panel.

In no case shall the amount of steel in long direction be less than two-thirds of that in the short direction.

**New York Code: Square or Nearly Square Panels.**

			Two-Way System	Four-Way System
Slab with Drop Panel				
Column Strips	Positive Bending Moment		$\frac{1}{80}Wl$	$\frac{1}{100}Wl$
	Negative Bending Moment		$\frac{1}{32}Wl$	$\frac{1}{32}Wl$
Middle Strips	Positive Bending Moment		$\frac{1}{133}Wl$	$\frac{1}{100}Wl$
	Negative Bending Moment		$\frac{1}{33}Wl$	$\frac{1}{33}Wl$
Slab without Drop Panel				
Column Strips	Positive Bending Moment		$\frac{1}{83}Wl$	$\frac{1}{74}Wl$
	Negative Bending Moment		$\frac{1}{36}Wl$	$\frac{1}{38}Wl$
Middle Strips	Positive Bending Moment		$\frac{1}{33}Wl$	$\frac{1}{100}Wl$
	Negative Bending Moment		$\frac{1}{33}Wl$	$\frac{1}{33}Wl$

**New York Code: Rectangular Panel.**

Where the ratio of long span to short span is less than 1.1 the panel may be considered as square panel with panel length equal to average panel length.

When the ratio of panel length is between 1.1 and 1.33 the bending moment coefficients specified for interior square panels shall be applied in the following manner:

In two-way systems the negative moments and the positive moment at right angles to the long direction shall be determined as for a square panel of a length equal to the greater dimension of the rectangular panel; and the corresponding moments on the sections at right angles to the short direction shall be determined as for a square panel of a length equal to the lesser dimension of the rectangular panel. In both cases the load  $W$  shall be taken as the load on the rectangular panel under consideration. The amount of reinforcement in the short direction shall be not less than two-thirds of that in the long direction.

In four-way systems, for the rectangular bands, the negative moment on the column head sections and the positive moment on the outer sections shall be determined in the same manner as indicated for two-way systems.

For the diagonal bands, the negative moments on the column head and midsections and the positive moment on the inner section shall be determined as for a square panel of a length equal to the average span of the rectangle. The load  $W$  shall be taken as the load on the rectangular panel under consideration.

**New York Code: Wall Panels.**

The negative moments at the first interior row of columns and the positive moments at the center of the exterior panels on moment sections parallel to the wall shall be increased 20 per cent over those specified above for interior panels. The negative moment-on-moment sections at the wall and parallel thereto shall be determined by the conditions of restraint, but the negative moment on the midsection shall never be considered less than 50 per cent and the negative moment on the column head section never less than 80 per cent of the corresponding moments at the first interior row of columns.

**Panels without Drop Panel or Capitals or Both.**

*Chicago Code:* In square panels where no column capital or no depressions are used the sum total of positive and negative bending moments shall be equal to that computed by the following formula:

$$M = \frac{Wl}{8} \left[ 1.53 - 4\frac{c}{l} + 4.18 \left( \frac{c}{l} \right)^3 \right]$$

where  $M$  = numerical sum of positive and negative bending moments, regardless of algebraic signs;

$W$  = total live and dead load on the whole panel;

$l$  = length of side of a square panel, c. to c. of columns;

$\frac{c}{l}$  = ratio of the radius of the column or column capital to panel length,  $l$ .

This total bending moment shall be divided between the positive and the negative moments in the same proportion as in the typical square panels for

two-way or four-way systems specified above for interior and wall panels, respectively.

*New York Code:* The general rules apply to flat slabs with or without drop panels. Any difference in treatment of the two types of design is indicated in each case. No provision is made for flat slabs without column heads. The code states that for structures in which column capitals are omitted, special computations should be filed with the Superintendent of Buildings.

*Line of Inflection.*—Both codes specify that in the design of reinforced concrete flat slab construction, for the purpose of making calculations of the bending moments at sections other than the critical section, the line of inflection shall be considered as being located one-quarter the distance, center to center, of columns, rectangularly and diagonally, from center of columns for panels without drops. The New York Code further specifies that for panels without drops a fraction one-quarter should be changed to three-tenths.

## REINFORCEMENT

**Tension Reinforcement.**—The required tension reinforcement should be computed by formula  $A_s = \frac{M}{f_s j d}$ . The effective depth  $d$  is the distance of the center of gravity of all effective bars in the section under consideration from the compression face of slab. The rules regarding the effective reinforcement are same as given on page 354, except that in the Chicago Code the area of positive reinforcement in the middle strips, as determined from the specified bending, is the area of bars in each diagonal band and not the effective area on the moment section in the strip. The effective area equals the area in both diagonal bands multiplied by the sine of the angle of inclination. This should be kept in mind when comparing the total amount of effective steel as required by the Chicago Code in four-way and two-way systems as well as in comparing with that required by other codes.

## ALLOWABLE STRESSES

**Allowable Stresses in Steel.**—The allowable stress in steel in New York Code is  $f_s = 16\ 000$  lb. per sq. in. irrespective of the character of steel used. In Chicago Code the allowable stress for medium steel is  $f_s = 18\ 000$  lb. per sq. in. It should be noted that to allow for this difference in allowable steel stresses, the bending moment coefficients in the New York Code were made proportionally smaller, so that the areas of reinforcement as computed according to New York Code with  $f_s = 16\ 000$  are practically the same as obtained by using Chicago coefficients and stresses  $f_s = 18\ 000$ .

**Compression Stresses.**—Compression stresses in any section of the slab may be computed by ordinary beam formulas using the specified bending moment for the section under consideration and for width of beam, the width of the section.

In computing the compression stresses at the column head in slab with drop panels the width of beam in the formula should be taken as equal to the width of the drop panel.

Chicago Code provides that if compression area at the column head is insuf-

ficient, it may be increased by introducing compression steel in the bottom of slab.

The allowable unit stresses should not exceed the stresses allowed in beam design. At the column head same increase in stresses is allowed as in beams at the support. (Namely, 750 lb. per sq. in. for 2000 lb. concrete.)

#### Special Provisions Regarding Flat Slab Reinforcement.

Splices in bars may be made wherever convenient, but preferably at points of minimum stress. The length of splice beyond the center point, in each direction, shall not be less than forty diameters of the bars, nor less than two feet. The splicing of adjacent bars shall be avoided as far as possible.

*New York Code has this additional provision:* "When the reinforcement is arranged in bands at least 50 per cent of the bars in any band shall be of a length not less than the distance center to center of columns measured rectangularly and diagonally; no bars used as positive reinforcement shall be of a length less than half the panel length plus forty bar diameters for cross bands, or less than seven-tenths of the panel length plus forty bar diameters for diagonal bands, and no bars used as negative reinforcement shall be of a length less than half the panel length. All reinforcement framing perpendicular to the wall in exterior panels shall extend to the outer edge of the panel and shall be hooked or otherwise anchored.

"Adequate means shall be provided for properly maintaining all slab reinforcement in the position assumed by the computations."

*Chicago Code provides as follows:* "In order that the slab bars shall be maintained in the position shown in the design during the work of pouring the slab, spacers and supports shall be provided satisfactory to the Commissioner of Buildings. All bars shall be secured in place at intersections by wire or other metal fastenings. In no case shall the spacing of the bars exceed nine inches. The steel to resist the negative moment in each middle strip shall extend one-quarter of the panel length beyond the center line of the columns in both directions.

"Slab bars which are lapped over the column, the sectional area of both being included in the calculations for negative moment, shall extend not less than twenty-five one-hundredths of the panel length for cross-bands, and thirty-five one-hundredths of the panel length for diagonal bands, beyond the column center."

#### WALLS AND OPENINGS

*Chicago Code provides:* "Girders and beams shall be constructed under walls, around openings and to carry concentrated loads.

"The spandrel beams or girders shall, in addition to their own weight and the weight of the spandrel wall, be assumed to carry 20 per cent of the wall panel load uniformly distributed upon them."

*New York Code states:* "In the design and construction of reinforced concrete flat slabs, additional slab thickness, girders or beams shall be provided to carry any walls or concentrated loads in addition to the specified uniform live and dead loads. Such girders or beams shall be assumed to carry 20 per cent of the total live and dead panel load in addition to the wall load. Beams shall also be provided in case openings in the floor reduce the working strength of the slab below the prescribed carrying capacity."

## CHAPTER VII

### CONCRETE AND REINFORCED CONCRETE COLUMNS

This chapter gives formulas for plain concrete columns (p. 403), columns with longitudinal bars (p. 405), columns with spiral reinforcement (p. 419), and columns reinforced with structural steel. In each case the authors' recommendations for design, as well as the requirements of various building departments, are given.

Details of design for columns with longitudinal steel (p. 412), for spiral columns (p. 432), and for columns with structural steel (p. 440) are presented and thoroughly discussed.

Particular attention is called to the section entitled "Economies in Column Design," p. 445. In this section, factors affecting the economy of reinforced concrete columns are discussed, and recommendations are given as to the most economical mix of concrete and the most economical proportions of steel to concrete.

Reduction of live load to be used in column design is given on p. 452.

Recommendations for columns subjected to bending are given on p. 458.

The bending moments in columns carrying crane loads are given on p. 464.

#### PLAIN CONCRETE COLUMNS AND PIERS

Columns or piers, the unsupported length of which does not exceed four times the least lateral dimension, may be built of concrete without reinforcement. The load to be carried by the columns should preferably be centrally applied. If the load is eccentric, for rectangular or square columns the eccentricity must be less than one-sixth of the dimension of the column in the direction of the eccentricity. For larger eccentricity, the column must be reinforced.

For central loads, the required area equals the total load divided by the allowable unit stress. This and other requirements may be expressed by the formulas below.

Let  $P$  = total central load in lb.;

$A$  = effective area of cross section of column in sq. in.;

$f_c$  = compressive unit stress in concrete in lb. per sq. in.

Then

*Total Load,*

$$P = Af_c. \dots \dots \dots (1)$$

*Required Effective Area,*

$$A = \frac{P}{f_c}. \dots \dots \dots (2)$$

*Stress in Concrete,*

$$f_c = \frac{P}{A}. \dots \dots \dots (3)$$

In the above formulas the same units of area must be used for  $A$  as for  $f_c$ . In the notation, it was assumed that the area,  $A$ , is in sq. in. and the stress,  $f_c$ , in lb. per sq. in. Therefore, the load,  $P$ , is in lb. If the area,  $A$ , is in sq. ft., and the load,  $P$ , in lb., the stress,  $f_c$ , will be in lb. per sq. ft.<sup>1</sup>

Effective area is the area within fireproofing as discussed on p. 272. For piers imbedded in earth, such as pedestals above the footings, the total area may be considered as effective, for plain columns not exceeding in height four times the least lateral dimension, as in such cases no fireproofing is required. Allowable unit stresses are same as given in table on p. 407.

Formulas for eccentrically loaded columns or piers are given on p. 170.

#### REINFORCED CONCRETE COLUMNS

Reinforced concrete columns may be divided according to the method of reinforcement into:

Columns with vertical bars only;

Columns with vertical bars and continuous closely spaced spiral;

Columns with structural steel core;

Columns with cast-iron core.

The columns with structural steel and cast-iron cores may also be provided with spiral reinforcement.

*Unsupported Length of Column.*—The unsupported length of reinforced concrete columns shall be taken as:

(a) In flat slab construction, the clear distance between the floor and under side of the capital;

<sup>1</sup> In European practice,  $P$  is in kilograms,  $f_c$  in kilograms per square centimeter, and, consequently,  $A$  in square centimeters.



(b) In beam-and-slab construction, the clear distance between the floor and the under side of the shallowest beam framing into the column at the next higher floor level;

(c) In floor construction with beams in one direction only, the clear distance between floor slabs;

(d) In columns supported laterally by struts or beams only, the clear distance between consecutive pairs (or groups) of struts or beams, provided that to be considered an adequate support, two such struts or beams shall meet the column at approximately the same level and the angle between the two planes formed by the axis of the column and the axis of each strut, respectively, is not less than 75 degrees nor more than 105 degrees.

When haunches are used at the junction of beams or struts with columns, the clear distance between supports may be considered as reduced by two-thirds of the depth of the haunch.

The above recommendations agree with Joint Committee, 1924, Specifications.

### COLUMNS WITH LONGITUDINAL BARS

A typical design of a column with vertical steel only is shown in Fig. 140. The formulas given below have been universally accepted for columns with longitudinal reinforcement. The various specifications and Building Codes differ only in the allowable unit stresses and the allowable maximum and minimum amount of steel (see table on p. 409).

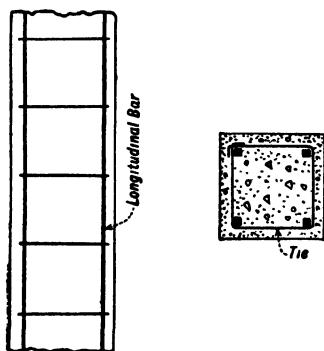

FIG. 140.—Typical Design of Column with Vertical Steel only. (See p. 405.)

Let  $P$  = total column load in lb.;

$A$  = effective area of cross section of column in sq. in.;

$A_s$  = area of cross section of vertical steel in sq. in.;

$p$  = ratio of area of vertical steel to area of concrete  
 $= A_s \div A$ ;

$f_c$  = compressive unit stress in concrete, lb. per sq. in.;

$f'_s$  = compressive unit stress in steel, lb. per sq. in.;

$f$  = average compressive unit stress, lb. per sq. in.;

$n$  = ratio of modulus of elasticity of steel to that of concrete.

**General Formulas.**

$$P = Af_c + (n - 1)A_s f_c = Af_c[1 + (n - 1)p]. \quad (4)$$

$$P = Af \quad \text{where } f = f_c[1 + (n - 1)p]. \quad (5)$$

$$p = \frac{A_s}{A}. \quad (6)$$

**Formulas to be Used in Designing Columns.**

Area of steel for assumed area of concrete,  $A$ , and specified stress,  $f_c$ .

$$A_s = \frac{P - Af_c}{(n - 1)f_c}. \quad (7)$$

Area of concrete and steel for assumed percentage of steel,  $p$ , and specified stress,  $f_c$ .

$$f = f_c[1 + (n - 1)p]. \quad (8)$$

$$A = \frac{P}{f}. \quad (9)$$

$$A_s = pA.$$

Values of  $f$  for different percentages of steel are given on p. 916.

**Formulas to be Used in Reviewing Designs.**

Safe load for specified unit stress,  $f_c$ , and known dimensions of column.

$$P = f_c[A + (n - 1)A_s]. \quad (10)$$

Unit stress in concrete and steel for given column load and known dimensions of column.

$$f_c = \frac{P}{A + (n - 1)A_s}. \quad (11)$$

$$f'_s = nf_c. \quad (11a)$$

**Authors' Recommendations for Columns with Longitudinal Steel Only.**

*Effective Area.*—Effective area of column is the area within fireproofing, in columns exposed to danger from fire.

In columns underground, also in reservoirs for water, full area may be taken as effective.

In wall columns faced with 4-in. brick laid in Portland cement mortar, the facing may be considered as fireproofing.

*Percentage of Steel.*—Minimum, 1 per cent; maximum, 6 per cent.

Where, for architectural reasons, the concrete column is larger than required by stresses, the minimum percentage of steel should be based on the area of concrete required by stresses and not by the area actually used. See Example 4, p. 410.

*Allowable Unit Stress,  $f_c$ .*

Mix of Concrete	Ultimate Strength $f'_c$ Lb. per Sq. In.	Allowable Unit Stress, $f_c$ Lb. per Sq. In.	Ratio of Moduli of Elasticity, $n$
1 : 2 : 4	2 000	450	15
1 : 1½ : 3	2 500	570	12
1 : 1 : 2	3 000	680	10

*Limiting Length of Column.*—Unit stresses in above table to be used in columns the unsupported length of which is equal to or smaller than forty times the least radius of gyration. Radius of gyration to be computed for concrete and steel. For longer columns reduce stresses as given on p. 434.

*Hoops or Ties.*—One-quarter in. hoops or ties, spaced not more than 12 in. nor more than 16 diameters of the longitudinal bar.

*Fireproofing.*—1½ in. from outside face of steel.

### Joint Committee Specifications, 1924.

Columns to be designed by Formulas (4) to (11).

*Effective Area.*—Total area of column is considered as effective.

*Amount of Vertical Steel.*—“The amount of longitudinal reinforcement considered in the calculations shall be not more than 2 per cent, nor less than 0.5 per cent, of the total area of the column. The longitudinal reinforcement shall consist of not less than four (4) bars of minimum diameter of ½ in., placed with a clear distance from the face of the column of not less than 2 in.”

*Allowable Unit Stress  $f_c$*  shall not exceed 0.20  $f'_c$ .

Same limitation as to unsupported length of column as given above.

*Lateral Ties.* “Lateral ties shall be not less than ¼ in. in diameter, spaced not more than 8 in. apart.”

*Fireproofing.* (See p. 272.)

**Requirements of Building Codes.**—The table on p. 409 gives the requirements of the Building Codes of the cities of Boston, Cleveland, Chicago, New York, and Philadelphia, as they were in effect in the year 1925.

**Design of Columns with Longitudinal Bars Only.**—In designing columns with longitudinal bars only, the method of procedure is as follows:

The load to be carried is computed first. The working stresses are then selected. Usually these are fixed by Building Codes; if not, the stresses recommended by the authors should be used. In a column there are two variables, namely, the size of the cross section and the amount of reinforcement. In determining the dimensions, therefore, it is necessary either to assume the size of the column and then compute the required area of steel from the formulas, or to assume the ratio of steel,  $p$ , and find the area of column and the amount of steel. The problem will resolve itself into one of the examples given below.

**Example 1.**—Given column load  $P = 400\,000$  lb. Design a square column of the smallest possible size, using the stresses allowed by the Boston Code.

**Solution.**—Since it is desired to get a column of the smallest possible cross section, the richest mix of concrete (1 : 1 : 2) and the largest percentage of steel ( $p = 0.04$ ) will be used. The allowable stress for 1 : 1 : 2 concrete is  $f_c = 742$  lb.,  $n = 10$ .

For  $p = 0.04$ , the average stress, from  $f = f_c[1 + (n - 1)p]$ , is

$$f = 742[1 + (10 - 1) \times 0.04] = 1\,019 \text{ lb. per sq. in.}$$

For this stress, the effective area of concrete  $A = \frac{P}{f} = \frac{400\,000}{1\,019} = 392.5$  sq. in.

The side of the square equals  $\sqrt{392.5} = 19.8$  in.

Adding 1½ in. on each side for fireproofing, the size of column is  $19.8 + 3 = 22.8$  in. Actually, a 23-in. square column should be used.

The required area of steel is  $A = pA = 0.04 \times 392.5 = 15.7$  sq. in. sixteen 1-in. square bars may be used.

Result: Column 23 in. square;

Mix, 1 : 1 : 2;

Sixteen 1-in. square bars.

**Example 2.**—Given column load,  $P = 400\,000$  lb. For architectural reasons, square columns are required. The outside dimension of column must not exceed 25 in. Find required mix of concrete and amount of steel, using Boston Code.

**Solution.**—The richest mix of concrete will be used, as it gives the most economical design. From table on p. 409, for 1 : 1 : 2 concrete the allowable stress, according to Boston Code, is  $f_c = 742$  lb.,  $n = 10$ . Fireproofing should be 1½ in. thick on each side.

Requirements of Building Codes of Various Cities  
(Effective in Year 1925)

Cities	Longitudinal Steel		Stress in Compression			Effective Area	n	Fire Proofing	Ratio Unsupported to Least Diameter	Ties		Remarks
	Maximum	Minimum	Mix	Ultimate	Allowable $f_c$					Minimum diam.	Spacing	
Boston.....	4%	1%	1 : 1 : 2	3300	742	Within fireproofing	10	1½"	12	¼"	12" no more than 16 diam. of bars	
			1 : 1½ : 3	2800	630		12					
			1 : 2 : 4	2200	495		15					
Cleveland...	6%	1%	1 : 2 : 4	2000	600	"	15	2"	12	¼"	12"	Minimum longitudinal steel 4½" rd. bars.
			1 : 1 : 2	2900	580	"	10					
Chicago.....	3%	¾"	1 : 1 : 2	2400	480	"	10	2"	12	¾"	12 diam. of bar, not more than 18 in.	Least area of column smaller than ¼ in. diam. shall be used. At least 1 sq. in. of steel must be used.
			1 : 1½ : 3	2000	400		12					
			1 : 2 : 4	.....	600		15					
New York...	4%	¾"	1 : 1½ : 3	.....	600	Total	12	2"	15	¼"	15 diam. 12"	Least dimension 12"
			1 : 2 : 4	.....	500	15						
Philadelphia.	3%	¾"	1 : 1½ : 3	600	600	Within fireproofing	12	2"	15	¼"	15 diam. 12"	Least dimension of column 12". At least 4 bars with minimum area per bar of 0.5 sq. in.
			1 : 2 : 4	500	500		12					

Notes: Unit stress in steel equals  $s/c$ . Percentage of steel is based on effective area, which is area within fireproofing for all cities except New York. Total allowable load, etc., are determined by formulas in text. Unsupported length of column is distance from the top of floor slab to bottom of beam or center of column head.

## 410 CONCRETE AND REINFORCED CONCRETE COLUMNS

The effective side of the square column, obtained after deducting fireproofing, is  $25 - 2 \times 1\frac{1}{2} = 22$  in. The effective area is  $A = 22^2 = 484$  sq. in.

The load carried by concrete alone is  $Af_c = 484 \times 742 = 359\,100$  lb.

The balance of the load to be carried by vertical bars is

$$P - Af_c = 400\,000 - 359\,100 = 40\,900 \text{ lb.}$$

Since the allowable stress in steel is  $(n - 1)f_c = 9 \times 742 = 6\,680$  lb., the required area of steel is

$$A_s = \frac{P - Af_c}{(n - 1)f_c} = \frac{40\,900}{6\,680} = 6.12 \text{ sq. in.}$$

Eight 1-in. round bars, giving an area of 6.28 sq. in., may be used.

Result: 25-in. square column;

1 : 1 : 2 mix of concrete;

Eight 1-in. round bars.

**Example 3.**—Column load,  $P = 400\,000$  lb. Find dimensions of column and area of steel, using 1 : 1 : 2 mix of concrete when the amount of steel for economical reasons is limited to 1 per cent, using Boston Code.

*Solution.*—The allowable stress for 1 : 1 : 2 mix, according to Boston Code, is  $f_c = 742$  lb. per sq. in.,  $n = 10$ .

For 1 per cent of steel, the average stress is

$$f = f_c[1 + (n - 1)p] = 742[1 + 9 \times 0.01] = 809 \text{ lb. per sq. in.}$$

The required effective area of concrete then is

$$A = \frac{P}{f} = \frac{400\,000}{809} = 494 \text{ sq. in.}$$

Effective side of square column,

$$d = \sqrt{494} = 22.2 \text{ in.}$$

Required area of steel,

$$A_s = pA = 0.01 \times 494 = 4.94 \text{ sq. in.}$$

Two 1-in. round bars plus six  $\frac{3}{8}$ -in. round bars give an area of 5.18 sq. in. Since  $1\frac{1}{2}$  in. fireproofing is required, side of column is

$$d + 2 \times 1.5 = 22.2 + 3 = 25.2 \text{ in.}$$

Actually the column side should be made 26 in.

Column 26 in. square;

1 : 1 : 2 mix.

Two 1-in. round bars plus six  $\frac{3}{8}$ -in. round bars.

**Example 4.**—The size of a rectangular wall column, as fixed by architectural requirements, is 40 by 16 in. The load is  $P = 150\,000$  lb. Find the required mix of concrete and the amount of vertical steel, using Boston Code.

*Solution.*—Allowing  $1\frac{1}{2}$  in. on each side for fireproofing, the area of the effective section is  $(40 - 3) \times (16 - 3) = 481$  sq. in. This section is larger than

required to carry the load. Using 1 : 2 : 4, mix, and one per cent of steel, the allowable average stress if  $f = f_c[1 + (n - 1)p] = 495 \times 1.14 = 564$  lb. per sq. in. The required area of concrete to carry a load of 150 000 lb. is

$$A = \frac{P}{f} = \frac{150\,000}{564} = 266 \text{ sq. in.}$$

The area of vertical steel will be based upon this required area of concrete. Therefore,

$$A_s = 0.01 \times 266 = 2.66 \text{ sq. in.}$$

Result: Use 1 : 2 : 4 mix, and six  $\frac{3}{4}$ -in round bars.

**Reviewing of Column.**—In reviewing columns already designed, two problems may present themselves. First, the dimensions of the column may be known, and the stresses may have to be computed for a given column load. Second, for known dimensions of column, it may be required to find the maximum load the column is able to carry.

Often the reviewer finds that the design is unsatisfactory and he is called upon to change the dimensions. In such a case he may retain the size of column and increase or decrease the amount of steel, he may change the mix, or he may change the whole design. In any case, the methods given for the design are used.

**Example 5.**—Dimensions and design of the panel are given. Live load is specified. From these the computed load on column is 300 000 lb. Dimensions of column are 24 in. square. Reinforcement consists of eight 1-in. round bars. Required fireproofing, 2 in.; mix of concrete, 1 : 1 $\frac{1}{2}$  : 3,  $n = 12$ .

Determine the stresses in concrete and steel.

*Solution.*—With fireproofing of 2 in., the effective area of column is  $A = (24 - 2 \times 2)^2 = 20^2 = 400$  sq. in. The area of steel is  $A_s = 8 \times 0.785 = 6.28$  sq. in. Hence,  $A + (n - 1)A_s = 400 + 11 \times 6.28 = 469.1$  sq. in.

The stress in concrete from Formula (11)  $f_c = \frac{P}{A + (n - 1)A_s}$ , is  $f_c = \frac{300\,000}{469.1} = 639$  lb. per sq. in.

The stresses in steel are  $f_s = 639 \times 12 = 7670$  lb. per sq. in.

This example may also be solved by using Table 21 on p. 916. The value of  $p$  is computed,  $p = \frac{6.28}{400} = 0.0157$ . Then the average stress,  $f$ , is found,

$f = \frac{300\,000}{400} = 750$  lb. per sq. in. For  $f = 750$  and  $p = 0.0157$ , the stress,  $f_c$ , is found from the table by interpolation.

Result:

$$f_s = 639 \text{ lb. per sq. in.}$$

$$f_c = 7670 \text{ lb. per sq. in.}$$

## DETAILS OF COLUMNS WITH LONGITUDINAL STEEL ONLY

**General Requirements.**—Steel bars used for column reinforcement must be straight. They must be placed in vertical position and be prevented from displacement by hoops or ties. In square and rectangular columns, the bars should be arranged symmetrically. They should preferably be placed along the perimeter of the effective area. Since vertical bars, if properly imbedded and placed symmetrically, take their stress regardless of their location in the column, the effective area of the column (contrary to action in a spiral column) has no relation to the area of concrete located between the lines of steel. Thus, a requirement of  $1\frac{1}{2}$  in. of fireproofing does not mean that the steel bars must be placed within  $1\frac{1}{2}$  in. of the surface. On the contrary, the bars should be placed far enough away from the forms to give ample room for placing concrete. A minimum distance of 2 in. is recommended.

Sometimes, when a large number of bars is used and it is not possible to accommodate all of them along the perimeter, some bars are placed in the middle section of the column. This is not advisable, however, as the bars in the central part are hard to keep in place. They also interfere with the placing of the concrete.

To get a symmetrical arrangement of reinforcement, an even number of bars should be used in a square or rectangular column. It is preferable that all the bars used in a column be of the same diameter. In many instances this is not possible without considerable waste of steel. Then the column reinforcement is made up of two groups of bars (each consisting of an even number of bars for square or rectangular columns). The bars in the two groups should vary in diameter by not more than one-eighth in. Thus, to get an area of steel equal to 6.9 sq. in., five  $\frac{7}{8}$ -in. round bars plus five 1-in. round bars may be used. To use ten 1-in. round bars would mean a waste of 3.13 lb. of steel per lineal foot of column, which for a large number of columns may amount to a considerable tonnage. Seven 1-in. square bars give a close enough area and may be used in round columns. They cannot be used in square or rectangular columns, however, because it would not be possible to arrange them symmetrically.

There is one objection to using bars of different diameters in one column. Where experienced labor and good supervision are not available, there is danger that all small sizes may be used in one



column and all large sizes in another. Under such conditions, bars of the same diameter should be used even if it means some waste of material.

At least four bars should be used per column. In good practice, the bars should be at least  $\frac{3}{8}$  in. rd. to give sufficient lateral strength to the columns to withstand any bending which may come on them, either by unequal loading or by some accidental horizontal pressure. In long buildings, the columns in the end row of panels are subjected to considerable bending due to temperature changes. The building lengthens or shortens from the middle toward the ends, so that the top of the end columns must deflect by an amount equal to the total expansion or contraction of one-half of the length of the building. The bending stresses produced thereby may be large, particularly in top columns. To prevent cracks, additional steel should be used.

When a large percentage of steel is used, it is advisable to use bars of large diameter so that the clear spacing along the perimeter between the bars is not smaller than 3 in. When the reinforcement of the column consists of very heavy bars, it is advisable, for practical reasons, to use at least four light bars. Their use is explained under "Assembling of Bars."

**Lapping of Bars.**—The stresses from the bars in the upper column should be transferred to the bars of the lower column by lapping of the bars. For this purpose, the bars from the lower column are extended into the upper column a sufficient distance to develop in them, by bond, the stresses carried by the bars of the upper column. (Lapping by extending the bars from the upper column into the lower column is not practicable, because the upper bars would have to be placed before the floor system below was poured and they could not be kept in position without considerable difficulty.)

The length of the lap depends upon the stresses carried by the bars. For columns subjected to vertical loading only, the length of lap is determined by compression stresses in the bar. For columns subjected to bending, the length of lap may be fixed by tensile stresses. In wall columns, for instance, the full tensile strength of the bar should be developed by the lap.

The length of lap may be taken from the table below, for the stresses to be developed and the diameter of the bar. The following simple rule may also be useful. For a bond stress of 100 lb. per sq. in. the required length of lap is equal to  $2\frac{1}{2}$  diameters of the bar for each

414 CONCRETE AND REINFORCED CONCRETE COLUMNS

1 000 lb. of unit stresses in the bar. For a bond stress of 80 lb. per sq. in., the required length of lap is equal to  $3\frac{1}{2}$  diameters of the bar for each 1 000 lb. of unit stress in the bar.

**Length of Lap for Different Stresses in Steel and Diameters of Bar  
Length Apply Either to Tension or Compression**

Based on allowable bond unit stress of 80 lb. for plain and 100 lb. for deformed bars

Unit Stress in Steel, $f_s$ Lb. per Sq. In.	Length of Lap in Inches											
	Plain Bars						Deformed Bars					
	Diameter of Bars *						Diameter of Bars *					
	$\frac{1}{2}$	$\frac{3}{8}$	$\frac{1}{2}$	$\frac{7}{8}$	1	$1\frac{1}{2}$	$\frac{1}{2}$	$\frac{3}{8}$	$\frac{1}{2}$	$\frac{7}{8}$	1	$1\frac{1}{2}$
6 000	9	12	14	16	19	21	8	9	11	13	15	17
7 000	11	14	16	19	22	25	9	11	13	15	18	20
8 000	13	16	19	22	25	28	10	13	15	18	20	23
9 000	14	18	21	25	28	32	11	14	17	20	23	25
10 000	16	20	23	27	31	35	13	16	19	22	25	28
11 000	17	21	26	30	34	39	14	17	21	24	28	31
12 000	19	23	28	33	38	42	15	19	23	26	30	34
13 000	20	25	30	36	41	46	16	20	24	28	33	37
14 000	22	27	33	38	44	49	18	22	26	31	35	39
15 000	23	29	35	41	47	53	19	23	28	33	38	42
16 000	25	31	38	44	50	56	20	25	30	35	40	45
18 000	28	35	42	49	56	63	23	28	34	39	45	51
20 000	31	39	47	55	63	70	25	31	38	44	50	56

\* Table may be used for round and square bars.

If the number of bars used in the upper column is smaller than in the column below, some saving in steel may be made by extending upward only as many bars as there are in the upper column. The remaining bars may be stopped just below the top of the slab. Thus, if the fifth floor columns are reinforced with twelve  $\frac{7}{8}$ -in. round bars and the sixth floor column with eight  $\frac{7}{8}$ -in. round bars, only eight  $\frac{7}{8}$ -in round bars need to be extended into the sixth floor, and the reinforcement of the fifth floor column may consist of eight long

bars and four short bars. This method should be used only on jobs with good supervision and experienced labor, as otherwise confusion may arise and some of the columns may get a larger proportion of the short bars than others.

When the number of bars in the upper column is larger than in the lower column, the lower bars are not sufficient to develop all the upper bars. Then, in addition to extending all bars into the upper column, it is necessary to use extra dowels equal in number to the difference between the number of upper bars and lower bars. These should be imbedded in the length required by bond in the lower columns and should extend the same length into the upper column.

If the diameter of the lower column is larger than that of the column above, the bars, if continued straight, would come outside of the upper column. To be brought within the effective area of the upper column, the bars should be provided with a reverse bend, as shown in Fig. 141. This process is sometimes called "goose-necking." Care should be taken that the inclined portion of the bar is placed within the portion of the column restrained by the floor system, because if the bend were placed within the unrestrained part of the column there would be a tendency for the inclined bar to develop an unbalanced horizontal component which is harmful to the concrete. While this is elementary and obvious, it is not always appreciated by designers.

In bars of small diameter, a small offset to bring the lower bars in line with the upper ones may be provided by "hickying." Bars below  $\frac{3}{4}$  in. may be "hickied" after the bar is in place, but before concrete is poured in lower columns. Bars over  $\frac{3}{4}$  in. in diameter cannot be readily bent when in place and should be bent before they are placed in the form.

An incorrect method of lapping the bars, often seen on construction, is shown in Fig. 142. The value of the bars as laps is lost, as the pressure from the column cannot readily be transferred to the inclined bars. Also, the bars may interfere with the flow of concrete during construction and pockets may form, thereby further weakening the columns.

**Butting Bars.**—If the column is reinforced with longitudinal bars of larger diameter, say over 1 in., the stresses from the bars in the column above may be transferred to the bars in the column below by butting the bars. The ends of the bars must be milled to even

bearing. When in place, their ends are kept in position by tight-fitting pipe sleeves. From the construction standpoint, it is best to extend the bars from the column below about 4 in. above the rough slab. After the slab is poured, a pipe sleeve 8 in. long is placed over the bar and rested on the concrete. The bars for the column above are then placed in the pipe sleeve.

If the number of bars in the column below is larger than in the column above, the extra bars may be stopped just below the top of the slab. If the number of bars to be butted in the upper column is larger than the number of available bars in the column below, dowels

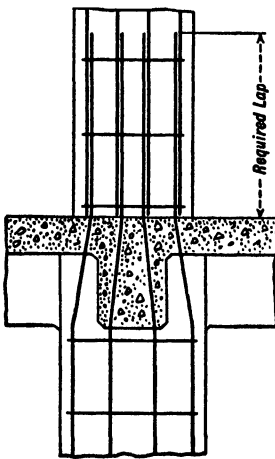

FIG. 141.—Correct Method of Splicing Column Bars. (See p. 415.)

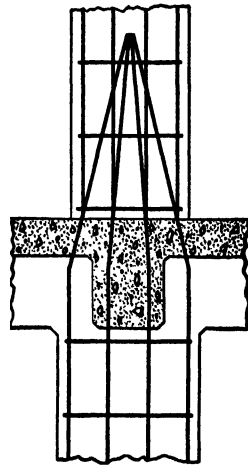

FIG. 142.—Incorrect Method of Lapping Column Bars. (See p. 415.)

of proper length should be placed in the column below, against which the bars of the top column are butted.

When the diameter of the upper column is smaller than that of the column below, the lower bars should be bent or goose-necked in the manner described in connection with lapped bars, so that the end of the lower bars will come directly under the bar above. Some designers slant the bars in the lower column for their full length to bring the ends in the proper position. This is obviously wrong.

The butt joint is not capable of resisting tension. When the columns are subjected to bending, sufficient steel should extend from the lower column to the upper column to resist any possible tension. Either extra bending steel should be used, or else part of the column

steel, sufficient to resist bending stresses, should consist of bars of small diameter and these developed by lapping. In cases where the bottom column has a larger number of bars than the top column, the extra bars not required for butting may be extended into column above to provide the required tensile steel.

**Dowels.**—The stresses from the column bars are transferred to the foundation by means of short bars called dowels. Their total length equals double the length required for developing the stresses in column bars. One half of the dowel is imbedded in the foundation and the other half laps the column bars. The number and size of the dowels must be same as that of the bars used for the columns above.

If the depth of the foundation is smaller than the length of imbedment required for the dowels, their ends should be provided with a right angle hook, which should be placed above the footing reinforcement.

**Foundation Plates.**—Instead of using dowels, the stresses in the bars may be transmitted to the concrete by resting the bars on steel plates of sufficient dimensions to keep the bearing stresses on concrete within working limits. In such a case, if the column needs to be anchored to the foundation, special anchor bars should be provided.

**Column Ties.**—The bars should be kept in position by column ties. They are usually made of  $\frac{1}{4}$ -in. round bars and spaced not more than 12 in. on centers (see requirements, p. 407).

The bending details of ties for square and rectangular columns are shown in Fig. 143, p. 417. In determining total length of tie allowance should be made for the steel in corners. The wire should

be lapped at a corner. This method is more satisfactory than lapping the wire between the corners, as the joint is more rigid and the steel bars are better kept in position.

For corner columns, the ties should be arranged as shown in Fig. 144, p. 418.

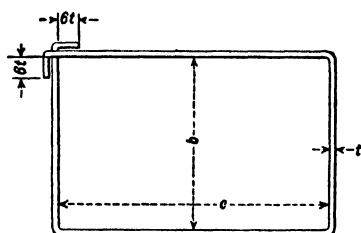

If Square,  $c = b$

$$\text{Total Length} \begin{cases} \text{Square} & = 4b + 17t \\ \text{Rectangular} & = 2(b + c) + 17t \end{cases}$$

FIG. 143.—Bending Details of Ties for Square and Rectangular Columns. (See p. 417.)

The ties for special columns should be designed with care, their purpose being kept in mind. Fig. 145 shows the ties for a special column. It consists of two parts, a rectangle and a stirrup.

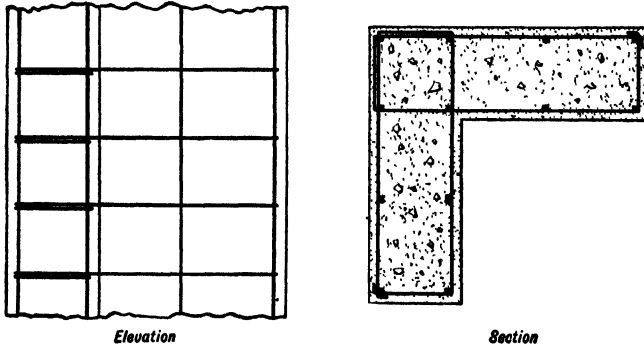

FIG. 144.—Ties for Corner Columns. (See p. 417.)

*Example of Column with Vertical Steel Only.*—Figure 146, p. 419, illustrates a typical column with vertical steel only as used in the new buildings for the Massachusetts Institute of Technology.<sup>2</sup> All the details are clearly shown.

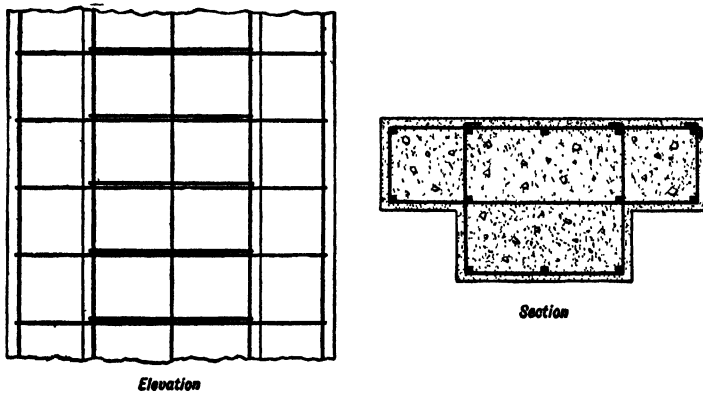

FIG. 145.—Ties for Special Columns. (See p. 418.)

**Assembling Column Steel.**—The column steel is usually assembled on horses. The skeleton, consisting of four corner bars and ties,

<sup>2</sup>Stone & Webster Co., Builders. Sanford E. Thompson, Consulting Engineer.

is assembled first. Two corner bars are placed on horses, the proper distance apart; the ties are then spaced and wired; then the other two corner bars are wired. If the weight of the total column reinforcement is not too great, all bars are wired before placing; otherwise, the skeleton of the column reinforcement is dropped into place first and finally the remaining bars are placed and wired.

When very heavy bars are used, say 1½-in. square bars weighing 5.3 lb. per lineal foot, the skeleton consisting of four bars, when assembled, would weigh several hundred pounds. It would have to be handled by a number of men, and there would be danger of damaging forms while placing the column steel. For this reason, when heavy bars are used for column reinforcement, it is a good scheme to use, in making up the required area, four light bars, say ¾-in. or ⅞-in., to be used for the skeleton. A skeleton composed of such bars can be readily handled and at the same time is stiff enough to keep its shape until the rest of the bars are placed.

**SPIRAL COLUMNS**

*Description of Spiral Columns.*—Spiral columns are columns reinforced either with continuous closely spaced spiral reinforcement or of closely spaced separate hoops placed as near as possible to the outside face of the column. In practice continuous spiral is used in preference to separate hoops.

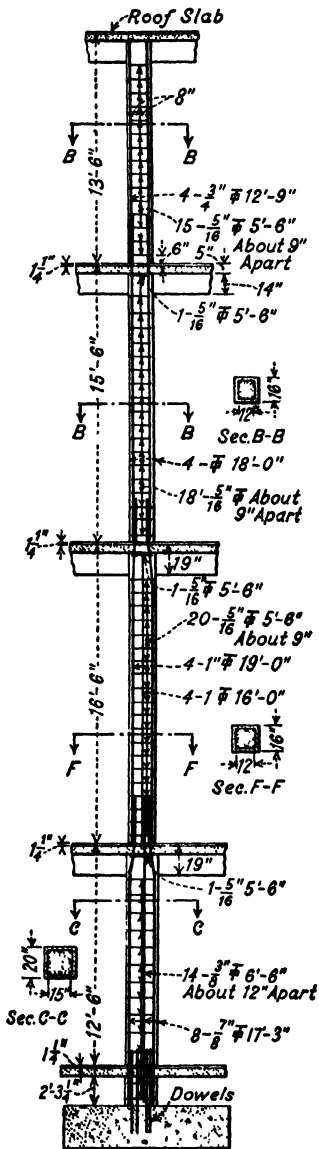

FIG. 146.—Typical Column with Vertical Steel Only. (See p. 418.)

The spiral reinforcement is based on the principle that concrete confined within the spiral is capable of withstanding very much larger stresses than concrete free to spread sidewise. The function of spirals, therefore, is to confine the concrete. In performing this function the spirals are subjected to tensile stresses.

Although spiral alone increases the strength of the column it is never used in practice without longitudinal reinforcement. There-

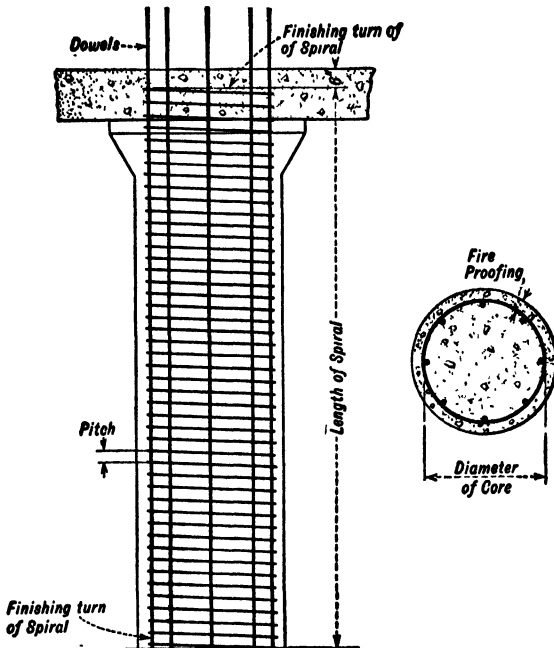

FIG. 147.—Spiral Column. (See p. 420.)

fore, for practical purposes a spiral column is a column reinforced with longitudinal reinforcement and with closely spaced continuous spiral placed near the outside face of the column. Such column is illustrated in Fig. 147, p. 420.

There is much difference of opinion as to the method of computing the strength of columns with spiral reinforcement. The reason for this divergence is discussed on p. 82, in connection with the test of columns. The method recommended by the authors, as well as the methods required by the Joint Committee, and by the New



York, Chicago, Cleveland, Philadelphia, and Boston Building Codes, will be given.

Let  $P$  = total column load in lb.;

$A$  = area of concrete core within spiral (the diameter of which equals the diameter of spiral measured to the center of wire) in sq. in.;

$A_s$  = area of cross section of vertical steel in sq. in.;

$p$  = ratio of area of vertical steel to area of concrete core  
=  $A_s \div A$ ;

$p_1$  = ratio of volume of spiral reinforcement to volume of concrete core;

$f_c$  = compressive unit stress in concrete, lb. per sq. in.;

$f'_c$  = ultimate compressive strength of concrete at 28 days, based on  $6 \times 12$  in. or  $8 \times 16$  in. cylinder tests, lb. per sq. in.;

$f'_s$  = compressive unit stress in steel, lb. per sq. in.;

$f_s$  = allowable stress in wire composing spiral reinforcement (as used by New York Code).

**Authors' Recommendation for Spiral Columns.**—*Formulas for Strength of Column.*—For spiral columns designed according to rules given below the formula for strength is the same as for columns with vertical steel only. The effect of the spiral is expressed by allowing larger unit stresses.

*Formula for Total Load,*

$$P = Af_c + (n - 1)f_cA_s, \quad . . . . . (12)$$

or, when  $A_s = pA$ ,

$$P = Af_c[1 + (n - 1)p]. \quad . . . . . (13)$$

These formulas should be used in the same manner as explained for columns with vertical steel only (see p. 406). Formulas (4) to (11a) apply here also.

*Allowable Unit Stresses.*

The allowable stress in concrete on spiral columns is equal to  $f_c = 0.35 f'_c$ . The stress in steel equals  $n$  times the concrete stress. Spirals are not figured as adding directly to the strength of the column.

The following stresses may be used:

Concrete Mix	Ultimate Strength, $f'_c$ Lb. per Sq. In.	Working Stress, $f_c$ Lb. per Sq. In.	$n$
1 : 1 : 2	3 000	1 050	10
1 : 1 : 3	2 500	880	12
1 : 2 : 4	2 000	700	15

*Requirement as to the Amount of Reinforcement.*

Vertical reinforcement, not less than 1 per cent, nor more than 6 per cent of the effective area of column.

Spiral reinforcement, not less than 1 per cent of the volume of the concrete enclosed within the spiral.

Pitch of spiral and other details as recommended under proper headings.

*Unsupported length* must not exceed 40 times least radius of gyration. For larger lengths, use reduction of stresses given on p. 435.

*Fireproofing.*—Two inches for round and octagonal columns. For square columns with round spiral, minimum 1½ in.

**Boston, Cleveland and Philadelphia Codes**

The formulas for spiral columns are the same as for columns without spiral. The amount of spiral reinforcement must not be less than 1 per cent of the volume of concrete within the spiral. For such columns the effect of the spiral is expressed in the allowable unit stress on concrete.

$$P = Af_c + (n - 1)A_s f_c, \dots \dots \dots (14)$$

also when  $A_s = pA,$

$$P = Af_c[1 + (n - 1)p]. \dots \dots \dots (15)$$

Allowable unit stresses and requirements are given in table below.

SPIRAL COLUMNS

Requirements for Spiral Columns. Boston, Cleveland, and Philadelphia Codes

Cities	Ultimate Strength of Concrete $f'_c$ , Lb. per sq.in.	Allowable Working Stress, $f_c$ , Lb. per sq.in.	$n$	Vertical Reinforcement		Spirals			Fire-proofing	Ratio of Diameter to Height of Column	Remarks
				Maximum	Minimum	Per cent	Maximum pitch	Minimum pitch			
Boston.....	3 300	1 155	10	4%	1%	1%	Not more than $\frac{1}{4}$ diam. nor $2\frac{1}{2}$ " in clear	.....	1 $\frac{1}{2}$ "	Maximum ratio of core to length of column $\frac{1}{6}$ .	
	2 800	980	12								
	2 200	770	15								
Cleveland....	2 000	850	15	5%	1%*	1%	3"	1 $\frac{1}{2}$ "	2"	Maximum ratio of outside diameter to length of column $\frac{1}{3}$ .	Spirals under 18 in. diameter should have two mechanical spacers. Other spirals three spacers.
Philadelphia.....	900	750	12	4%	1%	1%	3" or $\frac{1}{4}$ diameter of core of	.....	2"	Maximum ratio of least side of diameter to unsupported length of column $\frac{1}{4}$ .	
				.....	.....	.....	.....	.....	.....		

\* There shall be at least four vertical bars not less than  $\frac{1}{4}$  in. in diameter.

**New York Code**

*Formula for Total Load on Spiral Columns,*

$$P = Af_c + (n - 1)A_s f_c + 2p_1 A f_s, \quad \dots \quad (16)$$

also

$$P = Af_c \left[ 1 + (n - 1)p + 2p_1 \frac{f_s}{f_c} \right]. \quad \dots \quad (17)$$

From which, for known area of core,  $A$ , and percentage of spiral  $p_1$ ,  
*Area of Vertical Steel,*

$$A_s = \frac{P - A(f_c + 2p_1 f_s)}{(n - 1)f_c} \dots \dots \dots (18)$$

For known area of core  $A$  and area of steel  $A_s$ ,  
*Ratio of Spiral,*

$$p_1 = \frac{P - f_c[A + (n - 1)A_s]}{2A f_s} \dots \dots \dots (19)$$

*Allowable Unit Stresses to be Used in above Formulas:*

The following stresses may be used:

Concrete Mix	Allowable Stress, $f_c$ , Lb. per Sq. In.	$n$
1 : 2 : 4	500	15
1 : 1½ : 3	600	12

Allowable stress for cold drawn wire for spiral

$$f_s = 20\,000 \text{ lb. per sq. in. max.}$$

but not more than 35 per cent of the elastic limit of the wire.

*Requirement as to the Amount of Reinforcement.*

Vertical reinforcement not less than 1 per cent nor more than 4 per cent of concrete core.

Spiral reinforcement not less than ½ per cent nor more than 2 per cent. The ratio of spiral,  $p_1$ , is the volume of spirals per lineal foot of column divided by the volume of the enclosed concrete in a foot of length of column.

Pitch of spiral not more than one-sixth of diameter of core not more than 3 in.

*Fireproofing 2 in.*

Ratio of length of column to least side not more than 15, minimum diameter 12 in.

**Chicago Code**

*Formulas for Total Load on Spiral Columns,*

$$P = Af_c + (n - 1)A_s f'_c + 2\frac{1}{2}np_1 Af_c, \quad \dots \quad (20)$$

also

$$P = Af_c [1 + (n - 1)p + 2\frac{1}{2}np_1]. \quad \dots \quad (21)$$

*Area of core for assumed values of p and p<sub>1</sub>,*

$$A = \frac{P}{f_c [1 + (n - 1)p + 2\frac{1}{2}np_1]}. \quad \dots \quad (22)$$

*Area of vertical steel for assumed A and p<sub>1</sub>,*

$$A_s = \frac{P - Af_c [1 + 2\frac{1}{2}np_1]}{(n - 1)f'_c}. \quad \dots \quad (23)$$

*Allowable Unit Stresses.*—The values of  $f_c$  equal one-fourth of the ultimate strength of concrete  $f'_c$ . The table below gives the value of  $f_c$  and  $n$  for different mixes of concrete:

Mix of Concrete	Ultimate Strength, $f'_c$ , Lb. per Sq. In.	Allowable Stress, $f_c$ , Lb. per Sq. In.	$n$
1 : 1 : 2	2 900	725	10
1 : 1½ : 3	2 400	600	12
1 : 2 : 4	2 000	500	15

*Requirement as to the Amount of Reinforcement.*

**Vertical Reinforcement.**—Not less than the percentage of spiral nor more than 8 per cent of the core.

Vertical bars must not be spaced along the circumference of the spiral farther apart than 9 in., nor more than one-eighth of the circumference.

**Spiral Reinforcement.**—Minimum ½ per cent, maximum 1½ per cent.

**Pitch of Spiral.**—Maximum ⅓ diameter of core, but not more than 3 in.

*Fireproofing, 2 in.*

Ratio of length of column to least side shall not exceed 12.

**Joint Committee Specifications, 1924.***Formula for Total Load on Spiral Column,*

$$P = Af_c + (n - 1)pAf_c, \dots \dots \dots (24)$$

or

$$P = Af_c[1 + (n - 1)p], \dots \dots \dots (24a)$$

where

$$f_c = 300 + (0.10 + 4p)f'_c \text{ lb. per sq. in.} \dots \dots (25)$$

*Strength of Concrete,  $f'_c$ .*—The expected strength of concrete,  $f'_c$ , upon which the unit stress,  $f_c$ , depends according to the report, depends not only upon the mix of concrete, but also upon the “slump” of concrete during construction. (See Appendix, Vol. III.)

*Requirement as to Amount of Reinforcement.*

*Vertical Reinforcement.*—Not less than 1 per cent nor more than 6 per cent of the core. Minimum amount of steel to consist of at least six  $\frac{1}{2}$ -in. bars.

*Spiral.*—Percentage of spiral not less than  $\frac{1}{4}$  of the percentage of vertical bars.

*Pitch of spiral.*—Not more than  $\frac{1}{8}$  of the diameter of core, but not more than 3 in.

*Additional Requirements.*—Spiral must be held in place firmly and true to line by at least three spacer bars. Spiral reinforcement shall meet the requirements of the “Tentative Specifications for Cold-drawn Steel Wire for Concrete Reinforcement” of the American Society for Testing Materials.

*Fireproofing.*—Two inches for round column or octagonal columns. For square columns with round spiral minimum  $1\frac{1}{2}$  in.

**Use of Formulas for Spiral Columns.**

*Boston, Cleveland and Philadelphia.*—In these formulas for spiral columns, the percentage of spiral is fixed and does not enter into computations. The variables are the area of concrete core,  $A$ , and the amount of vertical bars,  $A_s = pA$ , as for columns with vertical bars only. The design of the column, therefore, proceeds in the same manner as for columns with vertical steel only, the difference being in the unit stresses.

The problems in this connection and their solution are the same as given on pp. 408 to 411 for columns with vertical steel only.

*New York Code.*—In the New York City formula for spiral columns, there are three variables: the area of concrete core,  $A$ , the

percentage of spiral,  $p_1$ , and the amount of vertical bars,  $A_s$ . The problem of designing is best solved by means of tables given on p. 918.

If no tables are available, the columns are designed by trial. The diameter of column is assumed first, then a ratio of spiral is adapted (see p. 432 for relation of  $p_1$  to pitch of spiral, also tables on pp. 930 to 933); finally, the amount of vertical steel is computed from formula

$$A_s = \frac{P - A(f_c + 2p_1f_s)}{(n - 1)f_c} \dots \dots \dots (26)$$

The problem may be also solved by assuming a size of column and ratio of vertical steel. Then the ratio of spiral is found from

$$p_1 = \frac{P - f_c[A + (n - 1)A_s]}{2Af_s} \dots \dots \dots (27)$$

If the design is unsatisfactory or uneconomical, another assumption is made. Knowing spiral ratio  $p_1$ , the pitch of spiral may be found by Formula (35), p. 432, for accepted diameter of wire. The pitch may also be found from tables on pp. 930 to 933.

If it is desired to get the smallest possible column, in the equation  $P = Af_c \left[ 1 + (n - 1)p + 2p_1 \frac{f_s}{f_c} \right]$ , substitute for  $p$  and  $p_1$  the largest allowable values ( $p_1 = 0.02$  and  $p = 0.04$ ). Then the smallest area is

$$A = \frac{P}{f_c \left[ 1 + (n - 1)0.04 + 0.04 \frac{f_s}{f_c} \right]} \dots \dots \dots (28)$$

If it is desired to use a special percentage of vertical bars and spiral, substitute the selected values of  $p$  and  $p_1$  in the above formula for  $P$ , and solve for  $A$  in the same manner as in the previous case.

To find the stresses for given dimensions of column and given load,  $P$ . Values of  $A$ ,  $p$ , and  $p_1$  are known. Value of  $f_s$  is also known as it depends upon the known strength of wire. Divide the load,  $P$ , by area,  $A$ , which gives the following relation:

$$f_c \left[ 1 + (n - 1)p + 2p_1 \frac{f_s}{f_c} \right] = \frac{P}{A}$$

in which all values except  $f_c$  are known. To find the value of  $f_c$  would require a solution of a second degree equation. To avoid this, a value for the ratio,  $\frac{f_s}{f_c}$ , may be assumed, and the equation

solved for  $f_c$ . The ratio of  $\frac{f_s}{f_c}$  is then checked, using the value of  $f_s$  just found. If it is near enough to the assumed ratio, the solution is correct; otherwise, repeat the performance with a revised ratio.

*Chicago Code.*—The method of procedure with the Chicago formula for spiral column is the same as with the New York formula. The smallest column is obtained in the same manner. Also, the method of procedure is the same if it is desired to use special percentages of steel. It must be remembered, however, that the percentage of vertical steel must not be less than that of spiral.

To review a column for known values of  $A$ ,  $p$ ,  $p_1$ , and for spiral column load,  $P$ . The stress  $f_c$  is found in formula,

$$f_c = \frac{P}{A[1 + (n - 1)p + 2\frac{1}{2}np_1]}, \quad \dots \quad (29)$$

in which all values, except  $f_c$ , are known.

*Joint Committee Rule, 1924.*—In the Joint Committee formulas for spiral columns there are three variables, namely  $A$ ,  $p$ , and  $f_c$ . The value of  $f_c$  depends not only upon the quality of concrete, but also upon the percentage of steel. The ratio of spirals varies with the variation in the ratio of vertical steel.

To design columns, it is necessary to assume percentages of steel, for which the stress,  $f_c$ , is found from Formula (25). Finally, the area of column is found from

$$A = \frac{P}{f_c[1 + (n - 1)p]}. \quad \dots \quad (30)$$

To get minimum size of column, assume the maximum value for  $p$ .

The design is more involved if it is required to find reinforcement for an assumed size of column. For instance, if the area of column,  $A$ , is known, then

$$f_c [1 + (n - 1)p] = \frac{P}{A}. \quad \dots \quad (31)$$

From this expression it is impossible to get directly the value of  $p$ , as the value of  $f_c$  is not known, being dependent upon  $p$ . To solve the problem, two simultaneous equations must be solved, namely

$$f_c [1 + (n - 1)p] = \frac{P}{A}, \quad \dots \quad (32)$$

and

$$f_c = 300 + (0.10 + 4p)f'_c. \quad \dots \quad (33)$$



In these equations,  $\frac{P}{A}$ ,  $n$ , and  $f'_c$  are known and  $f_c$  and  $p$  unknown.

By eliminating the value of  $f_c$ , we get a second power equation. This, solved, gives the percentage of steel,  $p$ .

To review a design for known values of  $P$ ,  $A$ , and  $p$ . The stress  $f_c$  is found from

$$f_c = \frac{P}{A(1 + (n - 1)p)} \cdot \cdot \cdot \cdot \cdot \cdot \quad (34)$$

This value, however, does not give any information as to the safety of the column. To get this, it is necessary to substitute the values of  $f_c$  and  $p$  in the formula  $f_c = 300 + (0.10 + 4p)f'_c$  and find the value of  $f'_c$ . Then compare this ultimate strength with the expected ultimate strength of the concrete.

From the above it is evident that working with Joint Committee formulas is complicated unless tables are available.

#### OCTAGONAL SPIRAL COLUMNS

Octagonal columns with spiral reinforcement are sometimes used because some architects prefer them to round columns on account of appearance and because it is easier to fit partitions to the flat surface of the column. In some instances, they are used because, through local conditions, they are more economical than round columns.

As the spiral is made round, the effective area and the strength of an octagonal column are equal to those of a round column of a diameter equal to the short diameter of the octagon. The gross area of an octagonal column equals  $\frac{3.31}{4}d^2$ , where  $d$  is the short diameter of the octagon, while the gross area of a circle is  $\frac{3.14}{4}d^2$ . An octagonal column requires, therefore, 5.4 per cent more concrete than a round column of the same strength.

When comparing the cost of round and octagonal columns, in addition to the extra cost of materials, the question of formwork should be considered. In flat slab work, in addition to the column form, the form for the column head must be considered. The relative cost varies with local conditions.

#### SQUARE SPIRAL COLUMNS

Tests prove that square spirals are not effective as such, since they are not capable of restraining the concrete laterally and prevent-

ing it from spreading under load. If it is necessary to use spiral reinforcement in square columns, the spiral must be made round and the column designed in the same way as a round column of the same diameter. The concrete at the edges, which is outside of the spiral, is wasted. A square spiral column requires 27 per cent more concrete than a round spiral column of the same strength.

Square columns with spiral reinforcement should be used only where for any reasons square columns are desirable or where round or octagonal column forms are not easily obtainable.

The protective covering for the spiral in square columns varies in thickness at different points in a square section. It is largest at the corners and smallest in the middle of the sides. This smallest thickness of the protective cover may be made  $\frac{1}{2}$  in. smaller than required for round columns, where the cover is of uniform thickness, but not less than  $1\frac{1}{2}$  in. This reduces somewhat the excess of concrete in square spiral columns.

#### OBLONG SPIRAL COLUMNS

Sometimes it is desirable to make the clear distance between the faces of the columns in one direction as small as possible, while

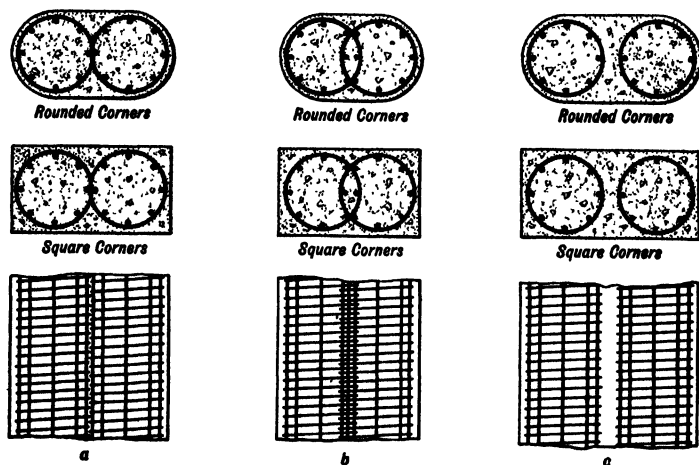

FIG. 148.—Spirals in Oblong Columns. (See p. 431.)

the clear distance in the direction at right angles is of minor importance. In such a case, oblong columns may be used. Under some conditions, oblong columns may be spirally reinforced.

The reinforcement of such oblong columns usually consists of two or more spirals. The cross section may be either rectangular or oval, i.e., with rounded corners.

To be economical, the relation of the small diameter to the large diameter of the column must be such as to permit the design shown on Fig. 148, *a* or *b*. In the column shown in Fig. 148*c*, the concrete between the two spirals is outside of the effective areas. It does not contribute anything to the strength of the column, and is, therefore, wasted.

The spiral oblong column actually consists of two spiral columns of small diameter, and should be designed as if the spiral columns were separated. It is obvious, however, that no extra concrete is required for protective covering between the spirals, as there the concrete is not exposed. The effective area in Figs. 148*a* and *c* equals the area of the two small spiral columns; while in Fig. 148*b*, where the spirals intersect, the actual area should be computed.

The rules for spiral columns apply equally here.

DETAILS OF SPIRAL COLUMNS

Data for Designing Spirals.—

Let  $p_1$  = ratio of spiral = volume of spiral divided by volume of concrete core;

$A_s$  = area of wire, square inches;

$A'_s$  = equivalent area of vertical steel of same volume as the spiral =  $p_1 \frac{\pi d^2}{4}$ ;

$d$  = diameter of column core, inches;

$s$  = pitch of spiral, inches;

$W$  = weight of spiral per foot of column height, feet.

*Pitch of Spiral,  $s$ , for Known Ratio of Spiral,  $p_1$  or Known Area  $A'_s$ .*

$$s = \frac{4A_s}{dp_1} \dots \dots \dots (35)$$

$$s = 3.14 \frac{A_s}{A'_s} d. \dots \dots \dots (35a)$$

*Ratio of Spiral,  $p'$ , for Known Pitch  $s$ .*

$$p_1 = \frac{4A_s}{ds} \dots \dots \dots (36)$$

*Equivalent Area of Vertical Steel of Same Volume as the Spiral.*

$$A'_s = 3.14 \frac{d}{s} A_s \dots \dots \dots (37)$$

*Weight of Spiral, W, per foot of Height of Column (not including spacers).*

$$W = 10.7 \frac{d}{s} A_s \dots \dots \dots (38)$$

**Wire for Spiral.**—Spirals are usually made of cold-drawn wire having tensile strength of at least 80 000 lb. per sq. in. The size of the wire is designated in the mill by gage numbers instead of by the diameter of the bar. The designers, however, use the diameter of the bar almost exclusively. The relation between the gage and the diameter of the bar is given in the table below:

**Standard Wire Used for Spirals**

Gage Numbers of Wire	Diameter of Equivalent Round Bar, in.	Actual Diameter of Wire, in.	Area of Wire, sq. in.	Weight of Wire per Foot, lb.
7 0	$\frac{1}{4}$	0.4900	0.189	0.636
5 0	$\frac{1}{8}$	0.4305	0.145	0.490
3 0	$\frac{3}{8}$	0.3625	0.103	0.347
0	$\frac{1}{16}$	0.3065	0.074	0.250
3	$\frac{1}{4}$	0.2437	0.047	0.158

The spiral should be made of a continuous wire. If this is impossible, the wire must be spliced to develop the full strength of the wire by bond. It must be remembered that the spiral acts in tension and not in compression.

**Pitch of the Spiral.**—The vertical distance, center to center, between two adjacent windings of the wire of the spiral is called the pitch of the spiral. The maximum pitch is always limited to a certain fraction of the core, and also, as an additional limitation,

it must not exceed 3 in. The minimum pitch is seldom specified, but it is limited by the practical consideration that the clear distance between the wires should be large enough to permit free flow of concrete from the core to the outside shell; otherwise, pockets might form at the wires, resulting in a porous fireproofing. The clear distance between the wires should not be less than 1 in., which fixes the minimum pitch for  $\frac{1}{2}$ -in. spiral at  $1\frac{1}{2}$  in., and for  $\frac{3}{8}$ -in. spiral at  $1\frac{3}{8}$  in.

**Spacers.**—It is important, in order that the pitch of the wire be made uniform, that the spiral should be maintained in a vertical position and that it should be secure from displacement during pouring of the concrete. For this purpose, the spiral must be securely wired to the vertical bars. The best results are obtained by using mechanical spacers.

The spacers consist of small angles, channels, or T-bars, one leg of which is notched at proper intervals to receive the spiral wire. At least two spacers should be used per column. Larger spirals may require three or four spacers. Usually, it is the best practice to have the spirals built up in the shop and deliver them to the job collapsed. In some cities (notably in New York), this has been against the regulation of the labor union. There the wire may come to the job coiled, but must be spaced and wired on the job. This increases the cost appreciably.

In estimating the weight of spiral, the weight of the spacer must be added to the weight of the wire. The weight of spacers per foot depends upon the cross section of the spacer and also upon the diameter of the wire, heavier wire requiring heavier spacers. The weight per lineal foot of two T-section spacers for  $\frac{1}{4}$ -in. wire varies from 1.60 to 2.0 lb.; for  $\frac{3}{8}$ , and  $\frac{1}{2}$ -in. wires from 2.0 to 3.0 lb.; for heavier wire 3.60 lb.

**Length of Spiral.**—By length of spiral is meant the vertical distance from the top to the bottom of spiral when erected. A good rule is to make the length of the spiral 6 in. shorter than the distance from top of slab to top of slab. An extra turn of the spiral should be added at the top and bottom, for lap. With such design, the top of the spiral is well imbedded in the concrete, and at the same time there is no danger of any wires extending above the slab owing to inaccuracy in manufacture.

It is true, as it is often argued, that the column is enlarged at the floor level by the floor system, especially in flat slab construction

where the column is enlarged at the top to form the column head. This may serve as an argument for stopping the spiral at some point within the column head.

On the other hand, the spiral columns are almost always of rich mix, while in the floor and the column head 1 : 2 : 4 mix is used. The saving in the cost of spiral would be small in comparison with the advantage of having a continuous spiral column; therefore, the rule given above is recommended.

**Cost of Spiral.**—The cost of spiral per ton is larger than the cost of bars per ton, to allow for the shopwork of bending and assembling. Also, the unit cost of drawn wire is larger than the unit cost of bars. The difference usually amounts to from \$15 to \$20 per ton.

In figuring relative cost of spiral and vertical bars, it should be remembered that the length of vertical steel is greater than the length of spiral. The length of vertical bars equals the story height plus the lap of the bar while the length of spiral equals the story height minus 6 in. The cost of the spacers, if used, should be added to the cost of the spiral.

**Details of Vertical Bars.**—Vertical bars should be extended above the top of the rough slab into the upper column, a sufficient amount to transmit by bond the compressive stresses from the column above to the column below. The remarks on p. 412 in connection with vertical bars for columns with longitudinal steel, apply here also.

### LONG COLUMNS

If the ratio of unsupported length of a column to the least side of smallest radius of gyration exceeds the values on which the formulas given in previous pages are based, the column becomes a long column and must be designed with reduced unit stresses.

The formula given by the 1924 Joint Committee is recommended.

Let  $P_1$  = total safe load on long column;

$P$  = total safe load on short column  $\left(\frac{l}{R}$  not more than 40);

$l$  = unsupported length of column in inches;

$R$  = least radius of gyration of effective area in inches;

$f_{c1}$  = allowable unit stress on long column;

$f_c$  = allowable unit stress on short column.

Then

$$P_1 = P \left( 1.33 - \frac{l}{120R} \right), \dots \dots \dots (39)$$

and

$$f_{e1} = f_c \left( 1.33 - \frac{l}{120R} \right) \dots \dots \dots (40)$$

It should be noticed that for  $\frac{l}{R} = 40$ , the expression in the brackets becomes unity.

**COLUMNS FOR FLAT SLAB CONSTRUCTION**

Special requirements for columns in flat slab construction are given in the chapter on "Design of Flat Slab Structures."

**STRUCTURAL STEEL COLUMNS IMBEDDED IN CONCRETE**

When small structural shapes are used and their area does not exceed 6 per cent of the effective cross section of the concrete, the column should be treated as a reinforced concrete column and designed according to the formulas given for columns with longitudinal bars, on p. 406. The angles should be fastened together with lattice work or stays, such as are used in structural steel design. The steel shapes should be covered with concrete of a minimum thickness of 2 in. To prevent the separation of this fireproofing from the rest of the concrete, it is advisable to place outside of the angles  $\frac{1}{4}$  in. round ties spaced about 18 in. on centers.

When the structural shapes are designed to resist the major part of the column load, the column becomes, in the strict sense, a structural steel column imbedded in concrete. Its design differs materially from that of the reinforced concrete column. The formulas for structural steel columns are not yet fully standardized and differ in building rules of different cities. Formulas recommended by the authors, and the requirements of several large cities, are given below.

**JOINT COMMITTEE, 1924, RULES FOR STRUCTURAL STEEL AND CAST-IRON COLUMNS, INDORSED BY AUTHORS**

The Joint Committee, 1924, provides rules for composite columns and structural steel columns. The allowable stresses for both types

are the same, the difference being in the requirement as to details. These rules are indorsed by the authors.

Let  $f'_c$  = ultimate compressive strength of concrete <sup>3</sup> at 28 days, lb. per sq. in.

$f_r$  = compressive unit stress in metal core, lb. per sq. in.;

$A$  = area of concrete core, sq. in.;

$A_s$  = area of structural steel, sq. in.;

$P$  = total safe axial load, lb.;

$R$  = least radius of gyration of the steel or cast-iron section, in.

$h$  = height of column, in.

**Composite Columns.**—Composite columns are columns consisting of structural steel or cast iron encased in a spirally reinforced concrete core.

The following formulas should be used for design of composite columns:

*Safe Load on Composite Column,*

$$P = (A - A_s)f'_c + A_s f_r, \quad \dots \dots \dots (41)$$

where

*Allowable Unit Stress in Concrete,*

$$f_c = 0.25f'_c. \quad \dots \dots \dots (42)$$

*Allowable Compressive Unit Stress on Steel Section,*

$$f_r = 18\,000 - 70 \frac{h}{R}, \quad \dots \dots \dots (43)$$

but shall not exceed 16 000 lb. per sq. in.

*Allowable Unit Stress on Cast Iron,*

$$f_r = 12\,000 - 60 \frac{h}{R}, \quad \dots \dots \dots (44)$$

but shall not exceed 10 000 lb. per sq. in.

The diameter of the cast-iron section shall not exceed one-half of the diameter of the core within the spiral. The spiral reinforcement shall be not less than 0.5 per cent of the volume of the core within the spiral and shall conform in quality, spacing, and other requirements to the provisions for spiral columns.

<sup>3</sup> Ultimate strength based on tests of 6 by 12 in. or 8 by 16 in. cylinders.



Ample section of concrete and continuity of reinforcement shall be provided at the junction with beams or girders. The area of the concrete between the spiral and the metal core shall be not less than that required to carry the total floor load of the story above, on the basis of a stress in the concrete of  $0.35f'_c$ , unless special brackets are arranged on the metal core to receive directly the beam or slab loads.

**Structural Steel Columns.**—A structural steel column is a column consisting of a structural steel section which fully encases an area of concrete, and which is protected by an outside shell of concrete at least 3 in. thick.

Formulas for safe load and unit stresses are the same as for composite columns.

The outside shell shall be reinforced by wire, mesh, ties, or spiral weighing not less than 0.2 lb. per sq. ft. of surface of the core, and with a maximum spacing of 6 in. between strands or hoops. Special brackets shall be used to receive the entire floor load at each story. The safe unit stress in steel columns, calculated by Formula (43), p. 436, shall not exceed 16,000 lb. per sq. in.

**RULES FOR STRUCTURAL STEEL OF VARIOUS BUILDING CODES <sup>4</sup>**

**New York Code Regulation for Structural Steel and Concrete.**—In columns of structural steel, thoroughly encased in concrete not less than 4 inches thick and reinforced with not less than one per cent of steel, the allowable load shall be 16 000 lb. per sq. in. on the structural steel, the percentage of reinforcement being the volume of the reinforcing steel divided by the volume of the concrete enclosed by the reinforcing steel. Not more than one-half of the reinforcing steel shall be placed vertically. The reinforcing steel shall not be placed nearer than one inch to the structural steel or to the outer surface of the concrete. The ratio of length to least radius of gyration of structural steel section shall not exceed 120.

$$P = A_s \times 16\ 000\ \text{lb.} \quad \dots \dots \dots (45)$$

This regulation differs from the Joint Committee Rules in one essential, namely, that no direct strength is attributed to the concrete, the increase being taken care of by increased unit stress in steel above that allowed for ordinary structural steel columns.

**Philadelphia Regulation for Structural Steel and Concrete.**—The Philadelphia ruling follows closely the New York rule, except

<sup>4</sup> Building Codes are given as of 1925. As changes occur they will be made in subsequent imprints of this treatise.

that the required sum of lateral longitudinal reinforcement outside of the shapes is to be 1 per cent of the concrete within the hoops, instead of within the steel section as required in the New York Code.

**Boston Rule.**—No increase in strength is attributed to the imbedment of structural steel in concrete. It is permissible, however, to utilize the concrete casing to carry the load, for one or more stories between the brackets on structural steel. The rule reads:

“Reinforced concrete buildings may be supported by structural steel or cast-iron columns, fireproofed in first-class construction as provided elsewhere in this act. Brackets shall be provided to transmit the load from the floors to the column. Such columns shall be computed as follows:

“(a) If the brackets are placed immediately below the floor, the structural steel or cast-iron columns shall be assumed to carry the load of all the floors above.

“(b) If the brackets are placed immediately above a floor, the structural steel or cast-iron columns shall be assumed to carry all the load above the brackets and the floor or floors below the brackets shall be carried on reinforced concrete encasing the metal, designed in accordance with the requirements of this act, to the next bracket below or to the foundation. In this case, however, the surrounding concrete shall be so separated from the steel or cast iron as to permit the separate action of both.

“Circular hollow steel or wrought-iron columns filled with concrete shall be allowed to carry a load equal to the capacity of the metal casing plus the capacity of the concrete filling. The average unit stress in the casing shall be that specified elsewhere in this act for columns, and that in the concrete filling shall be in the same ratio to the unit stress in the casing which the modulus of elasticity of the concrete bears to that of the casing.”

This rule is not logical, as it entirely neglects the effect of the concrete surrounding the steel, although it acknowledges its strength by allowing it to carry the floor loads when the concrete is separated from the steel section.

**Cleveland Code.**—The Cleveland Code divides the structural steel columns into two classes: the columns with solid web, and the columns with open web. For solid-web columns, no allowance is made for the strengthening effect of the concrete, on the assumption that no bond can exist between large flat surfaces of the steel section and the concrete. They must be designed with the same stresses as ordinary structural steel columns. For open-web columns, the unit stresses for the steel are increased over those allowed for struc-

tural columns. The rate of increase depends upon the type of column and also upon the ratio of the steel area to the area of concrete. The larger the percentage, the smaller is the allowable increase in unit stresses. This last provision is logical. The concrete section has a definite strength and rigidity. When a structural column is imbedded therein, the total strengthening effect of the concrete, within limits used in practice, will be practically the same, irrespective of the magnitude of the area of the steel column. The effect per unit area of the steel section will be larger if the steel section forms a small part of the total section and diminishes with the increase of the section. The rule reads as follows:

**“ Structural Steel Columns Encased in Concrete.—**

“(a) *Solid Web Columns.*—In columns of this type, the steel shall be designed to take the total dead and live loads, and the concrete shall be considered as fireproofing only. All columns of this type shall be wrapped with wire in such a manner as to securely hold the concrete in position. All loose scale or rust shall be removed before encasing the column in concrete.

“(b) *Open Web Columns.*—In columns of this type, the steel shall be designed to take the full dead and live loads with the following unit stresses, with no added allowance for the concrete:

- “ Gray columns and similar types,  
20 000 —  $300 \times$  the percentage of steel.
- “ For four-angle columns, latticed four sides,  
19 000 —  $300 \times$  the percentage of steel.
- “ For four angles with latticed web,  
17 500 —  $300 \times$  the percentage of steel.

“ Open-web columns shall be wrapped with one-eighth ( $\frac{1}{8}$ ) inch (or larger) wire at vertical intervals not greater than eight (8) inches.

“ The percentage of steel shall be based on the total area of the column, after deducting two (2) inches all around.

“ If the unsupported length of columns exceeds twelve (12) times the least outside dimension, the stresses shall be reduced as required for reinforced concrete columns.

“ In all columns under this section, positive connections shall be provided to transmit to the column steel the loads of all rod reinforced beams and girders framing into the column flanges.”

**Chicago Requirements.**—The Chicago Code provides for three combinations of structural steel with concrete.

First.—“Structural steel of box shape with lattice or batten plates filled with concrete. If no structural shape is less than 1 sq. in. in section and the spacing of the lacing or battens is not greater than

the least width of the columns, and the structural steel does not exceed 8 per cent of the area, then the column may be considered as a reinforced concrete column and designed by regular formulas in which the stress in concrete equals one-quarter ( $\frac{1}{4}$ ) of the ultimate strength of concrete and the unit stress in steel equals the unit stress in concrete multiplied by ratio  $n$ ."

Second.—“ For steel columns filled with, and encased in concrete extending at least three inches beyond the outer edge of the steel, where the steel is calculated to carry the entire live and dead load, the allowable stress per square inch shall be determined by the following formula:

$$18\,000 - 70\frac{L}{R}, \text{ lb., . . . . . (46)}$$

but shall not exceed 16 000 pounds.”

Third.—“ For steel columns filled with, but not encased in concrete, the steel shall be calculated to carry the entire live and dead load. In this case, the above formula may be used, but the allowable stresses shall not exceed 14 000 pounds.”

The above stresses should be compared with the following stresses allowed for structural steel columns not encased in concrete.

$$16\,000 - 70\frac{L}{R} \text{ lb. per sq. in. . . . . (47)}$$

In the above formula

- $L$  = length of column in inches;
- $R$  = least radius of gyration in inches.

#### DETAILS OF DESIGN OF STEEL SECTION

The details of the steel section depend largely upon conditions and upon the building department requirements. Naturally, when no allowance is made for the effect of the concrete surrounding the steel, the main object will be to get the best and cheapest steel section. On the other hand, when concrete is relied upon to resist stresses, it is desirable to get cooperation between the two materials, and a section must be selected which will provide best bond between the concrete and steel. The simplicity of the brackets and splices should also be taken into consideration, and a section selected which requires the least complicated brackets at the floor levels to transmit the floor load to the column.

Figure 149, *a* to *f*, inclusive, give the various sections in use. The cheapest section is likely to be the one requiring least shopwork and the one in which no material is lost for stay plates and lattice

work. Such is the section shown in Fig. 149, *e*. The objection to it is that it cannot be counted upon to cooperate with the concrete. In using this section, it is important to bind the concrete behind the flanges by means of ties, as otherwise the thin concrete may spall off. This section is accepted by the City of New York and by Philadelphia. In Cleveland, no increase of strength is allowed on such section. It can be used in connection with the Boston law, except that when concrete is depended upon to carry the floor load from floor to floor, the concrete behind the flanges cannot be considered, as it is too thin.

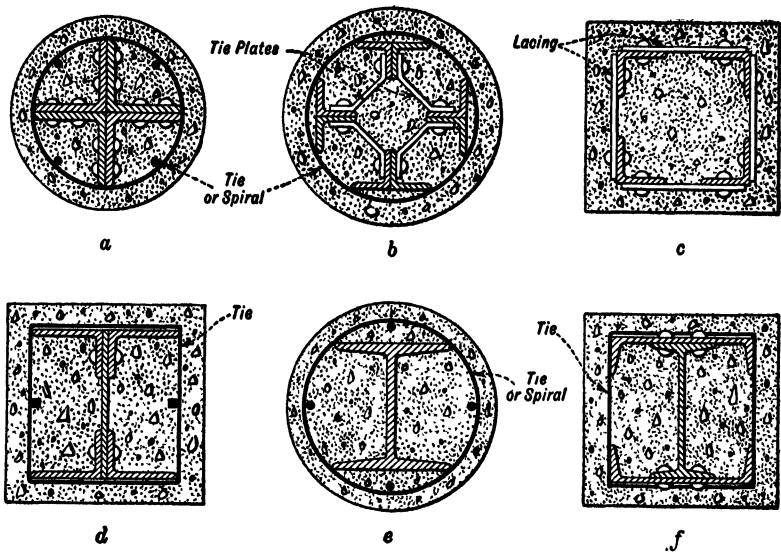

FIG. 149.—Structural Steel Columns Encased in Concrete. (See p. 440.)

The Gray Column, Fig. 149, *b*, is the best type of a concrete column. The objection to it is the large cost of fabrication.

The Star Shape Column, Fig. 149, *d*, has been used to some extent, as it is compact and fits well into a round column. It is particularly adaptable under the Boston Law. It should not be used where considerable bending is expected unless bending moment is resisted by vertical bars.

**Splicing Structural Columns.**—Splices should be designed in the same manner as for steel columns. No reliance should be placed on the concrete. The splices are best placed above the floor level.

The design of splices will depend upon whether the ends are machined or not.

If the ends are not machined, to insure good bearing on the lower section, the splice must be strong enough to transfer the full load through the rivets to the lower column. The number of rivets must be large enough to transfer the load from the column to the splice and then from the splice to the lower section.

If the ends are machined, as is generally the case, the load from the upper column is transferred directly by bearing to the section of the lower column. Only enough strength is required in the splice to keep the section securely in place during construction and to resist any bending moment to which the column may be subjected. In some types of columns, the concrete section may be counted upon to resist the bending moment, in connection with a proper amount of bars used to resist any possible tension.

**Steel Brackets.**—The construction of steel brackets to transmit the floor load to the steel column depends upon the cross section of the steel column and also upon the construction of the floor.

With a closed section, such as Fig. 149, *d*, *c*, or *f*, it is necessary to provide brackets at every floor for the load coming on the flange sides. In other sections, brackets may be placed only every two or three floors and concrete relied upon to transmit the load partly by bond to the steel section and partly to the brackets. In such cases, of course, the concrete must be strong enough to carry the floor loads as a column between the brackets. Under no circumstances should the brackets be omitted altogether and the bond relied upon to transfer the entire load.

In flat slab construction, the brackets are usually placed within the column head. Angles properly riveted are sufficient. For heavy loads, stiffeners under the angles may be required. The angles should be placed in such a position that they will not interfere with the pouring of the concrete. This fixes their position away inside of the column head where the width of the column head form is much larger than the column, so that there is room for the concrete to flow into the column form. In concreting, care should be taken that the column is properly filled with concrete, especially when it is counted upon, directly or indirectly, to strengthen the column.

In beam and girder construction, brackets should be supplied for every girder. These should be strong enough to transmit all the load to the steel section. When concrete is relied upon to transmit

the load to the story below, it should be of proper dimensions and strength to carry the load as a column.

Examples of brackets are shown in Figs. 150 and 151.

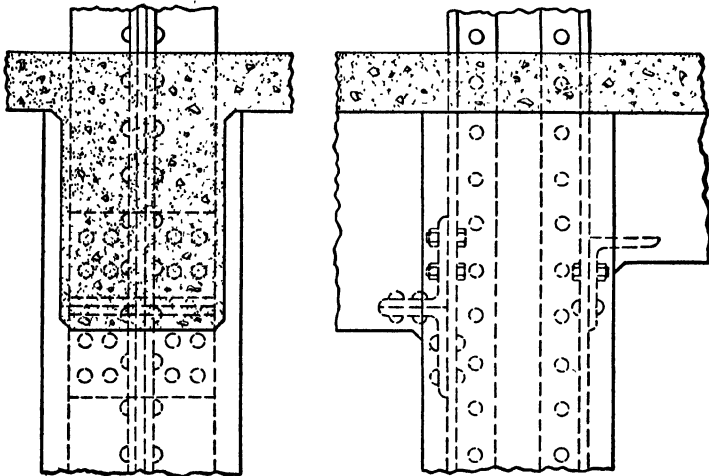

FIG. 150.—Steel Brackets for Floor Beams. (See p. 442.)

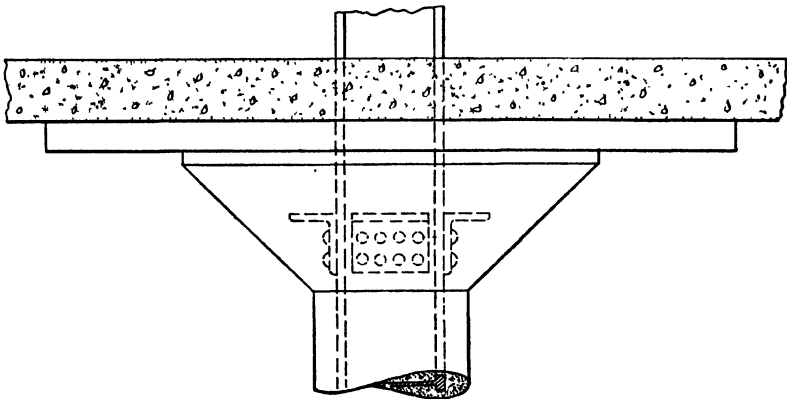

FIG. 151.—Steel Brackets for Flat Slab. (See p. 442.)

**Details of Base for the Steel Section.**—The load from the steel section is transmitted to the concrete of the foundation by means of a base designed in the same manner as for structural steel columns.

The base for a structural column is either cast or built up of plates and angles. Where easily obtainable, a base of thick solid slabs of rolled steel may be used. The thickness of the plate may run up to 6 in.

The problem in designing the base is to spread the load from the column on a sufficiently large area of the concrete foundation, so as not to exceed the allowable bearing stresses on concrete. After the area of the base is determined by dividing the column load by the allowable bearing stress, the base plate is strengthened, by angles in built-up bases, and in cast-iron bases by ribs of sufficient proportions to resist the stresses produced by the upward pressure of the foundation.

The thickness of solid rolled plate is determined by the bending moment due to the upward reaction. It may be obtained from the following formula.

- Let  $P$  = column load, lb. ;  
 $a$  and  $b$  = dimensions of foundation plate, in. ;  
 $c$  and  $d$  = outside dimensions of column, in. ;  
 $t$  = thickness of plate.

Then, for a stress in steel of 16 000 lb. per sq. in.,  
*Thickness of Foundation Plate,*

$$t = \sqrt{\frac{P(a - c)}{21\,300b}} \quad \text{or} \quad \sqrt{\frac{P(b - d)}{21\,300a}} \quad \dots \quad (48)$$

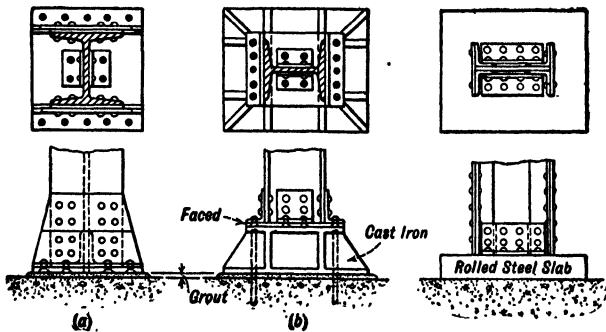

FIG. 152.—Bases for Steel Columns. (See p. 443.)

For square plates, both dimensions are equal. For rectangular plates, the larger of the two values should be accepted.



The column must be bolted or riveted to the base. The bases must also be bolted to the foundation. If uplift is possible, the bolt must be strong enough to resist it. The bolts should be carried so far into the concrete, and anchored in such a way, that enough weight of concrete above such anchorage is available to counteract the uplift.

Figure (a), (b), and (c) shows bases adaptable for steel columns.

**Cast-iron Core Imbedded in Concrete.**—A section of a column consisting of a cast-iron core imbedded in concrete is shown in Fig. 153. The cast-iron core is spliced by means of a pipe sleeve fitted on the outside of the core. Where the diameter of the core changes, special sleeve is provided. The ends of the core must be faced to even bearing on the lower core.

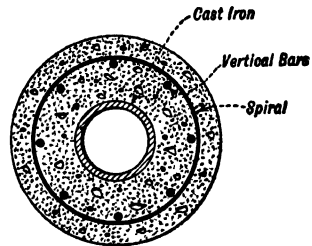

FIG. 153.—Details of Column with Cast-iron Core. (See p. 445.)

## ECONOMIES IN COLUMN DESIGN

**Economical Dimensions and Concrete Proportions.**—In a one-story structure, the problem is to select a column for which the cost of materials is a minimum. For structures several stories high, the additional question of formwork is introduced into the problem. The column load varies from story to story. If the cost of materials alone were considered, the greatest economy would be obtained by changing the size of the column at every story. However, the reduction in column size requires remaking of column forms (except where they are easily adjustable) and also the lengthening of forms for beams and girders running into the column. Changing of column size is economical when the cost of these changes in formwork is smaller than the saving in materials resulting from the reduction in the size of the column. In many cases, the changes in formwork cost more than the saving in materials. No general rule can be established, since the relation between the cost of materials and that of labor varies greatly in different localities. As a general proposition, it is safe to say that the columns should be carried the same size for at least two stories. In many instances, the same size of column may

be maintained through several stories, by successively reducing the amount of reinforcement and changing the mix of concrete.

The above suggestions do not apply to round columns, especially in flat slab construction. The column and column-head forms in such cases are usually made of sheet metal. As they are readily adjustable, no saving in cost is obtained by maintaining the size of the column unchanged. It should be remembered, however, that for standard forms the diameter of column is adjustable only for even inches; therefore, the diameter of column should always be in even inches.

To get best results, it is desirable that the designer should become acquainted with cost data in the location in which the job is to be built.

It is good practice to use the same mix of concrete for all columns on one floor. An exception may be made in case of wall columns, for all of which leaner mix may be used than in all interior columns. Confusion may result if some of the interior columns are made of one mix and the rest of some other mix.

Wall columns are usually rectangular in shape. To reduce formwork, it is advisable to maintain the same width of the column through its whole height and to effect the change in cross section by changing the thickness of the column. This method reduces the cost of remaking formwork, as all remaking is confined to two sides; also the forms for spandrels are used without remaking. This suggestion does not hold in cases where, for architectural considerations, special designs of column are required. In such cases, the shape of the concrete column must conform to the shape of the finished pier.

Where possible, the concrete column should extend to the edge of the window sash, and recesses should be provided in the concrete to receive the sash. The width of the column should then be fixed exactly after the width of the sash is determined. Very often, this width is in fraction of an inch as it is obtained by subtracting from the span the fixed width of the sash.

It is desirable to use columns of the same diameter throughout each floor of the building. When the loads of some odd columns in a floor are smaller than those of the typical column, but the difference is not appreciable, it may be advantageous to use not only the same concrete size, but also the same amount of steel as for the typical column, especially when it is difficult to distinguish the odd columns, by any peculiarity in their location, from typical columns. If a

a smaller amount of steel is used for odd columns there is danger of interchanging the special reinforcement with the reinforcement of the typical column, to the detriment of the latter. Of course, this does not apply to special columns, such as columns in elevator walls and staircases, which, because of their peculiar locations, are not likely to be confused with the typical columns.

**Economical Mix of Concrete.**—Under average conditions, the cost of 1 : 1 : 2 mix of concrete in place <sup>5</sup> is about 14 per cent greater than that of the 1 : 1½ : 3 mix, while the strength of 1 : 1 : 2 is 18 to 21 per cent greater than that of the 1 : 1½ : 3. The cost of the 1 : 1 : 2 is 24 per cent greater than that of the 1 : 2 : 4 mix, and the strength of the 1 : 1 : 2 is 45 to 50 per cent greater than that of the 1 : 2 : 4. The cost of the 1 : 1½ : 3 mix is about 8 per cent greater than that of the 1 : 2 : 4 mix, and the strength is 20 to 27 per cent greater.

From comparison of the increase in cost of richer mixture with the increase in allowable stresses, it is evident that the percentage of increase in strength is much larger than the percentage of increase in cost. Therefore, the richer mix is more economical for columns than the leaner mix. To obtain best economy, therefore, a rich mix of concrete should be used, except in top columns where the size may be governed by the requirements as to minimum size and 1 : 2 : 4 concrete gives sufficient strength. For lower columns, instead of increasing the size of the column, richer mix should be used.

**Economical Design of Columns with Longitudinal Reinforcement.**—The cost of steel in a column is forty to fifty times larger than the cost of concrete of the same volume, depending upon the mix of concrete. The smaller value is for 1 : 2 : 4 mix and the larger value for 1 : 1 : 2 mix. The allowable stress on vertical bars is only from ten to fifteen times larger than the allowable stress on concrete. It follows that it is much cheaper to use concrete than steel to support the load. Therefore, if it is required to increase the carrying capacity of a column, it is cheaper, so far as the cost of materials is concerned to increase the size of the column than to add vertical steel.

The most economical column, then, is one in which the minimum

<sup>5</sup> The cost of concrete used in comparison includes cost of materials, cost of plant, and cost of mixing and placing. Cost of formwork is not included. Richer concrete requires smaller columns. In some cases, this reduces the cost of formwork, thus increasing the advantage of rich mix.

permissible amount of vertical steel is used. Some building codes allow  $\frac{1}{2}$  per cent of vertical bars as a minimum. The authors do not recommend the use of a smaller amount of vertical steel than 1 per cent of the effective area of the column. Exception may be made to this rule in case of wall columns in which the column serves as a pilaster, and its area, as determined by architectural requirements, is larger than required by the stresses. In such cases, the area of column required by the load for the specified stresses and for 1 per cent of steel should be computed and the area of steel to be used should be made equal to 1 per cent of the area of column as determined. (See example 4, p. 410.) The steel so obtained should be distributed over the whole section and the proper amount of ties used. If the column is also subjected to bending, proper bending reinforcement should be provided.

**Economical Design of Spiral Columns.**—The economical design of spiral columns will differ for the different types of formulas now in use. The economy of columns designed according to the formulas given on pp. 421 to 426 is discussed below.

**Columns with Fixed Percentage of Spiral.**—Under this head come the columns designed according to the authors' recommendations and 1916 Joint Committee recommendations and according to Boston, Cleveland, and Philadelphia Codes. The formulas used in design of spiral columns are the same as for columns with vertical steel only, with the exception that larger unit stresses are allowed. The relation between the ratio of cost of steel to cost of concrete and the ratio of unit stresses is same as for columns with vertical steel only. As in the case of columns with bars only, the most economical spiral column is one with minimum allowable amount of vertical steel. Rich mix of concrete also is more economical than lean mix, as the allowable strength increases more than the cost of concrete.

**Columns with Variable Percentage of Spirals.**—Under this head come the rules of Chicago and New York.

*Chicago Code.*—Formula (20), p. 425 [ $P = Af_c + (n - 1)A_s f_c + 2\frac{1}{2}np_1 A_s f_c$ ] has three variables: area of concrete, percentage of vertical bars, and percentage of spirals. The effectiveness of vertical bars is the same as for columns with vertical bars only. They are, therefore, equally uneconomical means of increasing the strength in both cases. The spiral reinforcement in the formula is considered as two and one-half times as effective as vertical bars of equal volume. It is, therefore, a much more economical means of increasing the

strength of the column than the vertical bars. Comparing with concrete, the increase in strength produced by the spiral is  $2.5n$  times as large as that produced by the same amount of concrete. This ratio equals 25 for rich concrete and  $n = 10$ , and 37.5 for lean concrete and  $n = 15$ . The ratio of the cost of spiral to that of concrete of equal volume is almost always larger than the ratio of increase in strength, consequently, it is cheaper to increase the strength of column by increasing its size than by increasing the percentage of spiral, especially as an increase in the percentage of spiral reinforcement requires an equal increase in vertical steel. The most economical spiral column designed in accordance with the Chicago Code, then, is the one which has the smallest amount of spiral and vertical steel, but in which the concrete is of the richest mix.

When the size of column is fixed, the cheapest means of increasing its strength is by an increase in the amount of spiral reinforcement and a proportional increase of vertical steel, rather than by an increase in the amount of vertical steel alone.

*New York Code.*—In Formula (16), p. 424, for spiral columns according to this code [ $P = Af_c + (n - 1)A_s f_c + 2p_1 Af_s$ ] the effect of the spiral reinforcement is sixty-seven times larger than that of 1 :  $1\frac{1}{2}$  : 3 concrete of the same volume and eighty times larger than that of 1 : 2 : 4 concrete of the same volume.<sup>6</sup> Since the ratio of the cost of steel to the cost of concrete is usually smaller than the above values, it is evident that the spiral reinforcement is the most economical material in the make-up of the column so designed. The vertical steel, as in the previous cases, is the least economical material. The most economical column, then, is one in which the percentage of the spiral is the maximum allowable and the amount of vertical steel the least allowable. The richer mix is also more economical than the leaner mix for the reasons given in connection with columns with vertical bars. Although there is no requirement fixing the ratio of the percentage of vertical steel to that of the spiral, for good design it is advisable to use at least as large a percentage of vertical bars as of spirals.

**Relative Economy of Spiral Columns and Columns with Vertical Steel Only.**—The relative economy of the two types of columns depends upon the formulas used in designing. As a general proposi-

<sup>6</sup> This ratio is obtained from  $\frac{2f_s}{f_c}$ , using  $f_s = 20\ 000$  lb. per sq. in. and  $f_c = 500$  and 600 lb. per sq. in. respectively.

tion, spiral columns are more economical than columns with vertical steel only, with the exception of columns designed by the New York Code, as explained below.

*Boston Cleveland, and Philadelphia Codes.*—In columns designed in accordance with these codes, spiral amounting to 1 per cent of the effective area is used, and the effect of the spiral is taken care of by an increase in the allowable unit stresses on concrete. Referring to tables on p. 409 and on p. 423, this increase amounts to more than 50 per cent of the stresses used for columns without spiral reinforcement.

For instance, the allowable stress for 1 : 2 : 4 concrete, according to the Boston Code, is 495 lb. per sq. in., while for spiral columns the allowable stress is 770 lb. per sq. in. The increase in strength amounts to 275 lb., which is 56 per cent of the lower value. In addition, the unit stress in vertical steel is increased in the same ratio.

To get the relative economy of a spiral column and of a column with vertical bars only, it is necessary to determine the increase in cost produced by the use of the spiral. This depends upon the ratio of the cost of spiral to the cost of concrete. Under present conditions (year 1925), the ratio of the cost of spiral to the cost of equal volume of concrete is 45 for 1 : 2 : 4 concrete, 41.5 for 1 : 1½ : 3 concrete, and 36 for 1 : 1 : 2 concrete.<sup>7</sup> For these unit costs, 1 per cent of spiral increases the cost of column by 36 to 45 per cent of the cost of the concrete within the effective area.

Comparing the increase in allowable stresses (56 per cent) with the increase in cost (36 to 45 per cent), it is evident that the increase in strength is much larger than the increase in cost; consequently, a spiral column is more economical than a column with vertical bars only. It may also be stated, on the basis of the above and of the discussion on p. 447, that the most economical column designed according to the above codes is a spiral column of richest mix having the minimum allowable percentage of steel.

*New York Code.*—According to the New York Code, the spiral reinforcement does not affect the unit stresses in concrete. It increases the strength of the column directly, the increase being expressed by the term  $2p_1A_f$ , (see p. 424). As explained on p. 449, the ratio of increase in strength effected by the spiral reinforcement is

<sup>7</sup> Based on cost of spiral in place of 4½ cents per lb. and on following costs of concrete per cu. ft. in place: 1 : 2 : 4 mix, 50 cents; 1 : 1½ : 3 mix, 54 cents; and 1 : 1 : 2 mix, 62 cents.

larger than the increase in cost. The deduction would be that spiral columns are more economical than columns with vertical bars only. This is not always true, however, because in computing the strength of a column with vertical bars only, the Code does not require any allowance for fireproofing, but permits the use of the total cross section of the column as effective area. In spiral columns, on the other hand, 2-in. fireproofing is required, so that for equal diameter of column the effective area of a spiral column is less than the effective area of a column with vertical bars only. The difference is particularly large in columns of small diameter. For this reason, spiral columns designed as explained above are not economical for small diameters of columns although they are economical for large diameters.

*Chicago Code.*—According to the Chicago Code, spiral reinforcement increases the strength of column directly, as expressed by the term  $2\frac{1}{2}np_1Af_c$ , and indirectly by increasing the allowable unit stresses.

The direct increase in strength due to the spiral equals twenty-five times the strength of an equal volume of concrete for 1 : 1 : 2 mix; 30 times for 1 : 1½ : 3 mix; and 37½ times for 1 : 2 : 4 mix. This means, for 1 per cent of spiral, an increase in the average strength in concrete over the whole effective area amounting to 25 to 37½ per cent above the allowable stress on concrete for spiral columns, and 31 to 47 per cent above the allowable stress on columns with vertical steel only. The indirect increase in strength is caused by the larger allowable unit stress,  $f_c$ , on spiral columns.

While, for columns with vertical steel only, the allowable unit stress equals  $\frac{1}{4}$  of the ultimate compressive strength, the working stress in spiral columns amounts to  $\frac{1}{4}$  of the ultimate strength. This means an increase in working stresses, due to the spiral reinforcement, of 25 per cent, not only for the concrete, but also for the vertical steel.

When the direct and the indirect increases in strength, produced by the spiral, are added, the total increase in strength of a spiral column over a column with vertical steel only is found to be from 56 to 72 per cent, depending upon the mix of concrete.

The increase in cost due to 1 per cent of spiral amounts to 36 to 45 per cent of the cost of concrete, as explained on p. 449.

Comparing the increase in cost of concrete with the increase in strength of column, it is evident that the increase in strength is larger than the increase in cost. Therefore, a spiral column is more economical than a column with vertical steel only.

**Economy of Structural Steel Columns Imbedded in Concrete.—**

The use of structural steel in columns is not economical. It should be restricted to cases where a reduction in size of column is required, beyond that possible with spiral columns of rich mix and with the largest possible percentage of vertical steel. Usually, the structural steel is used in the lowest floors only, while in upper floors concrete columns are substituted as soon as the reduction in load permits it.

The objections to structural steel columns are as follows:

*Greater Cost of Structural Steel Columns as Compared with Reinforced Concrete Columns.*—Structural steel columns imbedded in concrete always cost more than reinforced concrete columns economically designed to carry the same load. The increase in cost depends upon the specification used. It is, of course, much larger for specifications in which no allowance is made for the strengthening effect of the concrete. With the formulas recommended by the authors, the increase in cost is considerably reduced, as both steel and concrete are utilized in carrying the load.

*Difficulties in Transferring the Floor Load and Tying the Floor to the Column.*—These are particularly serious in the case of beam and girder construction, where it may be difficult to make the beams and girders continuous. In flat slab construction, the difficulties are considerably reduced, especially with systems of flat slab reinforcement in which a small number of bars, or none at all, cross the column (see p. 369).

*Difficulties in Erecting Steel Columns.*—The steel cores are very heavy, usually weighing more than a ton. This offers a special problem in erection in a reinforced concrete job not equipped with facilities for lifting heavy members in the manner used in structural steel buildings. Therefore, it is either necessary to introduce special equipment on the job for handling the steel cores or to handle them at large expense without proper equipment. In either case, it is costly. To reduce the weight, it is advisable to limit the height of the steel cores to one story.

**REDUCTION OF LIVE LOAD IN BUILDINGS**

In designing columns, all the dead load and a certain proportion of the live load shall be used. By dead load is meant the weight of the floor system, floor finish, fixed partitions or walls, columns,



and other fixed loads. Live load is the load that comes on the floor in the course of its use. It is generally recognized that a larger live load must be allowed for the floor system than for columns, because overloading of a small section of the building is much more likely to occur than simultaneous overloading of a number of floors carried by a column. The likelihood of the latter occurrence decreases with the increase in the number of floors to be supported. To allow for this, the reduction is small for the columns in the top floors and increases with the number of floors.

**Authors' Recommendation.**—The authors recommend that in all buildings the columns be designed for the total dead load, plus a proportion of total live load above the columns given in the table below. In this table are given proportions to be used for ordinary buildings and also larger proportions for warehouses and heavy manufacturing buildings.

**Recommended Proportion of Live Load on Columns**

Number of Floors Carried by Column	Proportion of Live Load on Columns	
	Ordinary Buildings	Warehouses
1	1.00	1.00
2	0.85	0.90
3	0.80	0.87
4	0.75	0.84
5	0.70	0.81
6	0.65	0.78
7	0.60	0.75
8	0.55	0.75
9	0.50	0.75
10 and over	0.50	0.75

For use of this table see Example 6 on page 456.

Usually, no reduction is allowed for warehouses, the idea being that in a warehouse all floors are apt to be fully loaded at the same time. However, the chances of overloading a column in a warehouse are unquestionably much smaller than the chances of over-

loading a floor panel. In all warehouses, moreover, free aisles must be left for moving the goods. These two considerations convince the authors that some reduction is permissible for warehouses. The reduction recommended is smaller than for ordinary buildings.

**Boston Code.**—The Boston Code makes the following provisions for reduction of live load:

In all buildings except storage buildings, wholesale stores, and public garages, for all columns, girders, trusses, walls, piers, and foundations.

Carrying one floor.....	No reduction.
Carrying two floors.....	25 per cent reduction.
Carrying three floors.....	40 per cent reduction.
Carrying four floors... ..	50 per cent reduction.
Carrying five floors... . .	55 per cent reduction.
Carrying six floors or more... ..	60 per cent reduction.

In public garages, for all flat slabs of over three hundred square feet area reinforced in more than one direction, and for all floor beams, girders and trusses carrying over three hundred square feet of floor, and for all columns, walls, piers, and foundations, twenty-five per cent reduction.

**New York Code.**—New York allows a reduction of live loads only for buildings over five stories high. The Code states:

*Loads on Vertical Supports.*—Every column, post, or other vertical support shall be of sufficient strength to bear safely the combined live and dead loads of such portions of each and every floor as depend upon it for support, except that in buildings more than five stories in height the live load on the floor next below the top floor may be assumed at ninety-five per cent of the allowable live load, on the next lower floor at ninety per cent, and on each succeeding lower floor at correspondingly decreasing percentages, provided that in no case shall less than fifty per cent of the allowable live load be assumed.

**Chicago Code.**—The Chicago Code gives the following rules for reduction of live loads on columns:

*Walls, Piers and Columns—Dead and Live Loads.*—(a) The full live load on roofs of all buildings shall be taken on walls, piers, and columns.

(b) The walls, piers, and columns of all buildings shall be designed to carry the full dead loads and not less than the proportion of the live load given in the following table:

Floor	17	16	15	14	13	12	11	10	9	8	7	6	5	4	3	2	1
	%																
17	85	%															
16	80	85	%														
15	75	80	85	%													
14	70	75	80	85	%												
13	65	70	75	80	85	%											
12	60	65	70	75	80	85	%										
11	55	60	65	70	75	80	85	%									
10	50	55	60	65	70	75	80	85	%								
9	50	50	55	60	65	70	75	80	85	%							
8	50	50	50	55	60	65	70	75	80	85	%						
7	50	50	50	50	55	60	65	70	75	80	85	%					
6	50	50	50	50	50	55	60	65	70	75	80	85	%				
5	50	50	50	50	50	50	55	60	65	70	75	80	85	%			
4	50	50	50	50	50	50	50	55	60	65	70	75	80	85	%		
3	50	50	50	50	50	50	50	50	55	60	65	70	75	80	85	%	
2	50	50	50	50	50	50	50	50	50	55	60	65	70	75	80	85	%
1	50	50	50	50	50	50	50	50	50	50	55	60	65	70	75	80	85

(c) The proportion of the live load on walls, piers, and columns on buildings more than seventeen stories in height shall be taken in same ratio as the above table.

(d) The entire dead load and the percentage of live load on basement columns, piers, and walls shall be taken in determining the stress in foundations.

(c) In addition to the entire dead loads, not less than the following proportion of the percentage of live load on the basement columns, piers, and walls shall be taken in determining the number of piles for pile foundations and the area of concrete caissons.

- Classes I and VII..... 75 per cent.
- Classes II, III and VI..... 50 per cent.
- Classes IV, V and VIII..... 25 per cent.

In all foundations eccentric loading must be provided for.

## DESIGN OF COLUMN IN A BUILDING SEVERAL STORIES HIGH

The procedure in designing columns in a building several stories high is given in the example below.

**Example 6.**—Design an interior column in a building with six stories and basement, where the conditions are as follows: Panel, 20 ft. square; Live loads, 1st and 2nd floors, 250 lb. per sq. ft.; 3rd to 6th floors, 150 lb. per sq. ft.; Roof, 40 lb. per sq. ft.

Concrete dimensions are:

	1st and 2nd Floor	3rd to 6th Floor	Roof
Slab . . . . .	8½ in.	8 in.	6 in.
Drop panel . . . . .	4 in.	3½ in.	3 in.

Dimension of drop panel, 7 ft. 6 in. square.

Column head, 4 ft. 6 in.

Story heights, 12 ft. from floor level to floor level.

Floor finish consists of one inch granolithic applied separately.

Stresses recommended by the authors on pages 407 and 421 will be used.

Reduction of live load recommended for warehouses on page 453 will be used.

**Solution.**—The loads per panel in each floor will be computed first. Live load and dead load will be kept separately.

Area of panel,  $20 \times 20 = 400$  sq. ft.

	1st and 2nd Floor	3rd to 6th Floor	Roof
Live load . . . . .	$250 \times 400 = 100$ kips	$150 \times 400 = 60$ kips	$40 \times 400 = 16$ kips
Slab load . . . . .	106	100	75
Finish . . . . .	12	12	18
Sum . . . . .	$118 \times 400 = 47$	$112 \times 400 = 45$	$93 \times 400 = 37$
Drop panel . . . . .	3	2	2
Total dead load . . .	50 kips	47 kips	39 kips

Kips is an abbreviation of "Kilo pounds" and means thousands of pounds.

Further work will be simplified by tabulating the values as shown in table, page 457. After the design load is computed the size of columns is adopted in accordance with suggestions contained in this chapter. The required amount of reinforcement is finally found. The complete design of the column is given in the table.

EXAMPLE OF REINFORCED CONCRETE COLUMN DESIGN (See p. 456.)

Floor	Designation of Loading	Dead Load, in Kips †			Live Load, in Kips ‡			Proportion of Total Reduced Live Load	Reduced Live Load, Kips §	Total Design Load, Kips §	Concrete Dimensions				Allowable Unit Stress, % Lb. per Sq. In.	Load on Concrete, Kips §	Load to Be Carried, Kips §	Unit Stress in Steel, (n - 1) % Lb. per Sq. In.	Required Area of Vertical Steel, Sq. In.	Composition of Vertical Steel	Ties or Spirals, Size of Wire and Pitch
		Slab	C.	H	Gross Diam., In.	Diam. Core, In.	Area of Core, Sq. In.				Mix										
Roof	Slab	39			16				59		18	14	154	1 : 2 : 4	450	69	...	6300	6-1" rd.	1" rd., Ties 12 in. o. c.	
	Total	43	16		1.00	16															
6th	Slab	45			60				76		18	14	154	1 : 1 1/2 : 3	890	137	32	9790	6-1" rd.	Spirals 1/2" rd., 2 1/4" pitch	
	Total	93	76		1.00	76															
5th	Slab	45			60				122		20*	16	201	1 : 1 : 2	1060	213	53	9540	10-1" rd.	1" rd., 2 1/4" pitch	
	Total	144	136	60	0.90	122															
4th	Slab	45			60				171		24	20	314	1 : 1 : 2	1060	333	34	9540	6-1" rd.	1" rd., 2 1/4" pitch	
	Total	196	196	60	0.87	171															
3rd	Slab	45			60				215		26	22	380	1 : 1 : 2	1060	403	61	9540	11-1" rd.	1" rd., 2" pitch	
	Total	249	256		0.84	215															
2nd	Slab	47			100				288		30†	26	531	1 : 1 : 2	1060	563	30	9540	9-1" rd.	1" rd., 3" pitch	
	Total	305	356	100	0.81	288															
1st	Slab	47			100				356		32	28	616	1 : 1 : 2	1060	653	64	9540	11-1" rd.	1" rd., 2 1/4" pitch	
	Total	361	456		0.78	356															

C and C H means Column and Column Head

\* Column 22 in. gross diameter and 1 per cent of vertical bars is only a few cents per lineal foot cheaper than a 24 in. column. † Column 28 in. gross diameter would require 12 sq. in. of vertical steel. It should cost about 90 cents per lineal foot more than the adopted size of column. ‡ The required area of vertical reinforcement is less than 1 per cent of the area of the core. § To comply with the rules, an area of bars equal to 1 per cent will be used. ¶ Kips means thousands of pounds.

Notes: Load on concrete obtained by multiplying area of core by  $f_c$ . Load to be carried by steel is the difference between the total load and the load carried by concrete. Required area of vertical steel equals load to be carried divided by  $(n - 1)f_s$ .

The table may be simplified by eliminating the items "Columns and Column Head." This could be done by adding to the dead load of the floor the average weight of the column and column head.

In case where no live load reduction is permitted and no division of live and dead load is desired for designing footings, the live and dead load may be combined. The first column in the table, then, gives the design load.

For wall columns the weight of the curtain wall may be added to the slab load if it is constant in all floors, or treated as a separate item.

### COLUMNS SUBJECTED TO BENDING

**Bending in Interior Columns.**—For equal spans and uniform loading, there will be no bending in the interior columns for the dead load or for the live load extending over all spans. Some bending moment will be developed when the panels on one side of the column are loaded and those on the other side are not loaded. Usually, no allowance is made for the bending stresses thus produced. The bending moment in a column due to unbalanced live load may be determined as given in Volume II.

When the spans are not equal, bending moments will be developed in the interior columns both by dead and live loads. The bending stresses produced by this bending may be considerable and should be properly provided for.

Bending moments should be computed by formulas given in Volume II. These should be combined with the axial load in the manner explained in connection with wall columns. If necessary, tension reinforcement should be provided. This is required at the top of the column near the face outside the largest span, and at the bottom near the face inside the largest span.

**Wall Columns.**—When wall columns are connected by reinforcement with the floor construction, negative bending moment is developed in the floor construction at the column. This bending moment produces bending stresses in the wall column. The wall column, then, is subjected to the direct compressive stresses produced by the superimposed loads and to the bending moment transferred from the floor to the column.<sup>8</sup>

<sup>8</sup> See "Design of Wall Columns and End Beams" by Edward Smulski, *Journal American Concrete Institute*, July, 1915.

The magnitude of the bending moment at the wall column for ordinary conditions is given on p. 280. For special conditions, the rules given in Volume II should be used.

In some cases, additional bending moments in the wall column are developed by eccentrically applied spandrel loads or by the weight of the cornice. These bending moments may be of the same sign as the bending moment transferred from the floor construction, in which case they should be added to it; or they may be of opposite sign, in which case they should be subtracted from it.

In the top floor, the bending moment from the roof must be resisted by the top column alone. In the lower floors, part of the bending moment is resisted by the column below and part by the column above. The proportion of bending moment resisted by each of the two columns depends upon their rigidity, as expressed by  $\frac{I}{h}$  and  $\frac{I_1}{h_1}$ ; where  $I$  and  $I_1$  are moments of inertia and  $h$  and  $h_1$  are heights of the respective columns. If these ratios are equal or nearly equal, each column may be assumed as resisting one-half of the bending moment from the floor.

If the difference between the ratios of rigidity is appreciable, the proportion of the bending moment,  $M$ , resisted by the column having

a ratio of stiffness equal to  $\frac{I}{h}$ , is  $\frac{\frac{I}{h}}{\frac{I}{h} + \frac{I_1}{h_1}}M$ . For the other column,

the bending moment equals  $\frac{\frac{I_1}{h_1}}{\frac{I}{h} + \frac{I_1}{h_1}}M$ . The sum of the bending

moments is  $M$ .

It should be noticed that the moment in the column below the floor is negative, i.e., producing tension on the outside face of the column; while the moment above the floor is positive, producing tension at the inner face of the column. The deflection of the wall column is shown in Fig. 154, p. 460. The points of maximum tension are indicated there.

**Points of Application of Maximum Bending Moment.**—The maximum negative bending moment may be considered as applied at the bottom of the beam or girder of the floor construction which produces the bending, and the maximum positive bending moment

directly above the floor. Recommendation for flat slabs is given on p. 315. If the respective bending moments are plotted at the points of application of maximum moments, the straight line connecting

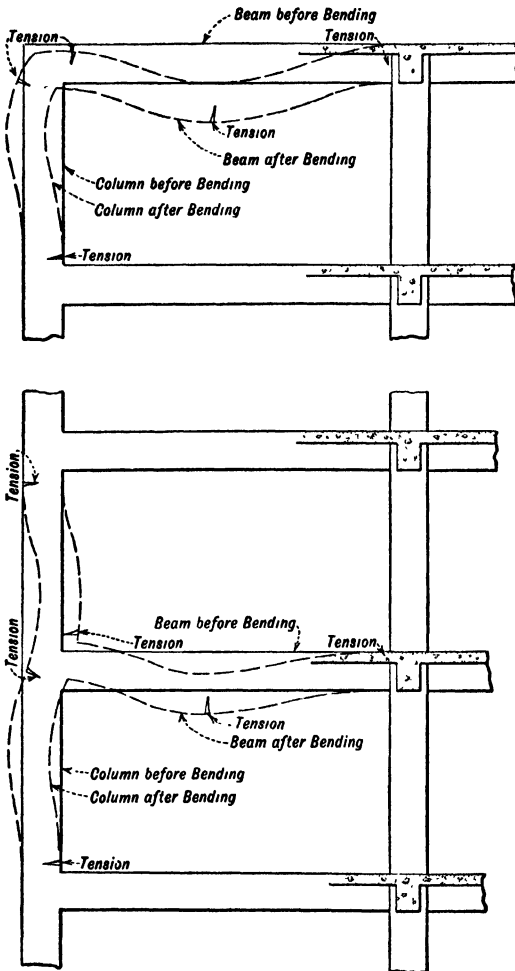

FIG. 154.—Deflection of End Beams and Wall Columns.  
(See p. 459.)

them gives the variation of bending moments in the column.

**Steps in Design of Exterior Columns.**—After the column loads and bending moments are determined, it is necessary to compute the maximum compression stresses for the combination of the concentric vertical column load and the bending moment, and to determine the amount of tensile reinforcement required to resist the tensile stresses for the most unfavorable combination of the concentric column load and the bending moment.

The first step is to determine the required dimensions for the column for the concentric column load alone.

Next, the maximum compression stresses are computed for the combination of maximum concentric column load and the maximum bending



moment. Either formula on p. 177, or formulas on p. 182, may be used, depending upon the amount of tensile stresses developed for this condition of loading. The maximum compression stresses thus obtained should not exceed the maximum allowable stresses as recommended on p. 463. In computing the combined stresses, the full section, including the fireproofing, may be used, in the same manner as in beams and slabs at the support. If the stresses exceed the allowable unit stresses the section should be increased.

The final step is to determine the required amount of tensile steel to resist the bending moment. For this purpose, the combination of the vertical column load and the bending moment which produces maximum tension should be used. This combination will be different from that used for determining maximum compression. There is a difference of opinion as to the method of determining the required amount of reinforcement to resist the bending moment in the column.

The following method, developed by the authors, is recommended for use:

For the top columns, where the vertical column load is small in comparison with the bending moment, the amount of tensile steel should be determined for the bending moment alone, the effect of the vertical load being disregarded. The amount of steel is determined from the beam formula,  $A_s = \frac{M}{f_s j d}$ , where  $d$  is the distance from center of tensile steel to the face of the column. If the amount of steel required by the column design is not sufficient, additional bars should be used. These do not need to extend the full length of the column, as the bending moment decreases rapidly.

For columns in lower floors, where the total dead load carried by the column is appreciable, the following method for computing tensile stresses in the column is recommended by the authors:

Assume that the structure above the floor under consideration is loaded with dead load only, but that the floor under consideration is loaded with dead and live load. Under such conditions, provide sufficient tensile strength in the column to give a factor of safety of 2 in case of overloading of the floor (with the structure above not loaded).

For this purpose, compute the dead load on the column above the floor under consideration. Add to it double the reaction due to live and dead load from the floor.

Compute the bending moment in the column produced by the dead and live load on the floor under consideration.

Multiply this moment by 2 and combine it with the column load computed above. Provide such an amount of steel in the column that the tensile stresses will not exceed double the allowable tensile stresses in steel.

This method gives the same factor of safety against cracks in column as is used in the floor construction.

This method will be understood from the following explanation: The column load above the floor under investigation is not affected by the loading condition in that floor. It may easily happen during the life of a structure, and even during construction of the structure, that the wall panels of one floor are overloaded, while no appreciable live load is placed on the floors above. With such loading, only the dead load above the floor can be counted upon as reducing the tensile stresses. This dead load is constant. It will not increase with the overloading of the slab. When double the design load is placed on the slab, the column load will be increased by the reaction of the slab, but the column load above the slab will not be changed. For this reason the constant dead load plus the reaction of the overloaded slab is combined with double bending moment.

**Anchoring of Bending Steel in Wall Column.**—The steel in the column used to resist bending stresses should be properly anchored, else the bars may pull out instead of resisting tension.

In the top of the top story columns, the outside bars should extend above the points of maximum bending moment a sufficient length to develop the strength of bar in tension. If this is not possible by straight imbedment, the bars should be properly hooked at the top in the slab. The inside bars are compression reinforcement.

In intermediate stories, the outside bars at the top of any column are sufficiently developed when they are extended into the column above, the proper distance from points of maximum moment to develop the strength of the bar in tension. The inside bars of any column serve as compression reinforcement below the slab and as tensile reinforcement above the slab. The length of imbedment of these bars in the column above, measured from top of slab, should be such as to develop the full tensile strength in the bar.

In all above cases, an imbedment equal to 40 diameters of the bar for deformed bars, and 50 diameters for plain bars, may be considered as ample.

**Allowable Unit Stresses for Members Subjected to Axial Compression and Bending.**—Considerable difference of opinion exists as to the allowable compressive unit stresses in members subjected to axial compression and bending. The maximum stresses are neither pure compression stresses nor pure bending stresses, but a combination of the two types. (For explanation of difference between the two types of stresses, see p. 30.) The proportion of the bending stress to the compression stress entering into the make-up of the maximum stress varies. It is 50 per cent or less of the total stress for condition of loading where no tension is developed in the section, and more than 50 per cent in columns where considerable tension is developed. The allowable compressive unit stress in the two cases should be different and should be fixed according to the proportion of the two types of stresses. The authors' recommendation is based upon this principle.

*Authors' Recommendations.*—For members subjected to axial compression and bending, the maximum compressive unit stress should not exceed values given below.

(a) When the whole section is under compression or when only negligible tension is developed, the maximum compressive unit stress should not exceed 1.4 times the allowable unit stress for axial compression. With allowable compression stress  $f_c = 0.225 f'_c$ , the combined stress will amount to  $0.315 f'_c$ .

(b) When considerable tension is developed in the section, the maximum compressive unit stress should not exceed the allowable unit stress in bending, namely  $0.4f'_c$ .

*Joint Committee Specifications, 1924.*—The recommendations of the Joint Committee, 1924, are as quoted below:

“Reinforced concrete columns subject to bending stresses shall be treated as follows:

“(a) With spiral reinforcement: The compressive unit stress on the concrete within the core area under combined axial load and bending shall not exceed by more than 20 per cent the value given for axial load by Formula (43).

“(b) With lateral ties: Additional longitudinal reinforcement may be used if required, and the compressive unit stress on the concrete under combined axial load and bending may be increased to  $0.30f'_c$ . The total amount of reinforcement considered in the computations shall be not more than 4 per cent of the total area of the column.

“Tension in the longitudinal reinforcement due to bending of the column shall not exceed 16 000 lb. per sq. in.”

*Cleveland, New York, and Philadelphia Codes.*—Codes of the Cities of Cleveland, New York, and Philadelphia specify that the stresses due to direct stress and bending shall not exceed in the extreme fiber the allowable fiber stress in bending.

**Columns Carrying Crane Loads or Loads on Brackets.**—Columns carrying crane loads or other loads on brackets are subjected to bending moments produced by the eccentric position of the load in respect to the center line of the column.

- Let  $P$  = load on the bracket, lb.;  
 $a$  = distance of point of application of load to center of column, in.;  
 $b$  = depth of bracket measured from center of tension to center of compression;  
 $l, l_1, l_2$  = column dimensions, in.;  
 $M$  = bending moment produced by load  $P$ , in.-lb.;  
 $M_1, M_2, M_3, M_4$  = bending moments in column at points indicated in corresponding figure;  
 $R$  = horizontal reaction, lb.

Then,

*Bending Moment in the bracket Due to Load, P,*

$$M = Pa. \dots \dots \dots (49)$$

For cranes, the load,  $P$ , should be computed when the crane is in the most unfavorable position as far as the column in question is concerned. Sufficient allowance should be made for impact.

The bending moments produced in the column by the bending moment,  $M$ , depend upon the end condition in the column, and also upon the position of the bracket on the column.

The following conditions are possible:

- (1) Column fixed at the bottom and free at the top. The column is subjected to a bending moment equal to  $M = Pa$  for its whole length below the brackets. (See Fig. 155 (1).)

- (2) Column hinged at both ends. (See Fig. 155 (2).)

*Horizontal reaction, top and bottom,*

$$R = P \frac{a}{l} \dots \dots \dots (50)$$

Moment above bracket,

$$M_1 = P \frac{a}{l} l_2 \dots \dots \dots (51)$$

Moment below bracket,

$$M_2 = - P \frac{a}{l} l_1 \dots \dots \dots (52)$$

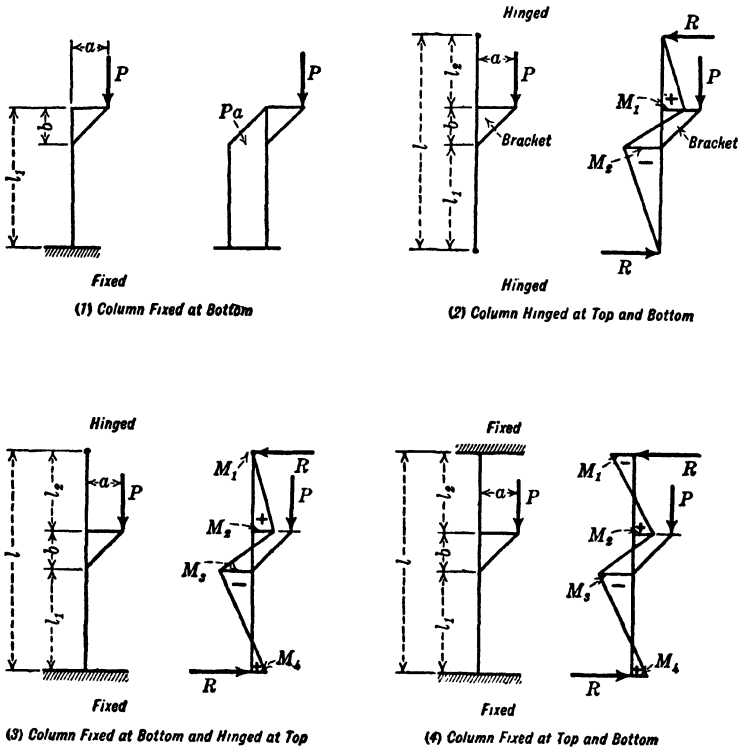

FIG. 155.—Columns Carrying Loads on Brackets. (See p. 464.)

(3) Column hinged at the top and fixed at the bottom: (See Fig. 155 (3)).

Horizontal reaction, top and bottom,

$$R = \frac{1}{2} P \frac{a}{l^3} [3(l^2 - l_2^2) - b(3l_2 + b)] \dots \dots \dots (53)$$

*Moments,*

$$M_1 = 0; \dots \dots \dots (54)$$

$$M_2 = + Rl_2; \dots \dots \dots (55)$$

$$M_3 = - Pa + R(l_2 + b); \dots \dots \dots (56)$$

$$M_4 = - Pa + Rl. \dots \dots \dots (57)$$

(4) Column fixed at top and bottom: (See Fig. 155 (4).)

*Horizontal reaction, top and bottom,*

$$R = 3P \frac{a}{l^3} [- l(2l_2 + b) + l_2^2 + (l_2 + b)^2]; \dots \dots (58)$$

*Moments,*

$$M_1 = - P \frac{a}{l^2} [l^2 - (2l_2 + b)(2l - l_2) + (l_2 + b)^2]; (59)$$

$$M_2 = M_1 + Rl_2; \dots \dots \dots (60)$$

$$M_3 = M_1 + R(l_2 + b) - Pa; \dots \dots \dots (61)$$

$$M_4 = P \frac{a}{l^2} [l^2 - (2l_1 + b)(2l - l_1) + (l_1 + b)^2]; \dots (62)$$

also

$$M_4 = M_1 + Rl - Pa = M_3 + Rl_1. \dots \dots \dots (63)$$

**Simplified Formulas.**—The above formulas may be simplified without appreciable error by assuming the depth of bracket, *b*, equal zero. The formulas change to:

(1a) Column fixed at the bottom, free at the top.

Formulas same as for case (1).

(2a) Column hinged at both ends. (See Fig. 156 (2a).)

*Horizontal reaction, top and bottom,*

$$R = P \frac{a}{l}. \dots \dots \dots (64)$$

*Moment above bracket,*

$$M_1 = Rl_2. \dots \dots \dots (65)$$

*Moment below bracket,*

$$M_2 = - Rl_1. \dots \dots \dots (66)$$

(3a) Column hinged at the top and fixed at the bottom.

(See Fig. 156 (3a).)

*Horizontal reaction, top and bottom,*

$$R = 1.5P \frac{a}{l} \left( 1 + \frac{l_2}{l} \right) \dots \dots \dots (67)$$

*Bending moments,*

$$M_1 = 0; \dots \dots \dots (68)$$

$$M_2 = + Rl_2; \dots \dots \dots (69)$$

$$M_3 = - Pa + Rl_2; \dots \dots \dots (70)$$

$$M_4 = - Pa + Rl. \dots \dots \dots (71)$$

(4a) Column fixed at top and bottom. (See Fig. 156 (4a).)

*Horizontal reaction, top and bottom,*

$$R = 6P \frac{a}{l} \frac{l_1 l_2}{l^2}. \dots \dots \dots (72)$$

*Bending moments,*

$$M_1 = - Pa \left[ 1 - 4 \left( \frac{l_2}{l} \right) + 3 \left( \frac{l_2}{l} \right)^2 \right]. \dots \dots (73)$$

$$M_2 = M_1 + Rl_2; \dots \dots \dots (74)$$

$$M_3 = M_1 + Rl_2 - Pa; \dots \dots \dots (75)$$

$$M_4 = M_1 + Rl - Pa = M_3 + Rl_1. \dots \dots (76)$$

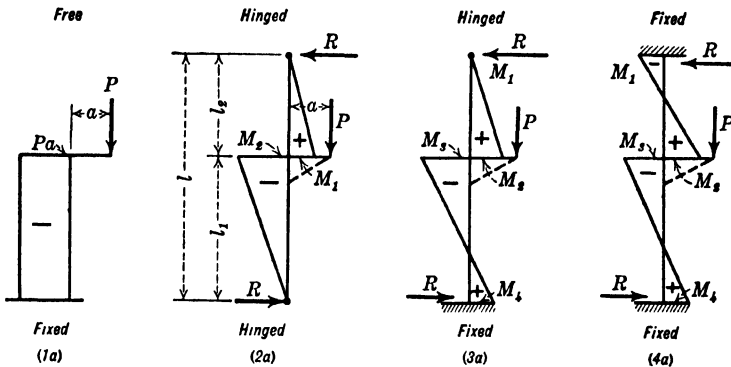

FIG. 156.—Columns Carrying Load on Brackets,  $b = 0$ . (See p. 466.)

The case of a rigid frame with crane brackets is treated in Volume II.

The first condition occurs: (a) when a post is firmly anchored to a heavy foundation; (b) when a column extends above the floor and is held sufficiently at the floor level, but has no support at the top capable of resisting a horizontal reaction; (c) when a post is imbedded in firm ground well tamped but is free at the top. In the last case, the stability of the post depends upon the resistance of the soil to compression. The post compresses the earth on the side





## CHAPTER VIII

### FOUNDATIONS AND FOOTINGS

Concrete excels as a material for foundations. Since the design of a foundation is governed not only by the weight of the superstructure, but also by the character of the supporting work or soil, this chapter includes a brief discussion of the method of determining the carrying capacity of soil and of the allowable soil pressures.

The method of designing concrete is given in detail.

The treatment of piles is discussed in Chapter IX.

#### DETERMINATION OF CARRYING CAPACITY OF SOIL

It is of prime importance for the safety of the structure that the foundation be designed with proper consideration for the conditions of the supporting soil. The character of the soil, therefore, must be carefully investigated. The most common methods are: wash borings, diamond drill borings, and test pits. **Wash borings** are made by driving a small pipe, up to 4 in. in diameter, and working a water jet inside of the pipe. The record of the material brought up to the surface gives a fair idea of the composition of the ground. The results, however, are not always sufficiently reliable, as the material is affected by the water. For more accurate investigation, **Diamond drill borings** are used. These are made by a sharp, hollow cutter which cuts through the soil and brings out a core of the material through which it passes. This gives reliable information on the conditions of the soil and the depth of the various layers. *Borings, to be of any value, must be made by experienced operators.* **Test pits**, as the term implies, consist of pits dug in the ground. This method of exploration is too expensive where the character of the soil varies appreciably from point to point, as it requires a large number of test pits. It is restricted to shallow excavations. Test pits are often used in combination with borings, for more thorough investigation. After borings are made, the most important places are selected on the basis of the borings, for test pits.

Results of the borings should be shown on the foundation drawings, to serve as a guide for determining the size of the foundation. Many building codes require such a record as a part of the foundation plans. In addition to the borings, investigation should be made of the type of foundation used in the buildings in the immediate vicinity. In some cases, the information gained from the borings and from prior experience will limit the choice to one or two types of foundation. Often there is considerable latitude in the choice of foundation. This is the case when the layers of the materials composing the ground increase in hardness with the depth.

For instance, if a layer of sand is underlaid by clay, which in turn rests on hardpan and rock, each of these layers could carry the foundation with an allowable unit pressure suitable for the particular soil. The question of depth is determined by relative economy. By going deeper, to a soil with large allowable soil pressure, the size and the cost of the footing would be decreased, but the cost of excavation would be increased. When there is danger of encountering water, it is cheaper to use larger footings on a higher layer than to go down to more solid ground. In many cases, however, the size and importance of the structure are such that a foundation in unyielding soil is required and the footings are carried to hardpan or rock even when support could have been obtained higher at smaller cost. This is done because in compressible soils some settlement is unavoidable, and even with carefully designed and properly proportioned foundation it may be impossible to prevent uneven settlement.

Sometimes it is found that a harder stratum of soil lies above much softer ground. In such a case, the foundation, if built on the upper layer, must be proportioned to the capacity of the underlying softer material.

### BEARING POWER OF SOILS

As a general rule, a foundation should not be built on soil containing organic matter, such as loam, nor on filled or made ground. It should be built on firm undisturbed soil and should be of such dimensions that the allowable bearing on the soil is not exceeded.

The sustaining power of soil depends upon its composition, the amount of water which it contains or is likely to receive, and the degree to which it is confined. Since the conditions vary in different localities, the allowable pressure on soils of the same name, as estab-

lished by experience, varies to some extent. It is always advisable to be guided by the experience obtained in laying other foundations in the vicinity where the building is to be erected.

The maximum allowable bearing values on soil, as specified by the Building Code of Boston, may be used as a guide in designing the foundation. These are selected because the nomenclature used in describing the soil is well defined, and the values have been arrived at as a result of broad engineering experience and numerous tests.<sup>1</sup>

Solid ledge rock . . . . .	100 tons per sq. ft.
Shale and hardpan . . . . .	10 tons per sq. ft.
Gravel, compact sand, and hard yellow clay . . .	6 tons per sq. ft.
Dry or wet sand of coarse or medium-sized grains, hard blue clay mixed or unmixed with sand, disintegrated ledge rock . . . . .	5 tons per sq. ft.
Medium stiff or plastic clay mixed or unmixed with sand, or fine-grained dry sand . . . . .	4 tons per sq. ft.
Fine-grained wet sand (confined) . . . . .	3 tons per sq. ft.
Soft clay protected against lateral displacement.	2 tons per sq. ft.

*Definitions.*—(a) Solid ledge: Naturally formed rock, such as the granites and others of similar hardness and soundness, normally requiring blasting for their removal.

(b) Shale: Laminated slate or clay rocks, removable with more or less difficulty by picking.

(c) Hardpan: A thoroughly cemented mixture of sand and pebbles, or of sand, pebbles and clay, with or without a mixture of boulders, and difficult to remove by picking.

(d) Gravel: A natural uncemented mixture of coarse or medium grained sand with a substantial amount of pebbles measuring one-fourth of an inch or more in diameter.

(e) Sand (compact): Requiring picking for its removal.

(f) Sand (loose): Requiring shoveling only.

(g) Sand (medium grain): Individual grains readily distinguishable by eye though not of pronounced size.

(h) Sand (fine-grained): Individual grains distinguished by eye only with difficulty.

(i) Hard clay: Requiring picking for its removal.

<sup>1</sup> Of particular interest are the investigations by Mr. Joseph R. Worcester, the results of which are published in *Journal, Boston Society of Civil Engineers*, January, 1914, p. 19.

(j) Disintegrated ledge rock: Residual deposits of decomposed ledge.

(k) Medium clay: Stiff and plastic but capable of being spaded.

(l) Soft clay: Putty-like in consistency and changing shape readily under relatively slight pressure.

If part of a structure rests upon unyielding soil, such as ledge rock or hardpan, and the rest on yielding soils, the allowable unit bearing value for the yielding soils should be reduced by from 50 to 30 per cent, the higher percentage to be used for soils with 2-ton capacity and the lower for soils with 6-ton capacity. The reason is obvious. Rock and hardpan are practically unyielding, and no settlement of the footings resting on them would take place. The footings resting on softer soils normally are expected to have some settlement. The structure resting partly on one and partly on the other material, therefore, would be subjected to unequal settlement. To avoid this, the normal settlement is reduced by reducing the allowable unit pressure for the yielding soil.

#### GENERAL RULES OF DESIGN

##### **Excessive and Unequal Settlement Must be Guarded Against.—**

In designing foundations, the following facts must be borne in mind:

(1) In yielding soils (everything softer than hardpan) some settlement of foundation is almost unavoidable.

(2) The possibility of settlement should be reduced as much as possible by the use of conservative unit pressures.

(3) The foundation should be designed so that the settlement, if any, will be uniform, i.e., that all footings will settle approximately the same amount.

The last requirement is of particular importance in reinforced concrete structures on account of the rigid connection between various parts of the structure. Uniform settlement, even of appreciable amount, does not produce any stresses in the members composing the structure. When there is unequal settlement, however, i.e., when part of the structure settles more than the rest, even if the settlement is of small amount, stresses of a character and magnitude not anticipated by the design are produced in the various members of the frame. In extreme cases, the settlement of one portion may result in the failure of the structure.

The first requirement will be satisfied by selection of the proper

allowable unit pressure on the soil and of an area of footing large enough to prevent the load from producing a pressure exceeding this. To satisfy the requirement for uniform settlement, it is necessary to proportion the area of each footing strictly according to the load the column resting on it is expected to carry. Often, for the sake of simplicity or appearance, columns carrying different loads are made of the same size, the size being determined for the largest column load. In designing footings, this is not permissible unless the difference in loading is inappreciable. The use of the same area of footing for columns carrying appreciably different loads may mean unequal settlement. This, of course, does not apply where the footings are carried to rock or hardpan and where no settlement is expected.

As a general rule, a new structure should not rest anywhere on an old foundation unless both the old and the new structures rest on unyielding soil. When future extension of a structure is expected, the outside footings are sometimes made large enough to support the future column load. In non-compressible soils, this would be permissible. In yielding soils, it often causes unequal settlement and more or less harmful effect, since the footings with provision for future loads are larger in proportion than the adjoining footings, which are designed only for the load they are now expected to carry. The end row of columns, where provision is made for future extension, would settle less than the rest of the structure; and cracks, of a size depending upon the amount of settlement, would be produced in the end panels. After the expected addition is built, another case of unequal settlement may occur, as the new footings may settle more than the old footings, which by that time may have settled to a standstill.

**Proportioning Area of Footing.**—The area of the footing is obtained by dividing the load by the allowable unit pressure on the soil. There are several methods of accomplishing this.

*Footings Proportioned for Dead Plus Full Live Load.*—The most common method of determining the area of the footing is by dividing the full column load, plus the weight of the footing, by the allowable unit pressure. No distinction is made in such cases, between the effect of the dead load and that of the live load on the settlement of the foundation.

*Footings Proportioned for Dead Load Only.*—In this method, a distinction is made between the effect of the dead load and that of the live load. It has been observed, in compressible soils, that the

rate of settlement is large at first and then decreases as the soil becomes compressed. In many cases, a large part of the settlement takes place while the structure is in process of construction and when it carries only the dead load. The effect of the dead load is thus larger than the effect of the total dead and live load, because the live load does not come until some time after the completion of the building. In many buildings, full loading with live load is never attained. In ordinary structures, the ratio of the dead load to the total load is much larger for outside columns than for interior columns. If the area of footings is based on the total live and dead load, and most of the settlement is produced by the dead load only, it follows that the exterior columns will settle more than the interior columns. To prevent for this, some engineers and also some building codes (notably that of the City of New York) require that, if for different columns in a building the ratio of live load to dead load varies, the areas of footings be computed on the basis of the dead load only, by dividing the dead load by a reduced soil pressure obtained in the manner given below. The loads on the foundation for the various columns are tabulated, and the dead and live loads are kept separate. The column that has the largest ratio of live load to dead load is then selected. For this column, the area of the footing is computed by dividing the total dead and live load by the maximum allowable soil pressure. The reduced pressure to be used in proportioning the areas of the remaining footings is then found by dividing the dead load for this column by the area just determined. The areas of other footings are finally obtained by dividing the dead loads carried by the footing by this reduced pressure. The following example illustrates this method:

It is desired to determine the size of footings for Columns 1 to 3, carrying loads given in table below, for a maximum allowable soil pressure of 6 000 lb. per sq. ft.

Column	Dead Load (Including Weight of Footing), lb.	Live Load, lb.	Total lb.	Ratio Live to Dead Load
1	200 000	400 000	600 000	2 00
2	150 000	200 000	350 000	1.33
3	220 000	200 000	420 000	0.91

In the table above, Column 1 has the largest ratio of live load to dead load; hence Column 1 is used for the determination of the reduced soil pressure. The required area for this column, for a maximum allowable soil pressure of 6 000 lb. per sq. ft., is 600 000 divided by 6 000, equals 100 sq. ft. The dead load of 200 000 lb., divided by the above area of 100 sq. ft. gives a unit pressure of 2 000 lb. per sq. ft., which is used as the *reduced pressure* on the foundation. The areas for the remaining footings are found by dividing their dead loads by this reduced pressure of 2 000 lb.

Column	Dead Load, lb.	Footing Areas	
		Dead Load Divided by Reduced Pressure, sq. ft.	Total Load Divided by Maximum Allowable Pressure
1	200 000	100	100
2	150 000	75	58
3	220 000	110	70

In the table just above, the dead loads of Columns 1 to 3 and the areas of footings computed on the basis of dead load only, using the reduced pressure, are given. The areas of footings that would have been obtained if computed by dividing the total load by the maximum allowable unit pressure are also given, for comparison.

After the areas are obtained, the stresses in the footings should be determined on the basis of the total dead and live load, but exclusive of the weight of the footing.

*Footings Proportioned for Dead Load Plus Fraction of Live Load.*—Some engineers vary the above method by proportioning the area of the footings, not for the dead load only, but for the dead load plus a fraction of the live load (usually one-third to one-half). The procedure is similar to that explained above. The area of the footing is found for the column with the largest ratio of live load to dead load, by dividing the total load by the maximum allowable pressure. Then the reduced unit pressure is computed by dividing the dead load, plus the selected fraction of live load, by the area. In determining the areas of the remaining footings, the dead load, plus the same fraction of the live load, is divided by the reduced unit pressure. This method is recommended by the authors.

**Footings Must be Concentric with the Column.**—To get uniform distribution of column load on the soil, the footing must be built so that its center of gravity will coincide with the theoretical point of application of the downward load. For independent footings, under concentrically loaded columns, this means that the area of the footing must be symmetrical and its center of gravity must coincide with the center of gravity of the column. With a pile foundation, the center of gravity of the cluster of piles must coincide with the center of the column. If these conditions are not fulfilled, the pressure on the foundation will not be uniform, and overloading of certain portions, with consequent unequal settlement, will be induced.

**Eccentric Footings.**—Footings for walls and columns on the property line are sometimes made with a projection on the inside only. The center of gravity of such footings does not coincide with the center of the column. The pressure is eccentric, and the distribution may be found as explained on p. 170. The maximum unit pressure is much larger than if the pressure were uniformly distributed. For an eccentricity equal to one-sixth of the width of the footing, the maximum pressure at outside of wall is double the average pressure and is zero at the other edge. Such design, obviously, is not permissible for columns carrying loads of any magnitude. It may be used only for walls carrying comparatively small loads, when they are kept from leaning outward by the pressure of the earth behind the wall. The active earth pressure, together with the passive resistance, may then be sufficient to offset the eccentricity.

Attempts are sometimes made to offset the effect of eccentricity on the foundation by making the connection between the column and the footing rigid and designing the column strong enough to resist a bending moment equal to the column load multiplied by the distance of the center of gravity of the column from the center of the footing. However, no attempt is made anywhere to balance the bending moment supposedly developed in the column. Such procedure is, obviously, insufficient. It is clear that it is not possible to develop bending in a column unless it is held rigidly somewhere, and unless the connection is strong enough to balance the same bending moment.

For instance, the bending moment produced in the column may be transferred to the floor construction. The floor beam in the first floor would then have to be strong enough to resist this bending



moment. This is not practicable for large column loads or large eccentricities, as it would require excessive strength in the beams. The combined footing, or cantilever footing, described on p. 522, offers a better solution.

It is often stated, in defense of eccentric footings, that the column load gradually spreads itself, so that by the time it reaches the ground it acts centrally on the footing. The unsoundness of this argument is evident. The column load cannot change its center of gravity by distributing itself to the foundation. Only an additional force could change its position. Even if the pressure should be uniformly distributed on the foundation, there would still remain the unbalanced bending moment produced by the load acting on the top of the column and the upward reaction at the bottom acting eccentrically in respect to the column load. This bending moment would turn, or tend to turn, the structure, even if the column and footing were perfectly rigid.

**Proper Design of Foundation at Property Line.**—When the building line coincides with the property line, the foundation must be placed within the building lines. In such cases, it is often impossible to build the footings for the wall columns concentric with the columns. To prevent eccentric pressure on the foundation, the footing for the wall column may have to be combined with the interior footing, see Fig. 173, p. 530, or the eccentricity taken care of by a strap beam extending from the wall column footing to the interior footing. The design of several types of such footings is given on pp. 533 and 538. For combined footings, it should be remembered that the center of gravity of the loads must coincide with the center of gravity of the foundations.

Sometimes, when the footings consist of caissons or caisson piles, it is necessary to place them some distance within the building line. Then the wall column, if placed at the building line, must be carried on a cantilever formed by extending the strap beam between the wall column and the interior column.

**Anchoring.**—In structures such as chimneys, narrow buildings, towers, trestles, and viaducts, the foundation must be designed with due consideration of the lateral wind pressure. If there is any possibility of uplift, the structure must be anchored to the foundation; and the weight of the foundation block, plus that of the earth above, must be sufficient to counteract the uplift with a proper factor of safety.

**Minimum Depth of Foundations for Outside Columns.**—Foundations for outside footings of a building, in localities affected by frost, must be carried below the frost line. In the vicinity of New York City, 3 to 4 ft. below ground level is considered ample.

Footings on lines abutting adjoining property are often carried to a depth of, say, 9 to 10 ft. below established grade, in order that they may not be disturbed by possible excavations on the abutting property. According to law, in case of excavation on adjoining lot, the owner of the existing building is required to support his foundation if it does not extend to the depth below grade, usually 9 to 10 ft., established by law.

**Encroachment on Public Streets.**—Before designing a foundation on the line of a building adjoining the street, it is necessary to investigate the local regulations. Some cities grant permission to encroach with the foundation under the street or sidewalk, so that it is possible to use concentric footings for wall columns. The distance of permissible encroachment is usually governed by the depth of foundation. In Chicago, for instance, permits are issued for foundations projecting into the street, according to the depth, for as much as 3 ft. at an 8-ft. level below grade, with the express understanding however, that any foundation less than 20 ft. below city datum shall be removed by the owner if it interferes with projected public works, such as sewers, subways, etc.

New York, on the other hand, does not allow any encroachment with foundations, although it allows some encroachment with such parts of the building the removal of which would not affect the stability of the building.

**Loads Used in Design of Foundation.**—The size of foundation is computed by dividing the load by the allowable soil pressure, as explained on p. 473. The load used in the determination of the area of the foundation or footing is the total load coming on the column carried by the foundation, plus the dead load of the foundation and the basement wall, if any. The same reduction in live load is permissible for the footings as is allowed in column design. (See p. 453.)

In computing stresses in the foundation, due to bending, the dead load of the footings and walls must not be included, as they produce no bending moments or shears in the foundation.

**How Stresses are Developed in Concrete Footings.**—Footings are generally designed for the upward reactions of the soil or of the piles supporting the footing. Since the upward reactions are not

active forces, the manner in which they produce stresses in the footing is not always understood. Obviously, the ground is not likely to rise in order to deflect the footings, and without deflection there can be no stresses.

The following explanation will make the matter clear. The column load coming on the footing is not distributed evenly over the whole foundation. At first, a large portion of the load comes directly under the column. This tends to produce, and actually does produce, a small settlement of the footing directly under the column. If the column were not connected with the footing the settlement would continue until the ground compressed sufficiently to hold the load. Since the column is connected with the footing, the incipient downward movement of the column produces shear in the adjacent sections and forces them down, although to a slightly less degree because of the bending produced. These sections in turn bring their neighboring sections into play, so that finally the whole footing presses on the earth and the whole footing settles. The amount of settlement is less at the edge than in the center, therefore, the footing assumes the shape of a curve of the same nature as the curve that would have been produced if the reactions of the ground were active pressures and were carried by the column as a support.

When a footing fails, it does not mean that the reactions of the soil move the footing upward, but that the projecting footing is not able to hold the column itself from settlement. The column settles, while the projections of the footing, instead of following the column, break away from it, as is evident from Fig. 157, p. 479.

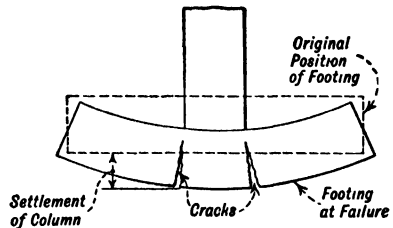

FIG. 157.—Failure of Footing.  
(See p. 479.)

**Footings Must be not only Strong Enough but also Rigid.**—From the foregoing discussion, it is evident that the footing not only must be strong enough to resist the upward reactions, but must be rigid enough to prevent the deflection under the reactions from becoming too great. It is obvious that if a projection of a footing under a loading equal to the reaction of the soil can deflect  $\frac{1}{2}$  in., then, conversely, the column would have to settle  $\frac{1}{2}$  in. before the whole footing would be brought into play. With a flexible footing,

the pressure would not be uniformly distributed over the foundation, but would be a maximum under the column and a minimum at the edges. The difference between maximum and minimum pressures increases with the flexibility of the footing.

### PLAIN CONCRETE FOOTINGS

The simplest type of footing consists of a plain concrete slab or block, the base of which is determined by the allowable unit pressure on the soil, and the depth determined by strength of concrete. For walls, for instance, the footing may consist of projections on both sides of the wall, as shown in Fig. 158*a*, p. 480. For a column, an independent footing, of a design shown in Fig. 158, *b* and *c*, may be

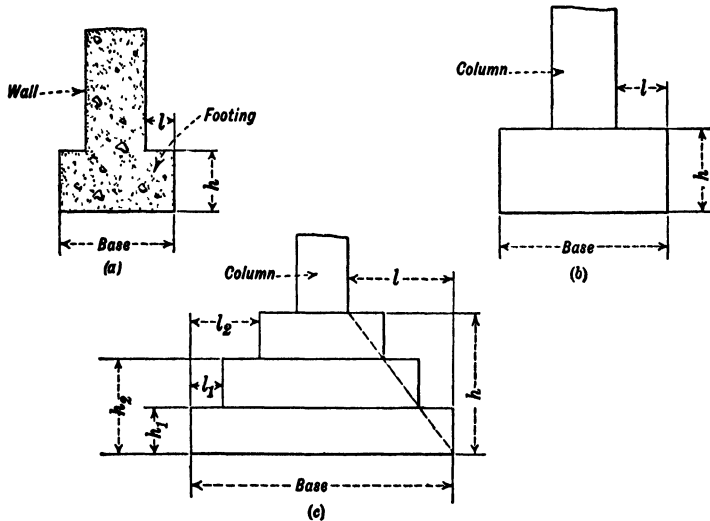

FIG. 158.—Plain Concrete Footing. (See p. 480.)

used. If the projections of the footing from the face of the column are small, the design in Fig. 158*b* may be used. Where the depth and the projections of the footing are large, the cost may be decreased by stepping it, as shown in Fig. 158*c*.

The area of the base of a footing is determined by dividing the superimposed load by the allowable unit pressure on the soil. The depth of the projections is obtained by figuring them as cantilevers loaded by the reaction of the soil and supported by the column.

The critical sections should be assumed at the face of the wall, column, or pedestal, and in stepped footings also at the face of each successive step. The ratio of the height of the projection to its length is governed by the allowable tensile stresses in plain concrete and the magnitude of the upward pressure. The table below gives the depth of the footing,  $h$ , expressed in terms of the length of the projection,  $l$ , for various unit pressures on soil and for an allowable tensile stress in concrete of 60 lb. per sq. in., the unit stress recommended for use in foundations. In a stepped footing, the depths  $h$ ,  $h_1$ , and  $h_2$ , corresponding to lengths of projections  $l$ ,  $l_1$  and  $l_2$ , respectively, should be taken from the table.

**Required Depth  $h$ , of Plain Concrete Footing in Terms of Length of Projection,  $l$**

Unit Pressure on Foundation, in Lb. per Sq. Ft.									
	2 000	3 000	4 000	5 000	6 000	7 000	8 000	9 000	10 000
$h$	0 8 <i>l</i>	1 0 <i>l</i>	1.2 <i>l</i>	1 3 <i>l</i>	1 5 <i>l</i>	1 6 <i>l</i>	1.7 <i>l</i>	1.8 <i>l</i>	1.9 <i>l</i>

The table assumes that the whole footing acts as a unit. This is the case only when the whole depth of the footing is poured in a continuous operation.

**REINFORCED CONCRETE FOOTINGS**

To distribute the column load over a large area of the ground without carrying the foundation in successive steps to a considerable depth and using a large mass of concrete, the foundation may be built of reinforced concrete. Reinforced concrete footings utilize the compressive strength of the concrete and therefore are more economical than the I-beam type of design formerly used.<sup>2</sup>

Reinforced concrete footings may be divided into five groups: (1) wall footings; (2) independent column footings of rectangular or square shape; (3) combined footings carrying more than one column; (4) cantilever or strap footings; (5) raft foundation.

<sup>2</sup> See Second Edition of "Concrete, Plain and Reinforced," page 643.

## WALL FOOTINGS

A wall footing, as a rule consists of a slab projecting the required distance on both sides of the wall as cantilevers. For small projections, it is most economical to use plain concrete wall footing, in which case the ratio of the length of the projection to the depth should be taken from table on p. 481. If the projections are large, it is cheaper to reinforce the footing. In figuring bending moments, each portion should be considered as a cantilever with the critical section at the face of the wall. The reinforcement, determined from the bending moment in the usual fashion, consists of bars placed at the bottom of the footing at right angles to the wall.

Special attention must be paid to bond stresses. The depth of the footing and the diameter of the bars must be such that the unit bond stress, based on the total external shear and determined by formulas given on p. 262, does not exceed the allowable unit stress. It is advantageous to use bars of small diameter. The use of deformed bars is advisable.

Diagonal tension also must be considered (see p. 247). As a basis for figuring the diagonal tension, the shear is taken, figured at a distance from the wall face equal to the effective depth of the footing. It is preferable to design the wall footings of such dimensions as to avoid the use of diagonal tension reinforcement.

In stepped footings, the steps must be of such depth that at no point of the footing the tensile stresses in steel, the bond stresses, or the diagonal tension in the concrete will exceed the allowable working unit stress.

**Example of Reinforced Wall Footing.**

**Example 1.**—Design a footing for a concrete wall 10 feet high, 14 inches thick, carrying a concentric superimposed load of 26 500 lb. per lin. ft. The allowable pressure on the soil is 5 000 lb. per sq. ft. The allowable stresses are  $f_c = 650$ ,  $f_s = 16\ 000$ ,  $n = 15$ ,  $u = 100$  and  $v = 40$ .

*Solution.*—The weight of wall is  $10 \times \frac{14}{12} \times 150 = 1\ 750$  lb. per lin. ft. and the assumed weight of footing 950 lb. per lin. ft. Since the wall carries a load of 26 500 lb. per lin. ft., the total load on foundation is  $26\ 500 + 1\ 750 + 950 = 29\ 200$  lb. With an allowable unit soil pressure of 5 000 lb., the footing requires an area equal to  $29\ 200 \div 5\ 000 = 5.84$  sq. ft. per lin. ft. of wall. A continuous footing 5 ft. 10 in. wide will be accepted. This gives a projection  $l = 2$  ft. 4 in. on each side of the wall. If plain concrete were used, the required depth of the projection would be 3 ft. because, from table on p. 481, for unit pressure of 5 000 lb.,  $h = 1.3l = 1.3 \times 2.33 = 3.03$  ft.

**Depth of Reinforced Concrete Footing.**—The total upward resisting pressure is 5 000 lb. per sq. ft. From this the weight of the footing may be deducted, leaving a net upward pressure of 4 840 lb. per sq. ft. The shear at the edge of the wall is  $2.33 \times 4\,840 = 11\,290$  lb. per lin. ft. The required depth for punching shear, for an allowable unit punching shear of 120 lb. per sq. in., is  $d = \frac{11\,290}{12 \times 120} = 7.85$ . This depth is less than required for other stresses. In wall footings, punching shear does not need to be considered.

The cantilever is 2 ft. 4 in. long and loaded with 4 840 lb. per sq. ft. The bending moment, therefore, is  $M = 2.33 \times 4\,840 \times 14 = 158\,000$  in.-lb. per lin. foot. The required depth, using the slab formula on p. 208 ( $d = 0.028\sqrt{M}$ ),  $d = 0.028\sqrt{158\,000} = 11.13$  in. This depth to steel is larger than required for punching shear and will be tried.

**Area of Steel.**—Using  $f_s = 16\,000$  lb. per sq. in.,  $d = 11.13$  in.,  $j = 0.875$ , the area of steel from formula is,  $A_s = \frac{M}{f_s j d}$ .

$$A_s = \frac{158\,000}{16\,000 \times 0.875 \times 11.13} = 1.01 \text{ sq. in. per lin. ft.}$$

$\frac{3}{4}$ -in. round bars spaced  $5\frac{1}{2}$  in. on center give an area of 1.01 sq. in.

**Bond Stresses.**—The external shear at the edge of the wall is 11 290 lb. per lin. ft. With  $\frac{3}{4}$ -in. round bars,  $5\frac{1}{2}$  in. o.c., there are 2.28 bars per foot. The perimeter of a  $\frac{3}{4}$ -in. round bar is 2.36. The perimeters of bars per foot equal

$\Sigma o = 2.28 \times 2.36 = 5.38$  sq. in. and the bond stress from formula  $u = \frac{V}{\Sigma o j d}$ ,

$$u = \frac{11\,290}{5.38 \times 0.875 \times 11.13} = 215 \text{ lb. per sq. in.}$$

The bond stress is too large. To reduce it, any of the following methods may be used: (1) smaller bars may be used; (2) area of steel may be increased and same depth retained; (3) depth of footing may be increased and same area of steel retained; (4) bars may be provided with hooks (sec p. 263). Any combination of the methods may be used.

In this case, the first method will be tried. Five-eighth inch round bars  $3\frac{1}{4}$ -in. on centers (3.70 bars per foot) will be substituted for  $\frac{3}{4}$ -in. round bars  $5\frac{1}{2}$  in. o.c. This gives an area of steel per foot of wall  $0.307 \times 3.70 = 1.13$  sq. in. The perimeter of a  $\frac{5}{8}$ -in. round bar is 1.96 in. The perimeter of bars per foot is  $\Sigma o = 3.70 \times 1.96 = 7.25$  and the bond stress

$$u = \frac{11\,290}{7.25 \times 0.875 \times 11.13} = 160.$$

This is still too large. As it would not be practicable to use bars smaller than  $\frac{5}{8}$ -in., since their spacing would be too small, it will be necessary to increase the effective depth in the ratio of  $\frac{160}{100}$ , where 160 is the computed stress and 100 the allowable stress. The increased depth is  $11.13 \times \frac{160}{100} = 17.81$ . To this must be added the protective cover. The total depth then is  $17.81 + 3.5 =$

21.31 in. Keeping the same reinforcement, with the increased depth, the unit bond stresses will be reduced to 100 lb. per sq. in. It is obvious that in such a case the full value of the steel in tension is not utilized, but is needed to satisfy the bond requirements.

**Diagonal Tension.**—Diagonal tension will be figured at a section distant from the wall a length equal to the effective depth. (See Fig. 159.) This section is marked 1-1 in the figure. Since the upward unit pressure is 4 840 lb. per sq. ft., the external shear there is  $V = 4\ 840 \times 0.83 = 4\ 020$  lb. and the unit shearing stress,  $v = \frac{4\ 020}{18 \times 0.875 \times 12} = 21.2$  lb. This value is less than the allowable unit shearing stress and the depth is satisfactory.

Final design.

$$d = 18 \text{ in.} \quad h = 21\frac{1}{2} \text{ in.} \quad \frac{5}{8}\text{-in. round bars} \quad 3\frac{1}{4} \text{ in. o. c.}$$

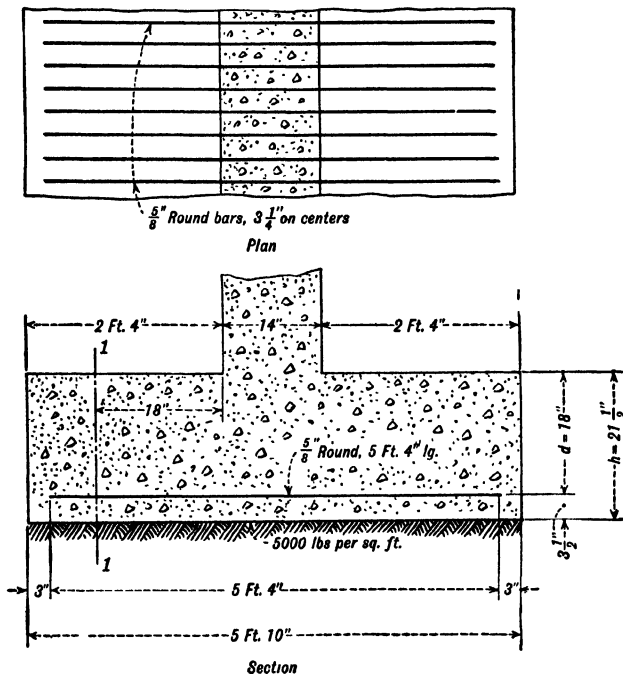

FIG. 159.—Details of Reinforced Concrete Wall Footing. (See p. 484.)

**Stepped and Sloped Wall Footing.**—The diagonal tension computed above is much smaller than the allowable diagonal tension. The thickness of the footing may be reduced at the edges without exceeding the working stresses, either by stepping as in Fig. 160, or



by sloping as in Fig. 161, p. 485. The principle of stepping and sloping is explained thoroughly in connection with independent footings.

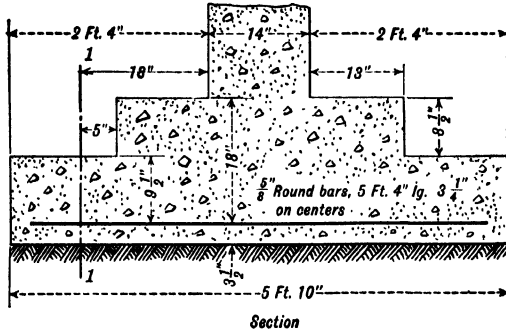

FIG. 160.—Stepped Wall Footing. (See p. 484.)

Sometimes, instead of stepping, the footing is sloped as shown in Fig. 161, p. 485. The slope must be such that the stresses at the intermediate points are not excessive.

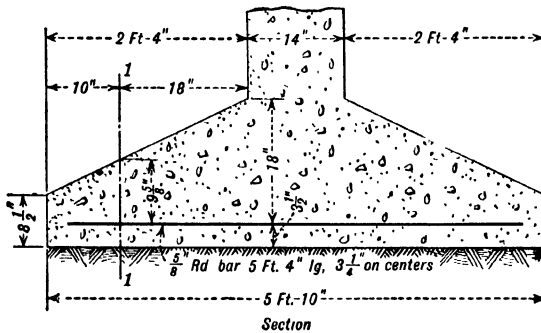

FIG. 161.—Sloped Wall Footing. (See p. 485.)

### INDEPENDENT COLUMN FOOTINGS

Independent column footings are of several types. The simplest type is shown in Fig. 167, p. 504. It consists of a rectangular or square slab of uniform thickness, reinforced in two or four directions. This type is economical only for small loads.

For larger loads, where the required depth is large, the stepped footing is more economical. This design is shown in Fig. 168, p. 507. The sum of the depths of all steps is equal to the required depth for the footing. This footing is designed in the same fashion as the slab type, except that it is necessary to investigate the tensile shearing and bond stresses at each step.

**Pedestals.**—The standard design of footings used by the authors and recommended for general use is provided with a pedestal which reaches from the top of the footing up to the bottom of the basement slab. (See Fig. 162.) The pedestal is of plain concrete and its cross section is sufficient to carry the column load with a unit stress of 450 lb. per sq. in. Since the pedestal is in the ground, no fireproofing

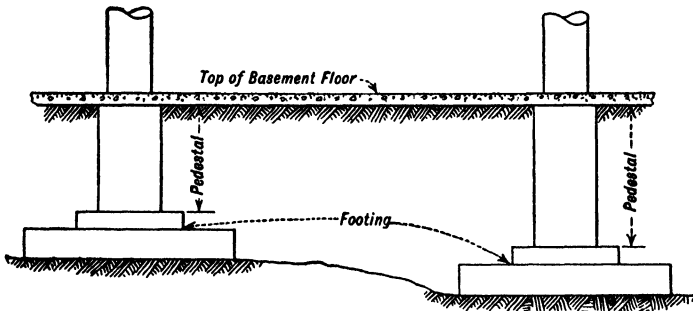

FIG. 162.—Pedestals below Basement Floor. (See p. 486.)

is necessary and its full cross section may be considered as effective. There are three reasons why the use of a pedestal is desirable.

First, having a larger circumference than the column above, it decreases the depth of footing required for punching shear, also the bending moment.

Second, it simplifies the construction when the top of the foundation is some distance below the basement slab, and especially when the tops of the footings for any reason are not on the same level. In such a case, if basement columns were placed directly on the footings, their lengths would vary with the varying distance from the top of the footings to the level of the basement slab. The pedestals are made of such height that their tops reach to the level of the bottom of the basement slab, so that all the basement columns may be made of the same length. The column steel and column forms can then

be made of the same length and can be ordered ahead of time without regard to the depth to which it will be necessary to carry the footings.

Third, when the top of the footing is some distance below the basement, the use of the pedestal is economical because it replaces the expensive highly reinforced column by cheaper plain concrete.

If the ratio of the height of the pedestal to its width exceeds the limit for plain concrete, the pedestal must either be reinforced or its width must be increased. The minimum height of the pedestal must be such that the sum of the depth of the footing and the minimum height of the pedestal is not smaller than required by punching shear at the edge of the column. (For explanation of punching, see p. 492.)

**Dowels.**—Bars, or dowels, of the same number and size as in the column above, should be imbedded in the pedestal or footing. When there is no chance of tensile stresses due to bending in the column, the dowels should extend 30 diameters into the pedestal (or footing) and the same length above the top of the pedestal, to be imbedded in the column. When considerable tension stresses are possible, the length of dowels should be governed by the tensile strength of bar. It is of no importance whether the column bars are placed immediately next to the dowels or whether they are placed a few inches apart. The stress in either case is not transferred directly from the bars to the dowels but through the concrete.

If the column above is of rich mix and spirally reinforced, the stress transmitted to the pedestal at the area of contact may be larger than the allowable bearing stress for plain concrete. (For bearing stresses, see p. 270.) For this reason, it may be advisable to extend the spiral into the pedestal a sufficient distance to gradually transmit the high pressure from the column into the body of the pedestal. Some designers accomplish this object by placing several layers of lateral hoops in the upper part of the pedestal.

**Stepped Footings.**—The bending moments and shears in a footing are a maximum at the edge of the column and decrease toward the ends. Therefore, it is often economical to reduce the thickness of the footing by stepping. To maintain the same factor of safety at all points, the reduction in the depth of the footing should not be larger than the reduction in the stresses. The problem is complicated by the number of stresses to be considered, not all of which decrease in the same ratio. These stresses are: punching shear (if considered), bending moment, bond, and diagonal tension.

Figure 163 (a), (b), and (c), for the three ratios 0.2, 0.3 and 0.4 of width of pedestal (or column) to width of base, illustrates the rate of decrease of the various stresses and may serve as a basis for dimensioning the blocks in stepped footings. In this discussion, the footing is assumed to be provided with a pedestal. If the pedestal is absent, it should be considered as replaced by the column.

In each of the three cases, the depths of footing required by punching shear, by the bending moments, and by the bond stresses (the measure of which is the external shear) were computed at various points and plotted in the diagram. To get a direct comparison between the rates of decrease, the maximum values were accepted as a unit and the intermediate values as fractions of this unit. The variation of each item is shown by the curves starting at the edge of the pedestal from a common point.

From the figures, it will be noted that the bending moments and the depths required by punching shear decrease in about the same ratio. The external shear, however, which is the measure of the bond stresses, decreases much more slowly. The depth required by diagonal tension is in the same ratio to the depth required by punching shear as the allowable shearing unit stress for plain concrete is to unit punching shear. However, diagonal tension does not need to be considered nearer to the column edge than the depth of the footing (see p. 502). Therefore, it is seldom a determining item.

**Width of Blocks in Stepped Footings.**—The curves showing the variation of stresses and bending moments may be used for the purpose of fixing the width of the blocks. The use of two blocks is recommended, as shown in Figs. 164 and 168. Also, it is assumed that a pedestal, as described on p. 486, is used. The thickness of the bottom block above the level of reinforcement is accepted as six-tenths of the total effective depth, and the thickness of the top block as four-tenths of the total effective depth.

The width of the top block depends upon whether the footing is designed so that the bond stresses are a maximum at the edge of the pedestal or at the edge of the top block. If the bond stresses at the edge of the pedestal are equal to the maximum allowable working stresses, then the external shear curve governs the width of the top block and it must come outside of the shear curve, as indicated by the dash lines.

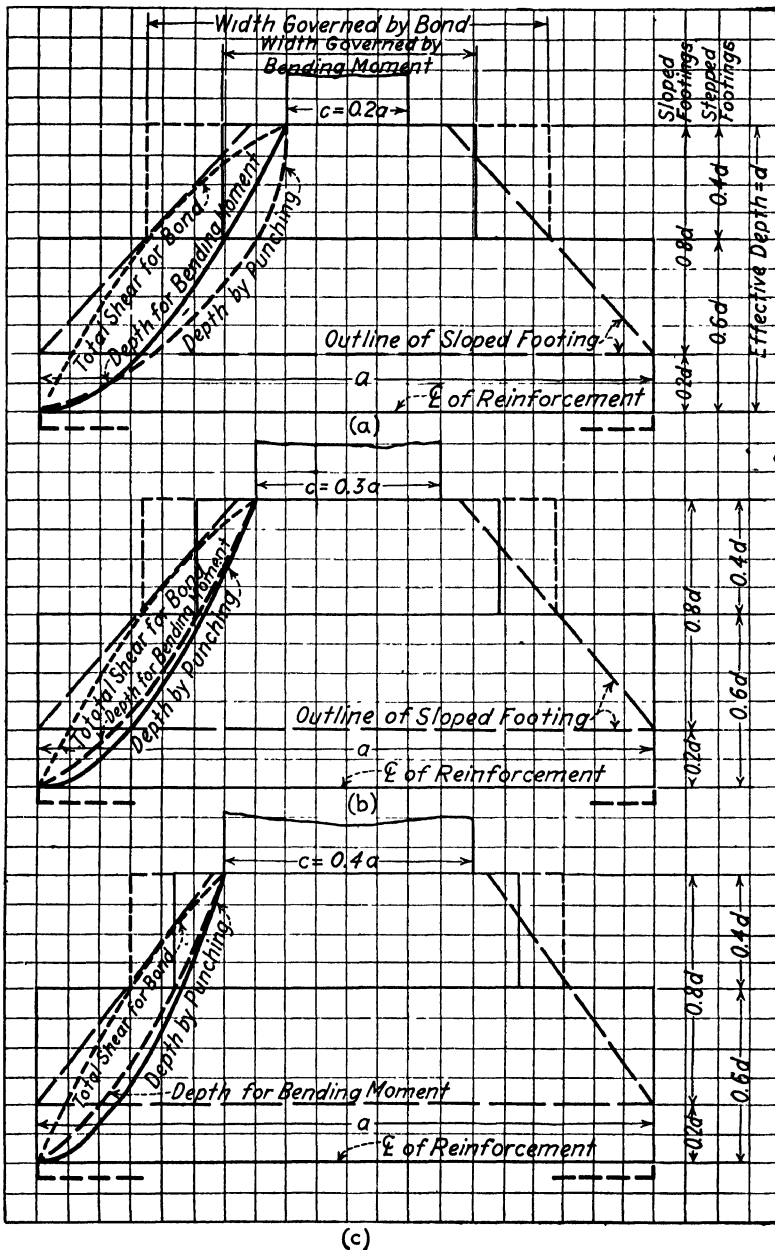

FIG. 163.—Variation of Stresses in Footings. (See p. 488.)

Usually, it is possible to make the top block of the smaller width required by the bending moment curve, and then arrange the steel so that the bond stresses at the edge of the top block do not exceed the allowable unit stresses. In such cases, the bond stresses at the edge of the pedestal will be smaller than the maximum allowable bond stresses. This method should be used, where possible. The amount of steel required at the edge of the top block will be the same as required at the edge of the pedestal, because the reduction in bending moments is the same as the reduction in depth. The width of the top block, determined on this basis, is given in table below.

If more than two blocks are used, their width should be fixed in the same manner as given above.

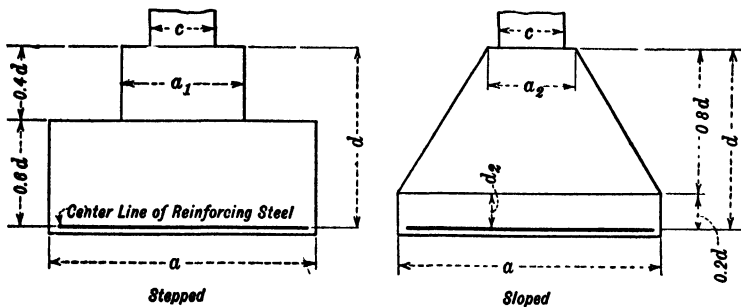

FIG. 164.—Standard Design of Footings. (See p. 490.)

#### Dimensions of Independent Stepped and Sloped Square Footings

Ratio Side of Pedestal to Side of Base, $\frac{c}{a}$	Stepped Footing	Sloped Footing	
	Width of top block, $a_1$ (Fig. 164)	Width at top, $a_2$ (Fig. 164)	Minimum depth above steel, $d_2$ (Fig. 164)
0.10	$0.36a$	$0.30a$	$0.2d$
0.15	$0.38a$	$0.31a$	$0.2d$
0.20	$0.40a$	$0.32a$	$0.2d$
0.25	$0.45a$	$0.34a$	$0.2d$
0.30	$0.50a$	$0.35a$	$0.2d$
0.35	$0.52a$	$0.45a$	$0.2d$
0.40	$0.55a$	$0.45a$	$0.2d$

**Sloped Footings.**—In sloped footings, the area of steel is determined at the edge of the pedestal (or column, if no pedestal is used). As the bond stresses there are likely to be near the maximum allowable value, the slope must be such as not to intersect the shear curve. The slope recommended for use, shown in Fig. 164, p. 490, is tangent to the shear curve.

**Comparison of Sloped and Stepped Footings.**—The sloped footing requires less concrete than the stepped footing. The reduction of stresses in the sloped footing is gradual. In spite of these two advantages, the use of sloped footing is not recommended, because the formwork required is more expensive and its increased cost more than balances any saving in material. Also, during concreting, the forms for sloped footing must be weighted down to prevent their being lifted by the concrete.

With the information given in the above figures and in table on p. 490, it is possible to design a sloped or stepped footing just as easily as a footing consisting of a slab only.

### DESIGN OF INDEPENDENT FOOTING

In designing independent footings, proceed as follows:

Determine the area of base of footing by dividing the column load, plus the assumed weight of the footing, by the allowable unit pressure on the soil. (If the area of base is determined on the basis of dead load only, proceed as explained on p. 473.)

Determine the area of the pedestal.

Determine the depth of footing required by punching shear, using the column load exclusive of weight of footing. (See p. 492 for discussion of punching shear.)

Select the type of footing to be used, i.e., whether single slab, stepped or sloped. The dimensions of stepped or sloped footing may be taken from table on p. 490.

Compute diagonal tension, to determine whether the assumed thicknesses at the various points are sufficient.

Compute the bending moments and the required amount of steel. In stepped footing, this should be done at each step unless the blocks are proportioned as shown in Fig. 164.

Compute bond stresses in steel.

**Explanation of Punching Shear.**—The heavy concentrated load on a column has a tendency to punch through the footing, by producing in it a hole of a size somewhat larger than the section of the column. To prevent this, the depth of the footing must be large enough to keep the punching shear within working limits.

There is a difference of opinion as to the formula to be used in determining the punching shear. Some rules require that punching stresses be computed by formula  $v = \frac{V}{bd}$ , and others by formula  $v = \frac{V}{bjd}$ , where  $V$  is external shear,  $b$  is perimeter of column, and  $d$  is depth to reinforced steel in footing. The former method is more reasonable and is recommended by the authors.

There is also a difference of opinion as to the working unit stresses. Most rules and building codes require that the unit shear in punching

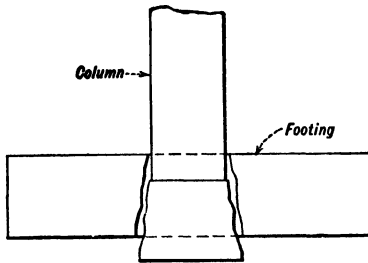

Fig. 165.—Failure Caused by Punching.  
(See p. 492.)

should not exceed the maximum shearing unit stress allowed for diagonal tension in beams with web reinforcement. This, for 2 000-lb. concrete, is usually taken at 120 lb. per sq. in. Recent tests, however, show that the strength in punching is much higher than at first assumed, and that it is practically impossible to cause failure by punching shear because the footing would

fail first from other causes. Therefore, the more modern rules (among them the report of the Joint Committee on Concrete and Reinforced Concrete, 1924) have no provision for computing punching shear. For square and rectangular footings, the general formula given above may be replaced by special formulas.

Since many building codes require computations for punching shear, and since, with proper punching unit stresses, a satisfactory depth of footing is obtained, the computations are retained by the authors and the recommended general formulas for computing punching shear are given below.

*Punching Unit Stress,*

$$v = \frac{V}{bd} \dots \dots \dots (1)$$



*Depth of Footing Governed by Punching Stress,*

$$d = \frac{V}{bv} \dots \dots \dots (2)$$

The recommended unit stress for 2 000-lb. concrete is  $v = 120$  lb. per sq. in.

(Do not confuse  $b$  used in this formula for perimeter of column with  $b$  used in other formulas for width of rectangular beam.)

This recommendation is made with the understanding that the depth obtained from Formula (2) should be used as a guide only, unless otherwise required by building code, and that, if more economical, a smaller depth may be used if proper provision is made for tensile stresses, diagonal tension, and bond stresses.

**Depth of Square and Rectangular Footings as Determined by Punching Shear.**—For square and rectangular footings, the general formula given above may be replaced by special formulas. When the depth of the footing is given, allowable punching unit shear is obtained by dividing the total shear at the edge of the column or pedestal by the allowable unit punching shear times the perimeter of the column or pedestal. The external shear,  $V$ , to be used may be obtained by multiplying the column load,  $P$ , by the ratio of the area outside of the column or pedestal to the total area of the footing.

Let  $P =$  column load, lb.;

$c =$  side of square pedestal (or column) or 0.78 diameter of round column, in.;

$c_1 =$  side of rectangle, in.;

$a$  and  $a_1 =$  sides of base of footing (in ratios  $\frac{c}{a}$  and  $\frac{cc_1}{aa_1}$  use all values in same units, preferably in feet);

$v =$  allowable punching unit stress, lb. per sq. in.

Then for square footing <sup>3</sup> the external shear is

$$V = P \left[ 1 - \left( \frac{c}{a} \right)^2 \right], \dots \dots \dots (3)$$

and the perimeter  $b = 4c$  and for rectangular footing

$$V = P \left( 1 - \frac{cc_1}{aa_1} \right), \dots \dots \dots (4)$$

<sup>3</sup> The total area of footing is  $a^2$  square feet, the area of pedestal or column is  $c^2$  square feet, area outside the pedestal  $a^2 - c^2$ , the ratio  $= \frac{a^2 - c^2}{a^2} = 1 - \left( \frac{c}{a} \right)^2$ .

Derivation for rectangular footings is similar.

and the perimeter  $b = 2(c + c_1)$ . Formula (2) then changes to:

*Depth Required by Punching,*

Square footing,

$$d = \left[ 1 - \left( \frac{c}{a} \right)^2 \right] P \frac{1}{4cv}, \dots \dots \dots (5)$$

also, if

$$C_{f1} = \frac{1}{4} \left[ 1 - \left( \frac{c}{a} \right)^2 \right], \dots \dots \dots (6)$$

$$d = C_{f1} \frac{P}{cv}, \dots \dots \dots (7)$$

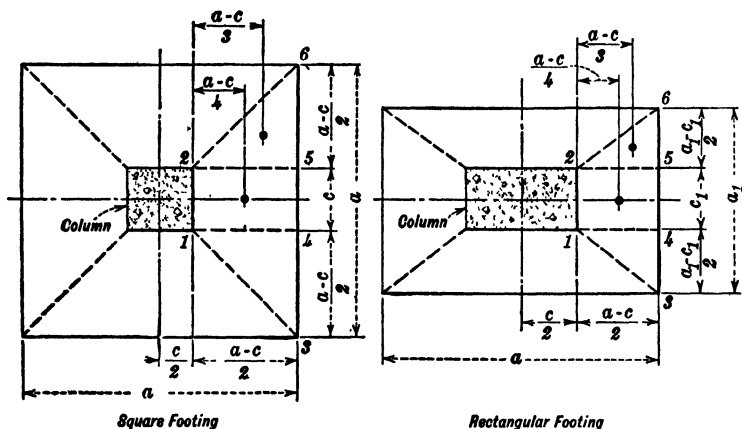

FIG. 166.—Square and Rectangular Column Footings. (See p. 495.)

Rectangular footings

$$d = \left( 1 - \frac{cc_1}{aa_1} \right) P \frac{1}{2(c + c_1)v}, \dots \dots \dots (8)$$

also, if

$$C_{f2} = \frac{1}{2} \left( 1 - \frac{c}{a} \frac{c_1}{a_1} \right),$$

$$d = C_{f2} \frac{P}{(c + c_1)v}, \dots \dots \dots (9)$$

Values of constants  $C_{f1}$  and  $C_{f2}$  may be taken from tables on page 495.

$$\text{Values of } C_{f1} = \frac{1}{4} \left[ 1 - \left( \frac{c}{a} \right)^2 \right]$$

$\frac{c}{a}$	0.1	0.15	0.20	0.25	0.30	0.35	0.40	0.45	0.50	0.55	0.60	0.65	0.70	0.75
$C_{f1}$	0.25	0.24	0.24	0.23	0.23	0.22	0.21	0.20	0.19	0.17	0.16	0.14	0.13	0.11

$$\text{Values of } C_{f2} = \frac{1}{2} \left( 1 - \frac{c c_1}{a a_1} \right)$$

$$\text{Values of } \frac{c_1}{a_1}$$

$\frac{c}{a}$	0.1	0.15	0.2	0.25	0.3	0.35	0.4	0.45	0.5	0.55	0.6	0.65	0.7
0.1	0.49	0.49	0.49	0.49	0.48	0.48	0.48	0.48	0.47	0.47	0.47	0.47	0.46
0.15	0.49	0.49	0.48	0.48	0.48	0.47	0.47	0.47	0.46	0.46	0.45	0.45	0.45
0.20	0.49	0.48	0.48	0.47	0.47	0.46	0.46	0.45	0.45	0.44	0.44	0.43	0.43
0.25	0.49	0.48	0.47	0.47	0.46	0.46	0.45	0.44	0.44	0.43	0.42	0.42	0.41
0.30	0.48	0.48	0.47	0.46	0.45	0.45	0.44	0.43	0.42	0.42	0.41	0.40	0.39
0.35	0.48	0.47	0.46	0.46	0.45	0.44	0.43	0.42	0.41	0.40	0.39	0.39	0.38
0.40	0.48	0.47	0.46	0.45	0.44	0.43	0.42	0.41	0.40	0.39	0.38	0.37	0.36
0.45	0.48	0.47	0.45	0.44	0.43	0.42	0.41	0.40	0.39	0.38	0.36	0.35	0.34
0.50	0.47	0.46	0.45	0.44	0.42	0.41	0.40	0.39	0.37	0.36	0.35	0.34	0.32
0.55	0.47	0.46	0.44	0.43	0.42	0.40	0.39	0.38	0.36	0.35	0.33	0.32	0.31
0.60	0.47	0.45	0.44	0.42	0.41	0.39	0.38	0.36	0.35	0.33	0.32	0.30	0.29
0.65	0.47	0.45	0.43	0.42	0.40	0.39	0.37	0.35	0.34	0.32	0.30	0.29	0.27
0.70	0.46	0.45	0.43	0.41	0.39	0.38	0.36	0.34	0.32	0.31	0.29	0.27	0.25

**Bending Moments in Footings.**—The footing is a circumferential cantilever and is subjected to radial and circumferential bending moments in the same manner as the portion of a flat slab at the column. While exact bending moments cannot be determined by simple statics, the simplified method given below gives satisfactory results for practical use. Although only moments perpendicular to the sections are figured (i.e., radial moments), the circumferential moments are taken care of by distribution of the reinforcement over the whole width of the footing. By utilizing the constants in the tables which follow for assistance in computing the bending moments, the work of designing is made very easy.

**Bending Moments for Design.**—A footing acts as a cantilever supported at the column and loaded uniformly by the upward

reaction of the soil. Referring to Fig. 166, p. 494, the bending moment caused by the upward reactions of the soil is a maximum at the edge of the column or pedestal. It may be determined by considering the footing as cut along the diagonal lines running from the corners of the pedestal or column to the corners of the footing. This divides the footing into four trapezoids, one of which is marked in Fig. 166 by 1, 2, 3, 6. The maximum bending moments about the edge of the pedestal may be found by multiplying the reactions of the soil acting on the trapezoid by the distance between its center of gravity and the edge of the pedestal, or by computing the bending moments of the simple component parts of the trapezoid, namely, the rectangle 1, 2, 4, 5, and the triangles 1, 3, 4, and 2, 5, 6. The bending moment of the rectangle equals the load multiplied by one-half the height of the rectangle, which in this case is  $\frac{a-c}{4}$ . The moment arm for the load on the triangles is  $\frac{a-c}{3}$ .

The reaction of the soil on the trapezoid, or on its component parts, equals the respective area multiplied by the unit reaction of the soil, which in turn equals the column load divided by the total area of the base of the footing. The dead load of the footing is not included in the column load, as it does not produce any bending moment, the upward reaction produced by it being counteracted by the weight of the footing.

The maximum bending moment may be expressed by the following formulas:

**Square Footing.**—For square footings.

- Let  $a$  = side of square base of footing;  
 $c$  = side of square pedestal or column (for round column  
 $c$  = 0.78 times diameter of column);  
 $P$  = total column load;  
 $C_{f3}$  = constant.

Then,

*Bending Moment at Edge of Pedestal (or Column),*

$$M = \frac{1}{24} \left(1 - \frac{c}{a}\right)^2 \left(2 + \frac{c}{a}\right) Pa, \quad \dots \quad (10)$$

or

$$M = C_{f3} Pa. \quad \dots \quad (11)$$

The bending moment is in the same units as  $P$  and  $a$ . If  $P$  is in lb. and  $a$  in in.,  $M$  is in in.-lb.

The constant  $C_{f3}$  may be taken from the table below, corresponding to the proper ratio of  $\frac{c}{a}$ . In computing ratio  $\frac{c}{a}$ , the values of  $a$  and  $c$  must be in the same units, preferably in feet.

**Constants  $C_{f3}$  for Square Footing**

To be used in Formula (11) for bending moment,  $M = C_{f3}Pa$  (See p. 496.)

	Ratio of Side of Pedestal (or Column) to Side of Footing, $\frac{c}{a}$												
	0.10	0.15	0.20	0.25	0.30	0.35	0.40	0.45	0.50	0.60	0.70	0.80	0.90
$C_{f3}$	0.071	0.065	0.059	0.053	0.047	0.041	0.036	0.031	0.026	0.017	0.010	0.005	0.001

For round column,  $c$  to be used in computing ratio  $\frac{c}{a}$  equals 0.78 times diameter of column; thus, if diameter of column is 2 ft. and side of base is 8 ft.,  $\frac{c}{a} = \frac{0.78 \times 2}{8} = 0.19$ , and  $C_{f3} = 0.60$ . In computing ratio  $\frac{c}{a}$ , both values must be same units.

**Rectangular Footing.**

- Let  $a$  and  $a_1$  = sides of rectangular base of footing;
- $c$  and  $c_1$  = widths of rectangular pedestal (or column);
- $P$  = total column load;
- $C_{f4}$  = constant.

Then,

*Bending Moment in the Direction of the Side  $a$  (about Section 1-2, in Fig. 166),*

$$M_a = \frac{1}{24} \left(1 - \frac{c}{a}\right)^2 \left(2 + \frac{c_1}{a_1}\right) Pa, \quad \dots \quad (12)$$

or

$$M_a = C_{f4} Pa. \quad \dots \quad (13)$$

The moment is in the same units as  $P$  and  $a$ . If  $P$  is in lb. and  $a$  is in in.,  $M$  is in in.-lb.

The constant  $C_{f4}$  may be taken from the table on p. 498 for the proper  $\frac{c}{a}$  and  $\frac{c_1}{a_1}$ . The moment in the other direction may be found by interchanging  $\frac{c}{a}$  and  $\frac{c_1}{a_1}$ . If a square column is used,  $c$  becomes

equal to  $c_1$ . For a round column,  $c$  and  $c_1$  equal 0.78 times diameter of column. In computing ratios,  $\frac{c}{a}$  and  $\frac{c_1}{a_1}$ , all values must be in same units, preferably in feet.

#### Constants $C_{f1}$ for Rectangular Footings

To be used for bending moment in direction  $a$  in formula,  $M = C_{f1}Pa$  (See p. 497.)

Ratio of One Side of Column to Corresponding Side of Footing, $\frac{c}{a}$	Ratio of Other Side of Pedestal (or Column) to the Other Side of Footing, $\frac{c_1}{a_1}$								
	0 10	0.15	0.20	0 25	0.30	0.35	0.40	0.45	0.50
0 10	0 071	0.073	0.074	0 076	0.078	0 079	0.081	0.083	0.085
0.15	0.063	0.065	0 066	0 068	0.069	0 071	0.072	0.074	0.075
0.20	0.056	0.057	0 059	0 060	0.061	0.063	0.064	0.065	0.067
0 25	0 049	0 050	0 052	0.053	0.054	0 055	0.056	0.057	0 059
0.30	0 043	0.044	0.045	0.046	0 047	0.048	0.049	0.050	0.051
0 35	0 037	0.038	0 039	0 040	0 041	0.041	0.042	0.043	0 044
0.40	0 032	0 032	0 033	0.034	0.035	0.035	0.036	0.037	0 038
0 45	0.027	0 027	0.028	0.028	0 029	0.030	0.030	0.031	0.032
0.50	0.022	0.022	0.023	0.024	0.024	0.024	0.025	0.026	0.026

For round columns or pedestals,  $c$  and  $c_1$  to be used in computing ratios  $\frac{c}{a}$  and  $\frac{c_1}{a_1}$  equals 0.78 times diameter of column. For square columns or pedestals,  $c$  equals  $c_1$ . In computing ratios  $\frac{c}{a}$  and  $\frac{c_1}{a_1}$ , all values must be in same units.

**Tension Reinforcement.**—After the bending moments are determined, the required area of the effective steel is computed from formula

$$A_s = \frac{M}{0.875df_s}$$

The bars composing this effective steel should be spaced uniformly in a width of the footing equivalent to the width of the column (or pedestal) plus twice the effective depth of the footing plus half of the remaining distance to the edge of the footing. This width can

be expressed by  $\frac{1}{2}(a + c + 2d)$ . Additional steel should be placed outside of this effective width, at a spacing equal to twice the spacing of the effective steel. This arrangement has been found satisfactory from tests.

**Distributing of Steel.**—The best method of arranging the reinforcement is to place the bars in two directions at right angles, parallel to the sides of the footing. The spacing of the bars should be uniform within the effective width.

Another satisfactory method consists of radials and rings arranged in the same manner as the reinforcement at the column in Smulski Flat Slab System (see p. 367).

Some designers place the steel in four directions, two rectangular and two diagonal directions. This arrangement gives four layers of steel. It is more complicated than the arrangements described above, and for this reason is not recommended.

**Design of Steel Placed in Four Directions.**—When steel is placed in four directions, the same formulas for bending moments may be used as for steel placed in two directions. The effective area of steel at any section would consist of the area of bars in the band perpendicular to the section, plus the area of the diagonal bars, multiplied by the sine of the angle between the bars and the section. For bars placed at  $45^\circ$ , the effect of diagonal bands in each direction would be equal to the area of bars in one band multiplied by 1.4.

**Length of Bars.**—Make bars about 6 in. shorter than the dimension of footing in the direction considered.

**Compressive Stresses.**—Usually, compressive stresses in footings are small. If it is required to compute them, the effective width in compression in footings of uniform thickness should be taken the same as the effective width for placing reinforcement.

In stepped footings, in computing the compressive stresses, the width of the blocks should be taken as the width of the beam.

Regular beam formulas, p. 207, may be used in figuring compression where  $b$  is the width discussed above; or else the ratio of steel,  $p$ , may be computed, and the compressive unit stress may be determined from this. The total effective area of reinforcement should be used in figuring the steel ratio,  $p$ . In stepped footings, the concrete area equals depth of footing multiplied by the width of the block in which the compression is being computed.

**Bond Stresses.**—In designing footings, the most important and often the determining feature is the bond stresses. The rate of

increase of bending moment in the cantilevers composing the footing is large and, therefore, large stresses in steel must be developed in a short distance. This produces large total bond stresses. After area of steel required for bending moment is found, the diameter of bars must be selected to provide the required total bond stresses without exceeding allowable working unit stresses (see p. 263).

The bond stresses are computed by formula  $u = \frac{V}{\Sigma ojd}$  (see p. 262), in which  $\Sigma o$  is the sum of perimeters of the reinforcement effective at the section considered,  $jd$  is the moment arm, and  $V$  is the external shear at the section considered.

The bond stresses must be computed at the section of maximum bending moment for the same loads used in computing the maximum bending moment. For stepped footings, the bond stresses must also be computed at the edges of each step. In sloped footings, bond stresses must be computed at one or two intermediate sections to determine whether the slope is satisfactory.

If the bond stresses are found to be excessive, they may be reduced by using bars of smaller diameter, since smaller bars have a larger circumference for the same cross section than larger bars. If it is impossible to keep the bond stresses within working limits by the use of small bars, it may be necessary either to increase the depth of the footing, retaining the same steel as before, or to increase the amount of steel, keeping the original depth, whichever is the more economical. In both cases the tensile stresses in steel are reduced. It should be kept in mind that the allowable unit bond stress may be increased by hooking the bars at the ends (see p. 263).

**External Shear for Figuring Bond Stresses.**—In determining the external shear to use in the formula for bond stresses, the footing may be considered as separated into trapezoids in the same manner as explained in connection with bending moments and illustrated in Fig. 166, p. 494. The total upward pressure on each trapezoid is the shear producing the bending moment. It should, therefore, be used in computing the bond stresses. For square footings, the external shear equals one-fourth of the total upward load outside the section considered. It may be expressed by the formula below.

Let  $c$  = side of pedestal (column or step), at edge of which shear is computed;

$a$  = side of square footing.

$P$  = column load, lb.



Then

*External Shear for Bond in Square Footing,*

$$V = \frac{1}{4} \left[ 1 - \left( \frac{c}{a} \right)^2 \right] P. \quad \dots \quad (14)$$

Making

$$C_{f1} = \frac{1}{4} \left[ 1 - \left( \frac{c}{a} \right)^2 \right],$$

the equation changes to

$$V = C_{f1} P. \quad \dots \quad (15)$$

The value of  $C_{f1}$  may be taken from the table on page 495.

The same formula may be used for computing external shear to be used in formulas for diagonal tension, in which case the value  $c$  equals the side at which diagonal tension is computed.

For rectangular footings, the external shear at side  $c$  is different from that at side  $c_1$ . It may be expressed by the following formula:

Let  $a$  and  $a_1$  = sides of footing;  
 $c$  and  $c_1$  = sides of column, block, or shear section.

Then

*External Shear for Bond Alongside  $c$  in Rectangular Footing*

$$V = \frac{1}{4} \left( 1 + \frac{c}{a} \right) \left( 1 - \frac{c_1}{a_1} \right) P, \quad \dots \quad (16)$$

or

$$V = C_{f5} P, \quad \dots \quad (17)$$

where

$$C_{f5} = \frac{1}{4} \left( 1 + \frac{c}{a} \right) \left( 1 - \frac{c_1}{a_1} \right)$$

External shear along side  $c_1$  may be obtained by interchanging  $\frac{c}{a}$  with  $\frac{c_1}{a_1}$ . The value of the constant  $C_{f5}$  may be taken from the table on p. 502.

In computing bond stresses, the values of  $c$  and  $c_1$  are the sides of the column or block at the edge of which bond stresses are desired.

In computing diagonal tension, the values  $c$  and  $c_1$  are the shear sections at which diagonal tension is computed.

$$\text{Values of } C_{r_s} = \frac{1}{4} \left( 1 + \frac{c}{a} \right) \left( 1 - \frac{c_1}{a_1} \right)$$

Values of $\frac{c_1}{a_1}$													
$\frac{c}{a}$	0.1	0.15	0.2	0.25	0.3	0.35	0.4	0.45	0.5	0.55	0.6	0.65	0.7
0.1	0.25	0.23	0.22	0.20	0.19	0.18	0.16	0.15	0.14	0.12	0.11	0.09	0.08
0.15	0.26	0.24	0.23	0.21	0.20	0.19	0.17	0.16	0.14	0.13	0.11	0.10	0.08
0.20	0.27	0.25	0.24	0.22	0.21	0.19	0.18	0.16	0.15	0.13	0.12	0.10	0.09
0.25	0.28	0.26	0.25	0.23	0.22	0.20	0.19	0.17	0.15	0.14	0.12	0.11	0.09
0.30	0.29	0.27	0.26	0.24	0.23	0.21	0.19	0.18	0.16	0.14	0.13	0.11	0.10
0.35	0.30	0.29	0.27	0.25	0.24	0.22	0.20	0.18	0.17	0.15	0.13	0.12	0.10
0.40	0.31	0.30	0.28	0.26	0.24	0.23	0.21	0.19	0.17	0.16	0.14	0.12	0.10
0.45	0.33	0.31	0.29	0.27	0.25	0.23	0.22	0.20	0.18	0.16	0.14	0.13	0.11
0.50	0.34	0.32	0.30	0.28	0.26	0.24	0.22	0.20	0.19	0.17	0.15	0.13	0.11
0.55	0.35	0.33	0.31	0.29	0.27	0.25	0.23	0.21	0.19	0.17	0.15	0.13	0.11
0.60	0.36	0.34	0.32	0.30	0.28	0.26	0.24	0.22	0.20	0.16	0.16	0.14	0.12
0.65	0.37	0.35	0.33	0.31	0.29	0.27	0.25	0.23	0.20	0.18	0.16	0.14	0.12
0.70	0.38	0.36	0.34	0.32	0.30	0.27	0.25	0.23	0.21	0.19	0.17	0.15	0.13
0.75	0.39	0.37	0.35	0.33	0.30	0.28	0.26	0.24	0.22	0.20	0.17	0.15	0.13

**Diagonal Tension.**—Tests indicate that in reinforced concrete footings, diagonal tension develops at a distance from the face of the column equal to the effective depth of the footing. In figuring the maximum diagonal tension, therefore, by the formula,  $v = \frac{V}{bjd}$  (see p. 247),  $V$  should be taken as the upward pressure between the edge of the footing and a line concentric with the pedestal (or column) and located at a distance from the face of the pedestal (or column) equal to the effective depth of the footing. The value  $jd$  is the moment arm at the section considered, while  $b$  is the length of this concentric line.

For square footings, where  $c$  is the diameter of the column and  $d$  is the effective depth of the footing, the concentric line is a square with a side equal to  $(c + 2d)$ . When the column is rectangular in section with sides  $c$  and  $c_1$ , the concentric line for diagonal tension is a rectangle with sides equal to  $(c + 2d)$  and  $(c_1 + 2d)$  respectively.

For square footings, the intensity of diagonal tension is the same at all four sides of the concentric line. For rectangular footings, on the other hand, there may be considerable difference in intensity at

the different sides of the rectangular concentric line. For this reason, it is advisable to compute diagonal tension for each side separately, using for  $V$ , in formula  $v = \frac{V}{bjd'}$ , the external shear at one side of the concentric line, and for  $b$  the length of one side of the concentric line.

The external shear,  $V$ , at each side may be computed by means of Formulas (14) and (16) on p. 501, in which case for  $\frac{c}{a}$ , or  $\frac{c}{a}$  and  $\frac{c_1}{a_1}$ , the ratio of the sides of the concentric line to the sides of the base of footing should be substituted. The tables on pp. 495 and 502 may be used for finding the constants  $C_{f1}$  and  $C_{f5}$ .

The formulas for diagonal tension are:

For square footings,

$$v = \frac{C_{f1}P}{(c + 2d)jd'} \dots \dots \dots (18)$$

where  $C_{f1}$  is from the table on p. 495, corresponding to a value in the table  $\frac{c}{a} = \frac{(c + 2d)}{a}$ .

For rectangular footings at line parallel to column side,  $c$ ,

$$v = \frac{C_{f5}P}{(c + 2d)jd'} \dots \dots \dots (19)$$

where  $C_{f5}$  is taken from the table on p. 502 where the value  $\frac{c}{a}$  is equal to  $\frac{c + 2d}{a}$  and  $\frac{c_1}{a_1}$  equal  $\frac{c_1 + 2d}{a_1}$ .

In the above formulas, if  $P$  is in pounds,  $c$  and  $d$  in inches, the unit stress,  $v$ , is in pounds per square inch.

**Examples.**—The following examples illustrate the method of designing reinforced concrete column footings.

### SIMPLE SLAB FOOTING

**Example 2.**—Find the dimensions of a footing for a column 28 in. square, carrying 350 000 lb., when the allowable pressure on the soil is 2 tons per sq. ft.

**Solution.**—Necessary area of base of footing is found by dividing the total superimposed load, plus assumed weight of footing (say 40 000 lb.), by allowable unit pressure on soil, which gives  $\frac{390\ 000}{4\ 000} = 97.5$  sq. ft. as the required area of

**Find Bond Stress.**—Bond stresses are determined by Formula (50), p. 262. The external shear outside the column is 331 000 lb. as determined in computing punching shear. The external shear at one edge of column is  $V = \frac{331\,000}{4} = 82\,750$  lb. When shear producing punching is not known, the external shear may be found from Formula (15), p. 501, using constant  $C_{71}$ . The number of effective bars per band is twenty-three  $\frac{3}{8}$ -in. round bars, the perimeter of which is  $23 \times 1.96 = 45.1$  in; therefore, the unit bond stress is

$$u = \frac{82\,750}{\frac{1}{4} \times 25 \times 45.1} = 84 \text{ lb. per sq. in.}$$

This bond stress may be used for deformed bars, but is somewhat excessive for plain bars in 1 : 2 : 4 concrete (see p. 263). Hence, use deformed bars.

The weight of the footing does not need to be considered in figuring bending moment, shear, diagonal tension, and bond stresses, because it is balanced by the upward reaction. It increases, however, the unit pressure on the soil; therefore, it was considered in determining the size of the base of the footing.

### SLOPED AND STEPPED FOOTINGS

The design shown in the previous example is not economical for deep footings. In such cases, either a sloped or a stepped footing should be selected. The design of both types of footings will be illustrated in the following example.

**Example 3.**—Design a footing for a 40-in. round column carrying a load  $P = 1\,000\,000$  lb. when the allowable soil pressure is  $p = 6\,000$  lb. per sq. ft.

**Solution.**—**Area of Footing.**—Assume weight of footing  $W = 50\,000$  lb.; then total load  $P + W = 1\,000\,000 + 50\,000 = 1\,050\,000$  lb.

$$\text{Required area of footing is } \frac{P + W}{p} = \frac{1\,050\,000}{6\,000} = 175 \text{ sq. ft.}$$

Use  $a = 13$  ft. 3 in., making area of footing  $a^2 = 175.5$  sq. ft.

**Size of Pedestal.**—(See p. 486.) For unit compressive stresses  $f_c = 450$  lb. per sq. in., the required area of pedestal to carry load  $P$  is  $\frac{1\,000\,000}{450} = 2222$  sq. in.

The side of the square pedestal is  $c = 47$  in. Use 48 in. square pedestal.

**Depth for Punching Shear at Edge of Column.**—Area of footing is 175.5 sq. ft. Area of column =  $\frac{314 \times 3.33^2}{4} = 8.7$  sq. ft. Area outside the column

is  $175.5 - 8.7 = 166.8$  sq. ft. Ratio  $\frac{166.8}{175.5} = 0.95$ . Load to be used in computing depth is  $0.95 P = 950\,000$  lb. Since circumference of column is  $40 \times 3.14 = 125.6$  in. and allowable shear  $v = 120$  lb. per sq. in.,

$$d = \frac{950\,000}{125.6 \times 120} = 63 \text{ in.}$$

This is the minimum depth from top of pedestal to plane of footing reinforcement. The depth could also be found by using table on page 495, as is shown below.

**Depth for Punching Shear at Edge of Pedestal.**—Since  $a = 13.25$  ft. and side of pedestal,  $c = 4.0$  ft.,  $\frac{c}{a} = 0.3$ , and  $1 - \left(\frac{c}{a}\right)^2 = 0.91$ . The load producing punching is  $P \left[1 - \left(\frac{c}{a}\right)^2\right] = 0.91 P = 910\,000$  lb. For perimeter of pedestal,  $4c = 4 \times 48 = 192$  in., and  $v = 120$  lb. per sq. in.

$$d_1 = \frac{910\,000}{192 \times 120} = 39.5 \text{ in.}$$

allowing  $3\frac{1}{2}$  in. from the bottom of footing to center of steel, the total depth of footing below pedestal  $h = 43$  in.

Same result for  $d_1$  is obtained from table on p. 495. For  $\frac{c}{a} = 0.3$ ,  $C_{72} = 0.23$ .

Hence,  $d_1 = 0.23 \frac{1\,000\,000}{48 \times 120} = 39.5$  in.

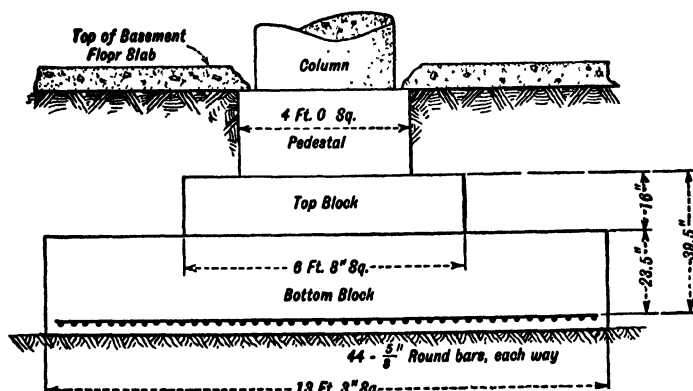

FIG. 168.—Stepped Footing. (See p. 507.)

**Shape of Footing.**—Standard design shown in Fig. 164, p. 490, will be used. The dimensions  $a$ ,  $c$ ,  $d$ , and  $d_1$  being known, the remaining values may be taken from table on p. 490.

**For Stepped Footings.**—The bottom block is  $0.6d_1 = 0.6 \times 39.5 = 23.7$  in.; use  $23\frac{1}{2}$  in. The top block is  $39.5 - 23.5 = 16$  in. For  $\frac{c}{a} = 0.3$ , from table on p. 490,  $a_1 = 0.5a$  or 6 ft. 8 in.

**For Sloped Footing.**—For  $\frac{c}{a} = 0.3$  from table, the value of  $a_2 = 0.35a$ , or 4 ft. 8 in. and  $d_2 = 0.2d = 8$  in.

**Diagonal Tension.**—Compute diagonal tension at a distance equal to  $d_1$  from face of pedestal. The side of the section is  $c + 2d_1 = 48 + 79 = 127$  in. = 10 ft. 7 in. The external shear to be used in computing diagonal tension may be obtained by the use of table on p. 495. Call  $c = 10.58$ ,  $a = 13.25$ ,  $\frac{c}{a} = \frac{10.58}{13.25} = 0.799$ , for which, by interpolation,  $C_{T1} = 0.09$ .

**Diagonal Tension for Stepped Footing.**—The depth of a stepped footing at section considered is equal to the depth of the bottom block, or 23.5 in. Hence, unit shear from Formula (36), p. 247,

$$v = \frac{0.09 \times 1\,000\,000}{127 \times \frac{1}{8} \times 23.5} = 34.7 \text{ lb. per sq. in.}$$

As this is smaller than the allowable shear, the design is satisfactory.

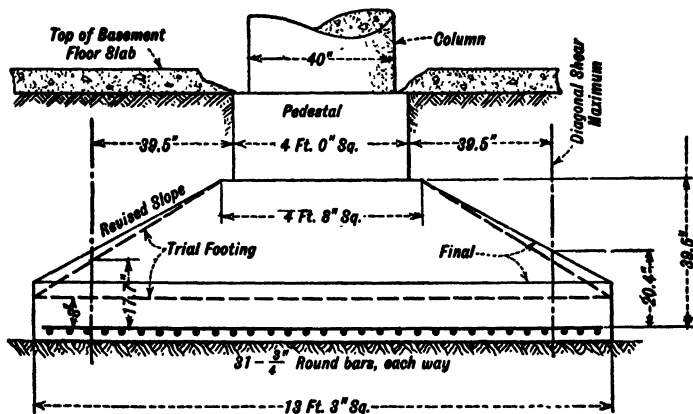

FIG. 169.—Sloped Footing. (See p. 507.)

**Diagonal Tension for Sloped Footing.**—The depth of a sloped footing at section considered is 17.7 in. Hence, unit shear

$$v = \frac{0.09 \times 1\,000\,000}{127 \times \frac{1}{8} \times 17.7} = 46.0 \text{ lb. per sq. in.}$$

With an allowable unit shear of 40 lb. per sq. in., this shear is too large. The slope of the footing should be changed so as to get, at the section considered, a depth equal to  $17.7 \times \frac{46.0}{40} = 20.35$  in. The revised slope is shown in Fig. 169, p. 508.

**Bending Moment.**—Find bending moment at edge of pedestal. The side of pedestal,  $c = 4$  ft., side of square footing,  $a = 13.25$  ft., ratio  $\frac{c}{a} = \frac{4}{13.25} = 0.3$ . Therefore, from table on p. 497, constant in formula  $M = C_{T2} P a^2$  is  $C_{T2} = 0.047$

<sup>2</sup> See p. 496.

and the bending moment at edge of pedestal,

$$M = 0.047 \times 1\,000\,000 \times 13.25 = 622\,800 \text{ ft.-lb. or } 7\,474\,000 \text{ in.-lb.}$$

Required area of steel for  $d_1 = 39.5$  in. is

$$A_s = \frac{7\,474\,000}{16\,000 \times 0.875 \times 39.5} = 13.5 \text{ sq. in.}$$

Thirty-one  $\frac{3}{4}$ -in. round bars give an area of 13.70 sq. in.

**Compressive Stresses in Concrete.**—Width of top block is 6 ft. 8 in., or 80 in.; the depth,  $d = 39.5$  in.;  $A_s = 13.5$  sq. in.; hence  $p = \frac{13.5}{39.5 \times 80} = 0.0043$ .

Since, with  $f_s = 16\,000$  and  $n = 15$ , for an allowable stress of 650 lb. in concrete  $p = 0.0077$ , and the ratio actually used is only 0.0043, it is evident that in this case compression is considerably below the allowable unit stresses.

**Bond Stresses.**—For sloped footings, with the slope accepted in design, the bond stresses should be investigated only at the edge of the pedestal where the external shear is the largest. For stepped footings, on the other hand, it is necessary to compute bond stresses also at the edge of the top block.

*Bond Stresses at Edge of Pedestal for Stepped and Sloped Footings.*—The external shear at the edge of pedestal, for figuring bond, is one-quarter of the load for punching shear

$$V = \frac{910\,000}{4} = 227\,500 \text{ lb.}$$

The depth is 39.5 in.; perimeter of thirty-one  $\frac{3}{4}$ -in. round bars is  $\Sigma o = 31 \times 2.35$

$= 72.8$  in. Hence, the bond stresses, from formula  $u = \frac{V}{\Sigma o j d}$ ,

$$u = \frac{227\,500}{72.8 \times 0.875 \times 39.5} = 90.5 \text{ lb. per sq. in.}$$

This bond stress is satisfactory for deformed bars. For plain bars, the stresses should be reduced as explained on p. 264.

*Bond Stresses at Edge of Top Block for Stepped Footing.*—The width of the top block, as seen in Fig. 168, is 6 ft. 8 in., and the depth of footing at the edge is 23.5 in. The external shear, for figuring bond stresses according to Formula (14), p. 501, is

$$V = \frac{1}{2} \left[ 1 - \left( \frac{6.66}{13.25} \right)^2 \right] 1\,000\,000 = 187\,000 \text{ lb.}$$

The same value would be obtained from formula  $V = C_n P$ , where  $C_n = 0.18$ , from table on p. 495. The perimeter of bars is the same as computed above, or  $\Sigma o = 72.8$  in. The bond stresses, computed as above, are

$$u = \frac{187\,000}{72.8 \times 0.875 \times 23.5} = 125 \text{ lb. per sq. in.}$$

This shear is too large unless the bars are hooked at the ends. If forty-four  $\frac{1}{4}$ -in. round bars are substituted for thirty-one  $\frac{3}{4}$ -in. round bars, the perimeter changes to  $\Sigma o = 44 \times 1.96 = 86.2$

$$u = \frac{187\,000}{86.2 \times 0.875 \times 23.5} = 105 \text{ lb. per sq. in.}$$

This stress may be considered satisfactory for deformed bars. If further reduction of bond stresses is desired, it will be necessary to increase the width of the block. The use of still smaller bars would not be wise, as their spacing would be too small. (See also p. 264.)

### RECTANGULAR FOOTINGS

Rectangular footings are often used for wall columns and for rectangular interior columns. If it is permissible to go outside of the building line, independent footings for wall columns will be found most economical. The wall columns usually being rectangular, the footing is also made rectangular. If not governed by other requirements the shape of the footing should be made such that the length of the projections of the footing from the column edge on all sides are equal, since this requires the minimum amount of materials. The area of the footing is obtained first by dividing the total load on the foundation by the allowable unit pressure on the soil. The sides of the rectangle of the base of the footing, which should have equal projection from the edge of the column on all sides, may be obtained by trial or from the following formula.

$$a = \frac{1}{2}(c - c_1) + \sqrt{A + \frac{1}{4}(c - c_1)^2}, \quad . . . \quad (20)$$

where  $a$  is one side of the rectangle,  $A$  is the area of base, and  $c$  and  $c_1$  are sides of the column. The values may also be taken from table on p. 511.

**Design of Rectangular Footing.**—Compute the area of the footing by dividing total column load, plus weight of footing, by the permissible unit pressure on the soil.

Select sides of the rectangle which will give the required area. For most economical design, select such dimensions for the sides that the projections on all sides are about equal. Use table, p. 511.

Compute depth of punching shear, as explained for square footings. (See explanation of punching shear, p. 492.)

Check the depth for diagonal tension, as for square footing.



Economical Length of Long Side,  $a$ , of Rectangular Footing

From Formula  $a = \frac{1}{2}(c - c_1) + \sqrt{A + \frac{1}{4}(c - c_1)^2}$ , where  $a$  = long side of footing,  $A$  = area of footing,  $c$  = long side of column,  $c_1$  = short side of column.

Area of Footing, $A$ , Sq. Ft.	Long Side of Footing, $a$ , in Feet																	
	Values of $c - c_1$ , in Inches																	
	2"	4"	6"	8"	10"	12"	14"	16"	18"	20"	22"	24"	26"	28"	30"	32"	34"	36"
20	4.5	4.6	4.7	4.8	4.9	5.0	5.1	5.2	5.3	5.4	5.5	5.6	5.7	5.8	5.8	6.0	6.1	6.2
30	5.5	5.6	5.7	5.8	5.9	6.0	6.1	6.2	6.3	6.4	6.5	6.6	6.7	6.8	6.8	7.0	7.1	7.2
40	6.4	6.5	6.6	6.7	6.8	6.8	6.9	7.0	7.1	7.2	7.3	7.4	7.5	7.6	7.6	7.8	7.9	8.0
50	7.1	7.2	7.3	7.4	7.5	7.6	7.7	7.8	7.9	7.9	8.0	8.1	8.2	8.3	8.4	8.5	8.6	8.7
60	7.8	7.9	8.0	8.1	8.2	8.3	8.3	8.4	8.5	8.6	8.7	8.8	8.9	9.0	9.0	9.2	9.3	9.4
70	8.4	8.5	8.6	8.7	8.8	8.9	9.0	9.1	9.1	9.2	9.3	9.4	9.5	9.6	9.7	9.8	9.9	10.0
80	9.0	9.1	9.2	9.3	9.4	9.5	9.5	9.6	9.7	9.8	9.9	10.0	10.1	10.2	10.2	10.4	10.5	10.6
90	9.6	9.6	9.7	9.8	9.9	10.0	10.1	10.2	10.3	10.3	10.4	10.5	10.6	10.7	10.8	10.9	11.0	11.1
100	10.1	10.2	10.3	10.4	10.6	10.7	10.7	10.9	11.0	11.2	11.3	11.5	11.1	11.2	11.3	11.4	11.5	11.6
110	10.6	10.6	10.7	10.8	10.9	11.0	11.1	11.2	11.3	11.3	11.4	11.5	11.6	11.7	11.8	11.9	12.0	12.1
120	11.0	11.1	11.2	11.3	11.4	11.5	11.5	11.6	11.7	11.8	11.9	12.0	12.1	12.2	12.2	12.4	12.5	12.6
130	11.5	11.6	11.6	11.7	11.8	11.9	12.0	12.1	12.2	12.3	12.4	12.4	12.5	12.6	12.7	12.8	12.9	13.0
140	11.9	12.0	12.1	12.2	12.2	12.3	12.4	12.5	12.6	12.7	12.8	12.9	13.0	13.1	13.1	13.2	13.3	13.4
150	12.3	12.4	12.5	12.6	12.7	12.7	12.9	12.9	13.0	13.1	13.3	13.3	13.4	13.5	13.5	13.6	13.7	13.8
160	12.7	12.8	12.9	13.0	13.1	13.1	13.2	13.0	13.4	13.5	13.6	13.7	13.8	13.9	13.9	14.0	14.1	14.2
170	13.1	13.2	13.3	13.4	13.5	13.5	13.6	13.7	13.8	13.9	14.0	14.1	14.2	14.3	14.3	14.4	14.5	14.6
180	13.5	13.6	13.7	13.7	13.8	13.9	14.0	14.1	14.2	14.3	14.4	14.4	14.5	14.6	14.7	14.8	14.9	15.0

Compute moments in the long and short directions. Compute areas of steel, and select the bars so that the bond stresses do not exceed the allowable values.

Slope or step the footing as explained in connection with square footings. The width of the blocks may be the same as in square footings having a ratio of width of footing to width of column equal to the ratio of the rectangular footing in the direction considered. The blocks will also be rectangular.

**Example 4.**—Design footing for column load  $P = 550\,000$  lb., column size  $c \times c_1 = 48 \times 24$  in. Allowable soil pressure  $p = 6\,000$  lb. per sq. ft.

*Solution.*—Assume dead load of footing  $W = 50\,000$  lb. Total load  $P + W = 550\,000 + 50\,000 = 600\,000$  lb.

Required area of footing is equal to  $(P + W) \div p = 600\,000 \div 6\,000 = 100$  sq. ft. The sides of the column are  $c = 48$  in., and  $c_1 = 24$  in.; hence  $c - c_1 = 24$  in. Sides of a rectangle having an area of 100 sq. ft. and having equal projections from the column on all sides may be found from table on p. 511. The long side is  $a = 11$  ft., and consequently the short side,  $a_1 = 100 \div 11 = 9.1$  ft. or 9 ft. 1 in. It will be exact enough for practical purposes to select a footing with a base of 9 ft. by 11 ft., having an area of 99 sq. ft.

**Depth for Punching Shear.**—The ratio of the load producing punching to the total load equals  $\left(1 - \frac{cc_1}{aa_1}\right) = 1 - \frac{8}{99} = 1 - 0.08 = 0.92$ . The load producing punching is  $550\,000 \times 0.92 = 506\,000$  lb. Perimeter of column  $b_1 = 2(48 + 24) = 144$  in. Hence, depth for punching shear for working stress of  $r = 120$  lb. per sq. in. is  $\left(\text{from formula } d = \frac{V}{120b}\right)$ ,

$$d = \frac{506\,000}{120 \times 144} = 29 \text{ in.}$$

**Bending Moments.**—Formula for moments is  $M = C_{fA}Pa$ . (See p. 497.)

$$\begin{array}{lll} a = 11 \text{ ft.} & c = 4 \text{ ft.} & \frac{c}{a} = 0.364 \\ a_1 = 9 \text{ ft.} & c_1 = 2 \text{ ft.} & \frac{c_1}{a_1} = 0.222 \end{array}$$

The constants  $C_{fA}$  for the bending moments may be taken from table on p. 498.

In the direction of the 11-ft. side, for  $\frac{c}{a} = 0.364$  and  $\frac{c_1}{a_1} = 0.222$ , by interpolation  $C_{fA} = 0.037$ . In a similar manner, the constant for the short side is found, using for  $\frac{c}{a} = 0.222$  and for  $\frac{c_1}{a_1} = 0.364$ . It is 0.059.

**Bending Moments:**

Long cantilever side,  $M = 0.037 \times 550\,000 \times 11 = 224\,000$  ft.-lb. or 2 688 000 in.-lb.

Short cantilever side,  $M = 0.059 \times 550\,000 \times 9 = 292\,000$  ft.-lb. or 3 504 000 in.-lb.

**Areas of Steel.**—The area of steel, computed from formula  $A_s = \frac{M}{jdf}$ , is:

$$\text{For long cantilever, } A_{s1} = \frac{2\,688\,000}{0.875 \times 29 \times 16\,000} = 6.6 \text{ sq. in.}$$

$$\text{For short cantilever, } A_{s2} = \frac{3\,504\,000}{0.875 \times 29 \times 16\,000} = 8.6 \text{ sq. in.}$$

The effective steel will consist of thirty-four  $\frac{1}{2}$ -in. round bars 10 ft. 6 in. in long direction and forty-four  $\frac{1}{2}$ -in. round bars 8 ft. 6 in. in short direction. This should be placed within the effective width. Also, two additional bars on each side should be placed outside the effective width.

**Bond Stresses.**—At edge of column, the shear on each side of the column to be used in figuring bond stresses may be found by determining the area of the trapezoid and computing the upward pressure acting on same. It may be found more easily by using the table on p. 502.

Thus, for the shear along the long side of column, for which, as computed above for short cantilever,  $\frac{c}{a} = 0.364$  and  $\frac{c_1}{a_1} = 0.222$ , we find a constant  $C_s = 0.27$ , and the shear  $V = 0.27 \times 550\,000 = 148\,000$  lb.

For the shear along the short side, interchange values of  $\frac{c}{a}$  and  $\frac{c_1}{a_1}$ , using for  $\frac{c}{a}$  in the table 0.222 and for  $\frac{c_1}{a_1}$  0.364. The constant from the table then is 0.19, and the shear  $V = 0.19 \times 550\,000 = 106\,000$  lb.

The shear along the long side, which is 148 000 lb., should be used in connection with steel running at right angles to it, i.e., steel running in short direction. Circumference of forty-four  $\frac{1}{2}$ -in. round bars is  $44 \times 1.57 = 69$  in. Hence from formula  $u = \frac{V}{\Sigma ojd'}$

$$u = \frac{148\,000}{69 \times 0.875 \times 29} = 84 \text{ lb. per sq. in.}$$

This is satisfactory for deformed bars. For plain bars, the number of bars would have to be increased in the proportion of the computed stress to the allowable stress, or  $\frac{84}{\frac{2}{3}}$ , or the bars provided with hooks at both ends. In this case it would be cheaper to use additional bars. Forty-six  $\frac{1}{2}$ -in. round bars will be required if plain bars are used.

The shear along the short side of the rectangle is 106 000 lb., and thirty-four  $\frac{1}{2}$ -in. round bars are used perpendicularly to that side. The sum of the perimeters is  $\Sigma o = 34 \times 1.57 = 53$  in. Using formula as above,

$$u = \frac{106\,000}{53 \times 0.875 \times 29} = 79 \text{ lb. per sq. in.}$$

This is satisfactory for plain and deformed bars.

**Sloped Footings.**—The rules for sloping footings, given on p. 490 for square footings, may be applied here. Since the slope is outside of the shear curve, bond stresses are satisfactory.

*Stepped Footings.*—If a stepped footing is used, the dimensions of the blocks should be made according to table on p. 490. The sides of the step are 5 ft. 10 in. and 3 ft. 10 in. The sizes of blocks conform to the bending moment line, but not to the external shear line. The same amount of steel as required at the edge of the column is satisfactory at the edge of the step for bending moment. It is, however, necessary to check the bond stresses, as they will be larger at the edge of the block than at the edge of the column.

*Bond Stresses at the Edge of Block.*—The depth of the step is 17.5 in. The sides of the step are 5 ft. 10 in. and 3 ft. 10 in. The values of  $\frac{c}{a}$  and  $\frac{c_1}{a_1}$  for the long side are  $\frac{5.82}{11.0} = 0.53$  and  $\frac{3.82}{9} = 0.43$ . The constant  $C_{fs}$  for these values (either computed by Formula (16) or taken from table) is 0.22, and the shear  $V = 0.22 \times 550\,000 = 120\,000$  lb. Since twenty-nine  $\frac{1}{4}$ -in. square bars act perpendicularly to this section, from  $u = \frac{V}{\sum o_j d}$ .

$$u = \frac{120\,000}{58 \times 0.875 \times 17.5} = 135 \text{ lb. per sq. in.}$$

This value for bond stresses is too large unless the bars are hooked. In the case under consideration, it is not feasible to reduce bond stresses by using smaller diameter bars, as it would require fifty-one  $\frac{1}{4}$ -in. square bars, the spacing for which would be too small. If hooked bars are not desired, either a larger number of  $\frac{1}{2}$ -in. square bars must be used or the width of the step must be made larger, whichever proves to be cheaper.

### CORNER COLUMN FOOTINGS

For architectural reasons, the corner columns are often made L-shaped. The footing must be made concentric with the center of

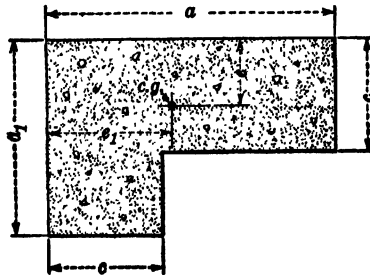

FIG. 170.—Illustration of Corner Column. (See p. 515.)

gravity of the column. The center of gravity may be found from the following formula.

Let  $a$  and  $a_1$  = sides of the column, inches.

$c$  = the thickness of column, inches.

$e$  = perpendicular distance of the center of gravity from the base  $a$  inches. (See Fig. 170, p. 514.)

Then

$$e = \frac{ac + a_1^2 - c^2}{2(a + a_1 - c)} \dots \dots \dots (21)$$

The perpendicular distance,  $e_1$ , from the base,  $a_1$ , may be found by interchanging  $a$  with  $a_1$  in the formula.

The above formula may also be written in the following form, giving the distance from base  $a$  in terms of  $a_1$ :

$$e = C_{f6}a_1, \dots \dots \dots (22)$$

where

$$C_{f6} = \frac{\frac{c}{a_1} \left( \frac{a}{a_1} - \frac{c}{a_1} \right) + 1}{2 \left[ 1 + \frac{a}{a_1} - \frac{c}{a_1} \right]}$$

The constant  $C_{f6}$  is given in table below, for different ratios of  $\frac{a}{a_1}$  and  $\frac{c}{a_1}$ .

$$\text{Values of } C_{f6} = \frac{\frac{c}{a_1} \left( \frac{a}{a_1} - \frac{c}{a_1} \right) + 1}{2 \left( 1 + \frac{a}{a_1} - \frac{c}{a_1} \right)}$$

$\frac{a}{a_1}$	Values of $\frac{c}{a_1}$								
	0.2	0.25	0.3	0.35	0.4	0.45	0.5	0.55	0.6
0.2									
0.4	0.433	0.451	0.468	0.484					
0.6	0.385	0.403	0.419	0.434	0.450	0.464	0.477	0.489	
0.8	0.350	0.367	0.383	0.399	0.414	0.428	0.442	0.454	0.466
1.0	0.322	0.339	0.356	0.372	0.387	0.402	0.416	0.430	0.443
1.2	0.300	0.317	0.334	0.350	0.366	0.382	0.397	0.411	0.425
1.4	0.282	0.299	0.316	0.333	0.350	0.366	0.381	0.396	0.411
1.6	0.266	0.284	0.302	0.319	0.336	0.352	0.369	0.384	0.400
1.8	0.253	0.272	0.290	0.307	0.325	0.342	0.358	0.375	0.390
2.0	0.242	0.261	0.279	0.297	0.315	0.332	0.350	0.366	0.383
2.2	0.233	0.252	0.270	0.289	0.307	0.325	0.342	0.359	0.377
2.4	0.225	0.244	0.263	0.281	0.300	0.318	0.336	0.353	0.371
2.6	0.217	0.237	0.256	0.275	0.293	0.312	0.330	0.348	0.366
2.8	0.211	0.230	0.250	0.269	0.288	0.307	0.325	0.344	0.362
3.0	0.205	0.225	0.244	0.264	0.283	0.302	0.321	0.340	0.358

The design of a corner footing does not differ materially from that of any other independent footing. The punching shear is usually small, as the perimeter of the column is large in proportion to the load carried. The bending moments are determined in the usual way.

#### INDEPENDENT FOOTINGS WITH PILES

If piles are used to carry the column load, the size and shape of the footing will depend upon the spacing of the piles. If the column is round or square, the piles should be placed so as to make the footing as nearly square as possible. In many cases, it is not possible to space piles so as to obtain a square footing. The shape of footing for different numbers of piles is shown in Fig. 171, p. 517. For different spacing, the shape of the footing will remain the same, but the dimensions of the sides will be altered proportionally.

For concrete piles carrying large loads per pile, the spacing of the piles will depend upon circumstances, as discussed on p. 542.

**Design of Footing on Piles.**—In the design of footings supported on piles, the upward reactions of the piles should be treated as concentrated loads. In figuring punching shear, only the reaction of piles outside of the pedestal need be considered.

Bending moments to be used in determining the steel areas are equal to the reactions of the piles multiplied by their distance from the edge of the pedestal. The piles producing bending moments in the direction considered are those within the trapezoid produced by the corner diagonals. If the lines of the trapezoid cut any piles, one-half of the pile so cut should be considered as acting in each of the two directions.

**Placing of Reinforcement.**—The reinforcement required by the bending moments should be distributed uniformly over the whole effective width of the footing, as in the case of footings resting on soil, because the object of the reinforcement is to make the whole footing act as a unit. Such an arrangement reduces the number of layers and also provides reinforcement for cross bending.

Some designers treat each line of piles separately. They concentrate the reinforcement required by the bending moment produced by each line of piles within a width across the line of piles somewhat larger than the diameter of the pile. Such arrangement is shown in Fig. 172, p. 518.

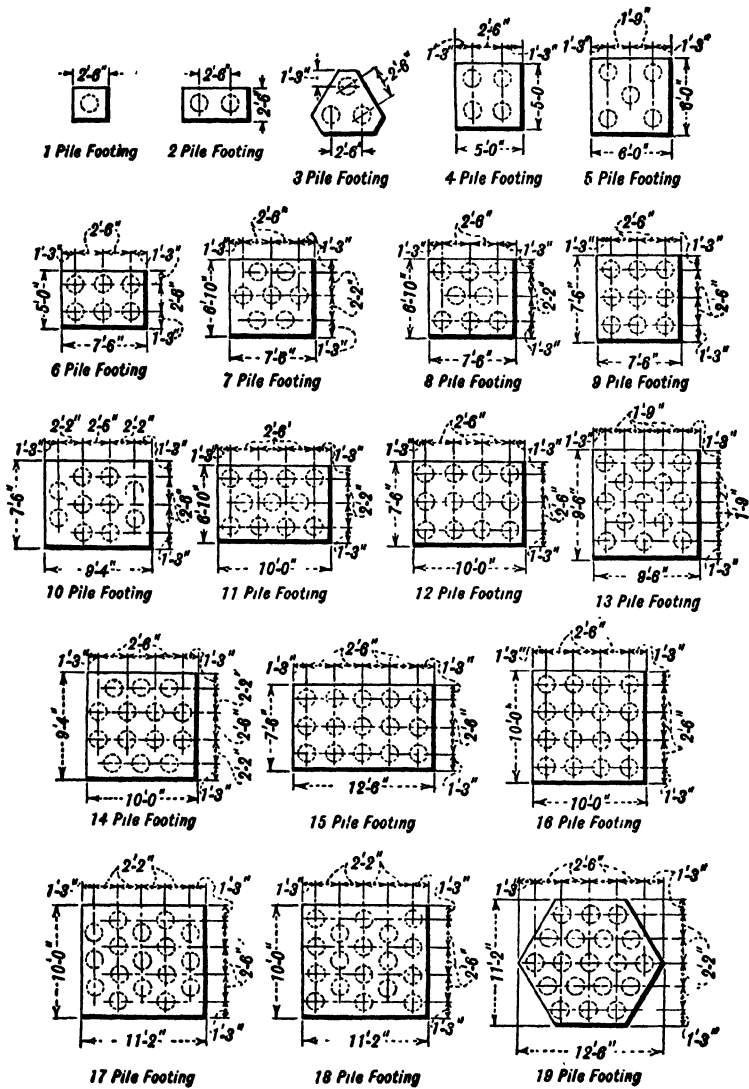

FIG. 171.—Shape of Footings for Different Arrangement of Piles. (See p. 516.)

This arrangement is wrong, for two reasons. First, there is no provision made for cross bending. It has been established that in a circumferential cantilever, such as an independent footing, circumferential stresses are developed in addition to radial stresses. The usual arrangement, where bars are placed in two directions, provides for these stresses even if they are not actually computed. In Fig. 172, there is no steel which could perform this function.

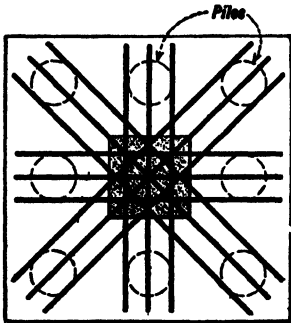

FIG. 172.—Incorrect Arrangement of Reinforcement above Piles. (See p. 516.)

The second objection is that, usually, to take care of bond stresses, a large number of bars of small diameter must be used, and if these are concentrated in a small width, the spacing must be made very small. When, on the other hand, a

small number of bars with larger diameter is used, the bond stresses are excessive, thus reducing the value of steel.

#### CONTINUOUS WALL COLUMN FOOTINGS

When it is not permissible to go outside the building line with the footing, independent footings cannot be used for the wall columns. In some such cases, it is possible to use a narrow footing of a width equal to the thickness of the basement column and extending the full distance between the columns. The basement wall may be used as part of the foundation.

**Bending Moment Reinforcement.**—The wall, as far as the reaction of the soil is concerned, acts as a beam extending between the columns. If the footing extends over several panels, the interior panels may be treated as continuous and the end panels as semi-continuous. The bending moments recommended are somewhat different from those used for continuous beams.

Let  $w$  = reaction of soil per lin. ft. of span in lb.;

$l_1$  = net span in ft.;

$l$  = span, center to center of column, in ft.; then

*Negative moment at center of interior span,*

$$M = \frac{wl_1}{16} = \frac{12wl_1}{16} \text{ in.-lb.}; \dots \dots (23)$$



*Positive moment at support,*

$$M_1 = \frac{wll_1}{12} \text{ ft.-lb.} = wll_1 \text{ in.-lb.} \dots \dots \dots (24)$$

In exterior panels, increase the bending moment in the center and at the interior support by 20 per cent.

It should be noted that the loads are acting upward. The position of the stresses and of steel, therefore, will be opposite to the position of stresses and of steel in ordinary beams.

The design of such a footing is given in the example below.

**Example 5.**—Design footings for wall columns spaced 20 ft. on centers, the load on which is  $P = 440\,000$  lb. The width of the column is 36 in. and the allowable soil pressure is  $p = 10\,000$  lb.

*Solution.*—Assume weight of wall and footing  $W = 60\,000$  lb. Total load on foundation is  $P + W = 440\,000 + 60\,000 = 500\,000$  lb. The required area of the footing,  $\frac{P + W}{p} = \frac{500\,000}{10\,000} = 50$  sq. ft.

Since the footing extends all the way between two adjoining columns, its length per column is equal to the spacing of columns, in this case 20 ft. The required width, therefore, is  $50 \div 20 = 2.5$  ft. The wall column will be of the same thickness, to make the distribution of the load uniform over the foundation.

**Design of Wall.**—The wall will be placed flush with the outside face of the column. The footing will be stepped inside.

In this type of footing, the wall acts as a beam loaded by the upward reaction of the soil and supported at the columns. The reaction per lineal foot producing bending moment is obtained by dividing the column load by the length of the footing (i.e., the spacing of columns). The weight of wall produces pressure on the foundation, but does not produce any shear or bending moments in the wall. The reaction per lineal foot is

$$440\,000 \div 20 = 22\,000 \text{ lb. per lin. ft.}$$

**Shear and Diagonal Tension.**—The thickness of the wall is governed by the requirement that the unit shearing stress shall not exceed the allowable unit stress. With columns 36 in. wide, the net span is 17 ft. and the external shear at the edge of the column is  $V = \frac{1}{2} \times 22\,000 = 11\,000$  lb. Since the effective depth of the wall is 11 ft., or 132 in., and the allowable unit shearing stress  $v =$

120 lb. per sq. in., the thickness of the wall, found from formula,  $b = \frac{V}{vjd}$ , is

$$b = \frac{11\,000}{120 \times 0.875 \times 132} = 13.5 \text{ in.}$$

Make wall 14 in. thick.

**Diagonal Tension Reinforcement.**—Diagonal tension reinforcement consists of stirrups, the size and spacing of which may be determined as for a beam. Formula (40), p. 248, may be used. Also, tables on p. 899 will be found useful.

**Projection of the Wall.**—The base of the footing is wider than the wall; therefore, it must project outside the wall within the building. The projection of the base must be made strong enough to prevent it from breaking off. It should be designed as a cantilever and, if necessary, reinforced with bars placed near the bottom at right angles to the wall.

If the projection is small, it should be made thick enough to withstand the bending stresses without reinforcement. The ratio between the depth and length of the projection may be taken from the table on p. 481. For large projections, it is more economical to use reinforcement. The steel must be placed near the bottom at right angles to the wall. It should run to the outside face of the wall and there be bent up and extended far enough into the wall to transfer to the wall the bending moment produced by the cantilever.

The moment on the cantilever produces torsion in the wall. This is partly offset by the earth pressure against the wall.

**Bending Moment Reinforcement.**—In the case under consideration,  $w = 22\,000$  lb.,  $l_1 = 17$  ft., and  $l = 20$  ft. The bending moments are:

Negative bending moment in the center, . . . . .

$$M = \frac{12 \times 22\,000 \times 17 \times 20}{16} = 5\,620\,000 \text{ in.-lb.}$$

Positive bending moment at the support,  $M_1 = 22\,000 \times 17 \times 20 = 7\,480\,000$  in.-lb.

The required area of steel can be obtained from Formula (3a), p. 204, using effective depth of wall as  $d$  and  $\frac{1}{4}$  as  $j$ .

Top reinforcement  $A_s = \frac{5\,620\,000}{\frac{1}{4} \times 132 \times 16\,000} = 3.0$  sq. in. Use 4 - 1-in. rd. bars.

Bottom reinforcement at columns =  $\frac{7\,480\,000}{\frac{1}{4} \times 132 \times 16\,000} = 4.0$  sq. in. Use 4 - 1-in. sq. bars.

**Bond Stresses.**—Shear at column edge, as computed previously, is  $V = 187\,000$  lb. Perimeter of four one-inch square bars is  $\Sigma o = 4 \times 4 = 16$  in. From

formula,  $u = \frac{V}{\Sigma o j d}$

$$u = \frac{187\,000}{16 \times 0.875 \times 132} = 100 \text{ lb. per sq. in.}$$

If deformed bars are used, this is satisfactory.

For plain bars, bond stresses must be reduced to 80 lb. per sq. in. by using an increased number of smaller bars of the total required area, the perimeter of which equals  $16 \times \frac{1.00}{.80} = 20$  in. Nine  $\frac{1}{2}$ -in. round plain bars, having an area of 3.98

sq. in. and circumference of 21.3 in., could be used. The use of deformed bars, however, in this case is distinctly advantageous.

**Arrangement of Steel.**—Since the wall is deep in proportion to the span, it is not advisable to bend any of the top reinforcement. The best method is to use straight bars at the top. Two one-inch round bars will extend the whole length of the footing and will be made 20 ft. long. Two other bars will extend 12 in. plus or minus beyond the points of inflection on each side. The distance between the points of inflection is equal to  $\frac{2}{3}$  of the net span of 17 ft., or 10 ft. 2 in.; therefore, the bars will be made 12 ft. 3 in.

The negative steel placed at the bottom will extend 12 in. on each side beyond the  $\frac{1}{2}$  of the net span.

**Compressive Stress.**—Since the ratio of the areas of steel to the area of concrete is less than 0.0077, compressive stresses are smaller than the allowable values and need not be computed. Also, since  $p$  is less than 0.0077, the value of  $j$  will exceed the value  $\frac{7}{8}$  used in the calculation. This discrepancy is on the side of safety, as it lowers the unit bond stress and the unit shear and reduces slightly the stress in the steel.

**Stresses in the Wall Due to Earth Pressure.**—The design of the wall for earth pressure is discussed on p. 640. In the present case, the wall will be considered as supported at the top and bottom. The earth pressure equivalent to a fluid pressure of a 30-lb. fluid will be assumed. The maximum pressure at the bottom is  $9 \times 30 = 270$  lb. per sq. ft. The bending moment is found by Formula (4), p. 640.

$M = 0.77 \times 270 \times 9^2 = 16\,800$  in.-lb. per horizontal foot of wall. If the wall 14 in. thick is considered as plain concrete without reinforcement, the tensile stress in concrete may be computed from the formula for homogeneous

beams,  $f_c = \frac{6M}{bd^2}$ . It is

$$f_c = \frac{6 \times 16\,800}{12 \times 14^2} = 42.9$$

Since, in addition to being supported on top and bottom, the wall is also supported at the columns, the actual stresses in the wall due to the earth pressure are much smaller than computed above, and would come below the 40-lb. tensile stress allowed for plain concrete. Therefore, no steel is required except some reinforcement for contraction due to temperature and shrinkage. This will be assumed as  $\frac{3}{8}$ -in. round bars 18 in. on centers, both ways. In addition, the wall is reinforced with inch reinforcement.

**Projection of the Wall.**—The footing is 30 in. wide and the wall 14 in. wide. With wall flush on one side, the projection is 16 in. The unit reaction of the soil (column load divided by area) is 8 800 lb. per sq. ft. Therefore, considering the projection as a cantilever, the bending moment at the edge of the wall is,

$$M = 8\,800 \times \frac{1}{2} \times 8 = 93\,900 \text{ in.-lb. per ft.}$$

The required depth, from Formula (11), p. 208, in which for  $f_s = 16\,000$  lb. per sq. in.,  $f_c = 650$  lb. per sq. in., and  $n = 15$ ,  $C_1 = 0.028$  is

$$d = 0.028 \sqrt{93\,900} = 8.5 \text{ in.}$$

The required area of steel,  $A_s = 0.0077 \times 8.5 \times 12 = 0.79$ .

Allowing  $3\frac{1}{2}$  in. below steel, the total depth of the projection is  $h = 8.5 + 3.5 = 12$  in.

### COMBINED FOOTINGS

It is sometimes necessary to combine the footings of two or more columns. This is required, for instance, when a wall column is placed at the building line and it is not permissible to project the footing of the column outside of the building line. An independent footing, in such a case, would be eccentrically loaded. To insure even distribution of the column load on the foundation, the footing for the wall column may be combined with the footing of the adjoining interior column.

Combined footings are sometimes used for a row of columns, in cases where the soil is compressible and it is desirable to avoid independent settlement of any one column. Thus, in the new Massachusetts Institute of Technology buildings, due to the peculiarity of the ground, the footings of all wall columns were made continuous even when independent footings were feasible.

Combined footings may also be used where the distance between adjoining columns is fairly small (as in corridor columns) and it is cheaper to build one combined footing for both columns than two independent footings.

**Pedestals.**—The paragraph on Pedestals, p. 486, in connection with independent footings, applies equally to combined footings.

**General Requirements.**—To insure uniform distribution of the column loads on the foundation, it is absolutely necessary that the center of gravity of the upward reaction of the soil should coincide with the center of gravity of the column loads. If the footing rests directly on the soil, then this requirement is fulfilled if the center of gravity of the area of the footing coincides with the center of gravity of the column loads. For pile foundations, the center of gravity of the piles (and not necessarily that of the footing) must coincide with the center of gravity of the column loads.

**Shape of the Base of Combined Footing.**—The shape of the base of the footing will depend upon conditions. If a combined footing is used for two unequal column loads, the base may be made in the shape of a trapezoid, the center of gravity of which coincides with the center of gravity of the column loads.

The parallel sides are placed at right angles to the line joining the two column centers, the longer side of the trapezoid being at the heavier column. It is more desirable, however, to use a base of footing rectangular in shape, as shown in Fig. 173, p. 530, as the design and construction of a rectangular footing is simpler than that of a trapezoidal footing. The inequality of column loads is taken care of by extending the footing the required length beyond the heavier column. The rectangular footing can be used only when the wall column load is equal to or smaller than the interior column load.

With equal column loads, the combined footing should be symmetrical when possible. Continuous footing for a row of equal column loads should extend beyond the end columns, to provide sufficient bearing area on the soil for the same.

The method of procedure in determining the base of footing is as follows: The required area of the footing is computed. The center of gravity of the column loads is found. This point is then considered as the center of gravity of the rectangle or the trapezoid (whichever shape is selected) and the dimensions of the base are so selected as to give the required area, as previously computed.

If the combined footing is for a wall column and an interior column, the footing at the wall column is made flush with the wall. The distance from the center of gravity of the column loads to the outside face of the wall is, therefore, fixed. This fixes the length of the rectangle, because the total length must be equal to twice this fixed distance from the center of gravity of the column loads to the outside face of the wall. When the length has been found, the width of the footing is determined by dividing the required area of the base by the length of the rectangle.

If the combined footing is for two interior columns, the length of the rectangle is not fixed. Any number of combinations of width and length of footing are possible. The arrangement is most economical if the length of the longer cantilever, measured from outside face of column, is equal to 0.35 of the net span between the columns. After the length is determined, the width of the footing is computed from the required area.

**Design of Combined Footing.**—In most cases, the bending moments and external shears in a combined footing may be found by statics. After they are determined, the footing is designed by formulas and principles given in the chapter on Reinforced Concrete.

The combined footing may be a slab of uniform thickness (Fig.

173). If the thickness required for punching shear at the columns is larger than the depth required for bending moments and diagonal tension, a pedestal of proper depth and width may be placed over the slab at the column. When the shearing stresses permit it, the cost of the footing may be reduced by eliminating some of the concrete in tension and using an inverted T-section for the cross section of the footing. The bottom flanges of the T-section act as cantilevers. If the tensile stresses exceed the allowable stresses for plain concrete, sufficient reinforcement should be used in the flanges of the T-section to resist the bending moment. The whole section must be built in a continuous operation.

**Bending Moments.**—*Combined Footings for Two Columns.*—A combined footing for two columns consists of either one or two cantilevers and a center span between the two columns. The footings are subjected to the reaction of the soil, which acts upward; hence, the bending moments are of opposite sign to the bending moments in ordinary beams where the loads act downward. On the cantilever, the bending moments are positive, producing tension in the lower part of the footing. In the middle portion of the center span, the bending moments are negative, producing tension near the top of the footing, while at the columns they are positive, i.e., of same character as for the cantilevers.

Let  $M_1$  = maximum bending moment at the column;

$M_2$  = maximum negative bending moment in middle of center span;

$w$  = upward soil pressure, lb. per lin. ft.;

$l_1$  = net span between columns in feet;

$l_2$  = the length of cantilever in feet.

The maximum positive bending moments on the cantilevers, acting at the outside edge of the column or pedestal, are found by multiplying the upward soil pressure on each cantilever by the distance from its center of gravity to the edge of the column or pedestal.

*Maximum Bending Moment for Cantilever.*

$$M_1 = \frac{wl_2^2}{2} \text{ ft.-lb.} = 6wl_2^2 \text{ in.-lb.} \quad \dots \quad (25)$$

The positive bending moment at inside edge of the column (in the center span) is theoretically equal to the maximum bending moment in the adjoining cantilever.

The magnitude of the negative bending moment in the middle portion of the center span may be obtained by combining the negative bending moments for the span, considered as simply supported, with the positive bending moments at the columns, produced by the cantilevers. When the bending moments at the two columns are equal (or nearly equal), the maximum bending moment acts in the middle of the center span and is equal to the maximum bending moment for a simple span minus the bending moment at the column.

*Maximum Bending Moment in Middle of Center Span.*

Then

$$M_2 = M_1 - \frac{wl_1^2}{8} \text{ ft.-lb. . . . . (26)}$$

For inch-pounds, multiply by 12.

For a large difference between the cantilever bending moments at the two columns, the maximum bending moment in the center span will act off center, and the above rule will not apply. In such case, the maximum bending moment can be obtained by plotting the positive and negative bending moments and determining the largest value by scaling or analytically, from the principle that the maximum bending moment in the center span acts at the point of zero shear. If the column load at the right is  $P_1$ , then the point of zero shear is at a distance equal to  $\frac{P_1}{w}$  from the right edge of the footing. Let  $l_3$  be the distance of this point from the inside edge of the column, then

$$M_2 = M_1 - \frac{wl_3^2}{2} \text{ ft.-lb. . . . . (27)}$$

The above formulas are based on the assumption that the bending moments at both sides of the column are the same. This assumption is correct if the effect of the rigid connection between the column and the footing is not considered. Actually, this effect is appreciable enough to affect the bending moments in the center span. For cantilevers smaller than 0.3 of the net span the bending moment at the columns in the center span is larger than the bending moment produced by the cantilever. On the other hand, for long cantilevers, part of the bending moment due to the cantilever is absorbed by the rigidity of the column, so that only one part of it is transferred to the center span.

To provide for this, the positive bending moment at the inside edge of a column with cantilever should not be less than  $\frac{wl_1^2}{16}$  and at wall column not less than  $\frac{wl_1^2}{24}$ . Also, in the middle of the center span, sufficient reinforcement should be provided for a negative bending moment  $\frac{wl_1^2}{20}$ , even if the computed bending moment is smaller, as would happen for cantilevers longer than  $0.38l_1$ .

*Combined Footing for a Row of Columns.*—A combined footing for a row of three or more columns may be treated as a continuous beam. With properly proportioned footings, there is smaller chance than in floor construction of unequal reactions on the various spans due to the variation of the live load, because there is small chance for the aggregate area of the floor tributary to one column to be much more lightly loaded by live load than the aggregate area of the adjoining columns. Therefore, not as much provision for the unbalanced loading need be made as is customary in continuous beams, and the bending moment in the center of spans may be smaller than in continuous beams in a floor. It may be made more nearly equal to the true theoretical moment with all spans loaded. It is a matter of judgment just how nearly equal the two bending moments can be made. An inexperienced designer is advised to use the same increased bending moment coefficients as recommended for continuous beams.

If the spans are unequal, special computations should be made. The tables and diagrams given in Volume II may be used.

**External Shear.** *Footings for Two Columns.*—Shears for computing diagonal tension and bond stresses are determined by statics. The shear from the cantilever at the edge of the column equals the total upward load on the cantilever. The shear at the edge of the column in the middle span equals the shear from the center span, if considered as simply supported, plus the shear due to the bending moment on the cantilevers. When the cantilevers on both sides are equal, the shears due to cantilever action balance; hence there is no increase in shear. For unequal cantilevers, the external shear at the edge of the columns with the larger cantilever will be increased by a value equal to the difference between the bending moments on the two cantilevers about the center of the columns, divided by the distance between the column centers. At the other column, the shear will be decreased by the same amount. The same results may be obtained



by subtracting at each end, from the column load, the upward reaction on the area between the edge of the footing and the inside edge of the column.

**External Shears for a Row of Columns.**—The shears should be computed in the same manner as explained for continuous beams.

**Transverse Bending Moments.**—If the width of the combined footing is larger than the width of the column, the upward pressure of the soil will produce a bending moment about an axis obtained by connecting the outside edges of the two columns. The part of the footing projecting beyond this axis acts as a cantilever, and the upward soil pressure produces a positive bending moment along the axis. This requires reinforcement placed near the bottom of the footing and running across the footing; this reinforcement may be either concentrated at the columns or spread along the whole width of the footing. While there is a preference for the former method, the latter method seems more logical. The transverse reinforcement is intended to prevent upward bending of the whole footing and not only of the portion near the column. The bending moment is produced all along the axis. It does not seem reasonable to resist it a great distance from the place where it was formed. The authors recommend, therefore, uniform spacing of the transverse bars over the whole footing.

**Diagonal Tension.**—Diagonal tension stresses are likely to be large and should always be computed. Reinforcement should be used to provide for diagonal tension, when required by stresses. The external shears to be used may be computed as explained in the previous paragraph, under proper headings. The diagonal tension reinforcement is best provided for by means of stirrups, because, owing to the large depth of the footing relative to its length, it is seldom feasible to bend the longitudinal bars in such a way as to make them useful for shear and bending moment.

### **Reinforcement for Combined Footing.**

*Footing Carrying Two Columns.*—The main reinforcement consists of longitudinal bars placed near the top of the footing in the center span and near the bottom at the two columns. The areas of steel are found from bending moments computed as explained on p. 524.

At least 50 per cent of the steel in the center span should extend from column to column. The remaining bars may be bent down at

proper places and carried near the lower face of the footing into the cantilever to serve as reinforcement for the center span at the column and also as cantilever reinforcement. Sometimes, the depth of the footing is too large in proportion to the length, so that the bend of the bars would be too steep. In such cases, the bars may remain straight and extend about a foot beyond the points of inflection. Bars should be investigated for bond stresses.

The steel at the columns consists of bent bars carried from the middle span, short bars, or a combination of both. Bond stresses are always very high and should be investigated. Although the bending moment is the same at both sides of the column, the shear is much larger at the inside edge. This may require a much larger amount of steel than that required by bending moment.

Cross reinforcement should be placed as explained under proper heading.

**Bond Stresses.**—Bond stresses in footings are always high and should be computed. In the middle span for the top steel, the shear at the point of inflection should be used in Formula (50), p. 262. For the bottom steel at the column, the bond stresses should be computed at both sides of the column. At the column, the bending moment is the same on both sides, so that the number of bars required by bending moment is the same.

Usually, however, the external shear at the inside edge of the column is larger than the external shear at its outside edge. Since the bond stresses depend upon shear, they are larger at the inside edge. The explanation is that the rate of increase in bending moment at the inside edge of the column is much greater and the tensile stresses in steel are developed in a much shorter distance than in the cantilever. In such cases, to reduce the bond stresses, the amount of steel must be increased, also the steel must be anchored at its free end to permit large allowable bond stresses.

The example below illustrates the design of a combined footing.

### Example of Combined Footing.

**Example 6.**—Find the dimensions of a combined footing for a wall column with a cross section 38 in. by 24 in., carrying a load  $P_1 = 400\,000$  lb. and an interior column 30 in. square with a load  $P_2 = 580\,000$  lb. The distance between column centers is 15 feet and the allowable unit pressure on soil  $p = 8\,000$  lb. per sq. ft. The outside edge of the foundation must coincide with the outside edge of the wall column.

**Solution. Area of Footing.**—Assume dead load of footing,  $W = 70\,000$  lb., then total load on foundation,  $P_1 + P_2 + W = 400\,000 + 580\,000 + 70\,000 = 1\,050\,000$  lb. For allowable unit pressure,  $p = 8\,000$  lb., the required area of footing is  $\frac{1\,050\,000}{8\,000} = 131$  sq. ft.

**Center of Gravity of Column Loads.**—The distance of the center of gravity of the column loads from center of wall column is found by computing the moment of the column loads about the center of wall column and dividing it by the sum of the column loads. Dead load of footing needs no consideration in determining the center of gravity of the column loads. The column load  $P_2$  is the only load producing a bending moment about the center of the wall column. This moment equals  $15 \times 580\,000$  ft.-lb. The sum of the column loads is  $400\,000 + 580\,000 = 980\,000$  lb.; hence, the distance from center of wall column to center of gravity is  $\frac{15 \times 580\,000}{980\,000} = 8.9$  ft.

**Shape of Footing.**—Use a rectangular footing with one side flush with the edge of the wall column. Its length will be determined from the requirement that the center of gravity of the rectangle should coincide with the center of gravity of the loads.

The distance from the edge of the footing to the center of the wall column is 1 foot. Since the distance from center of wall column to center of gravity of the loads, as computed above, is 8.9 ft., the distance from the edge of the footing to the center of gravity equals  $1 + 8.9 = 9.9$  ft. The center of gravity of a rectangle is in its middle. Therefore, 9.9 ft. found above, equals one-half of the length of the rectangle. Its full length, therefore, is  $9.9 \times 2 = 19.8$  ft.

**Width of Footing.**—Since required area of footing is 131 sq. ft., and its length 19.8 ft., the width equals  $\frac{131}{19.8} = 6.6$  ft. Use 6 ft. 9 in.

**Unit Pressure for External Shears and Bending Moments.**—Bending moments and external shears are produced by the column loads only, exclusive of the dead load of the footing.

$$\text{Unit pressure per sq. ft. is } \frac{400\,000 + 580\,000}{19.8 \times 6.75} = 7\,340 \text{ lb.}$$

$$\text{Pressure per lineal foot of footing } \frac{400\,000 + 580\,000}{19.8} = 49\,500 \text{ lb.}$$

**Bending Moments.**—As evident from Fig. 173, p. 530, the footing consists of the center span and of the cantilever beyond load  $P_2$ .

**Bending Moment of Cantilever.**—Length of cantilever to the edge of the outside column is 2.55 ft. Since pressure per lineal foot equals 49 500 lb., the bending moment on the cantilever is total load multiplied by moment arm, or

$$M_1 = 49\,500 \times 2.55 \times \frac{2.55}{2} \times 12 = 1\,930\,000 \text{ in.-lb.}$$

This moment is positive, causing tension at the bottom face of the footing.

*Bending Moment in Center Span.*—At the inside face of the interior column, the bending moment will be either the same as produced by the cantilever or  $\frac{wl_1^2}{16}$  ft. lb., whichever is larger (where  $w$  = pressure per lineal foot and  $l_1$  = distance in feet between inner faces of columns). For  $w = 49\,500$  lb.,  $l_1 = [15 - (1.0 + 1.25)] = 12.75$  ft., the bending moment from formula  $\frac{wl_1^2}{16}$  is  $\frac{49\,500 \times 12.75^2}{16} = 503\,000$  ft.-lb., or 6 036 000 in.-lb. This moment is larger than the bending moment due to the cantilever and will be used in computing the required reinforcement at the column.

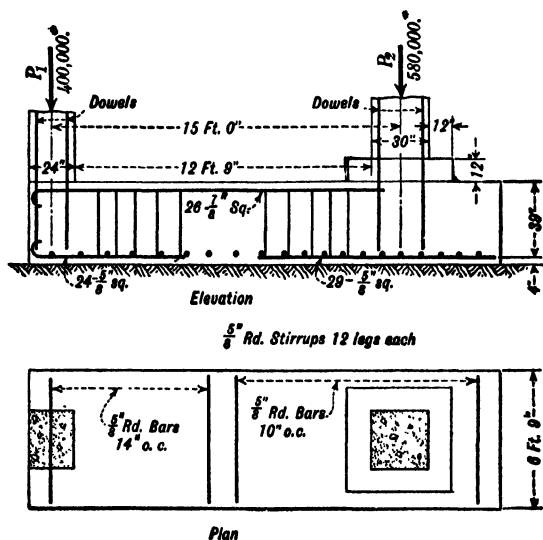

FIG. 173.—Combined Footings. (See p. 529.)

In the middle portion, the maximum bending moment will be computed at the point of zero shear. The distance of the point of zero shear from the outside edge of the wall column equals the wall column load divided by the pressure per lineal foot. It is  $\frac{400\,000}{49\,500} = 8.1$  ft. from outside face of column, or  $8.1 - 2 = 6.1$  ft. from inside edge of column. The maximum negative bending moment is now found by statics. Disregarding the indefinite amount of restraint at the wall column, the negative moment, from Formula (27), p. 525, where  $M_1 = 0$  and  $w = 49\,500$  lb. and  $l_s = 6.1$  ft., equals

$$M_2 = -49\,500 \times \frac{6.1^2}{2} = -921\,000 \text{ ft.-lb. or } -11\,052\,000 \text{ in.-lb.}$$

**External Shears.**

*Shear Due to Cantilever.*—External shear due to the cantilever at the outside edge of interior column, is equal to the pressure per unit of length multiplied by the length of the cantilever in feet. It acts downward and is therefore negative.

$$V_1 = 49\,500 \times 2.55 = 126\,200 \text{ lb.}$$

*Shears in Center Span.*—The external shears at the inside edge of the columns will be computed by subtracting the upward pressures from the respective column loads.

*External Shear at Inside Edge of Interior Column.*

$$V_2 = 580\,000 - 49\,500 \times 5.05 = 330\,000 \text{ lb.}$$

*External Shear at Inside Edge of Wall Column*

$$V_3 = 400\,000 - 49\,500 \times 2 = 301\,000 \text{ lb.}$$

**Depth of Footing.**—Depth of footing is determined either by bending moment or by diagonal tension, whichever gives the larger value. The depth should be checked for punching shear and, if required, a pedestal should be added on the top of the footing.

**Depth Determined by Bending Moment.**—In this case, the largest bending moment is the maximum negative moment of the center span,  $M = 11\,052\,000$  in.-lb. Using Formula (1), p. 204,  $d = C \sqrt{\frac{M}{b}}$ , in which width of footing  $b = 81$  in. and for unit stresses  $f_c = 650$  lb. per sq. in.,  $f_s = 16\,000$  lb. per sq. in. and  $n = 15$ ,  $C = 0.096$  (see p. 880). Depth as required by bending moment

$$d = 0.096 \sqrt{\frac{11\,052\,000}{81}} = 35.5 \text{ in.}$$

**Diagonal Tension.**—The largest external shear is at the inside edge of the interior column. For the depth found above,  $d = 35.5$  in., and a width of footing equal to 6 ft. 9 in. or 81 in., the unit shear from formula  $v = \frac{V}{bjd}$ , is

$$v = \frac{330\,000}{81 \times 0.875 \times 35.5} = 131 \text{ lb. per sq. in.}$$

This value is larger than the allowable working limit, which is 120 lb. per sq. in. The depth as determined for bending moment must be increased in the proportion of 130 to 120. The depth as required by diagonal tension is  $d = 35.5 \times \frac{130}{120} = 38.7$  in. Diagonal tension reinforcement must be provided for sections where  $v$  exceeds 40 lb. per sq. in.

**Longitudinal Reinforcement.**—Using depth of slab  $d = 39$  in. as required by diagonal tension, the amount of steel at the various sections will be found from equation

$$A_s = \frac{M}{jd_s'}$$

where  $j = 0.875$  and  $f_s = 16\ 000$  lb. per sq. in.

*Center of Footing,*

$$M_2 = 11\ 052\ 000 \text{ in.-lb.}$$

$$A_s = 20.3 \text{ sq. in.}$$

Twenty-six  $\frac{1}{4}$ -in. bars will be tried.

*Center Span at Interior Column,*

$$M = 6\ 036\ 000 \text{ in.-lb.}$$

$$A_s = 11.2 \text{ sq. in.}$$

Twenty-six  $\frac{1}{4}$ -in. round bars will be tried.

The bars must be extended into the cantilever.

*Cantilever,*

$$M_1 = 1\ 930\ 000 \text{ in.-lb.}$$

$$A_s = 3.6 \text{ sq. in.}$$

This amount of steel is smaller than the amount extended from the other side of the column.

**Bond Stresses.**—It is necessary to compute bond stresses in top and bottom reinforcement, as the footing may fail by slipping of the top or bottom bars.

*Bond Stresses in Top Reinforcement.*—Since, theoretically, there is no bending moment at the wall column, the bond stresses in the top steel there will be computed as for simply supported beams (note that top steel in footings corresponds to bottom steel in ordinary beams). At the other end of the footing, the bond stresses are smaller, because there they have to be computed at the point of inflection where the external shear is smaller. The shear at the edge of wall column is  $V_1 = 301\ 000$  lb. The bond stress with twenty-six  $\frac{1}{4}$ -in. square bars, having a total perimeter  $\Sigma o = 26 \times 3.5 = 91$  in., from formula  $u = \frac{V}{\Sigma o j d}$ , is

$$u = \frac{301\ 000}{91 \times \frac{1}{4} \times 39} = 97 \text{ lb. per sq. in.}$$

This is satisfactory for deformed bars.

*Bond Stresses in Bottom Steel.*—The amount of bottom steel is the same at both sides of the interior column. The external shear, however, is larger at the inside edge. The bond stresses will be figured for the larger shear.

The perimeter of twenty-six  $\frac{1}{4}$ -in. rd. bars is 61.2 in. For  $V_2 = 330\ 000$  lb. and depth 38.7 in., the bond stresses are

$$u = \frac{330\ 000}{61.2 \times \frac{1}{4} \times 39} = 158 \text{ lb. per sq. in.}$$

To reduce the excessive bond stresses, use twenty-nine  $\frac{1}{4}$ -in. sq. bars, the perimeter of which is  $29 \times 2.5 = 72.5$  in.

$$u = \frac{330\ 000}{72.5 \times \frac{1}{4} \times 39} = 134.$$

Further reduction of bond stresses by reducing the diameter of bars is not advisable. Instead, the depth of the footing may be increased by providing a block

at the column, and the bars will be extended beyond the point of inflection, in which case larger bond stresses are allowed.

**Transverse Reinforcement.**—The projection of the footing beyond the edge of the interior column is 2 ft. 1½ in., and beyond the edge of exterior column 1 ft. 9½ in. The transverse bending moment will be figured for both projections. The upward pressure per square foot is 7 340 lb. Hence, transverse bending moments per foot of length of the footing are:

$$M_3 = 7\,340 \times 2.12 \times \frac{25.5}{2} = 198\,000 \text{ in.-lb.}$$

$$M_4 = 7\,340 \times 1.79 \times \frac{21.5}{2} = 141\,000 \text{ in.-lb.}$$

For  $d = 38.5$  in.  $f_s = 16\,000$

$$A_{s3} = \frac{198\,000}{16\,000 \times \frac{7}{8} \times 38.5} = 0.37 \text{ sq. in.}$$

Use ¾-in. rd. bars, 10 in. on centers.

$$A_{s4} = \frac{142\,000}{16\,000 \times \frac{7}{8} \times 38.5} = 0.26 \text{ sq. in.}$$

Use ¾-in. rd. bars, 14 in. on centers.

## STRAP BEAMS TO CONNECT FOOTINGS

Instead of using a combined footing for a wall column and an interior column, as in the previous discussion, it may be desirable to build both footings separately and to take care of the eccentricity on the wall footing by connecting it with the adjoining interior footings by means of strap beam. The strap beam may or may not be used to transmit the load to the foundation, depending upon the design. Its primary function is to resist the bending moment produced by the eccentricity of the wall column load with respect to the wall footing reaction.

Such an arrangement is particularly useful when pile foundation is used for both columns, and it is desirable to place the piles in clusters next to the columns; it is also useful when the footings for both columns consist of caisson piles.

**Bending Moments and Shear in Strap Beams.**—For the purpose of determining bending moments and shears, the strap beam may be considered as a balanced double cantilever supported at the center of the wall footing. The short cantilever carries the wall column load,  $P_1$ , and the long cantilever carries the balancing reaction, which is

provided by the interior column with which the long arm is connected. The conditions of loading are seen from Fig. 174, p. 534.

To make the bending moments statically determinate, the strap beam is considered as free to rotate at the ends. With this assumption, from simple mechanics, the bending moment is zero at both ends and increases to a maximum at the point of support.

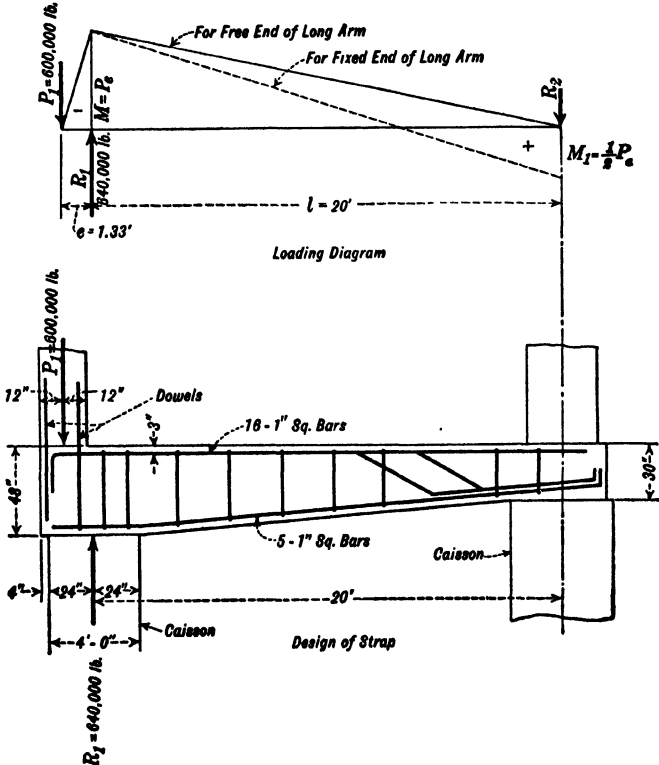

FIG. 174.—Loading and Moments in Straps. (See p. 534.)

- Let  $P_1$  = load on wall column, lb.;
- $l$  = distance between centers of the wall footing and the interior footing, ft.;
- $e$  = distance between center of wall column and wall footing, ft.;
- $R_1$  = reaction on wall footing, lb.;
- $R_2$  = reaction on interior footing due to load  $P$ , lb.;
- $M$  = bending moment.



Then

*Maximum Bending Moment in Strap Beam.*

$$M = - P_1 e \text{ ft.-lb. . . . . (28)}$$

*Reaction on Wall Footing.*

$$R_1 = P_1 \left( 1 + \frac{e}{l} \right) \text{ lb. . . . . (29)}$$

*Reaction on Interior Footing due to Load P.*

$$R_2 = - P_1 \frac{e}{l} \text{ lb. . . . . (30)}$$

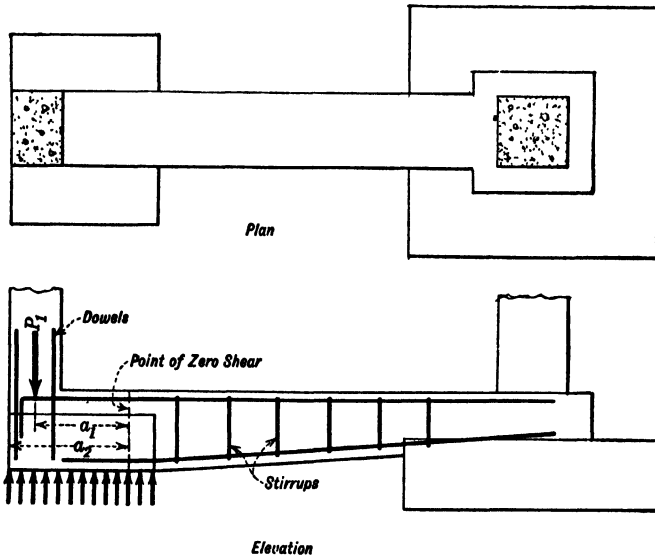

FIG. 175.—Strap for Footing with Uniformly Distributed Reaction. (See p. 536.)

It should be noted that the load for which the wall footing is designed is larger than the wall column load. The load on the interior footing is decreased by the reaction  $R_2$ .

The bending moment in Formula (28) is based on the assumption that the reaction  $R_1$  is concentrated in one point. This assumption gives the maximum possible bending moment. Actually, the reaction is distributed and the bending moment is therefore smaller.

Two cases may occur: (1) the reaction  $R_1$  consists of uniformly

distributed upward pressure; (2) the reaction consists of several rows of piles. In both cases the maximum bending moment acts at the point of zero shear.

For uniformly distributed reactions, the distance of the point of zero shear from edge of footing is found by dividing the column load  $P_1$  by the reaction per lineal foot. Such a condition is shown in Fig. 175. Assume that the unit reaction of foundation is  $p$  and that  $P = pa_2$ ; then  $a_2$  is the location of the point of zero shear from edge of footing reactions. If  $a_1$  is the distance between the load  $P$  and the point of zero shear, then

$$M = -P_1 \left( a_1 - \frac{a_2}{2} \right) \dots \dots \dots (31)$$

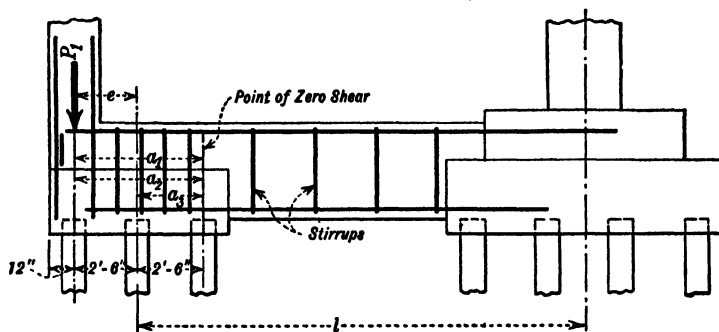

FIG. 176.—Straps for Footings on Piles. (See p. 536.)

For footings supported on piles, the location of maximum bending moment is at point of zero shear or point where shear changes sign. Usually this will be at the center of the last row or piles. If  $a_1$  is the distance from this point to the load  $P_1$ ,  $q_1$  is the reaction of the first row of piles and its distance  $a_2$ ,  $q_2$  the reaction of the second row of piles and its distance  $a_3$ , then

$$M = - [P_1 a_1 - (q_1 a_2 + q_2 a_3)] \dots \dots \dots (32)$$

For a larger number of piles it may be necessary to use  $a_3$ ,  $a_4$ , etc.

**Dead Load of Footing and Strap Beam.**—The dead load of footing and strap beam should be added to the footing load,  $R_1$ , in computing its size. In figuring the bending moment of the strap beam, however, the dead load of the strap may be disregarded.

**Design of the Strap Beam.**—The wall footing is designed first, and its center fixed. This gives the value of  $e$  and  $l$ . With these, the bending moment is determined. The width of the strap beam is made the same as the width of the column. When the bending moment and the width are known, the depth is computed from Formula (1), p. 204 ( $d = C \sqrt{\frac{M}{b}}$ ).

For the selected depth, the area of steel is computed from  $A_s = \frac{M}{jdf_s}$ .

The depth required by the bending moment is usually larger than that required by diagonal tension. It should be noted that the external shear producing diagonal tension in the long cantilever is constant and is equal to  $P_1 \frac{e}{l}$ .

Since the bending moment decreases toward the interior column, the depth of the strap beam may also be decreased. The minimum depth, of course, may not be smaller than required by diagonal tension produced by the shear  $P_1 \frac{e}{l}$ .

**Reverse Bending Moment at Interior Column.**—In the above discussion, it was assumed that the end of the cantilever at the interior column is free to turn. Since the strap beam must be connected either with the footing or with the column, this assumption is not correct. Owing to the rigidity of the connection of the strap beam with the interior column, some positive bending moment will be developed in the strap beam at the column. If the strap beam is fixed at the interior column, this bending moment is equal to one-half of the maximum bending moment,  $Pe$ . For intermediate conditions, intermediate values may be assumed. It is advisable to make generous provision for this bending moment.

**Provision for Unequal Settlement.**—The two footings joined by a strap beam may settle unevenly. This may produce stresses of opposite character to the stresses for which the footing is designed. To provide for this, the strap beam should be reinforced on top and bottom for its whole length. The authors recommend the use of one-third the amount of the steel in the bottom. This recommendation is arbitrary.

**Anchoring Reinforcement at Wall Column.**—In the short cantilever, full tensile stresses in the bars must be developed in the short

distance between the center of column and the center of footing. This distance usually is not sufficient for the purpose. The reinforcement must be extended to the edge of the wall column and then provided with a hook sufficient to develop the tensile stresses in the bar. Without such provision the construction would fail by bond.

**Types of Strap Beams.**—Figures 174 to 176 illustrate several of the types of strap beams most commonly used.

**Example of Strap Beam Design.**—In Fig. 174, p. 534, the columns rest on caissons.

The data are as follows:

$$P_1 = 600\,000 \text{ lb.};$$

$$P_2 = 1\,000\,000 \text{ lb.};$$

$$e = 16 \text{ in.} = 1.33 \text{ ft.};$$

$$l = 20 \text{ ft.},$$

$$R_1 = P_1 \left( 1 + \frac{e}{l} \right) = 600\,000 \left( 1 + \frac{1.33}{20} \right) = 640\,000 \text{ lb.};$$

$$R_2 = P_2 \frac{e}{l} = 40\,000 \text{ lb.};$$

$$M = P_1 e = 9\,600\,000 \text{ in.-lb.};$$

$$b = 44 \text{ in.} \quad d = 45 \text{ in.} \quad A_s = 15.3 \text{ sq. in.}$$

The arrangement of reinforcement is evident from the figure.

### RAFT FOUNDATION

When the allowable pressure on the soil is small, it may be necessary to spread the foundation over the whole area of the building. Such a foundation is called a raft foundation. It is often used in connection with piles, where they are driven in comparatively soft strata and it is desirable to space them as far apart as possible so as not to overload the ground in which the piles have bearing. The raft foundation is made either of flat slab construction or of beam and slab construction.

**Pressure on Foundation.**—As in the case of independent footings, to prevent unequal settlement, it is necessary to design the foundation so that the unit pressure on the soil is uniform. For uniformly distributed floor loading, this is not difficult. If the area of the foundation is equal to the area of the building, then the load on the foundation will be equal to the sum of the loads on all floors.

With uniformly distributed floor load, the foundation load will also be uniform.

The difficulty begins when the floor loads are not uniform, or when some columns carry additional loads. (Columns carrying the tank, for instance.) At wall columns also, the loading is proportionately larger than at the interior columns because it consists not only of the floor loading, but also of the weight of the wall. To provide for the additional load, it is necessary to extend the foundation outside of the building lines. The additional area to be provided is equal to the excess load on the wall column divided by the unit pressure on the foundation. When it is not possible to extend the foundation outside of the building, uneven pressure on the foundation will result. When this increased pressure does not exceed the maximum allowable pressure, the raft foundation may be used; but the construction between the wall columns and the first row of interior columns should be made strong enough not only to resist the upward pressures, but also to even up the settlement of the two columns. Uneven settlement of the wall column produces negative bending moment at the interior column and positive bending moment at the wall column. For large differences in unit pressure produced by the heavy columns, the design may be equalized by using piles under the heavy columns.

If raft foundation is used in connection with piles, the inequality in column loading may be taken care of by using closer spacing of piles at the heavier loaded columns.

**Flat Slab Foundation.**—The foundation may be of flat slab design, consisting of flat slab, drop panels, and column heads, as described in the chapter on Design of Flat Slab Structures, p. 319. The same formulas may be used as recommended for flat slab floors.

In this case, the pressure on the flat slab acts upward and the column load downward. The loading is of opposite sign to the loading in a floor; therefore the bending moments are also of opposite sign. At the columns, the bending moments are positive (instead of negative), producing tensile stresses at the bottom; therefore the tensile steel must be placed at the bottom of the slab. In the central parts of the slab, the bending moments are negative (instead of positive, as in a floor slab) and the reinforcement must be placed near the top of the slab.

To save form work, the drop panel may be placed below the slab. Instead of a column head of conical design, a cylindrical block of

concrete of a diameter equal to the diameter of the column head may be used. This is placed on the top of the slab.

Cinder fill, equal in depth to the height of the column head, is provided on the top of the foundation slab.

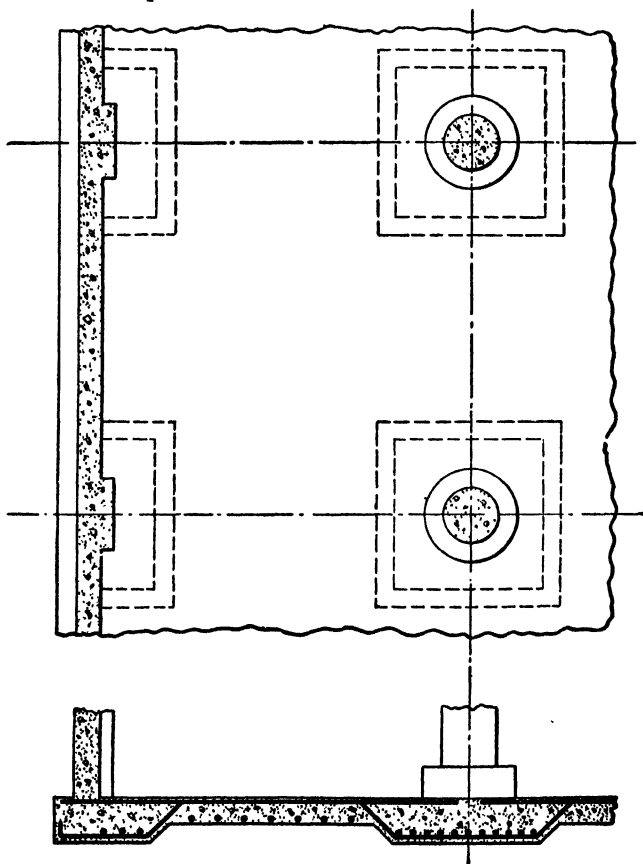

FIG. 177.—Details of Flat Slab Foundations. (See p. 539.)

**Beam and Slab Foundation.**—The design of the foundation may consist of a combination of beams, girders, and slabs. The principles of floor design must be followed in determining the concrete dimensions and the amount of steel. As explained in the previous case, the loading acts in the opposite direction to the floor loading, so that the location of the steel will be opposite to that in the floor.

The beams, or ribs, may be built either above or below the slab. When the ribs are above the slab, the beams are T-beams in the center and rectangular beams at the support. With ribs placed below the slab, the beams are T-beams at the columns and rectangular beams in the center of the span.

The design with beams above the slab is preferable, as better bearing on foundation is obtained. The space between the ribs is filled with cinders and the basement slab is placed on the top. It is necessary that the ribs be built monolithic with the slab. There is a tendency to pour the slab first, place the forms for the ribs on the slab, and finish pouring the ribs. This is absolutely wrong, as it is impossible to make the ribs and the slab act as a unit when they are poured in this way.

## CHAPTER IX

### PILES

A foundation may be supported on piles when the ground, for a great depth, consists of layers of soft materials on which it is either impossible or undesirable to rest the structure. The piles may be driven either to solid bearing on rock or hardpan or far enough into the firm ground to develop, by frictional resistance, the allowable capacity of the pile.

Piles may be of wood or concrete. The choice will depend upon economy and also upon the conditions affecting the permanency of the structure. For instance, when there is danger of their being attacked by teredo, or a likelihood that the level of low water will be materially lowered by future drainage, concrete piles should be given preference even at higher cost. The two kinds of piles will be treated separately.

**Spacing of Piles.**—The minimum spacing of piles depends upon two conditions. First, the piles must not be driven close enough together to compress the ground to an extent which would make impossible straight driving of adjacent piles. Second, the spacing must be such that the load transferred to the soil in which the pile has its bearing will not exceed the bearing value allowable on such soil. For instance, if the pile is driven into clay with an allowable unit bearing of 4 tons and the capacity of the pile is 20 tons, the area tributary to this pile must be at least 5 sq. ft., which requires a minimum spacing on centers of about 27 in. If piles are driven too close together the whole cluster with the surrounding earth may sink as a unit.

The minimum spacing on centers, as specified by most codes, is from 20 to 24 in. This spacing may be used if the ground is not compressible. New York City specifies a minimum spacing of 20 in., and a maximum of 36 in. In railroad work, closer spacing than 36 in. is not permitted. For use in building construction, under ordinary conditions, the authors recommend a spacing of piles of 30 in. on centers.



**Piles for Outside Bearing Walls.**—All bearing walls should have at least two rows of piles. For buildings over three stories in height, if two rows of piles are used, the spacing of the rows should be at least 36 in. on centers.

### WOOD PILES

Wood piles are commonly used for foundations because of their low cost. They may be either of soft timber, such as pine, spruce, or hemlock, or of hard timber, such as oak, cedar, or hickory. The following are the requirements for wood piles: They shall be sound, close-grained, solid, and without injurious ring shakes or loose knots. All knots shall be trimmed close to the body and all bark peeled soon after cutting. Piles shall be of uniform taper; not less than 6 in. in diameter at the point, and not less than 10 in. at the butt, for piles up to 25 ft. in length; and not less than 12 in. at the butt for longer piles. They shall be practically straight, a criterion of straightness being that a line drawn from the center of the butt to the center of the point shall be within the body of the pile. Short bends shall not be allowed.

The carrying capacity of the wood pile depends upon the character of the material into which it is driven. If the pile is driven to solid bearing on rock or hardpan, through firm material which is able to keep the pile from lateral displacement, its bearing capacity is equal to its strength as a short column. In such cases, the authors recommend 20 tons as the capacity of a pile. This capacity must be reduced when the pile is driven through material which, for any appreciable distance, does not offer resistance to lateral displacement of the pile. Such materials are water, mud, silt, peat, or fill. The pile should then be figured as a long column of a height equal to its unsupported length and of an average cross section within this length.

If the pile is not driven to solid bearing, its capacity depends upon the frictional resistance in bearing soil. It transfers the load to the soil gradually by friction. The capacity then is best determined by a load test. Where this is impossible, the capacity of the pile, i.e., the load to be used in design, is ascertained from its penetration under the last blows of the hammer. The most common formulas for the capacity of piles are the Wellington formulas, also known as the *Engineering News* formulas, given below. Their use is recommended by the authors.

Let  $P$  = capacity of pile, lb. ;  
 $W$  = weight of hammer, lb. ;  
 $h$  = fall of hammer, ft. ;  
 $s$  = penetration of pile at last blow, in., or average penetration for several consecutive blows.

Then  $P = \frac{2Wh}{s + 1}$  for pile driven with drop hammer, . . . (1)

and

$P = \frac{2Wh}{s + 0.1}$  for pile driven with steam hammer. . . (2)

Modern specifications require that  $s$  be taken as the average penetration for a series of blows, usually five to ten, and further require that the pile should be driven until the successive blows produce approximately equal or uniformly diminishing penetrations.

When the piles are designed for a certain capacity, they are driven until the final penetration,  $s$ , becomes small enough to give the required capacity when computed by Formulas (1) or (2). The weight of the drop hammer and the drop being known the maximum allowable penetration is computed and the pile driven until the penetration is reduced to this value. For instance, if a pile is designed to carry 20 tons, the weight of the drop hammer is 4 000 lb. and the drop is 10 ft., the maximum allowable penetration giving the required capacity obtained from the formula is  $s =$  one inch. The pile is driven until the penetration is reduced to one inch.

If it is impossible, with the length of pile at one's disposal, to get small enough penetration at the last blows, the capacity of the pile should be reduced according to the value of obtained final penetration and the proper number of piles added to give the desired resistance to the foundation. The size and strength of the footings should be increased if required by the larger number of piles.

**Cutting of Wood Piles.** All wood piles must be cut below permanent low water, so that the entire pile will always be wet. In such a case, unless destroyed by teredo, the piles may be expected to last indefinitely. It is important to determine whether there is any likelihood of the lowering of the low water level through future drainage. If so, the cutting level must be established with this in mind. The pile must be cut to sound wood which has not been injured by the hammer, as otherwise its value would be negligible.

**Driving Piles.**—Piles should be driven under the direction of men experienced in this work. They should be driven straight, since the value of inclined piles for vertical loads is small. Some engineers require that piles driven to hard strata be provided with metal shoes of proper design. The depth to which piles are to be driven should be determined by borings, in order to prevent overdriving of piles, which is even more harmful than underdriving. An overdriven pile is one that has been forced farther down after the point has reached solid bearing. The result is that it buckles, breaks, or splits, at the end. In any case its value is either lost or greatly reduced. If possible, all the piles in a cluster should be driven to the same depth.

Piles are driven by a drop hammer or a steam hammer. To prevent splitting of the tops, cushions are used. A water jet is often used in connection with the driving of piles, when it is possible to make the soil flow.

**Weight and Fall of Drop Hammer.**—The term drop hammer is used when the hammer is raised and then allowed to fall freely for 10 to 20 ft. before striking the pile. The raising is usually done by a hoisting drum.

The required weight of drop hammer depends upon the character of the soil and the weight of the pile. For hard soils, the hammer must be heavier than for soft. It should also be heavier than the pile, as otherwise a large part of the effect of the blow will be used up in overcoming the inertia of the pile. In general practice, the weight of hammer for wood piles varies from 2 000 to 5 000 lb., the most common weight being around 3 300 lb., and the fall from 5 to 20 ft. The best results are obtained when a heavy hammer is used with a comparatively low fall, as then the brooming of the butt is prevented. Another advantage of low fall is that the succession of blows is more rapid, thereby preventing the set of the soil around the pile.

**Steam Hammer.**—As the name implies, the steam hammer is operated by steam. It may be either single-acting or double-acting. A single-acting hammer is lifted by steam and falls by gravity, while for the double-acting hammer steam is used both in raising and in the fall. The weight of the striking part varies for different makes of hammers. For single-acting hammers, the weight of the moving part is around 5 000 lb., the stroke (or fall) around 3 ft., and the number of blows per minute about 60. The

weight of the moving part in a double-acting hammer is much smaller, varying from 1 250 to 2 550 lb. The downward pressure, however, of the weight and the steam is around 7 000 lb. The number of blows per minute varies from 100 to 200, the larger number being used with lighter hammers.

### CONCRETE PILES

Concrete piles are widely used. They have the following advantages over wood piles: (1) They have larger carrying capacity per pile, thus reducing the number of piles and decreasing the size of the foundation; (2) concrete piles do not need to be cut below low water, which often results in saving of expensive excavation; (3) they may be built of any length and size desired; (4) concrete piles are less affected by the teredo and other wood borers. (5) Concrete piles are immune to decay.

Concrete piles may be divided into three general groups: (a) pre-cast piles; (b) piles cast in place; (c) caisson piles.

**Pre-cast Piles.**—As the name implies, these piles are cast in the yard before the construction is begun, and then driven in the same manner as wood piles. Pre-cast piles, being simply long reinforced concrete columns, are designed according to the regular principles for reinforced concrete. There are several patented pre-cast piles on the market, but the patented features apply either to the method of driving, the design of the top of the pile to prevent it from splitting during driving, or the design of the shoe.

*Description of Pre-cast Piles.*—The cross section of the piles may be square, round, or octagonal. Square piles with chamfered corners are commonly used. The sides of the piles are preferably made straight.

Some designers prefer tapered sides because they are easier to drive, and also because some experiments tend to show that for piles relying on friction tapered sides are preferable. No taper should be used for piles that are to be driven into incompressible plastic clays, because such soils heave up, instead of compressing, when piles are driven into them. There is thus a tendency for the piles that are already in place to be heaved up when adjacent piles are driven.

When necessary, because of the character of the soil, the piles may be provided with shoes to facilitate driving and to prevent the end of the pile from breaking when it strikes a boulder.

The size of the cross section of the pile and its length are governed only by practical considerations. That cross section which will best suit the conditions, particularly with regard to ease in handling and driving, should be selected. As the handling and driving of long piles having large cross section may require costly equipment and heavy hammers, it is often preferable to use a larger number of piles of smaller cross section.

*Capacity of Pre-cast Pile.*—If driven to solid bearing, the pile acts as a column and its capacity is equal to its compressive strength, as discussed on p. 406.

If the carrying capacity of the pile is developed by frictional resistance, its value is determined either by load tests or by a formula from the penetration at the last series of blows. Most of the building codes require a load test for concrete piles, as the formulas used for wood piles are not directly applicable.

Mr. Charles R. Gow suggests the following modification of the Wellington formulas for pre-cast concrete piles:

- Let  $P$  = capacity of piles, lb.;
- $W$  = weight of hammer, lb.;
- $h$  = fall of hammer, ft.;
- $s$  = penetration of last blow (or average of several blows), in.;
- $w$  = weight of pile, lb.

Then  $P = \frac{2Wh}{s + \frac{w}{W}}$  for drop hammer, . . . . . (3)

and  $P = \frac{2Wh}{s + \frac{w}{10W}}$  for steam hammer. . . . . (4)

These formulas have not been as thoroughly checked as the formulas for wood piles, upon which they are based, but are recommended as the best present practice. They take into account the fact that, because of the greater mass of the pile, some of the force of the blow is lost in overcoming the inertia of the pile and is not available for producing penetration.

**Stresses in Pre-cast Piles.**—The pile must be designed to resist (1) the stresses developed in the pile after it is in place, (2) the stresses during handling, and (3) the stresses during driving.

After the pile is in place, it acts like a reinforced concrete column of an unsupported length depending upon the character of the soil through which it was driven. If driven through firm soil offering sufficient resistance against lateral movement, the pile acts like a short column. If driven through fill, silt, peat, mud, or water, which do not offer any lateral support, the pile acts as a long column and its unsupported length is equal to the depth of such material. The allowable stresses on the pile in all cases should be the same as for a reinforced concrete column of the same design and with the same ratio of slenderness. Its strength should be figured by reinforced concrete column formulas. (See Formulas (4) to (11), p. 406.) Piles driven to solid bearing on rock or hardpan should have straight sides, as the required strength is the same at all sections. In frictional piles, the load carried by the pile is gradually transferred to the ground, so that the lower sections are subjected only to a fraction of the total load on the pile. This makes it possible to taper the pile.

**Stresses During Handling.**—The pile is usually poured in horizontal position. While being lifted by a derrick it is subjected to bending produced by its own weight. The character and the magnitude of the bending depend upon the number of points of suspension. Piles up to 40 ft. in length are often suspended at their center of gravity during handling, so that the two parts of the pile act as cantilevers, producing maximum bending moments at the point of suspension. Tension and compression stresses are a maximum at the point of suspension. Long piles suspended in the middle would require a large amount of steel to resist bending stresses. Therefore, for lengths over 40 ft. they should be suspended at two points, during handling, while for very long piles three points of suspension may be necessary to reduce bending stresses. It is clear that the designer of the pile must know how the pile will be handled, in order to provide proper strength for bending.

As a much smaller factor of safety is required in this case, the allowable unit stresses may be 25 per cent larger than those recommended for permanent stresses.

*Pile Suspended at One Point.*

**Example 1.**—Find the required amount of steel for a 20-in. square pile of uniform cross section, 40 ft. long. Pile to be suspended in the middle in handling.

**Solution.**—The weight of the pile is  $\frac{20^2}{144} \times 150 = 417$  lb. per lineal foot.

Since the pile is suspended in the middle, the span of the cantilever is 20 ft. With a load of 417 lb. per lin. ft., the moment at the point of suspension is

$$M = 417 \times 20 \times 10 \times 12 = 1\,000\,000 \text{ in.-lb.}$$

With steel placed 2 in. from the surface of the pile in the clear, the effective depth of a 20-in. section is 17.5 in. If the allowable stress in steel,  $f_s = 16\,000$  plus 25 per cent = 20 000 lb. per sq. in., the required amount of steel, from formula  $A_s = \frac{M}{jdf_s}$  is

$$A_s = \frac{1\,000\,000}{0.87 \times 17.5 \times 20\,000} = 3.3 \text{ sq. in.}$$

Four 1-in. square bars near the tensile face will be used.

If the tensile face is definitely known, as is the case when provision is made for attaching the lifting hook, it is sufficient to provide this reinforcement in the tensile face only; otherwise, the same amount of steel should be used near each face. The corner bars may be counted at two faces.

*Pile Suspended at Two Points.*—When a pile with straight sides is suspended at two points in handling, the points of suspension should be located a distance equal to 0.206 of the pile length from each end of the pile. The bending moments at the points of suspension are then equal to the bending moment in the center of the pile. Such an arrangement requires the minimum amount of steel.

**Example 2.**—Find the amount of steel to resist bending stresses in handling for a 20-in. square pile of uniform section, 80 ft. long. Pile to be suspended at two points in handling.

*Solution.*—The points of suspension will be placed a distance from the ends equal to  $0.206l = 0.206 \times 80 = 16.5$  ft. The length of cantilevers, therefore, will be 16.5 ft. and the length of the middle span  $80 - 16.5 \times 2 = 47.0$  ft.

Weight of pile equals  $\frac{20^3}{144} \times 150 = 417$  lb. per lin. ft.

Bending moment in cantilever at points of suspension,

$$M_1 = 417 \times 16.5 \times \frac{16.5}{2} \times 12 = 682\,000 \text{ in.-lb.}$$

Bending moment in the center of middle span,

$$M = \frac{1}{8} \times 417 \times 47^2 \times 12 - 682\,000 = 1\,390\,000 - 682\,000 = 708\,000 \text{ in.-lb.}$$

From the above figures, it is evident that for the accepted spacing of suspension points the bending moments at the three critical sections are practically equal.

With clear distance from steel to surface of pile equal to 2 in., the effective depth of a 20-in. section is  $d = 17.5$  in. and the required area of steel for the

largest bending moment, using  $f_s = 20\,000$  lb. per sq. in., from formula  $A_s = \frac{M}{jd_s}$ , is

$$A_s = \frac{708\,000}{0.87 \times 17.5 \times 20\,000} = 2.32.$$

Use four  $\frac{1}{2}$ -in. round bars.

Since the ratio of steel is  $p = \frac{2.32}{17.5 \times 20} = 0.0066$ , the compression stresses are satisfactory. The advantage of suspending the pile at two points during handling is evident from the fact that the 80-ft. pile requires less steel for bending than the 40-ft. pile of the previous example, which was suspended in the middle.

**Stresses in Pre-cast Pile During Driving.**—Stresses during driving are those induced by the blows of the hammer at the top and those occasioned by uneven driving. Since concrete is brittle, direct blows of the hammer during heavy driving are apt to fracture and split the top of the pile unless it is protected by a cushion or the head is reinforced by special lateral reinforcement. Cushions reduce the effectiveness of the blow and slow down the progress of the driving, hence it is preferable to reinforce the top. The lateral reinforcement may consist of closely spaced spirals or of bands of steel. Some of the patented systems have a special reinforcement at the head, as explained in the descriptions of these systems. The giant pile is driven by a special method which entirely eliminates the stresses during driving.

The stresses occasioned by uneven driving tend to produce fracture of the end of the pile. Such stresses take place, for instance, when the pile strikes a boulder. The liability to fracture is reduced by providing a metal point for the pile and also by using, in addition to longitudinal bars, closely spaced lateral reinforcement throughout the pile, which reduces the brittleness of the concrete.

**Concrete Mixture for Pre-cast Pile.**—Concrete of 1 : 2 : 4 mix is ordinarily used for concrete piles. When the pile is driven to solid bearing and its capacity depends upon the strength of the pile acting as a column, richer concrete may be used with economy. In piles relying for their carrying capacity on frictional resistance, the use of rich mix would be a waste, as in such cases even the full strength of the leaner concrete cannot be fully utilized.

**Details of Design of Pre-cast Piles.**—Longitudinal bars should be spaced uniformly around the circumference of the pile and should be placed 2 in. in the clear from the face of the pile. The percentage of



longitudinal steel for column action should be at least 1 per cent of the cross section of the pile. Sufficient steel should be provided to resist bending stresses. In short piles, all the longitudinal reinforcement should extend the whole length of the pile. In long piles, where the amount of steel required to resist bending during handling is larger than the amount for column action, the bars required as column reinforcement should extend the whole length; the balance, required for bending only, may consist of short bars stopping where the bending moment due to handling permits it.

*Lateral Reinforcement.*—Lateral reinforcement may consist of separate hoops, or preferably of a continuous spiral. The spacing of the hoops or the pitch of the spiral is made closer at the point and at the head than in the central part of the pile. The following arrangement is suggested by the authors. In the head of the pile, for a distance of 3 ft., provide lateral reinforcement consisting of a continuous spiral, the amount of which should form not less than 1 per cent of the volume of the enclosed concrete. The pitch of the spiral should not be more than 3 in. For the remainder of the pile to within 4 ft. from the tip, place separate hoops at least  $\frac{1}{4}$  in. square, spaced not more than 10 in. apart. At the bottom, in the 2-ft. section above the pointed section, provide continuous spiral amounting to  $1\frac{1}{2}$  per cent of the volume of enclosed concrete. The same spacing of the spiral should be continued to the end of the pile. The total length of the spiral in the pointed part (the toe of the pile) and the section above should not be less than 5 ft.

*Pipe for Jetting.*—If it is intended to use water jet in driving, a thin pipe may be imbedded in the center of the pile. Sometimes a solid wooden core is well greased and placed in the center of the form. This is removed after the concrete has hardened, leaving a hole in the center. The core is often tapered, to make the removal easier. It is also advisable to turn the core while the concrete is green, so as to prevent the concrete from sticking.

*Hangers.*—To facilitate handling, provision should be made for attaching the tackle.

**Patented Pre-cast Piles.**—Several patented piles are on the market. They will be mentioned in the chronological order of their appearance. The choice between patented and non-patented pile will depend chiefly upon economical considerations of economy.

*Chenoweth Pile* is circular in cross section and is built without forms. A 2-in. pipe of a length somewhat greater than that of the

pile is placed on a movable table. Wire mesh of proper width is attached to the pipe along its length. The mesh is spread on the table, and longitudinal reinforcement is attached to it in the proper places. A layer of concrete is spread on the mesh. The pipe is then revolved, its revolution causing the concrete and the mesh to wind around the pipe. The wire mesh in the cross section has the appearance of a spiral.

*Gilberth Pile* is octagonal in cross section, tapered, and provided with semicircular longitudinal grooves in the middle of each face and a tapered cored passage in the center. The cored passage serves for the introduction of a water jet, and the semicircular grooves are intended to afford passages through which the water used in driving can come to the surface. After the pile is driven, the grooves are intended to increase the friction between the pile and the ground.

*Cummings Pile*.—The patented feature of this pile consists of a special circumferential and spiral reinforcement at the head, intended to prevent splitting or crushing at the top under severe impact of the hammer. Tests have proved that the type of reinforcement used serves the purpose.

*Bignell Pile* has as its distinguishing feature the use of a double jetting system. Two pipes, one within the other, are placed in the center of the pile. The larger pipe tapers from 4 in. at the head end to about 2 in. at the point. It has no outlet at the end, the water being forced to the outside faces of the pile and upward by short pipes placed at frequent intervals, at right angles to and connected with the main pipe. At their ends, at the faces of the pile, the short pipes are provided with right-angle elbows which force the stream of water upward. The second pipe, about 2 in. in diameter, is placed within the larger pipe. It has a separate inlet at the head and a separate outlet at the point. In driving the pile, water is introduced into both pipes. High pressure, up to 300 lb. per sq. in., is maintained in the second pipe, while a pressure of 100 to 150 lb. is used in the large pipe. The water at the end of the pile, coming with high pressure, loosens the ground, while the water coming out at the sides destroys the friction, so that in some soils the pile sinks under its own weight.

*Giant Pile* is characterized by a special method of driving, in which the concrete pile is not subjected to any driving stresses. The concrete pile is square, of uniform cross section, and properly reinforced. Its cross section depends upon the load to be carried.

Thus far, 16-in. square piles have been most commonly used. The concrete pile is firmly attached to a specially constructed cast-steel shoe (Fig. 178, below), which at its top projects on all sides beyond the face of the concrete pile. These projections serve as a support for a steel driving frame, consisting of two special channels, which is provided at the top with a driving head for receiving the blows of the hammer. All the force and the impact of the falling hammer are therefore transmitted by the driving channels



FIG. 178.—Cast-steel Shoe for Giant Pile. (*See p. 553.*)

directly to the shoe, permitting very severe driving without injury to the concrete. As the shoe progresses, the concrete pile is pulled after it.

The driving frame is clearly shown in Fig. 179, p. 554.

In the illustration, the pile is ready for driving, except that the driving channels will be lowered until they rest upon the point. The length of the driving channels may be greater than that of the pile, so that the pile may be driven to any depth below grade, and below water.

When the pile is down, the channels are withdrawn as a unit. The friction upon two sides of the pile at the time of withdrawing the channels prevents the upward movement of the pile with the channels. The channels are not removed from the pile driver.

A possible objection to this method of driving is the uncertainty

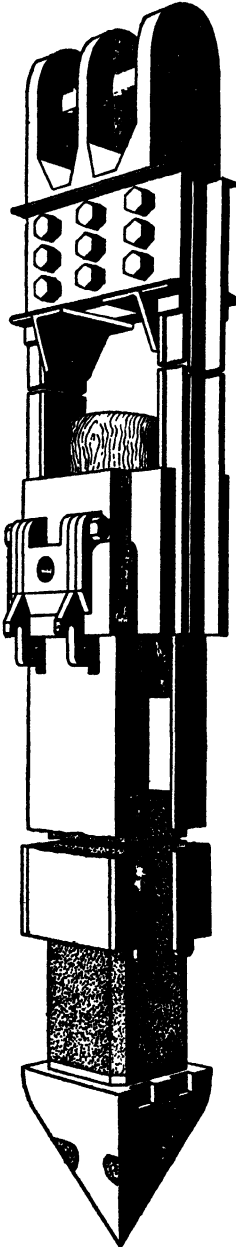

FIG. 179.—Giant Pile Ready to Drive. (See p. 553.)

as to whether, after the withdrawal of the frame, the space occupied by it will be filled by closing of the soil. This is not of great importance when the pile is driven to solid bearing. When the pile relies on friction for its strength, tests should be made to determine whether, in the particular soil, the closing is complete enough to offer the proper frictional resistance.

Giant piles have been driven in lengths up to 48 ft. in actual construction. In experimental work, they have been driven up to 60 ft.

**Cast-in-place Piles.**—As the name implies, cast-in-place piles are built in the position which they are intended to occupy in the completed structure. All cast-in-place piles are patented. The patents on some of them have already expired. The most popular of these are described below in the order of their appearance.

*Raymond Pile*, when completed, consists of a sheet-metal shell filled with concrete. The shell is tapered. The diameter of the shell at the point or bottom is 8 in., and it increases at a rate of 0.4 in. per foot of length of the pile. The diameter of the top of the pile, therefore, depends upon its length. A 20-ft. pile, for instance, has a top diameter of 16 in., while a 30-ft. pile has a diameter of 20 in. The shell is fabricated of black sheet steel, lock seamed, spirally corrugated on a 3-in. pitch. In the corrugations is placed a  $\frac{1}{4}$ -in. steel wire, which strengthens the shell against collapsing before concrete is placed and also serves as spiral reinforcement for the completed pile. The gage of the sheet metal and of the wire may be varied to suit conditions. Usually, the sheet metal is No. 24 gage and

the wire  $\frac{1}{4}$  in. diameter. The shell is made up of sections 8 ft. long, lapping each other. Raymond pile is shown in Fig. 180, p. 556.

Ordinarily, the concrete within the concrete pile is not provided with vertical reinforcing bars, as they are not necessary to resist the compression stresses. When, however, there is any reason to expect that the pile will be subjected to bending due to lateral forces, reinforcing bars may be placed in the shell prior to the pouring of the concrete.

The pile is constructed in the following manner: The shell is assembled to give the proper length. A collapsible steel mandrel is inserted into the shell and expanded to fit it tightly. The shell, with the mandrel, is then driven by means of a pile driver until the desired minimum penetration is attained. The mandrel is then collapsed and pulled out, and the shell is filled with concrete. Prior to the pouring of the concrete, the shell may be inspected. The decided advantage of the Raymond Pile over other cast-in-place piles is that the shell prevents water and earth from mixing with the concrete. It also protects the green concrete from damage from lateral pressure of the earth. The shape of the pile is, therefore, certain. For piles relying for their capacity on bearing, the taper of the pile is a disadvantage, as the cross section at the point is small. Raymond Piles have been built in lengths as great as 37 ft. 6 in.

*Raymond Composite Wood and Concrete Pile* consists of a wood pile, driven below permanent low water, upon which is superimposed a Raymond Concrete Pile. Before the wood pile is driven, the top of it is provided with a tenon  $9\frac{1}{2}$  in. in diameter and 18 in. long, squarely cut on the top and fitting closely into the opening in a specially prepared steel shell. A reinforcing bar, attached to the tenon, extends into the concrete pile and joins the two parts. Fig. 181 shows the junction of the wood pile and the concrete pile.

The wood pile is driven to ground level. The collapsible mandrel, encased in a spirally reinforced steel shell, is then fitted on the top of the wood pile. The combined pile is driven to its final penetration. The mandrel is withdrawn and the shell filled with concrete.

*Simplex Pile*, in its finished state, consists of a plain concrete shaft of a constant cross section throughout, usually about 16 in. in diameter. It is provided with a cast-steel or cast-concrete point. (See Fig. 182, p. 557.) The pile is built by fitting the cast point into

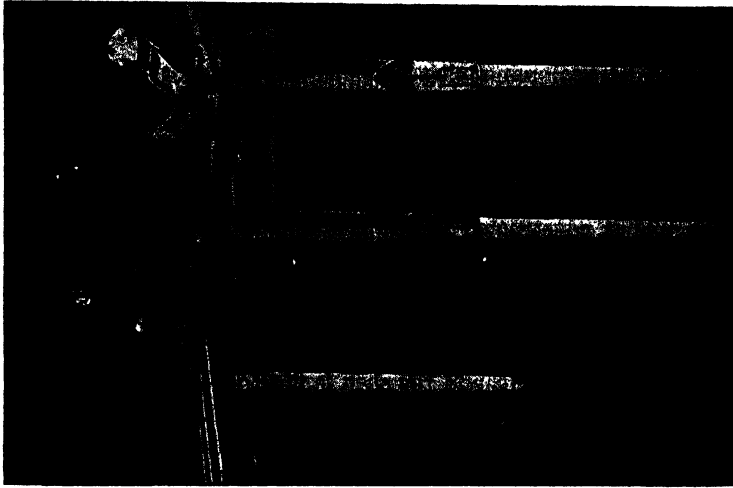

FIG. 181.—Raymond Composite Wood Pile.  
(See p. 555.)

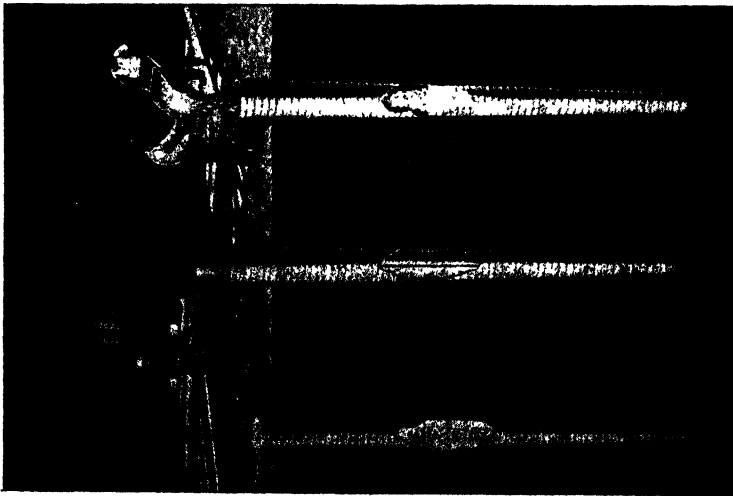

FIG. 180.—Details of Raymond Pile. (See p. 554.)

the bottom of a steel tube of the desired diameter, and driving them in the required position until the minimum penetration is attained. The steel tube is then gradually withdrawn by means of a pulling tackle, and at the same time the space is filled with concrete. Simplex piles have been used up to 50 ft. in length.

Particular care should be taken in filling the pile, not only to avoid arching of the concrete, but also to prevent the withdrawing of some of the concrete with the tube, thus leaving a void in the pile, which would destroy its value.

*Pedestal Pile* has the theoretical shape shown in Fig. 183, p. 558. It consists of a plain concrete shaft and a bulb-like enlargement or pedestal, which increases the bearing area of the pile.

It is built in the following manner: A steel casing, usually 16 in. in diameter, with a solid plunger fitted into it, is driven by a pile driver to the desired depth. The plunger is withdrawn and the casing partly filled with concrete. The plunger and a hammer are then dropped into the casing, forcing the concrete sidewise against the soil and gradually enlarging the bottom space. Successive fillings and rammings complete the bulb. After this, the rest of the pile is filled, and at the same time the steel casing is gradually withdrawn. To prevent the upward movement of the pile with the casing, the plunger and the hammer rest on the concrete while the casing is withdrawn.

From the method of producing the bulb, it is evident that its shape depends altogether upon the compressibility of the soil. It will be of uniform shape if the soil is homogeneous; otherwise, the soil may compress unevenly and result in an unsymmetrical bulb. This may produce eccentric stresses in concrete

*Peerless Pile*, when in place, consists of a cast-steel shoe and a thin concrete shell of uniform cross section resting on the shoe and

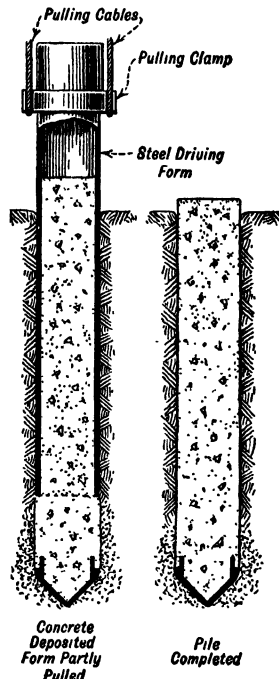

FIG. 182.—Details of Simplex Pile. (See p. 555.)

solidly filled with concrete. The shell is made up of sections and extends the full length of the pile.

The pile is built in the following manner: The point, with the superimposed shell, is driven by means of a plunger to the required penetration. Then the plunger is withdrawn and the shell is filled with concrete. To facilitate driving, the area of the top of the shoe is somewhat larger than the area of the shell. The hole made by the shoe is therefore somewhat larger than the shell. This makes it unnecessary to exert any pressure on the shell in order to cause it to follow the shoe.

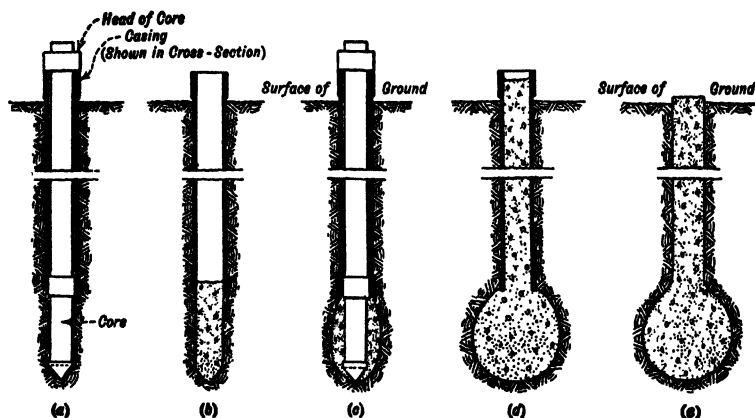

FIG. 183.—Details of Pedestal Pile. (See p. 557.)

This pile has the same advantages as the Simplex Pile. The shell protects the green concrete from lateral pressure.

*Miscellaneous Piles.*—Other piles have been developed, but their limited use does not warrant their description.

*Carrying Capacity of Cast-in-Place Piles.*—The cast-in-place piles rely, for their carrying capacity, either on the bearing of their points, or on friction. In a majority of cases, the concrete piles are designed for 30 tons.

Piles that rely on the bearing of their points may be considered as columns, and their strength should be determined in the manner explained in connection with pre-cast and wood piles. Under such conditions, the piles without taper are stronger than the tapered piles.



The capacity of cast-in-place piles that rely for their bearing power on friction may be determined by means of the *Engineering News* Formula. p. 544, with the same accuracy as for wooden piles. The penetration, the weight of hammer, and the fall are those used in driving the core. Some building codes require load tests on concrete piles not driven to rock.

*Advantages and Disadvantages of Cast-in-Place Piles.*—The cast-in-place piles can be built without delaying the construction. They do not require any storage space, nor expensive handling equipment; hence, they are particularly adapted for use where piles must be driven in built-up localities. As the length of the piles can be well regulated, it is not necessary to predetermine it by borings, as in the case of pre-cast piles.

The disadvantage of cast-in-place piles is that their shape cannot be inspected after erection. This applies particularly to piles built without a shell. Another disadvantage is that, unless the progress of driving is properly regulated, the setting of the concrete may be affected by the vibration caused by driving adjacent piles. The effect of vibration is harmful from the time of initial set, i.e., from about three to four hours after pouring until the concrete is thoroughly hard.

Piles for which the shell remains in the ground are superior to other cast-in-place piles. If the shell is strong enough, the green concrete is protected from injury by lateral pressure of the earth produced by the driving of adjacent piles. No foreign matter can enter the shell. When filled with proper care, the completed pile is of the shape contemplated.

The use of piles from which the casing is removed should be restricted to stiff soils, capable of retaining the shape of the hole until the concrete hardens. In numerous instances, excavation of piles has shown that their shape was distorted to such an extent as to render them useless.<sup>1</sup> Piles of this type should not be used where the chemical composition of the soil is such as to affect the setting qualities of the cement. Neither should they be used where the ground is likely to flow, nor where water would introduce admixtures of the earth into the concrete. In passing water-bearing strata, in piles without shell, the cement is likely to be washed out.

<sup>1</sup> See *History of the Concrete Pile Industry*, by Charles R. Gow. Proceedings Am. Concrete Institute, Vol. XIII, 1917, p. 202. Also *Engineering Record*, March 22, 1913.

In soils transmitting lateral pressure, the green concrete may be distorted by the pressures due to the force used in driving adjacent piles.

In all cast-in-place piles, special care must be used to prevent the formation of voids in the pile. Where the casing is gradually removed, care should be taken to prevent lifting of the concrete previously placed with the casing, as this would result in reduction of the cross section or separation of the pile into sections.

**Caisson Pile.**—The caisson pile usually replaces a whole cluster of piles. One pile is ordinarily used per footing. A caisson pile,<sup>2</sup> as

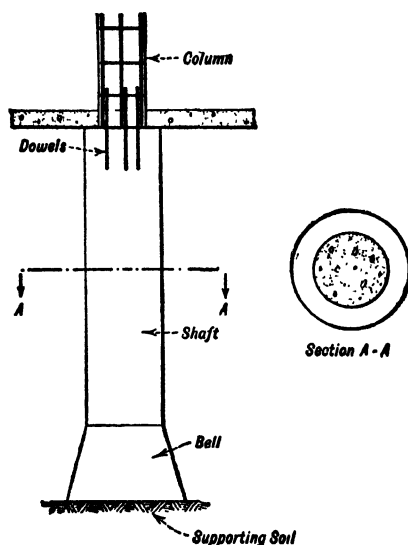

FIG. 184.—Caisson Pile. (See p. 560.)

shown in Fig. 184, p. 560, consists of a cylindrical shaft of plain concrete, strong enough to carry the column load, reaching from the bottom of the basement or ground floor slab to the bearing soil, where it is enlarged to provide the required bearing area on the soil. This enlargement, often called the bell, is in the shape of the frustum of a cone. The slope of the sides, usually  $60^\circ$  with the horizontal, is such that the stresses in the projection due to the soil pressure do not exceed the value permitted for plain concrete. The allowable inclination for different pressures may be taken

from the table on p. 481. If desired for any reason, the pier may be provided with vertical reinforcement. Horizontal reinforcement may also be used at the bottom of the bell if required by the stresses.

At the lot line, the enlargement of the pile may extend only so far as to be parallel to the lot line. To prevent eccentricity, the wall column may be connected with the first row of interior columns, by means of a strap beam.

The excavation for a caisson pile is made by sinking into the

<sup>2</sup> In the eastern part of the United States, they are often called Gow piles, from Charles R. Gow, who introduced them there.

ground short cylindrical sections of proper diameter, and simultaneously excavating the material within with pick and shovel. After the material is excavated to the full depth of the cylindrical section, another cylindrical section is driven, and this is repeated until the desired level is reached. The excavation is then enlarged to form the bell. No form is used for the sides of the bell. After the excavation is completed, concrete is deposited. It is desirable to pour the concrete into the whole pile, or at least into the bell-shaped portion, by a continuous process. As the depositing of the concrete progresses, the cylinder sides are removed.

The hollow cylinder may be made of wood staves or of sheet metal of proper thickness. The sheet metal may be in one piece or in several vertical sections bolted together. The wood forms are held in position by collapsible steel rings placed inside.

The smallest diameter of the shaft that is convenient for a man to work is considered to be 3 ft., which is strong enough to carry 508 000 lb. with a unit stress of 500 lb. per sq. in. Shafts for columns carrying smaller loads will have the same diameter. It is important to remember, however, that even if the same size of shaft is used for different loads, the area of the bell must be proportioned according to the load to be carried.

Thus, if the column loads (including weight of pile) are 400 000 lb., 450 000 lb., and 500 000 lb. respectively, the required diameters of the bell for the different columns, with an allowable soil pressure of 8 000 lb. per sq. ft., will be 8 ft., 8 ft. 6 in. and 9 ft. respectively, even if the shaft in all cases is 3 ft. in diameter.

Although the caisson pile is built in place, it is free from the disadvantages of the built-in-place single pile. The excavation can be thoroughly inspected before concreting, and the forms are sure to stay in place while the pile is being filled. As no pile driver is used in driving adjacent piles, no lateral stresses are set up in the green concrete. Neither is the concrete injured in setting by vibration.

**Example 3.**—Design a caisson pile to support a column load of 800 000 lb., using maximum allowable stress on concrete of 500 lb. per sq. in. and maximum bearing on soil of 8 000 lb. per sq. ft.

*Solution.*—The required area of the pier, to carry the load, equals  $800\,000 \div 500 = 1\,600$  sq. in. To give this area, a 45-in. round pier will be selected.

Assuming dead load of the pile as 60 000 lb., the total load on soil is 860 000 lb. The area required for bearing is:

$860\,000 \div 8\,000 = 108$  sq. ft. The required diameter of the bell is 12 ft. 3 in.

The inclination of the sides of the cone may be found as explained on p. 481. For a unit pressure of 8 000 lb., the height of the cone equals 1.7 times the projection of the bell.

**Steel Cylinder Foundation.**—Unlike the cast-in-place concrete piles, which rely wholly on concrete for strength, the steel cylinder foundation, such as the "Hercules" and "Steel Tuba" foundations, derives a large part of its strength from steel cylinders driven to solid rock. The diameter of the cylinders is 10, 12, 15, and 16 in., and the thickness of the cylinder wall not less than  $\frac{3}{8}$  in.

The cylinders are driven to solid rock by means of a steam hammer. Where the distance to rock exceeds 22 ft., the cylinder is driven in 20-ft. sections, and the sections, as driven, are joined by specially designed water-tight sleeves. The material is removed from the cylinder by compressed air. After the cylinder reaches solid bearing in rock, it is cleaned and filled with concrete. It is then cut to grade and leveled by an oxy-acetylene torch. An I-beam cap, of the dimensions given below, is placed on top to transfer the pressure from the footing to the cylinder. A reinforced concrete footing is built on top of the cylinder.

#### Dimensions of I-beam Caps

Diameter of Cylinder	Depth of I-beam	Length of I-beam
16 in.	20 in.	20 in.
15 in.	18 in.	18 in.
12 in.	15 in.	15 in.
10 in.	15 in.	15 in.

When driven to rock, the capacity of a steel cylinder pile is determined by its safe strength. The New York Building Department permits the following loads on steel cylinders:

#### Capacity of Steel Cylinder in Tons

Thickness of Steel, In.	Outside Diameter of Cylinder			
	10 $\frac{1}{2}$ in.	12 $\frac{1}{2}$ in.	15 in.	16 in.
$\frac{3}{8}$	56.7	73.6	93.5	102.9
$\frac{1}{2}$	65.4	82.9	103.2	113.4
$\frac{5}{8}$	73.4	92.3	112.8	123.7

In computing the strength of the cylinder, the assumption is made that rust will penetrate for  $\frac{3}{16}$  in. Therefore, the effective thickness is  $\frac{3}{16}$  in. smaller than the actual thickness of the cylinder.

Steel cylinders can be used only where they can be driven to solid rock. They are particularly advantageous in foundations built close to adjacent structures, where owing to the compactness of the foundation, it is often possible to get along without combined footings.

## CHAPTER X

### BUILDING CONSTRUCTION

Reinforced concrete has taken its place as an established material for building construction. Durable, fireproof, and economical in first cost, adaptable to various types of design, capable of carrying heavy loads, and at the same time susceptible of pleasing architectural treatment, it holds a unique position as a building material.

For the structural frame of factory and office buildings, for foundations and floors of steel frame structures, or as artificial stone for facing or trimming, its adaptability is recognized. For small buildings such as dwellings, its use is not so general, because of larger unit costs on small jobs; but in certain cases where, on the one hand, expense is not the criterion, and, on the other hand, where duplication of design reduces the cost, it is being adopted to advantage.

For first-class construction there are three requisites: (1) thoroughly tested materials; (2) design by an engineer familiar with reinforced concrete design; and (3) construction by an experienced builder working under careful supervision.

#### RELATIVE COSTS OF BUILDINGS OF DIFFERENT MATERIALS

For industrial and office buildings, reinforced concrete naturally competes with the steel frame, plain or fireproofed, and with mill construction. Cost is usually the important factor; but sometimes speed after breaking ground is the main consideration, as is the case, for example, in high buildings in the business sections of large cities, and structural steel may be selected on this account. If the time of fabrication of the structural steel must be included, however, the concrete building can be put up in a shorter time.

In selecting the type of building, it is necessary to consider not only the first cost, but also the average annual expense and deprecia-

tion over a term of years. It may be economical to increase the first cost for the sake of an annual saving in expense; if this saving will be sufficient, in the course of the useful life of the building, to make up for the higher initial expenditure.

Fireproofed steel frame construction is almost invariably more expensive in first cost than reinforced concrete.

The first cost of the reinforced concrete structure, in turn, may be greater than that of a steel frame, not fireproofed, or of mill construction. This depends, however, to a considerable extent, on the type of building. Thus, with very heavy loads, especially on long spans, concrete is cheaper than steel or mill construction. The dividing line varies with relative costs of material. Frequently it occurs at loads of 200 lb. per sq. ft. on spans in the neighborhood of 20 ft.<sup>1</sup>

To get any real comparison between buildings of different materials, a detailed estimate should be made of the first cost and the annual expenditures. The following table,<sup>2</sup> issued by the Universal Portland Cement Company,<sup>3</sup> illustrates the method:

**Comparative First and Maintenance Cost of Reinforced Concrete and Mill Constructed Buildings**

(From standpoint of Owner)

	Reinforced Concrete (Fireproof)	Mill Construction (Not Fireproof)
First cost of building.....	\$189 000.00	\$168 000.00
First cost of sprinkler system.....	14 000.00	14 000.00
	<hr/>	<hr/>
Total first investment.....	\$203 000.00	\$182 000.00
First cost fireproof more than mill construction.....		\$21 000.00

<sup>1</sup> See paper by L. C. Wason in Proceedings National Association of Cement Users, Vol. VII, 1911, p. 448.

<sup>2</sup> Similar computations are given by J. P. H. Perry in Proceedings National Association of Cement Users, Vol. VII, 1911, p. 443.

<sup>3</sup> See also *Concrete Cement Age*, July, 1916, p. 25.

*Maintenance*

Interest on first investment... 6%	\$12 180.00	\$10 920.00	6%
Tax on first investment..... 1%	2 030.00	1 820.00	1%
Depreciation on building... 0.5%	945.00	3 360.00	2%
Obsolescence..... 1.0%	1 890.00	3 360.00	2%
Depreciation on sprinkler..... 10%	1 400.00	1 400.00	10%
Repairs to building..... 0.25%	472.50	1 680.00	1%
Damage to building by vermin			
None.....		200.00	Est. low
Auxiliary fire equipment.			
Estimated.....	200.00	300.00	Estimated
Fire insurance on building.			
None required.....		235 20	14 cts. on \$100
	\$19 117.50	\$23 275.20	
Yearly expense fireproof less than non-fireproof.....			\$4 157.70

The yearly saving of \$4 157.70 capitalized at 6 per cent represents \$69 295. Therefore, actual cost of concrete building is \$119 705, in comparison with one of mill construction costing \$168 000.

Furthermore, there is a lower rate for fire insurance on the contents of the concrete building, which still further reduces the cost.

Reinforced concrete has been used economically for dwelling houses, but only where cheap cottages can be built in groups of similar pattern. With this exception, wood is cheaper, on account of the high cost of forms. Precast blocks, requiring no forms, are simplest for this class of work, but unless the surfaces are tooled the appearance is apt to be monotonous. In estimating the labor where forms are used, allowance must be made for time lost in waiting for the concrete to harden so that the forms can be raised. For this reason, a small gang of men should be employed—only enough to lay concrete to the height of one section of the forms per day.

For cellar and foundation walls of all classes of buildings, including brick and frame, concrete is superseding rubble masonry except where rubble stone is taken from the excavation so as to be very cheap.

Cement mortar plastered on to metal or wood lathing is used not only for outside walls, but in some cases for fire-resisting partitions in large buildings.



## ACTUAL COST OF REINFORCED CONCRETE BUILDINGS

The tables presented on page 568 give the approximate average cost per square foot of floor area and per cubic foot of volume of plain rectangular reinforced concrete buildings of various sizes and heights.

The costs include all details of construction, not only the concrete forms and reinforcement, but also windows, stairs, roof covering, and plumbing. Interior finish, which varies widely with the type of construction, is not included. The basis \* of the tables is as follows:

- (1) Floor loads, 150 pounds per square foot.
- (2) Story heights: first floor on a 3-foot fill;  
other floors 12 feet from slab surface to slab surface.
- (3) Column spacing, 18 feet on centers.
- (4) Floor design: girders between columns in one direction; beams between columns in other direction with two intermediate beams.
- (5) Excavation and foundations.†

Story Height	Outside Walls, per Linear Foot	Inside Walls per Linear Foot
1	\$5.45	\$2.80
2	6.15	3.75
3	6.85	5.00
4	7.20	6.00
5	7.60	7.05
6	7 90	8 45

- (6) Filling under first floor: 3-foot fill at \$1.00 per cubic yard in place.
- (7) Stairs: material and labor, \$200 per flight per story.
- (8) Stairways and elevator towers:
  - 2 stairways and 1 elevator tower for buildings up to 150 feet long.
  - 2 stairways and 2 elevator towers for buildings up to 300 feet long.
  - 3 stairways and 3 elevator towers for buildings over 300 feet long.
- (9) Floor finish: all floors of concrete with granolithic finish.
- (10) Walls:
  - (a) Curtain walls between pilasters, 3 feet high and 8 inches thick;
  - (b) Concrete walls for penthouses, 6 inches thick. Dimensions of penthouse are 10 feet by 10 feet;
  - (c) Concrete walls around the elevator and stairway openings are taken 6 inches thick, the elevator opening being 10 by 20 feet and the

\* Values fixed with the advice of Morton C. Tuttle Co. They conform to 1925 prices.

† Taken from paper presented before the New England Cotton Manufacturers' Association, April, 1904, by Mr. Charles T. Main. Prices revised by Mr. Main to conform to prices prevailing about January, 1925.

**Average Costs of Concrete Buildings per Square Foot of Floor Area (See p. 567)**  
 Costs include all items except interior finish

Width in Feet	Cost in Dollars per Square Foot of Floor Area											
	Length of building, in feet						Length of building, in feet					
	50	100	200	300	400	600	50	100	200	300	400	600
	1-Story						2-Story					
25	4.94	3.86	3.38	3.08	2.95	2.91	4.83	3.73	3.27	3.02	2.89	2.74
50	3.52	3.02	2.66	2.40	2.28	2.21	3.46	2.74	2.43	2.21	2.13	2.07
75	3.21	2.78	2.43	2.17	2.07	2.00	3.04	2.51	2.17	2.02	1.92	1.83
100	3.04	2.62	2.28	2.07	1.92	1.88	2.85	2.32	2.04	1.88	1.77	1.71
150	2.93	2.49	2.17	1.96	1.81	1.77	2.68	2.19	1.92	1.75	1.67	1.60
	4-Story						6 to 10-Story					
25	4.68	3.54	3.08	2.89	2.76	2.64	4.68	3.50	3.06	2.85	2.78	2.64
50	3.25	2.53	2.26	2.11	2.05	1.96	3.23	2.49	2.24	2.11	2.05	1.96
75	2.85	2.28	2.02	1.90	1.83	1.77	2.81	2.28	2.02	1.88	1.79	1.75
100	2.64	2.13	1.88	1.75	1.69	1.64	2.62	2.09	1.86	1.73	1.67	1.62
150	2.49	2.00	1.77	1.64	1.58	1.52	2.45	1.96	1.73	1.62	1.58	1.52

First floor on fill. Slab supported on the ground.

To use the table multiply the aggregate floor area (exclusive of the roof area) by the unit costs.

**Average Costs of Concrete Buildings per Cubic Foot of Volume (See p. 567)**  
 Costs include all items except interior finish

Width in Feet	Cost in Dollars per Cubic Foot of Volume											
	Length of building, in feet						Length of building, in feet					
	50	100	200	300	400	600	50	100	200	300	400	600
	1-Story						2-Story					
25	0.411	0.323	0.281	0.257	0.247	0.243	0.403	0.310	0.272	0.251	0.240	0.228
50	0.293	0.251	0.221	0.200	0.190	0.183	0.289	0.228	0.202	0.186	0.177	0.173
75	0.266	0.232	0.202	0.181	0.173	0.167	0.253	0.209	0.183	0.169	0.160	0.152
100	0.253	0.219	0.190	0.173	0.160	0.156	0.238	0.194	0.171	0.156	0.148	0.141
150	0.245	0.207	0.181	0.162	0.152	0.148	0.224	0.183	0.160	0.145	0.139	0.133
	4-Story						6 to 10-Story					
25	0.390	0.295	0.257	0.240	0.230	0.219	0.390	0.291	0.255	0.236	0.232	0.219
50	0.270	0.211	0.188	0.175	0.171	0.162	0.270	0.207	0.186	0.175	0.171	0.162
75	0.236	0.190	0.169	0.158	0.152	0.148	0.234	0.190	0.169	0.156	0.150	0.145
100	0.219	0.177	0.156	0.145	0.141	0.137	0.217	0.173	0.154	0.143	0.139	0.135
150	0.207	0.167	0.145	0.137	0.133	0.127	0.205	0.162	0.143	0.135	0.131	0.127

Values are based on conditions outlined on page 567. The tables are taken from "Concrete Costs" by the same authors, converted to 1925 prices, and the values are made up from tables of unit times and costs given in the same book carefully checked by contractors' estimates. For more complete details and for the unit values which are adapted to all conditions, see other tables and examples in "Concrete Costs."

Values are for symmetrical buildings.

stairways 10 by 10 feet, these two being adjacent so that the one intermediate 10-foot wall serves for both openings;

(d) For toilets, concrete walls 6 inches thick and 20 feet long, one wall for each 5 000 square feet of floor space.

Walls 8 inches thick, including reinforcement and forms, 75¢ per square foot.

Walls 6 inches thick, including reinforcement and forms, 68¢ per square foot.

- (11) Windows and doors: all openings for windows and doors, 75¢ per square foot.
- (12) Roof covering and flashing: five-ply tar and gravel roofing, 60¢ per square foot.
- (13) Plumbing: two fixtures on each floor up to 5 000 square feet of floor surface, and one additional fixture for each additional 5 000 square feet, \$150 per fixture.
- (14) Labor rates: carpenter labor, \$1.10 per hour; steel labor, \$1.10 per hour; and common labor, 65¢ per hour.
- (15) Concrete in place (including labor and materials): \$12.00 per cubic yard, or 44¢ per cubic foot.
- (16) Form lumber: \$45.00 per 1 000 feet B. M., delivered.
- (17) Steel for reinforcement: \$55.00 per ton, delivered.

For lighter loads than specified, the costs are slightly decreased, this decrease running up to 25 cents per square foot for a 75-pound load in a 10-story building. For a 300-pound load, the prices are increased from 12 cents for a 2-story building up to 25 cents per square foot for 10 stories. **It must be remembered that the tables are based on rectangular, symmetrical buildings. Allowance must be made for irregular layouts, which increase materially the cost of form construction.**

The variation in cost due to variation in spacing of columns is small. If columns are spaced 15 feet apart the cost is 6 per cent greater than where columns are spaced 25 feet apart.

## FLOOR LOADS

**Live Loads.**—In designing any structure, it is necessary to determine the design live load. This should be estimated from the investigation of the use for which the building is designed. The live load must not be smaller, however, than required by the building code of the city in which the building is erected. It should be borne in mind that the codes usually give the minimum values. If, from investigation, it should follow that the expected live load in the building under consideration is larger than the live load required by the code, the larger live load should be used.

To illustrate good practice, the following requirements of the Boston Building Code are given:

Live Load Required by Boston Building Code.

Class of Buildings	Pounds per Square Foot
Armories, assembly halls, and gymnasiums .....	100
Fire houses:	
Apparatus floors .....	150
Residence and stable floors .....	50
Garages, private, not more than two cars .....	75
Garages, public .....	150
Grandstands .....	100
Hotels, lodging houses, boarding houses, clubs, convents, hospitals, asylums and detention buildings:	
Public portions .....	100
Residence portions .....	50
Manufacturing, heavy .....	250
Manufacturing, light .....	125
Office buildings:	
First floor .....	125
All other floors .....	75
Public buildings:	
Public portions .....	100
Office portions .....	75
Residence buildings, including porches .....	50
Schools and colleges:	
Assembly halls .....	100
Class rooms never to be used as assembly halls .....	50
Sidewalks:	
(or 8 000 pounds concentrated, whichever gives the larger moment or shear) .....	250
Stables, public or mercantile:	
Street entrance floors .....	150
Feed room .....	150
Carriage room .....	50
Stall room .....	50
Stairs, corridors, and fire escapes from armories, assembly halls, and gymnasiums .....	100
Stairs, corridors, and fire escapes except from armories, assembly halls, and gymnasiums .....	75
Storage, heavy .....	250
Storage, light .....	125
Stores, retail .....	125
Stores, wholesale .....	250

The Boston Code provides further as follows:

Every plank, slab, and arch, and every floor beam carrying one hundred square feet of floor or less, shall be of sufficient strength to bear safely the combined dead and live load supported by it, but the floor live loads may be reduced for other parts of the structure as follows:

In all buildings except armories, garages, gymnasiums, storage buildings, wholesale stores, and assembly halls, for all flat slabs of over one hundred square feet area reinforced in two or more directions and for all floor beams, girders, or trusses carrying over one hundred square feet of floor, ten per cent reduction.

For the same, but carrying over two hundred square feet of floor, fifteen per cent reduction.

For the same, but carrying over three hundred square feet of floor, twenty-five per cent reduction.

These reductions shall not be made if the member carries more than one floor and therefore has its live load reduced according to the table below.

In public garages, for all flat slabs of over three hundred square feet area reinforced in more than one direction, and for all floor beams, girders, and trusses carrying over three hundred square feet of floor, and for all columns, walls, piers, and foundations, twenty-five per cent reduction.

*Reduction of Live Load in Column Design.*—The rules for reduction of live load used for design of columns is given in the chapter on Columns, p. 453.

**Dead Loads.**—Dead loads consist of the weight of the construction and of all fixed loads, such as floor finish, plaster, partitions, walls, etc.

The dead loads may be taken from following table:

Description	Weight, Pounds per Square Foot
Granolithic finish per inch of thickness (see p. 620) . . . . .	12
Hardwood floors:	
$\frac{1}{2}$ hardwood top, $1\frac{1}{8}$ intermediate floor, screeds, 2 in. cinder concrete fill (see p. 625) . . . . .	2.1
Same except $1\frac{1}{8}$ intermediate planking (see p. 625) . . . . .	23
Same except intermediate floor omitted (see p. 625) . . . . .	18
$\frac{1}{2}$ hardwood top, intermediate floor, $1\frac{1}{8}$ plank and tar base (see p. 626) . . . . .	16
3-in. wood block floor in coal tar pitch (see p. 626) . . . . .	10
Cinder concrete fill 2 in. thick . . . . .	14
Plaster on concrete or tile (2 coats) . . . . .	5
Plaster on lath . . . . .	10
Suspended ceiling . . . . .	12

**GENERAL DESCRIPTION**

Reinforced concrete buildings may be either of the skeleton or the wall bearing type.

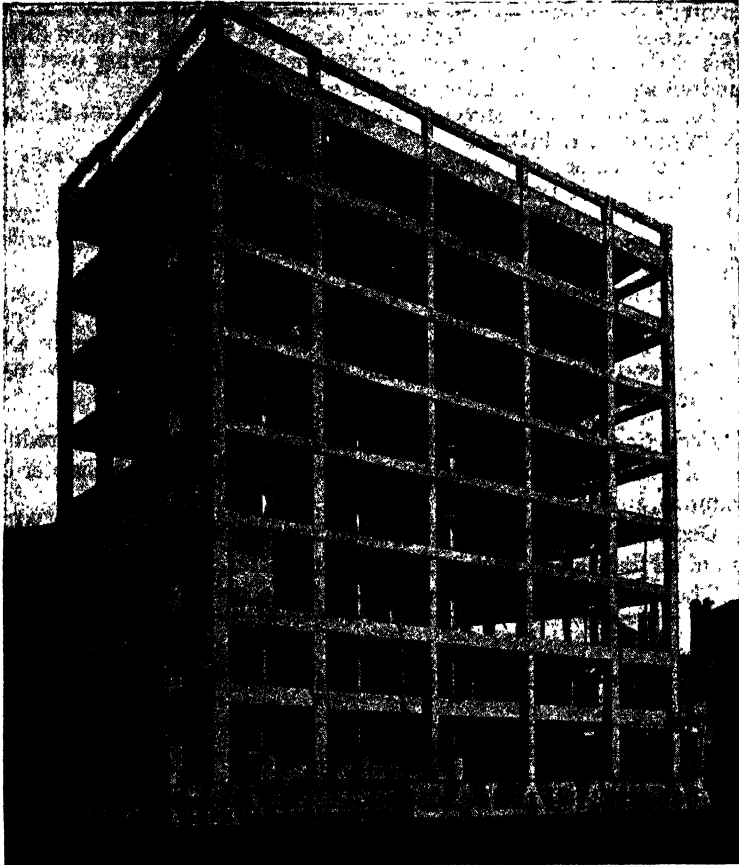

FIG. 185.—Skeleton of Salada Tea Building. (See p. 573.)

In the skeleton type, the reinforced concrete members form a self-sustaining skeleton consisting of concrete foundation or footings, columns resting thereon, and floor construction supported by the columns. The enclosing walls, or "curtain walls," are supported

by the skeleton, and may be built after the skeleton is completed.

In the wall-bearing type, the walls support the floor construction. The walls may be of brick, concrete, concrete block, or terra cotta blocks. The description of this type is given on p. 629.

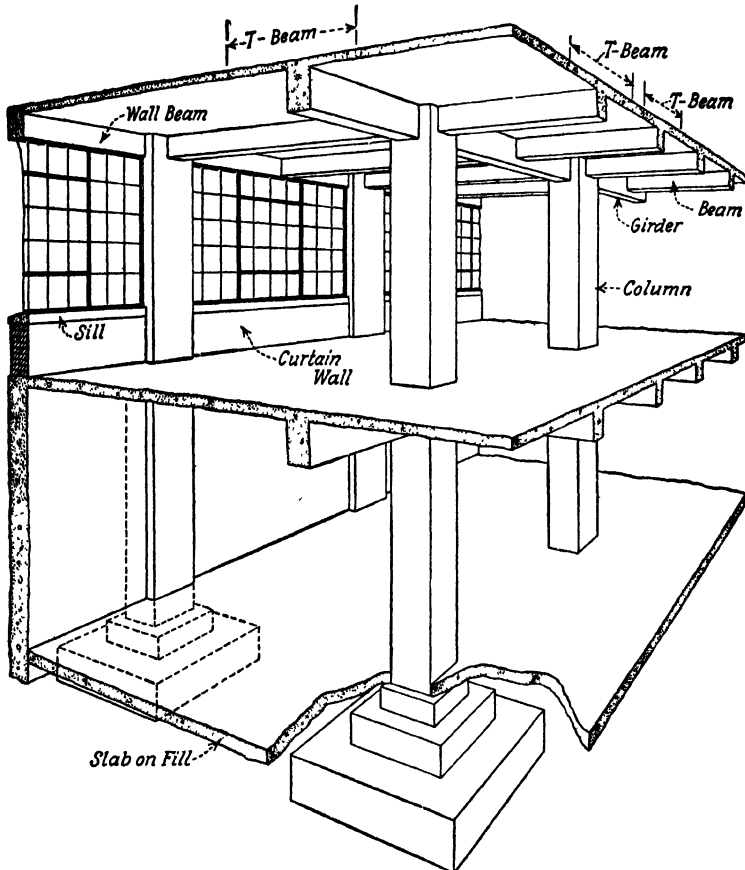

FIG. 186.—Perspective View of Beam and Girder Skeleton. (See p. 574.)

**Skeleton Type.**—A photograph of a completed skeleton of a reinforced concrete building is shown in Fig. 185, p. 572. The component parts of the building are plainly seen. The floor is of the flat slab design. Fig. 263, p. 752, shows the same building after it is enclosed by walls. The concrete skeleton is completely covered. In less orna-

mental buildings, the concrete columns or concrete spandrel beams, or both are exposed. (See p. 729.)

A clear understanding of the construction of a skeleton may be had from Figs. 186 and 187, showing, in perspective, sections of two

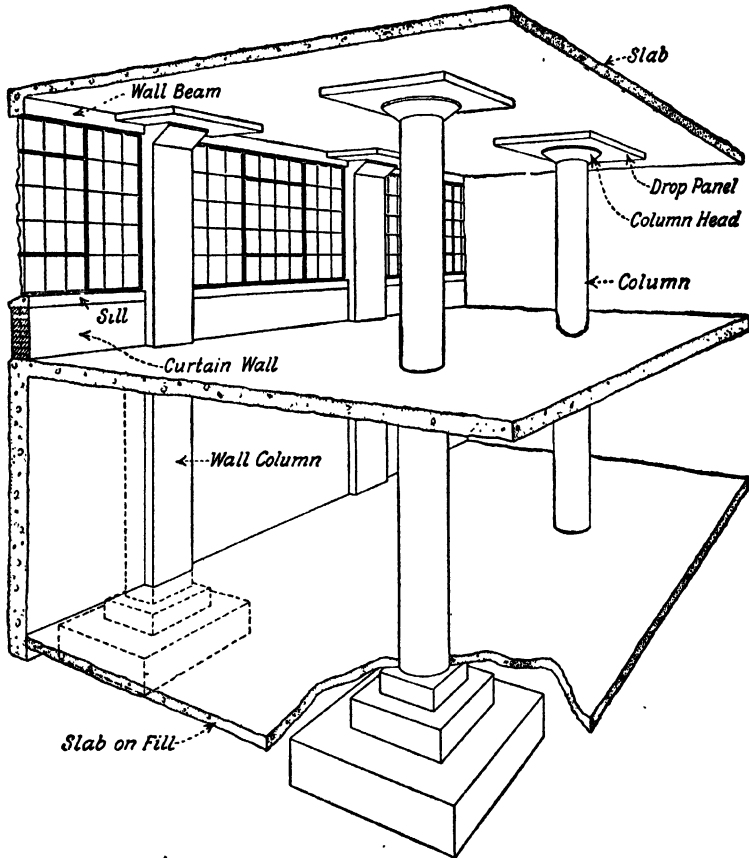

FIG. 187.—Perspective View of Flat Slab Skeleton. (See p. 574.)

buildings. In Fig. 186 the floor is of beam and girder design, and in Fig. 187 of flat slab design. The names of the component parts, which are described under proper headings in this section, are marked on the figures.

**Types of Floor System.**—Floor construction is of two general types: the beam and girder design, and the girderless or flat slab



design. Each of these may be further subdivided as indicated in the detail treatment.

### BEAM AND GIRDER DESIGN OF FLOOR

The beam and girder design is the oldest type of concrete floor construction. It follows the scheme used in steel construction, the load being carried by the slabs, which are supported by beams. The beams either run into columns or are supported by girders running into columns. The arrangement of beams and girders most usual in practice is shown in Fig. 188.

The light-weight floor systems described on p. 588 are modifications of the beam and girder design.

**Use of Beam and Girder Design.**—Originally, the beam and girder floor construction was used almost exclusively. Now its use is restricted by the development of the flat slab floor and the light-weight floor systems. The beam and girder floor is used for heavy loads in preference to flat slab construction, under the following circumstances: (1) when the enlarged heads of the flat slab type are objectionable, irrespective of the dimensions and arrangement of panels; (2) for oblong panels where flat slab construction is not feasible; (3) for very long spans; (4) when the structure is only one panel wide; (5) when the floor has many openings. For light loads, it is used in preference to light-weight floor: when the tile fillers are not readily obtainable; when there is a possibility of concentrated loads; when the appearance of exposed joists is objectionable and the use of furred ceiling is too expensive; when the use of furred ceiling is not warranted and the building is exposed to large fire hazards.

Beam and girder construction is also required in flat slab floors around staircases and elevator openings, and in odd panels.

**Economical Arrangement of Beams.**—The economy of construction depends to a great extent upon the arrangement of beams in a panel. In determining the most economical arrangement, not only the cost of materials, but also the cost of formwork must be considered. Close spacing of beams permits the use of lighter slab, thereby reducing the amount of concrete and steel, but it increases the cost of formwork. Wide spacing of beams saves formwork, but increases the amount of materials. An economical arrangement is that in which the sum of the cost of materials and the cost of formwork is a

minimum. It will vary with changing ratio of the cost of labor to the cost of materials. Where materials are scarce, but labor is

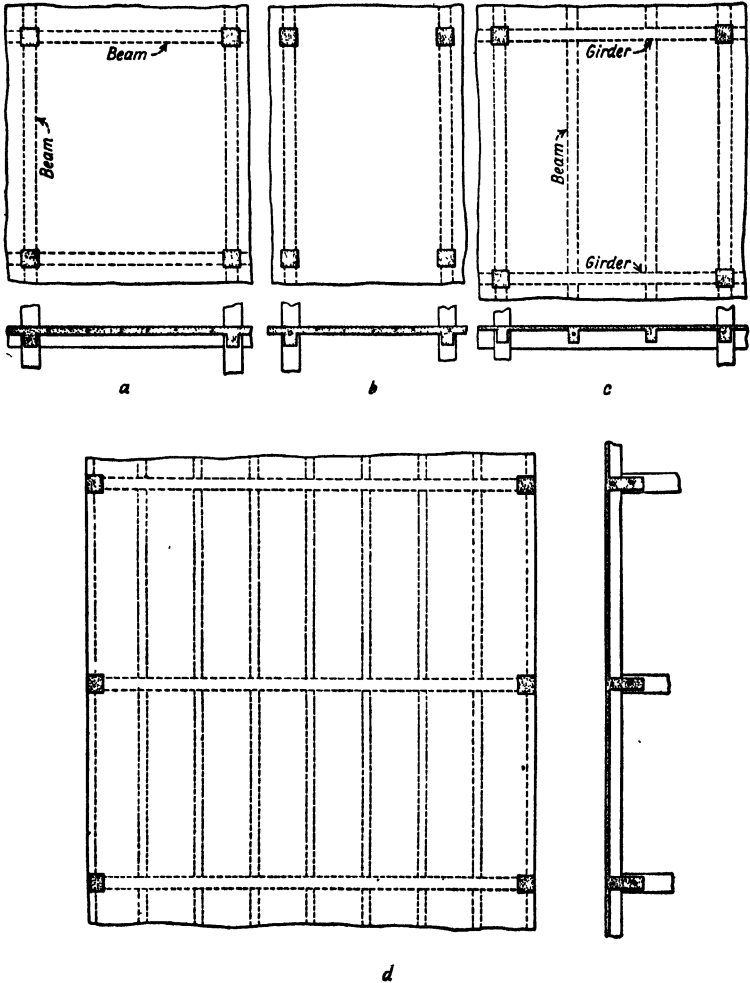

FIG. 188.—Arrangement of Beams and Girders. (See p. 578.)

cheap, it is more economical to save materials at the expense of extra formwork. The reverse is also true.

Economical design will depend also upon the relation between

the prices of the different materials. The design that is most economical in locations where stone and sand are cheap, and steel expensive, will not be economical where steel is relatively the cheaper material. In the first case the use of deep beams with comparatively little steel will make for economy, while in the other case the minimum allowable depth will prove most economical.

**Items Affecting Economical Arrangement of Beams.**—In the above discussion, the cost of concrete floor only was considered. Additional factors, some of which will be discussed below, often affect the economy.

*Cost of Columns and Footings.*—The spacing of beams in a panel affects the dead load of the floor system. This, in turn, influences the sizes and cost of columns and footings. The cost of columns and footings will be smaller with close spacing of beams, since then the thickness of slab is smaller and the weight of the floor construction is reduced. In high buildings, the extra dead load may affect the economy of the design, especially when the size of columns is limited and, therefore, to carry the extra load, a large percentage of steel would have to be used.

*Sprinklers.*—When sprinklers are used, their cost may also affect the economy of the arrangement of the beams. To make the sprinkler system effective, it is necessary to place, in each line of sprinklers, at least one sprinkler head in each bay, irrespective of the size of the bay, because, owing to interference of the beam with the play of water from a sprinkler head, the head in one bay has no effect on the adjoining bay. The number of sprinkler heads, therefore, increases with the increase in the number of bays in a panel.

Thus, the 20 by 22-ft. panel used in the example on p. 578 requires two lines of sprinkler heads. With a two-bay arrangement, two-sprinkler heads in each line per panel are sufficient, making in all four heads per panel. With a three-bay arrangement, three heads per line must be used, making a total of six heads per panel. The difference in the number of heads amounts to two heads per panel. Figuring the cost of sprinkler heads at \$8, the saving per panel amounts to \$16, or 3.6 cents per sq. ft. of the floor for the smaller number of beams.

*Plastering.*—When the ceiling is plastered, each additional beam in a panel adds to the cost of plastering, there is an increase not only in the area of the surface to be plastered, but also in the number of corners. Extra charge is made for each corner to be plastered.

Thus, in 1925, in a 20-ft. by 22-ft. panel, the cost of two-coat plaster work, around New York City, would be \$91.00 with two bays and with \$110.00 three bays, or a difference of 4 cents per sq. ft. in favor of the smaller number of beams.

**General Suggestions as to Spacing of Beams.**—If the cost of two types is nearly equal, preference should be given to the arrangement with fewer beams. The beams are then wider, and the slab thicker, so that the construction is more solid and is better able to withstand fire. Narrow beams and thin slab suffer much in case of a fire.

In oblong panels, the beams should run in the long direction and the girders in the short direction, unless a different arrangement is required for other reasons. An exception to this is a case with very long spans, as shown in Fig. 578, *d*. The formwork for the long beams would be costly, and therefore it is cheapest to place the girders on column centers the long way, and run intermediate cross beams. In oblong panels, one bay per panel will prove economical for short spans up to 15 ft. With such an arrangement, the beams running in the long direction frame into the columns and no cross girders are required. The introduction of an intermediate beam would require also cross girders, which are not needed with one-bay arrangement.

**Beams in Wall Panels.**—The distribution of light is affected by the direction of the floor beams in the wall panels. Beams parallel to the window form a larger obstruction to the light than beams perpendicular to the wall. For this reason, wherever the light is of any importance, the beams should be placed at right angles to the wall. Of course, this is not feasible with a design using intermediate beams, where the wall beam must be kept shallow to accommodate the windows. The intermediate beams would have to frame into the wall beams. Owing to limited depth of wall beams, it may not be possible to get sufficient strength to carry the intermediate beams.

#### EXAMPLE OF BEAM AND GIRDER DESIGN

The design of beam and girder floors is illustrated by the following example:

##### Example of Beam and Girder Design

**Example 1.**—Design a typical panel, consisting of slab, beam, and girder, for a reinforced concrete building to carry a live load of 200 lb. per sq. ft. The spacing of columns is 20 ft. by 22 ft. on centers. Granolithic finish, one inch thick, applied separately, will be used.







Specified unit stresses in lb. per sq. ft. are as follows:  $f_c = 800$ ,  $f_s = 16\ 000$ ,  $n = 15$ ,  $v = 40$  without stirrups,  $v = 120$  with stirrups,  $u = 80$  for plain bars and 100 for deformed bars. At support of continuous beams,  $f_c = 900$ .

**Solution.**—The girder is placed in the short direction and the beam in the long direction, as shown in Fig. 189, opposite p. 579.

**Constants.**—The following constants, taken from table on p. 205, correspond to the assumed working stresses:

Neutral axis and moment arm,  $k = 0.429$ ,  $j = 0.857$ .

Constants for depth of rectangular beam and slab respectively,  $C = 0.083$ ,  $C_1 = 0.024$ . Ratio of steel for balanced design,  $p = 0.0107$ .

**Bending Moments and Span Length.**—Bending moments recommended on p. 278 will be used. Span lengths are recommended on p. 277.

<b>Slab.</b>	Loads: Live load, 200 lb.	
	Slab load, 56 lb. (assumed)	
	Granolithic finish, 12 lb.	
	Total,	268 lb. per sq. ft.

Gross span  $\frac{20\ 0}{2} = 10\ \text{ft.}\ 0\ \text{in.}$

Assuming width of beam equal 1 ft., net span  $l = 10.0 - 1.0 = 9\ \text{ft.}\ 0\ \text{in.}$   
Using formula  $M = \frac{1}{12}wl^2$  ft.-lb. or  $wl^2$  in.-lb. (p. 279).

$$M = 268 \times 9^2 = 21\ 700\ \text{in.-lb.}$$

Depth of slab from formula  $d = C_1\sqrt{M}$  (p. 208) where  $C_1 = 0.024$

$$d = 0.024\sqrt{21\ 700} = 3.5\ \text{in.}$$

Using  $\frac{3}{4}$ -in. concrete below steel, the distance to center of bars will be 1 in. and the total depth  $h = 3.5 + 1 = 4.5$  in.

Area of steel from formula  $A_s = pbd$ .

$A_s = 0.0107 \times 3.5 = 0.038$  sq. in. per inch.

The spacing of  $\frac{3}{4}$ -in. rd. bars is obtained by dividing area of one bar by 0.038.

It is  $\frac{0.196}{0.038} = 5.15$  in. Use  $\frac{3}{4}$ -in. rd. bars 5 in. on centers.

The slab steel will consist of alternate straight and bent bars. The straight bar will extend over two bays and will be 20 ft. 6 in. long. The bent bars will serve as positive reinforcement in one bay, while the ends will be bent up and extended into the adjoining panel beyond points of inflection. (See plan.)

**Beam  $B_1$ .**—Beams  $B_1$  extend between girders, therefore Formulas (66), p. 279, will be used.

Span, center to center, 22 ft. Assuming width of girder equal 1 ft., net span,  $22 - 1 = 21$  ft. Spacing of beams, 10 feet.

Loads: Slab load $268 \times 10 = 2680$ lb.	
Beam, below slab,	300 lb. (assumed)
	2980 lb. per lin. ft.



For intermediate beams spanning between girders, use:

$M = \frac{1}{8}wl^2$  ft.-lb. or  $wl^2$  in.-lb. for negative and positive bending moment.  
(See p. 279.)

$$M = wl^2 = 2980 \times 21^2 = 1\,315\,000 \text{ in.-lb.}$$

External shear,

$$V = \frac{2}{3} \times 2980 = 31\,300 \text{ lb.}$$

*Breadth of Flange.*—Breadth of slab equals either 16 times the thickness of slab plus the breadth of stem of beam, or  $\frac{1}{4}$  of span of beam, whichever is smaller. Assuming  $b' = 12$  in.,  $b = 16 \times 4.5 + 12 = 84$  in. In this case,  $\frac{1}{4}$  of span of beam is smaller than the above value; therefore the breadth of flange will be made equal to  $\frac{1}{4} \times 21 \times 12 = 63$  inches.

*Cross Section as Determined by the Shear.*

$$V = 31\,300 \text{ lb.}$$

$$b' \left( d - \frac{t}{2} \right) > \frac{31\,300}{120} = 260 \text{ sq. in. (see p. 218)}$$

$b'$	$d - \frac{t}{2}$	Depth Required by Shear $d$
12 in.	21.6	23.85
14 in.	18.6	20.85
16 in.	16.2	18.45

*Minimum Depth at Support.*—In continuous beams, the beam at support is a rectangular one with steel in top and bottom. The depth should not be smaller than required at support. In this case, it is desired to bend up one-half of the reinforcement and use the other half as compression reinforcement. The available amount of compression reinforcement, therefore, is equal to one-half of the tensile reinforcement, or  $p' = \frac{1}{2}p_1$ . Assume  $a = 0.1$ . Since the allowable stress at support  $f_c = 900$ , the ratio  $\frac{f_s}{15f_c} = \frac{16\,000}{15 \times 900} = 1.18$ . In diagram for  $a = 0.1$

on p. 908, using line  $\frac{f_s}{15f_c} = 1.2$ , it is found that for  $p_1 = 0.0182$ ,  $p' = 0.0091$ .\*

This gives the required ratio between the compression and tension steel. The minimum depth, then, from Formula (26), p. 222, assuming  $b = 14$  in.

$$d = 1.05 \sqrt{\frac{1\,315\,000}{14 \times 0.0182 \times 16\,000}} = 18.9 \text{ in.}$$

\*In the diagram is drawn a straight line giving the required relation between the tensile steel and compression steel by connecting any two points for which  $p' = \frac{1}{2}p_1$ . The intersection of this line with the line corresponding to  $\frac{f_s}{15f_c} = 1.2$  gives the required ratio of tensile and compression reinforcement. For any other ratio a similar line may be drawn. Instead of the actual drawing of a line, the intersection may be obtained by using a straight edge.

*Economical Depth of T-beam.*—From Formula (18), p. 216,  $d = \sqrt{\frac{rM}{f_s b'}} + \frac{t}{2}$ ,  
if the ratio of unit cost of steel to cost of concrete is  $r = 70$ .

for $b' = 12$	$d = 21.9 + 2.25 = 24.15$
$b' = 14$	$d = 20.2 + 2.25 = 22.45$
$b' = 16$	$d = 18.9 + 2.25 = 21.15$

*Minimum Depth in the Center.*—This depth is governed by the compression stresses in the center, where the beam is a T-beam.

In this case the minimum depth is such that the neutral axis is within the flange. Therefore ordinary beam formula,  $d = C\sqrt{\frac{M}{b}}$ , is used.

For  $f_c = 800$ ,  $f_s = 16\,000$ ,  $n = 15$ ,  $C = 0.083$ .

Since  $M = 1\,315\,000$  in.-lb. and  $b = 63$  in., the required depth is

$$d = 0.083\sqrt{\frac{1\,315\,000}{63}} = 12.0 \text{ in.}$$

*Depth Finally Selected.*—By inspecting the various depths computed above, the following values will be selected:

$$b' = 14 \text{ in.}, d = 22.5 \text{ in.}, h = 22.5 + 2.5 = 25 \text{ in.}$$

This is the economical depth. It is larger than required at the support and somewhat larger than required by shear.

*Area of Steel.*

For  $d = 22.5$  in.,  $t = 4\frac{1}{2}$  in.,  $\frac{t}{d} = 0.2$ , the ratio of moment area is  $j = 0.91$ .

The area of steel, then, is, from Formula (19), p. 216,

$$A_s = \frac{1\,315\,000}{0.91 \times 22.5 \times 16\,000} = 4.0 \text{ sq. in.}$$

Use four 1-in. sq. bars with an area  $A_s = 4 \times 1 = 4.0$  sq. in.

One-half of the bars will be carried straight and the other half will be bent up. The bars will be arranged in one layer. To distribute the steel properly, the bars will be bent up at two points at each end. The points of bending are taken from Fig. 100, p. 294.

*Bond Stresses at Supports.*—Since  $V = 31\,300$  lb. and the perimeter of bars is  $\Sigma o = 4 \times 4 = 16$  sq. in.,  $j = 0.91$ ,  $d = 22.5$ , the bond stresses are:

$$u = \frac{31\,300}{0.86 \times 22.5 \times 16} = 101 \text{ lb.}$$

This is satisfactory for deformed bars.

*Diagonal Tension Reinforcement.*—Unit shear is plotted in Fig. 189, opp. p. 579. As it is desirable to utilize the bent bars for diagonal tension reinforcement, their location is marked on the shear diagram. As explained on p. 250, the bent bars may be considered as effective for a distance equal to  $d$ , provided their area is

sufficient to take the stresses. The area tributary to each group of bars is marked on the diagram.

Section *ab*. In this section stirrups must be provided. Shear to be resisted equals  $\frac{69 + 57}{2} \times 14 \times 12 = 10\,600$  lb. The area of  $\frac{1}{2}$  in. rd. stirrups with two legs equals  $0.196 \times 2 = 0.392$  sq. in. and the available strength equals  $392 \times 16\,000 = 6\,300$  lb. The required number of stirrups equals  $\frac{10\,600}{6\,300} = 1.7$ .

Use 2- $\frac{1}{2}$  in. rd. stirrups in section *ab*.

Section *bc*. This section extends  $\frac{1}{2}d$  on each side of the bent bar, therefore, the bent bar is effective in this section.

Shear to be resisted

$$\frac{57 + 39}{2} \times 14 \times 22 = 14\,800 \text{ lb.}$$

Stress to be resisted by bent bar  $0.7 \times 14\,800 = 10\,400$  lb.

Area of bent bar 1 - 1 in. sq. bar = 1.0 sq. in.

Available strength of bent bar  $1.0 \times 16\,000 = 16\,000$  lb. The available strength is larger than the stress to be resisted.

Section *cd*. The bent bar effective in this section is the same as in section *bc*. Since the shear is smaller than in the other section, the bent bar is sufficient to resist the stresses.

Section *de*. The shear in this section is small. Two  $\frac{1}{2}$  in. rd. stirrups will be used arbitrarily placed as shown in the diagram.

**Beams  $B_2$ .**—The unit loading and gross span for beams  $B_2$  are the same as for beam  $B_1$ , but their net span is smaller and the condition at the support different. Beams  $B_1$  run into flexible girders and therefore must be considered as continuous beams designed by Formulas (63) to (68), p. 278. Beams  $B_2$ , on the other hand, since they run into stiff columns, may be designed as building frames by Formulas (69) to (74), p. 279.

Net span of Beam  $B_2$  is  $l = 22 - 2 = 20$  ft.

Unit load

$$w = 2980 \text{ lb. per lin. ft.}$$

Negative bending moment (Formula (69), p. 279).

$$M_1 = -wl^2 = -2980 \times 20^2 = 1\,192\,000 \text{ in.-lb.}$$

Positive bending moment (Formula (70), p. 279).

$$M = 0.75wl^2 = 0.75 \times 2980 \times 20^2 = 894\,000 \text{ in.-lb.}$$

Shear

$$V = 2980 \times \frac{20}{2} = 29\,800 \text{ lb.}$$

The bending moment for this beam is smaller than for beam  $B_1$ . Usually it is desirable, for the sake of appearance, to use same size for beams  $B_2$  as for  $B_1$ . If not, the economical dimensions may be found as explained in connection with  $B_1$ .

Using same dimensions as for  $B_1$

$$b = 14 \text{ in.} \quad d = 22.5 \text{ in.} \quad h = 25 \text{ in.}$$

The areas of steel required by bending moments are:

At support

$$A_{s1} = \frac{1\,192\,000}{0.86 \times 22.5 \times 16\,000} = 3.85 \text{ sq. in.}$$

In the center of span

$$A_s = \frac{894\,000}{0.91 \times 22.5 \times 16\,000} = 2.73 \text{ sq. in.}$$

Use in the center  $2\text{-}\frac{1}{4}$ " round straight bars = 1.20 sq. in.

2-1" round bent bars = 1.57 sq. in.

Total 2.77 sq. in.

This area is satisfactory.

At the support the available reinforcement consists of two bent bars plus two bent bars extended from the adjoining span, making 4-1" round bars in all with an area of  $4 \times 0.785 = 3.14$  sq. in. The available area of bent bars is smaller than the required area. The difference  $3.85 - 3.14 = 0.71$  sq. in. is supplied by a straight bar.

As a result, reinforcement at the column consists of

4-1" round bent bars = 3.14 sq. in.

1-1" round straight bar = 0.79 sq. in.

Total 3.93 sq. in.

*Check of Compression Stresses at Support.*—In this case the dimensions of the beam as well as the amount of tension and compression reinforcement are fixed. If the  $2\text{-}\frac{1}{4}$ " round straight bars at the bottom of the beam are extended sufficiently into the columns to develop them by bond, they may be considered as compression reinforcement.

The compression stresses will be investigated

$$b = 14 \text{ in.} \quad d = 22.5 \text{ in.} \quad bd = 14 \times 22.5 = 315 \text{ sq. in.}$$

$$\text{Tension steel } A_s = 3.93 \text{ sq. in. } p_1 = \frac{3.93}{315} = 0.0125.$$

$$\text{Compression steel } A'_s = 2 \times 0.60 = 1.20 \text{ sq. in. } p' = \frac{1.20}{315} = 0.0038.$$

The top bars are covered by concrete  $1\frac{1}{2}$  in. thick. The distance from top to center of compression steel is

$$ad = 1\frac{1}{2} + (\frac{1}{4} \times \frac{1}{2}) = 2 \text{ in. } \pm \text{ and } a = \frac{2}{22.5} = 0.089.$$

Using diagram on page 908 for  $a = 0.08$ , find the value of  $\frac{f_s}{15f_c}$  corresponding to  $p_1 = 0.0125$  and  $p' = 0.0038$ , which is  $\frac{f_s}{15f_c} = 1.38$ . When steel is stressed in tension to  $f_s = 16\,000$  lb., the expression changes to  $\frac{16\,000}{15f_c} = 1.38$ , and the corresponding stress in concrete is

$$f_c = \frac{16\,000}{15 \times 1.38} = 773 \text{ lb. per sq. in.}$$

*Stirrups.*—Since the external shear of Beam  $B_2$  is practically equal to  $B_1$ , the same spacing of stirrups will be used for all beams.

*Girder  $G_1$ .*—Gross Span 20 ft. 0 in. Assuming that the minimum size of column is 18 in., the net span is  $20.0 - 1.5 = 18.5$  ft.

*Loading.*—Concentrated load  $2980 \times 22 = 65\,500$  lb. in center of span.

Weight of girder (below slab) 300 lb. per lin. ft.

*Bending Moments.*

Concentrated loads, considering the span as simply supported.

$$M = \frac{65\,500}{2} \times \frac{18.5}{2} \times 12 = 3\,640\,000 \text{ in.-lb.}$$

For continuous span, multiply by a ratio of  $\frac{8}{13}$ .

$$M = 3\,640\,000 \times \frac{8}{13} = 2\,430\,000 \text{ in.-lb.}$$

For uniform load,

$$M = 300 \times 18.5^2 = 103\,000 \text{ in.-lb.}$$

$$\text{Total} \quad 2\,533\,000 \text{ in.-lb.}$$

This bending moment will be used in the center and at the support.

*External Shear.*

$$V_1 = \frac{65\,500}{2} = 32\,750 \text{ lb., concentrated load}$$

$$V_2 = 300 \times \frac{18.5}{2} = 2\,770 \text{ lb., uniformly distributed load}$$

$$\text{Total } V = 35\,520 \text{ lb.}$$

Area required by shear,

$$b' \left( d - \frac{t}{2} \right) = \frac{35\,520}{120} = 296 \text{ sq. in.}$$

Minimum dimensions required by shear,

$$b' = 14 \text{ in.} \quad d - \frac{t}{2} = 21.2 \text{ in.}$$

$$b' = 16 \text{ in.} \quad d - \frac{t}{2} = 18.5 \text{ in.}$$

*Minimum Depth at Support.*—Since the ratios of steel in tension and compression for minimum depth for the girder are the same as for the beam  $B_1$ , namely,  $p_1 = 0.0182$ ,  $p' = 0.0091$ , the minimum depth at support

$$d = 1.05 \sqrt{\frac{2\,533\,000}{14 \times 0.0182 \times 16\,000}} = 26.2 \text{ in.}$$

This depth will be accepted. It is larger than required by shear.

*Area of Steel in the Center of Span.*

For  $d = 26.2$  in.,  $t = 4\frac{1}{2}$  in.,  $\frac{t}{d} = 0.17$ , from table on p. 221, the ratio  $j = 0.92$ .

The area of steel, then, is

$$A_s = \frac{2\,533\,000}{0.92 \times 26.2 \times 16\,000} = 6.57.$$

Use 6-1" rd. 4.71 sq. in. 3 straight 3 bent  
2-1" sq. 2.00 sq. in. 1 straight 1 bent

Total 6.71 sq. in. •

The bars will be placed in two rows. They will be bent in two places. To find the points at which to bend the reinforcement, the bending moment diagram must be drawn, as explained in Vol. II. The variation of bending moments for concentrated loads is different from the variation for uniform loading, therefore, the diagrams on pp. 292 to 297 do not apply. Since the bending moment due to the dead load is small, the same variation of the total bending moment may be taken as for the concentrated load alone. The bending moment diagram and the bending diagram for reinforcement are shown in Fig. 189, opposite p. 579.

*Bond Stresses,*  $V = 35\,500 \text{ lb.}, j = 0.89, d = 26.2.$

$$\Sigma o = 6 \times 3.14 + 2 \times 4 = 26.8 \text{ in.}$$

Hence,

$$u = \frac{35\,520}{0.89 \times 26.2 \times 26.8} = 57 \text{ lb.}$$

Bond stresses are satisfactory.

*Diagonal Tension Reinforcement.*—The shear diagram is drawn first. (See Fig. 189.) The location of the bent bars is then shown and the area tributary to each bent bar is marked off. The shear diagram is then divided into several sections. Each section is investigated as given below.

The shear diagram is divided into sections *ab*, *bc*, *cd*, *de*, and *ef*. The stresses in each section will be computed and the required reinforcement provided.

Section *ab*. In this section stirrups must be provided. Shear to be resisted equals  $\frac{68 + 67}{2} \times 14 \times 6 = 5700$  lb. Since the strength of  $\frac{1}{2}$  in. rd. U-Stirrup equals  $0.392 \times 16\ 000 = 6300$  lb., one stirrup is sufficient.

Section *bc*. This section extends  $\frac{d}{2}$  on both sides of the bent bar. The bent bar, therefore, is fully effective in this section. The diagonal tension to be resisted is  $(v - v')bs = \frac{67 + 65}{2} \times 14 \times 27 = 25\ 000$  lb. This produces stresses in bent bars in this section equal to  $A_s f_s = 0.7(v - v')bs = 0.7 \times 25\ 000 = 17\ 500$  lb. (See Formula (39), p. 248, also p. 15b.) Since in this section two 1-in. rd. bars are bent with an area  $0.785 \times 2 = 1.57$  sq. in. and a capacity  $1.57 \times 16\ 000 = 25\ 100$  lb., diagonal tension may be considered as taken care of.

Section *cd*. The stress to be resisted equals  $\frac{65 + 63}{2} \times 14 \times 27 = 24\ 200$  lb. The stress produced in a bent bar equals  $0.7 \times 24\ 200 = 16\ 900$  lb. In this section 1-1 in. sq. bar is bent up with an area of 1 sq. in. and capacity of 16 000 lb. This is smaller than 16 900 lb., therefore, the bar is not sufficient to take care of the diagonal tension stresses. The difference  $16\ 900 - 16\ 000 = 900$  lb. Divided by 0.7 this gives the stresses to be provided for by stirrup  $900 \div 0.7 = 1290$  lb. One  $\frac{1}{2}$  in. rd. U-stirrup in this section gives sufficient area.

Section *de*. The stress to be resisted equals  $\frac{63 + 60}{2} \times 14 \times 27 = 23\ 300$  lb.\* In this section 1-1 in. rd. bar is bent up. Its capacity equals  $0.785 \times 16\ 000 = 12\ 600$  lb. This divided by 0.7 and subtracted from the total stress to be resisted gives the stress to be taken care of by stirrups.  $23\ 300 - (12\ 600 \div 0.7) = 5300$  lb. This stress may be added to the stresses in section *ef*.

Section *ef*. The stress to be resisted equals  $\frac{60 + 59}{2} \times 14 \times 14 = 11\ 700$  lb. Adding to it 5300 lb. from the previous section makes the total stresses 17 000 lb. This requires three  $\frac{1}{2}$  in. rd. stirrups.

With the above figures as a guide stirrups are spaced as shown in the figure. One stirrup is placed on each side of the beam to take care of the load transmitted by the beam. Three additional stirrups are placed between the beam and the first bent up bar. The number of stirrups used near the column is larger than actually required.

### END PANEL

**Slabs.**—Slab in the end panel is of the same design as for interior panel.

**Beam  $B_1$ .**—The net span and loading is the same as for corresponding interior beam, namely Beam  $B_1$ .

$$l = 21 \text{ ft.}$$

$$w = 2980 \text{ lb. per sq. ft.}$$

Since beams  $B_2$  run into girders, they will be designed as continuous beams by means of Formulas (63) to (68), pp. 278 and 279.

Negative Moment

At Interior Column  $M_1 = -1.2 wl^2 = -1.2 \times 2980 \times 21^2 = 1\,580\,000$  in.-lb.

At Wall Column  $M_2 = -0.6 wl^2 = -0.6 \times 2980 \times 21^2 = 790\,000$  in.-lb.

Positive Moment is same as negative moment at interior column

$$M = 1\,580\,000 \text{ in.-lb.}$$

Use same dimensions as for interior span

$$b' = 14 \text{ in.} \quad d = 22.5 \text{ in.} \quad h = 25 \text{ in.}$$

The required area of steel is found from  $A_s = \frac{M}{jdj_s}$ .

In the center and at interior column

$$A_s = \frac{1\,580\,000}{0.91 \times 22.5 \times 16\,000} = 4.82 \text{ sq. in. at center}$$

$$5.10 \text{ sq. in. at support}$$

At the wall column the moment is equal to one-half of the moment in the center, therefore, the required area of steel

$$A_{s1} = \frac{1}{2}A_s = 2.55 \text{ sq. in.}$$

Use in the center 5-1" rd. bars = 3.92 sq. in.

1-1" sq. bar = 1.00 sq. in.

Total 4.92 sq. in.

Bend up 1-1" sq. bar and 2-1" rd. bars, which give an area of  $1.0 + 1.57 = 2.57$  sq. in. The bent bars extending from the adjoining interior span equal 2-1" sq. bars with an area of 2.0 sq. in. The total area, therefore, is  $2.57 + 2.0 = 4.57$  sq. in. Since the required area is 5.10 sq. in., the balance  $5.10 - 4.57 = 0.53$  sq. in. must be supplied by means of straight bar placed on the top. In this case 1- $\frac{1}{4}$ " rd. bar will be used.

The bars are arranged in accordance with diagram on page 293.

The reinforcement at the wall end of the beam is clearly shown in the elevation of the beam.

*Stirrups.*—Same stirrups will be used as for corresponding interior beam.

FLAT SLAB FLOOR CONSTRUCTION

Flat slab floor construction is used to a great extent in building construction. It is particularly adaptable to warehouses, industrial buildings, garages, and automobile service stations, where it is cheaper than any other type of floor construction.



In buildings with large spans and light live loads, flat slab construction may not prove economical, especially when column capitals are not permitted.

For very long spans, over 35 ft., the dead load of flat slab may be too large.

**Advantages of Flat Slab Construction.**—Following are the advantages of flat slab construction over beam and girder construction.

1. Lower cost (see comparison of cost on p. 788).
2. Smaller depth of construction which results in saving in height of building.

Under ordinary conditions the saving in height in a ten-story building over beam and girder construction is sufficient to add another story. This probably is of particular interest in cities, where the height of buildings is limited.

3. Flat ceilings give better distribution of light.
4. Due to absence of beams and corners in columns, flat slab construction resists fire better than any other type of concrete.
5. Greater efficiency of sprinklers, because there is no interference with the play of the stream of water.

**Design of Flat Slab Construction.**—Complete information regarding the design of flat slab construction is given in Chapter VI.

### LIGHT-WEIGHT FLOOR CONSTRUCTION

Under this heading come floor constructions in which the solid concrete slab is replaced by closely spaced concrete ribs connected at the top by a thin concrete slab, usually called topping. The space between the joists below the topping is either filled by tiles, or is hollow. Such floors may be divided into the following groups, according to the method used for the elimination of the tension concrete between the joists.

1. Hollow tile concrete floors.
2. Metal tile concrete floors.

In some cases, the metal tile is replaced by removable wood forms, as in the Bransom System. The design of this floor is the same as for metal tile. The forms are described in Volume III of this treatise.

**Use of the Light-weight Floors.**—This type of construction may be found economical where light floor loads are carried on long spans, and where smooth ceilings are required. It is used to a great extent

in schoolhouses, hospitals, and office buildings, in combination with either reinforced concrete or structural steel frame. It is not economical for heavy loads. Since the topping is thin, it should not be used where there is a possibility of concentrated loads.

The light-weight construction is lighter than the solid concrete slab construction. This reduces the dead load on the girders and columns. The actual economy of the construction will depend upon the relative cost of the concrete and the tiles. In determining the relative economy of a solid slab floor and a metal tile floor, in cases where flat ceiling is required, it is necessary, to add to the cost of the tile floor the cost of the metal lath which is required in metal tile floors for suspended ceiling, also the difference between the cost of plastering on metal lath and on concrete.

**Comparison of Various Types of Light-weight Systems.**—In deciding on the type of light-weight floor, the cost of the system, as well as the adaptability, should be considered. The hollow clay tile floor is better adapted for heavy loads than the metal tile floor, because the joists are spaced closer and therefore have larger shearing strength for the same depth. It is also more fireproof, as only the bottom of the joist is exposed to the fire. In metal tile floors, if no suspended ceiling is used, the narrow joist and the thin slab are exposed to the fire on all sides. The resistance of such floors to fire is much smaller than that of solid concrete floors.

When the ceiling is not plastered, the appearance of hollow tile floor is not pleasing. Metal tile floors built with removable forms, may be used without plastering.

### REINFORCED CONCRETE HOLLOW TILE FLOOR CONSTRUCTION

For long spans, the weight of the floor construction may be reduced by the use of a combination of hollow tile and reinforced concrete, in which hollow tile replaces the concrete in the tensile portion. The tile is lighter than the replaced concrete; therefore, the resulting construction weighs less than a solid concrete slab. The combination of hollow tile and concrete may be considered as intermediate between solid concrete floor and metal tile floor. It is considered by the authors as the best light-weight type.

**General Description.**—The most common combination of hollow tile and concrete is shown in Fig. 190, page 591. The construction consists of hollow tile, reinforced concrete joists poured between the

tiles, and concrete topping above the tiles, poured monolithic with the joists. The joists may run in one direction only, in which case the combination is called one-way hollow tile system (see p. 591), or they may run in two directions at right angles to each other, the construction in this case being called two-way hollow tile system (see p. 592). The joists are supported by reinforced concrete girders, by structural steel beams, or by walls. In the two-way system, supports must be provided on four sides.

The tile may be of burned clay, gypsum, or any other material adaptable for the purpose.

**Hollow Clay Tiles.**—Burned clay tiles are most commonly used. Figure 191 illustrates a typical hollow floor tile made of fire clay and used in the one-way system. In plan it is 12 in. square and varies in depth from a minimum of 4 in. to a maximum of 15 in. The surfaces of the tiles are usually scored, in order to bind the tile and the concrete more thoroughly and also to furnish a good plastering surface. When an all-tile ceiling is desired, special 1-in. tile slabs are placed between this under the joists. While this has the advantage of providing a uniform plastering surface, it increases the depth of construction by 1 in.

The weight of the tile depends upon the material of which it is made and also upon the thickness of the walls of the tile. The weights given in the table below are for burned clay tiles as manufactured by the National Fireproofing Co.

**Weight of Hollow Burned Clay Tile**

Size of Tile in Inches	Weight per Tile	Size of Tile in Inches	Weight per Tile
2 × 12 × 12	16 lb.	8 × 12 × 12	32 lb.
3 × 12 × 12	16 lb.	9 × 12 × 12	36 lb.
4 × 12 × 12	18 lb.	10 × 12 × 12	38 lb.
5 × 12 × 12	21 lb.	12 × 12 × 12	42 lb.
6 × 12 × 12	24 lb.	15 × 12 × 12	50 lb.
7 × 12 × 12	29 lb.		

In the one-way arrangement, the clay tiles are placed with ribs parallel to the direction of the joists. When the tiles are sound and are properly placed, comparatively little concrete finds its way inside.

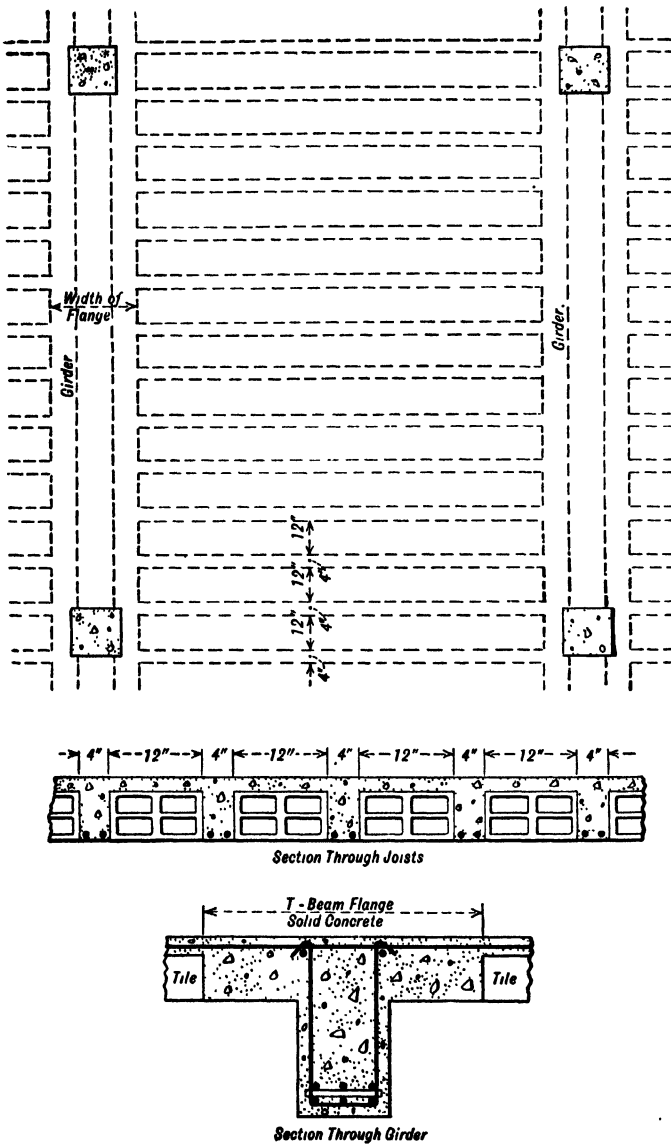

Fig. 190.—Hollow Tile and Concrete Floors. (See p. 590.)

When the tiles are broken or when the joints between the tiles are not properly sealed, considerable concrete may flow into the tiles, thereby increasing not only the weight of construction but also its cost.

In the two-way arrangement, some designers use regular tiles, claiming that no considerable amount of concrete flows into the tiles through the open ends. The authors do not consider such designs desirable, because it is impossible to estimate the increased weight of slab and amount of extra concrete. Special tiles, for the purpose of sealing the open ends, are on the market. In the arrangement shown in Fig. 192, p. 593, each group between four joists consists

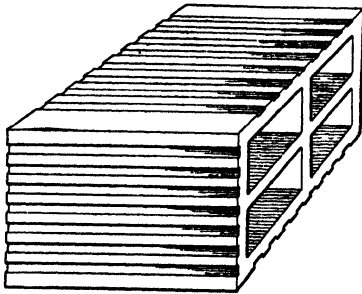

Fig. 191.—Typical Hollow Clay Floor Tile. (See p. 590.)

of six tiles, forming a 24-in. square. With 4-in. joists, their spacing in both directions is 28 in. on centers.

In another arrangement, the ends of the tiles are closed by means of channel tiles, the flanges of which are placed against the open ends of two adjoining tiles. The web of the channel is placed on the form, and its width fixes the spacing of the tiles. The width of the joist is equal to the clear distance

between the flanges of the channel. Additional soffit tiles are used, and an all-tile ceiling is thus obtained. (See Fig. 201, p. 613.)

**Gypsum Tiles.**—Hollow tiles may also be made of gypsum. The standard width of the gypsum tile is 20 in.; the spacing of 4-in. joists would therefore be 24 in. on centers.

Gypsum tile is lighter than clay tile. An additional advantage is that it can be readily cut in the field. It has the disadvantage, as compared with clay tile, that it is much more brittle and therefore requires more careful handling.

**Joists.**—The joists may be made of any width, by spacing the rows of tiles the desired distance apart. The minimum width of the concrete joists should be 4 in. This width has been adapted as standard by many users. A smaller width is sometimes used with burned clay tiles, but then the space is filled with cement mortar and not with concrete.

**Topping.**—The concrete topping over the tiles should be at least 2 in. thick, and should be poured in one operation with the joists. Since the concrete topping rests on the tiles, no bending stresses can be developed in the concrete and no bending reinforcement is necessary. It is advisable, however, to use some shrinkage

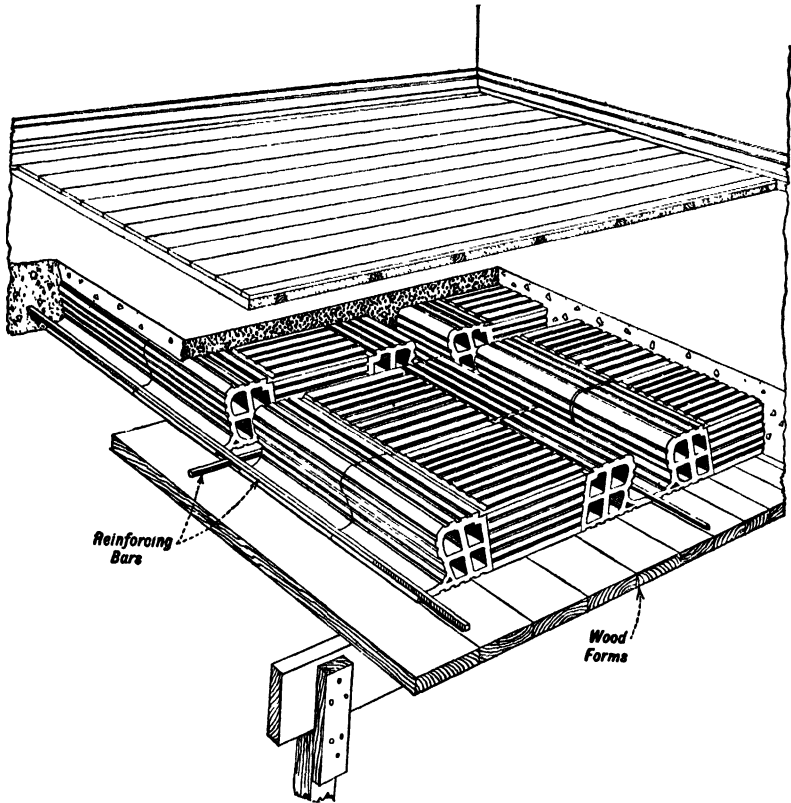

FIG. 192.—Hollow Clay Tiles for Two-way Combination Floor. (See p. 592.)

and temperature steel to prevent cracking of the topping. The amount to be used can be smaller than that required in metal tile slabs, as the contraction of the concrete is reduced somewhat by the adherence of the concrete to the tile.

In clay tile construction for light loads, the topping is sometimes omitted and the construction then consists of rows of tiles separated by rectangular concrete joists of the same depth as the tiles. Nat-

urally, the tiles must be strong enough to carry the load between the joists.

**Design of Joists.**—The floor loads are carried by the concrete joists, which, with the topping, form small T-beams. The design of the floor, therefore, resolves itself into the design of small T-beams. Each joist carries the dead load plus the live load of a strip of floor of a width equal to the spacing of the joists. The bending moments and shears are computed in the same manner as for regular concrete beams. The bending moment coefficients will depend upon the degree of restraint at the supports and upon the number of spans. The span to be used in design is discussed on p. 277.

For simply supported floors, such as those in which the joists rest on brick walls, it is necessary to compute shearing stresses at the support, the amount of steel in the center, and the compression stresses in the center. The economical depth and the depth required by deflection are usually larger than the depth governed by the compression stresses.

In continuous beams, in addition, the amount of steel and the compression stresses at the continuous support must be found. At the support, the topping, which in the center forms the flange of the T-beam, is in the tension zone, so that the joist becomes a rectangular beam. Usually, the compression stresses are high and compression steel is required. The depth required at support may be the governing depth.

**Shearing Stresses.**—Shearing stresses involving diagonal tension should always be computed. If it is desired not to use any diagonal tension reinforcement, the unit stresses must not exceed the value allowed for plain concrete. Many building codes require that, in computing shear, only the width of the concrete joist shall be considered as effective. At present, there is a tendency to make some allowance for the resistance of the clay tile to diagonal tension. The report of the Joint Committee of 1924 gives the following rule, which is endorsed by the authors:

*"Shear in Beam and Tile Construction.*—The width of the effective section for shear, as governing diagonal tension, shall be assumed as web plus one-half the thickness of the vertical webs of the concrete or clay tile in contact with the beam."

**Reinforcement of Joists.**—The amount of reinforcement is obtained from the bending moments, as recommended on p. 275. In selecting the number of bars, the bond stresses must be taken into

consideration. To keep the bond stresses within working limits, the use of bars of small diameter is recommended. Since the joists are narrow, the tendency is to use a small number of heavy bars. This produces excessive bond stresses.

It is not advisable to use more than two bars in one row. If a larger number of bars are used, they should be placed in two rows, in which case proper allowance must be made in computations for the reduced moment arm.

In continuous joists, it is advisable to use an even number of bars of nearly the same size. Bars forming about one-half of the total area of steel may be bent up and carried over the support. When the reinforcement of the joist consists of one bar only, it must be carried straight at the bottom for the full length of the joist. If it is not possible to divide the steel in half, the larger portion should be bent up. It is advisable to carry at least 40 per cent of the bottom steel straight to the support, and a larger amount is often required by compression stresses. The proper amount of steel should be provided at the support. The bent-up bars with the bars coming from the adjoining span are usually sufficient. If not, additional straight bars should be used. When no bars are bent up, the full area of steel required for negative bending moment must be provided by short bars.

The bars should be bent up at such points that the center of the bend coincides with the point of inflection. They should be extended into the adjacent span a sufficient distance to develop the bar in tension for negative moment. To serve this purpose, they must be extended at least 20 diameters beyond the points of inflection of that span. An attempt is often made to use the bent bars both as negative moment reinforcement and as diagonal tension reinforcement. The result is not satisfactory, as there is danger that neither of the stresses will be properly taken care of. At the end support, the proper amount of steel should be used to take care of any bending moments that may be developed. The magnitude of the negative bending moment to be taken care of will depend upon the amount of restraint. A minimum negative bending moment equal to  $\frac{1}{16}wl^2$  should be provided for.

**Points of Inflection.**—The location of the points of inflection should be computed on the basis of the net span and not the gross span. The distance to the point of inflection should be measured from the edge of the support and may be accepted as  $\frac{1}{4}$  of the net



span for interior spans and  $\frac{1}{4.5}$  for wall panels. When the bending moment is computed on the basis of the gross span, there is the tendency to consider the point of inflection as distant from the center of the support a distance equal to  $\frac{1}{3}$  of the gross span. For wide supports, this assumption fixes the point of inflection much nearer the support than it actually is, with the result that the negative bending moment is not properly provided for. While the assumption of gross span in figuring the bending moment is safe, it gives unsafe results in figuring the distance of the points of inflection.

**Spacing of Reinforcement.**—The bars should be placed not nearer to the sides of the tile than  $\frac{3}{4}$  in. This is required for bond and not for fireproofing, as the tile serves as a sufficient fire protection. The bars should be kept a proper distance above the form. When two layers of bars are used, they should be separated by a separator bar one inch in diameter. In narrow joists, it is difficult to keep the bars in place without mechanical spacers and chairs. In many instances, it has been found after the concrete was removed that the bars were misplaced, in pouring concrete, to such an extent that there was no concrete between the bars.

**Diagonal Tension Reinforcement.**—If the unit stresses exceed the allowable values for plain concrete, stirrups should be used. The size and spacing should be determined as explained on p. 247. The bent bars may be considered as resisting diagonal tension in the portion of the beam where they occur.

**Selection of Depth of Joist.**—In selecting the depth of joists, not only the stresses, but also the deflection must be considered. For a joist that is shallow in proportion to the span, the deflection may be excessive even if the stresses are within working limits. If the ceilings are plastered, the deflection should not exceed  $\frac{1}{360}$  of the span; if it is greater the plaster will crack.

Economy of design should also be considered in selecting the proper depth of joists. The economical depth will depend upon the relative cost of concrete tile and steel. By increasing the depth of the joist, the cost of concrete and tile is increased; but the cost of steel is reduced. A depth may be considered economical when any increase in it would give an increase in cost of concrete and tile greater than the accompanying decrease in cost of steel.

In many instances, the depth required for compression at the support is larger than the economical depth. At the support, the

joist is a rectangular beam with double reinforcement. The amount of compression steel may be assumed as one-half of the tension reinforcement, and the depth computed by means of the constants from Diagram, p. 908. The allowable compression stress at the support may be increased as explained on p. 282.

**Girders Supporting Joists.**—The girders supporting the joists may be either of reinforced concrete or of steel. If reinforced concrete girders are used, the required flanges for the T-beams are provided by omitting the tiles adjacent to the edge of the girder. (See Fig. 190, p. 591.) As a result, a solid slab is obtained on both sides of the girder, of the same depth as the depth of the joist. The flange so obtained may be deeper than required to resist the compression stresses. If this is the case, instead of omitting the tiles altogether, thinner tiles may be used. For instance, in a floor consisting of 10-in. tiles and 2-in. topping, by omitting tiles at the girders, the thickness of the flange of the girder would be 12 in. In most cases, this is more than is required by the stresses. If 6-in. flange is required for the girder, instead of omitting the tiles at the girder, 6-in. tiles are substituted for the 10-in. tiles. As a result, the flange of the girder will be 6 in. thick. While this method saves some concrete, it may lead to confusion on the job.

**Support on Brickwork.**—The joists should have a bearing on the wall of at least 6 in. The required area of bearing should be computed from the reaction of the joist and the allowable stresses on brickwork.

**Weight of Clay Tile Floors.**—In computing the dead load of the slab, the following weights may be assumed for burned clay tile with 4-in. concrete joist spaced 16 in. on centers and 2-in. topping. The weight of flooring and plaster should be added. If the thickness of topping is more than 2 in., the extra weight of concrete should be added.

Thickness of tile, in. . . . .	3	4	5	6	7	8	9	10	12	15
Amount of concrete per sq. ft. in cu. ft. . . . .	0.23	0.25	0.27	0.29	0.32	0.34	0.36	0.38	0.4	20.48
Average weight of tile and concrete, per sq. ft., lb. . . . .	45	50	55	60	65	70	75	80	90	105

**Erection.**—It is evident that for one-way arrangement of tiles the form boards need be used only under the joists. The width of the

boards must exceed the width of the joist by an amount sufficient to give support for the tiles.

The tiles must be erected in a straight line and kept in place during concreting. Misplacement of the tiles would reduce the width of the joist and might have serious consequences.

Tiles should be sprinkled with water before concrete is poured, as dry tile absorbs moisture from the concrete. If this is omitted, especially in dry weather, the topping will lose more water by absorption than the joists, causing cracking and uneven setting of concrete.

Since the joists are narrow, with a large amount of reinforcement, the large stones used as coarse aggregate would obstruct the flow of the concrete around the reinforcement and would form pockets. The maximum stone should therefore pass a  $\frac{3}{4}$ -in. sieve. The concrete must be carefully spaded and worked around the reinforcement.

The joists must be poured in one operation with the topping. Construction joints in the joist should be made in the center of the joist. Construction joints parallel to the joist should be made midway between the joists. It must be borne in mind that the topping acts as a flange for the joist, and nothing must be done which would interfere with this function.

**Example of Hollow Tile Floor.**—Figure 193 gives the floor plan of a building in which hollow tile construction was used. The arrangement of panels and the sizes are given. The computations for a typical panel are given below:

**Typical Design of Combination Hollow Tile and Reinforced Concrete Floor.**—The computations given below refer to the floor in the Ordnance Building shown in Fig. 193, p. 599.<sup>4</sup> The floor is intended for office use.

**Slab, Interior Span, 15 ft. 0 in.**— $M = \frac{wl^2}{12}$  for positive and negative bending moments.

Live load . . . . .	75 lb. per sq. ft.
2-in. cinder concrete fill and sleepers. .	15
$\frac{7}{8}$ -in. wood flooring . . . . .	5
$\frac{1}{2}$ -in. ceiling plaster . . . . .	5
Assume weight of slab . . . . .	60
<b>Total load . . . . .</b>	<b><math>w_1 = 160</math> lb. per sq. ft.</b>

<sup>4</sup> Arthur Wood, Architect, National Fireproofing Co., Engineers.

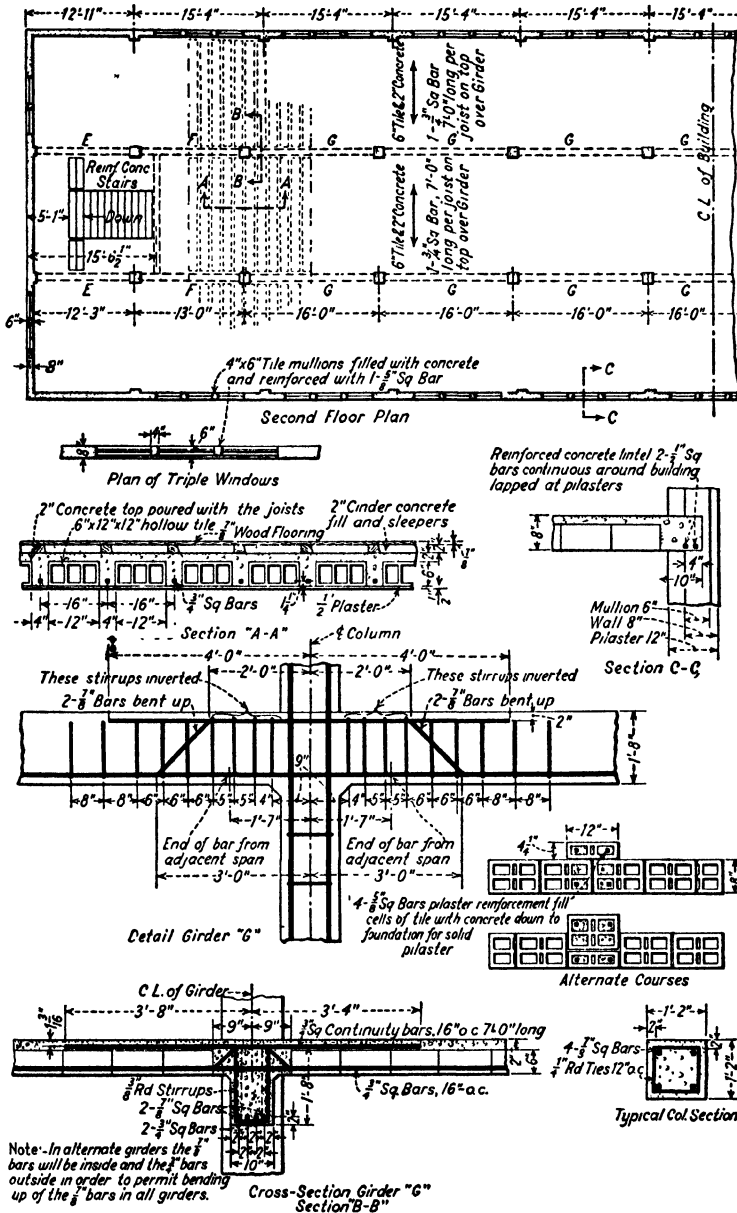

FIG. 193.—Floor Construction in Ordnance Building, Washington, D. C. (See p. 598.)

With joists spaced 16 in. on centers, the unit load per joist,  
 $w = 160 \times \frac{1}{2} = 213$  lb. per lin. ft.

Assume working unit stresses:

$$f_c = 650 \text{ lb. per sq. in.}$$

$$f_s = 16\,000 \text{ lb. per sq. in.}$$

$$v = 40 \text{ lb. per sq. in.}$$

$$u = 100 \text{ lb. per sq. in. (for deformed bars).}$$

If  $n = 15$ ,  $j = \frac{7}{8}$  (approx.).

The joists may be considered as T-beams. Their fixed dimensions are:

Width of flange. . . .  $b = 16$  in.

Width of stem. . . .  $b' = 5$  in. (4 in. concrete + 1 in. for tile shells)

Thickness of flange.  $t = 2\frac{5}{8}$  in. (2 in. concrete +  $\frac{5}{8}$  in. for tile shells)

The maximum shear at edge of girder. Net span equals  
 $15 - 1.5 = 13.5$ .

$$V = \frac{213 \times 13.5}{2} = 1\,440 \text{ lb.}$$

The maximum bending moment,

$$M = \frac{213 \times (15)^2 \times 12}{12} = 48\,000 \text{ in.-lb.}$$

Use 6-in. tile with 2-in. concrete top (weight = 60 lb. per sq. ft.) and, allowing  $1\frac{1}{4}$  in. below center of steel,  $d = 6\frac{3}{4}$  in.

The required area of steel is,

$$A_s = \frac{M}{f_s j d} = \frac{48\,000}{16\,000 \times \frac{7}{8} \times 6\frac{3}{4}} = 0.51 \text{ sq. in.}$$

Use one  $\frac{3}{4}$ -in. sq. bar in each joist ( $A_s = 0.56$  sq. in.).

The area of steel was found for an assumed value of  $j$ . The results will be checked by computing accurate values. Formulas on p. 134 are used.

**Check of Unit Stresses.**—(Use formulas on p. 134.)

$$kd = \frac{2nA_s d + bt^2}{2nA_s + 2bt} = \frac{(2 \times 15 \times 0.56 \times 6.75) + 16 \times (2\frac{5}{8})^2}{(2 \times 15 \times 0.56) + (2 \times 16 \times 2\frac{5}{8})} = 2.22 \text{ in.}$$

$2.22 \text{ in.} < 2\frac{5}{8} \text{ in.}$ ; therefore the neutral axis is in the flange.

$$k = \frac{kd}{d} = \frac{2.22}{6.75} = 0.329,$$

and

$$j = 1 - \frac{1}{3}k = 0.890.$$

Unit Stresses:

$$f_c = \frac{M}{\frac{1}{2}kjb d^2} = \frac{48\,000}{\frac{1}{2} \times 0.329 \times 0.890 \times 16 \times (6.75)^2} = 450 \text{ lb. per sq. in.}$$

$$f_s = \frac{M}{A_s j d} = \frac{48\,000}{0.56 \times 0.890 \times 6.75} = 14\,300 \text{ lb. per sq. in.}$$

$$v = \frac{V}{b' j d} = \frac{1\,440}{5 \times 0.842 \times 6.75} = 50.7 \text{ lb. per sq. in.}$$

Stirrups are necessary at ends of beam.

$$u = \frac{V}{\Sigma o j d} = \frac{1\,600}{3 \times 0.842 \times 6.75} = 94 \text{ lb. per sq. in.}$$

Bond stresses are satisfactory for deformed bars.

**Joist at Support.**—Assuming the negative bending moment over interior supports to be equal to the positive bending moment at the center of the span, the same amount of steel will be provided as in the center of the span. One  $\frac{3}{4}$ -in. square bar will be used at the top of each joist over the girder, with effective depth of  $6\frac{3}{4}$  in. from the bottom of the slab. These continuity bars will be made 7 ft. long to reach the quarter-points of the span each side of the girder. The positive reinforcement will be carried straight through the girder into the adjacent span, for a distance sufficient to take care of compression stress in the steel equal to the maximum stress as determined when the joist at the support is figured as a double reinforced beam.

Unit stresses due to negative moment at support. (See p. 139.)

$$p_1 = p' = \frac{A_s}{b' d} = \frac{0.56}{5 \times 6.75} = 0.0166$$

$$a = \frac{1\frac{1}{4}}{6.75} = 0.185$$

$$k = \sqrt{2n(p + p'a) + n^2(p + p')^2} - n(p + p') = 0.418$$

$$j = \frac{k^2(1 - \frac{1}{3}k) + 2p'n(k - a)(1 - a)}{k^2 + 2p'n(k - a)} = 0.842$$

$$f_s = \frac{M}{A_s j d} = \frac{48\,000}{0.56 \times 0.842 \times 6.75} = 15\,100 \text{ lb. per sq. in.}$$

$$f_s = f_s \frac{k}{n(1 - k)} = 723 \text{ lb. per sq. in. (At support, a stress 15 per cent higher than 650 is permitted = 750 lb., per sq. in.)}$$

$$f'_s = f_s \frac{(k - a)}{1 - k} = 6\,050 \text{ lb. per sq. in.}$$

Length of positive steel required beyond edge of support, as determined by bond for  $\frac{3}{4}$ -in. bar,

$$\frac{f_s l}{4u} = \frac{6\,050 \times \frac{3}{4}}{4 \times 100} = 11.4 \text{ in., say } 12 \text{ in.}$$

**Exterior Span.**—Use the same slab construction for the two exterior spans of 14 ft. 0 in.;  $M = \frac{WL}{10}$ .

$$V = \frac{213 \times 13}{2} = 1\,385 \text{ lb.}$$

$$M = \frac{213 \times (14)^2 \times 12}{10} = 50\,000 \text{ in.-lb.}$$

$$f_c = \frac{50\,000}{\frac{1}{2} \times 0.329 \times 0.890 \times 16 \times (6.75)^2} = 467 \text{ lb. per sq. in.}$$

$$f_s = \frac{50\,000}{0.56 \times 0.890 \times 6.75} = 15\,000 \text{ lb. per sq. in.}$$

$$v = \frac{1\,385}{5 \times 0.875 \times 6.75} = 48.8 \text{ lb. per sq. in.}$$

Stirrups at ends are required.

$$u = \frac{1\,491}{3 \times 0.875 \times 6.75} = 87.7 \text{ lb. per sq. in.}$$

Bond stress satisfactory for deformed bars.

### STEEL TILE FLOORS

Another type of light floor construction is the steel tile construction. In this type the concrete in tension is eliminated by metal tiles of proper design. The resulting construction is shown in Fig. 194, p. 603. These steel tiles are often called "metal pans," or "tin pans."

**General Description.**—Constructions of this type may be divided into one-way steel tile floors, in which the tiles run in one direction only, and two-way steel tile floors, in which the joists run in two directions at right angles to each other. In the one-way arrangement, each row of tiles consists of a number of tiles open on both ends, overlapping each other and provided at the ends with end caps. In the two-way arrangement, special tiles closed on four sides and on the top are used. They are often called domes.

The floor consists of joists from 4 to 6 in. wide, spaced about 26 in. on centers and connected by a thin concrete slab 2 to 3 in. thick, serving as a compression flange for the joists.

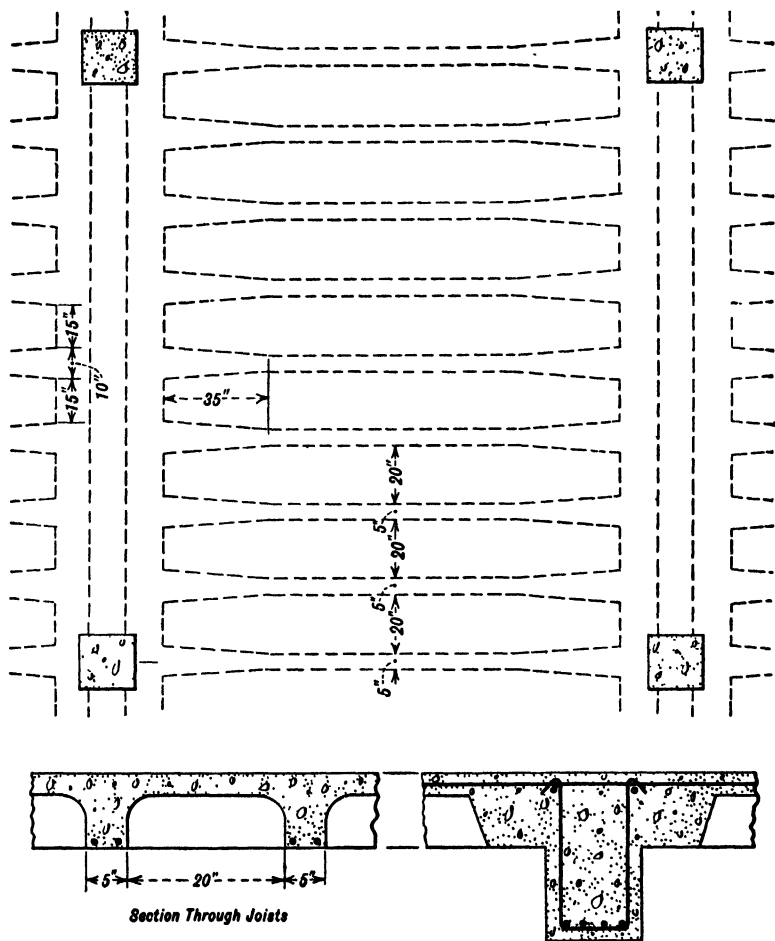

FIG. 194.—Typical Panel for Steel Tile Construction. (See p. 602.)

thick, serving as a compression flange for the joists. The depth of joists below the topping varies from 4 to 14 in., depending upon the span and the load.



**Steel Tiles.**—Two types of metal tiles are on the market: the removable tiles, which act only as a form and are removed after the concrete has hardened; and the permanent tiles, which are left permanently in the construction. Both types are of the general design shown in Fig. 195 and differ only in the strength of the sheet metal from which they are stamped. The removable tiles are made from sheet metal of 14 to 22 gage. The heavier tiles are preferable, as they last longer and keep their shape better after rehandling. For tiles left permanently in the construction, sheet metal of 24 to 26 gage is used. Permanent tiles must not be made too thin, or they will become distorted during construction. To stiffen the

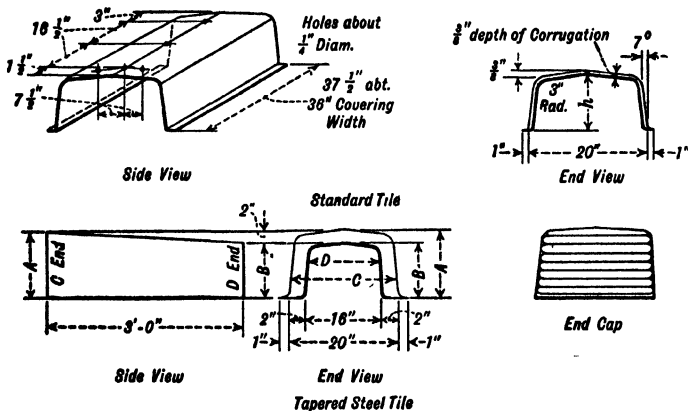

FIG. 195.—Details of Steel Tile. (See p. 604.)

steel tiles and enable them to withstand the hard usage they receive during construction, they are provided across their tops and sides with corrugations formed by heavy dies during fabrication.

The sides of the tiles are tapered and rounded at the junction of the slab and the joist. At the bottom, the tiles are provided with flanges one inch wide, which during construction rest on the forms and are lightly tacked thereto. Each row of tiles is closed at the ends by caps made of the same material and fitting the tiles. The cap is shown in Fig. 195.

#### Stock Dimensions of Steel Tiles.

*Standard Heights* adopted by all manufacturers are 4, 6, 8, 10 and 12 in. Some manufacturers also carry 14-in. tiles in stock.

In other respects, the standards adopted by various manufacturers differ to a great extent.

*Standard Width*, measured at the bottom between the edges of the sides (not including the width of the one-inch flanges) varies from 20 in. to 25 in. This difference in width affects the spacing of the joists in the floor and should be taken into account when comparing the strength of designs made by different firms. It is obvious that, with the same design for the joists, the floor will be stronger where the joists are spaced closer. For equal strength, the joists spaced farther apart should be thicker and have more reinforcement.

In addition to tiles of standard widths, each manufacturer carries special tiles to be used in the last row near the edges of the panel, where the regular tile is too wide.

*Standard Lengths* adopted by various manufacturers vary from 2 ft. to 4 ft. 6 in. Some manufacturers use two standard lengths. In one instance, they are 30 and 36 in. of covering length (the actual lengths are  $1\frac{1}{2}$  in. greater to allow for lapping). By combining the proper number of tiles of each length and by selecting proper lapping, forms for any length of joist may be obtained.

*Tapered Tiles*.—In addition to tiles of constant cross section, tapered tiles are manufactured. These are used at the ends of the joists where widening of the joists is required. The tapered tiles at one end are of the same width as the regular tiles, and at the other end the width is reduced by about 5 in. This taper is obtained in a length of 30 in. Often the tiles are tapered in height also.

The purpose of the taper is to increase the width of the concrete joist at the support, where additional shearing area is required. In continuous joists, the increased width also relieves the large compression stresses at the support.

*Adjustable Metal Tiles*.—Another type of metal tiles is shown in Fig. 196, p. 606. The differences between these and the tiles just described are as follows: The adjustable tiles are made of smooth, heavy sheet steel, No. 12 gage, instead of the lighter corrugated material used in other tiles. They are wider and longer. Their width is 31 in., against 20 to 25 in. used for the other tiles. The length is from 6 to 10 ft. The depth of tiles is adjustable, as is evident from Fig. 196. It should be noticed that the metal tiles may be removed without removing the form under the joist.

The metal forms are shown in place in Fig. 197. The pleasing appearance of the ceiling in the photograph, Fig. 198, is due to the

use of smooth metal for the tiles and to the small number of joints. Both photographs were obtained from Mr. Wm. H. Gravell, engineer for the two jobs.

**Method of Design.**—The design of the floor system resolves itself into the design of the joists composing the slab and of the girders carrying the joists.

For the purpose of design, the joists may be considered as small T-beams in which the topping serves as a flange. The following steps should be taken in designing:

(1) Depth and width of the joist should be assumed for the purpose of determining the dead load. (2) Bending moments and

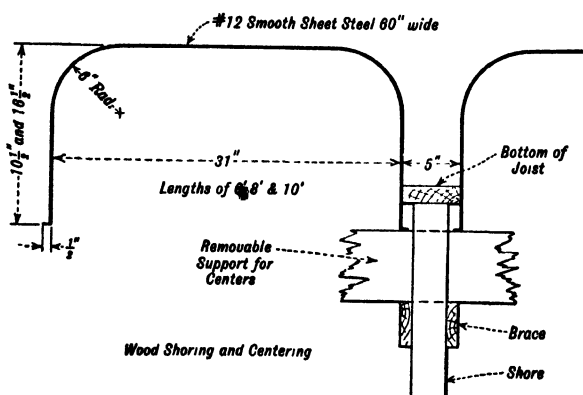

FIG. 196.—Adjustable Metal Tile. (See p. 605.)

shears should be computed. For continuous joists, use formulas on p. 278. (3) Shearing unit stresses should be determined. (4) Required amount of steel and the compression stresses in the center should be found by means of the T-beam formulas. (5) For continuous joists, compression stresses at the support should be computed by means of formulas for rectangular beams with steel in top and bottom.

Proper selection of the depth of the joist requires judgment. The depth must be sufficient not only to resist stresses but also to prevent excessive deflection. The remarks made in connection with hollow tile floors apply equally here.

If shearing unit stresses are larger than allowed for concrete, either stirrups should be used or the width of the joist should be

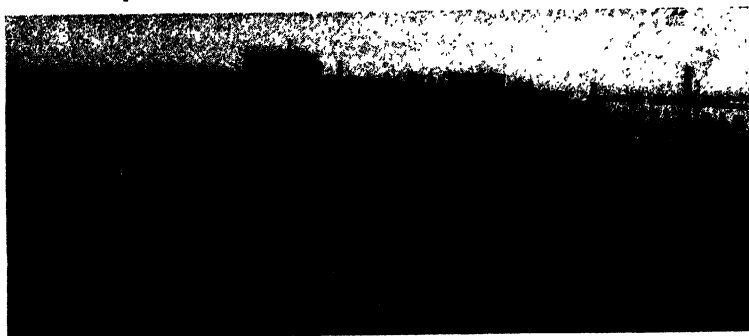

FIG. 197.—Metal Tiles in Place, Apartment de Luxe, Washington. (See p. 605.)

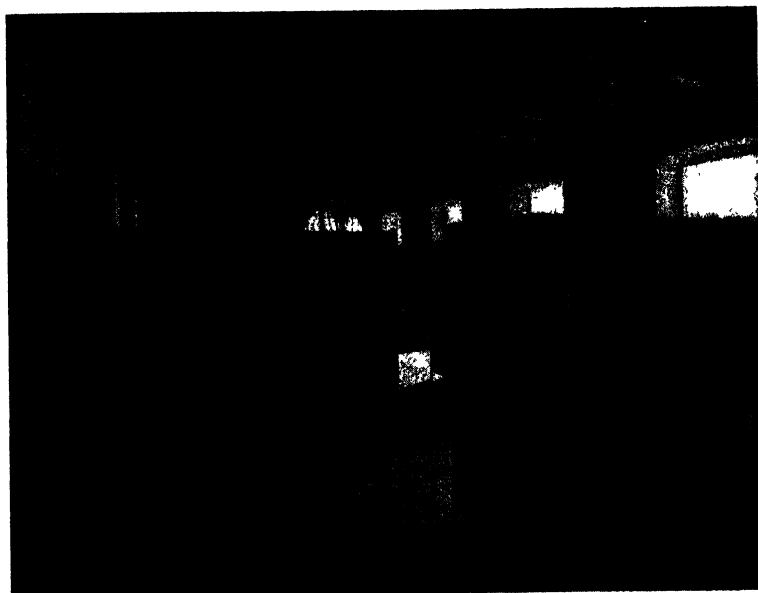

FIG. 198.—Ceiling in Penn Charter Gymnasium. (See p. 605.)

increased by the use of tapered tiles. The bent bars in continuous joists are seldom available for diagonal tension reinforcement, because, to be effective as negative bending moment reinforcement, the bent portion must be some distance from the points of maximum shear.

In continuous joists, compression stresses at the support must be provided for. To reduce compression stresses in concrete, either compression steel may be used or the width of the joists may be increased by the use of tapered tiles. In this connection, refer to p. 594, where the same subject is treated for hollow tile floors. Points of inflection should be computed as explained on p. 595.

Reinforcement for the joists should consist of bars of small diameter, else the bond stresses will be excessive. The bars should be placed at least one inch in the clear from the edge of the joist. Not more than two bars should be placed in a joist 5 in. wide. Bars should be held securely in place. In all respects, the design should comply with the requirements given for hollow tile joists on p. 594.

**Design of Topping.**—The topping, i.e., the thin concrete slab between the joists, serves two purposes: first, to carry the load placed thereon to the supporting joist; and second, to act as compression flange for the joists. For all practical purposes, the topping is a concrete slab restrained at both supports (i.e., at joists), and carrying the load on a span equal to the distance between the edges of the joists plus the thickness of the topping. Since it is not practicable to reinforce the thin slab for negative bending moment, to prevent cracking, the thickness of the slab should be such that the tensile stresses in the concrete, due to negative bending moment, will not exceed the safe value for plain concrete. (For 2 000-lb. concrete this is 40 lb. per sq. in.) The minimum thickness of the topping should be 2 in., exclusive of the finish. For a width of core of 20 in., this thickness is good for a live load up to 150 lb. per sq. in. For larger live loads, the thickness of the topping should be increased. For larger spans, the safe load is proportionally smaller. In many designs, the bending stresses in the topping are disregarded, and the concrete is subjected to considerable tension. The same disregard is found in tables prepared by some manufacturers of steel tiles. For instance, in one table, a live load of 666 lb. per sq. ft. is recommended for joist construction with a 2-in. topping, although this load would destroy the thin slab.

The topping acts also as a flange for the joists, and its thickness must be sufficient to resist the compression stresses developed by

the bending moments in the joists. For deep joists of long span, the thickness of topping may have to be increased to keep the compression stresses within working limits.

From the above, it is evident that the topping is a vital part of the construction, and that it is of importance to prevent its separation from the joist. Therefore, shrinkage stresses and temperature stresses must be resisted by reinforcement placed at right angles to the direction of the joist. This may consist either of small bars or of wire mesh. The cross-sectional area of the steel parallel to the joist should not be less than 0.2 per cent of the cross section of the topping for cases where steel tiles are left in the construction and the ceiling is plastered. When the under side of the topping is exposed, at least 0.3 per cent of temperature steel should be used.

In competitive designs, a small amount of temperature steel is used, such as  $\frac{1}{4}$ -in. bars 12 to 18 in. on centers. This practice produces structures having a much lower factor of safety than required in other types of reinforced concrete construction. The small saving thus obtained is out of proportion to the harm done to the strength of the floor.

When granolithic finish is used, it should not be considered as a part of the topping.

**Concentrated Loads.**—The steel tile floor is not well adapted for concentrated moving loads. A concentrated load applied on the thin slab would overstress the concrete in bending. Another disadvantage is that each joist would have to be designed to carry the full concentrated load, as the thin topping is not capable of bringing the adjoining joists into action. For this reason, steel tile floors should not be used for concentrated moving loads.

When the position of a fixed concentrated load is known, the joist under the concentration should be strengthened. For instance, under partitions, double joists are often used. When the concentrated load comes between the joists, the topping should be made thick enough to carry the load and should have the proper amount of reinforcement. If the position of the concentrated loads cannot be fixed in advance, or if there is a likelihood of its being shifted, it is best to use other types of construction better adapted for concentrated loads.

**Construction.**—Since the slab is thin and the ribs narrow, particular care should be given to the pouring of the concrete and the placing of the steel.

**Topping Must be Poured Monolithic with the Joists Below.—**

The number of construction joints should be as small as possible. If it is necessary to place a construction joint at right angles to the joist, it should be placed in the center of the span. Construction joints parallel to the joist, when unavoidable, should be placed midway between the joists.

To fill properly the spaces between the bars in the narrow joists, the concrete should be composed of coarse aggregate passing through  $\frac{3}{4}$ -in. mesh. Large stones may bridge in the forms and cause pockets. It is particularly important to force the concrete below the reinforcing bars in the joists. Puddling during placing of concrete is advisable.

The steel tiles must be removed with care, so as not to injure the thin topping and the edges of the joists.

**Examples of Steel Tile Floor Construction.—**An example of the use of the steel tile floor construction is shown in the designs of the hospital building on page 807. Another example is the design of the building for Barnes Foundation, shown on p. 630.

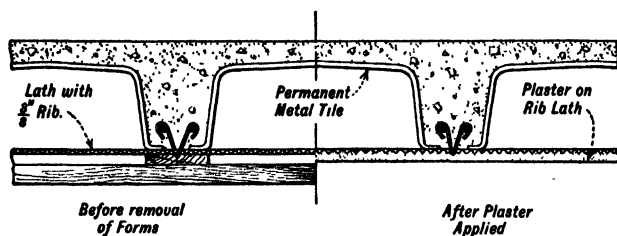

FIG. 199.—Method of Forming Flat Ceiling when Permanent Metal Tiles are Used. (See p. 610.)

**Flat Ceiling.—**In construction with metal tile floor, a flat ceiling is obtained by attaching metal lath to the concrete and plastering the lath with three coats of plaster.

When permanent tiles are used, metal lath is laid on the top of the wood forms before the metal tiles are placed. (See Fig. 199.) The tiles and the reinforcement are then placed, and the lath securely wired to the reinforcement of the joist. The concrete, when poured, engages the meshes of the metal lath; but this bond should not be relied upon to carry the plaster and should not be considered as replacing proper wiring of the lath to the reinforcement. After the forms are removed, the ceiling is ready for plastering.

The strength of lath for the ceiling should be sufficient to carry the plaster without undue deflection on a span equal to the spacing. The weight of the plaster, for ordinary three-coat work without ornamentation, amounts to 10 lb. per sq. ft. To avoid the use of furring channels, special types of lath with raised ribs are on the market. They are sold under various trade names, such as Herringbone Lath, Hy-Rib, Riplex, and others. Their common property is that the expanded metal sheets are stiffened by rigid integral ribs running longitudinally with the sheets. The height of these ribs varies, depending upon the different uses to which they are put. For ceilings, the height of the ribs is usually  $\frac{3}{8}$  in. The thickness of material varies with the span between the joists. The gage of metal required for spans used in common practice is: for spans up to 24 in., No. 28 gage; for spans between 24 and 27 in., No. 26 gage; for spans up to 32 in., No. 24 gage.

The rib of the metal lath should be placed against the support, and the mesh away from it. With this arrangement, the mesh offers a flat surface for plastering. The ribs are placed at right angles to the joists. Each rib should be anchored to the concrete.

When removable tiles are used, the wire lath must be attached under the joists after the forms are removed. For this purpose, wire hangers, provided on one end with a hook, are installed in the concrete. After the metal tiles are in place, the wire hangers are pushed through special holes, which are provided for the purpose in the tiles, either on the top or at the sides, and placed so that the hook becomes imbedded in the concrete. After the metal tiles are removed, furring rods or channels, spaced proper distances apart, are suspended from the hangers and metal lath attached to them. With the rib lath described above, furring bars or channels may be dispensed with.

If it is desired to have the ceiling some distance below the joists, suspended ceiling, as described on p. 613, should be used.

#### COMBINATION OF STRUCTURAL STEEL AND CONCRETE

A structural steel frame for beams, girders, and columns may be preferable to reinforced concrete for certain structures, such as city office buildings, simply for the reason that if the steel is fabricated in advance the buildings can be erected more rapidly although at higher cost.



In structural steel buildings, slabs between beams are usually built of concrete. The design of a panel with steel beams and girders is shown in Fig. 200. Concrete slabs are reinforced in the direction perpendicular to the beams. The main slab reinforcement should be run over the top of the beams and near the upper surface of the slab so as to make the slabs continuous. Transverse temperature steel is used, as recommended in connection with concrete slabs. Often, wire fabric or expanded metal are used for slab reinforcement.

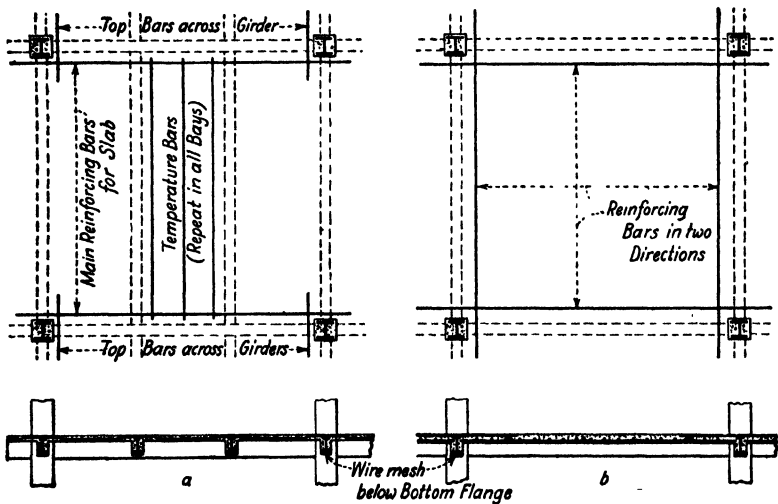

FIG. 200.—Typical Panel with Steel Beams and Girders and Concrete Slab.  
(See p. 612.)

Note: Main Reinforcement shown schematically by outside bars only. For typical arrangement see p. 210.

The cross section through slab and steel beams is shown in Fig. 200a. In such construction, the steel beams and girders are designed separately as plain steel sections, as, due to lack of bond, no allowance can be made for strengthening effect of concrete. The slab is designed according to the principles of reinforced concrete. New York City, however, allows special empirical rules for design of cinder concrete slabs supported by steel beams.

If the panel is square, or nearly so, the steel beams may be placed on four sides, as in Fig. 200b above, and the slab is then reinforced by bars running in two directions, or by an adaptation of the Smulski System consisting of radials and circles as shown in Fig. 128, p. 369.

The slab between beams also may consist of two-way tile and concrete floor as shown in Fig. 201, p. 613.

Floors may consist of a combination of steel girders and reinforced concrete beams and slabs, in which case proper seats in the steel frame are provided for the concrete beams.

The slab between steel beams is sometimes constructed in the form of a concrete arch. If not reinforced, the beam should be connected with tie-rods, to resist any possible unbalanced thrust. For arches with curved upper surfaces, a fill of cinders or a very lean concrete is used for leveling.

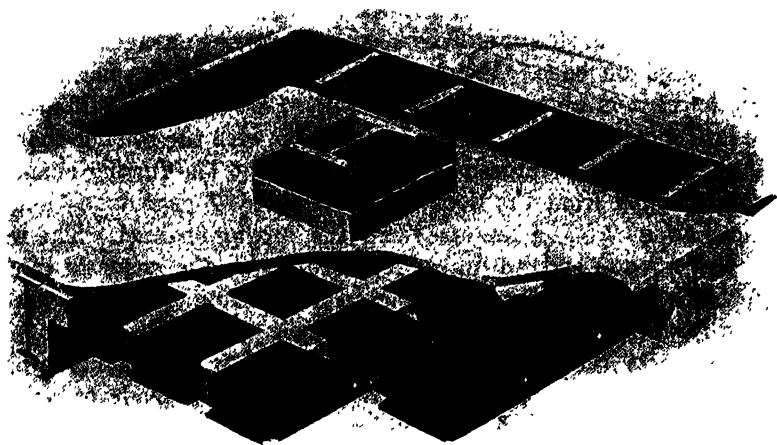

FIG. 201.—Details of Two-way Hollow Tile Floor Slab and Structural Steel Column Fireproofing. (See p. 613.)

### SUSPENDED CEILING

The term "Suspended Ceiling" is used when the plaster ceiling is more than 6 in. below the supporting floor construction. Its construction differs from the plaster ceiling directly attached to the floor construction, such as shown in Fig. 201, p. 613. Suspended ceilings are used:

- (1) To provide flat ceiling in case of beam and girder or joist construction in which case it is placed below the deepest beam.
- (2) To provide ornamental ceiling.
- (3) To lower a part of the ceiling.
- (4) To provide air space below the roof construction for prevention of condensation.

The suspended ceiling consists of plaster applied on metal lath which is suspended from the floor construction. The lath should be lapped both longitudinally and laterally so as to present a continuous lathed surface. To get proper rigidity and strength the lath must be strengthened by furring as described below. All furring and its supports and hangers must be strong enough to carry a load of at least 12 lb. per sq. ft. without undue deflection. The plaster will not crack for deflection up to  $\frac{1}{320}$  of the span of the furring. For ornamental ceilings, specially where false beams are used, the weight may exceed 12 lb. per sq. ft., for which proper allowance should be made in design of the furring and hangers.

The simplest design of suspended ceiling consists of lath, provided with longitudinal ribs or stiffeners, wired to furring channels, angles or flats placed on edge. Usually  $\frac{3}{4}$ -in. furring channels spaced about 2 ft. on centers give satisfactory results. Each rib or stiffener of the lath must be wired at each intersection with the furring channel using a 16 gage galvanized or annealed wire. The furring channels are suspended from the floor construction by 7 gage wire hangers spaced about 2 ft. on centers along the furring channel. The wire hangers on one end are imbedded securely in the concrete of the floor construction before the concrete is deposited. The free end is securely wound around the furring channel.

To insert the hangers, holes are drilled in the forms proper distances apart through which part of the wire is made to project the required length outside of the form. The end to be imbedded in concrete is preferably looped around the reinforcement of the floor construction.

When the lath is not stiffened, furring rods  $\frac{3}{8}$  in. diameter spaced 12 in. on centers should be placed across the furring channels and attached to them at each intersection. The lath is then wired to the furring bars.

Where it is not desirable to use the large number of hangers required by the previously described method, following method may be used: The lath is attached to the  $\frac{3}{4}$ -in. channels as in the previous case. These, however, instead of being suspended from the floor construction, are wired to from  $1\frac{1}{2}$  to 2 in. channels spaced about 3 ft. on centers and suspended from the floor construction by  $\frac{1}{4}$ -in. hangers. The spacing of hangers along the channel is about 4 ft. on centers.

Where wire hangers are not provided ahead of time, holes are

drilled in the concrete ceiling and expansion bolts are inserted. If the floor construction consists of hollow clay tiles, toggle bolts should be used to hold the hangers. Care should be taken that the load concentrated at each hanger is not large enough to break the tile.

Suspended ceilings are shown in Fig. 202, p. 616. Simple ceiling as well as more complicated designs are shown. The construction of false beams is also shown.

If more rigid construction is required, the wire hangers may be replaced by flat steel hangers which are ordinarily 1 in. wide and  $\frac{1}{8}$  or  $\frac{3}{8}$  in. thick. The hangers are provided with holes for  $\frac{3}{8}$ -in. diameter bolts to be used for securing them to the furring channels. Special design of the supporting members must be made when the suspended ceiling is unusual in any respect either on account of the weight of the ornamentation or because the spacing of the supporting members is large. Ordinary principles of design should then be employed.

#### INSERTS FOR ATTACHING SHAFTING AND SPRINKLERS

When it is desired to suspend shafting or sprinkler systems from the ceiling it is best to make provision for it by imbedding in concrete special inserts spaced proper distances apart.

Inserts may be of the threaded type where the bolts are screwed into the threads in the body of the inserts. Such inserts may be used only where no great accuracy in placing is required. To take care of any misplacement of the inserts during construction, special adjustable slotted inserts are used, in which the bolt may be moved several inches and thereby adjustment can be made.

In cases where it is not possible to fix the position of the shafting ahead of time, continuous inserts are used. These may be of any desired length and may even extend the full length of the building. With sufficient number of parallel rows of continuous inserts, shafting may be placed in any desired location.

The inserts must be attached firmly enough to the forms, so that no misplacement can take place during concreting. The simplest method is by nailing them to the forms with two or three nails. To facilitate this, many inserts have special projecting lugs for the nails. To save the labor of cutting the projecting nails after the forms are stripped, special means of attaching are developed. In some inserts a tight fitting wood block is placed within the slot of the insert. This

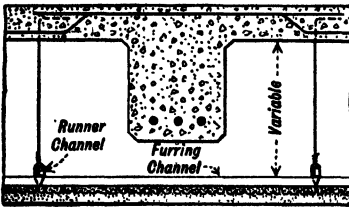

*Ceiling Suspended below  
Beam from Concrete Slab*

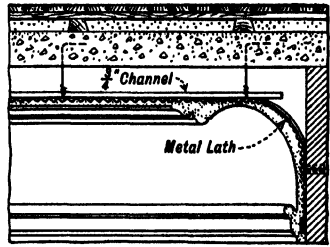

*Ceiling Suspended from  
Concrete Slab*

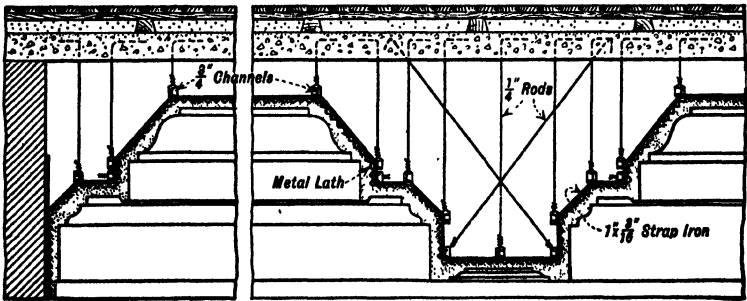

*False Beam and Cornice Suspended  
from Concrete Slab*

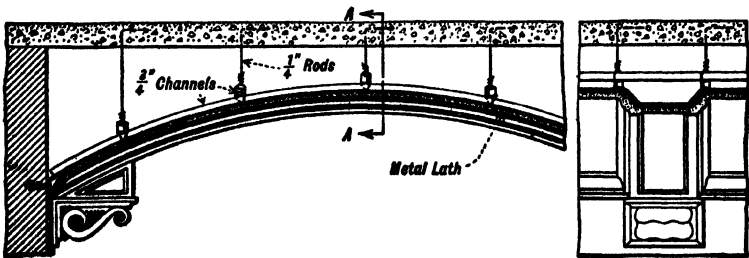

*Vaulted Ceiling Suspended  
from Concrete Slab*

*Section A-A*

**FIG. 202.**—Examples of Suspended Ceilings. (See p. 613.)

block is provided with nails or screws which are fastened to the form. After the forms are stripped, the wood block is pulled out of the insert within the nail.

There is considerable difficulty in attaching inserts to steel forms.

An adjustable insert and a continuous insert are shown in Fig. 203, below.

When no provision is made for attaching the shafting, small holes may be drilled in the ceiling for expansion bolts.

Where considerable load is to be supported through-bolts may be required extending all through the slab. In such case sleeves of proper diameter should be imbedded in the concrete to receive the

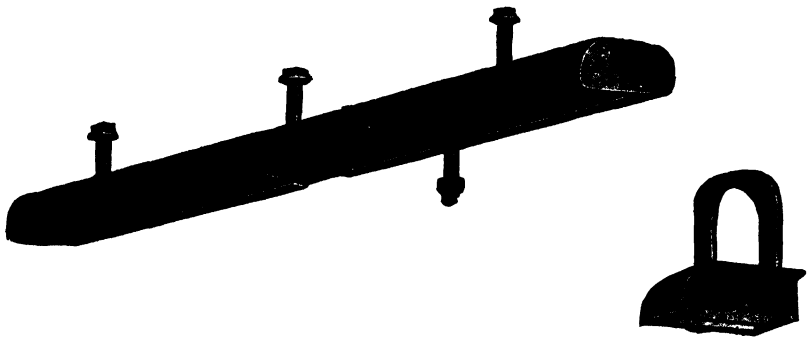

FIG. 203.—Inserts Used in Concrete Construction. (See p. 617.)

bolts. To prevent concrete flowing into the sleeves during concreting, they may be filled with sand. Very often through-bolts for attaching shafting are placed across beams. The hole for these through-bolts is also obtained by imbedding a sleeve in the beam.

The inserts should be of such design that they would not pull out from the concrete under the load of the suspending shafting or sprinkler system. In the inserts shown in Fig. 203 the loop in the individual insert extends some distance into the concrete while in the continuous insert the bolts extend into the concrete and serve as anchors.

**Protecting Exposed Corners.**—Exposed corners of concrete columns or curbs should be protected by steel angles of proper dimensions. These angles must be anchored into the concrete by means of bolts. There are specially constructed curb bars on the market which are provided with projecting anchors integral with the bars.

### BASEMENT AND GROUND FLOOR SLABS

This discussion applies to the basement floor slabs and to the first floor slabs in buildings without basement.

The basement floor may rest directly on and be supported by the ground, in which case it may be built of plain concrete or reinforced with temperature steel only. If the ground is not firm enough to carry the slab load, reinforced concrete floor must be used.

If the basement slab is subjected to upward water pressure, it must be designed for the upward pressure.

**Basement Floor Supported by the Ground.**—The integrity of the slab resting upon the ground depends upon the firmness of the subgrade and upon its uniformity. For this reason, the subgrade must be carefully prepared. All soft and spongy places must be removed, and the subgrade compacted by tamping. If the grade of the slab is above natural grade, the ground must be filled in with hard material. The use of soft material, trash, vegetable matter, and other perishable material is prohibited.

It is important to have the subgrade of uniform firmness, else the slab may settle unevenly and crack. If the subgrade is of sand or gravel, the basement slab may be laid directly upon it. A subgrade consisting of clay requires a subbase consisting of hard materials, such as gravel or clean, well-screened cinders. The subbase should be properly tamped and wetted before the concrete is laid. The wetting is helpful in compacting the subbase, but its main purpose is to prevent the absorption by the dry subgrade of water from the concrete. For this reason, the subbase or the subgrade, if a subbase is not used, should be wet at the time the concrete is placed upon it.

**Plain Concrete Slab.**—The basement slab may be built of plain concrete. To prevent cracking due to shrinkage and temperature changes, the floor should be divided into sections of not more than 100 sq. ft. To prevent buckling and heaving of the slab in case of expansion, it is advisable to provide elastic joints at the wall and at the column. In slabs subjected to heavy truck traffic, the joints should be rounded to prevent their being clipped off.

**Basement Slab with Temperature Steel.**—If it is desired to limit the number of joints the slab should be reinforced with temperature reinforcement placed in two directions at right angles. Reinforcement should also be used in all cases where it is not possible to get firm and uniform subgrade. The reinforcement then prevents cracks due to

bending, which occurs when a section of the subgrade yields more than the rest.

The amount of reinforcement will depend upon the distance between expansion joints in the slab, upon the expected variation in temperature, and finally upon the load to be carried by the slab. The minimum reinforcement should consist of  $\frac{1}{4}$ -in. round bars 12 in. on centers (or their equivalent). Wire mesh or expanded metal may be used to advantage. The reinforcement should be placed 2 in. above the bottom of the slab, and should be properly lapped. The reinforcement must not cross the expansion joints; otherwise, the slab would not be free to move at the joints and their purpose would be frustrated.

**Thickness of Basement Slab.**—Basement slab should be at least 4 in. thick, including the wearing surface.

Best results are obtained by using concrete of 1 : 2 : 4 mix for the base of the slab. The granolithic finish on the top should be of the same composition and should be laid in the same manner, as explained on p. 620 in connection with granolithic finish for reinforced concrete work.

In many instances, granolithic floor finish is not required, and the basement slab is built for the full thickness of the same concrete. After the concrete is brought to the required grade, it is leveled off by a strike board and then floated and compacted with a wood float.

**Basement Floor Supported by Columns.**—If it is not possible to get subgrade firm enough to support the load, the basement slab is supported on columns and designed in the same way as other suspended floors. The cost of the slab may be reduced by using intermediate short columns under the basement slab. For instance, in a 20 by 20 ft. span, intermediate columns placed in the center of the panel and halfway between the columns reduce the span of the slab to 10 ft. Of course, the use of intermediate short columns is economical only when foundation for them can be obtained without difficulty and at reasonable depth. Before deciding upon the type of construction, the saving due to reduction of span should be compared with the cost of the additional column and foundation. Intermediate columns reduce the load on the main foundation. This should be considered when making comparison.

**Basement Slab Subjected to Water Pressure.**—When the basement slab is subjected to upward water pressure, it should be reinforced to withstand the difference between the upward water pres-



sure at high water and the weight of the slab. The live load in the slab cannot be considered as contributing toward the balancing of the water pressure, because it is not always in place.

The bending moments due to water pressure are of opposite sign to those produced by downward load. Thus, at the column, the bending moment is positive and requires steel near the bottom, while between columns it is negative and requires steel near the top.

The construction of the basement slab to resist the upward pressure will depend upon conditions, such as the amount of pressure and the distance of the footings from the level of the slab. If the footings are some distance below the slab, they cannot be used to support the basement slab. The construction then must be tied to the columns. Flat slab construction will be cheapest if the spans permit, as it requires no formwork. For long spans, beams and girders may have to be used.

If the columns are reasonably near the surface, the beams and girders may be attached to the footings. They must be secured by reinforcement against uplift.

Sometimes it is necessary to design the basement slab for upward water pressure as well as for downward live load. The downward load to be used in design is the difference between the total live and dead load and the water pressure at low water.

## FLOOR SURFACES

In reinforced concrete buildings the surface finish of the floors depends upon conditions and also upon the use to which the building is subjected. Obviously, for example, different finish will be required for a hotel than for a warehouse. Also different portions of the same structure may require different finish.

### GRANOLITHIC FINISH

A common and durable floor finish for concrete and reinforced concrete floors is the granolithic finish. This consists of specially proportioned and specially applied concrete.

Two mixtures for granolithic finish are now in common use, namely:

1. Mixture composed of one bag of Portland cement, and 2 cu. ft. of fine aggregate such as very coarse sand.
2. Mixture composed of one bag of Portland cement, 1 cu. ft. of fine aggregate such as coarse sand and 1 cu. ft. of still coarser aggre-

gate consisting of clean, hard, crushed rock or pebbles. For still harder surface where appearance is of minor importance use one bag of cement,  $\frac{1}{2}$  cu. ft. coarse sand and  $1\frac{1}{2}$  cu. ft. coarser aggregate. The size of the coarser aggregate should be such that it will pass when dry a screen having  $\frac{3}{8}$ -in. openings and not more than 10 per cent will pass a screen having four meshes per lineal inch.

The last named mixture gives harder floor finish and should be used where the floor is subjected to considerable wear, such as trucking. It is harder to trowel and cannot be brought to so smooth a surface. It was designed originally by The Thompson and Lichtner Co. as a result of an extended series of tests with different compositions of material.

**Thickness of Granolithic Finish.**—The thickness of granolithic finish depends upon conditions. It should not be less than  $\frac{3}{4}$  in. for integral finish, which is laid before the concrete of the structural slab is set, nor less than 1 in. for bonded finish, laid after the concrete slab has hardened. Where subjected to severe wear, an increase in thickness is advised. Thicknesses of 1 in. for integral and  $1\frac{1}{2}$  in. for bonded are common practice.

The "integral finish," considered by itself is about one third cheaper than the "bonded finish," due chiefly to the reduction in the amount of materials and saving in the cost of preparing base for "bonded finish." Another advantage of integral finish is, that there is no question of bond involved between the slab and the finish.

In spite of these advantages the "bonded finish" is often preferred for the following reasons: The "integral finish" must be applied before the concrete of the structural slab has set. Thus the finishing gang must work overtime in order to finish all the floor placed on that day. This adds to the cost especially where extra rates must be paid for overtime. Second, to avoid injury to the finish, the use of the floor for further construction work must be delayed. Third, when placing forms for upper floors it is not possible, even with proper precautions, to prevent entirely damage and scratching of the finish. Fourth, in inclement weather the finish is exposed to the action of the rain and frost, unless particular precautions are taken. Fifth, there is always danger that through carelessness or design, the "integral finish" in part of the building at least will not be applied until the slab has hardened. All these items tend to reduce the economy of the "integral method."

The "bonded finish" has these advantages. It is usually applied

after the building is completed and closed in. It may be applied at any time and at any desired speed. The fresh finish does not need to be exposed to use until it has hardened sufficiently. No special protection for "bonded finish" is required as the building is closed in.

The most serious objection to "bonded finish" is, that if not properly bonded to the base, the granolithic may peel off. However, if applied in the manner recommended in the Specifications for Granolithic Finish in Volume III, satisfactory results will be obtained. It must be emphasized, that granolithic finish should be applied by skillful men, as poor workmanship, especially when coupled with poor selection of materials, is usually the cause of trouble with granolithic finish.

Also special emphasis should be placed on the requirement in the specification just referred to that all laitance and loose material should be removed, that the slab be thoroughly roughened and wetted, and finally that the surface be coated with neat cement paste just before placing the finish. It is more economical to remove the laitance and roughen the slab before the concrete becomes thoroughly hard. Two other factors are of vital importance, namely: Selection of an aggregate free from dust or very fine particles which rise to the surface with the cement so as to produce a "dusty" surface and the avoidance of a wet, sloppy mix which also prevents a thoroughly hard, dense surface.

**Advantages of Granolithic Finish.**—Floors with granolithic finish are sanitary. They may be easily cleaned by a hose. To facilitate this the floors are pitched to drain through scuppers. The pitch is usually  $\frac{1}{2}$  in. to the foot.

Granolithic finish is durable. If properly built it will resist severe wear, such as trucking for an indefinite period.

**Disadvantages of Granolithic Finish.**—Often granolithic finish is objected to by the users on account of larger conductivity of heat. This objection is gradually disappearing for floors above ground as it was largely psychological. If a building is heated uniformly the floor slab also maintains a uniform temperature. The objection is often removed by oiling or painting the floors, thus relieving the cold appearing color of concrete.

Granolithic is less resilient than wood. Work places for women required to stand all day should be covered with some material such as linoleum or rubber. For offices, also, a covering of this character is generally employed.

**Coloring of Granolithic Finish.**—Granolithic finish may be colored by mixing with the dry material for the concrete, in the entire finish, a proper amount, to be determined by trial, of mineral pigments. The materials should be mixed dry and thorough mixing is essential. As the admixture of coloring matter reduces somewhat the strength of the concrete, it should be limited usually to 5 per cent by weight of the cement. For description of coloring materials, see Volume III.

**Painting of Floors.**—Concrete floors may be painted to any desired color. If proper paint is used and is properly applied, it is as permanent as on wood floors. Naturally it wears out under foot traffic. Floors should not be painted where they are subjected to heavy wear. In such case the integral coloring is preferable.

**Directions for Laying Granolithic Finish.**—Complete directions for laying granolithic finish is given in Volume III of this treatise.

#### TERRAZO FLOOR FINISH

“Terrazo” is another type of cement finish. It consists of irregular marble or granite chips imbedded in cement mortar and ground to a smooth even surface. The finish is usually  $1\frac{3}{4}$  to  $2\frac{1}{4}$  in. thick and is applied in two layers. The first layer, or binder course, consists of 1 : 3 cement and sand mortar and is about 1 to  $1\frac{1}{2}$  in. thick. After the binder course is placed, tamped and leveled off, the finishing course is applied. This is composed of cement and stone chips, in proportions about 1 to 3 which are spread evenly over the whole surface and rolled. After this, additional chips are spread over the surface and rolled in.

The finishing course is allowed to harden for about 24 hours. Then the surface is ground by rotary rubbing machine. Small surfaces may be rubbed by hand. Carborundum brick is used for rubbing both by machine and by hand.

The color of terrazo finish depends upon the color of the chips. By proper selection of the material various color effects may be obtained.

Terrazo finish may be applied on green concrete slab or after the concrete has hardened. In the latter case, the base should be prepared as for granolithic finish by roughening, cleaning and wetting of the surface. Before the first course is placed the surface should be wet and then covered with neat cement paste as described for granolithic finish.

Method of placing terrazo finish is fully described in Volume III of this treatise.

## WOOD FLOOR FINISH

Wood floor surfaces are often used for residences, apartment houses, offices and hospitals; less often for factories and seldom for warehouses. The top flooring usually consists of hardwood such as oak or maple. Beech and birch also are sometimes used especially in combination with maple, which they resemble in appearance and wearing qualities.

Oak flooring is used in residences and more expensive buildings only. It may be either plain sawed or quartered. Plain sawed boards are obtained by sawing the whole log in parallel layers. Quartered oak is obtained by sawing the log parallel to the diagonal line in each quarter.

Maple flooring, sometimes mixed with other hardwood, is used in other types of buildings.

**Component Parts of Wood Flooring.**—Wood flooring consists of hardwood top boards, and wood sleepers and cinder concrete fill. Where heavy flooring is required, intermediate flooring, consisting of thin boards or heavy plank, is used.

**Dimensions of Hardwood Boards.**—The boards may be either 3 or 4 in. wide. The 3-in. boards give better results than the 4-in. width, but the advantages gained are not worth the extra expense. The thickness of boards depends upon the use of the building. Flooring nominally 1 in. thick is most commonly used. Sometimes, when the flooring is exposed to hard usage, the nominal thickness is increased to  $1\frac{1}{4}$  in. The actual finished thickness is about  $\frac{3}{8}$  in. smaller than the nominal dimensions.

The boards are usually tongue and groved and blind nailed.

**Wood Sleepers.**—The wood sleepers are usually spruce and their nominal cross section is 2 by 4 in. They are dressed on top and bottom and leveled on both edges so that the width on the top is reduced to 3 in. To prevent the sleepers from rotting when imbedded in concrete they should be creosoted or kyanized.

**Intermediate Flooring.**—Intermediate Flooring usually consists of 1 by 6 or 1 by 8 (nominal dimensions) spruce boards, surfaced on both sides.

Heavy planks, ordinarily used for intermediate floors, are spruce. They are commonly 2 by 6 in. or 2 by 8 in. nominal dimensions surfaced on both sides.

The life of the floor is increased if the boards are creosoted or kyanized.

**Description of Wood Flooring on Sleepers.**—Wood flooring may be divided into one-layer flooring and two-layer flooring.

**One-layer Flooring.**—One-layer flooring is satisfactory for light usage only. It consists of hardwood top nailed directly to 2 by 4 in. leveled sleepers. These are spaced 16 in. on centers and are imbedded in 2 in. thickness of cinder concrete.

A ply of rosin-sized building paper is laid underneath the hardwood flooring.

**Two-layer Flooring.**—Two-layer flooring consists of hardwood top, intermediate creosoted softwood flooring placed diagonally and 2 by 4 in. leveled sleepers imbedded in 2 in. thickness of cinder concrete. A ply of rosin-sized building paper is laid between the hardwood and the intermediate flooring. The sleepers are spaced 16 in. on centers.

A modification of the two-layer flooring consists of hardwood top placed diagonally 2 in. creosoted planks, which are secured to 2 by 4 in. leveled sleepers imbedded in 2 in. thickness of cinder concrete. The heavy plank permits an increase of the spacing of sleepers to 20 in. This type of flooring may be used for heavy trucking.

**Sleepers Imbedded in Concrete of the Slab.**—To reduce the cost of the flooring, the sleepers are sometimes imbedded in the concrete of the slab. This method, although it does away with the cinder concrete, and thereby reduces the dead load and the cost is not satisfactory for the following reasons: There is danger of injuring the concrete slab while imbedding the sleepers in partly set concrete. It is difficult to keep the screeds at proper level. The floor is apt to have a hollow sound.

**Laying Hardwood Floor on Sleepers.**—The hardwood floor may be laid as follows: The top of the supporting slab should be lower than the finished floor by the thickness of the screeds and flooring plus  $\frac{1}{2}$  in.

Sleepers are laid first. They are held a proper distance apart by temporary 1"  $\times$  6" boards placed on edge at right angles to the sleepers, and about 4 ft. apart. After the sleepers are leveled and wedged up in low places, the space between them is filled with cinder concrete mixed in proportion 1 : 3 : 5. This should be carefully packed under and around the sleepers. To prevent sleepers from becoming loose in case the concrete should shrink away, heavy nails are driven into them sideways. These become imbedded in concrete and assist in keeping the sleepers in position. The cinder concrete should extend to within  $\frac{3}{8}$  in. from the top of the sleepers.

After the cinder concrete has hardened, the sleepers are leveled and any irregularity removed. The flooring should not be placed until the concrete has dried sufficiently.

**Hardwood Floor on Tar Base.**—This flooring consists of hardwood top resting on plank under flooring, which is imbedded in hot mixture of tar and sand. To prevent warping of the planks such flooring is often built with a diagonal intermediate floor placed between the planks and the hardwood top.

The thickness and quality of the hardwood top and of the intermediate flooring are the same as described on page 624 in connection with other types of hardwood flooring. The planks for the underflooring are of spruce,  $1\frac{5}{8}$  in. thick, surfaced on both sides.

The layer of tar and sand is usually at least 1 in. thick. The planks are laid on the soft mixture about  $\frac{1}{4}$  in. apart and settled by hammering until stable bearing is obtained. After the planks are leveled they are edge-nailed together with 12d. common nails spaced 12 in. apart.

**Wood Block Floors.**—Wood block floors consist of blocks from 2 to 3 in. thick laid in coal tar pitch on the concrete base. The blocks are made of natural redwood or of creosoted leaf and hard pine.

Because of its wearing qualities the wood block floor is often used for special trucking aisles or spaces subject to heavy trucking in connection with floors elsewhere finished otherwise. The advantages of the wood block floor are exceptional durability under severe trucking and wearing conditions, resiliency, dustlessness, noiselessness and ease of cleaning. It is less slippery, either wet or dry, than most other surfaces.

The following method of placing wood blocks is recommended by Mr. MacMillan.<sup>5</sup>

The top of the concrete foundation shall be brought to a true, smooth and even finish exactly the depth below the finished floor level corresponding to the depth of the block to be used. This shall be accomplished by applying a mortar finish with a long handle wooden float or similar device. Care shall be taken to see that there are no projections in the concrete that will form an uneven bearing for the blocks.

After the concrete has thoroughly dried out, it is swept clean and given a thin, even coating of coal tar pitch, not exceeding  $\frac{1}{8}$  of an

<sup>5</sup> *Factory Floor Surfaces*, by A. B. MacMillan, Chief Engineer Aberthaw Company.

inch in thickness. The coating shall be allowed to harden before laying the blocks and shall not be applied over 20 ft. in advance of the block laying.

Upon the base, as above prepared, the blocks shall be laid tightly together, with the grain vertical; the courses of the blocks shall be kept straight and parallel, starting from one side of the building and carried through to the other side; all joints shall be broken by a lap of at least 2 in. In truckways, and whenever possible, the blocks shall be laid with their length at right angles with the line of traffic.

After every four rows of blocks shall have been laid in place, a piece of 2 × 4 in. planking shall be laid along the outside edge of the blocks and the courses driven together as tightly as possible. The blocks in each separate row shall also be tightened lengthwise just before the filler is applied, by forcing the blocks together from the ends, with a lever, pick or other instrument.

Against the walls on all sides of the floor, as well as around all columns and other obstructions, a bituminous expansion joint 1 in. in width shall be formed by first laying a wood strip of that width, and after removal filling the space to within an inch of the top with coal tar pitch.

After the blocks have been laid in place and brought to as true and level a surface as possible, the joints between the blocks shall be filled with coal tar pitch (or equal material) applied at a temperature of not less than 350° F. The filler shall be applied by flushing over the surface of the floor, using a rubber-edged squeegee to force it into the joints. Care must be taken to see that the filler penetrates the full depth of the blocks and that the joints are completely filled at the time of application. With proper care, the floor space will be almost free from filler. Dry, sharp sand shall then be swept over the floor completely covering the blocks, and shall be left on the floor until the blocks are well set, if possible for a period of three weeks. Traffic will, during that time, wear off the thin film of filler left on the surface. If any superfluous filler remains after the sand has been swept off and it proves obnoxious, steps may be taken to remove it with any one of the several approved methods.

#### COMPARISON OF FLOOR SURFACES IN CONCRETE BUILDING

A comparison of cost and durability of the various flooring discussed in the previous pages may be had from the table on page 628, taken from Mr. A. B. MacMillan's "Factory Floor Surfaces."



## Floor Surfaces in Concrete Buildings. By A. B. McMillan

Types of Floor Surfaces	Average Life, in Years		Safety (Non-slip Quality)†	First Cost*	Dollars per Square Foot			Annual Cost After Renewal*	Advantages (1) and Disadvantages (2)
	Trucking	Ft. wear			Annual Cost (Foot Traffic)*	Cost of Renewal*	Annual Cost After Renewal*		
Integral Granolithic	10 to 20	25	C	.10	.004	.25	.01	(1) Most economical of all floor surfaces. Longer life. Clean. Easily renewed. (2) Objection of operatives on account of hardness. Possibility of dusting. More difficult to attach machinery. Slippery when wet. Integral granolithic, as compared with bonded, has the advantage of slightly lower first cost and gives absolute assurance of bonding; but has the disadvantage, particularly in multi-story construction, of delaying progress to an extent that much more than offsets the advantage of lower first cost.	
Bonded or "Laid After" Granolithic	10 to 15	25	C	.14	.0056	.20	.008	(1) Cheapest of wood floors. (2) Takes 60 to 90 days longer to finish building than in case of granolithic floor. Moisture due to cinder fill takes 10 to 20 days longer than when tar base is used.	
Hardwood Top, Paper, Screeds and Cinder Concrete Fill	Not suitable	15	B	.30	.02	.18	.012	(1) A low cost wood surface adaptable to some purposes. (2) Not suitable for attaching machinery or for heavy trucking.	
Hardwood Top, Paper, Intermediate Floor, Screeds and Cinder Concrete Fill	Suitable for light trucking	20	B	.36	.018	.18	.09	(1) Adaptable for trucking. Light machinery can be secured to floor without drilling into concrete. (2) Greater weight and higher cost.	
Hardwood Top, Plank, Screeds and Cinder Concrete Fill	6 to 12	20	B	.47	.0235	.18	.009	(1) Omission of cinder concrete saves 10 to 20 days. Saves 2 inches of depth due to screeds. (2) Twisting and warping of plank apt to occur.	
Hardwood Top, Plank and Tar Base	6 to 12	20	B	.40	.02	.18	.009	(1) Twisting and warping of planks prevented. Better foundation for securing machinery. (2) Greater weight and higher cost.	
Hardwood Top, Intermediate Floor, Plank and Tar Base	6 to 12	20	B	.46	.023	.18	.009	(1) Withstands extra hard service. Dustless, resilient, noiseless. (2) Not adaptable for some manufacturing purposes. Dark in color. Shrinkage or swelling of blocks sometimes causes trouble.	
Wood Block Floors	10 to 20	25	A	.34	.0136	.34	.0136	(1) To indicate comparative protection from slippage, are necessarily arbitrary. It should be recognized that any floor will be slippery if oil or grease is allowed to collect and remain on its surface.	

\* All costs as of July, 1924. † A is the highest rating. The ratings, A, B, and C, to indicate comparative protection from slippage, are necessarily arbitrary. It should be recognized that any floor will be slippery if oil or grease is allowed to collect and remain on its surface.

## CHAPTER XI

### WALL-BEARING CONSTRUCTION

In buildings not exceeding three stories in height, the walls may be used to support the reinforced concrete floor construction. The construction is then called wall-bearing construction to distinguish it from the skeleton construction previously described.

The advantage of this type is that the bearing walls dispense with the columns, thus reducing the cost. It has the disadvantage, however, that during construction the speed of erection of floors depends upon the speed in erection of supporting walls. The two parts of the job are usually of different materials and handled by different trades. It often happens that delay in erection of the wall holds up the whole construction. This cannot happen in skeleton construction, where the erection of the complete skeleton is independent of other parts of the job.

The bearing walls are most often of brick, but they may be of concrete blocks, terra cotta blocks, or plain or reinforced concrete.

This type of construction is often used in schoolhouses and hospitals and also in private dwellings. Fig. 204, p. 630, shows a plan of a wall-bearing job.

The building illustrated is one of a group of buildings for the Barnes Foundation designed by Paul P. Cret, Architect, and William H. Gravell, Engineer. It consists of basement, two floors and roof. The floor construction is of the adjustable joist type described on page 605. It is supported by outside and inside brick walls. The details of the floor construction are clearly shown in the figure. Attention is called to the special type of stair construction in which the stair load is carried by beams placed at the edges of the stair slab. They are supported on one end by a floor beam and on the other end by brickwork. The stair slab is designed as spanning between the edge beams.

**Brickwork.**—To serve as bearing wall, the brickwork must be made strong enough to carry the superimposed loads with a proper

factor of safety. The bricks must be hard and must have a crushing strength of single brick on the flat of at least 2 300 lb. per sq. in.

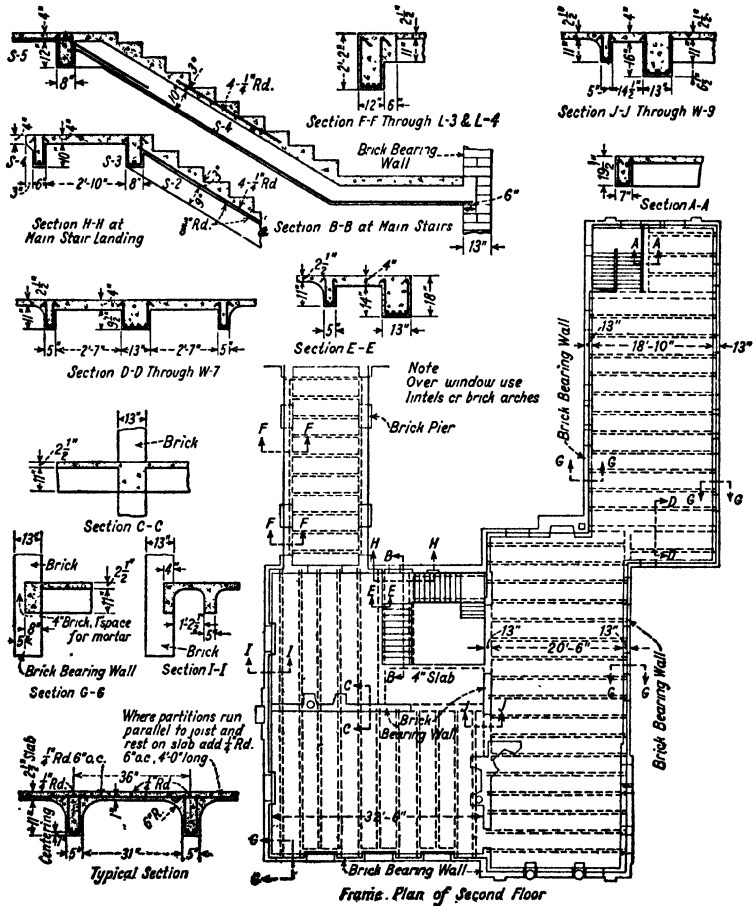

FIG. 204.—Floor Plan and Details of Barnes Foundation Building. (See p. 629.)  
 Paul P. Cret, Architect. William H. Gravell, Engineer.

They should be laid in Portland cement mortar. The brickwork should be properly bonded. It is generally required that one course of headers must follow every five courses of stretchers. Face brick,

if properly bonded to the rest of the brickwork by means of headers, may be considered as part of the thickness of the wall. If the face brick is tied to the wall by metal ties only, it must not be considered as effective in carrying the load.

**Stresses in Brickwork.**—The allowable stresses in brickwork depend upon the hardness of the brick and also upon the strength of the mortar. For supporting concrete construction, Portland cement mortar mixed in proportions as rich as one part cement to three parts sand (1 : 3) should be used for bearing walls.

The following unit stresses may be used:

	Allowable Stresses, lb. per sq. in.
Hard paving brick material (crushing strength of single bricks 5000 lb. per sq. in.) . . . . .	350 lb.
Pressed brick . . . . .	250 lb.
Hard common brick (crushing strength of single bricks 2300 lb. per sq. in.) . . . . .	200 lb.

**Bearing Stresses on Brickwork.**—When the available area of the wall is not less than twice as large as the area of application of a concentrated load, the allowable bearing stresses produced by the load may be equal to 1½ times the stresses recommended above. For smaller ratios between the area of wall and the area of application of the load, the allowable bearing stress may be reduced proportionally.

**Required Thickness of Brick Walls.**—The minimum thickness of the brickwork for outside walls of industrial buildings, warehouses, hotels, office buildings, schools, and hospitals should be as given in the table below:

Height of Building	Base- ment	1st Floor	2nd Floor	3rd Floor	4th Floor	5th Floor	6th Floor
One story . . . . .	12	12					
Two stories . . . . .	16	12*	12				
Three stories . . . . .	16	16	12*	12			
Four stories . . . . .	20	20	16	16	12		
Five stories . . . . .	24	20	20	16	16	16	
Six stories . . . . .	24	20	20	20	16	16	16

\* For schoolhouses use 16-in. wall.

**Limitations.**—The above table is valid for clear story heights up to 18 ft. For story heights from 18 ft. to 24 ft., 16-in. wall should be used instead of 12-in. For story heights from 24 ft. to 30 ft., 20-in. wall should be a minimum. No changes are required in other items of the table. For walls 50 ft. long and under, the thickness of the wall may be decreased by 4 in. the minimum thickness, however, should remain 12 in. The length of the wall should be considered either as the total length or as the length between cross walls.

Walls used as enclosures for staircases, elevator shafts, or other shafts, when their length does not exceed 25 ft., may be built 12 in. thick for upper 50 ft. and 16 in. thick for the remainder of the height of the building.

The thickness of the wall given in the table, or as modified by the above, should be considered as a minimum and should be increased if the stresses on brickwork exceed the allowable working stresses.

**Pilasters.**—For heavy concentrated loads due to girders or trusses, pilasters, buttresses, or piers should be provided. The dimensions of these should be such that the stresses on the brickwork are kept within working limits. In computing stresses, all dead load plus the proportion of live load recommended on p. 453 should be used.

The wall between pilasters may be reduced in thickness by one-half of the difference between the thickness of pilaster and the required thickness of wall without pilasters. The reduced thickness of the wall should not be less than 12 in. for walls less than 30 ft. high and 16 in. for walls over 30 ft.

When the thickness of the wall is reduced on account of the use of pilasters, their width must not be less than one-tenth of their spacing measured center to center.

**Interior Bearing Walls.**—Interior bearing of brick walls used in concrete construction should not be less than 12 in. thick nor less than one-fifteenth of the clear story height. The thickness must be increased when required by stresses. In computing stresses in brickwork, the reduction in live load recommended on p. 453 may be used.

**Construction at the Wall.**—When the ends of concrete beams rest on a brick wall, the bearing stresses should be investigated. If they are larger than the allowable stresses, as given on p. 631, the bearing area should be increased. This may be accomplished in several ways, as described below.

Steel bearing plates or steel shapes may be used to distribute the load on brickwork; the width of the beam may be enlarged; or, if this is not sufficient, projections may be provided on both sides of the beam. Such projections should be of the same depth as the beam, to facilitate the laying of brickwork above the floor.

The thickness of the bearing plates and the dimensions of the concrete projections may be determined by considering the part outside the beam as loaded by the upward reaction of the brickwork and supported at the beam. It may be necessary to reinforce the concrete projections by bars placed near the bottom, parallel to the wall.

A continuous distributing beam running along the wall may be used, especially in case of joist construction. This should preferably be of the same depth as the beams or joists. (See Fig. 204, p. 630.)

A continuous distributing beam may be considered, for designing purposes, as a continuous beam loaded by the upward reactions, and supported by beams or joists. The reinforcement will therefore be required near the bottom at the supported beam, and near the top between the beams. Usually, however, continuous bars are placed near both top and bottom

Where the distributing beam spans an opening, its action is reversed and it serves to carry the loading. Its dimensions will be governed, in this case, by the load and the span.

If possible, the distributing beam should be of the same width as the wall, for the sake of simplifying the construction. When it is not desirable to expose the concrete, the width of the beam is made  $4\frac{1}{2}$  in. smaller than the wall, allowing for brick veneer.

The advantage of the distributing beam is that it ties the construction and in a measure prevents unequal settlement of the brickwork. It is always used in joist construction. The brick is stopped at the bottom of the joists, and for the next story is started on the top of the concrete. This gives a much neater job than if an attempt were made to brick in the spaces between the joists below the slab. The distributing beam should be reinforced with at least four  $\frac{1}{2}$ -in. round bars, two near the top and two near the bottom. Of course, special provision must be made over windows and doors, depending upon the span of the opening and the load to be carried.

**Provision for Negative Bending Moment at the Wall.**—The brickwork placed above the concrete, especially when distributing beams are used, prevents free movement of the concrete construction.

The amount of restraint so produced is problematic and depends upon the amount of brickwork and the load which it carries. It is larger in the lower stories and decreases toward the top. Therefore, it is not advisable to rely on it in computing the beams. To prevent cracks, however, it is advisable to use a certain amount of reinforcement near the top of the beams and also along the distributing beams. One-half of the steel used at the first interior support will be found sufficient in ordinary cases of brick bearing jobs. This amount of steel corresponds to a bending moment for uniform loading equal to  $M = \frac{wl^2}{20}$ . (See also p. 278.)

### CONCRETE WALLS

**Reinforced Concrete Bearing Walls.**—Reinforced concrete may be used for bearing walls. Their thickness may be governed by the stresses, as in concrete columns. If built monolithic with the floor system, they may be exposed to bending and should be reinforced accordingly. Temperature steel should be used. Special reinforcement is required at the corners of the building to prevent the separation of the walls. Where a cross wall and a longitudinal wall are poured together, the horizontal bars of the cross wall should be extended into the longitudinal wall and hooked at the ends to prevent a crack. If it is not desired to have a connection between the walls, they should be poured separately so that they may expand, contract, and settle independently. A recess should be provided in the longitudinal wall; a few dowels may also be used to prevent the opening of cracks between the walls, but their effect should not be sufficient to make the walls cooperate.

Special reinforcement should be used above door and window openings. For wide openings, the necessary amount of reinforcement is found by considering the lintel as a beam. The reinforcement from the lintel should be run a sufficient distance into the wall to prevent a temperature and shrinkage crack at the junction.

The thickness of the concrete bearing wall may be determined by stresses, the ratio of slenderness being taken into account. Some codes specify that the thickness of the concrete wall shall be three-fourths of the thickness required for brick wall.

**Reinforced Concrete Enclosing Walls.**—The enclosing walls are sometimes built of reinforced concrete. When supported on the

framework, they do not need to be more than 6 in. thick, this thickness being sufficient to make the wall weather-proof. The walls should be anchored at all floors and reinforced with bars placed near their outside and inside faces; they should be made strong enough to resist a pressure of 30 lb. per sq. ft. applied either from the outside or from the inside. This pressure represents the wind pressure and any accidental pressure that may be exerted from the inside. Temperature steel is usually sufficient to resist any stresses due to such causes.

Recesses for the walls should be provided in the columns; also bonds or dowels (i.e., short steel bars) above the floor beam and below the spandrel should be used. If walls are used above and below a beam, the same bars may be used for bonds above the floor and below the spandrel. The bonds may consist of  $\frac{3}{8}$ -in. round bars spaced 24 in. on centers. These should be placed so that they come in the center of the wall.

*Temperature Reinforcement for Enclosing Concrete Walls.*—When concrete walls consist of panels between columns which are built separately, the amount of reinforcement given below may be used.

Thickness of Wall	Spacing of $\frac{3}{8}$ in. Round Bars at Each Face	
	Horizontal Bars	Vertical Bars
6 in.	18 in.	24 in.
8 in.	14 in.	24 in.
10 in.	11 in.	24 in.
12 in.	9 in.	24 in.

If walls are monolithic with the columns, at least one-quarter of one per cent of horizontal reinforcement is required to distribute the cracks properly. These should lap at the columns.

*Reinforced Concrete Fireproof Partitions.*—Reinforced concrete may be used for partitions, especially around staircases. The minimum thickness allowed by most building codes for reinforced concrete partitions is  $3\frac{1}{2}$  in. Such partitions are considered fireproof and may be used for enclosing staircases, shafts, and elevator wells. The



authors recommend in preference a thickness of at least 4 in., to give better space for pouring concrete around the reinforcement, with steel bars  $\frac{3}{8}$  in. round placed 12 in. on centers horizontally and 24 in. on centers vertically. The steel should be placed in the center of the wall. Special corner bars should be provided at the corners of the shaft or else the bars from one wall should be bent at right angles and extended into the other wall. The walls should be poured after the floor construction is completed. Bonds consisting of short bars spaced 2 ft. on centers should be provided above the floor and below the ceiling to tie the wall to the floor. Bars may be inserted into the pour hole. Pour holes spaced about 2 ft. on centers should be left in the slab above the wall to pour the concrete, although this is not necessary if the wall is under a beam, in which case holes may be left in the top of the wall forms and spouts arranged to receive the concrete.

Special reinforcement consisting of  $\frac{1}{2}$  or  $\frac{3}{8}$  bars should be provided at the top and sides of door and window openings. Short diagonal bars at the corners may also be used advantageously to prevent cracks.

## CHAPTER XII

### BASEMENT WALLS

Basement walls, that is, walls below grade, in reinforced concrete buildings or in steel buildings, may be thinner when made of reinforced concrete than when made of plain concrete. The principal reinforcement is supplied to resist stresses due to earth pressure. Some additional temperature and shrinkage reinforcement is needed, the amount depending upon the degree to which elimination of shrinkage cracks is desired, and also upon the design. More temperature steel is required for basement walls built monolithic with the column than for walls built separately between previously poured columns.

**Method of Construction.**—The basement wall may be built either monolithic with the basement columns or separately from them. The latter method reduces the cost of wall forms. When the wall is built separately from the columns, proper recesses along the column should be provided. These recesses are formed by nailing, on the inside of the column form, a strip of wood of proper width and thickness. Dowels may be used to tie the wall and column. The joint between the column and the wall may be kept waterproof by inserting in the recess proper plastic waterproofing material.

**Thickness of Wall.**—To be impervious to ground water, the basement wall should be at least 8 in. thick. Ordinarily, a 12-in. wall is used. This dimension may have to be increased if larger depth is required to resist earth pressure.

In ornamental structures, the thickness of the masonry in the first floor is sometimes greater than the required thickness of basement wall. If the difference is small, the greater thickness is adopted for the basement wall. If there is a large difference between the thickness of the masonry above and the basement wall, it may be economical to provide the basement wall at the top with a continuous bracket to carry the masonry. (See Fig. 265, p. 754, and Fig. 290, p. 808.)

**Earth Pressure.**—For a basement wall below grade, the magnitude of earth pressure is determined in the same way as for retaining walls. The unit pressure will depend upon the character of the soil. Under ordinary conditions, earth pressure equal to the pressure of a fluid weighing 30 lb. per cubic foot is considered ample.

When the wall abuts on a roadway or a railroad track, the moving load produces an additional pressure on the wall. This can be taken care of by figuring a surcharge, as explained in connection with retaining walls (p. 838). For streets, a surcharge equal to 3 ft. of earth may be used. For railroad track, the surcharge should be from 6 to 10 ft. depending upon the distance from the track and the weight of the locomotive to be operated.

Without surcharge, the pressure on basement wall varies according to a triangle. The pressure is zero at the ground level and a maximum at the level of the basement floor. There it equals the unit pressure multiplied by the depth in feet below the ground level. If the basement wall is 10 ft. deep and the unit pressure is 30 lb. per sq. ft., then the maximum pressure 10 ft. below ground is  $10 \times 30 = 300$  lb. per sq. ft.

The effect of the surcharge is the same as if the ground level were raised by the amount of the surcharge. Thus, with 3 ft. surcharge and a unit pressure of 30 lb. per sq. ft., the pressure at the ground level is not zero, but  $3 \times 30 = 90$  lb. Ten feet below ground the pressure would be  $(10 + 3) \times 30 = 390$  lb. per sq. ft., instead of 300 lb. for wall without surcharge. The pressure, instead of being represented by a triangle as in the case without surcharge, is a trapezoid.

Further explanation may be found in the chapter on Retaining Walls.

**Design of Basement Wall.**—The direction of reinforcement to resist the earth pressure depends upon the manner in which the wall is supported. It may be considered as a slab supported on the top and bottom, that is, on the first floor level by the floor construction and on the basement floor level by the resistance of the basement floor and the passive resistance of the earth below the basement slab. Another method is to consider the wall as a slab, supported by the columns and spanning horizontally between them. The third method is to reinforce the wall in two directions.

**Wall Supported on Top and Bottom.**—The first method, assuming the wall as a slab supported at top and bottom, is possible when there

are no wide openings in the basement wall. At wide openings there is no connection between the wall and the top slab; hence, there is no support for the wall at the top. This method is economical when the spacing of the columns is more than 40 per cent larger than the depth of the wall. Its use is also advisable when the basement columns are slender and would have to be materially strengthened if any earth pressure were transferred to them. The main reinforcement is placed vertically, near the inside face of the wall. Some horizontal steel is needed to prevent cracking due to temperature and shrinkage. Under ordinary conditions, this would consist, for a 12-in. wall, of  $\frac{3}{8}$ -in. round bars, 12 in. on center. Other thicknesses of wall may be reinforced proportionally. For a watertight wall, at least 0.3 of one per cent should be used. The temperature steel should be placed near the inside face. To prevent cracking of the wall at the column, due to bending moment produced by earth pressure, short horizontal bars should be placed at the column near the outside face.

On the top of the wall, the earth pressure is transmitted and resisted by the floor construction. At the bottom, reliable support for the slab must be provided. When the basement slab is at least 6 in. thick and extends over the full width of the building, the basement wall may be considered as supported at the bottom by the basement slab. Ordinarily, it is not advisable to rely on the basement slab alone, because very often the earth behind the wall is filled in and earth pressure is exerted against it before the basement slab is poured. To avoid trouble due to this, the wall should be carried down into solid ground below the basement slab for a distance of at least 9 in. The passive earth pressure then resists the reaction of the wall.

When the ground below the basement slab is not firm, it is not possible to rely on passive resistance of the ground for the horizontal support of the wall at the bottom. Unless the floor slab is designed to take the pressure from the wall there should be a beam extending from column to column and reinforced to transmit the load from the wall to the columns. Some designers provide a projection on the wall, on which the future basement slab will rest. If the slab is not reinforced and it rests on yielding ground, the projection is objectionable, because the slab after settling is likely to crack along the edges where it is held by the wall.

**Bending Moments Due to Earth Pressure.**—When the slab is supported on top and bottom, the bending moment and reaction may be found from the following formulas:

*Triangular Variation of Pressure.*—When the earth pressure varies as a triangle,

Let  $w$  = maximum unit earth pressure, lb. per sq. ft.;

$h$  = height of wall, ft.;

$R_1$  = reaction at the top;

$R_2$  = reaction at the bottom;

$M$  = maximum bending moment;

$x_1$  = distance of point of maximum bending moment from top.

Then

$$R_1 = \frac{1}{3} \frac{wh}{2}. \quad \dots \dots \dots (1)$$

$$R_2 = \frac{2}{3} \frac{wh}{2}. \quad \dots \dots \dots (2)$$

$$M = 0.064wh^2 \text{ ft.-lb.} \quad \dots \dots \dots (3)$$

$$= 0.77wh^2 \text{ in.-lb.} \quad \dots \dots \dots (4)$$

Maximum moment acts at a distance below the top equal to

$$x_1 = \frac{1}{\sqrt{3}}h = 0.58h. \quad \dots \dots \dots (5)$$

*Trapezoid Variation.*—When the earth pressure varies as a trapezoid, in addition to the above notation,

Let  $w_1$  = unit earth pressure on top, lb. per sq. ft.;

$w_2$  = unit earth pressure on bottom, lb. per sq. ft.

$$R_1 = \frac{2w_1 + w_2}{6}h. \quad \dots \dots \dots (6)$$

$$R_2 = \frac{w_1 + 2w_2}{6}h. \quad \dots \dots \dots (7)$$

$$M_{\max} = \frac{1}{8} \frac{w_1 + w_2}{2}h^2 \text{ ft.-lb. (approx.)} \quad \dots \dots (8)$$

$$= 0.75 (w_1 + w_2)h^2 \text{ in.-lb. (approx.)} \quad \dots (9)$$

The formulas for reactions are exact. The formula for bending moment is approximate and is based on the assumption that the total load is uniformly distributed. The formula for exact bending moment is complicated.

The distance between the point of maximum bending moment and the top may be obtained from the following formula:

$$x_1 = \frac{1}{(c-1)} \left[ -1 \pm \sqrt{\frac{1}{3}(2+c)(c-1)+1} \right] h, \quad \dots \quad (10)$$

where  $c = \frac{w_2}{w_1}$ .

When this value is found, actual maximum bending moment may be computed by ordinary rules of statics. Ordinarily, the approximate Formula (8), p. 640, gives accurate enough results.

**Example 1.**—Design basement wall for a building in which wall columns 3 ft. wide are spaced 20 ft. on centers. The distance from top of basement slab to top of first floor is 10 ft. and the top of the ground is 4 in. below the first floor. On one side of the building runs a railroad track producing an earth pressure equivalent to a surcharge of 6 ft.

*Solution.*—The wall, as shown in Fig. 205, p. 642, is supported at top and bottom. The theoretical support of the wall, at the top, may be assumed to be in the center of the slab, and at the bottom, 6 in. below the basement slab. The theoretical height of wall is  $h = 10$  ft. 8 in.

**Wall Slab without Surcharge.**—Taking the unit pressure at 30 lb. per sq. ft., the maximum pressure at the bottom is  $w = 30 \times 10.67 = 320$  lb. per sq. ft. The pressure is represented by a triangle, for which the maximum bending moment, from formula  $M = 0.77 wh^2$  (see p. 640).

$$M = 0.77 \times 320 \times 10.67^2 = 28\,000 \text{ in.-lb. per lin. ft.}$$

Assume 12 in. for thickness of wall; then  $d = 10.75$  in. and the required amount of steel, from  $A_s = \frac{M}{j d f_s}$ .

$$A_s = \frac{28\,000}{0.875 \times 10.75 \times 16\,000} = 0.19 \text{ sq. in. per lin. ft.}$$

$\frac{3}{4}$ -in. round bars, 12 in. on centers, give an area of steel equal to 0.196 sq. in. per lin. ft.

The ratio of steel to concrete is  $p = \frac{0.19}{10.75 \times 12} = 0.0015$ . Since this ratio is smaller than 0.077, the compression stress in the concrete is below the allowable value, and the thickness of wall is sufficient.

The pressure transmitted to the ground at the bottom is  $\frac{3}{4} \times 320 \times \frac{10.66}{2} = 1140$  lb. per lin. ft. Since the wall is imbedded 12 in. in the ground below the basement floor, the horizontal unit pressure on the ground is 1140 lb. per sq. ft. This is satisfactory.

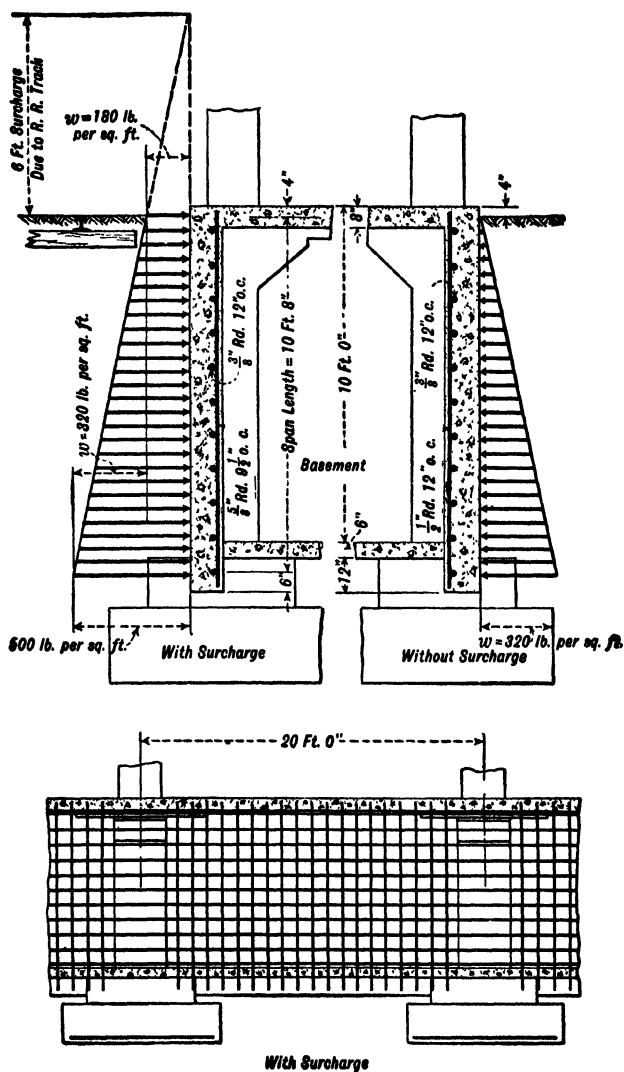

FIG. 205.—Details of Basement Wall Supported on Top and Bottom.  
(See p. 641.)

**Wall Slab on the Railroad Side.**—The slab is subjected to a surcharge pressure of 6 ft. The earth pressures are represented by a trapezoid shown in Fig. 205. At the top,  $w_1 = 180$  lb. per sq. ft., and at the bottom,  $w_2 = 500$  lb. per sq. ft.

The bending moment due to a loading in the form of a trapezoid may be found by Formula (9), p. 640.  $M = 0.75(w_1 + w_2)h^2$  in.-lb.

It is:

$$M = 0.75(180 + 500)10.67^2 = 58\,000 \text{ in.-lb.}$$

$$A_s = \frac{58\,000}{0.875 \times 10.75 \times 16\,000} = 0.385 \text{ sq. in.}$$

$\frac{3}{8}$ -in. round bars,  $9\frac{1}{2}$  in. on centers, give an area of 0.388 sq. in.

The ratio of steel,  $p = \frac{0.385}{12 \times 10.75} = 0.003$ , indicates that the stresses in concrete are well within the allowable working limits.

**Wall Supported at the Columns.**—When the basement wall is provided with wide window openings below the first floor level, or when bulkheads are provided in the slab, the wall cannot be considered as supported at top and bottom, and it may be economical to span the wall between the columns. The bending moments produced by the earth pressure will depend upon whether the wall is continuous over several spans or is only one span long.

The main reinforcement is horizontal, and is placed near the inside face of the wall. When the wall is continuous, negative reinforcement at the column near the outside face should be provided.

Some vertical temperature steel is commonly used. This may consist of  $\frac{3}{8}$ -in. round bars spaced 18 in. on centers. Sometimes, additional bars of larger diameter are used to support the horizontal bars during construction.

*Bending Moment in Wall Slab.*—If the ground is level, the earth pressure for any horizontal strip of wall is constant. The bending moments may be computed in the same way as for floor slabs. Since the intensity of earth pressure varies with the depth, the bending moments will be greatest for the lowest strip and will decrease toward the top. The thickness of the wall is usually constant for the whole height; therefore, with the decrease of bending moment, the amount of steel may be decreased.

*Providing for Negative Bending Moment.*—The negative bending moment in the wall slab may be provided for by bending one-half of the horizontal bars and extending them to the adjacent span, as in continuous slabs. It is often difficult to handle long bent bars,



especially on account of the interference of column steel, behind which the ends of the bars would have to be placed. The construction is simplified by keeping the positive reinforcement straight and by using, for negative reinforcement, short horizontal bars at the column near the outside face of the wall.

*End Spans of Wall.*—In end spans, the amount of steel should be increased by 20 per cent.

*Bending Moment in Column.*—The earth pressure transferred from the slab to the column produces bending in the columns. The earth pressure resisted by the column may be represented by a triangle or a trapezoid, and its magnitude equals the pressures on the wall multiplied by the span. In high buildings with heavy basement columns, the stresses in the column due to earth pressure are small, and do not have to be specially provided for. For heavy earth pressure and for light columns, the earth pressures may increase the stresses considerably. An inexperienced designer should compute the stresses in columns due to earth pressure in all cases, until he develops sufficient judgment.

The tensile stresses due to earth pressure in the center part of the column act at its inside face. When the column extends above the first floor, negative moments are developed at the junction of the column and the floor. The tensile stresses produced by this bending moment act at the outside face of the column. They should be added to the tensile stresses produced in the wall column by the bending moment transferred to the column from the floor construction.

*Earth Pressure.*—The variation of earth pressure along the vertical section of the wall is shown in Fig. 646. For a wall without surcharge, it varies as a triangle; and for a wall with surcharge, as a trapezoid. Along a longitudinal section of the wall, the pressure is constant. The wall is then considered as a slab loaded with uniformly distributed load along its span. The magnitude of this uniform load increases with the depth. The load and the bending moments will be a maximum at the bottom and will decrease to a minimum at the top, in the same ratio as the pressure on a vertical section. Since the thickness of the wall is the same throughout, the amount of steel required to resist the earth pressure will vary according to a triangle or trapezoid. After the area of steel at the top and bottom has been computed, the amount of steel at intermediate points may be obtained by interpolation, or graphically as in Fig.

206. The varying amount of steel is provided by varying the spacing of the bars. When the spacing becomes too large, bars of smaller diameter should be used.

### Example of Basement Wall Supported by Column.

**Example 2.**—Design basement wall, with columns 3 ft. wide and 2 ft. thick, spaced 20 ft. on centers. The distance from top of basement slab to top of first floor is 10 ft. Ground level is 4 in. below the level of the first floor. There is a continuous opening in the first floor slab, along the wall, for a bulkhead. On one side is a railroad track producing a pressure equivalent to a surcharge of 6 ft. (Compare the solution of this problem with that on p. 641.)

**Solution.**—The wall cannot be supported at the top on the floor slab, because of the opening for the bulkhead. It will be considered as spanning between the columns.

**Span.**—The distance, center to center, of columns is 20 ft. Since the column is 3 ft. wide, the net span is 17 ft. The design span, taken as the net span, equals  $l_1 = 17$  ft. (See p. 277.)

**Wall without Surcharge.**—The maximum unit pressure at the bottom is  $w = 305$  lb. per sq. ft., as is evident from Fig. 206. The bending moment for continuous wall with 17-ft. span and 305 lb. load, from formula  $M = wl^2$  in.-lb. is,

$$M = 305 \times 17^2 = 88\,100 \text{ in.-lb. per lin. ft. of height.}$$

For a 12-in. wall, the effective depth is  $d = 10.5$  in. The amount of steel: from formula  $A_s = \frac{M}{jdf_s}$ , is

$$A_s = \frac{88\,100}{10.5 \times 0.875 \times 16\,000} = 0.60 \text{ sq. in. per foot.}$$

$\frac{1}{2}$ -in. round bars, 6 in. on centers, will satisfy the requirement.

The spacing of the bars for other sections of the wall is shown in Fig. 206. It may be noted that near the top of the wall, where the area of steel required by bending moment is small, a larger amount of steel is used to provide for temperature and shrinkage.

**Walls with Surcharge.**—The maximum pressure on the top is 180 lb. per sq. ft.; on the bottom, 485 lb. per sq. ft. (See Fig. 206, p. 646.) The bending moments and the required amounts of steel will be computed at the top and bottom. These will be plotted and the amounts of steel at intermediate point determined.

**Top.** Pressure 180 lb per sq ft

$$M = 180 \times 17^2 = 52\,000 \text{ in.-lb. per lin. ft. of height.}$$

$$A_s = 0.354 \text{ sq. in. per ft.}$$

**Use  $\frac{1}{2}$ -in. round bars, 10 in. on centers.**

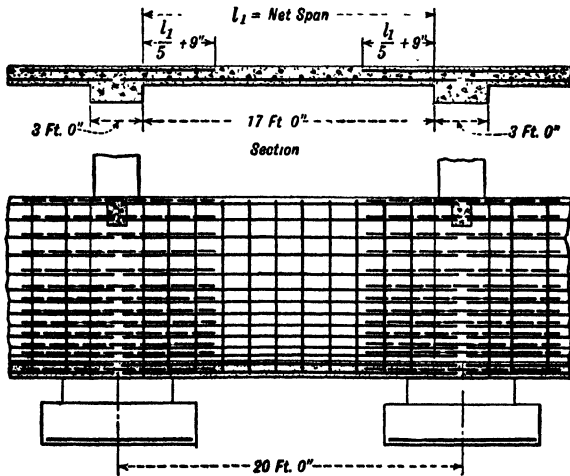
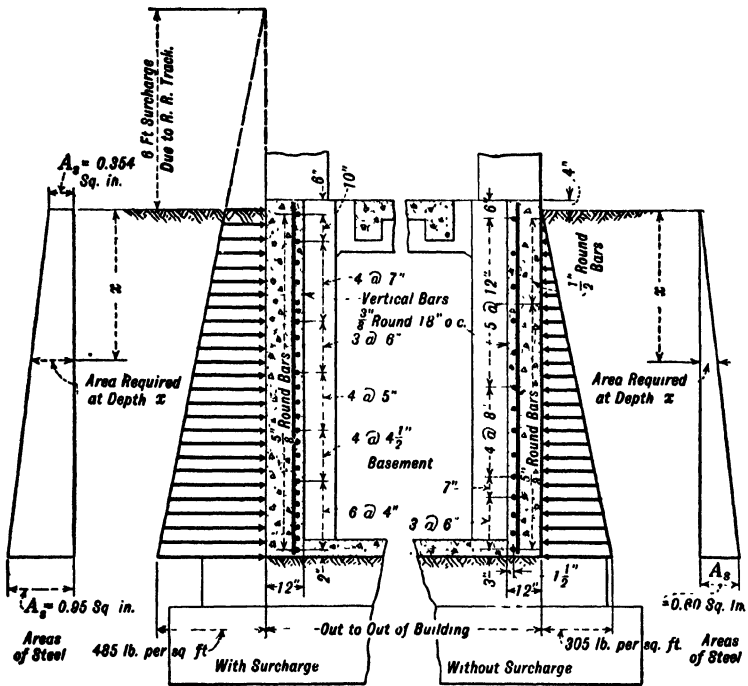

FIG. 206.—Detail of Basement Wall Supported at the Columns. (See p. 645.)

**Bottom.** Pressure 485 lb. per sq. ft.

$$M = 485 \times 17^2 = 140\,000 \text{ in.-lb. per lin. ft. of height.}$$

$$A_s = 0.95 \text{ sq. in. per ft.}$$

Use  $\frac{3}{8}$ -in. round bars,  $3\frac{1}{2}$  in. on centers

$$p = \frac{0.95}{10.5 \times 12} = 0.0075.$$

Since the per cent of steel is smaller than the value corresponding to a compression stress in concrete  $f_s = 650$  lb. per sq. in., the thickness of wall is satisfactory for compression.

The required area of steel and the arrangement at intermediate points may be seen in Fig. 206, p. 646.

**Basement Walls for Areaways.**—The design of walls for areaways depends upon conditions.

Walls for small areaways, one panel wide, may be considered as supported on the cross walls, and reinforced with horizontal bars placed near the inside face.

If the areaway extends over several spans, it is often possible to run struts at the top of the wall to the columns. The wall can then be designed as supported on top and bottom. Enough longitudinal steel must be used on the top to transmit the pressure to the struts. Such construction is shown in Fig. 265, p. 754.

If struts are not permissible and it is not possible to support the top of the wall, it must be designed as a cantilever wall. The base must be made strong enough and rigidly connected with the wall. The principle of the design is then similar to that explained for retaining walls. The base may be placed either outside the wall or between the wall and the building.

## CHAPTER XIII

### ROOF CONSTRUCTION

**Loading.**—Roofs should be designed for the dead load, the live load, and, in case of inclined roofs, for the wind pressure.

*The Dead Load* consists of the weight of the roof construction, of the cinder fill or tile placed on the top of the roof, and of the roof covering. The unit weights of the various materials used in the construction of the roof are given in the table below:

**Dead Loads on Roof**

Description	Weight, Lb. per Sq. Ft.
<i>Roof Covering:</i>	
Five-ply felt and gravel.....	6
Four-ply felt and gravel.....	5½
Tin.....	1
Metal covering.....	1½ to 2
Slate ½ to ¾-in. thick.....	7.25 to 9.5
<i>Insulating Materials:</i>	
Cinders, per in.....	7
Average weight of cinder fill.....	70
Cork or lith insulator.....	10
Tiles.....	12 to 25
Plastering on ceiling on concrete or tile.....	5
Suspended ceiling without ornamentation.....	10

*The Live Load* for which roofs are ordinarily designed is intended to take care of the weight of snow, and also of the weight of men walking upon the roof. Most building codes require a live load of 40 lb. per sq. ft. for flat roofs or roofs with a pitch of less than 20 degrees with the horizontal. For roofs with a larger pitch than

20 degrees, the live load may be reduced to 30 lb. per sq. ft. In localities having severe winters, such as the northern part of the United States and Canada, the live load may have to be increased to 50 lb. per sq. ft. to take care of the additional weight of snow and ice.

*Wind Pressure.*—Pitched roofs, when the pitch exceeds 20 degrees with the horizontal, should be designed for wind pressure, which should be assumed to act horizontally, with an intensity of 30 lb. per sq. ft. of vertical projection of the roof surface. In determining stresses in the roof members, this horizontal pressure should be resolved into pressures normal and tangent to the roof. It is usually considered that, with a wind pressure acting on one side of the roof, the live load is applied only on the lee side, as it is scarcely possible that with wind force of 30 lb. per sq. ft. any snow would remain on the side exposed to the wind.

*Drainage.*—A flat roof should be provided with a sufficient number of outlets to carry off the rain water. These should be properly distributed over the roof. To facilitate the running off of water, it has been customary to pitch the tops of the roofs. Lately, the necessity of pitching the top is questioned, with much justification, as with properly distributed outlets, most of the water will run off without any pitch. Some water may remain on the roof until it dries out, but this does no harm to the roofing. The only advantage of pitching the roof, therefore, seems to be that in case of cracks in the roofing the leakage through the slab would be smaller with pitched roof than with flat roof. With reliable roofing, the chances of leakage are remote. Therefore, the authors recommend dead level roofs when high-grade roofing is used.

*Pitch of Roof.*—The customary pitch for gravel roofs is  $\frac{3}{8}$  in. per lineal foot. For smooth tile, this pitch may be reduced to  $\frac{1}{4}$  in. per foot. Pitching of the roof is accomplished either by pitching the whole roof construction or by building the roof slab horizontally and providing a sloped fill on the top of the roof slab. The method to be adopted will depend, first, upon architectural requirements (i.e., whether there is any objection from the architectural standpoint to an inclined ceiling), and second, upon the method of prevention of condensation. Thus, if cinder fill is used on the top of the roof to prevent condensation, this could be utilized to give the required pitch. This also applies where light construction is placed above the roof to provide air space.

The simplest method of pitching a roof is to raise one edge of the building and make one continuous pitch across its whole width. This method is particularly advantageous where the roof slab is pitched, as the building of the formwork is simpler than for more elaborate pitching. It may be used only in narrow buildings; otherwise, the difference in story height on two opposite sides would be large. For wider buildings, a ridge or a valley may be provided along the center of the building. With large roof areas, considerable thought must be given to the method of pitching. First, the number of outlets should be computed. These should then be placed in the most suitable positions, and the pitch in the roofs provided accordingly. Two or three trials may be necessary to give the simplest solution of the problem. It should be remembered that the downspouts are best placed near columns, thereby restricting the number of possible positions for the outlets.

Figure 207, p. 651, shows the location of the outlets and the method of pitching adopted in building.

**Roof Insulation.**—Concrete roofs often require insulation to prevent condensation and loss of heat through radiation, in cold weather. Insulation of roofs is required in all buildings used for habitation, office buildings, hotels, hospitals, and schools. In warehouses, and in some cases in factories, solid concrete roofs covered with tar and gravel roofing require no additional insulation.

By condensation is meant the accumulation on the ceiling of moisture from the air, caused by a difference between the temperature of the concrete roof and that of the air in the building. To each inside temperature and degree of humidity there corresponds a definite temperature of the roof at which condensation will occur. This temperature is called the dew point. The object of insulation is to prevent the outside temperature from reducing the temperature of the inside surface of the roof to the dew point at the time when the conditions for condensation are most favorable, that is, when the difference between the inside and outside temperatures is greatest, and the humidity, or moisture content of the air, is also greatest.

The condensation depends upon the following factors:

(1) Greatest difference between outside and inside temperatures. Condensation increases with increase in difference.

(2) Expected moisture content or humidity at the time of greatest difference in temperature. Condensation increases with increase of humidity.





(3) Degree of conductivity of heat of the roof construction. For instance, for an 8-in. slab, the condensation will be smaller than for 2-in. topping in concrete joist construction.

Humidity may be atmospheric or it may be produced by some process of manufacture. Atmospheric humidity can usually be taken care of without difficulty by proper insulation. Special humidity may require special ventilation in addition to insulation. In some cases, complete prevention of condensation is impossible.

**Methods of Roof Insulation.**—There are several methods of roof insulation, and the choice between them will depend upon relative economy.

The methods are: (1) Providing dead air space between the ceiling and the roofing; (2) covering the roof slab with cinder fill; (3) covering the roof with insulators like fibrofelt, lith, or cork; (4) placing on top of the roof hollow tile either of clay or gypsum; (5) combination of tile with cinder fill or with fibrofelt. (The order in which these methods are arranged has no significance.)

In determining the relative economy of various types of insulators, the dead load of the insulator also should be considered. For instance, the dead load of cinder fill amounts to 70 lb. per sq. ft., while the dead load of cork insulator or lith amounts to about 10 lb. The additional dead load requires stronger roof construction, also heavier columns. The additional cost of construction must be added to the cost of the heavier insulator.

**Method of Providing Air Space.**—The best method of providing dead air space between the roof and the ceiling is by a suspended ceiling, such as that described on p. 613. Air space of any dimensions may be thus obtained.

A much less effective method, used in beam and girder and joist constructions, is by providing a plastered ceiling directly under the beams and joists, as described on p. 610. The air space thus provided is limited by the height of the beam or the joist. In addition, the joists are not insulated.

A cheaper method of providing air space above the ceiling, used to a great extent in Canada, consists of a light wood framework built some distance above and supported by the concrete slab. Usually, this consists of 2 by 4 in. planks placed and anchored to the concrete slab, and vertical wooden studs resting on the planks and spaced about 4 ft. on centers. Stringers supported by the studs carry rafters upon which rests tongue and grooved planking covered with appro-

priate roofing material. Proper pitch can be easily obtained. An objection to this method is that the roof is not strictly fireproof. If the roofing is fire-resistant this is not a serious objection.

A small air space may be obtained by placing wood strips of proper thickness, spaced from 12 to 18 in. apart, directly on the concrete. On these rest the boards, and on top the roofing.

*Cinder Fill.*—Cinder fill placed on the top of the roof slab is the most commonly used method of preventing condensation. The concrete slab is built level, and the desired pitch in the roof is provided by varying the thickness of the cinder fill. To be effective as insulator, the fill in the valleys should be at least 6 in. thick. The slopes should be so arranged that the thickness of the fill at high points is not excessive. It is desirable to limit the average thickness of the fill to 12 in., in which case its average weight will be about 70 lb. per sq. ft.

The cinder fill is made of wet hard cinders properly tamped and covered with a mortar coat one inch thick. The roofing is placed on the top of this coat. To provide for expansion of the cinder fill, a one-inch joint, filled with asphalt or other bituminous material, is usually provided at the parapet. This is particularly important with brick parapets, because, if the joint were not provided, the thrust due to expansion of the fill might injure the parapet, or, on the other hand, contraction cracks might allow penetration of water.

*Insulators.*—Roofs may be insulated by placing, on the top of the concrete slab, insulators such as fibrofelt, lith, or cork board, and covering them with roofing. The fibrofelt comes in various thicknesses up to  $1\frac{1}{2}$  in. Lith and cork board come in sheets. Lith may be obtained in thicknesses up to 4 in. Both materials can be sawed like wood, to fit the roof.

A coat of pitch is placed first, and the insulator is placed on the top and covered with another coat of pitch, upon which the roofing is applied in the regular manner. These materials show considerable resistance to loss of heat.

*Tile Insulators.*—Either clay or gypsum hollow tile may be used for roof insulation. When erected, the tiles are placed end to end so as to form a continuous air space. Gypsum tile offers larger resistance to loss of heat than clay tile, but under some conditions it deteriorates and loses its insulating properties, particularly when it is exposed to heat or when damp air can penetrate to it.

When tiles are used as insulators by themselves, the roofing is

placed directly on top of the tiles. Sometimes they are used in connection with cinder fill, fibrofelt, or cork. In such cases, the tiles are placed on the concrete and the additional insulator is placed on the top.

**Roof Covering.**—Concrete roof slab may be made impervious to water without any special covering, by the use of properly proportioned concrete reinforced with sufficient temperature reinforcement and troweled to a dense and hard surface. Since this is not a positive insurance against leakage, in building construction the roofs are usually covered with waterproof roof covering. Concrete roofs are

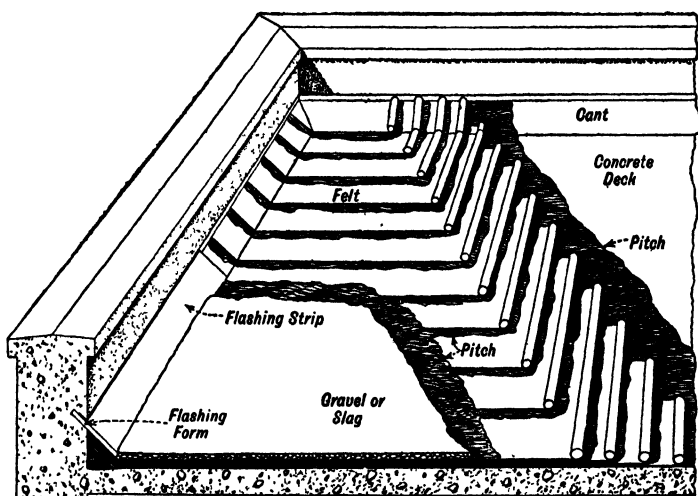

FIG. 208.—Method of Application of Tar and Gravel Roof. (See p. 655.)

used in reservoirs and structures of similar character where dampness of the under surface and occasional leakage are not objectionable.

The roof covering materials may be divided into three classes: namely, roof coverings relying for waterproofing on coal tar or asphalt; roof coverings consisting of slate or tile; and metallic roof coverings, such as tin, copper, and corrugated iron.

**Tar and Gravel Roofing.**—For substantially flat roofs, the tar and gravel roofing is used very extensively, as it gives a lasting roof surface at comparatively low cost. For roofs with large pitch, tar and gravel roofing cannot be used, as there is danger of the roofing running during hot weather. The maximum pitch for which this

roofing may be used depends upon the climate. In hot climates, it should not exceed one inch to the foot, and in cold climates three inches to the foot.

The tar and gravel roofing consists of three materials, namely, pitch, felt, and gravel or slag. The pitch provides the waterproofing qualities; the felt serves to keep the pitch in place; while the gravel, which is imbedded in pitch on the top of the roof covering, serves as a protection for the roofing both against injuries by physical action, like walking and scraping, and also against the action of the direct rays of the sun.

For satisfactory results, the materials and the workmanship must be of first-class quality. The method of application is as follows:

The pitch is spread first on the concrete; then the required number of layers or plies of tarred felt are placed. These are lapped in such a fashion that at each point of the roof there are the same number of layers. The tarred felt must be covered with pitch, so that in no place felt touches felt. The felt must be spread without

wrinkles, as these destroy the waterproofing qualities and contribute very largely toward breaking of the felt.

This method is illustrated in Fig. 208, p. 654. The relative thicknesses are evident from a large scale section through the roofing shown in Fig. 209, p. 655.

The following specifications, universally known as "Barrett's Specifications," are recommended for use.

*First*—Coat the concrete uniformly with Specification Pitch.

*Second*—Over the entire surface, lay four plies of Specification Tarred Felt, lapping each sheet twenty-four and one-half inches over preceding one, mopping with Specification Pitch the full twenty-four and one-half inches on each sheet, so that in no place shall Felt touch Felt.

*Third*—Over the entire surface, pour from a dipper a uniform coating of Specification Pitch, into which, while hot, imbed not less than four hundred pounds of Gravel or three hundred pounds of

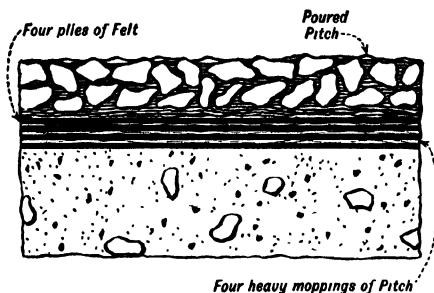

FIG. 209.—Section through Tar and Gravel Roofing. (See p. 655.)

**Slag** for each one hundred square feet. The Gravel or Slag shall be from one-quarter to five-eighths inch in size, dry, and free from dirt.

*General*—The Felt shall be laid without wrinkles or buckles. Not less than two hundred pounds of Pitch shall be used for constructing each one hundred square feet of completed roof, and the Pitch shall not be heated above 400 degrees Fahrenheit.

**Slate Shingle and Clay Tile.**—These materials are used on roofs with a pitch of more than 6 in. to the foot. Owing to the steepness of the roof, bituminous roofing cannot be used, as it would run. The shingles and tiles are nailed to 1 by 2 in. strips, imbedded in concrete under each row of shingles. This covering is made waterproof by proper lapping of the tile at all joints.

**Metallic Roofing.**—This is usually expensive and is seldom used in connection with concrete roofs. It has been found by experience that the metal lasts much longer if it is placed on planks instead of directly on concrete.

**Parapets.**—Buildings with flat roofs are usually provided with parapets extending above the roof. The purpose of the parapet is to give the building proper architectural proportions, to hide any drainage slopes, and finally, in non-fireproof buildings, to retard the spread of fire from the adjoining buildings. This last purpose need not be considered in reinforced concrete buildings.

The height of the parapet will depend upon the architectural design. It may be uniform for the whole building, or parts of it may be higher than the rest. The minimum height of parapets in business buildings is 3 ft. for outside walls and 18 in. for party walls.

The parapet is usually built of reinforced concrete, brick, or tile faced with brick. The selection of the material depends upon the type of the building and also upon economy.

*Concrete Parapets.*—Reinforced concrete parapets may have exposed concrete surfaces, or the surfaces may be faced with brick, stone, terra cotta, or any other suitable material. When exposed, the concrete surface may be plain or ornamental; but the ornamentation, if any, should be such as to require no elaborate formwork. Concrete cornices are often used. They may either be pre-cast or cast in place. When the shape of the cornice is simple, it may be built as a part of the parapet. For larger cornices with more intricate design, it is more economical to build the projecting parts separately from the supporting concrete parts. Proper provision, usually consisting of proper recesses and steel anchors, should be

made to support the separately built parts. When the surface of the concrete is exposed, sufficient temperature reinforcement should be provided to prevent shrinkage and temperature cracks.

When the parapet is faced with brick, an angle of proper dimensions should be used at the bottom to retain the face brick.

When terra cotta is used, proper anchors should be provided for attaching terra cotta blocks.

From a structural standpoint, the parapet may form a part of the supporting structure, i.e., it may form a beam supporting the roof load, in which case it should be designed to carry the loads coming upon it, according to the methods recommended for other concrete beams. In case the roof beam consists of a portion below the roof and a portion above the roof, it is best, from a structural standpoint, to have both parts built at one pouring. The design of the beam is then similar to that of any other beam. If, however, it is found economical to build the part above the roof separately, special provision should be made to insure the cooperation of the two parts. This is usually accomplished by providing stirrups throughout the whole length of the beam, extending from the bottom portion to the top portion. With stirrups spaced closely enough, it is possible to obtain a beam that has the same strength as if it were poured at one time. In case of heavy loads, however, it may be advisable to increase the required amount of reinforcement, to provide for the possibility of incomplete cooperation of the two parts.

When a concrete parapet supports a heavy cornice projecting some distance outside of the building, it is subjected to bending moments produced by the weight of the projecting cornice. This bending moment equals the weight of the cornice multiplied by the distance between the center of gravity of the cornice and the center of the parapet. In some cases, it is possible to resist this bending moment by vertical reinforcement in the parapet, placed near its inside face. The amount of such reinforcement equals the bending moment divided by effective thickness of parapet. The maximum stress in this reinforcement acts at the junction of the parapet and the roof construction, and the reinforcement must be properly anchored in the roof construction. The roof members in which the bars are anchored must be strong enough to resist the bending moment transferred from the parapet. Sometimes, however, the parapet wall is not sufficiently strong and special provision, such as

special brackets or extension of the columns above the roof, must be made to carry the cornice.

When the parapet does not serve any structural purposes, i.e., when the beam below is sufficient to carry the roof load, it may be built separately. It then requires only temperature reinforcement and dowels joining the parapet to the roof. The thickness of the parapet should be at least 8 in. For very high parapets, this thickness may have to be increased to 12 in.

At the parapet a cant, consisting of cinder concrete, should be built to prevent accumulation of water at the wall. A perspective drawing of a concrete parapet is shown in Fig. 210, p. 658.

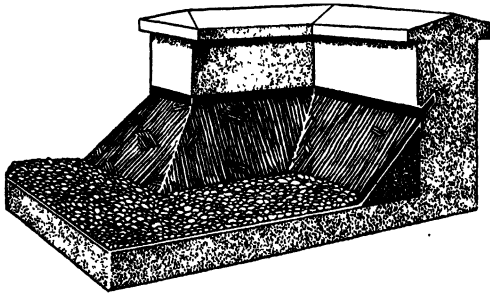

Fig. 210.—Concrete Parapet. (See p. 658.)

Better results are obtained by using special continuous reglets made of steel. These are tacked lightly to the inside of the forms for the parapet. Such reglet is shown in Fig. 210, p. 658.

Proper provision should be made, on the inside face of the parapet, for attaching the flashing. For this purpose, there must be a longitudinal groove along the parapet, which may be easily obtained by nailing to the form a strip of wood of proper dimensions.

*Coping.*—The coping for a reinforced concrete parapet may be built at the same time as the rest of the parapet, or it may be built separately. In the last case, special reinforcement consisting of three  $\frac{1}{2}$ -in. bars should be used in coping.

*Brick Parapet.*—A brick parapet should be at least 12 in. thick. It should be built of hard brick, laid in Portland cement mortar. If a cornice of any size is used in connection with a brick parapet, it should be anchored to the concrete frame rather than to the brick parapet. To prevent any possibility of displacement of the parapet, either proper recess should be provided in the concrete or else steel dowels should be extended up from the concrete into the brick.

To provide a slot in the brick for fastening the flashing in the connection, a special tile built with a groove of proper dimensions may be used to advantage.

The parapet wall should be provided with a coping of stone, terra cotta, concrete, or cast iron. The inside face of the parapet should be coated with tar, so as to prevent moisture and frost from penetrating the masonry.

**Walks on Roof.**—Where considerable walking is done on the roof, special walks should be provided to protect the roofing. A simple construction consists of 2 by 3 in. sleepers placed directly on the roof across the walk, with 1 by 2 in. slats, spaced 1 in. apart, laid over the sleepers.

Where the roof is used for a promenade, it should be surfaced with lasting material, such as vitrified tile.

First the roofing is placed as usual; then cement mortar is placed on top, and the tile is imbedded in the mortar. Expansion joints should be provided in the mortar, to prevent injury to roofing.

**Flashing.**—Flashing is provided to make the junction of the parapet and the roof waterproof and to prevent water from entering under the roofing at the parapet. There are several varieties of flashing in use.

*Metal Flashing.*—This may be of tin, galvanized iron, copper, or lead. It is usually nailed at the bottom to a nailing strip imbedded in the slab a proper distance from the parapet usually from 6 to 10 in. The vertical portion of the flashing is placed in a specially prepared groove or reglet in the parapet, the groove being filled with cement mortar after the flashing is in place. To prevent the mortar from coming out, the groove is tapered. The method of procedure is as follows: The felt is applied first, extending to the parapet. Then the metal is nailed on the top. Felt is then placed over the horizontal part of the flashing; and finally a coat of pitch and gravel is applied.

*Elastic Flashing.*—Figure 211 shows the flashing advocated by the Barrett Company. No metal is used. The felt and pitch are brought to the edge of the parapet.

## ROOF DESIGN

In buildings consisting of several stories and roof, all columns usually extend to the roof, so that the size of the panels in the roof is the same as the size of the panels in the floor. The difference between the floor and the roof, from a structural standpoint, is only in the magnitude of the loading. It is most economical to use for



the roof a design of the same type as for the floor, so as to be able to use the formwork from the floors below. Thus, if the floors are of flat slab design, the roof also will be a flat slab. If the floors consist of beams and girders, the roof will be of beam and girder design.

The loading for which the roof is designed is usually smaller than the floor load; therefore, beams of smaller dimensions may be used in the roof. Before deciding, however, upon a change in the size of the concrete beams, the cost of the changes in formwork must be seriously considered. In many cases, the saving in concrete materials, obtained by using smaller concrete dimensions in the roof, is more than offset by additional cost of the changes in formwork. A change in the amount of steel, instead of a change in the size of concrete members, will often accomplish the desired result more economically. If it is desired to change the dimension of beams, the depth of the beam, rather than its width, should be reduced. A reduction in width of the beam requires not only changes in the beam formwork, but also changes in the slab formwork, to provide for the greater distance in clear span between beams. The thickness of the slab can be reduced without affecting the formwork. It should be noticed that this automatically reduces the depth of the beam. Note that it is not the total depth of the beam, but the depth below the slab, which affects the formwork. In flat slab construction, a change in thickness of slab does not affect the formwork. Formwork needs to be changed only when the depth of the drop panel is reduced, and this change is very inexpensive.

Sometimes it is desired to get larger spans in the top floor than in the lower floors, by omitting one or more rows of columns. In such cases, the entire design of the roof is changed. In beam and girder construction, the cross beams will be of a much longer span, requiring special concrete dimensions and, therefore, special formwork. The same spacing of the longitudinal beams, however, should be used as in the lower floors, so as to utilize at least a part of the formwork. When the lower floors are of flat slab design, the design of the roof must be altogether changed, and such arrangement of beams used as will give greatest economy.

**Openings in Roof.**—In buildings intended for manufacturing purposes, it is often desired to get additional light and ventilation in the top story by the use of skylights or monitors.

With flat slab construction, the openings for skylights should be arranged so as to require the least amount of framing. If the sky-

light is placed in the central portion of the panel, it may be possible to get along without any framing. When framing is required, it consists of two beams at the edge of the skylight, supported by two girders running between columns at right angles to the beams.

To make the connection of the skylight with the roof weather-proof, it is advisable to place the skylight some distance above the highest point of the roof at the skylight. This is accomplished by providing, around the opening above the roof slab, a concrete curb 6 in. thick and of proper height. The curb is usually built after the slab is completed, and its height depends upon the height of the cinder fill at the skylight. To join the roof and the curb, dowels are provided, extending from the roof into the curb, and a water-tight joint must be made by clearing the old surface and spreading upon it neat cement parts. Flashing is extended from the roof to the top of the curb, where it is nailed to wooden nailing blocks provided for this purpose. (See Figs. 211 and 212.) The nailing blocks should be imbedded in concrete before it is set.

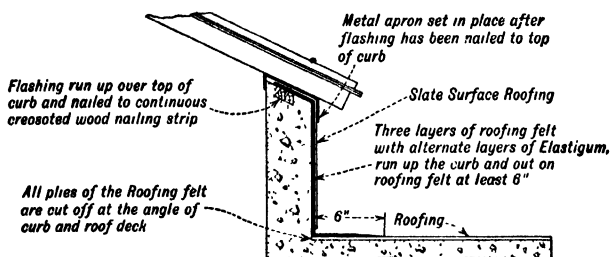

FIG. 211.—Flashing at Skylight. (See p. 661.)

### LONG SPAN ROOF CONSTRUCTION

In long span roof construction, concrete is seldom as cheap in first cost as light steel truss construction, but it has the advantage of being fireproof and of requiring practically no expense for maintenance. The appearance is also in favor of concrete construction. The maintenance charges for steel trusses are fairly high, as they need to be regularly repainted. Where steel trusses need to be fireproof, concrete construction is more economical than steel construction.

Several types of long span roof construction are in general use. These are simple girders, concrete trusses, rigid frames, and long

span arches. Of interest also is the long span roof construction developed by Richard E. Schmidt. (See p. 671.)

**Simple Girder.**—Simple girders have been used to quite an extent for long spans in garages and manufacturing establishments. They are usually supported by light concrete columns or by brick piers. The light concrete columns are seldom capable of offering appreciable restraint to the girders.

Thero of construction may consist of girders 18 to 20 ft. apart supporting transverse beams spaced about 8 ft. and carrying a 3-in. concrete slab. Light weight concrete construction, as described on p. 602, may be substituted for the transverse beams and slab. To save formwork for intermediate beam the spacing of girders may be made smaller and slab spanned between them as

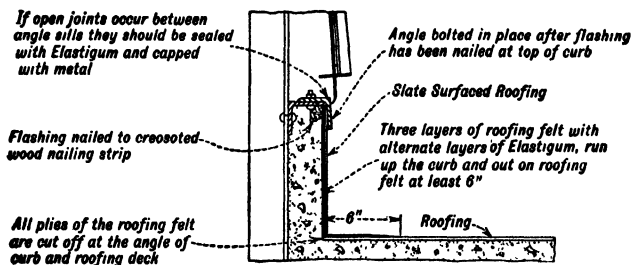
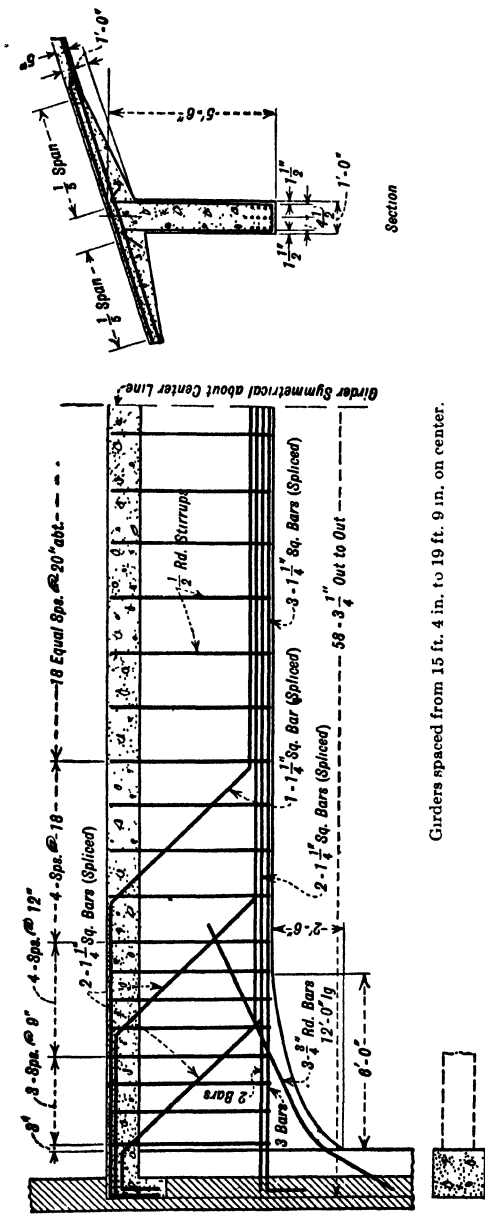

FIG. 212.—Flashing at Monitor. (See p. 661.)

shown in Fig. 213, p. 663. The girders are usually of T-shape design. For long span girders to resist compression stresses, the required thickness of the flange may be larger than the 3-in. slab used in the roof, in which case the slab is thickened on both sides of the girder sufficiently to furnish the required compression area. To reduce the cost of the girder and particularly its dead load, it may be economical to make the thickness of the stem in the middle portion of the girder, where the external shear is small, only large enough to accommodate the longitudinal reinforcement, and to increase it gradually towards the supports with the increase of the external shear. Before adapting such a design, it is necessary to investigate the cost of the concrete saved and the extra cost of the formwork. Since the dead load of the girder is reduced, there will be an additional saving in steel, due to the reduced bending moment, and also a saving in the size of supporting members.



Girders spaced from 15 ft. 4 in. to 19 ft. 9 in. on center.

Fig. 213.—Roof Girder for Winston-Salem Auditorium. (See p. 662.)  
Southern Engineering Co., Engineers. Edward Smulski, Consulting Engineer.

For the sake of appearance, it is advisable to provide in the center of the girder a camber of a depth at least equal to the total expected deflection of the girder. The objectionable appearance of a sag is thus avoided.

From the standpoint of design, long span girders do not offer any special difficulty. The bending moment is found from the formula for simple beams, the distance from center to center of the support being taken for the span. In computing the amount of steel and the compression in concrete, it may be advisable to use the formulas in which the compression in the stem of the T-beam is considered. The simplified method given on p. 224 will be found of advantage in this connection.

Particular attention is required in spacing the longitudinal reinforcement. As the bars are more numerous than usual, it may be necessary to place them in several layers. The use of more than three layers is not advocated. Special provision should be made for separating the layers of bars. This may be accomplished by placing across the main reinforcement short pieces of one-inch square bars 3 to 4 ft. on centers. A proper proportion of bars should be bent up and utilized as diagonal tension reinforcement. Before bending the bars, the required amount of steel at intermediate points should be determined. This requirement is particularly important in girders in which the restraint at the support is slight. (See Fig. 98, p. 292.) The points where reinforcement may be bent up will then be determined by bending moment in simple spans, and they will be much nearer the support than is the case in continuous beams. The use of standards applicable to continuous beams may be disastrous. At least one-third of the bars should be carried straight to the end of the beam. Under no circumstances should the bars be stopped short at any intermediate point, as there is no means, in such cases, to develop the stresses in the short bar, without its slipping.

When the ends of the girder are not free to move, short bars should be used on the top of the girder at the support, to insure against cracks, even if the restraint is not counted upon.

When a concrete girder rests on brickwork, the bearing stresses on the support should be investigated. If the weight of the girder produces excessive bearing stresses, the bearing area should be increased.

An example of long span girder construction is given in Fig. 213, p. 663, showing the roof girder used in the Winston-Salem Auditorium. The location of the girders is shown in Fig. 275, p. 781.











**Long Span Roof Girders as Rigid Frame.**—The cost of long span girders may be materially reduced, by building the girder monolithic with the supporting columns and designing the construction as a rigid frame. The use of rigid frames in America has not been as wide as the economy of this type of construction warrants. This is partly due to the fact that the design is somewhat complicated and that the building codes and standard specifications have no provision for such construction. The arbitrary bending moment requirements that are often imposed make proper use of rigid frames impossible.

**Design of Rigid Frames.**—Rigid frames should be designed according to formulas given in the section on rigid frames in Volume II. These are just as reliable as the ordinary beam formulas, as has been proved not only by a number of successful constructions but also by numerous tests.

**Rigid Frame with Horizontal Girders.**—Figure 214 shows a good example of a rigid frame design with horizontal girder. It has been used by Thompson & Binger in the construction of a boiler house for Hires Condensed Milk Co. in Morristown, N. Y. The span of the rigid frame in this design is 60 ft. and the height of the column 27 ft. 10 in. The dimensions are shown in the figure. It should be noticed that the flange of the T-shape was obtained by thickening the slab on both sides of the girders. Of interest also may be the method of splicing of the bars, which was necessary because it was not possible to get bars more than 60 ft. long. The frame was considered as partly restrained at the bottom. This is an intermediate case between a frame hinged at the bottom and one rigidly fixed there. The assumption was justified by the fact that the columns were tied by reinforcement to substantial footings.

**Rigid Frame with Ridged Roof.**—An interesting example of ridged roof construction may be found in Fig. 215, opp. p. 665, and also in the photographs, Fig. 216, p. 666, representing the foundry built for Garfield Smith & Company, by Villadsen Bros. The span of the frame is 70 ft., the height is 45 ft. The details of the design may be seen from the figure. The frames were designed as hinged at the bottom. Of interest also is Fig. 216, showing the method of erection of the reinforcement and of the formwork. The reinforcement for the columns and the beam was designed so that it could be separated into three parts. Each part was assembled on the ground and placed in the formwork as a unit. After all three

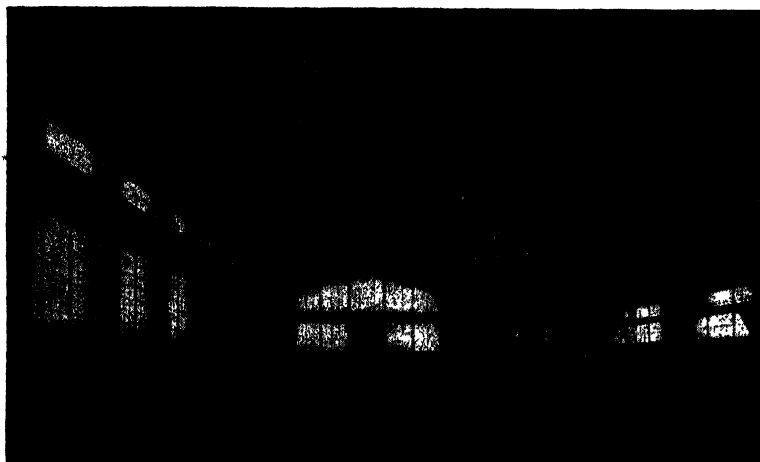

FIG. 216.—Views of Foundry Building for Garfield Smith & Co. (See p. 665.)

parts were in place, additional bars were placed, joining the three sections. The formwork was also divided into three sections. These were assembled on the ground and lifted into position by a derrick. Fig. 216 shows the central part of the form, with the rein-

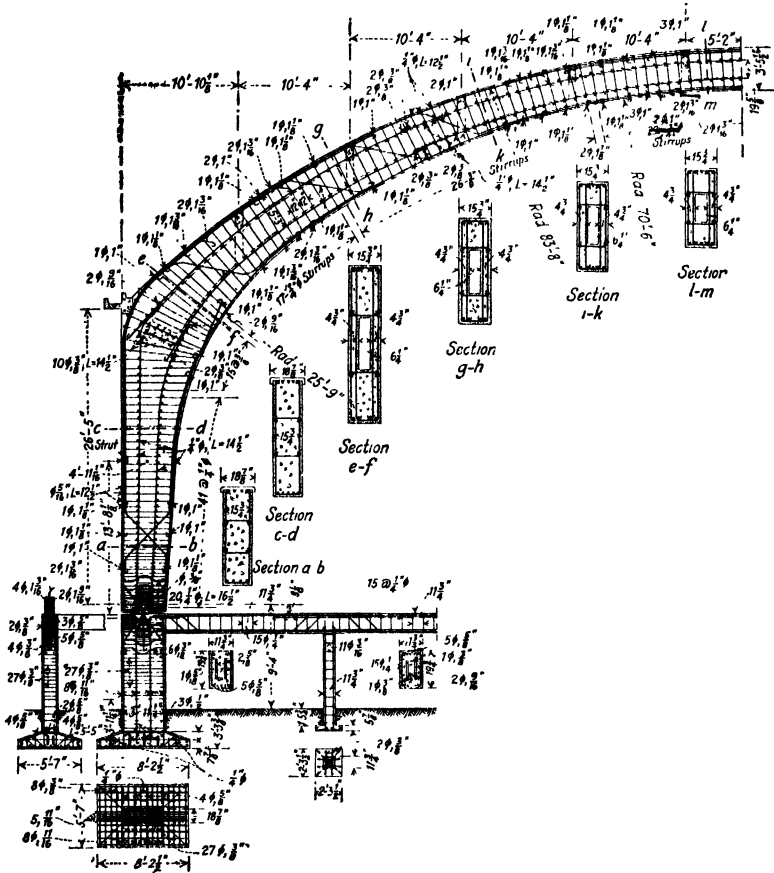

FIG. 217.—Hall Frame at Lausanne. (See p. 667.)

forcement placed within, being hoisted into position. This ingenious method undoubtedly contributed largely to the economy of the construction.

**Rigid Frame with Arched Roof.**—A good example of this type of construction is seen in Fig. 217, representing a frame in a reinforced

hall at Lausanne, Switzerland.<sup>1</sup> This hall is rectangular in shape, 183 ft. 9 in. (56 meters) long, and 114 ft. 10 in. (35 meters) wide, out to out. The construction consists of 8 frames spaced 26 ft. 3 in. (8 meters) on centers. Each frame consists of an arch supported on columns hinged at the bottom. The intrados is a three-centered curve, while the extrados is a segment of a circle, the radius of which is 82 ft. (25½ meters). This makes the depth of the arch a minimum at the crown, where it is 3 ft. 7 in. (1.10 meters) and a maximum at the springing line, where it is 8 ft. 3 in. (2.5 meters). The cross section of the frame is given in Fig. 217. It should be noted that the section is hollowed out, not so much to save material as to save dead load, thus reducing the bending moments and stresses. In America, owing to higher ratio of cost of labor to cost of material, this scheme may not be found economical.

The hinged effect at the bottom of the columns was obtained by building the foundation and the frame separately and employing a fan-shaped arrangement of dowels between the foundation and the frame. These dowels were effective in preventing any displacement of the frame, but were not capable of resisting any bending moments. Therefore, the frame can undergo angular movements due to changes of temperature and movements of foundation without producing any stresses.

The following assumptions were made: snow load, 16.5 lb. per sq. ft. (80 kg./m<sup>2</sup>); wind load for calculation of the arch, 30.6 lb. per sq. ft. (150 kg./m<sup>2</sup>). A temperature variation of 15 degrees Centigrade was allowed. The shrinkage stresses were taken care of by assuming their effect to be equal to a fall of temperature of 20 degrees Centigrade.

### CONCRETE ARCHES FOR LONG SPAN ROOFS

Reinforced concrete arches with tie-rods form an economical type of long span roof construction. Their use has not been as extensive as the advantages of the type would warrant, mainly because the design is somewhat complicated. The cost of form-work, which at first sight seems to be large on account of the curvature of the arch, need not be unduly expensive, because the intrados of the arch can be made up of a number of straight segments.

<sup>1</sup> La Technique Modern, Vol. 13, No. 1, Jan., 1921, pp. 12 to 14.

**Method of Design.**—The roof construction may consist of arch ribs placed across the building and spaced from 15 to 25 ft. on centers. The arch ribs support beams or joists running longitudinally, and these in turn support concrete slab. A monitor may be easily built on top of the arch.

The arches may be constructed with the supporting columns, in which case the construction becomes a rigid frame with curved top; or they may be independent of the supports, in which case the horizontal thrust produced by the arch must be resisted by tie-rods and the arches may be considered as hinged at the supports. Formulas for two-hinged arches, given in Vol. II, should be used.

The concrete dimensions of the arch and the required reinforcement should be computed for a condition of load producing maximum bending moments. Such a condition occurs when the live load is placed on one-half of the arch.

The tie-rods, however, should be computed for the maximum thrust, which is produced by the live load extending over the whole span of the arch. In computing stresses, the effect of the lengthening of the tie-rods, due to the horizontal thrust, should be taken into account. The assumption in all arch designs is based on the span remaining constant. This naturally will not be true in the case under consideration, as the lengthening of the tie-rods will permit a slight displacement of the supports, correspondingly increasing the span length.

Wind pressure may also have to be considered in designing the arches, especially when the building is exposed and the rise is comparatively large. The arch with tie-rods should be securely anchored to one support, but should be allowed to expand and move in the direction of the span length on the other support. If this motion is not provided for, the tie-rods will not become effective until the resistance of the support to sliding is overcome, because no stress can be taken by the tie-rods without corresponding increase in length. With such construction, no provision is required for temperature stresses.

**Example of Arch Roof.**—Figure 218, p. 670, shows the design of an arch 103 ft. 6 in. over all, with a rise of 17 ft. The spacing of arches in the building is 17 ft. center to center. The cross section of the arch, constant throughout, is  $11\frac{1}{2}$  by 24 in. The reinforcement consists of three  $\frac{7}{8}$ -in. round bars placed at top and three at bottom. These bars were properly lapped and also provided with

hooks at the ends. Three-eighth-inch round stirrups were spaced uniformly the whole length of the arch. The intrados of the arch was nominally a segment of a circle with a 90-ft. radius. To facili-

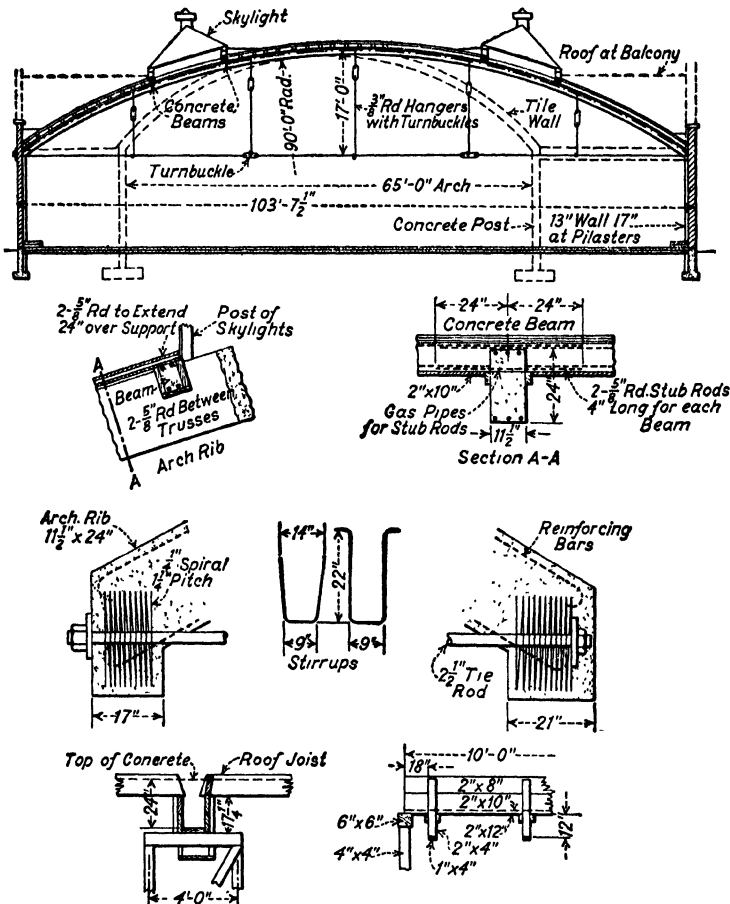

FIG. 218.—Details of Arch Roof. (See p. 669.)

tate the formwork, however, the intrados of the arch was made up of straight segments. This substitution is practically unnoticeable.

A single 2 1/2-in. tie-rod with turnbuckles resists the horizontal thrust. At each end of the tie-rod is a nut and bearing plate, as, is

evident from details, Fig. 218, p. 670. To prevent sagging, the tie-bars are supported by five  $\frac{3}{8}$ -in. hangers.

The roofing is carried by wood rafters 2 by 10 in., spaced 2 ft. on centers, seated in the ribs. The longitudinal skylights are supported by concrete beams running longitudinally with the building and supported by the arches.

The design was made by L. J. Mensch of Chicago.<sup>2</sup>

### LONG SPAN ROOF CONSTRUCTION

Long span roof construction of reinforced concrete has recently been developed and successfully used by Richard E. Schmidt, Garden & Martin, Architects and Engineers, of Chicago. A typical example of this construction is the armory designed to house the Illinois National Guard, Danville, Ill.

The main features of this design are protected by patent.

Figure 219, p. 672, and Fig. 220, p. 673, show details of the design and an interior view of this armory. The roof is supported by monolithically poured concrete trusses with a span of 85 ft. A monitor, with continuous steel sash both sides, is formed by cantilever beams extending from the peak of the roof. Roof of monitor consists of a 3-in. solid slab suspended from girders at end of these cantilever beams, and formed on the curve of a catenary to avoid dead load bending stresses. Tie-rods are used as bottom chord for the trusses and between ends of cantilever beams, to avoid bending stresses in main truss members.

Roof over gun shed, shown to the left of main truss, is of similar construction. Balconies for spectators are built between the main roof and the truss over gun shed, also at one end of building. Design of this balcony is shown by Fig. 219.

### CONCRETE ROOF TRUSSES

Figure 221 shows a design of a concrete roof truss used in the Graumann Theater in Los Angeles. Other details of this structure are shown in Fig. 270, p. 764, and Fig. 273, p. 779. The following description is taken from *Engineering News Record*, July 5, 1923.

The roof trusses are 126 ft. 6 in. in span, center to center of columns, 15 ft. 8 in. high; each truss has 61 tons of reinforcing steel and 231 cu. yd. of concrete, and carries a load of 750 tons. In the

<sup>2</sup> For full description, see *Engineering News Record*, Jan. 27, 1921, p. 167.



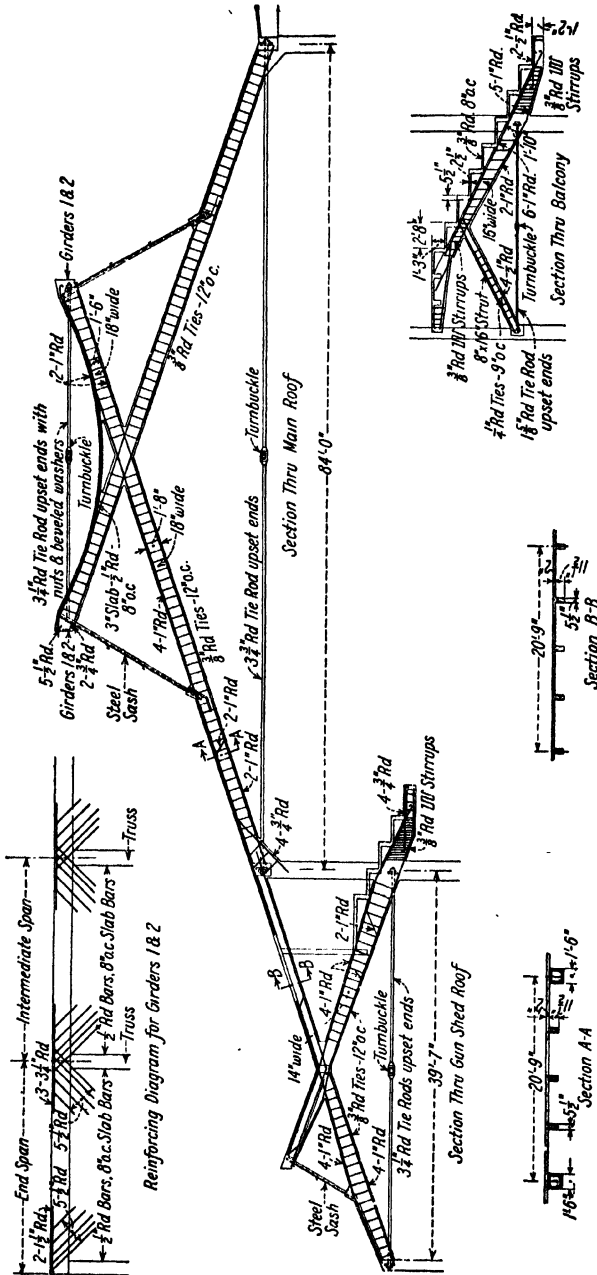

Fig. 219.—Details of Long Span Roof Construction in Armory at Danville, Ill. (See p. 671.)

building up of these trusses, the soffit of the truss, with its reversed decorative forms, was put in place first; the bottom chord steel was next laid out and fastened securely in place. Spacers, made of  $1\frac{1}{4}$  by  $1\frac{1}{4}$ -in. bars bolted together, placed approximately 10 ft. centers, were used to hold this bottom chord steel in place. Cement blocks were used to carry the load. Care was taken in placing these blocks to see that they were staggered so as to allow for the placing of the concrete. The bottom chord consists of  $1\frac{1}{4}$ -in. square deformed bars, 65 ft. long; a 6-ft. lap was used at the splices with three  $\frac{3}{4}$ -in. U-clamps. Particular care was taken to see that these U-clamps

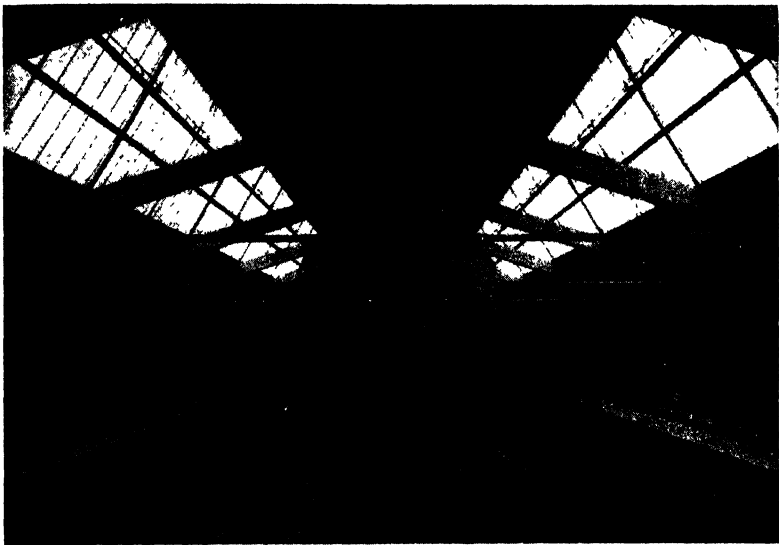

FIG. 220.—Interior View of Armory at Danville, Ill. (See p. 671.)

were securely in place and tight. The locations of these splices were all laid out so as to stagger with the splice in the bars adjacent to them. At the ends of the truss, the bottom chord bars were all hooked around the vertical column bars. Bars in the diagonal tension members were laid out so as to work in between each layer of the bottom chord. These bars were hooked on both ends with a cross bar running through the hooks, the top chord being rectangular in shape and reinforced as for a rectangular column.

For discussion of the use and design of reinforced concrete trusses, see p. 769.

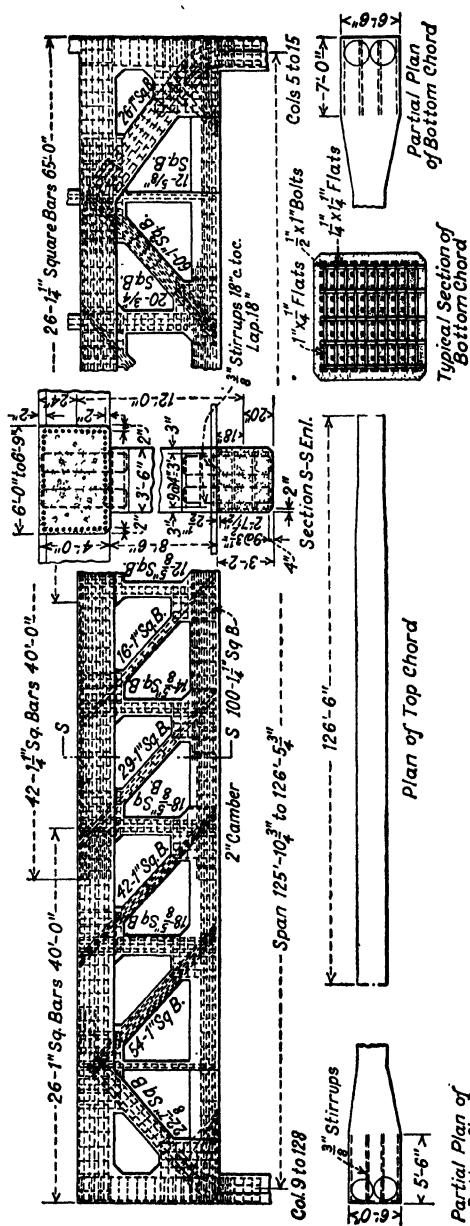

Fig. 221.—Roof Truss for Graumann's Theater in Los Angeles. (See p. 671.)  
Edwin Bergstrom, Architect.

## SAWTOOTH ROOFS

**Where Used.**—Sawtooth roofs are used in manufacturing plants where an abundance of light is required, but where it is necessary to avoid the glare due to direct sun rays and the consequent shadows. This is best accomplished by providing windows, facing north, in every or every other panel of the roof. The resulting construction is called sawtooth roof construction.

Sawtooth roofs may be built with the windows vertical or inclined. The construction of the roof with vertical windows is the simpler, and also makes it easier to keep the windows clean. However, the vertical window does not provide as much light as an inclined window of the same size, and for this reason inclined lights are in more favor with architects. The maximum inclination with the horizontal is governed by the requirement that at no time of the year direct rays should be permitted to enter the room. This angle depends upon the latitude and may be expressed by the following formula:

Let  $\alpha$  = inclination of the window with horizontal;  
 $a$  = latitude of the location.

Then

$$\alpha = 113^{\circ} 30' - a.$$

In the vicinity of New York,  $a = 41^{\circ}$ ; consequently, the angle of inclination is  $\alpha = 72^{\circ} 30'$ .

The angle between the window sash and the inclined slab will depend upon the desired size of the window and the depth to window sash. If possible, the angle should be made 90 degrees as this facilitates formwork.

**Types of Sawtooth Roofs.**—The sawtooth roof may consist of a frame, as shown in Fig. 222; or it may be provided with a horizontal tension member which resists the horizontal thrust produced by the inclined roof members. All intermediate beams should be parallel to the frame. Beams longitudinal with the skylight throw shadows on the underside of the slab, thus reducing the effectiveness of the light.

**Details.**—Special attention should be paid to details of the gutter, to make the windows weather-proof. The bottom of the window sash should be at least 18 in. above the gutter, on account of the possibility of snowdrifts. The gutter should be well drained. Down-spouts should be placed at frequent intervals. A gangway

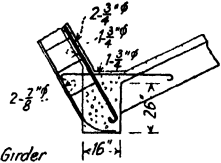
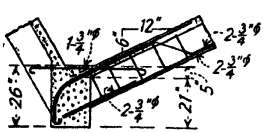
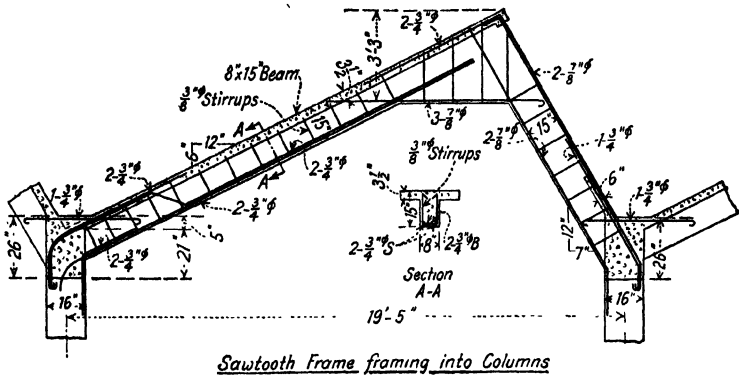

Intermediate Sawtooth Frame Supported by Girder

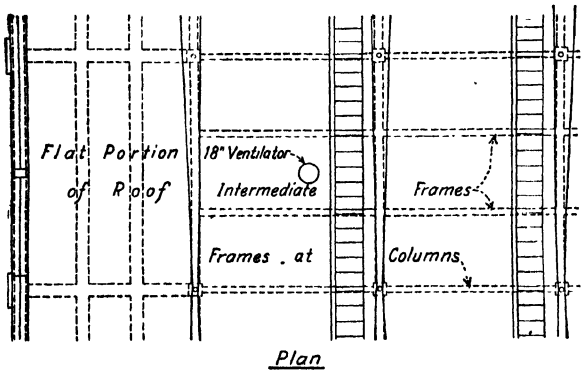

FIG. 222.—Details of Sawtooth Roof. (See p. 675.)

at least 2 ft. wide should be provided to facilitate the cleaning of the gutters. To prevent ice from closing the down-spouts, the under side of the gutters should be heated.

The details of roofing are shown in Fig. 223.

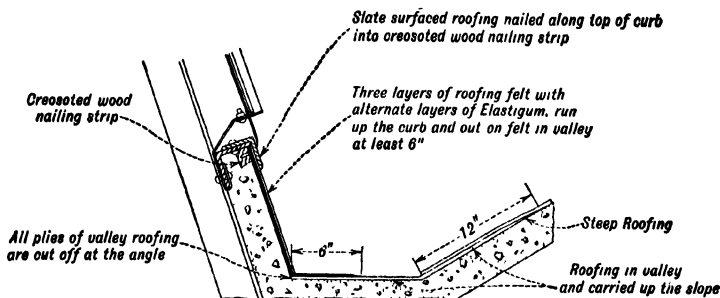

FIG. 223.—Details of Roofing for Sawtooth Roof. (See p. 677.)

### PRE-CAST CONCRETE ROOF TRUSSES

Pre-cast roof trusses were used for a shed of Pier 6, at Cristobal, Canal Zone. The shed is 945 ft. long and 159 ft. wide, and has a clearance under trusses of 25 ft. The arrangement of trusses is shown in Fig. 224, p. 678.

The construction is three panels wide. The main trusses, placed across the building, are 39 ft. long and 7 ft. deep, and are spaced 45 ft. on centers. They are supported by columns. The longitudinal trusses, 45 ft. long, 4 ft. deep, and spaced approximately 10 ft. on centers, are carried by the main trusses. A  $3\frac{1}{2}$ -in. slab is placed on the longitudinal trusses. The depth of slab is small for the 10-ft. span and is possible only because there was no snow load to be provided for. The design live load was only 10 lb. per sq. ft.

The design of the trusses is evident from Fig. 225, p. 679. The design of the pre-cast columns is also shown.

It is evident that the column on the top is provided with recesses to receive the cross trusses, as well as those longitudinal trusses which frame into the columns.

All the columns and trusses were pre-cast, and completed before being placed in position. Locomotive cranes were used in erection. Interesting details of the method of pouring the pre-cast members and erecting them are given in *Engineering News Record*, June 24, 1920, p. 1232.

## AUXILIARY STRUCTURES ABOVE ROOF

**Pent Houses.**—The enclosures surrounding the elevator machinery and the stair entrance to the roof extend above the main roof. The pent-house roof rests on the walls enclosing the pent house. In many cases, a large part of the pent-house roof is taken up by a skylight to provide light for the staircase or elevator shaft. If no

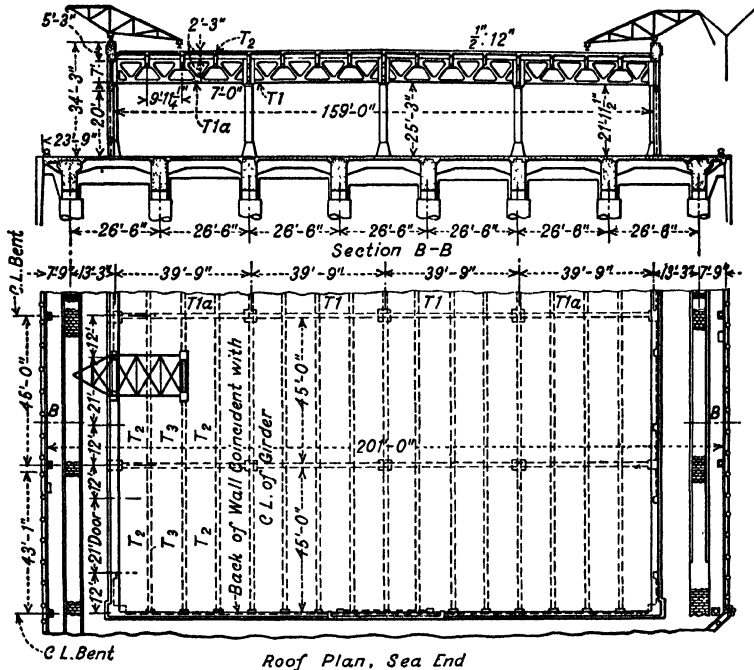

FIG. 224.—Partial Plan and Section of Pier 6 at Cristobal, Canal Zone.  
(See p. 677.)

skylight is required (as in staircases well provided with windows) the roof consists of a solid concrete slab.

The main roof construction must be made strong enough to carry the pent-house wall and roof. When the walls coincide with the outline of the opening, as is usually the case, the beams around the opening may be utilized to carry the pent house. Sometimes the location of the pent-house wall does not coincide with the location of the beams. Such designs should be avoided, because they require

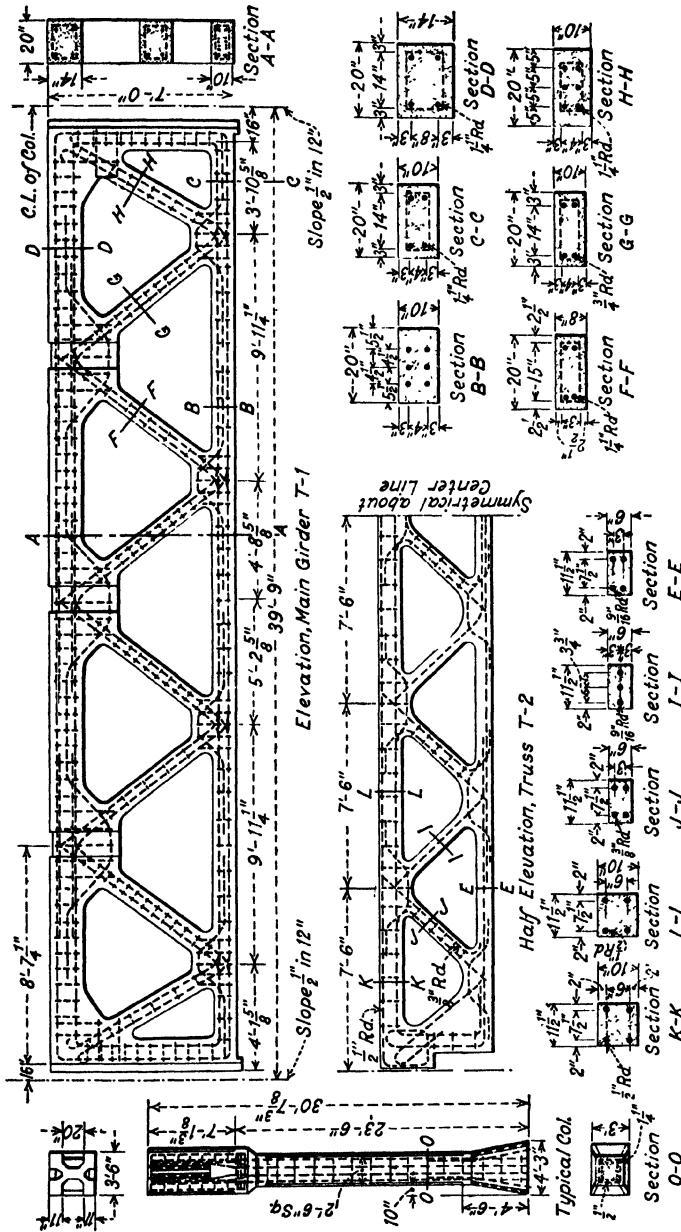

FIG. 225.—Details of Pre-cast Roof Trusses, Pier 6, at Cristobal, Canal Zone. (See p. 677.)



ROOF CONSTRUCTION

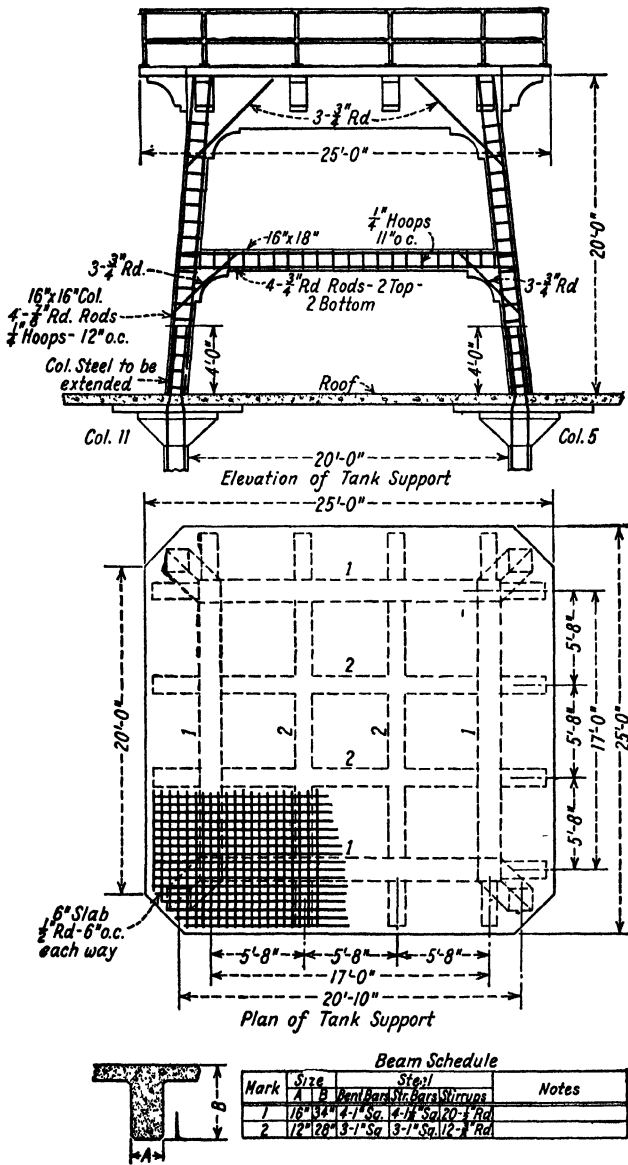

FIG. 226.—Water Tower. Clark Biscuit Co. at North Adams, Mass. (See p. 681.) Wm. Higginson, Architect.



Tower Roof Framing

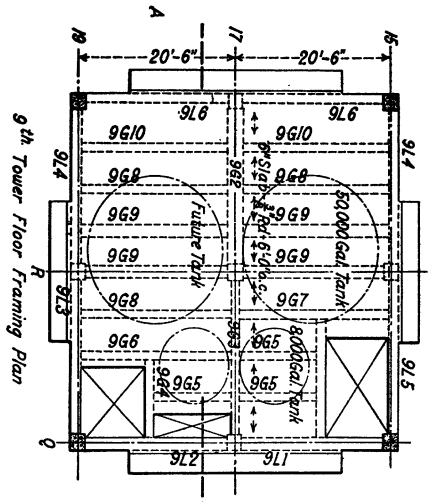
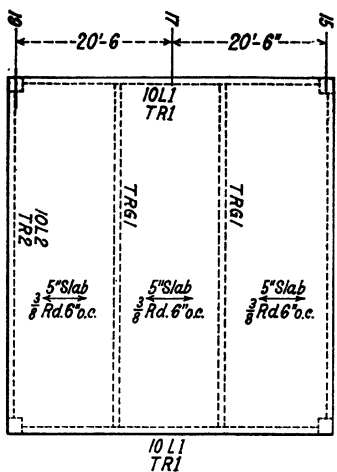
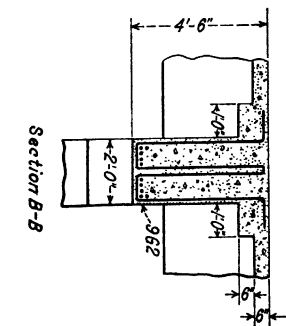
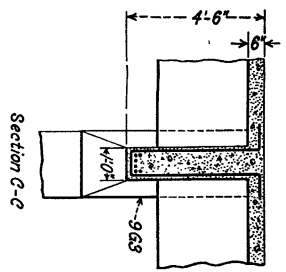
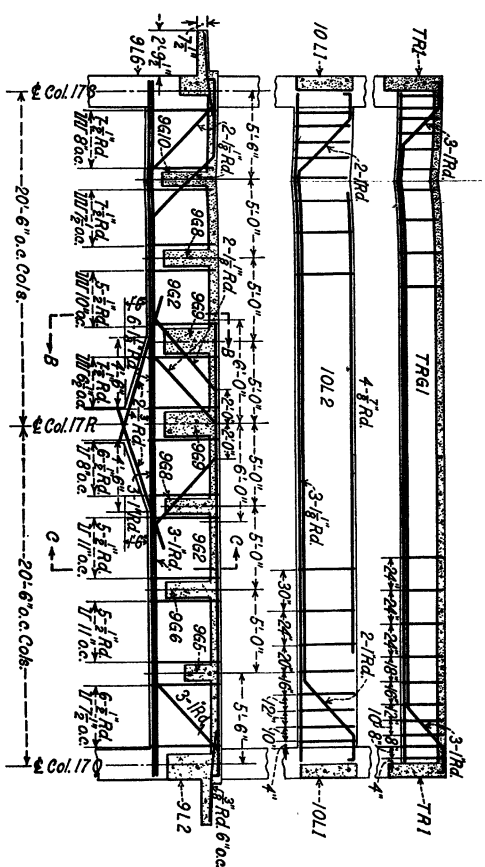

FIG. 228.—Details of Water Tower in Factory Designed for Bunite Bros. (See p. 661.)



Sectional Elevation A-A





## CHAPTER XIV

### STAIRWAYS, FIRE EXITS AND ELEVATOR SHAFTS

Stairs serve two purposes: first, they provide a means of exit in case of fire; second, they are used for travel from floor to floor.

In office buildings, tall hotels, warehouses, and factories, equipped with passenger elevators, the everyday use of the stairs is comparatively small. In such structures, stairways are required mainly for exit in case of fire. This purpose governs their number, location, and design. Occasionally, however, there may be considerable local movement between two adjoining floors, and special stairways, conveniently located, may then be provided. These special stairways need not be enclosed and do not form a part of the fire exits.

In private homes, schoolhouses, court houses, theaters, factories, and similar buildings without elevator service, the stairs serve mainly for everyday use. Their location is governed by convenience of movement from floor to floor, and their number may exceed that required for fire exits. The stairs required as fire exits should be enclosed. Others do not need fireproof enclosures.

Stairways are relatively expensive to construct. They also take up a large amount of space; hence, the tendency to use as few as possible. On the other hand, the proper number of stairs in proper locations may be of great value in the operation of the plant, or in the use of the building.

No general rule is possible for cases where the stairs are designed for constant use. The conditions in each building should be thoroughly studied before the location and number of stairs is decided upon.

Rules for design of stairs as fire exits are more general. They will be treated below.

**Fire Exits.**—There are two recognized means of exit from a building in case of fire: first, horizontal exits through or around a fire wall; second, stair exits. Stair exits may be used alone or in combination with horizontal exits.

**Horizontal Exits.**—These are exits through a fire wall, a fire exit partition, or a fireproof wall separating two buildings. The exit may lead to another building or to another part of the same building. It should be provided with a self-closing fire door (i.e., a door normally kept closed by some mechanical device) not less than 30 in. wide, the actual width depending upon the number of persons for whom the exit is intended. Horizontal exit also may be effected around a fire wall or a wall separating two buildings, by means of a balcony or an exterior bridge connecting two buildings or two parts of the same buildings. The balcony or the bridge should be at least 44 in. wide and constructed of incombustible material. It should be enclosed or provided with railings at least 4 ft. high. All doorways opening on the balcony or the bridge must be provided with self-closing fire doors. All window openings within 10 ft. of the balcony must be protected by fire windows. The purpose of these precautions is not only to protect adjoining buildings from fire, but also to prevent the entrance of smoke which would make the exit useless. There should be no obstruction on the balcony or the bridge. If the floors of the connected buildings are on different levels, gradients of not more than 1 ft. in 6 ft. should be provided.

While the horizontal exit is considered more effective than the stair exit, its usefulness depends upon conditions over which the designer of the building usually has no control. For instance, the adjoining buildings may belong to another owner and may not be available for a horizontal exit. This prevents their being used as often as the stair exits.

**Stair Exits.**—Stair exits may consist of enclosed interior stairways, smoke-proof towers, or outside stairways.

**Number of Exits Required.**—The requirements as to the number of fire exits in a building differ to some extent in the building codes of the various cities. In some codes, such as that of Chicago, the number is based upon the area of the building; while in other codes it depends upon the number of persons occupying the various floors of the building. The latter method is the more logical of the two, because if the capacity of each exit is known or assumed, their number will be governed by the number of persons who are expected to use them.

The building code, if applicable to the building, should be studied first. Where no code applies, the following suggestions may be adopted.

In all business buildings, at least two fire exits should be provided from every floor above the first, irrespective of the number of occupants of the floor. One of these should be a stair exit, while the other may be a horizontal exit. The exits should be arranged so that no part of any floor area shall be more than 100 ft. distant from a horizontal exit or an entrance to a staircase. Additional exits should be used if the number of occupants of any one floor served by the exits exceeds the capacity of two exits.

In all fireproof buildings that are more than three stories high, or occupied by more than fifty persons above the first floor, at least one of the stairways should be continuous and in fireproof enclosure. This should lead either to the street, alley, or open court, or to a fireproof corridor of proper width leading to the open air.

In all buildings over 90 ft. in height, one of the stairways should be a smoke-proof stair tower.

**Capacity of Stairways.**—It is a well-established principle that the capacity of the stairways as fire exits should be such that they may accommodate at one time all the persons engaged in the building. If horizontal exits are used, the number of persons to be taken care of by the stairways may be reduced proportionally. In determining the number and the width of stairways, the largest floor area served by them should be considered. The persons occupying such floor area should find accommodation in the staircase between their floor and the floor next below. The number of stairways, where the persons are distributed uniformly over each floor area, is determined by dividing the total number of persons per floor by the capacity of the stairways. Concentrated groups of persons or separated rooms may necessitate extra accommodation.

In determining the capacity of the stairways, it is necessary to make assumptions based on judgment. The rules adopted by various building codes naturally vary and only designate minimum requirements.

The New York Code allows per person on the stairs, a 22-in. width of stairs and one and one-half treads; and on the landing and in the hall within the staircase,  $3\frac{1}{2}$  sq. ft. of area. If, in addition, a horizontal exit is used, stairways need to be provided for only one-third of the persons occupying the floor under consideration. In an automatically sprinkled building, stairways for only one-half of the persons per floor need to be provided. When an automatically sprinkled floor is also provided with a horizontal exit, stairways

need to be provided for one-quarter of the number of persons occupying the floor. In no case, however, should the number of fire exits per floor be smaller than two, one of which must be a stair exit.

The National Board of Fire Underwriters recommends a somewhat simpler rule. The capacity of the stairway per floor may be considered as equal to fourteen persons for each 22-in. width of the stairway, plus one person for each 3 sq. ft. of the floor area of the hallway within the staircase of the floor under consideration and of the area of the stair landing between the floor under consideration and the next floor below. If the building is provided throughout with automatic sprinklers, twenty-one persons may be allowed, in the above rule for each 22-in. width of stairways.

Most of the modern codes agree as to the requirement that a width of 22 in. of stairs should be allowed for each person. The total width of the stairs must, therefore, be a multiple of 22 in., with a minimum of 44 in.

**Enclosed Staircases.**—In fireproof buildings, the staircases used as fire exits should be enclosed by fireproof partitions. The doorways leading to the staircase should be provided with self-closing fire doors. The unobstructed width of the stairs, landings, and hallways, within the staircase, should be at least 44 in. If a larger capacity is required, the stairs may be increased in width by increments of 22 in. This means that a minimum width of 22 in. is required per person. In a stairway 44 in. wide, two rows of persons can be accommodated. For three rows, the width must be 66 in., and for four rows 88 in. The open side of the stairs must be provided with substantial balustrades.

Hand rails should be provided on both sides of the stairs, and are allowed to project into the minimum width, if such projection does not exceed  $3\frac{1}{2}$  in. Stairs 88 in. wide should have an additional hand rail in the middle. The staircase should be free from any other possible obstruction. Winding stairs are absolutely prohibited in staircases serving as fire exits. At least one stairway should extend to the roof. The New York Code requires that if there are more than two staircases, at least two of them shall continue to the roof. An appropriate pent house built of brick or concrete should be provided above the roof.

The stairway should lead, in line of direct travel, to a street or open alley or to a hallway leading to a street. The hallway must be enclosed by fireproof partitions. The width of the hallway should



be sufficient to accommodate all who may use the stairways leading to it.

It is important that balconies, used as horizontal exits, be kept free. In winter, all snow must be removed from them.

**Scuttles.**—If no other provision is made for reaching the roof, scuttles should be provided, with a substantial iron ladder fixed in place. Scuttle opening should be at least 2 ft. by 3 ft.

**Smokeproof Stair Towers.**—In tall buildings, one of the enclosed staircases is required to be a stair tower. The height of the building requiring this differs in different codes.

The National Board of Fire Underwriters requires a smoke-proof tower or a horizontal exit for buildings over 90 ft. in height

The New York Code requires smoke-proof towers for buildings exceeding 85 ft. in height. In buildings provided with automatic sprinklers, this limit is raised to 125 ft.

A smoke-proof tower is similar in design to an enclosed staircase, except that the doors leading from it do not open directly into the building but on to an open balcony. The door leading from the building also opens on the same balcony. Both doors are self-closing fire doors. Such an arrangement is seen in Fig. 229, p. 687. The advantage of this arrangement is obvious. The staircase, having no connection with the building, cannot be filled with smoke.

## LAYOUT OF STAIRS

**Arrangement of Staircases.**—From a structural standpoint, it is advantageous to place the staircases in corner panels or wall panels, as such location offers the least interruption to the floor construction. also, the outside walls are then part of the enclosing walls of the staircase.

When elevators are used, the staircase may be advantageously placed next to the elevator wall. Very often, it is possible to accommodate the elevators and the staircase in the same floor panel, thus interfering less with the typical design of the floor construction. Some of the enclosing walls also serve for enclosing the elevator and the staircase.

In many cases, the staircase and the elevator wall are placed outside of the area of the floor, as in Fig. 230. Although this arrangement requires more walls, it simplifies the floor construction.

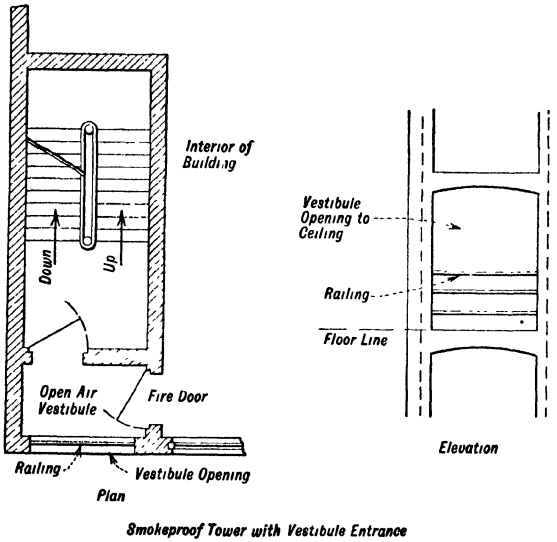
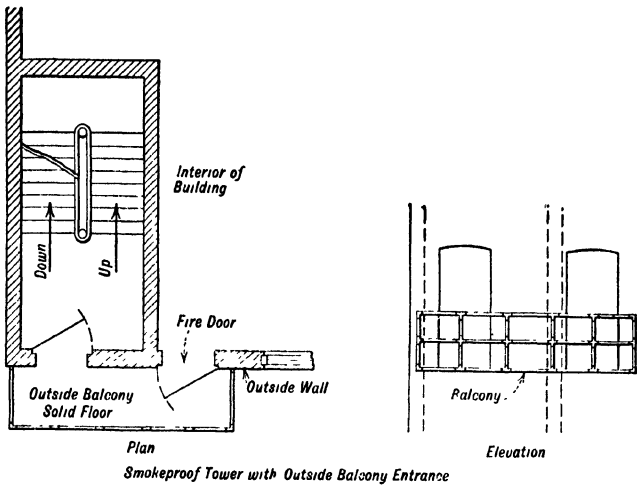

FIG. 229.—Smokeproof Stair Towers. (See p. 686.)

In factories, the stairs are placed in the service portion next to the lockers and lavatories. This section is usually separated from the working area of the floor.

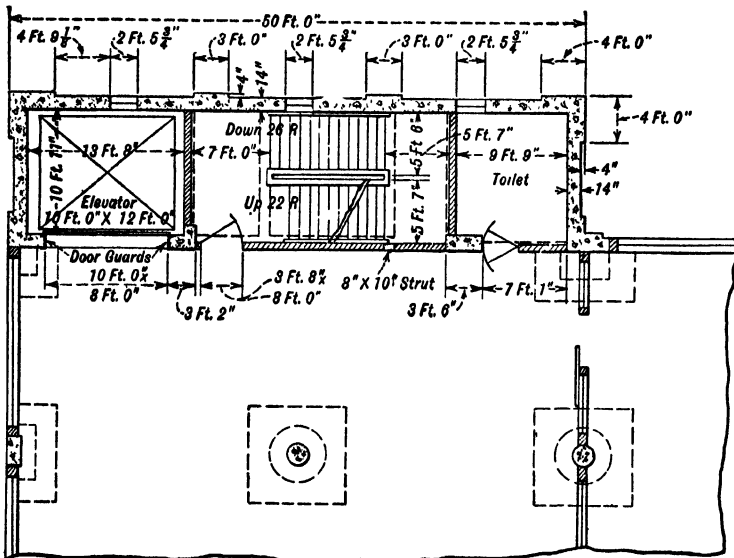
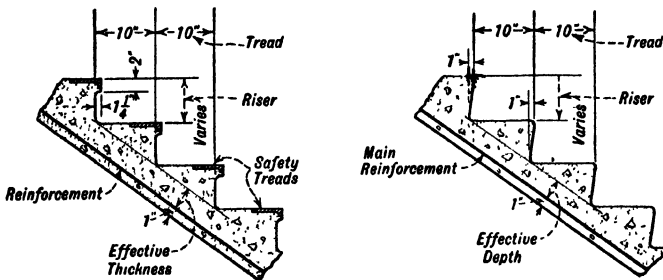

FIG. 230.—Staircase Placed Outside of Floor Area. (See p. 687.)



Details of Stairs

FIG. 231.—Details of Treads and Risers. (See p. 688.)

**Treads and Risers.**—The dimensions of the treads and risers will vary with different types of buildings.

In commercial buildings, the width of tread, exclusive of the nosing, measured as shown in Fig. 231, p. 688, may vary from 9½ to

10 in. The latter figure should be used in all stairs serving as fire exits and also in all stairs that are much used. Secondary stairs, such as those leading to the basement, may have 9-in. treads. It is a well-established rule that the same width of tread should be used throughout the staircase. An exception is sometimes made for stairs leading to the second floor, which are used oftener than the rest, by giving these a wider tread and a smaller rise, as well as greater total width.

The height of the riser, measured as shown in Fig. 231, p. 688, should be as near 7 in. as possible, and should not exceed  $7\frac{3}{4}$  in. The height of the riser is obtained by dividing the distance from finished floor to finished floor by the desired number of risers; and the same height should be used for all risers, even if it happens to be an odd fraction. If the floor heights in a building vary, the heights of risers may have to vary, but this variation must be as small as possible.

Special study should be made of the relation of tread to riser, for stairs in constant use, particularly in schoolhouses. If the width of the tread is increased, the height of the riser should be correspondingly decreased.

For ease of travel, as well as for appearance, the tread should be provided with a nosing, as shown in Fig. 231, p. 688.

**Slope of Subsidiary Factory Stairs.**—In addition to the regular stairs between floors, short stairways are frequently required in the operation of a factory. There is always a tendency to make these stairs too steep. Not only is this tendency observed in cases where it is necessary to avoid occupying too much space or to get in between machinery, but one often finds stairways, leading to a balcony or platform, so steep as to interfere with rapidity and convenience of travel. This may cause serious loss of time, in case of accident or breakdown of the machinery reached by the stairs.

Where space permits, short flights of stairs of this kind should have the same rise and tread as stairs between floors. If this is impracticable, one should adopt the rule, based on many years of practical experience, on the part of the authors, in factory operation and maintenance, that the slope of such subsidiary stairs be limited to 45 degrees. If this rule is made inflexible, some way will be found by the maintenance department to follow it. Stairs steeper than this are scarcely, if any, better than a permanent ladder, which occasionally must be put in. When ladders are unavoidable, spacing of rounds should be 12 in.

**Runs and Platforms.**—Runs or platforms, designed to give access to shafting or pulleys, or to facilitate the operation of machinery, should be built with at least  $6\frac{1}{2}$  ft. head room to avoid the necessity of stooping. If obstructions make it impossible to allow this head room, short stairs should be built down and up again into the run, since it is less tiring and safer to walk up and down stairs than to stoop or bend.

**Intermediate Landing.**—If the story height is more than 8 ft., the stairs should be provided with an intermediate landing. (Some codes allow single flight stairs for story heights up to 12 ft.) The width, i.e., the smallest dimension of the landing, should be the same as the width of the stairs. In straight runs of stairs (i.e., when the stairs, the landing, and the next flight of stairs are in line), the horizontal distance between risers should be 44 in.

**Live Load.**—All stairs, landings, and hallways should be designed for a live load of not less than 100 lb. per sq. ft.

### STRUCTURAL DESIGN OF STAIRS

**Two-flight Stairs.**—Figure 232 shows the most common arrangement of stairs in industrial buildings. The stairs between two floors consist of two flights with an intermediate landing. They may be designed by any one of the three methods described below. In each case, an inclined slab is used, with flat lower surface and with treads and risers formed on the top of the slab and integral with the slab.

**First Method.**—The inclined stair and the landing slab are considered as one slab, spanning between a beam at the floor level and a landing beam placed at the outside edge of the landing. (See Fig. 232, p. 692.)

For designing purposes, the span of the slab is assumed to be equal to the horizontal distance between the two supporting beams. It is then designed as if it were a straight slab.

The live load is taken at 100 lb. per sq. ft. of the horizontal projection of the slab. The unit dead load of the stair portion equals the total weight of stairs divided by projected horizontal area.

Since the stairs are usually poured separately from the rest of the building and are joined to the floor only by stair-dowels, the slab should be considered as simply supported, using  $M = \frac{1}{8}wl^2$ . The thickness of the slab is determined from Formula (11), p. 208.

This thickness in the inclined portion is measured on a line at right angles to the bottom surface, from foot of riser to bottom of slab. It is marked  $t$  in Fig. 232.

The reinforcement is placed at the bottom, longitudinally with the slab. Some of the bars are bent up and hooked at the landing beam, to prevent cracks due to negative moment. This is an important feature, though often neglected.

Cross reinforcement should be used to prevent temperature cracks. As a rule, a  $\frac{3}{8}$  bar should be placed in each riser, and three or four bars of the same diameter in the landings.

*Landing Beam.*—The landing beam, marked B3 in the figure, is designed to carry the reaction of the stairs and any wall load that may come on it. It may be suspended from the floor beam above, or supported by short piers resting on beams below.

In wall-bearing jobs, where the outside walls of the staircase are bearing walls, the edge of the landing may be supported on the wall. No landing beam is then required.

**Second Method.**—Beams are placed at both sides of the landing, as shown in Fig. 232, p. 692. The inclined stair slab is then designed as a slab supported by beams B1 and B2; the span is the horizontal distance between beam B1 and the center line of beam B2, and the loads are determined as in the first method. The slab may be considered as partly restrained at beam B2, which permits the use of bending moment  $\frac{wl^2}{10}$ . Thickness of the slab in the inclined portion is as explained in the first method.

The reinforcement is placed longitudinally at the bottom. Part of the steel may be bent up at beam B2 or special short bars, placed near the top surface of the slab, may be used.

Cross reinforcement should be used as explained above.

*Landing Beams.*—Landing beams should be designed as explained above, for the proper loads. They may be suspended, or supported by short columns. In wall-bearing jobs, beam B2 may be supported by the side walls. Beam B3 may be omitted, and the edge of the landing slab rested on the end wall.

**Third Method.**—In this method, the landing beam B2 is retained, but B3 is omitted. The inclined slab is then supported by beams B1 and B2, while the landing slab acts as a cantilever of the inclined slab.

The slab is designed as follows: The landing slab is considered as

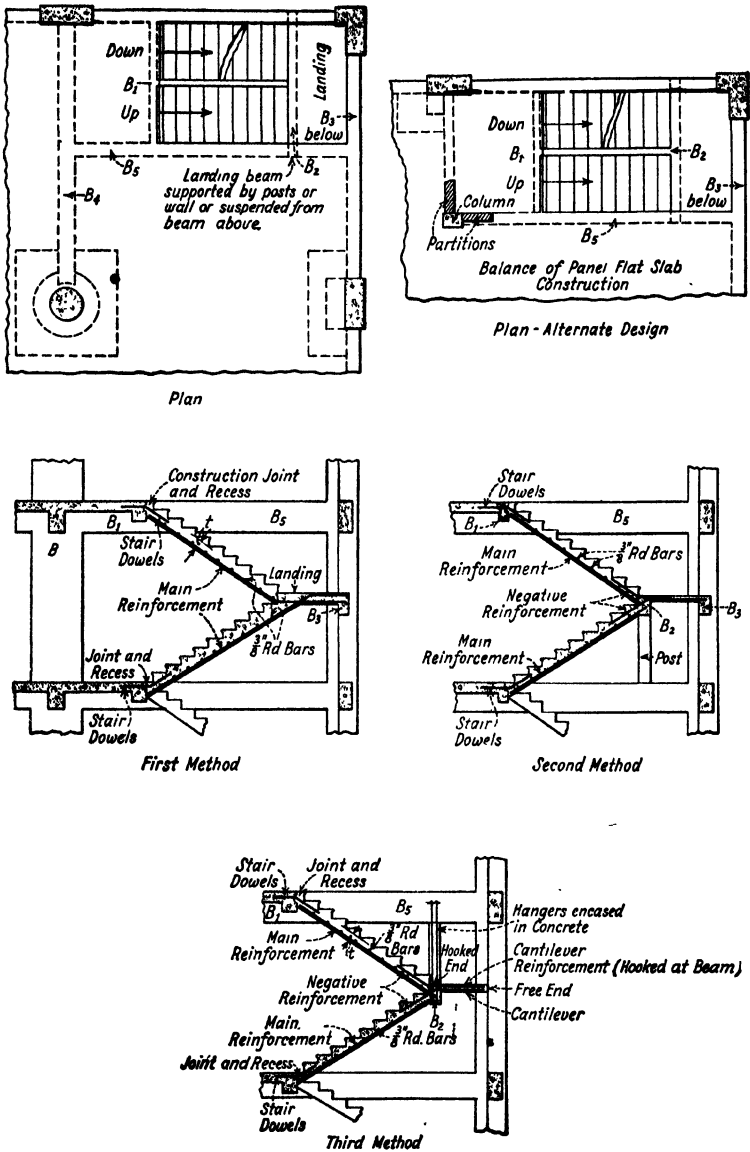

FIG. 232.—Structural Details of Stairs. (See p. 690.)

a cantilever loaded by the dead and live loads on the landing and the wall load, if any. The load produces a negative bending moment in the slab, with a maximum at the edge of beam B2. The inclined stair slab is considered as a slab supported by beams B1 and B2. The span and the loading are determined in the same manner as for the first method. In figuring the bending moment, the moment produced by the cantilever should be taken into account, and two conditions must be considered: one with cantilever fully loaded, which produces maximum negative bending moment; and the other with cantilever loaded only by the dead load, which gives maximum positive moment.

Reinforcement and thickness should be determined for all sections of the slab, the thickness of the inclined slab, as in previous cases, being measured on a line at right angles to the bottom of the slab.

The reinforcement should be arranged as follows: Some of the bars should run full length at the bottom and extend to the outside edges of the cantilever slab. The rest should be bent up at about one-fifth of the inclined span and extended near the top to the outside edge of the cantilever slab. If necessary, additional short bars should be placed near the top to supply the required amount of steel in the cantilever.

The top reinforcement should be properly supported by blocks or chairs. It must be remembered that the cantilever slab relies entirely for its strength upon the top reinforcement. Any misplacement of this would materially reduce the capacity of the slab. Short rods should extend a sufficient distance from the cantilever into the inclined slab to develop full strength of the bar in tension.

*Landing Beam.*—The landing beam must be made strong enough to carry all the load coming upon it. This will comprise the reaction of the inclined slab, consisting of one-half of the load upon it; the reaction of the cantilever, equal to all the dead and live load; and the reaction of the wall (if any). To these should be added the reaction produced by the cantilever, which equals the maximum bending moment on the cantilever divided by the horizontal span of the inclined slab. As in previous cases, the landing beam is either suspended or supported on short piers or side wall.

**Three-flight Stairs.**—Stairs are often constructed with three flights, as shown in Fig. 233, p. 694.

The construction between two floors consists of three inclined slabs provided with two intermediate landings.



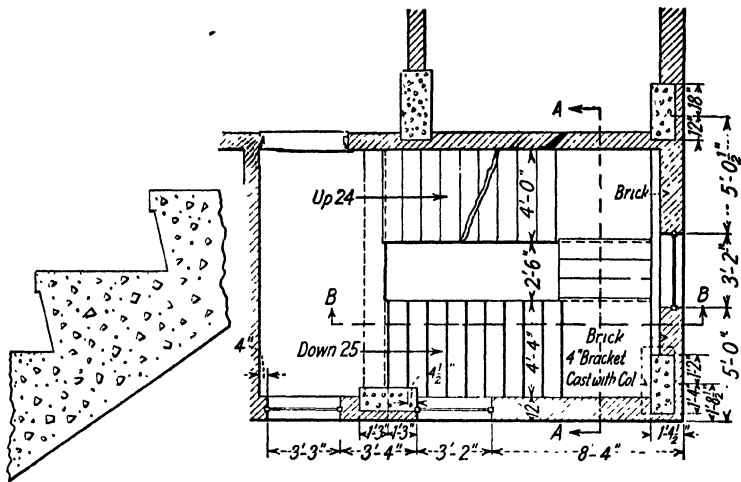

Detail of Stair Tread and Nosing

Plan of Second Floor

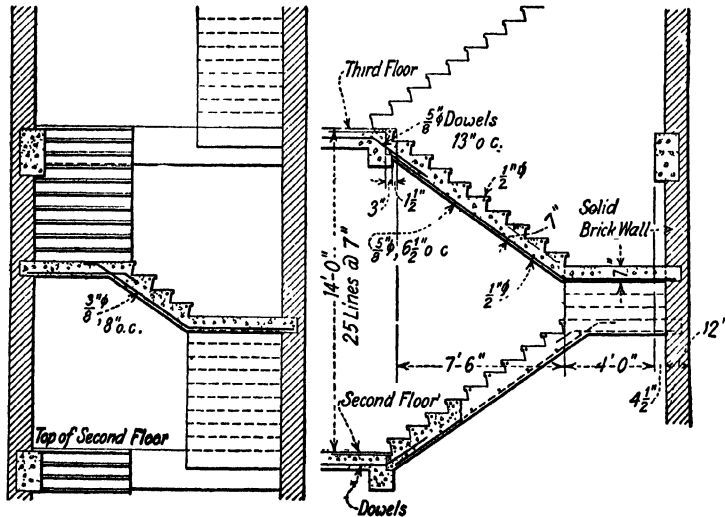

Section on Line A-A

Section on Line B-B

FIG. 233.—Stairs with Three Flights. (See p. 693.)

In the typical design shown in Fig. 233, the stairs are supported by a floor beam and by the brick work at the landings.

The two main sections are considered as slabs simply supported by the floor beam and by the wall. The reinforcement should extend the whole length of the slab to the edge. As shown in Fig. 233, in flights leading from the beam to first landing the bars are not continuous but are lapped at the juncture of the inclined slab and the landing. A continuous bar would have to be bent there in such a way that under tension there would have been a tendency of the bars straightening by pushing out the concrete in front of them.

The third section may be considered as spanning between the walls. Sometimes the landings have no support on the sides. Then for designing purposes, the third section is considered as a simple slab supported by the landings. There is no definite point of support. The length of the span to be used in computations must therefore be determined by judgment. Ordinarily, this may be taken as the horizontal projection of the inclined slab plus 2 ft. The bending moment is found from formula  $\frac{wl^2}{8}$ . The reinforcement should be extended on the bottom from the outside edge of one landing to the outside edge of the other landing, thus providing for any cross bending in the landing.

The two main sections are considered as simple slabs supported by the beam on one end and by the wall on the other end. These slabs should be designed for the load on the slab plus the reaction of the third section. This reaction may be considered as distributed over the whole width of the landing. The reinforcement should extend the whole length of the slab to the edge of the landing.

Cross bars should be provided in the treads, as in the other case.

### SPECIAL DESIGNS OF STAIRS

Stairs may also be constructed by providing beams at the edges and then supplying a thin slab between the supporting beams. Such construction is seen in Fig. 204, p. 630.

### ELEVATOR SHAFTS

The elevators should be placed in groups and where possible near the staircase thereby reducing the number of places where the continuity of the floor is interrupted. Where staircase is placed

outside of the building, as shown in Fig. 230, p. 688, the elevator shafts should also be so placed.

Elevator shafts always require special framing. To simplify the construction, they should be located in such a way as to get the simplest framing possible. Sometimes the cost of framing may be reduced by introducing additional columns at the corners of the shaft. This is particularly advantageous in flat slab construction, because it avoids framing of beams into main columns which requires cutting of forms for column heads. The supplementary columns, of course, must be placed outside of the shaft.

Sometimes the enclosing concrete walls of the shafts are made strong enough to act as bearing walls, thereby saving the cost of framing.

The size of the shaft must be large enough to accommodate the elevator car with the clearances required by the manufacturer. The shafts must be built with care. All beams must be plumb under each other, otherwise the clear space of the shaft is reduced. To prevent accidents, the gate sills should be provided with a nosing projecting into the shaft. Usually the sills are also provided with safety treads.

*Elevator Pit.*—A pit at least 3 ft. 6 in. deep must be provided below the lowest floor served by the elevator. For all elevators serving the basement, the bottom of the pit is below the basement slab. Sometimes elevators stop at the first floor, in which case the pit may be provided by depressing the first floor a proper distance.

The pit must have the same clear dimensions as the balance of the shaft. Therefore, no part of the footings or columns must project into the pit.

Ordinarily the pits are supported by the ground. The sides and the bottom slab are made 6 in. thick and are properly reinforced to resist earth pressure and also to prevent temperature cracks. Where the ground is not capable to support the construction the pit walls must be carried to the columns or supported on piles. Special anchorage is required when there is possibility of upward water pressure.

When built below water level, the pit should be waterproofed.

*Pent House.*—The construction above the elevator shaft is called the pent house. This contains the supports from which the elevator is suspended and for modern elevators also the elevator machinery. The pent house, usually above the roof is properly enclosed and



covered with a sky-light. The size of the pent house depends upon the disposition of the machinery. Also there must be enough room in case of necessary repairs or replacements.

The beams in the roof must be made strong enough to carry the weight of the pent house walls and roof and also of the elevator, counterweight and elevator machinery. These weights are usually heavy and must be well taken care of. To take care of the elevator loads 100% must be added to the actual loads for impact.

Grating of proper strength must be provided below the machinery.

**Example of Elevator Shaft.**—Details of elevator shaft are shown in Fig. 234, p. 697. This also shows the position of sheave beams and the reactions for which the supports must be figured. The loads given include an allowance for impact.

## CHAPTER XV

### STEEL WINDOW SASH

Steel window sash is used in the majority of commercial reinforced concrete buildings. The width of concrete pilasters is often determined by the width of the window opening, which in turn is governed by the dimensions of the standard window sash. The dimensions of the recesses to be provided in the concrete are also fixed by the sash. Therefore, to do this work intelligently, the designer should familiarize himself with the design of the window sash, its standards, and the methods of erection of sash in the buildings.

**Standards of Window Sash.**—The dimensions of sash are standardized as to design and dimensions, and sash of other dimensions than the standard can be obtained only at a considerably larger cost. Dimensions of windows therefore should be suited to standard sash.

**Steel Sections Used for Window Sash.**—Window sash is built of specially rolled, solid, low-carbon steel sections. These are strong and rigid enough to withstand all the strains to which the sash is subjected in handling and in use. The sash frame, however, is not strong enough to carry any brickwork above the window.

The following sections are used in window sash:

*Angle frame members*, or outside rails compose the frame of a sash unit.

*Muntins* are sections placed horizontally and vertically between the frame members.

*Weathering members* are used at the ventilators to make the sash weather-tight.

*Mullions* are sections used in connecting sash units to form a complete sash.

**Composition of Sash Units.**—A steel window sash consists of one or more sash units. The rectangular frame for each sash unit is built of four angle frame members. Between these, muntins are placed horizontally and vertically so as to divide the frame into the

required number of lights. A sash unit is often provided with a ventilator. Fig. 235, p. 701, shows a sash unit and the cross section of the various steel sections composing it, and also the construction of the ventilator.

As evident from the figure, the ventilator is a specially constructed small frame with the top and bottom of regular angle frame sections. The sides of the ventilator frame consist of muntins, to which, above the pivots, are attached steel weathering members. The top and bottom of the opening in the sash unit, to receive the ventilator frame, are built of angle frame members, and the sides consist of muntins with weathering members attached on the inside of the sash below the pivots. The hinges of the ventilator frame project beyond the plane of the sash; in some designs the hinges form a part of the weathering members. In other designs they are part of members that are double riveted to the ventilator and the fixed sash.

The pivot passing through the hinges is placed 2 in. above the center of the ventilator opening, to insure proper balance. The ventilator is operated by either stay bars or chains. The stay bar is attached to the ventilator at the bottom and is provided with notches to permit any degree of opening, and when not in use it is locked to the frame by a catch. When the ventilator is provided with chains, a catch is attached to the bottom member of the ventilator and a pulley to the top, while a clip is attached to the main frame to hold the chain.

**Composition of Window Sash.**—A complete window sash may consist of several sash units, all of which are of the same height but not necessarily of the same width. The units are connected by T-shaped mullions (see Fig. 235, p. 701), each mullion being bolted on both sides to the vertical frame members of two adjoining sash units. To allow for adjustments in any direction, the holes in the mullion, which correspond to the holes in the frame member, are oblong in vertical direction, while those in the frame are oblong in horizontal direction. The mullion extends at the top to the edge of the opening, and at the bottom its flange extends to the bottom of the sash member, while its stem extends down 2 in. below the window opening. (See Fig. 237, p. 703.)

**Relation of Wall Openings to Sash Dimensions.**—As will be noted from the details, the sash is secured in the window opening of a concrete building by grouting in a part of the flanges of the frame

members and the lower portions of the stem of the mullion. The size of the window opening, therefore, differs from the outside dimensions of the sash; but to avoid confusion, the sash is always designated, not by its outside dimensions, but by nominal dimensions which correspond directly to the size of the window opening. In a window consisting of a single sash unit, the wall opening is identical with the nominal dimension of the sash unit. For windows consisting of multiple sash units, the width of the opening is equal to

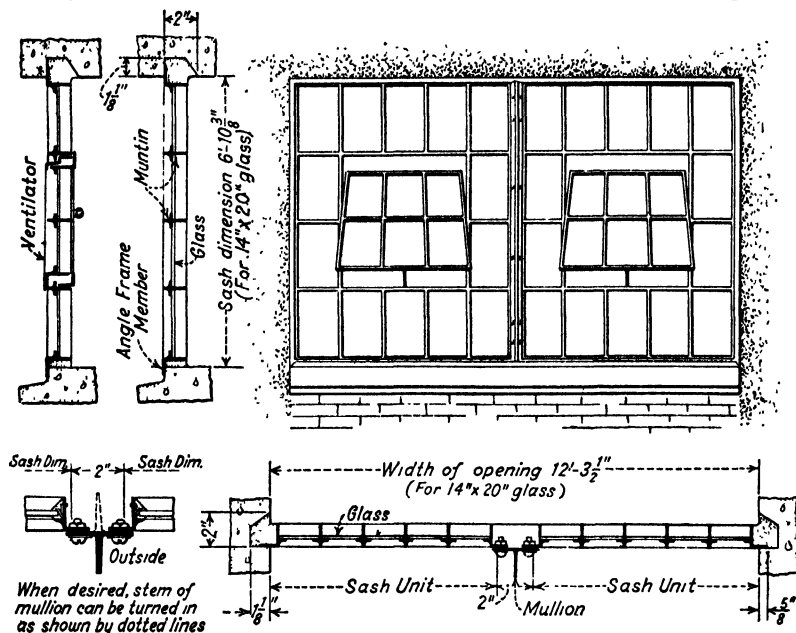

FIG. 235.—Window Sash. (See p. 700.)

the sum of the nominal widths of all the sash units, plus 2 in. for each mullion. In Fig. 235, a horizontal section through a sash illustrates the relation between the opening and the sash dimensions. The relation of the various parts is evident.

The relations between the parts of the sash and the total dimensions are as follows:

$a$  = distance, center to center, of muntins = width or height of glass plus  $\frac{3}{8}$  in.;

$A$  = distance, center to center, of inside leg of frame members =  $a$  multiplied by number of lights.



Width of sash unit =  $A + \frac{7}{8}$  in.

Width of opening = sum of widths of all sash units, plus 2 in. multiplied by the number of mullions.

Height of opening =  $A + \frac{7}{8}$  in. (in figuring  $A$ ,  $a$  is height of glass plus  $\frac{3}{8}$  in.).

**Recesses for Receiving Sash.**—In concrete and brick construction, some of the frame members extend into the concrete or brickwork and are secured therein by grouting. In concrete, the necessary recesses or grooves are formed by nailing, to the formwork of the beams and columns, strips of wood of proper dimensions. (See Fig. 236*b*, below.) These strips are removed after the concrete has hardened, and form the required recesses in the concrete. In brick wall, the frame angles are inserted into a groove between bricks, as shown in Fig. 236*a*, below. For windows consisting of a single unit, 1 inch reveal is required at the jamb, as shown in Fig. 236*c*.

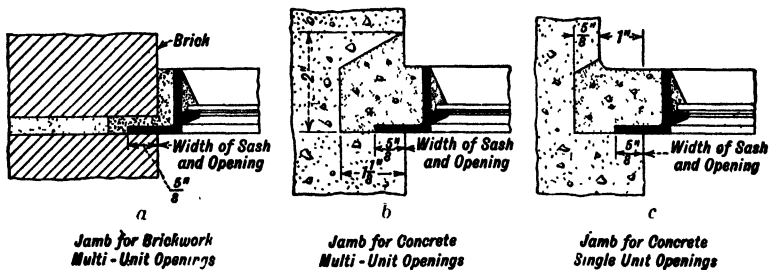

FIG. 236.—Details at Jamb. (See p. 702.)

**Erection of Sash.**—The sash comes to the job in fully assembled units. Each unit is placed in position separately, the units next to the jamb being set first. The top flange is moved into the top recess, and the side flanges of the frame are moved into the groove or recess of the jamb, and the remaining units are then set with their mullions. The mullions are first loosely bolted to two adjoining frames, the flange of the mullion always being placed outside of the frame. The stem of the mullion, in concrete construction, may be placed either outside or inside of the sash, as desired.

When sills are built in place, the brickwork or concrete of the spandrel is erected only to the bottom of the sill. The sash is then set and is supported at the bottom on blocks of proper depth, which should be placed at the corners only, to prevent distortion of the

sash. After all units are assembled, the window is lined up and plumbed. The mullion bolts are tightened and the sash is securely wedged against the jamb and the head. The sill is finished, and then all recesses are grouted. To keep the sash in place, wall ties are attached to it and concreted into the sill. (See Fig. 237, p. 703.)

If stone or pre-cast concrete sills are used, they should be placed before the erection of the sash is begun. The sill should be provided with horizontal grooves for the stem of the mullions, and also with holes for expansion bolts for fastening the sash to the sill. The sash is erected from the inside. In setting, the top of the sash is first inserted into the groove or recess in the head. The sash is then

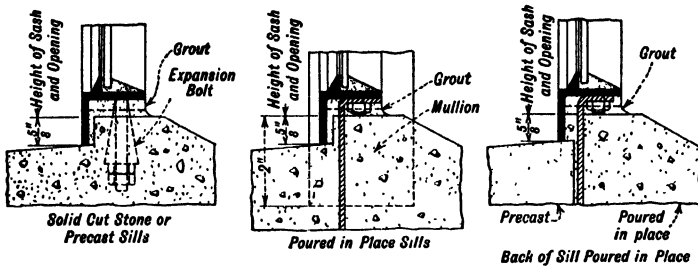

FIG. 237.—Details at Sills. (See p. 703.)

lifted sufficiently to clear the sill completely, and swing in position. Often, the sill is made of two parts, the outside part of stone, with the inside part cast in place. The stone sill is placed before the erection of the sash is begun. After that, the erection proceeds in the same manner as with cast-in-place sills. (See Fig. 237.)

**Painting.**—Sash is always painted with one coat at the factory. After erection, the sash should receive two additional coats.

**Glazing.**—The lights are inserted from the inside after the sash is erected. The glass is held in place by wire clips, four per glass. It should be carefully back-puttied in such fashion that the glass does not touch the steel. Putty is also applied on the inside. Special putty is used for steel sash.

## Symmetrical Combinations of Sash

Glass Sizes				Number of Lights in Total Width of Opening	Number of Sash Units to Fill Opening	Number of Lights in Each Unit
12"×18"		14"×20"				
Lights High	Height Dimension	Lights High	Height Dimension			
1	1' 7 $\frac{1}{4}$ "	1	1' 9 $\frac{1}{4}$ "			
2	3' 1 $\frac{3}{8}$ "	2	3' 5 $\frac{3}{8}$ "			
3	4' 8"	3	5' 2"			
4	6' 2 $\frac{1}{2}$ "	4	6' 10 $\frac{3}{8}$ "			
5	7' 8 $\frac{3}{4}$ "	5	8' 6 $\frac{1}{4}$ "			
6	9' 3 $\frac{1}{4}$ "	6	10' 3 $\frac{1}{8}$ "			
The over-all widths shown below may be had in any of the above heights.		The over-all widths shown below may be had in any of the above heights.				
3'	2"	3'	8"	3	1	3
4'	2 $\frac{1}{4}$ "	4'	10 $\frac{1}{4}$ "	4	1	4
5'	2 $\frac{1}{2}$ "	6'	0 $\frac{1}{4}$ "	5	1	5
6'	6"	7'	6"	6	2	3, 3
8'	6 $\frac{1}{2}$ "	9'	10 $\frac{3}{8}$ "	8	2	4, 4
9'	10"	11'	4"	9	3	3, 3, 3
10'	7 $\frac{1}{2}$ "	12'	3 $\frac{1}{2}$ "	10	2	5, 5
10'	10 $\frac{1}{8}$ "	12'	6 $\frac{3}{8}$ "	10	3	3, 4, 3
11'	10 $\frac{3}{8}$ "	13'	8 $\frac{3}{8}$ "	11	3	3, 5, 3
12'	11 $\frac{1}{8}$ "	14'	11 $\frac{1}{8}$ "	12	3	4, 4, 4
13'	11 $\frac{1}{2}$ "	16'	1 $\frac{1}{2}$ "	13	3	4, 5, 4
13'	11 $\frac{1}{4}$ "	16'	1 $\frac{1}{4}$ "	13	3	5, 3, 5
14'	11 $\frac{3}{8}$ "	17'	3 $\frac{3}{8}$ "	14	3	5, 4, 5
15'	2 $\frac{1}{2}$ "	17'	6 $\frac{1}{2}$ "	14	4	3, 4, 4, 3
16'	0 $\frac{1}{4}$ "	18'	6 $\frac{1}{4}$ "	15	3	5, 5, 5
17'	3 $\frac{1}{2}$ "	19'	11 $\frac{1}{2}$ "	16	4	4, 4, 4, 4
19'	4 $\frac{1}{2}$ "	22'	4 $\frac{1}{2}$ "	18	4	4, 5, 5, 4
20'	7 $\frac{1}{2}$ "	23'	9 $\frac{1}{2}$ "	19	5	5, 3, 3, 3, 5
21'	5"	24'	9"	20	4	5, 5, 5, 5

## STANDARD SIZES OF SASH

**Glass Sizes.**—Standard glass sizes are 12 by 18 in. and 14 by 20 in. Glass can also be had in 10 by 16 in., and 16 by 22 in. sizes. The glass sizes used in ventilators are different from those used in the rest of the sash, since the ventilator frame is reduced one inch on each side. In ventilators consisting of four lights only, each light is reduced by one inch, both in width and in height. For ventilators of more than four lights, the outside lights are reduced as above, while the inside rows of lights are one inch less in height but the same width as standard glass.

For fireproof buildings, wireglass should be used.

**Standard Sash.**—Most manufacturers have standardized the dimensions of the sash. The dimensions of the window opening, therefore, should be such as to fit the dimensions of the standard sash.

The standard sash is of two types: Warehouse Stock Sash and Standard Sash. Warehouse Stock Sash is carried in stock, assembled, at the warehouse. Standard Sash, while it consists of standard members, must be assembled after the order is received. There is ordinarily no difference in price between the two types, but since better deliveries can be had on Warehouse Stock Sash, it should be used in preference to the non-stock Standard Sash.

Special sash can be manufactured, but its use should be avoided whenever possible, as the price is much higher and a much longer time is required for delivery.

**Design of Window Opening.**—In designing the window opening, select first, the size of glass to be used, preferably from the two standards in general use, namely, 12 by 18 in. and 14 by 20 in. The larger glass gives the cheaper window.

Estimate the approximate size of the opening, from the span and the desired width of pilaster.

Decide tentatively on the number of lights and number of sash. Then compute the exact size of opening from formula given on p. 702. The number of ventilators then should be decided upon.

The problem may be easily solved by referring to the table on p. 704, which gives combinations of different standard sash sizes.

**UNDERWRITERS' PIVOTED SASH**

Under some conditions, where it is especially important to make the window fireproof, Underwriters' Sash is used.

The Underwriters' Sash differs from ordinary sash, mainly in that the glass is held on the inside, in addition to putty, by steel glazing angles  $\frac{1}{2}$  by  $\frac{3}{4}$  in., with the long leg bearing against glass and secured to the sash. The ventilators are provided with a chain containing one or two expansion clips at the top and a fusible link. When a fire occurs and the fusible link fuses, the ventilator closes and locks automatically.

## CHAPTER XVI

### STRUCTURAL PLANS FOR BUILDINGS

A set of plans for a building may be divided into several distinct parts. In the present discussion, the architectural and the structural plans only are considered.

The architectural plans consist of floor plans, sections, and elevations. They give an idea of how the complete structure will look. Usually, the structural features are only indicated. The dimensions of the structural members are given only when they affect the architectural features or when, for any reason, they are limited as to size.

The structural plans show the size and arrangement of the structural members. The portions of the construction which do not contribute towards its strength, and which are built after the structural frame is erected, are usually omitted. Thus the piping, the location of partitions, unless built of concrete—brickwork in skeleton structures, and similar features are not shown on the structural plans. Inserts also are shown separately.

Structural plans are of two classes:

1. General plans, forming a part of the architect's set.
2. Detail working plans to be used in the field.

#### GENERAL STRUCTURAL PLANS

General structural plans are prepared before the contract is awarded and form a part of the contract drawings. The completeness of these plans varies with the practice in the offices of the various engineers and architects.

1. *Complete Structural Plans.*—Some firms prepare complete structural plans, giving the concrete dimensions and the required reinforcement for all members in the structure.

2. *Typical Design Only.*—In many instances, the general structural plans give only the design of typical members. The specifications give the live loads and the allowable stresses. The actual

design of all members is left to the contractor's engineer, with the understanding that the methods outlined in the design of typical members will be followed and that the plans are subject to the approval of the architect's engineer.

3. *Floor Construction not Designed.*—Often in flat slab construction, the footings, columns and beams are either fully designed as in Case 1, or indicated by typical designs as in Case 2; while the selection of the type of floor construction or system of flat slab reinforcing is left to the contractor, with the understanding that the selected design must be acceptable to the architect or his engineer. The live load, stresses, and bending moments are specified.

4. *No Structural Plans Shown.*—In a large number of instances (the majority of buildings), the architectural plans submitted for bids do not include any structural plans. The live loads are specified. Sometimes specifications also have requirements as to the stresses and bending moments. In cities having building codes, this is omitted and the specifications call for a design which would satisfy the requirements of the building code. The structural design is left to the contractor.

The method to be adopted in any particular case depends upon circumstances.

Theoretically the first method, that of preparing complete structural plans, should give best results. Actually, however, this method is recommended only where the organization preparing the general plans is composed of engineers well trained both in theory and field practice of reinforced concrete construction.

Under ordinary circumstances the engineers of architects' offices cannot specialize in concrete construction, but must deal with all structural materials as necessity arises. While such experience tends to broad knowledge of structural engineering in general, it precludes the complete mastery of details of reinforced concrete. Therefore, either the second or the third method will give much more satisfactory results, especially when the working plans are checked.

The method where no structural plans are shown, is not recommended unless the working plans are checked by a competent engineer employed by the architect or unless the working plans are prepared by an engineer selected by the architect. If the matter is left entirely to the contractor, the safety of the structure depends altogether upon him or upon the engineer engaged by him. It is obvious

that this method either through intent or negligence may lead to unsafe designs. It is absolutely essential for the safety of the construction that the architect or owner employ an engineer in whom they have confidence, rather than to rely altogether upon the engineer of the material man or contractor. Often reliance is placed by architects upon the fact that the designs are checked and approved by the Building Department. In practice only the largest cities maintain engineers skilled in concrete construction. Even there mostly the checking is not complete but is confined to main features. In small cities the approval of plans is perfunctory.

**Purpose of General Structural Plans.**—The purpose of the general structural plans is:

1. To enable the contractor to estimate the required amount of concrete, steel, and formwork.

2. To serve as a positive guide in preparing the working drawings. These objects are not attained unless the plans and specifications show clearly what is wanted, particularly as regards the points upon which there is a possibility of a difference in opinion. If the engineer preparing the general plans does not make his intentions clear, the design, in these details, is left to the engineer preparing the working plans.

**General Instructions.**—Each office should establish rules governing the method of preparing structural drawings. To make the drawing clear, the lines having different meanings should be of different thickness and style. The following rules are suggested:

Building line, dash and dot line, dashes about  $\frac{3}{4}$  in. long, medium thickness, diluted ink.

Center lines of columns, light long dash and dot lines, diluted ink, dashes over one inch long.

Dimension lines, light solid lines, diluted ink.

Outline of concrete, solid black lines, medium thickness if visible, dash line of same thickness if invisible.

Reinforcement, heavy solid lines in elevation. In section use solid circles for round bars, solid squares for square bars.

Sections of concrete members should either be shown as concrete in the conventional way or shaded on the back of the tracing with a soft pencil. Care should be taken that the shading is not so heavy as to obscure any lettering nor lines of reinforcement.

Objection may be raised to showing reinforcement by solid lines. It is usually invisible in the concrete, and dash lines would be more



logical. However, (1) dash lines require much more time to draw, and (2) in many cases when bars meet at an angle, dash lines do not make clear just where each bar goes. Solid lines, therefore, are preferable and should always be used.

### COMPLETE GENERAL STRUCTURAL PLANS

Complete general structural plans consist of foundation plan and footing schedule; floor and roof framing plans with girder, beam, and slab schedules; and column schedules. The architectural plans usually show sufficient general sections and elevations, so that these are not repeated in structural plans. Special partial sections, however, will be found necessary.

**Numbering of Columns and Footings.**—Two methods of numbering columns and footings are now in general use.

In one method, the panel points on the floor plan are numbered by consecutive numbers, 1, 2, 3, 4, etc. The numbers are then used to designate the columns and footings at these points, and so C1, C2, C3, C4 would indicate columns 1, 2, 3, 4 and F1, F2, F3, F4, etc., corresponding footings. These designations are used in column and footing schedules. This method is simple, but it has the drawback that it is often difficult to locate the columns on the plan, especially in a large or irregular building. Also, duplication of numbers is possible, especially when new columns are added after the plans are completed.

In the second method, which is preferred by the authors, the mark of the column is fixed by its location. This is accomplished by the use of coordinates in the following manner. The main column lines that are horizontal on the plan are designated by small letters. The top column line is called a, and the others, in alphabetical order, b, c, d, e, etc. The main column lines that are vertical on the plan are designated by numerals, 1, 2, 3, beginning at the left. The panel points, located at the intersections of the two sets of lines, are designated by the letter and the number belonging to the intersecting lines. These designations are used for columns and footings. For instance, the panel point at the intersection of line b with line 3 is called b3, the column located there is called C-b3, and the footing F-b3.

Special column points located between the main column lines are designated by the addition of  $\frac{1}{2}$  to the number or a prime sign to

the letter. Thus, panel point  $b3\frac{1}{2}$  is located on line *b* between lines 3 and 4.  $b'3$  is located on line 3 between lines *b* and *c*.

This method of designation fixes the position in the building of every panel point. It is, therefore, preferable to the first method. Some contractors claim that the use of a letter and number is confusing in the field, but unquestionably the advantages overbalance any possible disadvantage.

**Numbering of Beams and Girders.**—Typical beams and girders are designated by a number indicating the floor, a letter, B, G, or L, designating a beam, a girder, or a lintel respectively, and a second number indicating the distinctive beam or girder on the floor. Thus 2B3 would mean beam 3 on second floor. On one floor, there are usually a large number of beams of the same span with the same concrete size and amount of steel. All these beams are given one common designating mark, which is marked on the floor plan in each place where the beam occurs. The dimensions of the beam are given in the schedule. It is advantageous to maintain the same designating marks on all floors, so that a beam 3B3 in the third floor will correspond to a beam 2B3 in the second floor and 5B3 in the fifth floor. Where the framing in the various floors is sufficiently different, this latter plan is not workable, and beams should be numbered on each floor without regard to numbers in other floors.

Where the panel points are designated by coordinates, as explained in the previous paragraph, the odd beams and girders, which occur only in one place, may be designated by their location. For a horizontal beam, the panel point at its left extremity is used; and for a vertical beam the panel point at its top end. Thus, a beam on the second floor, starting from the intersection of lines *d*, and 4, may be called 2B-*d*4. In a building having vertical beams, the location may be still more definitely fixed by adding *h* for horizontal beams and *v* for vertical beam. Thus, 2B-*d*4*v* is a beam in the second floor, starting from panel point *d*4 and running vertically down. For intermediate beams, the prime sign and  $\frac{1}{2}$  may be used, as explained in connection with designation of columns. For illustration of this method, see Fig. 239, p. 714.

This method of designating beams has been adopted as standard by several large contracting firms. It is of special advantage in the drafting room. If all beams are numbered consecutively, on the other hand, and in the process of design some odd beams are eliminated, the remaining beams must be renumbered or else the sequence

is destroyed. Also, beams are sometimes added after the schedule is finished, so that, for instance, beam B45 may be in the same panel with beam B3. This makes the checking difficult.

FOOTING SCHEDULE (For Stepped Footing)

Mark	1st Step			2nd Step			Pedestal	Reinforcement		Remarks
	a	b	e	c	d	f		Parallel to a	Parallel to b	
F <sub>1</sub>	12'-0"	12'-0"	2'-6"	6'-6"	6'-6"	1'-5"	3'-6" Sq	26- $\frac{5}{8}$ " $\phi$	26- $\frac{5}{8}$ " $\phi$	
F <sub>2</sub>	12'-0"	8'-4"	2'-3"	6'-6"	4'-0"	1'-5"	3'-6" Sq	20- $\frac{5}{8}$ " $\phi$	22- $\frac{5}{8}$ " $\phi$	

FOOTING SCHEDULE (For Sloped Footings)

	Base		Top		Height		Pedestal	Reinforcement		Remarks
	a	b	c	d	e	f		Parallel to a	Parallel to b	
F <sub>1</sub>	12'-0"	12'-0"	4'-0"	4'-0"	12"	3'-0"	3'-6"	26- $\frac{5}{8}$ " $\phi$	26- $\frac{5}{8}$ " $\phi$	

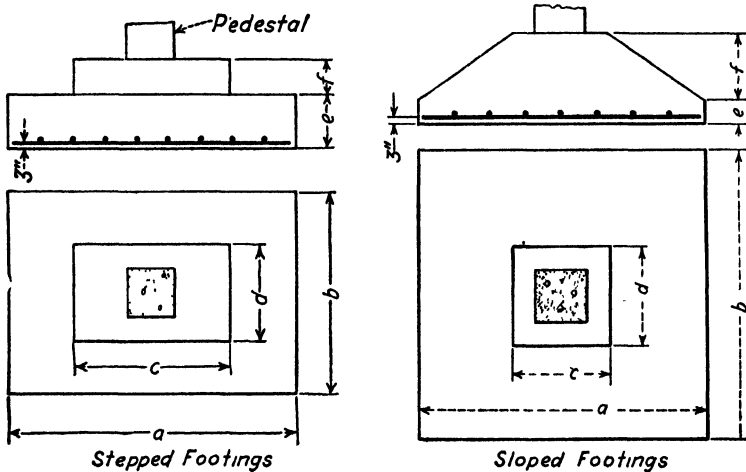

FIG. 238.—Method of Showing Independent Footings. (See p. 713.)

**Foundation Plan.**—The foundation plan, usually drawn to a scale  $\frac{1}{8}$  in. = 1 ft., shows the location of the footings and basement walls. The elevation of the basement slab may also be shown on the foundation plans. This is especially desirable where parts of the basement are lower than the rest.

When the condition of the ground is known, the elevation of the

footings should be given. This helps in estimating the amount of excavation and the length of the pedestals.

The outline of the footings may be shown on the plan. The rest of the information necessary for independent footings may be given in a schedule. A good form for a footing schedule is given below. This in conjunction with the sketch, gives all information required for independent footings. It is evident that the same schedule may be used for square and rectangular footings.

There is more difficulty in showing combined footings. Schedules will be found insufficient in this case. Details of combined footings should be shown in a sketch, which should give the concrete dimensions and the required steel. The reinforcement should be clearly shown by elevations and sections, in the position in which it is to be placed. This is important, as the design of combined footings is not sufficiently standardized. It is obvious that it would not be sufficient to give the number of bars only, without showing their location. If there are several combined footings of the same type, one sketch may be used for all. The various dimensions may be indicated by letters, and a schedule made up in the same manner as for independent footings. The length of the bars should be shown in the sketch in terms of the span. The determination of the actual length of bars may be left for working drawings.

The design of the wall should be shown by sections, which should be provided wherever there is a decided change in the height of the wall or the type of reinforcement. The reinforcement should be shown in such a way as to make the intentions of the designer clear. If horizontal bent bars extending into adjoining spans are used, one typical bending sketch at least should be shown; or a note should state clearly the design desired.

**Floor Plans.**—Floor plans may be drawn to a scale  $\frac{1}{8}$  in. = 1 ft. and in some cases to a scale  $\frac{1}{16}$  in. = 1 ft. The larger scale is preferred where the floor arrangement is at all complicated.

Where the arrangement of beams does not vary from floor to floor, one floor plan may be used for all typical floors, even if the live loads are not the same. The difference in size of beams or in reinforcement is taken care of by the schedules.

For any floor in which the bulk of the construction is typical and special arrangement is restricted to a small portion of the floor, the typical floor plan may be used in conjunction with a partial plan of the special section. The partial plan should be properly tied to the

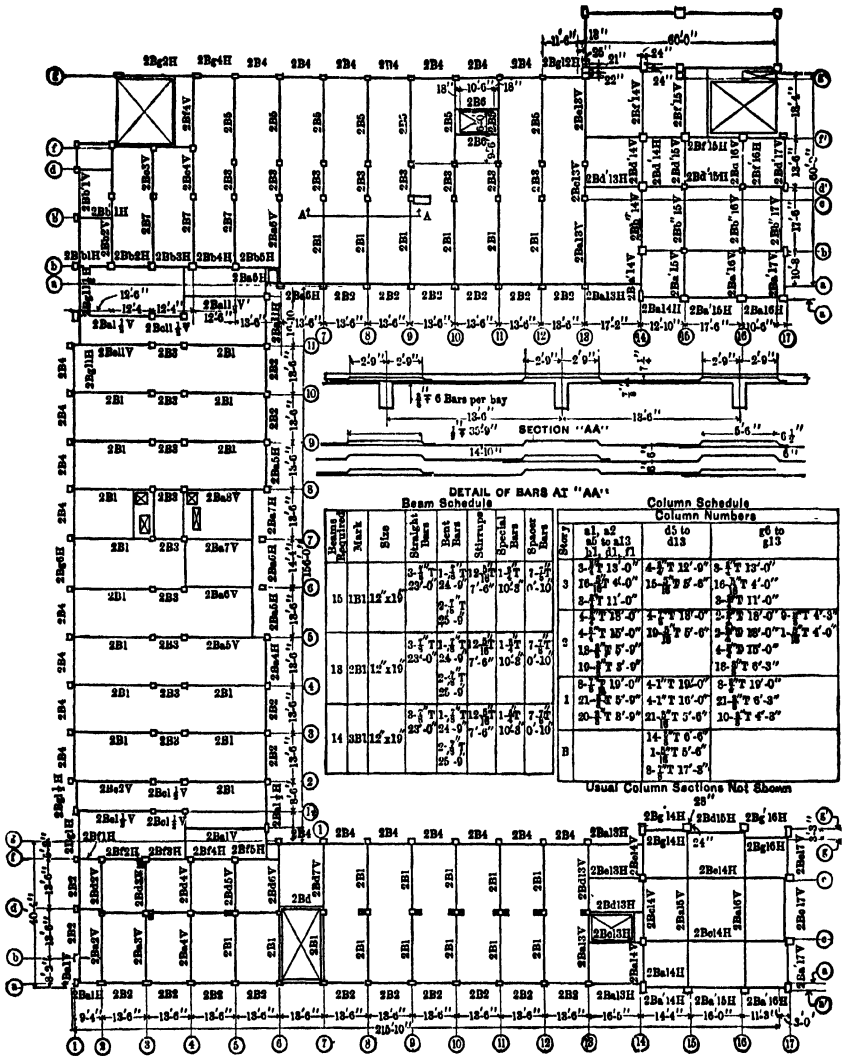

Note: For cross-section through this building see Fig. 290, p. 808.  
 Sections through facades are shown in Fig. 265, p. 754.

Fig. 239.—Typical Framing Plan and Steel Schedule. (See p. 711.)  
 Buildings 1, 3 and 5, Massachusetts Institute of Technology, Cambridge, Mass.  
 Stone & Webster, Builders. Sanford E. Thompson, Consulting Engineer.

typical plan and a note should be inserted on the typical plan, referring to the special arrangement. To prevent confusion, many engineers prefer to give an extra floor plan where any change in beam arrangement occurs.

A beam, on  $\frac{1}{8}$ -in. scale plans, is indicated by two lines; and on  $\frac{1}{16}$ -in. scale plans, by a single heavy line. The latter scale should not be used unless the position of the beams is clearly shown elsewhere. When the architectural plans give sufficient information as to sizes of openings and locations of beams, this information does not need to be repeated.

The roof plan is treated in the same manner as a floor plan. In many cases it is possible to use the typical floor plan for the roof.

**Beam and Girder Schedule.**—The location of the beams and girders are shown on the floor plan. Their dimensions and reinforcement are best shown in a schedule.

A typical beam and girder schedule is shown below. The best method of showing concrete dimensions is to give the width of stem and the total depth of beam or girder. Thus, beam 12 in.  $\times$  24 in. is a beam the width of stem of which is 12 in. and the total depth 24 in. A note should state whether depth is measured from finished surface or rough concrete.

Since the schedule does not always give the length of bars, it is essential for estimating purposes to show clearly how far the bars should be carried into the column or the adjoining span. In case hooks are used, their dimensions should also be given. In connection with the straight tension bars, it should be stated whether or not they are intended as compression steel at the support. If so, they must be carried far enough into the support to develop the compression stress, and this determines their length. Information regarding the lengths of bars and their arrangement is best covered by sketch of typical interior and exterior span. The length of bars may be shown in terms of the span, as in Fig. 240. A general note should state the conditions under which the design is made. The note should give the distance from bottom to outside face of bar. It should state that the same amount of steel should be placed at the support as at the center. All special requirements should be stated, so as to make it possible to estimate the amount of steel, with sufficient exactness, and later, to enable the contractor's engineer to make complete working drawings.

**Method of Showing Details.**—Details of beams should consist of elevations and section as shown in Fig. 240, p. 716. The bending of the bars should be shown to scale in the elevation. Bars should be labeled in elevation. This information should not be repeated. When straight and bent-up bars are used, for the sake of clearness the bars are drawn in the elevations in several layers, even if in actual construction they are intended to be placed in one layer. The actual position of the bars should be shown in the section. If no section is

BEAM &amp; GIRDER SCHEDULE

Mark	Concrete Dimension	Straight Bars No & Size	Bent Bars		Special Bars		Stirrups		Remarks
			No & Size	Sketch	No & Size	Location	No & Size, Sketch	Spacings, Each End	
1B1	12x24	2-7" $\phi$	2-7" $\phi$		—	—	2-3" $\phi$ U	6, 6, 12, 12, 15	
1B2	12x24	2-7" $\phi$	2-1" $\phi$		2-3" $\phi$	at End Col.	2-3" $\phi$ U	6, 6, 12, 12, 15	

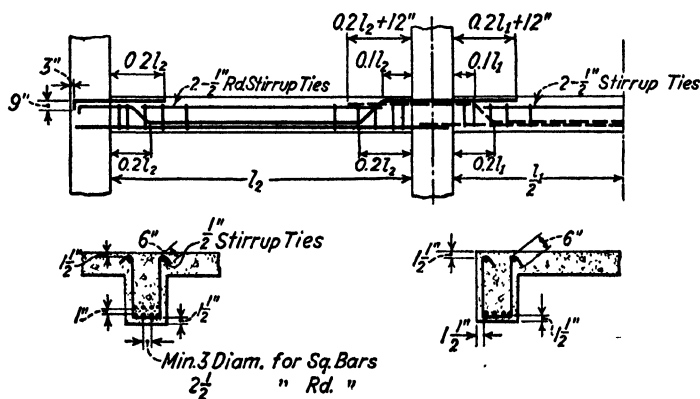

FIG. 240.—Beam and Girder Schedule. (See p. 716.)

used, it should be stated in a note that bars are shown in several layers for the sake of clearness and that actually they should be placed in one layer.

Where reinforcement is more complicated, it may be shown in elevation in the position occupied in actual construction. The bars are then drawn separately so as to give the bending of each bar clearly. This method is used in folding Figs. 214 and 215, for showing reinforcement for frames. It is evident that it would be impossible to make the arrangement of steel clear in any other way.

**Slab Details and Schedule.**—The thickness of slab and the required reinforcement are often shown directly on the floor plan. If these vary for different parts of the slab, a special slab schedule may be used. The customary mark for slab is S, and the method used is that described for beams. 2S1, 2S2, 2S3, for instance, would indicate different parts of the slab in the second floor. Information concerning the arrangement of slab steel at the support is often neglected, leaving an open field for mistakes in estimating. The purpose of the general drawings is to enable the estimator to make his estimate accurately, and the necessity for guesswork on his part must be entirely eliminated. It is evident that if no design is prepared the estimator is at liberty to use his own standard practice, which may differ from the assumption of the engineer and thus result in friction between the engineer and contractor. In case designs are made but essential details are omitted, the contractor must protect himself by assuming excess material to allow for differences of opinion, and this will result in increased cost. To avoid excess estimates, the designer preparing general designs must make his requirements absolutely clear. For details of slab reinforcement see p. 210 and folding page opposite p. 579.

**Flat Slab Details and Schedules.**—The flat slab reinforcement details should be shown by a floor plan and a schedule.

The thickness of the slab should be marked on the floor plan. The dimensions of the drop panels, column heads, and brackets should be dimensioned on the floor plan and also shown by typical sections. The reinforcement should be divided into groups of bars. Each group should be given a mark consisting of a letter and a number, the letter designating the group and the number the particular member of this group. The schedule should give the reinforcement for each group of bars. The same designating marks, of course, are used in the schedule and on the plan.

Reinforcement of a typical interior and exterior panel should be given in detail. These should show clearly how the bars should be bent, how far they should extend into the support, and how far they should extend into the adjoining panel. The lengths should be given in terms of the span, so that the details may also serve for odd panels.

The floor plan in Fig. 241, p. 718, the schedule and the bending sketches show the method clearly. The same method is used both for the four-way and two-way systems. In addition the plan should



Flat Slab Schedule 1st to 4th Floor											
Slab 8 1/2 Granolithic finish, bonded. Concrete 1:2:4											
Column Head 4'-3" diameter. Drop panel 4'x6'-10"x6'-0"											
No.	Notes	Quantity	Unit	Weight	Volume	Area	Perimeter	Length	Width	Height	Remarks
1	Reinforcing Bars	10,000	lbs	10,000							
2	Concrete	1,000	cu yd	1,000							
3	Formwork	1,000	sq ft	1,000							
4	Staircase	100	sq ft	100							
5	Staircase	100	sq ft	100							
6	Staircase	100	sq ft	100							
7	Staircase	100	sq ft	100							
8	Staircase	100	sq ft	100							
9	Staircase	100	sq ft	100							
10	Staircase	100	sq ft	100							
11	Staircase	100	sq ft	100							
12	Staircase	100	sq ft	100							
13	Staircase	100	sq ft	100							
14	Staircase	100	sq ft	100							
15	Staircase	100	sq ft	100							
16	Staircase	100	sq ft	100							
17	Staircase	100	sq ft	100							
18	Staircase	100	sq ft	100							
19	Staircase	100	sq ft	100							
20	Staircase	100	sq ft	100							
21	Staircase	100	sq ft	100							
22	Staircase	100	sq ft	100							
23	Staircase	100	sq ft	100							
24	Staircase	100	sq ft	100							
25	Staircase	100	sq ft	100							
26	Staircase	100	sq ft	100							
27	Staircase	100	sq ft	100							
28	Staircase	100	sq ft	100							
29	Staircase	100	sq ft	100							
30	Staircase	100	sq ft	100							

NOTE: Sketches for bars not shown. They are similar to those shown in Fig. 128 page 369.

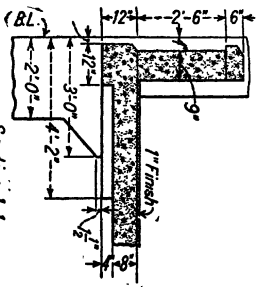
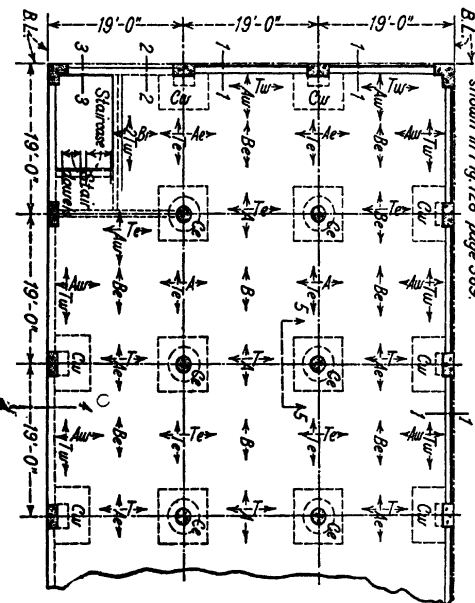

Section 1-1

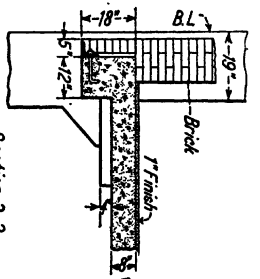

Section 2-2

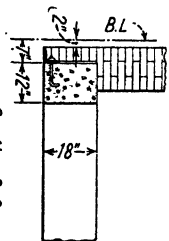

Section 3-3

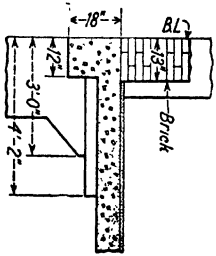

Section 4-4

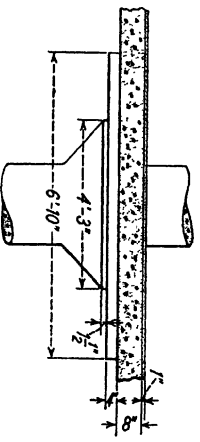

Section 5-5

FIG. 242.—Partial Plan Schedule and Sections for Flat Slab building. Smulski System. (See p. 719.)

(To face page 719.)



show details of typical interior and exterior panels as shown in Figs. 126 and 127.

In the Smulski (S. M. I.) system, the reinforcement is divided into units. The units between columns are designated by letter A, the

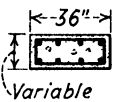
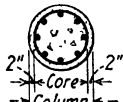
	Column Marks	C <sub>2</sub> to C <sub>9</sub> ind. D <sub>2</sub> to D <sub>9</sub> ind. E <sub>2</sub> to E <sub>9</sub> ind	C <sub>1</sub> , C <sub>10</sub> , D <sub>1</sub> , D <sub>10</sub> E <sub>1</sub> , E <sub>10</sub>		
Roof					
3rd. 12'-9" High 12'-0" Low	Col. load in 1000#	63	62		
	Column Size	36"x12"	16" rd.		
2nd. 12'-0"	Core Size	32"x12"	12" rd.		
	Vertical Bars	8- $\frac{3}{8}$ " $\phi$	2- $\frac{3}{4}$ " $\phi$		
1st. 15'-0"	Spirals or Ties	$\frac{1}{4}$ " $\phi$ Ties 12" o.c.	$\frac{1}{4}$ " $\phi$ Ties 12" o.c.		
	Col. load in 1000#	180	255		
Bas 11'-0"	Col. Size	36"x16"	32" rd.		
	Core Size	32"x12"	18" rd.		
Top of Footing 6'-0"	Vertical Bars	10- $\frac{3}{8}$ " $\phi$	6- $\frac{3}{8}$ " $\phi$		
	Spirals or Ties	$\frac{1}{4}$ " $\phi$ Ties 12" o.c.	$\frac{1}{2}$ " $\phi$ 2 $\frac{1}{2}$ " Pitch		
Dowels	Col. load in 1000#	298	162		
	Col. Size	36"x20"	26" rd.		
Pedestal	Core Size	32"x16"	22" rd.		
	Vertical Bars	12- $\frac{3}{8}$ " $\phi$	8- $\frac{7}{8}$ " $\phi$		
Dowels	Spirals or Ties	$\frac{1}{4}$ " $\phi$ Ties 12" o.c.	$\frac{1}{2}$ " $\phi$ 2 $\frac{1}{2}$ " Pitch		
	Col. load in 1000#	410	670		
Pedestal	Col. Size	36"x28"	30" rd.		
	Core Size	32"x24"	26" rd.		
Dowels	Vertical Bars	18- $\frac{3}{8}$ " $\phi$	10- $\frac{7}{8}$ " $\phi$		
	Spirals or Ties	$\frac{1}{4}$ " $\phi$ Ties 12" o.c.	$\frac{1}{2}$ " $\phi$ 2" Pitch		
Dowels		18- $\frac{3}{8}$ " $\phi$	10- $\frac{7}{8}$ " $\phi$		
	Pedestal	36"x28"	36" Sq.		
					

Notes: - Give thickness required for fireproofing  
 Give length of spirals in respect to heights  
 Give required lap for vertical bars  
 Give any other information required by special conditions

FIG. 243.—Column schedule. (See p. 720.)

center units by letter B, column head units by letter C, and bars across unit A by letter T. A number placed before the letter may be used to designate the story in which the unit is used, while a number following the letter serves to differentiate between varying units of the same type. (See Fig. 242, opp. p. 719.)

**Column Schedule.**—The column schedule should give concrete dimensions, concrete mix, number and sizes of vertical bars, spacing, and size of column ties. For spiral column it should give diameter of core, size of wire, and pitch of spiral. The height of column also should be given in the schedule, as it assists the estimator in getting his steel tonnage and is an aid in preparing general working drawings. The load for which the column is designed should also be given.

NOTES should give all the other information not contained in the schedule.

The thickness of concrete for fireproofing should be clearly shown on a sketch or covered by a note. It is necessary to state how much lapping is required for column steel, and how high the spiral should be carried. A sketch of the column ties should be shown, particularly in cases of unusual columns.

### WORKING PLANS

The difference between general structural plans and working drawings is evident from comparison of the purposes the two sets of plans are intended to serve. The general structural plans are intended for making up estimates and as a guide for preparation of final working drawings. The working plans are intended for use in the field. They must be complete and exact. Dimensions of all concrete members must be given. Not only the number and size of reinforcing bars, but also their length must be given.

**Recesses and Dowels.**—It is important to show on the working plans all recesses, dowels, and nailing blocks required in the concrete work. Recesses are required, for example, for window sash, while at the beams in staircases recesses and dowels should be shown. When concrete walls are used, dowels may be required in floor slabs to connect the wall to the slab, and also pour holes through which the wall concrete may be poured. Nailing blocks are required to nail the flashing and the doors, and sometimes at the windows. The importance of providing recesses and nailing blocks is evident, as drilling holes in solid concrete adds unnecessarily to the cost. Some contractors do not show any recesses on the drawings, but rely upon the superintendent or carpenter foreman to make proper provisions. This practice is not satisfactory.

**Inserts.**—Special plans should be made for the location of inserts. An attempt to show them on the floor plan, with other structural

data, would result in confusion. Usually, details of typical plans are sufficient.

**Building Lines.**—To facilitate laying out the building in the field, the plans should be tied to a set of lines called “building lines.” These are straight lines for each face of the building, which usually coincide with the main outside face of the building. For rectangular buildings, the building lines are rectangular; for polygonal buildings, they are polygonal, and so on.

The building lines are established on the ground, and all measurements are made from them. All recesses in the wall, for instance, are measured from the building line. The outside faces of the concrete for beams and columns are also located from the building line.

The building lines should be shown on the floor plans and in sections through the wall and wall beams. In sections, the building line is indicated by a vertical line. The distance from outside face of concrete to this line should be given. For instance, in a brick veneered building the building line would coincide with face of brick. The concrete work is then 5 in. from the building line.

**Foundation and Footing Plan.**—The information regarding numbering columns and footings, on p. 710, applies to working plans as well as to general plans, and all should correspond.

The foundation plan should have all the information required for the laying out, in the field, of all footings and basement walls. Footings may be shown in the manner described in connection with general plans (see p. 712). Outside footings should be tied to the building lines.

Footing schedules should contain, in addition to the information given on general plans (see p. 712), the number of footings of each type and the number and length of bars in each footing. For combined footings, bending sketches, completely dimensioned, should be given for each type of bent bar. The position of all bars in the footing should be definitely fixed, in a clear manner, either by a detail drawing or a note. The column dowels should also be given in the footing schedule, rather than in the column schedule, because the steel is required at the time the footings are built. The necessary information as to the spacing of dowels should be given. In spiral columns, this is fixed by the diameter of the column core.

The basement wall should be shown by sections and, if necessary, by elevations. Sections should be taken, not only for typical rein-

forcement, but also where the height, thickness, or amount of reinforcement differs from the typical. The section should show height of wall, thickness, reinforcement, distance from building line, and all other information required in the field. Not only the size and the spacing of the bars should be given, but also their length and their number. The position of the first bar should be fixed. If bars are bent, a bending sketch should be given. The position of the bent bar should be shown in elevation. This is of particular importance where the bars are placed in an unsymmetrical position; thus, in end panels, it is necessary to show how far into the column the bars should extend.

Sometimes the different panels of the wall are given designating marks, and each panel is marked. A schedule, similar to that used for slabs, gives the required information as to thickness of wall and amount of reinforcement.

Elevations of the basement slab should be given. Sections should be given where the elevation of basement wall changes, showing the retaining wall. All pits should be clearly indicated, with dimensions and their locations tied either to a building line or a column line. Cross sections through pits should show depth, thickness of wall, and details of reinforcement.

Sizes of all openings in the wall should be clearly given, and openings should be located with respect to column lines and floor elevations.

**Floor Plans.**—Floor plans should be drawn to a scale  $\frac{1}{8}$  in. = 1 ft. If floor construction is complicated, a larger scale should be used. Floor plans show the position of beams, the slab reinforcement, and sections.

Building lines should be shown on the floor plan. Where the center line of beams does not coincide with the center line of columns, the offset must be clearly shown. This is best accomplished by sections. Not only typical sections through the spandrel beam should be shown, but also sections in all places where the concrete dimensions or the distance from building line differ from the typical. All openings in the floor must be clearly dimensioned and should be tied to the adjoining center lines of columns or to building lines. When the floor plan is too complicated, especially if it shows slab reinforcement, the concrete dimensions and the details of the openings should be shown on a separate plan or a partial plan. This applies particularly to stair and elevator openings, which are usually

shown to  $\frac{1}{4}$ -in. scale in connection with stair details. Where recesses occur, they should be indicated in plan or in section.

**Beam Details.**—All beams should be marked on the floor plan by the method explained on p. 711 in connection with general plans. Beam schedules should give complete information. A convenient schedule, more complete than the one suggested for general structural plans, gives the following data: number of beams; more complete information on concrete dimensions; not only the depth and width of the beam, but also the depth of the slab on each side. If the section of the beam is irregular, so that full information cannot be conveyed by the schedule, a cross section through the beam should be shown.

The information on reinforcement, also, is more complete than for general plans. Not only the number of bars but also their length is given in the schedules. To insure proper location of the bars in a beam, a detail of the beam with full reinforcement, including stirrups, should be given (see Fig. 240, p. 716). This is particularly necessary where the reinforcement is not symmetrical. In the end beams, this should show how far the hooked ends of the bars must extend into the column. Some designers give this information in connection with bending sketches, by locating the ends of the bars with respect to the centerlines of columns (see Fig. 245). Marks of bent bars and stirrups (as noted below) should be noted in schedule.

*Straight Bars* in a beam are not provided with any mark, as on the job all straight bars of equal size and length are stacked together, irrespective of their destination in the structure. This simplifies the work.

In listing bars, the straight bars are kept together, arranged by sizes beginning with the largest, and also grouped by length.

*Bent Bars* should be given a designating mark, and each bar after it is bent should be tagged with its mark. Aluminum tags should be used and securely tied to the bars to prevent their loss. This is especially important where bent bars are shipped any distance and require repeated rehandling before they reach the job. Paper and cloth tags, sometimes used, are not satisfactory as they often get lost. This not only creates confusion on the job, but also is the cause of bars being used in the wrong position with great detriment to the construction. A bar without tag must be measured, and the bending sketch thus made compared with the bending schedules, to determine where the bar belongs. This is expensive in time and

money. Both the engineer responsible for the job and the contractor should insist upon secure tagging of bent bars.

*Marking of Bent Bars.*—Whatever method is used for marking bent bars, any possible duplication of numbers must be prevented.

A simple method is to give the bent bars the mark of the beam. Thus, if a beam is marked, in the schedule, 2B3, the bent bars may be also marked 2B3. If more than one type of bent bar is used in a beam, the different types may be differentiated by adding a small letter to the beam mark. Thus, 2B3a, 2B3b, and 2B3c are three types of bent bars in beam 2B3. This system of marking is not adapted to stirrups, as often the same type of stirrup can be used for a number of beams of different mark. Marks U1, U2, etc., may be used for all stirrups of the same dimensions, irrespective of their location. Thus, if beams B1, B3, B5, and B7 have the same concrete dimensions, they require the same type of stirrup and in each case the stirrup is marked U1. Sometimes, to prevent confusion in marking, a number designating the floor is prefixed to the mark. In such cases, 2U1 is a stirrup for a beam in the second story.

Another system of marking which is sometimes preferred, but which does not indicate location of bar and is thus less definite, employs figures only.

By this plan, the mark of each bar consists of three figures, such as 725. The first figure designates the size of the bar, representing the number of eighths of an inch in the diameter or side of the bar. Thus, a  $\frac{1}{8}$ -in. bar will be represented by 100; a  $\frac{1}{4}$ -in. bar by 200; a  $\frac{3}{8}$ -in. bar by 300; a  $\frac{1}{2}$ -in. bar by 400; a  $\frac{5}{8}$ -in. bar by 500; a  $\frac{3}{4}$ -in. bar by 600; a  $\frac{7}{8}$ -in. bar by 700; a 1-in. bar by 800; a  $1\frac{1}{8}$ -in. bar by 900, and so on. Bars of the same diameter but of different length and bending are differentiated by the last two numbers, which are consecutive. The first bent bar in the  $\frac{7}{8}$ -in. diameter list will be 701, the next 702, and so on. This method was used in Fig. 215, opp. p. 664.

**Bending Sketches.**—Every bent bar must have a detail sketch. It is not sufficient to show the general outline of the bar, as in general structural plans. All dimensions must be carefully worked out. The importance of this cannot be over emphasized. Poorly bent bars, even if detected before they are placed, must be rebent at the job at a higher cost than that of the original bending and often with vexing delays. The required dimensions are shown in Figs. 244 and 245.

In double bent bars the important dimensions for bending are the height of the bend, measured from outside to outside of bar



(usually called "out to out") and the horizontal length of the bend. The inclined length of the bent is not used in the field, but it must be computed to determine the length of the straight portions of the bar. If shown on bending sketch, it assists greatly in checking.

Bending sketches are usually made separately from the beam schedules. In the beam schedule, the mark of the bar is given and the type of bending indicated by a small sketch, which is of assistance in locating the bar when needed in the field. In the steel schedule, the same mark is used.

For convenience, bars of the same type of bending are placed on the same sheet. Thus, bending sketches are made for groups of double bent bars, groups of rings, and groups of stirrups.

BENDING SKETCHES												
Sketch No	Mark of Bar	Number of Bars	Length							f	g	
				h	a	b	c	d	e			h <sub>1</sub>
# 1	1B2	6	26'-4"	9"	3'-0"	18"	10'-6"	18"	7'-9"	0	18"	2'-2"
# 2	1B2a	3	7'-9"	9"	7'-0"	—	—	—	—	—	—	—
# 3	1B3	4	30'-0"	0"	7'-7"	18"	10'-6"	18"	7'-7"	0	18"	2'-2"
# 4	1B5	7	19'-0"	9"	4'-1"	18"	12'-0"	—	—	—	18"	2'-2"

FIG. 244.—Bending Sketches of Bars. (See p. 725.)

For trussed bars, separate bending sketches are often drawn for each mark of bar. This method requires more work in the office, but it simplifies the work in the field. The foreman can give a workman a sketch representing each bar to be bent by him.

Separate bending sketches may also be used for the purpose of indicating the position of the bars in the beam. Thus in Fig. 245, p. 726, the position of the ends of the bar is located in respect to the enter line of the columns. This is important where the position of the bar is not symmetrical.

Another method is to use one sketch for a number of bars, as shown in Fig. 244, p. 725. The sketch is drawn at the top of the schedule, and the dimensions for each bar are given in the schedule under the different headings. By proper marking of dimensions, one sketch can be used for all trussed bars listed on the sheet, with and without hooks. In Fig. 244 one sketch was used for four types of bent bars. This simplifies the work in the office. It is evident,

however, that the understanding of this schedule requires higher intelligence on the part of the workman than that of the other plan.

Stirrups may be shown either by making a drawing for each stirrup or by making a table similar to the one suggested for bent bars.

**Slab Details in Beam and Slab Construction.**—In many cases, all the information about slabs may be given on the floor plan. Thickness of slab, elevation, and type of finish should be marked directly on the plan. Reinforcement may also be shown on the plan unless the arrangement of panels is complicated, in which case a slab schedule must also be prepared. Sometimes the main reinforcement

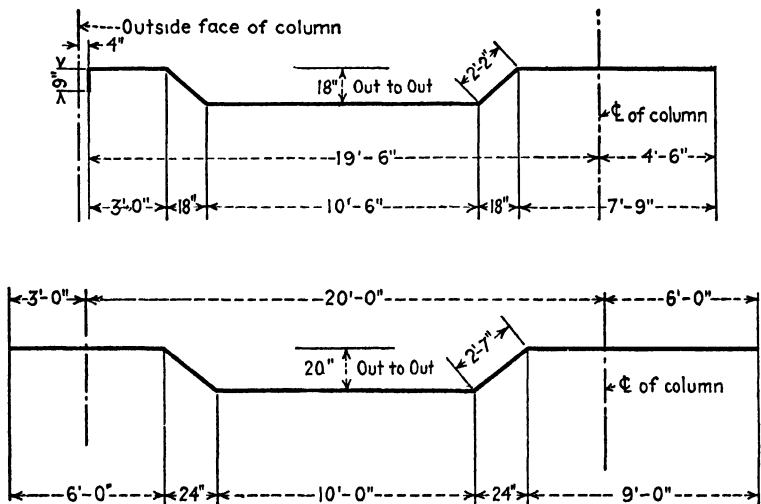

FIG. 245.—Separate Bending Sketches. (See p. 725.)

is shown on the floor plan, while odd panels are covered by a schedule. Not only the spacing of the bars but also their number and length should be given. The position of the first bar in each section is located by a dimension from some fixed line. The remaining bars are located sufficiently by giving their spacing. Method of bending should be clearly shown. In many designs, bars of one panel length are used. Straight bars alternate with bent bars. The first straight and the first bent bars are located, and the rest are covered by giving the number of bars of each type and the spacing. Where bars extend over several panels, the bars of one type of bending alternate with bars of some other type of bending. Sometimes bars of the same

type of bending are used but the ends are staggered. Each type of bar should be located as explained above. All these expedients are used to supply a sufficient amount of steel, not only in the center but also at the support, and with the smallest tonnage practicable. It is important to make the intention of the designer clear, since misplacement of bars may give an excess of steel in one section and not enough steel in some other section. The more complicated the arrangement, the more clearly it must be shown.

Position of the bars in the slab should be shown by a section indicating the type of bending required. When bars are to be bent before placing in the form, proper bending sketches should be provided. The straight bars are then listed separately from the bent bars. Where the bars are "hickied," i.e., bent after they are placed on the form, the location of the points of bending should be given, and the height of the bend should be worked out and shown. In this case, all bars are listed as straight bars.

**Flat Slab Construction.**—Working drawings for flat slab construction should be worked out in the manner described on p. 717 in connection with general plans. The steel schedules, however, must be complete, and the length of all bars must be given. In the schedule for the Smulski System the length of each ring and the required length of lap must be given.

If the bars are bent before placing, bending sketches must be prepared in the same manner as for beams. Different types of bars should be given an appropriate mark on the schedule. Bars should be tagged with an aluminum tag. If steel is bent on the forms, all bars should be listed as straight bars, care being taken to allow for the proper length required for the bend.

**Column Schedules.**—Column schedules for working drawings differ from those described on p. 720 only in that the lengths of all bars are given. The number of ties and their bending sketches are also given. Where the column bars are bent at the ends on account of difference in size of the upper columns, bending sketches must be prepared.

## CHAPTER XVII

### ARCHITECTURAL TREATMENT OF EXTERIOR AND INTERIOR OF REINFORCED CONCRETE BUILDINGS <sup>1</sup>

By HENRY C. ROBBINS

In this chapter the architectural treatment of the exterior and interior of reinforced concrete buildings is discussed. Illustrations of exterior and interior treatment, as well as details of construction of different types of buildings, are given.

The development of the exterior treatment of reinforced concrete buildings has grown quite naturally with the increase in their use and with the growing knowledge of the architectural possibilities of this type of construction, which was originally developed for utilitarian purposes rather than for artistic merit.

Beginning with the kind of building which frankly expressed its structural materials in piers, girders, and curtain walls of concrete, with liberal window openings, the concrete building has passed through various stages of architectural expression to its present state, in which, to all outward appearances, it may differ in no essential feature from other equally substantial forms of building construction.

The clothing of the reinforced concrete building with brick, stone, or terra-cotta, or a combination of these materials with concrete, makes possible a variety of architectural treatments which in the details of construction present no more serious difficulties than are ordinarily met in the design of buildings of other types. The interior finish of concrete buildings may also be as simple or as elaborate as the requirements demand, without seriously taxing the ingenuity of the designer as far as the practical execution is concerned.

It is intended in this chapter to describe and illustrate some of the accepted methods used in common practice to produce satisfactory results in both exterior and interior finish of such buildings.

<sup>1</sup> The authors are indebted to Henry C. Robbins for this chapter, which has been especially prepared by him for this treatise.

## EXTERIOR WORK

For the purposes of this discussion, the exterior treatment of concrete buildings may be divided into:

- (1) Concrete exterior;
- (2) Concrete in combination with brick, tile, or other masonry;
- (3) Brick exterior;
- (4) Stone or terra-cotta exterior.

## CONCRETE EXTERIOR

**Simple Treatment of Concrete Exterior.**—The simplest form of exterior treatment is found in the frank expression of the concrete structural members with curtain and parapet walls of the same material, as illustrated in Fig. 246, p. 729. Buildings of this type are generally found in the warehouse or factory building class.

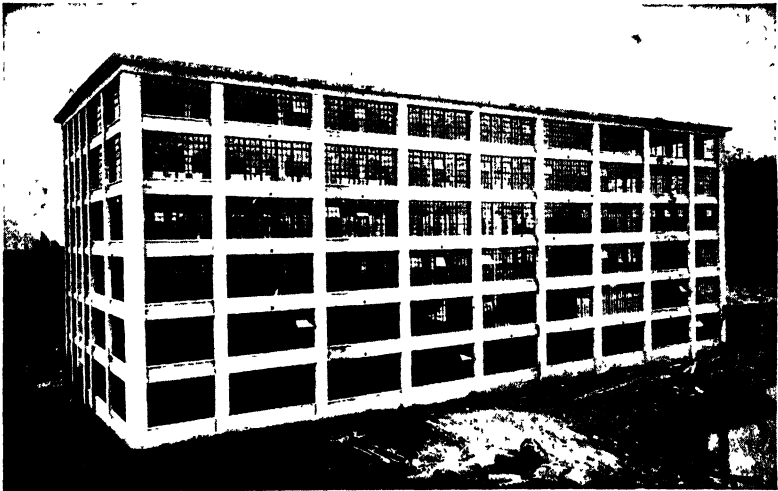

FIG. 246.—Simplest Form of Factory Building: Concrete Piers, Concrete Spandrels, and Curtain Walls. (See p. 729.)  
Turner Construction Co., Builders.

Details of concrete exterior are clearly shown in the part elevation, Fig. 247, and section, Fig. 248. As is evident from the illustrations, the exterior columns form the piers between the windows. The width of piers is governed, not only by the magnitude of the loads to be supported, but by architectural requirements and by the desired

width of the windows. With steel sash, the window extends from pier to pier, therefore the width of piers is governed by the standard width of sash. When more than one window in a panel is required, different window units may be separated by concrete mullions. The piers are joined together by spandrel beams at the floor levels, acting as lintels of the windows, and also as supports for the floor construction. Above the spandrel beams, and filling the space between the floor and the bottom of the windows, are concrete curtain walls. In

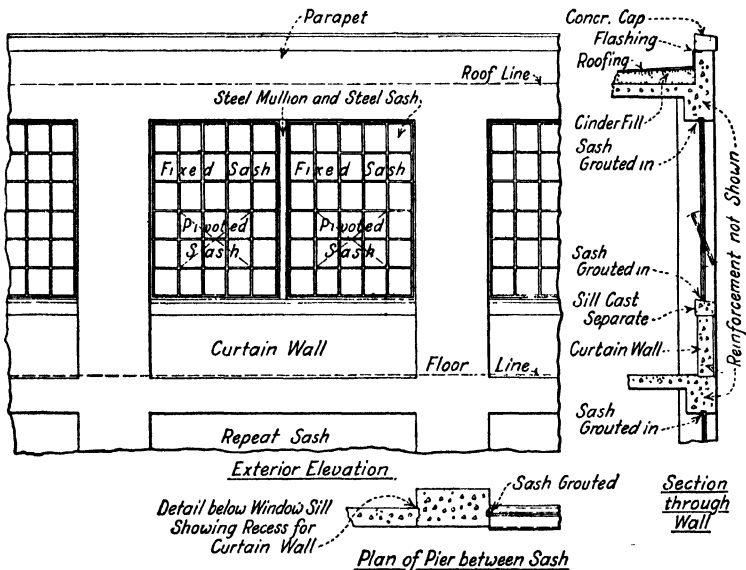

FIG. 247.—Details of Concrete Exterior. (See p. 729.)

the simplest form, their tops may be simply beveled to receive the wood window frame. Very often, especially when the steel sash is used, a separate sill is cast on top of the curtain wall after the sash is in place.

The roof spandrel beam may be continued above the roof level to form a parapet with a beveled top, or with a simple, square-edged projecting cap to give a finish to the wall.

The simplest and cheapest arrangement of exterior wall treatment is that in which the face of the piers coincides with the face of the spandrels. This, however, presents a rather crude and monotonous appearance.

The monotony may be relieved at very slight additional expense by setting the spandrel beams back from the face of the wall columns. The curtain walls are then placed slightly back from the face of the spandrel beams, and the concrete window sill is made to project over the curtain wall. Such an arrangement is shown in Fig. 248, p. 731. The appearance is also improved by the introduction of stronger or more massive treatment of end panels. This is frequently justified by placing the stair towers in these locations and

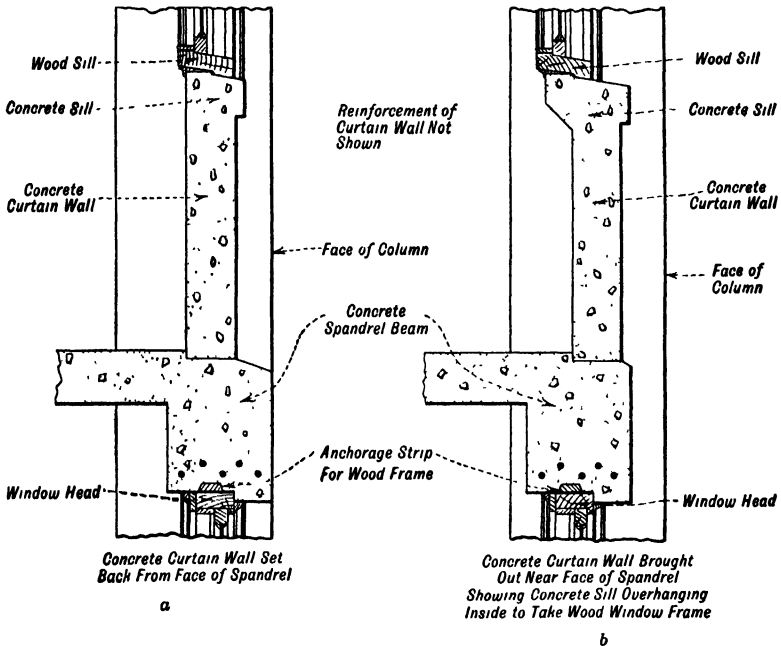

FIG. 248.—Sections through Spandrel Beam. Concrete Exterior. (See p. 731.)

changing the windows from the typical arrangement followed in the rest of the building to a smaller size with surrounding structural members of increased width.

The reveals and projections obtained by the methods described above help to break the monotony of an otherwise flat surface by the casting of shadows, which, after all, are responsible for much of the effect in all architectural composition.

The concrete curtain walls are shown in Fig. 248*a* and *b*. The construction in Fig. 248*b* may be used where the thickness of the curtain wall is less than the thickness of the window frame.

The concrete curtain walls are usually built separately after the frame is constructed. To prevent temperature cracks, they must be properly reinforced. (See p. 384.) Also, they must be tied to the building, and recesses or slots must be left in the columns to receive these walls as they are cast.

The treatment of the surface of the concrete itself is discussed under a separate heading below. (See p. 734.)

**Elaborate Treatment of Concrete Exterior.**—It is possible to carry the exterior design of concrete structures into quite elaborate detail, and very pleasing effects may thus be obtained. The means used for the purpose are: (1) more elaborate details of molded work; (2) special treatment of concrete surfaces; (3) combination of the two methods.

The selection depends upon the purpose for which the building is to serve and upon the extra expense that can be devoted to ornamentation. Pleasing effects may be obtained at a comparatively small cost, a combination of simple molded work with surface treatment of concrete.

*More Elaborate Detail of Molded Work.*—The appearance of concrete buildings may be improved by the addition of molded belt or string courses and cornices, and in more expensive buildings by the introduction of special ornamentation. In selecting the design, the character of the material must be kept in mind. The molding and the design of the cornices should be such as present the least problem in form construction. Projecting members with square corners, simple molded forms such as quarter rounds or plain cove moldings with flat fillets, plain sinkages, and other similar forms are the easiest to produce and are best adapted for concrete work. The effect should be obtained by general proportions of the mass rather than by refinement of details.

A simple but effective treatment of concrete exterior is shown in Fig. 249, p. 733, where the building is provided with simple cornice, pilaster caps, and bases. The entrance received rather more elaborate treatment.

Molded details may be poured with the structure, or they may be precast and placed in the construction in the same manner as other stone trim.

When molded in place, the moldings can be poured simultaneously with the rest of the construction, or the supporting frame may be built first and the belt courses and cornices poured separately.



The latter method simplifies the formwork, as the forms for the projecting moldings are supported on the structure instead of on the elaborate support which would be necessary if the molding were poured simultaneously with the structure. In this way the molding can be built truer to line, and better workmanship can be obtained. Also, special concrete may be employed. When belt courses are poured separately, proper recesses must be left in the supporting

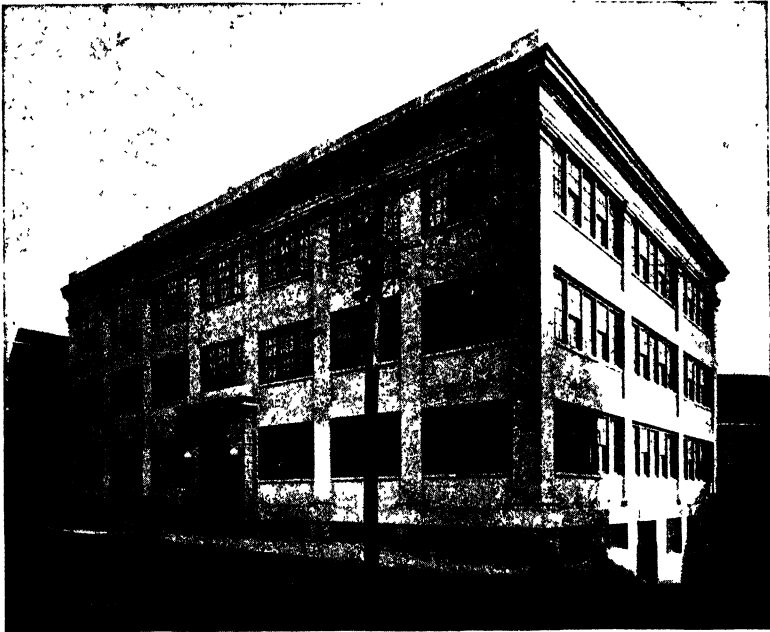

FIG. 249.—Building of the Frank E. Davis Fish Company, Gloucester, Mass.  
(See p. 732.)

Densmore, LeClear & Robbins, Architects and Engineers.

structure, while steel dowels, often called "bonds," should be provided to tie the two parts of the structure. To prevent cracking, the belt course must be reinforced by separate horizontal bars.

Wherever molded work is cast in place, it should be arranged, if possible, to bring the end of a day's pouring at the molded section, thus concealing the line that is always in evidence, in the finished work of plain surfaces, where one day's work ends and the next begins.

Important decorative work is best done in concrete pre-cast in the form of "cast stone" and built into the main structure. See Fig. 250.

p. 734, in which the cartouches on either side of the entrance and the key-block were cast separately and inserted.

*Treatment of Concrete Surfaces.*—Much can be done to produce an interesting exterior by the choice of surface treatment, which,

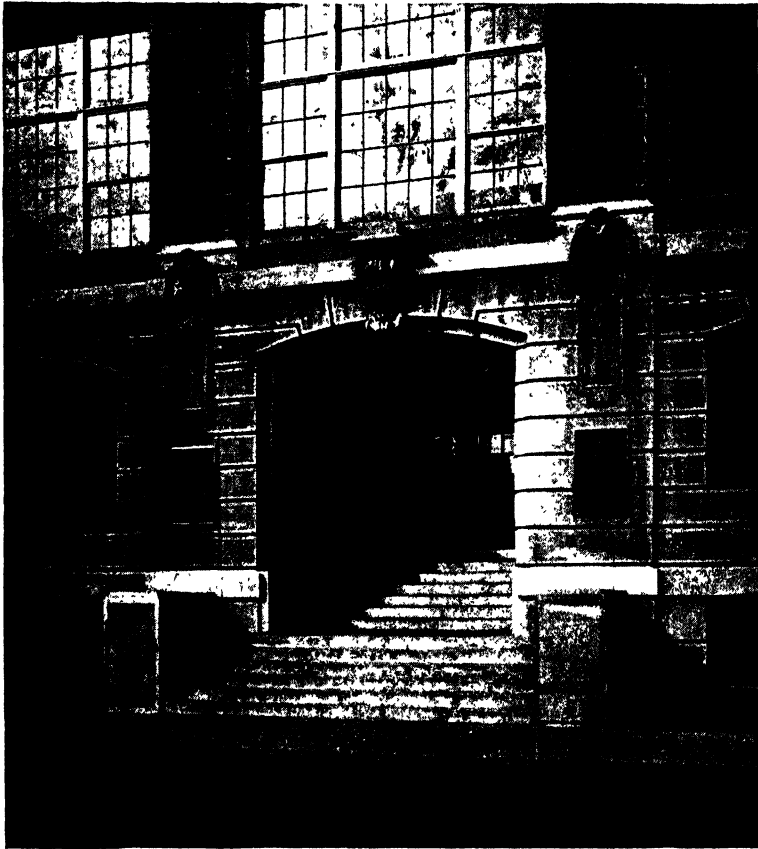

FIG. 250.—Entrance Detail, Carter's Ink Factory, Cambridge, Mass. (See p. 733.)  
Densmore, LeClear & Robbins, Architects and Engineers.

if carefully handled, goes far toward making up for the lack of elaborate molded work. Exposed concrete may be finished in a variety of methods, ranging from the smoothing of the surface, primarily to eliminate form marks and to fill voids, to the picking or hammering of the surface to reveal an aggregate chosen particularly for its color.

A dense, smooth surface is desirable for concrete which is to be exposed to view and upon which no great amount of finishing work is to be expended. To produce such a surface, thorough spading of the mass as it is deposited is essential, and tapping the outside of the formwork with a hammer or mallet is helpful in further settling the mixture into place, thus forcing the heavy aggregate back from the surface and bringing the mortar to the face.

For all concrete work which is to be exposed to view, it is desirable that the formwork be tight and smooth. It should be erected true to line and supported in a substantial and workmanlike manner. The materials should be as free as possible from defects which would show in the surface of the concrete.

In the usual commercial work, however, it is impossible to eliminate all voids, irregularities, and fins or slight projecting ridges which are caused by the mortar oozing through the cracks in the formwork. These defects must be corrected if a reasonably regular and unbroken surface is to be obtained.

*Surface Treatment by Rubbing.*—Most satisfactory results are obtained at the least cost when the finishing is undertaken while the concrete is still green. The fins then can be smoothed down and the entire surface brought to an even finish, by rubbing with a wood or cork float, using a mortar composed of one part of cement to two parts of fairly coarse sand as an abrasive, the mortar at the same time filling the voids.

With concrete which has set hard, it is obvious that more work is involved in producing a satisfactory finish. The fins must be removed by hammering, chipping, or rubbing with a carborundum stone, and the voids must be filled. After this has been done, a mortar composed of one part of cement to one part of screened sand is rubbed in, by means of a cork float manipulated in a rotary manner. The surface should be thoroughly saturated with water before the mortar is applied.

After the mortar, applied as described above, has thoroughly hardened, the entire surface is rubbed with a carborundum stone while water is being applied with a brush, until a smooth, even surface, uniform in tone, is obtained. This method was used in finishing the building shown in Fig. 249, p. 733.

It is essential that the mortar be thoroughly rubbed in during the first operation, so that no appreciable thickness of skim coat remains.

Otherwise, the coating will crack and peel off, if exposed to extremes of temperature.

An effective variation in the treatment described above may be obtained by using white cement in combination with the fine sand, in place of ordinary gray cement. In this case, the second rubbing, after the mortar has set, may be dispensed with. When this is done, the thin surface coating should be kept wet as it sets.

The so-called spatter or dash coats, so frequently employed in the finish of domestic stucco work, are not commonly used in reinforced concrete buildings of the commercial or industrial type, as they

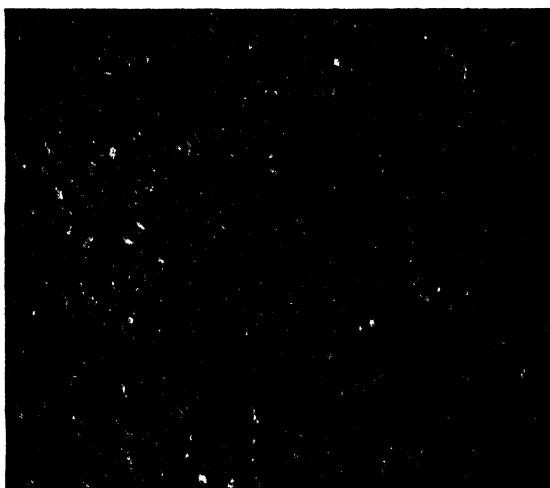

FIG. 251.—Example of Brush Finish. (See p. 736.)

usually involve expense in the preparation and finishing of the surfaces to be treated, out of proportion to the results to be obtained.

**Brush Finish.**—Green cement may be effectively treated also by washing with water to expose the aggregate, using a wire brush or a coarse, stiff fiber brush. Good judgment as to the proper degree of hardness of the concrete is required in using this method, since if the surface is too hard, the brush will not be effective in removing the mortar, while if it is too green, particles of aggregate will be dislodged, leaving a coarsely pock-marked surface. Ordinarily, this method of finishing must be undertaken in about twenty-four hours from the time of pouring. (See Fig. 251, p. 736.)

**Bush Hammer Finish.**—A more effective and also more costly finish than those described above is obtained by hammering or picking the surface to expose the aggregate. The bush hammer commonly used in stone masonry is a satisfactory tool for this purpose.

The brushing method previously described approaches the hammered or picked treatment in result, but it lacks the sparkle of the latter because hammering not only exposes the aggregate, but cuts it as well.

The condition of the concrete for a satisfactory hammered treatment must be the reverse of its condition for brushing; that is, it is necessary for it to be thoroughly set and hard, so that the aggregate is imbedded firmly enough not only to prevent dislodgment as the mortar is being cut back, but to withstand the actual cutting of the aggregate particles. This method presents a difficulty in the finishing at external corners, where it is practically impossible to prevent the cutting out of pieces of aggregate, thus leaving a ragged arris or corner. This may be obviated by first rubbing the surfaces at the corners to a smooth finish, as described above, and then hammering up to a sufficient distance from the corners to leave a smooth draft line, of a width to be in scale with the hammered field. (See Fig. 252, p. 738.) This treatment may be elaborated by choosing the surface aggregate for its color, but the common run of stone or gravel used throughout the work ordinarily will provide a satisfactory surface when exposed and cut.

**Coloring of Surface by Selection of Aggregates.**—If a special color of aggregate is desired and is available only in small quantity or at an extra cost, it may be deposited in the outer surface only of the portions to be so treated. This may be done by inserting a sheet-metal dam about 3 inches back of the inner face of the formwork, and depositing the special mixture between the dam and the formwork at the same time that the regular mixture is being poured in the balance of the member. The dam is raised gradually with the progress of deposition of the concrete. The spading is confined to the space above the bottom of the dam, else the two mixes may run together. It is not practicable to introduce this method in columns and piers, where the reinforcing steel, and particularly the column ties, complicate the handling of the dam; but in spandrel beams and walls, or in unreinforced members, it is quite feasible.

Another method of introducing special concrete near the surface

of the building was used in the construction of the Hide and Leather Building in New York City.<sup>2</sup>

After the steel reinforcements for the spandrel had been fabricated as usual, expanded metal was wired to the bars, leaving a distance varying from  $1\frac{1}{2}$  to 2 in. between the expanded metal and the outer

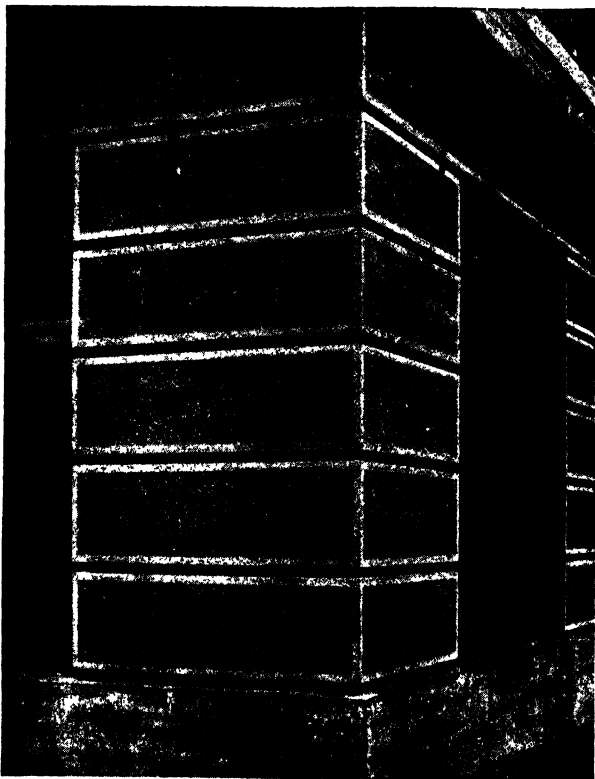

FIG. 252.—Example of Hammered Surface Surrounded by Smooth Draft Lines.  
(See p. 737.)

form. Into this outer space a special surface concrete was poured, consisting of one part of white Portland cement and two parts of a colored aggregate, the latter being composed of green stone chips, feldspar and quartz, ranging in size from  $\frac{1}{16}$  to  $\frac{1}{4}$  in. This surface concrete, which was hand-mixed and of dry consistency, was guided into the front space by a broad, flat chute, and tamped in place with

<sup>2</sup> Thompson & Binger, Architects and Contractors.

a special T-head tamper, the latter being made by fastening a 1-in. flat, 6-in. long, to a  $\frac{1}{2}$ -in. bar about 12 ft. in length.

The balance of the beam, i.e., the space between the expanded metal and the rear form, was poured with the usual concrete. Precautions were taken to have the facing concrete pile up about 1 ft. higher than the structural concrete during the process, to prevent the common aggregate from flowing to the outside face. After the forms for the exterior surface had been removed and the necessary patching done, the concrete was permitted to season during the winter; in the early spring it was ready to receive its final finish. The two lower floors were bush-hammered by stone masons. The upper floors, sixteen in number, were surfaced by a carborundum grinding machine, after which a colorless waterproofing was applied over the entire exterior. This treatment was given mainly to prevent the elements from attacking the surface of the concrete.

#### CONCRETE IN COMBINATION WITH BRICK, TILE OR OTHER MASONRY

This combination may be used in warehouse and factory construction, where the curtain walls are built of ordinary hard brick, and the cost approaches the cost of the simple all-concrete type. With proper treatment of concrete surfaces and use of more expensive filling materials, very ornamental effects may be obtained.

**Combination of Brick Curtain Wall with Concrete Piers and Spandrels.**—The most common construction of brick and concrete is that in which the piers and spandrel beams are of concrete and the curtain wall of brick. Such construction is shown in Fig. 253, p. 740, where the curtain walls and parapet are of red brick and the rest of the façade is carried out in concrete. The section in Fig. 254 shows the construction more fully. As in the case of the all concrete exterior, the size of the concrete pier is mainly governed by the required architectural proportions and the width of the window sash. The exposed concrete beam, which in the illustration rests entirely below the slab, carries the weight of the curtain wall and windows and also any floor load that may come upon it. The construction of the sill on the top of the brick curtain wall depends upon conditions and particularly upon the type of window. With steel window sash, concrete sills are commonly used, and are built after the sash is in place.

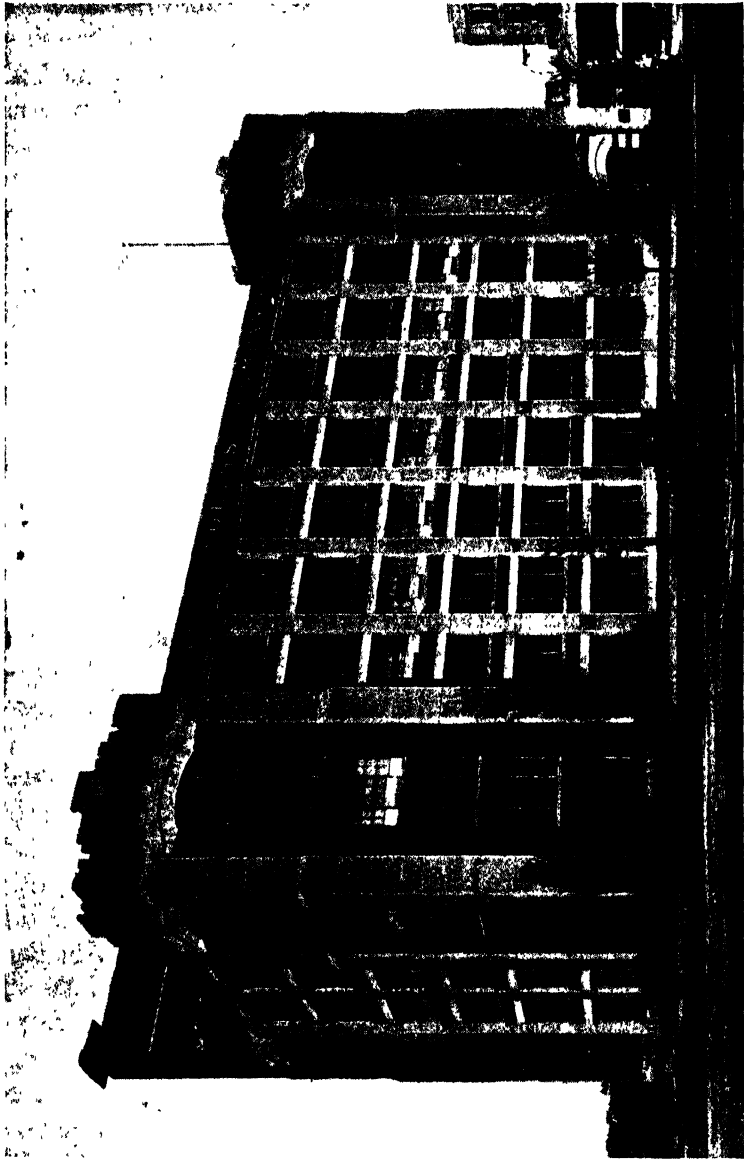

**FIG. 253.**—Youth's Companion Building, Boston, Mass. (See p. 739.)  
Densmore, LeClear & Robbins, Architects and Engineers.



An interesting variation from the ordinary treatment of spandrel beam and curtain wall, when the beam is entirely below the level of the floor which it supports, is the "upstanding" spandrel, which involves a somewhat less efficient structural design for this particular member, but has the advantage of bringing the tops of the windows close to the ceiling. Figure 255, p. 742, illustrates this form of construction and may be compared with Fig. 254, p. 741, the latter showing the usual dropped beam.

The brickwork in the spandrels may be plain or elaborate, the elaboration consisting of the use of different grades and colors of brick or different patterns.

Brick or tile work is often introduced into concrete piers, walls, and spandrels in the form of pattern work, making possible most effective treatments in both color and design. The possibilities in the combination of these materials are limited only by the ingenuity of the designer and the restrictions of expense. It is, of course, obvious that wherever concrete appears it may be finished in any of the methods discussed under "treatment of concrete surfaces."

The brickwork in the curtain wall may be replaced by ornamental terra cotta. Figure 256, p. 743, shows an interesting use of architectural terra cotta in curtain walls and in the spaces over the arches just below the cornice. The spandrels are elaborated by the use of terra-cotta pediments at the third-story level. The terra-cotta work is green-glazed and gives a most striking appearance in combination with the concrete, which is finished in white cement.

Consideration of the general proportions of the mass and concentration on a dominating feature bring about the same satisfactory results in architectural expression as may be obtained with the same study in any other type of construction. Figure 257, p. 744, is an excellent example of the possibilities of such study. While the main

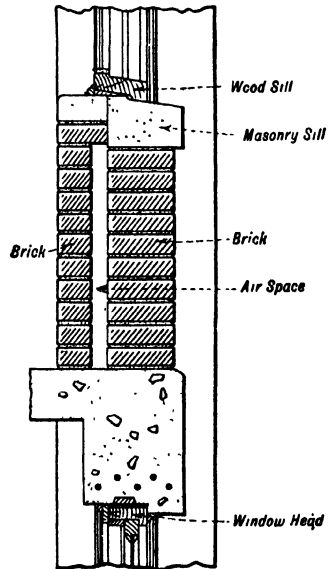

FIG. 254.—Section through Spandrel Beam. Concrete and Brick Exterior. (See p. 739.)

body of the building is given a touch of color in the brick spandrels and parapet wall, the tower is carried out entirely in concrete cast in place.

**Concrete Piers, Brick-faced Spandrel, and Brick Curtain Wall.**—The concrete spandrel beam, which is exposed in the previously

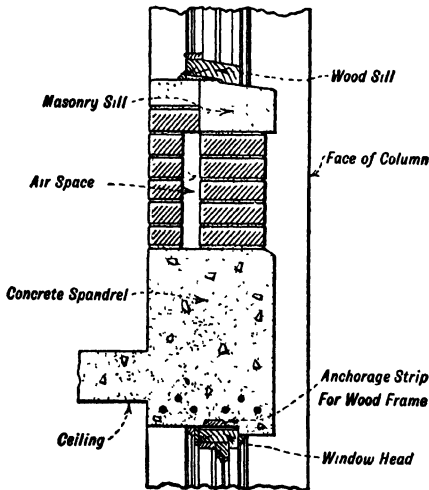

FIG. 255.—Upstanding Spandrel Beam Permitting Window Head to Come up Near Ceiling. (See p. 741.)

described type, may be covered with brick. The wall construction then consists of exposed concrete columns with the balance, except for the windows, covered with brick.

Figure 258, p. 745, illustrates this method. In this case, as in all cases where masonry is to be placed against concrete as an exterior facing, a space of about one inch should be allowed between the face of the concrete and the back of the masonry to allow for variations in the surface of the concrete member. The concrete beam is then set back

from the outside surface of the finished wall, a distance equal to the width of brick plus one inch.

When masonry is to be used as a facing for concrete, it is customary to support the facing material on structural steel angles securely bolted to the concrete members. For ordinary cases,  $\frac{3}{4}$ -in. bolts spaced 24 in. apart are used. This may have to be increased where the angles carry heavy load. The bolts, with heads and washers, or with the ends bent for anchorage in the concrete, are inserted in the formwork, with a threaded end left projecting a sufficient distance to pass through the leg of the angle and receive a nut and washer on the outside. These bolts may be held tight, during pouring, by nuts, one just inside and one outside of the formwork. The steel angle supporting the brick facing is usually 6 in. deep in order to get the anchor bolt well up into spandrel beam.

The spading of the concrete where the bolts occur must be done with care, so as not to displace the bolts or throw them out of line.

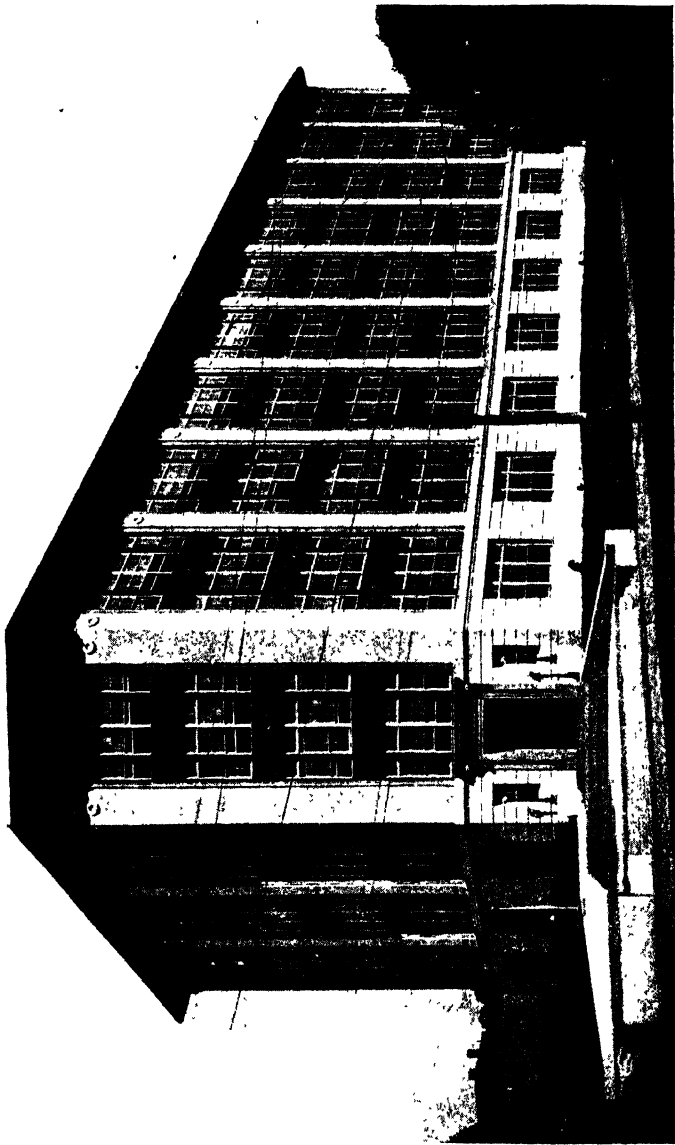

FIG. 256.—Building of Life Savers, Inc., Portchester, N. Y. (See p. 741.)  
Lockwood-Greene & Co., Engineers.

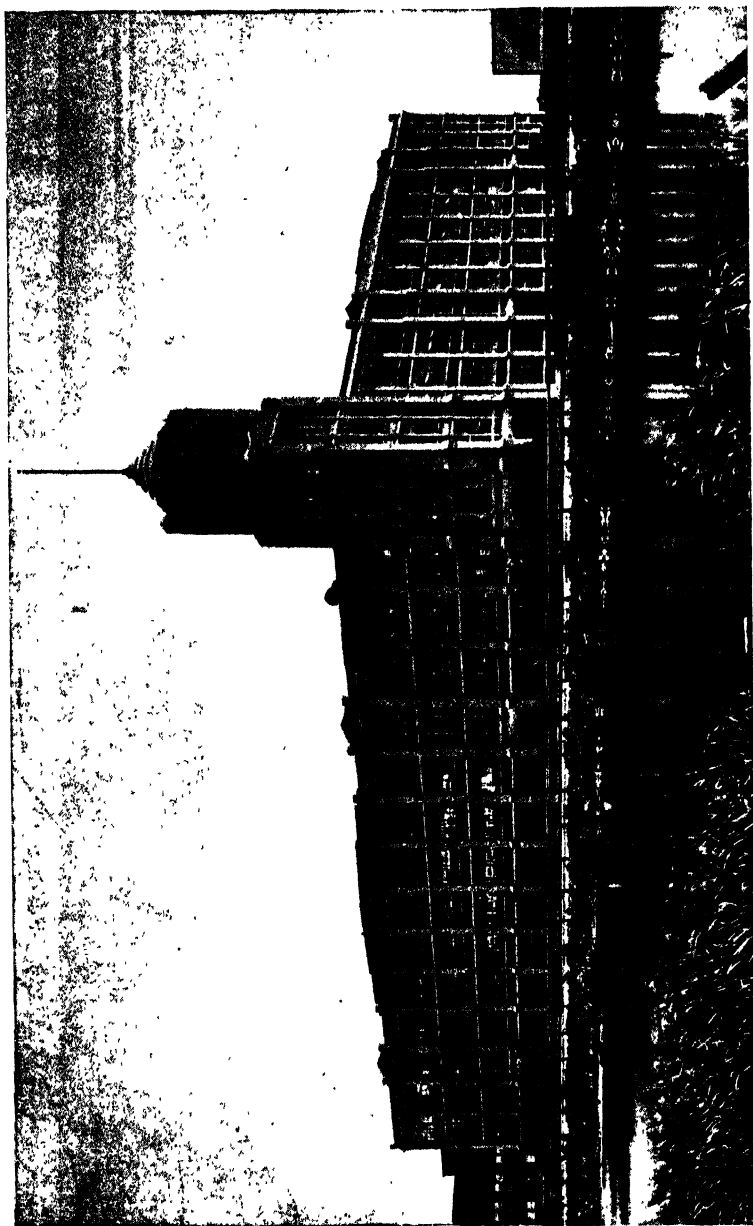

FIG. 257.—A. M. Creighton Factory, Lynn, Mass. (See p. 741.)  
Harold Field Kellogg, Architect. Turner Construction Co., Builders

Since the nature of concrete formwork is such that precision in the spacing of anchor bolts is somewhat difficult as compared with shop work in structural steel, it is well to allow for some slight variation, particularly in the horizontal direction of the bolt spacings, by slotting the steel shape instead of punching it. (See Fig. 258, p. 745.)

It is not practical to slot the angle vertically, but some allowance may be made for inaccuracy in vertical dimension, by making the slot slightly wider than the diameter of the bolt. This requires the use of a heavy washer under the nut and a thorough tightening of the latter to prevent slipping under the load of masonry.

**Backing of Curtain Walls.**—It is obvious that the backing of curtain walls, described above, may be of the same material as for similar work in other types of fireproof construction. The problem will vary with the

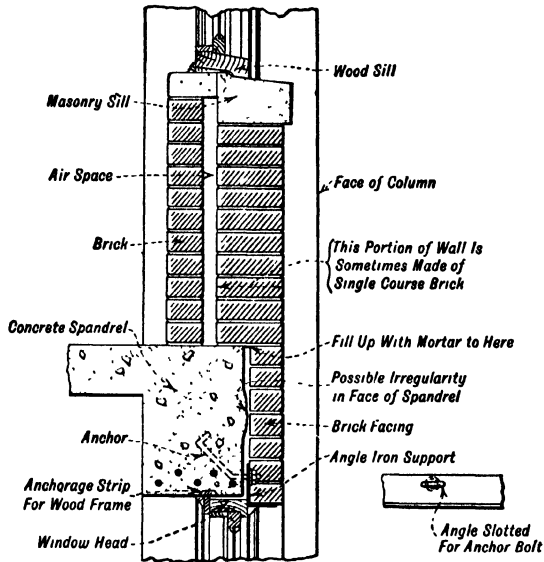

FIG. 258.—Spandrel Beam Faced with Brick, with Brick Curtain Wall. (See p. 742.)

character of the building and with the degree to which it is desired to avoid condensation. In most warehouses and factories, a small amount of condensation is not harmful. In such cases the curtain walls are made from 6 to 8 in. thick, without any special precautions. In structures such as office buildings, schools, hospitals, and buildings for habitation, where moisture inside must be avoided as far as possible, the choice of the backing material and the method of laying it should be given particular attention, to prevent the actual driving through of rain and also to eliminate condensation. Water troubles frequently appear even after the utmost care has been used in building, but the following methods may be used as being

good practice without involving great expense and as giving reasonably satisfactory results.

If the wall is to be of brick, an air space of 1 or 2 in. in width should be provided between the outer and inner courses, and care should be taken that this space be free from mortar.

A further precaution is to coat the inner surface of the outer coursing with a waterproofing material, this being done either as the wall is built up or after the outer coursing is built up to level and before the inner section is started.

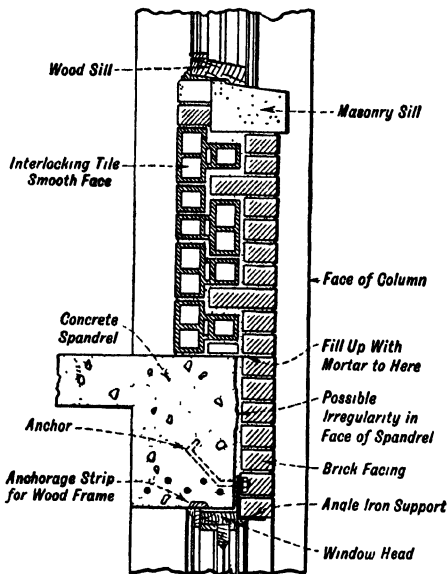

FIG. 259.—Spandrel Beam Faced with Brick, with Curtain Wall of Face Brick and Interlocking Tile. (See p. 746.)

metal ties. Figure 258, p. 742, shows a wall with brick backing, while Fig. 259, p. 746, shows a wall with backing of interlocking tile.

For buildings where the interior faces of these curtain walls are not to be plastered, the methods of construction described above are within the limits of good practice, since the amount of moisture which will come through is not of serious moment and is, under ordinary circumstances, evaporated before it becomes troublesome. When walls are to be plastered, however, it is the opinion of the author that no method of construction or treatment is as satisfactory or positive as the furring of the inside of the wall to provide vertical

the outside face of the wall may be coated with a colorless waterproofing agent. The use of either of these methods of applied waterproofing does not affect the conditions as regards condensation; but the air space in the wall, if it is free from obstructions, provides reasonably effective insulation. The backing of the wall may be of hollow tile of the interlocking variety, which provides for bonding with brickwork, or of the common form of hollow tile bonded with brick or with

metal ties. Figure 258, p. 742, shows a wall with brick backing, while Fig. 259, p. 746, shows a wall with backing of interlocking tile.

air spaces. This may be done with ordinary wooden or steel furring, upon which is placed the steel lathing and the plastering, or with tile furring blocks laid with the hollow spaces vertical.

### BRICK EXTERIOR

The next development beyond the partial use of masonry in connection with concrete is the complete clothing of the concrete skeleton structure with brick, in much the same manner as is practiced in buildings of skeleton steel construction. Figure 260, p. 748, shows a group of buildings entirely covered with brick and with no indication as to the type of construction.

This illustration was selected to show that concrete frame may be used irrespective of the elaborateness of the architectural treatment.

A less elaborate construction is shown in Fig. 262, p. 750. In the buildings shown in both illustrations, the outside treatment is independent of the size of concrete wall columns. These are, therefore, designed only for the load, as their size is not governed by architectural considerations. There the outside face of the columns must be in one vertical plane, any reduction in size of the structural column is obtained by setting back the inside face in the different stories. If the exterior design calls for a buttressed column, the structural member may be reduced in thickness, as the column goes up, to correspond to the changes in the set-backs of the exterior face.

In factory and warehouse construction, where the window occupies a large part of the wall, an arrangement shown in Fig. 261 may be used. The window sash extends from concrete pier to concrete pier. The veneer is applied outside of the building only. The shape of the concrete pier is as shown in the figures. The recesses in the columns are easily obtained by using rectangular forms with blocking of proper dimensions inserted in the corners.

The concrete wall beams ordinarily are set back just enough to allow a veneer of brick equal in thickness to one width of brick (usually 4 in.) plus one inch allowance for variations in the face of the concrete member. This may vary as necessary to meet the architectural treatment. If possible, the spandrel beam should be made deep enough to reach to the top of the window. This saves the expense of extra lintels over the windows.



Fig. 260.—Alden Park Manor, Brookline, Mass. (See p. 747.)  
Kenneth M. de Vos & Co., Architects and Builders. Harold Field Kellog and George R. Wirén, Consulting Architects.



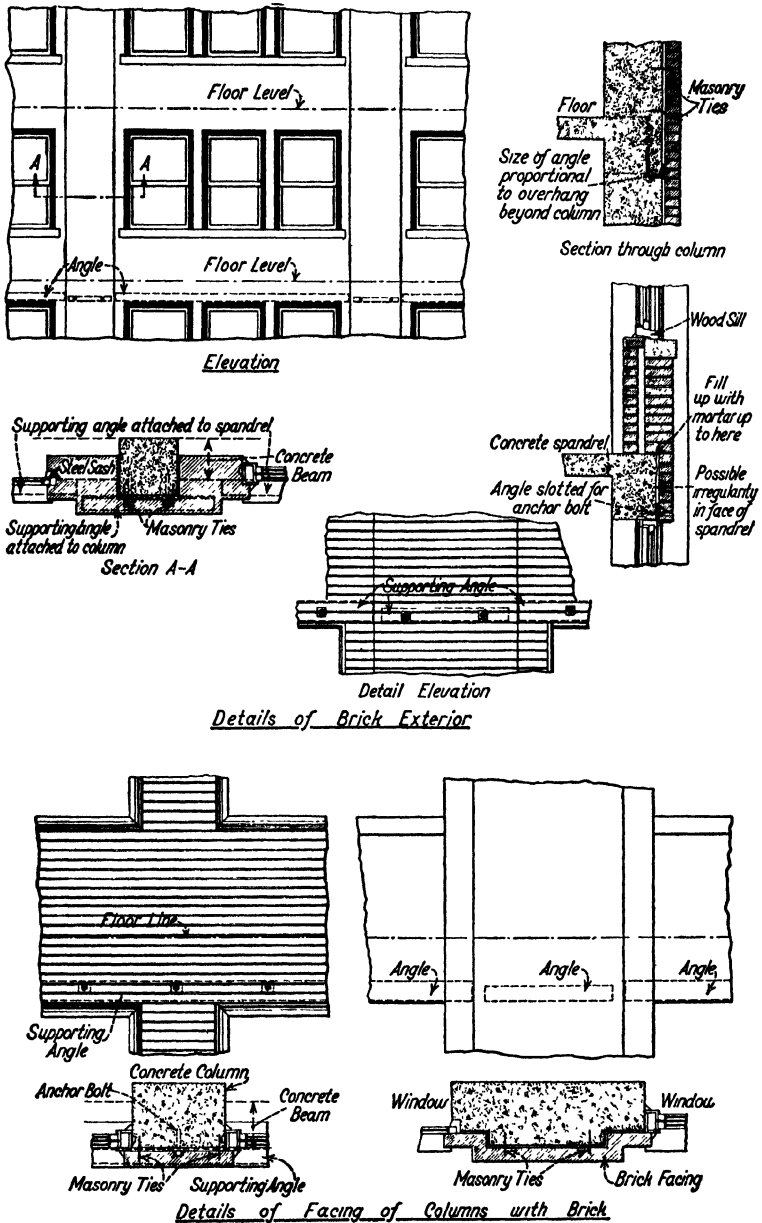

FIG. 261.—Partial Elevation and Sections of Brick Veneer Building.  
(See p. 747.)

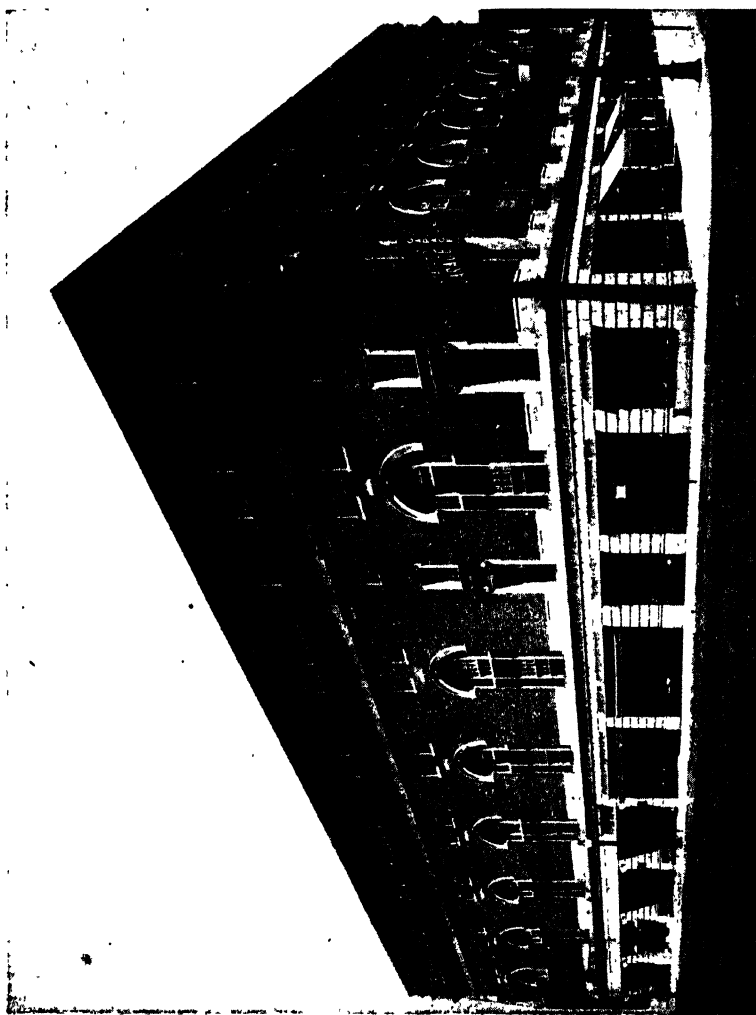

FIG. 262.—Statler Garage in Buffalo, N. Y. (See p. 747.)  
George B. Post, Architect. United Fireproofing Co., Contractors.

**Support of Veneer.**—The support of brick facing or any other such architectural treatment on the face of the structural members is accomplished by angle supports, in the same manner as described above in the discussion of masonry spandrel walls. (See p. 742.) The angle supports should extend along the spandrel beam and, in case of wall columns, across the face of the columns also. If spandrels are flush with wall columns, continuous angles may be used. When the spandrels are set back, separate short angles should be used across the column. The spacing of bolts and the method of securing them to the forms is the same as given on p. 742.

The steel supports for the facing should be bolted onto the structural members at each story. The angle on the spandrel is usually 6 in. deep to get the anchor bolt well into spandrel beam, while the angle on the column face can be 4 in. deep unless stronger angle is required by the load.

**Ties for Facing.**—In addition to the angle support, metal ties should be used for anchorage of the masonry to the concrete. These should be placed vertically, not more than six courses of brick apart. When the spandrel beam is no more than 20 in. deep, no ties are required. Horizontally the spacing may be 24 in. In the simplest forms, the ties consist of  $\frac{1}{4}$ -in. wire, preferably brass or copper, imbedded partly in the concrete and extending from it a sufficient length to reach well into the brick masonry. In constructing, holes are drilled in the form, the required distance apart, and the wire inserted to be buried in the concrete. The part of the wire to be imbedded in brick extends outside of the form.

To avoid the expense of drilling holes, ties of special design may be used. With these, the part intended to serve as anchorage in masonry is tacked to the formwork, while the part to be imbedded in concrete is bent back at right angles to the formwork. After the concrete is poured, this part of the tie becomes buried in the concrete mass. When the forms are stripped, the ties will detach themselves from the forms, but will of course remain anchored in the concrete. The ties should be of sufficient length and of such flexibility that the portion left outside the concrete surface can be bent to meet the coursing in the masonry and be laid into the joints as the facing is built up. If this method is used, it is not necessary accurately to predict the masonry jointing or to place the ties exactly at joint lines.

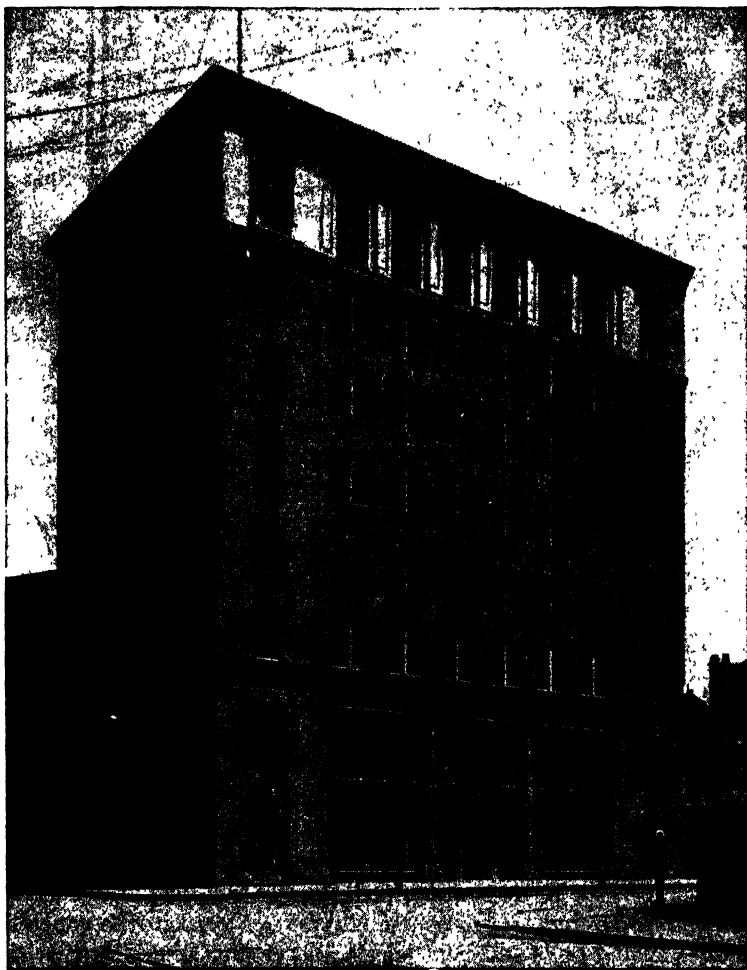

FIG. 263.—Building of the Salada Tea Co., Boston, Mass. (*See p. 753.*)  
Densmore, LeClear & Robbins, Architects and Engineers.

## STONE OR TERRA COTTA EXTERIOR

The use of stone or architectural terra cotta for the facing of reinforced concrete structures ordinarily presents no more difficult problems than are met in similar buildings where steel forms the structural members.

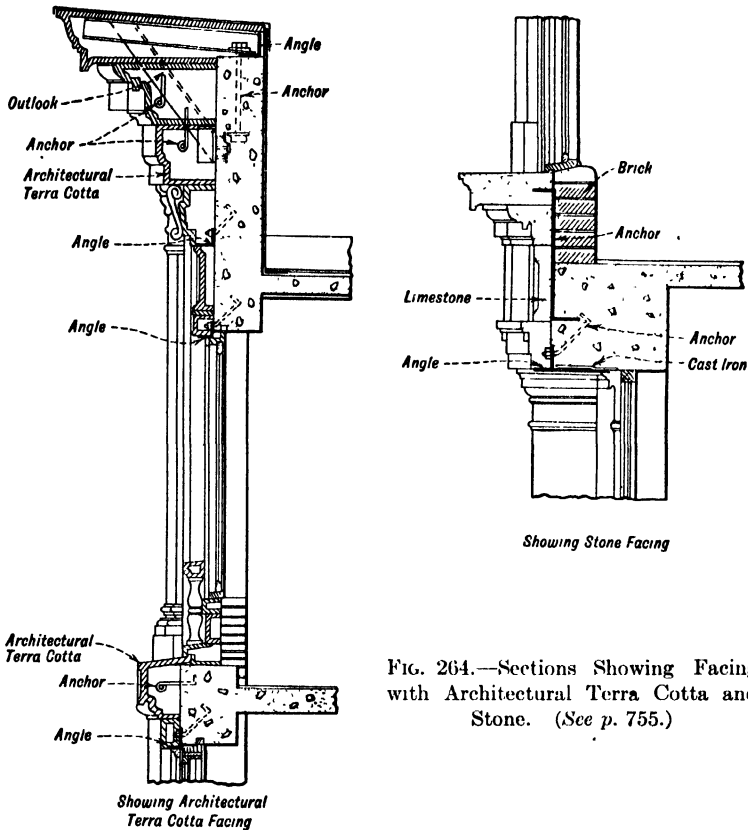

FIG. 264.—Sections Showing Facing with Architectural Terra Cotta and Stone. (See p. 755.)

Figure 263, p. 752, shows a concrete building, the lower stories of which are faced with limestone and the upper story with architectural terra cotta. In general, the manner of support and anchorage of the stone or the terra cotta is similar to the methods described above in the discussion of brick-faced buildings. In the building illustrated, the first two stories of stonework rest on the foundation wall,



while the remainder of the facing is carried on angle supports at each floor level.

Particular attention must be given to the anchorage of members having sufficient projection beyond the normal face of the wall to introduce possibilities of overturning. The use of heavy ties anchored in the concrete and turned into the stone, or of angle shapes secured to the structure and overlapping the top of the stone at the back, are methods frequently used; but each case is worthy of special study to determine the most satisfactory method. See Fig. 264, p. 753, for an illustration of facing with stone and architectural terra cotta.

Sections through ornamental façades on major and minor courts of the Massachusetts Institute of Technology buildings,<sup>3</sup> are shown in Fig. 265, p. 754. Attention is called to the method of facing of the concrete and also to the different methods used for anchoring the stonework. In some cases eye bolts were set in concrete spandrel beams spaced about 4 ft. 6 in. on centers, through which 1 inch base were placed. Anchors were carried from each stone and fastened around these bars. In other cases anchor bolts were anchored in the concrete and carried up between the joints of the limestone. Each anchor bolt was provided on the top with a plate and nut which hold the stones in place.

### INTERIOR FINISH

The finish of concrete which is exposed to view in the interior of buildings is open to as great a variety of treatments as is the case in exterior work. Much has been done in the way of unusual and interesting finished surfaces; but in the great majority of concrete buildings the architectural treatment of exposed interior concrete has not received the attention that has been given to exterior work. This is true because, except for the simplest possible handling of the material, other mediums in common use are as available and as readily applied as in any other type of building construction.

For purposes of discussion, the interior finish of concrete buildings may be divided into the following classes:

- (1) Simple finish.
- (2) Special finish.
- (3) Concrete painted.
- (4) Plaster finish.

<sup>3</sup> Stone and Webster, Builders, Sanford E. Thompson, Consulting Engineer.

**Simple Finish.**—Buildings in which the concrete structure is allowed to show on the inside are generally of the utilitarian type, in which good practice demands no more than a relatively clean, smooth surface. There are usually two kinds of defects in the concrete as it comes from the forms, which require attention to produce a satisfactory finish. These defects are the “fins,” left projecting from the face where the mortar has oozed through the joints in the formwork, and the “voids,” caused by a lack of homogeneity in the mixture and due usually to improper consistency of the mix or to insufficient spading as the concrete is deposited.

In ordinary practice, it is usually sufficient to smooth the projections by hammering and to fill the voids by rubbing in a rich cement mortar, using a wood or cork float or carborundum stone according to the degree of fineness desired. For a really smooth surface, the methods described in the discussion of exterior treatment may be used.

If the work is to be painted, it is essential, in filling the voids and smoothing, that no appreciable thickness of skim coat of mortar be left over the face of the concrete work, as such a coat is likely to peel under paint and flake off.

The choice of materials for formwork and the quality of workmanship used in placing it have an important bearing on the elimination of labor in finishing.

For all work except that which is intended to be left in a rough state, the wood for forms, against which the concrete is to be poured, should be planed to bring the boards to an even thickness and to eliminate the marks of the grain to prevent ridges, which are sure to develop when boards of even slightly differing thicknesses are used. The fitting together of the forms should be done with care, to eliminate as far as possible the cracks through which the mortar can flow. Knot-holes should be covered with tin or other suitable thin material, and where the finished surface is not to receive plaster the forms should be oiled.

Steel formwork also requires care in handling and placing, if a workmanlike finish is to be obtained.

Figure 266, p. 757, shows a ceiling surface resulting from the use of ordinary wood formwork and a column and column head cast in steel forms.

Improvement in the manufacture and setting of steel formwork has advanced to the stage where concrete as it is left after the forms



have been removed may approach the appearance of a plastered surface; but this is accomplished only with unusual care and special forms, and consequently with added expense.

**Special Finish.**—For more elaborate work than is commonly expected in the average concrete building, many devices may be used to produce attractive and unusual results. The forms may be left rough, purposely showing the grain of the wood as prominently as possible, to be treated later with paint to imitate a wooden surface.



FIG. 266.—Factory Interior, Salada Tea Building, Boston, Mass. (See p. 756.)

Plaster casts may be introduced into the forms, particularly into the sides and bottoms of beams, to give a desired pattern or design. In this case, relatively fine aggregate must be used for the concrete which is to come next to the cast.

The wooden formwork may be chosen for kind and quality, and may be left in place, solidly anchored into the concrete, when the mixture is poured.

The possibilities of interesting architectural effects, to be produced in ways similar to those mentioned above, are many and will suggest themselves to the resourceful designer, not only as to methods to be used but how and when to use them.

**Painted Concrete.**—Painting of interior concrete surfaces may be done in the same manner and with the same materials as would be used on ordinary plaster surfaces, except that it is advisable to precede the painting with a non-burning sizing coat which is especially prepared for use on concrete surfaces and which can be obtained from most paint manufacturers. The object of such a sizing coat is to prevent chemical action between the concrete and the paint, which, if not provided against, causes unsightly spotting of the painted surface.

It must not be assumed that the use of paint will hide the form marks or cover up other irregularities. In fact, such treatment, particularly if a glossy finish coat is used, will often make the faults in the surface appear more marked than if left unfinished. Painting does, however, give a surface which is more easily cleaned than if the concrete were left bare, and permits color treatments superior in appearance to the untreated concrete.

Either lead and oil paint or lithopone paint is satisfactory for use on concrete surfaces. Ordinary cold-water paint is also used extensively in industrial work for ceilings, and for walls above the height at which the paint is likely to be rubbed off, that is, 6 or 7 ft. above the floor.

In all painted work, the concrete should first be cleaned of any oil which may remain on the surface, due to the oiling of forms.

**Plaster Finish.**—The use of plastering as a finished surface is as much an accepted form in concrete construction as it is in any other type of building construction, but the problem of obtaining a satisfactory bond between plaster and concrete continues to be an important one. Concrete which is to be plastered should come from the forms as porous as sound construction will permit, and the use of oil or grease on the formwork should be avoided. The plastering of concrete ceilings requires unusual care, in order to avoid bond failure with the consequent dropping of sections of plaster finish.

It is probable that the only method of securing positive results in this direction is that of furring and wire lathing the surface as the foundation for the plaster work. This is an expensive treatment, and common practice does not require its adoption except in the most important cases.

There are on the market preparations in the form of specially prepared plaster which may be applied to the concrete surface as a foundation for the finished plastering, and which provide a reason-

ably satisfactory bond. An accepted practice for ceiling work is to prepare for the first or bonding coat by roughening the smooth portions of the concrete surface, by picking or hammering, and to make sure that if oil has been used on the forms it is thoroughly cleaned off. The amount of roughening varies widely, ranging from a surface hammered practically all over to hammered or picked spots of an area the size of the palm of the hand and spaced 3 to 6 in.



FIG. 267.—Main Office in Salada Tea Building, Boston, Mass. (See p. 760.)

apart. It is obvious that the more thoroughly the roughening is done, the less is the likelihood of bond failure.

It is of the greatest importance in connection with the plastering of ceiling surfaces that the plaster be applied in as thin coats as possible, and in no case should more than two coats be used. The plastering of vertical surfaces does not present as serious difficulties as are met in ceiling work, average concrete being a satisfactory base, particularly if the special plaster bonding coat mentioned above is used. Rough formwork, brushing the concrete while it is still green, or other similar methods may be used, where practical, to

produce vertical surfaces suitable for plastering without the necessity of special treatment.

Ornamental plaster work may be carried out on concrete members by the same method as commonly used in connection with other forms of construction. It is important, however, that no molded work be done on horizontal surfaces without furring or other suitable anchorage.

An interesting example of the interior treatment of a reinforced concrete building is shown in Fig. 267, p. 759, and this may be contrasted with a view of the interior of another story of the same building, Fig. 266, p. 757, where the construction is frankly exposed

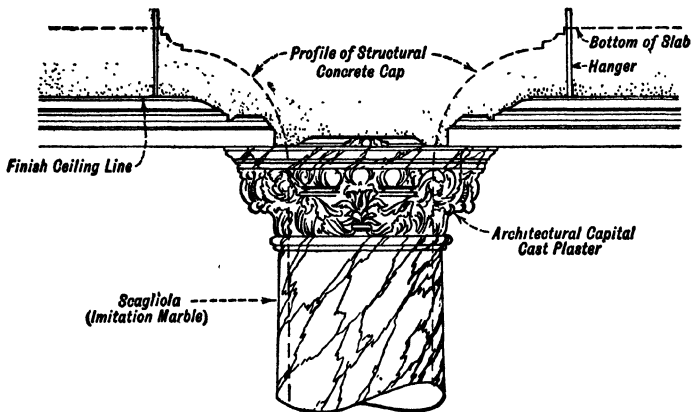

FIG. 268.—Detail of Suspended Ceiling and Architectural Column Cap. Interior of Salada Tea Building. (See p. 760.)

to view with no further treatment than painting. In this particular building, the construction is of the flat slab type with the usual flaring column heads.

The room shown in Fig. 267, p. 759, is in the first story of the building and is used as an office. The ceiling was furred down about one foot, concealing the sprinkler piping, and at the same time bringing the ceiling level down to a point on the flaring head of the column where the diameter of the structural head is such that a correctly proportioned column capital of cast plaster could be formed around it. (See Fig. 268, p. 760.) The columns themselves are encased in scagliola or imitation marble, with molded bases of the same material and plinths of dark marble. The molded ceiling,

carried on channel iron furring, is hung from the bottom of the structural slab of the second floor, the anchorage being provided by hangers imbedded in concrete or sockets for holding threaded rods, installed in place on the formwork and incorporated in the slab when it was poured. For details of suspended ceiling, see p. 616.

A much simpler treatment of a circular column head is shown in



FIG. 269.—Office Building Interior, Columns, Walls and Ceilings Plastered.  
(See p. 761.)

Fig. 269, p. 761. The plaster molding at the top of the capital in this case is run without furring, as it approximates the contour of the simple molding of the steel form.

It is obvious that, in beam and girder construction, the use of cornices, capitals, moldings, etc., is relatively simple, provided that such furring is used as is ordinarily employed under like conditions in other types of fireproof construction.

## CHAPTER XVIII

### CONCRETE IN CONSTRUCTION OF THEATERS AND AUDITORIUMS

Reinforced concrete is well adapted for theater construction. It has been used for this purpose in a large number of cases, in successful competition with steel construction. In localities distant from large steel fabricating plants, it is particularly economical, since the materials for reinforced concrete theater construction are more easily obtainable than structural steel members. It is also useful for balcony cantilevers in combination with steel trusses, whereby the difficult connections between the steel cantilevers and trusses are avoided.

The theater, for the sake of discussion, may be divided into the following parts: orchestra floor, balconies, proscenium, and roof. A general idea of a design of concrete theater may be obtained from Fig. 270, showing a section through Grauman's Theater Building in Los Angeles and Fig. 275 showing cross section through Winston-Salem auditorium.

#### ORCHESTRA FLOOR

The space under the orchestra floor is often entirely unexcavated or excavated only in part. When the ground is solid enough, the concrete floor for the unexcavated portion may rest directly upon it and be treated in same fashion as the ground floor in ordinary buildings. To prevent cracking due to contraction and shrinkage, some reinforcement, consisting of small bars or mesh, is advisable. The orchestra floor in the Winston-Salem auditorium, shown in Fig. 275, p. 781, rests directly on the ground.

If the space under the floor is excavated, or if it is not desirable to rest the slab on the ground, the construction of the orchestra floor consists of one-story columns supporting a reinforced concrete floor system. It differs from ordinary building construction in that the

slab is level only near the stage, and then slopes up. In many cases the slope is gradual at first and then more pronounced. The longitudinal cross section is then a curve with a horizontal tangent at the origin. When the rows of seats are parallel to the stage, all cross sections are alike. The only difference between such construction and ordinary building construction is that the columns in successive rows will increase in height and the beams or girders longitudinal with the building will be inclined, while the members across the building will be level.

Ordinarily, however, the seats in each row are placed on a curve which is either a segment of a circle or, more often, a three-centered curve. Since all seats in a row must be on the same level, the orchestra is not a plane but a warped surface. This complicates the floor construction. The best solution is to place inclined girders longitudinally with the building, and then arrange the beams tangentially to the curve of the seats. All beams in a row will then be on the same level.

Unless fixed by the requirements of the space below the orchestra floor, the spacing of the columns carrying the orchestra floor will depend upon economic considerations, and particularly upon the cost of foundation and length of columns. If the cost of foundation for each column is small and the columns short, they may be spaced more closely. For difficult foundation work, larger spacing of columns will be found economical. Usually, a spacing of 18 to 20 ft. will be found satisfactory.

Although beam and girder construction is generally used for orchestra floors, flat slab construction in many cases is more economical. Either type of floor is designed according to the principles discussed on pp. 303 and 575. The cross section through Grauman's theater, Fig. 270, p. 764, shows a design of supported orchestra floor. In this case the construction is of the beam and girder type with girders running longitudinally with the building.

The steps for the seats may either be made integral with the floor slab or be built separately of cinder concrete on top of the structural slab.

### BALCONY DESIGN

The most difficult problem in theater construction is to design the balconies without using intermediate columns in the orchestra. This is usually effected by the introduction of one or more fulcrum

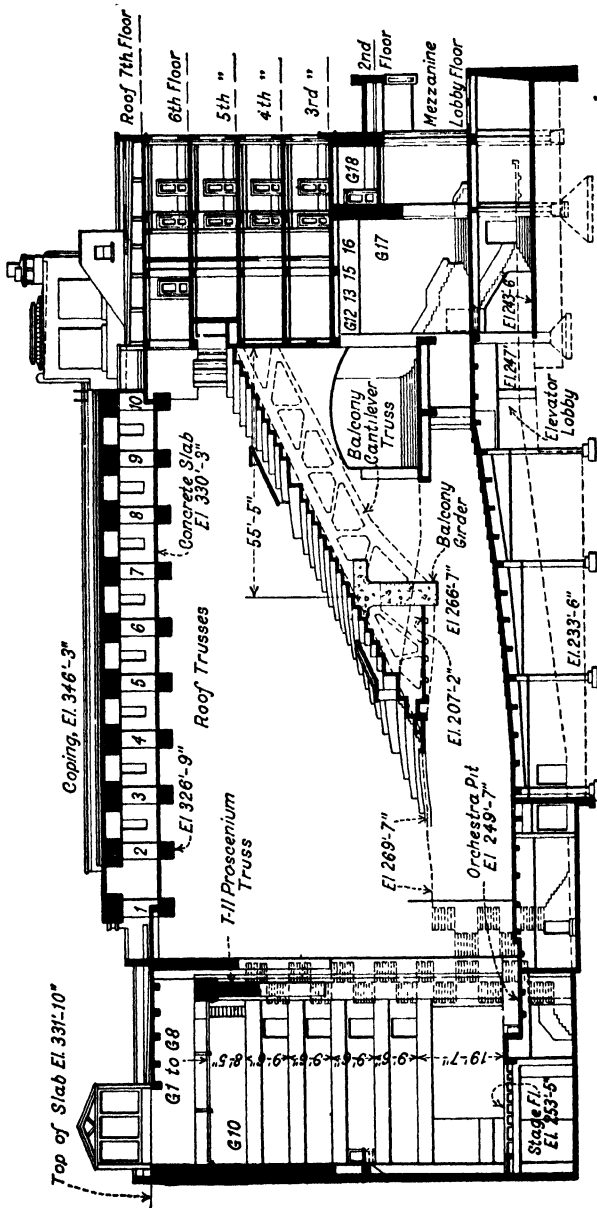

Fig. 270.—Cross Section through Grauman's Theater. (See p. 763.)  
Edwin Bergstrom, Architect.



girders running across the theater and serving as supports for the inclined cross beams carrying the balcony slab. As it is impossible to place the fulcrum girders at the edge of the balcony, the inclined cross beams must be cantilevered out, often to a considerable length.

### FULCRUM GIRDERS

**Arrangement of Fulcrum Girders.**—The arrangement and the number of fulcrum girders depend upon the width of the theater.

The simplest arrangement is shown in Fig. 271 *a*, p. 766. One fulcrum girder is placed as near the edge of the balcony as possible. It is supported on columns concealed in the wall, or, if this is possible without obstructing the view, a few feet from the wall. The latter arrangement is practicable, for example, when columns can be concealed in boxes or placed at the edge of outside aisles. Full-span fulcrum girders are particularly adaptable for small spans. They have been used, however, for spans as large as 126 ft.

The balcony seats are usually placed on a curve. With a fulcrum girder placed across the theater, as in the first arrangement, the cantilever arms at the sides may be too long. They may be reduced by using side diverging girders, one on each side; one end of each resting on a column placed in the side wall and the other end on the main fulcrum girder. (See Fig. 274, p. 780.)

Where the width of the theater is large, it may be economical to use the more complicated arrangement of fulcrum girders shown in Fig. 271 *b*, p. 766. Here two side girders are supported by four columns, and a middle girder spans between the side girders. This has the advantage of requiring spans not larger than 50 or 60 per cent of the width of the theater. It is economical to make the span of the side girders smaller than that of the middle girder. The aggregate length of the three girders in this arrangement is greater than the length of the one girder in the arrangement previously described, but their size is much smaller. The required depth for the middle girder is much smaller than would be required for a girder spanning the whole width of the theater, and it can be placed, therefore, nearer the edge of the balcony and thus reduce materially the cantilever arm of the balcony beams.

**Position of the Fulcrum Girder.**—Several considerations affect the position of the fulcrum girder in relation to the edge of the balcony. The first is the depth required for the girder. The available depth

is the distance between the top of the balcony floor and the line fixed by the minimum headroom for the seats below. At the edge of the balcony, this available depth is made as small as possible, and usually equals only a few inches. Since the balcony seats are stepped up, the available depth increases rapidly with the distance from the balcony edge. As far as the economical design of the girder alone is concerned, it would be placed where the available depth is equal to the economical depth for the span of the girder.

The second consideration is the design of the balcony cantilevers carried by the fulcrum girders. The length of the cantilever arms

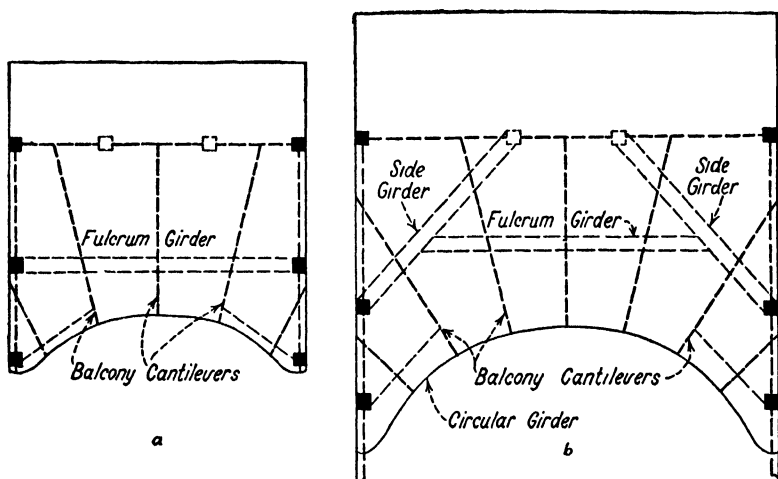

FIG. 271.—Arrangement of Fulcrum Girders. (See p. 765.)

obviously depends upon the distance between the fulcrum girder and the balcony edge. As explained in Vol. II, the cost of the cantilever is a minimum if the length of the cantilever arm is about equal to one-half of the anchor arm. It will be found, in most cases, that the two considerations are conflicting, and the problem is solved by considering the economy of the construction as a whole. Usually, it will be found economical, for the construction as a whole, to place the girder at a distance from the edge where the available depth equals the minimum depth for which a girder of the required span can be designed. The sacrifice in the economy of design of the girder will be more than offset by the economy in cantilever beams.

**Shape of Fulcrum Girders.**—The fulcrum girders may be either T-beams, trusses, or arches. The design of each type is discussed below under the proper heading.

**Fulcrum Girders as T-beams.**—The slab in the balconies is thin, and cannot serve as a flange for the girder. If a rectangular beam has not sufficient compression area, a special compression T-flange must be provided and the fulcrum girder built as shown in Fig. 277, p. 783. If possible, the flange should be large enough to make compression steel unnecessary. For allowable width of the flange see p. 218. The flange should be as symmetrical as possible about the center line of the girder. In most cases, the width of flange on the balcony side is limited by the shape of the balcony, but on the opposite side any width is available. For this reason some designers use a flange appreciably wider on one side than on the other. The authors do not approve of this, because in unsymmetrical beams the neutral axis is inclined and stresses in steel are not uniform. Special formulas would have to be used for unsymmetrical beams. In the design on p. 783, the flange was made symmetrical. The total width was fixed by the available width on the balcony side. This width was not sufficient, and therefore compression steel was used.

The web of the T-beam is fixed by the shear and also by the required width for the placing of the large number of bars. Sometimes it is economical to make the web wider near the supports, where the shear is a maximum. Also, the dead load of the beam may be reduced by paneling the web in the central portion of the beam.

In designing the girder, especially where the flanges are thin in comparison with the depth of the girders, it is advisable to use the formulas in which the compression stresses in the concrete below the flange are taken into account. A simple exact method is given on p. 224.

The fulcrum girders are almost always of single spans. Since the columns supporting them have a much smaller moment of inertia, it is not possible to restrain the ends of the girders to any extent. Therefore, they should be considered as simply supported, but top reinforcement at the support should be provided in sufficient amount to resist any negative bending that may be developed.

Special attention should be paid to the design of reinforcement. To accommodate the large number of bars, an unusually large number of layers are required. To develop full stresses in a large number of

bars placed in several layers with a comparatively small amount of concrete between the layers, the rules given below must be strictly followed:

*First.*—The bond stresses must be kept within working limits, while at the same time, to reduce the number of bars, their diameters should be made as large as permitted by bond stresses.

*Second.*—The bars in each row must be kept in place by positive means. The rows of bars should be separated by short bars of proper diameter placed across the main reinforcement between the layers, and spaced about 3 or 4 ft. on centers. The diameter of these cross bars must be equal to the diameter of the largest bar, but must not be less than one inch.

*Third.*—From 50 to 60 per cent of the number of bars should be bent up and carried to the top of the beam. The points of bending should be determined from the bending moment and well distributed. Some of the bent bars should be extended along the top to the end of the beam. All of the bars should be provided with hooks at their ends. The bending of the bars serves two purposes: (1), the bent portions act as diagonal tension reinforcement; and (2), by anchoring the trussed bars in the compression zone the development of their strength is insured. Since the bent bars are distributed through the beam, a large mass of concrete assists in developing the tensile stresses in the bars. The number of the straight bars depending upon bond alone is materially reduced.

All straight bars should be provided with hooks at the ends of the beam.

*Fourth.*—Stirrups should be used throughout the whole length of the beam, and kept in place by bars placed in the top of the beam.

*Fifth.*—The T-flange of the girder should be provided with cross bars having a total cross-sectional area of at least 0.2 per cent of the section of the flange. These should be supported and kept in place by longitudinal bars placed in the flanges.

*Sixth.*—Under no circumstances should the longitudinal reinforcement be reduced simply by stopping bars at points of reduced bending moment. Designs with a number of straight bars shorter than the span have been used, but cannot be condemned too strongly. It should be evident that stresses in the short bars cannot be induced without slipping of the bars (see p. 289). This would be doubtful practice even in small beams with one or two layers of bars. In

large beams, no amount of saving in steel that may result from this arrangement is sufficient to warrant the bad practice.

*Seventh.*—If there is any possibility of negative moment, top reinforcement, properly anchored at ends, should be used even if no advantage is taken of the restraint in computing the positive moment.

*Eighth.*—Columns supporting the girders should be designed to take care of any bending moment.

**Fulcrum Girders as Trusses.**—For large spans, the amount of concrete may be reduced by using concrete trusses instead of T-beams.

*Rectangular Truss.*—The trusses may be obtained simply by providing rectangular openings throughout the girder. The truss would then consist of chords and vertical members, except at the ends, where solid web may be used for the distance required to provide for shear. This type of construction is statically indeterminate. The chords and the vertical members are subjected not only to direct force but also to bending. The bending stresses in these members depend upon the external shear and are larger near the end than in the middle portion of the truss. Method of design of trusses is given in Volume II.

*Triangular Truss.*—To avoid the large moments in the members due to shear, concrete trusses are often designed with diagonals. The truss consists of triangles, and the direct stresses may be computed in the same manner as in steel trusses.

In addition to direct stresses due to truss action, all bending stresses due to the dead load of the members, and to any load placed between the panel points, should be computed. In computing bending moments, the members may be considered as continuous or fixed beams supported at the panel points. The stresses due to the bending moments should be combined with direct stresses as explained on p. 187.

Because of the rigidity of the joints, secondary bending stresses will develop. These, however, are no larger than in a steel truss under similar conditions. In the shallow steel trusses commonly used in theater construction, the rigidity of joints, due to heavy gusset plates, is about the same as in concrete construction. In both cases, proper allowance should be made for secondary stresses. Reinforcement in the truss members should be placed so that it is able to resist tension due to bending moments to which the members may be subjected.

In designing the top and bottom chords, it must be remembered

that the computed stresses will not be uniformly distributed over the whole sectional area of the member. The depth of the chords is large in comparison with the theoretical depth of the truss. After deflection, the top chord will shorten more at the top edge than at the bottom edge, although for chords of small depth this difference in deformation is small. In theater construction, owing to the large depth of the chords, the difference in shortening of the two edges is appreciable. The resulting variation in stresses is proportional to the variation in the deformations. The member must then be designed for an average unit stress smaller than the maximum allowable stress. The same principle applies to the stresses in the bottom chord.

**Allowable Compression Stresses in Trusses.**—Since the compression members in trusses are subjected to direct compression (similar to column stresses), the same unit stresses allowed for columns should be used, and not the stresses allowed for extreme fibers in flexure. However, when bending moments are considered in addition to direct stresses, the formulas on p. 170 should be used and the allowable combined stress may be accepted as explained on p. 463.

**Design of Tension Members in Trusses.**—In tension members, all the tensile stresses are resisted by the reinforcement, and the area of concrete is made only sufficient to properly cover the bars. The same spacing of bars should be used as recommended on p. 273. While a small number of large bars is easier to handle and makes a compact tension member, its use is recommended only in cases where the tension member extends the full length of the truss, where any splicing is accomplished by mechanical means, such as turnbuckles, and finally where the stresses are transferred to the concrete at the ends by nuts and anchor plates. When the tensile stresses in bars are developed by bond, a large number of small bars is advocated. In addition to direct tension, bending, due to dead load, and secondary bending stresses must be considered. In some cases, bending moments are so large that the concrete may assume the duties of resisting compression stresses produced by bending. Formulas given on p. 191 should be used.

Usually, however, the bending stresses are not sufficient to change the tension, due to direct stresses, to compression.

The proper design of the details and connections between members is of great importance. Bars should be spliced only at panel points. To avoid crowding of bars, as few splices as possible should be used.

The bars should extend over several panels and should be arranged so that only a few bars are spliced at any one panel point. At the joints, the bars of one member must extend far enough into the adjoining member (or the intersection of adjoining members) to develop the full strength of the bar, taking into consideration, of course, the character of the stresses to which the bar is subjected. A bar effective in one panel of the bottom chord, for instance, should extend beyond the panel point into the adjoining panel for a length equal to 40 diameters of the bar for deformed bars, and to 50 diameters for plain bars. The solid concrete at the joint, which corresponds to the gusset plates in steel construction, must be of sufficient size to enable the concrete there to transmit the stresses from any one member to the other members in the joint.

Each joint, in addition to the reinforcement of the members extending into it, should be provided with special horizontal and vertical reinforcement in the shape of hoops or stirrups. These serve to take care of any secondary stresses and preserve the integrity of the joint.

**End Panel Point.**—At the end panel points, proper provision should be made for diagonal tension due to the external shear. The structure may fail by forming a diagonal crack between the compression and tension members. To prevent this, the vertical area of concrete at the junction of the two members must be sufficient to keep the unit shearing stresses, computed as in ordinary beam design, from exceeding the maximum allowable working values. In addition, the authors recommend that the minimum horizontal cross section of the joint should be equal to the reaction divided by 100 lb. In this distance, the cross section of vertical stirrups should be equal to the reaction divided by 16 000 lb. Stirrups must be looped around the tensile bars at the bottom and around the compression bars at the top.

All tensile stresses are resisted by the reinforcement. The area of concrete is made only large enough to cover the bars. The tensile reinforcement in the bottom chord, if it consists of large bars, should be provided with a screw and nut at the end and an anchor plate of sufficient size to transfer all the stresses from the bar in bearing on the concrete. Reinforcement consisting of small bars should be provided with hooks at the ends. If possible, the tensile bars should hook up into the compression member. If not, they should hook around the reinforcement of the compression member.

**Relative Economy of T-Beam and Truss.**—The relative economy of the T-beam and the truss for fulcrum girders depends upon the cost of formwork. The truss has much less concrete and steel, but the formwork is complicated and the placing of concrete and steel more difficult. In many instances, the truss without diagonals, (that is, with rectangular openings) even if it is necessary to use solid web at the ends, may prove more economical than the lighter truss with diagonals because of cheaper formwork. In cases where a decided saving cannot be demonstrated, T-beam design should be used in preference to the truss as it is easier to build.

**Fulcrum Girders as Arches.**—Arch construction is well adapted for fulcrum girders for large spans. As it is not feasible to make the support unyielding enough to take the horizontal thrust, the arch must be provided with tie-bars of sufficient area to resist the thrust. If properly designed, the cost of the arch is smaller than the cost of the truss under similar conditions, mainly on account of the simplified formwork.

For designing purposes, the arch should be considered as hinged at the supports, which makes the horizontal thrust the only statically indeterminate quantity.

The cantilever beams may be placed between the top of the arch and the bottom level of the tie-bars. Tension bars of sufficient area to suspend the cantilever from the arch must then be used.

The method of design is discussed in Volume III.

**Special Concrete for Fulcrum Girder.**—To save dead load, it may be economical to use richer mix of concrete for fulcrum girders. A mix of 1 : 1½ : 3 or even 1 : 1 : 2 may prove economical, especially when, with the leaner mix, compression reinforcement would be required.

### BALCONY CANTILEVERS

The balcony floor slab is carried by beams, which in turn rest on the fulcrum girders. As already explained, the fulcrum girders must be placed some distance back from the edge of the balcony, and therefore the balcony beams must be cantilevered out beyond the girder.

Reinforced concrete is well adapted for the balcony cantilevers and is being used for this purpose, not only in reinforced concrete theaters but also in connection with structural steel fulcrum girders.



As a general proposition, the cantilever beam carrying the balcony consists at one end of the cantilever arm, resting on the fulcrum girder, and at the other end of span the anchor arm, anchored to the support to prevent uplift. In modern theaters, the length of the balcony may be considerable. With only one fulcrum girder, the length of the cantilever arm may exceed 30 ft.

If possible, the cantilever arm should not be longer than the anchor span. In no case should the uplift caused by the load on the cantilever arm (multiplied by proper factor of safety) with the anchor span unloaded, exceed the available downward reaction at the point of anchorage.

**Moments and External Shear in Cantilever.**—The beams must be designed for three assumptions as to the disposition of the live load, each of which produces maximum stresses in some part of the construction. The assumptions are as follows:

1. The cantilever arm is loaded, the anchor span not loaded.
2. The cantilever arm is not loaded, the anchor span loaded.
3. Both arms are loaded.

The first condition, where only the cantilever arm is loaded, produces maximum stresses in the cantilever arm and also maximum negative bending moments in the anchor span. The uplift is also a maximum for this condition.

The second condition, where the anchor arm only is loaded, produces maximum positive moments in the anchor span.

The third condition, where both arms are loaded, produces maximum shears in the anchor span and also maximum reactions on the fulcrum girder.

The moments and shears for the live load should be combined with those for the dead load. For some conditions of loading, the stresses produced by the live load are of opposite sign to those produced by the dead load, and if the two are added, the dead load stresses may balance partly or fully the live load stresses. Under such conditions the combination of live load stresses and dead load stresses by a simple addition, is not permissible, but the live load stresses must be multiplied by the required factor of safety. When the live load is doubled, the stresses produced by it are doubled also. The dead load stresses, however, remain the same, so that the reduction in the live load stresses due to the dead load stresses is proportionally only half as large for double the live load.

The following example explains the matter more fully. Assume

that the anchor span is 20 ft. long, cantilever arm 12 ft., uniformly distributed dead load 1 000 lb. per lin. ft., uniformly distributed live load 1 400 lb. per lin. ft.

*Dead Load Reactions:*

Due to load on cantilever arm:

At fulcrum girder, left . . . . .	12 000 lb. downward
At fulcrum girder, right . . . . .	3 600 lb. downward
At end support . . . . .	3 600 lb. upward

Due to load on anchor span:

At fulcrum girder, right . . . . .	10 000 lb. downward
At end support . . . . .	10 000 lb. downward

The sum of the two reactions gives:

Reaction due to dead load:

At fulcrum girder, left . . . . .	12 000 lb. downward
At fulcrum girder, right,	
	$10\ 000 + 3\ 600 = 13\ 600$ lb. downward
At end support . . . . .	$10\ 000 - 3\ 600 = 6\ 400$ lb. downward

No uplift due to dead load.

*Live Load Reactions, Cantilever Arm Only Loaded:*

At fulcrum girder, left . . . . .	16 800 lb. downward
At fulcrum girder, right . . . . .	5 040 lb. downward
At end support . . . . .	5 040 lb. upward

Uplift due to live load, 5 040 lb.

Combining the uplift due to the live load, equal to 5 040 lb., with the downward reaction due to the dead load, equal to 6 400 lb., it will be found that no uplift will occur for this condition of loading, and therefore no anchorage would seem to be necessary. But in such a case, practically no factor of safety against uplift would exist.

If, now, the live load on the cantilever is doubled, the uplift due to the live load will also be doubled, or  $2 \times 5\ 040 = 10\ 080$  lb. The downward reaction due to the dead load will remain the same. The net uplift, therefore, for double live load on the cantilever, will amount to  $10\ 080 - 6\ 400 = 3\ 680$  lb.

To get a factor of safety of 2 against uplift, it is necessary to anchor the structure strongly enough to resist an upward pull of 3 680 lb., even if for the combination of single live and dead load a downward reaction is obtained.

The same applies to the stresses due to negative bending moment in the anchor span. To provide a proper factor of safety, it may be necessary to provide negative moment reinforcement in places where the combination of one live load and dead load give positive moment. This difference between ordinary beam design and cantilever design must be constantly borne in mind.

To combine dead and live load moments when they are of opposite sign, the procedure is as follows: The moments due to live load are multiplied by the desired factor of safety. The moments due to dead load are subtracted. The difference is then divided by the same factor of safety and the dimensions of the member determined in the usual fashion.

In many parts, a reversal of stress may take place; that is, for some loading the stress will be tension, and for other loading, compression. The frequency of the reversal is not sufficient to require any reduction in unit stresses.

**Depth of the Cantilever Beam.**—In most cases, for designing purposes, the cantilever beam is considered as a rectangular beam.

The required depth of the cantilever beam is governed either by shear or by the negative bending moment, both of which are a maximum at the fulcrum girder.

In the cantilever arm, because of the slope of the balcony, the beam decreases in depth, and this decrease may be larger than the decrease in bending moments and shears. Therefore, it is not sufficient to determine the depth and the amount of steel at the support; it is also necessary to investigate the stresses at intermediate points and design the sections to correspond.

In the anchor span, the shears and bending moments are largest at the fulcrum girder. The depth of this girder, therefore, is made the same as for the cantilever arm at this girder, and the beam is then tapered toward the other support. The taper may be uniform, or a fairly steep hunch may be used at the support followed by a gentle taper toward the end of the beam.

The depth of the cantilever beam must be the same on both sides of the fulcrum girder, so that the compression stresses on one side may be resisted by compression stresses on the other side of the girder. If the depth were different, torsion would be developed in the girder. In some designs, the moment produced by the cantilever arm is resisted on the other side of the girder by a tie beam on the top and a strut at the bottom. It is obvious that in such designs

no provision is made for the shear produced by the bending moment, and as a result heavy secondary stresses are developed in both members.

**Reinforcement for Cantilever Beams.**—The reinforcement determined for the negative moment in the cantilever beam at the fulcrum girder must be extended on both sides. In the cantilever arm, at least one-third of the bars should extend on the top for the full length of the arm; the rest may be bent down to resist diagonal tension. In determining the points where it is permissible to bend the reinforcement, it is necessary to remember that, while the bending moments decrease with the distance from the support, the depth of the cantilever decreases. For steep balconies, the decrease in depth may be almost as rapid as the decrease in bending moments, in which case no reduction in negative steel is permissible and all bars must extend on the top for the full length of the cantilever arm.

In the anchor span, some of the top steel from the cantilever arm should be carried on the top, for the full length of the anchor span, because, for the most unfavorable position of the load, negative moment will be found throughout the span. This happens when the stresses due to live load on the cantilever arm only are multiplied by the factor of safety and are combined with the dead load stresses. The rest of the bars may be bent down, when permitted by the moments, and extended at the bottom for use as positive moment reinforcement. Sometimes, the cantilever is of such shape that it is difficult to extend the bars along the top from end to end without difficult bending. In such cases, bars may be spliced, provided great care is used to break joints. Some steel should be used at the bottom of the cantilever span, even if not required for compression.

Positive bending moment reinforcement in the anchor span should be treated as in ordinary beams.

**Cantilevers in Steel Construction.**—Concrete balcony cantilevers may be used with economy in connection with structural steel fulcrum girders. In all cases, the girders are deep enough to allow sufficient depth for an economical concrete member. The economy effected by the use of concrete instead of steel consists not only in the saving in the cost of the member itself, but also in the simplifying of the connections between the girder and the cantilever.

The design of a cantilever supported by a steel girder does not differ to any extent from that of a cantilever supported by a reinforced concrete girder. The only interesting part is the method of

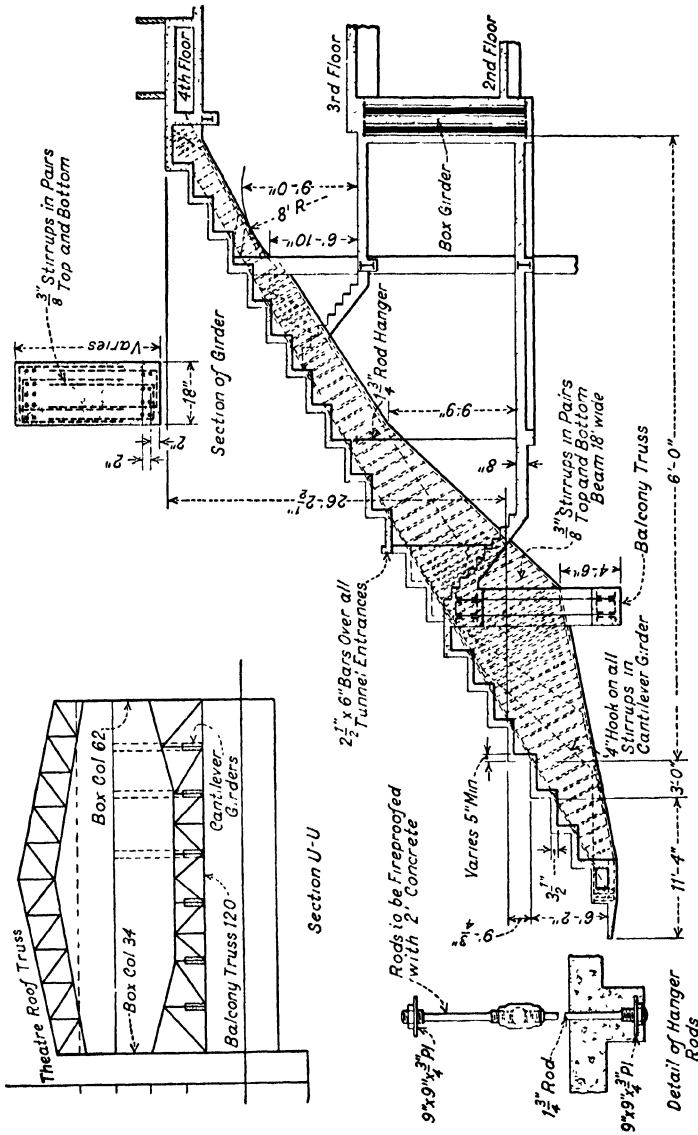

FIG. 272.—Reinforced Concrete Cantilever Supported by Steel Fulcrum Truss. (See p. 778.)

supporting the cantilever on the steel truss. In Fig. 272 is given a cantilever used in the theater auditorium of the State-Lake Building in Chicago.<sup>1</sup> The part of the supporting girder is also shown, as well as the detail of the seat for the cantilever. The concrete poured between the gusset plates and resting on the bottom chord, serves as a seat for the cantilevers.

**Cantilever Trusses for Balconies.**—Ordinarily, cantilevers are rectangular beams. For large spans, trusses have been used, as shown in Fig. 273, p. 779.<sup>2</sup>

### BALCONY FLOOR CONSTRUCTION

The top of the balcony is stepped. The most common construction consists of vertical ribs, spanning from cantilever to cantilever and forming the risers of the steps, and a thin slab spanned between the ribs. The thickness of the slab is usually 3 in. The ribs are about 5 in. thick, and their depth is governed by the required height of riser for the step. The ribs must be designed as beams, each carrying half of the load on the two adjoining slabs. The slabs should be reinforced with bars extending into the ribs. Although negative moment will be developed in the slab, it is not practicable to bend up the slab steel. Wire mesh is sometimes used as slab reinforcement. The top of the cantilever extends to the top of the floor and is also stepped.

Another method sometimes followed is to use an inclined slab between the cantilever beams (or inclined slab and joist construction) and then build the steps of lean cinder concrete built on the top. In this way the formwork is simplified, but the construction may prove heavier and more expensive than in the previous case.

### ROOF CONSTRUCTION

The roof construction may consist either of simple girders or of trusses. Arches with ties may also be used. The long span roof construction is discussed in Chapter XIII.

### THEATER AT WINSTON-SALEM, N. C.

**Examples of Theater Construction.**—A good illustration of the adaptability of reinforced concrete in theater construction is shown

<sup>1</sup> For description, see *Engineering News-Record*, Vol. 83, July 24, 1919, p. 178.

<sup>2</sup> For full description, see *Engineering News-Record*, July 5, 1923.



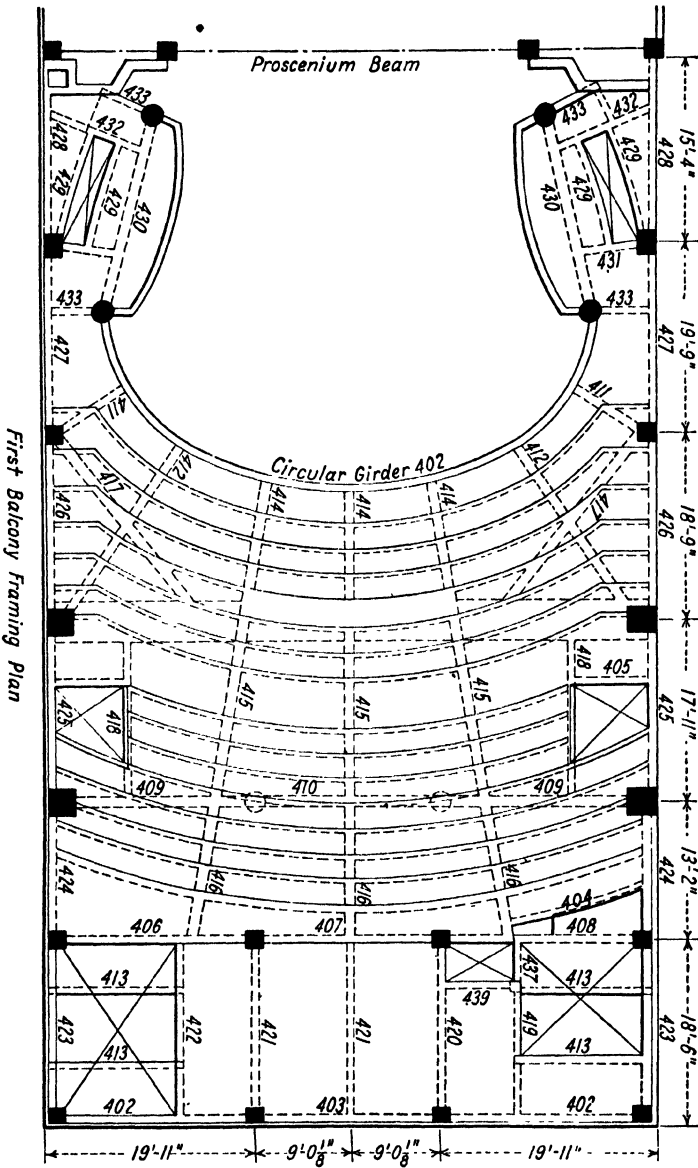

FIG. 274.—First Balcony Framing Plan. Winston-Salem, N. C., Auditorium. (See p. 784.)



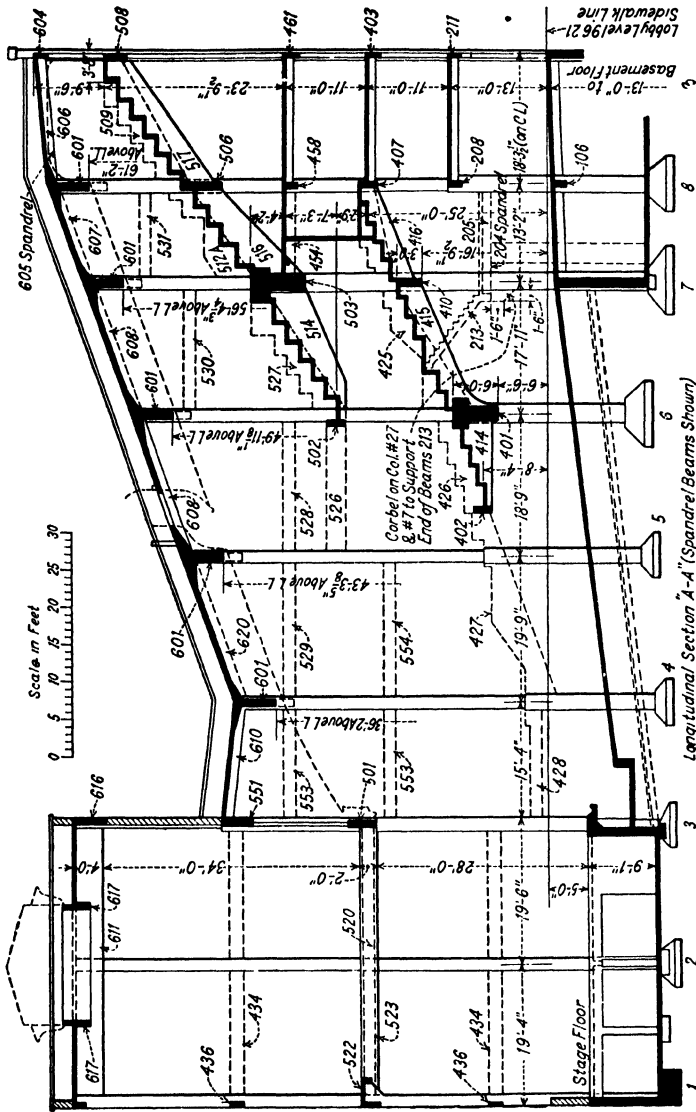

Fig. 275.—Cross Section through Winston-Salem, N. C., Auditorium. (See p. 784.)



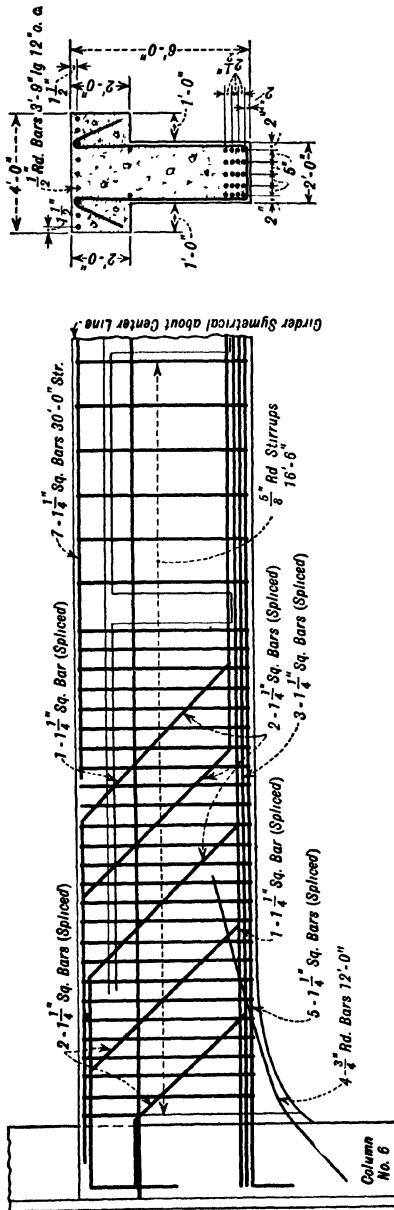

FIG. 277.—Details of First Balcony Fulcrum Girder. Winston-Salem, N. C., Auditorium. (See p. 784.)  
Southern Engineering Co., Engineers. Edward Smulski, Consulting Engineer.

in Fig. 274 to 277, taken from the design of the theater in Winston-Salem, N. C., designed by W. C. Northup, Architect.

The structural plans were prepared by The Southern Engineering Co., with Mr. Edward Smulski as Consulting Engineer. The plan of the first balcony is shown in Fig. 274. The cross section through the theater is shown in Fig. 275. Fig. 276 gives reinforcement in the first balcony cantilevers. Fig. 277 shows the design of the fulcrum girder.

## CHAPTER XIX

### REINFORCED CONCRETE IN DIFFERENT TYPES OF BUILDINGS

In this chapter, dealing with the different types of buildings in which reinforced concrete is commonly used, the economy of construction is briefly discussed and the design live loads are given. Recommendations are made as to proper spacing of columns and proper type of floor construction. Floor finish is also discussed.

The following types of buildings are considered: warehouses, p. 785; cold-storage warehouses, p. 792; manufacturing buildings, p. 792; buildings used for the manufacture or storage of automobiles, p. 795; office buildings, p. 803; hotels, apartment houses, and hospitals, p. 805; schools, p. 808.

#### WAREHOUSE CONSTRUCTION

Reinforced concrete is well adapted for warehouse construction, and a large majority of fireproof warehouses are built of this material.

**Type of Floor Construction.**—The majority of reinforced concrete warehouses are of flat slab construction. Beam and girder construction or joist construction is rarely as economical as the flat slab for this type of buildings. Joist construction should not be used for heavier live load than 125 lb. per sq. ft., because of the possibility of heavy load concentrations for which joist construction is not adapted.

An idea of the relative economy of several types of floor construction may be obtained from the table on p. 786, taken from a paper by A. F. Klein.<sup>1</sup> This table gives costs of three types of floor construction for a warehouse consisting of eight stories and basement, with 20 by 20-ft. panels designed for a live load of 250 lb. per sq. ft. The following unit costs were used:

<sup>1</sup> Analysis of Cost of Types of Fireproof Construction. By Arthur F. Klein. Journal Western Soc. of Engineers. Vol. XXIX, No. 7, July, 1924.

Comparison of Cost of Building with Three Types of Floor Construction

By A. F. Klein

Warehouse, 8 stories and basement. Panels 20 ft. by 20 ft. Live load 250 lb. per sq. in. 10 ft. clear story height.

Description	Type 1—Fig. 278—2-Way Slab and Girder Floor			Type 2—Fig. 279—Beam and Girder Floor			Type 3—Fig. 280—Flat Slab Floor		
	Quantity	Unit Cost	Cost	Quantity	Unit Cost	Cost	Quantity	Unit Cost	Cost
<b>Floor:</b>									
1 : 2 : 4 Concrete.....	3 521 cu. ft.	\$0 44	\$1 549 24	3 045 cu. ft.	\$0 44	\$1 339 80	2 628 cu. ft.	\$0 44	\$1 156 32
Forms (Slabs).....	3 600 sq. ft.	0 29	1 044 00	3 600 sq. ft.	0 31	1 116 00	3 600 sq. ft.	0 34	1 224 00
Forms (Girders, Beams and Girders, Drop Panels).....	1 393 sq. ft.	0 37	515 41	2 530 sq. ft.	0 37	936 10	9 pcs.	10 00	90 00
Reinforcing Steel.....	20 135 lbs.	0 048	966 48	20 319 lbs.	0 048	975 32	10 849 lbs.	0 048	520 75
<b>Columns:</b>									
1 : 2 : 4 Concrete.....	543 cu. ft.	0 44	238 92	575 cu. ft.	0 44	253 00	494 cu. ft.	0 44	217 36
Forms.....	9 pcs.	15 00	135 00	9 pcs.	15 00	135 00	9 pcs.	16 00	144 00
Reinforcing.....	12 834 lbs.	0 049	628 87	10 980 lbs.	0 049	538 02	8 994 lbs.	0 05	449 70
Cement Finish.....	3 600 sq. ft.	0 07	252 00	3 600 sq. ft.	0 07	252 00	3 600 sq. ft.	0 07	252 00

Total Cost = \$5 329 92

Cost per cu. ft. = \$0.124

Cost per sq. ft. = \$1.48

Total Cost = \$5 545 24

Cost per cu. ft. = \$0.126

Cost per sq. ft. = \$1.54

Total Cost = \$4 054.13

Cost per cu. ft. = \$0.102

Cost per sq. ft. = \$1.13

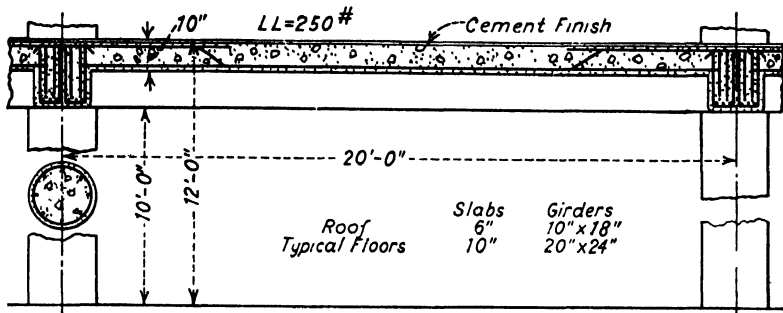

FIG. 278.—Type 1. 2-Way Slab and Girder Floor for 8-Story Warehouse. (See p. 786.)

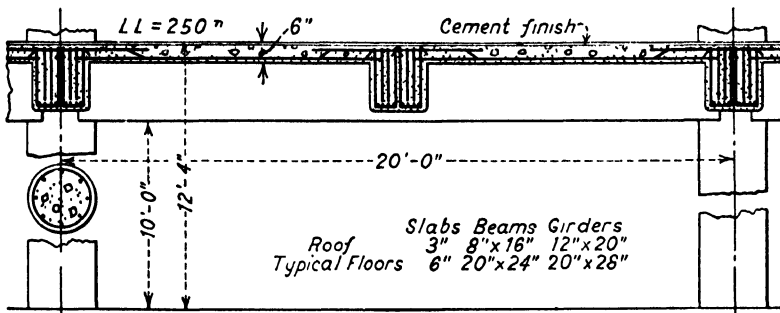

FIG. 279.—Type 2. Beam and Girder Floor for 8-Story Warehouse. (See p. 786.)

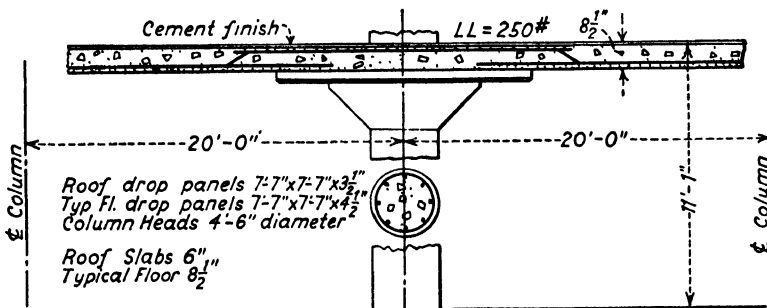

FIG. 280.—Type 3. Flat Slab Floor for 8-Story Warehouse. (See p. 786.)

## 788 REINFORCED CONCRETE IN DIFFERENT TYPES OF BUILDINGS

*Cost of Concrete.*—Cement, \$2.45 per barrel net. Crushed stone and torpedo sand, \$2.74 per cu. yd. delivered. On this basis, cost of 1 : 2 : 4 of concrete in place is \$12.50 per cu. yd., or 44 cents per cu. ft.; and of 1 : 1 : 2 concrete \$15.00 per cu. yd., or 54 cents per cu. ft.

*Lumber* for formwork figured at \$47.00 per thousand feet, board measure.

*Reinforced Steel.*—Cost of steel based on \$60.00 per ton, base, with a standard increase in price, for sizes below base. Following additional costs were used:

	Per ton
Trucking . . . . .	\$3.00
Standard bending of steel . . . . .	6.00
Bending stirrups . . . . .	18.00
Shop details . . . . .	3.00
Spirals . . . . .	90.00
Placing of steel . . . . .	20.00

The cost of formwork is based on the assumption that forms for 2½ floors will be provided, and therefore that they will be re-used four times.

Values given in the table are total estimated costs of an interior section of a building equal in area to 20 by 20-ft. panel and 8 stories high. The total costs are as follows:

	Cost per section of 8 stories.	Cost per sq. ft.
Flab slab design . . . . .	\$4 054.13	\$1.13
Square panel with four beams . . . . .	5 329.92	1.48
Beam and girder design . . . . .	5 545.24	1.54

The cost of flat-slab design is much lower than that of beam and slab designs. The difference in cost between the two-beam and girder types is small.

It must be noted that the above figures cannot be used for estimating the cost of the frame of an entire building as the cost of exterior panels will be larger, owing to heavier construction of floors, additional cost of spandrels, and also additional columns. In figuring the cost of an interior panel, the cost of one interior column only needs to be included, while for an exterior panel it is necessary to use one exterior column plus one-half of an interior column. In a corner panel, extra cost of corner column must be considered.



**Spacing of Columns.**—Column layout should be governed primarily by the requirements of the occupants. If no other consideration governs, the most commonly used and most economical spacing varies from 18 to 20 ft. The panels, preferably, should be made square or nearly square. Where the shape of the building can be made to suit, its length and width should be multiples of the accepted square panel. The end panels may be made somewhat smaller than the interior panels, as the moment coefficients in end panels are larger than in interior panels. With smaller span, it is possible to maintain the same dimensions in exterior and interior panels.

When the dimensions of the building are fixed by the size of the plot, the choice of the panel sizes is restricted. For instance, if the outside dimensions are 100 ft. by 120 ft., 20 by 20-ft. panels follow almost automatically. The 100-ft. length, divided into four parts instead of five, would give a panel length of 25 ft.; divided into six parts, it would give a panel length of 16 ft. 8 in.

The possible panel sizes in a 100 by 120-ft. building are 16 ft. 8 in. by 17 ft. 1 in., 20 by 20 ft., and 25 by 24 ft. The smallest panel may be cheaper than the 20 by 20-ft. panel, but the building will not be as useful. The 25 by 24-ft. panels are too expensive. Ordinarily therefore, 20 by 20-ft. panels would be selected.

If the building is not rectangular, the main column lines should be laid out at right angles to each other and the skewed portion composed of odd panels. This rule does not apply when the building lines form a rhomb or rhomboid. In such a case, the opposite sides are parallel, but the intersecting sides are not at right angles. The column lines then may be placed parallel to the sides of the building.

**Design Live Load.**—The magnitude of the design live load depends upon the uses for which the warehouse is designed. No warehouse should be designed for a smaller live load than 125 lb. per sq. ft., a live load permitted for furniture storage. This load should never be used if there is any possibility of a change in the ownership of the warehouse. For general storage, a minimum live load of 150 lb. per sq. ft. is recommended. In warehouses several stories high, a good plan is to design the first floor for 250 to 300 lb. per sq. ft., the next floor or two for 200 lb. per sq. ft., and the balance for 150 lb. per sq. ft. The rentability of such a warehouse is much superior to that of one in which all floors are designed for a small live load.

In determining the live load for a warehouse which is to be rented, it should be kept in mind that the adoption of too small live loads

may restrict the use of the warehouse considerably, and may make it less rentable, so that the small economy in construction may result in actual loss. The difference in cost between a warehouse designed for 150 lb. and one designed for 250 lb., at prices prevailing in 1925, is only 10 cents per sq. ft. This means an increase of about 8 per cent in cost of the structural frame, but only 3.5 per cent of the cost of the complete structure.

In large cities, the capacity of a floor is posted. Although in many cases this is only of theoretical value, still there is a possibility of the law being enforced. A warehouse that is constantly overloaded will develop cracks which, even if not dangerous, are unsightly and limit the market value of the building. The difference in cost between a building with light live load and one with heavy live load is negligible when the larger usefulness of the latter structure is taken into consideration.

**Loading Platform.**—Where possible, provision should be made for railroad deliveries of goods, by the addition of a covered loading platform extending the full length of the track. The width of the loading platform may have to be made large enough to afford temporary storage for the goods. The loading platform should be designed for a minimum of 300 lb. per sq. ft.

Where ground is available, the side tracks are run outside of the building and the platform projects from the building. It is usually covered with a permanent canopy. In U-shaped buildings, the tracks may be placed in the court.

In cities where the ground is very valuable, it is not possible to waste the space which would be required for tracks outside the building, and the tracks are therefore run into the building. A straight track, running parallel to a column line, can easily be accommodated in one panel width. The curve required to connect the side track with the main track should be placed preferably in the court or outside the building. If this curve is placed within the building, it is necessary to offset some of the columns in such a way as to give the required clearance for the train. Sometimes the position of the offset columns is maintained in all floors. Usually, however, it is cheaper, and gives a better job, to maintain uniform spacing of the columns above the second floor. The columns above the track are then carried by heavy girders placed below the second floor. Such girders will usually be of rather large dimensions. If possible, they should be built of reinforced concrete, even if the cost of the materials

is somewhat larger than for steel construction, because the reinforced concrete construction is simpler and therefore results in a smaller total cost. If the headroom is not large enough for a concrete girder, steel girders must be used. In such cases the supporting columns below the girders also should be of structural steel. Sometimes the depth of girders to carry the offset columns is made equal to the story height and the girders are placed between the second and third floors.

The center line of the tracks should be at least 8 ft. from the face of the building. The top of the loading platforms should be 4 ft. above the top of the rails.

**Loading Platform for Trucks.**—Each warehouse of any size must have provisions for loading merchandise on trucks and unloading it from them. The truck-loading platform is usually placed inside, in order to make the loading operations independent of weather conditions. It is often necessary to omit some columns in the driveway to facilitate the operation of trucks. This is expensive, as the upper columns must be carried on heavy girders. The level of the driveway should be 3 ft. 8 in. below the floor level, so as to bring the platform on the level with the truck floor.

**Elevators.**—In modern warehouses, elevators are used to move goods up and down, and their location, number, and size are therefore of particular importance. If it is impossible to ascertain ahead of time the number of elevators required, special provision should be made for installing additional ones in the future. This is done by providing the same framing as used in the elevator shaft, and covering the opening with a temporary removable slab. This expedient is often resorted to in cases where provision is made for additional stories. Until the upper floors are added, the space may be used for storage. With the increase in number of stories, the temporary slab is removed and additional elevators installed to provide for the increase in traffic.

**Floor Finish for Warehouses.**—Granolithic finish is commonly used in warehouses. When there is much heavy trucking and the main travel of trucks is along a well-defined lane, special hard finish is provided for the truck lanes.

### COLD-STORAGE WAREHOUSES

The foregoing discussion of warehouse construction applies equally to cold-storage warehouses. The difference in construction is only due to the use of insulators in the cold-storage warehouses.

The insulator usually consists of lith or cork board 4 to 8 in. thick, depending upon the degree of insulation required. The floors are insulated by laying the insulator on the concrete in hot asphalt. A 3-in. concrete slab is placed on the top of the insulator. To be effective, the insulation must be continuous. Not only the floors but also the columns must be insulated. The exterior columns usually consist of two sections, one carrying the floor load and the other the brickwork. A space is left between the two columns, sufficient for the placing of the insulator. For details of Insulation see *Engineering New-Record*, July 24, 1924, p. 140.

**Live Load for Cold Storage.**—Live load depends upon the weight of goods to be stored and may vary from 150 to 250 lb. per sq. ft. Floors carrying refrigerator machinery and tanks should be designed for special loads. The live load for floor sections carrying freezing tanks should be 350 lb. per sq. ft. To the load should be added the weight of the refrigerating coils suspended from the ceiling.

**Type of Floor Construction.**—Flat slab is the most commonly used floor construction for cold-storage warehouses. The statements made in regard to spacing of columns and other matters, in connection with ordinary warehouses, apply with equal force to cold-storage warehouses.

### MANUFACTURING BUILDINGS

Manufacturing buildings are of two types: One-story buildings, and multi-story buildings. One-story buildings are generally used where the process of manufacture requires breadth, length, and height. The roof spans in such buildings are large.

While reinforced concrete is often used in one-story constructions (see Garfield Foundry, p. 666), steel truss construction will be cheaper in first cost. The additional cost of upkeep, however, may more than balance the difference in first cost.

Fireproof multi-story buildings are almost universally built of reinforced concrete.

**Spacing of Columns.**—In designing a factory, a machinery layout of the floors should first be made, with due consideration of economy

of construction of the building. If no special arrangement of columns is required by the process of manufacturing, their spacing is governed entirely by economy of construction. While 18 to 20-ft. panels are usually most economical, larger spans may prove much more satisfactory from the standpoint of usefulness of the building. The additional cost of long spans may be more than offset by greater freedom in the arrangement of the machinery.

For buildings with special machinery, such as printing presses, the spans are governed by the dimensions of the panels. Thus, in the Youth's Companion Building,<sup>2</sup> the floor plan for which is shown in Fig. 281, p. 794, the spans were governed by the arrangement of the presses.

In shoe factories, where the process of manufacture progresses longitudinally with the building, construction two spans wide is considered advantageous. Thus, in the Ideal Shoe Factory,<sup>3</sup> shown in Fig. 282, the spacing of the columns across the building is 20 ft.

From the standpoint of cost of the structure, it is advisable to use equal spans throughout the building. However, to fit special requirements, the dimensions of the spans may have to be varied. Thus, in the Clark Biscuit Co. building, the spacing of the columns across the building was not equal, as it was adjusted to suit the requirements of the manufacturing process.

**Type of Construction.**—For single-story buildings, the roof construction may be of any of the long-span roof types described on pp. 661 to 679.

For multi-story buildings, flat slab construction is most commonly used. In cases where the spacing of columns is not adaptable to flat slab construction, beam and girder construction may be used for heavy loads and light weight construction for light loads.

**Design Live Loads.**—Design live loads depend upon the purpose for which the building is intended. Light manufacturing buildings may be designed for 100 to 125 lb. per sq. ft. Ordinary manufacturing requires a live load of 150 lb. per sq. ft. Heavy manufacturing buildings may have to be designed for 200 to 400 lb. per sq. ft. Portions of the building used for storage should be designed accordingly.

Full live load should be used in designing beams and slabs, also joists in light-weight floors. For girders carrying an area over 300

<sup>2</sup> Densmore, LeClear & Robbins, Architects, Sanford E. Thompson, Consulting Engineer.

<sup>3</sup> Mowll & Rand, Architects, S.M.I. Engineering Co., Engineers.

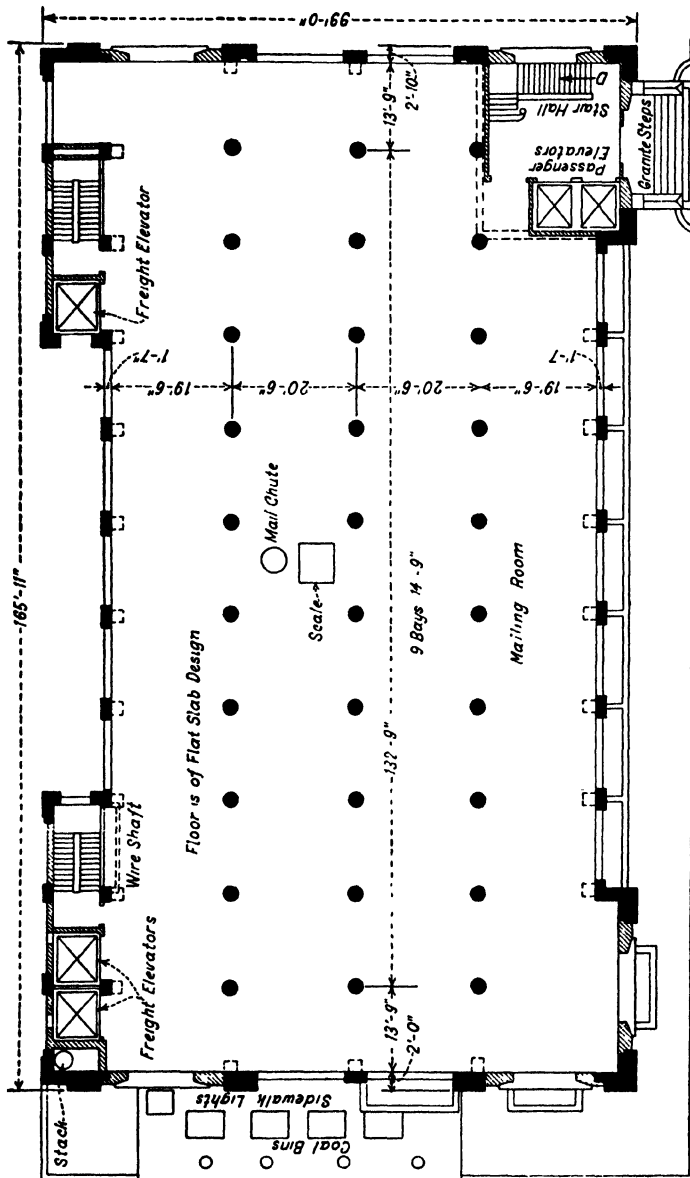

Fig. 281.—First Floor Plan. Youth's Companion Building, Boston. (See p. 793.)

sq. ft., as well as for flat slab construction, a reduction in live load of 15 per cent is permissible.

**Loading Platforms.**—See corresponding section on previous page under “Warehouse Construction.”

**Floor Finish.**—Because of the large variety of structures embraced in this section, no general recommendation as to floor finish is possible. Obviously, heavy manufacturing buildings require different treatment from light manufacturing buildings. In buildings with considerable trucking special floor finish may be required.

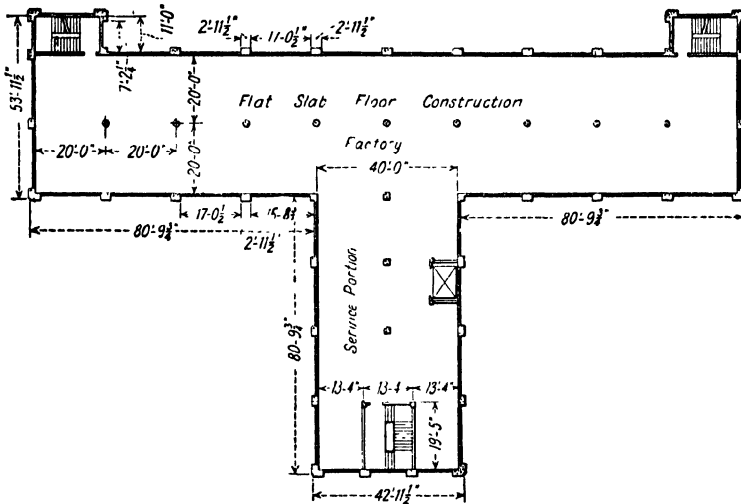

FIG. 282.—Ideal Shoe Factory, Brockton, Mass. (See p. 793.)

Granolithic finish seems to be the best all-round type suitable not only for ordinary use but also for trucking. However, the operatives sometimes object to it, and for this reason hardwood floor is often used. In some processes, the slight dusting which occurs in new granolithic floors is objectionable. This dusting will occur even with the best granolithic, unless it has a ground surface. For further discussion of floor finish, see p. 620.

AUTOMOBILE BUILDINGS AND GARAGES

Concrete is used to a great extent in the construction of buildings for use in connection with automobiles. These may be divided into buildings for the manufacture of automobiles, which are similar in

design to other manufacturing buildings, and buildings for the storage of cars, such as garages and service stations. The garages may be designed either as commercial garages, where the automobiles are handled within the building by garage men, or as private garages where the owner drives his cars in and out. Such garages are built by hotels and department stores for their patrons. The difference in the two cases in the arrangement of the columns may be considerable. Buildings for service stations and storage will be discussed below.

**Live Load.**—All garages and service stations should be designed for a live load of 150 lb. per sq. ft. This live load should be increased if the garage is likely to be used for storage of heavy trucks. Full live load should be used in the design of beam and girder or joist construction, for slabs, beams, and joists. For the design of the girders, however, when the area carried by the girder exceeds 400 sq. ft., the live load may be reduced by 25 per cent. The same reduction may be made in design of flat slab construction. The reason for the suggested reduction is obvious. While it is possible to place a wheel load on beams and slabs so as to get the effect of the full live load, it is hardly possible to load a large area sufficiently to produce the effect of a uniformly distributed load of 150 lb. per sq. ft.

**Size of Cars and Trucks.**—The spacing of columns and the width of aisles depends upon the overall dimensions of the cars. These are given below.

*Size of Passenger Cars.*—In the table below, the various makes of passenger cars are divided into five groups, and the average dimensions for each group are given.

Overall Dimensions of Passenger Cars

	Average Length	Width	Height
Ford, Star, Overland, Chevrolet. . . . .	11 ft. 7 in.	5 ft. 5 in.	6 ft. 4 in.
Durant, Essex, Buick, Studebaker, Maxwell, Dodge, Hupmobile, Dort. . . . .	13 ft. 6 in.	5 ft. 5 in.	6 ft. 4 in.
Willys-Knight, Jewett, Franklin, Buick, Oldsmobile, Lexington, H. C. Stutz, Hudson. . . . .	14 ft. 6 in.	5 ft. 8 in.	6 ft. 6 in.
Nash, Apperson, Jordan, Paige, Marmon, Studebaker, Haynes. . . . .	15 ft. 6 in.	5 ft. 8 in.	6 ft. 6 in.
Cadillac, McFarlan, Pierce Arrow, Packard.	16 ft. 6 in.	5 ft. 8 in.	6 ft. 7 in.

In each group, cars are arranged according to size.



From the above table, it is evident that an average space of 6 ft. 6 in. by 15 ft. is sufficient for most makes of passenger cars. The width of the storage aisles, from center to center of columns, therefore, may be made from 13 ft. 6 in. to 15 ft.

**Size of Trucks.**—The dimensions of trucks vary more widely than the dimensions of passenger cars. In the table below are given average overall dimensions for trucks of different capacities.

Overall Dimensions of Trucks

Capacity in Tons	Length	Width	Height
$\frac{1}{2}$ to $\frac{3}{4}$	15 ft.	5 ft. 6 in.	7 ft. 10 in.
1 to $1\frac{1}{2}$	18 ft.	5 ft. 9 in.	8 ft. 6 in.
2	18 ft. 6 in.	5 ft. 9 in.	9 ft. 3 in.
3	20 ft. 8 in.	6 ft. 6 in.	10 ft. 0 in.
5	21 ft. 0 in.	7 ft. 6 in.	11 ft. 0 in.

To accommodate trucks with high bodies, it may be advisable to make the story height of the first and second floors higher than for the rest of the garage.

The Ramp Buildings Corporation estimate that 50 per cent of trucks in use are delivery cars no larger than passenger cars and may be accommodated in a space 15 ft. by 6 ft. 6 in. Forty per cent of trucks are of less than 2-ton capacity, requiring an average space of 18 ft. by 7 ft. The balance of trucks (about 10 per cent) require a space of 20 ft. by 7 ft. 6 in. to 8 ft.

**Spacing of Columns.**—The spacing of columns should be equal to a multiple of the spacing required by a car, plus the maximum width of the column. From the table on p. 796, it is evident that the width of the car is from 5 ft. 5 in. to 5 ft. 8 in., or an average of 5.5 ft. Allowing 1 ft. between cars, the space required by one car becomes 6.5 ft. This space is ample for average drivers. In some cases, in order to provide for less experienced drivers, a space of 7 ft. is provided for each car. Larger space than 7 ft. is wasteful.

If 6.5 ft. is accepted as the required width for a car and the maximum width of the column is 2 ft., the required longitudinal spacing of columns for two cars per panel is  $2 \times 6.5 + 2 = 15$  ft.; for three cars per panel,  $3 \times 6.5 + 2 = 21.5$  ft.; and for four cars 28 ft. Any spacing of columns between 15 and 21.5 ft. would not be economical as it would be too large for two cars but not large enough for three cars.

In commercial garages, serving for storage of all makes of cars, the spacing of columns is made the same in all directions, as such garages are usually packed to capacity with cars, with comparatively small spaces for aisles and no clear passage from each car to the elevator or other means of exit. When it is necessary to get the car out, the cars standing in its way are shifted by the attendants.

In garages where the cars are brought in and out by the owner, special spaces are provided for storage of cars and separate aisles for getting in and out. These aisles are usually kept clear and have a direct connection with elevators or ramps. The columns are then arranged with a wide lateral spacing in the center, forming the aisle, with two smaller spacings of columns, one on each side of the center aisle, used as storage space. This group of three rows of panels is repeated all through the floor (see Fig. 284, p. 800). The widths of the aisle and the two side spans depend upon the size of the cars to be stored. In garages used for general storage, it is necessary to make provision for the largest car likely to be stored. A spacing of columns of 23 ft. 6 in. to 25 ft. for the center aisle and 13 to 15 ft. for the side spans is considered sufficient. The longitudinal spacing of the columns should be arranged so that the space can be used either for two or three cars. The spacing required for two cars is 15 ft. and for three cars 22 ft., allowing 6.5 ft. per car and 2 ft. for maximum size of the column.

**Ramps.**—Garages are usually provided with ramps leading from the street to the first story and also to the basement. To make the descent into the basement less steep, and also to provide ventilation for the basement, the first floor is placed several feet above the ground level. In garages consisting of several stories, the cars are usually brought up and down in elevators. In many instances, however, ramps are provided to all floors and the automobiles are brought up and down under their own power.

**Details of Ramps.**—The grade of ramps may be made as large as 15 degrees. The surface of the motor ramp should have a wood-float finish. Ramps near the street entrance should be treated so as to prevent the rear wheels of the cars from slipping when the ramps become wet. A very economical and satisfactory plan is to have them grooved every 4 in. with transverse "V" grooves,  $\frac{1}{4}$  in. to  $\frac{1}{2}$  in. deep, depending upon the thickness of the slab. Curbs 8 in. wide and 10 in. high should be provided on both sides of the ramp and also heavy pipe rails. The curb should wrap around columns

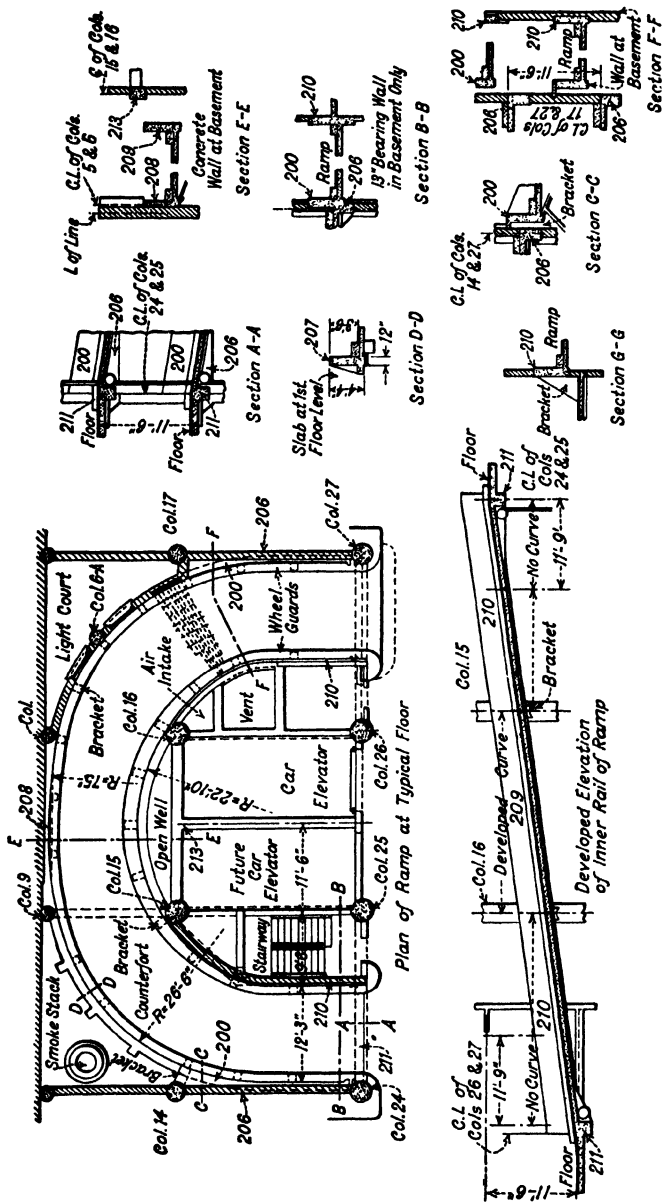

FIG. 283.—Curved Inclined Driveway in Washington Garage, Chicago. (See p. 800).

## 800 REINFORCED CONCRETE IN DIFFERENT TYPES OF BUILDINGS

to prevent mud guards from touching them. The view of both ends of the ramps should be unobstructed, else there would be danger of collision between the cars coming in and those going out.

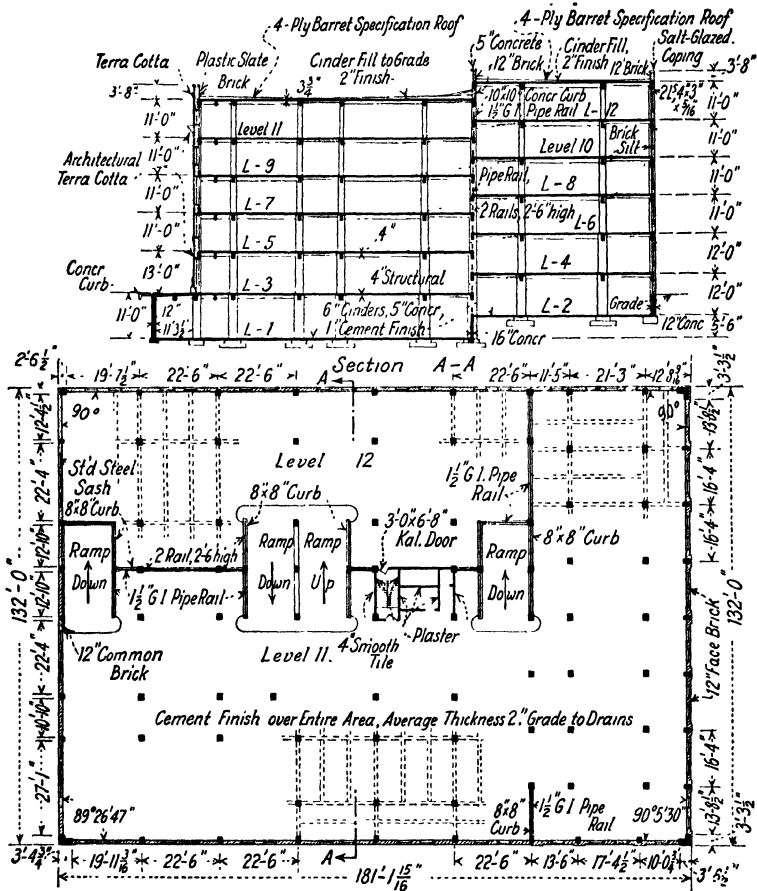

FIG. 284.—Details of Statler Garage in Buffalo. (See p. 801.)  
Geo. B. Post & Son, Architects. United Fireproofing Co. Contractors.

A curved inclined driveway, as used in the six-story Washington Garage<sup>4</sup> in Chicago, is shown in Fig. 283, p. 799. The average

<sup>4</sup> Holabird & Roche, Architects. For further description see *Engineering News-Record*, July 24, 1919, p. 188.

inclination of the driveway is 11 degrees, with 13 degrees at the inner curve and 9 degrees at the outer curve. The width of the driveway between curbs is 10 ft. 3 in. on the tangents and is increased to 11 ft. on the turns and reduced to 8 ft. at the middle of the curve.

**D'Hume Ramp System.**—With ordinary height between floors, the ramp must be very long and therefore must occupy too much of the garage space. This is remedied in the D'Hume Ramp System, by constructing the garage in two parts so arranged that the story in one part falls halfway between the stories in the other parts. With this arrangement it is necessary to build ramps only large

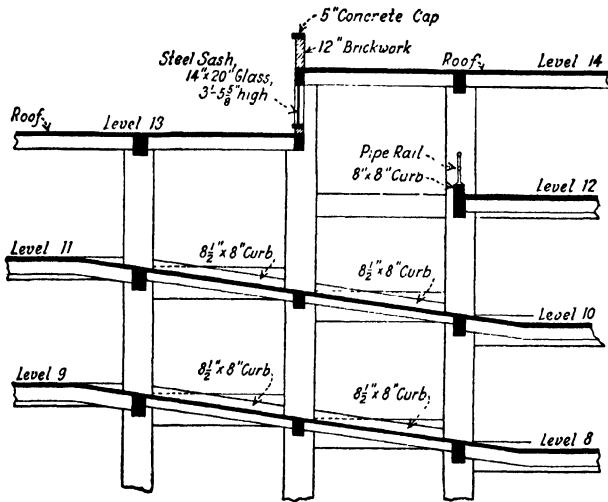

FIG. 285.—Section through D'Hume Ramp. (See p. 801.)

enough for one-half of the story-height. A design containing D'Hume ramps is shown in Fig. 284, representing a floor plan and cross section of the Statler garage in Buffalo. Photograph of the exterior of this building is shown in Fig. 262, p. 750. It may be of interest to mention that in this building slag was used as coarse aggregate for concrete. Section through the ramp is shown in Fig. 285, p. 801.

**Circular Ramps.**—Another solution of the same problem is employed in the Eliot Street Garage in Boston, where a continuous circular ramp is provided. This arrangement is less satisfactory than the previous one, as it occupies too much space.



**Typical Arrangement of Columns.**—Figure 286, p. 802, shows the arrangement of columns as used in Franklin Service Station in Boston, designed by Shepard & Stearns, Architects, S. M. I. Engineering Co., Consulting Engineers. The center span is 30 ft. wide, while the end span, on both sides, is 21 ft. 4 in. wide. The longitudinal spacing of columns is 27 ft. 9½ in.

**Construction of Garages.**—Flat slab is the most widely used floor construction for garages. It is used for spacings of columns up to 33 ft.

In cases where the spacing of columns is not well adapted to flat slab construction, beam and girder or light-weight floor construction may be used. The beam and girder or clay tile construction is preferable to the joist construction, because the thin slab between the joists is not well adapted for carrying heavy concentrated loads, unless provided with special reinforcement. Also, the thin slabs and narrow exposed joists would suffer considerably in case of a fire.

**Floor Finish.**—Granolithic floor finish is practically always used in buildings intended to house automobiles.

## OFFICE BUILDINGS

Reinforced concrete is being used in office buildings to an increasing extent. Ordinarily, concrete is cheaper than fireproofed structural steel, particularly when flat ceilings are required.

**Limit of Height for Concrete Buildings.**—Contrary to popular opinion, there is no limit to the possible height for concrete buildings, except that imposed in each particular case by considerations of economy. While not long ago a height of twelve stories was considered as the practical limit, even by engineers engaged in concrete construction, in recent years a number of buildings of considerably greater height have been erected. Usually, there is an objection to tall concrete buildings on account of the large size of the columns required in the lower floors. This objection is easily removed by substituting, in these floors, structural steel columns encased in concrete.

The Medical Arts Building <sup>5</sup> at Dallas, Texas, is a notable example of a tall concrete building. It is 19 stories and 255 ft. high above basement floor.

<sup>5</sup> C. E. Bargebaugh, Architect. For description see Concrete Frame and Exterior for High Tower Building, *Engineering News-Record*, April 5, 1923, p. 610.

The Hide and Leather Building, in New York,<sup>6</sup> is 18 stories, 215 ft. above the curb. In both of these instances, the concrete frame proved cheaper than structural steel.

**Shape of Building.**—The most important problems in the design of office buildings are those of light and ventilation. In modern office buildings, the courts are arranged so as to limit the width of the building to 75 ft. A typical floor plan is shown in Fig. 287. The passenger elevators are placed in one central location instead of being divided into groups.

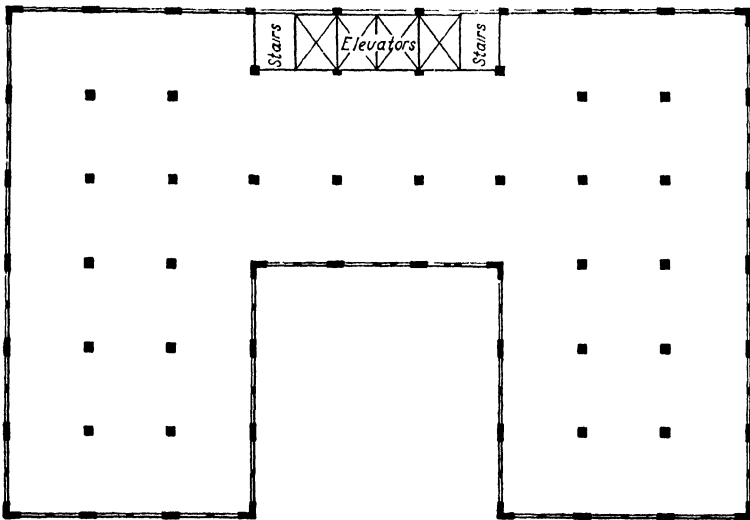

FIG. 287.—Typical Floor Plan for Office Building. (See p. 804.)

Theoretically, in long buildings, two groups of elevators, one at each end of the building, would serve the purpose better. However, offices very often occupy large areas, extending the full width of the building. In such cases it is not possible to make all offices accessible from both groups of elevators, and confusion results, especially for visitors.

**Spacing of Columns.**—In old office buildings, columns were placed along the sides of the central corridor. The cross section then consisted of large end panels and a small center panel. Such an arrange-

<sup>6</sup> Designed and built by Thompson & Binger Co., Raoul Gautier, Chief Engineer.



ment was satisfactory for small offices or subdivided offices. Now, with the advent of large, open office spaces, the office often occupies the full width of the building. Equal spacing of columns is therefore much more advantageous. This also results in cheaper construction, as the large spans required in the first case are replaced by smaller spans. If necessary, the space can be subdivided into smaller offices without difficulty. The corridor may be placed either in the center, dividing the space into offices of equal depth, or off center.

**Loading.**—A live load of 70 lb. per sq. ft. is usually sufficient for the upper floors of an office building. The first floor is usually designed for 150 lb. per sq. ft. In some locations it is advisable to design the office building for 120 lb. per sq. ft., to make it available for light manufacturing.

Dead load should include a proper allowance for partitions. This is usually 25 lb. per sq. ft. Weight of plaster should also be included in the dead load.

In light-weight floors, special joists should be provided for heavy partitions running in the direction of the joists. To provide for partitions by increasing the dead load is obviously insufficient. The partition load is carried by one joist only, as the thin topping is not sufficient to transfer the load to the adjoining joists.

**Types of Construction.**—Light-weight floors, such as clay tile floors and metal tile floors with plaster ceiling, are considered the most economical for office buildings.

Flat-slab construction is now gaining in favor, especially for office buildings designed for heavier loads. The original objection of architects to flared heads is gradually disappearing, especially since, with increased knowledge, the size of column heads and their shape may be made to suit architectural requirements. The interior of a flat slab office building is seen in Fig. 269, p. 761.

**Finish.**—Hardwood finish in offices and terrazzo or granolithic finish in corridors have been used very extensively. In recent years, linoleum, or rubber parquetry, is growing in favor. Also, granolithic finish, usually painted, is often used, but objection is made to it on account of hardness, noise, and conductivity of heat.

## HOTELS, APARTMENT HOUSES, AND HOSPITALS

Reinforced concrete is well adapted for the construction of hotels and apartment houses. In hotels, a corridor is usually placed in the

middle and the rooms on both sides of it. In old hotels, the columns were placed in the corridor wall, so that the width of the building was divided into two large spans at the ends with a short span in the middle. In modern hotels, each room has a bathroom or closets placed next to the corridor. This makes it possible to place the columns in the corners of the bathroom, farther away from the corridor, so that the end spans become practically equal in length to the center span. The cost of construction of the equal spans is smaller than that of the spans used in the old arrangement. The longitudinal spacing of the columns is governed by the size of the rooms. Similar construction is possible in apartment houses.

In hospitals, it is usually necessary to place the columns in the corridor wall.

**Design Loads.**—Hotels, apartment houses, and hospitals should be designed for a live load of 50 lb. per sq. ft. for private rooms and 100 lb. per sq. ft. for corridors and public rooms. In computing the dead load, proper allowance should be made for partitions. The weight of plaster and flooring should also be added to the dead load. These items are often neglected, with the result that the design is of inadequate strength.

**Type of Floor Construction.**—The economical type of floor construction naturally will vary with conditions. Usually, light-weight construction, as described on pp. 588 to 611, will prove satisfactory.

Flat slab construction is not used to any great extent, because of the objection to the flared heads. However, for spans up to 18 ft., it is possible to build flat slabs economically without flared heads. In many cases, the rooms can be arranged so as to permit even spacing of columns not more than 18 ft. apart, which permits the use of flat slab construction (without flared heads), at a cost much lower than that of light-weight slab. This is not possible where spans over 18 ft. are required in the bulk of the structure.

**Floor Finish.**—The most popular floor finish for this type of building is hardwood flooring, particularly in the living portions. Ter-razo is generally used for corridors, kitchens, service portions and bathrooms.

In recent years, linoleum and similar coverings are gaining in favor on account of their lower cost and great durability. With linoleum, there is also a gain in thickness of about 2 in.

Objections are made to the use of granolithic finish for buildings of this type. The hard appearance, which constitutes one of the

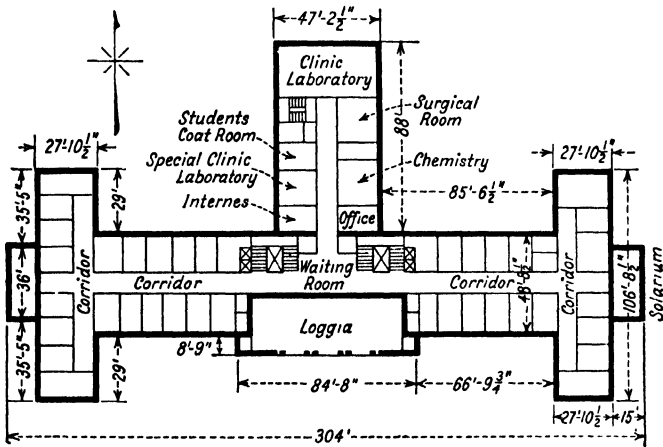

FIG. 288.—Layout of Rooms in Hospital for State of Wisconsin. (See p. 808.)

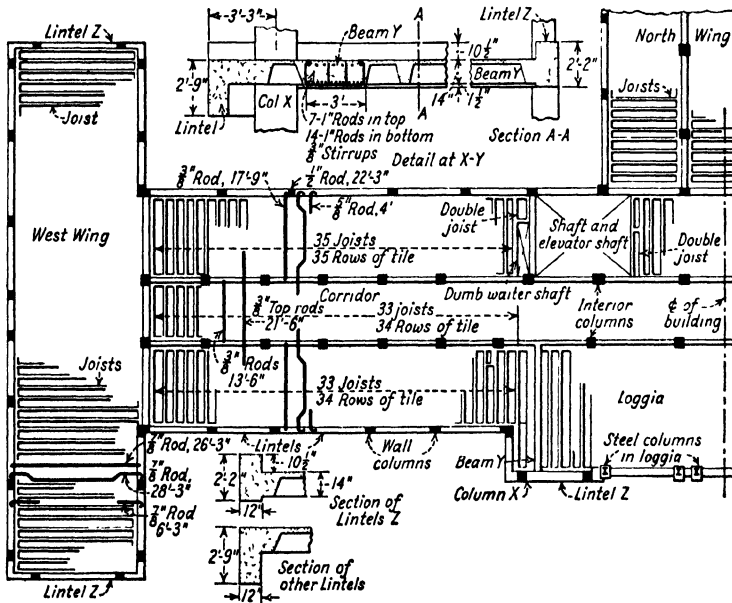

FIG. 289.—Design of Floor Construction for Hospital for State of Wisconsin. (See p. 808.)

objections, can be remedied by painting the floors a warm color.

**Design of Hospital.**—A typical design of a hospital for the State of Wisconsin <sup>7</sup> is shown in Figs. 288 and 289, p. 807. The arrange-

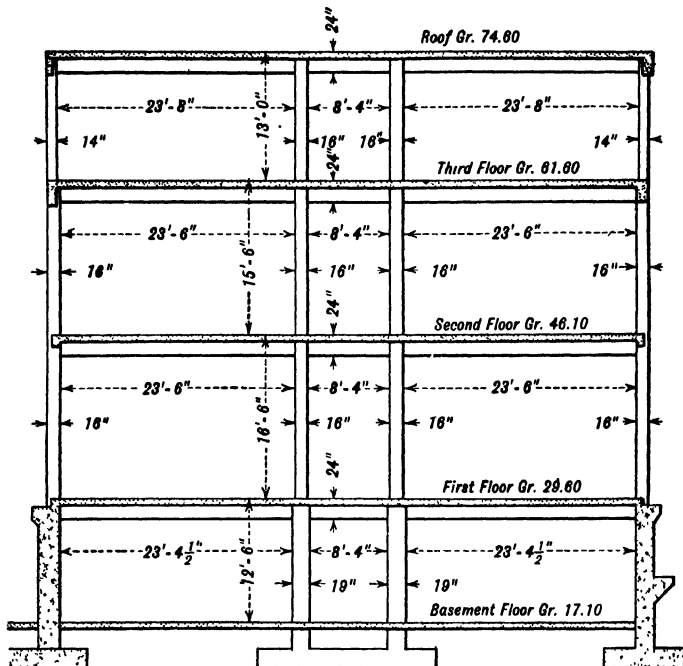

FIG. 290.—Typical Cross Section Showing Classrooms Opening on Corridor.  
(See p. 810.)

Massachusetts Institute of Technology, Cambridge, Mass.

ment of rooms is evident from Fig. 288, while the construction details are shown in Fig. 289.

### SCHOOL BUILDINGS

Reinforced concrete is used in the construction of school buildings, either for the whole frame or for floors only.

**Live Load.**—The following live load may be safely used in the design of the various parts of the school building:

<sup>7</sup> Structure and Facilities of a Modern Hospital. By Arthur Peabody, *Engineering News-Record*, April 10, 1924, p. 608.

	Live load lb. per sq. ft.
Class rooms.....	50
Corridors and stairs.....	100
Assembly rooms and auditoriums.....	100
Gymnasiums.....	100
Shops.....	100

**Wall-bearing vs. Skeleton Construction.**—School buildings are seldom over three stories high; therefore, wall-bearing construction is used to a great extent. Recent investigation show that skeleton construction may be built at the same cost and sometimes cheaper. It has the additional advantage that the concrete structure may be erected without any interference from the brickwork.

**Type of Floor Construction.**—The type of floor construction depends upon the size of the room and the purpose for which it serves.

**Class Rooms.**—The average class rooms are 32 ft. long and 22 ft. wide. They are arranged either on both sides of the corridor or on one side only. In wall-bearing construction, the walls along the corridor may be built as bearing walls. The floor construction then spans from wall to wall. The cost of the construction may be reduced by omitting the interior bearing walls and substituting columns placed along the corridor, with longitudinal beams to carry the floor as well as the corridor partitions. The class rooms must be built without any interior columns. Flat ceiling is also often required.

In class rooms beam and slab construction may be used for the floor, the beams spanning across the building, which is the short direction of the rectangle. The spacing of the beams should be about 8 ft., which permits the use of  $3\frac{1}{2}$ -in. slab. When flat ceilings are required, a suspended ceiling, consisting of steel rib lath suspended at the beam and at one or several intermediate lines, should be used.

Where hollow tiles or steel tiles are available, light-weight construction, as described on p. 588, may be used for the floor. The joist may span in the short direction only, or a two-way system may be used, with joists running in two directions at right angles to each other.

Sometimes a solid concrete slab, reinforced in two directions, may be used.

The hollow tile and solid concrete ceiling may be plastered directly

below the construction with two-coat plaster. Metal tile construction requires metal lath underneath with three-coat plaster.

*Special Rooms.*—In industrial training schools, the sections occupied by workrooms, shops, and drawing-rooms are much larger than the class rooms, but there is no objection to intermediate columns. Columns may be spaced with due regard to the economy of the structure. Flat slab construction is often used in special rooms.

*Gymnasiums and Auditoriums.*—Rooms serving for gymnasiums and auditoriums are usually of considerable length and width, without any intermediate columns.

In some cases, an attempt is made to combine the gymnasium and auditorium. This is usually not successful, because the floor of a gymnasium must be level and therefore is not well adapted for auditorium purposes.

Gymnasium and auditorium are often built side by side, so that the gymnasium or part of it may serve as a stage for the auditorium. In such case, means are provided for shutting off the whole or a part of the gymnasium so that both rooms may be used separately, if desired.

Usually, no additional story is placed above either of these rooms. The roof construction is ordinarily carried by steel trusses. While these are cheaper as to first cost than concrete members, they require larger cost of maintenance. If a permanent roof is required, it may be built as explained in connection with long-span roof construction (p. 661).

The galleries and the inclined floor in the auditorium may be designed as explained in connection with theater construction.

**Building for Massachusetts Institute of Technology.**—Figure 290, p. 808, shows typical framing plan for Buildings 1, 3 and 5 of the Massachusetts Institute of Technology.<sup>8</sup> The beams were arranged across the building. In portions of the building where classrooms are placed on both sides of the corridor, the columns are placed along the corridor. Fig. 290 gives the widths of the classrooms and of the corridor.

**Stairs.**—As all the up-and-down travel in school buildings is by means of the stairs, their number and location must be carefully worked out. The stairs must also serve as fire exits and must be

<sup>8</sup> Designed and built by Stone & Webster Engineering Corporation; William W. Bosworth, Architect. The concrete design and construction was under the supervision of Sanford E. Thompson, Consulting Engineer.

properly protected. As a general rule, each school building should have at least two staircases, located at opposite ends of the corridor. A larger number may be required.

The width of stairs is usually 4 ft. 6 in. The rise of steps varies, according to the age of the pupils, from  $6\frac{1}{2}$  to 7 in., and the tread from  $10\frac{1}{2}$  to 11 in.

**Floor Finish.**—The floor finish in class rooms, auditorium, and gymnasium is usually of hardwood. Linoleum and rubberized parqueting also give satisfactory results.

For corridors, lavatories, and other service portions, granolithic finish or terrazzo may be used.

## CHAPTER XX

### REINFORCED CONCRETE CHIMNEYS

#### FORMULAS FOR REINFORCED CONCRETE CHIMNEY AND HOLLOW CIRCULAR BEAM DESIGNS

REINFORCED concrete chimneys may be regarded as vertical cantilever beams supported at the base. The loadings to be provided for are (1) the weight of the chimney and (2) the wind pressure. Although the design is somewhat complicated by the fact that the beam is circular and hollow, the treatment is nearly identical with that of ordinary rectangular beams. In fact, the analysis which follows is based upon the several fundamental assumptions adopted in reinforced concrete beam design with only one additional assumption, viz.: that, since the concrete is usually thin as compared with the diameter of the chimney, no appreciable error is involved in assuming all material as concentrated on the mean circumference of the shell. An analysis for shear is given on p. 819. An example of chimney design and review is given on p. 829.

Although specially devised for a chimney, the formulas are applicable to any hollow beam.

The principles involved in the demonstration of the thickness of steel and concrete are taken by permission from the analysis by Messrs. C. Percy Taylor, Charles Glenday, and Oscar Faber.<sup>1</sup>

#### NOTATION

$W$  = weight of the chimney above the section under consideration, lb.;

$M$  = bending moment about that section due to wind or other cause, in.-lb.;

$P$  = total compression in concrete and steel, lb.;

$T$  = total tension in steel, lb.;

$n = \frac{E_s}{E_c}$  = ratio of modulus of elasticity of steel to that of concrete;

<sup>1</sup> *Engineering* (London), Mar. 13, 1908.



- $f_c$  = maximum compression unit stress in concrete (measured at the mean circumference), lb. per sq. in.;
- $f_s$  = maximum tension in the steel, lb. per sq. in.;
- $D$  = mean diameter of shell, in.;
- $r$  = mean radius of shell, in.;
- $t$  = total thickness of shell, in.;
- $t_c$  = thickness of concrete only, in.;
- $t_s$  = thickness of an imaginary steel shell of mean radius  $r$ , and having a cross-sectional area equivalent to the total area of reinforcing bars, in.;
- $A_s$  = total area of vertical reinforcing bars in the section under consideration, sq. in.;
- $k$  = ratio of distance of neutral axis, from mean circumference on compression side, to diameter  $D$ ;
- $j, z, C_P$  and  $C_T$  = constants for any given value of  $k$ . (Tables 1 and 2, p. 828);
- $jD$  = distance between center of compression and center of tension;
- $zD$  = distance from center of compression to center of force due to weight.

DERIVATION OF CHIMNEY FORMULAS

Referring to Fig. 291, if  $f_c$  is the maximum intensity of stress in the concrete at the mean circumference on the compression side, then the intensity of compression in the steel at that point is  $nf_c$ . Since  $f_s$  is the maximum intensity of stress in the steel at the mean circumference on the tension side, then the variation of the stress in the steel, across the section  $cd$ , is represented by the straight line  $ab$ , which cuts the line  $cd$  at  $e$ , thus locating the neutral axis or the line of zero stress. A constant value having been assumed for the modulus of elasticity of the concrete in compression, it therefore follows that, at any point of a given section, the stress in either the concrete or the steel is directly proportional to the distance between that point and the neutral axis.

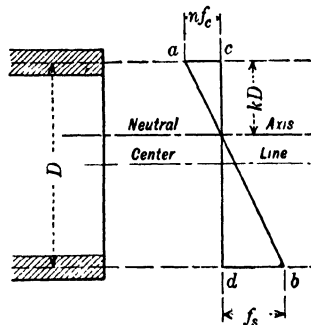

FIG. 291.—Resisting Forces in a Reinforced Chimney. (See p. 813.)

Calling  $kD$  the distance between the neutral axis and the mean circumference on compression side, as shown in Fig. 291, we have by similar triangles

$$\frac{kD}{D} = \frac{nf_c}{f_s + nf_c},$$

whence

$$k = \frac{1}{1 + \frac{f_s}{nf_c}}.$$

By this formula, the position of the neutral axis may be determined for any combination of  $f_c$ ,  $f_s$ , and  $n$ . The formula for  $k$  is the same as for rectangular beam.

If now, as shown in Fig. 292,  $\alpha$  represents half the angle subtended at the center by the portion in compression, we have

$$\cos \alpha = (1 - 2k)$$

from which, for any given value of  $k$ ,  $\cos \alpha$  becomes known, as well as  $\alpha$  and  $\sin \alpha$ . Thus, having located the neutral axis for any given combinations of  $f_c$ ,  $f_s$ , and  $n$ , and bearing in mind that the stress at any point of the shell is proportional to the distance between that point and the neutral axis, we can now determine the total force on the compression side, the total force on the tension side, and also the location of the center of compression and the center of tension.

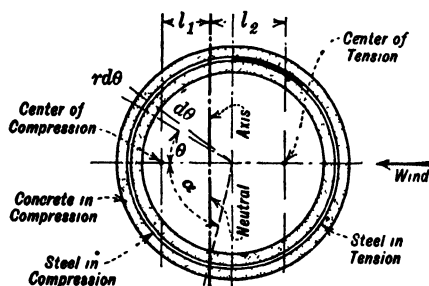

FIG. 292.—Distribution of Stresses in a Reinforced Concrete Chimney. (See p. 814.)

Considering a small radial element subtending an angle  $d\theta$ , as shown in Fig. 292, we have in this element, since the length of an arc is its radius times the angle,

$$\text{area of concrete} = t_c r d\theta,$$

$$\text{area of steel} = t_s r d\theta.$$

The distance from the element to the neutral axis is  $r(\cos \theta - \cos \alpha)$ , while the distance from the neutral axis to the point of extreme stress,

$f_c$ , is  $r(1 - \cos \alpha)$ . Therefore, the intensity of stress on this elemental area is

$$f_c \frac{r(\cos \theta - \cos \alpha)}{r(1 - \cos \alpha)} \text{ in the concrete,}$$

and

$$f_s n \frac{r(\cos \theta - \cos \alpha)}{r(1 - \cos \alpha)} \text{ in the steel.}$$

Assuming these intensities at the mean circumference to represent the average for the entire element, we have the total force on the elemental area (concrete and steel)

$$dP = (t_c + nt_s)rd\theta \frac{f_c r(\cos \theta - \cos \alpha)}{r(1 - \cos \alpha)}.$$

The total compression force,  $P$ , acting across two alpha is, therefore,

$$P = (t_c + nt_s)2 \int_0^\alpha \frac{f_c r(\cos \theta - \cos \alpha)}{(1 - \cos \alpha)} d\theta.$$

Integrating this expression, we obtain

$$P = f_c r(t_c + nt_s) \frac{2}{(1 - \cos \alpha)} (\sin \alpha - \alpha \cos \alpha).$$

Since any given position of the neutral axis determines  $\alpha$ , as shown above, this equation may take the form

$$P = C_P f_c r(t_c + nt_s), \dots \dots \dots (1)$$

in which  $C_P$  is a constant for a given position of the neutral axis. (See Table 1, p. 828.)

When the magnitude of  $P$  has been determined, its location, with respect to the neutral axis, may best be found by taking its moment about that axis and dividing by  $P$ , thus giving the distance from the neutral axis to the center of compression  $l_1$ , as shown in Fig. 292.

As before, the compressive force on an elemental area is

$$dP = (t_c + nt_s)rd\theta \frac{f_c r(\cos \theta - \cos \alpha)}{r(1 - \cos \alpha)}.$$

The distance of this force from the neutral axis being  $r(\cos \theta - \cos \alpha)$ , we have as its moment about that axis

$$dM_c = (t_c + nt_s)rd\theta \frac{f_c r^2(\cos \theta - \cos \alpha)^2}{r(1 - \cos \alpha)},$$

while the moment of the total compressive force  $P$  is

$$\begin{aligned} M_c &= (t_c + nt_s)2 \int_0^\alpha r f_c r \frac{(\cos \theta - \cos \alpha)^2}{(1 - \cos \alpha)} d\theta \\ &= (t_c + nt_s) \frac{2f_c r^2}{(1 - \cos \alpha)} \left[ \int_0^\alpha \cos^2 \theta d\theta \right. \\ &\quad \left. - 2 \cos \alpha \int_0^\alpha \cos \theta d\theta + \cos^2 \alpha \int_0^\alpha d\theta \right]. \end{aligned}$$

Integrating, we have

$$M_c = (t_c + nt_s) f_c r^2 \frac{2}{(1 - \cos \alpha)} \left[ (\alpha \cos^2 \alpha - \frac{3}{2} \sin \alpha \cos \alpha + \frac{1}{2} \alpha) \right].$$

Dividing  $M_c$  by  $P$ , we have

$$l_1 = \frac{M_c}{P} = \frac{(\alpha \cos^2 \alpha - \frac{3}{2} \sin \alpha \cos \alpha + \frac{1}{2} \alpha)}{(\sin \alpha - \alpha \cos \alpha)} r. \quad \dots \quad (2)$$

Following a similar method of procedure, it is possible to determine the total tension and the location of the center of tension.

In accordance with our assumption that the concrete does not resist any tensile stress, it is evident that in considering the forces on the tension side of the section we are concerned merely with the steel. On the tension side, a small element, therefore, has an area =  $t_s r d\theta$ .

The intensity of stress on this element, being proportional to its distance from the neutral axis, is

$$f_s \frac{r(\cos \theta + \cos \alpha)}{r(1 + \cos \alpha)},$$

while the total tension on the small element is

$$dT = t_s r d\theta f_s \frac{(\cos \theta + \cos \alpha)}{(1 + \cos \alpha)}.$$

The total force,  $T$ , on the tension side of the section is, therefore,

$$T = 2 \int_0^{(\pi - \alpha)} t_s r f_s \frac{(\cos \theta + \cos \alpha)}{(1 + \cos \alpha)} d\theta.$$

Integrating, we have

$$T = f_s r t_s \frac{2}{(1 + \cos \alpha)} (\sin \alpha + (\pi - \alpha) \cos \alpha).$$

Since, as before, any given position of the neutral axis determines  $\alpha$ , this equation may take the form

$$T = C_T f_s r t_s, \dots \dots \dots (3)$$

in which  $C_T$  is a constant for a given position of the neutral axis (see Table 1, p. 828). By a method similar to that used in considering the force on the compression side, we may write the moment, about the neutral axis, of the force on a small element on the tension side as

$$dM_T = t_s r d\theta f_s \frac{r(\cos \theta + \cos \alpha)^2}{(1 + \cos \alpha)},$$

while the moment of the total tensile force,  $T$ , about this axis is

$$M_T = 2 \int_0^{(\pi - \alpha)} t_s r f_s \frac{r(\cos \theta + \cos \alpha)^2}{(1 + \cos \alpha)} d\theta.$$

Integrating, we have

$$M_T = t_s r^2 f_s \frac{2}{(1 + \cos \alpha)} [(\pi - \alpha) \cos^2 \alpha + \frac{3}{2} \sin \alpha \cos \alpha + \frac{1}{2}(\pi - \alpha)].$$

Dividing  $M_T$  by  $T$ , we have as the distance of the center of tension from the neutral axis

$$l_2 = \frac{((\pi - \alpha) \cos^2 \alpha + \frac{3}{2} \sin \alpha \cos \alpha + \frac{1}{2}(\pi - \alpha))}{(\sin \alpha + (\pi - \alpha) \cos \alpha)} r \dots (4)$$

From Formulas (2) and (4), it is evident that the distance between the total force in compression and the total force in tension (i.e.,  $l_1 + l_2$ ) may, for any given position of the neutral axis, be expressed as a constant times the diameter  $D$ . Thus,  $l_1 + l_2 = jD$ , as shown in Fig. 293. Likewise, as shown in Fig. 293,  $zD$  may represent the distance from the center of compression to the center of the chimney,  $z$  also being a constant for any given position of the neutral axis.

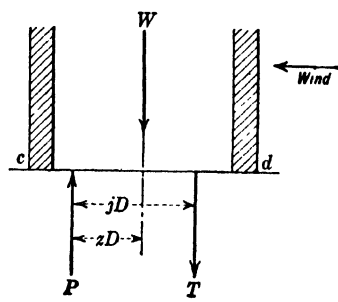

In a chimney, the tensile and compressive stresses which we have been considering are produced by a combination of wind pressure and the weight of the chimney. Thus, on any horizontal section,  $cd$ , as shown in Fig. 293, the forces external to that section are:

FIG. 293.—External and Internal Forces Acting upon a Chimney. (See p. 817.)

the horizontal pressure of the wind, causing a moment  $M$  about the section, and a central vertical load  $W$  representing the weight of that portion of the chimney above the section under consideration. These forces are resisted, and held in equilibrium, by the forces  $P$  and  $T$ , which represent the compressive and tensile stresses in the concrete and steel.

The system of forces, as shown in Fig. 293, must be in equilibrium. Hence, taking moments about the force  $P$ , we may write

$$TjD = M - WzD.$$

But

$$T = C_{Tf_s}rt_s.$$

Therefore

$$C_{Tf_s}rt_sjD = M - WzD.$$

Whence

$$rt_s = \frac{M - WzD}{C_{Tf_s}jD}.$$

The total area of steel,  $A_s = 2\pi rt_s$ .

Therefore

$$A_s = \frac{2\pi(M - WzD)}{C_{Tf_s}jD} \dots \dots \dots (5)$$

From Table I, p. 828, it may be seen that the constant  $j$  changes but slightly for a considerable variation in the position of the neutral axis. Taking  $\frac{2\pi}{j} = 8$  for all cases, equation (5) may be

$$A_s = \frac{8(M - WzD)}{C_{Tf_s}D} \dots \dots \dots (6)$$

While this formula is not exact, the error involved is inappreciable for almost any case, so that formula (6) may always be used instead of formula (5).

Applying now the condition that the summation of all vertical forces must be zero, we have

$$P - T = W.$$

Substituting values of  $P$  and  $T$  as previously found, the equation becomes

$$C_{Pf_c}r(t_c + nt_s) - C_{Tf_s}rt_s = W.$$

Transposing and solving for  $t_c$ , we obtain

$$t_c = \frac{W + (C_{Tf_s} - C_{Pf_c}n)rt_s}{C_{Pf_c}r}.$$

The total thickness of the shell is

$$t = t_c + t_s,$$

whence

$$t = \frac{W + (C_T f_s - C_P f_c n) r t_s}{C_P f_c r} + t_s.$$

For convenience in use, after  $A_s$  has been determined by the formula given above, by substituting  $r = \frac{D}{2}$  and  $t_s = \frac{A_s}{\pi D}$ , this formula for  $t$  may best be written

$$t = \frac{2W + (C_T f_s - C_P f_c n) \frac{A_s}{\pi}}{C_P f_c D} + \frac{A_s}{\pi D} \dots \dots (7)$$

In view of the fact that Formulas (5), (6) and (7) contain the constants  $z$ ,  $j$ ,  $C_T$  and  $C_P$ , which, as has been shown, are dependent for their value solely upon the location of the neutral axis, it is evident that, for any specific values of  $f_c$ ,  $f_s$ , and  $n$ , which in turn will determine the position of the neutral axis, the expressions for  $A_s$  and  $t$  will admit of a further simplification. For given values of  $f_c$ ,  $f_s$  and  $n$ , the necessary thickness of shell and area of reinforcement may be expressed merely in terms of the moment of the wind,  $M$ , the weight,  $W$ , and the mean diameter,  $D$ . The expressions, as given, however, seem best adapted to general use, and when supplemented by the tables given on page 828, are rendered quite simple of solution for specific values.

In Table 2, p. 828, are given values of  $k$ , the location of the neutral axis, for various combinations of  $f_c$ ,  $f_s$  and  $n$ ; while Table 1, p. 828, gives the corresponding values of the constants  $C_P$ ,  $C_T$ ,  $z$  and  $j$  for various positions of the neutral axis.

**Shear, or Diagonal Tension.**—When the necessary thickness of shell and vertical reinforcement have been determined, the size and spacing of the circular steel hoops must be considered. The external forces produce shear and diagonal tension, which may be analyzed similarly to like stresses in rectangular beams, and the reinforcement necessary to resist the diagonal tension, which is a function of the vertical tension, may be determined. Usually, this reinforcement is not so great as that which it is advisable to insert for the proper distribution of temperature stresses, but nevertheless it should be determined, in order to be sure that it is sufficient in quantity.

The concrete should never be relied upon to carry any tension or

vertical shear, because the expansion from the heat may cause vertical cracks in the concrete. These need not be considered dangerous, if sufficient horizontal reinforcement is provided, any more than the vertical cracks in a brick or tile chimney. Considering the stresses due to vertical shear, it may be easily shown that at any horizontal section of a chimney the vertical shear per inch of height is the total horizontal shear on that section divided by the distance between centers of tension and compression,  $jD$ . With this as a basis, there may be developed a formula for practical use in determining the necessary area and spacing of horizontal steel hoops at any given section. Thus,

Let  $h_i$  = height of chimney above section under consideration, ft. ;  
 $F$  = effective wind pressure against chimney, lb. per sq. ft. ;  
 $f_s$  = allowable tensile stress in steel hoops, lb. per sq. in. ;  
 $D$  = mean diameter of shell in. ;  
 $p_0$  = ratio of area of steel hoop to area of concrete.

The total external shear on any horizontal section of a chimney is equal to

$$V = \frac{D}{12} h_i F,$$

while the maximum longitudinal shear per inch of height is from beam formula

$$vb = \frac{V}{jd}$$

$$v \times 2t = \frac{D}{12} \frac{h_i F}{jD} = \frac{1}{12} \frac{h_i F}{j}.$$

Having seen that for all positions of the neutral axis  $j$  remains practically constant, and giving  $j$  an average value of, say, 0.783, we obtain, as the expression for the maximum vertical shear per inch of height,

$$v \times 2t = 0.106 h_i F,$$

while the shear or diagonal tension in one foot of height is

$$\text{Stresses to be resisted by hoops} = 12 \times 0.106 h_i F.$$

The area of steel in one foot of height of chimney will be  $12tp_0$ , and the stress the hoops in this height are capable of sustaining on their two sections is

$$\text{Available strength of hoops} = 2 \times 12tp_0 f_s.$$





trials with different working stresses in the steel until the computed thickness checks with the assumed thickness. In high chimneys of small diameter, it may be impossible to utilize a working stress in the steel greater than 7 000 or 8 000 lb. per sq. in.

#### DESIGN OF HOLLOW CIRCULAR BEAMS

The analysis of a hollow circular reinforced concrete beam, whose thickness, compared with its diameter, is small, is similar in principle to that of a chimney. In this case the weight of the member acts in the same direction as the external forces, so that in Formulas (6) and (7),  $W$ , the weight in the axial direction, is zero. The forces of compression,  $P$ , and tension,  $T$ , are equal. The area of steel and the thickness of shell are therefore obtained from Formulas (6) and (7), pp. 818 and 819, by making  $W = 0$ .

#### DESIGN OF REINFORCED CONCRETE CHIMNEYS

High factory chimneys of reinforced concrete are being built in this country and abroad. The cost, especially of those over 100 ft. high, is usually much less than that of a brick chimney. If designed and built upon the same principles and by the same methods which have proved essential in other types of reinforced concrete construction, they can be depended upon to give permanent satisfaction.

Reports<sup>2</sup> on a large number of chimneys have shown that concrete is unaffected by the heat from an ordinary steam boiler plant. The temperature in such chimneys seldom exceeds 700° Fahr., while 400° to 500° Fahr. is more usual. Experimental tests also indicate that concrete is not appreciably injured by temperatures of 600° to 700° Fahr.<sup>3</sup>

To provide for extremes, it is advisable, however, to build an independent inner shell of concrete or firebrick for at least a portion of the height. Concrete should not be used for a chimney in connection with special high temperature furnaces.

Since concrete and steel have substantially the same coefficient of expansion<sup>4</sup> there is no danger of heat causing a separation of the reinforcement from the concrete.

<sup>2</sup> A special investigation of reinforced concrete chimneys was made by Sanford E. Thompson in 1907 for the Association of American Portland Cement Manufacturers. Many of the points here discussed are summarized from the report, which is printed as Bulletin No. 18 of the Association.

<sup>3</sup> Tests of Metals, U. S. A.

<sup>4</sup> See Volume II of this treatise..

The expansive effect of heat is a more serious question. Stresses are set up in the shell of any masonry chimney, because of the hot interior and cold exterior surfaces. A concrete chimney, however, has thinner walls, and the stress is therefore less than in one of brick or tile; the concrete chimney is also better reinforced. Provision for temperature stresses are discussed in the paragraphs on design, which follow.

**Construction.**—A reinforced concrete chimney, because of its height and shape, is more difficult to construct than many other kinds of concrete construction, and it therefore should be handled by experienced builders.

It is essential in chimney construction that the materials be very carefully selected. The sand, as well as the cement, should be tested by determining the actual tensile strength of mortar made from it. The stone preferably should be of the nature of a hard traprock,  $\frac{1}{2}$ -in. maximum size. Proportions 1 : 2 : 3 have been found to give good results. A dry mix should not be used, since insufficient water will produce a porous concrete which does not adhere to the steel. The consistency must be wet enough to quake and form a jelly-like mass when lightly rammed, so as to properly imbed and bond the reinforcement. No exterior plastering should be permitted, because it is likely to check and scale. The steel should be round or deformed bars of good quality. Bars with flat surfaces, like T-bars, are inferior because the flat surfaces give a poor bond and the angles make the placing of the concrete difficult. Deformed bars of small size, quite closely spaced, are especially good for the horizontal steel to distribute the temperature stresses, and high-carbon steel of first-class quality also has advantages for the horizontal reinforcement.

**Example.**—The design of a chimney built in Brooklyn, N. Y., in 1907, is illustrated in Fig. 294, p. 824.

**Design of Reinforced Concrete Chimneys.**—A reinforced concrete chimney consists primarily of a concrete shell with vertical steel bars distributed uniformly along the circumference of the chimney. The shell must be of proper thickness and the steel bars sufficient in size and number to withstand the stresses due to the weight of the chimney and to the action of the wind. A chimney of this type differs essentially from one of brick, in that the diameter at the base is so small as compared to the height that the chimney would overturn under a heavy wind were it not for the vertical bars of steel which serve as anchors and hold it on the windward side.

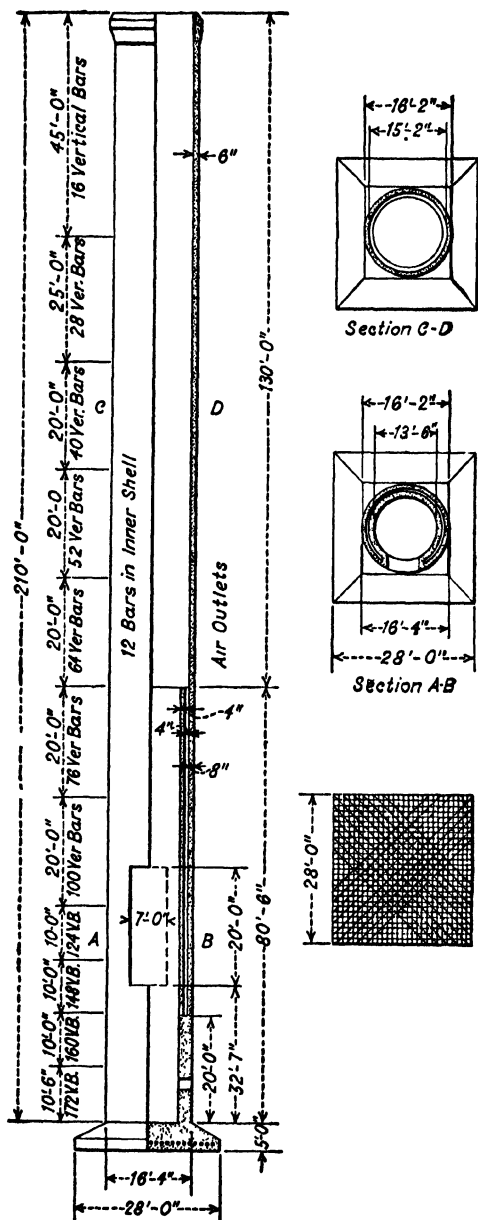

FIG. 294.—Design of Chimney of the Edison Electric Illuminating Co. Brooklyn, N. Y. (See p. 823.)

Wind, in blowing against a chimney, causes compression on the side opposite the wind and tension on the side against which the wind is acting. This compression is resisted by the concrete and steel on the leeward side, while the tension or pull is taken by the steel on the windward side.

In addition to the vertical reinforcement, a reinforced concrete chimney should be provided with horizontal hoops of steel, the object of which is to stiffen the vertical steel, to distribute cracks in the concrete due to a difference in temperature between the interior and exterior, and to resist the diagonal tension.

In designing a reinforced concrete chimney, the problem, then, is primarily to determine at various horizontal sections the necessary thickness of the concrete shell and the required amount of vertical reinforcement, so that the allowable working stresses in the concrete and in the steel shall not be exceeded under the action of the forces to which the structure may be subjected. The complete analysis and development of the most useful formulas are given in the first part of this chapter. The final formulas to be used in design are reproduced below.

The problem of the determination of stresses due to the difference in temperature between the interior and the exterior of the shell involves many uncertainties. The heat tends to expand the inner surfaces, producing tension in the outside surface of the shell and compression in the interior surface. Although the distribution of the stress is not clearly known, the variation of the heat through the shell not being uniform, tentative computations indicate high stresses, so that it is a question whether vertical temperature cracks can be entirely prevented any more than they can be prevented in brick or tile chimneys. The function of the horizontal steel may therefore be to distribute these cracks and to resist the vertical shear or diagonal tension. This horizontal steel should be distributed, therefore, by using small diameter bars closely spaced rather than large bars spaced further apart. Because of the possibility of vertical temperature cracks, the concrete should never be relied upon to carry tension or vertical shear, and the amount of horizontal reinforcement to resist this may be obtained in a fashion similar to the determination of vertical stirrups in a beam. The analysis for the shearing stresses is given on page 819, and the final formula is presented below together with suggestions for adapting the horizontal reinforcement to temperature stresses.

The amount of vertical reinforcement, the thickness of the shell, and the percentage of horizontal reinforcement may be obtained from the following formulas.

Let  $W$  = weight of the chimney above the section under consideration, lb.;

$M$  = moment of the wind about that section, in.-lb.;

$f_s$  = maximum tension in the steel, lb. per sq. in.;

$f_c$  = maximum compression in the concrete (measured at the mean circumference), lb. per sq. in.;

$n = \frac{E_s}{E_c}$  = ratio of modulus of elasticity of steel to that of concrete;

$D$  = mean diameter of shell (i.e., diameter of center of ring), in.;

$r$  = mean radius of shell, in.;

$t$  = total thickness of shell, in.;

$A_s$  = total area of vertical reinforcing bars in the section under consideration, sq. in.;

$k$  = ratio of distance of neutral axis, from mean circumference on compression side, to the mean diameter  $D$ ;

$z, C_P, C_T$  = constants for any given value of  $k$ , Tables 1 and 2, p. 828;

$p_0$  = ratio of cross-sectional area of steel hoop to vertical sectional area of concrete;

$h_1$  = height of chimney above section under consideration, ft.;

$F$  = effective wind pressure against chimney, lb. per sq. ft.;

Then

*Area of vertical bars*

$$A_s = \frac{8(M - WzD)}{C_P f_s D} \dots \dots \dots (9)$$

*Thickness of shell*

$$t = \frac{2W + (C_P f_s - C_T f_c n) \frac{A_s}{\pi}}{C_T f_c D} + \frac{A_s}{\pi D} \dots \dots (10)$$

*Ratio of steel hoops*

$$p_0 = \frac{h_1 F}{18.8 f_s t} + 0.0025 \dots \dots \dots (11)$$

Formulas (9), (10), and (11) correspond to Formulas (6), (7), and (8), pp. 818 to 821.

In the formula for  $p_0$ , the first term gives the ratio of steel to resist vertical shear or diagonal tension, and the second term is an arbitrary ratio designed to distribute the temperature strains. To best distribute the temperature strains, a maximum spacing of 6 in. to 10 in. is recommended for the horizontal bars.

In the formulas, the terms  $z$ ,  $C_P$  and  $C_T$  are constants, the values of which are fixed for any given position of the neutral axis. By means of Tables 1 and 2 (p. 828), these constants may be easily and quickly determined, so that the solution of Formulas (1) and (2) is rendered quite simple after the diameter and height of the chimney have been selected and the bending moments due to the wind have been computed for the various sections considered. The thickness of shell must be assumed in Formula (1) in order to determine the average diameter,  $D$ , and to compute the weight,  $W$ . A new computation may be made to correct this, if necessary. For economical distribution of concrete and steel, computation must be made for several sections in the height. It is not advisable to make the thickness of exterior shell less than 5 in. at any place, but the number of steel rods may be gradually reduced toward the top.

**Summary of Essentials in Design and Construction.**—In the investigation<sup>5</sup> referred to, the essential requirements are summarized as follows:

- (1) Design the foundations according to the best engineering practice.
- (2) Compute the dimensions and reinforcement in the chimney with conservative units of stress, providing a factor of safety in the concrete of not less than 4 or 5.
- (3) Provide enough vertical steel to take all of the pull without exceeding 14 000 or at most 16 000 lb. per sq. in.
- (4) Provide enough horizontal or circular steel to take all the vertical shear and to resist the tendency to expansion due to the interior heat.
- (5) Distribute the horizontal steel by numerous small rods, in preference to larger rods spaced farther apart.
- (6) Specially reinforce sections at which the thickness in the wall of the chimney is changed, or which are liable to marked changes of temperature.
- (7) Select first-class materials and thoroughly test them before and during the progress of the work.

<sup>5</sup> See footnote, p. 822.

**Table 1. Values of Constants  $C_P$ ,  $C_T$ ,  $z$  and  $j$  for Different Positions of the Neutral Axis, (i.e., for various values of  $k$ )**

For use with equations (5), (6) and (7), pages 818 and 819, and (9), (10), and (11), page 826.  $k$  is ratio of distance of neutral axis from mean circumference on compression side to the mean diameter  $D$ . Value of  $k$  to suit the condition of the problem is obtained from Table 2, below.

$k$	$C_P$	$C_T$	$z$	$j$
0.050	0.600	3.008	0.490	0.760
0.100	0.852	2.887	0.480	0.766
0.150	1.049	2.772	0.469	0.771
0.200	1.218	2.661	0.459	0.776
0.250	1.370	2.551	0.448	0.779
0.300	1.510	2.442	0.438	0.781
0.350	1.640	2.333	0.427	0.783
0.400	1.765	2.224	0.416	0.784
0.450	1.884	2.113	0.404	0.785
0.500	2.000	2.000	0.393	0.786
0.550	2.113	1.884	0.381	0.785
0.600	2.224	1.765	0.369	0.784

**Table 2. Location of Neutral Axis for Various Combinations of Compressive Stress,  $f_c$ , Tensile Stress,  $f_s$ , and Ratio of Moduli,  $n$ . (See p. 827.)**

Maximum Tensile Stress in Steel, $f_s$	$k$ Ratio of Depth of Neutral Axis to Depth of Steel Below Most Compressed Surface of Beam														
	$n = 10$					$n = 12$					$n = 15$				
	Maximum compressive stress in concrete, $f_c$					Maximum compressive stress in concrete, $f_c$					Maximum compressive stress in concrete, $f_c$				
	300	400	500	600	700	300	400	500	600	700	300	400	500	600	700
8 000	.272	.334	.384	.428	.466	.310	.375	.428	.474	.512	.360	.428	.484	.530	.568
9 000	.250	.308	.357	.400	.438	.285	.348	.400	.444	.483	.334	.400	.454	.500	.538
10 000	.231	.286	.334	.375	.412	.264	.324	.375	.418	.456	.310	.375	.428	.474	.512
11 000	.214	.266	.312	.353	.389	.246	.304	.353	.395	.433	.290	.353	.405	.450	.488
12 000	.200	.250	.294	.334	.368	.231	.285	.334	.375	.412	.272	.334	.384	.428	.466
13 000	.188	.236	.278	.316	.350	.217	.270	.316	.356	.392	.257	.316	.366	.409	.447
14 000	.176	.222	.263	.300	.334	.204	.255	.300	.340	.375	.243	.300	.349	.391	.428
15 000	.166	.210	.250	.285	.318	.198	.242	.286	.324	.360	.231	.286	.334	.375	.412
16 000	.158	.200	.238	.272	.304	.184	.231	.272	.310	.344	.220	.272	.319	.360	.396
17 000	.150	.190	.228	.261	.291	.175	.220	.261	.298	.330	.210	.261	.306	.346	.382
18 000	.143	.182	.218	.250	.280	.166	.210	.250	.285	.318	.200	.250	.294	.334	.368
19 000	.136	.174	.208	.240	.270	.160	.201	.240	.275	.306	.192	.240	.283	.322	.356
20 000	.130	.166	.200	.231	.260	.152	.194	.231	.264	.296	.184	.231	.272	.310	.344



(8) Mix the concrete thoroughly and provide enough water to produce a quaking concrete.

(9) Bond the layers of concrete together.

(10) Place the steel accurately.

(11) Place the concrete around the steel carefully, ramming it so thoroughly that it will slush against the steel and adhere at every point.

(12) Keep the forms rigid.

The fulfillment of these requirements will increase the cost of the structure; but if the recommendations are followed, there should be no difficulty in erecting concrete chimneys which will give thorough satisfaction and will endure.

In connection with reinforced concrete chimneys, the problems which arise are of two general kinds:

(1) A problem in design, involving the determination of the necessary thickness of shell and required amount of reinforcement at the various sections of a chimney of given height and diameter.

(2) A problem in the review or investigation of a chimney of given height and diameter having a certain thickness of shell and a given amount of reinforcement, to determine the stresses in the concrete and the steel under the action of certain forces.

The application of the foregoing formulas to such problems and the use of the accompanying tables may best be illustrated by the following numerical examples.

#### EXAMPLES OF CHIMNEY DESIGN

**Example 1.**—Given a chimney with height above section considered, 110 ft.; mean diameter at section considered, 10 ft.; allowable pressure in concrete ( $f_c$ ), 500 lb. per sq. in.; allowable tension in steel ( $f_s$ ), 14 000 lb. per sq. in.; ratio of moduli  $n$ , 15; wind pressure (on normal plane) 50 lb. per sq. ft., weight of concrete taken as 150 lb. per cu. ft. What is the necessary thickness of shell and amount of reinforcement at the given section?

*Solution.*—As in all chimney designs, it is necessary here to make a trial assumption of the thickness of shell in order to estimate the weight. Suppose we assume a 6-in. shell for the entire height above the section. Assuming that a wind pressure of 50 lb. per sq. ft. on a normal plane corresponds to  $\frac{8}{10}$  of 50 lb. or 30 lb. per sq. ft. on the projected diameter of a cylindrical surface, we have the bending moment due to the wind,

$$M = [10.5 \times 110 \times 30] \times \frac{1 \frac{1}{2}}{2} \times 12 = 22\,869\,000 \text{ in.-lb.}$$

and the total weight of the chimney above the section,

$$W = 3\,1416 \times 10 \times 0.5 \times 110 \times 150 = 259\,180 \text{ lb.}$$

For

$$f_c = 500, f_s = 14\,000, \text{ and } n = 15, \text{ Table 1 gives } k = .349.$$

For

$$k = .349, \text{ Table 2 gives } C_P = 1.637, C_T = 2.335, z = .427.$$

Substituting in equation (9),

$$A_s = \frac{8(22\,869\,000 - 259\,180 \times 427 \times 120)}{2.335 \times 14\,000 \times 120} = 19.6.$$

Therefore, 19.6 sq. in. of steel are required.

If  $\frac{3}{4}$ -in. round rods are selected, 45 of them will be required.

Substituting in equation (10), we have

$$t = \frac{2 \times 259\,180 + [(2.335 \times 14\,000) - (1.637 \times 500 \times 15)] \frac{19.6}{3.1416}}{1.637 \times 500 \times 120} + \frac{19.6}{3.1416 \times 120} = 6.6 \text{ in.}$$

Therefore a 6.6-in. shell would be used.

In general, the values of  $A_s$  and  $t$  as thus obtained should be readjusted by computing  $W$  on the basis of the computed thickness of shell. In the case at hand, however, the original assumption of a 6-in. thickness corresponds, for all practical purposes, to the computed thickness of 6.6 in., so that recomputation is, in this case, unnecessary. If the walls of the chimney taper in thickness, the value of  $W$  must be altered accordingly.<sup>6</sup>

When the required thickness of shell and amount of vertical reinforcement have been determined, there remains the question of the necessary horizontal or circular reinforcement. Substituting in Formula (11) for  $f_s$ , say, 14 000 lb., we have

$$p_o = \frac{110 \times 30}{18.8 \times 14\,000 \times 6.6} + 0.0025 = 0.0044.$$

Area of steel,  $A_s = 6.6 \times 12 \times 0.0044 = 0.35$  sq. in. per foot of height. Thus  $\frac{1}{2}$ -in. round rods should be spaced 6 $\frac{1}{2}$  in. on centers.

In a similar manner, any other section of the chimney may be proportioned.

#### REVIEW OF A CHIMNEY

**Example 2.**—Given a chimney with height above section considered, 90 ft.; mean diameter at section considered, 8 ft.; thickness of shell at section considered, 6 in.; vertical steel at section considered, sixty  $\frac{3}{4}$ -in. round rods; wind pressure (on normal plane, 50 lb. per sq. ft.); weight of concrete taken as 150 lb. per sq. ft.; ratio of moduli,  $n$ , 15.

What are the maximum stresses in the concrete and in the vertical steel at the section under consideration?

<sup>6</sup> In relatively high chimneys steel cannot be stressed to 14 000 lbs. per sq. in. (see p. 821.)

*Solution.*—A problem of this kind must necessarily be solved by a method of successive trials, since the position of the neutral axis is not known. The location of the neutral axis is determined by the values of  $f_c$ ,  $f_s$  and  $n$ , two of which, in this case, are unknown. The method of procedure, therefore, is to assume outright a trial position of the neutral axis, select the constants accordingly, substitute in equations (9) and (10) and solve them for  $f_s$  and  $f_c$ .

Then see if the position of the neutral axis, as fixed by these values of  $f_s$  and  $f_c$  and the given  $n$ , is the same as the position assumed at the start. If the two positions agree, then  $f_s$  and  $f_c$  as found are the actual stresses; if not, a new position of the neutral axis must be assumed, new constants selected, and new values of  $f_s$  and  $f_c$  computed from equations (9) and (10). Thus a series of trials must be made until the location of the neutral axis as assumed is consistent with the computed values of  $f_c$  and  $f_s$  together with the given  $n$ .

In this problem, assuming 30 lb. pressure on the projected area, we have the bending moment due to the wind,

$$M = [8.5 \times 90 \times 30] \times \frac{90}{2} \times 12 = 12\,393\,000 \text{ in. lb.}$$

and the total weight of the chimney above the section,

$$W = 3.1416 \times 8 \times 0.5 \times 90 \times 150 = 169\,646 \text{ lb.}$$

$$A_s = 60 \times .3068 = 18.41 \text{ sq. in.}$$

Now suppose we assume the neutral axis at, say,  $k = .400$

For  $k = .400$ , table on p. 828, gives  $C_P = 1.765$ ,  $C_T = 2.224$ ,  $z = .416$ .

Substituting in equation (9), we have

$$18.41 = \frac{8(12\,393\,000 - 169\,646 \times .416 \times 96)}{2.224 \times f_s \times 96}$$

whence  $f_s = 11\,400$ .

Substituting in equation (10), we have,

$$6 = \frac{2 \times 169\,646 + (2.224 \times 11\,400 - 1.765 f_c) \frac{18.41}{3.1416}}{1.765 \times f_c \times 96} + \frac{18.41}{3.1416 \times 96}$$

whence  $f_c = 416$ .

Now  $f_s = 11\,400$ ,  $f_c = 416$ , and  $n = 15$  gives  $k = .354$  which does not correspond with our original assumption of  $k = .400$ . Evidently the true  $k$  must lie somewhere between the assumed and determined values, hence if we now assume, say,  $k = .375$  and recompute, we obtain  $f_s = 11\,000$  and  $f_c = 435$ , the values of which together with  $n = 15$  gives  $k = .371$  which checks fairly well with the assumption of  $k = .375$ . For all practical purposes we may therefore say that the maximum stress in the steel is 11 000 lb. per square inch, while the maximum stress in the concrete is 435 lb. per square inch. The results indicate that both the thickness of shell and the amount of steel are greater than are necessary for safe stresses.

## CHAPTER XXI

### RETAINING WALLS

For walls designed to resist the pressure of earth or water, concrete is generally superseding other classes of masonry. In most localities, its cost is less than that of rubble masonry. Its adaptability for thin walls and for certain classes of face work often makes it a suitable substitute, in complicated designs, for first-class masonry, with a consequent large saving in cost. In combination with steel, its possibilities for special designs are almost unlimited.

Water-tightness, often an essential element for this class of structures, receives general treatment in Vol. III. Portland cement concrete may be made water-tight more readily than stone masonry laid in mortar of similar proportions to the cement and sand in the concrete, since large voids or stone pockets in the concrete are more easily prevented than the "rat-holes" so frequently found in the bedding of stones in mortar. Moreover, with careful selection of aggregates and skill in laying, thinner, impermeable walls may be built of concrete—strengthened with steel reinforcement—than is possible with stone masonry.

Reinforced concrete retaining walls cannot be designed by "rule of thumb," and therefore a careful consideration of the forces acting on them, and of the stresses in the concrete, is presented in this chapter. Since the earth pressure is the controlling factor, it will be necessary to introduce a practical discussion of this before taking up the details of the design and examples of the two principal types.

**Relative Economy of Plain and Reinforced Concrete Retaining Walls.**—Retaining walls to support the pressure of earth may be designed:

- (1) of gravity section with plain concrete or stone masonry;
- (2) of thin reinforced concrete section with spreading base or footing.

Reinforced concrete retaining walls are almost always more economical than gravity sections of either plain concrete or masonry.

In the gravity section, the materials cannot be fully utilized because the section must be made heavy enough to prevent overturning by its own weight. Counterforts or buttresses are of comparatively little advantage because, in stone masonry, or even in plain concrete, the wall is likely to break away from them. In reinforced concrete retaining walls, on the other hand, a part of the sustained material can be used to prevent overturning, and the section need only be made strong enough to withstand the moments and shears due to the earth pressure. Since the wall is lighter, exerts less pressure on the soil, and may be made, if necessary, with a very broad base, the special foundations or piling that are often necessary for a gravity wall may frequently be avoided. Reinforced concrete, properly designed, can be depended upon as absolutely reliable.

The economy of a reinforced concrete wall, over a wall of gravity section of either stone masonry or plain concrete, is obvious because of the saving in material. The cost of forms is practically the same for reinforced designs as for gravity section.

Mr. J. I. Oberlander reports<sup>1</sup> that twenty-three bids submitted on alternate designs of gravity and T-shaped reinforced concrete sections showed the average total cost per linear foot for the gravity section to be about one-third greater than that for the reinforced section. The unit price for the concrete in the reinforced section, however, was about 20 per cent greater than that for the gravity section.

#### WEIGHT OF EARTH

In the calculation of retaining walls, and many other structures, the weight of earth in place is a prime factor. The weights of dry material, based upon experiments by the authors, are represented in the following table. Most of the figures for weights of earth give the weights per cubic foot after excavation in a loose or a compacted condition. In the authors' experiments, the excavation was measured, so that the weights represent the material in place. As fills will eventually assume much the same characteristics as earth in original excavation, the figures may be employed for either natural earth or filled material. The weight of earth containing water varies with the character of the material and with the conditions. Gravel containing ordinary moisture weighs about 2 per cent more than

<sup>1</sup> Engineering and Contracting, May 19, 1915, p. 457.

dry gravel; and sand may weigh from 3 to 10 per cent more,<sup>2</sup> depending upon its fineness, since the finest sands absorb the moist water. Wet muck weighs about 75 lb. per cu. ft. These percentages assume that the bank is provided with natural drainage; if the earth is literally filled with water which cannot run off its weight will be increased by a quantity of water nearly equal in volume to the voids in the material, which vary, with the character of the material, from 20 to 50 per cent of the bulk of the earth in the bank.

Many of the values appear high, but they are the result of careful tests.

#### Average Weight of Ordinary Earth Before Excavation

	Lb. per Cu. Ft.
Sand . . . . .	105
Gravel . . . . .	135
Gravelly clay . . . . .	130
Loam . . . . .	90
Hardpan . . . . .	130
Dry muck . . . . .	40

**Drainage of Retaining Walls.**—The drainage of retaining walls is a highly important matter, and lack of drainage may cause either complete or partial failure. A common plan is to lay a drain of tile or of broken stone along the back of the base, opening at the ends of the wall or discharging through weep-holes.

The Delaware, Lackawanna & Western R.R.<sup>3</sup> builds 4-in. tiles through the wall at frequent intervals along the footing, with a right-angle elbow, turned up, on the inner side. A chimney of loose rubble, about 2½ by 3 ft., runs from each weeper up to the top of the wall.

The Rock Island Railroad,<sup>4</sup> in some track elevation work, laid a line of tile drain along the back of the wall and carried the water through the abutment by a weeper running to a storm sewer.

Mr. Lindenthal's high walls (see p. 873) were drained through weep-holes, placed every 10 ft., through each wall. From each weeper one 4 by 4-ft. dry rubble chimney was built up back of the wall to the surface.

<sup>2</sup> This larger weight applies to moist sand in place. Loose, moist sand on the other hand, as stated in Vol. III, weighs less than dry sand.

<sup>3</sup> *Engineering Record*, Jan. 3, 1914, p. 29.

<sup>4</sup> *Engineering News*, April 8, 1915, p. 670.

Another good method of drainage consists of a layer of loose stone over the entire back, with weep-holes placed at intervals.

**Frost.**—The depth of foundation must be sufficient to prevent heaving of the material in front of the wall, and to protect it from frost. A depth of 3 ft. may be given as a minimum, while 4 or 5 ft. is necessary in temperate or very cold climates.

Even with the base safely below frost level, special precautions are sometimes necessary to prevent heaving by frost-grip on the side of the wall or abutment. Such a case, cited by Edward H. Rigby,<sup>5</sup> was encountered in China, where frost gripped the side of bridge abutments to a depth of 5 ft. and lifted them, railroad, girder bridges, and abutments, clear off the pile foundations. Piers and abutments with sloping faces were lifted as much as those with vertical faces. Computations showed that the average lifting power of the frost was 1 000 lb. per sq. ft. of exposed surface, and that the remedy was to design the piers and bridges to overcome this force by dead weight.

### EARTH PRESSURE

The principal force governing the dimensions of a retaining wall is the earth pressure. The magnitude of the earth pressure depends upon the character of the soil, its moisture content, the slope of the earth back of the wall, and also the inclination of the back surface of the wall.

**Rankine's Theory.**—The magnitude of the earth pressure is affected by so many variables, that it is incapable of being solved by an exact method applying to all conditions. The best theory thus far advanced is Rankine's, based on the assumption that the earth is composed of granular particles without cohesion, held together only by friction developed between them.

**Direction of Earth Pressure.**—The unit earth pressures—also the total earth pressure—are assumed to act in a direction parallel to the slope of the ground (for level ground or ground sloping up). This is shown in Fig. 295, p. 836.

**Distribution of Earth Pressure.**—The unit earth pressure is assumed to increase proportionally with the depth below the ground level. The variation of the pressure may be represented by a triangle, as shown in Fig. 295. The unit pressure is zero at the ground level and a maximum at the bottom of the wall.

<sup>5</sup> *Engineering News*, March 5, 1908, p. 260.

- Let  $P$  = resultant earth pressure in lb. on a vertical surface for a length of wall equal to one ft.;
- $h$  = total height of wall, ft.;
- $h_x$  = depth below top of wall of any point, ft.;
- $w$  = weight of earth, lb. per cu. ft.;
- $\delta$  = angle of inclination of earth behind the wall;
- $\phi$  = angle of internal friction of the earth;
- $C_p$  = constant depending upon  $\delta$  and  $\phi$ . (See table on p. 837.)

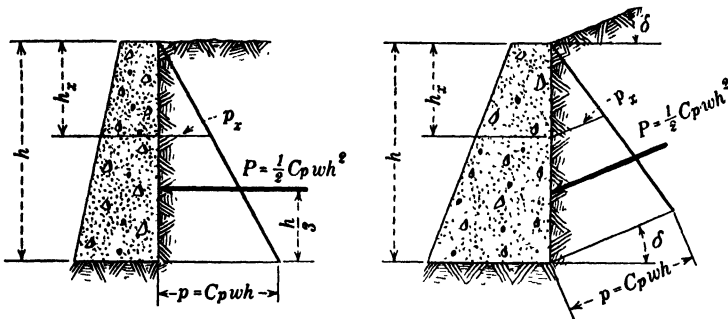

Value of  $C_p$  is different in the two cases

Fig. 295.—Distribution of Earth Pressure. (See p. 835.)

**Unit Pressures on Vertical Surface.—**

*Unit Pressure at Any Depth,  $h_x$ , below Ground Level,*

$$p_x = w \cos \delta \frac{\cos \delta - \sqrt{\cos^2 \delta - \cos^2 \phi}}{\cos \delta + \sqrt{\cos^2 \delta - \cos^2 \phi}} h_x, \quad \dots \quad (1)$$

calling

$$C_p = \cos \delta \frac{\cos \delta - \sqrt{\cos^2 \delta - \cos^2 \phi}}{\cos \delta + \sqrt{\cos^2 \delta - \cos^2 \phi}}$$

$$p_x = C_p w h_x. \quad \dots \quad (2)$$

*Maximum Unit Pressure at Bottom,*

$$p = C_p w h. \quad \dots \quad (3)$$

Values of  $C_p$  are given in table, p. 837.

**Special Cases of Earth Pressure.**—The above formula is general

Below are given formulas for special cases.

When ground is level,  $\delta = 0$ , and the constant  $C_p$  changes to

$$C_p = \frac{1 - \sin \phi}{1 + \sin \phi}.$$



When ground slopes at angle equal to angle of repose ( $\delta = \phi$ ), the constant becomes

$$C_p = \cos \delta.$$

**Total Pressure.**—Since the pressure is represented by a triangle, the total pressure is obtained by multiplying the maximum unit pressure at the bottom by one-half of the height. The point of application of the pressure is at one-third of the height from the bottom. Thus,

*Total Pressure,*

$$P = \frac{1}{2}C_pwh^2. \quad \dots \dots \dots (4)$$

Values of  $C_p$  may be taken from table below.

Values of Constant  $C_p$ .

$$C_p = \cos \delta \frac{\cos \delta - \sqrt{\cos^2 \delta - \cos^2 \phi}}{\cos \delta + \sqrt{\cos^2 \delta - \cos^2 \phi}}$$

Angle of Internal Friction $\phi$	Values of Constant $C_p$							
	Slope with Horizontal							
	1 to 1	1 to 1½	1 to 2	1 to 2½	1 to 3	1 to 4	Level	
	Corresponding Angle of Slope $\delta$							
	45°	33° 40'	26° 40'	21° 50'	18° 30'	14° 0'	0	cos $\phi$
55°	0 18	0 13	0 12	0 11	0 11	0 10	0 10	0 57
50°	0 29	0 18	0 16	0 15	0 14	0 14	0 13	0 64
45°	.	0 26	0 22	0 20	0 19	0 18	0 17	0 71
40°	...	0 36	0 29	0 26	0 24	0 23	0 22	0 77
35°	...	0 58	0 38	0 33	0 31	0 29	0 27	0 82
30°	.....	.. ..	0 54	0 44	0 40	0 37	0 33	0 87
25°	.....	.....	.....	0 60	0 52	0 46	0 40	0 91
20°	.....	.....	.....	.. ..	0 72	0 58	0 49	0 94

NOTE.—If the angle of internal friction of the earth is unknown, the following average values may be used: Coal, shingle and broken stone, 50°; earth, 35°; clay, 30°; sand dry, 30°; sand moist, 35°; sand wet, 20°.

**Surcharge.**—When the earth behind the wall is loaded in any way, as for example, when a highway or a railroad track runs along the

wall, or when the embankment is used for the storage of material, this loading causes additional pressure on the wall, which should be

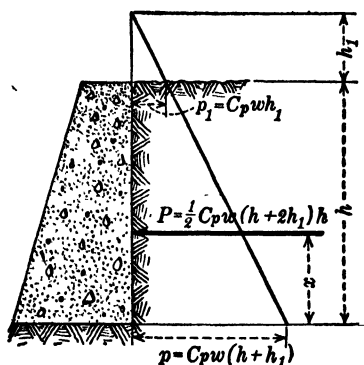

FIG. 296.—Earth Pressure with Surcharge. (See p. 838.)

provided for by replacing the weight of the load by an equivalent surcharge of earth. The height of this surcharge,  $h_1$ , is the load per square foot divided by the weight of a cubic foot of earth. Thus, a load of 500 lb. per sq. ft. is equivalent to a surcharge of 5 ft., if the earth weighs 100 lb. per cu. ft.

The earth pressure on a retaining wall with surcharge is represented by a triangle with the zero point at the top of surcharge.

The maximum pressure at the bottom is  $p = C_p w(h + h_1)$ , where  $h_1$  is the distance from level ground to top of surcharge. (See Fig. 296, p. 838.)

The pressure resisted by the wall is represented by a trapezoid, the top of which is  $C_p w h_1$  and the bottom  $C_p w(h + h_1)$ . The total pressure equals the area of the trapezoid.

In addition to notation on p. 836,

Let  $h_1$  = distance from level of ground to top of surcharge.

*Total Pressure with Surcharge,*

$$P = \frac{1}{2} C_p w(h + 2h_1)h. \quad \dots \quad (5)$$

*Height of Point of Application of Pressure above Bottom,*

$$x = \frac{h + 3h_1}{h + 2h_1} \frac{h}{3}. \quad \dots \quad (6)$$

**Wall with Inclined Back.**—The earth pressure,  $R$ , on an inclined plane  $ab$  (Fig. 297) is the resultant of  $P$ , the horizontal pressure on the vertical plane  $ac$ , and  $W$ , the weight of the prism of earth  $abc$ , and acts at one-third the height from the bottom.

**Resistance of Wall to Sliding.**—The horizontal component of the earth pressure causes the tendency of the wall to slide on its base. This force is opposed mainly by the friction between the base of the wall and the earth, which is equal to the vertical pressure multiplied

by the tangent of the angle of friction between concrete and earth.  
Let

- $F$  = total frictional resistance of the base;
- $W_1 + W_2$  = weight of concrete and earth above the base;
- $N$  = vertical component of earth pressure;
- $\psi$  = angle of friction between earth and concrete,

Then

$$F = (W_1 + W_2 + N) \tan \psi. \quad \dots \dots \dots (7)$$

If the friction is larger than the horizontal component of earth pressure multiplied by a factor of safety, the wall is secure against sliding. This rule may also be expressed as follows:<sup>6</sup> If the angle which the resultant pressure makes with the vertical is smaller than the angle of friction, the wall is safe against sliding.

The resistance to sliding is increased by the passive pressure of the earth in front of the wall, and particularly in front of the toe. Also, the cohesion of the earth back of the wall assists the resistance to some extent.

In many cases, the resistance to sliding is increased by a vertical downward projection of the base or a key, which may be placed in the middle of the base or at its heel end.

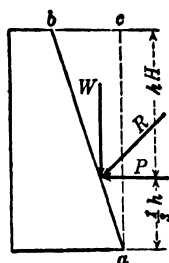

FIG. 297. — Earth Pressure on Inclined Back of Wall.  
(See p. 838.)

**Passive Earth Pressure.**—The passive pressure of a mass of earth, that is, its resistance to movement or compression, is many times as great as the active pressure. Because of the possibility of shrinkage of earth fill in front of the wall, away from the wall, the passive pressure of the earth in front of the wall cannot be counted on to counteract active pressure due to the earth behind the wall

**DESIGN OF RETAINING WALLS OF GRAVITY SECTION**

The thickness of gravity retaining walls is frequently determined by rule-of-thumb, but this is an unsatisfactory procedure. On work of any importance, much more economical results are obtained by special designs, governed by the character of the foundation soil and the earthbacking. Partial failures—tipping forward, cracking, and

<sup>6</sup> The horizontal component equals  $(W_1 + W_2 + N)$  multiplied by the tangent of the angle of the resultant with the vertical. If this angle is smaller than  $\psi$ , its tangent will be smaller; therefore, the horizontal force is smaller than friction.

sinking—are prevalent among retaining walls. In one case, a heavy gravity wall failed under the weight and impact of the backfilling dropped through a distance of 30 or 40 ft. from a large drag line scraper bucket. Where the foundation is so poor that such action is possible, the line of pressure should pass through the base, well within its middle third. Uneven settlement is then less likely to take place; and in any event the line of pressure has more opportunity to shift, without causing either uplift or excessive pressure on the base, than if the line passed through the forward edge of the middle third.<sup>7</sup>

The methods of determining the line of pressure and of computing pressure on foundation are similar to those discussed in connection with reinforced walls.

If empirical rules are to be used, one that is easily remembered is to make the base three-eighths of the height, for walls without surcharge. Another is to make the base at least as thick as would be necessary if the wall were to be subjected to water pressure under a head two-thirds the height of the wall.<sup>8</sup> A table of empirical values, adopted by Mr. Trautwine for thickness of base of masonry walls to resist earth pressure, is given below.

#### Thickness of Retaining Walls of Gravity Section with Earth Surcharge

By JOHN C. TRAUTWINE. (See p. 840.)

Ratio of Height of Earth to Height of Wall	Thickness of Base as Ratio to Height of Wall	Ratio of Height of Earth to Height of Wall	Thickness of Base as Ratio to Height of Wall
1	0.35	2	0.58
1.1	0.42	2.5	0.60
1.2	0.46	3	0.62
1.3	0.49	4	0.63
1.4	0.51	6	0.64
1.5	0.52	9	0.65
1.6	0.54	14	0.66
1.7	0.55	25	
1.8	0.56	or more	0.68

Walls designed by these empirical methods are unsafe under unusual pressures, such as quicksands, and detailed analyses must

<sup>7</sup> Certain failures of this type are discussed by Charles K. Mohler in *Engineering News*, Oct. 13, 1910, p. 384.

<sup>8</sup> Suggested by *Engineering News*, Sept. 26, 1912, p. 593.

be made. On the other hand, the designs obtained by empirical methods are in many cases unnecessarily conservative.

The height of the wall is assumed to be measured above the surface of the firm ground in front of it.

The batter of the face of a retaining wall is customarily limited to  $1\frac{1}{2}$  inches to the foot, and the back is usually vertical. This fixes the width on top.

The values in the table may be employed for long walls of concrete with no reinforcement. In many cases, because of the monolithic character of concrete, a ratio of thickness to height from 10 to 20 per cent less may be adopted with safety, if the character of the filling back of the wall precludes excessive pressure, and if the base is slightly spread. For more accurate determinations of gravity sections, the principles which follow, relating to reinforced designs, are applicable. When two walls enclose a narrow fill, they may be tied together by rods, as discussed on p. 872, and thinner sections used. Similarly, the ordinary single wall may be anchored to the ground behind it.

#### DESIGN OF REINFORCED CONCRETE RETAINING WALLS

**General Principles.**—A reinforced concrete retaining wall may fail as a whole, if it settles excessively or slides on its base. Its failure may also be caused by the failure of its component parts. For instance, in a cantilever wall, the vertical slab may break away from the foundation, or the toe cantilever may crack or shear off.

To prevent the failure of the wall as a whole, the base must be properly proportioned. In a properly proportioned retaining wall, (1) the pressures on the foundation must be within the allowable working limits, and must be properly distributed over the base; and (2) there must be sufficient resistance to sliding of the wall.

To prevent failure of the component parts, each part must be designed according to the accepted rules, to resist the stresses to which it is subjected. Also, the parts must be properly connected.

**Earth Pressure to be Used in Design.**—The base of a retaining wall is usually several feet below the level of the lower ground, in order to protect it from frost and to reach solid ground. There is, therefore, a certain amount of earth in front of the wall. In fixing the amount of earth pressure to which a wall is subjected, the question arises whether it would not be permissible to utilize the passive

pressure of the earth in front of the wall to resist a part of the earth pressure.

This is not permissible. The earth in front of the wall is usually a fill, which, until it becomes compacted, has very little passive resistance. Furthermore, the fill may shrink away from the wall. Finally, the fill may not always be in place at the time the earth pressure acts. A good rule is to design the wall for the amount of earth pressure acting above the top of the slab at the end of the base. (See Fig. 298 below.)

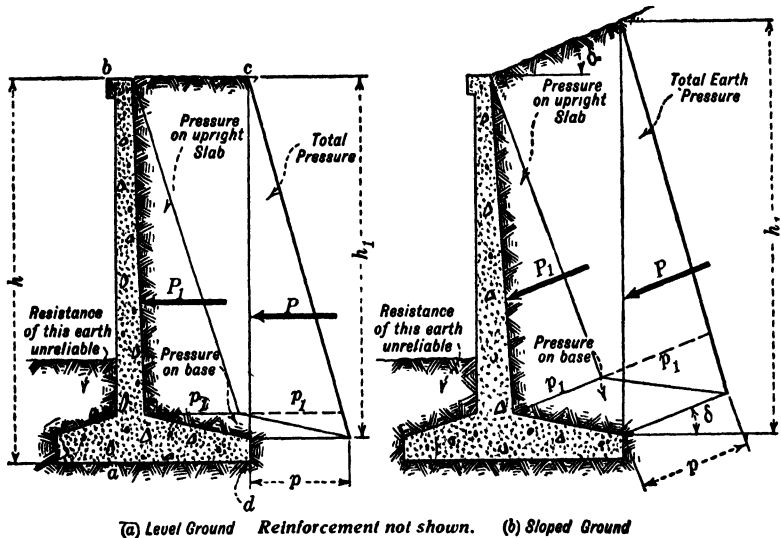

FIG. 298.—Earth Pressure on Reinforced Concrete Retaining Walls. (See p. 842.)

For walls supporting earth with a sloped surface, the height of the wall to be used in the formulas for earth pressure is the distance from the top of the slab at the end of the base to the top surface, measured on a vertical line. This distance is marked  $h_1$  in Fig. 298. The width of base should be designed for this earth pressure. The amount of earth pressure to be used in designing various parts of the wall is discussed under the proper headings.

**Factor of Safety for Retaining Walls.**—In all self-contained retaining walls, the earth pressure is resisted by the vertical loads acting on the retaining wall. It is a common characteristic of reinforced concrete retaining walls that they utilize not only their dead load, but also the weight of earth resting on their base, to counteract

the earth pressure. The amount of available weight of earth depends upon the width of the base back of the wall. The distribution of the pressure on the foundation depends upon the length of the toe, i.e., the part of the base in front of the wall. For any accepted dimensions of the base, the available vertical loads are fixed.

To get the pressure on the foundation, it is necessary to decide upon the proper assumption as to the earth pressure. The combination of the expected earth pressure, found from Formula (4), p. 837, with the vertical loads, would give the pressure on the foundation for working conditions only. This, however, does not solve the problem completely.

The retaining wall should be investigated for accidental earth pressure, the magnitude of which is equal to the expected earth pressure multiplied by a selected factor of safety. The object is to make the wall stable not only for working conditions, but also to insure a definite factor of safety, just as in other structures. Ordinarily, structures are subjected to one kind of loading. After the stresses at working loads have been computed, the stresses at increased loads may be computed by simple multiplication. If proper working stresses are adopted, the problem of the factor of safety is automatically solved (see p. 125). Retaining walls, on the other hand, are subjected to two kinds of loading, largely independent of each other. The pressure on the foundation is a resultant of the earth pressure and the weight of the wall and of the earth above the base. The earth pressure may increase without necessarily increasing the vertical loads. For twice the earth pressure, the pressure on the foundation will not be doubled, but instead its distribution will be altogether changed. The point of application of the resultant on the foundation for increased earth pressure will be moved towards the toe, as is evident from Fig. 303, p. 857. The difference between the maximum and minimum pressures will be larger.

The authors recommend that all walls should have at least a factor of safety of 2, as far as pressure on foundation is concerned.

**Allowable Unit Pressures on Foundation and Allowable Distribution.**—The proper selection of a base requires some judgment, as it is impossible to make rules applicable to all conditions. In no case, of course, should the pressures on the foundation for working conditions exceed safe bearing values on soil, as given on p. 471. If it is impossible to support the wall on soil within a reasonable depth below the surface, piles may have to be used.

For yielding soil, the pressure on foundation for working conditions should be distributed as uniformly as possible. Therefore, for

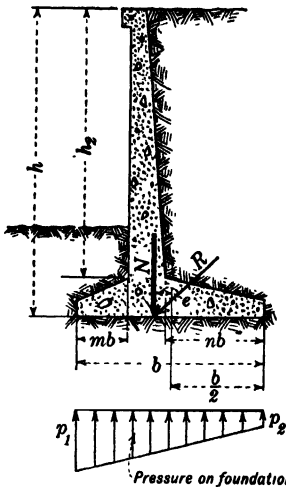

FIG. 299.—Proportions of T-wall. (See p. 844.)

expected earth pressure, the resultant should be well within the middle third, but for earth pressure multiplied by the factor  $r = 2$ , the resultant should strike the base at the outside edge of the middle third. The factor  $r$  is in this case equal to the factor of safety. For unyielding soils, such as hard pan or rock, the resultant for working loads may be allowed to intersect the base at the edge of middle third. In this case factor  $r = 1$ . For earth pressure times factor of safety of two the resultant would be outside the middle third and there would be theoretically, tension (or rather uplift) on the outer edge, but the pressures at the toe would still remain within safe limits and therefore the wall would not fail.

For intermediate conditions of the supporting soil, intermediate values of  $r$  (between 1 and 2) should be accepted for which the resultant is allowed to reach the edge of middle third.

The ratio  $r$  must not be confused with the factor of safety.

**Formulas for Width of Base.**—After the magnitude of the earth pressure is decided upon and the ratio,  $r$ , is selected, the approximate width of base may be computed from following formula:

Let  $b$  = width of base in feet, ft.;

$h$  = height of wall from bottom to top of ground, for level ground; distance from bottom to top of surcharge, for wall with surcharge, feet;

$h_1$  = distance from base to top of ground measured on a vertical erected at outside edge of base, for wall with sloped ground, feet;

$e$  = distance of point of application of forces  $R$  and  $N$  from center of base, ft.

$m$  = ratio of length of toe (measured to outside face of wall) to width of base. Fig. 299);

$r$  = selected ratio of earth pressure, for which the resultant is allowed to reach outside edge of middle third, to expected earth pressure.



$C_p$  = constant for determining earth pressure, p. 837;

$C_b$  = constant for determining width of base, p. 845.

*Width of Base* (approx.), when resultant strikes edge of middle third,

$$b = 0.94 \sqrt{\frac{rC_p}{(1-m)(1+3m)}} h \text{ for level ground, . . . (8)}$$

$$b = 0.94 \sqrt{\frac{rC_p \cos \delta}{(1-m)(1+3m)}} h \text{ for sloped ground, . . . (9)}$$

or

$$b = C_b h \text{ for level and sloped ground,}$$

where  $C_b$  is a constant from the table below, depending upon the ratio of toe to base,  $m$ , the constant of earth pressure,  $C_p$ , from table on p. 837, and the selected ratio  $r$ , for which the resultant should strike the edge of middle third. For sloped walls, the value of  $C_b$  should be taken from the table, that value being used which corresponds to the value of  $C_p$  multiplied by the cosine of the angle of slope.

VALUES OF CONSTANTS  $C_b$

$$C_b = 0.94 \sqrt{\frac{rC_p}{(1-m)(1+3m)}}$$

Value of $m$	Values of $rC_p$ for Level Ground and $rC_p \cos \delta$ for Sloped Ground																	
	0.05	0.10	0.20	0.30	0.40	0.50	0.60	0.70	0.80	0.90	1.0	1.2	1.4	1.6	1.8	2.0		
0	0.21	0.30	0.42	0.52	0.59	0.67	0.72	0.79	0.84	0.89	0.94	1.03	1.11	1.18	1.26	1.32		
0.05	0.20	0.29	0.40	0.49	0.57	0.64	0.69	0.75	0.80	0.85	0.90	0.99	1.06	1.13	1.20	1.27		
0.10	0.19	0.28	0.39	0.48	0.55	0.62	0.67	0.73	0.77	0.82	0.87	0.96	1.02	1.09	1.16	1.22		
0.15	0.19	0.27	0.38	0.47	0.53	0.60	0.65	0.71	0.75	0.80	0.85	0.93	1.00	1.07	1.13	1.19		
0.20	0.18	0.27	0.37	0.46	0.52	0.59	0.64	0.70	0.74	0.79	0.83	0.91	0.98	1.05	1.11	1.17		
0.25	0.18	0.26	0.37	0.45	0.52	0.58	0.63	0.69	0.73	0.78	0.82	0.90	0.97	1.03	1.10	1.16		
0.30	0.18	0.26	0.37	0.45	0.51	0.58	0.63	0.68	0.72	0.77	0.81	0.90	0.96	1.03	1.09	1.15		
0.35	0.18	0.26	0.37	0.45	0.51	0.58	0.63	0.68	0.72	0.77	0.81	0.89	0.96	1.02	1.09	1.15		
0.40	0.18	0.26	0.37	0.45	0.52	0.58	0.63	0.69	0.73	0.78	0.82	0.90	0.96	1.03	1.10	1.15		

If it is desirable to get uniform pressure on the foundation, the resultant should strike the base in the middle. For such a condition, the formula for width of base becomes:

*Width of Base* (approx.), when resultant strikes in the middle

$$b = 0.55\sqrt{\frac{C_p}{m(1-m)}}h \text{ for level ground, . . . . . (10)}$$

$$b = 0.55\sqrt{\frac{C_p \cos \delta}{m(1-m)}}h \text{ for sloped ground, . . . . . (11)}$$

where  $r$ ,  $C_p$ , and  $m$  are same as explained on page 845.

**Pressure on Foundation.**—Having determined the width of base, the pressure on foundation must be checked either by the approximate formulas (12) and (13) or the exact formulas (14) and (15). The approximate formulas look more complicated than the exact formulas, but they can be used directly, while the values  $N$  and  $e$  must be found before the exact formulas can be used. In important work exact formulas should be used.

**Approximate Pressure on Foundation.**—The pressure upon earth may be computed approximately from following formulas.

Let, in addition to notation on p. 844,

$w$  = unit weight of earth, lb. per cu. ft.;

$p_1$  and  $p_2$  = pressure at the toe and heel, respectively, lb. per sq. ft.

Then

*Maximum Unit Pressure at Toe, Level Ground* (approx.),

$$p_1 = wh \left[ 1.1(1-m)(1-3m) + 0.972C_p \left( \frac{h}{b} \right)^2 \right]. \quad . . . \quad (12)$$

*Minimum Unit Pressure at Heel, Level Ground* (approx.)

$$p_2 = wh \left[ 1.1(1-m)(1+3m) - 0.972C_p \left( \frac{h}{b} \right)^2 \right], \quad . \quad (13)$$

The formulas above give fairly accurate results for level ground.

**Exact Determination of Pressure on Foundation.**—The pressure on foundation is best determined by semi-graphical method. First, the dimensions of the wall are assumed and drawn to scale. The weights of the component parts are computed and shown as applied at their respective centers of gravity. Next, the earth pressure is computed and shown as applying at one-third the height above the base. Finally, the forces are combined graphically by the well-known method. The resultant is produced to the bottom of the base, and is then resolved into vertical and horizontal components. The vertical component produces pressure on the foundation, while the horizontal component produces a tendency to slide.

After the point of application of the resultant has been found, the unit pressures at the toe and at the heel may be found from the following formulas.<sup>9</sup> (See Fig. 299, p. 844.)

Let  $e$  = distance of point of application of forces  $R$  and  $N$  from center of base, ft.;

$N$  = normal component of the resultant,  $R$ , lb.

Then

Pressure at toe,

$$p_1 = \frac{N}{b} \left( 1 + \frac{6e}{b} \right), \text{ lb. per sq. ft. . . . . (14)}$$

Pressure at heel,

$$p_2 = \frac{N}{b} \left( 1 - \frac{6e}{b} \right), \text{ lb. per sq. ft. . . . . (15)}$$

For graphical method see Fig. 303, p. 857.

**Derivation of Formulas (8) to (13).**—In Fig. 298, the earth pressure is (Formula (4), p. 837),  $P = \frac{1}{2}C_p w h_1^2$ . Assuming  $h_1 = 0.9h$ , the formula changes to

$$P = \frac{1}{2} \times C_p w (0.9h)^2 = 0.405C_p w h^2.$$

The bending moment per foot of length of wall,

$$M = \left( \frac{0.9h}{3} + 0.1h \right) P = 0.4 \times 0.405C_p w h^3 = 0.162C_p w h^3.$$

The pressure on foundation due to the bending moment,

$$p_1 = \pm \frac{6M}{b^2} = \pm 0.972C_p w \frac{h^3}{b^2}.$$

Plus should be used for the toe and minus for the heel.

The vertical pressure on the foundation consists of the weight of earth and the weight of the wall. The weight of the toe may be neglected. The weight of the portion  $abcd$  may be considered as equal to the area multiplied by unit weight of earth. The weight of concrete is larger than that of earth, but the assumption is accurate enough for practical purposes. To compensate for greater weight of the base, the height may be increased by, say, 10 per cent. Thus the weight of the rectangle is (using same designations as in Fig. 299, p. 844)

$$W = w(1 - m)b \times 1.1h.$$

The distance of the center of gravity of this mass from the edge equals  $\frac{b}{2}(1 - m)$ . Thus the pressure is applied eccentrically on the founda-

<sup>9</sup> The principle is same as applied to eccentrically applied loads on p. 169.

tion and the eccentricity is  $\frac{b}{2} - \frac{b}{2}(1 - m) = \frac{b}{2}(1 - 1 + m) = \frac{m}{2}b$ .

With this eccentricity, the pressure will be distributed on the base as follows:

$$p = \frac{W}{b} \pm \frac{6W\frac{m}{2}b}{b^2} = \frac{W}{b}[1 \pm 3m] = w(1 - m)1.1h[1 \pm 3m].$$

Pressure at toe is  $1.1wh(1 - m)(1 - 3m)$ .

Pressure at heel,  $1.1wh(1 - m)(1 + 3m)$ .

Combining the pressures due to earth pressure with the above pressures, we have

Total pressure at toe,

$$\begin{aligned} p_1 &= 1.1wh(1 - m)(1 - 3m) + 0.972C_p w \frac{h^3}{b^2} \\ &= wh \left[ 1.1(1 - m)(1 - 3m) + 0.972C_p \left(\frac{h}{b}\right)^2 \right]. \end{aligned}$$

Total pressure at heel,

$$\begin{aligned} p_2 &= 1.1wh(1 - m)(1 + 3m) - 0.972C_p w \frac{h^3}{b^2} \\ &= wh \left[ 1.1(1 - m)(1 + 3m) - 0.972C_p \left(\frac{h}{b}\right)^2 \right]. \end{aligned}$$

*Resultant at Middle Third.*—Assume that it is desirable that the resultant strike the base at the middle third. For such a condition, the pressure at the heel is zero. Then,

$$p_2 = 0 = wh \left[ 1.1(1 - m)(1 + 3m) - 0.972C_p \left(\frac{h}{b}\right)^2 \right].$$

Solving this for  $\frac{b}{h}$ , we have,

$$\frac{b}{h} = \sqrt{\frac{0.972C_p}{1.1(1 - m)(1 + 3m)}} = 0.94 \sqrt{\frac{C_p}{(1 - m)(1 + 3m)}},$$

or

$$b = 0.94 \sqrt{\frac{C_p}{(1 - m)(1 + 3m)}} h = C_b h.$$

If it is desired that the resultant strike the base for earth pressure multiplied by ratio  $r$ , value of  $rC_p$  should be substituted in the formula for  $C_p$ .

Values of  $C_b$  may be obtained for different values of  $C_p$ , or  $rC_p$ .

*Resultant in the Center of Base.*—If it is desired to get the resultant in the middle of base, then  $p_1 = p_2$ ,

$$wh \left[ 1.1(1 - m)(1 - 3m) + 0.972C_p \left( \frac{h}{b} \right)^2 \right] = wh \left[ 1.1(1 - m)(1 + 3m) - 0.972C_p \left( \frac{h}{b} \right)^2 \right],$$

$$2 \times 0.972C_p \left( \frac{h}{b} \right)^2 = 1.1(1 - m)[1 + 3m - 1 + 3m],$$

$$\left( \frac{h}{b} \right)^2 = \frac{6.6m(1 - m)}{2 \times 0.972C_p'}$$

$$\frac{b}{h} = \sqrt{\frac{2 \times 0.972C_p}{6.6m(1 - m)}} = 0.55 \sqrt{\frac{C_p}{m(1 - m)}}$$

For ordinary conditions, when  $m = 0.3$ ,  $C_p = 0.3$ ,  $b = 0.65h$ .

CANTILEVER WALLS

**Description.**—A cantilever wall, in general, consists of an upright cantilever slab, retaining the wall, and a cantilever base slab, distributing the pressure on the foundation

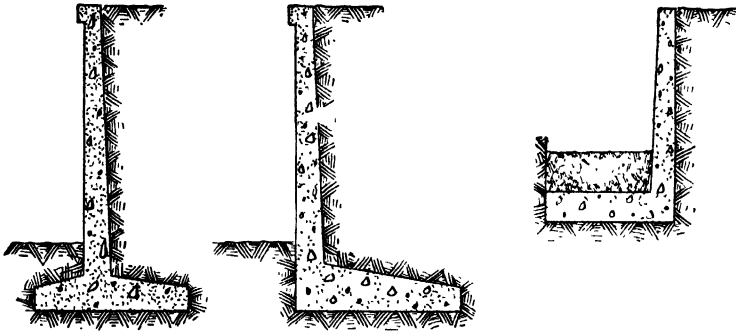

FIG. 300.—Types of Cantilever Walls. (See p. 849.)

NOTE: Reinforcement of wall not shown.

*The T-shaped Wall* resembles an inverted letter T. The upright slab is placed some distance from the toe, as shown in Fig. 300. This is the most commonly used type.

*The L-shaped Wall* resembles a letter L. The upright slab is placed at the toe edge of the base; as shown in Fig. 300, with earth

upon the top of the base. Such a design should be used only when the wall is placed on the property line and it is not permissible to extend the toe beyond the line.

The  $\perp$ -shaped Wall is seldom used, and only for small walls in connection with other structures. It is uneconomical, as there is little earth on top of the base.

**Design of Wall.**—The general proportions are assumed as explained on p. 845. The proportions are checked by drawing the resultant and finding the unit pressures on the foundation. When these are satisfactory, the various parts of the wall are designed for strength. In designing the various parts, the net expected earth pressure (not multiplied by factor of safety) should be used, as the factor of safety has been provided in selection of unit stresses

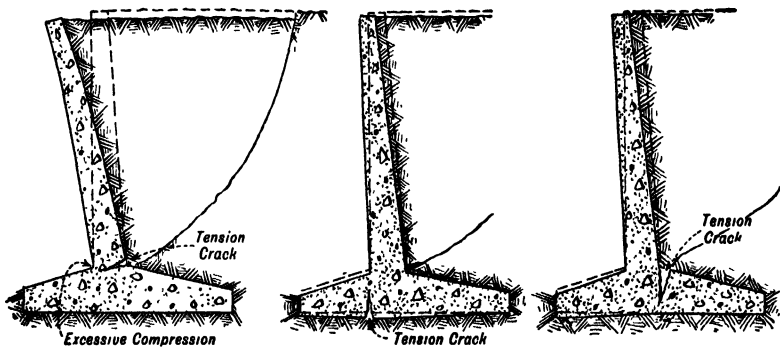

FIG. 301.—Failure of Component Parts of Cantilever Wall. (See p. 852.)

**Upright Slab.**—The upright slab is a cantilever loaded by the earth pressure, and supported at the junction of the slab with the base. It may fail by cracking at the inside face, by crushing of the concrete at the outside face, or by pulling out of the reinforcement. (See Fig. 301 above.)

The upright slab does not need to be designed for the same earth pressure for which the wall, as a whole, is designed. In Fig. 298 the triangles of earth pressure are shown for level ground and for sloped ground. The pressure acting on the wall as a whole is indicated by  $P$  with a maximum unit pressure  $p$ . The pressure to which the upright slab is subjected is indicated by  $P_1$  with a maximum unit pressure  $p_1$ . For level ground, Fig. (a), the earth pressure for the upright slab is somewhat smaller than for the wall as a whole, the difference being due to the difference in height. For sloped ground, Fig. (b),

there is considerable difference between the earth pressure acting on the wall, as a whole, and that for which the upright slab is designed.

The maximum bending moment at the bottom of the upright wall is determined by the formulas that follow:

- Let  $h_2$  = distance from top of wall to junction slab and base, ft. ;  
 $h_3$  = height of surcharge, ft. ;  
 $C_p$  = constant for earth pressure, table, p. 837 ;  
 $w$  = weight of earth, lb. per cu. ft. ;  
 $\delta$  = angle of slope of ground.

Then

*Maximum Moment, Level Ground,*

$$M = \frac{1}{6}C_p w h_2^3 \text{ ft.-lb. or } 2C_p w h_2^3 \text{ in.-lb. . . . . (16)}$$

*Maximum Moment, Wall with Surcharge,  $h_3$ ,*

$$M = \frac{1}{6}C_p w h_2^2 (h_2 + 3h_3) \text{ ft.-lb. or } 2C_p w h_2^2 (h_2 + 3h_3) \text{ in.-lb. (17)}$$

*Maximum Moment, Sloped Ground,*

$$M = \frac{1}{6}C_p \cos \delta w h_2^3 \text{ ft.-lb. or } 2C_p \cos \delta w h_2^3 \text{ in.-lb. . . . . (18)}$$

Moments at intermediate points may be obtained by substituting in the above equation, for  $h_2$ , the depth of the point under consideration below the top.

After the bending moments have been computed, the thickness of slab and the areas of steel are computed from ordinary slab formulas. The effect of the weight of wall and of the vertical component of earth pressure (if any) may be neglected. They increase the compression stresses and decrease the tensile stresses.

The bending moments decrease toward the top. This permits a reduction of thickness of slab and in amount of reinforcement. Usually, a thickness at the top is selected by judgment (8 to 12 in.) and a uniform slope is adopted for the wall, as governed by this minimum thickness on the top and the computed thickness (or "depth" considered as a slab) at the bottom.

In addition to the reduction of the thickness of slab, as explained above, the amount of steel may be reduced. This is usually accomplished by not extending all of the bars to the top. Some of them may be stopped forty diameters above the point where the bending moment is sufficiently reduced to permit the reduction in reinforcement. When it is not desired to compute moments at intermediate points, one-half of the bars may be stopped halfway up the wall

The bars must be anchored at the bottom by extending them into the base a sufficient distance to develop their strength by bond.

**Toe Cantilever (in front of Upright Slab).**—The toe cantilever is subjected to the upward soil resistance pressure and to the downward dead load of the cantilever and the weight of earth upon it. Usually, the two reducing factors are neglected and the cantilever designed for upward soil pressure only.

The toe cantilever may fail by cracking at the bottom, crushing of concrete on top, or pulling out of reinforcement. (See Fig. 301, p. 850.) To prevent failure, the dimensions should be computed according to the formulas for slabs in the chapter on Reinforced Concrete. The reinforcement must be anchored by extending far enough beyond the junction of toe and wall. The length of imbedment must be sufficient to develop the full strength of the bar.

The maximum bending moment acts at the edge of the wall. The pressure is represented by a trapezoid.

Let (in addition to notation on page 844),

$p_1$  = maximum pressure at toe, lb. per sq. ft.;

$p_2$  = minimum pressure at heel, lb. per sq. ft.;

$b$  = width of base, ft.;

$m$  = ratio of length of toe to width of base,  $b$ ;

$mb$  = length of toe, ft.

Then

*Maximum Bending Moment, Toe Cantilever,*

$$\text{or } \left. \begin{aligned} M &= \frac{1}{6}[p_1(3 - m) + mp_2](mb)^2 \text{ ft.-lb.} \\ &2[p_1(3 - m) + mp_2](mb)^2 \text{ in.-lb.} \end{aligned} \right\} \dots (19)$$

When the pressure at the heel is zero, then  $p_2 = 0$  and

$$\text{or } \left. \begin{aligned} M &= \frac{1}{6}p_1(3 - m)(mb)^2 \text{ ft.-lb.} \\ &2p_1(3 - m)(mb)^2 \text{ in.-lb.} \end{aligned} \right\} \dots (20)$$

*Maximum Shear at Edge of Wall,*

$$V = \frac{p_1(2 - m) + mp_2}{2}mb. \dots (21)$$

When pressure at the heel is zero

$$V = p_1 \frac{(2 - m)}{2}mb. \dots (22)$$



**Heel Cantilever (Back of Wall).**—The heel cantilever is subjected to the weight of the earth above it and, in case of inclined earth pressure, to its vertical component. These downward pressures are partly offset by the upward reaction of the soil. The bending moment due to downward loads should be computed separately, and from it should be subtracted the separately computed moment of the upward pressures.

The heel cantilever may fail by cracking at the top, at the junction between the wall and cantilever, by crushing at the bottom, or by pulling out of the reinforcement. (See Fig. 301, p. 850.) To guard against the first two classes of failures, the depth and the amount of steel must be computed according to formulas for reinforced concrete. To guard against bond failure, the ends of bars must be anchored in the wall, and the bond stresses in steel must be within working limits.

- Let  $n$  = ratio of length of heel to width of base;
- $nb$  = length of heel to inside face of wall, ft.;
- $h$  = height at inside face of wall, top to base, in ft.;
- $h_1$  = height at edge of toe, top to one foot above base, ft.;
- $h_2$  = height of upright wall above top of base slab, ft.;
- $p_1$  = maximum pressure at toe, lb. per sq. ft.;
- $p_2$  = minimum pressure at heel, lb. per sq. ft.

**Shears on Heel Cantilever for Level Ground.—**

*Downward Shear,*<sup>10</sup>

$$V_1 = 1.1whnb, \text{ lb.} \quad \dots \quad (23)$$

*Upward Shear,*

$$V_2 = \frac{p_2(2 - n) + np_1}{2}nb \text{ lb.} \quad \dots \quad (24)$$

*Resultant Shear to be Used in Design Acting Downward,*

$$V = (V_1 - V_2) \text{ lb.} \quad \dots \quad (25)$$

**Moments for Level Ground.**—When the ground is level, as in Fig. 299, the bending moments acting on the heel cantilever are:

*Downward Moment Due to Weight of Earth and Slab,*<sup>10</sup>

$$\text{or} \quad \left. \begin{aligned} M_1 &= 0.55wh(nb)^2 \text{ ft.-lb.} \\ &6.6wh(nb)^2 \text{ in.-lb.} \end{aligned} \right\} \dots \quad (26)$$

<sup>10</sup> Depth,  $h$ , was multiplied by 1.1 to compensate for the use of a larger unit weight of concrete than the unit weight,  $w$ , used in the formula.

*Upward Moment Due to Soil Pressure,*

$$\text{or } \left. \begin{aligned} M_2 &= \frac{1}{6}[p_2(3 - n) + np_1](nb)^2 \text{ ft.-lb.} \\ &2[p_2(3 - n) + np_1](nb)^2 \text{ in.-lb.} \end{aligned} \right\} \dots (27)$$

For total moment, deduct  $M_2$  from  $M_1$ . Thus

*Resultant Moment to be Used in Design (Acting Downward),*

$$M = M_1 - M_2. \dots (28)$$

**Shears on Heel Cantilever for Sloped Ground.—**

*Downward Shear Due to Weight of Earth and Slab,<sup>10</sup>*

$$V_1 = 0.55(h + h_1 + 1)wnb \text{ lb.} \dots (29)$$

*Downward Shear Due to Vertical Component of Earth Pressure,*

$$V_3 = \frac{h_1 + h_2}{2} C_p \sin \delta \tan \delta wnb \text{ lb.} \dots (30)$$

*Upward Pressure of Foundation,*

$$V_2 = \frac{1}{2}[p_2(2 - n) + np_1]nb \text{ lb.} \dots (31)$$

*Resultant Shear to be Used in Design (Acting Downward),*

$$V = V_1 + V_3 - V_2.$$

For small angles,  $\delta$ , value of  $V_3$  is negligible.

**Bending Moments on Heel Cantilever, Sloped Ground.—**

*Bending Moment Due to Weight of Earth and Slab,*

$$\text{or } \left. \begin{aligned} M_1 &= \frac{1 \cdot 1}{6} w(2h_1 + h + 2)(nb)^2 \text{ ft.-lb.} \\ &2 \cdot 2w(2h_1 + h + 2)(nb)^2 \text{ in.-lb.} \end{aligned} \right\} \dots (32)$$

*Bending Moment Due to Vertical Component of Earth Pressure,<sup>11</sup>*

$$\text{or } \left. \begin{aligned} M_3 &= \frac{1}{2} w(2h_1 + h_2) C_p \sin \delta \tan \delta (nb)^2 \text{ ft.-lb.} \\ &2w(2h_1 + h_2) C_p \sin \delta \tan \delta (nb)^2 \text{ in.-lb.} \end{aligned} \right\} \dots (33)$$

<sup>11</sup> The vertical component of the pressure, represented by *abcd* in the triangle of pressure, acts on the heel cantilever, as shown in Fig. 302. The vertical component of the earth pressure at the heel is  $C_p wh_1 \sin \delta$ , and at the edge of upright slab  $C_p wh_2 \sin \delta$ . To get vertical components for unit of length of base, these values must be multiplied by  $\tan \delta$ . Thus, at the heel, the vertical component per lineal foot is  $C_p wh_1 \sin \delta \tan \delta$ , and at the wall  $C_p wh_2 \sin \delta \tan \delta$ .

The formula for upward moment is the same as for level ground.

$$M_2 = \frac{(nb)^2}{6} [p_2(3 - n) + np_1] \text{ ft.-lb. } \left. \right\} \dots \dots (34)$$

$$2[p_2(3 - n) + np_1](nb)^2 \text{ in.-lb. } \left. \right\}$$

or

*Resultant Moment to be Used in Design (Acting Downward),*

$$M = M_1 + M_3 - M_2. \dots \dots (35)$$

For small angles,  $\delta$ , the value of  $M_3$  is negligible.

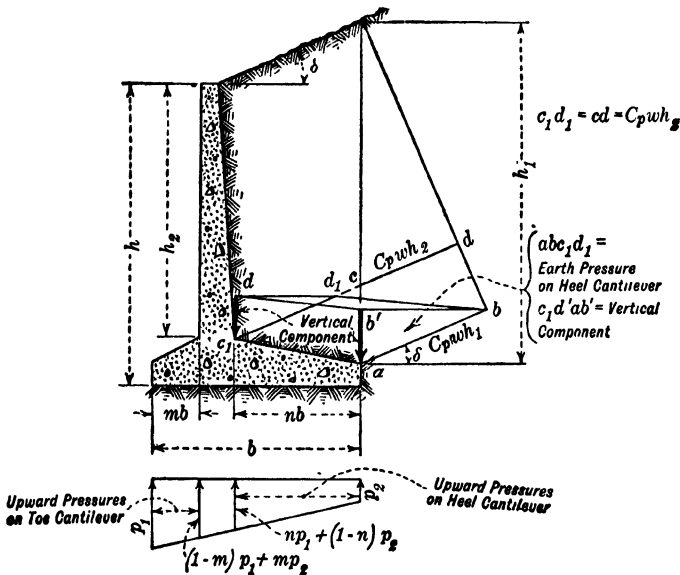

FIG. 302.—Forces Acting on Base Cantilevers of T-wall. (See p. 854.)

**Temperature Reinforcement.**—To prevent open vertical cracks in the wall, which are unsightly, the wall, even if well reinforced horizontally, should be built in sections not more than 60 ft. long. Grooved lock-joints should be provided at the ends of the sections. The amount of longitudinal temperature reinforcement necessary will depend upon the degree to which elimination of cracks is desired. It should not be less than 0.2 per cent of the volume of the concrete. For water-tight walls, this should usually be increased to 0.4 per cent. Two-thirds of the temperature reinforcement may be placed near the outside face, and one-third near the inside face of the wall.

Adjoining bars should be properly lapped, to develop their full strength by bond. Deformed bars are more effective than plain bars in distributing the fine cracks that may occur.

EXAMPLE OF T-SHAPED RETAINING WALL

**Example 1.**—Design a retaining wall, 12 ft. above ground, to support a sand fill, which slopes upward at a rate of 1 to 2, making an angle with horizontal of  $26^\circ 30'$ . Weight of sand is 100 lb. per cu. ft., and its angle of internal friction  $35^\circ$ . Use 1 : 2 : 4 concrete and mild steel with ratio  $n = 15$  and working stresses in lb. per sq. in.,  $f_c = 650$ ,  $f_s = 16\ 000$ ,  $v = 40$ ,  $u = 80$ , for plain bars, and  $u = 100$  for deformed bars.

It is desirable that the resultant should strike the base at the edge of the middle third for not less than  $1\frac{1}{2}$  times the expected earth pressure. Thus, ratio  $\gamma = 1.5$ .

**Solution.**—If the base is imbedded 4 ft. below the surface, to protect it from frost, the total height of wall from base to top is 16 ft.

**Proportions of Wall.**—The depth of wall is 16 ft. A ratio of length of toe to base,  $m = 0.3$ , will be assumed. For an angle of repose  $\phi = 35^\circ$  and an angle of slope  $\delta = 26^\circ 30'$ , the earth pressure constant, from the table on p. 837, is  $C_p = 0.38$ . The value of  $rC_p \cos \delta = 1.5 \times 0.38 \times 0.894 = 0.51$ . For this value and from  $m = 0.3$ , the constant from table on p. 845 is  $C_b = 0.58$ , and the length of base

$$b = C_b h = 0.58 \times 16 = 9.3 \text{ ft. Use } 9 \text{ ft. } 4 \text{ in.}$$

From this the length of toe,  $mb = 0.3 \times 9.3 = 2.8 \text{ ft. Use } 2 \text{ ft. } 10 \text{ in.}$

**Check of Assumed Base Width.**—The assumed proportions will now be laid out to scale as shown in Fig. 303. To facilitate computations, the concrete slabs are represented by rectangles. The thickness of the upright wall and of the base is assumed as 12 in. The weight is now computed. Taking unit weight of concrete at 150 lb. and of sand as 100 lb. per cu. ft.,

	Weight per Foot of Length	Distance from Heel to Center of Gravity	Moment of Weight About Heel
Slab	$W_1 = 15.0 \times 1.00 \times 150 = 2\ 250 \text{ lb.}$	5 ft. 6 in. + 6 in. = 6.00 ft.	13 500 ft.-lb.
Base	$W_2 = 9.33 \times 1.00 \times 150 = 1\ 400 \text{ lb.}$	$\frac{9.33}{2} = 4.67 \text{ ft.}$	6 550 ft.-lb.
Earth	$W_3 = 5.5 \frac{15.0 + 17.7}{2} \times 100 = 9\ 000 \text{ lb.}$	$\frac{5.5}{3} \frac{17.7 + 2 \times 15.0}{17.7 + 15.0} = 2.68 \text{ ft.}$	24 100 ft.-lb.
Total weight...	$W = 12\ 650 \text{ lb.}$	Total moment...	44 150 ft.-lb.

Distance from heel to center of gravity of all loads, equal to total moment divided by total weight, is  $\frac{44\ 150}{12\ 650} = 3.5 \text{ ft.}$

The earth pressure acting parallel to slope is represented by a triangle. It is assumed that the pressure on the face of the base is resisted by the passive pres-

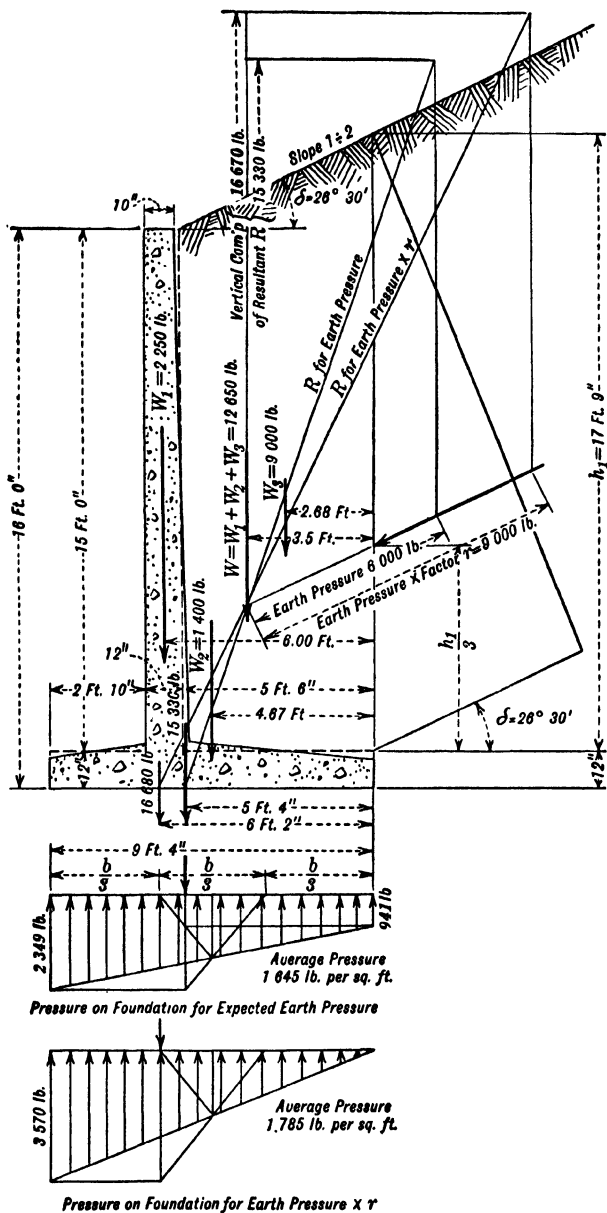

FIG. 303.—General Dimension of Wall. (See p. 856.)

sure at the toe. The total earth pressure, from Formula (4), p. 837, where  $C_p = 0.38$  is  $P = \frac{1}{2} \times 0.38 \times 100 \times 17.7^2 = 6\ 000$  lb. This applies at one-third of the height from bottom.

The components of the earth pressure are:

$$H = P \cos \delta = 6\ 000 \times 0.894 = 5\ 360 \text{ lb.}$$

$$V = P \sin \delta = 6\ 000 \times 0.446 = 2\ 680 \text{ lb.}$$

Plot the resultant downward force,  $W$ , at a distance of 3.58 ft. from the heel, and also the earth pressure,  $P$ , in proper position. Combine the two forces as shown in the figure. The resultant,  $R$ , strikes the base well within the middle third.

Combine again the force,  $W$ , with  $rP$ , i.e., for earth pressure multiplied by ratio  $r = 1.5$ . For this condition, the resultant strikes the base at the edge of the middle third.

**Pressure on Foundation.**—The pressure on the foundation is obtained from Formula (14), p. 847. The vertical component is 15 330 lb. and the eccentricity,  $e = 5$  ft. 4 in.  $-\frac{9$  ft. 4 in.}{2} = 8 in. = 0.67 ft.

$$p = \frac{15\ 330}{9.33} \pm \frac{6 \times 15\ 330 \times 0.67}{9.33^2} = 1\ 645 \pm 704 \text{ lb. per sq. ft.}$$

From this,

$$p_1 = 2\ 349 \text{ lb. per sq. ft.; } p_2 = 941 \text{ lb. per sq. ft.}$$

For the other condition, the pressure acts practically at the edge of the middle third. Therefore, the maximum pressure at the toe equals twice the average pressure.

$$p_1 = 2 \times \frac{16\ 670}{9.33} = 3\ 570 \text{ lb. per sq. in.}$$

Graphical method of determining pressure on foundation for known average pressure and location of force, is shown in Fig. 303, p. 856.

**Resistance to Sliding.**—The horizontal component of the earth pressure is  $rH = 8\ 050$  lb. The normal resultant is  $N = 16\ 670$ . Ratio  $\frac{rH}{N} = \frac{8\ 050}{16\ 670} = 0.484$  is much smaller than the tangent of the angle of friction, hence the design is satisfactory. (See p. 839.)

**Toe Cantilever.**—For explanation, see p. 852.

The maximum bending moment, from Formula (19), p. 852, when  $m = 0.3$ ;  $mb = 2.82$  ft.;  $p_1 = 2\ 357$  lb.;  $p_2 = 933$  lb.

$$M = 2[2\ 357(3 - 0.3) + 0.3 \times 933]2.82^2 = 106\ 000 \text{ in.-lb.}$$

The maximum external shear, from Formula (21), p. 852,

$$V = \frac{2\ 357(2 - 0.3) + 0.3 \times 933}{2} 2.82 = 6\ 050 \text{ lb.}$$

The depth of slab for bending moment, from formula  $d = C_1\sqrt{M}$ , where  $C_1 = 0.028$  (Table 2, p. 880).

$$d = 0.028\sqrt{106\,000} = 9.12 \text{ in.}$$

$$A_s = 0.0077bd = 0.0077 \times 12 \times 9.12 = 0.84 \text{ sq. in.}$$

$\frac{3}{8}$  bars, 4" on centers has an area of 0.921 sq. in.

*Bond Stresses* now will be investigated. The perimeter of a  $\frac{3}{8}$ -in. rd. bar is  $\sigma = 1.96$ . Since there are 3 bars per lineal foot, the value of  $\Sigma\sigma = 3 \times 1.96 = 5.88$ .

The unit bond stress is

$$u = \frac{V}{\Sigma\sigma jd} = \frac{6\,050}{5.88 \times 0.875 \times 9.3} = 126 \text{ lb.}$$

The bond stress is excessive. To reduce it, increase either the area of steel or the depth. In this case, the depth will be increased in the ratio of the computed to the allowable bond stress.

$$d_1 = 9.12 \times \frac{1.26}{0.88} = 11.5 \text{ in.}$$

Use a total depth of 15 in., which gives about 3 in. protection for the steel.

The bars must be extended 40 diameters beyond the junction of the toe and the wall, to develop their full strength. For  $\frac{3}{8}$ -in. bars, this amounts to 2 ft 1 in.

*Shear,*

$$v = \frac{6\,050}{11.5 \times 0.875 \times 12} = 50.0 \text{ lb. per sq. in.}$$

**Upright Slab.**—For explanation, see p. 850. As evident from Fig. 305, p. 862, the height of upright slab above the junction of slab and toe is  $h_2 = 14 \text{ ft. } 9 \text{ in.}$  Since  $C_p = 0.38$  and  $w = 100 \text{ lb. per sq. ft.}$ ,  $\delta = 26^\circ 30'$ ,  $\cos \delta = 0.894$ . The bending moment, from Formula (18), p. 851,

$$M = 2 \times 0.38 \times 0.894 \times 100 \times 14.75^2 = 218\,000 \text{ in.-lb.}$$

Thickness of slab, from formula  $d = C_1\sqrt{M}$  is

$$d = 0.028\sqrt{218\,000} = 13.1$$

Use  $h = 15$  in. With  $1\frac{1}{2}$  in. protection outside of bars, the distance to the center of steel is  $1.5 + \frac{0.75}{2} = 1.875$  in.

Area of steel, from formula  $A_s = pbd$ , where  $p = 0.0077$ , is  $A_s = 0.0077 \times 12 \times 13.1 = 1.21 \text{ sq. in.}$  This is satisfied by  $\frac{3}{4}$ -in. rd. bars placed 4.37 in. on centers. Use  $4\frac{1}{4}$ -in. spacing at the bottom.

At the top, where the bending moment is zero, the minimum practicable depth may be used. This is considered to be from 8 to 12 in. In this case, 10 in. depth is selected at the top and the slab made to slope uniformly to the maximum depth.

If it is desired to make some of the vertical bars shorter than the rest, bending moments at intermediate points should be found, and the required areas of reinforcement computed. Since the moments vary with third power of the height, the values at intermediate points may be obtained by multiplying the maximum moment by third power of the ratio of the height of the point to the total height of upright slab.

Height $h_x$	Ratio, $\frac{h_x}{h}$	$\left(\frac{h_x}{h}\right)^3$	Moment, Inch-pounds	Effective Depth, Inches	$A_s = \frac{M}{f_s j d}$ Sq. In.
$\frac{1}{4}h = 3.68$	$\frac{1}{4}$	$\frac{1}{64}$	3 400	9.35	0.03
$\frac{1}{2}h = 7.37$	$\frac{1}{2}$	$\frac{1}{8}$	27 200	10.6	0.18
$\frac{3}{4}h = 11.05$	$\frac{3}{4}$	$\frac{27}{64}$	92 000	11.85	0.56
$h = 14.75$	1	1	218 000	13.1	1.21

For maximum bending moment use  $\frac{3}{4}$ -in. rd. bars spaced  $4\frac{1}{4}$  in. on centers.

The length of bars may be obtained by drawing a free-hand sketch on cross-section paper, as shown in Fig. 304. The height is laid out to a convenient scale, for instance, one division for one foot. At each elevation, the required area of steel is laid out on a horizontal line, the divisions being used again as a measure. The points connected give a curve representing the required area of steel at any height. The reinforcement is laid out as used. In the sketch, an assumption was made that one bar in six would be carried to the top, making the top spacing of bars  $25\frac{1}{2}$  in. Next, the spacing of bars is reduced to  $12\frac{3}{4}$  in. by using two bars in each  $25\frac{1}{2}$  in. Then four bars are used in  $25\frac{1}{2}$  in., and finally six bars, making the bottom spacing  $4\frac{1}{4}$  in. The areas of bars are reduced to effective areas per lineal foot of wall, and plotted. Thus, one  $\frac{3}{4}$ -in. rd. bar in  $25\frac{1}{2}$  in. gives 0.207 sq. in. per lineal foot, two bars 0.41 sq. in. per lineal foot. The intersection of the vertical lines representing the areas of bars, with the curve representing the required areas of reinforcement, gives the theoretical point where the bars become unnecessary. The bars should be extended 40 diameters beyond this theoretical point. In important work, hooks should be provided at ends to prevent slip of bar.

**Heel Cantilevers.**—For explanation, see p. 853. Since  $nb = 5$  ft. 6 in.,  $n = \frac{5.5}{9.33} = 0.59$ ,  $p_1 = 2\,349$  lb.,  $p_2 = 941$  lb.,  $h = 16$  ft. 0 in.,  $h_1 = 17$  ft. 9 in.,  $h_2 = 15$  ft.,  $\sin \delta = 0.446$ ,  $\tan \delta = 0.499$ , the maximum bending moments are as follows:

Bending moment due to weight of earth and slab (Formula (32), p. 854).

$$M_1 = 2.2 \times 100(2 \times 17.75 + 16.0 + 2)5.5^2 = 357\,500 \text{ in.-lb.}$$

Bending moment due to vertical component of earth pressure, Formula (33), p. 854.

$$M_2 = 2 \times 100(2 \times 17.75 + 15.0)0.38 \times 0.446 \times 0.499 \times 5.5^2 = 25\,900 \text{ in.-lb.}$$



The maximum bending moment due to upward pressure, from Formula (34), p. 855, is

$$M_2 = 2[933(3 - 0.59) + 0.59 \times 2357]5^2 = 221\,000 \text{ in.-lb.}$$

The sum of the bending moment is

$$M = M_1 + M_3 - M_2 = 357\,500 + 25\,900 - 221\,000 = 162\,400 \text{ in.-lb.}$$

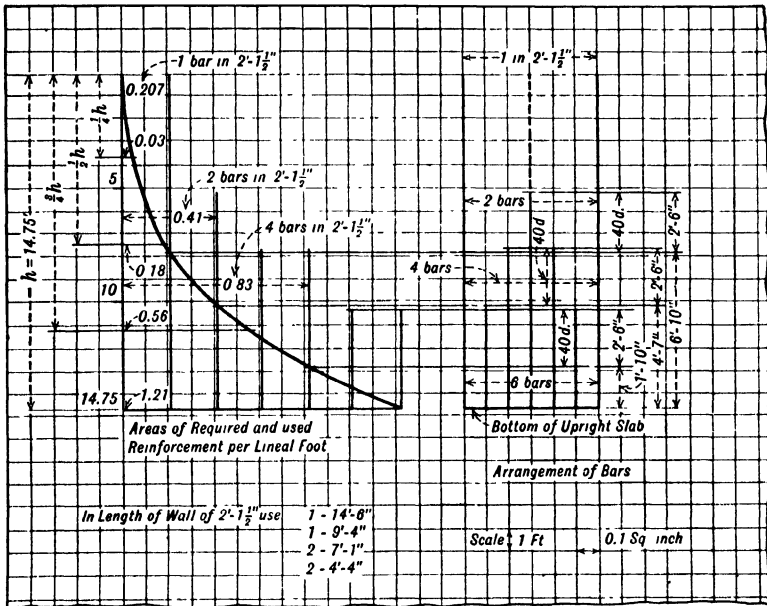

Note.—To reduce the large distance between bars at the top of the wall, the center bar of the above set is extended to the top of the wall as indicated by dash lines.

FIG. 304.—Points of Stopping Short of Vertical Bars in Upright Slab. (See p. 860.)

Thickness of slab, computed as before,

$$d = 0.028\sqrt{162\,400} = 11.3,$$

$$h = 11.3 + 1\frac{1}{2} + \frac{3}{8} = 13.18. \text{ Use } 13\frac{1}{2} \text{ in.},$$

$$A_s = 0.0077 \times 12 \times 11.3 = 1.04 \text{ sq. in.}$$

Use 3/4-in. rd. bars, 5 in. on centers, with an area of 1.06 sq. in.

**Temperature Reinforcement.**—In the upright slab, temperature and shrinkage reinforcement will consist of horizontal bars placed near both faces of the slab. The total amount will be assumed as equal to 0.2 per cent of the total concrete area. This requires  $12 \times 10 \times 0.002 = 0.24$  sq. in. of steel per foot of height at the top of the wall, and  $12 \times 15 \times 0.002 = 0.36$  sq. in. per foot of height at

the bottom. Of this steel, about two-thirds will be placed near the outside face and one-third near the inside face, as shown in Fig. 305. To support the bars near the outside face, either spacers or vertical bars should be used.

**Design of L-walls.**—L-walls consist of two instead of three cantilevers, as the toe cantilever is omitted. The method of design

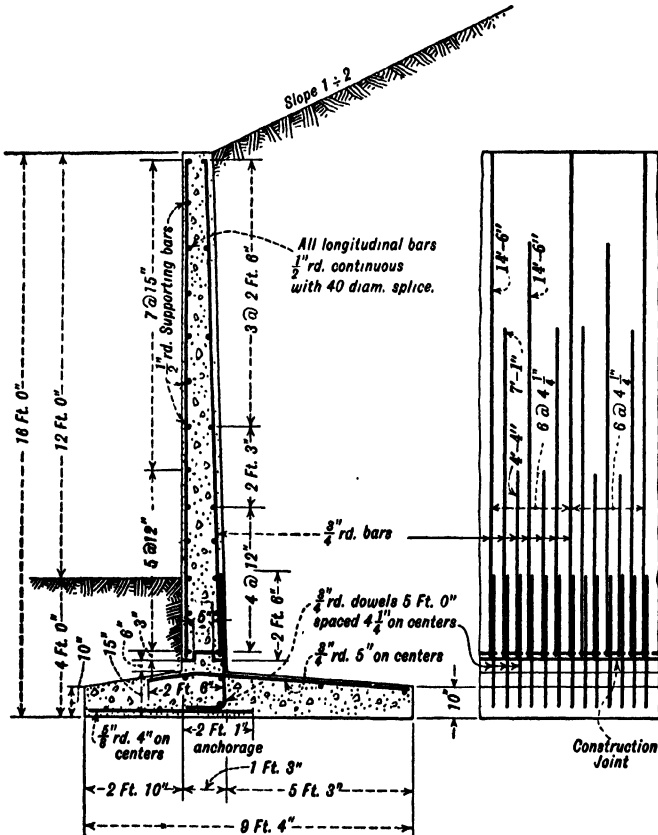

FIG. 305.—Details of T-wall designed in Example. (See p. 862.)

of the upright slab and the heel cantilevers is the same, as explained in connection with T-beams. The arrangement of reinforcement is shown in Fig. 306, p. 863.

**Erection of Cantilever Walls.**—In designing retaining walls, the method of erection should be considered. Ordinarily, it is desirable to erect the base slab first, before the forms for the upright slab are

erected. The forms for the upright slab are then supported on the base. To avoid the necessity of bracing forms on the bottom, a small section of the wall, say, 6 in. high, is built with the base. The wall forms then are bolted to this stump.

The wall reinforcement extends into the foundation slab. There would be considerable difficulty in keeping the long vertical bars in position during pouring of the foundation slab. To avoid this, dowels are inserted instead of full-length bars. One-half of each dowel is imbedded in the base and the other half extends above the construction joint to lap the tension reinforcement of the upright slab.

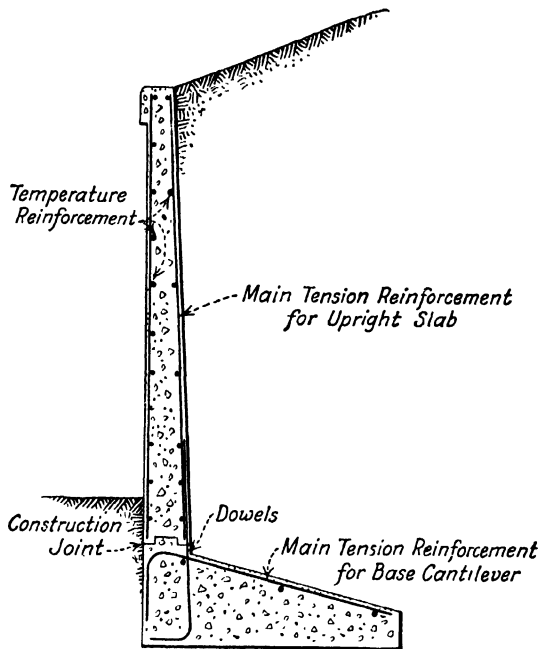

FIG. 306.—L-shaped Retaining Walls. (See p. 862.)

to transfer shear at the construction joint, a key should be used as shown in Figs. 305 and 306.

The length of dowels is such that each dowel is capable of developing, by bond, full strength of bar below and above the joint.

### WALL WITH COUNTERFORTS

To reduce the amount of steel and concrete in the upright slab and the toe cantilever, a design is often used with a counterfort between the two cantilevers, as shown in Fig. 307, p. 864.

**Relative Economy of Cantilever Walls and Walls with Counterforts.**—Whether the T-section of reinforced wall or the wall with counterforts is the more economical depends upon certain conditions.

The principal condition is the height of the wall, but the intensity of the earth pressure and the relative cost of concrete and steel and

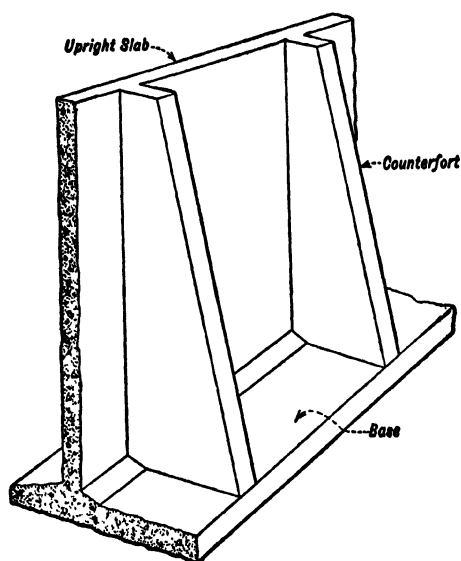

FIG. 307.—Isometric View of Wall with Counterforts. (See p. 863.)

forms also enter into the consideration. The T-section is preferable where skilled labor is scarce, as the construction is simpler and the placing of steel easier. The form construction in the counterforted wall is considerably more expensive. Comparative studies of the two types indicate that the counterfort type is scarcely ever economical when the height is less than 18 feet.

For lower walls, it will be found that the additional cost of formwork for the counterfort more than balances the saving in material.

**Design of Wall with Counterfort.**—General proportions of the base will be the same as for a cantilever wall of the same height and subjected to same earth pressure. The proportions should be checked, in the same manner as shown in the example for cantilever walls, p. 857.

**Stresses Acting on a Wall with Counterforts.**—An idea of the distribution of stresses in a wall with counterforts may be had from Fig. 308, which shows the possible causes of failure of such wall.

Figure (a) shows a failure caused by cracking of the counterfort. This occurs when the amount of tension reinforcement near the outside face of the counterfort is too small.

Figure (b) shows a failure caused by the separation of the upright wall from the counterfort, which is caused by insufficient anchorage of the wall to the counterfort. Since the upright slab is reinforced with horizontal bars, it cannot act as a vertical cantilever, as in T-wall. Separation of the upright wall from counterfort, therefore, means failure of wall.

Figure (c) shows failure of the upright slab produced by earth pressure. This is caused by insufficient amount of tension reinforcement.

An additional type of failure may occur by rupture of the toe cantilever. This is not illustrated. It is similar to that shown in Fig. 301, p. 850, in connection with failures of T-wall.

At the junction of the wall and the base, the slab is not free to deflect horizontally, as it is held by the base. A vertical bending moment will develop there, which should be resisted by short vertical bars placed near the inside face of the wall.

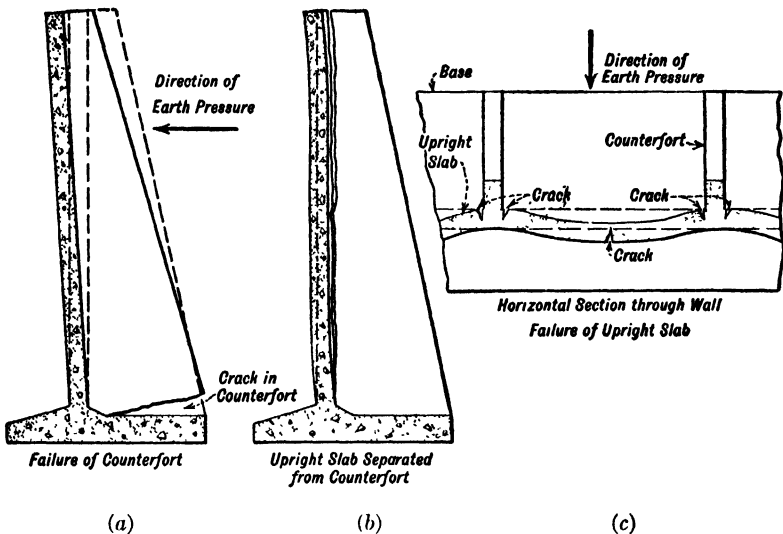

FIG. 308.—Failure of Component Parts of Wall with Counterforts. (See p. 864.)

**Upright Slab in Wall with Counterfort.**—The upright slab is a continuous slab loaded by earth pressure and supported by the counterforts. The principal reinforcement, therefore, is horizontal. In designing, consider horizontal strips of wall, say, one foot wide. The loading on each strip will be uniform and equal to the intensity of earth pressure acting at the height of the strip. The bending moment should be figured by formula  $M = \frac{wl^2}{12}$  for interior panels, and

$M = \frac{wl^2}{10}$  for end panels.

The earth pressures at the various strips varies from a maximum at the bottom of the slab to zero at the top. The thickness of slab is computed for the maximum pressure at the bottom of the slab. The slab may be made of uniform thickness. However, if the difference between the maximum thickness and the practical minimum is large, the wall may be sloped.

When the thickness of the slab has been decided upon, the amount of reinforcement required at different heights should be computed. Since the unit pressure varies according to a straight line from zero at the top to a maximum at the bottom, the bending moments also will vary in the same manner. If the heights are plotted on a vertical line and the moments at the bottom on a horizontal line, the triangle will represent moments at various points. These may be scaled.

Since the wall is a continuous slab, reinforcement should be provided at the supports. The reinforcement in the middle of the span will be placed near the outside face of the wall, and the reinforcement at the counterforts near the inside face of the wall.

**Toe Cantilever of Wall with Counterfort.**—The method of design of the toe cantilever is the same as for cantilever walls. The formula given on p. 852 may be used for bending moments and shear.

If the length of the toe cantilever is appreciable, some saving may be effected by using cantilever ribs spaced at the same intervals as the counterfort. The base slab may then be considered as spanning between the ribs.

**Horizontal Slab Back of Wall.**—The horizontal slab forming the base of the wall may be considered as though it were composed of continuous strips parallel to the wall, supported by the counterforts. Each strip is uniformly loaded, but the loading of the various strips of the slab varies from a maximum at the edge of the base to a minimum at the wall. For level ground, the loading of each strip is composed of the weight of the strip and of the earth above it, minus the upward pressure at the foundation.

For inclined ground, the downward load consists, in addition to the weight of earth and slab, of the vertical component of the earth pressure. If  $\delta$  is the angle of slope,  $C_p$  the earth pressure constant,  $h_1$  the distance from top of slab to top of ground at the end of base in feet, and  $h_2$  the height of wall above base in feet, then the intensity of the vertical component of earth pressure equals:

*Vertical Component of Earth Pressure at End of Base,*

$$N_{\max} = C_p w h_1 \sin \delta \tan \delta \text{ lb. per sq. ft.} \quad (36)$$

*Vertical Component of Earth Pressure at Wall,*

$$N = C_p w h_2 \sin \delta \tan \delta \text{ lb. per sq. ft.} \quad (37)$$

The loading is represented by a trapezoid, from which the load at any point may be computed.

**Counterforts.**—Counterforts are really upright cantilever T-beams held in position by the base slab and loaded by the earth pressure transferred to the counterfort by the vertical slab. A portion of the vertical slab may be considered as a flange of the T-beam. The amount of earth pressure on the cantilever may be determined as follows:

Let  $h_2$  = height of cantilever above base slab, ft.;

$s$  = spacing of cantilevers, ft.;

$C_p$  = constant from table on p 837, for earth pressure;

$\delta$  = angle of inclination of earth pressure;

$w$  = weight of earth per cu. ft.

Then

*Total Pressure upon Counterfort Acting Horizontally,*

$$P = \frac{1}{2} C_p \cos \delta w h_2^2 s \text{ lb.} \quad (38)$$

*Maximum Bending Moments in Counterfort,*

$$M = \frac{1}{6} C_p \cos \delta w h_2^3 s \text{ ft.-lb., or } 2C_p \cos \delta w h_2^3 s \text{ in.-lb.} \quad (39)$$

For level ground  $\delta = 0$ , consequently  $\cos \delta = 1$ .

The maximum bending moment and the total pressure act at the junction of the counterfort with the base slab. The pressure and bending moment at any other point may be found by substituting the proper value for  $h_2$ .

The amount of steel to resist bending moment may be found in the same manner as for an ordinary T-beam. The bars must be securely anchored at the bottom by bending them back into the base slab. The bending moment decreases rapidly. Since the cantilever slopes, the available depth of beam also decreases, but in a lesser degree. It will be found that it is possible to reduce the amount of tensile reinforcement by making some of the bars shorter than the rest. To find where the bars may be stopped, plot the required amount of steel and the available amount of steel. Carry the bar at least 40 diameters beyond the point where, theoretically,

its area can be dispensed with. Because of the importance of the counterfort, it is advisable to provide hooks at the ends of all bars except the longest.

Horizontal stirrups should be provided, not only to resist diagonal tension in the counterfort, but also to tie the wall to the counterfort. (See failure of wall, Fig. 308(b).) The stirrups must be looped around the tensile reinforcement in the counterfort and extend through the counterfort as far as possible into the slab, where the ends should be provided with hooks. The counterfort should also be tied to the base by means of vertical stirrups, the area of which should be sufficient to transfer, by tension in steel, all the downward load from the base to the counterfort.

**Spacing of Counterforts.**—The quantity of concrete and steel in a wall depends upon the spacing of counterforts. By reducing the spacing of the counterforts, the thickness of the wall and the base slab are reduced, hence the amount of concrete and steel is reduced. But, at the same time, the number of counterforts is increased, which means increase in formwork. The most economical spacing of counterforts is the one for which the total cost of materials and formwork is a minimum.

Ordinarily, 12 in. is considered a practical minimum thickness for the vertical longitudinal slab at the bottom. Investigation shows that the most economical spacing of counterforts is the one for which the required thickness of vertical slab is equal to this minimum thickness.

Considering 12 in. as the minimum thickness of vertical slab at the bottom, and using the following stresses in lb. per sq. in.,  $f_c = 650$ ,  $f_s = 16\ 000$ , the spacing of counterforts and the corresponding unit earth pressures at the bottom are given in the table below:

Spacing in Feet . . . . .	7 ft. 0 in	7 ft. 6 in	8 ft. 0 in	8 ft. 6 in.	9 ft 0 in	9 ft 6 in	10ft. 0in.
Unit pressure, lb. per sq ft	2 000 lb	1 860 lb	1 640 lb	1 450 lb	1 300 lb.	1 160 lb	1 050 lb

Thus, when the vertical slab is 24 ft. high above the base slab, weight of earth  $w = 100$  lb., and the constant  $C_p = 0.40$ , the pressure at the bottom is  $p = 0.40 \times 100 \times 24 = 960$  lb. per sq. ft. For this pressure, the economical spacing of counterfort is 10 ft.

For the same conditions, except that the ground surface, instead of being level, is inclined 1 to  $2\frac{1}{2}$  with the horizontal, constant



$C_p = 0.60$ , the pressure at the bottom is 1 440 lb.; consequently, the economical spacing will be 8 ft. 6 in. instead of 10 ft.

From the above, it is evident that, as would be expected, the economical spacing of counterforts depends not only upon its height but also upon the intensity of earth pressure.

**Thickness of Counterfort.**—The thickness of counterfort should not be smaller than required by diagonal tension. The external shear to be used in determining the thickness is the total pressure from Formula (38), p. 867.

The counterfort must be wide enough to accommodate all reinforcement without crowding, preferably in not more than two layers.

**Erection of Counterforted Wall.**—The counterfort should be poured with the vertical wall, in one continuous operation. No construction joints should be made in the counterfort. In the wall, construction joints should be vertical and placed midway between counterforts.

If the base cantilever is poured separately from the counterfort, concrete keys should be provided at the juncture of base and counterfort to transfer shear from the counterfort to the base.

**Design of Wall with Counterforts.**—Figure 309, p. 870, shows a typical design of a wall with counterfort, worked out in accordance with the rules previously given.

### SPECIAL DESIGNS OF RETAINING WALL

Special designs have been worked out with considerable ingenuity, where local conditions require departure from the standard sections. In railroad construction, it is often necessary to build retaining walls where every inch of available room up to the edge of the right-of-way is valuable, and where no trespassing on adjoining property is permissible.

**Cellular Wall.**—The simplest solution, in case of a railroad fill, is to use the L-shaped wall with or without counterfort. In cases where such a wall produces excessive pressure on the toe, the cellular type of wall, shown in Fig. 310, p. 871, may be used. It consists of a continuous base  $a$ , two parallel longitudinal walls  $b$  and  $b_1$ , and tie walls  $c$ . The space between the longitudinal walls is filled with earth.

The earth pressure is resisted by the weight of concrete and the weight of fill between the longitudinal walls. The pressure on the

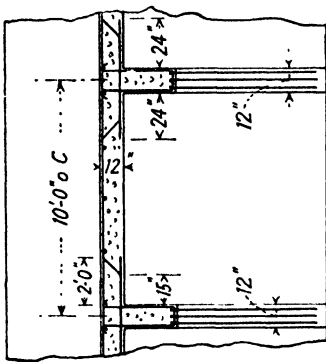

Horizontal Section

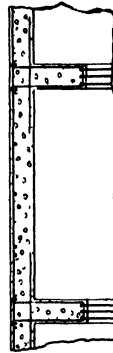

Alternate Arrangement of Slab Steel

Temperature Bars  $\frac{1}{2} \phi$   
All Horizontal Bars  $\frac{5}{8} \phi$

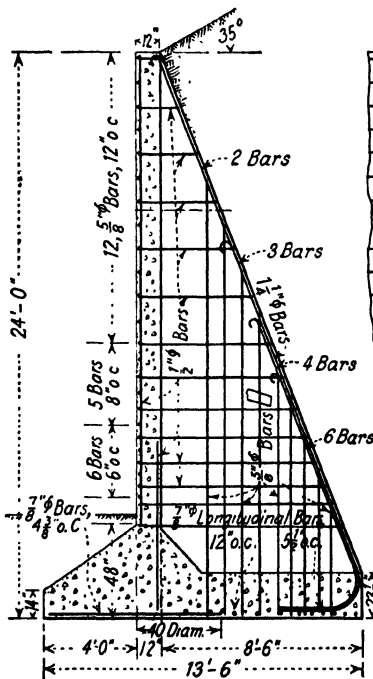

Cross Section

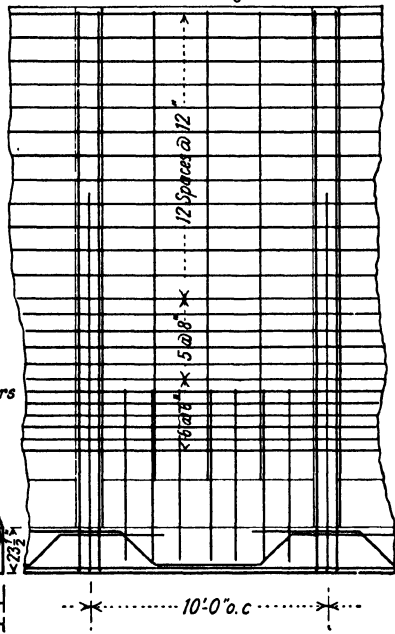

Rear Elevation

FIG. 309.—Details of Wall with Counterforts. (See p. 869.)

foundation is obtained by combining the horizontal earth pressure with the weight of the concrete and the fill. All possible conditions of loading must be considered. The line of pressure may be obtained graphically, by the method explained on p. 856 in connection with cantilever walls. The distribution of pressure on the foundation depends upon the location of the point of intersection of the line of pressure with the base. It may be computed as explained on p. 849.

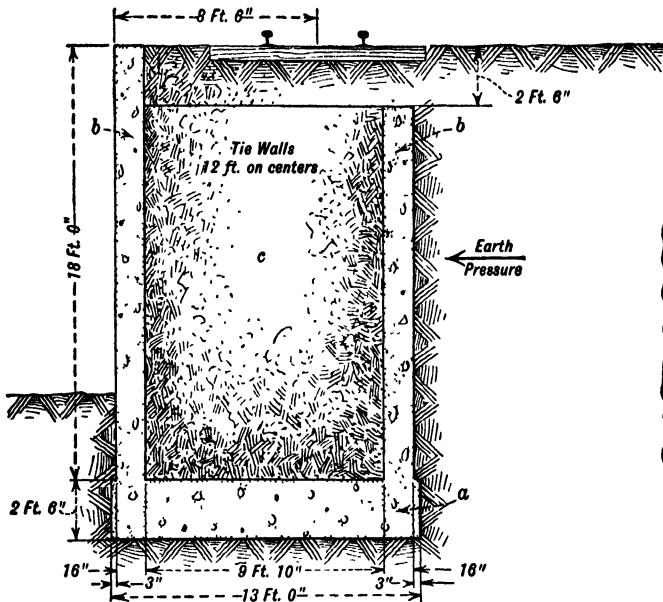

Reinforcement not shown.

FIG. 310.—Cellular Wall. (See p. 869.)

For designing purposes, the longitudinal walls are considered as slabs supported by the tie walls and loaded by the earth pressure produced by the fill and the surcharge caused by the train load. The reinforcement consists of longitudinal bars placed near the outside face of the wall, between the tie walls, and near the inside face at the tie walls. Vertical reinforcement should also be used, to prevent shrinkage and temperature cracks. The cross walls should be reinforced with horizontal bars of sufficient area to tie the longitudinal walls and prevent their separation under the pressure of the

earth in the cells. The base should be designed to resist the difference between the weight of earth and the upward pressure of the soil. They may be considered as supported by the cross walls.

**Lacher Design.**<sup>12</sup>—Where the cellular type produces much pressure on the toe, the Lacher design may be used. This consists of a

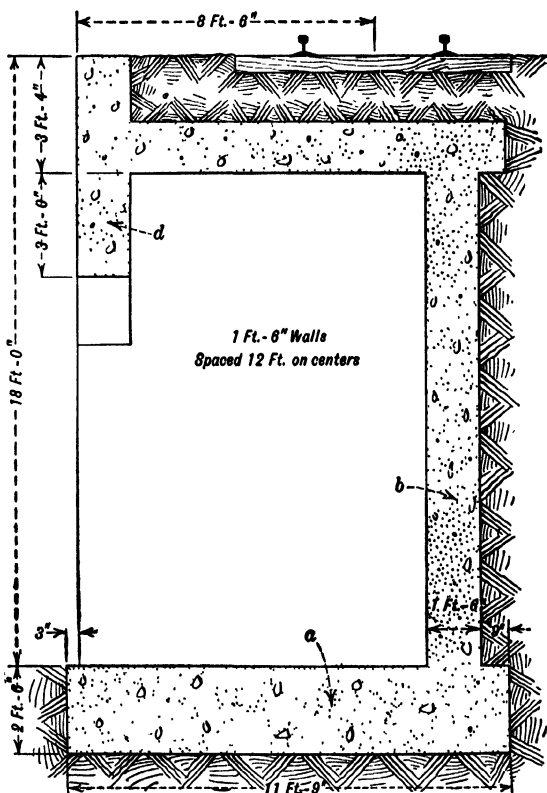

Reinforcement not shown.

FIG. 311.—Lacher Design of Retaining Wall. (See p. 872.)

continuous base, *a*, longitudinal wall, *b*, and cross walls, *c*, spaced 12 ft. on centers, and a longitudinal beam, *d*. The track is supported by pre-cast concrete slabs resting upon a beam, *d*, and a wall, *b*. The cost of the Lacher design, as estimated by Mr. Prior,

<sup>12</sup> J. H. Prior, in *Engineering and Contracting*, May 10, 1911, p. 530.

was larger than the cost of the cellular design. The Lacher design has the advantage, however, of producing lower pressure at the toe.

**Wall with Tie Rods.**—An interesting wall is that designed by Gustave Lindenthal for the New York Connecting Railroad. Here two longitudinal walls, 65 ft. high, enclose a railroad fill, nearly 60 ft. wide, carrying a surcharge loading of four tracks (*E 60* loading) and 100 per cent impact. The longitudinal walls are connected by transverse walls about 50 ft. apart. The earth pressure produced by the earth between the longitudinal walls is resisted by 2½-in. round tie-rods, spaced 10 ft. apart vertically and horizontally.<sup>13</sup> The ends of the tie-bars are threaded and provided with nuts. The pressure is transferred to the concrete by means of longitudinal and vertical 8-in., 16½-lb. channels, which are placed near the outside face of the walls. The bolts at the ends of the tie-rods bear against the anchoring channels. While the earth filling was being placed, the tie-rods were surrounded with concrete to form an 8-in. square section, for protection against rusting.

<sup>13</sup> The computations are discussed in *Engineering News*, May 6, 1915, p. 886.

## CHAPTER XXII

### TABLES AND DIAGRAMMS

This chapter gives tables and diagrams required in design. For convenience of reference the tables are grouped according to the subject matter.

The list of tables in the body of the book is also given.

#### General

	PAGE
Table 1.—Working Unit Stresses.....	879

#### Constants for Rectangular Beams and Slabs

Table 2.—Constants for Rectangular Beams and Slabs, $n = 15$ .....	880
Table 3.—Constants for Rectangular Beams and Slabs, $n = 12$ .....	881
Diagram 1.—Constants $R$ and $p$ for Different Stresses $f_c$ and $f_s$ .....	882
Diagram 2.—Value of $k$ , $j$ , and $\frac{f_s}{f_c}$ for Different Ratios of Steel.....	883
Explanation of Use of Diagrams given on Pages 882 and 883.	

#### Design of Rectangular Beams

Table 4.—End Spans of Continuous Rectangular Beams.....	884
Table 5.—Interior Spans of Continuous Rectangular Beams.....	885

#### Design of Slabs

Table 6.—Thickness of Slab and Reinforcement Required for Given Live Load. $f_c = 650$ , $f_s = 16\ 000$ , $n = 15$ .....	886	
Table 7.—Simply Supported Slabs,	$\left. \begin{array}{l} f_c = 800 \\ f_s = 16\ 000 \\ n = 15 \\ f_c = 800 \\ f_s = 18\ 000 \\ n = 15 \end{array} \right\}$	888
Table 8.—End Spans Continuous Slabs,		889
Table 9.—Interior Spans Continuous Slabs,		890
Table 10.—Simply Supported Slabs,		891
Table 11.—End Spans Continuous Slabs,		892
Table 12.—Interior Spans Continuous Slabs,		893

**Design of T-Beams**

PAGE

Diagram 3.—Values of Maximum Steel Ratios $p_m$ for Different Ratios $\frac{t}{d'}$	}	$f_s = 16\ 000$	894
Diagram 4.—Values of Constants $C_d$ for Different Ratios $\frac{t}{d'}$			
Diagram 5.—Values of Maximum Steel Ratios $p_m$ for Different Ratios $\frac{t}{d'}$	}	$f_s = 18\ 000$	895
Diagram 6.—Values of Constants $C_d$ for Different Ratios $\frac{t}{d'}$			
Table 13.—Values of $k$ , $j$ , and $C_T$ for Different $\frac{nA_s}{bt}$			896
Explanation of Use of Table and Diagrams given on Page 897.			

**Design of Stirrups**

Table 14.—Spacing of Stirrups	899
Table 15.—Number of U-stirrups in Uniformly Loaded Beam	900
Table 16.—Spacing of U-stirrups in Uniformly Loaded Beam	901
Explanation of Use of Tables given on Page 902.	

**Beams with Steel in Top and Bottom**

Diagram 7.—Ratios of $p'$ for Given $p_1$ , $\left\{ \begin{array}{l} f_c = 650, 750, 800, 900 \\ f_s = 16\ 000 \\ n = 15 \end{array} \right\}$	904
Diagram 8.—Ratios of $p'$ for Given $p_1$ , $\left\{ \begin{array}{l} f_c = 800, 900, 1000 \\ f_s = 16\ 000 \\ n = 12 \end{array} \right\}$	905
Diagram 9.—Ratios of $p'$ for Given $p_1$ , $\left\{ \begin{array}{l} f_c = 650, 750, 800, 900 \\ f_s = 18\ 000 \\ n = 15 \end{array} \right\}$	906
Diagram 10.—Ratios of $p'$ for Given $p_1$ ; $\left\{ \begin{array}{l} f_c = 800, 900, 1000 \\ f_s = 18\ 000 \\ n = 12 \end{array} \right\}$	907
Diagram 11.—Ratios of $p'$ and $p_1$ for Different $\frac{f_s}{15f_c}$ and $a = 0.02$ to $0.12$	908
Diagram 12.—Ratios of $p'$ and $p_1$ for Different $\frac{f_s}{15f_c}$ and $a = 0.14$ to $0.24$	909
Diagram 13.—Values of $j$ for Different Steel Ratios $p$	910
Explanation of Use of Diagrams given on Page 903.	

**Flat Slab Design**

Diagram 14.—Constants in Formulas for Thickness of Slab at Column	911
Diagram 15.—Constants in Formulas for Thickness of Slab in Middle of Slab	911

	PAGE
Table 17.—Flat Slab Constants $C_{10}$ and $C_{11}$ for Computing Compression in Concrete . . . . .	912
Table 18.—Flat Slab Constant $C_{12}$ for Computing Shearing Stresses at Column Head . . . . .	913
Table 19.—Flat Slab Constant $C_{13}$ for Computing Shearing Stresses at Edge of Drop Panel . . . . .	914

### Column Design

Table 20.—Properties of Column Sections, Areas, Volumes, etc. . . . .	915
Table 21.—Average Stresses Unit $f$ for Different Values of $f_c$ and $p$ . . . . .	916
Table 22.—Average Stresses $f_1$ in Spiral Column, New York Code . . . . .	918
Table 23.—Average Stresses $f_2$ in Spiral Column, Chicago Code . . . . .	919
Diagram 16.—Total Loads on Round Columns for Different Stresses $f$ . . . . .	919
Diagram 17.—Total Loads on Square Columns for Different Stresses $f$ . . . . .	919
Table 24.—Safe Loads, Square Columns with Vertical Reinforcement, $f_c = 450$ . (1 : 2 : 4 concrete) . . . . .	920
Table 25.—Safe Loads, Square Columns with Vertical Reinforcement, $f_c = 570$ . (1 : 1½ : 3 concrete) . . . . .	921
Table 26.—Safe Loads, Square Columns with Vertical Reinforcement, $f_c = 680$ . (1 : 1 : 2 concrete) . . . . .	922
Table 27.—Safe Loads, Round Columns with Vertical Reinforcement only, $f_c = 450$ . (1 : 2 : 4 concrete) . . . . .	923
Table 28.—Safe Loads, Round Columns with Vertical Reinforcement only, $f_c = 570$ . (1 : 1½ : 3 concrete) . . . . .	924
Table 29.—Safe Loads, Round Columns with Vertical Reinforcement only, $f_c = 680$ . (1 : 1 : 2 concrete) . . . . .	925
Table 30.—Safe Loads, Round Columns with Vertical Reinforcement and 1 per cent Spiral, $f_c = 700$ . (1 : 2 : 4 concrete) . . . . .	926
Table 31.—Safe Loads, Round Columns with Vertical Reinforcement and 1 Per Cent Spiral, $f_c = 890$ . (1 : 1½ : 3 concrete) . . . . .	927
Table 32.—Safe Loads, Round Columns with Vertical Reinforcement and 1 Per Cent Spiral Reinforcement, $f_c = 1060$ . (1 : 1 : 2 concrete) . . . . .	928
Table 33.—Column Spiral Forming 1 Per Cent of Core . . . . .	929
Table 34.—Values of $p_1A$ in Spiral Columns, ⅜-in. wire . . . . .	931
Table 35.—Values of $p_1A$ in Spiral Columns, ⅜-in. wire . . . . .	932
Table 36.—Values of $p_1A$ in Spiral Columns, ½-in. wire . . . . .	933
Explanation of Tables 34 to 36 given on Page 930.	

### Members Subjected to Direct Load and Bending

Diagram 18.—Constants $C_e$ in Formula $f_c = C_e \frac{N}{Ch}$ for $2a = h$ . . . . .	934
Diagram 19.—Constants $C_e$ in Formula $f_c = C_e \frac{N}{Ch}$ for $2a = 0.9h$ . . . . .	935
Diagram 20.—Constants $C_e$ in Formula $f_c = C_e \frac{N}{Ch}$ for $2a = 0.8h$ . . . . .	936



	PAGE
Diagram 21.—Constants $C_e$ in Formula $f_c = C_e \frac{N}{Ch}$ for $2a = 0.7h$ . . .	937
Diagram 22.—Values of $k$ for Different Eccentricities, } Both Sides	938
Diagram 23.—Values of $C_a$ , } Reinforced	939
Table 37.—Ratio of $\frac{d_c}{d}$ for Different Steel Ratios $p$ . . . . .	940
Diagram 24.—Values of $k$ for Different Eccentricities, } Tension Side	940
Diagram 25.—Values of $C_b$ , } Reinforced	941

**General Data**

Table 38.—Areas, Weights, and Circumferences of Square and Round Bars . . . . .	942
Table 39.—Areas of Groups of Bars of Uniform Size . . . . .	943
Table 40.—Area of Square Bars in Slabs for Different Spacing . . . . .	944
Table 41.—Area of Round Bars in Slabs for Different Spacing . . . . .	944
Table 42.—Properties of Sections . . . . .	945

**TABLES IN THE BODY OF THE BOOK**

Following tables are given in the body of the book.

**Properties of Reinforcement**

Areas, Weights and Perimeters of Round and Square Bars . . . . .	12
Wire Used as Reinforcement . . . . .	15
Properties of Expanded Metal . . . . .	16
Properties of Welded Wire Fabric . . . . .	17
Properties of Triangle Mesh Fabric . . . . .	18

**Bond Stresses**

Length of Lap for Different Stresses in Steel and Diameters of Bars . .	414
---	-----

**Spacing of Bars in a Beam**

Width of Beam Required by Different Number of Round and Square Bars . . . . .	274
---	-----

**Distribution of Concentrated Load on Wide Slab**

Effective Width of Slab for Concentrated Load . . . . .	70
---	----

**Beam and Slab Design**

Constants in Beam and Slab Design for Selected Unit Stresses . . . . .	205
Distribution of Load on Slab Reinforced in Two Directions . . . . .	212

**Columns**

Stresses Recommended by the Authors for Columns with Longitudinal Steel Only . . . . .	407
Stresses Recommended by the Authors for Spiral Columns . . . . .	422
Requirements of Building Codes of Various Cities Columns with Longitudinal Steel Only . . . . .	409

	PAGE
Requirements of Boston, Cleveland and Philadelphia Codes for Spiral Columns.....	423
Standard Wire Used for Spirals . . . . .	432
Recommended Proportion of Live Load on Columns.....	453
<b>Footing Tables</b>	
Required Depth of Plain Concrete Footing in Terms of Length of Projection . . . . .	481
Dimensions of Independent Stepped and Sloped Square Footings....	490
Constants $C_{f_1}$ for Square Footing in Formulas for Shearing Stresses...	495
Constants $C_{f_2}$ for Rectangular Footing in Formulas for Punching Shear.	495
Constants $C_{f_3}$ for Square Footing in Formulas for Bending Moments..	497
Constants $C_{f_4}$ for Rectangular Footing in Formula for Bending Moment	498
Constants $C_{f_5}$ for Rectangular Footing in Formula for Diagonal Tension	502
Economical Length of Long Side, $a$ , of Rectangular Footing.....	511
Constants $C_{f_6}$ in Formula for Center of Gravity of Corner Column....	515
<b>Chimney Tables</b>	
Values of Constants $C_P, C_T, z, j$ for Different Positions of Neutral Axis.	828
Location of Neutral Axis.....	828
<b>Retaining Wall Tables</b>	
Average Weight of Ordinary Earth before Excavation.....	834
Values of Constants $C_p$ in Formula for Earth Pressure.....	837
Constants $C_b$ in Formula for Length of Base.....	845
Spacing of Counterforts.....	868
Thickness of Retaining Wall of Gravity Section.....	840
<b>Miscellaneous Tables</b>	
Weight of Hollow Burned Clay Tile . . . . .	590
Weight of Clay Tile Floors . . . . .	597
Required Thickness of Brick Wall... . . . .	631
Dead Loads on Roofs.....	648
Live Loads Required for Different Buildings. . . . .	570
Dead Loads of Floor Finish, Plaster, Partitions, etc.....	571
Overall Dimensions of Passenger Cars.....	796
Overall Dimensions of Trucks.....	797

Table 1.—Working Unit Stresses.

Kind of Stress.	Notation.	Allowable Working Stresses.		Remarks.
		Percentage of Crushing Strength at 28 Days.*	For 2 000 Lb. Concrete, Lb. per Sq. In.	
(1)	(2)	(3)	(4)	(5)
Bearing . . . . .	$f_b$	†	†	
Axial compression . . . . .	$f_c$	22 5	450	{ Length of pier not to exceed 4 diameters
Columns (as described on page 406 or 421)	$f_c$	22 5	450	{ Length not to exceed 40 least radius of gyration
$f_c$	35	700	{ Length not to exceed 40 least radius of gyration	
				Vertical steel 1 to 4% and spirals 1% . . . . .
Compression in extreme fiber . . . . .	$f_c$	40	800	Use in beam formulas
Shear (punching shear) . . . . .	$f_c$	45	900	
Shear (as measure of diagonal tension) . . . . .	$v$	2	40	{ Stresses above 40 lb. must be provided for with web reinforcement
Bond . . . . .	$u$	4	80	
Steel in tension . . . . .	$f_s$	16 000	lb. per sq. in.	
Intermediate and high carbon steel . . . . .	$f_s$	18 000	lb. per sq. in.	

\* Strengths at 28 days for different proportions of concrete are given on p 205. See Volume III for discussion of strength of concrete.  
 † See Formulas (56), p. 271 and (57), p 272.

Table 2.—Constants for Rectangular Beams and Slabs

To be used in formulas for Depth of Beam,  $d = C\sqrt{\frac{M}{b}}$  or  $d = \sqrt{\frac{M}{Rb}}$  and  
 Depth of Slab,  $d = C_1\sqrt{M}$ ; in formulas for Moment of Resistance,  $M = \frac{bd^3}{C^2}$ ,  
 or  $M = Rbd^2$ ; in formula for Area of Reinforcement,  $A_s = pbd$ , or  $A_s = \frac{M}{jdf_s}$ .

Ratio of Moduli of Steel to Concrete,  $n = 15$ .

Working Strength of Steel, Lb. per Sq. In.	Working Strength of Concrete, Lb. per Sq. In.	Ratio Depth of Neutral Axis to Depth of Steel.	Ratio of Moment Arm to Depth of Steel $(1 - \frac{k}{3})$	Ratio Area of Steel to Beam Above Steel.	Constants.			
					For Beams.		For Slabs.	
					$C$	$R$		$C_1$
$f_s$	$f_c$	$k$	$j$	$p$				
14 000	500	0.349	0.884	0.0062	0.114	77.1	0.0329	
	550	0.372	0.876	0.0073	0.106	89.4	0.0306	
	600	0.392	0.869	0.0084	0.099	101.9	0.0286	
	650	0.411	0.863	0.0095	0.093	115.2	0.0268	
	700	0.428	0.857	0.0107	0.088	128.6	0.0254	
	750	0.446	0.851	0.0119	0.084	142.2	0.0243	
	800	0.462	0.846	0.0132	0.080	156.4	0.0231	
	850	0.477	0.841	0.0145	0.077	170.4	0.0222	
	16 000	500	0.319	0.894	0.0050	0.119	71.3	0.0341
		550	0.339	0.887	0.0058	0.110	83.0	0.0318
600		0.360	0.881	0.0067	0.103	95.0	0.0297	
650		0.378	0.874	0.0077	0.096	107.5	0.0277	
700		0.397	0.868	0.0087	0.091	120.4	0.0263	
750		0.414	0.862	0.0097	0.087	133.5	0.0251	
800		0.429	0.857	0.0107	0.083	146.7	0.0240	
850		0.444	0.852	0.0118	0.079	160.4	0.0228	
900		0.458	0.847	0.0129	0.076	174.5	0.0219	
18 000		500	0.294	0.902	0.0041	0.123	66.3	0.0355
	550	0.314	0.895	0.0048	0.114	77.1	0.0329	
	600	0.333	0.889	0.0056	0.106	88.9	0.0306	
	650	0.351	0.883	0.0063	0.100	100.8	0.0289	
	700	0.369	0.877	0.0072	0.094	112.9	0.0271	
	750	0.385	0.872	0.0080	0.089	125.9	0.0257	
	800	0.400	0.867	0.0089	0.085	138.7	0.0245	
	850	0.415	0.862	0.0098	0.081	151.9	0.0234	
	900	0.429	0.857	0.0107	0.078	165.4	0.0225	
	20 000	500	0.272	0.909	0.0034	0.127	62.0	0.0367
550		0.292	0.903	0.0040	0.118	72.5	0.0341	
600		0.311	0.896	0.0047	0.110	83.5	0.0318	
650		0.328	0.891	0.0053	0.103	94.9	0.0297	
700		0.344	0.885	0.0060	0.097	106.5	0.0280	
750		0.359	0.880	0.0068	0.092	118.8	0.0266	
800		0.374	0.875	0.0075	0.087	131.3	0.0251	
850		0.389	0.870	0.0083	0.083	143.8	0.0240	
900		0.403	0.866	0.0091	0.080	157.0	0.0231	

**Table 3.—Constants for Rectangular Beams and Slabs**

To be used in formulas for Depth of Beam,  $d = C\sqrt{\frac{M}{b}}$  or  $d = \sqrt{\frac{M}{Rb}}$ , and  
 Depth of Slab,  $d = C_1\sqrt{M}$ ; in formulas for Moment of Resistance,  $M = \frac{bd^2}{C^2}$ ,  
 or  $M = Rbd^2$ ; in formula for Area of Reinforcement,  $A_s = pbd$ , or  $A_s = \frac{M}{jdf_s}$ .

Ratio of Moduli of Steel to Concrete,  $n = 12$ .

Working Strength of Steel, Lb. per Sq. In.	Working Strength of Concrete, Lb. per Sq. In.	Ratio Depth of Neutral Axis to Depth of Steel.	Ratio of Moment Arm to Depth of Steel $(1 - \frac{k}{3})$	Ratio Area of Steel to Beam Above Steel.	Constants.		
					For Beams.		For Slabs
					$C$	$R$	
$f_s$	$f_c$	$k$	$j$	$p$			
14 000	700	0.375	0.875	0.0094	0.093	114.8	0.0268
	750	0.391	0.870	0.0105	0.088	127.6	0.0254
	800	0.407	0.864	0.0116	0.084	140.7	0.0242
	850	0.422	0.860	0.0128	0.081	154.1	0.0234
16 000	700	0.344	0.885	0.0075	0.097	106.7	0.0280
	750	0.360	0.880	0.0085	0.092	118.8	0.0266
	800	0.375	0.875	0.0094	0.087	131.3	0.0251
	850	0.389	0.870	0.0103	0.083	143.8	0.0240
	900	0.403	0.866	0.0113	0.080	157.0	0.0231
1 000	0.429	0.857	0.0134	0.074	183.8	0.0214	
18 000	700	0.318	0.894	0.0062	0.100	99.5	0.0289
	750	0.333	0.889	0.0070	0.095	111.0	0.0274
	800	0.348	0.884	0.0077	0.090	123.1	0.0260
	850	0.362	0.879	0.0086	0.086	135.1	0.0248
	900	0.375	0.875	0.0094	0.082	147.7	0.0237
1 000	0.400	0.867	0.0111	0.076	173.4	0.0219	
20 000	700	0.296	0.901	0.0052	0.104	93.3	0.0300
	750	0.310	0.897	0.0058	0.098	104.3	0.0283
	800	0.324	0.892	0.0065	0.093	115.6	0.0268
	850	0.338	0.887	0.0072	0.089	127.4	0.0257
	900	0.351	0.883	0.0079	0.085	139.5	0.0245
1 000	0.375	0.875	0.0094	0.078	164.1	0.0226	

**Use of Tables 2 and 3.**—The constants in Tables 3 and 4 may be used for determining concrete dimensions and the required amount of steel for rectangular beams and slabs for known bending moment  $M$ , and known stresses  $f_c$ ,  $f_s$ , and  $n$ . Care should be taken to use the table for proper value of  $n$ . For 1 : 2 : 4 concrete  $n = 15$  is commonly used. For 1 : 1½ : 3 concrete  $n = 12$  and 1 : 1 : 2 concrete  $n = 10$  are common.

In formulas for depth, if  $M$  is in inch-pounds and  $b$  is in inches, the depth will be also in inches. With  $M$  in foot-pounds,  $b$  should be in feet, and  $d$  will also be in feet. In both cases the constants remain the same. To change bending moment from foot-pounds to inch-pounds multiply the foot-pounds by 12.

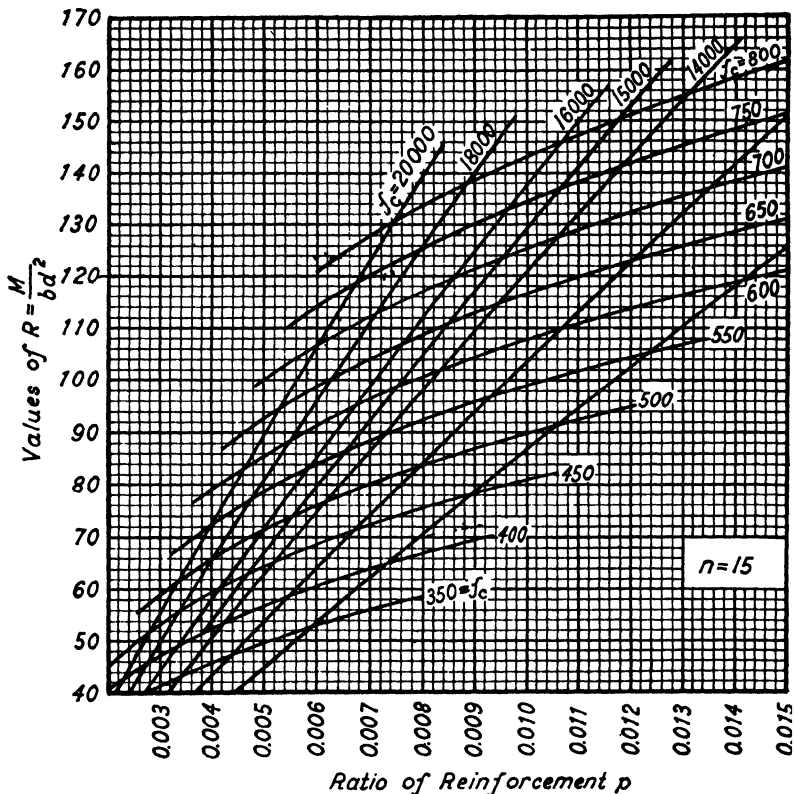

DIAGRAM 1.—Values of  $R$  and  $p$  for Rectangular Beams and Slabs.  
For Different Values of  $f_s$  and  $f_c$ .

**Use of Diagram 1.**—Following problems may be solved by means of this diagram:

1. Determine values of  $R$  and the ratio of steel,  $p$ , for any given stresses  $f_c$  and  $f_s$ .

In solving this problem find point of intersection of the curve corresponding to the stress  $f_c$  with the curve corresponding to the stress  $f_s$ . Vertical line down from this point gives the required ratio  $p$ , while a horizontal line gives the value of constant  $R$ .

For intermediate values, interpolate.

2. Find stresses  $f_s$  and  $f_c$  for known concrete dimensions  $b$  and  $d$ , known area of steel  $A_s$  and given bending moment  $M$ .

In solving this problem find  $R$  from  $R = \frac{M}{bd^2}$  and  $p$  from  $p = \frac{A_s}{bd}$ . Find in the diagram the point of intersection of a vertical line corresponding to the determined value of  $p$  with a horizontal line corresponding to the value of  $R$ . This point by interpolation between the  $f_c$  curves gives the stress  $f_c$  and between the  $f_s$  curves the stress  $f_s$ .

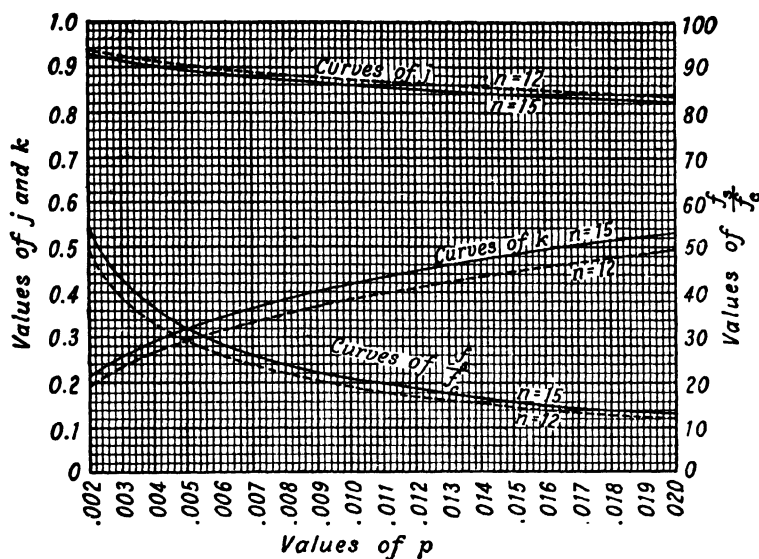

DIAGRAM 2.—Values of  $j$ ,  $k$ , and  $\frac{f_s}{f_c}$  for Different Ratios of Steel  $p$ .

**Use of Diagram 2.**—From this diagram the ratios  $j$  and  $k$  may be obtained directly for any ratio of steel  $p$ .

This diagram may also be used for computing stresses in a beam with known dimensions  $b$  and  $d$  known amount of steel  $A_s$  and given bending moment  $M$ .

In solving this problem compute value of  $p$  from  $p = \frac{A_s}{bd}$ . Find from diagram the corresponding value of  $j$  and  $\frac{f_s}{f_c}$ . Compute stress in steel from formula

$f_s = \frac{M}{A_s j d}$ , in which all values are known. Knowing the stress  $f_s$  and the ratio

$\frac{f_s}{f_c}$ , the stress in concrete may be readily found by dividing the stress by the

ratio  $\frac{f_s}{f_c}$ .

**Table 4. —Rectangular Beams—End Spans of Continuous Beams**  
Safe loading for beams one inch in width

Based on  $M = 10 \frac{wl^2}{8}$ ,  $f_c = 650$ ,  $f_s = 16\ 000$ ,  $n = 15$ .

For  $M = \frac{wl^2}{8}$  deduct 20 per cent from safe loads, using same steel area.

Depth of Beam (h) in.	Total Safe Dead and Live Load (w) per Linear Foot for Beams One Inch Wide (See important foot-notes)																	Weight of Beam One Inch Wide per Linear Foot lb.	Depth Below Steel (d) in.	Depth Below Steel (d') in.	Steel Area One Inch Wide (A) sq. in.	Safe Moment of Resistance (See p. 181) (M) in.-lb.			
	Span in Feet (l)																								
	5	6	7	8	9	10	11	12	13	14	15	16	17	18	19	20	25						30	35	
5	57	40	29	22	18	14	12	10	11	12	13	14	15	16	17	18	19	20	25	30	35	5.21	1.0	0.031	1 720
6	90	46	35	28	22	19	16	13	15	16	17	18	19	20	21	22	23	24	25	26	27	6.25	1.0	0.039	2 680
7	129	80	66	50	40	32	27	22	19	16	13	10	11	12	13	14	15	16	17	18	19	7.29	1.0	0.046	3 860
8	176	122	90	69	54	44	36	31	26	22	20	21	22	23	24	25	26	27	28	29	30	8.34	1.0	0.054	5 260
9	216	150	110	84	67	54	45	37	32	27	24	21	22	23	24	25	26	27	28	29	30	9.38	1.25	0.060	6 450
10	275	191	140	107	85	69	57	48	41	35	31	27	24	25	26	27	28	29	30	31	32	10.42	1.25	0.067	8 200
11	341	237	174	133	105	85	70	59	50	44	38	33	30	26	26	27	28	29	30	31	32	11.46	1.25	0.075	10 210
12	415	288	212	162	128	104	86	72	61	53	46	41	36	32	29	29	30	31	32	33	34	12.50	1.25	0.083	12 410
13	474	330	242	185	147	119	98	82	70	61	53	46	41	37	33	33	34	35	36	37	38	13.55	1.5	0.089	14 210
14	561	389	286	219	173	140	116	97	83	72	62	55	49	43	39	35	35	36	37	38	39	14.59	1.5	0.096	16 780
15	654	454	334	256	202	164	135	114	97	83	73	64	57	50	45	41	41	42	43	44	45	15.63	1.5	0.104	19 500
16	755	524	385	295	233	189	156	131	112	96	84	74	65	58	52	47	47	48	49	50	51	16.67	1.5	0.112	22 580
17	882	599	440	337	265	216	178	150	128	110	96	84	75	67	60	54	54	55	56	57	58	17.71	1.5	0.119	25 800
18	977	679	499	392	302	244	202	170	145	125	109	95	85	76	68	61	61	62	63	64	65	18.76	1.5	0.127	29 240
19	1037	720	529	405	320	259	214	180	153	132	115	101	90	80	72	65	65	66	67	68	69	19.80	2.0	0.131	31 030
20	1163	807	593	454	359	291	240	202	172	148	129	114	101	90	81	73	47	47	48	49	50	20.84	2.0	0.139	34 790
21	1297	897	732	561	443	359	297	249	212	183	159	140	124	111	99	90	57	57	58	59	60	22.92	2.0	0.154	42 950
22	1406	986	816	618	496	405	334	281	242	212	183	164	146	131	120	109	69	69	70	71	72	25.00	2.0	0.169	51 970
23	1506	1086	896	678	556	454	374	311	262	222	193	170	150	134	120	109	69	69	70	71	72	27.09	2.0	0.185	61 850
24	1606	1186	976	740	616	504	414	344	295	252	222	193	170	150	134	120	109	69	69	70	71	29.18	2.0	0.200	72 580
25	1706	1286	1056	804	664	552	464	394	344	304	272	242	212	193	176	161	113	78	57	57	58	31.26	2.0	0.216	84 180
26	1806	1386	1136	876	736	624	516	436	374	324	292	262	232	212	193	176	161	113	78	57	58	33.34	2.5	0.258	120 470
27	1906	1486	1216	948	796	684	576	484	414	364	332	302	272	252	232	212	193	176	161	113	78	35.42	2.5	0.304	167 600
28	2006	1586	1296	1020	840	736	624	544	464	404	372	342	312	282	262	242	222	202	182	162	142	37.51	2.5	0.350	222 260
29	2106	1686	1376	1092	900	804	684	596	516	444	414	382	352	322	302	282	262	242	222	202	182	39.59	2.5	0.400	297 600
30	2206	1786	1456	1164	984	864	736	644	564	484	432	402	372	352	332	312	292	272	252	232	212	41.67	2.5	0.450	397 600
31	2306	1886	1536	1236	1080	936	816	716	616	536	484	452	422	402	382	362	342	322	302	282	262	43.75	2.5	0.500	527 600
32	2406	1986	1616	1308	1176	1008	888	788	688	608	556	526	506	486	466	446	426	406	386	366	346	45.83	2.5	0.550	697 600
33	2506	2086	1696	1380	1260	1080	960	840	740	660	608	578	558	538	518	498	478	458	438	418	396	47.91	2.5	0.600	927 600
34	2606	2186	1776	1452	1344	1164	1032	912	812	732	680	650	630	610	590	570	550	530	510	490	470	50.00	2.5	0.650	1227 600
35	2706	2286	1856	1524	1416	1248	1116	1008	908	828	776	746	726	706	686	666	646	626	606	586	566	52.08	2.5	0.700	1627 600
36	2806	2386	1936	1608	1500	1336	1200	1104	1004	924	872	842	822	802	782	762	742	722	702	682	662	54.16	2.5	0.750	2127 600
37	2906	2486	2016	1680	1584	1440	1304	1216	1116	1036	984	954	934	914	894	874	854	834	814	794	774	56.25	2.5	0.800	2827 600
38	3006	2586	2096	1764	1668	1536	1392	1312	1212	1132	1080	1050	1030	1010	990	970	950	930	910	890	870	58.33	2.5	0.850	3727 600
39	3106	2686	2176	1848	1752	1632	1488	1408	1308	1228	1176	1146	1126	1106	1086	1066	1046	1026	1006	986	966	60.42	2.5	0.900	4927 600
40	3206	2786	2256	1932	1836	1728	1584	1504	1404	1324	1272	1242	1222	1202	1182	1162	1142	1122	1102	1082	1062	62.50	2.5	0.950	6427 600
41	3306	2886	2336	2016	1920	1824	1680	1600	1500	1420	1368	1338	1318	1298	1278	1258	1238	1218	1198	1178	1158	64.58	2.5	1.000	8527 600
42	3406	2986	2416	2100	2004	1912	1768	1688	1588	1508	1456	1426	1406	1386	1366	1346	1326	1306	1286	1266	1246	66.67	2.5	1.050	11027 600
43	3506	3086	2496	2184	2088	2000	1856	1776	1676	1576	1524	1494	1474	1454	1434	1414	1394	1374	1354	1334	1314	68.75	2.5	1.100	14527 600
44	3606	3186	2576	2268	2172	2088	1944	1864	1764	1664	1612	1582	1562	1542	1522	1502	1482	1462	1442	1422	1402	70.83	2.5	1.150	19527 600
45	3706	3286	2656	2352	2256	2176	2016	1936	1836	1736	1684	1654	1634	1614	1594	1574	1554	1534	1514	1494	1474	72.92	2.5	1.200	26027 600
46	3806	3386	2736	2436	2340	2264	2096	2016	1916	1816	1764	1734	1714	1694	1674	1654	1634	1614	1594	1574	1554	75.00	2.5	1.250	34027 600
47	3906	3486	2816	2520	2424	2352	2176	2096	1996	1896	1844	1814	1794	1774	1754	1734	1714	1694	1674	1654	1634	77.08	2.5	1.300	44527 600
48	4006	3586	2896	2604	2508	2440	2256	2176	2076	1976	1924	1894	1874	1854	1834	1814	1794	1774	1754	1734	1714	79.17	2.5	1.350	58527 600

1. For safe load of any width of beam multiply by width in inches.  
 2. For area of cross-section of steel for any width of beam multiply column (25) by width in inches.  
 3. Total loads of spans (l) and same depth of steel are inversely proportional to the squares of the spans.  
 4. Total loads for other depths of steel (d) and same span are proportional to the squares of the depth of steel.  
 5. The values in this table may apply to a very carefully graded 1 : 2 1/2 : 5 mixture of ordinary 1 : 2 : 4 mixture.  
 \* This is for a ratio of steel p = 0.0077 (0.77 per cent) which is required for the given working stresses.



**Table 5.—Rectangular Beams—Interior Spans of Continuous Beams**

Safe loading for beams one inch in width

Based on  $M = \frac{wl^2}{12}$ ,  $f_c = 650$ ,  $f_s = 16000$ ,  $n = 15$

Depth of Beam (h) in.	Total Safe Dead and Live Load (w) per Linear Foot for Beam, One Inch Wide (See important foot-notes)																	Depth to Steel (d), in.	Depth Below Steel (d'), in.	Steel Area in a Beam One Inch Wide*, sq. in.	Safe Moment of Resistance (See p. 131) (M) in.-lb.		
	Span in feet (l)																						
	5	6	7	8	9	10	11	12	13	14	15	16	17	18	19	20	25					30	35
5	68	48	35	26	22	17	11	12	12										5.21	1.0	0.031	1720	
6	74	55	42	34	26	23	19	16											6.25	1.0	0.039	2680	
7	108	79	60	48	38	32	26	23	19										7.29	1.0	0.046	3860	
8	211	146	108	83	65	52	43	37	31	26	24								8.34	1.0	0.054	5260	
9	250	180	132	100	80	65	54	47	38	32	27	25							9.38	1.25	0.060	6450	
10	330	229	168	128	102	83	68	58	49	42	37	32	20						10.42	1.25	0.067	8200	
11	409	284	209	160	126	102	84	71	60	53	46	40	36	31					11.46	1.25	0.075	10210	
12	498	346	254	194	154	121	103	86	73	64	55	49	43	38	35				12.50	1.25	0.083	12410	
13	569	396	290	222	176	143	118	98	84	73	64	55	49	41	40				13.55	1.5	0.089	14210	
14	673	467	343	263	208	168	139	116	100	86	74	66	59	52	47	42			14.59	1.5	0.096	16780	
15	785	545	401	307	242	197	162	137	116	100	88	77	68	60	54	49			15.63	1.5	0.104	19570	
16	906	629	462	354	280	227	187	157	134	115	101	88	78	70	62	56			16.67	1.5	0.112	22580	
17	1034	719	528	404	319	259	214	180	154	132	115	101	90	80	72	65	41		17.71	1.5	0.119	25800	
18	1172	815	599	458	362	293	242	204	174	150	131	114	102	90	82	73	47		18.76	1.5	0.127	29240	
19	1244	864	635	486	384	311	257	216	184	158	138	121	108	96	86	78	49		19.80	2.0	0.131	31030	
20	1396	968	712	545	431	349	288	242	206	178	155	137	121	108	97	88	56		20.84	2.0	0.139	34790	
22	1196	876	673	532	431	356	299	254	220	191	168	149	133	119	108	68	48		22.92	2.0	0.154	42950	
24	1447	1065	814	643	521	431	362	308	266	232	204	180	161	144	131	85	58		35.00	2.0	0.169	51970	
26	1266	968	763	620	512	431	367	317	276	242	215	191	172	155	100	68			27.09	2.0	0.185	61850	
28	1138	899	727	601	505	431	371	334	284	252	224	202	182	116	80	60			29.18	2.0	0.200	72580	
30	1319	1042	844	697	586	499	431	376	330	292	260	234	211	136	94	68			31.26	2.0	0.216	84180	
36	1888	1492	1208	998	839	715	617	536	472	418	373	335	302	193	134	98			37.51	2.5	0.258	120470	
42	2624	2074	1680	1358	1166	994	857	746	656	581	518	466	420	269	187	137			43.76	3.0	0.304	167500	
48	...	...	...	...	...	...	...	...	...	...	...	...	...	...	...	...	...			50.02	4.5	0.350	222260

**Notes.**  
 1. For safe load of any width of beam multiply by width in inches  
 2. For area of cross-section of steel for any width of beam multiply column (25) by width in inches  
 3. Total loads of spans (l) and same depth of steel are inversely proportional to the squares of the spans.  
 4. Total loads for other depths of steel (d) and same span are proportional to the squares of the depth of steel.  
 5. The values in this table may apply to a very carefully graded 1 : 2½ : 5 mixture or ordinary 1 : 2 : 4 mixture.  
 \* This is for a ratio of steel  $p = 0.0077$  (0.77 per cent) which is required for the given working stresses.

**Table 6.—Continuous Slabs.**  
Thickness of Slab and Reinforcement Required for Given Live Load

Based on  $M = \frac{wl^2}{12}$ ,  $f_c = 650$ ,  $f_s = 16\ 000$ ,  $n = 15$ . For  $M = \frac{wl^2}{10}$  (wall spans) add 9½% to depth of slab and area of steel.  
For  $M = \frac{wl^2}{8}$  (supported spans) add 22.5% to depth of slab and area of steel.

$h$  = Total thickness of slab. Effective depth,  $d = h - 1''$ ,  $A_s$  = Area of cross-section of steel per foot of width.

Span	Live Load Pounds per Square Foot *																											
	40 *		50 *		60 *		70 *		75 *		80 *		90 *		100 *		115 *		125 *		140 *		150 *					
	h	A <sub>s</sub>	h	A <sub>s</sub>	h	A <sub>s</sub>	h	A <sub>s</sub>	h	A <sub>s</sub>	h	A <sub>s</sub>	h	A <sub>s</sub>	h	A <sub>s</sub>	h	A <sub>s</sub>	h	A <sub>s</sub>	h	A <sub>s</sub>	h	A <sub>s</sub>				
Ft.	Sq. In.	In.	Sq. In.	In.	Sq. In.	In.	Sq. In.	In.	Sq. In.	In.	Sq. In.	In.	Sq. In.	In.	Sq. In.	In.	Sq. In.	In.	Sq. In.	In.	Sq. In.	In.	Sq. In.	In.	Sq. In.			
4	3	0.04	3	0.05	3	0.06	3	0.06	3	0.06	3	0.07	3	0.07	3	0.08	3	0.09	3	0.09	3	0.09	3	0.10	3	0.11	3	0.11
5	3	0.07	3	0.08	3	0.09	3	0.10	3	0.10	3	0.11	3	0.11	3	0.12	3	0.14	3	0.15	3	0.15	3	0.16	3	0.16	3	0.17
6	3	0.10	3	0.11	3	0.13	3	0.14	3	0.14	3	0.15	3	0.15	3	0.16	3	0.18	3	0.18	3	0.18	3	0.19	3	0.19	3	0.20
7	3	0.14	3	0.15	3	0.17	3	0.19	3	0.19	3	0.17	3	0.17	3	0.19	3	0.20	3	0.22	3	0.24	4	0.22	4	0.22	4	0.23
8	3	0.18	3	0.17	3	0.19	3	0.21	3	0.22	3	0.23	4	0.23	4	0.23	4	0.25	4	0.25	4	0.27	4	0.26	4	0.26	4	0.27
9	3	0.19	3	0.22	4	0.21	4	0.23	4	0.24	4	0.25	4	0.25	4	0.26	4	0.28	4	0.28	4	0.30	4	0.30	4	0.30	4	0.31
10	4	0.21	4	0.24	4	0.26	4	0.26	4	0.29	4	0.28	4	0.28	4	0.30	4	0.32	5	0.32	5	0.34	5	0.36	5	0.36	5	0.35
11	4	0.26	4	0.26	4	0.29	4	0.31	4	0.33	5	0.31	5	0.33	5	0.35	5	0.35	5	0.35	5	0.37	5	0.40	6	0.39	6	0.39
12	4	0.28	4	0.31	5	0.32	5	0.34	5	0.35	5	0.37	5	0.37	5	0.39	6	0.39	6	0.39	6	0.41	6	0.44	6	0.46	6	0.46
13	4	0.33	5	0.34	5	0.35	5	0.37	5	0.39	5	0.40	6	0.40	6	0.42	6	0.46	6	0.46	6	0.45	6	0.49	6	0.51	7	0.51
14	5	0.36	5	0.37	5	0.40	6	0.41	6	0.42	6	0.44	6	0.44	6	0.46	6	0.50	7	0.50	7	0.50	7	0.53	7	0.56	7	0.56
15	5	0.39	6	0.40	6	0.43	6	0.44	6	0.46	6	0.47	6	0.50	7	0.50	7	0.54	7	0.54	7	0.54	7	0.58	7	0.60	7	0.60
16	6	0.42	6	0.45	6	0.46	7	0.47	7	0.50	7	0.50	7	0.53	7	0.53	7	0.59	8	0.59	8	0.59	8	0.63	8	0.63	8	0.63
17	6	0.48	6	0.49	7	0.51	7	0.54	7	0.54	7	0.55	7	0.59	8	0.59	8	0.63	8	0.63	8	0.64	8	0.68	9	0.68	9	0.68
18	6	0.51	7	0.53	7	0.56	7	0.58	7	0.60	8	0.62	8	0.63	8	0.63	8	0.68	9	0.68	9	0.69	9	0.73	9	0.73	9	0.73
19	7	0.55	7	0.57	8	0.59	8	0.63	8	0.65	8	0.64	8	0.68	9	0.69	9	0.73	9	0.73	9	0.74	9	0.78	10	0.78	10	0.79
20	7	0.59	8	0.61	8	0.63	8	0.67	8	0.70	9	0.69	9	0.72	9	0.74	9	0.79	10	0.79	10	0.80	10	0.82	10	0.85	10	0.85

Live Load Pounds per Square Foot \*

Span	165 *		175 *		190 *		200 *		215 *		225 *		240 *		250 *		265 *		275 *		285 *		300 *		
	h	A.	h	A.	h	A.	h	A.	h	A.	h	A.	h	A.	h	A.	h	A.	h	A.	h	A.	h	A.	
																									Sq. In.
Ft.	In.	In.	Sq. In.	In.	Sq. In.	In.	Sq. In.	In.	Sq. In.	In.	Sq. In.	In.	Sq. In.	In.	Sq. In.	In.	Sq. In.	In.	Sq. In.	In.	Sq. In.	In.	Sq. In.	In.	
4	3	0.12	3	0.12	3	0.13	3	0.14	3	0.15	3	0.15	3	0.16	3	0.16	3	0.17	3	0.18	3	0.18	3	0.19	3½
5	3	0.18	3½	0.16	3½	0.17	3½	0.18	3½	0.19	3½	0.19	3½	0.20	3½	0.21	3½	0.22	3½	0.23	3½	0.23	3½	0.23	4
6	3½	0.23	3½	0.24	4	0.22	4	0.23	4	0.24	4	0.25	4	0.27	4	0.26	4	0.29	4½	0.26	4½	0.26	4½	0.27	4½
7	4	0.25	4	0.26	4½	0.25	4½	0.26	4½	0.27	4½	0.28	4½	0.30	4½	0.31	4½	0.32	5	0.30	5	0.30	5	0.31	5
8	4½	0.29	4½	0.30	4½	0.32	5	0.30	5	0.32	5	0.33	5	0.35	5	0.36	5½	0.34	5½	0.35	5½	0.35	5½	0.36	5½
9	5	0.33	5	0.34	5	0.37	5½	0.35	5½	0.37	5½	0.38	5½	0.40	5½	0.41	6	0.39	6	0.41	6	0.41	6	0.42	6
10	5½	0.37	5½	0.39	5½	0.41	6	0.39	6	0.42	6	0.43	6	0.45	6½	0.43	6½	0.45	6½	0.46	6½	0.46	6½	0.48	6½
11	6	0.42	6	0.43	6	0.46	6½	0.44	6½	0.47	6½	0.48	6½	0.51	7	0.49	7	0.51	7	0.52	7	0.52	7	0.54	7½
12	6½	0.46	6½	0.48	6½	0.51	7	0.49	7	0.52	7	0.54	7½	0.53	7½	0.54	7½	0.57	7½	0.58	7½	0.58	7½	0.60	8
13	7	0.51	7	0.53	7½	0.53	7½	0.55	7½	0.57	7½	0.59	8	0.59	8	0.60	8	0.63	8	0.65	8½	0.65	8½	0.68	8½
14	7½	0.56	7½	0.58	8	0.58	8	0.60	8	0.63	8	0.65	8½	0.65	8½	0.66	8½	0.69	9	0.68	9	0.68	9	0.70	9
15	8	0.61	8	0.63	8½	0.64	8½	0.66	8½	0.69	9	0.68	9	0.71	9	0.73	9½	0.73	9½	0.75	9½	0.75	9½	0.76	10
16	8½	0.66	8½	0.69	9	0.69	9	0.72	9½	0.72	9½	0.74	9½	0.77	10	0.76	10	0.79	10	0.81	10½	0.81	10½	0.83	10½
17	9	0.72	9½	0.71	9½	0.75	9½	0.78	10	0.78	10	0.81	10½	0.81	10½	0.83	10½	0.86	11	0.85	11	0.85	11	0.88	11
18	9½	0.77	10	0.77	10	0.81	10½	0.81	10½	0.85	10½	0.87	11	0.88	11	0.90	11½	0.90	11½	0.92	11½	0.92	11½	0.94	12
19	10	0.83	10½	0.83	10½	0.87	11	0.87	11	0.91	11	0.94	11½	0.94	11½	0.97	12	0.97	12	1.00	12	1.00	12	1.02	12½
20	11	0.87	11	0.90	11	0.94	11½	0.94	11½	0.95	12	0.98	12	1.02	12½	1.01	12½	1.03	13	1.04	13	1.04	13	1.07	13

\* Allowance is made for weight of concrete slab but not for superimposed granolithic or wood flooring. To allow for granolithic (if not considered as part of structural slab) or wood flooring with cinder fill use the column in table corresponding to 15 lb. larger load than the live load

Table 7.—Simply Supported Slabs.

Bending moment,  $M = \frac{wl^2}{8}$ . Unit stresses,  $f_c = 800$ ;  $f_s = 16\ 000$ ;  $n = 15$ . Effective depth,  $d = h - 1''$ .  
 Use for concrete with ultimate compression strength  $f'_c = 2\ 000$  lb. per sq. in.

Thickness of Slab $h$	Unit Weight of Slab	Area of Steel $A_s$ , Per Foot of Width	Span Length $l$ , in Feet														
			4	5	6	7	8	9	10	11	12	13	14	15	16	17	18
In.	Lb.	Sq. in.	Safe Live Load in Pounds per Square Foot														
3	37	0.26	256	151	93	59	36	21	10	17	23	12	21	11	14	16	18
3½	44	0.32	414	249	160	106	71	47	29	37	44	29	18	27	34	40	43
4	50	0.39	610	373	243	166	115	80	56	63	68	49	34	44	53	60	64
4½	56	0.45	846	521	345	239	170	122	88	93	97	73	55	66	75	83	88
5	62	0.52	.....	689	460	321	231	170	126	129	129	99	78	91	101	110	116
5½	69	0.58	.....	.....	596	420	305	227	170	167	168	131	102	120	131	141	148
6	75	0.64	.....	.....	.....	524	383	287	218	215	206	163	129	150	161	171	178
6½	81	0.71	.....	.....	.....	649	478	361	277	262	251	200	159	180	191	200	207
7	87	0.77	.....	.....	.....	.....	573	455	336	316	316	251	200	221	231	240	247
7½	94	0.83	.....	.....	.....	.....	.....	519	475	440	440	353	285	304	314	322	329
8	100	0.90	.....	.....	.....	.....	.....	.....	475	.....	.....	383	314	333	342	350	357
8½	106	0.96	.....	.....	.....	.....	.....	.....	.....	.....	.....	410	333	353	362	370	377
9	112	1.03	.....	.....	.....	.....	.....	.....	.....	.....	.....	.....	383	410	420	428	435
9½	119	1.09	.....	.....	.....	.....	.....	.....	.....	.....	.....	.....	437	466	476	484	491
10	125	1.15	.....	.....	.....	.....	.....	.....	.....	.....	.....	.....	487	516	526	534	541
10½	131	1.22	.....	.....	.....	.....	.....	.....	.....	.....	.....	.....	537	566	576	584	591
11	138	1.29	.....	.....	.....	.....	.....	.....	.....	.....	.....	.....	587	616	626	634	641
11½	144	1.35	.....	.....	.....	.....	.....	.....	.....	.....	.....	.....	637	666	676	684	691
12	150	1.41	.....	.....	.....	.....	.....	.....	.....	.....	.....	.....	687	716	726	734	741

Table 8.—Continuous Slabs—End Spans.

Bending moment,  $M = \frac{wl^2}{10}$ . Unit stresses,  $f_c = 800$ ;  $f_s = 16\ 000$ ;  $n = 15$ . Effective depth,  $d = h - 1''$ .  
 Use for concrete with ultimate compression strength  $f'_c = 2\ 000$  lb. per sq. in.

Thickness of Slab $h$	Unit Weight of Slab	Area of Steel $A_s$ , per Foot of Width	Span Length $l$ , in Feet															
			4	5	6	7	8	9	10	11	12	13	14	15	16	17	18	
In.	Lb.	Sq. in.	Safe Live Load, in Pounds per Square Foot															
3	37	0.26	330	198	126	83	55	35	22	12	20	10	17	24	14	10	10	
3½	44	0.32	529	323	211	143	99	69	48	32	28	28	36	48	30	28	28	
4	50	0.39	775	478	317	219	156	113	82	59	42	51	51	69	48	48	48	
4½	56	0.45	1071	666	445	312	226	167	124	93	69	77	58	84	64	68	68	
5	62	0.52	.....	877	590	417	305	228	173	132	101	108	84	112	88	88	88	
5½	69	0.58	.....	.....	762	542	399	301	230	178	139	142	147	147	118	118	118	
6	75	0.64	.....	.....	.....	673	498	378	292	228	180	142	184	147	148	148	148	
6½	81	0.71	.....	.....	.....	832	618	471	366	289	230	226	226	183	148	148	148	
7	87	0.77	.....	.....	.....	.....	738	565	441	350	280	337	273	223	182	148	148	
7½	94	0.83	.....	.....	.....	.....	.....	672	526	419	337	325	267	223	182	148	148	
8	100	0.90	.....	.....	.....	.....	.....	.....	619	494	399	383	315	261	217	180	149	
8½	106	0.96	.....	.....	.....	.....	.....	.....	.....	577	467	444	367	305	255	213	178	
9	112	1.03	.....	.....	.....	.....	.....	.....	.....	.....	540	509	422	352	295	248	208	
9½	119	1.09	.....	.....	.....	.....	.....	.....	.....	.....	.....	.....	481	403	339	286	242	
10	125	1.15	.....	.....	.....	.....	.....	.....	.....	.....	.....	.....	578	481	403	339	286	
10½	131	1.22	.....	.....	.....	.....	.....	.....	.....	.....	.....	.....	653	545	458	386	327	
11	138	1.29	.....	.....	.....	.....	.....	.....	.....	.....	.....	.....	730	610	514	435	370	
11½	144	1.35	.....	.....	.....	.....	.....	.....	.....	.....	.....	.....	813	682	575	488	416	
12	150	1.41	.....	.....	.....	.....	.....	.....	.....	.....	.....	.....	900	756	639	543	464	











DIAGRAMMS FOR T-BEAMS.

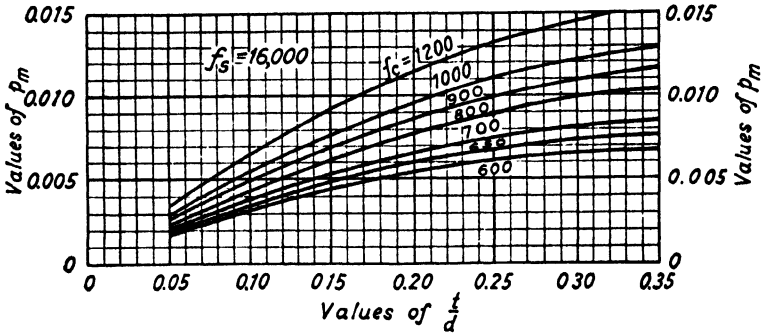
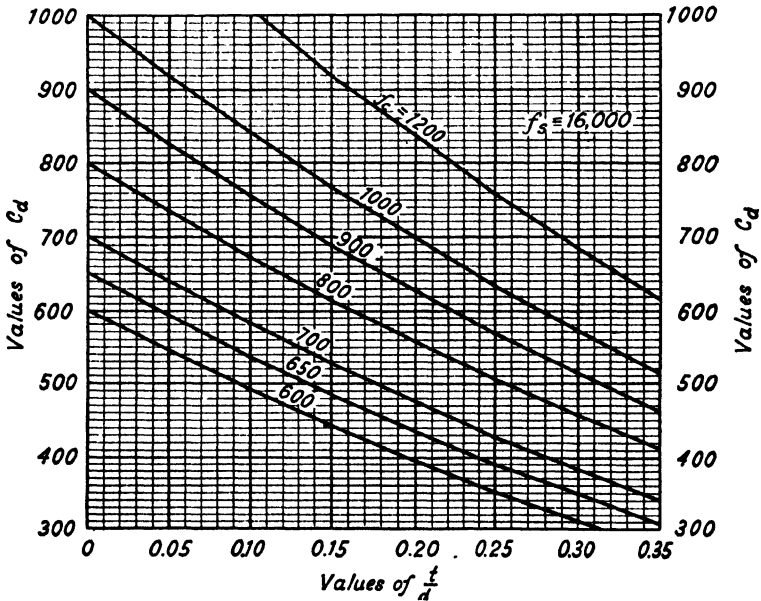

DIAGRAM 3.—Values of Maximum Steel Ratio  $p_m$  for Different Ratios  $\frac{t}{d}$ , Value of  $n$  Varied with  $f_c$ . Governed by Compression Stresses. (See p. 216.)



For Example, see p. 897.

DIAGRAM 4.—Values of Constants,  $C_d$  for Different Ratios  $\frac{t}{d}$ . In Formula for

$$\text{Minimum Depth, } d = \frac{M}{C_d b t}. \quad (\text{See p. 216.})$$

DIAGRAMMS FOR T-BEAMS

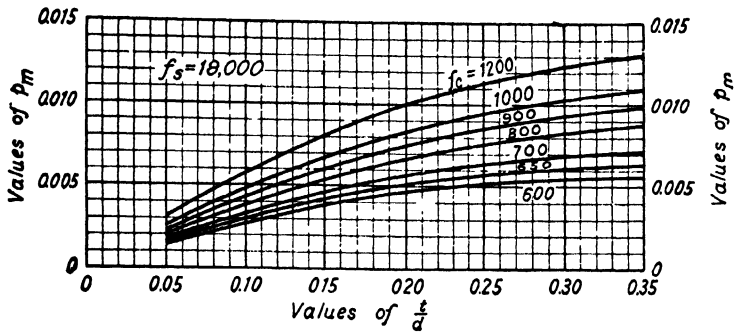
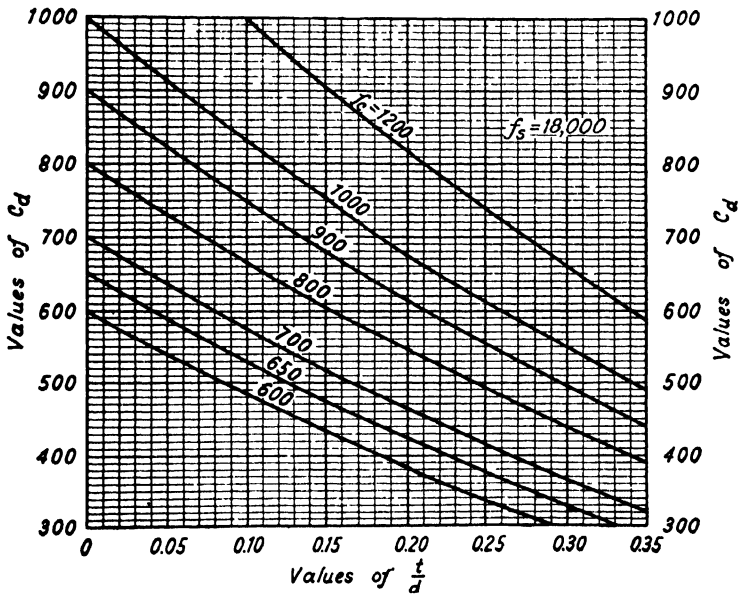

DIAGRAM 5.—Values of Maximum Steel Ratio  $p_m$  for Different Ratios  $\frac{t}{d}$ .

Value of  $n$  Varied with  $f_c$   
 Governed by Compression Stresses. (See p. 216.)



For Example, see p. 897.

DIAGRAM 6.—Values of Constants,  $C_d$ , for Different Ratios,  $\frac{t}{d}$ . In Formula for

$$\text{Minimum Depth, } d = \frac{M}{C_d b t}. \quad (\text{See p. 216.})$$

Table 13.—Use to Find Stresses  $f_s$  and  $f_c$  in T-Beams. (See p. 898.)

Values of  $k$ ,  $j$ , and  $CT$ , for Different Values of  $\frac{nA_s}{bt}$ . (See pp. 224 and 898.)

Ratio $\frac{nA_s}{bt}$	Value of $k$ . Use to find $j$ and $CT$ below.											
	Ratios of Thickness of Flange to Depth of Beam, $\frac{t}{d}$											
	0.10	0.12	0.14	0.16	0.18	0.20	0.22	0.24	0.26	0.28	0.30	0.32
0.1	0.136	0.145	0.154	0.164								
0.2	0.208	0.217	0.225	0.233	0.242	0.250	0.258	0.267	0.275	0.283		
0.3	0.269	0.277	0.285	0.292	0.300	0.308	0.315	0.323	0.331	0.338	0.346	0.354
0.4	0.321	0.329	0.336	0.343	0.350	0.357	0.364	0.371	0.379	0.386	0.393	0.400
0.45	0.345	0.352	0.359	0.365	0.372	0.379	0.386	0.393	0.400	0.407	0.414	0.421
0.5	0.367	0.373	0.380	0.387	0.393	0.400	0.407	0.413	0.420	0.427	0.433	0.440
0.55	0.387	0.393	0.400	0.406	0.413	0.419	0.426	0.432	0.439	0.445	0.452	0.458
0.6	0.406	0.412	0.419	0.425	0.431	0.437	0.444	0.450	0.456	0.462	0.469	0.475
0.65	0.424	0.430	0.436	0.442	0.448	0.455	0.461	0.467	0.473	0.479	0.485	0.491
0.7	0.441	0.447	0.453	0.459	0.465	0.471	0.476	0.482	0.488	0.494	0.500	0.506
0.75	0.457	0.463	0.469	0.474	0.480	0.486	0.491	0.497	0.503	0.509	0.514	0.520
0.8	0.472	0.478	0.483	0.489	0.494	0.500	0.506	0.511	0.517	0.522	0.528	0.533
Values of $k$	Values of $j$ . Use to find $f_s$ in Formula $f_s = \frac{M}{A_s j d}$											
	Ratios of Thickness of Flange to Depth of Beam, $\frac{t}{d}$											
	0.10	0.12	0.14	0.16	0.18	0.20	0.22	0.24	0.26	0.28	0.30	0.32
0.21	0.955	0.948	0.940	0.937	0.933	0.930						
0.22	0.955	0.948	0.940	0.935	0.931	0.927						
0.23	0.955	0.947	0.939	0.934	0.929	0.925	0.924					
0.24	0.954	0.947	0.938	0.933	0.928	0.923	0.921					
0.25	0.954	0.946	0.938	0.933	0.927	0.922	0.919	0.917				
0.26	0.954	0.946	0.937	0.932	0.926	0.920	0.917	0.914	0.913			
0.27	0.954	0.946	0.937	0.931	0.925	0.919	0.916	0.912	0.909			
0.28	0.954	0.946	0.936	0.931	0.924	0.918	0.914	0.910	0.906	0.907		
0.29	0.953	0.945	0.936	0.930	0.924	0.917	0.913	0.908	0.904	0.904		
0.30	0.953	0.945	0.936	0.930	0.923	0.916	0.912	0.907	0.902	0.901	0.900	
0.31	0.953	0.945	0.935	0.929	0.922	0.915	0.911	0.905	0.900	0.899	0.897	
0.32	0.953	0.945	0.935	0.929	0.922	0.915	0.910	0.904	0.898	0.896	0.894	0.893
0.33	0.953	0.945	0.935	0.929	0.921	0.914	0.909	0.903	0.897	0.895	0.892	0.890
0.34	0.953	0.944	0.935	0.928	0.921	0.913	0.908	0.902	0.896	0.893	0.890	0.887
0.35	0.953	0.944	0.934	0.928	0.920	0.913	0.907	0.901	0.894	0.891	0.888	0.885
0.36	0.953	0.944	0.934	0.928	0.920	0.912	0.907	0.900	0.893	0.890	0.886	0.883
0.37	0.953	0.944	0.934	0.927	0.920	0.912	0.906	0.899	0.892	0.889	0.884	0.880
0.38	0.953	0.944	0.934	0.927	0.919	0.911	0.905	0.899	0.891	0.887	0.883	0.879
0.40	0.952	0.943	0.933	0.927	0.919	0.911	0.904	0.897	0.890	0.885	0.880	0.875
0.42	0.952	0.943	0.933	0.926	0.918	0.910	0.903	0.897	0.889	0.883	0.880	0.872
0.44	0.952	0.943	0.932	0.926	0.918	0.910	0.903	0.896	0.888	0.881	0.879	0.870
0.48	0.952	0.943	0.932	0.925	0.917	0.909	0.902	0.896	0.887	0.879	0.875	0.868
0.52	0.951	0.943	0.931	0.925	0.916	0.909	0.901	0.895	0.886	0.877	0.870	0.866
Ratio of Moduli $n$	Values of $CT$ in Formula $f_c = CT f_s$ . (See p. 224).											
	Values of $k$											
	0.22	0.24	0.26	0.28	0.30	0.32	0.34	0.36	0.38	0.40	0.42	
15	0.019	0.021	0.023	0.026	0.029	0.031	0.034	0.038	0.041	0.044	0.048	0.048
12	0.024	0.026	0.029	0.032	0.036	0.039	0.043	0.047	0.051	0.055	0.060	0.060
10	0.028	0.032	0.035	0.039	0.043	0.047	0.052	0.056	0.061	0.067	0.073	0.073

## USE OF DIAGRAMMS AND TABLES FOR T-BEAMS

**Use of Diagrams 3 and 5.**—These diagrams give maximum ratio of steel,  $p_m$ , which can be used in a T-beam without exceeding the allowable compression stresses in concrete. Also they may be used to check a design for compression stresses.

**Example.**—Given  $M = 1\,800\,000$  in.-lb.,  $f_c = 650$ ,  $f_s = 16\,000$ ,  $n = 15$ ,  $d = 18$  in.,  $t = 4$  in.,  $b = 58$  in. Find required area of steel and see whether compression stresses are satisfactory.

**Solution.**—Area of steel is found from  $A_s = \frac{M}{f_s j d}$  where  $j$  is assumed as 0.90.

$$A_s = \frac{1\,800\,000}{16\,000 \times 0.90 \times 18} = 6.93. \quad \text{Hence the ratio of steel is } p = \frac{6.93}{18 \times 58} =$$

0.0066. For  $\frac{t}{d} = \frac{4}{18} = 0.222$ , and the stresses,  $f_c = 650$ ,  $f_s = 16\,000$  from Diagram 3 the ratio is  $p_m = 0.0063$ . This is larger than the computed value of  $p$ , consequently the compression stresses are larger than the allowable. By locating  $p = 0.0066$  in the same diagram it is found that the compression stresses are about 675 lb. per sq. in. Therefore the depth,  $d = 18$  in. cannot be used unless the compression flange is made thicker or compression steel is used. Ordinarily it is cheapest to increase the depth of beam.

**Use of Diagrams 4 and 6.**—These diagrams give the minimum depth of T-Beam as governed by compression stresses for any given dimensions  $b$  and  $t$ , given bending moment  $M$  and specified unit stresses  $f_s$  and  $f_c$ .

**Example.**—Find minimum depth of T-beam as governed by compression stresses  $f_c$ , when  $M = 1\,500\,000$  in. lb.,  $t = 4$  in.,  $b = 58$  in., and the stresses are  $f_c = 650$ ,  $f_s = 16\,000$ , and  $n = 15$ .

**Solution.**—Minimum depth will be found from formula  $d = \frac{M}{C_d b t}$  in which all values except  $C_d$  are known. Assume  $\frac{t}{d} = 0.24$ . (This value may correspond to minimum depth required by shearing stresses.) From the diagram 4, corresponding to specified stress  $f_c$ , and assumed  $\frac{t}{d}$ , the constant is  $C_d = 400$ .

Minimum depth therefore is

$$d = \frac{1\,500\,000}{400 \times 58 \times 4} = 16.2 \text{ in.}$$

**Use of Table 13.**—Rule for use of Table 13: Find  $k$ , use  $k$  to determine  $j$  and thus  $f_s$  in formula  $A_s = \frac{M}{jd f_s}$ . Use  $k$  also to find  $C_T$  and hence  $f_c$ .

**Example.**—Given  $M = 1\ 900\ 000$  in. lb. resisted by a T-beam with the following dimensions:  $b = 58$  in.,  $t = 4$  in.,  $d = 22$  in.  $A_s = 6.2$  sq. in. Find stresses  $f_c$  and  $f_s$ , assuming  $n = 15$ .

**Solution.**—Compute the ratios  $\frac{nA_s}{bt} = \frac{15 \times 6.2}{58 \times 4} = 0.4$  and  $\frac{t}{d} = \frac{4}{22} = 0.18$ . Find in Table 13, corresponding to the above ratios,  $k = 0.35$ . With this value of  $k$  and  $\frac{t}{d} = 0.18$ , find from the second part of the table  $j = 0.920$ , and, by interpolation,  $C_T = 0.036$ . Stresses in steel therefore  $f_s = \frac{1\ 900\ 000}{0.920 \times 22 \times 6.2} = 15\ 200$  lb. per sq. in., and  $f_c = C_T f_s = 0.036 \times 15\ 200 = 547$  lb. per sq. in.

#### BASIS FOR TABLE 14

Table 14 is based on the general formula  $s = \frac{A_s f_s}{v_1 b}$ , in which

- $s$  = spacing of stirrups, in inches;
- $A_s$  = area of two legs of stirrups, in square inches;
- $f_s$  = tension in stirrups = 16 000 lb. per sq. in.;
- $v_1$  = unit shear at the point under consideration to be resisted by stirrups, pounds per square inch.
- $V$  = average external shear at the point under consideration in pounds;
- $v'$  = unit shear to be resisted by concrete, pounds per square inch.
- $b$  = width of rectangular beam or width of stem of T-Beam in inches.

The value  $v_1$  depends upon the method of distribution of diagonal tension between the stirrups and the concrete.

For Method 1, where concrete is assumed to resist a definite amount of diagonal tension,  $v_1 = \frac{V}{bjd} - v'$ . For this the above formula for spacing changes to  $s = \frac{A_s f_s}{\frac{V}{jd} - v' b}$ , which is identical with Formula (40), p. 249.

For Method 2, where concrete is assumed to resist one-third of diagonal tension and the stirrup the balance,  $v_1 = \frac{2}{3} \frac{V}{jd}$ . This substituted in the above general formula gives  $s = \frac{1.5 A_s f_s}{\frac{V}{jd}}$ , which is identical with Formula (44), p. 249.

Values of  $v_1$  may be taken from a shearing stress diagram prepared as explained on p. 252.

Table 14.—Spacing of Stirrups. (See p. 902.)

Unit Shear to be Resisted by Stirrups, lb. per sq. in.	Spacing of Stirrups, in Inches									
	Width of Beam <i>b</i> , or Stem <i>b'</i> , in Inches									
	6	8	10	12	14	16	18	20	22	24
$\frac{1}{2}$ in. rd. U-Stirrup										
10	26	20	16	13	11	10	9	8	7	6
20	13	10	8	6	5	5	4	4	3	3
30	9	6	5	4	4	3	3	2	2	2
40	6	5	4	3	3	2	2	2	2	2
50	5	4	3	2	2	2	2			
60	4	3	3	2	2	2				
80	3	2	2	2						
100	3	2								
120	2	2								
140	2									
$\frac{3}{8}$ in. rd. U-Stirrup										
10	59	44	35	29	25	22	20	18	16	15
20	29	22	18	15	13	11	10	9	8	7
30	19	15	12	10	8	7	6	6	5	5
40	15	11	9	7	6	5	5	4	4	4
50	11	8	7	5	5	4	4	3	3	3
60	10	7	6	5	4	4	3	3	3	2
80	7	5	4	4	3	3	2	2	2	2
100	6	4	3	3	2	2	2	2		
120	5	4	3	2	2	2	2			
140	4	3	2	2	2					
$\frac{1}{2}$ in. rd. U-Stirrup										
10	104	78	63	52	45	39	35	31	28	26
20	52	39	31	26	22	20	17	16	14	13
30	35	26	21	17	15	13	11	10	9	9
40	26	20	16	13	11	10	9	8	7	6
50	20	15	12	10	8	7	6	6	5	5
60	17	13	10	9	7	6	6	5	5	4
80	13	10	8	6	5	5	4	4	3	3
100	10	8	6	5	4	4	3	3	3	
120	9	6	5	4	4	3	3	3		
140	7	5	4	4	3	3				
$\frac{3}{8}$ in. sq. U-Stirrup										
10	133	100	80	67	57	50	44	40	36	33
20	67	50	40	33	28	25	22	20	18	17
30	44	33	26	22	19	16	15	13	12	11
40	33	25	20	17	14	12	11	10	9	8
50	25	19	15	13	11	10	8	8	7	6
60	22	17	13	11	9	8	7	7	6	5
80	17	12	10	8	7	6	5	5	4	4
100	13	10	8	7	6	5	4	4	4	3
120	11	8	7	5	5	4	4	3	3	3
140	9	7	6	5	4	3	3	3		

For explanation, see pp. 252 and 898. For example see p. 902.

Table 15.—Number of U-Stirrups in Uniformly Loaded Beam.

(See p. 902.)

Number of Stirrups per Beam is  $2N_s = C_n bl$  $2N_s$  = number of stirrups per entire beam; $l$  = span of beam in feet; $b$  = breadth of beam in inches (in T-beam, breadth of stem); $v$  = shearing unit stress in beam at support in pounds per square inch; $v'$  = allowable shearing unit stress (or diagonal tension) in concrete alone in pounds per square inch; $C_n$  = constant from table below.Values of Constant  $C_n$  for Finding Number of Stirrups in Beam

Shearing Unit Stress at Support. $v$	$\frac{1}{8}$ -In. Round U-Stirrup. $A_s = 0.153$	$\frac{3}{8}$ -In. Round U-Stirrup. $A_s = .22$	$\frac{1}{2}$ -In. Round U-Stirrup. $A_s = .30$	$\frac{3}{4}$ -In. Round U-Stirrup. $A_s = .39$	$\frac{5}{8}$ -In. Round U-Stirrup. $A_s = .61$
60	0.017	0.011	0.008	0.006	0.004
65	0.024	0.016	0.012	0.009	0.006
70	0.032	0.022	0.016	0.012	0.008
75	0.041	0.028	0.020	0.016	0.010
80	0.050	0.034	0.025	0.019	0.012
85	0.059	0.041	0.030	0.023	0.015
90	0.069	0.047	0.035	0.027	0.017
95	0.080	0.054	0.040	0.031	0.020
100	0.090	0.061	0.045	0.035	0.022
105	0.100	0.068	0.050	0.039	0.025
110	0.111	0.076	0.056	0.043	0.027
115	0.122	0.083	0.061	0.047	0.030
120	0.133	0.091	0.067	0.051	0.033
130	0.156	0.106	0.078	0.060	0.038
140	0.178	0.121	0.089	0.068	0.044
150	0.202	0.137	0.101	0.077	0.050
160	0.225	0.153	0.112	0.086	0.055
170	0.248	0.169	0.124	0.095	0.061
180	0.272	0.185	0.136	0.104	0.067

NOTE.—Table is based on formula  $2N_s = \frac{6(v - v')^2}{vA_s f_s} bl$ , in which  $A_s$  is area of two legs of the U-stirrup.  $v' = 40$  lb. per sq. in., and  $f_s = 16\,000$  lb. per sq. in.

Method 1 of distribution of diagonal tension between concrete and stirrups is used. Concrete assumed to resist 40 pounds per square inch and stirrups the balance. (See p. 246.)



**Table 16.—Spacing of Stirrups in Beams with Uniformly Distributed Loading.**

(See p. 902.)

Spacing in Inches,  $s = C_b l$

- $l$  = span of beam in feet;
- $N_s$  = number of stirrups in each end of beam;
- $v$  = shearing unit stress in beam at support in pounds per square inch;
- $v'$  = allowable shearing unit stress (or diagonal tension) in concrete alone in pounds per square inch.

Values of Constant  $C_b$  for Finding Spacing of Stirrups

$v = 60$											$v = 70$									
$N_s$	1st	2nd	3rd	4th	5th	6th	7th	8th	9th	10th	1st	2nd	3rd	4th	5th	6th	7th	8th	9th	10th
2	0.29	1.00									0.38	1.29								
3	0.18	0.42	0.82								0.24	0.54	1.05							
4	0.13	0.29	0.36	0.71							0.17	0.37	0.47	0.91						
5	0.10	0.22	0.26	0.32	0.64						0.13	0.29	0.33	0.42	0.82					
6	0.09	0.18	0.20	0.24	0.30	0.58					0.11	0.23	0.26	0.31	0.39	0.74				
7	0.07	0.15	0.17	0.19	0.22	0.28	0.54				0.09	0.19	0.22	0.25	0.28	0.36	0.69			
8	0.06	0.13	0.14	0.16	0.18	0.21	0.26	0.50			0.08	0.17	0.19	0.21	0.23	0.27	0.33	0.64		
9	0.05	0.11	0.13	0.14	0.15	0.17	0.20	0.25	0.47		0.07	0.15	0.16	0.18	0.19	0.21	0.25	0.32	0.61	
10	0.05	0.10	0.11	0.12	0.13	0.14	0.16	0.19	0.23	0.45	0.06	0.13	0.15	0.16	0.17	0.18	0.20	0.24	0.30	0.58
$v = 80$											$v = 90$									
$N_s$	1st	2nd	3rd	4th	5th	6th	7th	8th	9th	10th	1st	2nd	3rd	4th	5th	6th	7th	8th	9th	10th
2	0.44	1.50									0.49	1.68								
3	0.28	0.63	1.22								0.31	0.70	1.36							
4	0.20	0.43	0.55	1.06							0.22	0.49	0.61	1.19						
5	0.16	0.34	0.39	0.49	0.95						0.17	0.38	0.44	0.55	1.07					
6	0.13	0.27	0.31	0.36	0.45	0.86					0.15	0.31	0.34	0.40	0.50	0.97				
7	0.11	0.22	0.25	0.29	0.33	0.42	0.81				0.12	0.25	0.29	0.32	0.37	0.47	0.90			
8	0.09	0.20	0.22	0.24	0.27	0.31	0.38	0.75			0.11	0.22	0.24	0.27	0.30	0.35	0.43	0.84		
9	0.08	0.17	0.19	0.21	0.23	0.25	0.30	0.37	0.70		0.09	0.19	0.21	0.23	0.25	0.28	0.33	0.42	0.79	
10	0.07	0.16	0.17	0.18	0.19	0.21	0.24	0.28	0.35	0.67	0.08	0.17	0.19	0.20	0.22	0.23	0.26	0.31	0.39	0.78
$v = 100$											$v = 120$									
$N_s$	1st	2nd	3rd	4th	5th	6th	7th	8th	9th	10th	1st	2nd	3rd	4th	5th	6th	7th	8th	9th	10th
2	0.53	1.80									0.58	2.00								
3	0.33	0.78	1.47								0.37	0.84	1.63							
4	0.24	0.52	0.66	1.27							0.26	0.58	0.73	1.41						
5	0.19	0.40	0.47	0.58	1.14						0.21	0.45	0.52	0.65	1.27					
6	0.16	0.33	0.37	0.43	0.54	1.04					0.18	0.38	0.41	0.48	0.60	1.15				
7	0.13	0.27	0.31	0.35	0.40	0.50	0.97				0.14	0.30	0.34	0.39	0.44	0.56	1.07			
8	0.11	0.24	0.30	0.29	0.32	0.37	0.46	0.90			0.13	0.26	0.29	0.32	0.36	0.41	0.51	1.00		
9	0.10	0.21	0.23	0.25	0.27	0.30	0.36	0.45	0.84		0.11	0.23	0.25	0.28	0.30	0.33	0.40	0.50	0.94	
10	0.09	0.19	0.20	0.22	0.23	0.25	0.28	0.33	0.42	0.81	0.10	0.21	0.23	0.24	0.26	0.28	0.31	0.37	0.47	0.90
$v = 140$											$v = 160$									
$N_s$	1st	2nd	3rd	4th	5th	6th	7th	8th	9th	10th	1st	2nd	3rd	4th	5th	6th	7th	8th	9th	10th
2	0.63	2.15									0.66	2.25								
3	0.40	0.90	1.75								0.41	0.95	1.84							
4	0.28	0.62	0.78	1.52							0.30	0.65	0.82	1.59						
5	0.22	0.48	0.56	0.70	1.37						0.23	0.51	0.58	0.73	1.43					
6	0.19	0.39	0.44	0.52	0.65	1.24					0.20	0.41	0.46	0.54	0.68	1.30				
7	0.15	0.32	0.36	0.41	0.47	0.60	1.15				0.16	0.34	0.38	0.43	0.50	0.63	1.21			
8	0.13	0.28	0.31	0.35	0.39	0.44	0.55	1.07			0.14	0.30	0.32	0.36	0.40	0.47	0.58	1.12		
9	0.12	0.25	0.27	0.30	0.32	0.36	0.42	0.53	1.01		0.12	0.26	0.29	0.31	0.34	0.37	0.40	0.56	1.06	
10	0.11	0.22	0.24	0.26	0.28	0.30	0.34	0.40	0.50	0.97	0.11	0.23	0.25	0.27	0.29	0.31	0.35	0.42	0.52	1.01

If larger number of stirrups are used divide the number by 2, find the spacing for this number from the table, and place intermediate stirrups between.

### USE OF TABLES FOR SPACING OF STIRRUPS.

**Table 14.**—This table may be used for any type of loading. Proceed as follows:

Compute shearing unit stress,  $v$ , at the supports and, in case of concentrated loads, at the points of concentration.

Draw shear diagram. Free hand drawing on cross section paper is sufficient.

Mark off shear resisted by concrete.

Select diameter of stirrup.

Scale at any desired point the shearing stress to be resisted by stirrups. In the table, opposite this stress, in section for the selected diameter of stirrup and the proper width of beam, find the required spacing of stirrup.

This procedure may be repeated until all stirrups are located. Often each spacing is repeated several times so that only three or four values need to be found from table.

When the spacing of stirrups found from the table is larger than the limiting spacing as given on p. 250, it should be made equal to the limiting spacing. This reduced spacing should be repeated until all diagonal tension is taken care of.

**Table 15.**—This table gives number of stirrups for beams with uniform loading only. Proceed as follows:

Select diameter of stirrup. Find unit shear at support,  $v$ . Find constant  $C_s$  opposite this stress in section corresponding to the selected diameter of stirrup. This constant multiplied by net span  $l$  in feet and breadth of stem  $b'$  in inches gives required number of stirrups. The spacing of stirrups are found as given below.

If the number of stirrups from the table is used for estimating of the amount of steel, it should be increased by 15 to 20 per cent to take care of the additional stirrups required where the theoretical spacing exceeds the limiting spacing as given on p. 250. However, to obtain the spacing by Table 16 use the computed number of stirrups (and not the increased number).

**Table 16.**—After computing the number of stirrups  $2N_s$  as explained above, find their spacing as follows:

Divide total number of stirrups by 2 to get  $N_s$ , the number of stirrups at one end.

From the section of the table nearest to the shearing unit stress at the support  $v$ , take the line of dimensions corresponding to the number of stirrups at one end,  $N_s$ . These multiplied by the net span, in feet, give the spacing of stirrups. Mark the spacing on the beam. If any spacing exceeds the limiting spacing as given on page 250, it should be reduced. Sufficient number of stirrups must then be added to the computed value of  $2N_s$  to cover the whole section requiring stirrups.

## DESIGN OF BEAMS WITH COMPRESSION STEEL.

**Diagrams 7 to 10.**—For the design of beams with steel in top and bottom Diagrams 7 to 10, pp. 904 to 907, may be used. Diagrams 11 and 12, pp. 908 and 909, may be used also but are less convenient except for stresses not covered in the others. The use of the diagrams is illustrated as follows:

**Example.**—Given, bending moment,  $M = 2\,000\,000$ ; available depth and breadth of beam, 32 in. and 14 in.; allowable stresses  $f_s = 18\,000$ , and  $f_c = 750$ ; and  $n = 15$ . The depth of the compression steel is  $ad = 2$  in.

Determine the amount of tensile and compressive steel.

**Solution.**—Since  $h = 32$  in.,  $d = 29$  in., and  $a = \frac{2}{29} = 0.069$ . From the formula  $A_s = \frac{M}{jdf_s}$ , where we may assume  $j = 0.9$  (see p. 240), we have

$$A_s = \frac{2\,000\,000}{0.9 \times 29 \times 18\,000} = 4.3 \text{ sq. in.}$$

Compute  $p = \frac{A_s}{bd} = \frac{4.3}{14 \times 29} = 0.0106$ . Refer to Diagram 9 in the section for  $f_s = 18\,000$  and  $f_c = 750$ , and find the value of  $p' = 0.0052$  corresponding to  $a = 0.06$  and  $p_1 = 0.0106$ .

Check the value of  $j$  by referring to Diagram 13, p. 910, and recompute if necessary.

Further explanation of use of diagrams are given on pp. 237 to 240.

## REVIEW OF BEAMS WITH COMPRESSION STEEL.

**Diagrams 11 and 12.**—For review of beams with steel in top and bottom, where it is required to determine the stresses when the dimensions of the beam and steel area are given, Diagrams 11 and 12, pp. 908 and 909 are to be used, as illustrated below.

**Example.**—Given  $A_s = 3.5$  sq. in.;  $M = 1\,230\,000$  in. lb.;  $A_s' = 2.0$  sq. in.; and ratio  $\frac{p_1}{p'} = 1.75$ . The depth of compressive steel is  $ad = 1.5$  in. Find  $f_s$  and  $f_c$ .

**Solution.**—Since  $h = 24.5$  in.,  $d = 23$  in. and  $a = \frac{1.5}{23} = 0.065$ . Compute

$$p_1 = \frac{3.5}{23 \times 10} = 0.0152, \text{ and } p' = \frac{2.0}{23 \times 10} = 0.0087.$$

From Diagram 11 (p. 908) for  $a = 0.06$  and  $p_1 = 0.0152$  and  $p' = 0.0087$  we have, by interpolation, a value of  $\frac{f_s}{15f_c} = 1.4$ . From the formula  $f_s = \frac{M}{jdA_s}$  where  $j = 0.9$  (see p. 240) we have  $f_s = \frac{1\,230\,000}{0.9 \times 23 \times 3.5} = 17\,000$  lb. per sq. in. Since  $\frac{f_s}{15f_c} = 1.4$ , and  $f_s = 17\,000$  we have  $f_c = \frac{17\,000}{1.4 \times 15} = 809$  lb. per sq. in.

Check the value of  $j$  by referring to Diagram 13, p. 910, and recompute if necessary.

Further explanation of use of diagrams are given on pp. 237 to 240.

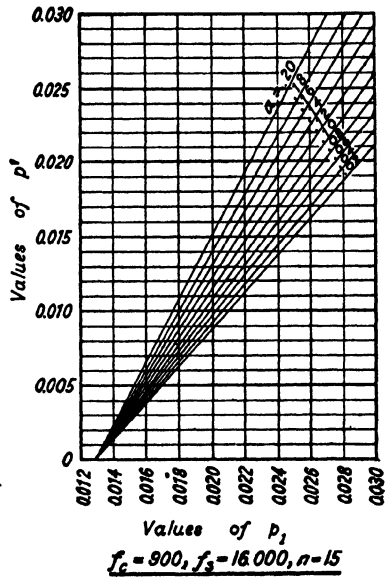
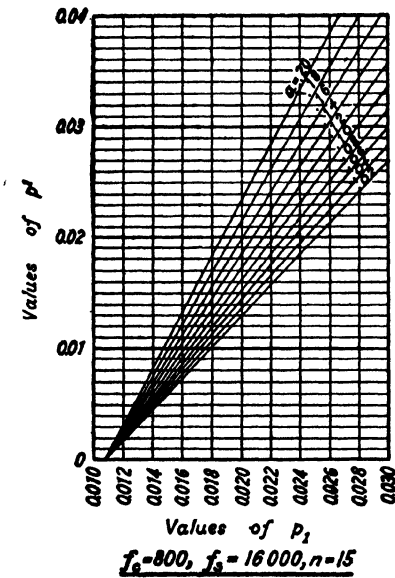
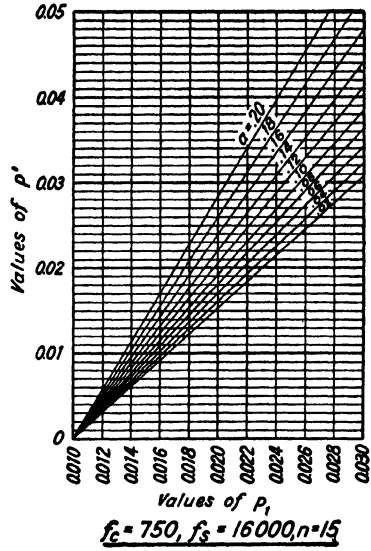
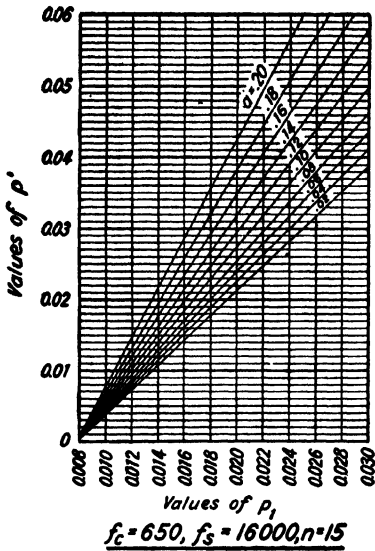

$p_1$  = ratio of tension steel;  $p'$  = ratio of compression steel;  $a$  = ratio of depth of compression steel to depth of tension steel.

DIAGRAM 7.—Ratio of Compression Steel,  $p'$  for Given Ratio of Tension Steel  $p_1$ . (See p. 903.)

Stresses in Concrete,  $f_c = 650, 750, 800, \text{ and } 900$ ;  
 Stress in Steel,  $f_s = 16\ 000$ ;  
 and  $n = 15$ .

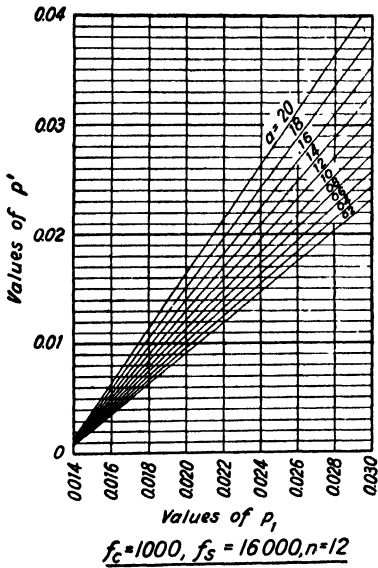
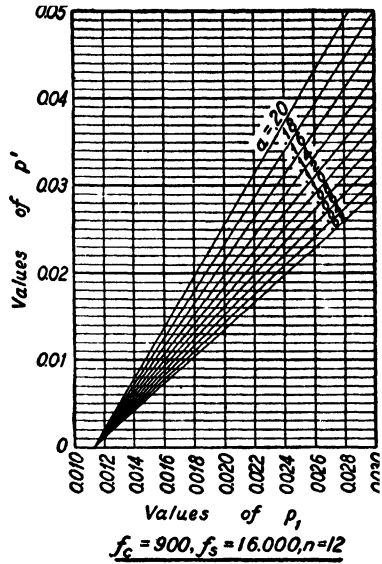
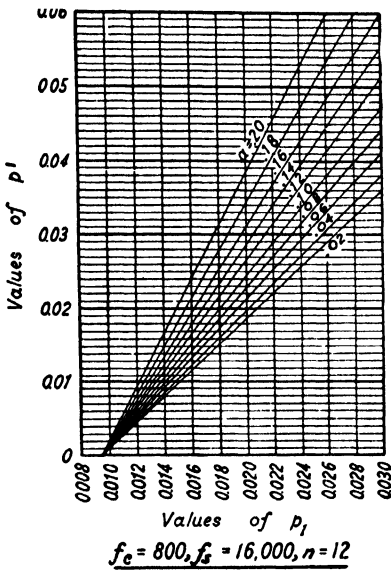

$p_1$  = ratio of tension steel;  $p'$  = ratio of compression steel;  $a$  = ratio of depth of compression steel to depth of tension steel.

DIAGRAM 8.—Ratio of Compression Steel  $p'$  for Given Ratio of Tension Steel  $p_1$ .  
(See p. 903.)

Stresses in Concrete,  $f_c = 800, 900, 1000$ ;  
Stress in Steel,  $f_s = 16000$ ;  
and  $n = 12$

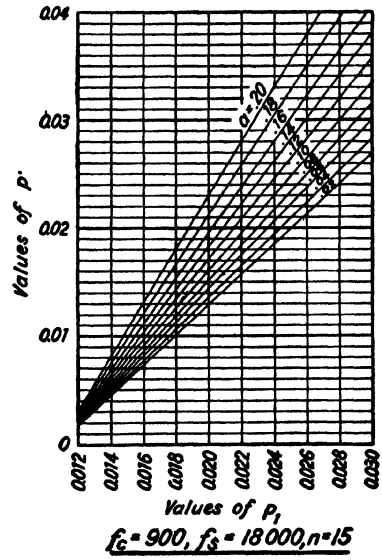
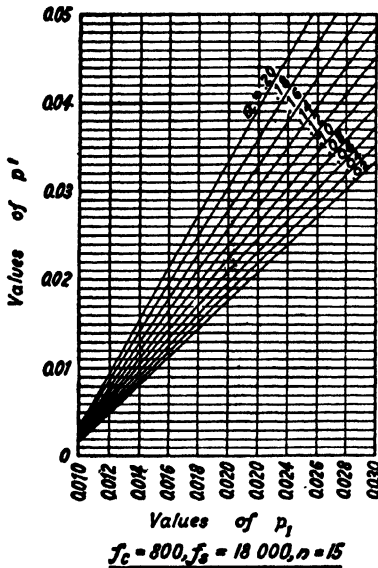
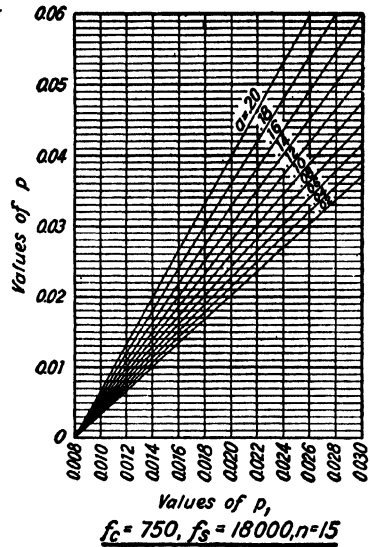
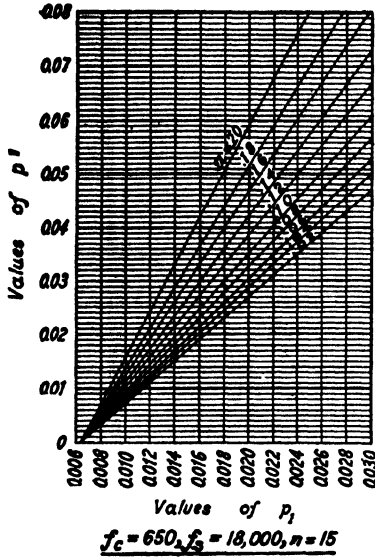

$p_1$  = ratio of tension steel;  $p'$  = ratio of compression steel;  $a$  = ratio of depth of compression steel to depth of tension steel.

DIAGRAM 9.—Ratio of Compression Steel  $p'$  for Given Ratio of Tension Steel  $p_1$ .

(See p. 903.)

Stresses in Concrete,  $f_c = 650, 750, 800, 900$ ;

Stress in Steel,  $f_s = 18\ 000$ ;

and  $n = 15$ .

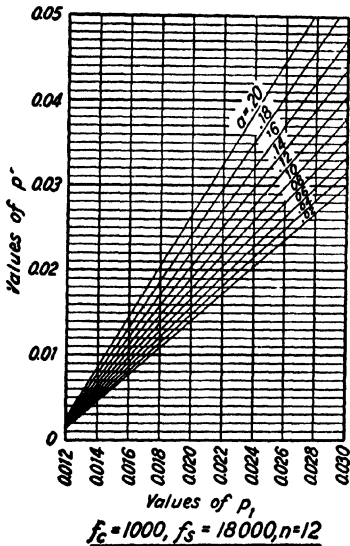
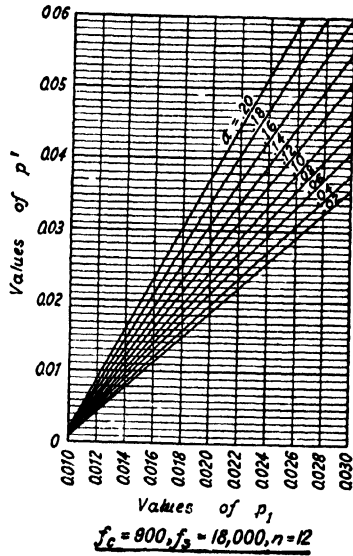
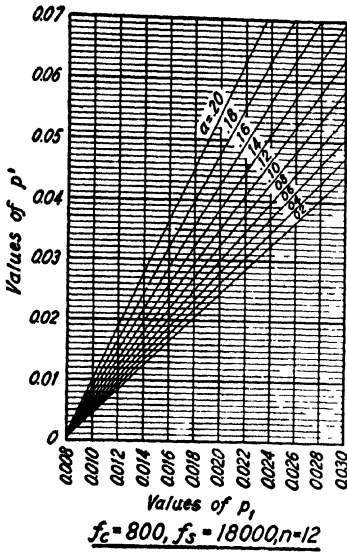

$p_1$  = ratio of tension steel;  $p'$  = ratio of compression steel;  $\alpha$  = ratio of depth of compression steel to depth of tension steel.

DIAGRAM 10.—Ratio of Compression Steel  $p'$  for Given Ratio of Tension Steel  $p_1$ .

(See p. 903.)

Stresses in Concrete,  $f_c = 800, 900, 1\ 000$ ;

Stress in Steel,  $f_s = 18\ 000$ ;

and  $n = 12$ .

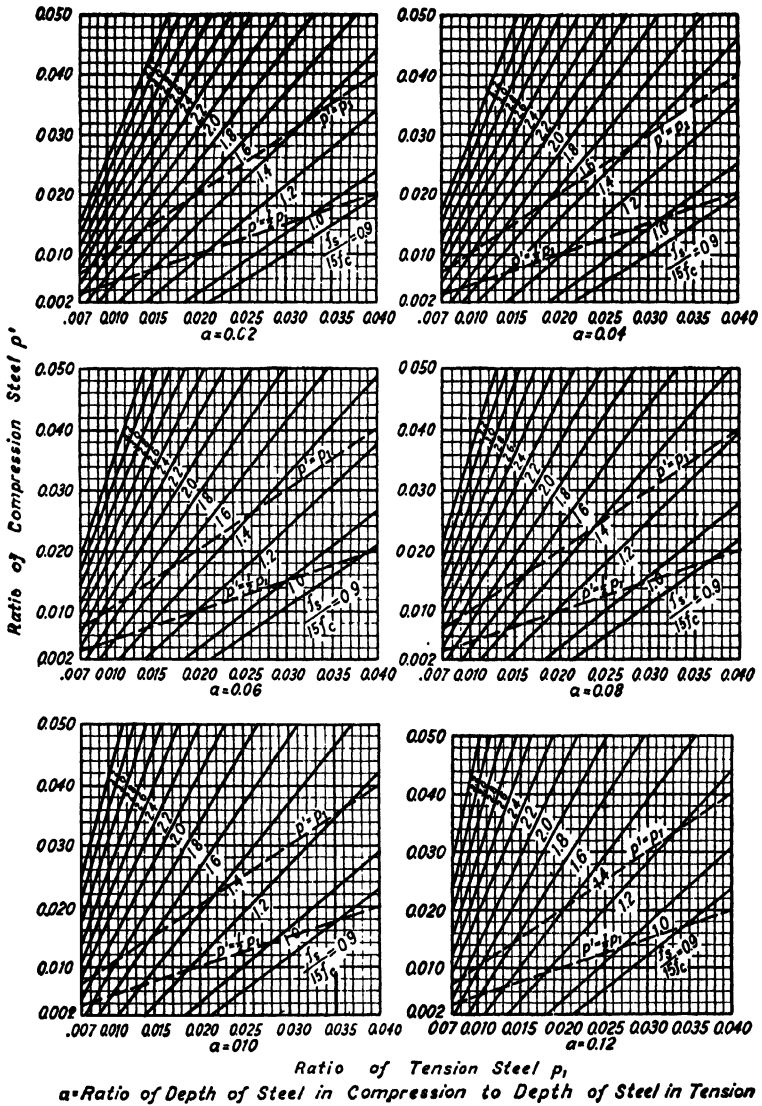

**DIAGRAM 11.**—Relation between Tensile and Compressive Steel in Beams with Steel in Top and Bottom. (See pp. 238 and 903.)



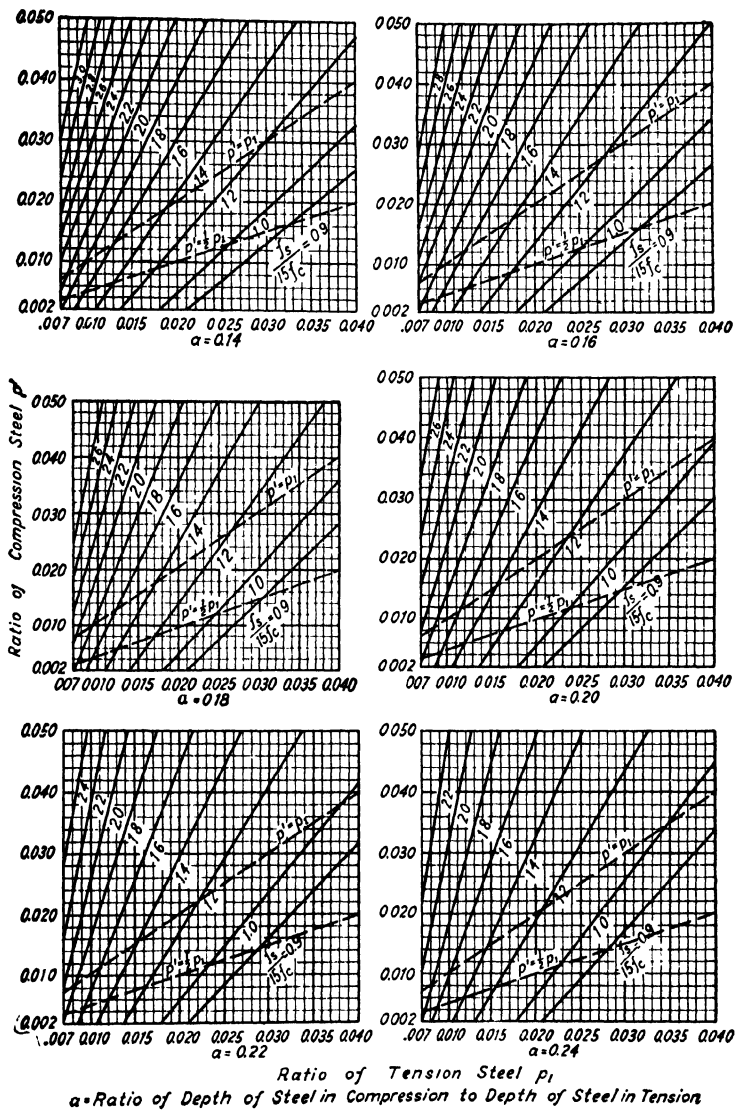
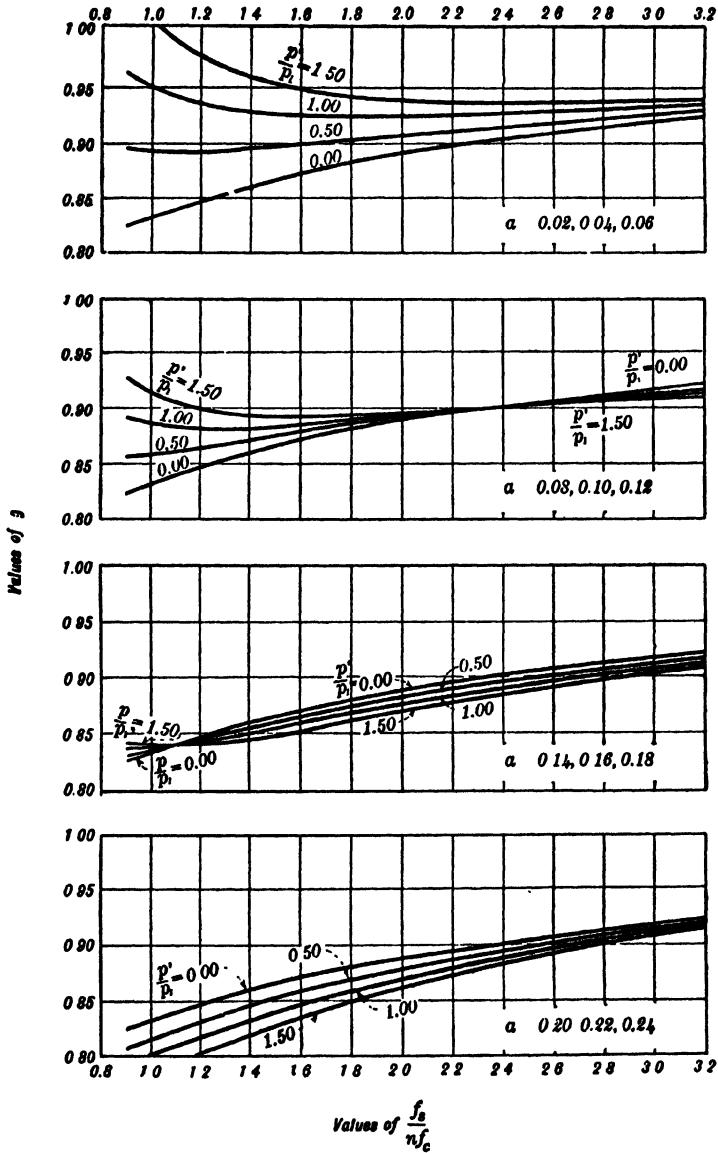

Diagram 12.—Relation between Tensile and Compressive Steel in Beams with Steel in Top and Bottom. (See pp. 238 and 903.)



$\alpha$  = Ratio of Depth of Steel in Compression to Depth of Steel in Tension.

DIAGRAM 13.—Values of  $j$  for Beams with Steel in Top and Bottom. (See p. 240.)

USE FOR FLAT SLAB DESIGN

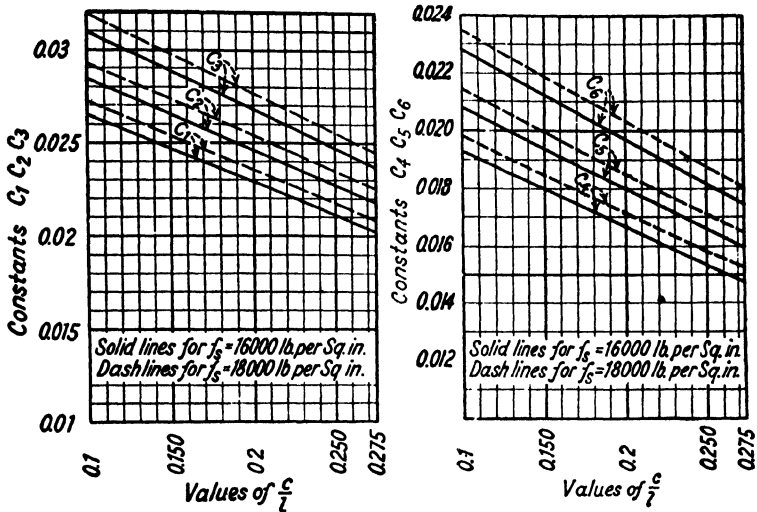

DIAGRAM 14.—Constants  $C_1$ ,  $C_2$ ,  $C_3$  and  $C_4$ ,  $C_5$ ,  $C_6$  in Formulas for Thickness of Flat Slab at Column. (See pp. 338 and 339.)

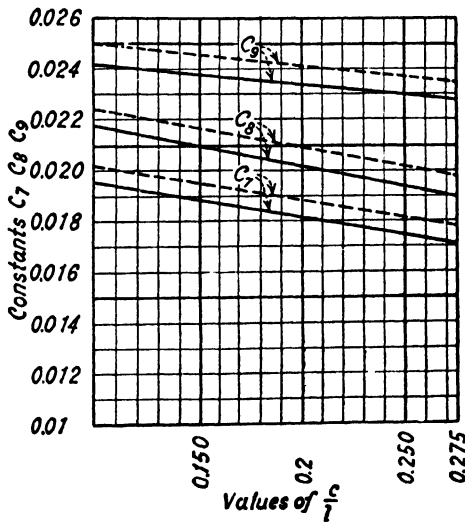

DIAGRAM 15.—Constants  $C_7$ ,  $C_8$  and  $C_9$  in Formulas for Thickness of Slab in Middle of Panel. (See pp. 340 and 341.)

Table 17.—Flat Slab Constants  $C_{10}$  and  $C_{11}$  for Computing Compression in Concrete.

Values of  $C_{10}$

$$C_{10} = \frac{0.25 \left( 1 - 1.2 \frac{c}{l} \right)}{jk} \text{ in Formulas (29), (31), and (32), p. 344.}$$

$\frac{c}{l}$	0.1	0.125	0.15	0.175	0.20	0.225	0.25	0.275
$C_{10}$	0.647	0.625	0.603	0.581	0.559	0.537	0.515	0.493

Values of  $C_{11}$

$$C_{11} = \left[ \frac{b}{l_1} + \left( \frac{1}{2} - \frac{b}{l_1} \right) \left( \frac{d}{d_1} \right)^2 \left( 2.5 \frac{d}{d_1} - 1.5 \right) \right] \text{ in Formula (31), p. 344.}$$

$\frac{d}{d_1}$	Values of $\frac{b}{l_1}$							
	0.2	0.25	0.275	0.3	0.325	0.35	0.375	0.4
0.45	0.1773	0.2311	0.2580	0.2849	0.3118	0.3387	0.3655	0.3924
0.50	0.1813	0.2344	0.2610	0.2875	0.3141	0.3406	0.3672	0.3938
0.55	0.1887	0.2406	0.2665	0.2925	0.3183	0.3444	0.3703	0.3962
0.60								
0.65	0.2158	0.2632	0.2868	0.3105	0.3342	0.3579	0.3816	0.4053
0.70	0.2367	0.2806	0.3026	0.3245	0.3464	0.3684	0.3903	0.4122
0.75	0.2632	0.3027	0.3224	0.3421	0.3619	0.3816	0.4013	0.4211
0.80	0.2960	0.3300	0.3470	0.3640	0.3810	0.3980	0.4150	0.4320
0.85	0.3353	0.3628	0.3765	0.3902	0.4040	0.4177	0.4314	0.4451
0.90	0.3822	0.4018	0.4116	0.4215	0.4313	0.4411	0.4509	0.4607
0.95	0.4367	0.4473	0.4525	0.4578	0.4631	0.4684	0.4736	0.4789

**Table 18.—Flat Slab Constant  $C_{12}$  for Computing Shearing Stresses at Column Head.**

$$C_{12} = \frac{m - 0.785 \left( \frac{c_2}{l} \right)^2}{33.0 \frac{c_2}{l}} \text{ in Formula (39), p. 349; } v = C_{12} w \frac{l}{d}$$

**Values of  $C_{12}$**

m	Values of $\frac{c_2}{l}$												
	0.16	0.18	0.20	0.22	0.24	0.26	0.28	0.30	0.32	0.34	0.36	0.38	0.40
00	0.185	0.164	0.147	0.132	0.120	0.110	0.101	0.094	0.087	0.081	0.076	0.071	0.066
098	0.182	0.161	0.144	0.130	0.118	0.108	0.099	0.092	0.085	0.079	0.074	0.069	0.065
096	0.178	0.157	0.141	0.127	0.115	0.106	0.097	0.090	0.083	0.077	0.072	0.067	0.063
094	0.174	0.154	0.138	0.124	0.113	0.103	0.095	0.088	0.081	0.076	0.071	0.066	0.062
092	0.170	0.151	0.135	0.121	0.110	0.101	0.093	0.086	0.079	0.074	0.069	0.064	0.060
090	0.167	0.147	0.131	0.119	0.108	0.099	0.091	0.084	0.078	0.072	0.067	0.063	0.059
088	0.163	0.144	0.128	0.116	0.105	0.096	0.089	0.082	0.076	0.070	0.065	0.061	0.057
086	0.159	0.140	0.125	0.113	0.103	0.094	0.086	0.080	0.074	0.069	0.064	0.059	0.056
084	0.155	0.137	0.122	0.110	0.100	0.092	0.084	0.078	0.072	0.067	0.062	0.058	0.054
082	0.151	0.134	0.119	0.108	0.098	0.089	0.082	0.076	0.070	0.065	0.060	0.056	0.053
080	0.148	0.130	0.116	0.105	0.095	0.087	0.080	0.074	0.068	0.063	0.059	0.055	0.051
078	0.144	0.127	0.113	0.102	0.093	0.085	0.078	0.072	0.066	0.061	0.057	0.053	0.050
076	0.140	0.124	0.110	0.099	0.090	0.082	0.076	0.070	0.064	0.060	0.055	0.052	0.048
074	0.136	0.120	0.107	0.097	0.088	0.080	0.073	0.068	0.062	0.058	0.054	0.050	0.046
072	0.132	0.117	0.104	0.094	0.085	0.078	0.071	0.066	0.061	0.056	0.052	0.048	0.045
070	0.129	0.113	0.101	0.091	0.083	0.075	0.069	0.064	0.059	0.054	0.050	0.047	0.043
068	0.125	0.110	0.098	0.088	0.080	0.073	0.067	0.062	0.057	0.052	0.049	0.045	0.042
066	0.121	0.107	0.095	0.086	0.078	0.071	0.065	0.059	0.055	0.051	0.047	0.044	0.040
064	0.117	0.103	0.092	0.083	0.075	0.068	0.063	0.057	0.053	0.049	0.045	0.042	0.039
062	0.114	0.100	0.089	0.080	0.073	0.066	0.060	0.055	0.051	0.047	0.044	0.040	0.037
060	0.110	0.097	0.086	0.077	0.070	0.064	0.058	0.053	0.049	0.045	0.042	0.039	0.036

Table 19.—Flat Slab Constant  $C_{13}$  for Computing Shearing Stresses at Edge of Drop Panel.

$$C_{13} = \frac{m - \left(\frac{c_2}{l}\right)^2}{42\frac{c_2}{l}} \text{ in Formula (42), p. 349; } v = C_{13}\omega\frac{l}{d}$$

Values of  $C_{13}$

m	Values of $\frac{c_2}{l}$												
	0.20	0.22	0.24	0.26	0.28	0.30	0.32	0.34	0.36	0.38	0.40	0.42	0.44
1.00	0.114	0.103	0.093	0.085	0.078	0.072	0.067	0.062	0.058	0.054	0.050	0.047	0.044
0.98	0.112	0.101	0.091	0.083	0.077	0.071	0.065	0.060	0.056	0.052	0.049	0.045	0.042
0.96	0.109	0.099	0.089	0.082	0.075	0.069	0.064	0.059	0.055	0.051	0.048	0.044	0.041
0.94	0.107	0.096	0.087	0.080	0.073	0.067	0.062	0.058	0.054	0.050	0.046	0.043	0.040
0.92	0.105	0.094	0.085	0.078	0.072	0.066	0.061	0.056	0.052	0.049	0.045	0.042	0.039
0.90	0.102	0.092	0.084	0.076	0.070	0.064	0.059	0.055	0.051	0.047	0.044	0.041	0.038
0.88	0.100	0.090	0.082	0.074	0.068	0.063	0.058	0.053	0.050	0.046	0.043	0.040	0.037
0.86	0.098	0.088	0.080	0.073	0.066	0.061	0.056	0.052	0.048	0.045	0.042	0.039	0.036
0.84	0.095	0.086	0.078	0.071	0.065	0.059	0.055	0.051	0.047	0.044	0.040	0.038	0.035
0.82	0.093	0.083	0.076	0.069	0.063	0.058	0.053	0.049	0.046	0.042	0.039	0.036	0.034
0.80	0.090	0.081	0.074	0.067	0.061	0.056	0.052	0.048	0.044	0.041	0.038	0.035	0.033
0.78	0.088	0.079	0.072	0.065	0.060	0.055	0.050	0.046	0.043	0.040	0.037	0.034	0.032
0.76	0.086	0.077	0.070	0.063	0.058	0.053	0.049	0.045	0.042	0.039	0.036	0.033	0.031
0.74	0.083	0.075	0.068	0.062	0.056	0.052	0.047	0.044	0.040	0.037	0.034	0.032	0.030
0.72	0.081	0.073	0.066	0.060	0.055	0.050	0.046	0.042	0.039	0.036	0.033	0.031	0.028
0.70	0.079	0.070	0.064	0.058	0.053	0.048	0.044	0.041	0.038	0.035	0.032	0.030	0.027
0.68	0.076	0.068	0.062	0.056	0.051	0.047	0.043	0.039	0.036	0.034	0.031	0.028	0.026
0.66	0.074	0.066	0.060	0.054	0.049	0.045	0.041	0.038	0.035	0.032	0.030	0.027	0.025
0.64	0.071	0.064	0.058	0.052	0.048	0.044	0.040	0.037	0.034	0.031	0.029	0.026	0.024
0.62	0.069	0.062	0.056	0.051	0.046	0.042	0.038	0.035	0.032	0.030	0.027	0.025	0.023
0.60	0.067	0.060	0.054	0.049	0.044	0.040	0.037	0.034	0.031	0.028	0.026	0.024	0.022

Table 20.—Properties of Column Sections.  
Areas, Volumes and Moments of Inertia

Dia- meter <i>d</i>	Round Columns.			Octagonal Columns.			Square Columns.		
	Area	Volume per Ft.	Moment of Inertia	Area	Volume per Ft.	Moment of Inertia	Area	Volume per Ft.	Moment of Inertia
	Sq. In.	Cu. Ft.	In. <sup>4</sup>	Sq. In.	Cu. Ft.	In. <sup>4</sup>	Sq. In.	Cu. Ft.	In. <sup>4</sup>
12	113.1	0.78	1 018	119.3	0.83	1 136	144	1.00	1 728
13	132.7	0.92	1 402	140.0	0.97	1 565	169	1.17	2 380
14	153.9	1.07	1 886	162.4	1.12	2 105	196	1.36	3 201
15	176.7	1.22	2 485	186.4	1.29	2 775	225	1.56	4 219
16	201.1	1.40	3 217	212.1	1.47	3 591	256	1.78	5 461
17	227.0	1.57	4 100	239.4	1.66	4 577	289	2.01	6 960
18	254.5	1.77	5 153	268.4	1.86	5 753	324	2.25	8 748
19	283.5	1.97	6 397	299.1	2.08	7 142	361	2.51	10 860
20	314.2	2.18	7 854	331.4	2.30	8 768	400	2.78	13 333
21	346.4	2.40	9 547	365.3	2.53	10 658	441	3.06	16 207
22	380.1	2.64	11 499	401.0	2.78	12 837	484	3.36	19 521
23	415.5	2.88	13 737	438.2	3.04	15 335	529	3.67	23 320
24	452.4	3.14	16 286	477.2	3.31	18 181	576	4.00	27 648
25	490.9	3.41	19 175	517.8	3.59	21 406	625	4.34	32 552
26	530.9	3.69	22 432	560.0	3.89	25 042	676	4.69	38 081
27	572.6	3.97	26 087	603.9	4.19	29 123	729	5.06	44 287
28	615.8	4.27	30 172	649.5	4.51	33 683	784	5.44	51 221
29	660.5	4.59	34 719	696.7	4.84	38 759	841	5.84	58 940
30	706.9	4.91	39 761	745.6	5.17	44 388	900	6.25	67 500
31	754.8	5.24	45 333	796.1	5.52	50 609	961	6.67	76 960
32	804.2	5.58	51 472	848.3	5.89	57 462	1 024	7.12	87 381
33	855.3	5.94	58 214	902.2	6.26	64 988	1 089	7.56	96 827
34	907.9	6.30	65 597	957.7	6.64	73 231	1 156	8.03	111 361
35	962.1	6.68	73 662	1 014.8	7.04	82 234	1 225	8.50	125 052
36	1 017.9	7.06	82 448	1 073.6	7.45	92 043	1 296	9.00	139 968
37	1 075.2	7.47	91 998	1 134.1	7.87	102 704	1 369	9.50	156 180
38	1 134.1	7.87	102 354	1 196.3	8.30	114 265	1 444	10.02	173 761
39	1 194.6	8.29	113 561	1 260.0	8.74	126 777	1 521	10.57	192 787
40	1 256.6	8.72	125 664	1 325.5	9.20	140 288	1 600	11.11	213 333

**Table 21.—Reinforced Concrete Columns.—Average Working Stresses,  $f$ .**  
 For different unit stresses in concrete and different percentages of longitudinal steel.  
 Based on  $f = f_c[1 + (n - 1)p]$ . (See p. 406.)

Ratio of Moduli of Elasticity	Ratio of Steel $p$	Allowable Average Unit Stress, $f$ , on Columns in Lb. per Sq. In.										
		$f_c = 400$	$f_c = 450$	$f_c = 500$	$f_c = 550$	$f_c = 600$	$f_c = 650$	$f_c = 700$	$f_c = 750$	$f_c = 800$	(11)	
$n$	(1)	(2)	(3)	(4)	(5)	(6)	(7)	(8)	(9)	(10)	(11)	
15	0.0075	442	497	553	608	663	718	774	829	884		
	0.0100	456	513	570	627	684	741	798	855	912		
	0.0125	470	529	588	646	705	764	823	881	940		
	0.0150	484	545	605	666	728	787	847	908	968		
	0.0175	498	560	623	685	747	809	872	934	996		
	0.0200	512	576	640	704	768	832	896	960	1 024		
	0.0225	526	592	658	723	789	855	921	986	1 052		
	0.0250	540	608	675	743	810	878	945	1 013	1 080		
	0.0275	554	623	693	762	831	900	970	1 039	1 108		
	0.0300	568	639	710	781	852	923	994	1 065	1 136		
	0.0325	582	655	728	800	873	946	1 019	1 091	1 164		
	0.0350	596	671	745	820	894	969	1 043	1 118	1 192		
	0.0375	610	686	763	839	915	991	1 068	1 144	1 220		
	0.0400	624	702	780	858	936	1 014	1 092	1 170	1 248		
	0.0425	638	718	798	877	957	1 037	1 117	1 196	1 276		
	0.0450	652	734	815	896	978	1 059	1 141	1 223	1 304		
	0.0475	666	749	833	916	999	1 082	1 165	1 249	1 332		
	0.0500	680	765	850	935	1 020	1 105	1 190	1 275	1 360		
	0.0550	708	797	885	973	1 062	1 150	1 239	1 328	1 416		
	0.0600	736	828	920	1 012	1 104	1 196	1 288	1 380	1 472		



	$f_c = 550$	$f_c = 600$	$f_c = 650$	$f_c = 700$	$f_c = 750$	$f_c = 800$	$f_c = 850$	$f_c = 900$	$f_c = 950$	$f_c = 1000$
0.0075	595	650	704	758	812	866	920	974	1028	1083
0.0100	611	666	722	777	833	888	943	999	1055	1110
0.0125	626	683	739	796	853	910	967	1024	1081	1138
0.0150	641	699	757	816	874	932	990	1048	1107	1165
0.0175	656	716	775	835	894	954	1014	1073	1133	1193
0.0200	671	732	793	854	915	976	1037	1098	1159	1220
0.0225	686	749	811	873	936	998	1060	1123	1185	1248
0.0250	701	765	829	893	957	1022	1084	1147	1211	1275
0.0275	716	782	847	912	977	1042	1107	1172	1237	1303
0.0300	732	798	865	931	998	1064	1130	1197	1263	1330
0.0325	747	813	882	950	1018	1086	1154	1222	1290	1358
0.0350	762	831	900	970	1039	1108	1177	1247	1316	1385
0.0375	777	848	918	989	1059	1130	1201	1271	1342	1413
0.0400	792	864	936	1008	1080	1152	1224	1296	1368	1440
0.0425	807	881	954	1027	1101	1174	1247	1321	1394	1468
0.0450	822	897	972	1047	1121	1196	1270	1345	1420	1495
0.0475	837	914	990	1066	1142	1218	1294	1370	1446	1523
0.0500	853	930	1007	1085	1163	1240	1317	1395	1472	1550
0.0550	883	963	1043	1124	1204	1284	1364	1444	1525	1605
0.0600	913	996	1079	1162	1245	1328	1411	1494	1577	1660

	$f_c = 600$	$f_c = 700$	$f_c = 750$	$f_c = 800$	$f_c = 850$	$f_c = 900$	$f_c = 950$	$f_c = 1000$	$f_c = 1100$
0.0075	641	747	801	854	907	961	1014	1068	1174
0.0100	654	763	818	872	926	981	1035	1090	1199
0.0125	668	779	834	890	946	1001	1057	1113	1224
0.0150	681	795	851	908	965	1022	1078	1135	1249
0.0175	695	810	868	926	984	1042	1100	1158	1273
0.0200	708	826	885	944	1002	1062	1121	1180	1298
0.0225	722	842	902	962	1022	1082	1142	1203	1323
0.0250	735	855	916	976	1036	1096	1156	1217	1338
0.0275	749	873	936	998	1060	1123	1185	1248	1372
0.0300	762	889	953	1016	1079	1143	1206	1270	1397
0.0325	776	905	969	1034	1099	1163	1228	1293	1422
0.0350	789	921	986	1052	1118	1183	1249	1315	1447
0.0375	803	936	1003	1070	1137	1204	1271	1338	1471
0.0400	816	952	1020	1088	1156	1224	1292	1360	1486
0.0425	830	968	1037	1106	1175	1244	1313	1383	1522
0.0450	843	984	1054	1124	1194	1264	1335	1405	1546
0.0475	857	999	1071	1142	1213	1285	1356	1428	1570
0.0500	870	1015	1087	1160	1232	1305	1377	1450	1595
0.0550	897	1047	1121	1196	1271	1345	1420	1495	1645
0.0600	924	1078	1155	1232	1308	1386	1463	1540	1694

Table 22.—Spiral Columns—New York Code.

$$\text{Values of } f_1 = f_c \left[ 1 + (n - 1)p + 2p_1 \frac{f_s}{f_c} \right]$$

in formula,  $P = Af_c \left[ 1 + (n - 1)p + 2p_1 \frac{f_s}{f_c} \right] = Af_1$ . (See p. 424.)

$$f_c = 600, f_s = 20\,000, n = 12.$$

Values of  $f_1$

Ratio of Spiral $p_1$	Ratio of Vertical Steel $p$ .						
	0.01	0.015	0.020	0.025	0.030	0.035	0.040
$f_c = 500 \quad f_s = 20\,000 \quad n = 15 \quad \text{mix} = 1 : 2 : 4$							
0.01	970	1 005	1 040	1 075	1 110	1 145	1 180
0.0125	1 070	1 105	1 140	1 175	1 210	1 245	1 280
0.15	1 170	1 205	1 240	1 275	1 310	1 345	1 380
0.175	1 270	1 305	1 340	1 375	1 410	1 445	1 480
0.20	1 370	1 405	1 440	1 475	1 510	1 545	1 580
$f_c = 600 \quad f_s = 20\,000 \quad n = 12 \quad \text{mix} = 1 : 1\frac{1}{2} : 3$							
0.01	1 066	1 099	1 132	1 165	1 198	1 231	1 264
0.0125	1 166	1 199	1 232	1 265	1 298	1 331	1 364
0.015	1 266	1 299	1 332	1 365	1 398	1 431	1 464
0.0175	1 366	1 399	1 432	1 465	1 498	1 531	1 564
0.020	1 466	1 499	1 532	1 565	1 598	1 631	1 664

Note: For spiral design recommended by the authors average stress  $f$  may be formed from Table 21, p. 916, for appropriate values of  $f_c$ , and tables on pp. 926 to 928 may be used for design. Pp. 929 to 934 give data applicable to all spiral columns.



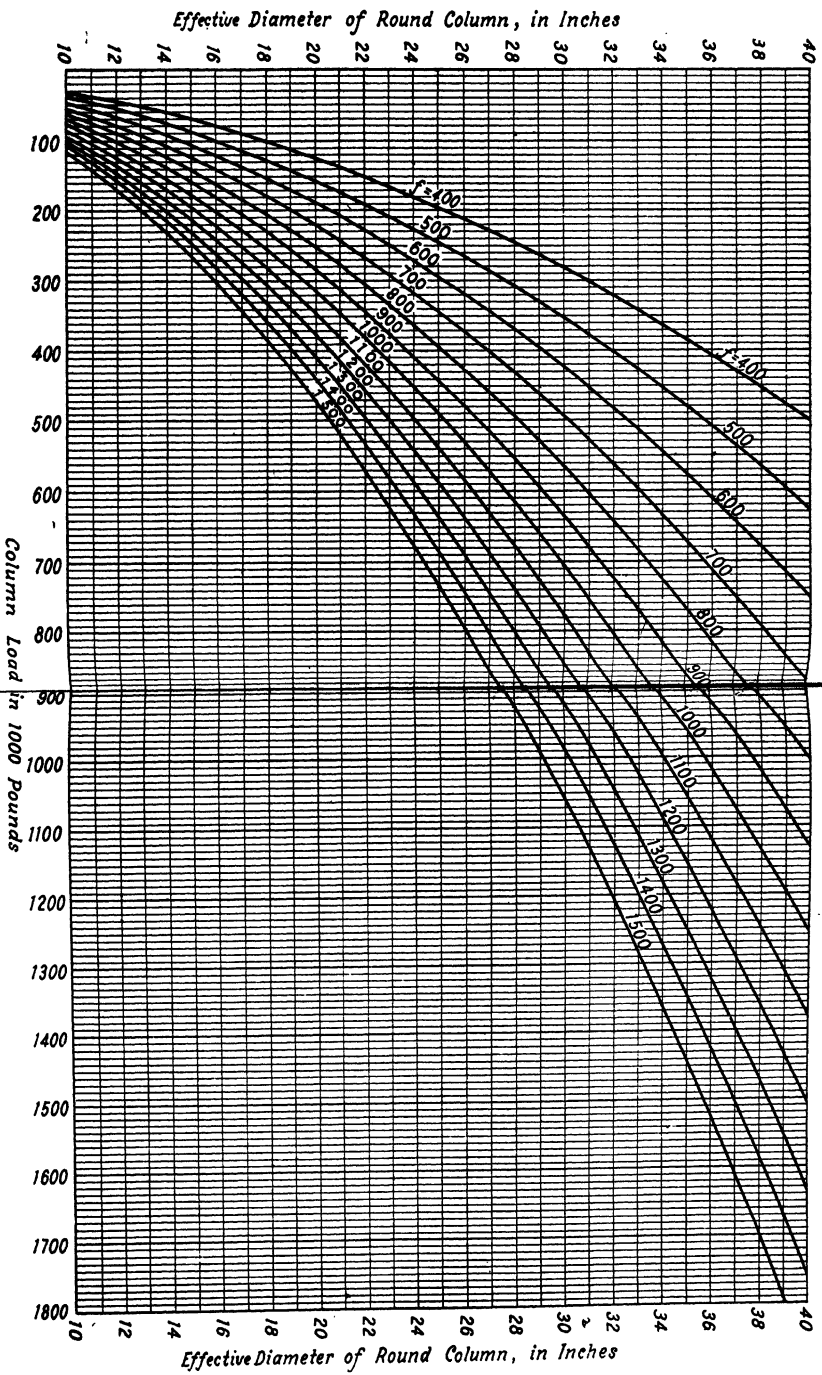

Diagram 16.—Total Loads on Round Columns for Different Average Stresses, *f*.  
 Based on Formula  $P = Af$ . (See p. 406.)

(See pages 919.)

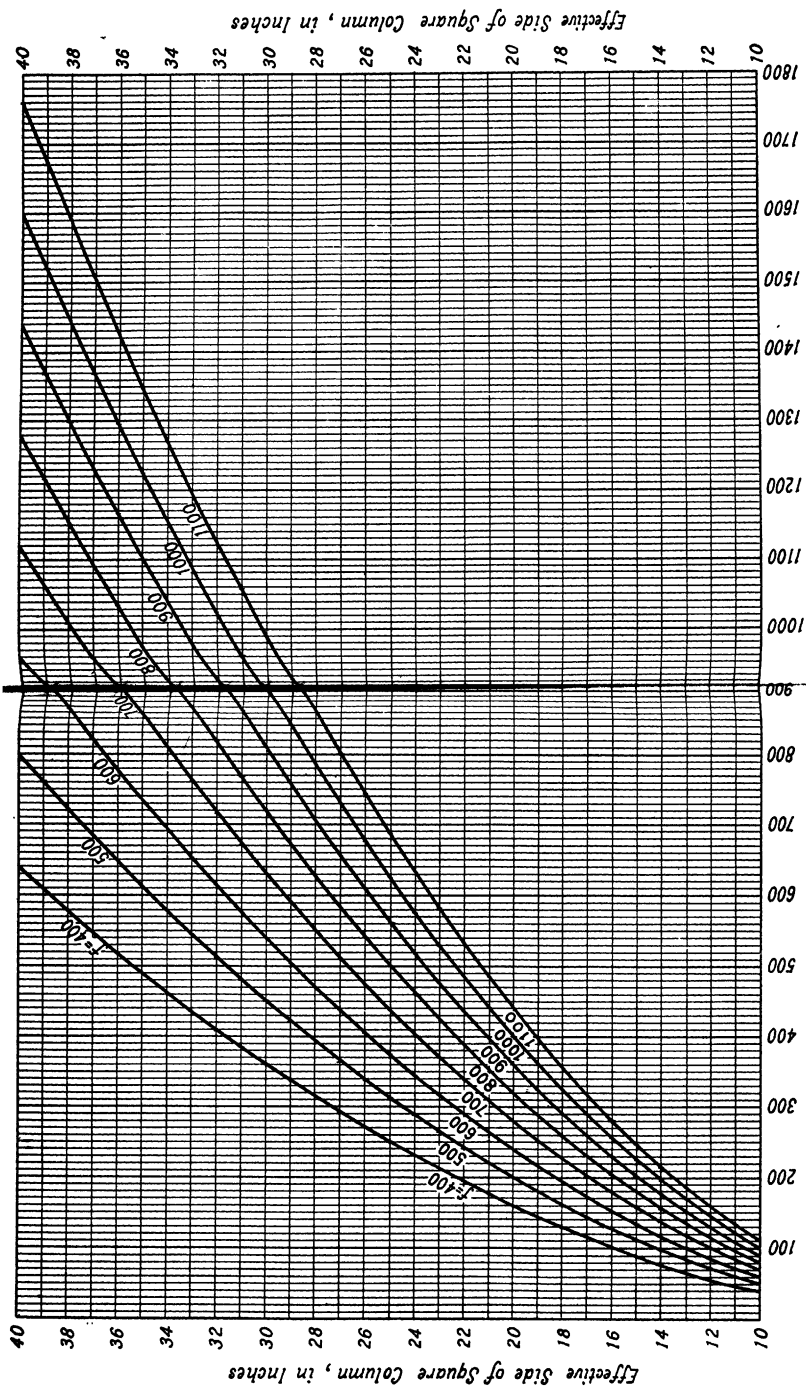

DIAGRAM 17.—Total Loads on Square Columns for Different Average Stresses  $F$ .  
Based on Formula  $P = Af$ . (See p. 406.)

(7% face page 818.)



**Table 23.—Spiral Columns—Chicago Code.**

$$\text{Values of } f_2 = f_c(1 + (n - 1)p + 2\frac{1}{2}np_1)$$

in formula,  $P = Af_c[1 + (n - 1)p + 2\frac{1}{2}np_1] = Af_2$ . (See p. 425.)

Values of  $f_2$

Ratio of Spiral $p_1$	Ratio of Vertical Steel $p$								
	0.01	0.015	0.020	0.025	0.030	0.035	0.040	0.050	0.60
$f_c = 725 \text{ lb.} \quad n = 10 \quad \text{mix } 1 : 1 : 2$									
0.005	881	913	946	979	1 011	1 044	1 076	1 142	1 207
0.0075	926	959	991	1 024	1 057	1 089	1 122	1 187	1 252
0.010	971	1 003	1 037	1 069	1 102	1 134	1 167	1 232	1 298
0.0125	.....	1 049	1 082	1 115	1 147	1 180	1 212	1 278	1 343
0.015	.....	1 095	1 127	1 160	1 192	1 225	1 258	1 323	1 388
0.0175	.....	.....	1 173	1 205	1 238	1 270	1 303	1 368	1 434
0.020	.....	.....	1 218	1 250	1 283	1 316	1 348	1 414	1 479
$f_c = 600 \quad n = 12 \quad \text{mix } 1 : 1\frac{1}{2} : 3$									
0.005	756	789	822	855	888	921	954	1 020	1 086
0.0075	801	834	867	900	933	966	999	1 065	1 131
0.010	846	879	912	945	978	1 011	1 044	1 110	1 176
0.0125	.....	924	957	990	1 023	1 056	1 089	1 155	1 221
0.015	.....	969	1 002	1 035	1 068	1 101	1 134	1 200	1 266
0.0175	.....	.....	1 047	1 080	1 113	1 146	1 179	1 245	1 311
0.020	.....	.....	1 092	1 125	1 158	1 191	1 224	1 290	1 356

Note: For spiral design recommended by the authors average stress  $f$  may be formed from Table 21, p. 916, for appropriate values of  $f_c$  and Tables on pp. 926 to 928 may be used for design. Pp. 929 to 934 give data applicable to all spiral columns.

**Table 24.—Square Columns with Vertical Reinforcement Only.**  
**Safe Loadings for Column of Various Sizes and Steel Required for Given Load.**  
 Based on  $P = Af_c[1 + (n - 1)p]$ . (See p. 406.)

Width of Columns		Ratio of Area of Steel to Effective Area of Concrete													
in.	in.	p = 0.010		p = 0.015		p = 0.020		p = 0.025		p = 0.030		p = 0.035		p = 0.040	
		Safe Load	Area of Steel	Safe Load	Area of Steel	Safe Load	Area of Steel	Safe Load	Area of Steel	Safe Load	Area of Steel	Safe Load	Area of Steel	Safe Load	Area of Steel
		1000 lb.	sq. in.	1000 lb.	sq. in.	1000 lb.	sq. in.	1000 lb.	sq. in.	1000 lb.	sq. in.	1000 lb.	sq. in.	1000 lb.	sq. in.
		P	A <sub>s</sub>	P	A <sub>s</sub>	P	A <sub>s</sub>	P	A <sub>s</sub>	P	A <sub>s</sub>	P	A <sub>s</sub>	P	A <sub>s</sub>
		Effective Width of Columns													
		in.													
		1 : 2 : 4 Concrete f <sub>c</sub> = 450 n = 15 (Authors' Recommendation)													
11	10	25	0.5	27	0.7	28	1.0	30	1.2	31	1.5	33	1.7	34	2.0
12	11	33	0.6	35	1.0	37	1.3	39	1.6	41	1.9	43	2.2	45	2.6
13	12	41	0.8	44	1.2	47	1.6	49	2.0	52	2.4	54	2.8	57	3.2
14	13	51	1.0	54	1.5	57	2.0	61	2.5	64	3.0	67	3.5	70	4.0
15	14	62	1.2	66	1.8	70	2.4	73	3.0	77	3.6	81	4.2	85	4.8
16	15	74	1.4	78	2.2	83	2.9	87	3.6	92	4.3	97	5.0	101	5.8
17	16	87	1.7	92	2.5	97	3.4	103	4.2	108	5.1	113	5.9	119	6.8
18	17	101	2.0	107	2.9	113	3.9	119	4.9	125	5.9	131	6.9	138	7.8
19	18	115	2.3	123	3.4	130	4.5	137	5.6	144	6.8	151	7.9	158	9.0
20	19	131	2.6	139	3.8	147	5.1	156	6.4	164	7.7	172	9.0	180	10.2
21	20	148	2.9	157	4.3	166	5.8	176	7.2	185	8.7	194	10.1	203	11.6
22	21	185	3.6	197	5.4	208	7.2	219	9.0	231	10.8	242	12.6	253	14.4
23	22	221	4.4	240	6.6	254	8.8	268	11.0	282	13.2	296	15.4	310	17.6
24	23	271	5.3	288	7.9	305	10.6	321	13.2	338	15.9	355	18.5	371	21.2
25	24	321	6.3	340	9.4	360	12.5	380	15.6	399	18.8	419	21.9	439	25.0
26	25	374	7.3	397	10.9	420	14.6	443	18.2	466	21.9	489	25.5	512	29.2
27	26	431	8.4	458	12.6	484	16.8	511	21.0	537	25.2	564	29.4	590	33.6
28	27	493	9.6	523	14.6	554	19.2	585	24.0	614	28.5	644	33.6	675	38.4
29	28	559	10.9	593	16.3	627	21.6	662	27.2	698	32.7	730	38.1	765	43.6
30	29	628	12.3	667	18.4	706	24.5	744	30.6	783	36.8	821	42.9	860	48.0
31	30	706	14.0	744	20.0	783	27.0	821	34.0	860	42.0	899	49.0	938	57.0
32	31	794	15.8	832	22.0	871	29.0	910	37.0	949	45.0	988	54.0	1027	63.0
33	32	893	17.8	931	24.0	970	32.0	1010	40.0	1049	49.0	1088	58.0	1127	68.0
34	33	1004	19.9	1043	26.0	1083	35.0	1122	43.0	1161	52.0	1200	62.0	1239	73.0
35	34	1127	22.2	1166	28.0	1205	38.0	1244	46.0	1283	56.0	1322	66.0	1361	78.0
36	35	1263	24.7	1302	30.0	1341	41.0	1380	49.0	1419	59.0	1458	69.0	1497	81.0
37	36	1412	27.4	1451	32.0	1490	44.0	1529	52.0	1568	62.0	1607	72.0	1646	84.0
38	37	1574	30.2	1613	34.0	1652	47.0	1691	55.0	1730	65.0	1769	75.0	1808	87.0
39	38	1749	33.1	1788	36.0	1827	50.0	1866	58.0	1905	68.0	1944	78.0	1983	90.0



**Table 25. Square Columns with Vertical Reinforcement Only**  
 Safe Loadings for Columns of Various Sizes and Steel Required for Given Load  
 Based on  $P = Af_c[1 + (n - 1)p]$ . (See p. 406.)

Width of Columns		Width of Columns		Effective Width of Columns		Ratio of Area of Steel to Effective Area of Concrete															
in.		in.		in.		$p = 0.010$		$p = 0.015$		$p = 0.020$		$p = 0.025$		$p = 0.030$		$p = 0.035$		$p = 0.040$			
in.	in.	in.	in.	in.	in.	Safe Load	Area of Steel	Safe Load	Area of Steel	Safe Load	Area of Steel	Safe Load	Area of Steel	Safe Load	Area of Steel	Safe Load	Area of Steel	Safe Load	Area of Steel		
						$P$	$A_s$	$P$	$A_s$	$P$	$A_s$	$P$	$A_s$	$P$	$A_s$	$P$	$A_s$	$P$	$A_s$	$P$	$A_s$
						1000 lb	sq. in.	1000 lb	sq. in.	1000 lb	sq. in.	1000 lb	sq. in.	1000 lb	sq. in.	1000 lb	sq. in.	1000 lb	sq. in.	1000 lb	sq. in.
11	10	7	10	31	0.5	32	0.7	34	1.0	36	1.2	37	1.5	39	1.7	40	2.0	40	2.0	40	2.0
12	11	8	11	40	0.6	42	1.0	44	1.3	46	1.6	48	1.9	50	2.2	52	2.6	52	2.6	52	2.6
13	12	9	12	51	0.8	54	1.2	56	1.6	59	2.0	61	2.4	64	2.8	66	3.2	66	3.2	66	3.2
14	13	10	13	63	1.0	66	1.5	69	2.0	73	2.5	76	3.0	79	3.5	82	4.0	82	4.0	82	4.0
15	14	11	14	77	1.2	80	1.8	84	2.4	88	3.0	92	3.6	96	4.2	99	4.8	99	4.8	99	4.8
16	15	12	15	91	1.4	96	2.2	100	2.9	105	3.6	109	4.3	114	5.0	118	5.8	118	5.8	118	5.8
17	16	13	16	107	1.7	112	2.5	118	3.4	123	4.2	128	5.1	133	5.9	139	6.8	139	6.8	139	6.8
18	17	14	17	124	2.0	130	2.9	136	3.9	142	4.9	149	5.9	155	6.9	161	7.8	161	7.8	161	7.8
19	18	15	18	142	2.3	149	3.4	156	4.5	164	5.6	171	6.8	178	7.9	185	9.0	185	9.0	185	9.0
20	19	16	19	162	2.6	170	3.8	178	5.1	186	6.4	194	7.7	202	9.0	210	10.2	210	10.2	210	10.2
21	20	17	20	183	2.9	192	4.3	201	5.8	210	7.2	219	8.7	228	10.1	237	11.6	237	11.6	237	11.6
22	21	18	21	208	3.2	204	5.4	251	7.2	262	9.0	274	10.8	285	12.6	296	14.4	296	14.4	296	14.4
23	22	19	22	228	3.6	240	6.0	307	8.8	321	11.0	334	13.6	348	15.4	362	17.6	362	17.6	362	17.6
24	23	20	23	279	4.4	293	7.9	368	10.6	385	13.2	401	16.0	418	18.5	434	21.2	434	21.2	434	21.2
25	24	21	24	335	5.3	351	9.4	435	12.5	454	15.6	471	18.8	493	21.9	513	25.0	513	25.0	513	25.0
26	25	22	25	395	6.3	415	9.4	507	14.6	530	18.2	553	21.9	576	25.5	598	29.2	598	29.2	598	29.2
27	26	23	26	461	7.3	494	10.9	507	16.8	530	21.0	553	25.0	576	29.4	600	33.6	600	33.6	600	33.6
28	27	24	27	532	8.4	559	12.6	585	18.8	611	24.0	638	28.5	664	33.6	690	38.4	690	38.4	690	38.4
29	28	25	28	608	9.6	638	14.4	668	19.2	698	24.0	729	32.7	759	38.1	789	43.0	789	43.0	789	43.0
30	29	26	29	689	10.9	725	16.3	757	21.8	791	27.2	826	32.7	860	38.1	894	43.0	894	43.0	894	43.0
31	30	27	30	775	12.3	814	18.4	852	24.5	890	30.6	929	36.8	967	42.9	1005	49.0	1005	49.0	1005	49.0

1 : 1½ : 3 Concrete  $f_c = 570$   $n = 12$  (Authors' Recommendation)

**Table 26. Square Columns with Vertical Reinforcement Only**  
**Safe Loadings for Columns of Various Sizes and Steel Required for Given Load**  
 Based on  $P = Af_c[1 + (n - 1)p]$ . (See p. 406.)

Width of Column		Ratio of Area of Steel to Effective Area of Concrete													
in.	in.	p = 0.010		p = 0.015		p = 0.020		p = 0.025		p = 0.030		p = 0.035		p = 0.040	
		Safe Load	Area of Steel	Safe Load	Area of Steel	Safe Load	Area of Steel	Safe Load	Area of Steel	Safe Load	Area of Steel	Safe Load	Area of Steel	Safe Load	Area of Steel
		1000 lb	sq. in.	1000 lb	sq. in.	1000 lb	sq. in.	1000 lb.	sq. in.	1000 lb.	sq. in.	1000 lb	sq. in.	1000 lb.	sq. in.
Effective Width of Column		P	A <sub>s</sub>	P	A <sub>s</sub>	P	A <sub>s</sub>	P	A <sub>s</sub>	P	A <sub>s</sub>	P	A <sub>s</sub>	P	A <sub>s</sub>
in.		1000 lb. sq. in.													
11	10	36	0.5	38	0.7	39	1.0	41	1.2	42	1.5	44	1.7	45	2.0
12	11	47	0.6	49	1.0	51	1.3	53	1.6	55	1.9	57	2.2	59	2.6
13	12	60	0.8	62	1.2	65	1.6	67	2.0	70	2.4	72	2.8	75	3.2
14	13	74	1.0	77	1.5	80	2.0	83	2.5	86	3.0	89	3.5	92	4.0
15	14	90	1.2	93	1.8	97	2.4	101	3.0	104	3.6	108	4.2	112	4.8
16	15	107	1.4	111	2.2	116	2.9	120	3.6	124	4.3	129	5.0	133	5.8
17	16	125	1.7	130	2.5	136	3.4	141	4.2	146	5.1	151	5.9	156	6.8
18	17	145	2.0	151	2.9	157	3.9	163	4.9	169	5.9	175	6.9	181	7.8
19	18	167	2.3	174	3.4	181	4.5	187	5.6	194	6.8	201	7.9	208	9.0
20	19	190	2.6	198	3.8	205	5.1	213	6.4	221	7.7	229	9.0	237	10.2
21	20	214	2.9	223	4.3	232	5.8	241	7.2	250	8.7	258	10.1	267	11.6
22	21	248	3.6	259	5.4	270	7.2	281	9.0	292	10.8	303	12.6	314	14.4
23	22	297	4.4	310	6.6	324	8.8	337	11.0	351	13.2	364	15.4	378	17.6
24	23	352	5.3	368	7.9	385	10.6	401	13.2	417	15.9	433	18.5	449	21.2
25	24	403	6.3	422	9.4	442	12.5	461	15.6	480	18.8	500	21.9	519	25.0
26	25	463		482		502		521		540		559		578	
27	26														
28	27														
29	28														
30	29														
31	30	540	7.3	563	10.9	585	14.6	607	18.2	630	21.9	652	25.5	674	29.2
32	31	623	8.4	649	12.8	675	16.9	701	21.0	726	25.2	752	29.4	779	33.6
33	32	712	9.6	742	14.8	771	19.2	801	24.0	830	28.8	859	33.6	889	38.4
34	33	807	10.9	841	16.3	874	21.8	907	27.2	941	32.7	974	38.1	1007	43.6
35	34	908	12.3	946	18.4	983	24.5	1020	30.6	1058	36.8	1095	42.9	1133	49.0

1 : 1 : 2 Concrete  $f_c = 680$   $n = 10$  (Authors' Recommendation)

in in  
 11 in. Reinforcing  
 11 in. Reinforcing

**Table 27.—Round Columns with Vertical Reinforcement Only**  
**Safe Loadings for Columns of Various Sizes and Steel Required for Given Load**  
 Based on  $P = Af_c[1 + (n - 1)p]$ . (See p. 406.)

Diameter of Column	Diameter of Column	Effective Diameter of Column	Ratio of Area of Steel to Effective Area of Concrete													
			$p = 0.010$		$p = 0.015$		$p = 0.020$		$p = 0.025$		$p = 0.030$		$p = 0.035$		$p = 0.040$	
			Safe Load	Area of Steel	Safe Load	Area of Steel	Safe Load	Area of Steel	Safe Load	Area of Steel	Safe Load	Area of Steel	Safe Load	Area of Steel	Safe Load	Area of Steel
11	10	7	20	0.4	21	0.6	22	0.8	23	1.0	25	1.2	26	1.3	27	1.5
12	11	8	26	0.5	27	0.8	29	1.0	30	1.3	32	1.5	34	1.8	35	2.0
13	12	9	33	0.6	35	1.0	37	1.3	39	1.6	41	1.9	43	2.2	45	2.5
14	13	10	40	0.8	43	1.2	45	1.6	48	2.0	50	2.4	53	2.7	55	3.1
15	14	11	49	1.0	52	1.4	55	1.9	58	2.4	61	2.9	64	3.3	67	3.8
16	15	12	58	1.1	62	1.7	65	2.3	69	3.0	72	3.4	76	4.0	79	4.5
17	16	13	68	1.3	72	2.0	76	2.7	81	3.3	85	4.0	89	4.6	93	5.3
18	17	14	79	1.5	84	2.3	89	3.1	93	3.8	98	4.6	103	5.4	108	6.2
19	18	15	91	1.8	96	2.7	102	3.5	107	4.4	113	5.3	118	6.2	124	7.1
20	19	16	103	2.0	109	3.0	116	4.0	122	5.0	128	6.0	135	7.0	141	8.0
21	20	17	116	2.3	124	3.4	131	4.5	138	5.7	145	6.8	152	7.9	159	9.1
22	21	18	130	2.5	138	3.8	146	5.1	155	6.4	162	7.6	170	8.9	178	10.2
23	22	19	145	2.8	154	4.3	163	5.7	172	7.1	181	8.5	190	9.9	199	11.3
24	23	20	161	3.1	171	4.7	181	6.3	191	7.8	201	9.4	211	11.0	221	12.8
25	24	21	178	3.5	189	5.2	200	6.9	210	8.7	221	10.4	232	12.1	243	13.8
26	25	22	195	3.8	207	5.7	219	7.6	231	9.5	243	11.4	255	13.3	267	15.2
27	26	23	213	4.2	226	6.2	239	8.0	252	10.4	265	12.5	279	14.8	292	16.6
28	27	24	232	4.5	247	6.5	261	8.6	273	11.3	289	13.7	304	17.2	315	19.4
29	28	25	252	4.9	267	7.0	283	9.8	298	12.3	314	14.7	329	18.6	345	21.2
30	29	26	273	5.3	289	8.0	306	10.6	323	13.3	340	15.9	356	20.6	373	23.2
31	30	27	294	5.7	312	8.6	330	11.5	348	14.3	366	17.2	384	20.0	402	22.9
32	31	28	316	6.2	335	9.2	355	12.3	374	15.4	393	18.8	413	21.5	433	24.6
33	32	29	339	6.6	360	9.9	381	13.1	401	17.5	423	21.2	443	23.1	464	26.4
34	33	30	363	7.1	385	10.6	407	14.1	430	19.7	452	24.2	474	24.7	496	28.3
35	34	31	387	7.5	411	11.3	435	15.1	459	21.9	482	26.6	506	26.1	530	30.2
36	35	32	413	8.0	438	12.1	463	16.1	489	20.1	514	24.1	540	28.1	565	32.2
37	36	33	439	8.6	466	12.8	493	17.1	520	21.4	547	25.7	574	29.8	600	34.2
38	37	34	465	9.1	494	13.6	523	18.5	551	22.7	580	27.2	608	31.8	637	36.3
39	38	35	494	9.6	524	14.4	554	19.2	585	24.1	615	28.9	645	33.7	675	38.5

2 in. Fireproofing  
 1 1/2 in. Fireproofing



**Table 29. Round Columns with Vertical Reinforcement Only**  
**Safe Loadings for Columns of Various Sizes and Steel Required for Given Load**  
 Based on  $P = Af_c[1 + (n - 1)p]$ . (See p. 406.)

Diameter of Column		Ratio of Area of Steel to Effective Area of Concrete													
in.	Diameter of Column	p = 0.010		p = 0.015		p = 0.020		p = 0.025		p = 0.030		p = 0.035		p = 0.040	
		Safe Load	Area of Steel	Safe Load	Area of Steel	Safe Load	Area of Steel	Safe Load	Area of Steel	Safe Load	Area of Steel	Safe Load	Area of Steel	Safe Load	Area of Steel
Effective Diameter of Column		1000 lb. sq in. 1000 lb. sq in.		1000 lb. sq in. 1000 lb. sq in.		1000 lb. sq in. 1000 lb. sq in.		1000 lb. sq in. 1000 lb. sq in.		1000 lb. sq in. 1000 lb. sq in.		1000 lb. sq in. 1000 lb. sq in.		1000 lb. sq in. 1000 lb. sq in.	
in.		P	A <sub>s</sub>	P	A <sub>s</sub>	P	A <sub>s</sub>	P	A <sub>s</sub>	P	A <sub>s</sub>	P	A <sub>s</sub>	P	A <sub>s</sub>
1 : 1.2 Concrete. f <sub>c</sub> = 680 n = 10 (Authors' Recommendation)															
11	10	28	0.4	30	0.6	31	0.8	32	1.0	33	1.2	34	1.3	36	1.5
12	11	37	0.5	39	0.8	40	1.0	42	1.3	43	1.5	45	1.8	48	2.0
13	12	47	0.6	49	1.0	51	1.3	53	1.6	55	1.9	57	2.2	59	2.5
14	13	58	0.8	61	1.2	63	1.6	65	2.0	68	2.4	70	2.7	73	3.1
15	14	70	1.0	73	1.4	76	1.9	79	2.4	82	2.9	85	3.3	88	3.8
16	15	84	1.2	87	1.7	91	2.3	94	2.9	98	3.4	101	4.0	105	4.5
17	16	98	1.5	102	2.0	107	2.7	111	3.3	115	4.0	119	4.6	123	5.3
18	17	114	1.8	119	2.5	124	3.5	128	4.4	133	5.3	138	5.4	142	6.2
19	18	131	2.0	135	2.7	142	4.4	147	5.0	153	6.0	158	6.2	163	7.1
20	19	149	2.0	155	3.0	161	4.0	167	5.0	174	6.0	180	7.0	186	8.0
21	20	168	2.2	175	3.4	182	4.5	189	5.7	196	6.8	203	7.9	210	9.1
22	21	186	2.5	195	3.8	203	5.1	212	6.4	220	7.6	228	8.9	236	10.2
23	22	205	2.8	215	4.5	223	5.7	232	7.1	240	8.5	254	9.9	262	11.3
24	23	225	3.0	242	4.7	252	6.3	262	7.9	271	9.4	281	11.0	290	12.6
25	24	257	3.5	267	5.2	278	6.9	289	8.7	299	10.4	310	12.1	320	13.8
26	25	282	3.8	293	5.7	305	7.6	317	9.5	328	11.4	340	13.3	352	15.2
27	26	308	4.2	321	6.2	333	8.3	346	10.4	359	12.5	372	14.5	384	16.6
28	27	336	4.5	351	6.5	363	9.0	377	11.3	391	13.6	405	15.8	419	18.1
29	28	364	4.8	379	7.4	394	9.8	409	13.3	424	15.7	439	17.2	454	19.6
30	29	394	5.3	410	8.0	426	10.6	442	13.3	459	15.9	475	18.6	491	21.2
31	30	424	5.7	442	8.6	459	11.5	477	14.3	494	17.2	512	20.0	530	22.9
32	31	457	6.2	475	9.2	493	12.3	513	15.4	532	18.5	551	21.5	570	24.6
33	32	490	6.9	510	9.9	529	13.2	550	16.5	571	19.8	591	23.1	611	26.4
34	33	524	7.5	545	10.6	567	15.1	588	17.7	610	21.2	632	24.7	654	28.3
35	34	560	7.5	583	11.3	606	15.1	629	18.9	652	22.6	675	26.4	698	30.2
36	35	596	8.0	620	12.1	645	16.1	670	20.1	694	24.1	719	28.1	743	32.2
37	36	634	8.6	660	12.8	686	17.1	713	21.4	739	25.7	765	29.0	791	34.2
38	37	673	9.1	700	13.6	728	18.1	758	22.7	784	27.2	811	31.8	839	36.3
39	38	713	9.6	743	14.4	772	19.2	802	24.1	821	28.9	860	33.7	890	38.5

**Table 30. Round Spiral Columns with Vertical Reinforcement and 1% Spiral**  
 Based on  $P = Af_c[1 + (n - 1)p]$ . (See p. 421.) Required Spiral given in Table 33, p. 929.

Diameter of Column	Diameter of Column	Ratio of Area of Vertical Steel to Effective Area of Concrete																			
		p = 0.010		p = 0.015		p = 0.020		p = 0.025		p = 0.030		p = 0.035		p = 0.040		p = 0.045		p = 0.050		p = 0.060	
	Effective Diameter of Column	Safe Load	Area of Steel	Safe Load	Area of Steel	Safe Load	Area of Steel	Safe Load	Area of Steel	Safe Load	Area of Steel	Safe Load	Area of Steel	Safe Load	Area of Steel	Safe Load	Area of Steel	Safe Load	Area of Steel	Safe Load	Area of Steel
	in.	lb.	sq. in.	lb.	sq. in.	lb.	sq. in.	lb.	sq. in.	lb.	sq. in.	lb.	sq. in.	lb.	sq. in.	lb.	sq. in.	lb.	sq. in.	lb.	sq. in.
11	10	31	0.4	32	0.6	34	0.8	36	1.0	38	1.2	40	1.3	42	1.5	44	1.7	46	1.9	48	2.3
12	11	51	0.6	52	0.8	48	1.0	47	1.3	50	1.5	52	1.8	55	2.0	57	2.3	60	2.5	65	3.0
13	12	61	0.5	64	1.0	57	1.3	60	1.6	63	1.9	66	2.2	70	2.5	72	2.9	76	3.2	82	3.8
14	13	63	0.8	66	1.2	70	1.6	74	2.0	78	2.4	82	2.7	86	3.1	89	3.5	93	3.9	101	4.7
15	14	76	1.0	80	1.4	85	1.9	90	2.4	94	2.9	99	3.3	104	3.8	108	4.3	113	4.8	122	5.7
16	15	90	1.1	96	1.7	101	2.3	106	2.8	112	3.4	117	4.0	123	4.5	129	5.1	134	5.7	145	6.8
17	16	105	1.3	112	2.0	118	2.7	124	3.3	131	4.0	137	4.6	144	5.3	150	6.0	157	6.6	170	8.0
18	17	122	1.5	130	2.3	137	3.1	145	3.8	153	4.6	159	5.4	168	6.2	174	6.9	182	7.7	197	9.2
19	18	140	1.8	149	2.7	158	3.5	167	4.4	175	5.3	183	6.2	192	7.1	200	8.0	209	8.8	227	10.6
20	19	160	2.0	170	3.0	180	4.0	190	5.0	200	6.0	209	7.0	220	8.0	229	9.0	239	10.1	259	12.1
21	20	181	2.3	191	3.4	203	4.5	213	5.7	225	6.8	235	7.9	247	9.1	257	10.2	269	11.3	291	13.6
22	21	203	2.5	215	3.8	228	5.1	240	6.4	253	7.6	265	8.9	278	10.2	290	11.4	303	12.7	327	15.0
23	22	225	2.8	231	4.3	243	5.7	257	7.1	281	8.5	295	9.9	309	11.3	322	12.8	337	14.2	365	17.3
24	23	251	3.1	266	4.7	282	6.3	297	7.8	312	9.4	328	11.0	343	12.6	359	14.1	374	15.7	405	18.8
25	24	276	3.5	293	5.2	310	6.9	327	8.7	344	10.4	360	12.1	378	13.8	394	15.6	412	17.3	445	20.8
26	25	303	3.8	322	5.7	340	7.6	359	9.5	378	11.4	396	13.3	415	15.2	434	17.1	452	19.0	489	22.6
27	26	331	4.2	351	6.2	372	8.3	392	10.4	412	12.5	432	14.5	453	16.6	473	18.7	494	20.8	535	24.9
28	27	361	4.5	384	6.8	406	9.0	428	11.4	450	13.6	472	15.8	494	18.1	517	20.3	538	22.6	583	27.1
29	28	391	4.9	415	7.4	440	9.8	463	12.3	487	14.7	510	17.2	536	19.5	558	22.1	583	24.5	632	29.1
30	29	424	5.3	450	8.0	476	10.6	502	13.3	528	15.9	556	18.6	580	21.2	606	23.9	632	26.5	684	31.8
31	30	456	5.7	484	8.6	513	11.5	541	14.3	569	17.2	595	20.0	625	23.9	652	25.8	680	28.6	737	34.4
32	31	491	6.2	522	9.2	552	12.3	582	15.4	612	18.5	642	21.5	672	24.6	702	27.7	733	30.8	793	36.9
33	32	527	6.6	559	9.6	593	13.2	623	16.5	654	19.9	686	23.1	719	26.8	752	29.7	786	33.0	850	39.6
34	33	564	7.1	598	10.6	634	14.1	668	17.7	703	21.2	738	24.7	772	28.3	807	31.8	841	35.3	911	42.4
35	34	600	7.5	638	11.3	676	15.1	713	18.9	750	22.6	789	26.4	824	30.2	860	34.0	896	37.7	970	45.3
36	35	642	8.0	681	12.1	721	16.1	760	20.1	799	24.1	839	28.1	878	32.2	918	36.2	957	40.2	1086	48.3
37	36	681	8.6	720	12.8	760	17.1	803	25.7	850	25.7	890	29.9	934	34.2	974	38.5	1015	42.8	1100	51.3
38	37	724	9.1	768	13.6	813	18.1	857	22.7	902	27.9	946	31.8	991	36.3	1035	40.8	1079	45.4	1188	54.5
39	38	766	9.6	814	14.4	863	19.2	909	24.1	956	28.9	1000	33.7	1050	43.3	1095	43.3	1145	48.1	1280	57.7

2 in. Preproofing

1 in. Preproofing

**Table 31. Round Spiral Columns with Vertical Reinforcement and 1% Spiral**  
Based on  $P = Af_c[1 + (n - 1)p]$ . (See p. 421.) Required Spiral given in Table 33, p. 929.

Diameter of Column	Diameter of Column	Ratio of Area of Vertical Steel to Effective Area of Concrete																			
		p = 0.010		p = 0.015		p = 0.020		p = 0.025		p = 0.030		p = 0.035		p = 0.040		p = 0.045		p = 0.050		p = 0.060	
		Area of Load Steel	Safe Load	Area of Load Steel	Safe Load	Area of Load Steel	Safe Load	Area of Load Steel	Safe Load	Area of Load Steel	Safe Load	Area of Load Steel	Safe Load	Area of Load Steel	Safe Load	Area of Load Steel	Safe Load	Area of Load Steel	Safe Load	Area of Load Steel	Safe Load
11	10	38	0.4	40	0.6	42	0.8	44	1.0	45	1.2	47	1.3	49	1.5	51	1.7	53	1.9	57	2.3
12	11	50	0.5	52	0.8	54	1.0	57	1.3	59	1.5	62	1.8	64	2.0	67	2.3	69	2.5	74	3.0
13	12	63	0.6	66	1.0	69	1.3	72	1.6	75	1.9	78	2.2	82	2.5	85	2.9	88	3.2	94	3.8
14	13	78	0.8	81	1.2	85	1.6	89	2.0	93	2.4	97	3.0	101	3.1	105	3.5	108	3.9	116	4.7
15	14	94	1.0	98	1.4	100	1.9	108	2.4	113	2.9	117	3.7	122	3.8	127	4.3	131	4.8	141	5.7
16	15	111	1.1	117	1.7	123	2.3	128	2.8	134	3.4	140	4.0	145	4.5	151	5.1	156	5.7	167	6.8
17	16	130	1.3	137	2.0	143	2.7	150	3.3	157	4.0	164	4.6	170	5.3	177	6.0	183	6.6	196	8.0
18	17	151	1.5	159	2.3	166	3.1	174	3.8	182	4.6	190	5.4	198	6.2	205	6.9	212	7.7	227	9.2
19	18	173	1.8	182	2.7	191	3.5	200	4.4	209	5.3	218	6.2	227	7.1	235	8.0	244	8.8	261	10.6
20	19	198	2.0	208	3.0	218	4.0	228	5.0	238	6.0	248	7.0	258	8.0	268	9.0	277	10.1	297	12.1
21	20	223	2.3	234	3.4	245	4.5	256	5.7	269	6.8	280	7.9	291	9.1	302	10.2	313	11.3	335	13.6
22	21	251	2.5	264	3.8	276	5.1	288	6.4	301	7.6	313	8.9	325	10.2	338	11.4	350	12.7	375	15.3
23	22	279	2.8	293	4.3	307	5.7	322	7.1	336	8.5	350	9.9	364	11.3	377	12.8	391	14.2	419	17.0
24	23	310	3.1	325	4.7	340	6.3	356	7.8	371	9.4	386	11.0	402	12.6	417	14.1	432	15.7	463	18.8
25	24	342	3.5	359	5.2	376	6.9	392	8.7	410	10.4	427	12.1	444	13.8	461	15.6	478	17.3	512	20.8
26	25	375	3.8	394	5.7	412	7.6	431	9.5	449	11.4	468	13.3	487	15.2	505	17.1	524	19.0	561	22.8
27	26	410	4.2	430	6.2	450	8.3	471	10.4	492	12.5	512	14.5	533	16.6	552	18.7	574	20.8	614	24.9
28	27	447	4.5	469	6.8	492	9.0	514	13.3	536	13.6	558	15.8	580	18.1	602	20.3	625	22.6	669	29.1
29	28	484	4.9	508	7.4	531	9.8	557	12.3	580	14.7	604	17.2	623	19.6	652	22.1	676	24.5	724	29.5
30	29	524	5.3	550	8.0	576	10.6	602	13.3	628	15.9	654	18.6	680	21.2	706	23.9	732	26.5	784	31.8
31	30	564	5.7	593	8.6	620	11.5	650	14.3	678	17.2	706	20.0	735	22.9	762	25.8	790	28.6	846	34.4
32	31	608	6.0	638	9.2	669	12.2	699	15.4	729	18.5	759	21.5	789	24.6	819	27.7	849	30.8	910	36.9
33	32	650	6.6	685	9.9	715	13.2	750	16.5	782	19.8	814	23.1	848	26.4	878	29.7	917	33.0	976	39.6
34	33	698	7.1	733	10.6	767	14.1	802	17.7	837	21.2	871	24.7	906	28.3	940	31.8	975	35.3	1044	42.4
35	34	745	7.5	782	11.3	820	15.1	850	18.9	893	22.6	930	26.4	968	30.2	1004	34.0	1041	37.7	1115	45.3
36	35	795	8.0	834	12.1	874	16.1	913	20.1	952	24.1	992	28.1	1031	32.2	1070	36.2	1110	40.2	1188	48.2
37	36	845	8.6	885	12.8	927	17.1	970	21.1	1011	25.7	1054	29.9	1096	34.2	1137	38.5	1180	42.8	1262	51.3
38	37	897	9.1	941	13.6	986	18.1	1030	22.7	1075	27.1	1119	31.8	1163	36.3	1208	40.8	1252	45.4	1341	54.5
39	38	950	9.6	998	14.4	1060	19.2	1090	24.1	1138	28.9	1185	33.7	1235	38.5	1280	43.3	1328	48.1	1430	57.7

1.  $f_c$ : 3 Concrete  $f_c = 890$  n : 12 (Author's Recommendation)

2 in. Preprobing  
1 in. Preprobing

**Table 32. Round Spiral Columns with Vertical Reinforcement and 1% Spiral**  
 Based on  $P = Af_c[1 + (n - 1)p]$ . (See p. 421.) Required Spiral given in Table 33, p. 929.

Diameter of Column	Diameter of Column	Ratio of Area of Vertical Steel to Effective Area of Concrete																			
		p = 0.010		p = 0.015		p = 0.020		p = 0.025		p = 0.030		p = 0.035		p = 0.040		p = 0.045		p = 0.050		p = 0.060	
		Area of Load Steel	Safe Load	Area of Load Steel	Safe Load	Area of Load Steel	Safe Load	Area of Load Steel	Safe Load	Area of Load Steel	Safe Load	Area of Load Steel	Safe Load	Area of Load Steel	Safe Load	Area of Load Steel	Safe Load	Area of Load Steel	Safe Load	Area of Load Steel	Safe Load
11	10	44	0.4	46	0.6	48	0.8	50	1.0	52	1.2	54	1.3	55	1.5	57	1.7	59	1.9	63	2.3
12	11	58	0.5	60	0.8	63	1.0	65	1.3	68	1.5	70	1.8	72	2.0	75	2.3	77	2.5	82	3.0
13	12	74	0.6	77	1.0	80	1.3	83	1.6	86	1.9	89	2.2	92	2.5	95	2.9	98	3.2	104	3.8
14	13	91	0.8	94	1.2	98	1.6	102	2.0	106	2.4	110	2.7	113	3.1	117	3.5	121	3.8	128	4.7
15	14	110	1.0	114	1.4	119	1.9	123	2.4	128	2.9	132	3.3	137	3.8	142	4.3	146	4.8	155	5.7
16	15	131	1.1	136	1.7	142	2.3	147	2.8	152	3.4	158	4.0	163	4.5	169	5.1	174	5.7	185	6.8
17	16	153	1.3	160	2.0	166	2.7	172	3.3	179	4.0	185	4.6	192	5.3	198	6.0	204	6.6	217	8.0
18	17	178	1.5	185	2.3	192	3.1	200	3.8	207	4.6	214	5.4	222	6.2	229	6.9	237	7.7	251	9.2
19	18	204	1.8	213	2.7	221	3.5	230	4.4	238	5.3	246	6.2	255	7.1	263	8.0	272	8.8	289	10.6
20	19	232	2.0	242	3.0	251	4.0	261	5.0	271	6.0	280	7.0	290	8.0	299	9.0	309	10.1	328	12.1
21	20	252	2.3	273	3.4	284	4.5	295	5.7	305	6.8	316	7.9	327	9.1	338	10.2	349	11.3	370	13.6
22	21	294	2.5	306	3.8	319	5.1	331	6.4	343	7.6	355	8.9	367	10.2	379	11.4	391	12.2	416	15.3
23	22	328	2.8	341	4.3	354	5.7	368	7.1	382	8.5	395	9.9	409	11.3	422	12.8	436	14.2	463	17.0
24	23	363	3.1	375	4.7	393	6.3	408	7.8	423	9.4	438	11.0	453	12.6	468	14.1	483	15.7	513	18.8
25	24	400	3.5	417	5.2	433	6.9	450	8.7	466	10.4	483	12.1	500	13.8	516	15.6	532	17.3	566	20.8
26	25	430	3.8	457	5.7	476	7.6	494	9.5	512	11.4	530	13.3	548	15.2	566	17.1	584	19.0	621	22.8
27	26	480	4.2	500	6.2	520	8.2	540	10.4	559	12.5	579	14.5	600	16.6	618	18.7	638	20.6	678	24.9
28	27	522	4.5	543	6.8	566	9.0	588	11.3	610	13.6	633	15.8	653	18.1	674	20.3	696	22.6	739	27.1
29	28	567	5.0	590	7.4	613	9.8	637	12.3	660	14.7	684	17.2	708	19.6	740	22.1	754	24.5	801	29.5
30	29	614	5.3	639	8.0	664	10.6	690	13.3	715	15.9	740	18.6	766	21.2	791	23.9	816	26.5	867	31.8
31	30	662	5.7	689	8.6	716	11.5	744	14.3	771	17.2	798	20.0	826	22.9	852	25.8	880	28.6	936	34.4
32	31	712	6.2	741	9.2	771	12.3	800	15.4	829	18.5	859	21.5	888	24.6	917	27.7	947	30.8	1006	36.9
33	32	764	6.6	795	9.9	826	13.2	858	19.8	890	19.8	920	25.1	950	26.3	980	29.7	1021	33.0	1078	39.6
34	33	816	7.1	850	10.6	884	14.1	916	17.7	951	21.2	985	24.7	1019	28.3	1052	31.8	1086	35.3	1153	42.4
35	34	872	7.5	908	11.3	944	15.1	980	18.9	1015	22.6	1051	26.4	1089	30.2	1123	34.0	1160	37.7	1231	45.3
36	35	929	8.0	967	12.1	1005	16.1	1044	20.1	1082	24.1	1120	28.1	1159	32.2	1197	36.2	1235	40.2	1312	48.2
37	36	989	8.6	1028	12.8	1068	17.1	1110	21.4	1150	25.7	1191	29.9	1233	34.2	1272	38.5	1312	42.6	1395	51.5
38	37	1048	9.1	1092	13.6	1135	18.1	1178	22.7	1222	27.2	1265	31.6	1308	36.3	1351	40.8	1393	45.1	1481	54.5
39	38	1112	9.6	1156	14.4	1202	19.2	1249	24.1	1295	28.9	1340	33.7	1389	38.5	1433	43.3	1480	48.1	1570	57.7

2 in. Pretopping

1 in. Pretopping



Table 33.—Column Spiral—Forming One Per Cent of Core.

Diameter of Core, In.	Diameter of Wire											
	1/4-In.		3/8-In.		1/2-In.		5/8-In.		3/4-In.		7/8-In.	
	Pitch, In	Per Cent	Pitch, In	Per Cent	Pitch, In	Per Cent	Pitch, In.	Per Cent	Pitch, In	Per Cent	Pitch, In.	Per Cent
8	2 1/4	1 09	3 1/4	1 02								
9	2	1 09	3 1/4	1 05								
10	2	0 98	3	1 02								
11	1 1/4	1.02	2 1/4	1 01								
12	1 1/4	1 09	2 1/4	1 02								
13	1 1/4	1 01	2 1/4	1 05								
14	1 1/4	1.12	2 1/4	0 98	3	1 05						
15	1 1/4	1.05	2	1.02	3	0 98						
16	1 1/4	0 98	1 1/4	1 10	2 1/4	1.00						
17	.		1 1/4	1 03	2 1/4	1 04						
18	.		1 1/4	0 98	2 1/4	0 98						
19	.		1 1/4	1 08	2 1/4	1 03	3	1 06				
20	.		1 1/4	1 02	2 1/4	0.98	3	1 00				
21	.		1 1/4	0 98	2	1 05	2 1/4	1 04				
22	.		1 1/4	1 11	2	1 00	2 1/4	0 99				
23	.		1 1/4	1 07	2	0 96	2 1/4	1 05				
24	.		1 1/4	1 02	1 1/4	1 05	2 1/4	1 00	3	1 09		
25	.		1 1/4	0 98	1 1/4	1 01	2 1/4	1 07	3	1 05		
26	.		..	..	1 1/4	0 97	2 1/4	1 03	3	1 01		
27	.		..	..	1 1/4	1 09	2 1/4	0 99	3	0 97		
28	.		..	..	1 1/4	1 05	2 1/4	0.95	2 1/4	1 02		
29	.		.	.	1 1/4	1.02	2	1 04	2 1/4	0 99		
30	.		.	.	1 1/4	0 98	2	1 00	2 1/4	1 05		
31	.		.	.	.	.	2	0 97	2 1/4	1 01		
32	.		.	.	.	.	1 1/4	1 07	2 1/4	0 98	3	1 04
33	.		.	.	.	.	1 1/4	1 04	2 1/4	1 06	3	1 00
34	.		.	.	.	.	1 1/4	1 01	2 1/4	1 03	3	0.98
35	.		.	.	.	.	1 1/4	0 98	2 1/4	1 00	2 1/4	1.03
36	.		.	.	.	.	1 1/4	1 11	2 1/4	0 97	2 1/4	1 00
37	.		.	.	.	.	1 1/4	1 08	2	1 06	2 1/4	0 98
38	..		.	.	.	.	1 1/4	1 05	2	1.03	2 1/4	1.05
39	.		.	.	.	.	1 1/4	1 03	2	1 01	2 1/4	1.02
40	.		.	.	.	.	1 1/4	1 00	2	0 98	2 1/4	0 99

This table gives arrangement of spiral for which the ratio of volume of spiral to volume of concrete core is practically 0 01. These spirals may be used in columns designed according to the author's recommendations on p. 421, and the rules of the Cities of Boston, Cleveland, and Philadelphia, given on p. 422.

**Use of Tables 34 to 36.**—Tables 34 to 36 give values of  $p_1A$  which are equivalent areas of vertical steel having same volume as the volume of spiral. They were computed from Formula (37), p. 432 and may be used for solving following problems:

1. Find required pitch of spiral, when ratio of spiral,  $p_1$ , and diameter of core are given. In solving, take from the second column of the table the area of core,  $A$ , corresponding to the given diameter. Multiply this by the given  $p_1$  to get the value of  $p_1A$ . Select tentatively diameter of wire for spiral. In the table for the selected size of wire find the pitch corresponding to the diameter of core and the value of  $p_1A$ . If the pitch is too small (or too large) use heavier (or lighter) wire.

2. Design Spiral Column by New York Code. The load attributed to the spiral in New York Code formulas may be found by multiplying the value  $p_1A$ , from the table by 40 000 lb.

If diameter of column core is known (or assumed) the ratio of vertical steel may be accepted and the load carried by concrete and vertical steel found from  $P_1 = Af_c[1 + (n - 1)p]$  or  $Af$ . Table 21 may be used to find  $f$  and Diagram 16 to find  $P_1$ . If the total load is  $P$ , the difference to be resisted by spiral is  $P - P_1$ . Dividing this by 40 000, the value of  $p_1A$  is obtained. This value located in any one of the tables, opposite the diameter of the core, gives the diameter and pitch of spiral. The best arrangement of spiral should be selected.

The problem may also be solved by accepting the diameter of wire and pitch of spiral and finding the value of  $p_1A$ . This multiplied by 40 000 lb. gives the load resisted by the spiral. To this add the load resisted by the concrete alone (area of core multiplied by 600 lb.). Deduct this sum from the total column load and divide by 6 600 lb. (for 1 : 1½ : 3 mix). This gives the area of vertical steel.

3. Design spiral column by Chicago Code. The methods given above also may be used with proper modification to design columns according to the Chicago Code.

Table 34.—Values of  $p_1A$  in Spiral Columns.

Where  $p_1$  = Ratio of Spiral and  $A$  = Area of Concrete Core  
 These Values are Equivalent Areas of Vertical Steel having Same Volume as the  
 Volume of Spiral

$\frac{3}{8}$ -in. Wire

Diameter of Core $d$	Area of Core $A$	Pitch of $\frac{3}{8}$ Wire						
		1.5	1.75	2.0	2.25	2.5	2.75	3.0
10	78.5	2.31	1.98	1.73	1.54	1.39	1.26	1.15
11	95.2	2.54	2.18	1.91	1.67	1.53	1.39	1.27
12	113.1	2.78	2.38	2.08	1.85	1.67	1.52	1.39
13	132.7	2.99	2.56	2.24	1.99	1.80	1.63	1.49
14	153.9	3.22	2.76	2.41	2.14	1.93	1.76	1.61
15	176.7	3.45	2.95	2.58	2.29	2.07	1.89	1.72
16	201.1	3.68	3.15	2.76	2.45	2.21	2.01	1.84
17	227.0	3.91	3.35	2.93	2.60	2.35	2.14	1.95
18	254.5	4.14	3.55	3.10	2.76	2.49	2.26	2.07
19	283.5	4.37	3.74	3.27	2.91	2.62	2.39	2.18
20	314.2	4.60	3.94	3.45	3.06	2.76	2.51	2.30
21	346.4	4.83	4.14	3.62	3.22	2.90	2.64	2.41
22	380.1	5.06	4.33	3.79	3.37	3.04	2.77	2.53
23	415.5	5.29	4.53	3.96	3.52	3.18	2.89	2.64
24	452.4	5.52	4.73	4.14	3.68	3.31	3.02	2.76
25	490.9	5.75	4.92	4.30	3.83	3.45	3.14	2.87
26	530.9	5.98	5.12	4.48	3.98	3.59	3.27	2.99
27	572.6	6.21	5.32	4.65	4.14	3.73	3.39	3.10
28	615.8	6.44	5.52	4.83	4.29	3.87	3.52	3.22
29	660.5	6.67	5.71	4.99	4.44	4.00	3.65	3.33
30	706.9	6.90	5.91	5.17	4.60	4.14	3.77	3.45
31	754.8	7.13	6.11	5.34	4.75	4.28	3.89	3.56
32	804.2	7.36	6.30	5.51	4.90	4.42	4.02	3.68
33	855.3	7.59	6.50	5.69	5.06	4.56	4.15	3.80
34	907.9	7.82	6.69	5.86	5.21	4.69	4.28	3.91
35	962.1	8.05	6.89	6.03	5.36	4.83	4.40	4.03
36	1017.9	8.28	7.09	6.20	5.52	4.97	4.52	4.14
37	1075.2	8.51	7.28	6.38	5.67	5.11	4.65	4.26
38	1134.1	8.74	7.49	6.54	5.82	5.25	4.78	4.37
39	1194.6	8.97	7.68	6.72	5.98	5.38	4.90	4.48
40	1256.6	9.20	7.88	6.89	6.13	5.52	5.03	4.60

Values above upper heavy line are for more than 2 per cent of spiral.

Values below lower heavy line are for less than 1 per cent of spiral.

To Find Ratio of Spiral  $p_1$ .—Divide value from table by area of concrete core.

To Find Weight of Spiral.—Multiply the corresponding value of  $p_1A$  by 3.4 and by the length of spiral plus twice the pitch (to allow for extra turns on top and bottom). Add weight as spacers. (See p. 433.)

To Find Load Carried by Spiral.

Chicago Code.—Multiply value of  $p_1A$  from table above by  $2\frac{1}{2}nf_c$ , which for 1 :  $1\frac{1}{2}$  : 3 concrete equals 18 000 lb. and for 1 : 1 : 2 concrete equals 18 125 lb.

New York Code.—Multiply value of  $p_1A$  from table above by 40 000 lb.

Table 35.—Values of  $p_1A$  in Spiral Columns.Where  $p_1$  = Ratio of Spiral and  $A$  = Area of Concrete Core

These values are equivalent areas of vertical steel having same volume as the volume of spiral

 $\frac{1}{4}$ -in. Wire

Diameter of Core $d$	Area of Core $A$	Pitch of $\frac{1}{4}$ wire.						
		1.5	1.75	2.0	2.25	2.5	2.75	3.0
10	78.5	3.14	2.69	2.35	2.09	1.88	1.71	1.57
11	95.2	3.45	2.95	2.59	2.30	2.07	1.88	1.72
12	113.1	3.76	3.22	2.82	2.50	2.26	2.06	1.88
13	132.7	4.08	3.49	3.05	2.72	2.45	2.23	2.04
14	153.9	4.39	3.76	3.29	2.92	2.63	2.40	2.20
15	176.7	4.71	4.03	3.52	3.13	2.82	2.57	2.35
16	201.1	5.02	4.30	3.76	3.34	3.01	2.74	2.51
17	227.0	5.33	4.57	3.99	3.55	3.20	2.92	2.66
18	254.5	5.65	4.84	4.23	3.76	3.39	3.08	2.82
19	283.5	5.96	5.10	4.46	3.97	3.57	3.26	2.98
20	314.2	6.27	5.37	4.70	4.18	3.76	3.43	3.14
21	346.4	6.59	5.64	4.94	4.38	3.96	3.60	3.29
22	380.1	6.90	5.91	5.17	4.60	4.14	3.77	3.45
23	415.5	7.22	6.18	5.40	4.81	4.33	3.94	3.60
24	452.4	7.53	6.44	5.64	5.01	4.51	4.12	3.76
25	490.9	7.84	6.71	5.87	5.22	4.71	4.29	3.92
26	530.9	8.16	6.99	6.11	5.43	4.90	4.45	4.08
27	572.6	8.47	7.26	6.34	5.64	5.08	4.63	4.23
28	615.8	8.79	7.52	6.58	5.85	5.27	4.80	4.39
29	660.5	9.10	7.79	6.81	6.06	5.46	4.97	4.55
30	706.9	9.41	8.06	7.05	6.27	5.65	5.14	4.71
31	754.8	9.73	8.33	7.29	6.47	5.84	5.31	4.86
32	804.2	10.04	8.59	7.51	6.69	6.02	5.49	5.02
33	855.3	10.35	8.86	7.75	6.90	6.21	5.66	5.18
34	907.9	10.67	9.13	7.99	7.10	6.40	5.83	5.33
35	962.1	10.98	9.40	8.22	7.31	6.59	6.00	5.49
36	1017.9	11.29	9.67	8.46	7.52	6.78	6.17	5.65
37	1075.2	11.61	9.93	8.69	7.73	6.96	6.34	5.81
38	1134.1	11.92	10.21	8.92	7.93	7.16	6.51	5.96
39	1194.6	12.23	10.47	9.16	8.15	7.34	6.69	6.11
40	1256.6	12.55	10.74	9.40	8.36	7.53	6.86	6.28

Values above upper heavy line are for more than 2 per cent of spiral.

Values below lower heavy line are for less than 1 per cent of spiral.

To Find Ratio of Spiral  $p_1$ .—Divide value from table by area of concrete core.Weight of Spiral.—Multiply the corresponding value of  $p_1A$  by 3.4 and by the length of spiral plus twice the pitch (to allow for extra turns on top and bottom). Add weight of spacers. (See p. 433.)

Load Carried by Spiral.

*Chicago Code*.—Multiply value of  $p_1A$  from table above by  $2\frac{1}{2}nf_c$ , which for 1 :  $1\frac{1}{2}$  : 3 concrete equals 18 000 lb. and for 1 : 1 : 3 concrete, 18 125 lb.*New York Code*.—Multiply value of  $p_1A$  from table above by 40 000 lb.

**Table 36.—Values of  $p_1A$  in Spiral Columns.**

Where  $p_1$  = Ratio of Spiral and  $A$  = Area of Concrete Core  
 These values are equivalent areas of vertical steel having same volume as the volume of spiral  
 ½-in. Wire

Diameter of Core $d$	Area of Core $A$	Pitch of ½ Wire.						
		1.5	1.75	2.0	2.25	2.5	2.75	3.0
10	78.5	4.10	3.51	3.07	2.73	2.46	2.24	2.05
11	95.2	4.51	3.86	3.38	3.00	2.71	2.46	2.25
12	113.1	4.92	4.21	3.68	3.27	2.95	2.69	2.46
13	132.7	5.33	4.56	3.99	3.55	3.20	2.91	2.66
14	153.9	5.74	4.91	4.30	3.82	3.44	3.14	2.87
15	176.7	6.15	5.26	4.60	4.09	3.69	3.36	3.07
16	201.1	6.56	5.62	4.91	4.37	3.94	3.58	3.28
17	227.0	6.97	5.97	5.22	4.64	4.18	3.81	3.48
18	254.5	7.38	6.32	5.53	4.91	4.43	4.03	3.69
19	283.5	7.79	6.67	5.83	5.19	4.67	4.26	3.89
20	314.2	8.20	7.02	6.14	5.46	4.92	4.48	4.10
21	346.4	8.61	7.37	6.45	5.73	5.17	4.70	4.30
22	380.1	9.02	7.72	6.75	6.01	5.41	4.93	4.51
23	415.5	9.43	8.07	7.06	6.28	5.66	5.15	4.71
24	452.4	9.84	8.42	7.37	6.55	5.90	5.38	4.92
25	490.9	10.25	8.77	7.67	6.82	6.15	5.60	5.12
26	530.9	10.66	9.13	7.98	7.10	6.40	5.82	5.33
27	572.6	11.07	9.48	8.29	7.37	6.64	6.05	5.53
28	615.8	11.48	9.83	8.60	7.64	6.89	6.27	5.74
29	660.5	11.89	10.18	8.90	7.92	7.13	6.50	5.94
30	706.9	12.30	10.53	9.21	8.19	7.38	6.72	6.15
31	754.8	12.71	10.88	9.52	8.46	7.63	6.94	6.35
32	804.2	13.12	11.23	9.82	8.74	7.87	7.17	6.56
33	855.3	13.53	11.58	10.13	9.01	8.12	7.39	6.77
34	907.9	13.94	11.93	10.44	9.28	8.36	7.62	6.97
35	962.1	14.35	12.28	10.74	9.55	8.61	7.84	7.18
36	1017.9	14.76	12.63	11.05	9.83	8.86	8.06	7.38
37	1075.2	15.17	12.98	11.36	10.10	9.10	8.29	7.59
38	1134.1	15.58	13.34	11.66	10.37	9.35	8.51	7.79
39	1194.6	15.99	13.69	11.97	10.65	9.59	8.74	7.99
40	1256.6	16.40	14.04	12.28	10.92	9.84	8.96	8.20

Values above upper heavy line are for more than 2 per cent of spiral.

Values below lower heavy line are for less than 1 per cent of spiral.

**To Find Ratio of Spiral  $p_1$ .**—Divide value from table by area of concrete core.

**To Find Weight of Spiral.**—Multiply the corresponding value of  $p_1A$  by 3.4 and by the length of spiral plus twice the pitch (to allow for extra turns on top and bottom). Add weight of spacers (See p. 433.)

**To Find Load Carried by Spiral.**

**Chicago Code.**—Multiply value of  $p_1A$  from table above by  $2\frac{1}{2}rf_c$ , which for 1 : 1½ : 3 concrete equals 18 000 lb. and for 1 : 1 : 2 concrete, 18 125 lb.

**New York Code.**—Multiply value of  $p_1A$  from table above by 40 000 lb.

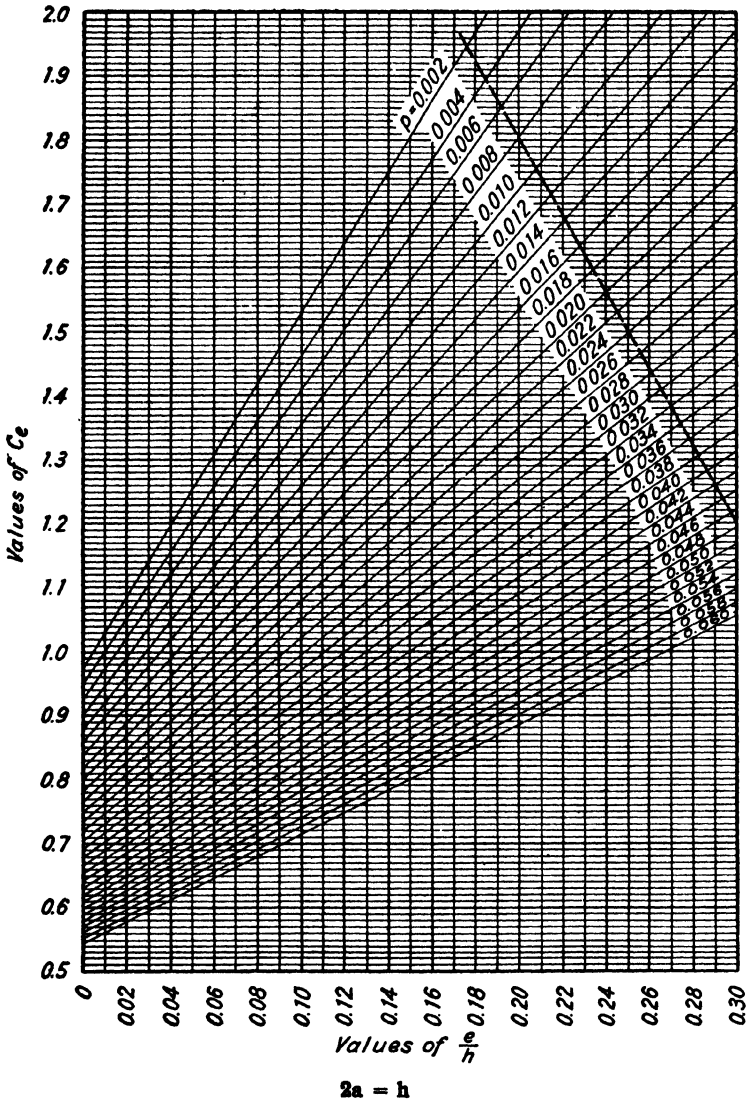

Use in Formula for Max. Compression Stress,  $f_c = C_c \frac{N}{bh}$ . (See p. 177.)

DIAGRAM 18.—Constants  $C_c$  for Members Subjected to Direct Compression and Flexure. (See p. 177.)

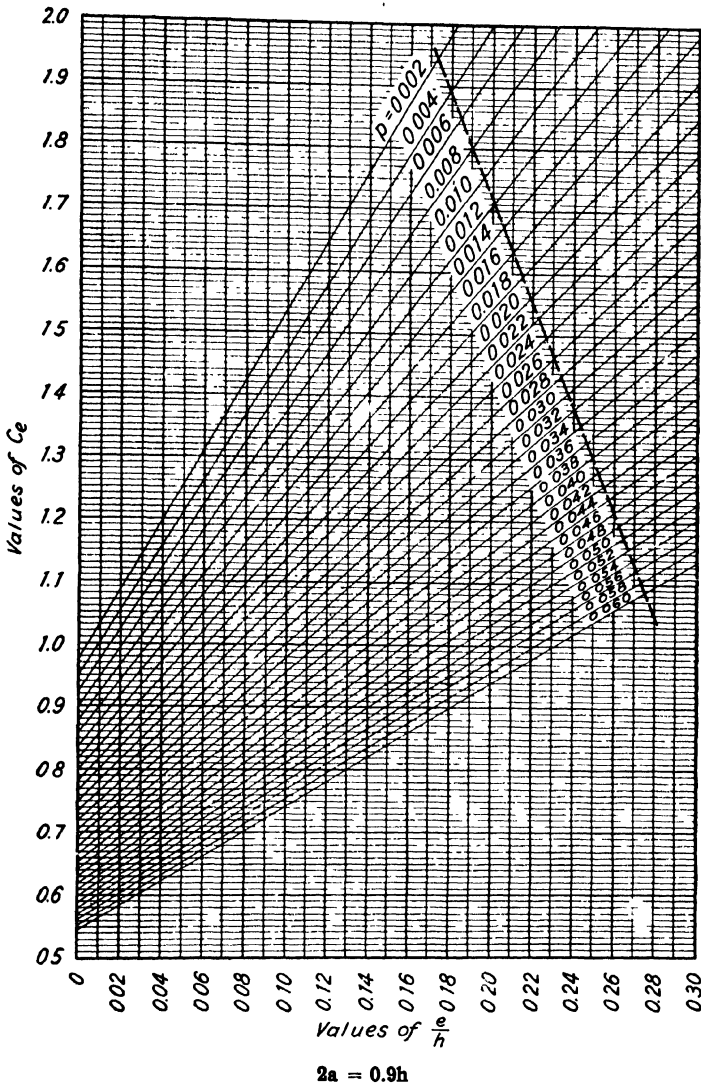

Use in Formula for Max. Compression Stress,  $f_c = C_c \frac{N}{bh}$ . (See p. 177.)

DIAGRAM 19.—Constants  $C_c$  for Members Subjected to Direct Compression and Flexure. (See p. 177.)

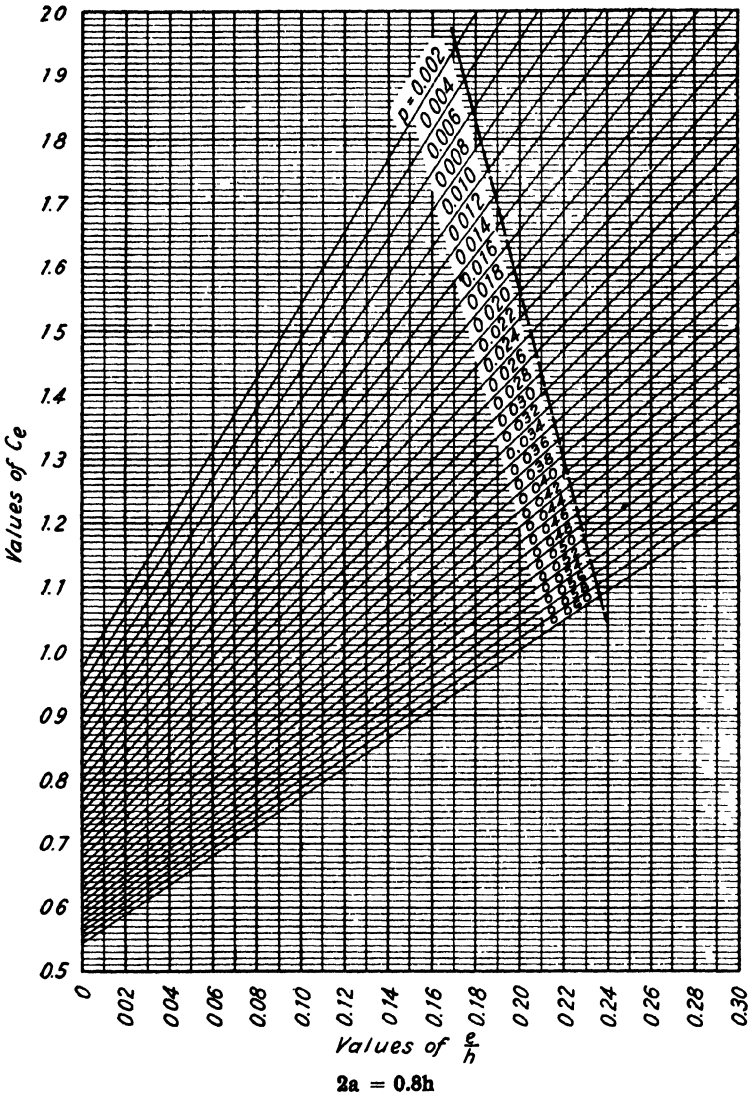

Use in Formula for Max. Compression Stresses,  $f_c = C_e \frac{N}{bh}$ . (See p. 177.)

DIAGRAM 20.—Constants  $C_e$  for Members Subjected to Direct Compression and Flexure. (See p. 177.)



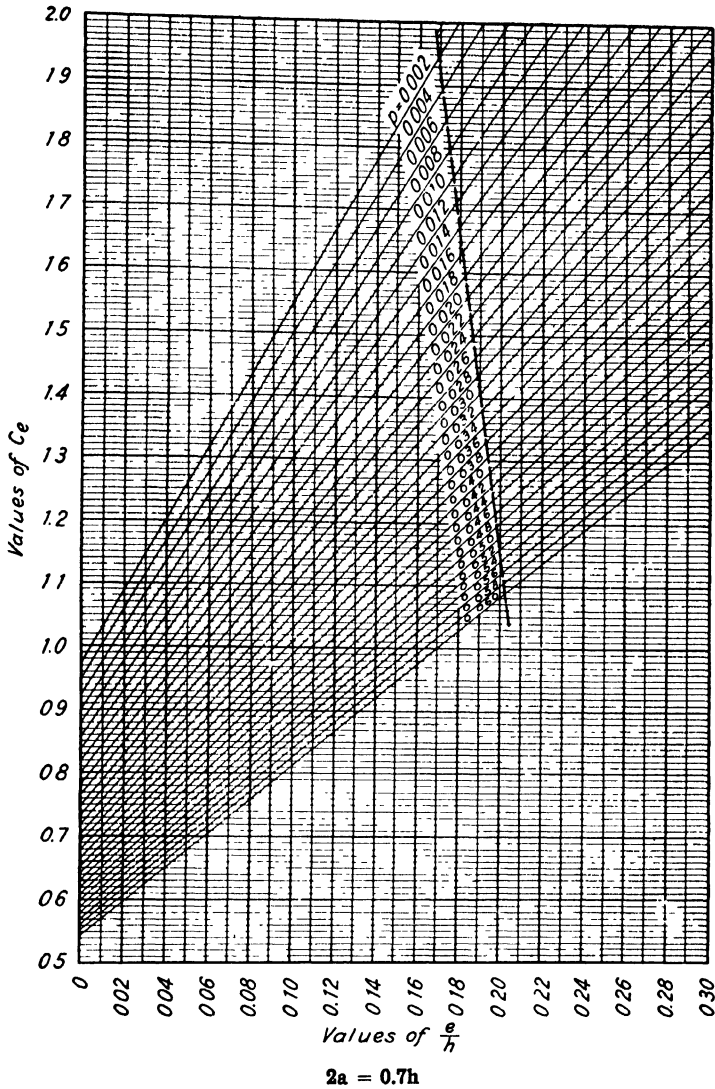

Use in Formula for Max. Compression Stresses  $f_c = C_c \frac{N}{bh}$ . (See p. 177.)

DIAGRAM 21.—Constants  $C_c$  for Members Subjected to Direct Compression and Flexure. (See p. 177.)

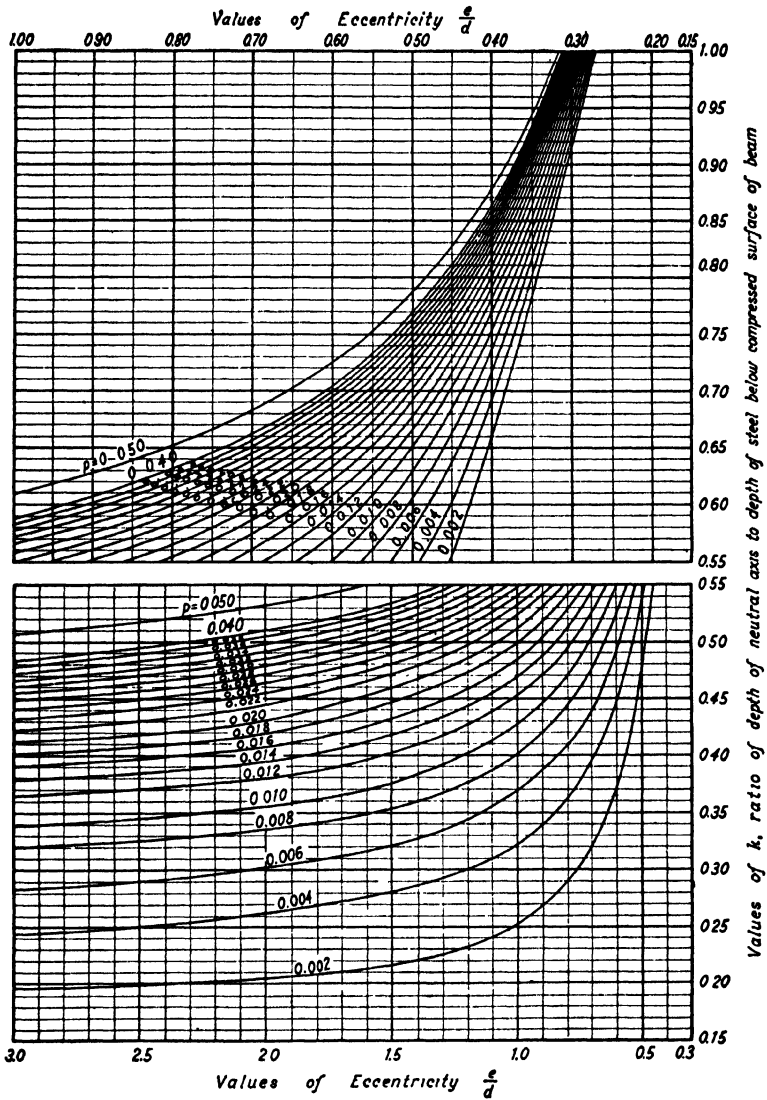

$h = 1.2d. \quad n = 15$

Both Sides Reinforced.  $p = \frac{A_s}{bd}$  where  $A_s$  is Reinforcement at Both Sides.

DIAGRAM 22.—Direct Stress and Flexure. Ratio of Depth of Neutral Axis,  $k$ , for Different Eccentricities. Part of Section in Tension. (See p. 184.)

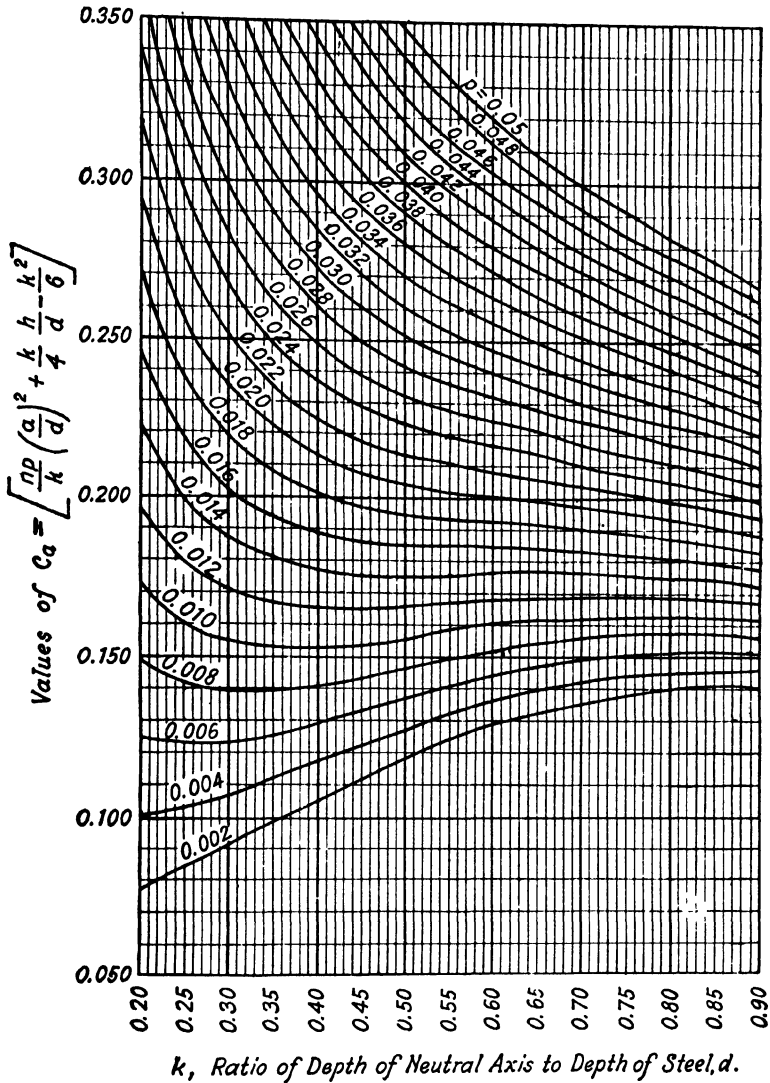

$h = 1.2d. \quad n = 15$

Both Sides Reinforced.  $p = \frac{A_s}{bd}$ , where  $A_s$  is Reinforcement at Both Sides.

DIAGRAM 23.—Direct Stress and Flexure. Constant  $C_a$  in Formula (125), p. 182. Part of Section in Tension. (See p. 184.)

**Table 37.—Ratio of  $\frac{d_c}{d}$  for Different Steel Ratios  $p$ . (See p. 186.)**

		Steel Ratios $p$										
		0.002	0.003	0.004	0.005	0.006	0.007	0.008	0.009	0.010	0.011	0.012
$\frac{d_c}{d}$		0.565	0.570	0.576	0.581	0.586	0.590	0.595	0.600	0.605	0.609	0.613

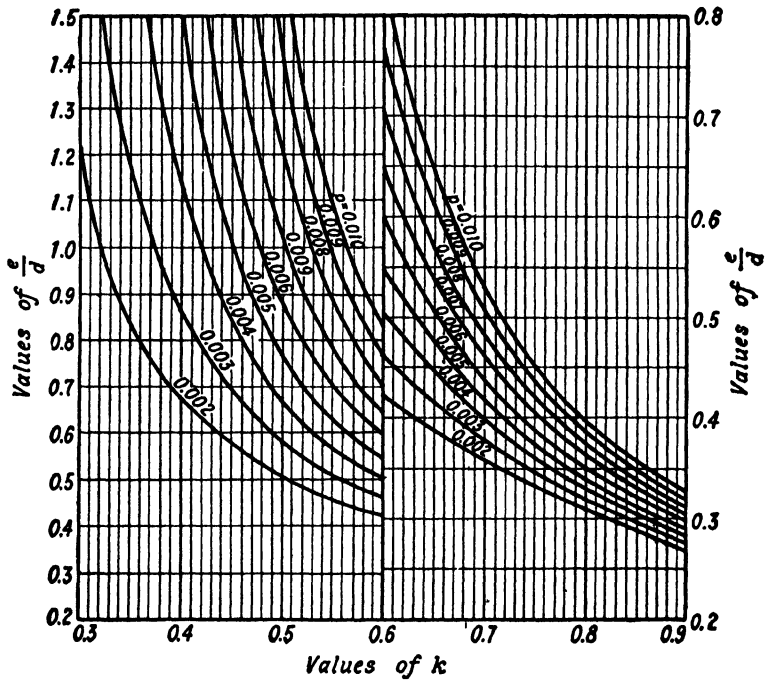

$d = 0.9h. \quad n = 15$

Tension Side only Reinforced.  $p = \frac{A_s}{bd}$

**DIAGRAM 24.—Direct Stress and Flexure. Ratio of Depth of Neutral Axis,  $k$ , for Different Eccentricities. Part of Section in Tension. (See p. 187.)**

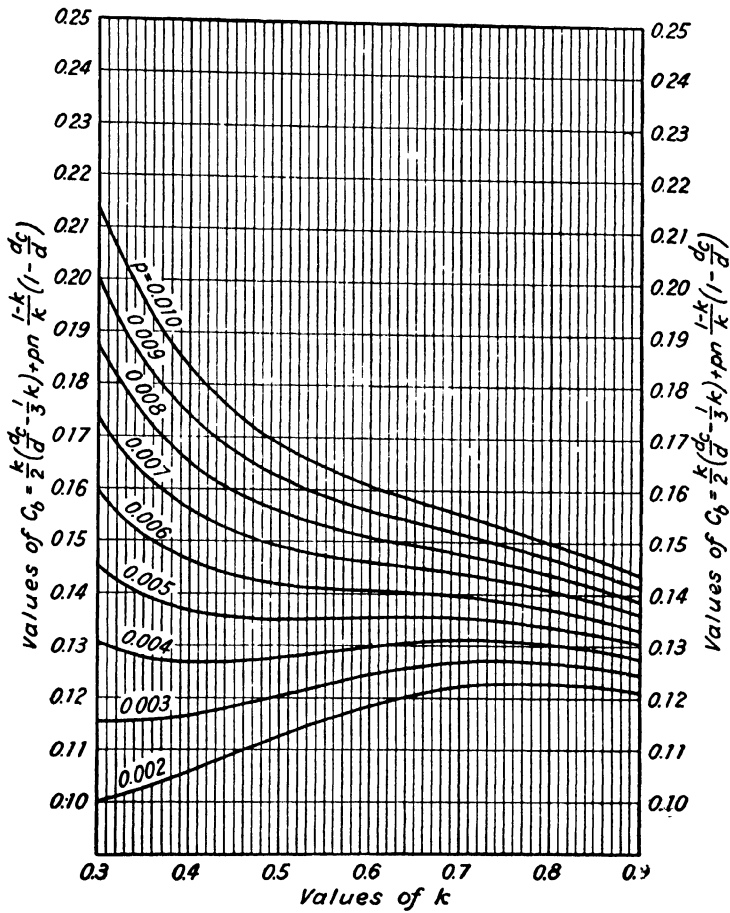

$d = 0.9h. \quad n = 15$

Tension Side only Reinforced.  $p = \frac{A_s}{bd}$

DIAGRAM 25.—Direct Stress and Flexure. Constants  $C_b$  in Formula (133), p. 187 Part of Section in Tension. (See p. 187.)

Table 38.—Areas, Weights, and Circumferences of Square and Round Bars.

One cubic foot of steel weighs 490 lb.

Thickness or Diameter of Bar in Inches	Square Bars.		Round Bars.			Thickness or Diameter of Bar in Inches	Square Bars.		Round Bars.		
	Area, Sq. In.	Weight per Ft., Lb.	Area, Sq. In.	Circumference, In.	Weight per Ft., Lb.		Area, Sq. In.	Weight per Ft., Lb.	Area, Sq. In.	Circumference, In.	Weight per Ft., Lb.
0						2	4.000	13.60	3.142	6.283	10.68
$\frac{1}{16}$	0.004	0.013	0.003	0.196	0.010	$2\frac{1}{16}$	4.254	14.46	3.341	6.480	11.36
$\frac{1}{8}$	0.016	0.053	0.012	0.393	0.042	$2\frac{1}{8}$	4.516	15.35	3.547	6.676	12.06
$\frac{3}{16}$	0.035	0.119	0.028	0.589	0.094	$2\frac{3}{16}$	4.785	16.27	3.758	6.872	12.78
$\frac{1}{4}$	0.063	0.212	0.049	0.785	0.167	$2\frac{1}{4}$	5.063	17.22	3.976	7.069	13.52
$\frac{5}{16}$	0.098	0.333	0.077	0.982	0.261	$2\frac{5}{16}$	5.348	18.19	4.200	7.265	14.28
$\frac{3}{8}$	0.141	0.478	0.110	1.178	0.375	$2\frac{3}{8}$	5.641	19.18	4.430	7.461	15.07
$\frac{7}{16}$	0.191	0.651	0.150	1.374	0.511	$2\frac{7}{16}$	5.941	20.20	4.666	7.658	15.86
$\frac{1}{2}$	0.250	0.850	0.196	1.571	0.667	$2\frac{1}{2}$	6.250	21.25	4.909	7.854	16.69
$\frac{9}{16}$	0.316	1.076	0.249	1.767	0.845	$2\frac{9}{16}$	6.566	22.33	5.157	8.050	17.53
$\frac{5}{8}$	0.391	1.328	0.307	1.964	1.043	$2\frac{5}{8}$	6.891	23.43	5.412	8.247	18.40
$\frac{11}{16}$	0.473	1.608	0.371	2.160	1.262	$2\frac{11}{16}$	7.223	24.56	5.673	8.443	19.29
$\frac{3}{4}$	0.563	1.913	0.442	2.356	1.502	$2\frac{3}{4}$	7.563	25.71	5.940	8.639	20.20
$\frac{13}{16}$	0.660	2.245	0.519	2.553	1.763	$2\frac{13}{16}$	7.910	26.90	6.213	8.836	21.12
$\frac{7}{8}$	0.766	2.603	0.601	2.749	2.044	$2\frac{7}{8}$	8.266	28.10	6.492	9.032	22.07
$\frac{15}{16}$	0.879	2.989	0.690	2.945	2.347	$2\frac{15}{16}$	8.629	29.34	6.777	9.228	23.04
1	1.000	3.400	0.785	3.142	2.670	3	9.000	30.60	7.069	9.425	24.03
$1\frac{1}{16}$	1.129	3.838	0.887	3.338	3.014	$3\frac{1}{16}$	9.379	31.89	7.366	9.621	25.04
$1\frac{1}{8}$	1.266	4.303	0.994	3.534	3.379	$3\frac{1}{8}$	9.766	33.20	7.670	9.818	26.08
$1\frac{1}{4}$	1.410	4.795	1.108	3.731	3.766	$3\frac{1}{4}$	10.160	34.55	7.980	10.014	27.13
$1\frac{1}{8}$	1.563	5.312	1.227	3.927	4.173	$3\frac{1}{8}$	10.563	35.92	8.296	10.210	28.20
$1\frac{3}{16}$	1.723	5.857	1.353	4.123	4.600	$3\frac{3}{16}$	10.973	37.31	8.618	10.407	29.30
$1\frac{1}{2}$	1.891	6.428	1.485	4.320	5.049	$3\frac{1}{2}$	11.391	38.73	8.946	10.603	30.42
$1\frac{5}{16}$	2.066	7.026	1.623	4.516	5.518	$3\frac{5}{16}$	11.816	40.18	9.281	10.799	31.56
$1\frac{3}{8}$	2.250	7.650	1.767	4.712	6.008	$3\frac{3}{8}$	12.250	41.65	9.621	10.996	32.71
$1\frac{7}{16}$	2.441	8.301	1.918	4.909	6.520	$3\frac{7}{16}$	12.691	43.14	9.968	11.192	33.90
$1\frac{1}{2}$	2.641	8.978	2.074	5.105	7.051	$3\frac{1}{2}$	13.141	44.68	10.321	11.388	35.09
$1\frac{9}{16}$	2.848	9.682	2.237	5.301	7.604	$3\frac{9}{16}$	13.598	46.24	10.680	11.585	36.31
$1\frac{5}{8}$	3.063	10.41	2.405	5.498	8.178	$3\frac{5}{8}$	14.063	47.82	11.045	11.781	37.56
$1\frac{11}{16}$	3.285	11.17	2.580	5.694	8.773	$3\frac{11}{16}$	14.535	49.42	11.416	11.977	38.81
$1\frac{3}{4}$	3.516	11.95	2.761	5.891	9.388	$3\frac{3}{4}$	15.016	51.05	11.793	12.174	40.10
$1\frac{13}{16}$	3.754	12.76	2.948	6.087	10.030	$3\frac{13}{16}$	15.504	52.71	12.177	12.370	41.40

Table 39.—Areas of Groups of Bars of Uniform Size.

Diameter of Bar in Inches	Number of Bars.														
	1	2	3	4	5	6	7	8	9	10	12	14	16	18	20
ROUND BARS															
1/4	0.049	0.098	0.147	0.20	0.25	0.29	0.34	0.39	0.44	0.49	0.59	0.69	0.79	0.88	0.98
5/16	0.077	0.153	0.230	0.31	0.38	0.46	0.54	0.61	0.69	0.77	0.92	1.07	1.23	1.38	1.53
3/8	0.110	0.221	0.331	0.44	0.55	0.66	0.77	0.88	0.99	1.10	1.32	1.55	1.77	1.99	2.21
7/16	0.150	0.301	0.451	0.60	0.75	0.90	1.05	1.20	1.35	1.50	1.80	2.10	2.40	2.71	3.01
1/2	0.196	0.392	0.589	0.78	0.98	1.18	1.37	1.57	1.77	1.96	2.36	2.75	3.14	3.53	3.93
5/8	0.248	0.497	0.746	0.99	1.24	1.49	1.74	1.99	2.24	2.48	2.98	3.48	3.98	4.47	4.97
3/4	0.307	0.614	0.920	1.23	1.54	1.84	2.15	2.46	2.76	3.07	3.68	4.30	4.91	5.52	6.14
7/8	0.371	0.742	1.114	1.48	1.86	2.23	2.60	2.97	3.34	3.71	4.45	5.19	5.94	6.68	7.42
1	0.442	0.884	1.325	1.77	2.21	2.65	3.09	3.53	3.98	4.42	5.30	6.19	7.07	7.95	8.84
1 1/8	0.518	1.037	1.555	2.07	2.59	3.11	3.63	4.15	4.67	5.18	6.22	7.26	8.30	9.33	10.37
1 1/4	0.601	1.203	1.804	2.41	3.01	3.61	4.21	4.81	5.41	6.01	7.22	8.42	9.62	10.82	12.03
1 1/2	0.690	1.380	2.071	2.76	3.45	4.14	4.83	5.52	6.21	6.90	8.28	9.66	11.05	12.43	13.81
1 3/8	0.788	1.571	2.356	3.14	3.93	4.71	5.50	6.28	7.07	7.85	9.42	11.00	12.57	14.14	15.71
1 1/2	0.894	1.788	2.682	3.58	4.47	5.36	6.25	7.14	8.03	8.92	10.70	12.58	14.46	16.34	18.22
1 5/8	1.007	2.014	3.021	4.03	5.04	6.05	7.06	8.07	9.08	10.09	12.11	14.22	16.33	18.44	20.55
1 3/4	1.137	2.274	3.411	4.54	5.68	6.81	7.95	9.08	10.21	11.34	13.61	15.92	18.23	20.54	22.85
1 7/8	1.283	2.566	3.849	5.13	6.27	7.41	8.55	9.69	10.83	11.97	14.36	16.75	19.14	21.53	23.92
2	1.445	2.890	4.335	5.78	7.17	8.56	9.95	11.34	12.73	14.12	16.61	19.10	21.59	24.08	26.57
2 1/8	1.624	3.248	4.872	6.56	7.95	9.34	10.73	12.12	13.51	14.90	17.49	19.98	22.47	24.96	27.45
2 1/4	1.820	3.640	5.460	7.28	8.67	10.06	11.45	12.84	14.23	15.62	18.31	20.80	23.29	25.78	28.27
2 1/2	2.033	4.066	6.099	8.13	9.52	10.91	12.30	13.69	15.08	16.47	19.26	21.75	24.24	26.73	29.22
2 3/8	2.264	4.528	6.792	9.08	10.47	11.86	13.25	14.64	16.03	17.42	20.31	22.80	25.29	27.78	30.27
2 1/2	2.513	5.026	7.539	10.03	11.42	12.81	14.20	15.59	16.98	18.37	21.36	23.85	26.34	28.83	31.32
2 5/8	2.780	5.560	8.340	11.12	12.51	13.90	15.29	16.68	18.07	19.46	22.55	25.04	27.53	30.02	32.51
2 3/4	3.064	6.128	9.192	12.32	13.71	15.10	16.49	17.88	19.27	20.66	23.85	26.34	28.83	31.32	33.81
2 7/8	3.365	6.730	10.095	13.65	15.04	16.43	17.82	19.21	20.60	21.99	25.18	27.67	30.16	32.65	35.14
3	3.683	7.366	11.049	15.13	16.52	17.91	19.30	20.69	22.08	23.47	26.66	29.15	31.64	34.13	36.62
3 1/8	4.018	8.036	12.054	16.74	18.13	19.52	20.91	22.30	23.69	25.08	28.27	30.76	33.25	35.74	38.23
3 1/4	4.370	8.740	13.110	18.48	19.87	21.26	22.65	24.04	25.43	26.82	30.01	32.50	34.99	37.48	39.97
3 1/2	4.739	9.478	14.217	20.37	21.76	22.85	24.24	25.63	27.02	28.41	31.60	34.09	36.58	39.07	41.56
3 3/8	5.124	10.248	15.372	22.42	23.51	24.76	26.05	27.44	28.83	30.22	33.31	35.80	38.29	40.78	43.17
3 1/2	5.525	11.050	16.575	24.63	25.42	26.83	28.22	29.61	31.00	32.39	35.58	38.07	40.46	42.85	45.04
3 5/8	5.942	11.884	17.828	27.00	27.39	29.18	30.57	31.96	33.35	34.74	37.43	39.82	42.21	44.59	46.97
3 3/4	6.375	12.750	19.163	29.53	29.92	31.91	33.30	34.69	36.08	37.47	40.76	43.15	45.53	47.97	49.91
3 7/8	6.824	13.648	20.552	32.22	31.61	33.80	35.19	36.58	38.07	39.46	42.75	44.64	46.53	48.42	50.30
4	7.289	14.578	22.001	35.07	33.56	36.35	37.74	39.13	40.52	41.91	45.44	47.33	49.22	51.11	52.99
4 1/8	7.770	15.540	23.514	38.08	35.67	39.56	40.85	42.16	43.55	44.94	48.47	50.36	52.25	54.14	55.92
4 1/4	8.267	16.534	25.091	41.25	37.94	43.13	44.27	45.54	47.03	48.52	51.60	53.49	55.38	57.27	59.05
4 1/2	8.780	17.560	26.730	44.58	40.37	46.46	47.79	49.08	50.57	52.06	54.99	56.98	58.97	60.86	62.64
4 3/8	9.309	18.618	28.443	48.07	43.66	50.85	51.58	53.17	54.66	56.15	58.54	60.43	62.32	64.21	65.99
4 1/2	9.854	19.708	30.234	51.72	47.01	54.76	55.93	57.42	58.91	60.40	62.79	64.68	66.57	68.46	70.24
4 5/8	10.415	20.830	32.101	55.53	50.50	59.13	60.32	61.81	63.30	64.79	67.18	69.07	70.96	72.85	74.63
4 3/4	10.992	21.984	34.044	59.50	54.13	63.46	64.97	66.46	67.95	69.44	71.83	73.72	75.61	77.50	79.28
4 7/8	11.585	23.170	36.073	63.63	57.91	67.65	69.82	71.31	72.80	74.29	76.68	78.57	80.46	82.35	84.13
5	12.194	24.388	38.188	67.92	61.80	70.98	73.25	74.74	76.23	77.72	80.11	82.00	83.89	85.78	87.56
5 1/8	12.819	25.638	40.389	72.37	65.87	75.23	77.60	79.09	80.58	82.07	84.46	86.35	88.24	90.13	91.91
5 1/4	13.460	26.916	42.676	77.00	70.00	79.56	82.03	83.52	85.01	86.50	88.89	90.78	92.67	94.56	96.34
5 1/2	14.117	28.234	45.049	81.81	74.31	83.61	86.18	87.67	89.16	90.65	93.04	94.93	96.82	98.71	100.49
5 3/8	14.790	29.580	47.508	86.81	78.81	88.21	90.78	92.27	93.76	95.25	97.64	99.53	101.42	103.31	105.19
5 1/2	15.479	30.958	50.053	92.00	83.50	93.80	96.37	97.86	99.35	100.84	103.23	105.12	107.01	108.90	110.78
5 5/8	16.184	32.368	52.694	97.47	88.37	99.46	102.03	103.52	105.01	106.50	108.89	110.78	112.67	114.56	116.34
5 3/4	16.905	33.810	55.421	103.12	93.42	105.13	107.70	109.19	110.68	112.17	114.56	116.45	118.34	120.23	122.01
5 7/8	17.642	35.284	58.236	108.95	98.65	111.06	113.63	115.12	116.61	118.10	120.49	122.38	124.27	126.16	127.94
6	18.395	36.790	61.139	114.96	104.06	117.09	119.66	121.15	122.64	124.13	126.52	128.41	130.30	132.19	133.97
6 1/8	19.164	38.328	64.130	121.15	109.65	123.28	125.85	127.34	128.83	130.32	132.71	134.60	136.49	138.38	140.16
6 1/4	19.949	39.896	67.209	127.52	115.42	129.55	132.12	133.61	135.10	136.59	138.98	140.87	142.76	144.65	146.43
6 1/2	20.750	41.494	70.376	134.07	121.37	135.90	138.47	139.96	141.45	142.94	145.33	147.22	149.11	151.00	152.78
6 3/8	21.567	43.130	73.631	140.80	127.48	142.23	144.80	146.29	147.78	149.27	151.66	153.55	155.44	157.33	159.11
6 1/2	22.400	44.804	76.974	147.71	133.75	148.60	151.17	152.66	154.15	155.64	158.03	160.02	161.91	163.80	165.58
6 5/8	23.250	46.516	80.405	154.80	140.18	155.03	157.60	159.09	160.58	162.07	164.46	166.35	168.24	170.13	171.91
6 3/4	24.117	48.234	83.924	162.07	146.75	161.50	164.07	165.56	167.05	168.54	170.93	172.82	174.71	176.60	178.38
6 7/8	24.999	49.998	87.531	169.52	153.37	168.01	170.58	172.07	173.56	175.05	177.44	179.33	181.22	183.11	184.89
7	25.896	51.792	91.226	177.15	160.14	174.64	177.21	178.70	180.19	181.68	184.07	185.96	187.85	189.74	191.52
7 1/8	26.809	53.616	95.009	184.96	167.05	181.33	183.90	185.39	186.88	188.37	190.76	192.65	194.54	196.43	198.21
7 1/4	27.737	55.470	98.880	192.95	174.10	188.10	190.67	192.16	193.65	195.14	197.53	199.42	201.31	203.20	204.98
7 1/2	28.680	57.354	102.839	201.12	181.33	195.03	197.60	199.09	200.58	202.07	204.46	206.35	208.24	210.13	211.91
7 3/8	29.639	59.268	106.886	209.47	188.75	202.14	204.71	206.20	207.69	209.18	211.57	213.46	215.35	217.24	219.02
7 1/2	30.614	61.212	111.021	218.00	196.35	209.43	212.00	213.49	214.98	216.47	218.86	220.75	222.64	224.53	226.31
7 5/8	31.605	63.186	115.244	226.71	204.12	216.90	219.47	220.96	222.45	223.94	226.33	228.22	230.11	232.00	233.78
7 3/4	32.612	65.190	119.555	235.60	212.05	224.55	227.12	228.61	230.10	231.59	233.98	235.87	237.76	239.65	241.43
7 7/8	33.635	67.224	123.954	244.67	220.14	232.34	234.91	236.40	237.89	239.38	241.77	24			

Table 40.—Area of Square Bars in Slabs for Different Spacing.

Area of Reinforcement in Square Inches

Di- men- sion (In.)	Spacing of Bars													
	2 In.	2½ In.	3 In.	3½ In.	4 In.	4½ In.	5 In.	5½ In.	6 In.	7 In.	8 In.	9 In.	10 In.	12 In.
½	0.37	0.30	0.25	0.21	0.19	0.17	0.15	0.13	0.12					
⅙	0.59	0.47	0.39	0.33	0.29	0.26	0.23	0.21	0.19	0.17	0.15	0.13		
⅓	0.84	0.67	0.56	0.48	0.42	0.37	0.34	0.31	0.28	0.24	0.21	0.19	0.17	0.14
⅔	1.15	0.92	0.77	0.66	0.57	0.51	0.46	0.42	0.38	0.33	0.29	0.25	0.23	0.19
1	1.50	1.20	1.00	0.86	0.75	0.67	0.60	0.55	0.50	0.43	0.37	0.33	0.30	0.25
⅙	1.90	1.52	1.27	1.08	0.95	0.84	0.76	0.69	0.63	0.54	0.47	0.42	0.38	0.32
⅓	2.34	1.87	1.56	1.34	1.17	1.04	0.94	0.85	0.78	0.67	0.59	0.52	0.47	0.39
⅔	2.84	2.27	1.99	1.62	1.42	1.33	1.13	1.03	0.94	0.81	0.71	0.66	0.57	0.47
1	3.37	2.70	2.25	1.93	1.69	1.50	1.35	1.23	1.12	0.96	0.84	0.75	0.67	0.56
⅙	3.96	3.17	2.64	2.26	1.98	1.76	1.58	1.44	1.32	1.13	0.99	0.88	0.79	0.66
⅓	4.59	3.67	3.06	2.62	2.30	2.04	1.84	1.67	1.53	1.31	1.15	1.02	0.92	0.77
⅔	5.27	4.22	3.52	3.01	2.64	2.34	2.11	1.92	1.76	1.51	1.32	1.17	1.05	0.88
1	6.00	4.80	4.00	3.43	3.00	2.67	2.40	2.18	2.00	1.71	1.50	1.33	1.20	1.00

Table 41.—Area of Round Bars in Slabs for Different Spacing.

Area of Reinforcement in Square Inches

Dia- meter (In.)	Spacing of Bars.													
	2 In.	2½ In.	3 In.	3½ In.	4 In.	4½ In.	5 In.	5½ In.	6 In.	7 In.	8 In.	9 In.	10 In.	12 In.
½	0.29	0.23	0.20	0.17	0.15	0.13	0.12							
⅙	0.46	0.36	0.31	0.26	0.23	0.20	0.18	0.17	0.15	0.13				
⅓	0.66	0.53	0.44	0.38	0.33	0.29	0.26	0.24	0.22	0.19	0.17	0.15	0.13	
⅔	0.90	0.72	0.60	0.51	0.45	0.40	0.36	0.33	0.30	0.26	0.23	0.20	0.18	0.15
1	1.18	0.94	0.78	0.67	0.59	0.52	0.47	0.43	0.39	0.34	0.29	0.26	0.24	0.20
⅙	1.49	1.19	0.99	0.85	0.75	0.66	0.60	0.54	0.50	0.43	0.37	0.33	0.30	0.25
⅓	1.84	1.47	1.23	1.05	0.92	0.82	0.74	0.67	0.61	0.53	0.46	0.41	0.37	0.31
⅔	2.23	1.78	1.48	1.27	1.11	0.99	0.89	0.81	0.74	0.64	0.56	0.49	0.45	0.37
1	2.65	2.12	1.77	1.51	1.32	1.18	1.06	0.96	0.88	0.76	0.66	0.59	0.53	0.44
⅙	3.11	2.48	2.07	1.78	1.56	1.38	1.24	1.13	1.04	0.89	0.78	0.69	0.62	0.52
⅓	3.61	2.88	2.40	2.06	1.80	1.60	1.44	1.31	1.20	1.03	0.90	0.80	0.72	0.60
⅔	4.14	3.31	2.76	2.37	2.07	1.84	1.66	1.51	1.38	1.18	1.03	0.92	0.83	0.69
1	4.71	3.77	3.14	2.69	2.36	2.09	1.88	1.71	1.57	1.35	1.18	1.05	0.94	0.78

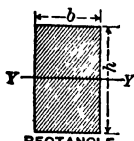
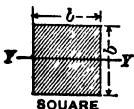
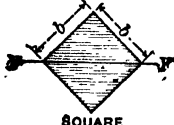
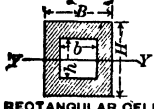
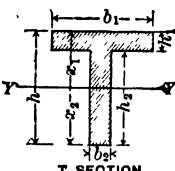
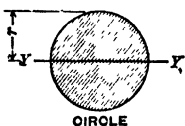
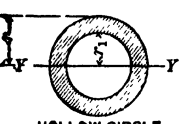

Table 42.—Properties of Sections.

Section	Area $A$	Moment of Inertia $I$	Distance of Neutral Axis from Most Strained Fiber *	Radius of Gyration, $\sqrt{I \cdot A}$
 <p>RECTANGLE</p>	$bh$	$\frac{bh^3}{12}$	$\frac{h}{2}$	$0.289h$
 <p>SQUARE</p>	$b^2$	$\frac{b^4}{12}$	$\frac{b}{2}$	$0.289b$
 <p>SQUARE</p>	$b^2$	$\frac{b^4}{12}$	$\frac{1}{2}b\sqrt{2}$	$0.289b$
 <p>RECTANGULAR CELL</p>	$BH - bh$	$\frac{1}{12}(BH^3 - bh^3)$	$\frac{H}{2}$	$\sqrt{\frac{BH^3 - bh^3}{12(BH - bh)}}$
 <p>T SECTION</p>	$\begin{aligned} &\text{Area of flange} + \text{area of web} \\ &= A_1 + A_2 + \frac{A_1 A_2 (h_1 + h_2)^2}{4(A_1 + A_2)} \end{aligned}$	$\frac{A_1 h_1^2 + A_2 h_2^2}{12}$	$x_1 = \frac{h}{2} \frac{A_1 h_2 - A_2 h}{2(A_1 + A_2)}$ $x_2 = \frac{h}{2} + \frac{A_1 h_2 - A_2 h}{2(A_1 + A_2)}$	
 <p>CIRCLE</p>	$\pi r^2$	$\frac{\pi r^4}{4}$	$r$	$\frac{r}{2}$
 <p>HOLLOW CIRCLE</p>	$\pi(r^2 - r_1^2)$	$\frac{\pi(r^4 - r_1^4)}{4}$	$r$	$\frac{\sqrt{r^2 + r_1^2}}{2}$

For reinforced concrete sections the reinforcement may be considered as replaced by concrete, having an area equal to  $n$  times the area of reinforcement and placed at the same distance from gravity axis. (See p 173)

\* Applicable only to homogeneous (not reinforced) beams.



## INDEX

---

### A

- Abrams, D. A., 52, 53, 55, 57  
Acme flat slab system, 362  
Adjustable metal tiles, 605  
Aggregates, choice of, 6  
    coarse, 3  
    coloring surface by, 737  
    effect on modulus of elasticity, 201  
    fine, 2  
    floor surfaces, 621  
    grading, 3  
    selection, 1  
    size, 273  
Air space below roof, 652  
Alden Park Manor, 748  
Anchored ends, working stresses, 263  
Anchoring bars, 265  
    chimneys, etc., 477  
    column reinforcement, 269  
    compression reinforcement, 268  
    footing reinforcement, 537  
    hooks, 163, 269  
    plate, 163  
    problems of, 267  
    retaining wall reinforcement, 853  
    steel in wall columns, 317, 462  
    straight imbedment, 163  
    web reinforcement, 244  
Angle of bent reinforcement, 291  
    column heads for flat slabs, 320  
Apartment de Luxe, metal tiles for, 607  
    houses, 805  
Arch roof, details, 676  
Arches. See also Vol. III.  
    fulcrum girders as, 772  
Area, column sections, 915  
    reinforcing bars, Table 12, 942, 943,  
    944

- Armory at Danville, 673  
Assembling column steel, 418  
Assumptions, rectangular beam theory,  
    126  
Auditoriums, concrete, 762, 810  
Automobiles, dimensions of, 796  
Auxiliary structures above roof, 678  
Axial compression and bending, col-  
    umns, 463

### B

- Bach, C., 24, 38, 49, 50, 52, 58, 59, 60,  
    62, 65, 93, 95  
Backing of curtain walls, 745  
Balanced design, 203  
    rectangular beams, 132  
Balcony, cantilevers, 772  
    cantilever trusses, 778, 782  
    design, 763  
    floors, 778  
    framing, 780  
    fulcrum girder for, 765  
Barrett's Specifications, tar and gravel  
    roofs, 655  
Bars. See also Reinforcement  
    aluminum identification tags, 723  
    spacers, 211  
    table of sizes, 12, 942, 943, 944  
Barton spider-web reinforcement, 359  
Base for structural steel columns, 443  
Basement slabs, 618  
    supported by columns, 619  
    thickness, 619  
    under water pressure, 619  
Basement walls, 637, 638  
    waterproofing of, 637  
Batter, retaining walls, 841  
Beam, design tables, 880

- Beam and girder schedules, 716  
   and girder type floors, 575  
 Beam and slab, 383  
   foundation, 540  
 Beams. See also Wall beams  
   See also T-beams  
   balanced design, 132, 203  
   bending moments to use, 275  
   compression below flange, 137  
   constants for rectangular, 205, 880,  
     881  
   continuous at support, 281  
   depth, formula, rectangular, 131, 204  
   design constants, 205  
   details on plans, 723  
   diagonal tension in, 147  
     formulas for, 247  
     reinforcement for, 248, 252  
     tests, 38  
   failure by compression, 50  
   by tension, 35  
   false, 615  
   formulas,  
     design, rectangular beams, 204  
     steel top and bottom, 234  
     T-beam, 216  
     unsymmetrical T-beams, 142  
     wedge-shaped beams, 140  
     review, rectangular beams, 207  
     T-beams, 224  
   haunch, 284, 405  
   hollow circular, 822  
   neutral axis, rectangular, 130, 207  
     steel top and bottom, 139  
     T-beam, 134, 220  
   numbering, 711  
   reinforcing for, 41  
   resisting forces, 129  
   restraint of, 275  
   in flat slab, 377  
   safe loads, table, 884  
   schedules for, 715  
   shearing stresses, 143, 150  
   spacing of tension bars, 273  
   spandrel, 334, 459, 746  
   steel in top and bottom, theory, 137  
     simplified formulas, 234  
     diagrams, 904 to 909
- Beams, straight-line theory, 127  
   and actual conditions, 142  
   stresses, actual and computed, 24  
   test of continuous, 64  
     rectangular, 20  
     steel top and bottom, 48  
     T-beam, 35  
   theory of rectangular beams, 124  
     steel top and bottom, 137  
     T-beam, 133  
     unsymmetrical T-beams, 142  
     wedge-shaped beams, 140  
   unbalanced design, 132  
   wall, 379, 578  
   width required by reinforcement,  
     Table, 274  
 Bearing stresses, 270  
   brickwork, 631  
 Bend, angle of reinforcement, 291-297  
   test, 8  
 Bending, columns subjected to, 458  
   combined with, direct tension, 189  
   direct compression, 187  
   thrust, 187  
 Bending bars, point of, 287  
   slabs, 355  
   beam reinforcement, points of, 292-  
     297  
   diagrams, for beam reinforcement,  
     292-297  
 Bending moments, beam design, 275  
   building frames, 279  
   coefficients, from test of continuous  
     beams, 65  
   combined footings, 524  
   continuous beams, 277  
   diagrams for determining point of  
     bending of bars, 292-297  
   exterior columns, 314  
   flat slabs, 328  
     See also Flat Slabs  
     interior panels, 331  
     wall panels, 333  
   footings, 495  
   permissible variations in flat slabs,  
     335  
   strap beams, 533  
 Bending sketches, 724

- Bent bars, marking of, 724
- Bent-up bars as web reinforcement:  
 area and spacing, 156, 249  
 example, 582, 587  
 formulas for, 156, 249  
 limiting spacing, 250
- Bergstrom, Edwin, 764, 779
- Bignell pre-cast pile, 552
- Bond, allowable unit stresses, 263  
 anchorage in beam reinforcement,  
 effect on, 26  
 deformed bars, 53, 263  
 design formulas for, 262, 268  
 distribution of stresses, 57  
 surface of bar, 53  
 on temperature cracks, 299  
 elements of, 51  
 function of external shear, 261  
 green concrete, 56  
 hook in beam, effect on, 263  
 influence of age, 54  
 of mix, 54  
 length of lap for, table, 414  
 load, effect of position on, 58  
 mix, effect of, 59  
 necessary to develop tensile strength  
 of bar, 354  
 plain bars, 53, 263  
 problems of, 264  
 proportions of concrete, effect, 59  
 ratio length of imbedment to diam-  
 eter bar, 52  
 resistance, 52, 260  
 shape of bar, effect, 53  
 steel to concrete, explanation, 260  
 stirrups, 40  
 strength, 50  
 stress, requirements, 132  
 stresses, 10, 56, 151, 263  
 flat slabs, 351  
 footings, 499, 500, 528  
 fulcrum girders, 768  
 importance of computation, 261  
 small vs. large bars, 262  
 unit stresses, allowable, 268
- Bonded finish for floors, 621
- Borings, results of, 469
- Boston Building Code, 347
- Boston Building Code, bearing values  
 of soils, 471  
 columns, 408, 421, 438, 448, 450  
 live loads, 454, 570  
 structural steel and concrete col-  
 umns, 438  
 width of flange in T-beam, 218
- Bracket loads on columns, 464
- Bransom System, floors, 588
- Brick, exterior, 747
- Brick parapets, 658  
 piers, strength, 77  
 stresses on, 78, 631  
 veneer building, 749  
 wall and concrete frame, 739  
 wall thickness, 31
- Brickwork, bearing walls, 335, 629
- Bridges. See Vol. III
- British building rules, 202
- Brush, finish, 736  
 hammer finish, 737
- Buckling of columns, 81, 87
- Building Codes. See Code in Question
- Building construction, 564
- Building, frames, formulas, 279  
 lines, 721  
 plans, 707  
 tests on completed, 113
- Bunte Bros., factory, 681
- Bureau of Standards, 77
- Butting bars, 415
- Buttresses, retaining walls, 833
- C
- $C_a$ , values of, 939
- $C_b$ , values of, 941
- $C_d$ , values of, 894, 895
- $C_e$ , values of, 934
- $C_{f1}$ , for square footings, 495
- $C_{f2}$ , for rectangular footings, 495
- $C_{f3}$ , for square footings, 497
- $C_{f4}$ , for rectangular footing, 498
- $C_{f5}$ , for rectangular footing, 502
- $C_p$ , values for earth pressure, 837
- $C_T$ , table of values, 896
- $C_1$  to  $C_8$ , diagram, 911

- $C_{10}$  and  $C_{11}$ , table, 912  
 $C_{13}$ , table, 913  
 $C_{13}$ , table, 914  
 Caisson pile, 560  
 Caissons, 477  
 Cantilever balcony truss, Grauman's Theater, 779  
     *vs.* ordinary beam, 775  
 Cantilever retaining walls, 849  
 Cantilevers, design of, 772  
 Capacity of stairways, 684  
 Carrying capacity, soil, 469  
     wood piles, 542  
 Carter's Ink Co. Factory, 734  
 Cast-in-place piles, 554, 558, 559  
 Cast-iron core, concrete columns, 445  
 Cast stone, 733  
 Ceilings, ornamental, 614  
     suspended, 19, 613  
 Cellular walls, 869, 871  
 Cement, 2  
     flash set, 2  
     mixing, 4  
     protection of reinforcement, 9  
     ramming, 2  
     slump test, 4  
     testing, 2  
     water in, 4  
 Chairs, metal, 356  
 Cheapest exterior treatment, 730  
 Chenoweth pre-cast pile, 551  
 Chicago Building Code, 218, 322, 347  
     columns, 396, 408, 421, 425, 439, 448, 451  
     exits, 683  
     flat slabs, 312, 317, 396  
     live loads, 454  
 Chimney, Edison Electric Ill. Co., Brooklyn, 824  
 Chimneys, concrete, 812  
     constants for neutral axis, 828  
     construction, 827  
     design, 822, 827  
     essentials, 827  
     mix of concrete for, 823  
     temperatures, 822  
     thickness concrete, 819  
 Cinder fill, roofs, 653  
 Cinder fill, foundations, 540  
 Circular beams, 822  
     plain sections, stresses in, 172  
     reinforced section, 179  
 Circular ramps, 801  
 Circumferential flat slab reinforcement, 117, 367  
 Clark Biscuit Co. Building, 793  
 Clearances, elevator shaft, 696  
 Cleveland Building Code, 218  
     columns, 408, 438, 448, 450, 464  
 Coefficient of contraction, concrete, 300  
 Cold weather, laying in, 299  
 Cold-storage, live loads, 792  
     warehouses, 792  
 Coloring of surfaces, 737  
 Columns. See also Exterior Columns.  
     See also Interior Columns.  
     See also Spiral Columns.  
     See also Wall Columns  
 Column caps, 760  
 Columns, 403  
     action under test, 86  
     allowable unit stresses,  
         axial compression and bending, 463  
         composite columns, 436  
         plain concrete columns, 879  
         spiral columns, 421  
         vertical bars only, 406  
     axial compression and bending, 463  
     bars, 412  
     bars, lapping of, 413  
         butting, 415  
         in spiral column, 434  
     bearing stresses, 271  
     bending in, 458  
     bracket loads, 464  
     buckling, 81, 87  
     building codes for, 408, 409, 422, 437, 450  
     cast-iron core, 445  
     comparison of cost, 445  
     composite, 436  
     concrete, effect of richness, 76  
     concrete *vs.* brick, 77  
     core. See Effective area  
     cost of concrete *vs.* forms, 445  
     crane loads, 464

- Columns, deformations, plain steel, 89  
 design example, 456  
 dowels, 417  
 eccentric load on, 164  
 economy of design, 445  
 economy spiral vs. vertical steel only, 449  
 effective area, 406  
 exterior. See Exterior columns  
 factor of safety, 79  
 failure, 76, 79  
 fireproofing of, 272, 407  
 flat slab construction, 305  
 formulas, general, 158  
   for design, long columns, 435  
   plain concrete, 404  
   spiral columns, 421, 422, 424, 425, 426  
   vertical steel only, 406  
 heads for flat slab, 319  
   angle of, 319, 320  
   slab thickness at, 338  
   stresses at, 199  
 hinged effect at bottom, 668  
 interior for flat slabs, 305, 310, 312  
 lapping of reinforcement, 413  
 limitation of size for flat slabs, 307  
 limiting length, 407  
 live load on, reduction of, 453  
 load on footings, 479  
 long, formulas for, 434  
   tests on, 93  
 mix, influence of, 80  
 modulus of elasticity, 76  
 numbering, on floor plan, 710  
 oblong spiral, 431  
 octagonal spiral, 429  
 octagonal vs. round, 429  
 orchestra floor, 763  
 plain, test of, 81  
 point of maximum bending moment, 459  
 Poisson's ratio, 76  
 proportions of concrete for, 446  
 ratio of rigidity in flat slab, 459  
 reduction of live load, 452  
 reinforcement, anchorage of, 269, 413  
   disposition of, 414
- Columns, reinforcement, influence of, 80  
 uniform size of, 412  
 repeated loads, test under, 77  
 review of design, 411  
 round with 1 per cent spiral, tables of loads, 926, 927, 928  
 round with vertical reinforcement, tables of loads, 923, 924, 925  
 schedule for, 719  
 spacing in garages, 797  
 spiral design of, 419, 421, 422, 430, 448  
   test of, 82, 89  
 splicing structural steel, 441  
 splitting effect of bars, 79  
 square columns, table, 920, 921, 922  
 square spiral not effective, 430  
   test of, 88  
 steel, assembling of, 418  
 strength, formula for, 160, 421  
 stresses in spiral, 422  
   with vertical steel only, 205  
 structural steel in concrete, 435  
 supporting basement, 619  
 tensile steel, amount, 461  
 test of, 76  
 ties, 417  
 total loads on, 919  
 unsupported length, 405  
 vertical and spiral reinforcement, test of, 84  
 vertically reinforced, test of, 78  
 yielding of, 108
- Combined footings, 522  
 bending moments, 524  
 external shear, 526  
 for interior columns, 523  
 shape of base, 522  
 unequal loads on, 522
- Comparative costs of columns, 445  
 floors, 786
- Comparison of floor surfaces, 627
- Composite columns, 436  
 piles, 555
- Compression, below flange in T-beam, 137  
 due to eccentricity, 191  
 failure of beam by, 30, 32

- Compression, reinforcement for beams,  
     50  
     anchorage of, 268  
     diagrammatic solution, 237  
     formulas for design, 234  
     flat slabs, 345  
     influence on deflection, 63  
     problems in design, 232  
     ratio of, 236, 283  
     supports, 282, 283  
     T-beams, 225, 230  
     stress in concrete at supports,  
         223  
     stresses in flat slabs, 341  
 Concentrated loading, stirrups for, 254  
 Concrete, definition of. See item in  
     question  
 Concrete buildings, cost, 567  
     height, 803  
     shape of, 804  
     types, 572  
 Concrete chimneys, 812  
     coefficient of contraction, 300  
 Condensation under roofs, 649  
 Condron Company, 362  
 Considère, 22  
 Consistency of concrete, 26  
 Constants. See also  $C_a$ , etc.  
     beam and slab design, 205, 880  
 Continuous beams:  
     design, 285  
     details, 281  
     diagrams for points of bending  
         bars in, 293-297  
     equal span, formulas for, 278  
     minimum depth, 222  
     points of inflection, 289  
     span of, 277  
     tension in steel at supports, 288  
     tests, 64, 115  
     unequal spans, 280  
     unsymmetrical loading, 280  
     vs. building frames, 277  
     web reinforcement for, 157  
 Continuous slabs, formulas for, 209,  
     279  
     arrangement of reinforcement, 210  
     wall column footings, 518  
 Coping, 658  
 Corner column footings, 514  
 Corrugated Bar Co., 99, 105, 363  
 Cost, columns, 445  
     columns and footings, 577  
     reinforced concrete buildings, 567  
     spiral reinforcement, 434  
     various floors, 786  
     types of construction, 564  
 Counterforts, 833, 863, 867  
 Coverings for roofs, 654  
 Cracks, 20, 66  
     cantilever slab, 119  
     diagonal tension, 40, 147, 153, 157  
     percentage reinforcement, 300  
     shrinkage, 300  
     spacing of, 300  
     temperature, 299  
 Crane loads on columns, 464  
 Cret, Paul P., 629  
 Cross bars, 37  
     fulcrum girders, 768  
     in slabs, 211  
     over girders, 211  
 Cross-section Massachusetts Inst. Tech.,  
     808  
     theater auditorium, 781  
 Cubes, strength of, 50  
 Cummings pre-cast pile, 552  
 Curb bars, 617  
 Curbs for garage drives, 798  
 Curtain wall backing, 745  
 Curtain walls, 572  
  

D

 Dash coat finish, 736  
 Dead load, balcony cantilevers, 774  
     on floors, 571  
     roofs, 648  
 Deere and Webber Building, test on,  
     113  
 Deflection, beams, 61, 115  
     compressive steel, influence on, 63  
     end beams and wall columns, 460  
     flange width, influence on, 62  
     slabs, 69, 103, 198, 326  
     steel, influence of, 61  
     theoretical and actual, 65



- Deformations, concrete, 72, 341  
   in reinforcement, 28  
   of columns, plain steel, 89  
   plastic in slab, 109  
   relations to stress, 387  
   spiral columns, 82  
   steel, 72, 117
- Deformed bars, purpose of, 10
- Delaware, Lackawanna and Western  
   R. R., 834
- Densmore, Le Clear and Robbins, 733,  
   734, 740, 752, 759
- Depth of beam increase by haunch, 284  
   beams, formula for, 131  
   cantilevers, 775  
   footings, 493  
   foundation, 470
- Designation of structural members on  
   plans, 710
- Detail of column cap, 760
- Detailing methods, 716
- D'Hume Ramp System for garages, 801
- Diagram, solving stress by, 176
- Diagonal tension:  
   allowable unit stress, 244  
   assumptions for, 153  
   beam and tile floors, 596  
   bent bars for, 248, 251  
   chimneys, 819  
   combined footings, 527  
   distribution of between concrete and  
     steel, 245, 246, 247  
   element of beam under, 152  
   failure by, 46, 147  
   footings, 482, 502  
   for moving loads, 258  
   formulas for, 148, 247  
   reinforcement in flat slab for, 350  
   reinforcement for, 247  
   requirements for web design, 218  
   stirrups for, 247, 252  
   stresses, 241  
   test, 35, 38, 48  
   uniformly distributed load, 156
- Diamond drill borings, 469
- Direct stress and bending, 169.  
   See also Thrust and Bending moment
- Direct stress and bending, allowable  
   stress, 463  
   circular section, 179  
   formulas for design:  
     total section in compression, 177  
     part section in tension, 180, 182,  
     186  
   negative thrust and moment, 167,  
     189  
   plain section, 169  
   reinforced section, 173  
   sign of bending moment and position  
     of thrust, 166  
   steel in tensile face only, 189  
   tension, 162
- Distributing beams, 633
- Dowels, for columns, 417  
   on plans, 720  
   pedestals, 487  
   retaining walls, 863
- Drainage, retaining walls, 83±  
   roofs, 649
- Drop panels for flat slabs, 322  
   advisability of, 322  
   at wall columns, 324  
   dimensions, 323  
   shear stress at, 914
- E
- Earth, weight of, 833
- Earth, pressure, basement walls, 638,  
   644  
   distribution of, 835  
   passive, 839  
   Rankine's theory, 835  
   retaining walls, 841, 842  
   special cases, 836  
   surcharge, 837  
   variation of, 640
- Eastern Concrete Construction Co., 60
- Eccentric footings, 476
- Eccentric loading, 164  
   See Direct Stress and Bending  
   See Thrust and Bending Moment
- Eccentric thrust, relation to bending  
   moment, 165  
   stress caused by, 171

- Eccentricity, effect of, 177  
   limiting, 178  
 Economical, arrangement floor beams, 575  
   depth, T-beams, 220  
   design, column reinforcement, 447  
     rectangular beams, 213  
   mix for columns, 447  
 Economy, cantilever *vs.* counterfort walls, 863  
   columns, spiral *vs.* vertical steel only, 449  
   concrete construction, 564  
   concrete *vs.* rubble masonry, 832  
   deformed bars, 10  
   floor construction, 806  
   foundation depth, 470  
   plain *vs.* reinforced walls, 832  
   reinforced concrete, 123  
   reinforced concrete footings, 481  
   reinforcing steel, 9  
   rich mix, 213  
   structural steel and concrete columns, 452  
   T-beams *vs.* truss, 772  
   various types floor, 785  
 Edison Electric Illuminating Co. Chimney, 824  
 Effective area, columns, 406  
   section for thrust and bending, 179  
   width slabs, 72  
 Elastic flashing, 659  
   joints, ground slabs, 618  
   limit, 50  
 Elcannes reinforcing bars, 14  
 Elevator pit, 696  
   provision for additional, 791  
   shafts, 682, 695  
 Elevators, warehouse, 791  
 Eliot St. Garage, Boston, 801  
 Emperger, 93  
 Engineering News pile formula, 543, 559  
 Exits required in buildings, 683  
 Expanded metal reinforcement, 15, 18  
 Expansion joints in roofs, 653  
 Exterior columns, bending moment on, 314  
 Exterior columns, design of, 312, 460  
   rigidity, 313  
 Exterior treatment buildings, 728
- F
- $f_c$ , allowable unit stress, 879  
 $f_s$ , allowable unit stress, 879  
 Faber, Oscar, 812  
 Facing with terra cotta, 753  
 Factor of safety, 30  
   columns, 79, 80  
   definition of, 125  
   reinforcing steel, 8  
   retaining walls, 842  
 Factory, floors, 795  
 Failure, at footing, 479  
   cantilever walls, 850  
   green concrete, 46  
   retaining walls, 841  
   torsion, 95  
   wall with counterforts, 865  
 False beams, 615  
 Fillets for T-beams, 146  
 Finish, brush, 736  
   exterior, 728  
   hammer, 737  
   interior, 755  
   floor surfaces, 620  
 Fire exits, 682  
   protection, reinforcement in beams, 272  
 Fireproof partitions, concrete, 635  
 Fireproofed columns, 88, 93, 407  
 Fireproofing, 422  
 First balcony fulcrum girder, 783  
 Flange, compression below, 137  
   T-beam, compression neglected, 133  
   T-beams, 36  
   width, influence deflection, 62  
 Flanges, shearing in, 37  
 Flash set of cement, 2  
 Flashing, 659  
 Flat ceiling, 610  
   slab design, 911  
 Flat slab, action of, 198  
   action of rings, 373

- Flat slab, advantages of, 304**  
 beams, 377  
 bending moments, 328, 331, 332, 334  
     Chicago Code, 398  
     New York Code, 399  
 bond stresses, 351  
 Chicago regulation, 396  
 columns for, 305  
     bending moments in exterior, 314  
     exterior, limitation of, 312  
     interior, limitation of, 307  
 column heads, 319  
     author's rules, 319  
     Chicago Code, 397  
     New York Code, 397  
 compression at column head, 342  
     in center, 346  
     Chicago Code, 401  
     New York Code, 401  
 compression reinforcement, 345  
 description of, 304  
 design details, 360  
 design strips, 330  
 diagonal tension reinforcement, 350  
 drop panels, 322  
     authors' rules, 322  
     Chicago Code, 397  
     New York Code, 397  
 example of design, 390  
 formulas for area of steel, 351  
 formulas for bending moments, 331  
     interior panel, 332  
     wall panels, 334  
 formulas for compression stresses,  
     343  
     at column head, 344  
     in center, 346  
 interior columns, 305  
     authors' recommendation, 307  
     Chicago Code, 396  
     New York Code, 396  
 maximum bending moment, dis-  
     tribution of, 330  
 method of design, 389  
 New York regulation, 397  
 openings, in, 375  
 points of inflection, 199  
 problems in design, 389
- Flat slab, sections of maximum bend-  
 ing moments, 329**  
 separated in simple parts, 371  
 shearing stresses, 346  
     critical sections for, 348  
     formulas for, 349  
 Smulski system, 369, 376  
     test of, 104  
 steel, working unit stresses, 351  
     Chicago Code, 401  
     New York Code, 401  
 stresses at column head, 199  
 stresses in central portion, 200  
 suspended action impossible, 387  
 systems:  
     Acme system, 363  
     Barton's spider web system, 359  
     four-way system, 358  
     Smulski system, 367  
     three-way system, 374  
     two-way system, 362  
 theory, 194  
 thickness of slab, 325  
     authors' rules, 327  
     Chicago Code, 397  
     New York Code, 397  
 thickness of slab at column head,  
     formula, 338  
 thickness of slab in center, formula,  
     340  
 two-way system, 364, 365  
     test of, 99  
 wall beams, 379  
     above slab, 381  
     below slab, 379  
 wall columns, 312  
     authors' recommendation, 312  
     Chicago Code, 397  
     New York Code, 397
- Flexure, 164, 173  
 Floor, girders supporting joists, 597  
     joists, 592  
     loads, 569  
     plans, 708, 713, 722, 804  
     surfaces, 620, 627  
 Floors, balcony, 778  
     beam and girder design, 575  
     example, 578

- Floors, concentrated loads on light-weight, 609**  
 concrete and tile, 597, 689  
 construction of light-weight, 609  
 cracking of topping, 594  
 dead loads on, 571  
 economical arrangement of beams, 575  
 economy, relative of different types, 786  
 factory, 795  
 finish, 805, 806  
 flat slab construction. See Flat slab  
 garages, 795  
 granolithic finish for, 622  
 hardwood finish for, 625  
 hollow tile, 590  
 hospitals, 807  
 light-weight, 588  
 painting of, 623  
 school buildings, 808  
 steel tile, 602  
 structural steel and concrete, 613  
 tile, 590  
 two-way tiling, 592  
 types, 574, 787  
 warehouse, 791  
 wood block, 626  
 wood finish, 624
- Footing plans, 721**
- Footings, 469, 481**  
 See also combined footings  
 area of, 473  
 bending moments on, 495  
 bond stresses in, 499  
 column loads on, 479  
 combined, 522  
 concentric, 476  
 constants for formulas, 495, 497, 498, 502, 515  
 continuous wall column, 518  
 corner column, 514  
 critical sections of plain concrete, 481  
   of reinforced footing, 496  
   for diagonal tension, 502  
 dead loads on, 536  
 depth of plain table, 481
- Footings, diagonal tension in, 502**  
 eccentric, 476  
 external shear in, 500  
 failure of, 479  
 independent column, 485  
 independent stepped, 490  
 piles under, 516  
 plain concrete, 480  
 projection of wall, 520  
 proportions of independent, 491  
 punching shear on, 492  
 rectangular, 510  
 schedules, 721  
 sloped, 484, 491, 506  
 sloped vs. stepped, 491  
 stepped, 484, 487, 490, 506  
 strap beams for, 533, 536  
 stresses, variation of, in independent, 489  
 types, 481  
 wall, 482
- Formulas. See subject notation for, 128**
- Foundations, 469**  
 at property line, 477  
 beam and slab, 540  
 design loads for, 478  
 encroachment on public streets, 478  
 flat slab, 539  
 outside columns, 478  
 plans, 712, 721  
 plates for, 417  
 raft, 538  
 steel cylinder, 562
- Foundry for Garfield, Smith & Co., 666**
- Four-way flat slab details, 718**  
 system reinforcement, 358
- Framing plan, 714**
- Frank E. Davis Fish Co., building, 733**
- Franklin Service Station, 802**
- Freytag, 87, 88**
- Frictional resistance of piles, 543**
- Frost, power of, 835**
- Fulcrum girders for theaters, 765, 769**
- Furring, 614**  
 inside walls, 746

## G

Garages, 795  
 column spacing, 797  
 inclined driveway, 799  
 live loads, 796  
 Garfield & Smith Co., 665  
 German building rules, 202  
 Giant pre-cast pile, 552  
 Girders, numbering on plans, 711  
 schedules, 715  
 supporting joists, 597  
 Glass, sizes of, 705  
 Glazing, 703  
 Glenday, Charles, 812  
 Goldbeck, A. T., 69  
 Goosenecking, 415  
 Gow, Charles R., 547  
 Graf, O., 95  
 Granolithic floor finish, 609, 620, 623  
 Graphical spacing of stirrups, 252  
 Grauman's Theater, 671, 674, 764, 779  
 Gravell, William H., 629  
 Gravity walls, design of, 839  
 Gymnasiums, 810  
 Gypsum tiles, 592

## H

Hammered surface, 738  
 Hardwood floors, 625  
 Hatt, W. K., 99, 104, 112  
 Haunches, 284, 405  
 Havemeyer bars, 13  
 Heel cantilever walls, 852  
 Height of concrete buildings, 803  
 Herringbone lath, 611  
 Hickey for bending bars, 355, 415, 727  
 Hide and Leather Building, 738, 804  
 Higginson, Wm., 681  
 Hinged effect, bottom of columns, 668  
 Hollow circular beams, 822  
 tile, 589, 590, 598, 809  
 Homogeneous beams, stresses in, 241  
 Hooks in reinforcement, 59, 60, 63, 266,  
 269  
 Hoops. See Spiral reinforcement  
 chimney reinforcement, 819, 825  
 strength, 820

Hospitals, 805  
 design, 808  
 State of Wisconsin, 807, 808  
 Hotels, 805  
 Howard J. E., 80  
 Hughes, C. A., 97  
 Humidity, 652  
 Humphrey, Richard L., 25, 27, 62  
 Hy-rib, 19, 611

## I

Ideal Shoe Factory, 793  
 Identification tags on bars, 723  
 Imbedment, formulas for, 267  
 length, 267, 462  
 Imitation marble, 760  
 Inclined drive, garage, 799  
 stirrups, 243  
 Independent footings with piles, 516  
 Inertia, moment of, 174, 281  
 Inflection, coefficient of, 65  
 points of, 110, 289  
 Inserts for shafting, 615  
 Insulation of roofs, 650  
 Interior, columns, 305, 310, 312  
 finish, 755  
 office building, 761  
 panels, bending moment in, 331

## J

*j*, formulas, rectangular beams and  
 slabs, 130, 207  
 steel top and bottom, 240  
 T-beam, 134, 221  
*j*, rectangular beams and slabs, tables,  
 205, 880, 881  
*j*, steel top and bottom, diagram, 910  
*j*, T-beam, table, 221, 897  
 Jetting, pre-cast piles, 551  
 Joint Committee, year 1916, 246, 448  
 year 1924, 161, 245, 246, 282,  
 324, 331, 333, 337, 405  
 1924 Full Report. See Vol. II  
 Joist, depth, 596  
 loads from slabs, 74  
 Joists for floors, 594

## K

- k**, diagrams, direct stress and flexure, 938, 940
  - rectangular beams, 883
- k**, formula, direct stress and flexure, 183, 193
  - rectangular beam, 130, 207
  - steel in top and bottom, 139
  - T-beam, 134, 137
- k**, tables rectangular beams and slabs, 205, 880, 881
  - T-beam, table, 897
- Kahn, Arthur, 803
- Kahn trussed reinforcing bars, 13
- Kellog, Harold Field, 748
- Kenneth, M. de Vose and Co., 748
- Klein, Arthur F., 785

## L

- L-shaped retaining walls, 849
- Lacher design, walls, 872
- Laitance, 5
- Lap, plan bar, 121
- Lapping of bars, length, 414
- Life Savers Inc. Building, 743
- Limestone, 272
- Lindenthal, Gustave, 834, 873
- Linoleum floor finish, 805
- Lintel beam, 103
- Live load, balcony cantilevers, 774
  - beams, table of, 884
  - building codes, 454
  - buildings, 452, 570, 805
  - cold storage, 792
  - columns, 453
  - floors, 569
  - garages, 797
  - reduction for columns, 452
    - authors' recommendation, 453
    - Boston Code, 454
    - Chicago Code, 454
    - New York Code, 454
  - reduction for large areas, 454
  - school floors, 808
- Load transference, flat slabs, 386
- Loading, concrete beams, 20, 884

- Loading, concrete chimneys, 812
  - eccentric, 164
  - effect on neutral axis, 27
  - effect on reinforcement, 27
  - floors, 569
  - for foundation design, 478
  - office floors, 805
  - platforms, 790
  - roofs, 648
  - slabs, 69, 102, 886
  - slab stress at maximum, 109
  - slabs to joists, 74
  - tests of buildings under, 113
- Lockwood, Greene Company, 743
- Long columns, 434
- Long column span roof construction, 661, 671
- Longitudinal reinforcement. See also Vertical reinforcement.
  - for shear, 146
  - fulcrum girders, 768
  - steel, columns with, 405
- Lord, A. R., 88, 113
- Losse, L. H., 25, 27, 62

## M

- MacMillan, A. B., 626, 627
- Manufacturing buildings, 792
- Marking of bent bars, 724
- Mass. Institute of Tech., façades, 754
  - framing plan, 714
  - section, 808, 810
- Maurer, E. R., 220
- Medical Arts Building, Dallas, 803
- Melan arch, 122
- Mensch, L. J., 671
- Metal flashing, 659
  - lath, 18
  - roofing, 656
- Mills, Charles M., 299
- Minimum depth T-beam, 219
- Mix of concrete, basement slabs, 619
  - concrete chimneys, 823
  - concrete columns, economy of, 447
  - for use, 4
  - fulcrum girders, 772
  - granolithic finish, 620

- Mix of concrete, influence of**, 24, 80,  
     83, 87  
     pre-cast piles, 550  
     stress in steel and concrete, due to,  
     87
- Modulus of elasticity**, 31, 80  
     columns, 76  
     concrete, 38, 202  
     effect of, if constant, 127  
     for beams, 127  
     variation with stresses, 142  
     rupture, plain concrete beam, 48
- Moisture protection of steel**, 273
- Moment arm, formulas, beam with  
 compression steel**, 240  
     rectangular beams, 130, 207  
     T-beam, 134, 221  
     tables and diagrams, beams with  
     compression steel, 910  
     rectangular beams, 205, 880, 881,  
     883  
     T-beams, 897
- Moment coefficients**, 102
- Moment of inertia, effect on bending  
 moment**, 281  
     for different sections, table, 945
- Moment of resistance, rectangular  
 beam**, 130  
     T-beam, 136
- Monotype reinforcing bars**, 14
- Morris, C. T.**, 70, 74
- Morrow, D. C.**, 374
- Moving loads, diagonal tension for**, 258
- Mullions**, 699
- Muntins**, 699
- Mushroom system of reinforcement**,  
 359
- N
- National Board of Fire Underwriters**,  
 685
- National Fireproofing Company**, 590
- Negative thrust**, 165
- Neutral axis, formulas, direct stress and  
 flexure**, 183, 193  
     rectangular beam, 130, 207  
     steel in top and bottom, 139
- Neutral axis, formulas, T-beam**, 134,  
 137, 224  
     tables and diagrams, direct stress  
     and flexure, 938, 940  
     rectangular beams, 205, 880, 881,  
     883  
     T-beam, 897  
     tests, 27, 35
- New Channon Building, test**, 342
- New York Building Code**, 160, 218, 322  
     cinder concrete, 612  
     columns, 396, 408, 421, 424, 437, 448  
     450, 464  
     flat slab regulations, 347, 396  
     live loads, 454  
     panels, 399, 400  
     piles, 514  
     smoke-proof stair towers, 686  
     spiral columns, 426, 918  
     stairways, 685  
     steel cylinder foundation, 562
- New York Connecting R. R.**, 873
- Nichols, John R.**, 196
- Nielson, N. S.**, 196
- Norecross system of reinforcement**, 358
- Northup, W. C.**, 784
- Notation**, 128
- Numbering of columns**, 710  
     of girders, 711
- O
- Oberlander, J. T.**, 833
- Office buildings**, 803  
     floor plan, 804  
     interior, 761
- Office, Salada Tea Co.**, 759
- Openings, roof**, 660  
     slabs, 375
- Orchestra floor**, 763
- Organic matter, effect**, 2
- Ornamental ceilings**, 614  
     façades, 754
- Outside columns, foundations for**, 478
- P
- p*, values for beam and slabs 882  
*p'*, ratio for given *p*, 904

- $p_1$ , values in spiral columns, 931  
 Paine Furniture Company's roof, 651  
 Painted concrete, 758  
 Painting window sash, 703  
 Panels. See also Interior panels.  
   See also Wall panels  
   building codes for, 400  
   sizes, warehouses, 789  
   steel tile construction, 603  
   wall vs. interior, 104  
 Parabolic distribution stress, 30, 143  
 Parallel bars, spacing, 273  
 Parapets, 656  
 Passive earth pressure, 839  
 Pedestals, 486  
   pile, 557  
 Peerless pile, 557  
 Penetration of piles, 543  
 Penn Charter Gymnasium ceiling, 607  
 Pent house for elevator shaft, 696  
 Pent houses, 678  
 Philadelphia Building Code, 218  
   columns, 408, 421, 437, 448, 450, 464  
 Pier 6, roof truss, Cristobal, 677  
 Piers, strength of brick, 77  
 Pilasters, 632  
 Piles, 477, 542  
   See also Cast-in-place piles  
   See also Pre-cast piles  
   Bignell pre-cast, 552  
   brooming, 545  
   caisson, 560  
   capacity, cast-in-place, 558  
   cast-in-place, 554  
   Chenoweth pre-cast, 551  
   composite, 555  
   concrete, 546  
   Cummings pre-cast, 552  
   cutting of wood, 544  
   driving, 545  
   driving pre-cast piles, 550  
   Engineering News formulas, 543  
   frictional resistance, 543  
   Giant pre-cast, 552  
   Gilbert pre-cast, 552  
   inclined, 545  
   independent footings, 516  
 Piles, outside bearing walls, 543  
   pedestal, 557  
   Peerless cast, 557  
   penetration, 543  
   pre-cast, 546  
   raft foundation, 539  
   Raymond cast, 554  
   retaining walls, 843  
   Simplex cast, 555  
   spacing, 542  
   stresses in pre-cast, 548  
   Wellington formulas, 543  
   wooden, 543  
 Pipes imbedded in concrete, 357  
 Pitch of roofs, 649  
   of spiral reinforcement, 431  
 Plain concrete, columns, 403  
   factory, 729  
   footings, 480  
   section, direct stress and bending  
     on, 169  
     general, formula for stress on, 169  
 Plan, Pier 6, roof truss, Cristobal, 678  
 Plans, building, 707  
   flat slab building, 718  
   floors, 713  
   foundations, 712  
   working, 720  
 Plaster casts, 757  
   finish, 758  
 Plastic deformation of concrete, 34.  
 Plate anchorage, 163  
 Platforms for access, 690  
 Plinth, 322  
 Point of bending reinforcement, 287  
 Points of inflection, 110  
   beam and tile floors, 595  
   continuous beam, 289  
   effect of reinforcement on, 386  
   flat slabs, 119, 336  
 Poisson's ratio, 76, 121, 197, 199  
 Post, George B. & Son, 750, 800  
 Pre-cast piles, 546, 547, 548, 550  
   roof trusses, 677  
 Pressure on raft foundation, 538  
   wall foundations, 841  
 Pressures on retaining walls, 836  
 Prior, J. H., 872



Probst, T. E., 64, 67  
 Properties of sections, 945  
 Proportions for concrete, 4  
 Protective covering, reinforcement, 272  
 Pull-out tests, 51  
 Punching shear, 492

## R

*R*, values of, for beam and slab, table,  
 205, 880, 881, 882  
 diagram, 883  
*r*, effect of cost of formwork on, 221  
 Raft foundation, 538  
 Railroad sidings for warehouses, 791  
 Ramps for garages, 798  
   circular, 799  
   D'Hume, 801  
 Ramp Building Corporation, 797  
 Rankine's theory, earth pressure, 835  
 Raymond pile, 554  
 Recesses on plans, 720  
 Rectangular bands, 88  
 Rectangular beams,  
   see also Beams  
   approximate formulas, 207  
   balanced design, 202  
   compression reinforcement, 232  
   economical design, 213  
   formulas for design, 203  
   review, 206  
   plain sections, stress formula, 170  
   safe loads, table, 884  
   stress distribution, 180  
   theory, 127  
   table of constants, 880  
 Reduction of live load on columns, 452  
   for large areas, 453  
 Reglets, 658  
 Reinforced concrete bearing walls, 634  
   definition, 122  
 Reinforced concrete, definition, 122  
 Reinforcement, 7  
   allowable stresses, 8, 879  
   anchorage of. See Anchorage.  
   angle of bend, 291  
   bearing stresses, 54  
   bending bars, 355

Reinforcement, bending diagrams for,  
 291  
   bond stresses, 10  
   circumferential *vs.* band, 117  
   Clinton wire fabric 17  
   compression, 50  
   corrosion of, 9  
   definition of, 7  
   deformation in, 28, 72  
   deformed bars, 10  
   diagrams to determine points of  
     bending, 292-297  
   Elcannes bars, 14  
   expanded metal, 15  
   factor of safety, 8  
   failure of, 22  
   floor plan drawing, 726  
   four-way flat slab system, 353  
   fulcrum girders, 767  
   grade steel, 8  
   hard steel, 9  
   Havemeyer bars, 13  
   identification tags for, 723  
   intermediate grade, 9  
   Kahn new rib bars, 13  
   Kahn trussed bars, 13  
   lapping of bars, 413  
   length of inbedment in columns, 462  
     lap, 414  
     spiral, 433  
   metal lath, 18  
   minimum, for columns, 413  
     for economy, 136  
   moisture protection for, 273  
   Monotype bars, 14  
   necessity of securing in place, 356  
   neutral axis, influence on, 27  
   over doors, etc., 634  
   per cent, influence of, 25  
   pitch of spiral, 432  
   plain *vs.* deformed, 10  
   point of bending in beams and  
     slabs, 209, 287, 290  
   properties of bars, 12  
   properties of bars, steel, 7  
   protection of, 9, 272  
   ratio in slabs, 211  
   T-beams, 894

- Reinforcement, rib lath, 17**  
 rings, action of, 373  
 shapes, 10  
 shock, protection from, 10  
 shrinkage stresses, 298  
 slabs over girders, 211  
 Smulski flat slab system, 367  
 spacing for aggregates, 273  
 splicing of, 61, 265, 267  
 steel, brittleness of, 10  
 structural shapes for columns, 88, 441  
 supports, 209  
 tables of sizes, 942  
 temperature, in walls, 855  
 temperature stress, 298  
 temperature under, 9  
 three-way flat slab system, 374  
 torsion, resistance to, 94  
 triangle mesh, 17  
 two layers, 30  
 two-way, flat slab system, 352  
 vertical spacing, 274  
 weight of spiral, 433  
 wire, 14, 17  
 yield point, significance of, 202
- Relative cost of buildings of different materials, 564**
- Repeated loads on columns, 77**
- Reservoirs. See Vol. III**
- Restraint of ends of beam, 275**  
 slabs at wall, 333
- Retaining walls, 832**  
 cantilever, 849  
 cellular, 869  
 drainage, 834  
 economy of types, 832  
 factor of safety, 842  
 failure, 841  
 L-shaped, 849  
 line of pressure on, 840  
 piles under, 843  
 pressure on foundation, 846, 848  
 sliding of, 838  
 T-shaped, 849  
 temperature reinforcement, 855  
 upright slab, 850
- Rib lath, 19**
- Rich mix, economy in rectangular beams, 214**  
 economy in slabs, 213
- Rigby, Edward H., 835**
- Rigid frame, with arched roof, 667**  
 roofs, 665
- Ring reinforcement, 370**
- Rings, effectiveness as reinforcement, 352, 373**  
 splicing, 121  
 stress distribution in, 110
- Riplex, 611**
- Risers, stairs, 688**
- Road construction, 12**
- Roadbed, distribution of load on, 75**
- Roads and Pavements. See Vol. II**
- Robbins, Henry C., 728**
- Rock Island R. R., 834**
- Roof, air space below, 652**  
 arched with rigid frame, 667  
 cinder fill for, 653  
 concrete arches for, 668  
 condensation under, 649  
 construction, 648  
 coverings, classes, 654  
 dead loads, 648  
 design, 659  
 drainage of, 649  
 expansion joints in, 653  
 foundry for Garfield Smith & Company, 666  
 girder, Winston-Salem Auditorium, 663  
 insulation of, 650  
 long span, 661, 668, 671  
 openings in, 660  
 Paine Furniture Company, 651  
 pitch of, 649  
 rigid frame, 665  
 sawtooth, 675  
 theater, 778  
 trusses, concrete, 671  
 Grauman's theater, 674  
 pre-cast, 678  
 walks on, 659  
 wind pressure on, 649
- Rubble masonry, 832**
- Runs and platforms, 690**

## S

- Safe loads, rectangular beams, 884**  
     slabs, 886  
**Sagar, W. L., 97**  
**Salada Tea Company Building, 752,**  
     757, 759  
**Sand, organic matter in, 2**  
     testing, 3  
**Sash, dimensions, 700**  
     standard sizes, 705  
     Underwriters' pivoted, 706  
**Sawtooth roofs, 675**  
**Scagliola, 760**  
**Scheit, H., 61, 64**  
**Schmidt, Garden & Martin, 671, 681**  
**School buildings, 808**  
**Scuttles to roof, 686**  
**Sea water, concrete in, 6**  
**Sections, properties of, 945**  
**Separate bending sketches for bars, 726**  
**Settlement, foundations, 472**  
     unequal, 472  
**Shafting inserts in ceiling, 615**  
**Shapes, reinforcement, 10**  
**Shear, beams, 143, 244**  
     cantilevers, 773  
     chimneys, 817, 819  
     column heads, 913  
     definition of, 143  
     diagram, moving loads, 258  
     drop panels, 914  
     external, magnitude of, 144  
     footings, 500  
     formula for stress, 148  
     horizontal, 144, 150  
     longitudinal, cause of, 144  
     longitudinal T-beam, 144  
     magnitude, solution for, 145  
     strap beams, 533  
     stress, 143, 148, 151, 244, 346  
     vertical, 56, 144, 150  
**Shepard & Stearns, 803**  
**Shock on concrete, 10**  
**Shrinkage stresses, reinforcement for,**  
     298  
**Sidewalks. See Vol. II**  
**Simplex pile, 555**
- Simplex system reinforcement, 359**  
**Sinks, Frank F., 362**  
**Skeleton concrete buildings, 572**  
**Skylight openings, 660**  
**Slabs. See also Basement slabs**  
     See also Flat slabs  
     area round bars, 945  
     square bars, 945  
     arrangement of reinforcement for,  
         210  
     basement, 618  
     bending moment in continuous, 209,  
         278  
     bending of reinforcing bars for, 210  
     breaking load for wide, 72  
     cantilever, tests on, 116  
     constants, table of, 880, 881  
         for selected stresses, 205  
     continuous, 208  
     cross reinforcement of, 211  
         over girders, 211  
     design, 205, 208  
         constants for, 205, 880, 881  
         tables, 886, 888-893  
     details and schedule, 716  
         on floor plan, 726  
     distribution of load, square or ob-  
         long, 212  
     eccentric loads on, 70  
     economy of rich mix, 213  
     effective width for concentrated  
         load, 69, 70, 72  
     example, 579  
     formulas for design, 208  
     reinforcement, arrangement of, 210  
         formula for, 211  
         over girders, 211  
     safe loads on tables, 886, 888-893  
     span of, 209, 277  
     steel, points of bending, 209  
         ratio, 211  
         stresses in, 131  
     structural steel beams, 611  
     stresses in wide, under concen-  
         trated load, 69  
**Slabs, supported by four beams, 211**  
     temperature steel for, 618  
     tests, 99, 116

- Slabs, thickness, formula for, 208  
two-way hollow tile and structural steel, 613
- Slate shingles, 656
- Slater, W. A., 31, 113
- Sleepers, 624
- Sliding of retaining walls, 838
- Slip of tension bars, 51
- Sloped footings, 490
- Smoke-proof stairways, 686
- Smulski, Edward, 99, 110, 111, 112, 116, 224, 233, 367, 784
- Smulski flat slab tests, 104
- Smulski flat slab system, action of, 369  
flat slab sections, 719  
reinforcement, 353, 367  
schedule, 727
- Soil, bearing power of, 470  
carrying capacity of, 469  
definitions of varieties, 471  
effect of organic matter on bearing power, 470  
unequal settlement, 472
- Southern Engineering Company, 784
- Spacers for reinforcement, 275, 357  
bar, 211  
spiral columns, 433
- Spacing, area bars for various, 945  
columns, 793, 797, 804  
reinforcement. See type in question
- Spalling, 91
- Span length, 277
- Spandrel, beam faced with brick, 746  
beams, 334  
loads, 459  
torsion, 336
- Spatter coat, 736
- Special sash, 705
- Spiral columns, 419  
See also Columns  
description, 419  
design, 431  
details, 432  
economical design, 448  
equivalent area vertical steel, 432  
columns, example, 456  
formulas, authors' recommendation, 421
- Spiral columns, formulas, Boston, Cleveland, and Philadelphia Code, 422  
Chicago Code, 425  
New York Code, 424  
oblong, 430  
octagonal, 429  
ratio length to diameter core, 422  
relative economy, 449  
square, with round spiral, 429  
square spiral not effective, 430  
tests on, 82
- Spiral reinforcement, columns, 160, 419  
cost, 434  
length, 433  
pitch, 431  
relation of pitch and ratio of spiral, 431  
weight, 432
- Spitzer, 79, 93
- Splices in reinforcement, 61
- Splicing, rings, 121  
staggering of, 163  
structural columns, 441
- Spouting of concrete, 357
- Sprinklers, 577
- Stairs, 682, 810, 811  
capacity, 684  
enclosed, 685  
intermediate landings, 690  
landing beam, 691  
layout of, 686  
methods of design, 690  
nosing, 688, 689, 694  
reinforcement, 693  
slope of, 689  
special design, 630  
three-flight, 693  
treads and risers, 688  
two-flight, 690  
winding, 685
- Stairways, smoke proof, 686
- Standard sizes of sash, 705
- Standards for window sash, 699
- Statcal limitations, flat slab theory, 194
- Statler Garage, 750, 800, 801
- Steel. See Reinforcement  
bearing plates, 633

**Steel, brackets, 442**  
   columns, 314  
   cylinder foundations, 562  
   ratio modulus to that of concrete, 201  
   tile, dimensions, 604  
   tile floors, 602  
   window sash, 699  
**Stepped footings, 487**  
**Stirrups, 36, 38, 96, 242, 251**  
   action of, 153  
   area of vertical, 154, 248  
   counterforts, 868  
   design tables, 899  
   diagonal tension in, 153  
   formulas for design, 247, 248  
   fulcrum girders, 768  
   graphical spacing, 252  
   held by top bars, 290  
   inclined, 243  
   limiting spacing, 156, 250  
   number of, for uniformly distributed loading, table, 900  
   spacing depends upon type of loading, 253  
   spacing for vertical, 154, 247  
     for inclined, 156, 249  
     for uniformly distributed load, table, 901  
   spacing table, 899  
   support for, 290  
   theory, 147  
   types of, 243  
**Stone & Webster, 755**  
**Stone exterior, 753**  
**Straight-line formula, 127, 142**  
   theory, 123  
**Strap beams in footings, bending at interior columns, 537**  
   connecting footings, 533  
   loading, 534  
   pile foundation, 536  
   types, 538  
**Strength, brick piers, 77**  
**Stresses, actual and computed, 24, 125, 128**  
   allowable unit, table, 879  
   allowable, in concrete at supports, 223

**Stresses, assumptions of distribution**  
   in rectangular beam, 143  
   bearing in hooks, 163  
   direct and flexure. See Direct stress and bending  
   eccentric thrust, caused by. See Direct stress and bending  
   effect of moduli on, 202  
   interdependence between steel and concrete, 206  
   parabolic distribution of, 30, 143  
   relation to deformation, 387  
   rings, distribution in, 110  
   steel and concrete compared, 87  
   unit, 247  
   variation, 127, 143  
   wall with counterforts, 865  
**Structural steel, and concrete balcony cantilevers, 776**  
   and concrete columns, difficulties of, 452  
   and concrete columns, economy, 452  
   and concrete floors, 611  
**Structural steel columns, base for, 443**  
   brackets for, 443  
   encased in concrete, details of, 440, 435  
**Support of veneer, 751**  
**Supports, tension in steel at, 288**  
   working stresses at, 282  
**Surcharge, 638, 837**  
**Surfaces, coloring of, 737**  
   floor, 620  
   rubbing of concrete, 735  
   treatment of concrete, 734  
**Suspended ceilings, 19, 613, 652**  
   Salada Tea Building, 760  
**Suspension action of flat slabs, 387**  
**Symbols, table of, 128**

## T

**T-beams, 35**  
   area of steel in, 135, 221  
   compression below flange, 133  
   simplified formula, 224  
   compression flange, 116, 217  
   reinforcement, 225, 230

- T-beams, depth at center governed by compression, 219  
 design, 215  
 design diagrams, 894, 895  
 tables, 897  
 details of design, 223  
 diagram of steel ratio, 894  
 economical depth, 220  
 exact *vs.* approximate formulas for, 227  
 failure by tension, 35  
 fillets, effect on strength, 146  
 flange, effective width of, 36  
 formulas for design, 216  
   simplified, compression below flange, 224  
   simplified irregular flange, 228  
   unsymmetrical flange, 142  
 formulas, derivation of, 133  
 fulcrum girders, 767  
 how obtained, 215  
 longitudinal shear in, 144  
 minimum depth, 135, 220  
 minimum depth at support, continuous beam, 222  
 moment arm for, 221  
 moment of resistance, 136  
 neutral axis for, 133  
   table, 897  
 shearing stresses in flanges, 37  
 stresses in, 224  
 test of, 35  
 theory of, 133  
*vs.* truss, 772  
 width of flange, 36, 217
- T-shaped retaining walls, 849  
 Tags on reinforcing bars, 723  
 Talbot, Arthur N., 28, 35, 47, 76, 80, 83, 88, 89, 93, 113, 143  
 Taper of piles, 542  
 Tapered tile, 605  
 Tar and gravel roofs, 654  
 Taylor, C. Percy, 812  
 Temperature in chimneys, 822  
 Temperature reinforcement, base-ment walls, 635  
   retaining walls, 855  
   stresses, reinforcement for, 298
- Tensile strength of concrete, 21  
 Tension, and bending combined on rectangular section, 191  
   center of, in chimneys, 816  
   concrete beam in, 140  
   diagonal, 147  
   direct, 162  
   entire section, subjected to direct, 190  
   members, composition of, 162  
   thickness of, 164  
   trusses, 770  
 Tension reinforcement of columns, 461  
   of slab across beams, 146  
   steel, center of span, 287  
 Tension, failure by, of T-beam, 35  
 Teredo, 542  
 Terra cotta exterior, 753  
 Terrazzo floors, 623, 805  
 Tests, 20  
   beams with compressive reinforcement, 50  
   bend test of bars, 8  
   bond of concrete and steel, 51  
   cement, 2  
   columns with vertical steel, 78  
     spiral reinforcement, 82  
     structural steel, 88  
   continuous beams, 115  
   cracks in beams, 115  
   Deere & Webber Building, 113  
   diagonal tension, 38  
   flat slab construction, 98  
   long columns, 93  
   octagonal flat slab, 116  
   plain concrete columns, 75  
   pull-out of bars, 51  
   sand, 3  
   slabs, 71, 100, 117, 120  
   slump, 4  
   Smulski system, 104  
   T-beams, 36  
   Turner-Carter Building, 115  
   value of, for structures, 113  
   Wenalden Building, 114  
 Test pits for ground exploration, 469  
 Theater balcony truss, 779  
 Theaters, concrete construction, 762

- Theory, flat slab, 194  
   least work, 313  
   rectangular beams, assumptions, 126  
   reinforced concrete, 122
- Thompson & Binger, 665, 738  
 Thompson, Sanford E., 116, 621, 755  
 Three-flight stairs, 693  
 Three-way system of reinforcement, 374
- Thrust and bending moment, 164  
   allowable unit stresses, 463  
   character of stresses, 463  
   circular sections, plain, 172  
     reinforced, 179  
   columns under, 458  
     design of, 460  
   condition of loading for maximum stress, 187  
   diagrams for design:  
     part of section in tension, 938, 939  
     tension side reinforced, 940, 941  
     whole section under compression, 934-936  
   effective section, 179  
   general formula, 169  
   negative thrust, 190  
     part of section under compression, 191  
     whole section under tension, 190  
   plain section, 170  
   relation between position of eccentric thrust and sign of bending moment, 166  
   reinforced section, general formulas, 173  
     circular, 179  
     one surface intension, 180  
       rectangular, 175  
   reinforcement in tension face only, 185  
   sign of, governed by bending moment, 165
- Tie rods, long arched roofs, 669  
   retaining walls, 872
- Ties for facing, 751  
   sag in, 163
- Tile floor, construction, 589  
   Tile floor, weight, 590, 597  
   Tile insulators, 653  
   Tiles, adjustable metal, 605  
     gypsum, 592  
     hollow clay, 590  
     metal, 611  
     removable, 611  
     tapered, 605
- Toe-cantilever walls, 852  
 Top bars to hold stirrups, 290  
 Topping for hollow tile floors, 593  
   for metal tile floors, 608  
   pouring, 610
- Toronto tests, 97  
 Torsion, cause of, 94  
   failure by, 95  
   lintel beam, 104  
   resistance of concrete in, 94  
   spandrel beams, 336  
   stresses due to, 94  
   ultimate stress, 96
- Traprock, 272  
 Trautwine, John C., 840  
 Treads, stairs, 686  
 Treatment of concrete surfaces, 734  
 Triangle mesh, 17  
 Truck loads, distribution on road bed, 75  
 Truck-loading platforms, 791  
 Trucks, dimensions of, 797  
 Trusses, 769  
 Turneaure, F. E., 22, 220  
 Turner, C. P. A., 359  
 Turner-Carter Building, test on, 115  
 Turner Construction Company, 729, 744  
 Two-flight stairs, 690  
 Two-way system reinforcement, 362  
   flat slab tests, 99  
 Types of concrete buildings, 785  
   floor construction, 785, 787
- U
- Unbalanced design, rectangular beams, 132, 203  
 Underwriters' pivoted sash, 706

Unequal settlement, footings, 537  
 raft foundation, 539  
 Uniform loading, stirrups for, 253  
 Uniformly distributed load, diagonal  
 tension with, 156  
 United Fireproofing Company, 760, 800  
 Universal Portland Cement Company,  
 565

## V

Villadsen Brothers, 665  
 Variations in bending moment, 335  
 Vertical bars for columns, 434  
 Vertical shearing, measure of diagonal  
 tension, 241  
 spacing, reinforcement, 274  
 Voids due to reinforcement, 273

## W

Walks on roofs, 659  
 Wall beams, 379, 382  
 general remarks, 385  
 Wall bearing construction, 572, 629  
 vs. skeleton construction, 809  
 column footing, continuous, 518  
 columns, anchorage of steel, 462  
 bending of, 458  
 deflection of, 460  
 footings, 482  
 foundations, 841  
 panels in flat slab, 333  
 panels in flat slab, New York Code,  
 400  
 Chicago Code, 400  
 restraint of flat slabs, 333  
 tie rods, 872  
 Walls. See also Basement walls  
 See also Retaining walls  
 basement, 637  
 supported at columns, 643  
 supported top and bottom, 638  
 concrete, 634  
 waterproofing of, 637  
 Warehouse, column spacing  
 construction, 785  
 elevators, 791  
 floor finish, 791

Warehouse, live loads, 453, 789  
 panel sizes, 789  
 wash borings, 469  
 Wawrzyniak, O., 61  
 Washington Garage, inclined drive-  
 way, 799, 800  
 Water jet, pile driving, 545  
 Water pressure on basement, 619  
 Waterproofing walls, 746  
 Watertight work, 6, 98  
 Water tower, Clark Biscuit Company,  
 680  
 Watertown Arsenal Tests, 77, 80  
 Wayss, 87, 88  
 Weather tightness, curtain wall, 382  
 Web area of T-beam, 218  
 determined by diagonal tension,  
 218  
 resistance, effect of age on, 47  
 Web reinforcement, 242  
 action of, 152  
 anchorage of, 244  
 area and spacing, 248  
 cantilevers, 158  
 continuous beams, 157  
 description of, 243  
 design of, 251  
 proportion of diagonal tension  
 resisted by, 153, 245  
 tests, 48  
 theory, 147  
 usefulness of, 157, 242  
 Web resistance, effect of horizontal  
 steel on, 47  
 Wedge-shaped beams, 140  
 Weight, clay tile floors, 597  
 earth, 833  
 of bars, table, 942  
 Welded wire fabric, 17  
 Wellington formulas for piles, 543  
 Wenalden Building Test, 114  
 Westergaard, H. M., 196  
 Western Newspaper Union Building,  
 370  
 destruction test, 346  
 Width of flange, T-beams, 217  
 Wind, chimney loads, 812, 825  
 pressure on roofs, 649, 669



- Winding stairs, 685  
Window opening, 705  
  sash, 699, 701, 703  
Winston-Salem Auditorium, 663, 762,  
  778, 780, 784  
Wire reinforcement, 14, 432  
Wiren, George R., 748  
Withey, M. O., 48, 58, 59, 79, 83, 91, 93  
Wood, block floors, 626  
  floors, 624, 805  
  piles, 543  
    cutting top of, 544  
    sleepers for floors, 624  
Working plans, 721
- Working stresses, table of, 879
- Y
- Yield point, effect of reinforcement on,  
  86  
  of steel, 202  
  influence of mix on, 83  
Young, C. R., 97  
Youths' Companion Building, 740, 793,  
  794
- Z
- Zipprodt, R. R., 31

## DATE OF ISSUE

This book must be returned  
within 3, 7, 14 days of its issue. A  
fine of ONE ANNA per day will  
be charged if the book is overdue.

---

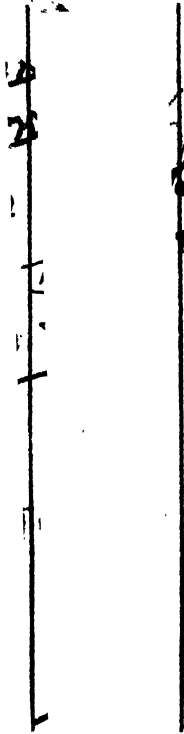

V 1

TAYLOR & others.  
620-136 T19CH  
Concrete Plain & Reinforced.

33957

7 Dec 60

5 Mar

4 Jan 61

2 Feb 61 2617

14 Feb 70

30 Dec 2738

15 Apr 70

8 Dec 3017

28 Jun 63

26 Jul 69 A 9207

12 Mar A 23

18-1066

27 Oct 63