

Birla Central Library

PILANI (Rajasthan)

Class. No. 612...111.16

Book No. L467.H.....

Accession No. 69071.....

HEMATIN COMPOUNDS AND BILE PIGMENTS

Their Constitution, Metabolism, and Function

HEMATIN COMPOUNDS AND BILE PIGMENTS

THEIR CONSTITUTION; METABOLISM, AND FUNCTION

By **R. LEMBERG, Dr. Phil.**, INSTITUTE OF MEDICAL RESEARCH,
ROYAL NORTH SHORE HOSPITAL, SYDNEY, AUSTRALIA
and **J. W. LEGGE, M. Sc.**, DEPARTMENT OF BIOCHEMISTRY,
UNIVERSITY OF MELBOURNE, AUSTRALIA

1949

INTERSCIENCE PUBLISHERS, INC., NEW YORK
INTERSCIENCE PUBLISHERS LTD., LONDON

COPYRIGHT, 1949, BY INTERSCIENCE PUBLISHERS, INC.

ALL RIGHTS RESERVED — This book or any part thereof must not be reproduced without permission of the publishers in writing. This applies specifically to photostatic and microfilm reproductions.

INTERSCIENCE PUBLISHERS, INC.
215 Fourth Avenue New York 3, N. Y.

For Great Britain and Northern Ireland:
INTERSCIENCE PUBLISHERS LTD.
2a Southampton Row London

**PRINTED IN THE UNITED STATES OF AMERICA BY
THE MURRAY PRINTING COMPANY, WAKEFIELD, MASS.**

TO
HANNA LEMBERG
AND
GERTRUDE AVON LEGGE

f

PREFACE

There is no need to emphasize the importance of a field of science which includes among its subjects hemoglobin, the hematin enzymes, porphyrins, and bile pigments. No monograph or handbook has previously been available in the English language; in German we have the valuable handbook of H. Fischer and H. Orth on the chemistry of pyrrole derivatives, but this has been written entirely from the viewpoint of the organic chemist.

In textbooks of biochemistry and physiology the subject is rarely treated with the care which its importance demands. Perhaps because of the lack of a suitable monograph serious errors are frequent, hypotheses of doubtful value are given as facts, and there is a time lag of many years, sometimes of decades, between the present-day knowledge available and that summarized in the textbooks. A factor which may have contributed to this is that errors, inescapable in the rapid development of this field, have, for reasons of prestige, not always been withdrawn as clearly and frankly as would have been in the interest of science. After completion of the script of this book two valuable reviews were published: "Heme-Linked Groups and Mode of Action of Some Hemoproteins," by H. Theorell, and "Distribution, Structure, and Properties of the Tetrapyrroles," by S. Granick and H. Gilder, both reviews in Volume VII (1947) of *Advances in Enzymology*.

This book is therefore intended to fill two requirements. It is intended to summarize the present state of our knowledge for the student and for workers in other fields, as well as enable the research worker or anyone wishing to acquire special knowledge in this particular field to gather less laboriously than has hitherto been possible the information needed. For the benefit of the latter particularly, but also for that of the general student, the treatment is as critical as possible and every endeavor has been made to avoid dogmatic statements.

The scope of the book had of necessity to be strictly limited. Physicochemist, organic chemist, biochemist, physiologist, bacteriologist, botanist, zoologist, pathologist, and clinician are all interested in various aspects of the subject. Our main emphasis is biochemical, as the title is intended to indicate. Problems of organic structure are dealt with only in so far as they are of importance for an understanding of the functional and metabolic aspects. More emphasis is given to the physicochemical background. The chemistry of hemoglobin and the hematin enzymes is so intimately linked with general problems of protein chemistry that it is impossible to draw a clear line of demarcation. Again, our selection has been guided by consideration as to whether or not a connection could be established between a particular property and aspects of function or metabolism. On the other hand, the functional aspect of the hematin enzymes has been considered from a chemical rather than from a biological angle; the latter is to be found in works on biological oxidation and is beyond the scope of this book. A large number of facts have been discussed which may be of interest for clinicians and pathologists, but it should be realized that they have been selected because they throw light on aspects of normal metabolism, rather than from a general medical viewpoint.

It is obviously impossible to give a complete treatment of this immense subject in a few hundred pages. Hemoglobin alone is probably the most extensively studied biological product; many thousands of research papers deal with it. No special apologies are required for the omission of reference to many publications. The purpose of this book, however, and the need for severe restriction of the extensive bibliography necessitated other, more serious, omissions. We have attempted to give due weight to pioneer work and have treated in detail the latest publications in which our present knowledge is most fully represented, but we have been forced to omit reference to many papers in the intermediate period. At the time of their appearance, these may have contributed greatly to our knowledge. They are quoted, however, in the later publications and may be readily found by a reference to the latter.

We should explain why we elected not to cite in the text all author names and to refer frequently to publications only by a reference number. Again, this was necessitated by the dual purpose of the book: to enable the student not specially interested in this particular problem to read the text without interruption, and to permit the

research scholar to obtain complete information. Every effort has been made to see that names have been mentioned of the workers who have important discoveries to their credit.

Another attempt to solve the problem of the dual purpose of the book is the use of large and small print. *It must be particularly stressed that the parts set in small type are not by any means considered less important or interesting than those set in large type.* On the contrary, they frequently contain the discussion of problems of particular interest for the research scholar, while those set in large type contain the basic facts of primary interest for the student.

A special difficulty has been the lack of a uniform, generally accepted nomenclature. A questionnaire on nomenclature was sent to some authorities working in the field to whom we are indebted for letting us have their opinion. It is evident that this anarchy of nomenclature is felt keenly, but that at present no possibility exists of arriving at a generally accepted agreement. We hope that the suggestions we have made will contribute to the solution of this problem. Those who do not like some of the names we suggest may consider them as shorthand symbols, the meaning of which has been strictly defined in the various chapters.

The period during which the book was written was a propitious choice for the completion of the work, due to the pause in the publication of research papers during the war. The important literature published up to July, 1946, has been included. In some cases, it was difficult to secure copies of papers published during the war years in countries of the European continent. Reprints kindly sent by scholars, and particularly photocopies prepared by the Australian Council for Scientific and Industrial Research and the Bibliofilm Service of the United States Department of Agriculture, Washington, have helped overcome this problem. Not all papers that might have been of importance could, however, be read in full; some had to be quoted from abstracts.

Every effort has been made to bring the book up-to-date by adding short footnotes in which important recent contributions have been cited and shortly discussed. These additions include the period from middle of 1946 to about June, 1948. We wish to thank the publishers for the indulgence they have shown us by permitting these additions at so late a stage of publication of the book.

Our thanks are due to Dr. W. W. Ingram, Director of the Institute, and to the authorities of the Royal North Shore Hospital, for pro-

viding us with all facilities required for our task. The National Health and Medical Research Council of Australia has supported the work of both authors with research grants for a number of years; it has also made a special grant to one of us (J. W. L.) for a period of four months, which allowed him to contribute extensively to several sections of this book, and has provided us with grants for secretarial help. We are indebted to the Trustees of the Estate of the late Sir Henry S. Wellcome for permitting one of us (J. W. L.) to continue his work on this book during his tenure of a Fellowship in England. Mr. J. P. Callaghan, who has been working in this institute as a research worker under a grant from the National Health and Medical Research Council, has contributed Chapter II and has otherwise greatly assisted in writing and checking other chapters.

We are greatly indebted to Prof. D. Keilin and Prof. F. J. W. Roughton, to Drs. P. George, N. E. Goldsworthy, J. Keilin, D. P. Mellor, M. F. Perutz, W. P. Rogers, R. N. Robertson, and to Mr. H. F. Holden for valuable advice; to Prof. A. J. Canny, Dr. E. B. Durie, J. L. Still and Mr. H. F. Holden for reading parts of the script; to Drs. F. Bodansky and B. I. Horecker for sending unpublished material for quotation; to Mr. W. A. Rawlinson for the original diagram on which Figure 1, Chapter VI, is based; to various authors whose work we have quoted *in extenso*, particularly Prof. L. Pauling and Prof. W. M. Clark, and to their publishers for permission to use these quotations; and to several authors who have sent us reprints of their publications.

The work would have been impossible without the loyal support of the members of the staff of the Institute, particularly of my collaborators, Mr. E. C. Foulkes and J. Falk, who, together with Mr. Callaghan, have read and reread the manuscript and proofs.

We shall be indebted to our readers for pointing out errors and obscurities, so that they may be corrected in later editions.

The book will have fulfilled its purpose if it shows to the student and the general reader how much remains to be done in this interesting field of biochemistry, and if it opens new aspects to the research worker and inspires him to attack unsolved problems.

CONTENTS

| | |
|----------------------------------------------------------------------------------|-----|
| Preface | vii |
| I. Introduction | 1 |
| 1 Biological Significance of the Pyrrole Pigments | 1 |
| 2 Fundamentals of the Chemical Structure of Pyrrole Pigments | 3 |
| 3 Variability of the Pyrrole Pigments | 6 |
| 4 Metabolism of Pyrrole Pigments | 7 |
| II. Methods of Investigation. In collaboration with J. P. CALLAGHAN | 9 |
| 1 Introduction | 9 |
| 2 Spectroscopy | 10 |
| 2.1 The Direct Vision Spectroscope | 10 |
| 2.2 The Hartridge Reversion Spectroscope | 10 |
| 3 Absorption Spectrophotometry | 11 |
| 3.1 Theoretical | 11 |
| 3.1.1 Theory of Light Absorption | 11 |
| 3.1.2 The Absorption Curve | 14 |
| 3.1.3 Determination of Concentration by Spectrophotometry | 14 |
| 3.1.4 Spectrophotometric Titrations | 15 |
| 3.2 Methods of Measurement | 16 |
| 4 Colorimetry and Fluorescence Measurement | 17 |
| 4.1 Colorimetry | 17 |
| 4.2 Fluorescence | 18 |
| 5 The Photochemical Absorption Spectrum | 18 |
| 6 Magnetochemistry and Bond Type | 21 |
| 6.1 Electronic Basis of Bond Formation | 21 |
| 6.2 Magnetic Properties of Molecules | 24 |
| 6.3 Determination of Paramagnetic Susceptibility | 25 |
| 6.4 Magnetochemical Titrations | 25 |
| 7 Potentiometric Methods | 25 |
| 7.1 Determination of Dissociation Constants | 26 |
| 7.1.1 Elementary Theory | 26 |
| 7.1.2 Titration Curves | 27 |
| 7.1.3 Titration Curves of Proteins | 27 |
| 7.1.4 Differential Titration of Proteins | 28 |
| 7.2 Oxidation-Reduction Potentials | 28 |
| 7.2.1 Fundamental Oxidation-Reduction Equation | 29 |
| 7.2.2 Effect of pH | 32 |
| 7.2.3 Change in Aggregation | 35 |
| 7.2.4 Combination of Oxidant and Reductant with Other Substances | 36 |
| 7.2.5 Interaction between Oxidation-Reduction Systems | 44 |
| 7.2.6 Electroactivity and Electroinactivity | 44 |
| 8 Other Methods | 45 |

| | |
|---------------------------------------------------------------------|------------|
| III. Porphyrin Chemistry | 47 |
| 1 Introduction | 47 |
| 1.1 Historical | 47 |
| 1.2 Occurrence of Porphyrins in Nature | 48 |
| 2 Structure of Biologically Important Porphyrins | 49 |
| 2.1 Definition and Side Chains of Various Porphyrins | 49 |
| 2.2 Nomenclature and Symbols | 53 |
| 2.3 Structural Isomerism | 54 |
| 2.4 Syntheses | 56 |
| 3 Individual Porphyrins | 58 |
| 3.1 Porphin | 58 |
| 3.2 Etioporphyrins | 59 |
| 3.3 Porphyrins with Two Carboxylic Acid Groups | 59 |
| 3.3.1 Mesoporphyrin IX | 59 |
| 3.3.2 Protoporphyrin IX | 60 |
| 3.3.3 Deuteroporphyrin IX | 61 |
| 3.3.4 Hematoporphyrin IX | 61 |
| 3.3.5 Porphyrins with Carbonyl Groups in Side Chains | 62 |
| 3.4 Porphyrins with Four and More Carboxylic Acid Groups | 63 |
| 3.4.1 Coproporphyrins | 63 |
| 3.4.2 Uroporphyrins | 66 |
| 3.4.3 Porphyrins with Five to Seven Carboxylic Acid Groups | 68 |
| 4 Aspects of the Physical Chemistry | 68 |
| 4.1 Solubility and Acid-Base Character | 68 |
| 4.2 Adsorption and Surface Properties | 70 |
| 4.3 Light Absorption | 71 |
| 4.4 Fluorescence | 76 |
| 5 Porphyrinogens | 77 |
| 6 Stereochemistry and Fine Structure of Porphyrins | 78 |
| 6.1 Resonance | 78 |
| 6.2 X-ray Analysis of Phthalocyanins | 80 |
| 6.3 The Evidence against Resonance | 83 |
| 6.4 Absorption Spectra and Fine Structure of the Nucleus | 84 |
| 7 Methods of Isolation and Estimation of Porphyrins | 85 |
| 7.1 Isolation | 85 |
| 7.2 Estimation | 87 |
| 8 Tetrapyrrolic Ring Compounds Related to Porphyrins | 89 |
| 8.1 Azaporphyrins | 89 |
| 8.2 Oxyporphyrins | 91 |
| 9 Porphyrin Complex Salts | 93 |
| IV. Bile Pigments | 95 |
| 1 Introduction | 95 |
| 1.1 Definition | 95 |
| 1.2 Structure | 95 |
| 1.3 Synthesis | 99 |
| 1.4 Stereochemistry | 100 |
| 2 Bile Pigment Classes and the Problem of Nomenclature | 103 |
| 2.1 Inadequacies of Present Nomenclature | 103 |
| 2.2 Systematic Nomenclatures | 105 |

| | | |
|-------|----------------------------------------------------------------------------------------------------|-----|
| 2.3 | Relation of Color and Light Absorption to Structure | 107 |
| 2.4 | Gmelin Reaction and Oxidation Products of Bilatrienes | 109 |
| 3 | Bilatrienes. Verdins | 113 |
| 3.1 | Structure | 113 |
| 3.2 | Individual Bilatrienes | 114 |
| 3.2.1 | Bilatriene, Biliverdin | 114 |
| 3.2.2 | Mesobilatriene, Mesobiliverdin ("Glaucobilin") | 115 |
| 3.2.3 | Other Bilatrienes | 116 |
| 3.3 | Reactions and Properties | 116 |
| 4 | Biladienes-(a,c). Rubins | 118 |
| 4.1 | Structure | 118 |
| 4.2 | Individual Biladienes-(a,c) | 120 |
| 4.2.1 | Bilirubin | 120 |
| 4.2.2 | Mesobilirubin | 120 |
| 4.3 | Color Reactions | 121 |
| 4.4 | Absorption Spectra and Metal Complexes | 121 |
| 4.5 | Surface Properties and Adsorption | 123 |
| 5 | Biladienes-(a,b) and Related Substances | 123 |
| 5.1 | Biliviolinoid Substances | 123 |
| 5.2 | Mesobiliviolin (Mesobiliviolin Type I, Lemberg) | 125 |
| 5.2.1 | Structure | 125 |
| 5.2.2 | Absorption Spectra and Complex Salts | 126 |
| 5.2.3 | Occurrence of Mesobiliviolin in Nature | 127 |
| 5.3 | Mesobilierythrin (Lemberg), Mesobilirhodin (Siedel), and Phycocerythrobilin | 128 |
| 5.4 | Bilipurpurins [Biladiene-(a,b)-ones-(c)] and Related Substances | 130 |
| 5.4.1 | Structure | 130 |
| 5.4.2 | Properties | 131 |
| 5.4.3 | Bilichrysyne | 133 |
| 5.4.4 | Bilerythrinoid Oxidation Products of Bilatrienes | 133 |
| 6 | Bilanes, Bilenes, and Related Substances | 134 |
| 6.1 | Occurrence of Mesobilane and Tetrahydromesobilane and the Corresponding Bilenes in Feces and Urine | 134 |
| 6.2 | Mesobilane and Mesobilenes | 136 |
| 6.2.1 | Structure | 136 |
| 6.2.2 | Properties of Mesobilane and Mesobilene-(b) | 138 |
| 6.3 | Tetrahydromesobilane (Stercobilinogen, Urobilinogen B), and Tetrahydromesobilene-(b) (Stercobilin) | 140 |
| 6.3.1 | Structure | 140 |
| 6.3.2 | Properties | 141 |
| 6.4 | <i>d</i> -Urobilin | 143 |
| 6.5 | Porphobilin | 144 |
| 6.6 | Bilenediones and Bilenetetrols (Choletelins) | 144 |
| 7 | Bile Pigment Chromoproteins | 145 |
| 7.1 | Chromoproteins of Red and Blue Algae | 145 |
| 7.2 | Bile Pigment Chromoproteins in Animals | 148 |
| 8 | Dipyrrolic and Related Pigments Occurring in Nature | 149 |
| 8.1 | "Bilifuscins" (α, α' -Dihydroxypyromethenes) | 149 |
| 8.2 | Pentdyopent | 150 |
| 8.3 | Porphobilinogen | 151 |
| 8.4 | Bacterial Pigments | 152 |

| | | |
|-----------|---------------------------------------------------------------------------------------------------------|------------|
| 9 | Estimation of Bile Pigments | 153 |
| 9.1 | Estimation of Bilirubin | 153 |
| 9.2 | Estimation of Urobilin and Urobilinogen | 156 |
| V. | Hematin Compounds | 159 |
| 1 | Basis of Metal Complex Formation | 159 |
| 1.1 | Stereochemistry of Complex Formation | 159 |
| 1.2 | Bond Type in Metal Complexes | 160 |
| 1.3 | Absorption Spectrum and Bond Type | 162 |
| 2 | Nomenclature | 163 |
| 3 | Hemes, Hemins, and Hematins | 166 |
| 3.1 | Hemes | 166 |
| 3.2 | Hemins | 167 |
| 3.3 | Hematins | 169 |
| 4 | Hemochromes and Hemichromes | 174 |
| 4.1 | Hemochromes | 174 |
| 4.1.1 | Affinity of Heme for Bases | 174 |
| 4.1.2 | Stereochemistry of Base Combination | 176 |
| 4.1.3 | Absorption Spectra | 176 |
| 4.2 | Hemichromes | 177 |
| 4.2.1 | Stability of Hemichromes | 177 |
| 4.2.2 | Bond Type in Hemichromes | 178 |
| 4.2.3 | Composition and Structure | 178 |
| 4.2.4 | Affinity of Hematin for Bases | 182 |
| 4.2.5 | Absorption Spectra | 183 |
| 5 | Combination of Hematin Compounds with Oxygen, Hydrogen Peroxide, Carbon Monoxide, and Cyanide | 184 |
| 5.1 | Compounds with Oxygen and Hydrogen Peroxide | 184 |
| 5.2 | Carbon Monoxide Compounds | 185 |
| 5.2.1 | Carbon Monoxide Heme | 185 |
| 5.2.2 | Carbon Monoxide Hemochromes | 185 |
| 5.3 | Cyanide Compounds | 187 |
| 5.3.1 | Dicyanide Ferriporphyrin | 187 |
| 5.3.2 | Cyanide Ferroporphyrins | 188 |
| 5.3.3 | Mixed Cyanide-Base Hematins | 190 |
| 5.3.4 | Absorption Spectra of Cyanide Compounds | 191 |
| 5.3.5 | Linkage of Cyanide | 191 |
| 5.4 | Other Compounds of Heme and Hematin | 191 |
| 6 | Metalloporphyrins Containing Nickel, Cobalt, and Manganese | 192 |
| 7 | Oxidation-Reduction Potentials of Hematin Compounds | 193 |
| 7.1 | Oxidation-Reduction Potentials at Constant pH | 193 |
| 7.1.1 | The Heme-Hematin System | 193 |
| 7.1.2 | Systems Involving Coordinating Substances | 194 |
| 7.1.3 | Determination of Constitution of Hemochromes | 196 |
| 7.2 | Influence of pH | 197 |
| 7.3 | Influence of Buffer Anions | 201 |
| 8 | Hematin Compounds of Aza- and Oxyporphyrins and Other Hematin Compounds | 201 |
| 8.1 | "Red, Red-Green, and Green Hemins" | 201 |
| 8.2 | Monoazahematin Compounds | 202 |
| 8.3 | Oxyporphyrin Hematin Compounds | 203 |
| 8.4 | Hematins c | 203 |

| | |
|-----------------------------------------------------------------------------------------------------------------------------|------------|
| VI. Hemoglobin | 207 |
| 1 Introduction | 207 |
| 1.1 Definition of Hemoglobin | 207 |
| 1.2 Nomenclature | 208 |
| 2 Preparation and Properties | 211 |
| 2.1 Preparation | 211 |
| 2.1.1 Oxyhemoglobin | 211 |
| 2.1.2 Myohemoglobin | 213 |
| 2.1.3 Criteria for Purity | 213 |
| 2.2 Properties of Ferrous Compounds | 214 |
| 2.2.1 Oxyhemoglobin (HbO ₂) | 214 |
| 2.2.2 Hemoglobin (Reduced Hemoglobin, Ferrohemo- globin, Hb) | 215 |
| 2.2.3 Carboxyhemoglobin (Carbon Monoxide Hemo- globin, HbCO) | 215 |
| 2.2.4 Nitric Oxide Hemoglobin (HbNO) | 216 |
| 2.2.5 Cyanhemoglobin | 216 |
| 2.2.6 Carbylamine Hemoglobin (HbCH ₂ NC) | 217 |
| 2.2.7 Nitrosobenzene Hemoglobin | 217 |
| 2.3 Properties of Ferric Compounds | 218 |
| 2.3.1 Hemoglobin (Methemoglobin, Ferrihemoglobin, Hi) 2.3.2 Hemoglobin Hydroxide (Alkaline Methemoglobin, HiOH) | 218 |
| 2.3.3 Hemoglobin Fluoride (HiF) | 219 |
| 2.3.4 Hemoglobin Cyanide (Cyanmethemoglobin, Ferri- hemoglobin Cyanide) | 219 |
| 2.3.5 Hemoglobin Azide | 221 |
| 2.3.6 Nitric Oxide Hemoglobin | 221 |
| 2.3.7 Hemoglobin Hydrosulfide | 221 |
| 2.3.8 Hydrogen Peroxide Hemoglobin | 221 |
| 2.3.9 Compounds with Cyanate and Thiocyanate | 222 |
| 2.3.10 Other Hemoglobin Compounds | 222 |
| 2.4 Denatured Globin Hemochrome and Other Protein Hemo- chromes | 222 |
| 2.4.1 Denatured Globin Hemochrome | 222 |
| 2.4.2 Denatured Globin Hemochrome (Kathemoglobin) | 223 |
| 2.4.3 "Acid Hematin" | 223 |
| 2.4.4 Hemochrome Formation from Myohemoglobin | 224 |
| 2.4.5 Protein Hemochromes Occurring in Nature | 225 |
| 2.5 Summary of Spectroscopic Properties | 225 |
| 3 Linkage of Protein to Prosthetic Group | 230 |
| 3.1 Introduction | 230 |
| 3.2 The Linkage of Heme Iron to Globin | 231 |
| 3.2.1 Magnetochemical Evidence | 231 |
| 3.2.2 Evidence That Heme Iron Combines with Imid- azoles | 232 |
| 3.2.2.1 Origin of the Imidazole Hypothesis | 232 |
| 3.2.2.2 Present Status of the Imidazole Hypoth- esis | 233 |
| 3.2.2.3 Linkage in Hemoglobin | 236 |
| 3.2.2.4 Objections to the Imidazole Hypothesis | 238 |

| | | |
|---------|----------------------------------------------------------------------------------|-----|
| 3.3 | Role of Hematin Side Chains in Linkage | 239 |
| 3.3.1 | Introduction | 239 |
| 3.3.2 | Synthetic Hemoglobins | 239 |
| 3.3.3 | Compounds of Globin with Porphyrin and Non-ferrous Metalloporphyrins | 240 |
| 3.3.4 | Compounds of Porphyrins and Metalloporphyrins with Simple Substances | 241 |
| 3.3.5 | Methemalbumin (Ferrihemalbumin) | 243 |
| 3.3.6 | Differential Titration of Globin and Hemoglobin | 244 |
| 3.4 | Other Oxygen-Carrying Pigments | 245 |
| 4 | Globin and Hemoglobin as Proteins | 245 |
| 4.1 | Molecular Weight | 245 |
| 4.1.1 | Hemoglobin | 245 |
| 4.1.2 | Dissociation of the Hemoglobin Molecule | 246 |
| 4.1.3 | Myohemoglobin | 247 |
| 4.2 | Shape of Hemoglobin Molecule and Arrangement of Hemes | 248 |
| 4.2.1 | Shape of the Hemoglobin Molecule | 248 |
| 4.2.2 | Globin and Cleavage Products of Hemoglobin | 250 |
| 4.2.3 | Arrangement of the Hemes | 251 |
| 4.3 | Denaturation | 253 |
| 4.3.1 | Definition | 253 |
| 4.3.2 | Bond Changes on Denaturation | 254 |
| 4.3.3 | Reversible Denaturation | 255 |
| 4.3.3.1 | Action of Alkali | 255 |
| 4.3.3.2 | Action of Acid | 256 |
| 4.3.3.3 | Other Reagents | 257 |
| 4.3.4 | Chemical Changes on Denaturation | 258 |
| 4.3.5 | Reaction between Cephalin and Oxyhemoglobin | 258 |
| 4.4 | Preparation of Native Globin | 258 |
| 5 | Hemoglobin Equilibria | 260 |
| 5.1 | Equilibria in Simple Systems — Interaction between Hemes | 260 |
| 5.1.1 | Introduction | 260 |
| 5.1.2 | Hufner's Equation | 262 |
| 5.1.3 | Hill's Equation | 262 |
| 5.1.4 | Adair's Equation | 263 |
| 5.1.5 | Pauling's Equation | 265 |
| 5.1.6 | Present Status of the Equilibrium Problem | 267 |
| 5.1.7 | Relation between n and α | 269 |
| 5.1.8 | Hemoglobin-Hemoglobin Equilibrium | 270 |
| 5.1.9 | Attempt to Discover Intermediates Directly | 271 |
| 5.2 | Hemoglobin Systems Containing More Than Six Species of Intermediate | 271 |
| 5.2.1 | Introduction | 271 |
| 5.2.2 | Haldane Effect | 271 |
| 5.2.3 | Complex Oxidation-Reduction Systems | 274 |
| 5.2.4 | Variation of Oxygen Affinity and Oxidation-Reduction Potential with pH | 275 |
| 6 | Kinetics of Hemoglobin Reactions | 278 |
| 6.1 | Methods | 278 |
| 6.2 | Kinetics of Individual Reactions with Carbon Monoxide and Oxygen | 279 |
| 6.2.1 | $\text{HbO}_2 \rightarrow \text{Hb} + \text{O}_2$ | 279 |

| | | |
|-------|------------------------------------------------------------------------------------|-----|
| 6.2.2 | $\text{Hb} + \text{O}_2 \rightarrow \text{HbO}_2$ | 279 |
| 6.2.3 | $\text{CO} + \text{Hb} \rightarrow \text{HbCO}$ | 281 |
| 6.2.4 | $\text{HbCO} \rightarrow \text{CO} + \text{Hb}$ | 281 |
| 6.2.5 | $\text{CO} + \text{HbO}_2 \rightarrow \text{HbCO} + \text{O}_2$ | 282 |
| 6.2.6 | $\text{HbCO} + \text{O}_2 \rightarrow \text{HbO}_2 + \text{CO}$ | 283 |
| 6.2.7 | Kinetics of Reactions within the Erythrocyte | 284 |
| 6.2.8 | Kinetics of Myohemoglobin Reactions | 284 |
| 6.3 | Kinetics of Other Reactions | 285 |
| 7 | Interpretation of Kinetic Data | 285 |
| 7.1 | Relation to Theories of Equilibrium | 285 |
| 7.1.1 | Anomalous Support for Hüfner's Theory | 285 |
| 7.1.2 | Reactivity of Freshly Reduced Hemoglobin | 286 |
| 7.2 | Comparison of Kinetics of Myohemoglobin and Hemoglobin | 287 |
| 7.3 | Differences between the Kinetics of Oxygen and Carbon Monoxide Reactions | 287 |
| 7.3.1 | Effect of pH | 287 |
| 7.3.2 | Differences in Heats and Entropies of Reaction | 288 |
| 7.3.3 | Spectroscopic Differences | 289 |
| 8 | Structural Basis of Heme-Heme Interaction | 291 |
| 8.1 | Classification of Hemoglobin Equilibria | 291 |
| 8.2 | Pathway of the Interaction | 292 |
| 8.3 | Hemoglobins of Different Molecular Weight | 295 |
| 9 | Determination of Hemoglobin | 295 |
| 9.1 | Estimation of Hemoglobin for Clinical Purposes | 295 |
| 9.1.1 | Specificity | 295 |
| 9.1.2 | Errors of Technique and Standardization | 296 |
| 9.2 | Manometric and Gasometric Methods | 297 |
| 9.3 | Spectrophotometric, Photoelectric, and Spectrocolorimetric Methods | 298 |
| 9.4 | Colorimetric Methods | 300 |
| 9.5 | Other Methods and Estimation of Hemoglobin in Plasma, Urine, and Tissues | 301 |
| 9.6 | Special Estimations | 302 |
| VII. | Comparative Biochemistry of Hemoglobins | 305 |
| 1 | Introduction | 305 |
| 2 | Biological Distribution | 306 |
| 3 | Chemical Basis of Spectroscopic Differences | 308 |
| 3.1 | Classification | 308 |
| 3.2 | Chlorocruorin | 308 |
| 3.3 | Erythrocrucorin | 309 |
| 3.4 | Hemoglobin and Myohemoglobin | 309 |
| 3.5 | Influence of Protein on the Spectrum | 310 |
| 4 | Molecular Weight Classes of Respiratory Pigment | 311 |
| 4.1 | Classification | 311 |
| 4.2 | Extracellular Oxygen Carriers | 311 |
| 4.3 | Intracellular Oxygen Carriers | 312 |
| 4.4 | Dissociation of Erythrocrucorins | 312 |
| 4.5 | Physiological Implication of Particle Size | 312 |
| 5 | Protein Differences | 314 |
| 5.1 | Isoelectric Points | 314 |
| 5.2 | Amino Acid Analysis | 315 |

| | | |
|--------------|-----------------------------------------------------------------------------------------------|------------|
| | 5.2.1 Invertebrate Oxygen Carriers | 315 |
| | 5.2.2 Vertebrate Oxygen Carriers | 315 |
| | 5.2.3 Myohemoglobin | 317 |
| | 5.3 Solubility | 318 |
| | 5.4 Other Protein Reactions | 319 |
| 6 | Variation of Protein within a Species | 319 |
| | 6.1 Ontogenetic Variation | 319 |
| | 6.1.1 Fetal Hemoglobin | 319 |
| | 6.1.2 Alkali Resistance | 319 |
| | 6.1.3 Amino Acid Composition | 320 |
| | 6.1.4 Size and Shape | 320 |
| | 6.2 Intraspecific Variation — Adult Pigments | 321 |
| | 6.2.1 Methods | 321 |
| | 6.2.2 Alkali Resistance | 321 |
| | 6.2.3 Differences in Composition | 321 |
| | 6.2.4 Spectroscopy and Affinity for Gases | 322 |
| 7 | Microenvironment of Oxygen Carriers | 322 |
| | 7.1 Extracellular Carriers | 322 |
| | 7.2 Erythrocyte | 323 |
| | 7.2.1 Concentration of Hemoglobin | 323 |
| | 7.2.2 Spectrum of Hemoglobin within the Erythrocyte | 323 |
| | 7.2.3 Oxygen Affinity | 323 |
| | 7.3 Myohemoglobin in the Muscle Cell | 324 |
| 8 | Bases of Adaptation | 324 |
| | 8.1 Environment of the Oxygen Carriers | 324 |
| | 8.2 Mechanisms | 326 |
| | 8.2.1 Variation of the Heme | 326 |
| | 8.2.2 Variation of the Protein | 326 |
| | 8.2.3 Variation of Microenvironment | 326 |
| 9 | Functional Adaptation — Mammalian Respiration | 327 |
| | 9.1 Significance of Sigmoid Dissociation Curve | 327 |
| | 9.2 Interaction between Oxygen and Carbon Dioxide Transport | 328 |
| | 9.3 Fetal Respiration | 329 |
| 10 | Functional Adaptation — Myohemoglobin | 330 |
| 11 | Functional Adaptation — Submammalian Pigments | 331 |
| | 11.1 Diversity of Environments | 331 |
| | 11.2 Adaptation to Low Pressure of Oxygen | 332 |
| | 11.3 Role of Absolute Reaction Velocities | 334 |
| | 11.4 Store or Carrier? | 335 |
| VIII. | Hematin Enzymes, I. The Cytochrome System | 337 |
| 1 | Introduction | 337 |
| 2 | Simple Hematin Compounds as Oxidative Catalysts | 341 |
| 3 | The Cytochrome System | 343 |
| | 3.1 Introduction | 343 |
| | 3.2 Spectroscopic Observations on Cytochromes | 344 |
| | 3.3 Cytochrome <i>c</i> | 347 |
| | 3.3.1 Isolation, Properties, and Estimation | 347 |
| | 3.3.2 Nature of the Active Center of Cytochrome <i>c</i> and Its Linkage to Protein | 350 |
| | 3.3.3 Protein of Cytochrome <i>c</i> | 356 |

| | | |
|------------|----------------------------------------------------------------------------------------------|------------|
| 3.4 | Cytochromes b | 358 |
| 3.5 | Cytochrome a | 360 |
| 3.6 | The Respiratory Ferment and Cytochromes Related to It | 362 |
| 3.6.1 | Respiratory Ferment | 362 |
| 3.6.2 | Inhibitors | 363 |
| 3.6.3 | Cytochrome a ₁ | 365 |
| 3.6.4 | Cytochrome Oxidase | 366 |
| 3.6.5 | Cytochrome a ₂ | 367 |
| 3.6.6 | Cytochrome a ₂ | 370 |
| 4 | "Pasteur Enzyme" | 371 |
| 5 | Biological Function of the Cytochrome System | 373 |
| 5.1 | Introduction | 373 |
| 5.2 | Pathways of Cellular Oxidation through the Cytochrome System | 374 |
| 5.3 | The Cytochrome System in Various Organisms | 377 |
| 5.3.1 | Cytochrome c and Cytochrome Oxidase in Animal Tissues | 377 |
| 5.3.2 | The Cytochrome System of Plants | 379 |
| 5.4 | Study of Respiration by Inhibitors | 379 |
| 5.5 | Importance of the Cytochrome System for Supply of Energy and Cell Function | 383 |
| 6 | Theory of Mode of Action of the Respiratory Ferment | 384 |
| 6.1 | Autoxidation | 384 |
| 6.2 | Radical Chain Theory | 386 |
| 6.3 | Hemoglobin as a Cytochrome Oxidase Model | 388 |
| 6.3.1 | Introduction | 388 |
| 6.3.2 | Hemoglobin Formation | 389 |
| 6.3.3 | Oxidation of Groups in Globin | 390 |
| 6.3.4 | Formation of Hemoglobin by Reducing Substances in the Presence of Oxygen | 391 |
| 6.3.5 | Autoxidation of Hemoglobin | 392 |
| 6.3.6 | Oxidizing Action of Oxygen Liberated from Oxy-hemoglobin | 395 |
| 6.4 | Mode of Action of the Respiratory Enzyme | 397 |
| IX. | Hematin Enzymes, II | 401 |
| 1 | Introduction | 401 |
| 1.1 | Historical | 401 |
| 1.2 | Model Reactions with Simple Hematin Compounds | 402 |
| 1.2.1 | Catalatic Activity | 402 |
| 1.2.2 | Peroxidative Activity | 402 |
| 2 | Catalase | 403 |
| 2.1 | Isolation | 403 |
| 2.2 | Spectroscopic and Magnetochemical Properties of Catalase and Compounds of Catalase | 405 |
| 2.3 | Inhibitors | 409 |
| 2.4 | Estimation and Enzyme Kinetics | 410 |
| 2.5 | Nature of the Prosthetic Group | 413 |
| 2.6 | Protein of Catalase | 414 |
| 2.7 | Biological Function of Catalase | 415 |
| 2.7.1 | Occurrence of Catalase | 415 |
| 2.7.2 | Protection against Hydrogen Peroxide | 416 |
| 2.7.3 | Catalase as a Peroxidative Enzyme | 417 |

| | | |
|-------|---------------------------------------------------------------------------------------------------------|-----|
| 3 | Peroxidases and Dihydroxymaleic Acid Oxidase | 419 |
| 3.1 | Introduction | 419 |
| 3.2 | Horse-radish Peroxidase | 420 |
| 3.2.1 | Isolation | 420 |
| 3.2.2 | Absorption Spectra and Magnetochemical Properties of Peroxidase and of Its Compounds | 420 |
| 3.2.3 | Inhibitors | 421 |
| 3.2.4 | Kinetics and Estimation | 422 |
| 3.2.5 | Protein of Peroxidase | 424 |
| 3.2.6 | Linkage of Prosthetic Group and Protein | 425 |
| 3.3 | Other Plant Peroxidases | 428 |
| 3.4 | Milk Peroxidase | 429 |
| 3.5 | Peroxidase of Adrenal Medulla | 430 |
| 3.6 | Peroxidase of Leucocytes (Myeloperoxidase, "Verdoperoxidase") | 430 |
| 3.7 | Cytochrome c Peroxidase | 432 |
| 3.8 | Dihydroxymaleic Acid Oxidase | 433 |
| 3.9 | Biological Function of Peroxidases | 434 |
| 3.9.1 | Plant Peroxidases | 434 |
| 3.9.2 | Animal Peroxidases | 435 |
| 4 | Mode of Catalatic and Peroxidative Action | 436 |
| 4.1 | Peroxidase and Dihydroxymaleic Acid Oxidase | 436 |
| 4.1.1 | Mode of Action of Peroxidase | 436 |
| 4.1.2 | Mode of Action of Dihydroxymaleic Acid Oxidase | 437 |
| 4.2 | Catalase | 439 |
| 4.2.1 | Radical Chain Theory | 439 |
| 4.2.2 | Keilin's Theory | 440 |
| 4.2.3 | Theories of Stern and Sumner | 442 |
| 4.2.4 | Attempts at a New Theory | 442 |
| 4.2.5 | Anticatalases and Philocatalases | 443 |
| 4.2.6 | "Coupled Oxidation" of Alcohol | 444 |
| 5 | Enzymes Possibly of Hemoprotein Nature | 446 |
| 5.1 | Hydrogenase | 446 |
| 5.2 | Nitrogen Fixation | 448 |
| 5.3 | Possible Hematin Nature of Catalysts in Photosynthetic Processes | 450 |
| X. | Chemical Mechanism of Bile Pigment Formation and Other Irreversible Alterations of Hemoglobin | 453 |
| 1 | Introduction and Nomenclature | 453 |
| 2 | Model Experiments on Bile Pigment Formation. Verdohemochromes | 456 |
| 2.1 | Introduction | 456 |
| 2.2 | Bile Pigments Formed from Verdohemochrome | 459 |
| 2.3 | Preparation and Properties of Verdohemochromes | 461 |
| 2.4 | Structure of Verdoheme | 464 |
| 2.5 | Mechanism of Formation of Verdohemochromes | 467 |
| 3 | Photochemical Formation of Bile Pigments from Porphyrin Metal Complexes | 471 |
| 4 | Formation of Biliverdin from Hemoglobin <i>in Vitro</i> . Choleglobin | 471 |
| 4.1 | Introduction | 471 |
| 4.2 | Properties of Choleglobin | 472 |
| 4.2.1 | Spectroscopic Properties | 472 |

| | |
|---------------------------------------------------------------------------------------------------------------|------------|
| 4.2.2 Spectrophotometric Analysis | 474 |
| 4.3 Structure of the Prosthetic Group | 474 |
| 4.4 Mechanism of Choleglobin Formation | 475 |
| 4.4.1 Principle of the Mechanism | 475 |
| 4.4.2 Stroma Factor | 477 |
| 4.4.3 Green Pigment | 478 |
| 4.4.4 Various Hydrogen Donors Producing Choleglobin | 478 |
| 4.4.5 The "Viridans" Effect | 480 |
| 5 "Easily Detachable Iron" and Nonhemoglobin Iron in Blood | 482 |
| 5.1 Easily Detachable Iron | 482 |
| 5.2 Nonhemoglobin Iron | 484 |
| 5.3 Differences between Carbon Monoxide Capacities before and after Reduction | 485 |
| 6 Pseudohemoglobin and Cruoralbin | 486 |
| 6.1 Pseudohemoglobin | 486 |
| 6.2 Cruoralbin and Cruoratin | 488 |
| 6.3 Formation of Similar Green Hemoglobins without Cyanide | 489 |
| 6.4 Reaction Mechanism | 489 |
| 7 Sulfhemoglobin | 490 |
| 7.1 Historical | 490 |
| 7.2 Properties of Sulfhemoglobin | 491 |
| 7.3 Protein of Sulfhemoglobin | 492 |
| 7.4 "Sulfhemoglobin" as a Mixture of Sulfhemoglobin and Choleglobin | 492 |
| 7.5 Sulfur Content of Sulfhemoglobin and Mode of Formation | 493 |
| 7.6 Reconversion of Sulfhemoglobin to Protoporphyrin Derivatives and Nature of Its Prosthetic Group | 495 |
| 7.7 Myosulfhemoglobin | 497 |
| 7.8 Distinction between Sulfhemoglobin and Compounds with Similar Absorption Spectra | 497 |
| 8 Verdoheme and Choleheme Compounds in Hematin Enzymes | 499 |
| 8.1 Verdohemochrome Formed from Cytochrome c | 499 |
| 8.2 Bile Pigment Hematin in Liver Catalase | 499 |
| 9 Breakdown of Hemoglobin and Myohemoglobin to Dipyrrolic Compounds | 500 |
| XI. Hemoglobin Catabolism, I. Breakdown to Bile Pigments | 503 |
| 1 Introduction | 503 |
| 1.1 Formation of Bile Pigments from Hemoglobin | 503 |
| 1.2 Earlier Theories of the Mechanism | 504 |
| 1.3 Importance of Biliverdin | 505 |
| 1.4 Modern Views on the Mechanism of Hemoglobin Breakdown | 507 |
| 2 Life Span of the Erythrocyte | 508 |
| 2.1 Introduction | 508 |
| 2.2 Life Span of the Cell Deduced from Pigment Metabolism | 509 |
| 2.2.1 Bilirubin Excretion | 509 |
| 2.2.2 Urobilin Excretion | 510 |
| 2.2.3 Other Methods | 510 |
| 2.3 Life Span of the Cell Deduced from Histological and Immunological Evidence | 511 |
| 2.4 Significance of the Mortality Curve | 512 |

| | | |
|----------|-------------------------------------------------------------------------------------------------------------|------------|
| 3 | Enzyme Systems of the Erythrocyte | 513 |
| 3.1 | Origin and Possible Function..... | 513 |
| 3.2 | Carbohydrate Metabolism of the Erythrocyte..... | 514 |
| 3.3 | Other Reducing Systems in the Erythrocyte..... | 516 |
| 3.3.1 | Glutathione..... | 516 |
| 3.3.2 | Ascorbic Acid..... | 517 |
| 4 | Hemoglobinemia (Methemoglobinemia) | 518 |
| 4.1 | Hemoglobin as Normal Component of the Erythrocyte..... | 518 |
| 4.2 | Hemoglobin Formation by Foreign Substances..... | 519 |
| 4.3 | Reduction of Hemoglobin <i>in Vivo</i> | 522 |
| 5 | Intracorpuseular Alterations Preceding Destruction of the Erythrocyte and Hemolysis | 522 |
| 5.1 | Introduction..... | 522 |
| 5.2 | Sulfhemoglobinemia..... | 523 |
| 5.3 | Intracellular Changes after Phenylhydrazine..... | 524 |
| 5.4 | Alteration of Erythrocyte Stability..... | 526 |
| 5.5 | Changes in Stored Blood..... | 528 |
| 5.6 | The Dying Cell <i>in Vivo</i> | 529 |
| 5.7 | Protection of Hemoglobin in the Erythrocyte..... | 531 |
| 5.8 | Disintegration of the Dying Cell..... | 532 |
| 5.9 | Renal Excretion of Extracorpuseular Hemoglobin..... | 534 |
| 6 | Anemias | 535 |
| 6.1 | Introduction..... | 535 |
| 6.2 | Hemolytic Anemias..... | 536 |
| 6.3 | Pernicious Anemia..... | 537 |
| 6.4 | Physiological Hemolysis of the Newborn..... | 537 |
| 7 | Site of Bile Pigment Formation | 538 |
| 7.1 | The Reticuloendothelial System..... | 538 |
| 7.2 | Bile Pigment Formation in Body Fluids and Tissue Cultures..... | 540 |
| 7.3 | Role of Liver, Spleen, and Bone Marrow in Bile Pigment Formation..... | 541 |
| 7.4 | Observations on Formation and Occurrence of Choleglobin and Sulfhemoglobin in Tissues Other Than Blood..... | 542 |
| 7.5 | Breakdown of Myohemoglobin..... | 543 |
| 8 | Bilirubin | 544 |
| 8.1 | Quantitative Transformation of the Prosthetic Group of Hemoglobin to Bile Pigment..... | 544 |
| 8.2 | Reduction of Biliverdin to Bilirubin..... | 545 |
| 8.3 | Bilirubin in Blood Plasma..... | 546 |
| 8.3.1 | Normal Concentration of Plasma Bilirubin..... | 546 |
| 8.3.2 | "Direct" and "Indirect" Bilirubin..... | 546 |
| 8.4 | Excretion of Bilirubin..... | 549 |
| 8.4.1 | Excretion by Liver into Bile..... | 549 |
| 8.4.2 | Enterohepatic Circulation..... | 549 |
| 8.4.3 | Excretion of Bilirubin in Urine..... | 550 |
| 9 | End Products of Hemoglobin Catabolism | 550 |
| 9.1 | Transformation of Bilirubin to Urobilin in the Animal Body..... | 550 |
| 9.1.1 | Introduction..... | 550 |
| 9.1.2 | Formation of Urobilin in the Intestine..... | 551 |
| 9.1.3 | Extraintestinal Formation of Urobilin..... | 553 |

| | | |
|-------------|-----------------------------------------------------------------------------------------|------------|
| 9.2 | Endogenous Urobilin Metabolism | 554 |
| 9.2.1 | Enterohepatic Circulation | 554 |
| 9.2.2 | Absorption from the Intestine | 555 |
| 9.2.3 | Re-excretion of Urobilin by the Liver | 555 |
| 9.2.4 | Physiological and Clinical Value of Estimation of Total Urobilin Excretion | 556 |
| 9.2.5 | Urobilin in Blood Plasma | 557 |
| 9.2.6 | Urobilinuria | 558 |
| 9.3 | Other End Products of Hemoglobin Catabolism | 559 |
| 9.3.1 | Fecal Pigments | 559 |
| 9.3.2 | Urinary Pigments | 559 |
| 9.3.3 | Dipyrrolic Compounds | 559 |
| 10 | Liberation of Hematin Iron and Fate of Globin | 561 |
| 10.1 | Introduction | 561 |
| 10.2 | Excretion of Iron | 562 |
| 10.3 | Nonhematin Iron in Tissues | 562 |
| 10.3.1 | Bile Pigment Iron | 562 |
| 10.3.2 | Transport Iron | 563 |
| 10.3.3 | Storage Iron | 565 |
| 10.3.4 | Estimation of Nonhematin and Hematin Iron | 566 |
| 10.3.5 | Chemical Nature of Nonhematin Iron | 567 |
| 10.4 | Fate of Globin | 568 |
| 11 | Catabolism of Hematin Enzymes | 568 |
| 12 | Distribution of Bile Pigments in Nature | 569 |
| 13 | The Physiological Function of Bile Pigments | 570 |
| XII. | Hemoglobin Catabolism, II. Hematin and Porphyrins | 573 |
| 1 | Introduction | 573 |
| 2 | Metabolism of Hematin | 573 |
| 2.1 | Hematin and Methemalbumin in Blood Plasma | 573 |
| 2.2 | Hematin in Blood Extravasations and in the Malarial Red Cell | 574 |
| 2.3 | Metabolism of Hematin | 575 |
| 2.4 | Toxicity of Hematin | 577 |
| 3 | Porphyrin Metabolism | 577 |
| 3.1 | Introduction | 577 |
| 3.2 | Endogenous Porphyrin Metabolism | 578 |
| 3.2.1 | Introduction | 578 |
| 3.2.2 | Distribution of Porphyrins in the Human Body | 579 |
| 3.2.3 | Destruction of Porphyrins | 582 |
| 3.2.4 | Conversions of One Porphyrin to Another | 582 |
| 3.2.5 | Influence of Liver and Kidney on Urinary Porphyrin Excretion | 583 |
| 3.2.6 | Porphyrin Metabolism in Other Species | 584 |
| 3.3 | Excretion of Porphyrins | 586 |
| 3.3.1 | Introduction | 586 |
| 3.3.2 | Excretion of Porphyrins of Isomeric Types I and III | 586 |
| 3.3.3 | Porphyryns in Normal Excreta | 588 |
| 3.3.4 | Porphyryns in Pathologic Excreta | 589 |
| 3.3.5 | Formation of Porphyrins by Bacterial Decomposi- tion of Hematin Compounds | 592 |

| | | |
|--------------|----------------------------------------------------------------------------------------------------------------|------------|
| 3.4 | Is Pathological Porphyrin Formation Due to Deranged Breakdown of Hemoglobin?..... | 593 |
| 3.4.1 | Introduction..... | 593 |
| 3.4.2 | Porphyrin in Hemolytic Diseases..... | 593 |
| 3.4.3 | Porphyrin in Liver Diseases and Porphyria..... | 594 |
| 3.4.4 | Porphyrin in Lead Intoxication..... | 596 |
| 3.4.5 | Porphyrin Formation by Aromatic Amino Compounds..... | 596 |
| 3.4.6 | Porphyrin Formation by Hemoglobin Breakdown .. | 598 |
| 3.4.7 | Porphyrin Formation from Other Hematin Compounds..... | 599 |
| 3.5 | Pharmacology and Toxicology of Porphyrins..... | 599 |
| 3.5.1 | Photosensitization..... | 599 |
| 3.5.2 | Other Toxic Actions..... | 600 |
| 3.5.3 | Physiologic Action..... | 601 |
| XIII. | Formation of Hemoglobin and Synthesis of Porphyrins in the Animal Body..... | 603 |
| 1 | Introduction..... | 603 |
| 2 | Some Hematologic Data..... | 603 |
| 2.1 | Development of the Red Cell..... | 604 |
| 2.2 | Quantitative Hematologic Data..... | 605 |
| 3 | Requirements for Hemoglobin Synthesis in the Animal Body..... | 607 |
| 3.1 | Introduction..... | 607 |
| 3.2 | Building Stones of Hemoglobin..... | 608 |
| 3.2.1 | Iron..... | 608 |
| 3.2.2 | The Porphyrin Nucleus..... | 608 |
| 3.2.3 | Globin..... | 610 |
| 3.3 | Factors Necessary for Hemopoiesis..... | 611 |
| 3.3.1 | Antipernicious Anemia Principle and Folic Acid.. | 611 |
| 3.3.2 | Vitamins..... | 613 |
| 3.3.3 | Minerals..... | 617 |
| 3.4 | Control of Hemopoiesis by Endocrine Factors..... | 620 |
| 4 | Absorption of Iron and Its Incorporation in the Hemoglobin Molecule..... | 621 |
| 4.1 | Iron Requirements..... | 621 |
| 4.2 | Absorption of Iron from the Gastrointestinal Tract..... | 621 |
| 4.3 | Incorporation of Iron in the Hemoglobin Molecule..... | 622 |
| 5 | Relations between Hemoglobin Formation, Hemoglobin Concentration in the Blood, and Hemoglobin Destruction..... | 624 |
| 5.1 | Introduction..... | 624 |
| 5.2 | Influence of Oxygen Tension and Anoxia of the Bone Marrow on Hemopoiesis..... | 625 |
| 5.3 | Direct Relations between Hemoglobin Breakdown and Hemopoiesis..... | 625 |
| 6 | Synthesis of Respiratory Enzymes..... | 627 |
| 7 | Synthesis of Porphyrins by the Living Cell..... | 628 |
| 7.1 | Porphyryns as Intermediates and By-Products of Hemoglobin Synthesis..... | 628 |
| 7.2 | Porphyrin Formation in the Embryo..... | 630 |

| | | |
|-------------|-------------------------------------------------------------------------------------------------------------------------------------------|------------|
| 7.3 | Porphyrin Synthesis in Microorganisms | 631 |
| 7.3.1 | Porphyrin Synthesis in Bacteria | 631 |
| 7.3.2 | Porphyrin Synthesis in Yeast | 632 |
| 8 | Synthesis of the Porphyrin Nucleus | 632 |
| 8.1 | Previous Theories | 632 |
| 8.2 | Attempts at a New Theory of Porphyrinogenesis | 637 |
| 8.2.1 | Precursors and Mechanism | 637 |
| 8.2.2 | Ratio of Type I to Type III Porphyrins | 643 |
| XIV. | Pyrrole Pigments in Evolution | 647 |
| 1 | Introduction | 647 |
| 2 | Paleontology of Porphyrins | 648 |
| 3 | Primitive Pyrrole Pigments | 649 |
| 4 | Respiratory Hematin Enzymes | 651 |
| 5 | Hematin Pigments of Unknown Function | 653 |
| | Bibliography | 655 |
| | Subject Index | 727 |
| | Appendix: Absorption Spectra Data for Oxyhemoglobin, Hemoglobin, Hemoglobin, Carboxyhemoglobin, and Hemoglobin Cyanide | 747 |

CHAPTER I

INTRODUCTION

1. BIOLOGICAL SIGNIFICANCE OF THE PYRROLE PIGMENTS

Life on earth, in its present form at least, depends almost entirely on the process of photosynthesis in green plants. In this process the light energy of the sun is used for the synthesis primarily of carbohydrates and secondly of proteins, fats, and other substances which serve as food materials for animals and man, as well as for the synthesis of vitamins. Light energy is in this way transformed into chemical energy, which can be stored, and which becomes available for the energy requirements of the plant and animal world. In addition this process liberates oxygen, which all aerobic organisms require for cellular respiration. Chlorophyll, the green pyrrole pigment of the leaves, plays a decisive role in photosynthesis. No photoassimilation has so far been discovered without chlorophyll, although other substances such as carotenoids, and in some algae chromoproteins also act as photosensitizers in conjunction with chlorophyll.

To deal with chlorophyll and the processes of photosynthesis is beyond the scope of this book. The reader is referred to the recent monograph of Rabinowitch (2198). Only some evolutionary aspects of general importance for the theory of evolution of the pyrrole pigments will be discussed in Chapter XIV. There is, in addition, some evidence for the participation of a hematin compound as a catalyst in the photosynthetic process; this will be discussed in Chapter IX.

The second fundamentally important biological process, that of cellular respiration, depends equally on pyrrole pigments. It has been

known for a long time that the red blood pigment, hemoglobin, serves as carrier of oxygen to the tissues in all vertebrates (with one exception, *Amphioxus*) and in some invertebrates, and that a closely related substance, myohemoglobin, plays a role in storing oxygen in the red muscles of vertebrates, and in a few muscles of invertebrates. It has been only during the last twenty years, however, that the more general and fundamental importance of hematin compounds for the process of cell respiration has become evident — through Warburg's studies on the respiratory ferment and Keilin's rediscovery of the cytochromes, previously observed spectroscopically by MacMunn. In the process of cellular respiration, which occurs in all aerobic organisms, the chemical energy of the organic substances is made available for a variety of energy requirements of the living cell. While the details of these transformations have still to be worked out, it is evident that the energy is used much more efficiently in the process of respiration than in fermentation processes. In the former, the total energy of carbohydrate (674 kcal. per mole of glucose) which is gained from light energy in the photosynthetic process is released again:

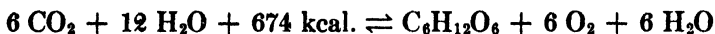

In fermentation processes, on the contrary, only part of this energy is released, the remainder being left in the compounds formed by these fermentations, such as alcohol, lactic acid, and butyric acid. In addition to the respiratory ferment (cytochrome oxidase) and a variety of cytochromes, other hematin enzymes (catalase, peroxidases) are found in the cells of the aerobic organisms. The role of the latter enzymes in the respiratory process is not yet fully understood, but they certainly possess functional importance. The hematin enzymes are discussed in Chapters VIII and IX.

We thus find pyrrole pigments as essential biological catalysts (in the wider sense of the term) of most fundamental biological processes, and their close study is obviously required if we want to understand these processes.

Recently it has become likely that another enzyme, hydrogenase, may belong to the hematin compounds. If this is correct, pyrrole pigments may have played a role at an early evolutionary stage of life on earth (*cf.* Chapter XIV) before photosynthesis and respiration developed.

2. FUNDAMENTALS OF THE CHEMICAL STRUCTURE OF PYRROLE PIGMENTS

Practically all the pyrrole pigments occurring in nature contain four pyrrole rings linked by four single carbon atoms to a system in which a high degree of resonance is produced by conjugation of a large number of double bonds. We can distinguish, first, two types. In the porphyrins, and in the hematin and chlorophyll compounds, we have a system in which the four pyrroles are kept together by four single carbon atoms in the form of a closed planar ring system

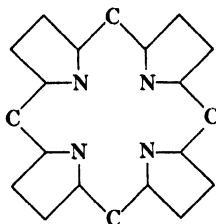

Figure 1

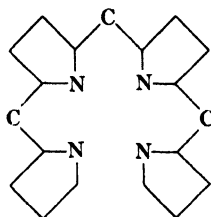

Figure 2

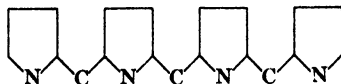

Figure 3

(Fig. 1). In the bile pigments one of these carbon atoms is missing and the system is therefore less rigid, and (at least in some substances) can be pictured equally well as an open ring system (Fig. 2) or as a tetrapyrrole chain (Fig. 3). It will be shown that, while the latter is customary, the former rather is correct. Of the closed ring tetrapyrrole substances two main types can be distinguished (*cf.* Table I). The first group comprises the porphyrin derivatives proper, which possess the most stable type of ring system (porphin), comparable to the fully aromatic system in benzene (Fig. 4).

Theoretically this system is not the most unsaturated one, the latter being that represented by Figure 5. So far no derivative of the latter ring system (Fig. 5) has been discovered, and it appears doubtful whether it exists.

TABLE I
Tetrapyrrolic Compounds

| I. Closed ring | II. Open ring |
|-----------------------------------------------------------------------------------------------------------------------------------------------------------------------------------------------------------------------------------------------------|-------------------------------------------------------------------------------------------------------------------------------------------------------------------------------------------------------------------------------|
| <p><i>A. Porphyrins</i></p> <ul style="list-style-type: none"> Free porphyrins Iron complexes (hematins) Linked to protein Hematin enzymes Hemoglobin | <p><i>C. Bile pigments</i></p> <ul style="list-style-type: none"> Bilirubin, biliverdin, urobilins (Zn, Cu, Fe complexes) Linked to protein (metal-free) Phycocerythrin Phycocyanin |
| <p><i>B. Dihydro- and tetrahydroporphyrins</i></p> <ul style="list-style-type: none"> Chlorins, rhodins Magnesium complexes (chlorophylls, bacteriochlorophyll) Esterified with phytol Linked to protein? | |

Porphyrins are found free in nature, but are far more important in the form of iron complexes (hematins), in which the iron replaces the two central hydrogen atoms of Figure 4, but is bound equally by all four nitrogen atoms. In the biologically important hematin com-

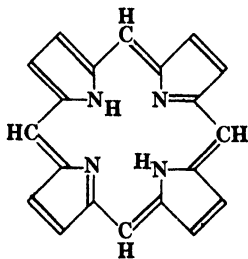

Figure 4

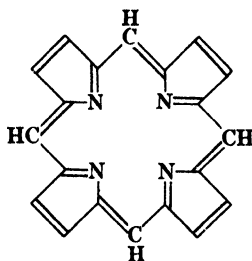

Figure 5

pounds — hemoglobin and the hematin enzymes — we find this complex as the prosthetic group of a hemoprotein.

The second group of closed ring compounds comprises those with ring systems containing two (chlorophylls) or four (bacteriochlorophyll) hydrogen atoms more than the porphyrin system. Chlorins and

rhodins, prepared in the test tube from chlorophylls a and b are such dihydroporphyrin derivatives. We shall not discuss at this stage the side chains with which the eight β -positions of the pyrrole rings are substituted, but it must be mentioned that in chlorophyll and bacteriochlorophyll one of these side chains is linked with one of the four carbon atoms which connect two pyrrole rings, forming a fifth (isocyclic) ring (Fig. 6). In the chlorophylls, the carboxylic acid groups of the side chains are esterified with methyl alcohol and with phytol (an alcohol with a long hydrophobic chain) which gives the chlorophylls the character of waxes. We know little as yet about the combination of chlorophylls with proteins and, while such a combination appears likely, it has not yet been proved that a specific chlorophyll-protein exists in the chloroplasts.

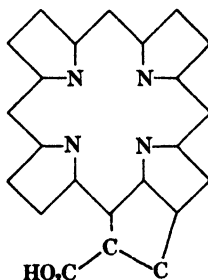

Figure 6

The tetrapyrrole open chain compounds are known mainly as metabolic products of the breakdown of hemoglobin in the animal body. The bile pigments, *e.g.*, bilirubin, biliverdin, and urobilins, belong to this class.

A far greater variety of more or less stable hydrogenation stages exists in this class than is found in the tetrapyrrolic substances with closed ring systems. This explains the variety of differently colored (red, green, violet, yellow) bile pigments. Except as stages in the breakdown of closed ring tetrapyrrolic metal complexes, the metal complexes of these pyrrole pigments have not yet been found to possess any physiologic significance. Lately it has been shown that bile pigments occur in lower animal species, in which they cannot be derived from hemoglobin breakdown. In some instances they form ornamental pigments, *e.g.*, in the egg shells of birds. The only compounds of this class for which a functional importance has been

demonstrated are the chromoproteins of red and blue algae (phycocerythrins and phycocyanins), which act as photosensitizers in algal photosynthesis.

3. VARIABILITY OF THE PYRROLE PIGMENTS

In addition to the variations described — closed ring system or open chain, porphin or hydroporphin — the pigments can be further modified in a variety of ways:

(1) By various side chains in the β -positions of the pyrrole nuclei. Numerous porphyrins exist which differ in the nature of these side chains, *e.g.*, protoporphyrin, coproporphyrin, and uroporphyrin. In the hematin series, we find such differences between hemoglobin, cytochrome c, and cytochromes a (to which latter the respiratory ferment probably belongs) and in the chlorophyll series, between chlorophylls a and b and bacteriochlorophyll. Several of the hematin compounds (hemoglobin, myohemoglobin, erythrocruorins, catalase, horse-radish peroxidase), contain however, the same porphyrin — protoporphyrin — and do not differ in the side chains of the prosthetic group.

(2) By a difference in arrangement of the same side chains on the porphin nucleus. We know, for example, several isomeric coproporphyrins.

(3) By the metal held in complex combination: magnesium in the chlorophylls, iron in the hematin enzymes and hemoglobin. Complexes of porphyrins with metals other than iron, *e.g.*, copper and zinc, occur in nature. A copper porphyrin (turacin) occurs as an ornamental pigment in bird feathers, but compounds of this type do not possess important biological functions. While the role of magnesium in chlorophyll is still uncertain, that of iron in the respiratory pigments and enzymes is of fundamental significance.

(4) The metal held in complex combination, especially when this is iron, may be of different valency. Thus hemoglobin is functionally active only in the ferrous state, peroxidases and probably catalase in the ferric, while in cytochromes and cytochrome oxidase the biological function is connected with the oscillation of the iron between the divalent and trivalent forms.

(5) Some metals, particularly iron, which can form coordination compounds with more than four atoms, combine with two further groups in addition to the four nitrogen atoms of the porphin ring.

In this way are bound, first, other nitrogenous substances, such as pyridine or ammonia, or the protein globin in hemoglobin; second, the molecules on which hemoglobin or the hematin catalysts act (oxygen, hydrogen peroxide); and, third, the specific inhibitors used in the study of the hematin enzymes (*e.g.*, cyanide, carbon monoxide).

(6) Finally, the nature of the compound is profoundly modified by the specific combination of the hematin with a specific protein (*cf.* Chapters VI, VIII, and IX). The nature of the protein not only determines whether the particular compound is suitable for the function of carrying oxygen, or as an oxidative, catalytic, or peroxidative catalyst; it is also the basis of the observed specificity of, for example, hemoglobins in different species, genera, and phyla, and also of the ontogenetic differences found, for example, between fetal and adult hemoglobins.

4. METABOLISM OF PYRROLE PIGMENTS

The cells of most aerobic organisms have a considerable potentiality for synthesizing the porphyrin nucleus, and only in a few species must this be added in the food as a vitamin. We shall show in Chapter XIII that the synthesis of the porphyrins is closely linked with carbohydrate metabolism. Even with the scanty evidence available at present, it is possible to devise a satisfactory theory for their formation from intermediate products of carbohydrate metabolism, although the final experimental proof is still lacking.

Like all other substances the pyrrole pigments undergo catabolic changes, the rate of which in the case of hemoglobin is of considerable magnitude. We still know very little about the metabolism of the chlorophylls, the hematin enzymes, or myohemoglobin, but the principle of the breakdown of hemoglobin to bile pigments has been elucidated by the work of Lemberg. This will be discussed in Chapters X and XI.

CHAPTER II*

METHODS OF INVESTIGATION

1. INTRODUCTION

The substances with which this book is concerned are all of an exceedingly complex character, so much so that their chemical constitution has been determined only comparatively recently, or remains still unknown. This fact, together with the profound physiologic importance of these substances, has led to the use of a variety of physicochemical methods for their investigation, producing results unobtainable by purely chemical means.

That such methods may be used is due to the fact that hematin compounds and their derivatives possess a number of remarkable properties. All absorb radiant energy, often in comparatively narrow regions of the spectrum, the position and intensity of the maxima of these absorption bands being characteristic constants for each substance. Some re-emit the absorbed radiation in the form of fluorescence in the visible spectrum. The majority contain acidic and basic groups, either in the porphyrin group or in nitrogenous compounds coordinated with the iron atom or in both. The iron atom may assume both the ferrous and the ferric state, giving rise to oxidation-reduction potentials; it also confers on all those compounds in which it occurs magnetic properties which vary with the nature of the linkage between it and the attached groups. Finally, those compounds which contain protein lend themselves to methods specific to this class of substances.

We shall not discuss in detail the technique of the various methods

*Contributed by J. P. Callaghan.

employed. A number of works are available (449, 991, 1213, 2200, 2529, 2588, 3026) which provide this information, and more extensive bibliographies may be found there also. Rather is it necessary that the reader shall be familiar with the general outline of the theory and technique of the methods, and their particular application and significance to the present subject.

2. SPECTROSCOPY

The property of characteristic light absorption has been utilized as the most readily available means of distinguishing many of the substances with which we are concerned. It must, however, be appreciated that, although observation of absorption spectra is a versatile and powerful weapon when properly used, it is open to serious errors. While it is certainly true that under identical conditions the same substance cannot have different absorption spectra, spectra which are apparently identical are insufficient evidence for chemical identity. As an example may be cited the variety of substances having an absorption band at about $630\text{ m}\mu$ (*cf.* Chapter X). It is always necessary to demonstrate identical *alterations* in spectra when chemical reactions are performed, before identity of two substances can be considered in any degree certain.

2.1. The Direct Vision Spectroscope

The simple direct vision spectroscope is quite indispensable for work on compounds in this field. The instrument should be of medium dispersion, since high dispersion may obscure faint bands. A wavelength scale is an advantage for approximate location of bands, but the instrument should be regarded as primarily qualitative, and accurate wavelength determinations made by other means. The more elaborate small dispersion microspectroscope is of advantage for investigation of complex spectra, *e.g.*, those of the cytochromes, in tissues and turbid media.

2.2. The Hartridge Reversion Spectroscope

This instrument is designed for accurate location of sharp absorption bands. It consists essentially of two relatively high dispersion grating spectroscopes, arranged so that the two spectra produced from one entering light beam are contiguous along their length, but are reversed in direction, one having the short wavelengths (blue)

to the left, the other the long waves (red). Means are provided for moving the two spectra longitudinally, so that an absorption band produced by insertion of an absorbing substance in the entering light beam may be made to coincide in the two spectra. The amount of movement necessary to produce such coincidence is a linear function of the wavelength of the band. The micrometer screw controlling the motion is calibrated, and wavelengths may be read with accuracy to about one angstrom unit. By taking a large number of readings on the same solution, greater accuracy is attainable (937).

Since in the Hartridge spectroscope the whole width of the absorption band is made to coincide in the two spectra, the wavelength measured is that of the center of the band, not necessarily that of maximum absorption. Consequently small deviations are often observed between the band positions measured by this means and by the spectrophotometer. The apparent position of an asymmetric band depends on the concentration, and the minimum concentration allowing an exact reading of the band position should be used.

3. ABSORPTION SPECTROPHOTOMETRY

3.1. Theoretical

3.1.1. The Theory of Light Absorption. When a parallel beam of monochromatic light passes through a homogeneous absorbing medium, the intensity of the beam diminishes exponentially with the thickness of the medium. If I_0 is the intensity of the incident beam, I that of the emergent beam, and l the thickness of the medium, we have the relationship:

$$\log_{10} I_0/I = \epsilon l$$

where ϵ is called the extinction coefficient. The ratio I/I_0 is called the transmittance, its reciprocal the opacity, and the function $d = \log_{10} I_0/I$ is called the density. Hence:

$$d = \epsilon l$$

If in addition the absorbing medium is a solution in which the dissolved molecules are independent of one another and are equally influenced at all concentrations by the molecules of a colorless solvent, the density is a linear function of the concentration of the solute. This is Beer's law. We may now write:

$$d = \epsilon_p C l$$

TABLE I
Spectrophotometric Constants

| Term | Symbol | Alternative symbols | Relationships |
|-----------------------------------|------------------|---------------------|------------------------------------------------------------------------------------|
| Transmittance | τ | | $\tau = I/I_0$ |
| Density | d | D, E | $d = \log_{10} I_0/I = \epsilon l$ |
| Extinction coefficient | ϵ | K | $\epsilon = 1/l \log_{10} I_0/I = d/l$ |
| Specific extinction coefficient | ϵ_{sp} | K_{sp}, ϵ | $\epsilon_{sp} = 1/Cl \log_{10} I_0/I = d/Cl$ (C is in g. per liter) |
| Molar extinction coefficient | ϵ_{mol} | ϵ | $\epsilon_{mol} = 1/Cl \log_{10} I_0/I = d/Cl$ (C is in gram moles per liter) |
| Millimolar extinction coefficient | ϵ_{mM} | | $\epsilon_{mM} = \frac{\epsilon_{mol}}{1000}$ |
| Absorption ratio | A | | $A = \frac{1}{1000 \epsilon_{sp}} = C/1000 \epsilon$ |
| Absorption coefficient | μ | | $\mu = 1/l \ln I_0/I = \epsilon \ln 10$ |
| Molar absorption coefficient | β | β_{mol} | $\beta = 1/Cl \ln I_0/I = \epsilon_{mol} \ln 10$ (C is in gram moles per liter) |

where C is expressed in grams per liter and ϵ_{sp} is called the specific extinction coefficient, or:

$$d = \epsilon_{mol}Cl$$

where C is expressed in gram molecules per liter and ϵ_{mol} is called the molar extinction coefficient. The millimolar extinction coefficient, where C is in millimoles per liter, is written ϵ_{mM} and is one-thousandth of this. Since the values of the millimolar extinction coefficient for most substances are convenient small numbers, we shall use this constant throughout this book. Where this cannot be done because of uncertainty in the molecular weight of the substance, the specific extinction coefficient will be substituted.

Beer's law is frequently, but not always, obeyed. When it is not, the deviation may be attributed to failure of the solution to comply with the requirements of independence of the solute molecules, and constant influence of the solvent with concentration. In other words we may conclude that association, dissociation, complex formation, or change in solvation has occurred. Beer's law holds for very many of the substances dealt with in this book.

A variety of symbols has been used for recording spectrophotometric data. There is no uniformity from country to country nor even among authors in one particular country. The particular set of symbols chosen is therefore a matter of personal preference. There is no doubt that international standardization would be highly desirable, but since this has not yet been accomplished we shall use here the symbols given in the relationships above. These are shown, together with alternative symbols, in Table I. Also shown are a number of other constants sometimes found in spectrophotometric work, but the list is not exhaustive. It should be noted that specific extinction coefficients are sometimes given in terms of concentration in grams per milliliter, and that Warburg uses the constant molar absorption coefficient in the same way, *i.e.*, with C expressed in gram moles per milliliter.

Since the laws of light absorption are strictly followed only with monochromatic light, the various spectrophotometric constants are true constants only under the same conditions. In practice measurements are made using light sources giving a continuous spectrum, portion of which is selected at each setting of the spectrometer. The band width transmitted is a function of the width of both entrance and exit slits, and, unless these are continuously varied, will be greater in the red than in the blue part of the spectrum, since the dispersion changes with wavelength. The effect of spectral impurity will be most marked on very sharp absorption bands, the extinction coeffi-

icients of sharp maxima being depressed, those of sharp minima increased, with respect to those which would be found with strictly monochromatic light.

When more than one absorbing substance is present in solution and Beer's law still applies, each substance operates independently on the light beam. Hence the resultant density is the sum of the densities due to the individual components.

3.1.2. The Absorption Curve. A plot of one of the photometric constants against the wavelength of the incident light constitutes a spectrophotometric curve. For the purposes of biochemistry, the most convenient constants are the specific and molar (or millimolar) extinction coefficients, so that the curve is an absorption curve. Some workers, however, use transmittance curves, and certain commercial spectrophotometers are calibrated in terms of transmittance.

The absorption bands visible in a simple spectroscopy are represented on an absorption curve by peaks, the clear portions of the spectrum by troughs. Some spectra however, appear to have distinct bands visually, but their corresponding absorption curves show only regions of changing curvature, with no minima separating them. Such spectra are frequently found in mixtures of substances which separately have sharp bands, but whose bands overlap on superposition. They may, however, also occur in pure substances.

A pure substance, under identical conditions, has a characteristic absorption curve, and the molar extinction coefficient at any wavelength is a constant. The wavelengths usually recorded are those of the maxima of absorption, particularly that of the most intense band, where several exist.

When the absorption curves of two substances in equal concentration are superposed, they will in general cross at one or more points, called isosbestic points. The absorption curves of equilibrium mixtures of two interconvertible substances of constant total concentration will likewise pass through the isosbestic points, and the experimental determination of this condition is a criterion of an equilibrium mixture.

3.1.3. Determination of Concentration by Spectrophotometry. When a single absorbing substance is present in solution, Beer's law has been shown to apply, and the specific or the molar extinction coefficient at a suitable wavelength has been measured, the concentration of the substance in such a solution can be calculated from its extinction. The most suitable wavelength is usually

that of a maximum of absorption, since here will occur the greatest absolute change of density with concentration.

In a similar manner the concentration of an absorbing substance may be determined in the presence of a second substance if a wavelength can be found where the second substance has a very small absorption relative to that to be determined. This will, however, rarely be the case where both absorb in the visible part of the spectrum. Since, however, the extinction coefficients of such substances are additive at all wavelengths, we can write:

$$\epsilon' = \epsilon'_{sp_a} C_a + \epsilon'_{sp_b} C_b \quad (\text{for wavelength } \lambda')$$

$$\epsilon'' = \epsilon''_{sp_a} C_a + \epsilon''_{sp_b} C_b \quad (\text{for wavelength } \lambda'')$$

from which, if the specific extinction coefficients of the two substances *a* and *b* at the wavelengths λ' and λ'' are known, and are sufficiently different, the concentrations C_a and C_b can be calculated.

Likewise, by measurement at *n* different wavelengths at which the specific or molar extinction coefficients are known, the concentrations of *n* absorbing substances simultaneously present may be determined.

A simplification of this procedure may often be found. If the two substances constitute an equilibrium mixture, and the total concentration *C* is known, measurement at one wavelength will suffice. In this case:

$$\frac{C_a}{C} = \frac{\epsilon - \epsilon_b}{\epsilon_a - \epsilon_b} \quad \text{and} \quad \frac{C_b}{C} = \frac{\epsilon_a - \epsilon}{\epsilon_a - \epsilon_b}$$

It is sometimes possible to reduce the number of absorbing components in a solution by chemical transformations. It may be possible to eliminate one component completely, when the remainder may be more easily determined, or one substance present may be converted into one of the others. In the latter case the sum of two components is found in terms of a single component. If a number of different transformations is possible in a complex solution, it may even be possible to determine all components by means of several single- or two-component investigations, instead of the more complex investigation involving all components. Good examples of the application of methods of this type are found in the work of Lemberg and collaborators (1701).

3.1.4. Spectrophotometric Titrations. For the investigation of equilibria in hematin systems, the change of one substance into

another on addition of increasing quantities of a reagent is frequently followed spectrophotometrically. Full data are provided by taking a series of complete absorption curves, but frequently sufficient data may be obtained from readings at a single wavelength where the most pronounced change in absorption occurs. If the molar extinction coefficients of both the initial and final products are known, the percentage transformation at any stage of the titration can be computed directly; however, these constants can also be found from the data of the titration itself (453). The study of Hogness and collaborators (1307) on cyanide ferriprotoporphyrin is an excellent example of the application of spectrophotometric titration methods.

3.2. Methods of Measurements

For the purposes of spectrophotometry the optical spectrum is usually considered as comprising three regions, the ultraviolet, the visible, and the infrared, although both the first and last of these may be subdivided (*cf.* 3026, p. 745). The technique of measurement of an absorption spectrum is determined by the wavelength range under consideration. In the case of hematin compounds and their derivatives, the most significant absorption bands occur principally in the visible portion of the spectrum, with the near ultraviolet as the next significant region. A few compounds have pronounced infrared bands, but comparatively little attention has so far been paid to this region.

Information on the design and construction of various instruments and on the technique of spectrophotometric measurement, together with bibliographies, will be found in the works of Heilmeyer (1213), Weissberger (3026), Twyman and Allsopp (2840), and in numerous papers and reviews.

Users of spectrophotometers, particularly elaborate commercial photoelectric types, should clearly realize that such instruments require regular calibration of the density and wavelength scales. This is a simple procedure in most cases, but is one which should under no circumstances be neglected. With automatic recording instruments a daily check can be made without any trouble, by taking the absorption curve of a suitable standardized glass filter. With visual instruments the wavelength scale can be checked occasionally by means of a neon lamp, and the density scale may be checked by a reading on a standardized glass filter, at one or two selected wavelengths. Elementary precautions of this nature will preclude the possibility of such confusion as recently overtook one well-known German school. If an instrument is originally properly designed and constructed, a little regular care will suffice to maintain its working at the highest possible accuracy.

4. COLORIMETRY AND FLUORESCENCE MEASUREMENT

4.1. Colorimetry

Although strictly speaking the laws of light absorption hold only for monochromatic light, it is possible with many substances to utilize comparatively wide wave bands, even white light, for colorimetric comparisons. The technique by which the depth of a column of solution of unknown concentration is varied until its color matches that of a standard solution is too well known to need elaboration here. Readers are referred to works such as those of Gibb (991) and Weissberger (3026) for detailed discussion.

Methods of comparison whereby the two optical fields are not contiguous — that is, the simple comparator type of instrument — have been used extensively for such purposes as hemoglobin estimation, but are suitable only for the roughest work. Where accuracy is needed, a good colorimeter, or a comparator incorporating a dividing prism, is an essential.

For colorimetry against glass or other artificial standards to be reasonably accurate with white light, it is necessary that the absorption spectrum of the substance possess no very sharp bands. On this account oxyhemoglobin and carboxyhemoglobin are not suitable for this technique but acid and alkaline hematin are. Even when standards of the same substance are used, simple colorimetry is not always suitable for sharp-banded substances. The difficulty is often resolved by the use of color filters, thus reducing the width of the spectral band transmitted by the instrument. In some cases spectrophotometry offers a simple alternative. By observation of the colorimeter field with a spectroscope, the strength of corresponding absorption bands can be matched. This technique is particularly useful for porphyrins and hemochromes.

The tendency in modern work is for absolute photometry, usually with photoelectric methods, to replace optical comparison methods. Further, accuracy is improved by using filters to narrow the spectral region employed, the colorimeter thus approaching the spectrophotometer. A very large number of instruments of this type has been described, many being commercially available. While there can be no question of the advantages of photoelectric methods, it must be said that most instruments have their own disadvantages, sometimes serious. Some of these are undoubtedly due to bad design, or to various misconceptions. One of the most serious of the latter

is the idea that the use of two photocells with one light source automatically eliminates the effect of fluctuations of the latter — whereas in fact it only does so if the light falling on the two photocells is equal when readings are made.

As with spectrophotometers, it is essential for a user of any type of photoelectric equipment to know his instrument — its principles and design, its capabilities and deficiencies — and to check its accuracy periodically. While photoelectric devices are capable of greater accuracy than visual, they are also subject to more sources of error, which are in many cases less evident to the user.

4.2. Fluorescence

Measurement of fluorescence is used for the determination of porphyrins and some bile pigments. For many purposes, simple visual comparison of the solution of the substance to be measured with a series of correctly graded standards when viewed under filtered ultraviolet illumination is sufficiently accurate. The use of filters between the fluorescing solution and the eye may often be of advantage in removing interfering fluorescence of a different color. The ultraviolet light used to excite the fluorescence is commonly derived from a mercury arc shielded by a Woods glass filter to remove both the greater part of the visual spectrum and the shorter, biologically dangerous, ultraviolet rays.

For more accurate work, photoelectric comparison is needed, and several of the more elaborate photoelectric absorptimeters are fitted with attachments for exciting and comparing fluorescence. The same precautions are needed in operating these instruments as with photoelectric colorimeters, but also great care must be taken to see that none of the exciting radiation enters the photoelectric cell.

With fluorescence measurements, proportionality of intensity to concentration is maintained only over a small range, at low concentration. Further, *pH* frequently influences the fluorescence, as do also some organic compounds and inorganic salts. Precautions must therefore be taken to ensure that the best conditions for the excitation of fluorescence are obtained.

5. THE PHOTOCHEMICAL ABSORPTION SPECTRUM

An ingenious indirect method of determining the absorption spectrum of an enzyme present in too small concentration to produce any measurable effect with conventional spectrophotometric methods

was developed by Warburg in the course of his studies of the respiratory ferment. His experiments on the inhibition of the respiration of yeast and other cells showed that cyanide and carbon monoxide are effective inhibitors and that the carbon monoxide inhibition is reduced by irradiation, due to dissociation of the carbon monoxide compound of the catalyst.

If certain conditions are fulfilled, the rate of respiration can be assumed to be proportional to the concentration of active catalyst. The degree of inhibition by carbon monoxide then becomes a measure of the ratio of carbon monoxide-combined enzyme to total enzyme. This ratio, and with it the degree of inhibition of respiration by carbon monoxide of a given partial pressure, is altered by the illumination, the magnitude of the effect being a function of the energy of the light and of the absorption coefficient of the light-sensitive carbon monoxide compound. If light of the same energy, but of different wavelengths, is used, it will then be possible to map the relative absorption curve of the carbon monoxide compound of the enzyme. Only a short summary of the mathematical treatment can be given; for greater detail the reader is referred to Warburg's original papers (*cf.* Chapter VIII, also 2924, 2928, 2930, 903).

Let A_0 be the respiratory rate of the cells in the absence of carbon monoxide. A_1 the same in the presence of carbon monoxide in the dark. $[\text{FeO}_2]$ and $[\text{FeCO}]$ the concentrations of uncombined and carbon monoxide-combined enzyme, respectively. K the dissociation constant of the carbon monoxide-compound in the dark. n the "residual respiration," and $[\text{O}_2]$ and $[\text{CO}]$ the partial pressures of oxygen and carbon monoxide. Then we have:

$$\frac{A_1}{A_0} = n = \frac{[\text{FeO}_2]}{[\text{FeO}_2] + [\text{FeCO}]} \quad (1)$$

$$\frac{n}{1 - n} = \frac{[\text{FeO}_2]}{[\text{FeCO}]} = K \frac{[\text{O}_2]}{[\text{CO}]} \quad (2)$$

From these equations the relative affinity of the respiratory ferment for oxygen and carbon monoxide can be found.

Further, if B is the velocity constant of the formation, Z of the decomposition of the oxygen compound, and b and z the corresponding constants for the carbon monoxide compound, while Z_r is a term corresponding to the disappearance of the oxygen compound by respiration, we may write:

$$K = \frac{B}{Z + Z_r} \times \frac{z}{b} \quad (3)$$

Under illumination, let the residual respiration be changed to n' with corresponding dissociation constant of the carbon monoxide compound K' . Then it follows that:

$$K' = \frac{n'}{1 - n'} \frac{[\text{CO}]}{[\text{O}_2]} = \frac{B}{Z + Z_r} \times \frac{z + z'}{b} \quad (4)$$

the alteration of n to n' being due to the additional photodissociation velocity constant z' . From equations 3 and 4 we get:

$$\frac{K' - K}{K} = \frac{z'}{z} \quad (5)$$

If I is the intensity of the light, β the molar absorption coefficient, and ν the frequency, the photochemical equivalence law of Einstein gives:

$$z' = \frac{I\beta}{N h \nu} \quad (6)$$

N being Avogadro's number and h Planck's constant.

For light of the same energy but of different frequencies, ν_1 and ν_2 corresponding to wavelengths λ_1 and λ_2 , we have, attaching the subscripts 1 and 2 to the relevant terms:

$$\frac{K'_1 - K}{K'_2 - K} = \frac{z'_1}{z'_2} = \frac{\beta_1 \nu_2}{\beta_2 \nu_1} = \frac{\beta_1 \lambda_1}{\beta_2 \lambda_2} \quad (7)$$

Since λ_1 and λ_2 are known, and K , K'_1 , and K'_2 can be measured by means of equations 2 and 4, the ratio β_1/β_2 can be found.

The respiration of the cells is first measured in the dark in oxygen-nitrogen and oxygen-carbon monoxide mixtures of the same oxygen concentration. Thus n is measured and K calculated. The system is then exposed to strong monochromatic light of different wavelengths and of measured intensity and thus K'_1 and K'_2 are obtained. Finally the respiration is measured once more in the dark in order to establish whether any irreversible alteration has occurred.

By measuring the rate of change of respiration under intermittent light it is possible by varying the periods of illumination and darkness, to measure z , the velocity constant of dissociation of the carbon monoxide compound in the dark. Then the absolute values of β , and the concentration of the catalyst in the cell, can be determined.

The theory was tested on compounds the absorption spectrum of which could be measured spectrophotometrically, first with carbon monoxide ferrocysteine (512) and later with carbon monoxide pyridine hemochrome (1579). In each case the photochemical method gave the correct absorption spectrum. The law of Einstein was found

to hold — one light quantum splitting one molecule of carbon monoxide from carbon monoxide pyridine hemochrome, though not from carbon monoxide hemoglobin (374).

It may be noted that the light sensitivity of a carbon monoxide compound is inversely proportional to its dissociation velocity constant in the dark (*cf.* equation 5 above). Since this constant increases with temperature, while z , the velocity constant of a photochemical reaction, remains unaltered, low temperatures are ideal for the measurement. There is, however, a limit since the rate of respiration decreases with temperature and becomes too small for convenient measurement.

An absorption spectrum determined by this means is known as a "photochemical absorption spectrum." The method can obviously be used only when the substance under consideration is a respiratory catalyst which is inhibited by combination with some suitable, readily measurable substance such as carbon monoxide, the resultant compound being dissociated by light.

6. MAGNETOCHEMISTRY AND BOND TYPE

The determination of the type of bonds by which the iron or other metal atom is linked to the pyrrolic nitrogen atoms of the porphyrin and to other attached molecules is of great importance, and is frequently solved by magnetochemical measurements. A brief résumé follows of those features of atomic structure and electronic valency theory which are of special concern for the hematin compounds. For more detailed treatment the reader is referred to standard texts and reviews (622, 2125, 2529).

6.1. Electronic Basis of Bond Formation

The distribution of electrons in the outer orbitals of atoms of the iron group which are concerned in metalloporphyrin complex formation, is shown in Table II.

Pauli's Exclusion Principle requires that no more than two electrons can occupy a single orbital, and that when two are present the directions of spin must be opposed. It is not, however, necessary for all available orbitals to be filled, or even occupied at all. In an atom or monatomic ion, the electrons tend to occupy first the more stable orbitals, two electrons of opposed spin entering each orbital. When

TABLE II
Electron Arrangements in $3d$, $4s$, and $4p$ Orbitals

| Metal | Ions | | | Covalent complexes | | | |
|-----------|-----------|-----------|-----------|--------------------|-----------|-----------|-------------|
| | $3d$ | $4s$ | $4p$ | $3d$ | $4s$ | $4p$ | |
| Mn^{2+} | • • • • • | • | • • • • • | • • • • • | • • • • • | • • • • • | d^5sp^3 * |
| Mn^{3+} | • • • • • | • • | • • • • • | • • • • • | • • • • • | • • • • • | d^4sp^3 * |
| Fe^{2+} | • • • • • | • • | • • • • • | • • • • • | • • • • • | • • • • • | d^6sp^3 |
| Fe^{3+} | • • • • • | • • • | • • • • • | • • • • • | • • • • • | • • • • • | d^5sp^3 |
| Co^{3+} | • • • • • | • • • • | • • • • • | • • • • • | • • • • • | • • • • • | d^6sp^3 † |
| Co^{2+} | • • • • • | • • • • • | • • • • • | • • • • • | • • • • • | • • • • • | d^7sp^3 |
| Ni^{2+} | • • • • • | • • • • • | • • • • • | • • • • • | • • • • • | • • • • • | d^8sp^3 |

* Magnetochemical evidence not yet available. See Chapter V.

† Cf. Mellor, D. P., and Craig, D. P. (1905).

a number of orbitals of equal energy are available, electrons tend to occupy them singly, keeping their spins parallel. This is indicated in the case of all the metallic ions of Table II, pairing of electrons taking place in the $3d$ shell only when each orbital is already occupied by one electron.

Both ionic and covalent bonding of the metal atoms occur. In the former case, the electronic structure is as shown in the left-hand section of the table, this type of bond leaving the $3d$ orbitals unaffected. In consequence ionic bonds are associated with relatively large numbers of unpaired electrons. The metal is held in combination by the electrostatic attraction between its own ionic charge and the charge on the surrounding nitrogen atoms of the complex. The source of the latter charge will be discussed in specific cases in Chapter V, Section 1.

An atom can form an electron pair (covalent) bond for each available stable orbital, these being in general those of the valency shell. However, in the case of the elements listed in Table II, the orbitals of the $3d$ level have much the same energy as those of the $4s$ and $4p$ (valency) shell. In the metallic ions these $3d$ orbitals are occupied in many cases only by single electrons, by the pairing of which one or more $3d$ orbitals can become available for covalent bond formation.

When, as in the present cases, there are a number of electron orbitals available of but slightly differing stability, it is found that "hybridization" takes place, resulting in the production of symmetrically disposed, energetically equivalent bond orbitals, giving bonds of greater strength than any of the component bond orbitals. There are only certain combinations of electronic orbitals for which hybridization produces increased bond strength; thus, in the case of all the ions of Table II except cobaltous and nickelous, hybridization occurs among two $3d$, one $4s$ and three $4p$ electronic orbitals, giving six bond orbitals directed toward the corners of a regular octahedron. Hybrid bond orbitals are designated by the letters representing the quantum levels involved, with the number of electronic orbitals in each case attached as a superscript. Thus, in the example just given, the bonds are referred to as of d^2sp^3 type. In the case of cobaltous and nickelous ions, only one $3d$ orbital is available for covalent bond formation. It is found that the strongest bonds which can be formed in this case arise from hybridization of this orbital with the $4s$ and two $4p$ orbitals, giving four bond orbitals of type dsp^2 , directed toward the corners of a square. One $4p$ orbital is unused. Similarly, although

in the case of manganese ion there are actually three $3d$ orbitals available, the optimum strength is attained by bonds of a d^2sp^3 type.

Since there can be no resonance between structures involving different numbers of unpaired electrons, there is a sharp discontinuity between the fully ionic and fully covalent structures represented in Table II. On the other hand, although hybridization of d , s , and p orbitals usually occurs, it is possible to assume the formation of up to four weak covalent bonds involving only the s and p orbitals, leaving the d orbitals unaffected. In this case the number of unpaired electrons is characteristic of ionic bonds, although some covalent bonding has also occurred. Consequently bond types determined on the basis of the number of unpaired electrons are usually spoken of as "essentially ionic" or "essentially covalent" to allow for such a possibility.

6.2. Magnetic Properties of Molecules

When placed in a magnetic field, all substances exhibit a magnetic polarization due to the accelerating effect of the field on the electrons of the substance, the polarization induced being opposed to the applied field. Substances in which this type of polarization occurs are repelled by a magnet and are said to be diamagnetic. Little information about molecular structure can be gained from diamagnetism. Since diamagnetism contributes to the resultant magnetic susceptibility of all substances, a correction for it must be applied when paramagnetic susceptibility alone is required to be measured.

Paramagnetic polarization, which is in the same direction as the external field, results from the presence in the substance of atoms, ions, or molecules with permanent magnetic dipole moments. These are due partly to the spin magnetic moments of unpaired electrons, and in part to the magnetic moments due to orbital motion of electrons. The latter factor is usually negligible in the substances with which this book is concerned. We shall, therefore, in the following assume that the paramagnetic susceptibility is due entirely to the spin of the unpaired electrons, with the proviso that in some cases a correction may have to be applied.

The molar magnetic susceptibility (χ_{mol}) of a system containing only one type of dipole, is given by:

$$\chi_{mol} = N\alpha + \frac{N\mu^2}{3kT}$$

where N is Avogadro's number, k Boltzmann's constant, α the molecular diamagnetic susceptibility, μ the spin dipole moment, and T the absolute temperature. The diamagnetic term in this equation is small and can usually be ignored. The dipole moment is usually given in Bohr magnetons, and in this unit μ is obtained from the equation:

$$\mu = \sqrt{\frac{3 kT}{N} \chi_{mol}} = 2.84 \sqrt{\chi_{mol} T}$$

The relationship between the magnetic dipole moment and the number of unpaired electrons, n , is given by the equation:

$$\mu = \sqrt{n(n + 2)} \text{ Bohr magnetons}$$

Thus values of μ of 1.73, 2.83, 3.88, 4.90, and 5.92 Bohr magnetons correspond to 1, 2, 3, 4, and 5 unpaired electrons, respectively.

6.3. Determination of Paramagnetic Susceptibility

Since the magnetic dipoles are oriented in the direction of the external field, a force of attraction exists between a magnet and a paramagnetic substance. This property is utilized to measure magnetic susceptibility, several different varieties of magnetic balance having been developed. Details of the methods can be obtained from various books and reviews (2529, 3026, etc.).

6.4. Magnetochemical Titrations

When a chemical reaction results in change of bond type of the metal atom of a hematin compound, determination of magnetic susceptibility can be used to follow the course of a titration. Numerous papers of Pauling and collaborators and of Theorell deal with the technique and application of this method. In many problems investigated by the former workers, the titration involved reduction of a ferric or oxygenated ferrous compound by dithionite. For example, this technique was used in an endeavor to establish the existence of intermediate compounds in the oxygenation of hemoglobin, hemoglobin having ionically and oxyhemoglobin covalently bound iron.

7. POTENTIOMETRIC METHODS

Apart from the routine measurement and control of hydrogen ion concentration necessary for accurate experimental work, potentiometric methods used in hematin chemistry fall into two main

groups: *determination of dissociation constants of acidic and basic groups and measurement of oxidation reduction potentials.* Although from a thermodynamic point of view these are closely related, it will be convenient to discuss them separately. The former needs little comment since it is familiar to most students; the latter will be treated more extensively.

7.1. Determination of Dissociation Constants

7.1.1. Elementary Theory. To establish the nomenclature and symbols to be used, the simple approximate theory of acidic and basic dissociation is given. In practice, the use of more exact equations will frequently be necessary. For these, *cf.* 449 and 608.

For an acid:

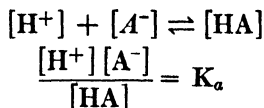

If α is the fraction of acid dissociated:

$$[H^+] = K_a \frac{1 - \alpha}{\alpha}$$

Taking the logarithm of the reciprocal of each side:

$$\log \frac{1}{[H^+]} = \log \frac{1}{K_a} + \log \frac{\alpha}{1 - \alpha}$$

or:

$$pH = pK_a + \log \frac{\alpha}{1 - \alpha} \quad (1)$$

When $\alpha = 0.5$ (*i.e.*, acid is half dissociated):

$$pH = pK_a$$

Similarly for a base, if β is the fraction dissociated:

$$p(OH) = pK_b + \log \frac{\beta}{1 - \beta} \quad (2)$$

It is now usual to express basic dissociation constants in terms of pH instead of $p(OH)$. We can therefore write:

$$pH = 14 - pK_b - \log \frac{\beta}{1 - \beta} \quad (3)$$

and when the base is half dissociated, $pH = 14 - pK_b$. Then for both acid and base, at half dissociation $pH = pK$, where for an acid $pK = pK_a$ and for a base $pK = 14 - pK_b$.

The logarithmic expression of dissociation constants as pK values is convenient, and has been extended beyond the field of acidic and basic dissociations. In any equilibrium involving equimolecular ratios of the reactants and product, we may write:

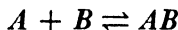

whence by a process similar to the above:

$$p(A) = pK + \log \frac{\alpha}{1 - \alpha}$$

where α is the degree of dissociation of the product AB . At 50% dissociation, the pK is the logarithm of the reciprocal of the concentration of either reactant. Where the equilibrium is more complicated, pK has this same meaning for each step if the association is stepwise. This use of the term pK should be carefully distinguished from that discussed above, although the two are analogous.

7.1.2. Titration Curves. If salts are assumed to be completely dissociated, equation 1 may be written in the form:

$$pH = pK_a + \log \frac{[\text{salt}]}{[\text{acid}]} \quad (4)$$

expressing the relationship between the pH and the extent of stoichiometric neutralization of the acid. It must be emphasized that this equation is only approximate, owing to the limitation imposed by the above assumption; further, the acid cannot be assumed to be completely undissociated, and a curve of pH against degree of neutralization drawn by means of this equation will deviate from an experimental curve more with strong acids than with weak. However, over the middle portion of the curves, the correspondence is usually good with weak acids so that the pK value may be found from an experimental titration curve. The titration curve is sigmoid, with the pK at the point of inflexion.

7.1.3. Titration Curves of Proteins. Proteins contain a large number of groups capable of acidic or basic dissociation, so that titration of a protein solution with an acid or alkali is possible. By plotting the number of equivalents of reagent added against the pH , it is possible to determine the number of dissociable groups with pK values within a given pH range. For a detailed treatment, the reader is referred to the work of Cohn and Edsall, and papers of Wyman, Theorell, and other workers. It has been found possible to identify, in each pH range, dissociable groups belonging to various amino acid residues.

7.1.4. Differential Titration of Proteins. When a protein enters into combination in such a manner that one or more of its dissociable acidic or basic groups are involved, there will in general be found differences between the titration curve of the original protein and that of the compound. Differences in the curves in a particular *pH* region indicate that groups dissociating in this region are in some way involved in the combination. It has been found possible by this means to suggest the particular amino acid residues responsible for combination with the prosthetic group in a number of hemoproteins, and also those involved in combination with oxygen or in changes of linkage associated with change of valency of the iron atom. In the hemoproteins, the picture is complicated by the presence of carboxyl groups in the hematin side chains, and of hydroxyl groups attached to the iron atom in the ferric compounds. Examples of the use of the method and the results obtained are given in Chapters VI and IX.

7.2. Oxidation-Reduction Potentials

Measurement of oxidation-reduction potentials has contributed important data toward the solution of numerous problems encountered in the chemistry of hematin compounds. Its use depends on the capacity of the iron atom (or some other metal atom in synthetic metalloporphyrins) to exist in either oxidized or reduced state. The problem is by no means a simple one since a great number of other variables have to be taken into account, including, for example, change of *pH*, ionization of one or both of the components of the reaction, coordination of components with other substances, and change of aggregation accompanying reduction or coordination. Consequently although the use of a general equation expressing the effect of all possible variables is theoretically admissible, the mathematical manipulations involved in this are prohibitively complicated. The experimental treatment likewise requires some simplification of the problem, since it is seldom possible to secure adequate data on all aspects of such a complex system.

The practice is therefore adopted of "breaking down the continuum into a plexus of equations" (Clark) and of utilizing graphical methods for the interpretation of results.

It is obviously outside the scope of this elementary review to attempt a complete or even entirely rigorous exposition of the theory of oxidation-reduction potentials. The reader is referred in

the first place to the admirable accounts given by Clark (449,450). Here, it will be sufficient to give the derivation of the parts of the theory most essential for an interpretation of the experimental data recorded in other chapters.

7.2.1. Fundamental Oxidation-Reduction Equation. In general an oxidation-reduction system may be defined by one or other of the equations (where ϵ represents one electron):

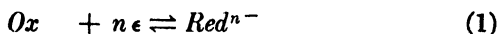

or by any equation expressing conditions intermediate between these. The system contains two components; one, the oxidant (*Ox*) being capable of reversible reduction to the other, the reductant (*Red*). The oxidation-reduction process is accompanied by changes in the ionic charge of the components, the latter being indicated by the superscript $n+$ and $n-$. To avoid undue complexity, equation 2 is selected as the basis for further treatment. The equilibrium of this system is defined by the equation:

$$\frac{(Ox^{n+}) (\epsilon)^n}{(Red)} = K \quad (3)$$

where parentheses indicate activities.

Consider also the system defined by equation 4:



Utilizing the hydrogen pressure, P (in atmospheres), to express hydrogen concentration, we may write:

$$\frac{(H^+) (\epsilon)_H}{\sqrt{P}} = K_H \quad (5)$$

defining the equilibrium condition for this system, which is in fact a hydrogen electrode.

An unattackable electrode (bright platinum or gold) is inserted into the solution containing the first system, the hydrogen electrode is assembled with platinized platinum electrode and hydrogen gas in the usual manner, and the two solutions are connected by means of a potassium chloride bridge or other means of eliminating liquid junction potentials caused by unequal rates of diffusion of ions. Since the "electron activity"* of the two sections of the combined system differs, connection of the two metallic electrodes by an external conducting path results in the production of an electric current from the side of greater electron activity to that of less. If the external

* The physical significance of the term "electron activity" need not be discussed since it is used here simply as a mathematical convenience and is eliminated from the final equations.

conducting path is arranged so that the pressure of electrons in it can be exactly counterbalanced, as in the potentiometric method, the condition is attained for measurement of the free energy change of a reversible process.

For the transfer of one faraday (F) of electrons from activity $(\epsilon)_H$ to activity (ϵ) we have:

$$-\Delta A = EF = RT \ln \frac{(\epsilon)_H}{(\epsilon)} \quad (6)$$

ΔA is the change in free energy, and E is the electromotive force in volts. Substituting in equation 6 the value of $(\epsilon)_H$ from equation 5:

$$E = \frac{RT}{F} \ln \frac{K_H \sqrt{P}}{(\epsilon) (H^+)} \quad (7)$$

Putting:

$$\frac{RT}{F} \ln K_H = E_H \quad (8)$$

$$E = E_H + \frac{RT}{F} \ln \frac{\sqrt{P}}{(H^+)} - \frac{RT}{F} \ln (\epsilon) \quad (9)$$

If the conditions of the hydrogen electrode are now defined so that when $P = 1$ and $(H^+) = 1$, $\epsilon_H = 1$, then from equation 5, $K_H = 1$ and from equation 8, $E_H = 0$, and we have:

$$E_h = -\frac{RT}{F} \ln (\epsilon) \quad (10)$$

where E_h signifies that the E.M.F. is referred to the potential of the normal hydrogen electrode as zero.

Equation 10 may be regarded as the fundamental oxidation-reduction potential equation since by substitution for ϵ the value obtained from the equilibrium equation of the particular system under consideration, the relationship of E_h to the factors determining the system can be found.

In the present case, from equation 3:

$$\epsilon = \left(K \frac{(Red)}{(Ox^{n+})} \right)^{1/n} \quad (11)$$

whence from equation 10:

$$E_h = E_0 - \frac{RT}{nF} \ln \frac{(Red)}{(Ox^{n+})} \quad (12)$$

where $E_0 = -\frac{RT}{nF} \ln K$, a constant for the system. When $(Red) = (Ox^{n+})$, $E_h = E_0$, giving the "characteristic potential" of the system.

In the above derivation, we have expressed all the relationships in terms

of the activities of the various components. If concentrations are used, equation 12 becomes:

$$E_h = E_0 - \frac{RT}{nF} \ln \frac{[Red]}{[Ox^{n+}]} - \frac{RT}{nF} \ln \frac{\gamma_{Red}}{\gamma_{Ox^{n+}}} \quad (13)$$

brackets indicating concentrations.

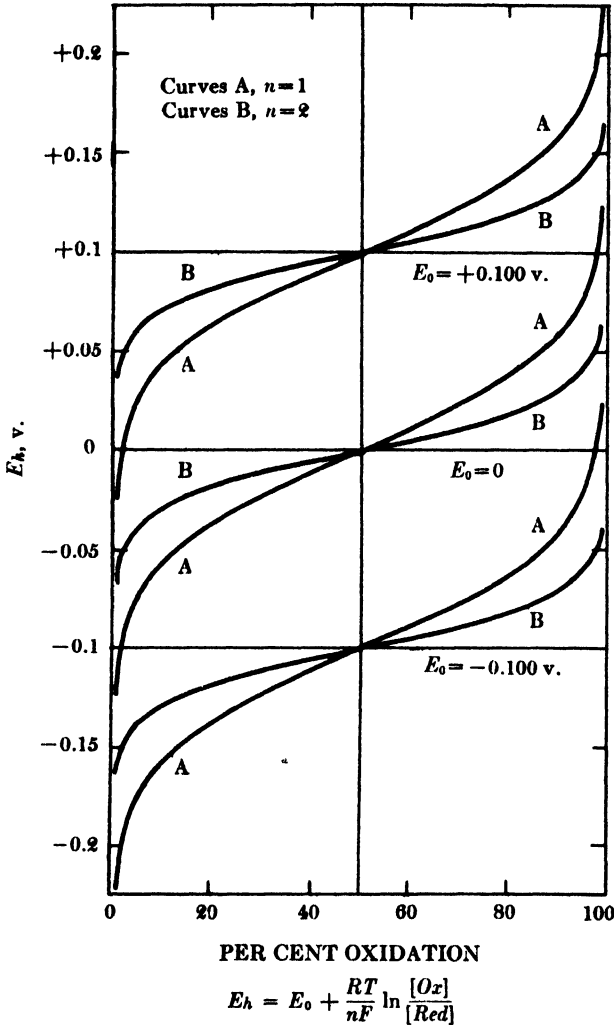

Fig. 1. Hypothetical oxidation-reduction curves.

It is commonly assumed that the activity coefficients of oxidant and reductant are equal, so that the last term of equation 13 becomes zero and:

$$E_h = E_0 - \frac{RT}{nF} \ln \frac{[Red]}{[Ox^{n+}]} \quad (14)$$

Oxidation-reduction potentials are frequently depicted graphically by plotting the value of E_h against the percentage of reduction. It will be seen that equation 14 is the equation of a family of curves of identical shape, disposed parallel to one another along the E_h axis according to the value of E_0 , the latter being a characteristic constant for the particular system. Figure 1 shows a series of hypothetical curves corresponding to three different values of E_0 . The curves are seen to be symmetrical about the values of E_0 , which lies on a point of inflexion. The slope at this point gives the value of n .

7.2.2. Effect of pH. The equations which have been derived are useful only if the concentration of the oxidant in its ionic form is known. The fraction of total oxidant present in this condition varies with pH, since at certain values of the latter, combination of the ionic oxidant with hydroxyl ions will occur, fractions of the oxidant assuming successively the forms $(OH)Ox^{(n-1)+}$, $(OH)_2Ox^{(n-2)+}$. . . $(OH)_nOx$. Consequently with a given concentration of total oxidant the value of E_h varies with pH. The same considerations hold for other systems in which the ionic relationships of oxidant and reductant are different (*cf.* equation 1, Sect. 7.2.1. above).

When, as is usual, only the concentration of total reductant and oxidant is known, it is necessary to replace the concentration of ionic forms in the electrode equation by equivalent expressions involving the total concentration of the components, and the various dissociation constants concerned. The general relationship is complicated and it would serve no useful purpose to investigate it further. The nature of the potential change is better appreciated by examination of individual cases as they arise.

To illustrate the effect and the general procedure adopted it will suffice to examine further the system with which we have so far been dealing, since this is the simplest type of system likely to be encountered in hematin chemistry. It is not to be assumed that any actual system will conform in practice to this simple relationship; in fact, due to the intervention of other factors, sometimes incompletely understood, most cases investigated have been found to be rather more complex.

If the presence of carboxylic acid groups in the porphyrin side chains is neglected, their dissociation being considered as unaffected by the valency change, heme and a number of heme derivatives possess an iron atom with a residual charge of zero. On oxidation, the iron acquires a positive charge of one unit, enabling it to combine reversibly with a single hydroxyl ion. The simplest complete equation which could be envisaged for the system is:

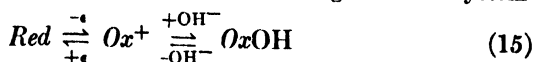

for which the oxidation-reduction equation has been derived (equation 14).

$$E_h = E_0 - \frac{RT}{F} \ln \frac{[Red]}{[Ox^+]}$$

From the second part of equation 15, we have:

$$\frac{[Ox^+][OH^-]}{[OxOH]} = K_O = \frac{[Ox^+]K_W}{[OxOH][H^+]} \quad (16)$$

whence:

$$[OxOH] = \frac{[Ox^+]K_W}{[H^+]K_O} \quad (17)$$

Let S_O be the concentration of total oxidant, and S_R that of total reductant; then:

$$S_R = [Red] \quad (18)$$

and:

$$S_O = [Ox^+] + [OxOH] \quad (19)$$

Substituting in equation 19 the value of $[OxOH]$ from equation 17 and solving for $[Ox^+]$, we have:

$$[Ox^+] = S_O \frac{[H^+]K_O}{[H^+]K_O + K_W} \quad (20)$$

Hence by substitution in equation 14:

$$E_h = E_0 - \frac{RT}{F} \ln \frac{S_R}{S_O} + \frac{RT}{F} \ln \frac{[H^+]K_O}{[H^+]K_O + K_W} \quad (21)$$

If the pH is kept constant, the last term of equation 21 is constant, whence:

$$E_h = E'_0 - \frac{RT}{F} \ln \frac{S_R}{S_O} \quad (22)$$

This is the equation commonly employed in oxidation-reduction potential studies at constant pH. It may be treated graphically in the same manner as equation 14.

To visualize the effect of change of pH, make S_O equal to S_R in equation 21. Then:

$$E_h = E_0 + \frac{RT}{F} \ln \frac{[H^+]K_O}{[H^+]K_O + K_W} \quad (23)$$

In general, K_O will be much larger than K_W . At low pH values, when $[H^+]K_O$ is also much greater than K_W , the last term of equation 23 becomes zero, and the potential is invariant. As the hydrogen ion concentration is reduced, a point is reached where $[H^+]K_O = K_W$. In the neighborhood of this point, the second term acquires a finite negative value, and E_h becomes more negative with increasing pH. When the value of $[H^+]$ is such that $[H^+]K_O$ is much smaller than K_W , the second term of equation 23 approximates:

$$\frac{RT}{F} \ln \frac{[H^+]K_O}{K_W}$$

The whole equation then becomes:

$$E_h = E + \frac{RT}{F} \ln [H^+] \quad (24)$$

where:

$$E = E_0 + \frac{RT}{F} \ln \frac{K_0}{K_w}$$

i.e., a constant. At 30°C., and transformed to common logarithms, this is equivalent to:

$$E_h = E + 0.06 \log [H^+] \quad (25)$$

Consequently in this *pH* region the value of E_h becomes more negative with increasing *pH*, by 0.06 v. per *pH* unit.

In the case of systems other than that represented by equation 15, a similar procedure to that followed above leads to equations of the same general type, the effect of *pH* on E_h being determined by the form of the last term.

It is common practice to represent the relationship of E_h to *pH* graphically, keeping S_O equal to S_R and plotting E_h as ordinate and *pH* as abscissa. A series of such curves is shown on pp. 198, 199. In general, a change in slope of the curve is found corresponding to each dissociation constant of oxidant or reductant connected with the reduction process. The midpoint of the transition gives the *pK* value of the dissociation. Between these points, the curve approaches a straight line, the slope of which corresponds to rates of change of E_h with *pH* of 0.06, 0.03, 0.00, etc. v. per *pH* unit, this value depending on the value of *n* and the ionic change involved.

If oxidant and reductant contain acidic or basic groups other than those affected directly by the reduction process, these additional groups may exhibit a difference in dissociation constant between the oxidized and reduced forms. The energy change concerned in this must then be accounted for, and the E_h/pH relationship assumes a more complicated form. In hemoglobin such groups exist in the form of imidazole groups linking heme to globin; *cf.* Chapter VI. The possible effect of side chain carboxylic acid groups is discussed in Chapter V, Section 7.1.3. Two useful conclusions can be drawn: (a) When other conditions are constant, demonstration of a relationship between E_h and *pH* expressed by the equation:

$$- \frac{\Delta E_h}{\Delta pH} = 0.0601 \text{ (at 30°C.)}$$

indicates that the reductant must possess one more hydrogen ion (or one less hydroxyl ion) than the oxidant for each electron necessary to convert oxidant to reductant. (b) If, on increase of *pH*, *x* equivalents of hydrogen ions per mole are dissociated from the reductant, the value of $-(\Delta E_h/\Delta pH)$ will decrease by $x(0.06)/n$. If under the same conditions, dissociation of *x* equivalents of hydrogen ion take place from the oxidant, the value of $-(\Delta E_h/\Delta pH)$ will increase by the same amount. The same argument holds if dissociation of a hydrogen ion is replaced by the association of a hydroxyl ion. The numerical value is of course for 30°C.

7.2.3. Change in Aggregation. If reduction results in a change in the degree of aggregation of the components, a further complication is introduced. To illustrate the effect, a system will be assumed in which the monomeric form of the oxidant requires one electron for reduction. The general form of such a system is:



where $pm = n$. The electrode equation, derived from equation 14 then becomes:

$$E_h = E_0 - \frac{RT}{nF} \ln \frac{[Red_m]^p}{[(Ox_n)^{n+}]} \quad (27)$$

Owing to the presence of the higher order term, equation 27 does not give a titration curve symmetrical about E_0 . Figure 2 shows the curve plotted

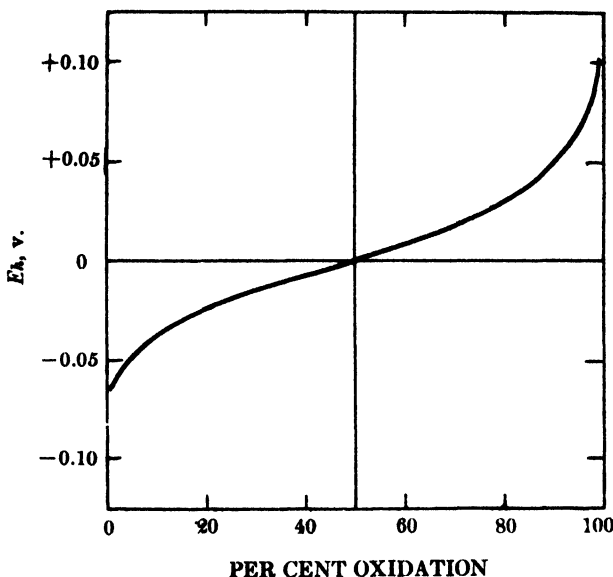

$$E_h = E_0 + \frac{RT}{2F} \ln \frac{[Ox_2]}{[Red]^2}$$

Fig. 2. Hypothetical oxidation-reduction curve showing effect of change of aggregation.

for the case where $n = p = 2$ and $m = 1$. In this case, E_0 lies at the point of 50% oxidation; other values of m and p result in its displacement from this central position. The difference should be noted between this curve and those of Figure 1 (Sect. 7.2.1.). It follows that symmetry of an experimental titration curve is evidence that $p = 1$ and no change of aggregation occurs, while, if a curve lacking symmetry is obtained, change of aggregation must be presumed.

7.2.4. Combination of Oxidant and Reductant with Other Substances. The simple metalloporphyrins, as will be seen later, possess the capacity of combining with a variety of other substances. When the linkage occurs by coordination with the metal atom, such combination, as in the hemochromes, is usually characterized by a measurable, often high, dissociation constant, so that the energy change contributes to the oxidation-reduction potential. Clark and collaborators (453) were the first to develop equations describing these systems, and have carried out detailed studies (451,536,2749, 2872) in an endeavor to establish the nature of the equilibria met with in practice. The results of their work are discussed in Chapter V, Sections 4, 6, and 7. The development of the equations is somewhat involved, and several simplifying assumptions are made. Since Clark's papers are of fundamental importance, and present great difficulty to the nonmathematical student on account of the highly condensed form of the mathematical treatment, an attempt will be made to supply the details of the algebra. The following derivation, and also Chapter V, should be read in conjunction with the papers of Clark and collaborators.

Oxidation and reduction of a metalloporphyrin are assumed to follow equation 26. The typography will henceforth be simplified by abbreviating *Red* to *R* and *Ox* to *O*. The *pH* is kept constant, so that the electrode equation in terms of concentrations may be written:

$$E_h = E'_0 + \frac{RT}{nF} \ln \frac{[O_n]}{[R_m]^p} \quad (28)$$

The addition of a nitrogenous base, *B*, results in its independent coordination with both oxidant and reductant. The equations are:



in which no change of aggregation of either oxidant or reductant is assumed to occur on combination with *B*. From equation 29 we have:

$$\frac{[O_n][B]^q}{[O_nB_q]} = K_O \quad (31)$$

And from equation 30 it follows that:

$$\frac{[R_m][B]^r}{[R_mB_r]} = K_R \quad (32)$$

From these equations, by substitution for $[R_m]$ and $[O_n]$ in equation 28 equation 33 is obtained:

$$E_h = E'_0 + \frac{RT}{nF} \ln \frac{S_O}{(S_R)^p} + \frac{RT}{nF} \ln \frac{m^p}{n} + \frac{RT}{nF} \ln \frac{K_O}{(K_R)^p} + \frac{RT}{nF} \ln \frac{(K_R + [B]^r)^p}{K_O + [B]^q} \quad (33)$$

where:

$$S_O = n[O_n] + n[O_n B_q] \quad (34)$$

and:

$$S_R = m[R_m] + m[R_m B_r] \quad (35)$$

Equation 33 has been simplified by assuming, as before, that no changes of activity coefficients occur on oxidation or reduction; the apparent constants represented by equations 31 and 32 have been treated as true constants.

The shape of experimentally obtained titration curves gives information about the values of a number of the constants in this equation. The curves are obtained by fixing in each case all the variables except one.

(1) As in Section 7.2.3, if all conditions are constant except the ratio of S_O to $(S_R)^p$, symmetry of the curve indicates that $p = 1$.

(2) If $p = 1$, the slope of the titration curve under the same conditions gives the value of n . If $p = 1$, $m = n$. If $p = m = n = 1$, and the temperature is taken as 30°C., equation 33 reduces to:

$$E_h = E'_0 + 0.0601 \log \frac{S_O}{S_R} + 0.0601 \log \frac{K_O}{K_R} + 0.0601 \log \frac{K_R + [B]^r}{K_O + [B]^q} \quad (36)$$

If $[B]$ is maintained constant, equation 36 becomes:

$$E_h = E_B + 0.06 \log \frac{S_O}{S_R} \quad (37)$$

where E_B indicates the potential at 50% reduction of the system at constant concentration of free base. Two further conclusions derive from equation 36.

(3) If the potential increases with addition of coordinating substance, all other conditions remaining constant, K_O is greater than K_R . If the potential decreases under the same conditions, K_R is greater than K_O .

(4) If on addition of base, all other conditions being constant, the potential approaches a limiting potential, it follows that $q = r$. At the limiting potential the last term of equation 36 is constant, so that the equation may be written:

$$E_h = E'_0 + k_1 + 0.0601 \log \frac{K_O}{K_R} + k_2 \quad (38)$$

i.e.,

$$E_2 = E'_0 + 0.0601 \log \frac{K_O}{K_R} \quad (39)$$

It is important to recognize from this result that the change of potential $E_2 - E'_0$ accompanying the addition of a coordinating base to a fixed mixture of reduced and oxidized metalloporphyrin is a measure of the *ratio* of the two dissociation constants. The course of the curve between E'_0 and E_2 is determined by the absolute values of K_O and K_R and the concentration of total metalloporphyrin S (see equation 36). Since at the conditions of the limiting potential E_2 full combination with base is approximated, the electrode potential is given by the equation:

$$E_h = E_2 + 0.0601 \log \frac{[OB_q]}{[RB_r]} \quad (40)$$

The last term of equation 36 is expressed in terms of the concentration of free base $[B]$. In those cases where the concentration of total base (S_B) is high in relation to the concentration of total metalloporphyrin, $[B]$ is negligibly different from S_B ; at low concentrations of total base, however, the difference may be great. It is therefore necessary to transform equation 36 in terms of S_B instead of $[B]$, since S_B can be measured.

To do this, Clark uses the following definitions, in addition to the previous assumption that $p = m = n = 1$:

$$S_B = [B] + q[OB_q] + r[RB_r] \quad (41)$$

$$S = S_O + S_R \quad (42)$$

(see equations 34 and 35)

$$x = \frac{[O]}{[R]} = \text{antilog} \frac{E_h - E'_0}{0.0601} \quad (43)$$

(from equation 28):

$$y = \frac{[OB_q]}{[RB_r]} = \text{antilog} \frac{E_h - E_2}{0.0601} \quad (44)$$

$$\alpha = \frac{S_O}{S} \quad (45)$$

The problem is now to substitute for $[B]$ in equation 36 so that the resulting equation is in terms of measurable quantities. From equation 41:

$$\begin{aligned} [B] &= S_B - q[OB_q] - r[RB_r] \\ &= S_B - (qy + r)[RB_r] \text{ from equation 44} \\ [RB_r] &= (S_R - [R]) \text{ from equation 35} \\ &= S - S_O - [R] \text{ from equation 42} \\ &= S - \alpha S - \frac{[O]}{x} \text{ from equations 45 and 43} \\ &= S - \alpha S - \left(\frac{S_O}{x} - \frac{[OB_q]}{x} \right) \text{ from equation 34} \\ &= S - \alpha S - \frac{\alpha S}{x} + \frac{y}{x} [RB_r] \end{aligned}$$

i.e.,

$$\left(1 - \frac{y}{x}\right)[RB_r] = \left(1 - \alpha - \frac{\alpha}{x}\right)S$$

i.e.,

$$\begin{aligned} [RB_r] &= \frac{1 - \alpha - \frac{\alpha}{x}}{1 - \frac{y}{x}} \times S \\ &= \frac{x(1 - \alpha) - \alpha}{(x - y)} \times S \end{aligned}$$

therefore:

$$\begin{aligned} B &= S_B - \frac{(qy + r)}{(x - y)} [x(1 - \alpha) - \alpha]S \\ &= S_B - ZS \end{aligned}$$

where:

$$Z = \frac{(qy + r)}{(x - y)} \times [x(1 - \alpha) - \alpha] \quad (46)$$

Hence the required equation may be written:

$$\begin{aligned} E_h = E'_0 + 0.0601 \log \frac{S_O}{S_R} + 0.0601 \log \frac{K_O}{K_R} \\ + 0.0601 \log \frac{K_R + (S_B - ZS)^r}{K_O + (S_B - ZS)^q} \end{aligned} \quad (47)$$

If it is now assumed that the same number of molecules of base, namely two, combines with both oxidized and reduced metalloporphyrin, and S_O is made equal to S_R (*i.e.*, 50% reduction), $q = r = 2$ and $\alpha = 0.5$. Under these conditions:

$$Z = \frac{(y + 1)(x - 1)}{(x - y)} \quad (48)$$

and:

$$E_h - E'_0 = 0.06 \log \frac{K_O}{K_R} + 0.06 \log \frac{K_R + (S_B - ZS)^2}{K_O + (S_B - ZS)^2} \quad (49)$$

In the systems under consideration, the main interest centers not on the oxidation-reduction potential relationships as such, but on what information they can provide on the constitution of the substances taking part in the system, and their relationships with one another. Equation 49 should lead to values for the dissociation constants K_O and K_R , but the complexity of the last term, involving Z , makes the use of the equation difficult. Clark has shown, however, that graphical approximations may yield useful results.

A further assumption, in conformity with experience with base metalloporphyrins, is made, namely that the affinity of the reduced form for base is much higher than that of the oxidized, *i.e.*, $K_O > K_R$.

Inspection of equation 49 suggests that there are three values of $[B]$ (*i.e.* of $S_B - ZS$) in terms of K_O and K_R which will give unique values of $E_h - E'_0$.

(1) When $[B]^2 = K_R$: *i.e.*, $(S_B - ZS)^2 = K_R$:

$$E_h - E'_0 = 0.06 \log \frac{2 K_O K_R}{K_O K_R + (K_R)^2}$$

by substitution in equation 49. Since it has been assumed that $K_R < K_O$, $(K_R)^2$ is negligible in relation to $K_O K_R$. Then $E_h - E'_0 = 0.06 \log 2 = 0.0181$ v. From equation 43, it follows that $x \doteq 2$, and $[O] \doteq 2 [R]$; and from equations 32 and 35, $[R] = [RB_2] \doteq 0.5 S_R$. But, since $S_O = S_R$ under the conditions chosen, we have from equation 42, $S_R = 0.5 S$, *i.e.*, $[RB_2] = 0.5 S_R = 0.25 S$. Further, from equations 34 and 35, $[O] + [OB_2] - [R] - [RB_2] = 0$, from which by substitution for $[O]$ and $[RB_2]$, $[OB_2] \doteq 0$. Hence one quarter of the metalloporphyrin is combined with base, and the base metalloporphyrin is practically entirely in the reduced condition. Proceeding, since $[OB_2] \doteq 0$, from equation 44, $y \doteq 0$. Then by substitution for x and y in equation 48, $Z \doteq 0.5$.

Also:

$$[B]^2 = K_R \doteq (S_B - 0.5 S)^2$$

and:

$$S_B \doteq \sqrt{K_R} + 0.5 S^*$$

If $q = r$, but has a value other than 2, the point where $[B]^r = K_R$ satisfies the above conditions, except that $Z = r/4$ and:

$$S_B \doteq r \sqrt{K_R} + \frac{r}{4} S$$

(2) When $[B]^4 = K_O K_R$, we obtain by substitution in equation 49:

$$E_h = E'_0 + 0.0601 \log \frac{K_O}{K_R} + 0.0601 \log \frac{K_R + \sqrt{K_O K_R}}{K_O + \sqrt{K_O K_R}}$$

i.e.,

$$E_h = E_2 + 0.0601 \log \frac{K_R + \sqrt{K_O K_R}}{K_O + \sqrt{K_O K_R}}$$

from equation 39. Adding these two equations, and dividing by 2:

* Note typographical error in Clark's paper (453, p. 552) where S_B is equated to $K_R - 0.5 S$. The correct result, as given above, is used throughout the rest of Clark's discussion. Note also in Clark's equation 19 on the same page, a figure 2 has been omitted from the denominator.

$$\begin{aligned}
 E_h &= \frac{E'_0 + E_2}{2} + 0.0601 \log \sqrt{\frac{K_O}{K_R}} + 0.0601 \log \frac{K_R + \sqrt{K_O K_R}}{K_O + \sqrt{K_O K_R}} \\
 &= \frac{E'_0 + E_2}{2} + 0.0601 \log \frac{K_R \sqrt{K_O} + K_O \sqrt{K_R}}{K_O \sqrt{K_R} + K_R \sqrt{K_O}} \\
 &= \frac{E'_0 + E_2}{2}
 \end{aligned}$$

From equations 28 and 40, by addition:

$$2 E_h - (E'_0 + E_2) = 0.0601 \log \frac{[OB_2] [O]}{[RB_2] [R]}$$

i.e.,

$$\log \frac{[OB_2] [O]}{[RB_2] [R]} = 0$$

and

$$[OB_2] [O] = [RB_2] [R] \quad (a)$$

but from equations 31 and 32:

$$K_O K_R = [B]^4 = \frac{[O] [B]^2 [R] [B]^2}{[OB_2] [RB_2]}$$

Hence:

$$[O] [R] = [OB_2] [RB_2] \quad (b)$$

From equations *a* and *b* it follows that:

$$[O] = [RB_2] \text{ and } [R] = [OB_2]$$

and from equations 34, 35 and 42:

$$[OB_2] + [RB_2] = 0.5 S$$

i.e., half the metalloporphyrin is combined with base. Then from equations 43 and 44, $y = 1/x$, and from equation 48, $Z = 1$. Hence:

$$[B] = (S_B - ZS) = S_B - S$$

It will be observed that, so long as $q = r$, the point at which $[B]^{2r} = K_O K_R$ satisfies the above conditions, irrespective of the value of r , except that $Z = r/2$ and $[B] = S_B - r/2 S$.

(3) When $[B]^2 = K_O$:

$$\begin{aligned}
 E_h &= E'_0 + 0.06 \log \frac{K_O}{K_R} + 0.06 \log \frac{K_R + K_O}{2 K_O} \\
 &= E_2 - 0.06 \log \frac{2 K_O}{K_R + K_O} \text{ from equation 39}
 \end{aligned}$$

but since K_R is much smaller than K_O :

$$E_2 - E_h = 0.06 \log 2 = 0.0181 \text{ v.}$$

Then from equation 44, $y \doteq 0.5$ and $[RB_2] \doteq 2[OB_2]$; also from equation 31, $[O] = [OB_2]$; but since $S_O = S_R$:

$$[O] + [OB_2] - [R] - [RB_2] = 0$$

i.e., $[R] \doteq 0$. From equation 43, $x \doteq \infty$, and from equation 48, as $x \rightarrow \infty$, $Z \doteq 1.5$. Then:

$$[B] = \sqrt{K_O} \doteq S_B - 1.5 S$$

i.e., $S_B \doteq \sqrt{K_O} + 1.5 S$. From equations 34, 35 and 42:

$$S = [O] + [OB_2] + [R] + [RB_2] = 4 OB_2 = 2 RB_2$$

Hence at this point, three quarters of the metalloporphyrin is combined with base ($[OB_2] + [RB_2] = \frac{3}{4} S$) while practically no reduced metalloporphyrin remains uncombined ($[R] \rightarrow 0$). As in cases (1) and (2), if $q = r$, but does not equal 2, the point where $[B]^r = K_O$ satisfies the above conditions, except that $Z = 1.5 r/2$, and:

$$S_B = r\sqrt{K_O} + \frac{1.5 r}{2} S$$

It will be seen that at these three points relations exist expressing the dissociation constants K_O and K_R in terms of measurable quantities, *i.e.*, S_B , the total base added, and S , the total metalloporphyrin. On making measurements of the oxidation-reduction potential of the system under the conditions specified, that is with constant pH, 50% reduction, and at 30°C., the base concentration being the only variable, the values of E_0 (at zero base concentration) and E_2 (the limiting potential at high base concentration, if the system is such that equal numbers of molecules of base combine with oxidant and reductant) and a series of values of E_h corresponding to various values of S_B may be found.

It has to be determined how best to plot the data so obtained, in order to locate the three unique points. Usually, such results are plotted with E_h as ordinate and S_B as abscissa. However, Clark shows that this does not lead to the best results.

By differentiation of equation 49 with respect to $\log(S_B - S)$, substituting in the result the condition at the second unique point that $(S_B - S)^{2r} = K_O K_R$, and making the usual approximations on the assumption that $K_O > K_R$, it may be shown that, at this second point:

$$\frac{dE_h}{d \log(S_B - S)} \doteq 0.0601 r \quad (50)$$

Hence in the present case, where $r = 2$:

$$\frac{dE_h}{d \log(S_B - S)} = 0.12$$

Consequently if E_h is plotted against $\log(S_B - S)$ the curve so obtained has a slope of 0.12 at its central point.

Figure 3, and the description of the method employed, are taken from the paper of Clark and collaborators, with appropriate modifications, and should be sufficiently explanatory.

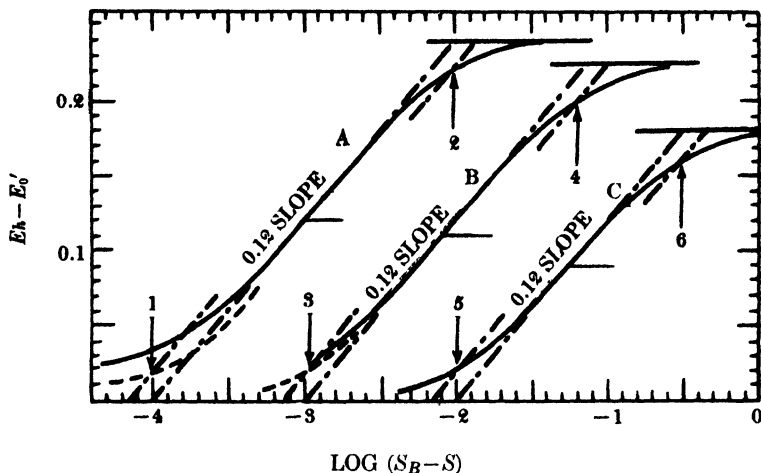

Fig. 3. The solid lines represent the theoretical relation of $E_h - E_0'$ to $\log(S_B - S)$ when $q = r = 2$, $0.5S = S_r = S_0 = 1 \times 10^{-4} M$. The broken lines represent the same theoretical relation with $\log(S_B - 0.5S)$ as abscissa. Curve A, $K_R = 1 \times 10^{-3}$, $0.5 \log K_R = -4.00$ (point 1); $K_0 = 1 \times 10^{-4}$, $0.5 \log K_0 = -2.00$ (point 2); $E_2 - E_0 = 0.2400$ (0.06 coefficient). Curve B, $K_R = 1 \times 10^{-5}$, $0.5 \log K_R = -3.00$, (point 3); $K_0 = 5 \times 10^{-3}$, $0.5 \log K_0 = -1.15$ (point 4); $E_2 - E_0 = 0.2219$ (0.06 coefficient). Curve C, $K_R = 1 \times 10^{-4}$, $0.5 \log K_R = -2.00$ (point 5); $K_0 = 1 \times 10^{-1}$, $0.5 \log K_0 = -0.50$ (point 6); $E_2 - E_0 = 0.1800$ (0.06 coefficient). After Clark *et al.* (453).

"Figure 3 illustrates a method of graphical analysis based upon the use of these approximations and unique points. Since Z is unity at the center point, $\log(S_B - S)$ is made the abscissa in order that the important orienting diagonal, of slope 0.12, may coincide with the center point. When the ratio of K_0 to K_R is as large as any of the values indicated, the diagonal is very close to the tangent through the mid-point and accordingly can be well placed. This diagonal will intersect the line of E_0' where:

$$0.5 \log K_R = \log [B]$$

Now if $[B] = (S_B - S)$, as it does in Curve C, this point of intersection will be 0.0181 volt below the corresponding point of the association curve, drawn with $\log(S_B - S)$ as abscissa. Curves B and A show progressively greater departure from this relation, yet at the unique point in question $Z = 0.5$, so that, if a supplementary curve be plotted with $\log(S_B - 0.5S)$

as abscissa, the unique point falls on the supplementary curve very close to 0.0181 volt above the aforementioned intersection. We shall show that it is not always possible to report a reliable value for E'_0 . When deprived of this base line, one may use the obvious, alternative method shown in Figure 3; namely, to intersect the appropriate curve with a line parallel to the orienting diagonal and 0.0181 volt above. For the curves shown and on the scale used in Figure 3 it would be difficult to discern any difference along the upper part of the curves whether the abscissa were made $\log (S_B - S)$, $\log S_B$, or the $\log (S_B - 1.5 S)$ which is demanded for the location of the unique point where:

$$0.5 \log K_O = \log [B]$$

If necessary a drawing of larger scale may be used and the principle described for the finding of K_R applied to the estimation of K_O .

If at and near the center of an association curve K_O is much greater than $[B]^q$ and K_R is much less than $[B]^r$, the value of r will be determined by the maximal slope of the association curve, which is given by equation 50."

7.2.5. Interaction between Oxidation-Reduction Systems. Consider two systems A and B , represented at constant pH by the electrode equations:

$$E_{h_A} = E'_{0_A} - \frac{RT}{nF} \ln \frac{S_{R_A}}{S_{O_A}} \quad (51)$$

and:

$$E_{h_B} = E'_{0_B} - \frac{RT}{nF} \ln \frac{S_{R_B}}{S_{O_B}} \quad (52)$$

and let E'_{0_A} be more positive than E'_{0_B} . If solutions containing these separate systems are mixed, they will in general interact in a manner to make E_{h_A} equal to E_{h_B} . At equilibrium, by subtracting equations 51 and 52:

$$E'_{0_A} - E'_{0_B} = \frac{RT}{nF} \ln \frac{[S_{R_A}][S_{O_B}]}{[S_{O_A}][S_{R_B}]} \quad (53)$$

The direction of the interaction thus depends not only on the values of the characteristic potentials E'_0 of the two systems, but also on the initial ratios of oxidant to reductant. It is not to be expected that a system of higher characteristic potential will always oxidize one of lower. Under certain conditions of initial ratio of oxidant to reductant, the reverse will be the case, the same equilibrium point being reached from whichever side it is approached. This has sometimes been forgotten in biological work.

Under the conditions prevailing within the cell, it should also be remembered that there is frequently no true equilibrium between various oxidation-reduction systems (cf. Chapter VIII).

7.2.6. Electroactivity and Electroinactivity. In the foregoing discussion it has been tacitly assumed that when a bright platinum or gold electrode is inserted into a solution containing an oxidation-reduction system, a potential

difference will be set up between the electrode and the solution the value of which, in relation to a second standard electrode, may readily be measured. This is not always so.

It has been found that, while many systems do indeed behave in this simple manner, and are amenable to precise measurement, others give potentials which are quite unstable, and an intermediate group take long periods, perhaps hours, to reach stability. No satisfactory explanation has been given of this phenomenon of electroactivity, electroinactivity, and sluggishness. It is of considerable importance in biological work, since it may seriously restrict the range of oxidation-reduction potential investigations unless means can be found to overcome the difficulties.

Addition to an electroinactive or sluggish system of a second system which is electroactive and can in addition react readily with the first system frequently provides a means of stabilizing the potential and arriving at the required values for the system under investigation. Examples of this are found in the work of Taylor (2751-2753) on the sluggish hemoglobin-hemoglobin system, and in the discussion of Clark (450).

8. OTHER METHODS

A number of other physical methods have found wide application in the study of hematin compounds. Some are of very general applicability, such as osmotic pressure measurements, and x-ray studies of molecular size and shape. Others are methods commonly employed in protein chemistry, including electrophoresis, diffusion measurements, and ultracentrifugal sedimentation measurements.

These methods all yield information concerning the size, shape, or electric charge of the molecules or particles investigated. Their use in the present field involves little of difference from their application elsewhere. The reader is therefore referred for accounts of their basic theory and practical details to standard works on the various subjects (2,2721,3026).

CHAPTER III

PORPHYRIN CHEMISTRY

1. INTRODUCTION

1.1. Historical

“Iron-free hematin” was first mentioned by Scherer in 1841 (2440) and Mulder and van Goudoever in 1844 (2003). In 1871 Hoppe-Seyler (1337) obtained a purple pigment by the action of concentrated sulfuric acid on hemoglobin which he called hematoporphyrin; a similar product, “Dichromatinsäure,” resulted from the action of alkali on chlorophyll (1339). This was later recognized by Willstätter (3091) as a mixture of porphyrins. Porphyrin in pathologic urine was observed in 1874 by Baumstark (195).

The first pure product was hematoporphyrin hydrochloride, which Nencki and co-workers (2032–2034, 2036) obtained by treatment of hemin with hydrobromic acid in glacial acetic acid. Shortly afterward (1901) they isolated another porphyrin, mesoporphyrin, by treatment of hemin with hydriodic acid. Although Saillet (2414) had noted spectroscopic differences between the urinary porphyrin and hematoporphyrin, the prosthetic group of hemoglobin and also the porphyrin found in pathological urines by Salkowsky, Garrod, and Saillet (1891–1893) were prematurely identified with hematoporphyrin, and until very recent times were still thus described in most medicine and physiology textbooks (*cf.* 2).

Our knowledge of the variety of porphyrins was developed later, first by Willstätter's work on chlorophyll porphyrins, and then rapidly in the years after 1923 by the work of Fischer and Schumm

on the porphyrins in the animal body. Although Laidlaw had protoporphyrin in his hands as early as 1904 (1632), and Willstätter and Küster knew in 1912 that hemin contained vinyl side chains, while hematoporphyrins had hydroxylated ethyl side chains, a clear distinction between protoporphyrin and hematoporphyrin was only made after Schumm had demonstrated the spectroscopic and H. Fischer the chemical difference in the years 1923–1926. The same years saw the isolation of coproporphyrin, uroporphyrin, and deuteroporphyrin.

Work on the structure of the porphyrins began shortly before the beginning of the twentieth century. Nencki and Zaleski, Piloty, Knorr and Hess, Willstätter and Fischer studied the products of reductive decomposition (pyrrole bases and pyrrole carboxylic acids), while Küster investigated the oxidation products (hematinic acid, methylethylmaleimide). In 1913 the correct formula for the ring system of the porphyrins was suggested by Küster (1609). He assumed four pyrrole rings linked by four single carbon atoms to a sixteen-membered ring system. This formula was based on sound evidence and was stereochemically possible. At that time, however, multimembered ring systems were not yet known, and the conception was so bold that not even Willstätter was prepared to accept it. Willstätter assumed a tetrapyrrolethylene formula, while Fischer for many years defended a stereochemically unlikely formula with two eight-membered rings. By 1921 Küster had dropped his original formula, which was later proved correct by the painstaking research of Fischer and by his brilliant syntheses.

By 1929 Fischer and co-workers had found a complete synthesis of protoporphyrin and hemin and had synthesized a large number of other porphyrins. This work established not only the nature of the side chains, but also their position relative to each other, which is the basis of the isomerism of porphyrins. Hemin was recognized as a complex iron salt and chlorophyll as a complex magnesium salt by Willstätter. Laidlaw (1632) and Zaleski (3156) first reintroduced metals into porphyrins.

1.2. Occurrence of Porphyrins in Nature

In few species is porphyrin found in such large amounts that its color is readily perceptible to the naked eye or that the absorption can be examined with the spectroscope. The strong red fluorescence of porphyrins in ultraviolet light is a far more sensitive method of detection. By this it could be

shown that traces of porphyrins are widespread in both the animal and plant kingdoms, as well as in a variety of microorganism, such as yeast. The biochemistry of porphyrins in animals and microorganisms is discussed in detail in Chapters XII and XIII in connection with the catabolism and anabolism of hemoglobin and other hemoproteins. Plants have been investigated less systematically, but traces of coproporphyrin have been found by Fischer and co-workers in several plants and plant products, such as flour (*cf.* 861, pp. 398, 480).

In Table I we summarize instances in which porphyrins are found in the animal kingdom in unusually large amounts or under conditions under which no direct connection with hemoglobin metabolism is evident.

In some instances, *e.g.*, in the hen's egg shell, porphyrin is present as a calcium salt, in others, *e.g.*, in the colored spots on the egg shells of other birds as a protein compound. It is possible that porphyrins may be frequently in more or less firm combination with proteins.

2. STRUCTURE OF BIOLOGICALLY IMPORTANT PORPHYRINS

2.1. Definition and Side Chains of Various Porphyrins

The porphyrins are derivatives of the cyclic ring system porphin(e),* $C_{20}H_{14}N_4$ (Fig. 1), which contains four pyrrole-like rings welded together to a complicated ring system by four CH groups (methene

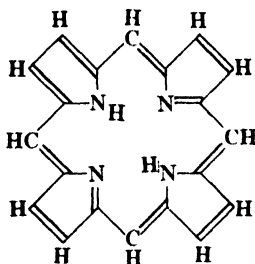

Fig. 1. Porphin.

groups). It contains a central sixteen-membered ring of twelve carbon and four nitrogen atoms condensed with four pyrrole rings. A fuller discussion of this structure will be found in Section 6.

* Dr. Patterson, Chairman of the American Committee on Organic Nomenclature, suggested using the name porphine because of its weakly basic properties, but to continue using porphyrin without the final *e*. This suggestion has been adopted by Rothmund, but not by H. Fischer. Etioporphyrin is, however, a base as well as porphin.

TABLE I
Occurrence of Porphyrins in Animals

| Animal | Species | Porphyrin | Tissue | Reference |
|---------------|-----------------------------------------------------------------------|------------------------------------------------------|----------------------------------------------------------------------------------------------------|---------------------------------------------------------|
| Mammals | <i>Sciurus niger</i> (fox squirrel) | Uroporphyrin | Normally in bones | Turner (2836) |
| | Man, cattle, pig | Uroporphyrin | Bones and teeth under pathological conditions (congenital porphyria) | Cf. Chapter XII |
| | Rodents (rat) | Protoporphyrin | Harderian glands | Derrien and Turchini (561) |
| | Hedgehog | Coproporphyrin | Spines | Cf. Chapter XII |
| Aves | Several species | Protoporphyrin | Brown pigmentation in dark hen's egg shells; black, red, brown spots on egg shells of many species | Derrien and Turchini (562) |
| | South African <i>Ovides</i> (<i>Lophotis, Lissotis</i>), owls | Coproporphyrin III | Feathers | Fischer and co-workers (844, 842, 847); Völker (2898) |
| | <i>Asio flammeus</i> (subarctic species) | Uroporphyrin | Bones | Derrien and Turchini (560, 562, 564-566); Völker (2896) |
| | Turaco | Uroporphyrin copper complex | Feathers | Derrien and Turchini (564) |
| Annelids | <i>Lumbricus</i> (earth worm) | Protoporphyrin(?) | Red streak | Fischer and Hilger (2928) |
| | <i>Pteria</i> (South American pearl mussel) | Uroporphyrin | Shell | Rimington (2263) |
| Coelenterates | Corals and sea anemones | Conchoporphyrin "Polyperythrin" Moseley (1992) | | Dhéré (571) |
| | | | | Fischer and co-workers (819, 835, 839, 8644) |
| | | | | MacMunn (1835) |

TABLE II
Porphyrins and Their Side Chains

| | | | | |
|------------------|----------------------|-------------------|-------------------------------|-----------------------------------------------------------------------------------------------------|
| Etioporphyrin | $C_{22}H_{24}N_4$ | 4 CH_3 (methyl) | 4 C_2H_5 (ethyl) | 4 M, 4 E |
| Mesoporphyrin | $C_{34}H_{44}O_4N_4$ | 4 CH_3 | 2 C_2H_5 (ethyl) | 2 $CH_2CH_2CO_2H$ (propionic acid) |
| Protoporphyrin | $C_{34}H_{36}O_4N_4$ | 4 CH_3 | 2 $CH = CH_2$ (vinyl) | 2 $CH_2CH_2CO_2H$ |
| Deuteroporphyrin | $C_{36}H_{36}O_4N_4$ | 4 CH_3 | 2 H | 2 $CH_2CH_2CO_2H$ |
| Hematoporphyrin | $C_{34}H_{38}O_4N_4$ | 4 CH_3 | 2 $CH(OH)CH_2$ (hydroxyethyl) | 2 $CH_2CH_2CO_2H$ |
| Coproporphyrin | $C_{38}H_{40}O_4N_4$ | 4 CH_3 | — | 4 $CH_2CH_2CO_2H$ |
| Uroporphyrin | $C_{40}H_{40}O_4N_4$ | — | — | $\left\{ \begin{array}{l} 4 CH_2CH_2CO_2H \\ 4 CH_3CO_2H \text{ (acetic acid)} \end{array} \right.$ |

The porphyrins differ structurally from porphin and from one another by various side chains which substitute the eight hydrogen atoms in the β -positions of the pyrrole rings in porphin. While porphin does not occur in nature and has been synthesized comparatively recently, some of the porphyrins are found free in many living species, while others are of importance as the metal-free components of hematin compounds.

Table II gives the names and formulas of the porphyrins which are of importance for the subject of this book, together with the side chains by which they are characterized and symbols which will be used for these side chains in later formulas in order to save space.

It will be seen that with the exception of uroporphyrin all other porphyrins carry four methyl side chains. Etioporphyrin (or more correctly "mesoetioporphyrin," *cf.* Section 3.2.) carries in addition four ethyl groups, but no acidic groups. The next four porphyrins are all closely related to protoporphyrin, the porphyrin from which hemoglobin and hemin are derived. They all carry two propionic acid groups in addition to the four methyl groups. The remaining two places are either unsubstituted (deuteroporphyrin) or substituted by nonacidic alkyl groups (ethyl in mesoporphyrin, vinyl in protoporphyrin and α -hydroxyethyl in hematoporphyrin). Coproporphyrin contains four methyl and four propionic acid side chains, uroporphyrin (probably) four acetic acid and four propionic acid side chains. Thus mesoporphyrin can be considered dicarboxylated, coproporphyrin tetracarboxylated, and uroporphyrin octacarboxylated etioporphyrin, while the other blood porphyrins are closely related to mesoporphyrin, from which they differ by having two side chains different from the two ethyl groups of mesoporphyrin.

The symbols for the side chains need little explanation. In the German literature "Ae" (Aethyl) is used for ethyl and "S" ("Säure") for the propionic acid side chain. AC will be used for the acetic acid side chain in order to differentiate it from acetyl (Ac).

The discussion of chlorophyll and the porphyrins derived from it is beyond the scope of this book. The main differences between chlorophyll derivatives and porphyrins, dihydroporphin system and isocyclic ring, have been discussed in Chapter I. Some of the porphyrins derived from chlorophyll, *e.g.*, pheoporphyrin a_5 and phylloerythrin still contain this isocyclic ring, others, such as phylloporphyrin, a remnant of it in the form of a methyl group substituting one of the methene groups between pyrroles, while others again, such

as rhodoporphyrin and pyrroporphyrin, resemble the blood porphyrins. Only the latter are given in Table III. It should be noted that the etioporphyrins derived from chlorophyll contain one ethyl group less than the mesoetioporphyrin derived from blood pigment.

TABLE III
Some Chlorophyll Porphyrins

| Porphyrin | Side chains |
|--------------------------------|---------------------------------------------|
| Rhodoporphyrin | 4 M, 2 E, 1 P, 1 CO ₂ H |
| Pseudoverdoporphyrin | 4 M, 1 E, 1 V, 1 P, 1 CO ₂ H |
| Pyrroporphyrin | 4 M, 2 E, 1 P, 1 H |
| Phylloporphyrin | 4 M, 2 E, 1 P, 1 H, (1 ≥ CCH ₃) |
| Pyrroetioporphyrin | 4 M, 3 E, 1 H. |
| Phylloetioporphyrin | 4 M, 3 E, 1 H, (1 ≥ CCH ₃) |

2.2. Nomenclature and Symbols

Some of the porphyrins mentioned in Table I have been named differently by other writers, notably Schumm, but these names have been superseded by the names given in Table I. Table IV supplies a list of such synonyms.

TABLE IV
Earlier Names for Porphyrins

| | |
|----------------------------|----------------------------------------------------------------------------------------------------------------|
| Protoporphyrin | Hematoporphyrinoidin (Schumm), Hematerinsäure (Küster), Snapper's porphyrin, Kämmerer's porphyrin, ooporphyrin |
| Deuteroporphyrin | Copratoporphyrin (Schumm) |
| (Deuterohematin) | Copratin |
| Coproporphyrin | Kotporphyrin, enteroporphyrin |
| Uroporphyrin | Urinporphyrin |

In medical literature, it is unfortunately still customary to speak of hematoporphyrinuria, instead of porphyrinuria. This dates back to the end of the last century when hematoporphyrin was the only porphyrin known (*cf.* above). We now know that it does not occur in nature, and that the porphyrins to be found in urine are coproporphyrin and uroporphyrin (*cf.* Chapter XII).

In order to save space, we have developed a simplified diagrammatic representation of the porphyrin nucleus. H. Fischer has introduced the symbol *A* (Fig. 2) for porphin which depicts the eight β -positions of the four pyrrole nuclei and thus allows satisfactory

indication of the nature and order of the side chains by replacing H with the appropriate symbols. Since this book is concerned a good deal with changes in the porphyrin nucleus, particularly the carbon

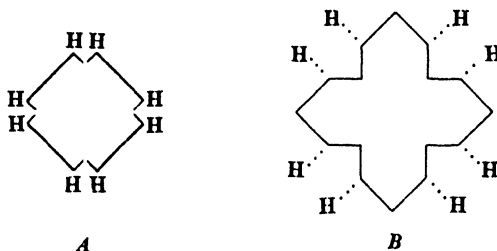

Fig. 2. Symbols.

atoms which unite the pyrrole rings, however, a different symbol will be used which allows changes in the nucleus as well as in the side chains to be depicted. The symbol *B* (Fig. 2) gives the central sixteen-membered ring in a way not deviating very far from its true shape, but omits the four pyrrole rings. The four corners of the cross pointing inward represent the four nitrogen atoms, the four corners pointing outward the methene bridges between pyrrole rings. The eight substituents in the β -position of the pyrrole rings are connected by dotted lines to the carbon atoms of the central ring, from which they are actually separated by the β -carbon atoms of the pyrrole rings. The formulas of the different porphyrins are given by inserting the symbols for the β -side chains (*cf.* Table II) in the appropriate positions.

2.3. Structural Isomerism

Of each of these porphyrins distinguished by the nature of their side chains, again several isomerides are possible, since the relative order of the side chains can also vary. The simplest case is that of the etio-, copro-, and uroporphyrins, in which only two different kinds of substituents occur, *e.g.*, methyl and ethyl in etioporphyrin. Here four isomerides are possible, which have been called I-IV by H. Fischer (Fig. 3).

Only compounds derived from I (alternating substitution) or III (unsymmetrical substitution) have been found in nature and it will be seen that those derived from III are far more important.

If three different types of side chains are present, as in the blood

porphyrins, the number of possible isomerides is increased to fifteen. The reader may work this out for himself or look up the handbook of Fischer and Orth (861, p. 409). It suffices to say that protopor-

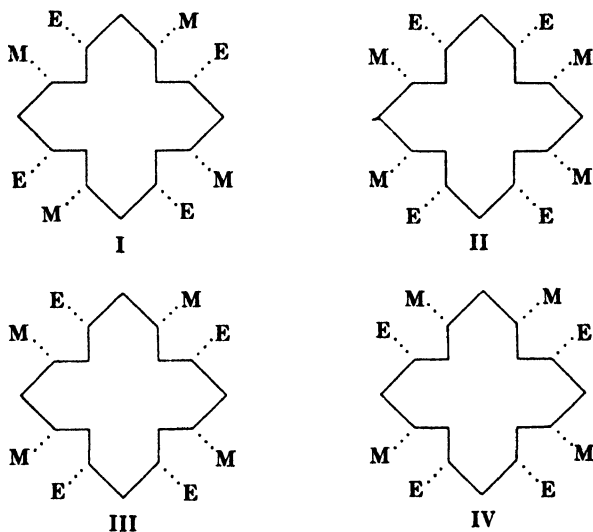

Fig. 3. Isomerides of etioporphyrin.

phyrin and the other porphyrins derived from hemoglobin and natural hematin compounds are all of type IX (Fig. 4). The evidence for the structure of the porphyrins is dealt with fully in Fischer's work (861)

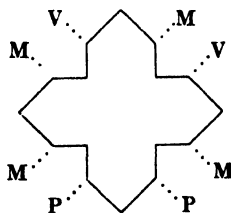

Fig. 4. Protoporphyrin.

and in a number of reviews, to which the reader is referred (603, 790-792, 794, 883, 1887, 2255, 3028). There are also a number of earlier reviews by Willstätter, Küster, Fischer, and Schumm (783, 786, 787, 789, 882, 1540, 1601, 2506, 3086, 3091).

2.4. Syntheses

By the masterly synthesis of an exceedingly large number of porphyrins Fischer and his school have satisfactorily proved the structure of the porphyrin nucleus, as well as the nature and arrangement of the side chains. These syntheses are fully described in Fischer's handbook, and we will outline here only one, the synthesis of hemin (861, p. 372). This synthesis established the structure of protoporphyrin, deuteroporphyrin, and hematoporphyrin as well as that of hemin (Fig. 5).

The structure and synthesis of the simpler pyrrole compounds, on which the hemin synthesis is based is found in the first volume of Fischer's handbook (861). At first simple pyrrole compounds are condensed to systems in which two pyrrolic rings are linked together by a methene (CH) group (pyrromethenes). For the synthesis of unsymmetrical porphyrins of type IX a symmetrically substituted pyrromethene and an unsymmetrically substituted pyrromethene are required. The latter (pyrromethene A) is obtained by condensation in alcoholic hydrobromic acid of a pyrrole α -aldehyde with a pyrrole containing an unsubstituted α -position (step 1 of Fig. 5). For the synthesis of the symmetrically substituted pyrromethene B a pyrrole with a methyl group in α -position is brominated to an α -bromomethylpyrrole; in boiling water this condenses to yield a symmetrically substituted dipyrrolymethane (step 2). The carbethoxyl group is saponified and the dipyrrolymethane α,α' -dicarboxylic acid is converted into pyrromethene B by bromination in acetic acid, two bromine atoms also replacing the carboxyl groups (step 3). The two pyrromethenes are condensed to deuteroporphyrin IX by heating in a succinic acid melt at 180–190° C. (step 4). The two vinyl groups are now introduced in the following way: deuteroporphyrin is converted into deuterohemin (step 5) and two acetyl groups are introduced by treating deuterohemin with acetic anhydride and stannic chloride (step 6). Diacetyldeuterohemin, on removal of iron, yields diacetyldeuteroporphyrin (step 7). The acetyl groups are then reduced to hydroxyethyl groups by boiling diacetyldeuteroporphyrin in alcoholic potassium hydroxide, hematoporphyrin thus being obtained (step 8). Finally the α -hydroxyethyl side chains are converted into vinyl groups by removing two molecules of water by heating in high vacuum in 25% hydrochloric acid (step 9). Protoporphyrin IX is finally transformed into hemin by introduction of iron in the presence of chloride.

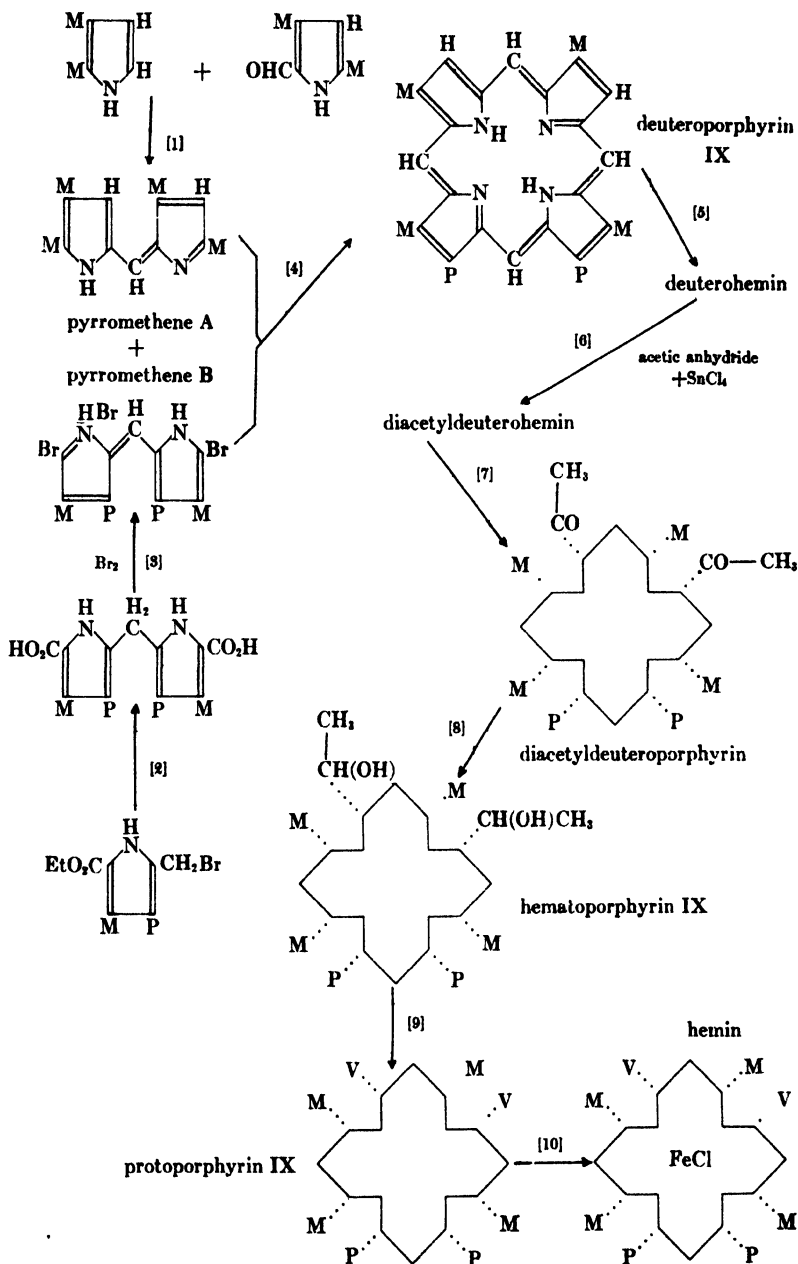

Fig. 5. Synthesis of hemin.

Corwin and co-workers have discovered a possible source of error in such syntheses (493-495). The condensation of a pyrrole α -aldehyde with an α -unsubstituted pyrrole often does not proceed as simply as indicated in step 1 of Figure 5. A tripyrrylmethane is formed first and this may afterward break down to symmetrical as well as to unsymmetrical pyrromethene:

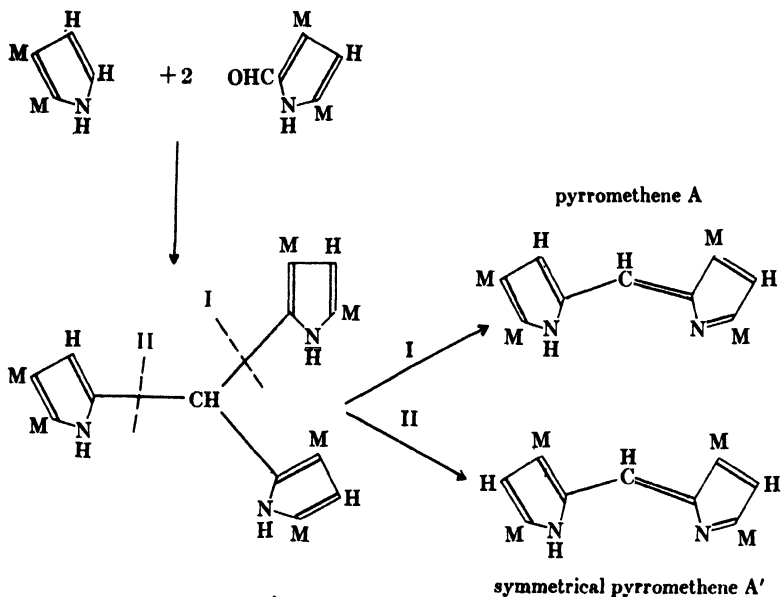

Fig. 6. Pyrromethene synthesis, according to Corwin *et al.* (493-495).

Corwin and Krieble (496) confirmed, however, the structure of pyrromethene A and of deuteroporphyrin IX in spite of some divergent findings on the melting point of pyrromethene A. A similar re-examination of the structure of coproporphyrin III, which is based on evidence of the same type, should be undertaken. Evidence on the unsymmetrical structure of natural bile pigments derived from hemoglobin had also strongly supported the unsymmetrical structure of hemin and the porphyrins derived from it (*cf.* Chapter IV).

3. INDIVIDUAL PORPHYRINS

3.1. Porphin, $C_{20}H_6N_4(H)_8$

Porphin was first prepared by Fischer and Gleim (818), by boiling pyrrole- α -aldehyde with formic acid and alcohol, later by Rothmund (2352, 2353) by condensation of pyrrole with formaldehyde. The

latter synthesis if carried out at 90–95° C. yielded a porphin with an absorption spectrum rather similar to that of Fischer's preparation, but not quite identical (*cf.* below). At 150° C. another "porphin" with different absorption spectrum and lower HCl number (*cf.* Section 6.3.) was obtained, which Rothmund considers to be an isomere. The existence of two isomeric porphins would be of considerable theoretical significance (*cf.* Section 6.3.) if it could be confirmed; the present evidence is unconvincing and the porphin of Rothmund is probably a mixture of porphin with other substances (*cf.* Pruckner, 2188; see also 125a).

3.2. Etioporphyrins

Willstätter believed that etioporphyrin was the noncarboxylated porphyrin of both hemin and chlorophyll. Fischer showed, however, that the chlorophyll–etioporphyrin was a mixture of two porphyrins, phylloetioporphyrin and pyrroetioporphyrin. The etioporphyrin from hemin has the constitution $C_{20}H_6N_4(CH_3)_4(C_2H_5)_4$. Pyrroetioporphyrin, $C_{20}H_6N_4(CH_3)_4(C_2H_5)_3H$, has one ethyl group less, and phylloetioporphyrin has the same side chain arrangement as this, but has one additional methyl group on one of the methene groups of the central ring (*cf.* Table III). Etioporphyrin should be called more correctly mesoetioporphyrin, since it arises by decarboxylation of mesoporphyrin, while protoporphyrin can be decarboxylated to a similar porphyrin with vinyl side chains, $C_{20}H_6N_4(CH_3)_4(C_2H_5)_2(C_2H_3)_2$. The properties of etioporphyrin III and its preparation by synthesis or by decarboxylation of mesoporphyrin IX and coproporphyrin III are described in Fischer's book (861, p. 199). Etioporphyrin, having no carboxyl groups, is an extremely weak acid with a pK of 16 (1808).

3.3. Porphyrins with Two Carboxylic Acid Groups

3.3.1. Mesoporphyrin IX. $C_{20}H_6N_4(CH_3)_4(C_2H_5)_2(CH_2CH_2CO_2H)_2$. This substance was first prepared by Nencki (2036) by mild treatment of hemin with hydriodic acid and phosphonium iodide. The iron is removed and the vinyl groups of protoporphyrin are hydrogenated to ethyl groups. Instead of phosphonium iodide, sodium sulfite can be used for the removal of excess iodine (2652). Good yields (60%) are obtained if protoporphyrin is reduced by hydriodic acid in acetic acid in the presence of ascorbic acid (2478,1058).

Mesoporphyrin dimethyl ester is obtained in 60% yield, if hemin is heated with hydrazine hydrate in pyridine and the mixture is then heated with methyl alcoholic hydrogen chloride. Mesohemin can be prepared from hemin in a similar way with still better yield (817). Finally formic acid and colloidal palladium can be used for the preparation of mesoporphyrin from hemin (535,867,2749).* The melting point of the dimethyl ester is 216° C. The sodium salt of mesoporphyrin is insoluble in aqueous alkali and this property is used for the purification. Mesoporphyrin IX occurs naturally in human feces (3170).

3.3.2. Protoporphyrin IX. $C_{20}H_{16}N_4(CH_3)_4(C_2H_5)_2(CH_2CH_2CO_2H)_2$. Hoppe-Seyler recognized that reduced hemoglobin yielded porphyrin much more readily on treatment with acids than oxyhemoglobin. While Laidlaw (1632) prepared protoporphyrin from blood after bacterial reduction, but failed to recognize the difference of this porphyrin from hematoporphyrin, it was not until Schumm and his co-workers (2098,2100,2493,2496) had carried out their spectroscopic investigation that the difference between these two compounds was recognized. Meanwhile porphyrins differing in a similar way from hematoporphyrin were found in the intestine in occult gastrointestinal hemorrhage (Snapper's porphyrin) (2583), in putrefying blood (Kämmerer's porphyrin) (840,1448,1449) and in birds' egg shells (ooporphyrin) (841,842). Following Fischer and Schneller's crystallization of Kämmerer's porphyrin (875), Fischer established their identity and renamed the porphyrin protoporphyrin (847) on account of its close relationship to hemoglobin.

For the preparation of protoporphyrin it is essential to avoid the attack of strong acids or strongly reducing substances on the vinyl side chains. Several workers (867,1232,1763,2102) have made use of the easier removal of iron from reduced hemoglobin by acids for the purpose of preparing protoporphyrin, the most recent modification being that of Grinstein and Watson (1057). By similar methods the iron can be removed from pyridine hemochromogen (867,1121,2104). Other methods of preparation include the action of formic acid and iron powder on hemin (866) and the action of stannous chloride on hematin prepared from blood with oxalic acid in acetone (1121). A good method is the reduction of hematin in acid solution by sodium amalgam (Schumm, 2496,2502).

The crude porphyrin is purified by crystallization from pyridine-petroleum ether (1057,1115,1121), by chromatography of the dimethyl ester solution in chloroform-petroleum ether on alumina or calcium carbonate (1057), or

*Also from protoporphyrin (495a).

by precipitation of the insoluble potassium salt and crystallization from formic acid-methyl alcohol (1122). Protoporphyrin crystallizes in several forms (2247), but this is due to the presence of impurities in some preparations (885,1121).

Protoporphyrin in solution is rather unstable, particularly if exposed to light. From solutions in dilute hydrochloric acid, it is extracted with chloroform. Potassium and sodium salts are only slightly soluble. The melting point of its dimethyl ester was found to lie between 225 and 230° C.

3.3.3. Deuteroporphyrin IX. $C_{20}H_6N_4(CH_3)_4(H)_2(CH_2CH_2CO_2H)_2$. Deuteroporphyrin was first observed by Schumm (2497,2501,2504,2510) in feces after hemorrhage into the gastrointestinal tract or after ingestion of a diet containing blood. Schumm found it to differ from coproporphyrin and called it copratoporphyrin, but Fischer's name deuteroporphyrin was later generally accepted. It is also found in putrefying meat and in blood after prolonged alkaline putrefaction (851). By heating hemin in resorcinol, the two vinyl groups are removed and the deuterohemin thus formed can be readily converted to deuteroporphyrin (837,2505). In contradistinction to coproporphyrins, deuteroporphyrin is extracted by chloroform from its solution in 0.2% hydrochloric acid; it forms an insoluble sodium salt. The melting point of its dimethyl ester is 224° (496). Its synthesis and transformation into hemin has been described in Section 2.

3.3.4. Hematoporphyrin IX. $C_{20}H_6N_4(CH_3)_4(CHOHCH_3)_2(CH_2CH_2CO_2H)_2$. Although probably not of biological importance, hematoporphyrin has played an important historical role (compare Section 1). It is formed from hemin by the action of hydrobromic acid in glacial acetic acid (2032-2034). In this process as well as during the action of concentrated sulfuric acid on hemoglobin or hemin (Hoppe-Seyler), one molecule of water is added to each of the two vinyl groups, transforming them into α -hydroxyethyl groups $-CH(OH)CH_3$. Since two optically active centers are created by this reaction, hematoporphyrin may be a mixture of diastereoisomeric forms. Its synthesis from deuteroporphyrin IX and transformation into protoporphyrin and hemin have been described in Section 2.4.

The occurrence of hematoporphyrin in nature has so far not been established; it is not impossible, however, that hematoporphyrin or similar por-

phyrins may be present in insufficiently purified coproporphyrin and deuteroporphyrin fractions. Some of the "pseudodeuteroporphyrins" of Watson (2424,2986) may perhaps contain a porphyrin with one vinyl and one hydroxyethyl side chain, *e.g.*, that found in the bile after perfusion of rabbit liver with protoporphyrin (2424). An increase of "coproporphyrin" has been found in the excreta after meat diet, and a "deuteroporphyrin" has been observed in the feces of rabbits after lead and sulfonal poisoning (*cf.* Chapter XII and 829,849). These need further investigation.

Hematoporphyrin forms a more easily soluble sodium salt than other porphyrins with two propionic acid side chains. Its dimethyl ester melts at 212°. The dimethyl ether dimethyl ester (tetramethyl-hematoporphyrin) can be readily obtained in large crystals, but occurs in several modifications with four different melting points (861, p. 425; 1292). It is not yet clear whether these are due to polymorphism only, or whether diastereoisomerism plays a rôle.

The oxidation of tetramethylhematoporphyrin to α -methoxyethylmethylmaleimide (Fig. 7), with a yield of two molecules of this sub-

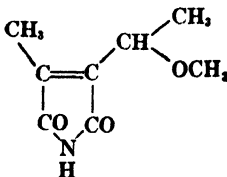

Fig. 7. α -Methoxyethylmethylmaleimide

stance from one molecule of the porphyrin (884), was of significance since it finally disproved the earlier formulation of hematoporphyrin with one hydroxyethyl and one hydroxyvinyl side chain and the formulation of hemin with one vinyl and one acetylene side chain.

3.3.5. Porphyrins with Carbonyl Groups in Side Chains.

Diacetyldeuteroporphyrin has been mentioned as an intermediate product in the synthesis of hemin. Porphyrins containing acetyl side chains may arise by oxidation of the vinyl group to the acetyl group. Thus the "cryptoporphyrin" of Negelein (2021,2022), later recognized as a product of photooxidation of protoporphyrin in acid solution, may be a monoacetylmonovinyl porphyrin. Such porphyrins are of particular interest since the spectroscopic properties of their hematin compounds resemble those of Warburg's respiratory enzyme and of the cytochromes a (*cf.* Chapter VIII). The same holds for porphyrins with formyl (CHO) instead of acetyl side chains.

One of these porphyrins, the *spirographis porphyrin*, was isolated by Fox from chlorocruorin, a hemoglobin-like blood pigment of some polychete worms and snails (931,932). Its structure was investigated by Warburg (2927,2954,2957) and finally cleared up by Fischer and Seemann (880) as $C_{20}H_6N_4(CH_3)_4(C_2H_5)(CHO)(CH_2CH_2CO_2H)_2$ (Fig. 8).

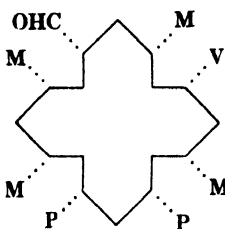

Fig. 8. Spirographis porphyrin.

In the resorcinol melt spirographis hemin is transformed into deuterohemin IX, both the vinyl and formyl groups being removed. This shows that it belongs to the isomeride type of the blood porphyrins. Spirographis porphyrin has also been synthesized (888) and has been obtained from protoporphyrin by oxidation with osmium tetroxide (806a).

To the formyl-substituted porphyrins belong also porphyrins derived from chlorophyll b, which have the formyl group in place of one of the methyl groups.

The simplest method of identifying the presence of a porphyrin containing =CO groups is the observation of the spectroscopic changes which take place after the compound has been condensed with hydroxylamine or a similar reagent (cf. Chapter VII).

3.4. Porphyrins with Four and More Carboxylic Acid Groups.

3.4.1. Coproporphyrins. $C_{20}H_6N_4(CH_3)_4(CH_2CH_2CO_2H)_4$. Of the four possible isomerides two, coproporphyrin I and coproporphyrin III (Fig. 9) are of special importance. The syntheses of these porphyrins were carried out by Fischer (801,827,862, cf. also 2872). Coproporphyrin I was first found in feces, later in urine (780-782). Coproporphyrin III was first isolated by van den Bergh and collaborators (235) from the urine of a patient with chronic porphyria. The alkali salts of coproporphyrins are easily soluble in water.

Identification of coproporphyrin isomers. For the tetramethyl ester of coproporphyrin I melting points of 248–258° C. are given in the literature. The tetramethyl ester of coproporphyrin III melts remarkably lower and

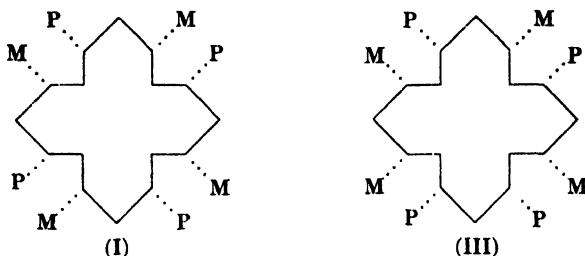

Fig. 9. Coproporphyrins I and III.

its identification is complicated by the fact that it has a “double melting point,” *i.e.*, it coalesces at least partially at temperatures variously reported as 130–153°, resolidifies, and melts again at 150–179° C. Jope and O’Brien have recently studied the melting points of the esters carefully and give a melting points composition curve (1426) (Fig. 10).

From Figure 10 it is evident that melting point determinations do not permit one to detect less than 10% coproporphyrin III in coproporphyrin I unless the resolidification point is also taken, and likewise allow up to 15% coproporphyrin I in coproporphyrin III to escape detection. The melting points of the copper complex salts of the esters (1914, 2896) may give more reliable results — for I, 284°, and for III, 206°; the melting point given by Fischer (861, p. 491) is too low. It is also noteworthy that the melting point of synthetic coproporphyrin III does not tally entirely with that of coproporphyrin III ester from natural material. The synthetic ester evidently shows the primary melting point less well, but melts at a temperature well below that of the second melting point of the natural ester (158–162° as compared with 173–179°) (1426; *cf.* also 801, 827, 862).

The identification of a porphyrin as coproporphyrin III merely on the basis of the melting point of its methyl ester is therefore quite inadequate. It is possible, *e.g.*, that admixture of other porphyrins to coproporphyrin I may considerably depress the melting point of its ester and thus lead to a wrong identification with coproporphyrin III. Whenever possible microanalyses should be carried out, the uniformity of the porphyrin ester should be demonstrated by chromatography, and melting points of its metal complex salts should be studied.

The separation of the coproporphyrin I and III tetramethyl esters is usually effected by recrystallization from methyl alcohol in which the type I ester is much less soluble. From this one would expect the type III ester remaining in the mother liquors to contain a little type I ester; ether has also been used for this separation (2271). A separation by chromatography on alumina with elution of the type III ester by 35% aqueous acetone has been claimed (2999), but could not be confirmed (1426). The esters can be

distinguished by their fluorescence *pH* curves in the *pH* range 2-6, but this method is only applicable to pure preparations (773). Schwartz and co-workers (2512) have recently observed that coproporphyrin I and III

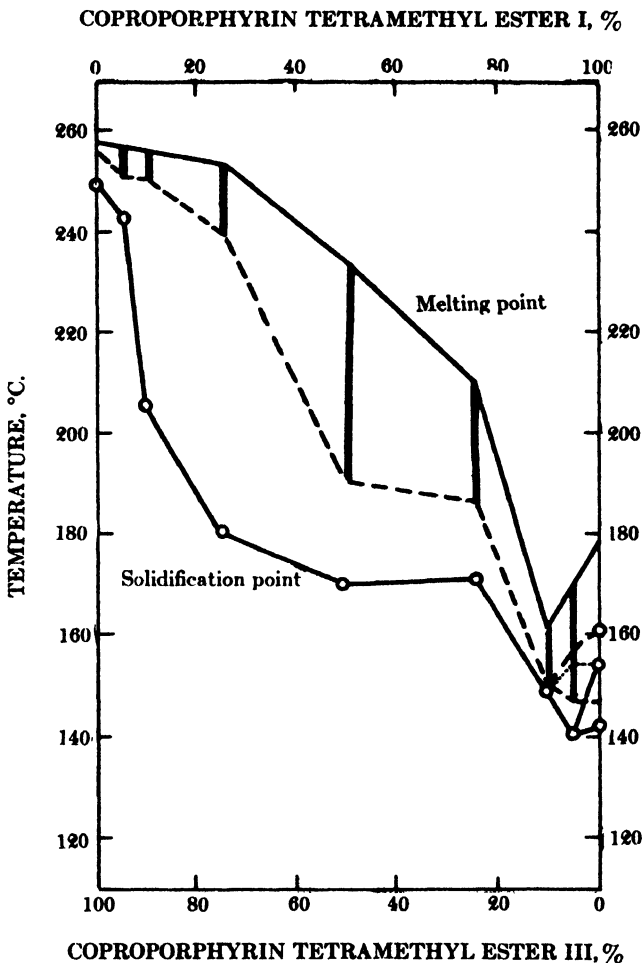

Fig. 10. Melting point-composition curve for the tetramethyl esters of coproporphyrins I and III (after Jope and O'Brien, 1426): temperature at which softening and loss of double refractions begins on heating (---); lower melting point characteristic of coproporphyrin III tetramethyl ester (...); melting point (—); solidification point (o—o).

esters can be differentiated by the quenching of the fluorescence of type I ester in 30% acetone in water, when the concentration of the porphyrins was between 25 and 70 μg . per 100 ml.

3.4.2. Uroporphyrins, $C_{20}H_4N_4(CH_2CO_2H)_4(CH_2CH_2CO_2H)_4$. In contradistinction to the porphyrins described so far, uroporphyrins are ether-insoluble substances. Uroporphyrin I was discovered by Fischer in the urine of a patient with chronic porphyria (see 779). It also occurs in the shells of the Pteria mussel (see 819,835, and 2641). Its structure has so far been determined by exclusion of other possibilities rather than by direct proof or synthesis. On decarboxylation (heating in oil bath or in 1% hydrochloric acid under pressure at 180° C.) coproporphyrin I is obtained, though in rather small yield. This proved uroporphyrin to be a tetracarboxylated coproporphyrin.

At first it was assumed that uroporphyrin contained methyl and methylmalonic acid, $CH_2CH(CO_2H)_2$, side chains. Later it was found, however, that natural uroporphyrin I was neither identical with the synthetic isuroporphyrin I containing these side chains, nor with the corresponding synthetic porphyrin with methyl and succinic acid, $CH(CO_2H)CH_2CO_2H$, side chains. Both gave oxidation products (hematinic acids) and octamethyl esters differing from those obtained from natural uroporphyrin I, in contrast to earlier findings (cf. 825); the absorption spectrum of isuroporphyrin was also not identical with that of uroporphyrin (681, p. 508 ff.). The porphyrin with four succinic acid side chains has four active carbon atoms, and a porphyrin of this structure would be expected to be found in nature in optically active form; natural uroporphyrin is, however, optically inactive. The only alternative is the placing of the four extra carboxylic acid groups on the four methyl groups of coproporphyrin. Pyrroleacetic acids are in fact remarkably easily decarboxylated (835), and it was shown that a synthetic porphyrin with four CH_2CO_2H groups and four methyl groups was decarboxylated under the conditions under which uroporphyrin is transformed to coproporphyrin (855). Hence uroporphyrin I is very probably formula I of Figure 11. The melting point of its octamethyl ester was found by various authors as 284–291° C. Fischer gives 302° (cor. 311° C.), while Watson and collaborators (1056) find the melting point of the ester purified by chromatography to be 284°; these authors ascribe higher melting points to admixture of complex salts or of products of partial saponification.

“*Uroporphyrin III (?)*” was isolated by Waldenström (2905,2906, 2908,2910) from the urine of patients with acute porphyria (cf. Chapter XII, Section 4.3.4.). It is not extractable with ether, but can be extracted with ethyl acetate from solutions in dilute acetic

acid (pH 3.5). On decarboxylation Waldenström obtained coproporphyrin III. The octamethyl ester of uroporphyrin III melts at about $255-260^\circ$. Spectroscopically there is no difference between uroporphyrins I and III, but the fluorescence minimum of uroporphyrin III lies at pH 3.1 to 3.2, while that of uroporphyrin I is at pH 2.9 to 3.0 (2910). In this respect uroporphyrin III differs from uroporphyrin I in the same manner as coproporphyrin III from coproporphyrin I (*cf.* 861, p. 596). Recently experiments of Watson and collaborators (1056,3002, *cf.* also 2193) have thrown some doubt on the existence of uroporphyrin III as an entity.

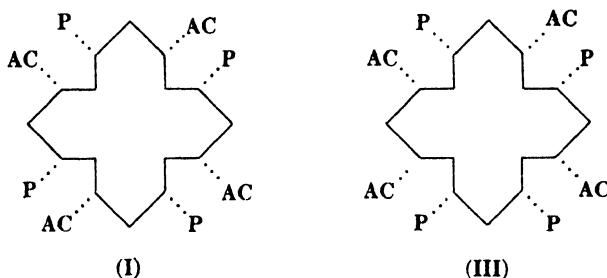

Fig. 11. Uroporphyrins I and III.

Their results are, however, confusing. In their first paper they report fractionation by chromatographic analysis of esters corresponding in their behavior to uroporphyrin III ester. One fraction had the melting point of uroporphyrin I (284°), and a second, a melting point of 208° . The latter, which according to analytical results was the ester of a heptacarboxylic rather than of an octacarboxylic acid, yielded coproporphyrin III on decarboxylation. Sometimes they were able to isolate this ester and sometimes they obtained only the ester of uroporphyrin I from the feces of their porphyria patients. In their second paper, however, they describe a Waldenström ester which could not be fractionated by chromatography but which on decarboxylation yielded even more coproporphyrin I and less coproporphyrin III than their fractionable esters. They assume that both kinds of Waldenström ester were mixtures of uroporphyrin I with a heptacarboxylic ester of type III, and that in the nonfractionable preparation the amount of the latter was so small that it migrated on the column together with uroporphyrin I ester. This assumption is not convincing.

It should be pointed out, however, that Waldenström's own observations contain a contradiction. Waldenström (2911) found that uroporphyrin III is not present as such in the urine, but arises by action of acid on a dipyrrolic colorless precursor (porphobilinogen). While the former is certainly often not correct (a uroporphyrin occurs in acute porphyria in the body as such; *cf.* Watson and co-workers, 1056,3002, and Prunty, 2193), there can be no

doubt that acid causes a large increase of the porphyrin concentration in the shed urine. The porphyrin formed in this way can hardly be uniform uroporphyrin III, if Waldenström's assumption that it is formed from porphobilinogen is correct. Two dipyrrolic precursors would be needed to yield uroporphyrin III, and their autocondensation would lead to the formation of other isomeric uroporphyrins.

It is also remarkable that Fischer found turacin to be the copper complex salt of uroporphyrin I, while Rimington (2263) obtained coproporphyrin III by the decarboxylation of the uroporphyrin from turacin. Before more reliable methods of identifying the isomers of copro- and uroporphyrin are worked out, it would appear wise to draw conclusions from these identifications only with caution (*cf.* Chapter XII).

3.4.3. Porphyrins with Five to Seven Carboxylic Acid Groups. The evidence for a heptacarboxylic acid in "uroporphyrin III" has just been discussed. The conchoporphyrin of the Pteria shell was found to be a pentacarboxylic acid (839), yielding coproporphyrin I on decarboxylation; melting point of the ester is 271–273°. It is possible that some other porphyrins encountered in human excretions (599,894) belong to this class of porphyrins between coproporphyrins and uroporphyrins. Pentacarboxylic acids have also been observed as decarboxylation products of uroporphyrins (1056).

4. ASPECTS OF THE PHYSICAL CHEMISTRY

4.1. Solubility and Acid-Base Character

Porphyrins are amphoteric compounds with isoelectric points or zones at about *pH* 3 to 4.5; their acid character depends on the carboxyl groups in their side chains and is therefore lacking in the etioporphyrins; their character as weak bases depends on the presence of two tertiary nitrogens in the pyrroline nuclei. Zwitterions play no role. Porphyrins are therefore easily flocculated and practically insoluble in dilute acetic acid.

The partition of porphyrins between water and organic solvents, particularly ether, depends on the nature of the side chains and on the *pH*. The large plate of the porphin ring confers upon the molecule a hydrophobic character which is counteracted by the hydrophilic carboxylic acid groups in the side chains, particularly under conditions under which they carry electric charges (as in alkaline solution). Porphyrins without acidic side chains can be extracted from ether only by strong mineral acids, which form dihydrochlorides. Porphyrins with two to four carboxylic acid side chains pass from the aqueous phase into ether at a *pH* of 3–4, at which their ionizable groups carry no charges; they are extracted from ether by mineral

acid as hydrochlorides and by alkali as carboxylic acid salts. Porphin octacarboxylic acids (uroporphyrins) cannot be extracted by ether, unless their carboxylic acid groups are esterified.

The extraction of porphyrins from ether by strong acids is a property of great importance for their purification. Willstätter found that different porphyrins require hydrochloric acid of different concentration for extraction from ether and defined the HCl number as the concentration of hydrochloric acid in per cent which from an equal volume of ether solution of a porphyrin extracts two-thirds of the porphyrin (3088). Less frequently used is the distribution number ("Verteilungszahl"), which is the percentage of porphyrin extracted by 100 ml. hydrochloric acid of stated concentration from one liter of ether solution containing 3 mg. of porphyrin (*cf.* 1523a).

The HCl number depends not only on the dissociation constant of the porphyrin as base, but also on the distribution coefficients of free porphyrin and its hydrochloride in water and organic solvent (3170). Hence the esters, which are certainly not weaker bases than the free porphyrins, have a higher HCl number, and porphyrins with hydrophilic side chains (*e.g.*, coproporphyrin with four carboxylic acid groups and hematoporphyrin with two alcoholic groups in addition to two carboxylic acid groups) have a low HCl number. The *pK* of the basic groups of porphyrins cannot be measured in water on account of the insolubility of the free porphyrins; however, by titration with perchloric acid in glacial acetic acid solution Conant (474) found two basic groups of *pK* 2.5 in etioporphyrin and mesoporphyrin.

The HCl numbers of some of the most important porphyrins are collected in Table V. The "pH number" corresponds on the alkaline

TABLE V
HCl Numbers of Some Porphyrins

| Porphyrin | HCl numbers | |
|------------------|------------------------------------|--------------|
| | Free porphyrin | Methyl ester |
| Porphin | 1.7 (Fischer), 3.3 (Rothenmund) | — |
| Isoporphin | 0.5 | — |
| Protoporphyrin | 2-3 | 5.5 |
| Mesoporphyrin | 0.5 | 2.5 |
| Deuteroporphyrin | 0.3 to 0.4 | 2.0 |
| Hematoporphyrin | 0.1 | — |
| Coproporphyrin | 0.08 | 1.5 |
| Uroporphyrin | — | ca. 7.0 |

side to the "HCl number" on the acid side (2827). It is defined as the *pH* of a buffer solution which extracts half the porphyrin from

four volumes of its ether solution; this value has so far not been used extensively.

The carboxyl groups of porphyrins are easily esterified. Refluxing for 30 minutes in 1% methyl alcoholic hydrochloric acid or keeping at room temperature in methyl alcohol saturated with hydrochloride gas transforms them into the methyl esters, which can be taken up in chloroform, washed with sodium carbonate solution, and recrystallized from a chloroform–methyl alcohol mixture. Both free porphyrins and esters are slightly soluble in alcohols. The crystals of porphyrins and their esters have a violet metallic surface color. The esters can be saponified by the action of methyl alcoholic potassium hydroxide at room temperature.

4.2. Adsorption and Surface Properties

The porphyrin ring forms a large planar plate (*cf.* Section 6) of predominantly hydrophobic character. In the porphyrins with two propionic acid side chains of type IX (*e.g.*, protoporphyrin) the adjacent carboxylic acid groups confer hydrophilic character only to one edge of the essentially planar molecule (Fig. 12).

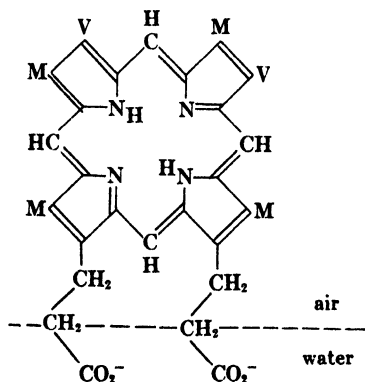

Fig. 12. Surface activity of protoporphyrin and hematin.

On a water surface protoporphyrin^{*} (and also hematin) thus forms monolayers of somewhat unstable condensed solid films with molecules vertically orientated and closely packed, in which the two carboxyl groups are turned toward the water, the two vinyl groups toward the air. The cohesion between the molecules themselves is

greater than the adhesion to water. The area of one molecule is 70 \AA^2 closely agreeing with the area for molecules, if vertically close-packed (68 \AA^2), while placed horizontally on the surface it would require about 125 \AA^2 . Presence or absence of metal in complex combination has little effect on the surface properties except that hematin films are more homogeneous and collapse less easily. The side chains, however, are of decisive importance. The surface activity increases with increasing pH owing to the ionization of the carboxyl groups. Hematoporphyrin, which instead of the vinyl groups has hydrophilic hydroxyethyl groups, lies flat on the water surface and forms vapor-expanded films compressible to liquid films (Alexander, 38).

If alkaline solutions of protoporphyrin and hematin are injected under monolayers of a variety of proteins, they penetrate rapidly into them (faster at pH 8.2 than at pH 7.2) and transform the protein films into rigid monolayers (tanning), increasing the surface pressure and decreasing the surface potential. The less surface-active coproporphyrin is not bound to protein monolayers. The porphyrins were also shown to penetrate into monolayers of cholesterol and octadecylamine. While the penetration into cholesterol is largely influenced by interaction with the hydrophobic part of the porphyrin molecule, the interaction with octadecylamine films resembles that with protein. This makes it likely that the interaction is between the carboxylic acid groups of porphyrin and the amino groups of protein. One has to bear in mind that, in the "denatured protein" of the monolayer, amino groups which in the native protein may not be available due to interaction with the protein's own carboxylic acid groups may be free and immersed in the substrate. In the case of serum albumin, cataphoresis experiments have shown that the linkage with protoporphyrin also occurs in solution (Stenhagen and Rideal 2622).

These experiments of Alexander and of Stenhagen and Rideal are of importance for the problem of the combination of porphyrins and porphyrin metal complexes with proteins, which will be discussed in Chapter VI (Sections 3.3.3. and 3.3.4.) in connection with the problem of the linkage of hematin to proteins. They clearly demonstrate the specific importance of the nature and of the position of the side chains. The different behavior of coproporphyrin toward protein monolayers may explain, *e.g.*, why coproporphyrin is found in nature only as iron-free porphyrin, while *in vitro* it forms hematin compounds as readily as protoporphyrin.

4.3. Light Absorption

The absorption spectra of porphyrins are so characteristic that they are of fundamental importance for the recognition of porphyrins,

for their estimation, and for the differentiation of some porphyrins from one another. The bands are sharp and thus the position of the maxima can be readily established, particularly with the Hartridge Reversion Spectroscope.

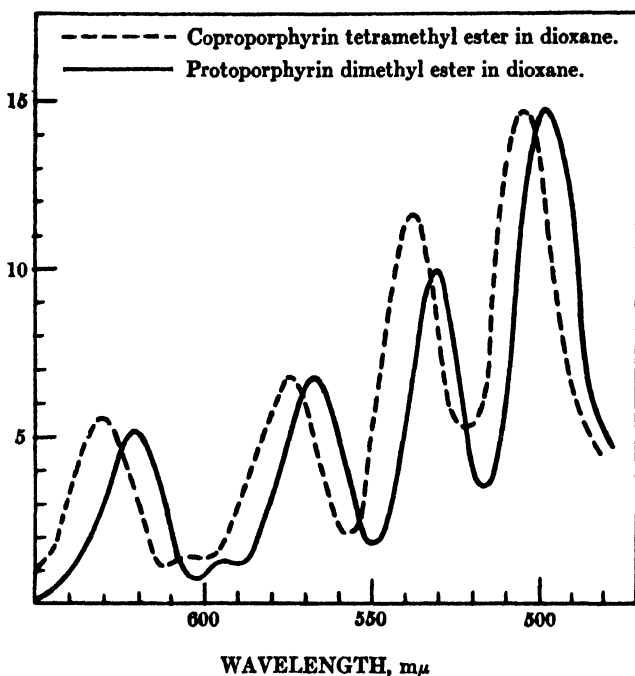

Fig. 13. Absorption curves of porphyrin esters in dioxane (after Stern and Wenderlein, 2640).

Porphyrins dissolved in organic solvents have a typical four-banded absorption spectrum in the visible region, although a number of finer bands can be observed in addition to the four main bands. The strength of the main bands increases toward shorter wavelengths. In addition there is a still stronger band at about 400 mμ, which was first observed by Soret in hemoglobin and found by Gamgee (979) in porphyrins. It is usually called the Soret band. The visible absorption curve of coproporphyrin tetramethyl ester in dioxane is given in Figure 13. The absorption spectra of porphyrins dissolved in dilute alkali are similar to this "neutral spectrum"; the carboxyl groups of the propionic acid side chains are separated from the

chromogenic nucleus by aliphatic chains, and anion formation exerts therefore only a small influence on light absorption in the visible part of the spectrum (*cf.* Tables VI and VII). The absorption bands are, however, somewhat altered in position and are less sharp. Par-

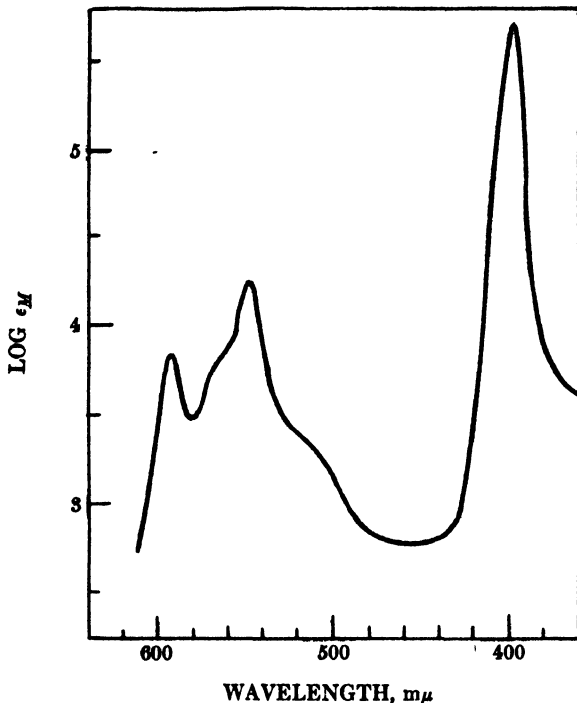

Fig. 14. Absorption spectrum of coproporphyrin tetramethyl ester in 0.15 *N* hydrochloric acid (after Jope and O'Brien, 1426).

ticularly the band in the ultraviolet is shifted 20–30 mμ toward shorter wavelengths and is greatly decreased in strength (1310,1426). These phenomena are interpreted as being due to an aggregation or polymerization of porphyrin molecules and are also observed with porphyrin metal compounds such as hematin. They will therefore be discussed further in Chapters V and VI.

In contradistinction to anion formation, the formation of porphyrin cations occurring on the nitrogen atoms of the porphyrin system has a more profound influence on the absorption curve. In the spectroscopy the "acid porphyrin spectrum" shows only two distinct absorption bands with a very weak third band between them.

TABLE VI
Absorption Spectra in $m\mu$ of Porphyrins and Their Esters^a

| Porphyrin | Solvent ^b | I | Ia | II | III | IV | Soret | Ref. |
|-----------------------|-----------------------------------------------|----------------|------------------------------------|-------------|--------------|------------|-------|-------------------------|
| Porphin | Dioxane | 613 | (602) | 560.5 | 517.5 | 487 | | 2612, 2643 ^c |
| Deuteroporphyrin | Ether-acetic acid | 621.5 | (595.5) (577) | 566 | 526 | 494 | | 861 |
| Mesoporphyrin | Ether-acetic acid Pyridine | 623.5 (612.5) | (596.5) (578.5) | 567.5 (559) | 528.5 | 494.5 | 591 | 310 |
| Coproporphyrin | Ether-acetic acid Chloroform Chloroform | 623.5 622.5 | (597.5) (577.5) (596.3) (577.5) | 568 568 | 528.5 533 | 495 499 | 405 | 2053 1515 954 |
| Uroporphyrin Ester | Chloroform Chloroform | 626 | (599) | 570.5 | 536 | 501 | 408 | 954 |
| Protoporphyrin | Ether-acetic acid Pyridine | 632.5 | (604) (585) | 576 | 537 | 502 | 595 | 310 |

^a The absorption spectra of esters do not differ from those of the free porphyrins in the same solvent.

^b In pyridine the position of the maxima I and II is the same as in ether-acetic acid, while maxima III and IV are shifted about 5 $m\mu$ toward longer waves. In chloroform the maxima III and IV are similarly shifted toward longer wavelengths, while the maxima I and II are slightly (ca. 1 $m\mu$) shifted toward shorter wavelengths.

^c Cf. also (818, 2352, 1555, 1556); it is doubtful, however, whether the porphin of Rothemund was a uniform substance, cf. Pruckner (2188).

The spectrophotometer (Figs. 13 and 14), however, reveals a fourth very weak band in the blue-green and a high Soret band. The whole spectrum in the visible is compressed; band 1 and particularly band 3 are increased, but band 2 and 4 are greatly diminished in intensity. This interpretation

TABLE VII
Absorption Spectra^a of Porphyrins in 0.1 N Potassium Hydroxide

| Porphyrin | Position of bands, $m\mu$ | | | |
|------------------|---------------------------|-------|-------|------------|
| Deuteroporphyrin | 611.5 | 559.5 | 535.5 | Indistinct |
| Mesoporphyrin | 618 | 567.5 | 538.5 | 502 |
| Coproporphyrin | 617.5 | 565.5 | 538.5 | 503 |
| Uroporphyrin | 612 | 560.5 | 539 | 504 |
| Protoporphyrin | 642 | 591 | 540 | Indistinct |

^a According to Schumm (2506).

differs from that of A. Stern, who assumed a correlation between the weak absorption band 1a, lying between bands 1 and 2 of the neutral spectrum and the first absorption band of similar position of the porphyrin spectra in hydrochloric acid. It is, however, in agreement with the observations of Pruckner (2188), who found that increase of the symmetry of the molecule increased the absorption bands 1 and 3. The transformation of a porphyrin into a cation or metal complex increases the symmetry of the molecule (*cf.* Section 6).

The absorption spectra of the porphyrins are described in detail in many publications (36,130,861,1085,1213,2053,2189,2506,2641-2643), the ultraviolet absorption is described particularly in some papers (310,954,1183). The main results are summarized in Tables VI, VII, and VIII. At the temperature of liquid air, when vibrational energy changes are diminished, the bands become still sharper and are partly split up and shifted toward shorter waves. It can be seen from these tables that the replacement of hydrogen by saturated side chains in porphyrin or deuteroporphyrin causes a slight shift of the absorption curves toward longer wavelengths, while the introduction of unsaturated vinyl side chains (protoporphyrin) causes a much larger shift of more than 10 $m\mu$. There is a difference of 9 to 10 $m\mu$ in the position of the absorption bands of porphyrins with saturated and unsaturated side chains, which is of considerable importance for the study of porphyrin compounds, since a great variety of pyrrole compounds show the same influence of unsaturated side chains on the position of absorption bands. The absorption spectra of the isomeride types I and III are identical, nor can coproporphyrin be distinguished spectroscopically from mesoporphyrin. The introduction

of four carboxylic groups into the ethyl groups of etioporphyrin has no spectroscopic effect; the separation of the carboxyls by two aliphatic carbon atoms from the resonance system is able to prevent

TABLE VIII
Absorption Spectra of Porphyrins in Hydrochloric Acid^a

| Porphyrin | Position of bands, $m\mu$ | | | Ref. | |
|------------------|---------------------------|---------|------------------------------------|---------------------------------------------------------------------|------------|
| Porphin | | | 542 ($\epsilon_{mM} = 12.35$) | 861 | |
| Deuteroporphyrin | 591 | | 548 | 2506 | |
| Mesoporphyrin | 593 | (572.5) | 548.5 (509) | 404 401 (2 N HCl) 400 (alcohol) $\epsilon_{mM} = 48$ | 310 954 |
| Coproporphyrin | 593.5 | (574) | 550.5 (ca. 510) | 405 $\epsilon_{mM} = 43.7$ | 861 |
| | 591 | | 548 | 401 (0.1 N HCl) ^b $\epsilon_{mM} = 53.0$ | 1426 |
| | $\epsilon_{mM} = 6.8$ | | $\epsilon_{mM} = 17.0$ | | |
| Uroporphyrin | 597 | (577) | 553.5 (511.5) | 410.5 406 | |
| | $\epsilon_{mM} = 5.2$ | | $\epsilon_{mM} = 16.3$ | (2 N HCl) | 310 |
| Protoporphyrin | 602.5 | (582) | 557.2 | 411 408 (2 N HCl) | 310 |

^a25% HCl unless otherwise stated.

^bStronger HCl shifts the visible absorption maxima slightly toward the red, not decreasing the absorption up to 3 N HCl; the Soret band is, however, considerably decreased by strong HCl (cf. also 1231, 1515, 2097, 2640).

these groups from influencing the spectrum. In uroporphyrin, however, with only one carbon atom between carboxyl and the resonance system of the nucleus, the bands lie more toward the infrared than those of copro-, meso-, or etioporphyrin.

4.4. Fluorescence

The red fluorescence of porphyrin solutions in mineral acid or in organic solvents is so strong that it did not escape the notice of the discoverers (2801). Solutions in hydrochloric acid of 0.01 to 1.0 μg . per ml. porphyrin emit a distinctly visible and measurable fluorescence even under rather weak ultraviolet light. The fluorescence is excited by light absorbed by the Soret band (*i.e.*, violet and ultra-

violet light of a wavelength of more than $280\text{ m}\mu$) as well as by light absorbed in the visible range (29a). It has been used by many investigators for the demonstration of small amounts of porphyrins (322, 560, 562, 564–566, 568, 1179, 1181), even of the infinitesimally small amounts of porphyrin in a single erythrocyte (1505; cf. Chapter XII), and for their estimation (cf. Section 7).

The fluorescence spectra of porphyrins have been carefully studied by Dhéré (573, 578–580, 586) and later by Stern and co-workers (2631, 2632, 2637, 2643). As we have pointed out in the case of the absorption spectra, the formation of hydrochlorides brings about a more radical change than does the ionization of the carboxyls. The fluorescence spectra behave similarly, the spectra of solutions in mineral acid (Dhéré's type II) differing considerably from those given by solutions of porphyrins in organic solvents or alkali (Dhéré's type I). The latter shows a main emission band which almost coincides with the first absorption band in the orange of porphyrin solutions in organic solvents, and three further bands toward the infrared. Stern found another weak emission band at wavelengths which coincide with those of the weak absorption band Ia (at about $595\text{--}604\text{ m}\mu$) of the porphyrins, and further emission bands in the infrared. Dhéré's type II fluorescence spectrum, that of the porphyrins in mineral acid also shows an emission band at the position of the first absorption band (about $600\text{ m}\mu$) and two to three further bands toward the infrared. The work of Dhéré contains excellent photographs of these emission spectra. The influence of the side chains on the position of the emission bands is quite similar to that on the absorption bands (1551).

The intensity of the fluorescence of porphyrins in aqueous solution shows a minimum at the isoelectric point or zone of the porphyrins (cf. also 2266). By studying the fluorescence–pH curves, even isomeric porphyrins, *e.g.*, coproporphyrins I and III can be distinguished, but the method requires experience and pure substances. At the acid side of the isoelectric point the fluorescence of coproporphyrins I and III does not differ and has a maximum at pH 1–2, but the curves differ between pH 2 and 6 (1298, 1426), evidently due to the electrostatic interaction of two carboxyl groups with one another. Uroporphyrins I and III show similar differences (2910).

Porphyrins in gelatin phosphoresce when irradiated with visible light of $580\text{--}480\text{ m}\mu$ (132).



5. PORPHYRINOGENS

By the addition of six hydrogen atoms, porphyrins with saturated side chains, *e.g.*, mesoporphyrin, are converted into colorless porphyrinogens (874). These contain four pyrrole nuclei linked by CH_2

groups, which no longer allow conjugation of double bonds and resonance (*cf.* Chapter IV). On reoxidation, they are reconvertible to the porphyrins from which they were formed by reduction, but also may give rise to some urobilinoid substances. The dipyrrolyl-methane linkage is rather easily broken, as will be seen in the chapter on bile pigments.

6. STEREOCHEMISTRY AND FINE STRUCTURE OF PORPHYRINS

6.1. Resonance

It is now known that benzene and other aromatic compounds do not have alternating double and single linkages as ascribed to them in the Kékulé formulas  and , but that all six bonds are equal and of a character and length between a single and a double bond. This state of such "aromatic" molecules, which cannot be expressed adequately by our present formulas, is called a resonance state, and is characterized by the fact that the energy content of the molecule is lower than that of any of the forms with definitely placed double and single bonds. From the infrared spectrum of pyrrole, Pauling (2124) has concluded that pyrrole contains a resonance structure between the "normal" formula (Fig. 15a), with a pair of

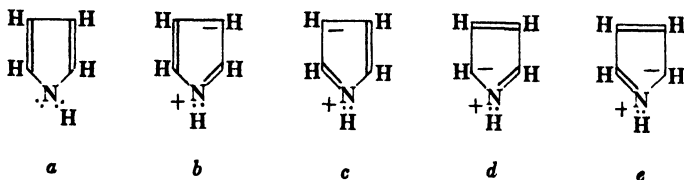

Fig. 15. Resonance formulas of pyrrole, according to Pauling (2125).

free electrons on the nitrogen atom, and four other formulas (Fig. 15 *b-e*), which accounts for the fact that pyrrole is rather a proton donor (acid) than a proton acceptor (base).

One might therefore expect even more evidence of resonance in structures like pyrromethenes and porphyrins. There is, indeed, a good deal of evidence in favor of all these compounds having resonance structure. The aromatic character of pyrromethenes and porphyrins is confirmed by their heats of combustion (2635).

If pyrromethenes of the structures *A* and *B* were isomers as indicated by

the formulas, it ought to be possible to synthesize the two pyrromethenes as indicated in Figure 16. Many such syntheses have been carried out by Fischer and collaborators, but both syntheses give one and the same pyrromethene. This does not, in itself, prove resonance, since one of the two tautomeric isomerides may be unstable. On the first glance, resonance

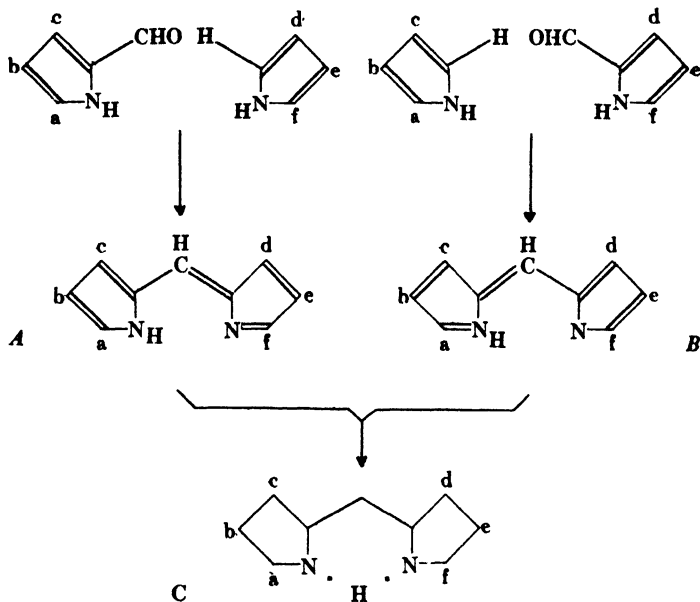

Fig. 16. Nonexistence of pyrromethene isomerides.

between *A* and *B* appears even impossible, since in these formulas the hydrogen atom on the pyrrole nitrogen is bound in *A* to the left, and in *B* to the right pyrrole ring; it is well known that resonance is only possible when no

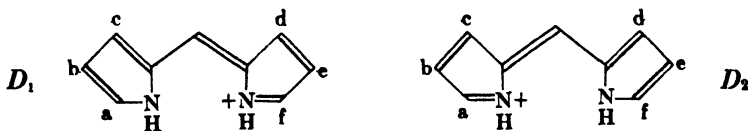

Fig. 17. Pyrromethene cations as resonance structure.

atoms, but only electrons, change their places. It will be seen later, however, that there is evidence in such compounds of hydrogen linkage between the two nitrogen atoms, which permits the assumption of resonance (Figure 16C).*

*Resonance forms with separated charges have been left out of consideration; they contribute less to the resonance state than the uncharged forms.

There is one point which strongly supports the resonance formula *C'* with hydrogen bond linkage. The cations of the acid salts of pyrromethenes (Fig. 17) can certainly be considered as resonance forms *D*₁ and *D*₂. If the free bases were tautomeric isomerides, whereas the salts were resonance forms, one would expect that the additional resonance stabilization (diminution of energy) connected with salt formation would cause the pyrromethenes to have a basicity comparable to that of the guanidines. The strong basicity of guanidines and similar compounds is explained by Pauling (2125, p. 213) on the basis that the guanidinium ion is greatly stabilized by resonance among three equivalent structures (*A*₁, *A*₂, and *A*₃, Fig. 18), while the free

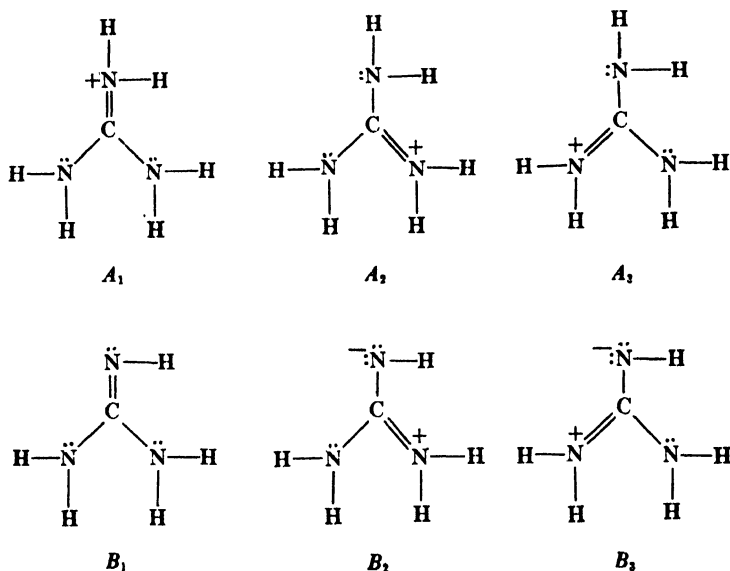

Fig. 18. Resonance stabilization of guanidinium ions and free guanidine (according to Pauling).

base itself resonates among three structures which are not equivalent, (*B*₁, *B*₂, and *B*₃), the latter two contributing much less to the resonance. The *pK* of pyrromethenes is not known exactly, but there can be no doubt that they are rather weak bases, comparable in strength to the porphyrins for which a *pK* of 2.5 has been found (474). This can be accounted for by the assumption that the free base is already stabilized by resonance (formula *C'*, Fig. 16) so that no great additional stabilization is caused by the formation of the ion.

6.2. X-Ray Analysis of Phthalocyanins

The most important evidence in favor of resonance structure of the porphyrins has, however, come from the studies of closely related

synthetic compounds, the phthalocyanins (Linstead, 1751), and this evidence has also put beyond doubt the completely planar structure of the porphin nucleus. Phthalocyanin is a tetrabenzotetrazaporphin (*cf.* Section 8), *i.e.*, a porphin in which the four methene groups combining the pyrrole rings are replaced by tertiary nitrogen and the four pyrrole rings are condensed with benzene rings in their β -positions (Fig. 19).

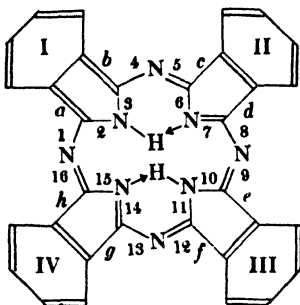

Fig. 19. Phthalocyanin.

Phthalocyanin was the first organic structure to yield to an absolute direct x-ray analysis from a double series of absolute intensity measurements of reflections with and without a central metal atom, *e.g.*, nickel, by which the hydrogen atoms in the center of the molecule can be replaced as in the porphyrins (2282-2284). This alters little the position of the other atoms in the molecule.

Phthalocyanin is a large, strictly flat molecule, $9.9 \times 12.5 \times 4.7$ A, *i.e.*, of the thickness of flat aromatic molecules. The four benzene rings are regular hexagons with 120° angles and a carbon-to-carbon distance of 1.39 A. There is no indication of the quinoid ring (I in Fig. 19) and the whole molecule is centrosymmetrical. In the closed inner ring system of eight carbon and eight nitrogen atoms, the distances (1-16) are all equal, of 1.34 A length, which indicates resonance character. The eight carbon-to-carbon bonds combining the benzene rings with their inner rings (*a-h*) are again all equal, and their length (1.49 A) indicates only weak double bond character. There is no true difference between pyrrole and pyrrolene nuclei. There is a distinct deviation however, from tetragonal symmetry in free phthalocyanin, two pairs of pyrrole nitrogen atoms being much closer in one direction than in the other perpendicular to it, the distance in the former direction being 2.65 A, corresponding to the distance of the

hydrogen bond. This deviation from tetragonal symmetry is decreased by complex salt formation.

These results can only be understood by assuming a continuous resonance system. Even a random distribution of different molecules in the crystals could not explain the degree of symmetry found. The resonance also explains why the three valencies of the pyrrole nitrogen atoms lie all in the same plane, which is of great importance for the formation of complex salts.

While the resonance system of porphyrins differs from that of phthalocyanin on account of the replacement of the isoindole rings by unsymmetrically substituted pyrrole rings, the sixteen-membered internal ring structure is essentially the same and there is no reason to doubt resonance in porphyrins. There is, therefore, no difference between the four pyrrole rings. The Küster-Fischer formula represents, like the phthalocyanin formula of Figure 19, only one of several possible "resonating" structures. Complete x-ray studies of porphyrin crystals have so far not yet been carried out. Octamethylporphyrin, which would be expected to be fully planar, is not available in good crystals. O'Daniel and Damaschke (2063) have subjected the crystals of one modification of tetramethylhematoporphyrin to x-ray analysis. Although this porphyrin contains side chains which cannot be expected to lie in the plane of the porphyrin ring, nothing has been found to contradict an essentially planar structure of the molecule. There can be little doubt that the porphyrin ring and the first eight atoms of the substituting side chains of porphyrins lie in one plane and that this planar part of the molecule is at least 10 Å in diameter (*cf.* 1125*a*). An attempt to prove the existence of a hydrogen bond between the pyrrole nitrogen atoms of porphyrins by infrared spectrophotometry (2874) has not given conclusive evidence.

An *N*-methylporphyrin has been prepared by Ellingson and Corwin (666) and by McEwen (1809). In this substance the methyl group is too large to be accommodated in the plane of the molecule between the four pyrrole nitrogens, and the N-CH₃ bond must be distorted out of this plane. It is of interest that the *N*-methylporphyrin does not form a normal zinc complex salt, but that the zinc compound contains chlorine. The ZnCl group bound to one pyrrole nitrogen probably lies on the side of the porphyrin plate opposite to the methyl group. From the similarity of the absorption spectra of neutral porphyrins and *N*-methylporphyrins on the one hand, of

porphyrin cations and metal complex salts on the other, Erdman and Corwin (697*a*) have recently concluded that there is no hydrogen bonding in porphyrins. For the reasons adduced in Sections 4.3. and 6.4., their evidence cannot be considered as conclusive.

6.3. The Evidence against Resonance

A great number of porphyrin syntheses have failed to indicate the existence of nuclear isomerism (as distinct from isomerism caused by different order of side chains relative to themselves). There are, however, some claims for the existence of such isomerism. Conant and Bailey (473) found an isorhodoporphyrin which was further studied by Dietz and Werner (591). It differed from rhodoporphyrin in absorption spectrum and HCl number. Conant had suggested a prototropic isomerism (assuming in one porphyrin attachment of the hydrogen atoms to adjacent, in the other, to opposite, pyrrole rings). Since rhodoporphyrin is a highly unsymmetrically substituted porphyrin (*cf.* Table III), such a difference may conceivably exist, even with hydrogen-bonded nitrogen (Fig. 20) (1361). Dietz and Werner showed,

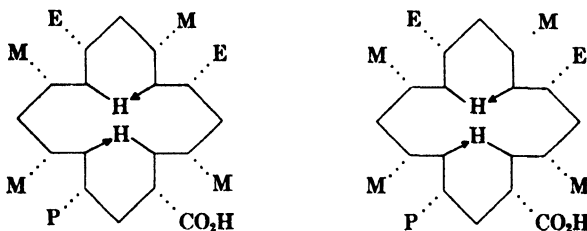

Fig. 20. Prototropic isomerism.

however, that the zinc, magnesium, and iron complex salts were also different and reconvertible into the isomeric porphyrins. Moreover, they observed that on catalytic hydrogenation isorhodoporphyrin took up one more molecule of hydrogen than rhodoporphyrin. It appears very likely that the "isorhodoporphyrin" is identical with the "pseudoverdoporphyrin" of Fischer, which was shown (*cf.* 861, p. 537) to have a vinyl group instead of one ethyl group of rhodoporphyrin. The conversion of isorhodoporphyrin into rhodoporphyrin by 50% sulfuric acid, claimed by Dietz and Werner, should be reinvestigated, since it is possible that not rhodoporphyrin but a spectroscopically similar porphyrin with a hydroxyethyl group may have resulted from a conversion of the vinyl into the hydroxyethyl group.

A nuclear isomerism would appear to be still less likely for porphin and porphins substituted symmetrically on all four methene groups between the pyrrole nuclei. The existence of such an isomerism has been claimed by Rothmund (2352, 2353) and Knorr and Albers (1555, 1556). Rothmund obtained an "isoporphin" when pyrrole and formaldehyde were condensed at 150° C. instead of at 90° C. as in the synthesis of porphin. Tetraphe-

nylporphin, obtained by condensation of pyrrole with benzaldehyde, could also be separated into fractions with different HCl numbers and absorption spectra. Again, the absorption spectra of the complexes also differed, which excludes prototropic isomerism. Pruckner (2188) has shown that one of the presumed isomerides of tetraphenylporphin had an absorption spectrum with a much higher band in the red, which indicates its nature as a dihydroporphin (chlorin) rather than a porphin.* She has also drawn attention to the fact that a comparison of the absorption spectra of Rothmund's porphin and isoporphin with that of the porphin of Fischer and Gleim (818) as measured by Stern and Molvig (2636) indicated that neither of Rothmund's substances was uniform.

The evidence against the resonance structure of the porphin nucleus is thus unconvincing.

6.4. Absorption Spectra and Fine Structure of the Nucleus

A number of attempts have been made to draw conclusions as to the fine structure of the nucleus from data on the absorption spectra of porphyrins. In numerous papers Stern and collaborators (2631,2632,2637,2642,2643) have tried to deduce the position of the pyrrole or pyrrolene nuclei and of the double bonds in relation to the substituting side chains in porphyrins and related compounds. In view of the resonance character of the porphin nucleus (*cf.* 6.2. and 6.3.) such conclusions must be accepted with reserve. The influence of the substituting side chains ought to be considered dynamically rather than statically as Stern does. Some of his correlations are rather arbitrary; one may doubt, *e.g.*, whether azaporphyrins are so similar to chlorophyll derivatives as to allow conclusions to be drawn with regard to the constitution of the latter. These conclusions have, indeed, been later abandoned by Pruckner (2188), one of Stern's co-workers, who now stresses the influence of the substituents on the symmetry of the whole molecule rather than on the position of double bonds in the porphin nucleus as a cause of the variations in the absorption spectra. The absorption bands I and III of the neutral porphyrin spectrum (*cf.* Table VI) appear to be increased by a greater degree of symmetry, the bands II and IV by unsymmetrical substitution.

The attempts of Clar and Hauowitz (444) to deduce diradical character for porphyrins from their absorption spectra are not convincing (*cf.* 482,1085,2642). Attempts have been made to fit the position of porphyrin absorption and fluorescence bands into energy level schemes (1185,1234,2198a). Hellström assumes five different electron excitations with two oscillation frequencies due to oscillation in phase of several atoms of the ring. Hausser, Kuhn, and Seitz assume only one electron excitation with superimposed oscillations. They explain the mirror image-like arrangement of fluorescence and absorption bands by assuming that in absorption the changes are from ground level without oscillation to excited levels with oscillations, while in fluorescence the changes are from excited levels without oscillation to oscil-

*This has been proved to be so by Calvin and co-workers (125a).

lating ground levels. While Hellström used absorption spectra measured at room temperature, Hausser and co-workers used the spectra obtained at the temperature of liquid air. According to Rabinowitch (2198a) the absorption bands of porphyrins in the visible part of the spectrum are due to a common electronic transition with superimposed vibrational changes, but different electronic transitions are responsible for the Soret band, and for the bands in the red and infrared of dihydro- and tetrahydroporphyrin derivatives.

7. METHODS OF ISOLATION AND ESTIMATION OF PORPHYRINS

7.1. Isolation

The ether-soluble porphyrins can be directly extracted from urine with ether after acidification, or from feces, bile, or serum with mixtures of ether and acetic acid. The excess of acetic acid is partly removed by washing the ether solution, and the porphyrins are extracted by 5% hydrochloric acid from ether and, after neutralization of this extract with sodium acetate, again taken back into ether. The above procedure is particularly necessary and must be repeated for the separation of the porphyrins of feces and bile from accompanying bile pigments. The ether must be peroxide-free, and precipitates appearing in the interfaces should be redissolved in acetic acid and, if they contain porphyrins, worked up again. The easy contamination of porphyrins by traces of metal from glassware or reagents (particularly copper and zinc) had already been observed by Willstätter and needs careful watching. The porphyrin solutions should not be unduly exposed to light. As an alternative to the concentration of porphyrins by solvent extraction, flocculation and adsorption have been used. Garrod (980) used freshly precipitated calcium phosphate as adsorbent (*cf.* also 599). It is better, however, to filter through a short column of aluminium oxide, or to shake with talc (1056,2906). Flocculation at the isoelectric point, *pH* 3 to 4, is only effective if the urine is extremely rich in porphyrin, and is only to be recommended for concentrated and previously purified solutions.

For the separation of the ether-soluble porphyrins, Zeile (3170) recommends the following procedure. Four extractions of the ether solution with one fifth of the volume of 0.54% hydrochloric acid removes coproporphyrin, deuteroporphyrin, and mesoporphyrin. This leaves protoporphyrin in the ether, which is now extracted with one fifth of the volume of 8% hydrochloric acid. The solution in

0.54% hydrochloric acid is brought to a concentration of 0.1 to 0.15% hydrochloric acid by partial neutralization with alkali and is extracted with chloroform. This removes deuteroporphyrin and mesoporphyrin and leaves coproporphyrin in the aqueous phase. Mesoporphyrin is separated from deuteroporphyrin by extracting it from 0.67% hydrochloric acid with ether. A little of the mesoporphyrin remains in the protoporphyrin fraction. This method is better than the method of Schumm used by Dobriner (599), in which protoporphyrin is extracted from the 5% hydrochloric acid solution by chloroform. For the separation of fecal porphyrins, Dobriner (600,603) has developed a scheme which makes use of the insolubility of the sodium salts of some porphyrins. This scheme, slightly shortened, is given in Table IX. The preliminary saponification of natural porphyrin ester was found to be necessary (598).

TABLE IX
Separation and Identification of Fecal Porphyrin^a

-
- (1) Extraction of total crude porphyrins with ether-acetic acid and purification by ether-HCl procedure.
 - (2) Saponification of natural esters with 20% NaOH followed by separation of soluble and insoluble Na salts.
 - (a) Coproporphyrin, soluble.
 - (b) Deuteroporphyrin and protoporphyrin, insoluble.
 - (3) Extract ether solution with 0.6% HCl.
 - (a) Coproporphyrin extracted from ether by 0.2% HCl. Extraction of this solution with chloroform-petroleum ether leaves coproporphyrin in 0.2% HCl.
 - (b) Deuteroporphyrin extracted. Reduce HCl conc. to 0.2% and extract deuteroporphyrin with chloroform.
 - (c) Protoporphyrin not extracted. Extract once more with 1% HCl. Protoporphyrin extracted from ether by 5% HCl and from this by chloroform.

Finally, the methyl esters are prepared and recrystallized from chloroform-methyl alcohol and identified. Coproporphyrin I and III esters are separated as described in the text.

^a According to Dobriner (600,603).

For the extraction of protoporphyrin from blood (226,229,231), blood or erythrocytes are homogenized in a mixture of three parts ethyl acetate with one part acetic acid and are shaken for a few minutes. After washing the filtrate with water, protoporphyrin is extracted with 5% hydrochloric acid, brought into ether after buffering, and re-extracted with acid.

Isolation of uroporphyrins. For the isolation of uroporphyrin from urine, acetic acid is added to 1-2% and the ether-soluble porphyrins are first removed by ether extraction. Waldenström (2906) then

adsorbs the porphyrin on a column of aluminium oxide, removes other pigments by washing the column first with 20% acetic acid and then with glacial acetic acid, and finally elutes uroporphyrin with dilute ammonia. Grinstein *et al.* (1056) use talc as adsorbent and esterify the adsorbate directly with methyl alcoholic hydrochloric acid. From bones or shells uroporphyrin may be directly extracted as ester by treatment with methyl alcoholic hydrochloric acid after pre-extraction with petroleum ether or ether + alcohol. It is then brought into chloroform.

Final purification. For the final purification and identification the porphyrins are usually transformed into their methyl esters and identified by their melting points and mixed melting points. For further purification the methyl esters may be subjected to fractional crystallization, or to chromatography on alumina, calcium carbonate, or talc (835,845,1056,2911).

7.2. Estimation

For the estimation of porphyrins extraction methods similar to those described above are used. For the estimation of total porphyrins in urine the ether solution is extracted with 5% hydrochloric acid (Fischer).

Spectrocolorimetric and fluorimetric methods are particularly suitable for quantitative porphyrin estimations. Whenever sufficient material is available, the spectrocolorimetric method is preferable. The fluorimetric methods are far more sensitive and must be applied for porphyrin estimations in urine of normal or nearly normal porphyrin content. There is, however, greater need for purification of the porphyrin solutions, since impurities interfere with the porphyrin fluorescence, and this purification is difficult to carry out without losses.

Spectrocolorimetric method. The main absorption band of a porphyrin solution in dilute hydrochloric acid is sharp and excellently suited for comparison with that of a standard porphyrin solution. If pure coproporphyrin is not available, mesoporphyrin in 0.5% hydrochloric acid can be used for the standard, which keeps for many weeks in the dark. The method was first used by Weiss (3025), who employed amyl alcohol for extraction and extracted the porphyrins from this by phosphoric acid. It is preferable to use the method of Fischer as recommended by Schreus, in which porphyrin is concentrated first by ether extraction and then by extraction with hydrochloric acid (2465,2986). Losses of porphyrin during the removal of excess acetic acid by washing (2830) can be minimized by buffering the washwater with sodium acetate.

Spectrophotometry and photoelectric colorimetry. Photoelectric colorimetry with suitable light filters in the visible range has been used by Dobriner and collaborators (601). For the estimation of the exceedingly small amounts of protoporphyrin in erythrocytes, photoelectric measurement of the strong absorption band at about $410\text{ m}\mu$ has been recommended by Grinstein and Watson (1059). While protoporphyrin is rather unstable and easily altered by irradiation, the absorption of the Soret band diminishes much less than the strength of fluorescence. Spectrophotometric methods in the visible and ultraviolet can also be used (1298,2053,2506,2508,2509).

Fluorimetric method. Measuring the strength of fluorescence has been used extensively for porphyrin estimations (226,365,369,663,757,760,1059,1594,1781,1879,2792,2851). Porphyrins are the only substances with a red fluorescence in acid solution which occur in feces or urine.

Several complicated fluorimeters have been constructed or are on the market. Estimations sufficiently exact for clinical purposes can be carried out with a very simple apparatus consisting of a box with a source of ultraviolet light in Woods' glass in the upper part and two windows in the front and back. Through the latter the solutions of standard and unknown in nonfluorescent thin-walled test tubes are inserted. They are inspected through the front window, which is closed by a filter, allowing only red light to pass. Standards containing 0.05 to 1 μg . porphyrin per ml. are used. A somewhat more elaborate apparatus on the same principle, constructed by Schuster, is used by Rimington (2519). Rimington's paper should be consulted for details of the method (2266). A final acid concentration of 0.25% hydrochloric acid is more suitable for the estimation of copro- and uroporphyrins (maximal fluorescence) than 5% hydrochloric acid used by earlier investigators.

It may be advisable to repeat the estimation after repurification of the porphyrin by passage through ether and hydrochloric acid, in order to ensure absence of substances interfering with fluorescence. For this purpose extraction of the hydrochloric acid solutions with chloroform and petroleum ether has been suggested (760,1594); the former would, of course, also remove protoporphyrin from fecal porphyrin solutions. Another suggestion was to oxidize the interfering substances (760), but this procedure is not to be recommended (763).

Boas (298) transforms the porphyrins into hematins with ferrous acetate, and then extracts them with chloroform. He uses the benzidine reaction for the estimation. Schreus and Carrié (406) found this method as reliable as the fluorescence method, but one may doubt whether the very small amounts of porphyrin can be quantitatively converted into hematin; since the porphyrins will have to be isolated beforehand in any case, the method appears to be unduly complicated.

Twenty-four hours' specimens of urine are required, and feces should be collected if possible over 2-3 days. Losses of porphyrins may occur during the collection of the urine, even when kept in a dark bottle under toluene, by adsorption to urinary sediments (2830). For the extraction of fecal porphyrins, hydrochloric acid of no more than 5% strength should be used,

since stronger acid would also extract weakly basic chlorophyll derivatives (366,1594).

It is open to doubt whether the easy splitting of reduced hematin compounds by acids has not sometimes falsified the results of porphyrin estimations in blood and organs. The protoporphyrin content of blood, *e.g.*, is so small that a very slight degree of hemoglobin decomposition during the isolation would suffice to lead to entirely wrong results. This may explain the greatly divergent results for the protoporphyrin content of erythrocytes found by various authors. Thomas (2797) reports that 10% alcoholic hydrochloric acid forms protoporphyrin from hemoglobin on irradiation with light.

8. TETRAPYRROLIC RING COMPOUNDS RELATED TO PORPHYRINS

8.1. Azaporphyrins

The azaporphyrins form an interesting link between the porphyrins in which the four pyrrolic rings are linked by \gg CH groups and the phthalocyanins in which four isoindole (benzopyrrole) nuclei are linked by tertiary nitrogen. In the azaporphyrins one, two, or four of the \gg CH groups* linking pyrrolic rings are replaced by tertiary nitrogen.

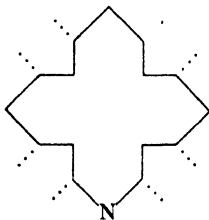

Fig. 21. Monoazaporphyrins.

They were first obtained by Fischer and collaborators and named iminoporphyrins, later imidoporphyrins. The nomenclature used here was suggested by Helberger (1231). It is comprehensive and needs no specific explanation.

* These groups have been termed "ms" (meso) groups by Fischer (*cf.* 861, p. 173) and labeled α , β , γ , δ . The term "meso" is, however, unsuitable for obvious reasons and the lettering has not always been applied consistently (*cf.* also Chapter IV), and α , β in this connection must not be confused with the α - and β -positions on the pyrrole nucleus.

Monoazaporphyrins were synthesized by heating α, α' -dibromopyrromethenes with sodium hydroxide (814), as a by-product of the synthesis of diazaporphyrins on heating α, α' -dibromopyrromethenes with ammonia (845), and from pyrromethenes bearing a bromomethyl group in α - and a urethane group in α' -position (688). None of these syntheses has an unequivocal reaction mechanism.

It is therefore important that the structure of monoazaporphyrin has been established in an entirely different and simple way by Lemberg (1687). If verdohematin compounds in which one of the methene groups of the porphyrin ring has been removed by oxidation (*cf.* Chapter X) is treated with ammonia, monoazahematin compounds are formed. The reaction can be formulated as:

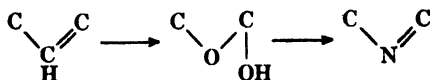

By treatment of monoazamesohemin with hydrazine hydrate in acetic acid, monoazamesoporphyrin is obtained, the absorption spectrum of which agrees well with that of monoazaetioporphyrin of Fischer and Friedrich (814, 2639). The absorption bands of monoazamesoporphyrin in ether-acetic acid are: I, 614; Ia, 588; II, 562; III, 534; IV, 502 $m\mu$.

The influence of the side chains on the position of the absorption bands of azaporphyrins and their compounds is exactly the same as with the porphyrins. The bands of the proto compounds with vinyl groups lie about 10 $m\mu$ nearer to infrared. In their neutral absorption spectrum and their red fluorescence, the monoazaporphyrins closely resemble porphyrins (*cf.* also their iron complex salts, Chapter V), and they also show the strong band in the ultraviolet (2189). The absorption spectrum of monoazamesopor-

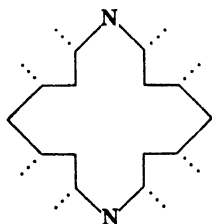

Fig. 22. Diazaporphyrins.

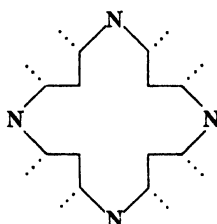

Fig. 23. Tetraazaporphyrins.

phyrin solutions in hydrochloric acid shows positions of the absorption bands similar to those of mesoporphyrin (595, 551 $m\mu$), but the first band is stronger than the second. The fluorescence spectra of the solutions in hydrochloric acid also differ (2643).

Diaza- and tetraazaporphyrins have also been synthesized (484,688,809, 821,1921). The absorption and fluorescence spectra of these compounds in neutral solvents again resemble those of porphyrins. They show the absorption band in the ultraviolet, but the first absorption band in the red is much stronger and the fourth band in the blue-green weaker (2189,2638,2639,2642, 2643). The absorption spectra of the green hydrochlorides are quite different from those of porphyrins, however, suggesting salt formation on the nitrogen atoms connecting the pyrrole rings. The salts do not fluoresce. The absorption spectrum of phthalocyanins, while differing considerably from that of tetraazaporphyrins, still shows some similarity in type (2639).

Azapyromethenes have been synthesized by Rogers (2330).

8.2. Oxyporphyrins

Green oxidation products containing two more oxygen atoms than porphyrins were obtained by Fischer (861, pp. 269-274; 816,857,887) from etioporphyrin and mesoporphyrin by treatment with hydrogen peroxide in concentrated sulfuric acid. At first formulas with hydroxyl groups on the methene groups (I, Fig. 24) were assumed for these compounds, later addition of hydrogen peroxide on two adjacent positions of one pyrrole nucleus (II, Fig. 24) was preferred by Fischer (861). By treatment of the copper complex of dioxymesoporphyrin with concentrated sulfuric acid a monoxymesoporphyrin was obtained, to which the structure III (Fig. 24) may be ascribed. The absorption spectra of dioxy- and monoxymesoporphyrin do not differ (Stern and Deželić, 2633). Both porphyrins have high HCl numbers, *e.g.*, monoxymesoporphyrin 14.5.

A different type of oxyporphyrin was obtained by Lemberg and co-workers (1698) by oxidation of pyridine hemochrome with small amounts of hydrogen peroxide in the presence of ascorbic acid, and by splitting of the red-brown oxyporphyrin hemochrome thus obtained with hydrochloric acid

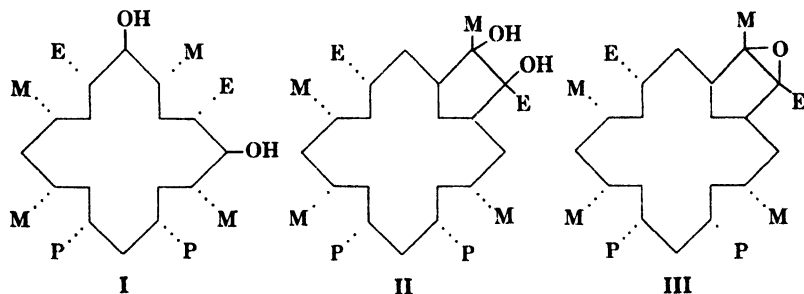

Fig. 24. Oxymesoporphyrins of Fischer.

under nitrogen. By further oxidation the hemochrome was easily transformed into verdohemochrome with removal of one of the methene groups between pyrrole rings (*cf.* Chapters V and X). This suggested that the first

oxidation had occurred on this methene group (Fig. 26, I). The absorption spectra of the oxyporphyrin complex salts (hemochrome and copper complex) bore close resemblance to those of the complex salts of phylloporphyrin, which carries a methyl group on one of the methene groups (Fig. 25). The free oxyporphyrin in ether was of blue-green color. Its absorption spectrum

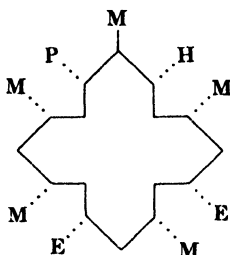

Fig. 25. Phylloporphyrin.

(I, 650; II, 584; III, 546; IV, 511 $m\mu$; order of strength: I, IV, III, II) did not resemble that of phylloporphyrin, but rather that of Fischer's oxymesoporphyrin. Similarly its solution in 20% hydrochloric acid was not red, but green, and had its strongest absorption band in the orange (I, 623.5; II, 568.5 $m\mu$). The absorption spectra deviated more, however, from those of Fischer's oxymesoporphyrin than could be due to the presence of vinyl instead of ethyl side chains, and the oxyporphyrin had a much lower HCl number (0.25).

From these results it was concluded that in the complex salts the oxyporphyrin is present in the form of hydroxyporphyrin (formula I of Fig. 26) with hydroxyl on one methene group, while the free porphyrin is tautomerized (perhaps only partially) to structure II (Fig. 26). These conclusions

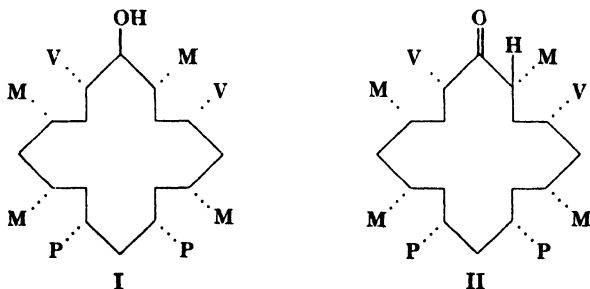

Fig. 26. α -Oxyporphyrin of Lemberg *et al.* (1698).

were confirmed by Libowitzky and Fischer (1731,1732) by the isolation and analysis of the corresponding copro compounds and by the benzylation of the hydroxyl group. In contradistinction to the unesterified hydroxypor-

phyrin, the benzoylated hydroxyporphyrin remains spectroscopically similar to phylloporphyrin, tautomerization being prevented by the esterification.

Fisher names the compounds isooxyporphyrins, "oxy" connoting hydroxy in the German language.

9. PORPHYRIN COMPLEX SALTS

The ability of porphyrins to combine with various metals has repeatedly been mentioned in the preceding pages. The most important of these complexes are the iron compounds, the hematin. They will be discussed fully in Chapter V, together with the theory of complex salt formation and the properties of some metal compounds (cobalt, nickel, and manganese) which resemble hematin compounds in certain aspects and which allow interesting comparisons. The nature of the porphyrin metal compounds as internal complexes was recognized by Willstätter (3091), who described magnesium complexes of porphyrins as phyllins. Compounds with zinc had been obtained by Schulz (2487), with cobalt by Laidlaw (1632), with nickel and tin by Milroy (1957), and with manganese by Zaleski (3156). Hill (1275) used the following methods for the preparation of a large number of porphyrin complex salts: (a) heating with metal acetate in acetic acid; (b) heating with metal salt in ammonia; (c) introduction of sodium and potassium by alcoholates in pyridine; (d) introduction of magnesium by Grignard reagent (*cf.* also 3091 and 861, p. 611); (e) introduction of aluminum and arsenic by using the trichlorides in pyridine; (f) introduction of silver with silver oxide or silver carbonate in alcohol.

A better way of preparing phyllins is by heating porphyrins with magnesium bromide in pyridine (810). The stability of the metal complexes varies greatly. Water removes sodium, potassium, and arsenic; dilute acetic acid, magnesium and lead; hydrochloric acid, silver, zinc, tin (Sn^{2+}) and iron (Fe^{2+}); concentrated sulfuric acid, copper, iron (Fe^{2+}), nickel and cobalt; while tin (Sn^{4+}) and aluminum could not be removed.

Hill distinguishes between three types of spectra: those of the alkali metals and thallium (2634) resemble the acid porphyrin spectrum in that the first band is much weaker than the broad second. (The similarity to the one-banded hemoglobin spectrum may be fortuitous or may be due to predominantly ionic linkage of the alkali metals.) The second class has two bands of about equal strength comparable to oxyhemoglobin, while in the third the first band is the stronger, comparable to hemochromes (*cf.* Chapter V). These similarities are probably fortuitous, particularly since Stern

and Deželić (2634) have shown that the ratio of the maximum absorption of the two bands varies gradually from palladium (3.4) over zinc (1.1) to mercury (0.9); while the copper complexes of most porphyrins have a stronger first band, those of porphin and a few porphyrins have the second band stronger (2643). Table X gives the position and relative strength of the absorption maxima of some metal complexes of mesoporphyrin IX dimethyl ester, according to Stern and Deželić (2634), unless another reference is given.

TABLE X
Absorption Spectra of Metal Complex Salts of Mesoporphyrin Ester ^a

| Metal | Solvent | Band position, m μ | | | Ratio of strength of absorption |
|-------------------|----------|------------------------|-------|-------|---------------------------------|
| Tl | Dioxane | 580 | 544 | (508) | II > I |
| Ag | Dioxane | 556 | 523 | | I > II |
| Cu | Dioxane | 561 | 525 | | I > II |
| Zn | Dioxane | 570 | 534 | | I \geq II |
| Hg | Dioxane | 564 | 534 | | II \geq I |
| Ni | Dioxane | 550 | 514 | | I \gg II |
| Pd | Dioxane | 544 | 510 | | I \gg II |
| Mg ^b | Methanol | 572 | 536 | (506) | I \gg II |
| InCl | Benzene | 578 | 540 | | I = II |
| GaCl | Benzene | 572 | 534 | | I > II |
| SnCl ₂ | Benzene | 578 | 540 | | II > I |
| GeCl ₄ | Benzene | 578 | 540 | | II \geq I |
| Pb | Dioxane | 580 | (531) | | I \gg II |
| VO | Dioxane | 570 | 533 | (500) | I > II |

^aAll values but one according to Stern and Deželić (2634).

^bAccording to Fischer, Plötz, and Filser (865).

Stern found the frequency difference, $\Delta_{\alpha,\beta}$, between the two bands practically the same for all the complex salts (1180–1225 cm.⁻¹), except for the nickel complex, for which it was larger (1273 cm.⁻¹), and the silver and lead complexes, for which it was smaller (1134 and 995 cm.⁻¹, respectively). The sodium, potassium, magnesium, zinc, cadmium, and tin (Sn²⁺) salts fluoresce, while others, *e.g.*, the iron and copper salts, do not fluoresce (1167). While the absorption spectrum of porphyrins is greatly altered, that of dihydroporphin compounds and diazaporphyrins is much less influenced by the combination with metals, *e.g.*, magnesium or copper (2643).

CHAPTER IV

BILE PIGMENTS

1. INTRODUCTION

1.1. Definition

The term "bile pigments" or "bilinoid pigments" is today no longer applied to all pigments found in the bile of animals or derived from such pigments, but to a particular class of pyrrolic compounds (tetrapyrrene derivatives). Thus although it occurs in the bile of herbivorous animals, phylloerythrin (previously called bilipurpurin or still more unsuitably cholehaematin) is no longer included in this class since it is a porphyrin derived from chlorophyll. On the other hand, we now know that bile pigments are more widely distributed in nature than was previously assumed (*cf.* Chapter XI, 11.) and that they also occur as products of plants (*cf.* Section 7 of this chapter).

1.2. Structure

All the tetrapyrrene derivatives found in nature contain a skeleton of four pyrrolic rings linked by three carbon atoms, a structure

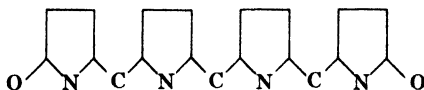

Fig. 1. Bile pigment skeleton.

which is usually represented as a linear chain with an oxygen atom at both ends (Fig. 1 — on stereochemical grounds, this formula in most

cases is not quite correct; see p. 102). Bile pigments thus differ from porphyrins in having an open chain tetrapyrrolic system instead of the closed porphyrin ring. Related to this difference in structure are fundamental differences in chemical behavior. The porphyrins have a remarkably stable resonance structure. For this reason we had to deal only with the "aromatic" porphyrins and the unstable fully hydrogenated porphyrinogens. (A dihydroporphin ring plays a role in chlorophyll chemistry, but it is also rather unstable and easily transformed into the porphin ring.) In the open chain tetrapyrrolic pigments, however, a number of dehydrogenation stages exist between the aromatic biliverdins (I), and the fully hydrogenated leuco compounds (II), *e.g.* mesobilirubinogen (Fig. 2). Each differs

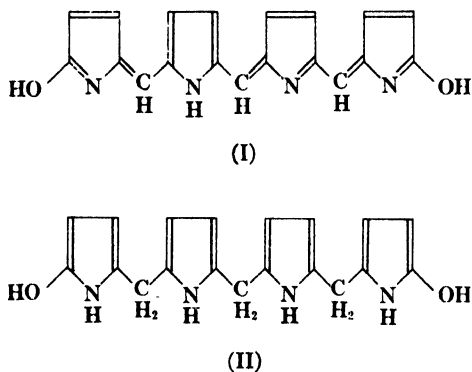

Fig. 2. Two hydrogenation stages of bile pigments.

from the other in color, type of absorption spectrum, and properties (*cf.* Table II, page 106). This explains the bewildering variety of the bile pigments, their greater instability, and the fact that they show all the colors of the rainbow.

This greater complexity of bile pigment chemistry is compensated for by a smaller variation in number and order of side chains of naturally occurring bile pigments. So far only compounds with side chains of proto (4 M, 2 V, 2 P) and meso type (4 M, 2 E, 2 P) (*cf.* Chapter III) have been found in nature, and of these only type IX (Fig. 3).

This can be explained by the discovery of Lemberg (1681, 1682) that bile pigments in animals are not formed from porphyrin but from hematin compounds (Chapter X), and by the fact that proto-porphyrin alone is found to occur in higher animals as iron complex

salt. The algae chromoproteins (Section 7) also contain bile pigments of type IX; they are either derived from chlorophyll or their synthesis is linked up with that of chlorophyll. Surprises may, how-

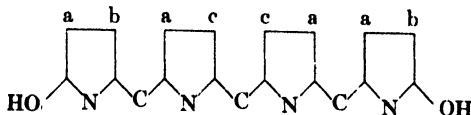

Fig. 3. Type IX bile pigments.

ever, still be in store for us. Thus dipyrrolic compounds which on condensation might yield bile pigments with copro or uro side chains evidently play a role as intermediates in hemoglobin synthesis, and dipyrrolic compounds with the uro type of side chains have been found in the urine of porphyria patients and have been condensed *in vitro* to bile pigments probably of uro type (Waldenström, *cf.* Section 6.5.).

The correct structure of the bile pigments was recognized comparatively late (in 1931) and most of the earlier reviews (882,883, 1597,1602) are now mainly of historical value, although they contain much interesting detail. In Fischer's book (861) the synthetic work which led to the recognition of the correct structure of bilirubin is fully dealt with, but other bile pigment classes are treated less adequately and considerable progress has been made in this field since 1938. This later development has been only incompletely reviewed (860,1534,1683,2990). A few other reviews (1349,2240,2371) deal with the physiology of bile pigments, which will be discussed in Chapter XI.

For many years (1911-1926) Fischer had assumed a tetrapyrrolyl-ethylene structure for bile pigments, while Küster defended another more complicated formula. The correct tetrapyrrene formula was discovered in 1931 by Fischer and Hess (826) in an interesting manner. An attempt was made to use the Schumm method (2505) for the removal of vinyl groups from hematin in the hope of preparing a deuterobilirubin from bilirubin. No clear-cut results were obtained. (Later, Fischer and Reinecke isolated a vinyl-substituted dipyrrolic body from the resorcinol melt of bilirubin (869).) Fischer now applied the method to mesobilirubin, although the removal of its ethyl groups could hardly be expected. The results are an interesting justification of the value of occasionally carrying out a logically pointless experiment.

This experiment gave Fischer the key to the correct interpretation of the structure of bile pigments (826,2554). So far bilirubinic acid (Fig. 4) had been the only dipyrrolic product obtained from bilirubin

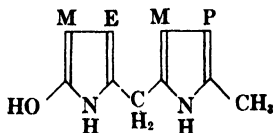

Fig. 4. Bilirubinic acid.

by mild reduction (872,873,2153). Now a pyromethene was obtained which had an unsubstituted α -position instead of the methyl group.

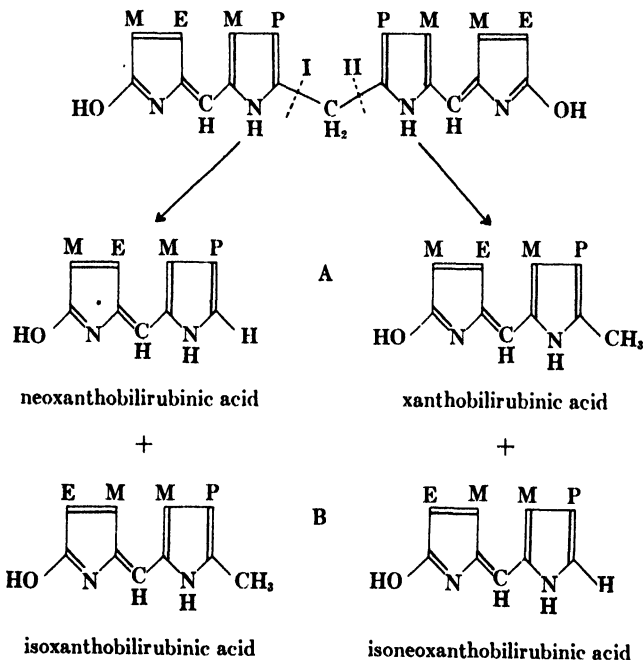

Fig. 5. Decomposition of mesobilirubin in the resorcinol melt.

This showed that the breakdown of mesobilirubin in the resorcinol melt occurred on either side of a methane bridge combining two pyromethenes (Fig. 5) and thus led to the ultimate proof of the

structure for bilirubin. At first a symmetrical arrangement of the side chains was assumed, but later (2554) it was discovered that each of the two types of pyrromethenes, α -hydroxy- α' -methylpyrromethene (*A*) and α -hydroxy- α' -unsubstituted pyrromethene (*B*), was actually again a mixture of two isomers, all of which were subsequently synthesized. The arrangement of the side chains is thus nonsymmetrical and the same as in protoporphyrin IX and hematin (Fig. 5).

Using the shorter term bilinic acid suggested by Piloty (2153) for the dipyrromethane bilirubinic acid, the rather unwieldy names of Fischer "xanthobilirubinic, isoxanthobilirubinic, neoxanthobilirubinic, and isoneoxanthobilirubinic acids" may be suitably replaced by the more self-descriptive terms "dehydrobilinic, isodehydrobilinic, nordehydrobilinic and isonordehydrobilinic acids," respectively, the prefix "nor" being customarily used to describe the lack of a methyl group. The iso compounds have the ethyl, the others the methyl group, in the neighborhood of the hydroxyl.

1.3. Synthesis

The nonsymmetrical structure of the naturally occurring bile pigments made their synthesis difficult. It also proved impossible to obtain vinyl-substituted bile pigments in the way this had been achieved in the porphyrin class (by reduction of acetyl side chains to hydroxyethyl and dehydration to vinyl). While the problem of the synthesis of bile pigments from simple pyrrole compounds had been solved in principle by Fischer and co-workers by 1935, biliverdin and bilirubin were first synthesized from hemin by Lemberg (1681, 1715). Biliverdin was isolated and shown to be dehydrobilirubin by Lemberg (1674, 1676, 1680, 1691, 1692); it is reduced to bilirubin by zinc in ammonia or by enzyme systems (1715).

Table I summarizes the historical development of the synthesis of bile pigments. Biliverdin and bilirubin were finally synthesized by Fischer and Plieninger (863) in 1942 (Fig. 6). By treatment of opsopyrrolecarboxylic acid with hydrogen peroxide in pyridine, it is transformed into two isomeric α -hydroxypyrroles (1) which are separated and the constitution of which has been proved independently. Their propionic acid side chains are transformed into the urethan side chains (3) and (4), as described in the figure, and the two hydroxypyrroles then condensed separately with α -formylopsopyrrolecarboxylic acid obtained from the starting material in the Gattermann-Koch reaction (2). Thus two pyrromethenes are obtained in reactions 5 and 7, into one of which a formyl group is introduced (6).

The pyrromethene- α -aldehyde is now condensed with the other pyrromethene in reaction 8 to a bilatriene. Finally the urethan groups are transformed into vinyl groups (9) as described in the figure.

The transformation of hematin and hemoglobin into bile pigments will be described in Chapter X. Theoretically, four different iso-

TABLE I
Synthesis of Bile Pigments

| | | |
|-----------------------------------------|-----------------------------------------------------------------------------------------------------------------------------------|-----------------------------------------------|
| 1931-1934 Synthesis of intermediates | Preparation of α -hydroxypyrromethenes from α -bromopyrromethenes by reaction with acetates or sodium methoxide. | Fischer and co-workers, Siedel, 798,815,2554. |
| 1932-1934 Synthesis of intermediates | Preparation of α -hydroxypyrroles from pyrroles with hydrogen peroxide in pyridine. | Fischer and co-workers, 824,889. |
| 1931 | Synthesis of a mixture of mesobilirubin isomerides from α -OH, α' -H — substituted pyrromethenes with formaldehyde. | Fischer and Hess, 826. |
| 1932 | Synthesis of isomeric mesobiliverdins by condensation of α -OH, α' -H — substituted pyrromethenes with formic acid. | Fischer and co-workers, 803. |
| 1935 | Synthesis of mesobiliverdin ("glucobilin"). | Siedel, 2550. |
| 1935 | Synthesis of biliverdin and bilirubin from hemin. | Lemberg, 1681,1715. |
| 1936 | Synthesis of mesobilene. | Siedel and Meier, 2557. |
| 1937 | Synthesis of mesobilirubin. | Siedel, 2551. |
| 1939 | Synthesis of vinyl-substituted pyrromethenes and bile pigments. | Fischer and Reinecke, 869. |

merides may thus arise from protoporphyrin IX by removal of one of the four methene groups, α , β , γ , or δ , and its replacement by hydroxyl groups (Fig. 7), while no less than 52 isomeric bilirubins are possible. Only one of these bile pigment isomerides, IX α , has been isolated so far either from natural bile pigments or from the *in vitro* transformation of hematin and hemoglobin into bile pigments. Evidently the methene group α between the two pyrroles bearing no acid side chains is removed preferentially.

1.4. Stereochemistry

Bile pigments are conventionally written as linear tetrapyrrolic chains (*cf.* biliverdin in Fig. 6 and the formulas in Tables II and III).

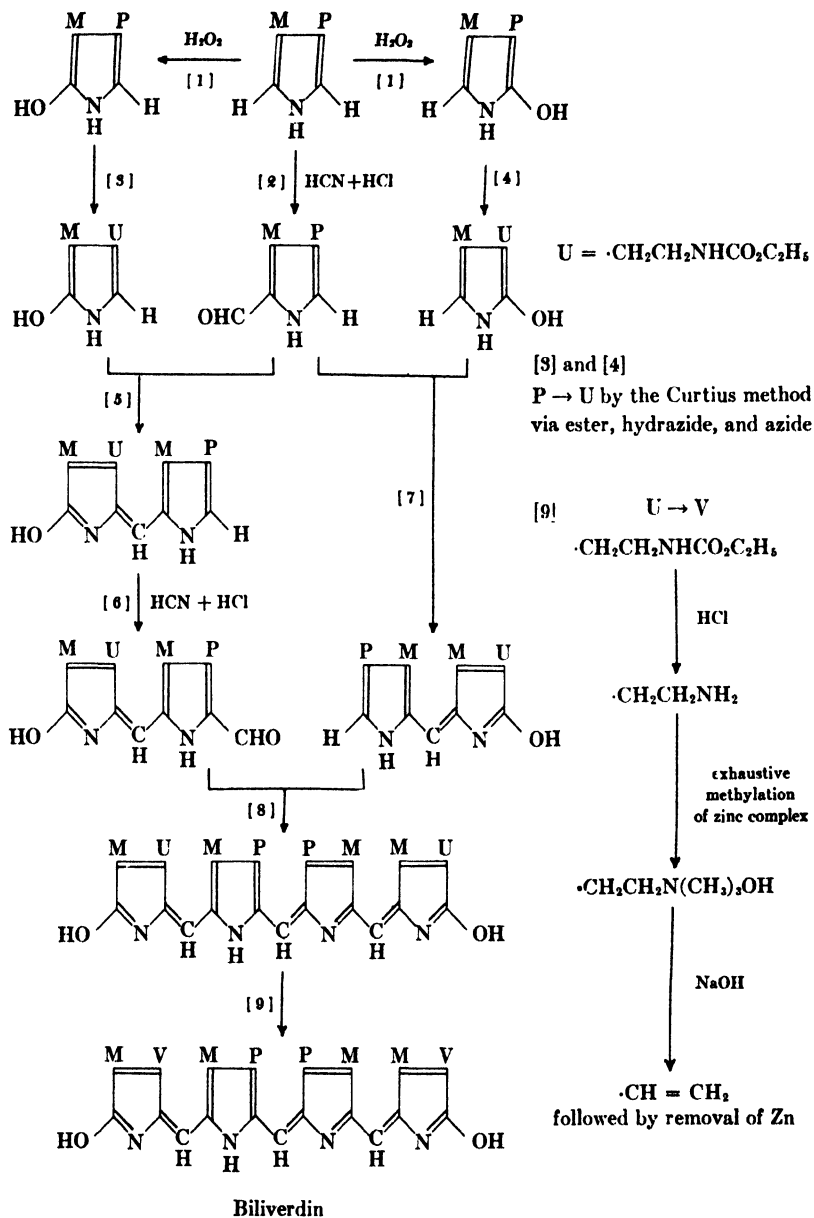

Fig. 6. Synthesis of biliverdin.

Since they are formed, however, by opening the porphyrin ring of hematin (*cf.* Chapter X) as pictured in Figure 7 (IX \rightarrow IX α), the correct formulas are cyclic rather than linear. There is, of course,

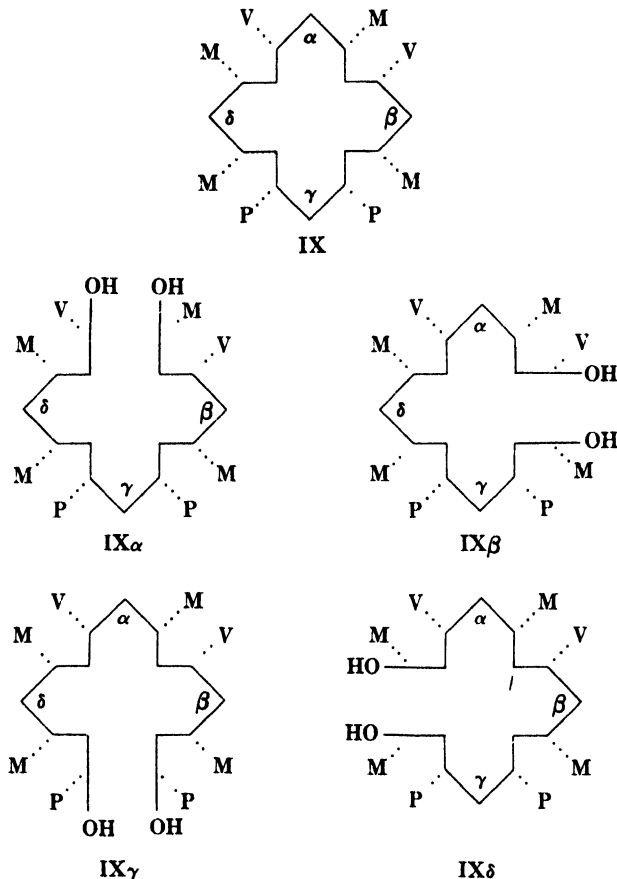
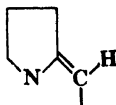

Fig. 7. Isomeric bile pigments that might be derived from protoporphyrin, IX.

free rotation around the single bonds between the combining carbon atoms and the pyrrole rings, allowing the molecule to assume a variety of shapes in space. Thus bilirubin forms extremely unstable films of weak solid or viscous liquid type, occupying up to 140 A², in contradistinction to protoporphyrin and hematin (38). Only the linear formulas of the leuco compounds with three methylene groups between the four pyrroles are, however, strictly identical with their

cyclic formulas. In the bile pigments containing methene groups, the double bond linking the carbon to the pyrrolic ring places the methene hydrogen in the *trans* position to the pyrrole nitrogen:



not in the *cis* position:

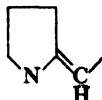

as the linear formulas suggest (1684). The true linear formula for bilirubin would thus be formula I rather than formula II in Figure 8.

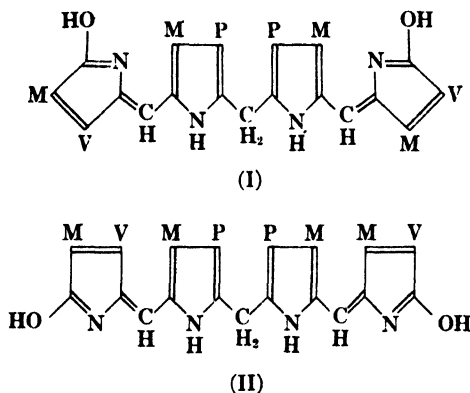

Fig. 8. Linear formulas of bilirubin.

We shall nevertheless continue to use the linear formulas as a rule, since they save space and are more readily visualized. For most purposes, the difference is of no significance, but considerations of complex salt formation should be based on the cyclic formulas.

2. BILE PIGMENT CLASSES AND THE PROBLEM OF NOMENCLATURE

2.1. Inadequacies of Present Nomenclature

The inadequate and inconsistent nomenclature of the bile pigments has always added to the difficulties for the student, although this can

hardly explain the astonishing degree of ignorance of this field of biochemistry shown by some textbook writers. The various classes of bile pigments are usually distinguished by their color, *e.g.*, bilirubins, biliverdins, biliviolins, but this nomenclature has not been consistently used (*e.g.*, "urobilins"), and it has recently become clear that there are more such classes than can be readily distinguished by their color.

It is highly desirable that the nomenclature of the side chains be adjusted to coincide with that of the porphyrin series. We should therefore speak of proto and meso compounds. As is customary in the hematin series, the prefix "proto" may be omitted (*e.g.*, "bilirubin" instead of "protobilirubin"). Inconsistencies introduced by the vagaries of historical development can unfortunately no longer be removed entirely, but priority claims should not stand in the way of a rational nomenclature. Thus, urobilin contains meso side chains, while porphobilin (*cf.* below) is probably a urobilin, a "urobilin" with uro side chains.

The term "bilin" combined with a prefix should only be used to mean a bile pigment from a certain biological source (*e.g.*, phycobilin, pterobilin, helioporobilin, urobilin, stercobilin). The term "glauco-bilin" for mesobiliverdin is a misnomer and should be abandoned. The same holds for urobilin or stercobilin, if these terms are meant to connote a definite chemical structure. At least two urobilins exist in the urine and the same two occur in the feces. The terms stercobilin (Watson) and urobilin should, therefore, not be used to characterize any one of them as a chemical entity, and the same holds for urobilinogen and stercobilinogen. Siedel's term "urobilin IX α " is particularly unfortunate, since the other urobilin ("stercobilin") has also the side chain arrangement IX α , and the term "natural urobilin" used by Fischer is definitely misleading.* Copromesobiliviolin for a mesobiliviolinoid pigment from feces is another misnomer which has been abandoned.

* Nothing could show better the confusion to which this nomenclature has led than the following statement of Siedel (2557, p. 114): "Während sich nun sowohl Heilmeyer und Krebs, wie C. J. Watson, für die Identität des Sterkobilins mit dem Urobilin aussprachen, entdeckten H. Fischer, Halbach, and Stern als einen entscheidenden Unterschied die optische Aktivität des Sterkobilins." In fact the first-named authors had correctly established the identity of the major urobilinoid constituent (Watson's "stercobilin") of urine and feces, while the difference in optical activity is between this and the second urobilinoid constituent found occasionally in both urine and feces, the "urobilin IX α " of Siedel.

2.2. Systematic Nomenclatures

There is thus evident need for a concise chemical nomenclature. Systematic nomenclatures have been suggested by Fischer (798,820) and Siedel (2551,2557). The term "tetrapyrane" was introduced for the fully hydrogenated system and the number of double bonds indicated in the usual way by "ene," "diene," "triene." (Fischer and Siedel, according to German usage, use these words without the final "e.")

At first Fischer used the numbering A, which was later (820) replaced by B (Fig. 9). The latter has also been adopted by Siedel.

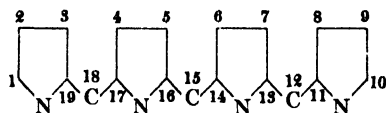

(A)

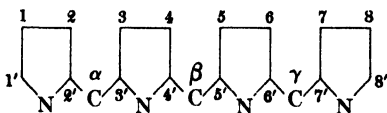



(B)

Fig. 9. Numbering of atoms in bile pigments.

The terms "bilan" and "bilin" were suggested by Siedel for the fully hydrogenated tetrapyrane and the aromatic system of tetrapyrrotrienes (biliverdins), respectively, which bear hydroxyl groups in 1' and 8'. After what has been said above about the use of the term "bilin," its application for one special class of bile pigments is not to be recommended. It is also better to avoid "ms" in (B), standing for "meso" and supposed here to refer to the central carbon atom β , not to the side chains.

The full name of bilirubin, according to the earlier nomenclature of Fischer would be 1,10-di(hydr)oxy-2,4,7,9-tetramethyl-3,9-divinyl-tetrapyrro-11,18-diene-5,6-dipropionic acid. (The position of double bonds is indicated by the lower number of the two doubly linked carbon atoms.) In Siedel's nomenclature, the name of bilirubin would be either 1',8'-di(hydr)oxy-1,3,6,7-tetramethyl-2,8-divinyl-

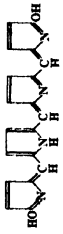
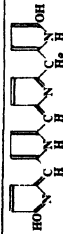
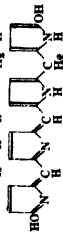
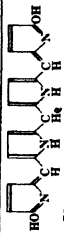
TABLE II
Bile Pigments as Hydrogenation Stages^a of Bilatrienes

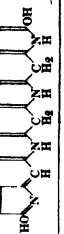
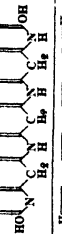
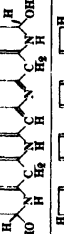
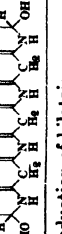
| Suggested nomenclature | Position of double bonds | Customary class name | Compounds belonging to this class | Formulas ^b | Color | No. of conjugated double bonds | Simpler compounds of similar properties | Zinc complex salts, color and fluorescence |
|------------------------|--------------------------|----------------------------------|--------------------------------------------------------------|-----------------------------------------------------------------------------------|---------------|--------------------------------|------------------------------------------|---------------------------------------------------|
| Bilatrienes | (2'a, 5'b, 7'c) | Verdins | Biliverdin (Dehydrobilirubin) Mesobiliverdin (Glucobilin) |  | Green to blue | 10 | | Green; no fluorescence |
| Biladienes-(a,b) | | Violins | Mesobiliviolin |  | Violet | 8 | Some tripyrenes | Blue-green fluorescence to blue; red fluorescence |
| Biladienes-(a,c) | (2'a, 4'b)? | Erythrins ^c (Rhodins) | Mesobilierythrin (Mesobilirhodin) |  | Red | 7 | Bilenes-(b) | Red-violet; yellow fluorescence |
| Bilenes-(b) | (2'a, 7'c) | Rubins | Bilirubin Mesobilirubin |  | Orange | 5 | α -Hydroxypyrrromethenes | Red; no fluorescence |
| Bilenes-(b) | (5'b) | | Mesobilene-(b) (Urobilin IX _a , K-urobilin) |  | Yellow | 5 | α,α' -Dimethylpyrrromethenes | Red; green fluorescence |
| Bilenes-(a) | (2'a) | | Dihydromesobilirubin |  | Yellow | 5 | α -Hydroxypyrrromethenes | No fluorescence |
| Bilane | | | Mesobilane (Mesobilirubinogen) |  | Colorless | 2 | Dipyrrylmethanes | |
| Tetrahydrobilene-(b) | (5'b) | | Tetrahydro-mesobilene-(b) (Stercobilin) |  | Yellow | 5 | α,α' -Dimethylpyrrromethenes | Red; green fluorescence |
| Tetrahydrobilane | | | Tetrahydro-mesobilane (Stercobilinogen) |  | Colorless | 2 | Dipyrrylmethanes | |

^aThis does not imply that all these stages can actually be obtained by reduction of bilatrienes.

^bThe side chains are omitted. ^cThe structure of the erythrins is still doubtful.

ms-dihydrobilin-4,5-dipropionic acid (or-bilidiene-($2'\alpha$, $7'\gamma$)- instead of (*-ms*-dihydrobilin-).

Simplified nomenclature. For our purpose, a greatly simplified nomenclature is sufficient, which in principle follows Siedel's second suggestion and uses, where necessary, the numbering indicated above in *B*, but with a, b, and c instead of α , β , and γ , and without *ms*. This obviates any confusion with the numbering of methene groups (α , β , γ , δ) in protoporphyrin. The term bilane is used for the fully hydrogenated tetrapyrane including the two hydroxyl groups in 1' and 8'.

Bilirubin thus becomes simply biladiene-(a,c) and biliverdin, bilatriene. This systematic nomenclature should not exclude the use of the older terms, such as bilirubin or biliverdin, where their meaning is sufficiently precise.

Table II shows that the better known naturally occurring bile pigments can be readily brought into this systematic nomenclature (column 1).

In some cases the chemical structure has not been elucidated completely. Reference to Table III will show that other bile pigments of different, though related, structure may have spectroscopic properties so similar to those of some described in Table II that a differentiation with small amounts of material obtained from biological sources may be impossible. In such cases, terms such as "urobilinoid," "biliviolinoid," etc. must still be used, but it should be clear that they imply a certain type of bile pigment of similar color and spectroscopic properties rather than a distinct chemical entity. The position of the double bonds, which is usually not required for the nomenclature, is given in column 2 making use of the numbering of Figure 9B; the customary type names are given in column 3, and examples of bile pigments belonging to this class in column 4.

2.3. Relation of Color and Light Absorption to Structure

Table II gives the classes of bile pigments in order of increasing hydrogenation. It can be seen that, with decreasing number of conjugated double bonds (column 7, formulas in column 5), the color of the pigments changes from green through violet, red, orange, and yellow to colorless, the absorption bands being shifted toward shorter wavelengths. This follows the general rule found for polyenes by Hausser and collaborators (1184), which is probably explained by the creation of a large number of resonance states with increased number of conjugated bonds, so that the energy required for the

change from one to the other is diminished. The number of conjugated bonds is diminished far more by the reduction of the central methene group b of bilatrienes than by reduction of the groups a or c. Hence biladienes-(a,c) are orange (rubins) with the main absorption band in the blue, while biladienes-(a,b) are violet (violins) with main absorption in the yellow and green part of the spectrum. This holds in spite of the fact that many of the pigments have indicator properties and a different absorption spectrum in acid and alkaline solution. The complicated band spectra of the porphyrins are not seen in bile pigments and the bands are usually less sharp, although the complex salts of biliviolinoid pigments have a somewhat more complicated and sharp absorption spectrum.

The absorption bands of the various classes differ in height less than in position, since hydrogenation has less effect on the total number of double bonds than on their conjugation. Thus bilirubin has two systems of five conjugated double bonds while biliverdin has ten conjugated double bonds and one crossed double bond. Actually, the double bond formulas can only give a rough picture of the resonance of the molecules.

Column 8 of Table II gives simpler pyrrolic compounds which resemble the bile pigments of that particular class in their color, and in the color, absorption, and fluorescence of their zinc complex salts (column 9). Where the conjugation of double linkages is interrupted by a methylene group, the group isolated by this is no longer in resonance with the remaining system; a resonating system without such groups should therefore have similar spectroscopic properties. Hence in mesobilene-(b) the two flanking pyrroles have little influence. It resembles α,α' -dimethylpyrromethenes and forms similar green-fluorescing zinc complex salts.

In bilirubin two α -hydroxypyrromethene groups are linked by the methylene group and, like the α -hydroxypyrromethenes, bilirubins do not form fluorescent zinc salts. This is probably due to the fact that the hydroxylated pyrroline ring in bilirubin and α -hydroxypyrromethenes occurs in the tautomeric form:

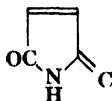

rather than as:

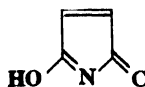

as given in the formulas. Lactim-lactam isomerism (usually wrongly called keto-enol isomerism) has again and again been called in to explain differences between bile pigment classes or other phenomena, *e.g.*, the "direct" or "indirect" reaction of serum bilirubin (*cf.* Chapter XI) (798,1349,1606,2552,2554). Later this explanation was always found to be wrong. As in uric acid and isatin, one would expect an equilibrium between tautomerides rather than the existence of different tautomeric isomerides.

The biladienes-(a,c) are the class of compounds known for the longest time (bilirubin, mesobilirubin). While the bilatrienes were found much later, they have proved to be the key to the understanding of the formation of bile pigments from hemoglobin and for the elucidation of the chemistry of the oxidation products of bilirubin (*cf.* Table III). Biladienes-(a,b) are of interest since they occur as prosthetic groups of chromoproteins in algae (Section 7). While bilenes-(a) so far have not been found in nature, the distinction between mesobilene-(b) and tetrahydromesobilene-(b) and between mesobilane and tetrahydromesobilane is of great importance for the chemistry and physiology of urobilins and stercobilins.

2.4. Gmelin Reaction and Oxidation Products of Bilatrienes

The color play which develops when bile is treated with nitric acid containing nitrous acid was the first reaction of bile pigments to be discovered. It was described by Tiedemann and Gmelin in 1826 (2805) and is today well known to every student of medicine as the Gmelin reaction. Only recently, however, some semblance of order has been introduced into the difficult field of oxidation products of bilirubin.

What confused earlier investigators particularly was the close similarity of some of these oxidation products to reduction products of bilirubin. So closely similar are their absorption spectra and behavior that earlier investigators found it impossible to distinguish them from one another. One physiologist even came to the conclusion that one had to admit the formation of one substance from another by oxidation as well as reduction! Even today, such a differentiation is not easy.

Numerous suggestions for its explanation have been brought forward, *e.g.*, breakdown to tripyrrenes and pyrromethenes. "Keto-enol" isomerism of various stages and quinhydrone formation between them have been assumed (*cf.* 861, p. 715) although several compounds can be isolated which differ in acid as well as in alkaline solution and give different complex salts. Some workers naively adopted a different name and structure for each color

shade, disregarding the possibility of mixtures of compounds. Later, apparently pure colors turned out to be due to mixtures, *e.g.*, the "green" stage to mixtures of blue-green bilatriene with unaltered bilirubin and the blue "cyanin" stage to mixtures of bilatriene with violet pigments (1680,2552). The hydroxyl groups of bilirubin are not necessary for the reaction as was shown by the fact that synthetic tetrapyrrodienes without these groups also give the Gmelin reaction (343).

The explanation of the Gmelin reaction, at least in principle, became clear only after the first change to blue-green had been proved to be a dehydrogenation of bilirubin to a bilatriene (verdin) (Lemberg, 1680) and after Siedel (2552,2553,2555,2556) had found the explanation for the fact that oxidation beyond this stage leads to a series of compounds which resemble substances containing more hydrogen than bilatrienes. If a bilatriene is oxidized, some of the pyrrole-linking methene groups through which the conjugation of double bonds runs are oxidized to carbonyl groups or disappear by addition of nitrous acid or hydrogen peroxide (or in the presence of methyl alcohol by two methoxyl groups), as shown in Figure 10. The

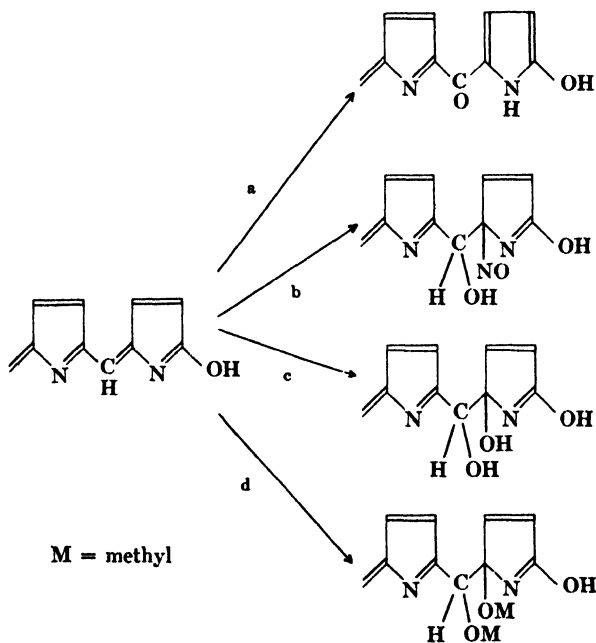

Fig. 10. Gmelin reaction.

conjugation of double bonds is thus interrupted, as it is by reduction which replaces $\gg C-CH=C <$ by $\gg C-CH_2-C \ll$. For the absorption spectra the presence of a carbonyl group or a hydroxymethylene group between pyrrole rings instead of a methylene group makes little difference. The reaction takes place first on one of the methene groups (*a* or *c*) and later on both. The second step of the Gmelin reaction thus leads from bilatrienes (verdins) to biladienones or biladienediols, called bilipurpurins by Siedel or biliviolins type II by Lemberg, which closely resemble the biladienes-(a,b) (biliviolins). The third step, involving the second of these two methene groups, leads to bilenediones or bilenetetrols (choletelins), which closely resemble bilenes-(b) ("urobilins"). In spite of their name choletelins are not the end products of the oxidation which probably now involves the methene group *b* and finally leads to colorless breakdown products (substituted maleimides). The main types of the oxidation products up to the choletelin stage are summarized in Table III.

In the nomenclature of the Fischer school the compounds which contain carbonyl groups between pyrroles are described by using the prefix "oxo" in front of the name of the corresponding compound with methylene. We prefer to follow the accepted nomenclature of ketones.

Some other oxidation reactions follow a similar pattern. Oxidation with bromine in the presence of methanol follows mainly reaction *d* in Figure 10 (Siedel and Grams, 2556). The same probably holds for the oxidation of biliverdin zinc complexes with iodine or bivalent copper salts studied by Lemberg (1679,1680,1711). Two atoms of iodine are required for the conversion of the biliverdin zinc complex into the zinc complex of a bilipurpurin.

Although the principle of the Gmelin reaction and these related reactions can be considered as well established, many of the details remain to be worked out, and the formulas given in Table III can only be considered as provisional (*cf.* Sections 5.3., 5.4.). Generally the reaction leads to complicated mixtures, which have to be separated by chromatography. The variety of reactions depicted in Figure 10 is not the only complication. With the nonsymmetrically substituted bile pigments the oxidation of the bilatriene stage can begin either at the methene *a* or *c*, leading to a mixture of pigments. Most of the oxidation products obtained in a crystalline state have so far been prepared from synthetic, symmetrically substituted bile pig-

TABLE III
Oxidation Products of Bilatrienes

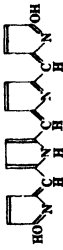
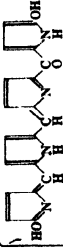
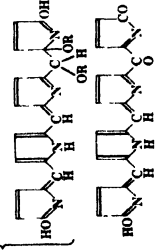
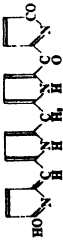
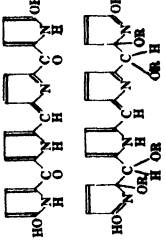
| Systematic nomenclature | Customary names | Formulas | Color | No. of conjugated double bonds | Similar type of hydrogenated compound | Zinc complex salts | Formation |
|---------------------------------------------|--------------------|-----------------------------------------------------------------------------------|------------|--------------------------------|---------------------------------------|----------------------------------|----------------------------------------------------------------|
| Bilatrienes | Verdins |  | Blue-green | 10 | | Green; no fluorescence. | First step of Gmelin reaction; dehydrogenation of rubins. |
| Biladiene-(a,b)-ones (c) | Purpurins (Stedel) |  | Violet | 8 | Biladienes-(a,b) (violinoid) | Green to blue; red fluorescence. | Second step of Gmelin reaction; iodination of biliverdin-zinc. |
| Biladiene-(a,b)-diols and related compounds | |  | | | | | |
| Dehydrobilene-(a)-one (c) | Chrysin |  | Yellow | 5 | α -Hydroxy-pyrro-methenes | | Autoxidation of violins II or of chrysin. |
| Bilene-(b)-diones-(a,c) | Choletelins |  | Yellow | 5 | Bilenes-(b) (urobilinoid) | Yellow; green fluorescence. | Third stage of Gmelin reaction. |

ments. With bilirubin or biliverdin itself the vinyl side chains undergo alterations. By the addition of groups to double bonds two optically active carbon atoms are formed so that diastereoisomerides may arise. Finally further oxidations ("bilviolins type II" to "bilviolins type III") and isomerizations ("bilviolins type II" to chrysin) further complicate the picture (Lemberg and Lockwood, 1711).

3. BILATRIENES. VERDINS

3.1. Structure

Even before their synthesis, the structure of these compounds was clear from their properties and their relation to bilirubins (803,1676):

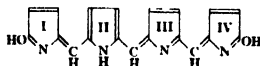

The deep color is in agreement with the conjugation of double bonds through the whole length of the molecule, and the nonhydroxylated pyrrole nucleus (III) with the existence of stable hydrochlorides. Biliverdin contains two hydrogen atoms less than bilirubin to which it is related as pyromethene is to a dipyrromethane.

The dehydrogenation of rubins can be carried out with ferric chloride (803,1676), nitric acid (1680), benzoquinone (820,1612,2152), lead dioxide (820), hydrogen peroxide (1703), or by autoxidation (1680), although not all of these (*e.g.*, nitric acid and autoxidation) are suitable for oxidation of bilirubin, since they attack its vinyl groups. This also holds for hydrogen peroxide (1852), unless special precautions (1703) are taken. The two hydrogen atoms removed by these procedures can easily be added again by zinc dust or by enzymic reduction (690,803,1715), with reversion into bilirubin.

The hydrochlorides or hydrobromides of biliverdins give double salts with ferric chloride and ferric bromide, which are not complex salts of biliverdins, but salts of the complex acids $H(FeCl_4)$ and $H(FeBr_4)$ or "double salts" of biliverdin hydrochloride with ferric chloride. The name "ferrobilins" applied to them by the Fischer school has misled some authors to assume that they are biliverdin complexes related to the verdohematin compounds (Chapter X).

A series of "verdins" exist in the porphyrin series which are isomerization products of synthetic rhodins (861, pp. 547,554). They have a resonance structure similar to that of biliverdin (Fig. 11). The porphyrin ring is closed,

but the conjugation of its double bonds is interrupted by enolization of a rhodin carbonyl group bound to one of the methene groups⁵

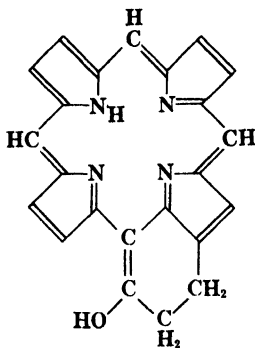

Fig. 11. Verdins (with closed ring system).

3.2. Individual Bilatrienes*

3.2.1. Bilatriene, Biliverdin. Biliverdin ($C_{33}H_{34}O_6N_4$) was isolated from icteric urine and investigated by Scherer as early as 1845 (2438). It is remarkable that his effort to purify the substance came nearer to success than those of many later workers. Städeler gave a formula with 10, Maly and Küster with 8, and Küster, later, with 7, oxygen atoms. Pure bilatriene was first isolated by Lemberg and Barcroft from dog placenta and called uteroverdin (1691,1692). It was then obtained by dehydrogenation of bilirubin (1676). Oocyan, the green-blue pigment from bird egg shells, for which at first a tripyrrene structure was tentatively assumed (1674), was also found to be identical with biliverdin (1676,1680). The close relationship of oocyan with uteroverdin had been recognized early by Thudichum (2802).

The occurrence of biliverdin in nature is discussed in Chapter XI.

Biliverdin can be obtained by autoxidation of bilirubin in alkaline solution, but the yield is poor (1680), the "biliverdin" thus formed being a mixture of bilatrienes with altered side chains. The green color produced from bilirubin by oxidants in the Fouchet and Huppert tests and as the first step in the Gmelin reaction is also due to bilatrienes. Biliverdin is prepared by dehydrogenation of bilirubin (1676) or by coupled oxidation of hemoglobin and ascorbic acid (1712). It is moderately soluble in ether with greenish-blue color and extracted

* Only the naturally occurring bile pigments of type IX α are discussed.

from ether by 1% hydrochloric acid with blue-green color. Hence some authors stress the green, others the blue, color.

The Willstätter method (extraction from ether by hydrochloric acid of graded strength) was first applied in bile pigment chemistry by Lemberg in the investigation of phycobilins (1673) and for the separation of oocyan from protoporphyrin (1674); the method is generally useful for the purification of bile pigments of more strongly basic character. The hydrochloride is only slightly soluble in dilute hydrochloric acid, a property which facilitates purification. It crystallizes from concentrated solutions in fine green needles. Biliverdin itself, if sufficiently pure, crystallizes well from methyl alcohol.

In contradistinction to mesobiliverdin, biliverdin is destroyed by heating with concentrated sulfuric acid. Biliverdin reacts with hydrobromic acid in glacial acetic acid, but the bromoethyl side chains formed are not easily hydrolyzed so that no pure hematobiliverdin results.

The biliverdin dimethyl ester crystallizes in two forms of different optical properties but with the same melting point and mixed melting point. These forms can be explained by differences in crystal growth (Rawlins, *cf.* 1680). The melting point of the ester produced from bilirubin is 215–223° C. (1680), of the synthetic ester, 206–209° (863), of the ester from hemin, 208° (1681), and from hemoglobin (by coupled oxidation with ascorbic acid), 216° (1707).

Biliverdin dimethyl ester ferrichloride, $C_{35}H_{38}O_6H_4 \cdot HFeCl_4$, was first described as "green hemin ester" by Warburg and Negelein (2952); its structure was elucidated by Lemberg (1681) (*cf.* Chapter X). It forms pleochroitic elongated platelets pointed at the ends, and has no definite melting point. Ferric chloride and hydrochloric acid are removed by washing the chloroform solution with water.

3.2.2. Mesobilatriene, Mesobiliverdin ("Glaucobilin"). This substance $C_{33}H_{38}O_6N_4$ was obtained by Fischer and collaborators (803,820) by dehydrogenation of mesobilirubin, and named "glaucobilin." It can also be obtained by ferric chloride oxidation of mesobilane and mesobilene-(b) (1680) or by heating mesobilirubin, mesobilane, and even tetrahydromesobilene in concentrated sulfuric acid. It is very stable and can be heated with sulfuric acid at 100° C. without decomposition. In ether solution it is a purer blue than biliverdin.

Siedel and Fischer (2545) at first believed that glaucobilin belonged to a class of bile pigments different in structure from biliverdin (*cf.* 800) and Siedel (2551) objected strongly to the introduction of

the generic term verdins and its use in the combination mesobiliverdin. It suffices to say that this nomenclature has meanwhile been adopted by the Fischer school.

Melting point of *mesobiliverdin dimethyl ester*, prepared from mesobilirubin is 214–222° (803), 221° (1680) and from mesoheemin (*cf.* Chapter X), 218–219° (1681). Siedel (2550) finds a higher melting point, 232°.

Mesobiliverdin dimethyl ester ferrichloride, $C_{36}H_{42}O_6N_4 \cdot HFeCl_4$, melts at 276° (803), 265° (1681).

3.2.3. Other Bilatrienes. Bilatrienes with other side chains have not yet been isolated in pure form. Lemberg and Legge (1703) have shown that a bilatriene with oxidized side chains accompanies biliverdin in the reaction mixture obtained by prolonged oxidation of bilirubin by hydrogen peroxide. It differs from biliverdin by its somewhat lower light absorption (ϵ_{nm}^{880} of hydrochloride 19.0, of biliverdin hydrochloride 28.0) and its higher HCl number. It is not extracted from ether by 2% hydrochloric acid. The existence of this compound has led Petermann and Cooley (2139) and Malloy and Evelyn (1852) to the mistaken belief, based on photocolometric data alone, that biliverdin is only a mixture of bilirubin with "a stable blue stage."

3.3. Reactions and Properties

Reactions. On treatment with "yellow" nitric acid or with dilute nitrous acid bilatrienes show the later stages of the Gmelin reaction (green-blue-violet-red-yellow). They do not couple with diazotized sulfanilic acid, and occasional statements to the contrary are due to the use of "biliverdin" samples containing bilirubin. Very small amounts of bilatrienes can be found by the following method: to a solution in ammoniacal alcohol some zinc acetate and very small amounts of iodine are added. A blue-green solution with intense red fluorescence and a sharp absorption band in the orange results, due to the formation of the zinc complex salt of a biliviolinoid pigment (*cf.* Section 5.4.2.).

The position of this absorption band in the orange part of the spectrum can be used to determine whether the bilatriene contains proto or meso side chains; in the former case the absorption band is found at about 635 $m\mu$, in the latter at about 625 $m\mu$. Bilirubin and mesobilirubin behave similarly (97), but the phenomenon is less striking.

Absorption curves of biliverdin and of biliverdin hydrochloride are given in Figure 12 and data of the extinction coefficients of biliverdin and mesobiliverdin are given in Table IV.* The maximum of

* All the absorption curves of the "biliverdins" in Heilmeyer's book (1213) are obviously those of mixtures of biliverdin with bilirubin (pages 161, 167) and other

absorption in the visible part of the spectrum lies in the red; the maximum for the vinyl compound lies 10 $m\mu$ further toward the

TABLE IV
Absorption Spectra of Biliverdins

| Substance | Solvent | Absorption maximum | | Reference |
|----------------|--------------------|--------------------|-----------------|---------------------|
| | | $m\mu$ | ϵ_{mM} | |
| Biliverdin | Methanol | 640 | 10.4 | 1324,1676,1691,1712 |
| | | 392 | 25 | |
| | 5% HCl in methanol | 680 | 28 | |
| | | 377 | 48 | |
| Mesobiliverdin | 5% HCl in methanol | 670 | 30.9 | 1676,2190 |
| | | 363 | 46.8 | |
| | | 309 | 17.8 | |

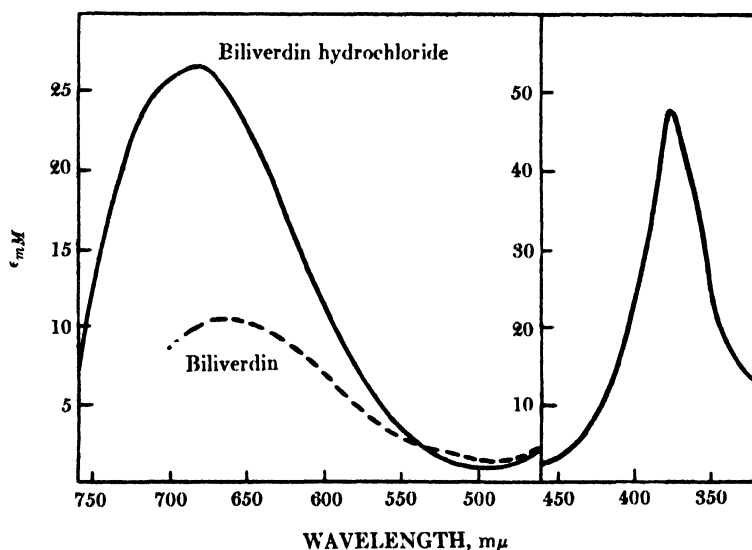

Fig. 12. Absorption curves of biliverdin and its hydrochloride in methanol.

infrared than that of the meso compound, as in the porphyrin series. There is also an absorption band in the ultraviolet, which is high if

bile pigments of biliviolinoid type (page 161; page 254, curve 4). This also holds for Fischer's "mesobiliverdin" (page 167). The only exception is the "blue dehydrogenation product of etiomesobilirubin" (page 167) of Fischer which shows a true bilatriene curve.

compared with that in the visible part of the spectrum, but low if compared with the Soret band of porphyrins or hematin compounds.

Complex salts. Although the zinc complex salts of bilatrienes do not fluoresce (possibly they fluoresce in the infrared) and have the same color as the free biliverdins, there is nevertheless a change of the absorption spectrum with shift of the maximum toward the red (mesobiliverdin-zinc, 685 $m\mu$). By a spectrophotometric study of the complex salt formation, it could be shown that one atom of zinc combines with one molecule of biliverdin (1680,1688). This is only possible if the biliverdin reacts in cyclic form and if one of the hydroxylated pyrrole rings is in lactim, the other in lactam, form; probably the whole molecule is in resonance through a hydrogen bond between the OH group and the doubly linked oxygen atom:

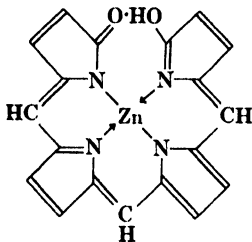

The formula is supported by the observation of Fischer and collaborators (864) that bilatrienes with methoxyl instead of hydroxyl groups did not form zinc complex salts. The significance of this observation for the problem of the structure of verdohemochrome will be discussed in Chapter X.

Bivalent copper forms a similar complex of olive color (1680). The absorption bands of the copper complexes usually lie nearer the infrared than those of the corresponding zinc complexes, and in this instance the absorption band lies partly in the infrared (2556). Excess bivalent copper oxidizes the copper biliverdins to copper bilipurpurins.

4. BILADIENES-(a,c). RUBINS

4.1. Structure

This structure of the bilirubins was established by Fischer and his co-workers, both from the study of the degradation products of mesobilirubin in the resorcinol melt (Section 1.2.) and by synthesis (Section

1.3.). It accounts well for the properties of the rubins, their similarity to α -hydroxypyrrmethenes, their very weakly basic character (1598), and their dehydrogenation to bilatrienes. The weakly basic character is due to the lack of nonhydroxylated pyrrole nuclei, the α -hydroxylated pyrroles tautomerizing to the lactam form:

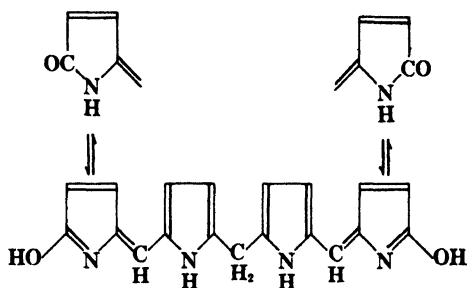

Instead of two vinyl side chains Fischer at first assumed one condensed furane ring in addition to one vinyl group, a structure not in agreement with the fact that only two molecules of hydrogen were taken up in the catalytic hydrogenation of bilirubin to mesobilirubin; later he assumed a dihydrofurane ring condensed to a pyrrole ring:

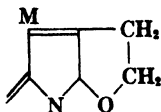

which in his book (861, p. 625, 637) he claimed to have finally established. The evidence was based on the so-called "nitrite body" an ill-defined product of the oxidation of bilirubin by nitrous acid, and on the observation that one of the two molecules of hydrogen added in the catalytic hydrogenation of bilirubin to mesobilirubin was taken up faster than the second. The evidence was discussed by Lemberg (1681) and rejected. Fischer has now confirmed the formula with two vinyl side chains by synthesis and by the fact that two moles of diazoacetic ester can be added to the vinyl side chains of bilirubin as to those of protoporphyrin (864). The "nitrite body" was shown to be methylvinylmaleimide, reducible to methylethylmaleimide, while previously it had been claimed that the reduction yielded a cyclic isomeride of this compound.

4.2. Individual Biladienes-(a,c)

4.2.1. Bilirubin. Bilirubin, $C_{33}H_{36}O_6N_4$, is best obtained from ox gallstones, which consist to a large extent of calcium bilirubinate. This method had already been used by Städeler in 1864 (2607) and has been further developed by Küster (1598,1599,1603,1610) and Fischer (776,826;861,p.634).

The isolation consists in the liberation of bilirubin from its salt by acid, the removal of impurities by extractions with ether and alcohol, in which bilirubin is almost insoluble, and the extraction of bilirubin with chloroform. This procedure has to be repeated many times, since layers of the bilirubinate appear to be coated with layers of impurities. With the fancy prices demanded for ox gallstones, methods using other starting materials are welcome. Two methods have been described for its isolation from pig bile (996); one gives a smaller yield but is less laborious and the product is almost pure (1688). More recently preparations from bile have been described (1730) and patented (2119,2120) which use chlorobenzene as solvent for bilirubin. All of the bilirubin preparations on the market require recrystallization and some are very impure.

Bilirubin crystallizes from chloroform in typical rhomboid prisms or plates, occasionally in finer leaflets. Its surface color varies from light orange yellow to deep red-brown and is no indication of purity. While it keeps well in the dry state and moderately well in chloroform solutions protected from light, alkaline solutions are very unstable; and alcoholic solutions, even those containing chloroform, tend to become colloidal, particularly if the bilirubin is pure. Great care is thus needed in making up standard solutions of bilirubin. Bilirubin gradually blackens on heating and does not melt. It forms a red compound with strong hydrochloric acid (1211), which is perhaps the hydrochloride of the tautomeric form with hydroxypyrrolene nuclei.

4.2.2. Mesobilirubin. Mesobilirubin, $C_{33}H_{40}O_6N_4$, is obtained from bilirubin by catalytic hydrogenation (820,859,868) or by treatment with hydrazine hydrate in pyridine (864). It is more easily soluble in chloroform and of somewhat yellower color than bilirubin. It melts at $315^{\circ}C$. (coalescing at 360°), which distinguishes it from bilirubin. Two safer ways of distinguishing the substances exist, which are applicable to small amounts. The first involves conversion to the biliverdin, and heating the later in concentrated sulfuric acid (cf. Section 4.1.); the second involves treatment with iodine in the presence of zinc acetate in alcohol, followed by spectroscopic exami-

nation of the position of the absorption band in the orange, using a Hartridge Reversion Spectroscope. Bilirubin yields an absorption band at $635\text{ m}\mu$, mesobilirubin at $625\text{ m}\mu$.

Mesobilirubin dimethyl ester hydrochloride forms red hexagonal leaflets from methyl alcoholic hydrochloric acid, melting point, 190° .

4.3. Color Reactions

The Gmelin reaction and related reactions have been discussed above (Section 2.4.).

Diazo reaction. The coupling of bilirubin with diazonium salts (usually diazotized sulfanilic acid) to give azo dyes was discovered by P. Ehrlich in 1883 (651) and has been developed by van den Bergh as the standard method of estimation of bilirubin in serum (221, 233, 239, cf. Section 9 and Chapter XI). The reaction is more complicated than was previously assumed and involves a splitting of the bilirubin molecule at the central methylene group (861, p. 722; 820). The compound which actually couples with the diazobenzene sulfonic acid is neoxanthobilirubinic acid (dehydronorbilinic acid):

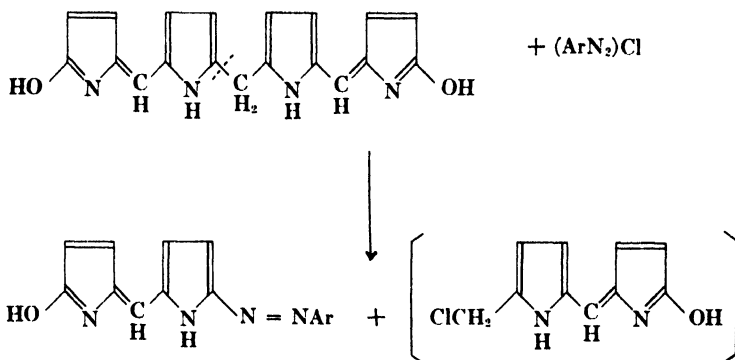

where Ar = aryl. Hence, while mesobilirubin reacts in the same way, the bilatrienes do not give the reaction.

4.4. Absorption Spectra and Metal Complexes

Figure 13 shows the absorption curve of bilirubin in chloroform. This solution obeys Beer's law. Bilirubin in blood serum (cf. Chapter XI) has a somewhat weaker band at $460\text{ m}\mu$ ($\epsilon_{mM} = 42$). The solutions in aqueous alkali resemble the colloidal solutions in cholic

acid in their absorption. They do not obey Beer's law and, in contrast to the chloroform solution, contain aggregates. The position of the absorption band of mesobilirubin is the same as that of α -

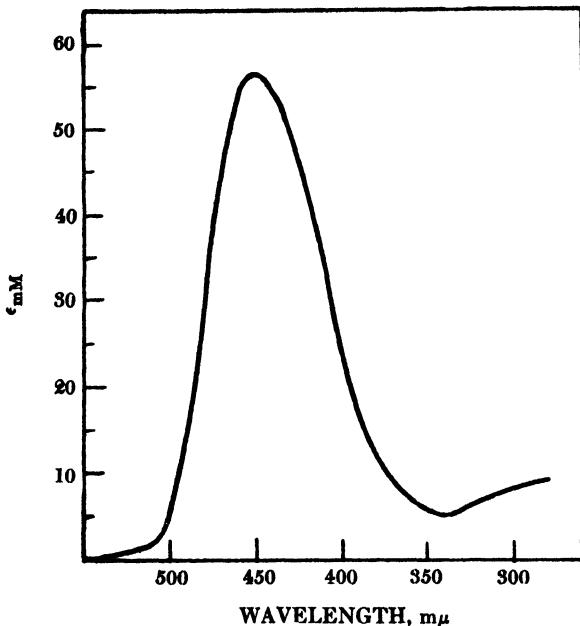



Fig. 13. Absorption curve of bilirubin in chloroform (after Heilmeyer, 1213).

hydroxyl pyrromethenes with saturated side chains; it lies much nearer the ultraviolet than that of nonhydroxylated pyrromethenes (2190).

TABLE V
Absorption Spectra of Bilirubins

| Substance | Solvent | Absorption maximum | | Reference |
|---------------|------------------|--------------------|-----------------|-------------------------------|
| | | m μ | ϵ_{mM} | |
| Bilirubin | Chloroform | 450 | 55-56 | 1205, 1213, 1223, 1243, 1999- |
| | Alcoholic alkali | 450 | Weaker | 2001 |
| | Aqueous alkali | 420-440 | Still weaker | |
| | Cholic acid | 420 | Low | 1213, p. 153 |
| Mesobilirubin | Chloroform | 425 | 61.4 | 1213, p. 164 |
| | Dioxane | 426 | 70.8 | 2190 |

Complex salts. It is doubtful whether metal complexes of rubins exist; the green "bilirubin Cu complex salts" of Küster (1607,1608) are evidently compounds of biliverdin and of biliviolinoid oxidation products of bilirubin. Fischer found no complex salt formation of bilirubin with zinc (778). The addition of zinc acetate to ammoniacal solutions of bilirubin appears to produce a color change, but this has not yet been studied in detail. Certainly no fluorescent zinc complexes are formed. According to Siedel and Fischer (2554) the dimethyl ethers of α -hydroxypyrrromethenes and of mesobilirubin form, however, complex salts. One can again conclude from this that in

mesobilirubin the rings I and IV are present in the lactam form  and thus no tertiary nitrogen is available to coordinate with the metal, while in the ethers the lactim form  is fixed and thus two tertiary nitrogen atoms which are able to coordinate with the metal are present (1690).

4.5. Surface Properties and Adsorption

The spreading of bilirubin on water has been mentioned in Section 1.4. Bilirubin is bound to serum albumin, not to egg albumin (215,2132), completely at pH 7.2, incompletely at pH 8.2 (2623). The penetration of bilirubin into cholesterol, octadecylamine, and protein monolayers has been studied by Stenhagen and Rideal (2622). In the protein monolayers no specificity was found, rigid tanned layers being formed with all proteins at pH 7.2. The authors conclude that bilirubin, like the porphyrins, is bound to the ϵ -amino groups of lysine. Serum albumin contains much more lysine than egg albumin and the ϵ -amino groups of egg albumin are assumed to be inaccessible in the native protein owing to interaction with its own carboxylic acid groups, while in the monolayers they become uncovered. The authors observe that the penetration of bilirubin into monolayers of cholesterol is faster at lower pH, while the reverse is true for its penetration into octadecylamine. This, they assume, may explain why a low pH favors stone formation in the bile. Increasing acidity would decrease the interaction of bilirubin with a carrier of amine nature in the bile (Pedersen), but would increase its interaction with cholesterol. It would also decrease the solubility of bilirubin.

5. BILADIENES-(a,b) AND RELATED SUBSTANCES

5.1. Biliviolinoid Substances

By a great variety of methods a class of bile pigments can be obtained which have the following striking properties in common: they are readily dissolved in neutral organic solvents to give red to red-violet solutions; in mineral acids their solutions are violet to

blue-violet, with a strong absorption band in the orange to yellow parts of the spectrum; their zinc complex salts are green to blue with a remarkably strong red fluorescence, a strong absorption band in the orange, and a weaker one in the yellow. Such compounds have been obtained:

- (a) by ferric chloride oxidation of mesobilane and mesobilene (858,1673, 1678-1680,1690,2550);
- (b) from mesobilane with copper salts as copper complexes (777;800;861, p. 691; 1673);
- (c) as prosthetic groups of phycocyanin of algae (1673,1690);
- (d) from feces and urine (861, p. 654; 1995;2971-2973);
- (e) by synthesis (2550);
- (f) from the blue to violet stages of the Gmelin reaction or by oxidation of bilirubins and biliverdins by nitrous acid (1680,1688,2552,2555,2556);
- (g) by bromine oxidation of bilirubins (859,1269,2556);
- (h) by treatment of bilirubins or biliverdins with iodine in the presence of zinc acetate (97,174,1680,1679,1711);
- (i) from bilirubins and biliverdins with cupric salts (859,1605,1607,1673, 1681);
- (j) from biliverdins with quinone in alcohols (870);
- (k) from oxidized verdohemochrome or choleglobin (1681,1712);
- (l) from biliverdin by the action of oxygen liberated from oxyhemoglobin by acids (1686);
- (m) by action of light on porphyrin sodium complex salts (804).

We know now, particularly through the work of Siedel (2550,2552, 2553,2555,2556), that two main classes of biliviolinoid pigments exist. The substances obtained by methods enumerated under *a-d* are biladienes-(a,b), in fact always mesobiladiene-(2'a,5'b) (Fig. 14),

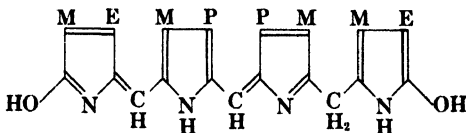

Fig. 14. Mesobiladiene-(2'a,5'b); mesobiliviolin.

while those under *e-m*, mainly formed by oxidation of rubins or verdins, are products containing more oxygen, such as biladiene-(a,b)-ones-(c), biladiene-(a,b)-diols or related substances (*cf.* Section 2.4. and Table III).

Nomenclature. Siedel calls the former biliviolins, the latter bilipurpurins and has separated mesobiliviolins from mesobilipurpurins by chromatography. (The name "bilipurpurin" has been used before for the substance now

called phylloerythrin (1770). The difference in color between the two classes is by no means always as distinct as the names "violins" and "purpurins" would indicate, and the bilipurpurins again comprise several structural types, the first of which were observed by Lemberg and Lockwood (1711). Hence Lemberg (1771,1712) used the terms biliviols type I for Siedel's biviols, and biliviols type II and type III for two distinct types of bilipurpurins. Meanwhile, still other types of bilipurpurins have been found by Siedel and co-workers. Since only biliviolinoid mesobiladienes have been found so far in nature, and the various types of biliviolinoid oxidation products have only been obtained in the test tube, and since no simple chemical names are available, it simplifies matters to refer to Siedel's nomenclature. Both biliviols and bilipurpurins are again summarized under the term "biliviolinoid substances" which should be used to describe any natural product of still unknown structural type which possesses the spectroscopic properties of biliviols.

5.2. Mesobiliviolin (Mesobiliviolin Type I, Lemberg)

5.2.1. Structure. The "mesobiliviolin" obtained by Fischer and Niemann (858) by oxidation of mesobilane with ferric chloride was a complicated mixture, in which Lemberg (1673,1680,1690) established the presence of mesobilene-(b), mesobilierythrin, and mesobiliverdin in addition to mesobiliviolin. When its solution in chloroform-ether (1:1) is passed through a column of talc, the violet ring of mesobiliviolin migrates in front of the red ring of mesobilierythrin (Siedel,

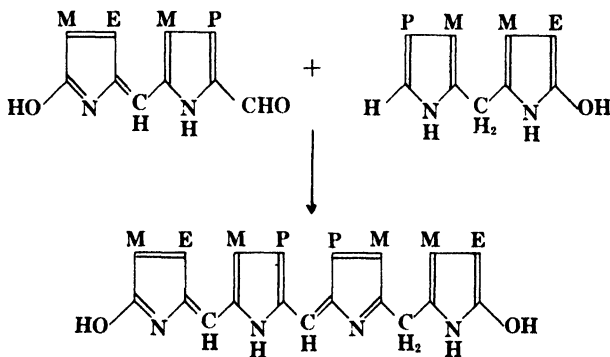

Fig. 15. Synthesis of mesobiliviolin (Siedel).

2550). Siedel thus isolated mesobiliviolin. He also synthesized it by condensation of formylneoxanthobilirubinic acid with isoneobilirubinic acid (Fig. 15). Since oxidation of the methylene groups of

mesobilane can occur at b and c quite as well as at a and b, the product obtained from mesobilane is probably a mixture of side chain isomerides. Other side chain isomerides with a different order of side chains have also been synthesized by Siedel (2559).

By reduction of their "mesobiliviolin" Fischer and Niemann (858; 861, p. 709) obtained "mesobiliviolinogen" which they found to differ from mesobilane. Siedel and Möller (2559), however, showed that mesobiliviolin yields mesobilane on reduction. On catalytic hydrogenation, mesobiline-(a) was obtained (reduction of methene group b to methylene) in agreement with Siedel's formula. The transformation to mesobilirubin (mesobiladiene-(a,c)) by zinc in glacial acetic acid (2552) is, however, not easily explained by this formula; it would require an isomerization with shift of hydrogen from the methylene group at c and pyrrole ring IV to the methene group b and pyrrole ring III. The formula would lead us to expect a spectroscopic similarity to tripyrrodienes. Similar tripyrrodienes with one α -hydroxyl group and bromide or CO_2Et in α' have indeed been found (Fischer and Reinecke, 871; Siedel, 2553). Its relatively strong basicity is accounted for by the true pyrroline ring III. It is extracted completely from ether by 0.1 *N* hydrochloric acid. So far decent crystals of the substance or of its hydrochloride have not yet been obtained, probably because it is a mixture of isomerides (*cf.* Sect. 2.4.).

TABLE VI
Colors and Absorption Spectra of Mesobiliviolin
and Its Zinc Complex Salt

| Compound | Solvent | Color | Absorption maximum | |
|---------------------------------|---------------------------------------------|---------------------------------------|-------------------------|--------------|
| | | | $m\mu$ | cmM |
| Mesobiliviolin | Chloroform | Red-violet | 570 (diffuse) | |
| Mesobiliviolin hydrochloride | Chloroform shaken with 0.02 <i>N</i> HCl | Blue (in artificial light, violet) | 607 | 21.3 |
| | 0.1 <i>N</i> aqueous HCl | Blue | 598 | |
| Mesobiliviolin- zinc | Methanol | Blue | 625, (575) ^a | |

^a Siedel (2550) found the bands at 630 and 573 $m\mu$. The position varies somewhat with pH and concentration of ammonia, and also, since the bands are not symmetrical, with the concentrations of the pigment, if measured spectroscopically; admixture of mesobiliverdin shifts the bands toward the infrared.

5.2.2. Absorption Spectra and Complex Salts. In Table VI colors and absorption maxima of solutions of mesobiliviolin in various

solvents and of its zinc complex salt are summarized. The absorption curve of the zinc complex salt is very similar to that of a mesobilipurpurin given in Figure 21.

The zinc complex salt possesses an exceptionally strong red fluorescence. The copper complex has a similar absorption spectrum and color, but does not fluoresce. A fluorescent mercury complex has been described by Dhéré and Roche (584,585), but the preparation which they studied was the "mesobiliviolin" mixture of Fischer.

It is easy to differentiate the red fluorescence of mesobiliviolin-zinc from that of porphyrins. Mineral acids decompose the zinc complex and destroy its fluorescence, while porphyrins fluoresce in acid solution.

5.2.3. Occurrence of Mesobiliviolin in Nature. Certain red and blue algae (*cf.* Section 7) contain a blue chromoprotein, phycocyanin, which may be obtained crystalline. Lemberg (1673) first isolated a bile pigment from phycocyanin by heating with concentrated hydrochloric acid at 80°C. in the absence of air. He named the pigment "phycocyanobilin." By splitting the protein in boiling 10% methyl alcoholic alkali, mesobiliverdin was obtained. This fact, together with the other properties of the bile pigment, led Lemberg to identify it with mesobiliviolin (1690). Analyses gave the empirical formula $C_{34}H_{44}O_8N_4$ for phycocyanobilin, while for mesobiliviolin a formula $C_{33}H_{40}O_6N_4$ would be expected, but Lemberg emphasized at that time that noncrystalline bile pigments usually give too high oxygen values.

Siedel (2550) and Fischer (861, p. 733) suggested that phycocyanobilin may be a proto, not a meso, compound. Under the conditions of the formation of mesobiliverdin from phycocyanin, however, biliverdin is not transformed into mesobiliverdin. Later (2553) Siedel confirmed the identity of phycocyanobilin with mesobiliviolin. A purpurin structure is ruled out by the fact that ferric chloride oxidizes phycocyanobilin into mesobiliverdin (diene \rightarrow triene) (1688).

Occurrence in feces. The "copromesobiliviolin," later more suitably called mesobiliviolin, isolated by Watson from normal human feces (2971-2973), is probably the same substance. It can be occasionally observed as by-product of fecal porphyrin (1688,2837). Fischer and Halbach (822) did not find it in feces, whereas Baar and Hickmans (107) occasionally found it in large amounts. In view of the ease with which mesobilane is oxidized to mesobiliviolin (*cf.* below), the latter is probably not preformed in feces but arises by oxidation of mesobilane. Thus Watson (2995) observed mesobiliviolin formation if mesobilane in hydrochloric acid solution was exposed to air and found that the yield from feces became small when the extraction

procedure was accelerated. In contradistinction to Watson (2989, p. 2488) however, we have not observed mesobiliviolin formation from tetrahydro-mesobilane (*cf.* below). Hoesch (1301) had already observed that some urines form biliviolin when treated with ferric chloride, while others do not. The biliviolinoid pigments observed in dog bile (199), in gallstones (833) and in gastric juice (1467) are almost certainly secondary oxidation products of bilirubin.

5.3. Mesobilierythrin (Lemberg), Mesobilirhodin (Siedel), and Phycoerythrobilin

This type of red bile pigment was first obtained by Lemberg (1690) as the prosthetic group of phycoerythrin (*cf.* Section 7) and called *phycoerythrobilin*. It could be obtained only in the form of its chloroform-soluble methyl ester, which probably still contained a small peptide chain. A spectroscopically identical compound was shown to occur in the "mesobiliviolin" mixture obtained from mesobilane or mesobilene-(b) by ferric chloride oxidation, and named mesobilierythrin (1690).*

Treatment with ferric chloride in hydrochloric acid transformed it into mesobiliviolin and from this it was concluded that mesobilierythrin represented an oxidation stage between mesobilene-(b) and mesobiliviolin. The fact that on heating with alkali in methanol phycoerythrin yielded a mixture of mesobiliverdin and mesobilirubin, while phycocyanin gave only the former (1690), supported the assumption that phycocyanobilin (mesobiliviolin) was an oxidation product of phycoerythrobilin. If mesobiliviolin is a biladiene, this cannot be correct, since there is no other stage of dehydrogenation available between bilene and biladiene. Mesobilierythrin must then be an unstable isomeride of mesobiladiene, which on heating with acid alone is isomerized. The faster change of color to blue on heating in acid in the presence of air may be due to further oxidation of the mesobiliviolin to mesobiliverdin.

Siedel separated the compound from the "mesobiliviolin" mixture by chromatography and called it "mesobilirhodin" (2550). He also obtained it by synthesis from formylneobilirubinic acid and isoneoxanthobilirubinic acid (Fig. 16). According to this, mesobilierythrin is an isomeride of the mesobiliviolin (Fig. 17), differing from it only in the position of one double bond (5'b in the violin, 4'b in the erythrin). One may ask whether the erythrin formula of Siedel might not just represent a resonating form of this violin, if one assumes hydrogen linkage between the nitrogen atoms (*cf.* Fig. 18). We have seen in Chapter III, Section 6.3., that no reliable evidence for

* Siedel has given as the reason for his altering the name erythrin to rhodin that the former was used for the prosthetic group of phycoerythrin. This is not so; it had, in fact, been given to the product obtained by oxidation of mesobilane which forms a component of Fischer's "mesobiliviolin" mixture.

such prototropic isomerism has been found. Moreover, not only violins and erythrins differ spectroscopically, but also their hydrochlorides and complex salts. This kind of isomerism has been found neither in the bilene-(b)

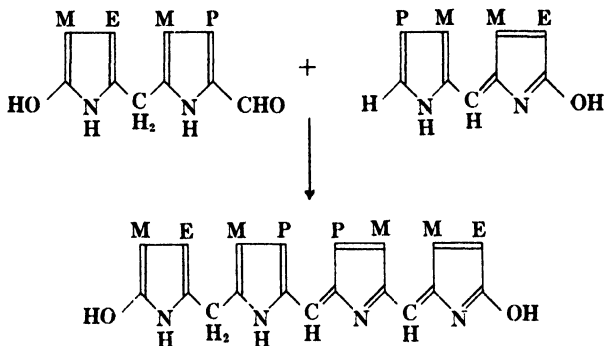

Fig. 16. Synthesis of mesobilerythrin (Siedel).

nor in the bilatriene series (*cf.* 861, p. 701). In the present case, matters are complicated by the presence of a resonating tripyrrolic system (rings II, III, and IV), substituted nonsymmetrically on one side only by a pyrrol-

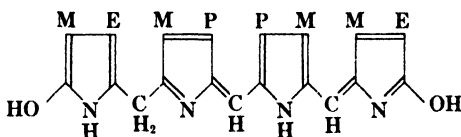

Fig. 17. Mesobiliviolin, differing from mesobilerythrin only in position of double bonds.

methyl group. In the bilene-(b) series only rings II and III, in the bilatriene series all four rings, form the resonating system. While it is impossible to state that in such a case isomerism could not occur, it must be considered

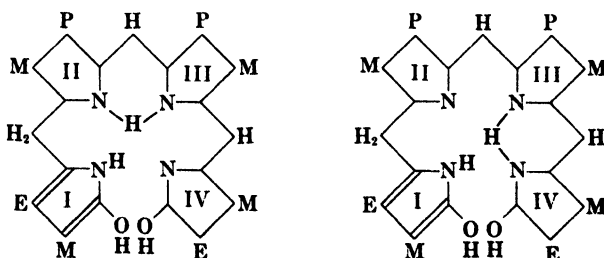

Fig. 18. Siedel's violin and erythrin formulas as resonance forms.

doubtful. The spectroscopic and other properties of mesobilerythrin resemble those of mesobilene-(b) more closely than those of mesobiliviolin. Like mesobilene-(b) it is more hydrophilic than mesobiliviolin and passes from ether into 0.1% acetic acid. For this reason a dehydromesobilene-(b) formula (Fig. 19) should be considered. This formula satisfactorily explains

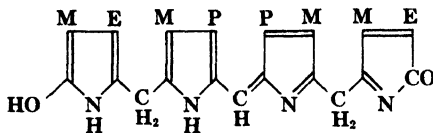

Fig. 19. Structure suggested for mesobilerythrin.

the formation of mesobilerythrin from mesobilane and mesobilene-(b) by oxidation and its isomerization to mesobiliviolin. Siedel's synthesis, which gives mesobilerythrin in poor yield, can hardly be considered certain evidence for the structure, but the oxidation of mesobilene-(a) to mesobilerythrin by nitrous acid or autoxidation (2552,2559) cannot be satisfactorily explained with the formula of Figure 19. The problem of the structure of erythrins must therefore remain open.

Properties. In the chromatogram the red ring of mesobilerythrin migrates before the violet ring of mesobiliviolin (2550). No pure crystalline preparation has yet been obtained. The position of the absorption maxima of solutions of mesobilerythrin and of its zinc complex are summarized in Table VII.

TABLE VII
Color and Absorption Spectra of Mesobilerythrin
and Its Zinc Complex Salt

| Compound | Solvent | Color | Absorption maximum, $m\mu$ | Ref. |
|-----------------|------------------------|-------------------------------------------|------------------------------|------|
| Mesobilerythrin | Chloroform | Red | Diffuse band in the green | 1690 |
| Hydrochloride | Chloroform plus HCl | Red-violet | (605), (557), 497 | 2550 |
| | 5% HCl | Red-violet | 560, 495 | 1690 |
| Zinc complex | Methanol | Pink; greenish- yellow fluorescence | (630), 509 | 1690 |

5.4. Bilipurpurins [Biladiene - (a,b) - ones - (c)] and Related Substances

5.4.1. *Structure.* Siedel and Fischer (2554) still assumed these substances to be isomerides of bilatrienes. Lemberg (1679) demonstrated, how-

ever, that two atoms of iodine were required for the oxidation of biliverdin-zinc to bilipurpurin-zinc. He assumed for (what we now call) bilipurpurins a structure of dehydrobilatrienes, while Fischer and Reinecke (870) formulated similar substances obtained by oxidation of biliverdins with quinone in methanol as dimethoxybilatrienes with methoxyl on the carbon atoms between pyrrole nuclei. The correct mechanism of the reaction has been demonstrated by Siedel (*cf.* Section 2.4.) but the structure of the various types of compounds in this class cannot yet be considered finally established. Later work of Siedel and co-workers and of Lemberg and Lockwood then revealed how complicated these reactions are. These investigations, carried out during the war in Germany and Australia, have still to be correlated.



Siedel and co-workers (2553,2555,2556) studied the oxidation of symmetrically substituted mesobiliverdin XII under various conditions, and isolated a variety of purpurins by chromatography, some in crystalline state. In some instances the substances were pure enough for analysis, in others they were characterized only by the position of the absorption maximum of their zinc complex, which is not a satisfactory criterion (*cf.* footnote to Table VI).

Lemberg and Lockwood (1711, *cf.* also 1681,1712,2666) showed that the mesobilipurpurin and bilipurpurin produced by the oxidation in methanol with two atoms of iodine per mole of the corresponding biliverdin zinc complexes (bilipurpurins type I, then called bilivolins type II, *cf.* Section 2.4.) were unstable. In the presence of air they underwent autoxidation to weakly basic bilipurpurins type II (then called bilivolins type III), while under nitrogen they isomerized to yellow compounds (bilichrysin)s.* The latter could be obtained crystalline and the analyses showed that their tetrapyrrolic system contained three oxygen atoms in addition to the four oxygens present in the two carboxylic acid groups. The scheme of Figure 20 may be tentatively suggested for these reactions.

5.4.2. Properties. In view of the confusing variety of similar compounds and the fact that they have so far not yet been found in nature, we restrict ourselves to describing only some of their main characteristics.

The absorption spectra of purpurin solutions in aqueous hydrochloric acid and those of the zinc complex salts in methanol are practically indistinguishable from those of violins (*cf.* Table VI). The absorption curve of mesobilipurpurin I-zinc (formed from mesobiliverdin-zinc with iodine in methanol) is given in Figure 21. The fluorescence spectrum of this compound has been studied by Dhéré (570); it shows only one emission band lying toward the infrared of the first absorption maximum. Both as zinc complex and as hydrochloride mesobilipurpurin I shows only weak absorption bands in the ultraviolet (1324). Bilipurpurins are able to form hemochromes (1681). The absorption maxima of the protobilipurpurin-zinc complexes

* Siedel and Fröwis (2555) obtained apparently similar substances by reduction of bilipurpurins with zinc dust in acetic acid. In our experiments reduction was

excluded. The compounds of Siedel and Fröwis probably contain the  grouping instead of the  groupings of the chrysin.

lie 10 μ more toward the infrared than those of the corresponding meso compounds.

Mesobilipurpurin I can be distinguished from mesobiliviolin as well as from mesobilipurpurin II by the behavior of its chloroform solution toward

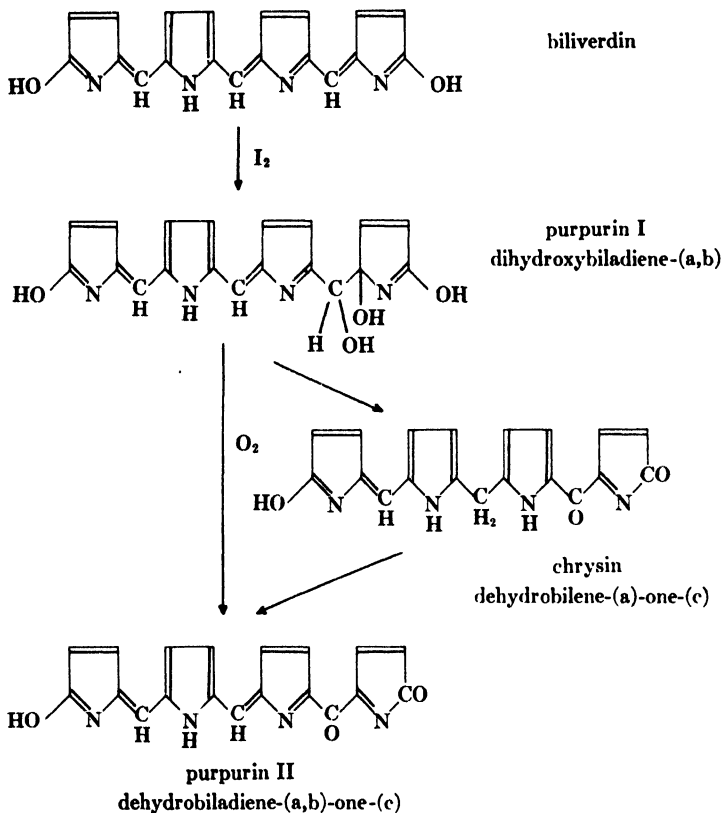

Fig. 20. Bilipurpurins and bilichrysin.

aqueous hydrochloric acid. Shaking with 1% hydrochloric acid transforms mesobiliviolin into its hydrochloride, which remains in the chloroform phase with blue color; it extracts mesobilipurpurin I from the chloroform as red-violet hydrochloride and leaves mesobilipurpurin II in the chloroform as neutral compound. Shaking the chloroform solutions with hydrochloric acid of different concentrations appears to be a suitable test for differentiation of bilipurpurins (1712). A curious phenomenon is the favoring of the hydrochloride formations in the chloroform phase by an increase of temperature. Probably higher temperature favors the formation of an unstable, more strongly basic tautomeric form in equilibrium with a less basic form.

Mesobilipurpurin II differs from mesobiliviolin also in its double-banded spectrum (544,501 $m\mu$) in neutral chloroform solution which is of orange-red color. As compared with mesobilipurpurin I the absorption band of the zinc complex lies more toward the ultraviolet (619 $m\mu$ as compared with 623 $m\mu$).

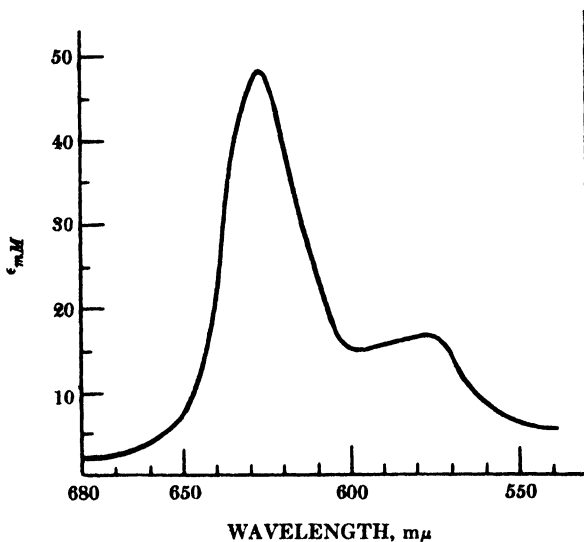

Fig. 21. Absorption curve of mesobilipurpurin-zinc in methanol.

The mesobilipurpurin "622" of Siedel and Fröwis (2555) appears to resemble our mesobilipurpurin II, while compounds corresponding to our mesobilipurpurin I may have been obtained by bromine or quinone oxidation of mesobiliverdin (870,2556). The present data however, allow no clear conclusions.

5.4.3. Bilichrysin. *Mesobilichrysin* has been obtained in pure crystalline form. Its analysis indicated the formula $C_{33}H_{38}O_7N_4$. Sodium amalgam gave mesobilane, while oxidation with ferric chloride or autoxidation in ammoniacal solution in the presence of zinc salt yielded mesobilipurpurin II. The yellow needles have a melting point of $240^\circ C$. The absorption curve in alcohol with 0.02% ammonia shows an absorption band at 416 $m\mu$ ($\epsilon_{mM} = 40.5$) and a weaker band at 311 $m\mu$ ($\epsilon_{mM} = 23$) (1324).

Bilichrysin was also prepared in crystalline form. It has no definite melting point.

The yellow color of the chrysin indicates interruption of the conjugated system in the center (cf. Section 2.3.), which is in agreement with the formula suggested in Figure 20.

5.4.4. Bilierythrinoid Oxidation Products of Bilatrienes. Bilierythrinoid pigments may also occur among the oxidation products of bilatrienes,

e.g., in the Gmelin reaction. Siedel and Möller (2559) have prepared such a compound ("oxorhodin") by ferric chloride oxidation of "oxourobilin" (bilene-(b)-one; Fig. 22).

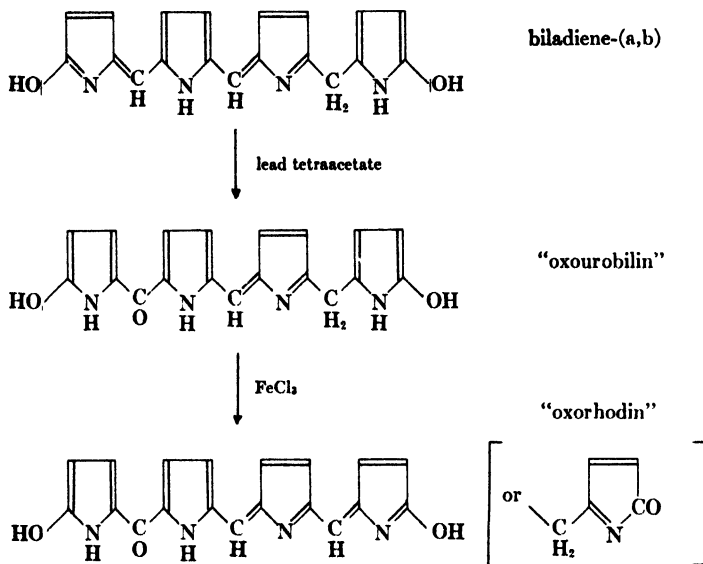

Fig. 22. Bilierythrinoid oxidation product of bilatriene.

6. BILANES, BILENES, AND RELATED SUBSTANCES

6.1. Occurrence of Mesobilane and Tetrahydromesobilane and the Corresponding Bilenes in Feces and Urine

In 1868 Jaffé (1408) described a pigment from bile and urine which he called urobilin, and which he obtained from feces a year later. It has been found to occur normally in feces, and in small amounts in normal urine, while larger quantities occur in pathological urine. The fecal urobilin was later named stercobilin by van Lair and Masius (1633), but since it is now known that fecal urobilin is the source of urinary urobilin, one of the names urobilin or stercobilin is redundant.

Le Nobel (2057) found that urobilin occurred as a chromogen, which he called urobilinogen, and which is readily oxidized to urobilin, while Neubauer (2042) discovered that urobilinogen was the chromogen which gave the Ehrlich aldehyde reaction (652). For a long time afterward it was assumed that the substance occurring in

urine and feces was only the chromogen, and that urobilin and stercobilin arose from it by oxidation during the extraction. Heilmeyer, however, has observed the urobilin absorption spectrum in quite fresh urines not previously exposed to light (1225); it is therefore probable that both the chromogen and the oxidized form of the pigment are present.

Jaffé had reduced bilirubin to a urobilin-like substance, which was later studied by Maly (1855,1856) and called "hydrobilirubin." It may be described today as impure mesobilene-(b). Many early investigators studied urobilin from various sources (*e.g.*, normal and pathological urine), and endeavored to determine its relation to "hydrobilirubin." Since, however, none of their preparations was pure, and since complicating factors such as complex salt formation were then still unsuspected, the results were contradictory and confusing. From reading MacMunn's work (1839) on the differences between "normal" and "febrile" urobilin, for instance, one gains the impression that he was largely misled by impurities such as porphyrins (this was pointed out by Hopkins, 983,1333), and by the vagaries of unintentional complex salt formation, but that in a few cases he did observe a true difference. Although a difference between the nitrogen content of urobilin and "hydrobilirubin" claimed by Garrod and Hopkins (983,1334) was shown later by Fischer to be due to impure urobilin, the earlier workers also described spectroscopic differences and differences in oxidizability, which Fischer disregarded, but which were later confirmed.

The problem appeared to be solved after Fischer isolated mesobilirubinogen (mesobilane) from several pathological urines (778,853, *cf.* also 2982) and showed it to be identical with mesobilane prepared from bilirubin. Fischer claimed that urobilinogen was identical with mesobilirubinogen, and that urobilin was a hopelessly complicated mixture of oxidation products. This view received general acceptance, and even today, more than twelve years after it became clearly recognized as less than half the truth, it is found in practically every textbook of physiology and in most textbooks of biochemistry.

In 1920, Eppinger (697) considered it unfortunate that Fischer did not investigate the fecal stercobilinogen and stercobilin. The omission was remedied in 1932, when Watson, working in Fischer's laboratory, isolated pure stercobilin (*cf.* above). Lemberg's ferric chloride oxidation test (in 1934) demonstrated a clear differentiation between "stercobilinogen" and mesobilane, and showed that most urines con-

tained little, if any, of the latter (1713). Heilmeyer (1218) and Watson (2981) meanwhile isolated "stercobilin" from urine. Its constitution as tetrahydromesobilene was established by Fischer (Section 6.3.1.).

In spite of this, the claim that mesobilane and urobilinogen are identical, was never clearly abandoned by the Fischer school (*cf.* Siedel, 2553). The confusion was hidden behind a nomenclature which distinguished between "stercobilin" and "stercobilinogen" on the one hand and urobilin, mesobilene-(b), and urobilinogen, mesobilane, on the other, although this differentiation was in evident contradiction to the intestinal origin of urinary urobilinogen and urobilin, which was now well known (*cf.* Chapter XI).

By the ferric chloride test and by spectroscopy, Lemberg and collaborators (1713; *cf.* also Baumgärtel, 194) found that no normal urines and only a few pathological urines contain more than 20% of the total urobilinoids as mesobilene. Watson found that all urines containing abnormal amounts of urobilin were levorotatory, due to the presence of the strongly levorotatory "stercobilin" (2989, p. 2484). He isolated mesobilane as well as "stercobilin" from normal feces. It thus appears that both substances are about equally absorbed from the intestine (2995). The sensitive copper test for mesobilane (formation of copper-biliviolin, 777) also indicates the presence of some mesobilane in most urines (845). Müller observed as early as 1893 that the zinc biliviolin bands appear "nicht ganz selten," if extracts of human feces in ammoniacal zinc salt solution stand exposed to the air (1995). The latter two tests, however, are not quite conclusive since they are given by bilirubin, which may have been present in the urines.

It has now become clear, then, that both feces and urine contain the two urobilinogens, mesobilane and tetrahydromesobilane and the two urobilins, mesobilene and tetrahydromesobilene (*cf.* Table VIII), but the tetrahydro compounds usually prevail. A third urobilinogen should exist, corresponding to the *d*-urobilin described below.

The problem of the formation of the urobilinogens and urobilins from bilirubin will be discussed in Chapter XI.

6.2. Mesobilane and Mesobilenes

6.2.1. Structure. Bilanes are the colorless chromogens of the bile pigments (*cf.* Tables II and VIII). They are very weakly basic compounds, the proton being added to the pyrrole ring with a *pK* of

about -2 (474).^{*} Lacking tertiary nitrogens they form no complex salts. They are easily autoxidizable. On condensation with *p*-dimethylaminobenzaldehyde they are converted into red pigments. The nature of this "Ehrlich aldehyde reaction" is not yet understood (861, p. 716).

TABLE VIII
Urobilinogens and Urobilins

| | | |
|---------------------------|---|-----------------------------------------------------------------------------------------------------------------------------------------|
| Mesobilane | | Mesobilirubinogen (leuco compound of mesobilirubin and bilirubin) "Urobilinogen" (normally smaller part of uro- and stercobilinogen) |
| Tetrahydro-mesobilane | | "Stercobilinogen" (normally larger part of uro- and stercobilinogen) |
| Mesobilene-(b) | | "Urobilin-IX α " (normally smaller part of uro- and stercobilin) |
| Tetrahydro-mesobilene-(b) | | "Stercobilin" (normally larger part of uro- and stercobilin, levorotatory) |
| ? | ? | <i>d</i> -Urobilin (dextrorotatory) |

The autoxidation of bilanes leads to the corresponding bilenes-(b), urobilinoid pigments. The correct formula for mesobilene-(b) was suggested by Lemberg (1677,1678) on the basis of the fact that ferric chloride oxidation yielded bilatriene but not biladiene-(a,c) (rubin), which contains methylene in the b position, and also on the basis of their similarity to pyromethenes. The structure was finally established by the synthesis of mesobilene-(b) ("urobilin IX α ") by Siedel (2550) from formylneobilirubinic acid and isoneobilirubinic acid (Fig. 23).

Ferric chloride oxidizes mesobilene-(b) to mesobilerythrin, mesobiliviolin, and mesobiliverdin (1677,1680,1690), while nitric acid

^{*}This association of pyrrole with proton must be distinguished from the dissociation of pyrrole as proton donor with a *pK* value of 16 (cf. Chapter III, Section 3.2).

destroys the flanking hydroxypyrrrole rings so that the Gmelin reaction is negative. Synthetic bilenes-(b) with methyl instead of hydroxyl groups in the α -position give the Gmelin reaction (843).

The bilenes-(b) form stable hydrochlorides and zinc complex salts with green fluorescence similar to those of α,α' -dimethylpyrromethenes (878;861, p. 7).

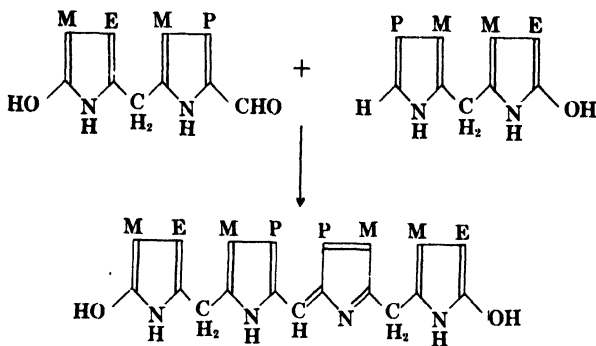

Fig. 23. Synthesis of mesobilene-(b).

Mesobilene-(b) and tetrahydromesobilene-(b) are more hydrophilic than the other bile pigments. This is probably due to their relatively strong basic character, as a result of which the pK values as base and as carboxylic acid are less than two pH units apart. Thus the substances are partly ionized even at their isoelectric point, while most other bile pigments have an isoelectric zone at which they are unionized.

Mesobilene-(a) (cf. Table II) has been obtained as the product of incomplete catalytic hydrogenation of mesobilirubin (addition of two hydrogen atoms at the methene group c of mesobiladiene-(a,c). It has therefore been called dihydromesobilirubin, a name which must not be confused with dehydromesobilirubin (mesobiliverdin). The autoxidation or ferric chloride oxidation of mesobilane begins with the oxidation of the methylene group b and hence leads to mesobilene-(b), not to mesobilene-(a). Mesobilene-(a) gives no Gmelin reaction, but the Ehrlich aldehyde and diazo reactions are positive. Ferric chloride oxidizes it to a red compound (mesobilierythrin?). It does not form a fluorescent zinc salt.

6.2.2. Properties of Mesobilane and Mesobilene-(b). *Mesobilane* (*mesobilirubinogen*, *urobilinogen A* of Watson) was prepared by Fischer as a colorless crystalline substance of melting point $197-202^{\circ}\text{C}$.

by sodium amalgam reduction of mesobilirubin and by catalytic hydrogenation of bilirubin or mesobilirubin (776,778,852).

The condensation product with *p*-dimethylaminobenzaldehyde has an absorption maximum found by most authors at 555–557 $m\mu$ (Heilmeyer, Turner, Niemann), while Watson observed it at 560–565 $m\mu$. $\epsilon_{mM}^{557} = 64.5$ (1213, p. 215; 1608).

Mesobilene-(b) (*urobilin IX α* of Siedel, *K-urobilin* * of Watson) has been obtained crystalline by Watson (2980–2982), Siedel (2550,2557) and Fischer (822). Rather pure preparations had previously been obtained by Terwen (1735). It crystallizes from chloroform or acetone in orange-red needles or prisms. A melting point of 190°C. is reported by Watson and by Fischer and Halbach for natural mesobilene-(b), while Siedel gives 177°C. for the synthetic substance. The hydrochloride crystallizes from chloroform in small rectangular or boat-shaped, orange-red crystals of melting point 190–200°. The substance is optically inactive.

Absorption spectra and complex salts. As would be expected from the fact that resonance cannot occur beyond the two central pyrrole rings, the absorption spectrum of mesobilene-(b) is similar in character to that of α,α' -dimethylpyrromethenes, the bands lying, however, about 10 $m\mu$ toward the red. The band shift on hydrochloride-formation, 40 $m\mu$ toward the red, is the same in both classes. Table IX summarizes the absorption spectra of mesobilene-(b), its hydrochloride, and its zinc complex salt.

Heilmeyer observed an "alkaline" absorption curve with the maximum at 510 $m\mu$ which gradually developed from an initial curve with an indistinct maximum at 450 $m\mu$. Obviously the initial curve is the true "alkaline curve" while the former is that of a complex salt. With the very dilute solutions of urobilin used in spectrophotometry, very small amounts of metal from solvent, glass, or metal rings of spectrophotometer cups suffice to form complex salts, and this has confused many earlier observers. In fact urobilinoids can be used as microchemical reagents for copper or zinc (252).

By complex salt formation the absorption band is shifted about 60 $m\mu$ toward the red. The zinc complex salts of urobilinoid substances were observed by the first investigators owing to their extremely strong green fluorescence and are used for the recognition of urobilins in the Schlesinger reaction. They are easily decomposed by dilute acids with disappearance of the fluorescence. In this way

* The term *K-urobilin* is, however, used by the Fischer school to denote a mixture of side chain isomerides of mesobilene-(b) in contradistinction to mesobilene-(b) *IX α* .

the fluorescence of urobilin-zinc can be readily differentiated from the green fluorescence of other substances or drugs which may be found in urine or feces (*e.g.*, atebtrin). As in the porphyrin series the similar urobilin-copper complexes do not fluoresce.

TABLE IX
Absorption Spectra of Mesobilene-(b) and Its Compounds

| Compound | Solvent | Absorption maximum | | Reference |
|-----------------------------|-----------------------|--------------------|-------------------|---------------------------------------------|
| | | m μ | ϵ_{mM} | |
| Mesobilene-(b) (neutral) | Dioxane | 452 | 25.1 | Pruckner and Stern, 2190 |
| | | 330 | 3.6 | |
| Hydrochloride | Alcohol | 490 ^a | 50.1 | Lemberg, 1677, <i>cf.</i> also Watson, 3001 |
| | | 375 | 7.4 | |
| | 3% HCl in methanol | 494 ^a | 46.7 ^b | |
| Zinc complex | methanol | 509.5 ^c | | Lemberg, 1677 |

^a Band position measured by Pruckner and Stern spectrophotometrically, by Lemberg with the Hartridge Reversion Spectroscope. Lemberg and co-workers (1713) found the position of the main band 492.5 m μ in the visual spectrophotometer, 490.0 m μ in the ultraviolet spectrophotometer.

^b Sample amorphous, but evidently nearly pure. Heilmeyer (2390; 1213, p. 209) observed far lower and very varying values (11.2 to 32) for ϵ_{mM} , probably because of partial dissociation and (in aqueous solution) formation of a colloidal solution in the medium which did not contain excess HCl.

^c In the presence of ammonia: 506 m μ .

6.3. Tetrahydromesobilane (Stercobilinogen, Urobilinogen B) and Tetrahydromesobilene-(b) (Stercobilin)

6.3.1. Structure. Tetrahydromesobilene-(b) was isolated from feces as pure crystalline hydrochloride by Watson (2970, 2972-2974) and called stercobilin. The first analyses indicated a formula with eight oxygen atoms. Heilmeyer and Krebs (1218) claimed that reduction of stercobilin yielded mesobilane. Watson found, however, that no crystalline mesobilane could be obtained by reduction of stercobilin, and Lemberg (1677) first showed clearly that stercobilinogen differed from mesobilane. By ferric chloride, stercobilinogen was oxidized only to stercobilin, while mesobilane yielded mesobiliviolin and mesobiliverdin. This was later confirmed by Watson (2981) and Fischer (823). To explain these results Lemberg in 1934 assumed a mesobiledione formula which was based on the O₈ formula. Again the analyses of the incompletely purified substance

had given too high oxygen values. Later analyses of Heilmeyer and Krebs (1218), Watson (2981), and Fischer and co-workers (823), established that stercobilin contained only six oxygen atoms, the same number as mesobilene-(b), but four hydrogen atoms more than the latter. Its dehydrogenation with concentrated sulfuric acid leads to mesobilatriene.

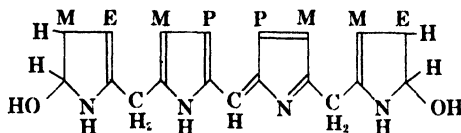

Fig. 24. Tetrahydromesobilene-(b), according to Fischer.

Fischer and co-workers discovered that, in contradistinction to mesobilene-(b), stercobilin was optically active. They suggested the formula shown in Figure 24. Siedel has recently suggested a different

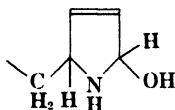

Fig. 25. Siedel's modification of Fischer's formula.

position of the double bond in the pyrrole rings I and IV (Fig. 25), but this formula would appear to demand a more strongly basic character for tetrahydromesobilane and -bilene than they possess. The four asymmetric carbon atoms in these two pyrrolic rings explain the optical activity.

The presence of the extra four hydrogen atoms does not affect the proton dissociation from the tertiary nitrogen; the difference in basicity, if any, between mesobilene-(b) and tetrahydromesobilene-(b) is slight. The hydrophilic character of these compounds may be used preparatively. They pass from the ether-acetic extract of feces or urine into the aqueous phase when the extract is washed with dilute sodium acetate. In this way a mesobiliviolin which is often found accompanying them (*cf.* Section 5.2.3.) may be removed (2972,2974).

6.3.2. Properties. *Tetrahydromesobilane* has not yet been obtained crystalline. It condenses with *p*-dimethylaminobenzaldehyde in hydrochloric acid to a red pigment which has an absorption band of the same position and strength as that of the pigment obtained from mesobilane, *cf.* above (1218,2984). This is fortunate, since all earlier

estimations of urobilinogen and stercobilinogen were based on the data obtained with mesobilane, while the chromogen predominant in urine and feces is tetrahydromesobilane.

Tetrahydromesobilene-(b) (neutral) has a melting point of 236° C. (822). The monohydrochloride was purified by Watson and, later, both Heilmeyer (1218) and Watson (2974) found a dihydrochloride. The latter, however, easily loses one molecule of hydrochloric acid on drying at 65° C. (2981). Crystallized from acetone both melt at 146–149° C., from chloroform at 125–128° C. With ferric chloride stable ferrichlorides of stercobilin (m.p. 187–190° C.) and its dimethyl ester (m.p. 160–162° C.) are formed (2981). The optical rotation of a solution of the hydrochloride in chloroform is very strong, $[\alpha]_{589}^{20} = -3500^{\circ}$ (822,823).

According to Heilmeyer and Beickert (1215) the hydrochloride is oxidized by hydrogen peroxide or by chloric acid to a red compound, rubrobilin. Its absorption band in acid solution lies at 520 m μ .

TABLE X

Absorption Spectra of Tetrahydromesobilene-(b) and Its Compounds

| Compound | Solvent | Absorption maxima | | Reference |
|--------------------------------------------|-----------------------|-------------------------|-----------------|-------------------------------|
| | | m μ | ϵ_{mM} | |
| Tetrahydro- mesobilene-(b) (neutral) | Dioxane | 456 322 | 33.0 4.0 | Pruckner and Stern, 2190 |
| | Abs. alcohol | 460 | low | Watson, 2981 |
| | 95% alcohol | 490 | 80.5 to 86 | Watson, 2981 |
| | | | | Heilmeyer, 1218 |
| Hydrochloride | Alcohol | 488 ^a 372 | 55.0 8.5 | Pruckner and Stern, 2190 |
| | 3% HCl in methanol | 492.0 ^a | | Lemberg, 1677 |
| | Chloroform | 490 | 66 | Heilmeyer, 1218 |
| | Alcohol | 490 | 37–71 | Heilmeyer, 1213, p. 211; 2390 |
| | | | | |
| Zinc complex | Alcohol | 506.5 ^b | | Lemberg, 1677 |
| Copper complex | Alcohol | 515 | | Lemberg, 1677 |

^a Position measured by Pruckner and Stern spectrophotometrically, by Lemberg with the Hartridge Reversion Spectroscope. Lemberg and co-workers (1713) found the band position 490.0 m μ in the visual spectrophotometer, 487.0 m μ in the ultraviolet spectrophotometer.

^b Not clearly distinguishable from zinc mesobilene-(b) band.

Spectroscopic differentiation between mesobilene-(b) and tetrahydromesobilene-(b). Measured in the Hartridge Reversion Spectroscope, the hydrochloride of tetrahydromesobilene-(b) has an absorption band at $492\text{ m}\mu$, 20 \AA less toward the infrared than that of mesobilene-(b) (Lemberg, 1677, 1713; cf. 3001). The same difference has been observed spectrophotometrically by Pruckner and Stern (?190), cf. Tables IX and X, together with similar differences in the position of the weak bands in the ultraviolet. Another spectroscopic difference between the two compounds was noted as early as 1897 by Hopkins and Garrod (1334). When a solution of tetrahydromesobilene in sodium bicarbonate is acidified by a slight excess of very dilute sulfuric acid, an absorption band at $530\text{ m}\mu$ ("E" band) appears. This phenomenon is not given by mesobilene-(b). Siedel could not observe this, but it was confirmed by Lemberg and collaborators (1713).

Absorption spectra. Apart from this slight shift of the absorption maxima toward the ultraviolet, the colors and absorption spectra of tetrahydromesobilene-(b) and of its compounds closely resemble those of mesobilene-(b) (cf. Table X). The extinction coefficients are higher than those of mesobilene-(b), but this may be due to the fact that the latter, being less stable, may not yet have been obtained so pure as tetrahydromesobilene-(b).

The fluorescence spectrum of the urobilin-zinc complexes shows only one broad emission band extending from the position of the absorption maximum through the green part of the spectrum (Dh er and Roche, 584).

6.4. *d*-Urobilin

In preliminary publications (2513,2515,2998) Watson and collaborators report the isolation of a dextrarotatory urobilin from infected bile.

The strong optical dextrorotation, $[\alpha]_{589}^{20} = +4000^\circ$, excludes the possibility that *d*-urobilin is a mesobilene-(b) containing an optically active impurity. The simplest explanation would be that bacteria different from those reducing mesobilane in the feces to *l*-tetrahydromesobilane (cf. Chapter XI) reduce it in the bile to an enantiomorph *d*-tetrahydromesobilane. Two observations do not favor this assumption. The position of the absorption band of *d*-urobilin is said to coincide with that of mesobilene-(b), not of *d*-tetrahydromesobilene-(b); and by heating in dioxane-hydrochloric acid the formation of mesobiliviolin and mesobiliverdin was observed. The latter also corresponds to the behavior of mesobilene rather than of tetrahydromesobilene; one may think of a structure with a different position of the hydrogen atoms in the pyrrole rings I and IV as in the formula suggested by Siedel for tetrahydromesobilene-(b), cf. Figure 25. Watson claimed that bacteria play no role in the observed conversion of mesobilane to *d*-urobilin.

In order to explain the development of optical activity one would have to postulate in any case optically active reducing systems; it appears more likely that these are bacterial enzyme systems rather than nonbacterial reducers present in the bile (*cf.* Chapter XI). The full publication of the experiments will have to be awaited before the matter can be judged further.

6.5. Porphobilin

By action of hydrochloric acid on "porphobilinogen," a chromogen found in the urine of patients with acute porphyria (Section 8.3.), Waldenström (2911) obtained a urobilinoid substance which he called porphobilin. Porphobilin is ether-insoluble and probably urobilene-(b), *i.e.*, a bilene with the same side chains as uroporphyrin. It can be reduced to a bilane, which differs from porphobilinogen in molecular weight and in its Ehrlich reaction. According to Waldenström porphobilinogen, a dipyrromethane, yields both porphobilin and uroporphyrin by the action of hydrochloric acid.

Porphobilin differs from urobilins by being precipitated with zinc acetate and by not giving a zinc salt with green fluorescence.

6.6. Bilenediones and Bilenetrols (Choletelins)

As in the case of the biliviolinoid pigments (*cf.* Section 5.4.), urobilinoid pigments are obtained by oxidation of bilatrienes. Their structure has been discussed in Section 2.4. (*cf.* also Table III).

Heynsius and Campbell (1268,1269) and Stokvis (2670) obtained a substance very similar to urobilin by the oxidation of bilirubin; a zinc complex salt of a urobilinoid pigment was, for instance, formed by oxidation of an ammoniacal solution of bilirubin by iodine in the presence of zinc salt. They called this substance choletelin. At that time it appeared mysterious that

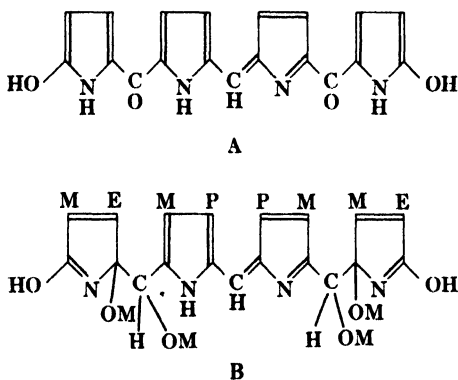

Fig. 26. Choletelins.

"urobilin" should be formed from bilirubin by oxidation as well as by reduction. The phenomenon was confirmed by Barrenscheen and Weltmann (174).

Choletelins can also be obtained as the penultimate step (not the ultimate step as the name suggests) of the Gmelin reaction of bilirubins or biliverdins (802,1713). A bilene-(b)-dione-(a,c) structure (Fig. 26A) was suggested for them by Lemberg (1679) and Siedel (2552) obtained such a compound. Other choletelins, *e.g.*, the crystalline choletelin obtained by nitrous acid oxidation of synthetic mesobiliverdin XIII ester with bromine in the presence of methanol, were found, however, to have the hilenetetrol structure (Fig. 26B) (2556).

The absorption band of the zinc compound of this substance was found at 515 $m\mu$; it resembles the zinc compounds of urobilins by its strong green fluorescence.

Choletelins can be differentiated from bilenes-(b) by the fact that the former are not attacked by ferric chloride, while bilenes-(b) are oxidized to violet biladienes and green bilatriene. In this choletelins behave exactly like tetrahydromesobilenes-(b), but they can be distinguished from the latter by sodium amalgam reduction followed by ferric chloride oxidation. Tetrahydromesobilene is reduced to its chromogen from which it is regenerated by oxidation. Choletelins, however, yield a chromogen (probably mesobilane) which is now oxidizable beyond the bilene stage to purple biladienes and green bilatrienes.

7. BILE PIGMENT CHROMOPROTEINS

7.1. Chromoproteins of Red and Blue Algae

The chromatophores of red algae (Florideae and Bangiaceae) and of blue algae (Cyanophyceae) contain red and blue water-soluble pigments in addition to chlorophyll *a* and carotenoids. The first observer of these strongly fluorescent pigments was apparently N. von Esenbeck (702) in 1836. The names phycoerythrin and phycocyan (or phycocyanin) were given by Kützing (1613). Molisch established their protein nature in 1894 (1971,1972). A good review of the earlier literature has been given by Kylin (1625).

Phycoerythrins and phycocyanins crystallize remarkably well and are sometimes found as crystals in the cells of the algae. Some of our phycoerythrin and phycocyanin crystal preparations have kept for twenty years in their mother liquor (about 10% ammonium sulfate solution), on slides under Canada balsam, without losing their shape or optical properties.

Kylin separated the pigments from each other by fractional precipitation with ammonium sulfate and studied many of their properties. Their large scale preparation was described by Lemberg (1670,1673), who developed a spectrophotometric method for the estimation of phycoerythrin and phycocyanin in mixtures.

TABLE XI
Chromoproteins of Algae

| Pigment | Color | Fluorescence ^a | Absorption bands ^b | | Mol. wt. ^c | Isoelectric point (1672,2808) | Crystal form | Occurrence |
|-----------------------------|---------------|---------------------------|-------------------------------|-------------------------------|-----------------------|----------------------------------|---------------------------------------------------------------------------------------|-----------------------------------------------------------------------------------------------------------------------------------|
| | | | m μ | $\epsilon_{1\%}^{1\text{cm}}$ | | | | |
| R-phycoerythrin | Red | Orange-yellow | 566 | 7.92 | 280,000 | 4.25 | Hexagonal prisms (1625,1971) | Common in Rhodophyceae and Bangiaceae, in which they are sometimes the only chromoproteins; also in Cyanophyceae (301, 302,3083). |
| | | | 539 | 6.50 | | | | |
| | | | 496 | 5.68 | | | | |
| C-phycoerythrin | Red | Orange | 552 | | | | In Cyanophyceae (315,1628); in <i>Palmelloccoccus minutus</i> (Proto-coccalae) (317). | |
| R-phycoocyanin ^d | Violet-blue | Red | 614 | 6.35 | 278,000 | 4.5 | Rhombic leaflets (1673) | In Rhodophyceae (e.g., <i>Ceramium</i>) and Bangiaceae ^e (<i>Porphyra</i>). |
| | | | 551 | 4.06 | | | | |
| C-phycoocyanin | Greenish blue | Red | 615 ^f (625) | 9.74 | | 4.76 | Flat needles or rhombohedral prisms (1673) | Common in Cyanophyceae (315, 1627,2718); also in <i>Porphyra tenera</i> ^e and <i>Palmelloccoccus</i> (317). |

^a Fluorescence spectra (cf. 581,582,1670,2302).

^b Absorption spectra in the visible (cf. 1625,1670,1672,1673,2302). The extinctions are remarkably high, they are greatly diminished by mild acid treatment. Absorption spectra in the ultraviolet (cf. 2712,2718,2719).

^c Determined in the ultracentrifuge at pH 9-10 (698,2709,2712,2718,2719). In more alkaline solutions dissociation into half molecules occurs.

^d R-phycoocyanin probably contains both mesobiliviolin and mesobiliterin as prosthetic groups (1673, p. 232).

^e Kitasato (1542) and Svedberg (2718) obtained R-phycoocyanin from 'norii', while Lemberg (1673) obtained C-phycoocyanin.

^f 615 m μ was observed by Boreseh (317), Svedberg (2718), and Lemberg (1673); 625 m μ by Boreseh (315) and Dhéré (582). Perhaps there are two different C-phycoocyanins.

An excellent starting material is the Japanese delicacy "nori," which consists of carefully purified and dried *Porphyra tenera* Kjelm. (Bangiaceae) and was first used by Kitasato (1542). Similar algae are said to be harvested and used as a foodstuff under the name "laver" in England or "stoke" in Ireland (2430). *Ceramium rubrum* (Florideae) and the fresh water alga (*Aphanizomenon flos aquae*) were also used.

Kylin and Kitasato made unsuccessful attempts to obtain clues to the nature of the prosthetic pigment group. They hydrolyzed the chromoproteins with proteolytic enzymes and with acid and alkali. The compounds obtained by their methods were, however, not the free prosthetic groups but still rather large polypeptides. This explains the failure of Kitasato to obtain pyrrole bases on hydriodic acid reduction of this "prosthetic group" of phycoerythrin and also later erroneous results of Levene and Schormüller (1723, cf. 1690).

The prosthetic group is bound much more firmly than is heme in hemoglobin and can only be set free by drastic action of acid (1671, 1673), or by treatment with alkali which, however, causes secondary alteration (1689, 1690). The nature of the prosthetic groups, phycocyanobilin and phycoerythrobilin, as bile pigments and their identity with mesobiliviolin and mesobilierythrin was established by Lemberg (1671, 1673, 1689, 1690); their chemical structure has already been discussed in Sections 5.2. and 5.3. The linkage between prosthetic group and protein appears to be a peptide linkage between the propionic acid side chains of the prosthetic groups and amino groups of the protein.

There is, however, evidence for a second labile linkage, broken by mild acid treatment. The native chromoproteins, which are metal-free, do not combine with zinc although the free prosthetic groups and also the chromoproteins denatured by mild acid treatment do so. The pyromethene grouping which reacts with the metal is masked in the intact chromoprotein, but is set free very early. At the same time the strong fluorescence of the native chromoproteins disappears.

From the yield of phycocyanobilin (mesobiliviolin), Lemberg (1672) concluded that a molecule of C-phycocyanin contained eight molecules of the prosthetic group. According to this the molar extinction coefficient of phycocyanin (per mole of prosthetic group) would be extraordinarily high ($\epsilon_{mM}^{416} = 332$). A large decrease of the extinction on liberation of the prosthetic group, and even subsequent to treatment of the chromoprotein with dilute mineral acid was indeed observed (Lemberg, 1673), but nevertheless it appears more likely from a comparison of the extinction coefficients of mesobiliviolin with that of phycocyanin that one molecule of the chromoprotein contains sixteen, not eight, molecules of mesobiliviolin.

Table XI gives a summary of individual phycoerythrins and phyco-

cyanins, their properties, and their occurrence. The nomenclature was suggested by Svedberg, the letters R and C denoting Rhodophyceae and Cyanophyceae, according to the plant family in which the particular chromoprotein is more commonly found. For a fuller account of their occurrence in algae see references (315,318,1627).

There may be other phycoerythrins (965,1267,1268) and phycocyanins (1627,1973), but their individuality has not been safely established (cf. 315, 1670). Phycoerythrin and phycocyanin have also been found in flagellates, dinoflagellates, and in a blue diatom (2428).

The chromoproteins have the character of plant globulins. They are easily precipitated by ammonium sulfate in crystalline form. At their isoelectric points they are slightly soluble in water.

7.2. Bile Pigment Chromoproteins in Animals

From the wings of the common European cabbage butterfly Wieland and collaborators (3072,3076), isolated green and blue chromoproteins. The prosthetic group, which they called *pterobilin* was obtained crystalline in the form of its dimethyl ester. The analyses gave the formula $C_{32}H_{44}O_6N_4$, i.e., that of bilatriene (biliverdin) dimethyl ester. The stability of pterobilin toward concentrated sulfuric acid and the position of the absorption bands of the zinc-biliviolin compound obtained from it show, however, that pterobilin is mesobilatriene.

In a preliminary note, Okay (3073) has reported the occurrence of chromoproteins similar to phycocyanin and phycoerythrin accompanying carotenoids in the integument of *Mantis religiosa* and other Orthoptera. Certain glands of the mollusc *Aplysia* secrete intense violet pigments, from which Lederer (1663, cf. also earlier work of Derrien, 563) isolated *aplysiovioletin* and *aplysiorhodin* by fractional ammonium sulfate precipitation. Evidently these are bile pigment chromoproteins closely related to phycocyanin and phycoerythrin. Earlier evidence for the presence of such compounds has been reviewed by Lemberg (1670). This was, however, far less convincing and in some instances the blue or green color of carotenoid proteins and the similar color which carotenoids give with concentrated acids has been confused with that of bile pigments and bile pigment chromoproteins. The blue pigment of the Mediterranean fish *Crenilabrus* and related species, first studied by v. Zeynek, is, however, probably related to phycocyanin (Fontaine, 913).

Meldolesi and collaborators (1898) have isolated myobilin, a chloroform-soluble polypeptide, from the feces of patients with muscular atrophy and destruction of myohemoglobin. It contains mesobilifuscin (an α,α' -dihydroxypyromethene) as its prosthetic group.

Serum bilirubin is not present free in the blood, but is combined with protein (cf. Chapter XI, 8.3.2.). Two forms of serum bilirubin have been found, one reacting with diazotized sulfanilic acid in the serum ("direct" bilirubin) and another form which requires certain additions (alcohol, caffeine) for this reaction ("indirect" bilirubin). Both forms contain bilirubin combined to protein; in the "direct" bilirubin the latter is probably

serum albumin, while the nature of the protein in "indirect" bilirubin is not yet established; some workers claim it to be globin (2623,1223,2162).

8. DIPYRROLIC AND RELATED PIGMENTS OCCURRING IN NATURE

While these compounds are not bile pigments in the proper sense, they are chemically and physiologically related to them and are therefore treated in this section; some were previously considered to be bile pigments and have only recently been recognized to contain two, not four, pyrroles.

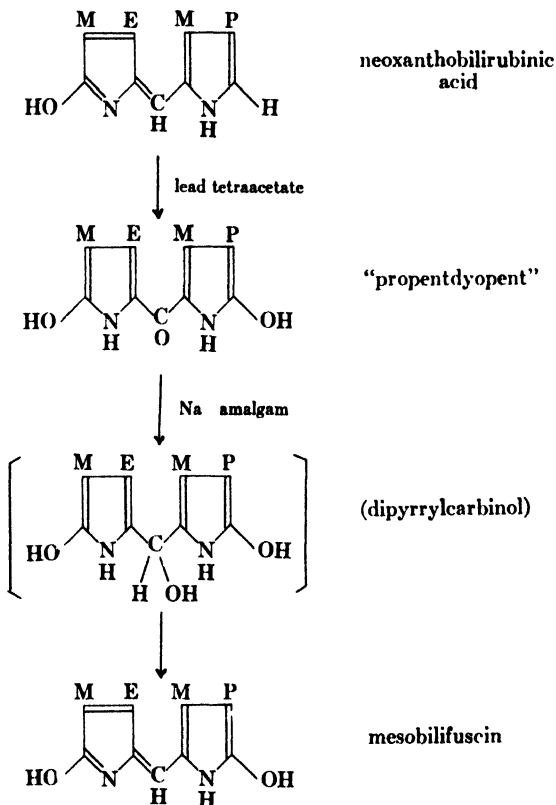

Fig. 27. Formation of mesobilifuscin (Siedel and Möller, 2558).

8.1. "Bilifuscins" (α, α' -Dihydroxypyrrromethenes)

Bilifuscin is a brown alcohol-soluble pigment obtained as a by-product of the preparation of bilirubin from gallstones (353,2607,3012,3182). Its

constitution was elucidated by Siedel and Möller (2558) (cf. Fig. 27). It is probably a mixture of side chain isomerides.

Mesobilifuscin (with an ethyl instead of the vinyl group) is the prosthetic group of myobilin (cf. above). The "body II" obtained by Fischer as a by-product of the sodium amalgam reduction of bilirubin to mesobilane (861, p. 693), was identified as the same substance and evidently arises from bilifuscin present as an impurity in the bilirubin. The structure of mesobilifuscin was proved by its formation from the corresponding α, α' -dibromopyrromethene with sodium methoxide (replacing bromine by hydroxyl), and also in the way illustrated in Figure 27. The methyl ester was not obtained crystalline; its melting point is 172–176° C. The absorption spectrum shows no distinct absorption band, the absorption rising from 500 $m\mu$ toward a faint maximum at 280 $m\mu$. The zinc salt is insoluble and does not fluoresce.

From the sweat and urine of certain sheep showing a golden coloration of their wool, Rimington and Steward (2275) isolated a brown pigment which they called *lanaurin*. It gave no typical bile pigment reactions. Analyses indicated the formula $C_{33}H_{38}O_{10}N_4$ but can equally well be interpreted as indicating $C_{10}H_{10}O_2N_2$. From this and from observations on the products of reduction by hydroiodic acid it can be concluded that lanaurin is identical with bilifuscin and thus a dipyrrolic pigment. The conclusion of Rimington that the golden coloration is caused by a hereditary hyperactivity of hemoglobin breakdown is in agreement with this (cf. Chapter X, 9.).

Probably the "copronigrin" of Watson, an artifact obtained from human feces (2971), belongs to the same class, and Siedel suggests the same for "xanthorubin" (609,687,1897) (cf. Chapter XI, 7.1.). The absorption spectrum of xanthorubin in ethereal solution (609,687) is, however, in disagreement with Siedel's assumption, and suggests rather that xanthorubin is a bilipurpurin.

3.2. Pentdyopent

The reaction series given in Figure 27 also supplies evidence of the nature of pentdyopent. Bingold has described in a series of papers (270,272–275, 277) the formation of a substance with an absorption band at 525 $m\mu$ (hence the name pentdyopent). It is formed when hematin or hemoglobin is exposed

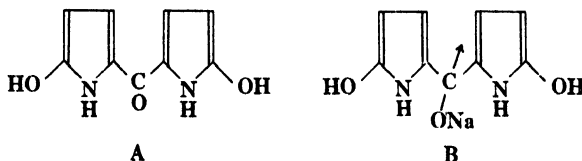

Fig. 28. Suggested formulas for propentdyopent (A) and pentdyopent (B).

to rather large concentrations of hydrogen peroxide in the absence of catalase and the colorless solution (propentdyopent) then treated with potassium hydroxide and dithionite. In ammonia the band is found at 540 $m\mu$. The

compound had been described as early as 1870 by Stokvis, who called it "reduzierbares Nebenprodukt" (*cf.* 1366). Fischer and co-workers (807,856) had assumed propentdyopent to be an α,α' -dihydroxydipyrrolicarbinol, with a hydroxymethylene group in the center, but the investigation of Siedel

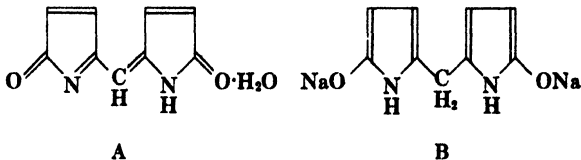

Fig. 29. Propentdyopent (A) and pentdyopent (B), according to Siedel (2553).

and Möller (2558) suggests that it is rather an α,α' -dihydroxydipyrrolylketone with the carbonyl group in the center. Pentdyopent itself was considered by Siedel in 1940 as the alkali salt of the dipyrrolicarbinol but from its properties a ketyl (radical) structure (Fig. 28) appears more likely. In a later review (2553), Siedel suggested the formula shown in Figure 29A for propentdyopent and the formula in Figure 29B for the red alkali salt of pentdyopent, but the formulas in Figure 28 appear to be more likely.

8.3. Porphobilinogen

By chromatographic analysis, Waldenström (2906,2911; *cf.* also Prunty, 2192) isolated a chromogen from the urine of patients with acute porphyria. He called it porphobilinogen, since, on treatment with acids, it was transformed into uroporphyrin and the urobilene-(b) porphobilin (*cf.* Section 6.5.). Diffusion experiments indicated a molecular weight corresponding to only two pyrrole rings.

While condensation of *p*-dimethylaminobenzaldehyde with mesobilane gives a chloroform-extractable red pigment with only one absorption band, the condensation of it with porphobilinogen gives a chloroform-insoluble red pigment with a two-banded absorption spectrum (570,2192,2837,2906). Similarly neither porphobilinogen nor porphobilin can be extracted from the urine by organic solvents.

By the action of alkali, porphobilinogen may be changed into a tetrapyrrolic chromogen giving an Ehrlich dye with only one absorption band. This is probably the true leuco compound of porphobilin (urobilane); on autoxidation it yields porphobilin.

The insolubility of these compounds in organic solvents as well as the ease with which uroporphyrin is formed from the dipyrrolic chromogen are good evidence that this contains acetic and propionic acid side chains like uroporphyrin. It is probably a dipyrrolylmethane substituted with these side chains, while the tetrapyrrolic chromogen into which it is converted by alkali is a urobilane, and porphobilin the corresponding urobilene-(b).

Ehrlich diazoreaction in urines. Some urines give a positive Ehrlich diazo reaction (coupling with diazobenzenesulfonic acid to a red dye). Heilmeyer

(1213, p. 249)* assumed that this reaction was due to a tryptophane derivative present in these urines. By coupling with diazotized dichloroaniline, Sachs, however (2410, 2411), obtained a crystalline azo dye $C_{21}H_{24}O_7N_4Cl_4$. The chlorine content shows that two molecules of the diazonium compound have coupled with one molecule of the chromogen. The chromogen thus has the composition $C_{19}H_{20}O_7N_2$. This can hardly be brought into harmony with the assumption of a tryptophane derivative, but agrees with a structure of a dipyrrolymethane containing acetic acid and propionic acid side chains of the structure shown in Figure 30. Such a compound would condense with

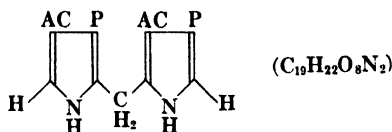

Fig. 30. Possible formula for the urinary chromogen reacting with diazobenzenesulfonic acid.

two moles of diazonium reagent in the two free α -positions and would be identical with, or closely related to, porphobilinogen. Waldenström reported that porphobilinogen coupled with the diazo reagent (2911).

Decisive evidence for the occurrence of such dipyrrolic compounds with uro side chains would be of great importance for the problem of porphyrin synthesis in the body (*cf.* Chapter XIII).

3.4. Bacterial Pigments

We may mention here two interesting bacterial pigments. *Prodigiosin*, the red pigment of *Serratia marcescens* (*Bacillus prodigiosus*) is a pyrrylpyrromethene of the structure shown in Figure 31. Its structure was proved by

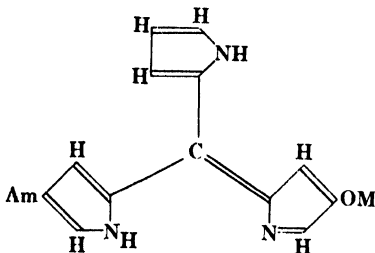

Fig. 31. Prodigiosin (Am = amyl).

Wrede and collaborators (3122-3124) and by Raudnitz (2214). It has absorption bands at 573.5 and 501 $m\mu$ (650).

* In Heilmeyer's book (1213), Figures 112 and 113 have evidently been interchanged, Figure 113 giving the absorption curve of the azo dye.

Violacein, the pigment of *Chromobact. violaceum*, may be a pyrrole pigment. Tobie (2812) obtained pyrrole bases by reduction of violacein with hydriodic acid. Its constitution is still unknown. Neither its properties (650,2687) nor its composition (1560,3125) indicate any close relationship to biliviolinoid pigments. Wrede gives the composition as $C_{42}H_{35}O_4N_6$ or $C_{50}H_{42}O_2N_6$ and finds that seven to eight moles of hydrogen are taken up on catalytic hydrogenation to the leuco stage. Kögl, however, finds the composition $C_{35}H_{25}O_6N_6$ or $C_{42}H_{30}O_7N_6$, forming a penta-acetate $C_{35}H_{15}O_6N_6(CH_3CO)_5$ or hexa-acetate $C_{42}H_{22}O_7N_6(CH_3CO)_6$. Since the substance is insoluble in sodium carbonate, it does not contain carboxylic acid groups.

9. ESTIMATION OF BILE PIGMENTS

9.1. Estimation of Bilirubin

Bilirubin in blood serum is still today occasionally measured by its light absorption. The "icteric index" of Meulengracht simply compares the color of the serum with that of an 0.01% potassium dichromate solution (1922). Since other yellow pigments occur in the serum (*e.g.*, carotenoids, but also dilute hemoglobin adds to the yellow color) this test can only claim to give a rough picture of the bilirubin level in pathological cases and even then can occasionally be grossly misleading. This is made no better by the use of complicated methods, *e.g.*, spectrophotometry, since hemoglobin and carotenoids, like bilirubin, absorb light in the blue part of the spectrum. Nevertheless, direct spectrophotometry of bilirubin has often been used, *e.g.*, by Veržár and in the important work of Mann (2541). This method has been shown by many workers to give high and unreliable values (1216,1223,1997, 1998,2138,2869,3107).

Van den Bergh's method, the method of choice for estimating blood bilirubin, is based on the coupling with diazotized sulfanilic acid to a dye which is red in weakly acid solution and blue in strongly acid or alkaline solution. The numerous modifications of the original method of van den Bergh (221,234; *cf.* many textbooks) which have been suggested and are still being suggested show that an ideal solution has not yet been found. In the original method, the blood proteins were precipitated by alcohol and the indirect bilirubin (*cf.* Section 7.2. and Chapter XI, 8.3.2.) was thus converted to a form reacting with the diazo reagent. The dye was measured colorimetrically or by comparison with standards without buffering the solution.

The main disadvantage of this method is the loss of a variable amount of bilirubin (up to 50%) by adsorption on the precipitated proteins. "Direct" bilirubin in particular is liable to be adsorbed. Van den Bergh and Grotepass (227) later suggested precipitation of the protein from alkaline solution. Thannhauser and Andersen

(2757) tried to overcome the difficulty by allowing the "direct" bilirubin to react before precipitating the serum proteins by alcohol and ammonium sulfate, but even this method does not avoid losses completely (1368) and occasionally fails to give perfectly clear solutions.

Methods have therefore been developed which allow coupling without precipitation of serum proteins. They are based either on the principle of Malloy and Evelyn of using alcohol concentrations sufficient to allow coupling but insufficient to precipitate the proteins from diluted serum (1851,2522,637) or on that of Jendrassik and Cleghorn (1413), who found that caffeine causes "indirect" bilirubin to couple with the diazo reagent. The disadvantage of the Malloy-Evelyn method is that it requires a great dilution of the sera, so that, unless the bilirubin concentration is high, only sensitive photoelectric methods of estimation can be applied. Since there is a distinct danger of development of slight cloudiness by the addition of alcohol, the photoelectric method can give very deceptive results. Thus the method of Jendrassik and numerous modifications of it find increasing application (1022,1416,2211,3043,3107,3109).

Estimation of "direct" and "indirect" bilirubin. As will be seen in Chapter XI, the differentiation between "direct reacting" and "indirect reacting" bilirubin may be of clinical importance for the distinction of hemolytic jaundice from other types of jaundice, but quantitative differential estimations have so far not been shown to be of greater diagnostic value than the simple direct van den Bergh reaction. There is a great deal of arbitrariness attached to definitions of a "direct reaction." Thus Malloy and Evelyn (1851) recommend reading after thirty minutes, Watson (637) after one minute. Definitions of what is meant by a "delayed" or "biphasic" reaction are still more vague. Attempts have been made to determine "direct" bilirubin as the difference between total and "indirect" bilirubin, by extracting the latter with chloroform (549,2534,2855-2857), but the results thus obtained do not tally with the results by direct estimation of "direct" bilirubin (637).

Gray and Whidborne (3043) found a real difference in reaction velocity only between the serum bilirubin in hemolytic jaundice on one hand, and that in obstructive jaundice or hepatitis on the other. With the latter, "prompt," "delayed," and "biphasic" reactions depend solely on bilirubin concentration, the apparent difference in velocity of reaction being caused by the fact that, above a concentration of 1.6 milligram per cent bilirubin (in the final dilution), Beer's law is no longer obeyed by the diazo dye. Van den Bergh's original observation is thus accurate, but confusion has arisen from attempts to elaborate upon the types of reaction.

Estimation of the dye. The "bilirubin"-azobenzenesulfonic acid dye (cf. Section 4.3.) has indicator properties. It is blue in strongly acid solution, red in weakly acid and neutral solution, and blue in alkaline solution. The

alkaline form is unstable (1588) and its use for estimations can therefore not be recommended. The red form (pH 3.0 to 4.0) has an absorption maximum at 530 $m\mu$. The absorption curves have been studied by several authors (1153,1216,1588,1599,2793,2794). The blue solution in mineral acid has a still stronger maximum at 580 $m\mu$ ($\epsilon_{mM} = 79$) (1213, p. 156).

The red form is more frequently used for the estimation, preferably with suitable buffering. Its color can be compared with that of a cobaltous sulfate standard, or a methyl red standard buffered to pH 4.63 (1153), or it may be measured spectrophotometrically (1688); with the latter method it is possible to introduce a correction for the slight cloudiness of sera, by measuring at a second wavelength at which the azo dye does not absorb. It is desirable to standardize these solutions with pure bilirubin, which should be freshly recrystallized for this purpose.

Estimation of bilirubin in the form of the hydrochloride of the azo dye has been suggested by Thannhauser and Andersen (2757) and has been used as a basis of spectrophotometric methods (1216,2794;1213, p. 159). It may be impossible, however, to use this without precipitating serum proteins. Determination of the blue alkaline solution has been used by Jendrassik and Gróf (1416) and With (3109). Plasma and serum give the same results (1397,363,3107), but, since it is necessary to avoid hemolysis, serum is preferable.

Estimation of bilirubin in the urine. For the estimation of bilirubin in urine, the diazo method has also been used (1022,2522), but absolutely fresh urine must be used to avoid oxidation of bilirubin to biliverdin, which does not couple. The method has also been used after adsorption of bilirubin to a barium sulfate precipitate* and extraction with alkali (1041,1629), but it is doubtful whether this offers any advantages and it may entail losses (2568).

Methods depending on oxidation to biliverdin. For estimation of bile pigments in urine and bile, methods by which bilirubin is oxidized to the blue-green biliverdin in acid solution are more satisfactory, since they include the latter substance in principle. This method was developed as early as 1845 by Scherer (2438) and applied to urine by Huppert (1370). It is the basis of the Fouchet test for abnormal amounts of bile pigment in serum, in which the oxidation is carried out by trichloroacetic acid containing ferric chloride and the biliverdin adsorbed to the protein precipitate. Perchloric acid has also been used (83,465). Several authors (1250,1329,1557,2373,2199,3065) have used the oxidation to biliverdin by the Hammarsten reagent (nitric acid, hydrochloric acid, and alcohol) or by yellow nitric acid for the quantitative estimation of bile pigments, and have found higher values particularly in bile, but also in serum, than by the diazo method (1250).

The green color is compared with that of a standard prepared similarly from bilirubin, or with a copper sulfate-dichromate standard. The basic weakness of these methods is that biliverdin is not the end product of the reaction but is oxidized further to bilipurpurins so that an arbitrary end point is used. This has been correctly stressed by Peterman and Cooley (2139), but their method, which is based on the erroneous assumption that

* The adsorption of bile pigments on baryta was already known to Berzelius (253).

biliverdin is a mixture of a blue and yellow pigment, is a step in the wrong direction. Malloy and Evelyn (1852) oxidize the bilirubin with a mixture of hydrogen peroxide, hydrochloric acid, and alcohol, and although this method also does not lead to a uniform oxidation product, it is so far the best oxidation method available, since only bilatrienes absorbing in the red are formed (*cf.* 1703).

Biliverdin occasionally accompanies bilirubin in the serum. Methods to estimate it directly are not yet available and the determination from the difference between total bile pigment as obtained by the oxidation methods and bilirubin as obtained by the van den Bergh reaction can only be considered a rough approximation.

9.2. Estimation of Urobilin and Urobilinogen

As has already been stated (*cf.* Section 6.1.), only part of the urobilin of urine or feces is present as such, the remainder being in the form of its reduced derivative urobilinogen. Furthermore, there are present two different urobilins, together with their corresponding urobilinogens, although this complication is of less importance.

Since separate determinations of urobilins and urobilinogens (3082) can hardly be recommended, two methods of estimation are available. In the first, the urobilinogens are oxidized to urobilins, which are determined fluorimetrically as the zinc complex, or spectrophotometrically in acid solution; in the second, the urobilins are reduced to urobilinogens, which are determined by colorimetry or spectrophotometry of the red dye formed by coupling with *p*-dimethylamino-benzaldehyde.

The choice of method depends on a number of factors. Since it is difficult, if not impossible, to extract urobilin itself quantitatively from feces and urine, the reduction methods are preferable for exact physiological experiments, particularly on human feces. Even these methods, however, entail a loss of about 25% of the fecal urobilinogen (2984). On the other hand, determination as urobilin is necessary for some animal feces (rats, rabbits) where reduction by ferrous hydroxide to urobilinogen does not succeed (1688). Oxidation methods are also well suited to urinary determination, particularly for clinical purposes, where extraction of the pigments is unnecessary. For estimations on bile, the oxidation is carried out with ferric chloride, which converts bilirubin present to biliverdin. The latter, is then removed and adsorbed to a ferric hydroxide precipitate, after which the urobilin may be determined in the usual way (15,672,2383).

Oxidation methods. Adler (13) oxidized urobilinogen with iodine in alcohol in the presence of zinc acetate and thus obtained the strongly fluorescent urobilin zinc complex, which could be determined fluorimetrically. This method was used as a qualitative test by Schlesinger (2443). In our opinion it is an excellent semiquantitative test for urobilin (*cf.* also 2010) in urine,

and could probably be converted into a good quantitative estimation for clinical purposes, provided close attention were paid to the optimal conditions for the fluorescence, that the iodine oxidation were carried out with greater care than usual, and that tetrahydromesobilene, not mesobilane, were used as standard. Against the use of iodine for the oxidation of urobilinogen to urobilin, Barrenscheen and Weltmann (174) raised the objection that bilirubin, which may be present in the urines to be tested, is oxidized by iodine to choletelins which also possess fluorescent zinc salts. No choletelin formation can, however, be observed in urines containing bilirubin under the conditions of the test.

Rudert and Heilmeyer (2390) have criticized this method and it has fallen into disrepute. There is no doubt that Adler obtained values with it which were far too high, but the cause of this was the use of an impure standard. Then only mesobilane was available, which is easily oxidized, and the oxidation of this to mesobilene is difficult to carry out quantitatively. Rudert and Heilmeyer also worked with this substance as standard. The urobilinogen of urine and feces, however, consists mainly of tetrahydromesobilane, which is oxidizable without loss to tetrahydromesobilene. The latter can be obtained in pure form and is quite stable.

Synthetic fluorescent substances, *e.g.*, acridine compounds, have been used for the purposes of comparison (380,672,645,2154,2376,2383). So far, they have not been standardized against pure tetrahydromesobilene.

To ensure that the green fluorescence of the test solution is due to zinc urobilin and not to an acridine compound which may be present in the urine, it is only necessary to acidify the solution. The urobilin fluorescence is destroyed, while that of atebirin, for example, persists. In order to detect urobilin in the presence of atebirin, urobilin is precipitated with basic lead acetate, set free again with oxalic acid, and after neutralization with ammonia, tested with zinc acetate (2893).

Urobilin can also be determined spectrophotometrically in aqueous or alcoholic solutions containing hydrochloric acid; the varying values obtained by Heilmeyer for the extinction coefficients of urobilins (*cf.* Tables IX and X) were largely due to the fact that he measured in solutions of the hydrochloride in water or alcohol. The method, however, necessitates extraction of urobilin from the urine, with consequent losses.

Reduction methods depend on reduction of urobilin to urobilinogen, and the determination of the latter as the red dye obtained by coupling with *p*-dimethylaminobenzaldehyde. At first reduction by alkaline fermentation was used (431), but later Terwen introduced reduction by ferrous hydroxide in alkaline suspension (1735,2756). The condensation with the aldehyde is carried out in ether containing acetic acid, thus avoiding the formation of red indole derivatives (2969). A modification of Terwen's method is used by Watson (2969,2984, *cf.* also 2521). The dye can be determined colorimetrically (2514) or spectrophotometrically (1204,1217). Tetrahydromesobilane derived from crystalline tetrahydromesobilene ("stercobilin"), as well as crystalline mesobilane, have been used as standards, giving the same results.

According to Watson, false positives claimed by Naumann (2012) are of no practical significance since they are only caused by porphobilinogen,

which gives a dye with different absorption bands, and is also easily distinguished from urobilinogen by its inability to pass into organic solvents. The simple qualitative Ehrlich color test for urobilinogen in urine can, however, give misleading results, mainly due to indole (2010). Nitrite in urine (0.2 milligram per cent) also interferes with the test (216). A green reaction occasionally observed in such urines is due to the oxidation by nitrous acid of bilirubin present in the urine, producing biliverdin.

Watson's method of estimation, referred to above, requires a 48-hour specimen of feces and a 24-hour specimen of urine; it is laborious and time consuming. It is superior, however, to other simplified modifications (2914, 2598, cf. 2617) and to estimations on single samples of feces or urine (2598, cf. also 2992, 3067). It should be used for investigational purposes, but whether it would give greater information for most clinical purposes than repeated semiquantitative tests, is difficult to assess. Thus Watson himself has recently (3003) suggested a simplified, though less exact, procedure for single samples of urine or feces.

Analysis of mixtures of mesobilene-(b) and tetrahydromesobilene-(b). Following Lemberg's clarification of the relation between these two compounds, Lemberg, Lockwood, and Wyndham (1713) investigated the relative amounts of the two in a large number of normal and pathological urines. Their method was only semiquantitative; it involved the determination of the position of the main absorption band of the hydrochlorides in the Hartridge Reversion Spectroscope, allowing a rough estimation of the relative amounts of each from the position of the band. Since the difference in band position between the two hydrochlorides is only 20 Å, the method is not very exact.

Legge (1667) developed a quantitative modification of the ferric chloride oxidation method. Ferric chloride does not oxidize tetrahydromesobilene, but transforms mesobilene into a mixture of mesobiliverdin and mesobilipurpurin. By spectrophotometric measurement of the absorption of the hydrochloride mixture before oxidation at 492 m μ , and after oxidation at this and two other suitable wavelengths, the amounts of tetrahydromesobilene and mesobilene in the mixture can be determined.

CHAPTER V

HEMATIN COMPOUNDS

1. BASIS OF METAL COMPLEX FORMATION

In the chapters on porphyrins and bile pigments, the ability of these substances to combine with metals has repeatedly been mentioned. In the present chapter the main stress will be on the nature and properties of the metal compounds as complexes, while the structure of the organic part of the molecule will be treated as a secondary matter. Several different metals can form such complexes, and certain of these can combine with additional inorganic and organic molecules. The latter combination not only greatly influences their properties, but also is of profound importance for understanding their biological function.

Willstätter recognized that the metal compounds of porphyrins and similar substances (*e.g.*, chlorophyll) were not salts, but that, since the metal compounds were soluble in organic solvents, the metal was held in complex combination. Combination occurred with both porphyrin esters and with etioporphyrin; free carboxyl groups were therefore not necessary. It was then postulated, in the terminology of Werner's theory, that the metal replaces the two hydrogen atoms of two pyrrole rings while it is bound simultaneously by coordinate linkage to the two tertiary nitrogen atoms of two pyrroline rings.

1.1. Stereochemistry of Complex Formation

Haurowitz (1167) pointed out that complex salt formation left the molar volume of porphyrin almost unaltered, and concluded that the metal atom replaces the two central hydrogen atoms without straining

the rest of the molecule. This was confirmed by the x-ray studies of Robertson (2284, *cf.* also 175) on phthalocyanin (*cf.* Chapter III) and nickel phthalocyanin. In metal-free phthalocyanin, the space between the four central nitrogen atoms, normally occupied by two hydrogen atoms, has a radius of 1.35 Å, slightly larger than the atomic (not ionic) radii of most metal atoms (nickel, 1.24; zinc, 1.32; iron, 1.27; cobalt, 1.25 Å). When nickel combines with phthalocyanin, slight alterations of the angles in the inner sixteen-membered ring, particularly on two of the four nitrogen atoms linking isoindole rings, and slight alterations of the bond lengths, cause the distance of the nitrogen atom from the center of the molecule to be decreased from 1.92 to 1.83 Å. This closely corresponds to the sum (1.85 Å) of the radii of doubly linked nitrogen (0.61 Å) and nickel (1.24 Å).

The replacement of two hydrogen atoms, each bound to only two of the nitrogens, by the nickel atom, equally bound to all four pyrrole nitrogens, enables the whole molecule to become nearly tetragonal in symmetry. In this way the four nitrogen atoms lie approximately at the corners of a square whose center is the nickel atom. The resonance of the molecule accounts for the fact that the three valencies of the nitrogen atoms lie in one plane with an angle of 110° inside the pyrrole ring and two angles of 125° outside.

1.2. Bond Type in Metal Complexes

It will be seen by reference to Chapter II, Section 6., that the metal atoms can be bound in complexes of the type under discussion by either ionic or covalent linkages, the number of unpaired electrons in the $3d$ orbitals and hence the magnetic properties of the substance differing according to the bond type.

Our principal concern is with the hematin compounds themselves, that is, those complexes in which the metal present is iron. The simplest of these is heme, in which the ferrous iron atom is linked only to the four nitrogens of the porphyrin. In this substance magnetochemical data (2126, 2127, 2129, 1173) show the existence of four unpaired electrons, the bonds consequently being essentially ionic. The fully ionic linkage would involve the replacement of the two pyrrole hydrogens by the positively charged ferrous ion, the two negative charges left on the porphyrin being equally distributed by resonance among all four nitrogen atoms. Apart from any charges resulting from ionization of side chain carboxyl groups, the complex has a resultant charge of zero.

Hemin and hematin resemble heme in having essentially ionic bonds, but in this case, the iron being in the ferric state, the complex has a unit residual positive charge. It is in consequence associated with a negatively charged dissociable ion, for which in hematin, when the ion is hydroxyl, a definite dissociation constant can be determined.

There is still some disagreement as to the type of bonds in heme, hemin, and hematin. Pauling believes the bonds to be of mixed ionic-covalent character, involving one $4s$ and three $4p$ orbitals, with the $3d$ orbitals filled with unpaired electrons. Huggins (1362) assumes a covalent linkage through the $4d$ orbitals. Such porphyrin metal compounds do not differ much in their chemical properties (solubility in organic solvents, firmness of linkage between metal and porphyrin) from the covalently linked compounds, either because the metal ion still resides in the center of the molecule and its electric charge is thus screened off, or because the linkage is also essentially covalent though not of d^2sp^3 type.

When additional molecules enter the complex, the bond type of the iron may be either ionic or covalent according to the circumstances. The introduction of two simple nitrogenous molecules into a ferroporphyrin (heme) gives rise to a substance known as a hemochrome ("hemochromogen") (*cf.* Section 2.), which is diamagnetic, and consequently has no unpaired electrons. The bond type is thus d^2sp^3 covalent, four of the octahedrally disposed bonds being coplanar, and directed to the porphyrin nitrogen atoms, the fifth and sixth being at right angles to the plane of the porphyrin and, respectively, above and below it. These latter two bonds are utilized in attaching the two additional nitrogenous molecules. We shall have occasion in subsequent sections to discuss the type of linkage formed by the iron in a variety of individual cases, particularly where more complex coordinating molecules such as proteins are involved.

Magnetochemical measurements show that nickel phthalocyanin and nickel porphyrins are diamagnetic, having no unpaired electrons (1174,1545,1546). The bonds are hence covalent, and as shown in Figure 2 (Chap. II, Sect. 6.1.), are of dsp^2 type. Since dsp^2 bonds are directed toward the corners of a square, combination of nickel with phthalocyanin and porphyrins in the planar arrangement offers no difficulties. However, other metals, such as magnesium and beryllium, which usually have a tetrahedral sp^3 symmetry of their bonds, combine with these substances giving complexes which appear

from spectroscopic evidence (see Section 1.3.) to contain covalently linked metal. It would seem that the steric requirements of the porphyrin impose upon these metals the necessity of forming a type of covalent bond different from that normal to them, having coplanar directional character.* Alternatively it is possible that, despite the spectrum, the bonds may be ionic, in which case the difficulty vanishes.

1.3. Absorption Spectrum and Bond Type

It will be seen later that hematin compounds tend to show certain group similarities of spectral type. Although present knowledge of the relationship of spectrum to structure is inadequate, it is possible to discern some reasonably well defined relationships between the type of spectrum and the nature of the linkage of the metal atom.

Theorell (2775) distinguishes four types of absorption spectra of iron porphyrin compounds in a scheme which is given here in a somewhat modified form.

1. Ferric compounds with essentially ionic bonds. Brown or green, with absorption bands in the red. Examples: hemin, hematin; hemoglobin; hemoglobin fluoride; peroxidase, peroxidase fluoride; catalase, catalase azide.

2. Ferric compounds with essentially covalent bonds. Red compounds with one broad (cyanide compounds) or two narrower rather flat bands in the green. Examples: hemoglobin cyanide and hydrosulfide; hemichromes; ferricytochrome c; peroxidase cyanide and hydrosulfide; alkaline peroxidase; catalase cyanide.

* For the metal complex salts of some pyrromethenes one would expect tetrahedral arrangement of the metal valencies, since planar arrangement would appear to cause a considerable distortion by overlapping of side chains, e.g., methyl groups in the α -positions (2172):

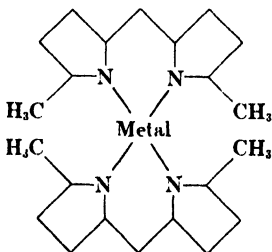

Indeed, the nickel complex has been found to be paramagnetic (1906); the palladium complex is diamagnetic, but evidence from this as to the type of bondage is inconclusive.

3. Ferrous compounds with essentially ionic bonds. Purple-red compounds with a broad band at about 560 $m\mu$. Examples: heme; hemoglobin; ferropoxidase.

4. Ferrous compounds with essentially covalent bonds. Brilliant red compounds with two well-defined bands in the green. Examples: hemochromes; oxy- and carbon monoxide hemoglobin; cytochrome c; carbon monoxide ferropoxidase.

Although it is clear that this scheme is certainly an over-simplification (*cf.* Chapter VI), the spectra being influenced by factors other than bond type, it provides a useful guide for classification of hematin compounds.

2. NOMENCLATURE

We shall apply the name "hematin compounds" to the iron complexes of porphyrins and of similarly constituted tetrapyrrolic substances,* when we refer to them irrespective of the nature and arrangement of side chains, the valency of the iron atom, and the presence or absence of additional nitrogenous or other groups linked to the iron atom. A more specific nomenclature is required to differentiate between ferrous and ferric iron porphyrin compounds, and between these compounds and those which have other groups (*e.g.*, two molecules of a nitrogenous compound) bound to the iron atom, or which, as in the case of ferric hematin compounds, are bases which can form salt-like derivatives.

Our knowledge of the exact structure of many of these substances is still too incomplete to attempt a systematic nomenclature of the hematin compounds according to the rules usually adopted in complex chemistry. Even if this were possible the names would be too long for general use. Conventional names, or names which give an indication of structure without being fully descriptive, must therefore be used. Unfortunately a variety of such nomenclatures is used by various authors. The nearest approach to a systematic nomenclature is that proposed independently by Clark (452,453) and by Drabkin (617,620) (Table I). Its use is strongly recommended for substances the constitution of which is exactly known, and where precision is required. Nevertheless shorter names are still needed as generic terms, and in some cases for medical and other general purposes.

* It has been suggested that this name be restricted to the iron porphyrins (2307), but this raises difficult problems in the nomenclature of the parallel series of tetrapyrrolic substances with altered porphyrin nucleus (*cf.* Section 8, and Chapter X)

TABLE I. Nomenclature of Hematin Compounds

| Formula ^a | Valency of iron | Earlier names | Nomenclature of Pauling (1946) and Barron (196) | Specific (Clark and Drabkin) | Nomenclature suggested | General |
|-------------------------------------------------------------------------------------------------------------------------------------------------------|-----------------|----------------------------------------|-------------------------------------------------|------------------------------------------|--------------------------|---------|
| $\left[\begin{array}{c} \text{N} & & \text{N} \\ & \diagdown & / \\ & \text{Fe} & \\ & / & \diagdown \\ \text{N} & & \text{N} \end{array} \right]$ | 2 | Reduced hematin, haem, heme | Ferroheme | Ferroporphyrin | Heme | |
| $\left[\begin{array}{c} \text{N} & & \text{N} \\ & \diagdown & / \\ & \text{Fe} & \\ & / & \diagdown \\ \text{N} & & \text{N} \end{array} \right]$ | 2 | Hemochromogens, reduced hemochromogens | Ferrous (ferro) hemochromogens | Base (e.g., dipyrindine) ferroporphyrins | Hemochromes ^c | |
| $\left[\begin{array}{c} \text{OH} & & \text{OH} \\ & \diagdown & / \\ & \text{Fe} & \\ & / & \diagdown \\ \text{N} & & \text{N} \end{array} \right]$ | 3 | Hematin, hydroxyhematin, oxyhematin | Ferriheme hydroxide | Ferriporphyrin hydroxide | Hematin | |
| $\left[\begin{array}{c} \text{N} & & \text{N} \\ & \diagdown & / \\ & \text{Fe} & \\ & / & \diagdown \\ \text{N} & & \text{N} \end{array} \right]^+$ | 3 | Hemins, e.g., (chloro) hemin | Ferriheme chloride, etc. | Ferriporphyrin chloride, etc. | Hemins (chloride, etc.) | |
| $\left[\begin{array}{c} \text{N} & & \text{N} \\ & \diagdown & / \\ & \text{Fe} & \\ & / & \diagdown \\ \text{N} & & \text{N} \end{array} \right]^+$ | 3 | Parahematin | Ferric (ferri) hemochromogens | Base (e.g., dipyrindine) ferriporphyrin | Hemichromes ^c | |

^a The four bracketed N atoms represent the pyrrole nitrogens of the porphyrin nucleus which lies in a plane perpendicular to that of the paper. The N' atoms above and below Fe represent N atoms of other compounds added (e.g., pyridine). The charges of the complex refer to hematin compounds not having carboxylic acid groups.

^b With regard to the structure of the hematins and hemichromes at different pH values, cf. below.

^c Holden (1977) has suggested the spelling hemocrom and hemocrom, but this has little to recommend it, particularly in view of the spelling of cytochrome which is a hemochrom. The name "hemochrom" has previously been used by Herzfeld and Klinger (1957), but their substance was later identified with hematin (1968) and the "hemochrom" of Bohr (1909) was also undoubtedly hematin.

Table I provides a comparison of several of the more commonly used nomenclatures, and indicates the system we shall use in this book. It will be seen that in the nomenclature proposed for general use only two departures are advocated from names previously used, that is, in the use of "hemochrome" and "hemichrome" in place of "hemochromogen" and "parahematin." The term "hemochromogen" is associated historically with an erroneous conception of one of these substances as the colored component of hemoglobin. These compounds are in any case not "chromogens" in the chemical sense, *i.e.*, leuco compounds. The new term has the additional advantage of greater brevity.

For general use, the term "base-iron-porphyrins" (*e.g.*, pyridine ferroprotoporphyrin) for "hemochromes," as required by the Clark-Drabkin nomenclature, is unduly cumbersome. In addition, it excludes substances in which the nature of the organic part is not known with certainty but which are of definite hemochrome nature (*e.g.*, verdohemochromes).

The terms "hemo-" and "hemi-," denoting, respectively, ferrous and ferric hematin compounds have been used by several workers (*e.g.*, Anson and the school of Heubner) and have more recently been suggested again by Holden (1317). Objections have been raised to them on the basis of possible errors of spelling or pronunciation, but these are just as likely to occur with the "ferro"- "ferri" system of Pauling and Barron. For the present, however, it is proposed to italicize the *i* or *o* in these words when the state of oxidation of the iron is of importance, to avoid any possibility of error. The term "hemochromes" will occasionally be used as a generic term including hemichromes (as has been done elsewhere with "hemochromogen"), in which case the *o* will not be italicized.

Whatever nomenclature is used, the prefix indicating the nature of the porphyrin side chains is frequently omitted when these are of the proto type. Thus "hematin" signifies "protohematin." Substances containing different porphyrins will be distinguished by the appropriate prefix; for example "mesohematin" and "coprohemin," signifying the hematins from meso- and coproporphyrin, respectively. In certain cases where the type of porphyrin is of no consequence, and which will be obvious from the context, omission of the prefix will also be made.

3. HEMES, HEMINS, AND HEMATINS

3.1. Hemes

While earlier workers had considered "hemochromogen" to be the prosthetic group of hemoglobin, Anson and Mirsky (65,69, cf. also Keilin, 1475) recognized that it was a more complex compound (cf. Chapter VI). The true prosthetic group, iron protoporphyrin, was later called heme. Hemes are rather unstable and easily oxidizable substances which are obtained when a solution of hematin in alkali is reduced in the absence of nitrogenous substances. In this way it was probably first obtained by Bertin-Sans and de Moitessier (251), and in crystalline form by Dhéré and co-workers (574). Protoheme is unstable and rapidly oxidized in contact with air. The more stable etioheme has been prepared in pure crystalline form and has been analyzed by Fischer, Treibs, and Zeile (886). Magnetochemical investigations (2127,2219) indicate ionic linkage (four unpaired electrons) of the iron, in solutions of heme in dilute aqueous sodium hydrox-

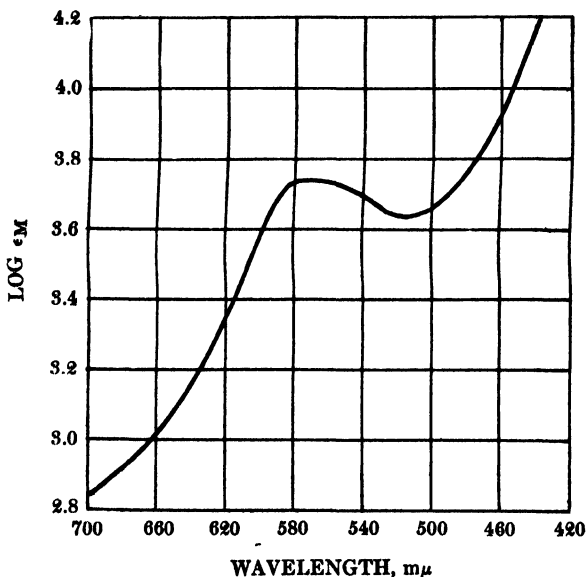

Fig. 1. Absorption curve of heme (393)

ide. With solvents containing carbonyl or hydroxyl groups, such as acetone and alcohol, hemes combine to form loose compounds (1120).

From the fact that heme iron is not removed by *o*-phenanthroline or α,α' -dipyridyl (bipyridine), we can conclude that the iron in heme is far less dissociated than the iron in ferrocyanide, at least in neutral solvents. While for the removal of iron from ferric hematin compounds concentrated sulfuric acid is required, dilute hydrochloric acid or even glacial acetic acid is able to remove iron from heme or hemochromes (886,2823,2872). Conversely, iron is readily introduced into porphyrin by heating with ferrous acetate in acetic acid, the autoxidation of the heme to hemin shifting the equilibrium toward complete formation of hemin.

Figure 1 shows the absorption curve of heme in phosphate buffer at pH 7. The asymmetric nature of the broad band in the green indicates that it is the resultant of two separate bands, the maxima of which lie approximately at 550 $m\mu$ and 575 $m\mu$, the latter being the more intense. Under certain circumstances these two bands may be distinguished in the visual spectroscope.

According to this curve, $\epsilon_{mN}^{575} = 5.5$. Varying values (5.0 to 6.7) have been found for the absorption in different buffers (Drabkin, 629; Heilmeyer, 1213; and Zeile and Grant, 3165).

Drabkin (629) and Warburg and co-workers have found the position of the Soret band at 415 $m\mu$, while Callaghan's study indicates that the maximum lies at a somewhat shorter wavelength.

3.2. Hemins

Chlorohemin, generally called *hemin*, $C_{34}H_{32}O_4N_4FeCl$, is the form in which the prosthetic group of hemoglobin has been longest known and is most stable. Typical rhomb-shaped crystals of " α -hemin" (Teichmann, 2754) are obtained if a hemoglobin solution is heated with acetic acid containing some sodium chloride to a temperature just below the boiling point. This method, which is of interest for the detection of blood stains in forensic medicine, is also the best method of preparation of hemin (Schalfejeff, 2035,2436; Fischer, 797). Hemin is recrystallized from pyridine-chloroform (1601) or quinine-chloroform (1307) mixtures.

Hemins probably contain the positively charged complex:

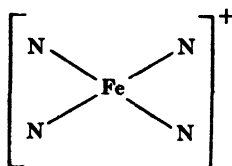

since Haurowitz (1157) found that etiohematin, which has no carboxyl groups in its side chains, as well as hemin esters, migrate toward the cathode in slightly acid alcoholic solutions. If this formula is correct, the various hemins, containing, for example, bromide, iodide, thiocyanate, azide, formate, or acetate, instead of chloride (861, p. 380), do not differ in solution but only in solid form, and are to be considered salts of the base hematin or hydroxyhematin. This is assumed by Pauling and by Clark and Drabkin, as the nomenclature shows, and also by Lindenfeld (1748). Richter (2248) raised the objection that very little chloride ion can be removed from hemin crystals by boiling water (1114), but in view of the slight solubility of hemin in water and the shielding of the chloride ions from the water by the large planar molecules, this objection does not appear to be serious.

The hemins with other radicals resemble α -chlorohemin. Denigès (555), for instance, obtained azide hemin in typical Teichmann crystals. With cyanide, however, hematin combines in a different manner (*cf.* below).

Different crystal forms of chlorohemin have been observed (1748, 2248). α -Chlorohemin crystallizes in various forms (2248), but all show oblique extinction and dichroism and differ in habit only. β -Hemin crystals, with straight extinction, are obtained from alcoholic solutions (885, 1113, 1114, 1600, 1604, 2247, 2248) while ψ -hemins are soluble in alcohol acidified with sulfuric acid. It is still uncertain whether these forms are only crystallographic modifications caused by impurities (for example, by partial esterification of the propionic acid side chains with the alcohol), polymorphous modifications (1748), or whether they have a different structure of the complex. A linkage

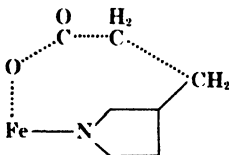

Fig. 2. Stereochemical improbability of ring formation between iron atom and carboxyl group of the same molecule in hematin compounds: bonds lying in porphyrin plane (—); bonds lying outside porphyrin plane (· · ·).

of the iron to the carboxylic acid groups of the propionic acid side chains of the same molecule has been assumed by Küster and Richter, but is stereochemically excluded. Richter (2248) claims erroneously that the formula shown in Figure 2 contains an eight-membered ring

without tension. He overlooks the fact that the iron, pyrrole ring, and the methylene group bound to it lie in one plane, and that the oxygen atom lies perpendicularly above the iron.*

Hamsik (1118,1120, cf. also 2035,2903) obtained evidence that acetone can be bound to chlorohemin by dipole or covalent linkage. The absorption spectrum of alcoholic hematin solutions suggests combination with alcohol (536, cf. also 501), but Richter could find no evidence for a compound of alcohol with solid hematin.

The hemins of some other porphyrins have also been obtained crystalline, among them *spiroporphis hemin*, $C_{32}H_{32}O_6N_4Cl$ (932,933, 2957).

3.3. Hematins

If we write only the central iron atom and the two carboxylic groups present in hemin, the reaction which occurs when hemin is dissolved in excess alkali can be formulated as follows:†

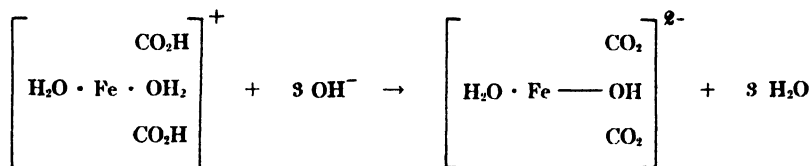

It gives rise to a divalent anion of ferriporphyrin hydroxide (1116, 1120,1990). The presence of the hydroxyl group in this complex can be shown by methylation with dimethyl sulfate (1157), which gives a trimethylated product, or by formation of tripotassium salt with potassium methylate (3087). The dimethyl ester of ferrimesopor-

* It is interesting to compare this formula with that of the cysteine adduct of protoheme (3167), in which such a ring occurs, containing, however, one more atom:

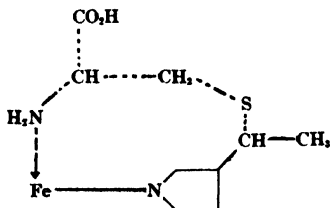

† Additional water molecules, to maintain a coordination number of 6 (in aqueous solution) were postulated by Haurowitz and Clark (453,1175).

phyrin in alkaline alcoholic solution is uncharged and does not migrate in the electric field (1157):

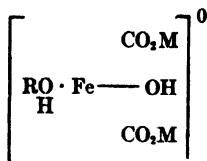

If hemin is dissolved in excess alkali and titrated with acid, precipitation occurs when approximately one equivalent of alkali remains unneutralized. The resulting hematin or hydroxyhemin is usually formulated as:

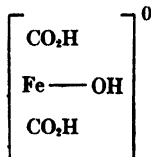

The pK of the dissociation $(\text{FeOH}) + \text{H}^+ \rightleftharpoons (\text{Fe} \cdot \text{OH}_2)^+$ lies, however, at a more alkaline pH than the pK of the dissociation of the carboxylic acid groups (451).^{*} One would, therefore, rather expect the following sequence of reactions on neutralization of alkaline hematin solutions:

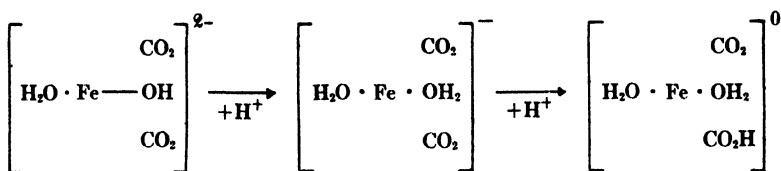

It is probably the last complex, which, having lost its electric charge, precipitates with loss of water and with polymerization.

According to the conditions, the resulting solid may have either the composition of hydroxyhemin or of partial or full anhydrides (Hamsik, 1117, 1120, 1122). The formula given for hematins in Table I is thus strictly correct only for alkaline hematin solutions. Amorphous hematin freshly precipitated from alcoholic alkaline solution by acetic acid, or "crystalline hydroxyhemin" prepared from crystals of pyridine hemichrome by removal

^{*} Cf. also Shack and Clark (2538a), who found a pK value of 7.6 for ferriprotoporphyrim.

of pyridine (885,1122) or from acetylhematin crystals by hydrolysis (1122) are readily reconverted into hemins, *e.g.*, into formylhematin or acetylhematin

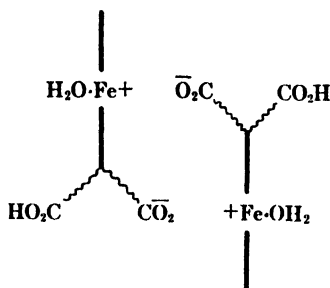

Fig. 3. Hydroxyhematin. In this projection diagram the lines with the iron in the middle represent the porphyrin molecule lying perpendicularly to the plane of the paper. The serrated lines between the carboxylic acid groups and the porphyrin nucleus represent the $-\text{CH}_2\text{CH}_2-$ group of the propionic acid side chains, one attached to a pyrrole ring above, the other to one below the plane of the paper.

in concentrated formic or acetic acid, or into chlorohematin. They have the composition of hydroxyhematin and are soluble in sodium bicarbonate solution, alcohol, and pyridine.

If the hematin precipitate is left standing in the mother liquor or if heat is used in the preparation, the hematin becomes insoluble in sodium bicarbonate solution and alcohol, less soluble in pyridine, and no longer convertible into crystalline hemins. These β -hematins (*cf.* 1601,2507) have the composition of half or full anhydrides of hydroxyhematin (1122). The facts that they are insoluble in sodium bicarbonate solution, that α -hematin esters are not transformed into β -hematin compounds on standing, and that β -hematins are reconvertible into α -hematin esters by esterification (3087) indicate that the carboxylic acid groups of hematin are involved in β -hematin formation. "Hydroxyhematin" itself is probably a dimeric substance of the formula shown in Figure 3. Here the iron is bound to the propionic acid groups by electro-

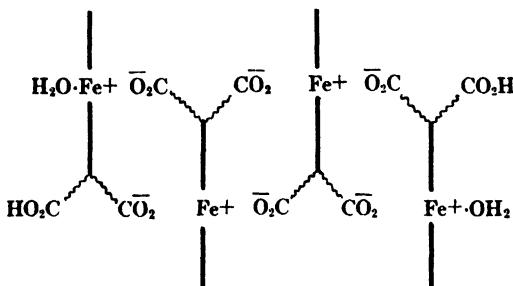

FIG. 4. β -Hematin (half-anhydride)

static linkage, as well as to the pyrrole nitrogen atoms. Still more complicated polymerizations probably occur on standing and may be accelerated by heating, resulting in the elimination of water molecules, and formation of β -hematins (*cf.* Fig. 4) and ψ -hematins.

It is still a matter of controversy whether hematin in alkaline solutions is to be considered polymeric, dimeric, or monomeric. Dialysis (1172), diffusion (3171),* and ultracentrifuge (1028) experiments indicate that the solutions of heme and hematin are polydisperse, with particle sizes varying between 30,000 and 60,000. The potentiometric titrations of Conant and Tongberg (481) in borate buffer of pH 9.15 fit the assumption of monomeric heme and dimeric hematin, but are in experimental disagreement with later results of Barron (180), which suggest that both are monomeric. From potentiometric studies on nicotine iron porphyrin, Davies (536) concluded that uncombined hematin was dimeric in aqueous, but monomeric in 50% aqueous alcoholic, phosphate buffer. In a careful spectrophotometric study of the equilibrium of hematin with dicyanide hematin, Hogness and collaborators (1307) found that hematin was a dimeric compound (*cf.* 2538a).

In view of the fact that hematin dissolved in sodium carbonate reacts rapidly with globin to form hemoglobin hydroxide, Holden (1313) suggests that under these conditions a dynamic equilibrium exists between polymeric and monomeric hematin. The latter may well only exist in very low concentration. The sharpening of the visible and ultraviolet absorption bands of hematin in alcoholic solution accords with this idea. Holden (private communication) has found that, except at great dilution, hematin in organic solvents polymerizes, as is shown by the rapid diminution in the height of its Soret band.

There is evidence for the combination of hematin with borate (180,188; *cf.*, however, 2538a), so that the presence of buffer anions may have some effect on the state of aggregation (*cf.* Sect. 5.). It was claimed (1615,3157) that a solution of hemin in phosphate buffer of pH 6 differs in color and catalytic properties from one of hematin in the same buffer; the former is probably a colloidal solution.

The structure of "acid hematin" obtained by ether extraction of an alkaline hematin solution after acidification with hydrochloric acid is also not clearly understood. While it appears unlikely that the dissociated hydroxyl group would recombine under these conditions, there is no evidence that the substance in ether solution is hemin, hemin crystals being insoluble in ether. "Acid hematin" may perhaps be a coordination compound of hemin with ether, which is not readily formed from crystalline hemin. A more likely alternative is that it is hydroxyhemin as shown in Figure 3.

Hematin forms solid, somewhat collapsible monomolecular films on water-air interfaces, in which the molecules stand vertically, with the two juxtaposed carboxylic acid groups buried in the water (*cf.* Chapter III, Section 4.2.) (38,1363).

* The porous disk diffusion method of Anson and Northrop (applied by Zeile and Reuter, 3171) gave, however, too high values for the molecular weight of cytochrome c.

Bond type. According to Pauling and co-workers (2126,2127,2129), the linkage between iron and porphyrin is essentially ionic (with five unpaired electrons on the iron) in crystalline hemin, or in solutions of hematin in alkali in the presence of sucrose, or in anhydrous pyridine. While confirming the result of Pauling for alkaline solution in the presence of sucrose, Rawlinson (2219) found in the absence of

TABLE II
Spectrophotometric Data for Acid and Alkaline Hematin

| Substance | Solvent | Absorption maxima | | Reference |
|----------------------------------|-------------------------------------------|-------------------|-----------------|------------------------|
| | | $m\mu$ | ϵ_{mM} | |
| Acid | | | | |
| hematin | Glacial acetic ^a | 630-635 | | 1213 |
| | | 540 | | 1213 |
| | | 510 | | 1213 |
| | | 400 | | 1213 |
| | Alcoholic HCl | 400 | 131-151 | 954,1270 |
| | Alcoholic HCl + gelatin ^b | 379 | 45.6 | 10,1270 |
| | Ether | 650 | | |
| Alkaline | | | | |
| hematin | 10% aq. NaOH | 580 | 10.5 | 1213 |
| | Aq. alkali ^c | 610-615 | 4.23 to 4.7 | 180,455, 629,1213,1307 |
| | pH 11-13 | 492 | 6.55 | 1307 |
| | | 385 | 44-49 | 180,455,629,1213 |
| | | | 57.5 | 1307 |
| | Alcoholic NaHCO ₃ ^d | 590 | | 1251 |
| | | 402.5 | 79.5 | 1270 |
| Borate buffer ^d pH 10 | 585 | 4.62 | 1213 | |

^aThe absorption spectra of hemin and hematin in glacial acetic acid appear to be identical.

^bThe shift of the Soret band and its reduced intensity under these conditions indicate some association (Hicks and Holden, 1270).

^cThe higher value for the extinction of the Soret Band found by Hogness and collaborators (1307) may be due to greater dilution of their solutions. Note also that the curves given by these workers are for dimeric hematin.

^dThe explanation of the shift of the bands toward shorter wavelengths at pH values below 11 is not clear, but may be due to dissociation of the hydroxyl ion of the hematin in this region.

the latter a smaller magnetic susceptibility, indicating only three unpaired electrons. An alkaline solution of hematin may, therefore, contain hematin compounds with covalent bonds; this may be connected with polymerization, occurring by covalent bond formation

between the hydroxyl group of one hematin molecule and the iron atom of a second. Sucrose and other alcohols may be able to break this linkage, and thus produce monomeric hematin with ionic linkages.

4. HEMOCHROMES AND HEMICHROMES

4.1. Hemochromes

Hemochromes had been prepared in crystalline form from hematin long before, their relationship to hemoglobin was correctly understood (*cf.* Chapter VI). v. Zeynek (3174) obtained solid ammonia hemochrome by reduction of hematin in ammoniacal alcohol with hydrazine hydrate; he and his collaborators later prepared crystalline pyridine hemochrome (1459,3175), which contained two molecules of pyridine bound to heme (*cf.* also 886,1276,1277). Heme can combine to form hemochromes with a great variety of nitrogenous substances including ammonia, primary amines, carbylamines, hydrazine, pyridine, and pyridine compounds such as nicotine, imidazole compounds, and piperidine. Hence it also combines with denatured proteins, in which hemochrome-forming groups are accessible and sterically in a favorable position (*cf.* Chapters VI and VIII). Cyanide also forms compounds with heme, but their nature is different from that of hemochromes (*cf.* Section 5.3.).

The possibility exists that one molecule of heme may combine with one molecule of each of two different nitrogenous compounds. Compounds of this type containing one molecule of cyanide with one of base have been described by Hill (1277), Krebs (1579), Anson and Mirsky (74), and Drabkin (620). The evidence for the formation of mixed hemochromes with pyridine and globin will be discussed in Chapter VI, Section 2.4.4.

Magnetochemical investigations have shown that in hemochromes the iron is bound to the four porphyrin nitrogens and to two additional nitrogen atoms of the combining nitrogenous substances by six d^2sp^3 covalent bonds, with no unpaired electrons. The paramagnetism of heme thus disappears in hemochrome formation and hemochromes are diamagnetic (2126).

4.1.1. Affinity of Heme for Bases. The affinity of heme for various nitrogenous bases varies considerably. It is very high for denatured globin (621,1322) and cyanide, intermediate for pyridine and 4-methylimidazole, low for ammonia, methylamine, phenylhy-

drazine, and hydrazine, and still lower for glycine. Lysine and arginine do not form hemochromes, while histidine does (2776).

It has been claimed (3165,1277) that the dissociation curve does not conform to the assumed reaction equation:



but in the more extensive studies of Clark and collaborators it was usually found to do so.*

TABLE III
Dissociation of Hemochromes

| Substance | pK |
|--------------------------------------------------|---------------------------------------------------|
| Pyridine ferroprotoporphyrin | 5.05 (1277), 6.3 (1322) |
| Nicotine ferroprotoporphyrin | 6.95 (1277), 5.5* (536) ^a |
| α -Picoline ferroprotoporphyrin | about 4.0 (1322) |
| 4-Methylimidazole ferroprotoporphyrin | about 5.3 (1322) |
| Piperidine ferroprotoporphyrin | about 5.0 (1322) |
| Methylamine ferroprotoporphyrin | about 3.5 (1322) |
| Nicotine ferromesoporphyrin | 5.9* (536) ^b , 5.7* (536) ^c |

^a At 30° C. ^b At 16° C. ^c At 23° C.

In Table III the majority of values have been calculated from the available data, using this equation. Davies' values (536), marked with an asterisk, were obtained from oxidation-reduction potential measurements (cf. Section 5.) in ethanol-water solution, for which the equation:

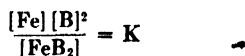

was found to hold. However for nicotine ferroprotoporphyrin in aqueous solution the equilibrium fitted the equation:

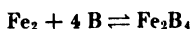

and the constant:

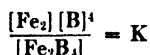

had a value of 1.2×10^{-10} .

Dimerization of hemochromes, postulated here by Davies, has also

* According to the recent investigation of Shack and Clark (2538a), dimeric ferroprotoporphyrin combines with four moles of pyridine to give two moles of monomeric dipyrindine ferroprotoporphyrin; spectrophotometric evidence for a two-step association was obtained.

been claimed for pyridine hemochrome above pH 10 (180); it is, however, difficult to understand how such a polymerization could occur.

4.1.2. Stereochemistry of Base Combination. Only substances which have their nitrogen atoms in exposed positions can combine with the iron of heme without steric hindrance due to collision between the remainder of the molecule and the large porphyrin plate. Thus pyridine combines readily, α -picoline less easily, and substances like quinoline, α, α' -dipyridyl, and *o*-phenanthroline not at all (1292). The two last-named substances have a high affinity for iron, forming complex salts by chelation, in this way removing the iron even from ferrocyanide. They are unable to form complexes with heme, since only one iron valency is available on each side of the porphyrin plate, the latter being relatively so large that chelate ring formation cannot occur around it. A similar situation occurs with ethylenediamine, only one amino group of which can combine with the iron; the hemochrome formed thus contains two molecules of this substance. Only substances of very specific sterical properties, with large crevasses between suitably situated exposed nitrogen atoms, can combine with heme in such a manner that two nitrogen atoms of the same molecule are linked to one heme iron atom (1683, p. 427). We find this type of linkage in denatured protein hemochromes and in cytochrome *c* (cf. Chapter VI and VIII).

4.1.3. Absorption Spectra. The hemochrome structure is characterized by the extreme sharpness of the α -band lying in the region of 550–560 $m\mu$. Since all hematin compounds can be readily transformed to hemochromes by the addition of alkali, base, and reducing agent, this band provides one of the best means for the spectroscopic detection of hematins. The position of the bands is influenced by both the base and porphyrin. The effect of varying the base has been investigated by a number of workers (cf. Anson and Mirsky, 65). Thus the first band of ammonia and of hydrazine hemochrome lies at 555 $m\mu$, that of pyridine and of denatured globin hemochrome at 558–560 $m\mu$. One must remember, however, that the position of the bands depends on the solvent and on the degree of association (cf. 1475) and can be very different in supersaturated solutions in which precipitation of the hemochrome is impending. The position of the absorption bands of mesohemochromes differs from that of the protohemochromes by the usual 10 $m\mu$.

In Table IV the most reliable quantitative data on the extinction coefficients of some hemochromes are collected, together with the

TABLE IV
Spectrophotometric Data of Hemochromes in the Visible Region

| Porphyrin | N-compound | First absorption band | | Second absorption band | | Ref. |
|--------------|--------------------|-----------------------|-------------------|------------------------|-----------------|-----------|
| | | $m\mu$ | ϵ_{mM} | $m\mu$ | ϵ_{mM} | |
| Proto | Pyridine | 558 | 31 to | 525 | 16.2 | 621, 1710 |
| | | | 35.3 | | | 619, 3165 |
| Proto | Denatured globin | 558 | 30.6 to | 530 | 14.0 to | 621 |
| | | | 30.9 | | | |
| Meso | Pyridine | 547 | 33.2 | 518 | 18.9 | 619 |
| Copro | Pyridine | 545 | | 516 | | 2506 |
| Spirographis | Pyridine | 582 _a | | | | 2957 |
| Spirographis | α -Picoline | 585 | | 537.5 | | 182 |
| Spirographis | Pilocarpine | 588.3 | | 544.1 | | 182 |
| Cytochrome c | | 550 | 26.1 to | 521 | 14.7 to | 621 |
| | | | 28.4 ^b | | | |

^aOn treatment with hydroxylamine the band is shifted 25 $m\mu$ toward violet to the position of protohemochrome, the oxime ($-\text{CH}=\text{NOH}$) group having a similar spectral influence to the vinyl group ($-\text{CH}=\text{CH}_2$).

^bThe lower values refer to a solution in 0.2 *N* NaOH, the higher ones to a solution of pH 4.5.

band positions of a number of others. The influence of variation of base and porphyrin can be clearly seen.

4.2. Hemichromes

All hemochromes react with atmospheric oxygen, their bivalent iron being oxidized to the trivalent state with the formation of hemichromes. The velocity of autoxidation is closely connected with the oxidation-reduction potential of the particular hemochrome/hemichrome system (179, *cf.* Section 7.).

4.2.1. Stability of Hemichromes. Keilin (1475) held that hemichromes (parahematis) are stable only at a pH near the neutral point, and dissociate into hematin and nitrogenous compound in more acid or more alkaline solutions. While this is possibly correct for denatured globin hemichrome (*cf.*, however, Chapter VI, 2.4.2), it certainly does not hold in general. Thus, from the study of absorption spectra (180;1687, p. 242) as well as from Barron's and Clark's studies of the oxidation-reduction potentials (*cf.* below), there is

definite evidence that hematin combines with pyridine in alkaline solutions; it has even been shown that casein and denatured albumin form hemichromes in alkaline, not in neutral, solution (1322). Whereas the absorption spectra and stability of hemochromes are little affected by pH changes above a certain pH value, absorption spectra and (at least in some cases) stabilities of hemichromes depend on the pH. This is explained by the presence of a hydroxyl group which, bound to the ferric iron atom in alkaline solutions, dissociates with increasing acidity.

Clark and collaborators (451,2872) have reported the first measurements of a *pK* for the dissociation of hydroxyl from a ferriporphyrin hydroxide:

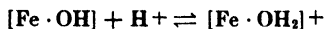

and a few values for the dissociation of hydroxyl from hemichromes. The *pK* of ferricproporphyrin hydroxide was found to be 7.44, that of pyridine coprohemin hydroxide 9.94 (potentiometrically) or 10.3 (spectrophotometrically), that of nicotine coprohemin hydroxide 8.92. For pyridine protohemin a *pK* value of 8.96 at 25° C. (1699) has been found by spectrophotometry.

4.2.2. Bond Type in Hemichromes. The bonds in alkaline solution of pyridine hemichrome were shown by the magnetochemical method to be of d^2sp^3 covalent type, with 1 unpaired electron (2219). The same result was found for ferricytochrome in neutral and weakly alkaline solutions (Chapter VIII). Hemin dissolved in neutral aqueous 50% pyridine was found to have a magnetic susceptibility of 3.1 Bohr magnetons, which Rawlinson explains as due to incomplete hemichrome formation (2219). If this explanation is correct, it follows that pyridine hemichrome dissociates much more readily in neutral than in alkaline solution, since in alkaline solution containing only 20% pyridine the bonds were found to be fully covalent.

4.2.3. Composition and Structure. The facts that ferric hematin compounds tend to polymerize and that they react with hydriions and hydroxyl ions introduce an enormous complexity into the problem of the composition and structure of hemichromes. The experimental difficulties are increased by the small solubility particularly of the uncombined hemes and hematins in water and the great oxidizability of hemes. Thus it has not yet even been possible to establish whether hematin combines with one molecule of base to form a hemichrome, or with two.

Clark and collaborators have attacked the problem by means of an ingenious combination of potentiometric and spectrophotometric titrations (451-453, 536, 2749, 2872; see also Chapter II). Despite the wealth of information their work has produced, the results did not, for the reasons mentioned above, succeed in eliminating all discrepancies. Thus their potentiometric results for nicotine ferriporphyrin (536) indicate that this substance contains one molecule of base, while the spectrophotometric study of pyridine ferriporphyrin (451) is only in harmony with the assumption that in this case two molecules of base are concerned. While in the latter case spectrophotometric methods cannot distinguish between the two possible reactions:

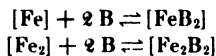

their results for pyridine ferricoproporphyrin showed no evidence for polymerization.

The evidence from the analytical composition of solid hemichromes is also contradictory. Pyridine hemichrome has been obtained crystalline by precipitation from pyridine with ether or petroleum ether (886, 1122) but loses its pyridine too readily to give reliable data. A somewhat more stable collidine compound had the composition $\text{C}_{34}\text{H}_{32}\text{O}_4\text{N}_4\text{FeCl} \cdot \text{C}_8\text{H}_{11}\text{N}$ thus containing one molecule of base (838). Rather stable compounds of hemin and hematin are formed with imidazole compounds (imidazole, 4-methylimidazole, pilocarpine) (1122, 1643). From hematin in neutral chloroform-ethanol solution Langenbeck (1643) obtained compounds of the composition $\text{C}_{34}\text{H}_{32}\text{O}_5\text{N}_4 \cdot 2 \text{B}$ where B represents one molecule of base. Hamsik (1122), however, isolated methylimidazole compounds of chlorohemin and formylhemin which contained three molecules of base per atom of iron.

In the face of such conflicting evidence, no really satisfactory picture of the structure of the hemichromes can as yet be presented. The most probable structure on the acid side of the pK of the iron-attached hydroxyl group may be represented by formula I, Figure 5, B representing one molecule of the coordinating nitrogenous base. Formula II of the same figure would be suggested in alkaline solution, one molecule of base being removed by the entry of the hydroxyl group. However, on the basis of their results, Clark and collaborators incline to the view that even in the presence of the hydroxyl group, two molecules of base still remain. Unless the hydroxyl group is bound to some part of the porphyrin molecule other than the iron

— which is unlikely in view of the effect of pH on spectrum and stability — Clark's postulate requires the assumption of hepta coordination, and the formula III of Figure 5.

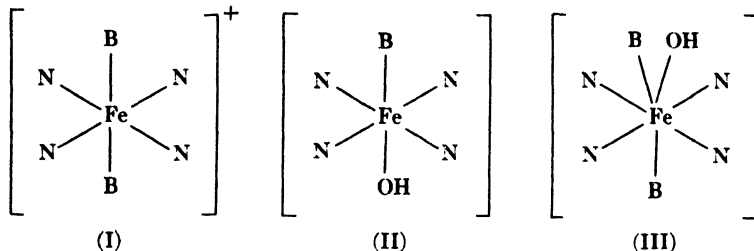

Fig. 5. Structure of hemichromes.

This formula is difficult to reconcile with the sterical configuration of the hematin molecule. Since the bonds are essentially covalent any suggestion that the iron atom lies outside the plane of the porphyrin nitrogens is not acceptable.*

Hepta coordination has been found for some compounds, *e.g.*, $(\text{CbF}_7)^{2-}$ and $(\text{TaF}_7)^{2-}$ (*cf.* 2125, p. 110), but in these the bond character is predominantly ionic. Nevertheless a sterical arrangement similar to that in these

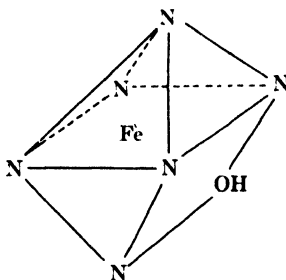

Fig. 6. Stereochemistry of hepta coordination.

complex fluorides, with four porphyrin nitrogens at the corners of one square face of a trigonal prism, the hydroxyl group and one pyridine nitrogen at the other corners of this prism, and the second pyridine nitrogen above the center of the opposite side of the first-mentioned square face, must be considered as a rather improbable possibility (Fig. 6).

* The suggestion of Michaelis (1936) that linkage to hydroxyl may replace bonds between iron and porphyrin nitrogen cannot be accepted. Whatever happens to the bond, the hydroxyl group cannot enter the position previously occupied by the porphyrin nitrogen, since the rigid arrangement of the porphyrin molecule keeps the iron atom in its place.

For several other hematin compounds hepta, or even octa coordination, has also been assumed, *e.g.*, for carbon monoxide carbylamine hemoglobin, hydrogen peroxide azide catalase, carbon monoxide hydrogen peroxide azide catalase and related hydrogen peroxide compounds of hemoglobin, as well as ethanol hemoglobin hydroxide (501) (*cf.* Chapters VI and IX), but there is no satisfactory evidence for the existence of these compounds.

The data of Clark and Perkins make it necessary to reject an explanation of the structure of hemichromes based only on the equilibrium of the compounds $\text{Fe}^{3+} + \text{B}_2$ and $\text{Fe}^{3+} + \text{OH}$ with base and hydroxyl ions. The possibility that a further species $\text{Fe}^{3+} + \text{B OH}$ may exist, introducing the additional equilibrium:

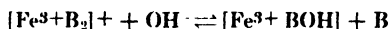

is, however, not discussed.*

Whatever view is taken of the foregoing possibilities, the analytical data for the imidazole hemichromes still require interpretation. Hamsik's com-

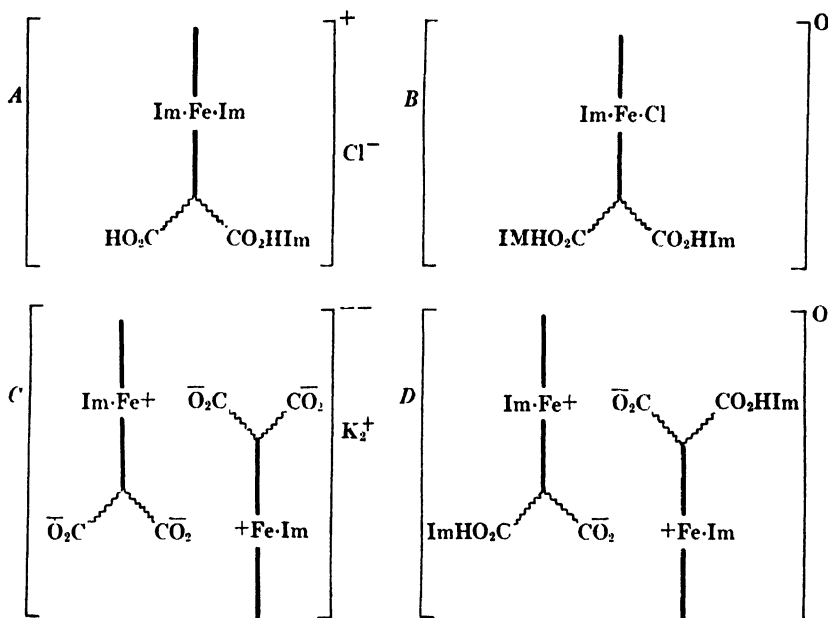

Fig. 7. Imidazole hematin compounds.

pounds containing three molecules of base per atom of iron can only be explained by the assumption of salt formation with one or two of the side chain carboxylic acid groups of the hemin (A or B, Fig. 7). This may also

* In their recent paper, Shack and Clark (2538a) come to the conclusion that pyridine ferriprotoporphyrin hydroxide has this composition, but that, in contrast to dipyrindine ferriprotoporphyrin, it is dimeric.

occur if hematin is used, instead of hemin in organic solvents. In 1% potassium hydroxide in methanol, Hamsik obtained a monopotassium monoimidazole hematin. The fact that only one of the two carboxylic acid groups is ionized requires the dimeric formula (*C*, Fig. 7) for this compound. A similar formula (*D*) may also be postulated to explain the diimidazole compound of hematin in neutral solution, but the analyses of Langenbeck and Hamsik favor a formula with five, not four, oxygen atoms per atom of iron.

4.2.4. Affinity of Hematin for Bases. It has been established by Clark (542,543) that in alkaline solution linkage of bases to heme is stronger than to hematin. It will be seen in Section 5. that this rule may not apply for cyanide compounds close to the neutral point. Owing to our lack of exact knowledge of the nature of the equilibrium involved, it is not possible to use dissociation constants or their corresponding pK values to express the affinity. In consequence we have listed in Table V the negative of the logarithm of the base

TABLE V
— log [B] at Which Half Dissociation of Hemichrome Occurs

| Hemichrome | pH | — log [B] | Ref. |
|----------------|-------|-----------|------|
| Nicotine proto | 11.1 | 1.29 | 536 |
| Nicotine meso | 11.10 | 1.34 | 536 |
| Pyridine copro | 12.7 | 0.89 | 451 |

concentration (— log B) at which 50% combination occurs. If it is assumed that in the strongly alkaline solution used the equilibrium is represented by the equation:

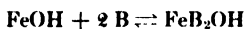

it follows that $pK = 2(-\log B)$. This transformation makes the values given comparable with the pK values given for hemochromes in Table III.

It will be seen by comparison of Tables III and V that most hemichromes are still half dissociated at base concentrations of about 0.1 *M*, at which hemochromes are fully combined.

The problem of the affinity of imidazole compounds to hematin compounds is of particular importance in view of the rôle ascribed to the heme-histidine linkage in hemoglobin and cytochrome *c*, but it has received insufficient attention. The great affinity of imidazole compounds for hematin observed by Langenbeck (1643) is often unduly stressed, and a superficial study of the literature is misleading

since it gives the impression that imidazoles have a far greater affinity for hematin than for heme.

Using alkaline solutions, Holden (1322) found heme to combine less readily with 4-methylimidazole than with pyridine and from his data it may be calculated that half dissociation of the resulting hemochrome occurs at a base concentration of $7 \times 10^{-3} M$, a value comparable with that for other hemochromes. From Langenbeck's results the corresponding figure for 4-methylimidazole hemichrome in 1% aqueous sodium carbonate solution may be estimated as about $7 \times 10^{-2} M$, comparable with other hemichromes.

The data on combination of hematin with histidine are very scanty and somewhat contradictory. Although Hamsik (1122) found histidine hemichrome easily dissociable in neutral methanol solution, and Haurowitz (1175) observed no reaction with histidine, Barron's data on oxidation-reduction potentials as a function of nitrogenous substance concentration (180, p. 296) indicate that in alkaline solutions above pH 9 histidine and pilocarpine are bound more firmly to heme than to hematin. No observations have been made on the combination of hematin with histidine peptides. From the results quoted, it is clear that although the difference in dissociation between 4-methylimidazole hemochrome and 4-methylimidazole hemichrome may be much smaller than that between pyridine hemochrome and pyridine hemichrome in neutral solution, the affinities in alkaline solution of imidazoles for heme and hematin bear the same relation as those of other nitrogenous bases. The available data do not show whether this relationship is maintained with decreasing alkalinity or whether, like the cyanide compounds, the affinities become more nearly equal or perhaps reverse (*cf.* Section 7.2.).

4.2.5. Absorption Spectra. The absorption spectrum of pyridine hemichrome in neutral solution has two bands similar in position to those of pyridine hemochrome, a fact which has confused earlier workers. The fact that pyridine hemichrome is reduced to the hemochrome by impurities present in crude pyridine has contributed to this confusion. Actually the two absorption spectra are very different. Pyridine hemichrome has only a weak band at $558 m\mu$ ($\epsilon_{mM} = 8.5$) and a stronger band at $530 m\mu$ ($\epsilon_{mM} = 10.2$). The quantitative data are derived from a paper of Barron (180).

Barron has also shown that the absorption in alkaline solution, *i.e.*, that of pyridine hemichrome hydroxide, is quite different from that

of alkaline hematin. It resembles in shape that of the hemichrome in neutral solution, but the bands are shifted toward the red and are less intense. ($\epsilon_{mM}^{600} = 5.8$ to 6.1 ; $\epsilon_{mM}^{576} = 6.5$ to 6.6 (180,620,629). Lemberg has made similar observations with monoazahemichromes (1687).

5. COMBINATION OF HEMATIN COMPOUNDS WITH OXYGEN, HYDROGEN PEROXIDE, CARBON MONOXIDE, AND CYANIDE

5.1. Compounds with Oxygen and Hydrogen Peroxide

The combination of hemoproteins with molecular oxygen and hydrogen peroxide is of fundamental importance for the action of respiratory carriers and enzymes concerned in tissue oxidation. Subsequent chapters will deal in detail with the specific influence of the protein on the direction of the reaction. The property of reversible combination with oxygen is conferred almost entirely by the protein to which heme is combined, and model experiments for this reaction cannot be carried out with simple hematin compounds. In the latter case combination with oxygen indeed occurs, but the compound is unstable and the complex immediately goes over into the ferric state. The unique properties of hemoglobin do not reside in the fact that in it the heme is able to combine with oxygen, but in the fact that the ferrous oxygen compound is stable. Its difference from the simple hematin compounds is, however, only quantitative as even globin is unable to prevent slow autoxidation. As will be shown later (*cf.* Chapter X), it is necessary to postulate a short but definite lifetime for the oxygen compounds of hemochromes. Thus Warburg's explanation for the function of the respiratory ferment is not so unjustified as it has been considered by some authors. Warburg assumed that the ferrous form of the respiratory ferment first combines reversibly with oxygen and that its iron is then oxidized to ferric state (*cf.* Chapter VIII).

There is a good deal of indirect evidence that heme compounds can combine similarly with hydrogen peroxide, giving unstable complexes in which not only does the iron later undergo oxidation to the ferric state, but also other changes occur involving an oxidation of the porphyrin ring. This will be discussed in Chapter X, since it has been found by Lemberg to be the mechanism of bile pigment formation. Hydrogen peroxide however, also combines with ferric

hematin iron. While the polarographic evidence for the existence of hematin-hydrogen peroxide complexes (330) was later withdrawn (331), Haurowitz (1169,1172) has observed that pyridine hemichrome forms an hydrogen peroxide complex having absorption bands at 590 and 570 m μ . Similar compounds of hemoglobin have been studied by several authors (Chapter VI) while other compounds of the same type are formed by peroxidase and catalase (Chapter IX). According to Euler and Josephson (721) the affinity of hematin for hydrogen peroxide is greater than that of catalase.

5.2. Carbon Monoxide Compounds

The importance of carbon monoxide and cyanide as inhibitors in the study of biologically important hematin enzymes has already been stressed in Chapter I and will be discussed in greater detail in Chapter VIII. Carbon monoxide combines only with ferrous heme derivatives.

That both heme and hemochromes in absence of excess of combined nitrogenous substance, combine with one molecule of carbon monoxide has long been known (65,1276,1277,1341,1356,1957,2185). F. Pregl (2185) obtained a carbon monoxide hemochrome in solid form, and demonstrated that ferricyanide liberated one mole of carbon monoxide per mole of heme. There are, however, some ferrous heme derivatives, such as cytochrome c, which do not combine with carbon monoxide.

5.2.1. Carbon Monoxide Heme. Earlier workers found that heme combines with carbon monoxide only in alkaline solution, but it was later shown that this was due to the slower rate of reaction in acid solutions, possibly due to the polymerization of the heme. The final equilibrium is not altered (456). A formula in which the sixth point of coordination is filled by a molecule of water was suggested by Hill (1277). Warburg (2949) found that one light quantum dissociates one molecule of carbon monoxide heme.

5.2.2. Carbon Monoxide Hemochromes. Carbon monoxide heme combines with bases like pyridine to form carbon monoxide hemochromes but an excess of pyridine expels the carbon monoxide. Carbon monoxide hemochromes were observed by Anson and Mirsky (65) and R. Hill (1276,1277). Krebs (1578,1579) found that they are more readily dissociated by light than is carbon monoxide heme. The equilibrium of the reaction:

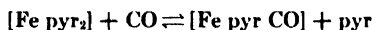

has been studied by Clifcorn and collaborators (456). Their value for the dissociation constant of carbon monoxide from carbon monoxide pyridine hemochrome (1.24×10^{-4}) unfortunately cannot be compared exactly with the dissociation constant of denatured globin carbon monoxide hemochrome of Anson and Mirsky (1.63×10^{-6}), since the former was measured at 25°, the latter at 36.5° C. The carbon monoxide, however, appears to be more firmly bound to the denatured globin hemochrome.

Absorption spectra of carbon monoxide hemochromes are of special interest, since the photochemical spectrum of the respiratory ferment is actually that of its carbon monoxide compound, and belongs to this class. The absorption spectrum of denatured globin carbon monoxide hemochrome is the same as that of carbon monoxide hemoglobin, having bands at 570 and 540 m μ (1276,2455), the second being slightly higher.

Warburg and collaborators (2957) have attached great significance to the position of the Soret band as an indication of the type of porphyrin present in carbon monoxide hemes and hemochromes. That such is not necessarily the case is shown by the fact that, on the one hand, carbon monoxide compounds containing the same heme but different nitrogenous bodies sometimes show differences in the position of the Soret band (*cf.* Keilin, 1479), while, on the other, compounds containing different hemes show identical positions. These relationships will be clear from Table VI.

TABLE VI
Spectroscopic Data for Carbon Monoxide Compounds

| Substance | Soret band | | Other bands | | Ref. |
|------------------------------|------------|-----------------|-------------|-----------------|------------------|
| | m μ | ϵ_{mM} | m μ | ϵ_{mM} | |
| CO protoheme | 415 | 158 | 543 | 14.6 | 621,29 5 2455 |
| | | | 573 | 15.1 | |
| CO spirographis heme | 410 | | | | 797 |
| CO chlorocruorin | 440 | | | | 1324 |
| CO pyridine protohemochrome | 440 | | | | 1324 |
| CO hydrazine protohemochrome | 410 | | | | 797 |

There is still need for a systematic study of carbon monoxide hemochromes, particularly those containing imidazole as the coordinating base.

5.3. Cyanide Compounds

Cyanide ion has been found to form compounds with heme, hematin, and hemochromes. The well-known substance cyanhematin was known to Hoppe-Seyler as early as 1865. "Dicyanide hemochromogen" is of more recent discovery, and compounds containing both cyanide and base attached to heme or hematin have been found later still. The state of knowledge with regard to all of these is, however, far from satisfactory, a serious deficiency in view of the fundamental importance of cyanide inhibition as a tool in enzyme chemistry.

These substances show marked differences from the hemochromes and hemichromes and are therefore treated separately. For the same reason we shall use the Clark-Drabkin nomenclature, not the terms "cyanide hemochrome" or "cyanide hemichrome."

5.3.1. Dicyanide Ferriporphyrin. Hogness *et al.* (1907) have shown spectrophotometrically that cyanide combines with hematin in alkaline solution (*pH* 10.7 to 13.2) according to the equation:

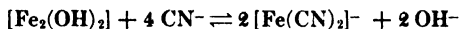

The compound so formed thus evidently has the structure:

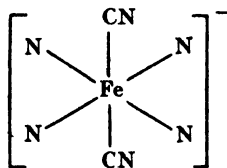

In this figure the charges due to the side chain carboxyl groups are omitted; the complex has one negative charge more than normal hemochromes.

Drabkin (620) has suggested that the addition of cyanide to hematin may occur stepwise. However, he gives no evidence to show that this is so. It has recently been shown (393), in conformity with Hogness, that the absorption curves of mixtures of hematin and dicyanide hematin of constant total hematin concentration and at *pH* 10.6 show only one isosbestic point in the visible region, and that therefore only one compound of hematin with cyanide exists, at least in the *pH* region investigated.

The reaction between hematin and cyanide at low *pH* values has not been investigated to any extent. It is known, however, that

dicyanide ferriporphyrin is formed, at sufficiently high cyanide concentrations, to a pH at least as low as 6. It may be seen from Hogness' results that the reaction is assisted by increasing acidity until the region of the pK of the hydroxyl group of the hematin is reached. The pK of hydrocyanic acid, however also lies in this region, with consequent fall in cyanide ion concentration with further reduction in pH. It would therefore be expected that with constant total cyanide, an optimum of formation of dicyanide ferriporphyrin would occur in the pH region 9–10. Zeile (3157) noted that color and catalytic activity of cyanide hematin at pH 6 differed from those of cyanide hematin in more alkaline solution.

When crystalline hemin is dissolved in water-free hydrocyanic acid, the spectrum produced is that of dicyanide ferriporphyrin (Haurowitz, 1157,1166).

5.3.2. Cyanide Ferriporphyrins. The reaction of heme with cyanide is one of stepwise association (69,393,620). At low cyanide concentrations the spectrum is similar to that of hemochromes; at high concentrations there is likewise a sharp two-banded spectrum, but the bands are shifted toward the red, and the order of strength is reversed (see Table VII). At cyanide concentrations intermediate between those necessary for these two types of spectrum, a diffuse four-banded spectrum appears. Holden (1317) suggested that the latter represented a third cyanide compound, but more recent work (393) has shown that this is not correct.

From the work of Anson and Mirsky (69), Drabkin (620), Hill (1277), Holden and Freeman (1322), and Callaghan and Giovanelli (393), it is reasonably certain that two heme cyanide compounds exist, containing one and two cyanide groups per iron atom, respectively, and therefore meriting the names monocyanide and dicyanide ferriporphyrin.* The latter is the well-known "cyanide hemochromogen." Its structure is probably:

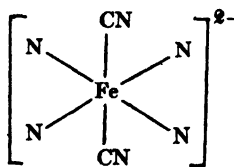

with two negative charges more than normal hemochromes.

*The same was recently found by Shack and Clark (2538a).

The equilibria involved in the formation of the heme-cyanide derivatives are not clearly understood. The compounds have been investigated principally at high pH values. Here the two steps of association are quite distinct,

TABLE VII
Spectrophotometric Data and Dissociation Constants
of Cyanide Compounds

| Substance | Absorption maxima | | References | Dissociation constant |
|-----------------------------------------|---------------------------|----------------------------------|---------------------------------------|-----------------------------------------------------------|
| | m μ | ϵ_{mM} | | |
| Dicyanide ferriprotoporphyrin | 545 422 | 11.2 to 12 88 | 180,393,620,621,1307,1579 180,1307 | 0.53 ^a (1307) |
| Pyridine cyanide ferriprotoporphyrin | 545 | 11.8 | 620 | |
| Monocyanide ferroprotoporphyrin | 552-555 524 415 | 15.3 10.3 | 620,393 393 | ca. 4×10^{-6} (pH 10.8) ^b (393) |
| Dicyanide ferroprotoporphyrin | 565-570 537-540 430 | 10.6 to 11 14.0 to 15.2 88 | 180,393,620,621 180 | 1.5×10^{-6} ^c (536) |
| Globin cyanide ferroprotoporphyrin | 562 | | 74 | |
| Dicyanide ferrospiroporphyrin | 598 550 | | 182 | |

$${}^a K = \frac{[\text{Fe}_2(\text{OH})_2][\text{CN}]^4}{[\text{Fe}(\text{CN})_2]^2[\text{OH}]^2} \quad {}^b K = \frac{[\text{Fe}][\text{CN}]}{[\text{FeCN}]} \quad {}^c K = \frac{[\text{Fe}][\text{CN}]^2}{[\text{Fe}(\text{CN})_2]}$$

the monocyanide compound being formed almost to completion before the formation of the dicyanide compound is evident. At pH values between 7 and 8, both compounds are still formed, but higher cyanide concentrations are necessary. The decrease in formation of the monocyanide with reduction of pH cannot be accounted for simply by association of cyanide ions to

hydrocyanic acid (pK 9.1) (393). Further, the possibility that the compound is one of heme with hydrocyanic acid is excluded by the same effect. In Table VII the dissociation constants are given on the basis of the simple equations:

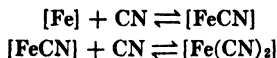

the constant for the dicyanide ferroporphyrin being the product of those derived from the two equations.

5.3.3. Mixed Cyanide-Base Hematins. Hill (1277) found that nicotine hemochrome combines more readily with cyanide than does heme, and Anson and Mirsky (74) prepared a similar denatured globin cyanide hemochrome. Krebs (1578), and Drabkin (620) found that pyridine, nicotine, and denatured globin hemichromes unite with cyanide at much lower concentrations than does hematin. The compounds so formed are of particular importance in that the cyanide inhibition of the respiratory ferment consists in the formation of a similar cyanide protein ferriporphyrin.

The available data do not indicate the nature of the equilibrium, or its dependence on pH , or even the nature of the complex formed. The latter may conceivably be any one of the following (for the ferric form):

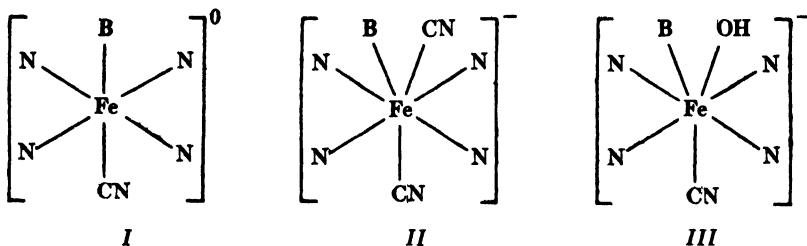

If formula I is correct, the charge on the cyanide base complex differs from that on the dicyanide complex; however there is no difference in spectral type between these two compounds, nor between them and hemoglobin cyanide, except that dicyanide ferriporphyrin has a lower and less distinct Soret band. The second formula is supported by Krebs' observation that combination with cyanide is not proportional to cyanide concentration. The third requires the reaction to be pH dependent; although whether this is so or not is unknown, there is no change of spectrum with pH . Both the second and third formulas require the assumption of hepta coordination, which has already been made by Clark for the hemichromes themselves.*

Except in the case of nicotine cyanide ferroporphyrin and denatured globin

* Formula I is supported by the recent work of Shack and Clark (2538a).

cyanide ferroporphyrin, the mixed cyanide-base compounds are known only in the ferric state. Reduction of pyridine cyanide ferriporphyrin for example, results in the production of pyridine hemochrome (Drabkin, 620).

5.3.4. Absorption Spectra of Cyanide Compounds. Dicyanide ferriporphyrin has a single broad absorption band in the green region of the spectrum, differing in this regard from the normal hemochromes. Monocyanide ferroporphyrin has a hemochrome type of spectrum, but is anomalous in having only one nitrogenous group coordinated with the iron atom. Dicyanide ferroporphyrin, with two nitrogenous groups, has, as we have seen, a two-banded spectrum, but the order of strength of the bands is reversed from that of hemochromes (Table VII).

5.3.5. Linkage of Cyanide. The cyanide compounds have in common with the hemochromes and hemochromes covalent linkage of the nitrogenous substance with the iron atom. It is, however, difficult to correlate the form of the absorption spectrum with the constitution of the various complexes. Pauling assumes that in these substances the cyanide is linked through the carbon, not the nitrogen, atom; if this is so, we may perhaps assume that it is this mode of linkage which influences the spectrum, and that the charge on the complex has little or no effect. In this way, the similarity of spectrum of dicyanide ferriporphyrin, cyanide base ferriporphyrin, and cyanide hemoglobin may be explained, but not, on the other hand, the similarity of hemochromes and monocyanide ferroporphyrin.

5.4. Other Compounds of Heme and Hematin

Combination of heme or hematin with a number of different substances has been reported. Methylcarbylamine and its homologs ($R \cdot N = C$) combine only with heme, not with hematin compounds (*cf.* Warburg and collaborators, 2918, 2954, 2956). Methylcarbylamine hemoglobin is discussed in Chapter VI, Section 2.2.6. Similarly Holden has recently reported that acetonitrile ($CH_3 \cdot C \equiv N$) combines with heme giving spectra similar to those with two and four bands obtained at low and intermediate concentrations of cyanide. Whether the substances obtained are fully analogous to the cyanide compounds, the failure to obtain the dicyanide type of spectrum being due to a very high dissociation constant of the corresponding diacetonitrile ferroporphyrin, or whether the four-banded spectrum belongs to a different type of compound, remains to be determined.

Compounds with azide have received unduly little attention. Ball (124) assumes that azide behaves similarly to cyanide in combining with both ferrous and ferric hematin compounds.

Sulphydryl compounds of simple hematis are unknown.

6. METALLOPORPHYRINS CONTAINING NICKEL, COBALT, AND MANGANESE

Nickel, cobalt, and manganese combine with various porphyrins giving complexes which have points both of similarity and difference with hemes and hematins. The relationships are best understood by reference to Chapter II, Table II, Sect. 6.1., which shows the type of bonds possible with these metals. No combination of porphyrins with chromium has been observed.

The nickel porphyrins, discussed in Section 1 of this chapter, are diamagnetic, and are unable to combine with bases to form hemochrome-like compounds. The electronic structure of nickel gives rise to four dsp^2 covalent bonds, so that after entry into the porphyrin molecule, no bonds are available for hemochrome formation. The two-banded spectrum which the nickel porphyrins have in common with hemochromes thus indicates merely a diamagnetic covalent complex, regardless of whether this is of dsp^2 or d^2sp^3 type.

Table II of Chapter II (Sect. 6.1.), indicates that manganous complexes should be of d^2sp^3 covalent type, similar to those of ferric iron, and that manganic complexes of a similar type should be expected to occur. The manganese porphyrins have not yet been studied magnetochemically, but Taylor (2749) has shown by spectrophotometric and potentiometric methods that both manganous and manganic porphyrins combine with two molecules of pyridine. The absorption spectra of manganoporphyrin and of dipyridine manganoporphyrin are of Theorell's type II and resemble somewhat those of hemichromes. They probably contain covalently linked manganese. The spectra of manganic compounds have only one band in the green and probably contain ionic linkages.

The cobaltic complexes should be of d^2sp^3 type, should be diamagnetic, and should resemble hemochromes. A hemochrome-like absorption spectrum has indeed been found for cobaltiporphyrins (1313,2749). While Taylor did not find any spectrophotometric evidence for combination of cobaltimeso-porphyrin with nicotine, Holden (1313) reported spectroscopic differences of pyridine, imidazole, and globin compounds in the position of their two absorption bands. The type of spectrum is not altered by these combinations.

Cobaltoporphyrins have only one absorption band in the green part of the spectrum, which is of Theorell's type III. They have thus essentially ionic bonds, and from Table II, Chapter II, it can be seen that d^2sp^3 coordination is impossible for cobaltous ion. Holden found no clear evidence of combination of cobaltoporphyrin with nitrogenous compounds except with native globin, which, however, also forms compounds with free porphyrins. Taylor found a slight decrease of the absorption band of cobaltoporphyrin in the presence of nicotine or cyanide, which in itself would not suffice to establish that combination occurs. Oxidation-reduction potential measurements, however, prove that it does so. On addition of nicotine to cobaltoporphyrin the potential becomes more positive, showing that the affinity of cobaltoporphyrin for nicotine is greater than that of cobaltiporphyrin.

The potential of the cobalt and manganese base compounds does not change with pH, so that the oxidants probably remain in the ionic form, and do not associate with hydroxyl ions. The potentials of the uncombined

metal porphyrins could not be measured. Table VIII shows that the potentials of the base cobalt and manganese porphyrins are lower than those of the corresponding iron compounds.

TABLE VIII
Oxidation-Reduction Potentials of Cobalt and Manganese
Mesoporphyrin Compounds^a

| N-compound | Metal | E'_0 , v. ^b |
|--------------------|-------|--------------------------|
| α -Picoline | Co | - 0.185 |
| Nicotine | Co | - 0.192 |
| Pyridine | Co | - 0.265 |
| Nicotine | Mn | - 0.296 |
| α -Picoline | Mn | - 0.320 |
| Pyridine | Mn | - 0.387 |

^a According to Clark and co-workers (452). ^b 30° C.

7. OXIDATION-REDUCTION POTENTIALS OF HEMATIN COMPOUNDS

The change of iron valency plays a fundamental role in the function of cytochromes (*cf.* Chapter VIII); the study of the oxidation-reduction potentials of the simpler hemochrome and hematin systems is therefore of great interest. In addition, it has been found possible to derive from oxidation-reduction potential data a good deal of information concerning the equilibria involved in hemochrome formation.

7.1. Oxidation-Reduction Potentials at Constant pH

7.1.1. The Heme-Hematin System. It has proved difficult to establish reliable data on the heme-hematin system, stable potentials being obtained only over a narrow range of hematin concentration (180). The system is relatively inactive electrochemically (*cf.* Chapter II, Section 7.2.6.). The first studies were carried out by Conant and co-workers (472,481), who titrated hematin in borate buffer with titanous chloride as reducing agent and ferricyanide as oxidizing agent. They established that one equivalent per iron atom was involved and that the potential decreased with increasing pH. Conant's curves fitted the assumption of monomeric heme and dimeric hematin, the potential becoming more negative with increas-

ing hematin concentration. Barron (180) found, however, a positive shift under the same conditions, individual curves fitting the assumption that both heme and hematin were monomeric. Barron's study still provides the best values of the protoheme protohematin system.*

When hemes derived from different porphyrins are used, the same difficulties obtain, and are in some cases enhanced, *e.g.*, with meso-hematin, the reductant in this case being so insoluble as to make redox potential measurements impossible (Davies, 536).

7.1.2. Systems Involving Coordinating Substances. When a coordinating substance is added to a solution containing heme and hematin, the potential usually becomes quite stable, so that precise measurement is possible. Conant and Tongberg made the first

TABLE IX
Oxidation-Reduction Potentials of Hemochrome-Hemichrome Systems^a

| N-compound | Porphyrin | $E'_0, v. b$ |
|--------------------|--------------|--------------|
| Cyanide | Spirographis | - 0.113 |
| | Proto | - 0.183 |
| | Hemato | - 0.200 |
| | Meso | - 0.229 |
| | Copro | - 0.247 |
| Pilocarpine | Spirographis | - 0.068 |
| | Proto | - 0.170 |
| α -Picoline | Spirographis | - 0.010 |
| | Proto | - 0.033 |
| | Hemato | - 0.099 |
| Pyridine | Proto | + 0.015 |
| | Hemato | + 0.004 |
| | Etio | - 0.029 |
| | Copro | - 0.036 |
| | Meso | - 0.063 |
| — | Spirographis | - 0.230 |
| | Proto | - 0.316 |

^a According to Barron (180,182,183) and Clark and co-workers (452).

^b pH 9.63, 30° C.

measurements on pyridine hemochrome, and other hemochrome systems were studied by Barron (180,184). The most extensive investigation so far recorded is that of Clark and collaborators (536,542,543, 2872,2749), of which the theoretical treatment has been given in Chapter II.

By combination with bases or cyanide the characteristic potential is shifted in a positive direction in increasing order by cyanide,

* Although $n = 1$, Shack and Clark conclude that both heme and hematin are dimeric (2538a).

imidazole compounds, picoline, pyridine, and nicotine, indicating that the affinity to the reductant is greater than to the oxidant. The nature of the porphyrin also affects the potential, which is lowest with hemochromes of porphyrins with saturated side chains, higher with protoporphyrin, and still higher with spirographis porphyrin (Barron, 182). The latter is of interest since the respiratory ferment may contain carbonyl groups in the side chains.

Table IX and Figure 8 illustrate these facts. Table IX is compiled from Barron's papers (180,182,183) and those of Clark (*loc. cit.*).

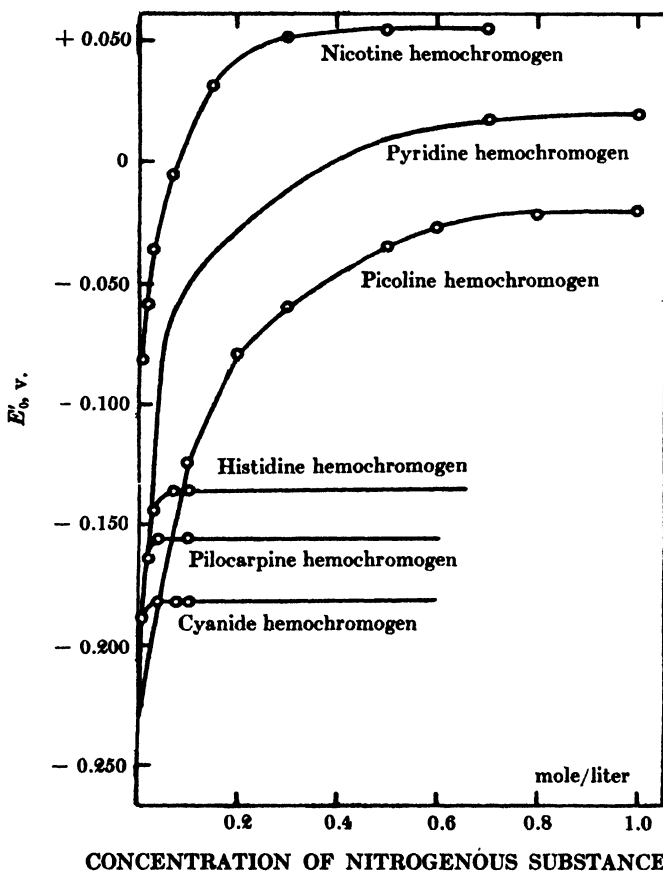

Fig. 8. Increase of oxidation-reduction potential on association with bases (after Barron, 180).

It will be seen in Chapter VIII that the potentials of the cytochromes (except cytochrome b) are much higher than those of any of the hemochromes listed above. The denatured globin-hemochrome system has a potential of -0.158 v. at pH 9.17, and -0.098 v. at pH 7.06, values rather close to those of the pilocarpine and histidine hemochrome systems (180). The potential of the hemoglobin-hemoglobin system is much more positive (*cf.* Chapter VI, 5.1.7.).

7.1.3. Determination of Constitution of Hemochromes. It was shown in Chapter II that oxidation-reduction potential data at constant pH might be expected to yield values for the number of molecules of base combining with oxidant (hematin) and reductant (heme), the state of aggregation of all four components of the system (*i.e.*, heme, hematin, hemochrome, hemichrome), and the number of electrons involved in the reduction process.

As has been noted in previous sections of this chapter, this has been possible only to a limited extent, due to the conditions imposed by the particular systems. Thus, for example, the mesoporphyrin system is restricted by the insolubility of mesoheme compounds.

The equations given in Chapter II involved certain assumptions as to properties of the system. If a system is found to conform to these equations, the correctness of the assumptions is demonstrated. If it does not, alternative formulations must be employed which fit the experimental facts. Assumptions of this nature are: (a) that there is no change of aggregation on coordination with base; (b) that equal numbers of base molecules, namely two, combine with both oxidant and reductant; and (c) that there is no stepwise association of heme or hematin with base.*

There are, however, other assumptions which require further consideration. These are, firstly, that there is no interaction of buffer anions with oxidant and reductant — this is discussed in Section 7.3.; and secondly, that the carboxylic acid groups in the side chains may be considered fully ionized, and as having no effect on the potential. The latter assumption is probably correct at the rather alkaline pH used in Clark's studies, although the existence of the monoimidazole monopotassium salt of Hamsik (*cf.* Section 4.2.3.) renders it a little doubtful. However, in those porphyrins where the carboxyl groups are separated from the porphyrin nucleus by a saturated chain, they

* *Cf.* further discussion in the paper of Shack and Clark (2538a).

can be influenced by the oxidation-reduction process only if they are concerned in formation of polymers (Section 3.3.) and if the degree of polymerization is affected by the valency change.

7.2. Influence of pH

The earlier studies established the fact that in general both the heme-hematin system and the hemochrome-hemichrome system follow the relationship*:

$$-\frac{\Delta E_h}{\Delta pH} = 0.06$$

The studies of Clark and collaborators showed that this relationship holds for all compounds with pyridine bases above a certain pH

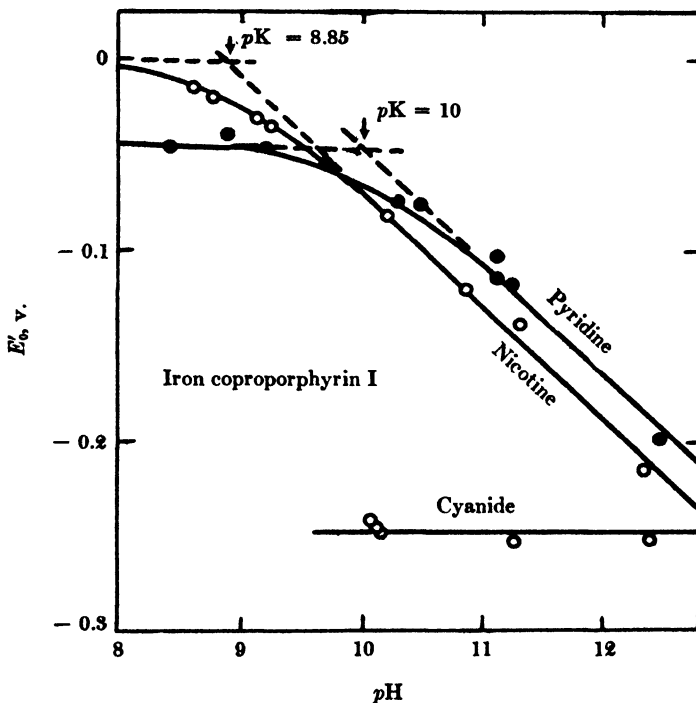
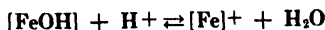

Fig. 9. Base iron coproporphyrin systems — relation of potential to pH (after Vestling, 2872).

* A later statement by Barron (183) that the slope for the heme-hematin system is given by the relationship, $-\Delta E_h/\Delta pH = -0.06$, is erroneous.

value, but that with reduction in pH an inflection point is found below which E_h becomes invariant with pH ($-(\Delta E_h)/(\Delta pH)=0$). The nature of the curves (Fig. 9) indicate that this is due to a dissociation of the oxidant, *i.e.*, the hemichrome, which may be represented:



the two negative charges on the side chain carboxyl groups being

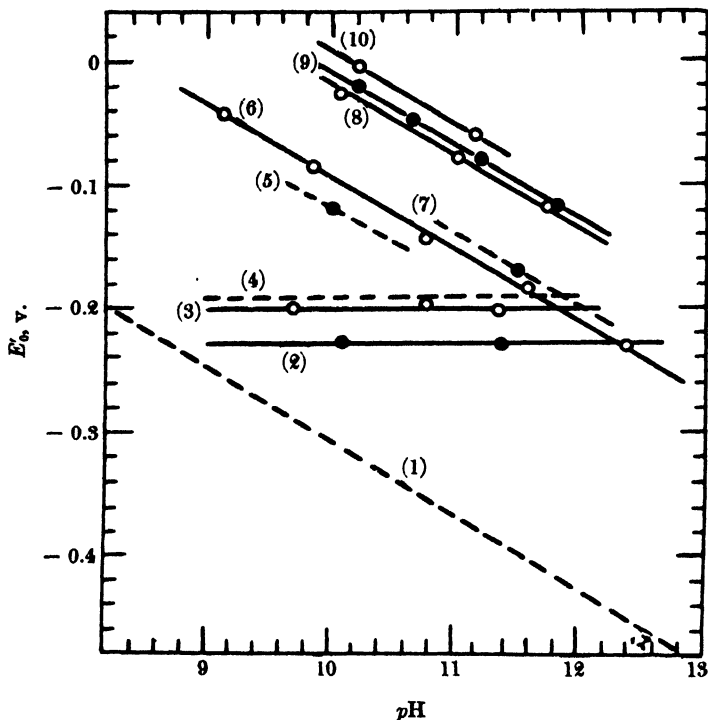

Fig. 10. Relation of potential to pH (after Clark, 452): (1) iron protoporphyrin (estimated by Barron); (2) cyanide iron mesoporphyrin; (3) cyanide iron hemato-porphyrin; (4) cyanide iron protoporphyrin (after Barron); (5) α -picoline iron hemato-porphyrin; (6) pyridine iron mesoporphyrin in alcohol-water; (7) nicotine iron meso-porphyrin in alcohol-water; (8) nicotine iron protoporphyrin; (9) pyridine iron hemato-porphyrin; (10) nicotine iron protoporphyrin in alcohol-water.

omitted. That the dissociation concerned is connected with a group attached to the iron atom, and is not associated with the side chain carboxyl groups is supported by the fact that etioporphyrin hemo-chromes in which no carboxyl groups occur, show the same E_h/pH relationship.

The only exceptions to the above E_h/pH relationship are found in the case of the cyanide compounds, and the imidazole (pilocarpine, histidine) hemochromes. In the latter, it is possible that the measurements were made in the region of the pK of the hemichrome and that too few points on either side of this have been measured (*cf.* Fig. 11). In the former it is quite definite that the oxidation-reduction potential

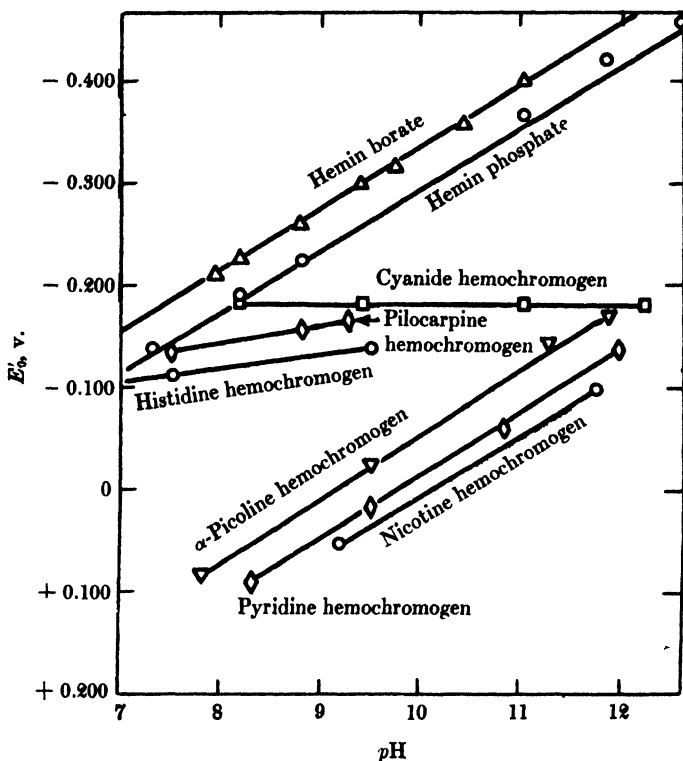

Fig. 11. Relation of potential to pH (after Barron, 180). Note that E'_h decreases along the ordinate.

is invariant over a wide range of pH in the alkaline region (Fig. 10 and Fig. 11).

The structural interpretation of these facts is by no means clear. The suggestions of Clark and Davies for the hemichromes have already been discussed (Section 4.2.). In the case of the cyanide compounds it is assumed by Davies that the affinity of the heme and hematin for cyanide is so great that competition between cyanide

and hydroxyl ions for a position of attachment to the iron atom of the ferriporphyrin does not take place at the concentration of cyanide used in the determinations. If, however, hepta coordination is admissible as the explanation of the hydroxyl ion of the hemichromes, it would have to be assumed that in the cyanide ferriporphyrins, electrostatic repulsion by the negatively charged cyanide groups renders the introduction of an additional negatively charged ion impossible.

It should, however, be understood that in the systems where:

$$-\frac{\Delta E_h}{\Delta pH} = 0.06$$

all the oxidation-reduction potential measurements require is the presence in the oxidant of one more dissociable hydroxyl ion than in the reductant, or the equivalent of this. The nature of the dissociable group is left for other methods to determine.

Figures 10 and 11 show the *pH* dependence of the oxidation-reduction potentials of several hematin systems.

The relationship between the oxidation-reduction potentials of the heme-hematin system and the cyanide iron porphyrin system is of great importance in connection with the cyanide inhibition of hematin catalysis. Reference to Figure 10 shows that the potential of hematin decreases with increasing *pH*, in consequence of which the potential of cyanide iron porphyrin, being invariant, becomes relatively more positive. The assumption which has occasionally been made of a fixed difference of characteristic potential (E'_0) between the two systems is thus quite without foundation as is also the widely accepted belief that combination of hematin compounds with cyanide invariably lowers the oxidation-reduction potential.

At biological *pH* values, the relationship between the two systems is not entirely clear. The curves depicted in Figure 10 approach one another with decreasing *pH*; whether they will actually cross, and the affinities of oxidant and reductant for cyanide thus become reversed, depends on the position of the *pK* of the hydroxyl dissociation of hematin, since there is no reason for assuming any change of slope of the curve of the cyanide system in this region. According to Barron's data (Fig. 11), the two curves actually meet at *pH* 8.2, and the slope of the hematin curve is unchanged even below this value. With the more positive hemochromes, however, the *pH* at which the affinity of the ferrous form for cyanide becomes greater

than that of the ferric form is shifted further to the alkaline side, away from the biological pH range. This does not necessarily hold, however, for all hematin cyanide compounds, particularly not if the hematin compound combines with undissociated hydrocyanic acid (*cf.* Chapter VIII).

7.3. Influence of Buffer Anions

Barron claimed that buffer anions combined with hematin and thus exerted an influence on the oxidation-reduction potential, but his data show this only for borate ion; the points for phosphate and veronal buffers lie on the E_h/pH curve of a solution of hematin in alkali without buffers.

Clark *et al.* were unable to find evidence for any such effect, although admitting that it had not been entirely excluded (*cf.* 2835a). There is no doubt, however, that under certain circumstances, the presence of buffer anions may bring about a change in the activity coefficients of oxidized and reduced metalloporphyrins and of their compounds with bases, so that allowance must be made for this in the equations developed in Chapter II.

Evidence has been adduced for the combination of anions with other hematin compounds, in the case of peroxidase and catalase (*cf.* Chapter IX).

8. HEMATIN COMPOUNDS OF AZA- AND OXYPORPHYRINS AND OTHER HEMATIN COMPOUNDS

8.1. "Red, Red-Green, and Green Hemins"

At a time when our knowledge of hematin compounds was still little developed, Warburg (2928) suggested that three different types of hematin compounds existed, red (porphyrin) hemins, green (chlorophyll) hemins, and green-red pheohemins (respiratory ferment and spirographis hemin). This classification has now been shown to be much too primitive, and should no longer be used. Azahematin and oxyporphyrin hematins have little structural relationship to formylporphyrins of spirographis or of pheoporphyrin b type, but still would have to be classed as red-green hemins. The shift of absorption bands required to transform a "red" into a "green-red" hemin can be brought about in several very different ways, by structural alterations both in the side chains (the substances in this

case still remain porphyrin hemins) and in the nucleus. Similarly "green hemins" of very different structure exist. The "green hemin" of Warburg and Negelein (2952) (verdohemin, *cf.* Chapter X) has a structure widely different from that of green pheophorbid or chlorin hematin compounds or from that of green polyazahematin.

8.2. Monoazahematin Compounds

Monoazahemin, $C_{33}H_{31}O_4N_5FeCl$, and monoazamesohemin, $C_{33}H_{35}O_4N_5FeCl$ are crystalline compounds, greatly resembling hemin and mesohemin. Their structure is discussed in Chapter III, Section 8.1. They were obtained by Lemberg (1687) by the action of ammonia on verdohemochrome, followed by treatment with hydrochloric acid. The iron is held even more firmly than in hemin, little being removed even by concentrated sulfuric acid. The greater stability of the azaheme nucleus (and also of complex salts of phthalocyanin) is perhaps related to the fact that replacement of $\begin{array}{c} \diagup \\ \text{CH} \\ \diagdown \end{array}$ by $\begin{array}{c} \diagup \\ \text{N} \\ \diagdown \end{array}$ narrows the ring and thus makes the iron atom an even better fit between the four nitrogen atoms of the pyrrolic rings.

Like heme, azaheme combines with nitrogenous bases giving hemochromes which are oxidizable to hemichromes. As in the porphyrin series the affinity of monoazaheme to ammonia is smaller than that to pyridine or denatured globin. The azahemochromes have a typical hemochrome spectrum, although the two bands are somewhat closer together than in normal porphyrin-hemochromes and visible as separate bands only at low concentration. The α -bands of pyridine azahemochromes lie 8μ further toward the red than those of the corresponding pyridine hemochromes, and the usual $10\text{-}\mu$ difference is found between proto and meso compounds. Spectroscopically the distinction of ammonia azahemochromes from ammonia hemochromes is easier than that of the corresponding pyridine compounds. The difference in the position of the α -bands is in this case 11μ , the bands of ammonia monoazahemochrome lying at 572 and 550μ (weak). The Soret band of azahematin compounds has the same position and height as that of hematin compounds. Azahemichromes are red in neutral, green in alkaline, solution. While the spectral difference is similar to that between hemichromes and hemichrome hydroxides, it is much more apparent to the naked eye.

Holden has made the remarkable observation that at pH 6.4 a blue-green ferrous azaheme cyanide compound is formed with an absorption band at 603μ , while in alkaline solution a dicyanide ferroazaporphyrin of the usual type occurs.

The close similarity between azahematin and hematin compounds disappears, however, when they are combined with native globin since the globin compound of the azaheme does not combine reversibly with oxygen, but is

oxidized to azahemoglobin. The spectrum of azahemoglobin shows little difference from that of denatured globin azahemochrome.

Azahemoglobin at pH 6 has no band in the orange comparable with that of hemoglobin.

The ease with which verdohemochrome is transformed into monoazahematin compounds makes it appear likely that the latter should be found in nature; in fact to judge from its absorption spectrum (hemochrome band 570 μ , hemochrome 625 μ), the hemochrome found by Ball and Meyerhof (125) in the eggs of *Limulus polyphemus* may be an azahemochrome.

8.3. Oxyprophyrin Hematin Compounds

These compounds were first obtained by Lemberg and collaborators (1698) by treatment of pyridine hemochrome with very dilute hydrogen peroxide in the presence of ascorbic acid; they were also later found by Libowitzky and Fischer (1731,1732). Their structure has been discussed in Chapter III. The red oxyprotohemochrome has two absorption bands identical in position with those of pyridine protohemochrome, but the β -band is the stronger. Oxygen transforms it to the green oxyprotohemochrome (absorption band 640 μ), which is unstable. In the presence of ascorbic acid and atmospheric oxygen, it is readily converted into verdohemochrome, but even with oxygen alone it is further oxidized. The hematin of oxyprophyrin in ether is also unstable and changes into brown compounds of unknown structure which no longer give hemochromes with pyridine (1731, 1732).

Holden and Lemberg (1324) have studied the ultraviolet absorption of oxyhemochromes. A moderately strong Soret band was found: pyridine oxyferroprotoporphyrin $\epsilon_{mM}^{430} = 46$, carbon monoxide pyridine oxyferroprotoporphyrin: $\epsilon_{mM}^{422} = 76$.

Oxyhemochromes are mainly of interest as the first intermediates in the formation of bile pigments from hematin compounds; this aspect will receive further discussion in Chapter X.

8.4. Hematins c

The term "hematin c," which is used to describe a number of compounds of only distant relationship, arises from the fact that these substances have been studied mainly in order to gain some insight into the nature of cytochrome c. The phenomena of their production have in common the transformation of protohematin into water-soluble, ether-insoluble compounds, the hemochromes of which have spectra of the meso rather than the proto type. This spectral change indicates that addition has occurred to the unsaturated vinyl side chains, and the hydrophilic nature of the product may be ascribed to the hydrophilic nature of the added groups.

It is also possible, in some instances, for such groups to enter the

methene groups of the porphyrin nucleus; in this manner, mesohematin can also be transformed into a hematin c.

Preparation. Keilin (1476) observed that by alternate reduction and oxidation of protohematin with sodium dithionite and ferricyanide, respectively, a hematin c was obtained. Zeile (3159) found that the ether-insoluble porphyrin c obtained from this by acid contained three to four sulfonic acid groups. Since mesohematin gives similar products, the porphyrin nucleus is also substituted. These compounds are thus not related to the compounds derived from cytochrome c, from which they differ also by losing their iron much more readily on treatment with acids, yielding "porphyrin c" (2308), and by not being transformed into hematoporphyrin by hydrobromic acid in glacial acetic acid (2768,3159). With native globin they unite, giving a hemichrome, not a hemoglobin (2306).

These facts should be a warning that sodium dithionite, which is frequently used as a reducer in hematin and hemoglobin investigations, is by no means harmless, and can cause unexpected side reactions (*cf.* Chapter VIII, Section 3.3.2.).

A similar ether-insoluble porphyrin c is obtained from hematin after treatment with sulfur dioxide, particularly on irradiation (3176). Hemoglobin under these conditions yields a porphyrin peptide containing one to two sulfur atoms, which cannot be split by pepsin or trypsin, probably because it contains a stable $-\text{SO}_2-$ linkage between the peptide residue and the prosthetic group. On treatment with hydrochloric acid, a porphyrin c is obtained. By peptic digestion of sulfhemoglobin, Haurowitz obtained a "sulfheminprotease" (1160), which is evidently of the same type, whereas the heminprotease of Waelsch (2902) differs in yielding hematoporphyrin on splitting.

Hematin c of a different type have been obtained by Zeile (3159,3169) by addition of amino acids, amines, and quaternary bases to the vinyl side chains of protohematin. The hematin c so formed have side chains such as:

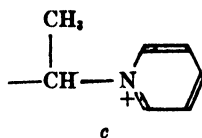
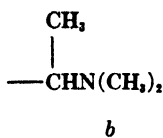
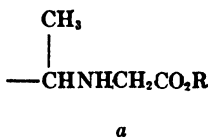

Of these, the third type (c) alone yields hematoporphyrin on treatment with hydrobromic acid. They all combine with native globin to form hemoglobins (2308). During the peptic digestion of hemoglobin, addition of amino acids to the vinyl side chains may occur, giving artifacts, which on acid treatment yield a hematin c and porphyrin c of this type (160,2433).

A special type of hematin c is that in which combination takes place with cysteine. Here, linkage is through the sulfur instead of the nitrogen. This sulfur-containing compound is the only type of hematin c (or porphyrin c)

which closely resembles the corresponding products from cytochrome c. Consequently, it will be discussed in Chapter VIII in connection with the latter substance. Here it suffices to note that the linkage:

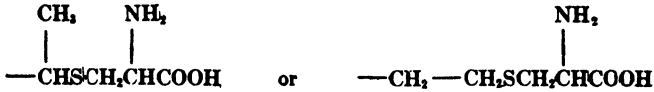

is split by hydrobromic acid, with transformation of the hematin c into hematoporphyrin:

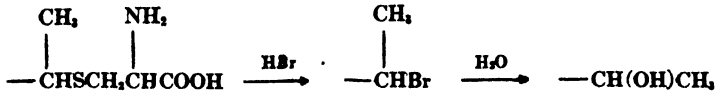

CHAPTER VI

HEMOGLOBIN

1. INTRODUCTION

1.1. Definition of Hemoglobin

In the previous chapter we have seen that heme combines with various nitrogenous compounds to form hemochromes. Toward carbon monoxide and oxygen the hemochromes behave as does heme; both are able to form dissociable compounds with carbon monoxide while reaction with oxygen leads to rapid oxidation to ferric compounds.

When heme is combined with the protein globin, the resulting substance, hemoglobin, is able to form a dissociable compound with oxygen in which the iron remains in the ferrous state. If the environment of the hemoglobin molecule is otherwise held constant, the fraction combined with oxygen is found to be a function of the partial pressure of the gas. On evacuation, molecular oxygen is set free. This unique property distinguishes hemoglobin from other classes of hematin compounds.

This behavior is based on the electronic configuration of the iron atom within the compound. Metalloporphyrins in which the iron is replaced by another element, are able to combine with globins (1282, 1313), but such metalloporphyrin globin compounds have not been reported as being able to unite reversibly with oxygen. The porphyrin nucleus and the globin are, however, also important, since no ferroporphyrin compounds with proteins other than globin, nor any other type of iron compounds are known which possess this property.

Within the class of ferroporphyrin globins, however, a certain variation is possible without loss of oxygen combining power. A globin from one species may combine with a hematin found in another, such as *Spirographis* hematin, or with a synthetic hematin such as mesohematin, and the resulting compound may be transformed into a true oxyhemoglobin. Conversely, the hematin most frequently found, protohematin, is combined with a slightly different globin in every species.

The ability to combine reversibly with oxygen may be lost by alteration of the porphyrin nucleus without denaturation of the protein, as in azahemoglobin or verdoglobin, as well as by denaturation of the globin in which the porphyrin nucleus remains unaltered.*

The present chapter endeavors to give a coherent picture of the hemoglobin molecule in the light of modern chemistry. Differences between hemoglobins from various sources are considered in this chapter only in so far as they throw light on the reactions of an ideal hemoglobin molecule which is an abstraction from the numerous hemoglobins found in nature. The difference between the hemoglobins found in nature may thus be left until Chapter VII, which deals with the comparative biochemistry and physiology of this pigment class.

1.2. Nomenclature

With the increasing number of hemoglobin derivatives reported during the last twenty years, the nomenclature has become rather confused. A number of amendments recently put forward have been in the direction of choosing names which reflect the composition of the compound more closely than does the older nomenclature (Keilin, 1475). The most detailed nomenclature, developed by Clark (452, 453) and Drabkin (617, 620) for use with hemochromes, has not so far been extended to the hemoglobins and would make the nomenclature of the hemoglobin derivatives unnecessarily unwieldy. Here it may become necessary, for example, to distinguish myohemoglobin (muscle hemoglobin, myoglobin) from the hemoglobin contained in

* Hemocyanin, the respiratory blood pigment of some invertebrates, is a copper protein which does not contain the porphyrin nucleus.

While synthetic iron or copper compounds able to unite reversibly with oxygen are so far unknown, the cobaltous complexes of salicylaldehyde-ethylene diimine and related substances, and also of histidine, have recently been shown to have this property (cf. 381a, 395a, 590a, 1936a). In these compounds one molecule of oxygen is bound between two cobalt atoms.

erythrocytes, or to indicate the species from which the hemoglobin has been isolated.

As discussed in Chapter V, we shall use the prefix hemo to denote both ferrous and ferric compounds, hemo for compounds of ferroporphyrin, and hemi for compounds of ferriporphyrin. This not only obviates any possible confusion between reduced hemoglobin and hemoglobin in the wider sense, comprising ferrous and ferric compounds, but also that between "hemi-globin" (a globin of half the usual molecular size; this may be termed "semiglobin") and

TABLE I
Nomenclature of Hemoglobin Derivatives^a

| | Older nomenclatures | | |
|---------------------------------------|-------------------------------------|----------------------------|------------------------------------------------|
| | Suggested ^b | Keilin (1475) | Pauling and Coryell (2127) |
| Ferrous iron, native protein | Hemoglobin | Hemoglobin | Ferrohemoglobin |
| | Oxyhemoglobin | Oxyhemoglobin | Oxyhemoglobin |
| | Carboxyhemoglobin | Carboxyhemoglobin | Carbonmonoxy- hemoglobin |
| Ferric iron, native protein | Hemiglobin | Methemoglobin | Ferrihemoglobin |
| | Hemiglobin hydroxide | Alkaline methemoglobin | Ferrihemoglobin hydroxide |
| | Hemiglobin cyanide | Cyanmethemoglobin | Ferrihemoglobin cyanide |
| Ferrous iron, denatured protein | (Denatured) globin hemochrome | Globin hemochromogen | Denatured globin ferrohemochromogen |
| | (Denatured) globin CO hemochrome | Globin CO hemochromogen | Denatured globin CO ferro- hemochromogen |
| Ferric iron, denatured protein | (Denatured) globin hemichrome | Globin parahematin | Denatured globin ferrihemochromogen |

^a The prefix "myo" denotes derivatives of myohemoglobin, for example, myo-oxyhemoglobin. Derivatives in which other hematins are present, are referred to as meso-oxyhemoglobin, etc.

^b Cf. Anson (63), Heubner (1527), Holden (1317).

hemoglobin as ferric hemoglobin; the latter possibility was raised as an objection against the use of hemoglobin instead of ferrihemoglobin by Drabkin. (Oxy- and carboxyhemoglobin are so well known to be ferrous compounds that the "o" need not be italicized.) Myohemoglobin then represents the ferric form of muscle hemoglobin or

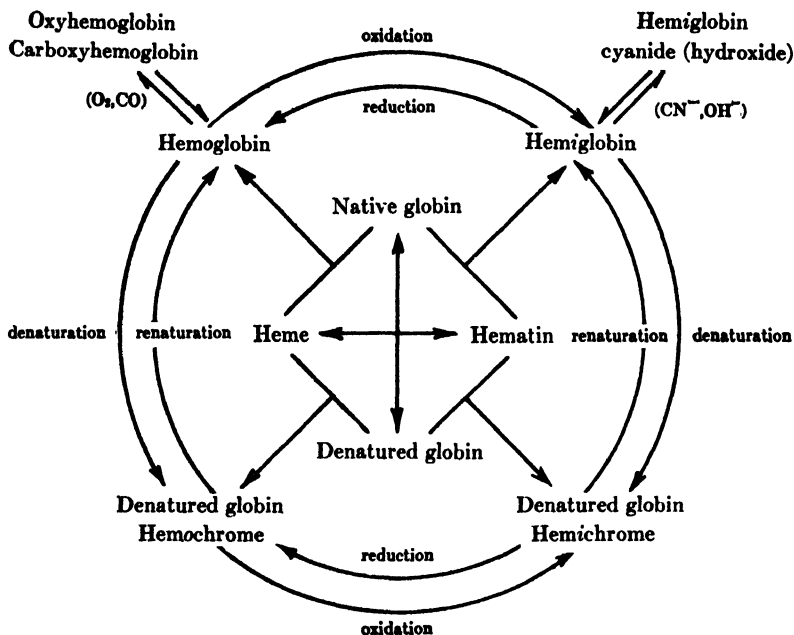

Fig. 1. Interrelationship of hemoglobin derivatives.

myomethemoglobin. The same nomenclature is used for compounds such as sulfhemoglobin and sulfhemoglobin.

We shall use the symbols Hb and Hi for hemoglobin and hemoglobin, respectively, in formulas of their compounds with other addenda. This is the simplest way to make the iron valency clear in symbols for all hemoglobin compounds.

Similar usage could also be introduced for the invertebrate hemoglobins, for example, erythrocrucorin and erythricrucorin or chlorocrucorin and chloricrucorin for the reduced and oxidized forms, respectively, and might even be extended to cytochrome (cytochrome and cytichrome). At the present juncture we shall not extend the *o-i* principle to these compounds. It may also be pointed out that it is not of general applicability (*cf.* peroxidase, catalase) in the class of the hematin enzymes. For all these compounds the nomen-

clature suggested by Pauling and Coryell (*cf.* Table I) will be used, which denotes ferrous and ferric compounds by the prefixes *ferro* and *ferri*, respectively.

We have been tempted to adopt Drabkin's procedure of using a terminal "an" to denote denaturation of protein. Denatured globin ferroprotoporphyrin would thus become mercifully abbreviated to "hemoglobin." Our decision against this usage has been influenced by several reasons. "Globan" has been suggested for a number of years without finding application by many workers. This may be due to the fact that the ending "an," while having no chemical significance nevertheless suggests a definite and unique chemical nature. It is doubtful whether the product of a process so complicated and variable as is protein denaturation should be given such a name. It would be necessary, anyhow, to distinguish between the "hemoglobin" resulting from irreversible, and that resulting from reversible, denaturation. Finally, as long as readers are still unfamiliar with the hemo-hemi distinction, watching for a second vowel in the word and distinguishing between hemoglobin, hemoglobin, hemoglobin and hemoglobin would certainly confuse them (as well as the printer).

Table I presents the nomenclature that will be used in the present work, together with the older nomenclatures of Keilin (1475) and Pauling and Coryell (2127). Figure I indicates briefly the interrelationships of the different hemoglobin derivatives.

2. PREPARATION AND PROPERTIES

2.1. Preparation

2.1.1. Oxyhemoglobin. Since this pigment is the starting point for most work on the chemistry of hemoglobin derivatives, numerous methods are available for its preparation from blood in a pure state. For most purposes, the criteria of a good preparation are: complete solubility in the pH range 5 to 9, freedom from contamination by stroma debris, and finally the minimum amount of hemoglobin.

The first step consists of removal of the plasma protein by repeated centrifugation in isotonic or slightly hypertonic solution. The next step is hemolysis of the corpuscles, which may be carried out by alternate freezing and thawing, addition of minimal quantities of distilled water, or by treatment with organic solvents such as toluene or ether. The latter reagents denature and coagulate the stroma proteins and lipides with minimal effect on the hemoglobin. Alternatively, the stroma may be precipitated after hemolysis by distilled water by adjusting the pH to 6.5 and allowing the solution to stand

in the refrigerator, a procedure which, however, accelerates hemoglobin formation. The oxyhemoglobin must next be induced to crystallize. In some species, *e.g.*, rat and horse, this frequently takes place without further treatment when the cells are hemolyzed, while the pigment from ox, sheep, pig, or man is more difficult to crystallize. With a readily crystallizable hemoglobin, the *pH* is adjusted to 6.8 and if crystallization does not commence, alcohol is cautiously added. The latter procedure should be avoided if possible, since it facilitates denaturation of the protein. Crystallized human oxyhemoglobin has only recently been prepared by Drabkin (627).

Since the above procedures destroy the reducing mechanisms present in the erythrocyte, a small amount of hemoglobin is generally found in the preparation; this may be avoided if carboxyhemoglobin is used instead of the oxyhemoglobin. In spite of all precautions, however, a small amount of nonhemoglobin iron is generally found, even in the best preparations.

The preparations most frequently used are generally modifications of the methods of Heidelberger (1202) or of Ferry and Green (747). Heidelberger's preparation of crystalline oxyhemoglobin starts with washed horse or dog erythrocytes. Toluene is added to the cells and a 4:1 mixture of carbon dioxide and oxygen bubbled through the suspension. After standing and centrifugation, excess toluene and a denatured stroma-toluene emulsion can be removed leaving a concentrated solution of oxyhemoglobin which may crystallize spontaneously. If not, alcohol is cautiously added up to 20%. In the method developed by Ferry and Green, the washed cells are hemolyzed by the addition of the minimum quantity of distilled water, stroma debris removed in a Sharples centrifuge and crystallization is induced by adjustment of the *pH*. In dilute solutions, with easily soluble oxyhemoglobins, or where only small amounts of a derivative are required, dialysis against saturated solutions of ammonium sulfate or 2.8 *M* phosphate buffer of *pH* 6.8 may be used to induce crystallization.

The crystal form is not only a function of the species (627,2224) from which the hemoglobin was taken, but also of the purity of the sample, the acid used in its preparation, and the anion of the anticoagulant (747). Thus human oxyhemoglobin crystallizes in the tetragonal system, while horse oxyhemoglobin is obtained in the form of orthorhombic crystals from citrated and of monoclinic crystals from oxalated blood (627).

When the hemoglobin derivative is prepared for respiratory physiology experiments, crystallization is frequently not necessary; freshly laked erythrocyte solutions tend to give more reproducible results than solutions which have received further treatment (1286). Treatment of solutions of partially purified hemoglobin with adsorbents

to remove traces of special impurities such as catalase may also alter the affinity of the pigment for oxygen (45) (Chapter VII). Where necessary the removal of salts is effected by dialysis or electro-dialysis (703).

2.1.2. Myohemoglobin. The preparation of this pigment is more difficult than that of oxyhemoglobin from corpuscles since the pigment content of the starting material is much lower than in the corpuscles and more foreign material is present. In addition, myohemoglobin derivatives are much more soluble than those of hemoglobin. Present methods are derived from that used by Theorell (2759) in his preparation of the pigment from horse heart after removal of blood by perfusion. In this preparation other soluble proteins are removed by lead acetate. After removal of the lead with phosphate, the pigment is crystallized by dialysis against saturated ammonium sulfate. On account of the much greater speed with which myoxyhemoglobin autoxidizes, myohemoglobin is the major pigment found in the crystals; to avoid this, myocarboxyhemoglobin may be prepared. Hill (1279) has shown that the oxygen capacity of the pigment is not affected by the lead treatment.

Morgan (1987) has shown that horse myocarboxyhemoglobin is readily soluble in 3 *M* phosphate solutions, in which carboxyhemoglobin will dissolve only to the extent of 1 mg. per liter. Traces of hemoglobin remaining after perfusion may be removed by this procedure. Myohemoglobin shows species differences (1987,2760), but these have not so far been used for preparative purposes.*

2.1.3. Criteria for Purity. The blood pigment was shown by Bunge in 1891 to contain iron and, by 1903, investigation, in particular that carried out in Hüfner's school (1353,1355), had established values for the iron content, which have been remarkably close to those of later investigators. Taken in conjunction with the measurement of the oxygen capacity, these results showed that one molecule of oxygen is combined with one atom of iron. Hüfner's figure was 1.34 ml. per g. hemoglobin, which gives an iron content of 0.335%.

Hüfner's proof of the stoichiometric combination between iron and oxygen was not immediately accepted (*cf.* Barcroft's monograph, 141, for discussion). A large number of workers, however, (*cf.* 1989 and 2142 for bibliography) have fully confirmed Hüfner for all

* Recently, Theorell and de Duve (2787a) have prepared human myohemoglobin in crystalline form.

species of hemoglobin so far examined, including that of invertebrates (935). Their results, however, tend to give iron values slightly in excess of those derived from the oxygen capacity. This discrepancy, while no longer of interest for the problem of the stoichiometric combination of oxygen with hemoglobin, is of considerable importance in relation to hemoglobin metabolism (Chapter X, 5.3.).

The purity of a hemoglobin preparation is therefore best defined in terms of the iron content and oxygen capacity. The former should lie between 0.335 and 0.340% in a salt-free sample and the amount of oxygen reversibly bound should lie within 1 or 2% of the theoretical figure. Further discussion on quantitative analysis of hemoglobin and its derivatives is found in Section 9.

2.2. Properties of Ferrous Compounds

2.2.1. Oxyhemoglobin (HbO₂). The absorption spectrum of oxyhemoglobin shows two sharp bands in the green, which give its solutions a characteristic bright red color. On dilution, solutions of oxyhemoglobin acquire a yellowish tinge, which serves to distinguish this pigment from carboxyhemoglobin, which forms a pink solution when diluted. The spectrum of oxyhemoglobin is insensitive to changes in *pH* between 5.5 and 10; outside these ranges, denaturation of the protein commences. The pressure at which the pigment is fully combined with oxygen, however, is extremely sensitive to changes not only in *pH* but also in protein concentration and ionic strength. The dissociation of oxyhemoglobin is not light sensitive.

Measurements of magnetic susceptibility (2127) show the compound to be diamagnetic, the iron bonds being, therefore, covalent. Since the oxygen molecule in its normal state contains two unpaired electrons, it has undergone a profound change in electrical structure on combination with hemoglobin, the system resonating between structures A and B, where the electrons in the 3*d* orbitals of iron are represented by dots (Pauling and Coryell, 2127). The absorption curve of oxyhemoglobin is shown in Figure 2, Section 2.5.

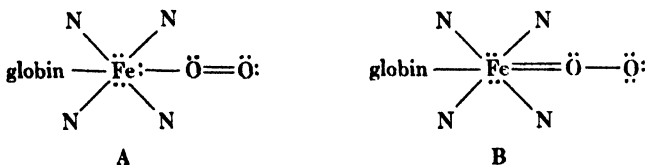

2.2.2. Hemoglobin (Reduced Hemoglobin, Ferrohemoglobin, Hb). This is prepared from oxyhemoglobin by evacuation, equilibration with inert gases, or by the addition of chemical reducing agents such as Stokes' solution, titanous tartrate, ammonium hydrosulfide, or sodium dithionite ($\text{Na}_2\text{S}_2\text{O}_4$). With the first one of these methods care must be taken that some denaturation does not occur from frothing, while with the chemical reducing agents, the $p\text{H}$ must be controlled. A large excess of the reagent and reoxygenation are particularly dangerous if dithionite is the reducer, since hydrogen peroxide is formed during its autoxidation. These considerations are of the greatest importance if alterations of the molecule are to be avoided.

Hemoglobin has a broad band, maximum $560\text{ m}\mu$. While oxyhemoglobin or denatured globin hemochrome are fairly readily detectable with the hand spectroscope in the presence of excess hemoglobin, small amounts of hemoglobin in the presence of the other compounds are not. The spectrum is not sensitive to changes of $p\text{H}$ between 5.5 and 9.5, while outside these limits denaturation may commence, the actual $p\text{H}$ limits of stability varying somewhat with different hemoglobins.

The magnetic susceptibility of hemoglobin shows that it has four unpaired electrons per iron atom, the bond being, therefore of an ionic type (2127,2748).

2.2.3. Carboxyhemoglobin (Carbon Monoxide Hemoglobin, HbCO). Carboxyhemoglobin was discovered by Claude Bernard in 1858 (248) and independently by Hoppe-Seyler a little later. Since the affinity of hemoglobin for carbon monoxide is much greater than that for oxygen, the former gas readily replaces the latter. The spectrum of carboxyhemoglobin in the visible region is difficult to distinguish from that of oxyhemoglobin with the hand spectroscope although the α band of the latter is sharper. The maximum of the α -band shifts from $577\text{ m}\mu$ in oxyhemoglobin to $570\text{ m}\mu$ in carboxyhemoglobin; this may readily be distinguished with a reversion spectroscopy. The spectrum of carboxyhemoglobin like that of oxyhemoglobin, is not sensitive to $p\text{H}$ changes. The molecule contains no unpaired electrons, the bonds being covalent. Pauling and Coryell (2127) assign to carboxyhemoglobin a structure resonating between A and B:

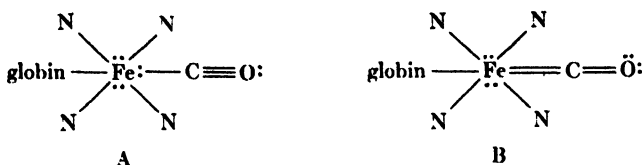

Carboxyhemoglobin, in common with other carbon monoxide-heme compounds, is sensitive to light, the reaction affected being the dissociation $\text{HbCO} \rightarrow \text{CO} + \text{Hb}$. Four light quanta are required for the removal of one molecule of carbon monoxide from one iron atom of carboxyhemoglobin but only one quantum is necessary with myocarboxyhemoglobin (374).

It is often essential to work with hemoglobin solutions in the absence of oxygen and for many purposes the formation of carboxyhemoglobin is sufficient to cut down oxidative changes in the porphyrin structure to a minimum. Since no reagents are available which readily combine irreversibly with carbon monoxide, without at the same time injuring the protein, evacuation and repeated washing with inert gases is the only means of removing the carbon monoxide from carboxyhemoglobin, a process facilitated by strong illumination.

2.2.4. Nitric Oxide Hemoglobin (HbNO). This compound was first observed by Hermann in 1865 (1247) and may be formed in the absence of oxygen by the reaction between nitric oxide and hemoglobin, but for many purposes it is sufficient to reduce a mixture of oxyhemoglobin and sodium nitrite with dithionite.

Nitric oxide hemoglobin has a spectrum similar to that of oxyhemoglobin and carboxyhemoglobin, but the bands are not so sharp, and the minimum is not so well defined. It is found on magnetochemical investigation to have one unpaired electron per iron atom (500) which must, however, be attributed to the nitric oxide. Iron bonds are, therefore, covalent and of character similar to those in oxyhemoglobin and carboxyhemoglobin. Nitric oxide is even more firmly bound to hemoglobin than is carbon monoxide and will therefore replace this molecule from its linkage with hemoglobin. Even when ferricyanide is present, which removes hemoglobin from the system, the dissociation of HbNO proceeds extremely slowly (1489).

2.2.5. Cyanhemoglobin. Cyanhemoglobin is still a somewhat controversial compound and it is doubtful if it has yet been obtained without admixture of other pigments. In 1926, two groups of workers, Balthazar and Phillippe (128) and Anson and Mirsky (cited in 2669) observed that, on the addition of reducer to hemoglobin cyanide between pH 6 and 10, bands appeared at 561 and 533 μ and later slowly faded to the spectrum of hemoglobin. If the cyanide concentration is increased, the two-banded spectrum is more

stable. Stitt and Coryell (2669) found the unstable cyanide compound to be diamagnetic and assumed it to have the same type of structure as carboxy-hemoglobin, with covalent bonds. Holden (1315) observed that the spectrum was typical of a hemochrome. He concluded that the substance was a native globin hemochrome similar to that prepared by Hill (1275) and that cyanide was not combined with the heme. Kiese and Kaeske (1527) however, observed that myohemoglobin reacts to form a cyanide compound and that in 20% urea at pH 6.8 hemoglobin likewise reacts with cyanide. These observations cannot be reconciled with Holden's view, and we conclude that a true cyanhemoglobin exists. In hemoglobin the distal imidazole group (Section 3.2.2.) may compete with the cyanide and render the compound unstable. No such reaction takes place with myohemoglobin. In the presence of urea the structure of hemoglobin is altered and the competing influence of the imidazole weakened.

The myocyanhemoglobin compound can be considered related to the mixed native globin pyridine hemochromes which Kiese and Kaeske obtain from myohemoglobin (*cf.* Section 2.4.4.).

2.2.6. Carbylamine Hemoglobin (HbCH₃NC). This compound was first observed by Warburg in 1929 (2956). He observed that the dissociation of carboxyhemoglobin was diminished by the presence of methylcarbylamine, but that the light sensitivity of the reaction was increased. He concluded that both carbon monoxide and carbylamine were bound to the hemoglobin and observed a slight difference between the absorption spectra of "carbon monoxide-carbylamine-hemoglobin" and carboxyhemoglobin. This is probably another example of the Haldane effect (Section 5.2.2.), which may operate in all complex hemoglobin systems; if hemoglobin is partially saturated with carbon monoxide, the affinity of the remaining hemoglobin for oxygen is increased. In the same way, the linkage of methylcarbylamine to one or two of the hemes in the hemoglobin molecule may increase the affinity of the remainder for carbon monoxide. Hemoglobin itself, however, has a much weaker affinity for methylcarbylamine than for oxygen or carbon monoxide.

The spectrum of carbylamine hemoglobin is remarkably similar to that of cyanhemoglobin, the maxima in the visible region lying at about 565 and 530 $m\mu$. The magnetic susceptibility of methylcarbylamine hemoglobin has not been measured, but the related ethylcarbylamine compound, which has a similar spectrum with sharp bands lying at 554 $m\mu$ and 525 $m\mu$, has no unpaired electrons and therefore covalent bonds (2397).

2.2.7. Nitrosobenzene Hemoglobin. Loeb, Bock, and Fitz (1769) in 1921 obtained a violet hemoglobin compound while investigating nitrobenzene poisoning. It has been shown by Jung (1441,1443) and Keilin and Hartree (1496) to be nitrosobenzene hemoglobin. The compound has two weak bands at 567 $m\mu$ and 543 $m\mu$. Nitrosobenzene can displace oxygen and carbon monoxide from their combination with hemoglobin, but if the partial pressure of carbon monoxide is increased sufficiently, it again replaces the nitrosobenzene. Other aromatic nitroso compounds are able to form hemoglobin compounds. Jung and Keilin and Hartree have shown that nitrosobenzene

hemoglobin is formed during the complex reactions which take place between oxyhemoglobin and phenylhydroxylamine (*cf.* Chapters VIII, 6.3.3., and XI, 5.3.).

2.3. Properties of Ferric Compounds

2.3.1. Hemiglobin (Methemoglobin, Ferrihemoglobin, Hi). Hemiglobin may be formed from any of the hemoglobin derivatives by the action of reagents such as potassium ferricyanide which oxidize the iron to the ferric state. Its structure as ferric hemoglobin, first postulated by Küster and his pupils (2227), was proved by Conant and co-workers (470,478,479). Hemiglobin may also be formed by the autoxidation of oxyhemoglobin (Chapter VIII, 6.3.5.) or by coupled oxidation. The equilibrium between hemo- and hemiglobin is discussed in Section 5.1.7. Hemiglobin is frequently found as an abnormal blood pigment (*cf.* Chapter XI, 5.2.).

The solutions are brown and the compound has a four-banded absorption spectrum with a band in the orange-red at $630\text{ m}\mu$ which may be detected in the presence of a twentyfold excess of oxyhemoglobin. Magnetochemical measurement has shown the existence of five unpaired electrons; the bonds are therefore of an ionic type (499,502).

Hemiglobin may be written as having the formal structure (*cf.*, however, Section 3.2.2.5.) given below. In alkaline solution a proton is removed from this system and hemiglobin hydroxide is formed (Section 2.3.2.), in which the residual hydroxyl is less readily replaced by other groups. The groups which combine with hemiglobin are frequently different from those which combine with hemoglobin.

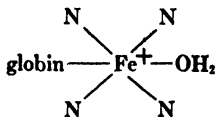

2.3.2. Hemiglobin Hydroxide (Alkaline Methemoglobin, HiOH). Hemiglobin carries a positive charge and as the *pH* becomes greater than 7, the sixth bond position of the iron becomes occupied by an hydroxyl ion. A change in the magnetic susceptibility occurs. The band in the red diminishes in intensity and shifts to $600\text{ m}\mu$, while the weaker bands in the remainder of the spectrum (577 and $540\text{ m}\mu$) become more pronounced; the spectrum shows some similarity to that of oxyhemoglobin. It resembles still more closely that

of a mixture of denatured globin hemichrome with some alkaline hematin (*cf.* Section 2.4.4.).

This has led Holden and Hicks (1923) to suggest that hemiglobin hydroxide is an equilibrium mixture of a native globin hemichrome with a substance in which hematin is not bound to the globin through the iron. This might explain the anomalous magnetochemical behavior of hemiglobin hydroxide, but it is doubtful whether it can satisfactorily explain the potentiometric data.

The magnetic susceptibility measurements put this compound in a class by itself. Four dsp^2 covalent bonds are considered as resonating among the six adjacent atoms, making the bond approximately two-thirds covalent and one-third ionic. Reaction:

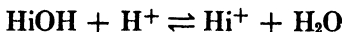

has a pK value of 8.1, whether measured by spectrophotometry (99,1155) or magnetochemical titration (502).

On account of the spectral change when hemiglobin hydroxide is formed, this compound is less readily detectable in the presence of excess oxyhemoglobin than is hemiglobin, and the pH should always be shifted to 6 or 7 before making spectroscopic examination of blood for the presence of hemiglobin.

2.3.3. Hemiglobin Fluoride (HiF). Fluoride ions combine with hemiglobin to form hemiglobin fluoride. The solutions are red in color with a band at $610 m\mu$ and bands in the green. Hemiglobin fluoride was first crystallized by von Zeynek in 1901 (3177; *cf.* Haurowitz, 1155). The affinity of hemiglobin for fluoride is small and dependent on the pH . The reaction $\text{Hi}^+ + \text{F}^- \rightleftharpoons \text{HiF}$ is insensitive to pH changes between 5 and 7. The equilibrium calculated from spectrophotometry (Lipmann, 1756; Havemann, 1188) agrees well with the equation $\log K_{\text{HiF}} = -2.23 + 0.59 \sqrt{\mu}$, deduced from magnetochemical data (502), μ being ionic strength. As the solutions are made more alkaline, the reaction becomes:

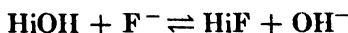

and the equilibrium:
$$\frac{[\text{HiOH}][\text{F}^-]}{[\text{HiF}][\text{OH}^-]}$$

has a K value of 0.78×10^4 .

2.3.4. Hemiglobin Cyanide (Cyanmethemoglobin, Ferrihemoglobin Cyanide). Hemiglobin cyanide was discovered by Haldane

in 1899 (1100). When carefully neutralized cyanide is added to hemoglobin, the color changes from brown to bright red and the spectrum shows a single absorption maximum at 540 m μ . The substance was first crystallized by von Zeynek (3177) in 1901, who showed that one molecule of cyanide was combined with one iron atom (*cf.* also Haurowitz, 1166). The magnetic susceptibility corresponds to one unpaired electron per iron atom, signifying covalent bonds.

Holden (1315) assumed that cyanide is bound irreversibly to protein in hemoglobin cyanide. The dissociation constant has, however, been measured by several workers. Recently it has been shown that hemoglobin cyanide gradually inhibits the cytochrome oxidase system, which also indicates a slow dissociation (34); the affinity of cytochrome oxidase for cyanide seems to be higher than that of hemoglobin. The cyanide is also removed by prolonged dialysis against running water (392), although some alteration of the free hemoglobin may occur.

Many of the reagents which combine with hemoglobin are themselves completely ionized at *pH* 5; at a *pH* greater than this we need only consider the combination of the ion with hemoglobin or hemoglobin hydroxide. Hydrogen cyanide however is a weak acid (*pK* = 9.1) and we must therefore consider the influence of *pH* on the dissociation of the reagent as well as on the hemoglobin \rightleftharpoons hemoglobin hydroxide equilibrium. The three cases are:

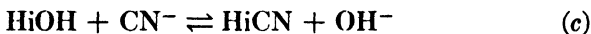
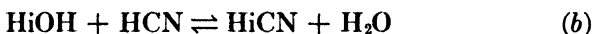

Reactions *a* and *c* * are sensitive to *pH* while *b* is not.

For equilibrium (a), Coryell, Stitt, and Pauling (502) found a *pK* value of - 1.25 by measurements of magnetic susceptibility, while Havemann (1187, 1188) found - 1.02 by photoelectric colorimetry. For equilibrium (b), Haurowitz (1166) and Havemann (1187) found a *pK* value of 5.5. Reaction (c) has not yet been studied. The experimental *pK* value for reaction (b) disagrees with that calculated from the *pK* value of reaction (a) and the *pK* of the dissociation of hemoglobin hydroxide. Reaction (b) cannot be measured accurately, since there is no *pH* at which it is unaccompanied by either (a) or (c). Similar divergencies have, however, been reported for the equilibria of hemoglobin hydroxide with other anions (1188, 1756; *cf.*, however, 502). They are probably due to the interaction of the dissociation of heme-linked groups of globin with the dissociation of anions from the iron (*cf.* Section 3.2.2.3).

* Unless heptacoordination occurs: $\text{HiOH} + \text{CN}^- \rightleftharpoons \text{Hi(OH)(CN)}$.

2.3.5. Hemiglobin Azide. This compound was discovered by Smith and Wolf (2576) in 1904 and later studied by Keilin in 1926 (1482). One molecule azide combines with one iron atom. On adding sodium azide to hemiglobin the color changes to bright red, the spectrum showing a feeble band at 690 $m\mu$, with bands in the green at 575 and 542 $m\mu$. The spectrum is insensitive to changes in pH . The magnetic susceptibility (498,501) corresponds to one unpaired electron per iron atom, with covalent bonds.

Since hydrogen azide is a strong acid one would not expect to find pH dependence in the acid range, but only for the reaction $HiOH + N_3^- \rightleftharpoons HiN_3 + OH^-$. The reaction $Hi^+ + N_3^- \rightleftharpoons HiN_3$ is independent of pH . Keilin found the pK value for the latter reaction to be between 5.1 and 5.2, while Kiese and Kaeske (1527) found $pK = 5.16$. The affinity of hemiglobin for azide is thus almost as great as that for cyanide.

2.3.6. Nitric Oxide Hemiglobin. This compound was first observed by Keilin and Hartree in 1937 (1489). Solutions are red in color, with bands in the green at 568 and 531 $m\mu$. The magnetic susceptibility of the compound has not been measured. The dissociation constant has not yet been reported, but the nitric oxide may be replaced by cyanide to form hemiglobin cyanide. Nitric oxide hemiglobin is unstable, undergoing slow autoreduction to nitric oxide hemoglobin.

2.3.7. Hemiglobin Hydrosulfide. Keilin (1478) observed this compound in 1933. Solutions are red in color, with bands in the green at 570 and 545 $m\mu$. The dissociation of hemiglobin hydrosulfide and its dependence on pH have not been reported since, like nitric oxide hemiglobin, it undergoes autoreduction. In the presence of oxygen, further changes take place, which are discussed in Chapter X. The magnetic susceptibility corresponds to one unpaired electron per iron atom, with covalent bonds.

2.3.8. Hydrogen Peroxide Hemiglobin. This compound was discovered by Kobert (1558) in 1900. It is red in solution with bands at 589 and 545 $m\mu$. Hemiglobin forms analogous compounds with ethyl hydrogen peroxide and methyl hydrogen peroxide (1485,2658). The hydrogen peroxide compound has been studied by Haurowitz (1166) and Keilin and Hartree (1485). Haurowitz has shown that in alkaline solutions the peroxide may be replaced by the hydroxyl ion according to the equation $Hi^+H_2O_2 + OH^- \rightarrow HiOH + H_2O_2$. The hydrogen peroxide is therefore less firmly bound to the hemiglobin than the cyanide ion and, on addition of cyanide to solutions of the hemiglobin hydrogen peroxide compound, hemiglobin cyanide is formed. Hemiglobin can compete with catalase for hydrogen peroxide, since the hydrogen peroxide hemiglobin can be detected spectroscopically when hydrogen peroxide is added to a solution containing the two hemoproteins.

Hydrogen peroxide hemiglobin is an unstable compound; the

hydrogen peroxide is decomposed peroxidatively without liberation of oxygen, a portion of the hemoglobin being destroyed in the process (1485).

2.3.9. Compounds with Cyanate and Thiocyanate. Spectroscopic investigation has shown the existence of a number of other substances which are able to combine with hemoglobin. Among these are fulminate (173), cyanate (1200,2472), and thiocyanate (1442). The spectral changes occurring when the latter two compounds combine with hemoglobin are slight, the spectrum being of the same character as that of hemoglobin, with slight differences in the position and height of the absorption bands.

Havemann (1188) has investigated the equilibrium between thiocyanate and hemoglobin. Since thiocyanic acid is a strong acid, only two cases need be considered:

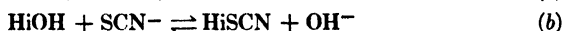

The first of these is not sensitive to *pH* changes, and *pK* = 3.14. The second equilibrium is *pH*. dependent, *pK* = 9.8.* The affinity of hemoglobin for thiocyanate falls between that for fluoride and that for cyanide. The magnetic susceptibilities of these compounds have not yet been measured.

2.3.10. Other Hemoglobin Compounds. Ethanol and ammonia have been claimed to form compounds with hemoglobin hydroxide (501), the ethanol compound having five unpaired electrons (ionic bonds), while the ammonia compound has one unpaired electron (covalent bonds).

For the reaction $\text{HiOH} + \text{C}_2\text{H}_5\text{OH} \rightarrow \text{HiOH} \cdot \text{C}_2\text{H}_5\text{OH}$, *pK* = 0.41; for the reaction $\text{HiOH} + \text{NH}_3 \rightarrow \text{HiOH} \cdot \text{NH}_3$, *pK* = 0. If these reactions have been interpreted correctly, the resulting compounds contain iron in heptavalent coordination (four linkages to porphyrin nitrogens, one to globin, one to hydroxyl, and one to ethanol or ammonia); cf. Chapter V, Section 4.2.3.

In ammonia hemoglobin hydroxide, six covalent bonds resonating between seven linkages would have to be assumed.

With imidazole, hemoglobin forms a compound whose spectrum resembles that of hemoglobin hydroxide (2397). Imidazole hemoglobin has one unpaired electron and hence covalent bonds. The imidazole is not very firmly bound to the hemoglobin (*pK* = about 2.7 at *pH* 7).

2.4. Denatured Globin Hemochrome and Other Protein Hemochromes

2.4.1. Denatured Globin Hemochrome. For the preparation of substances so far dealt with, conditions have been chosen so that minimal change has occurred in the proteins. If the *pH* of a solution of hemoglobin is shifted much beyond *pH* 11, denatured globin hemo-

$$K = \frac{[\text{HiOH}][\text{SCN}^-][\text{H}^+]}{[\text{HiSCN}]}$$

chrome is formed. The typical two-banded hemochrome spectrum slowly appears with the very sharp maximum at $558\text{ m}\mu$ and the weaker and broader band at $528\text{ m}\mu$. Denatured globin hemochrome, like the other hemochromes, is unable to combine reversibly with oxygen, but with carbon monoxide it forms a double-banded spectrum, indistinguishable from that of carboxyhemoglobin. The affinity of denatured globin hemochrome for carbon monoxide is less than half that of hemoglobin.

2.4.2. Denatured Globin Hemichrome (Kathemoglobin). This compound is formed when hematin is combined with denatured globin, when denatured globin hemochrome is allowed to autoxidize, or when dilute sodium hydroxide is added to hemoglobin or to oxyhemoglobin and the solution is partly neutralized. Solutions of denatured globin hemichrome in weakly alkaline solution are brownish and have the characteristic hemichrome spectrum, a weak band at $558\text{ m}\mu$ and a stronger one at $530\text{ m}\mu$.

In contrast to Anson and Mirsky (65), Keilin (1475) and Hauowitz (1157) claimed that in alkaline solution denatured globin hemichrome is not stable, but dissociates into free hematin and denatured globin. The two-banded absorption spectrum observed in the nearly neutral solution, disappears on alkalization. In contradistinction to the absorption spectrum of hematin in alkali, however, that of "alkaline hematin" obtained from hemoglobin does not show an absorption band in the visible region (99,1249). King and Delory (1535) also showed the two spectra to be different. The product obtained from hemoglobin showed greater absorption over the whole of the visible range, the difference being least at $610\text{ m}\mu$. It is difficult to judge whether this difference can be explained by a different degree of dispersion caused by the protein. With pyridine hemichrome, affinity for the base was not shown to change when the solutions were made strongly alkaline, and it is possible that the spectral change observed with denatured globin hemichrome is similar to that accompanying the reaction hemichrome \rightarrow hemichrome hydroxide (Chapter V, 4.2.) and thus does not indicate dissociation at high pH.

2.4.3. "Acid Hematin." If the pH of a solution of hemoglobin is made more acid than pH 3-4, the characteristic linkage of the prosthetic group with the protein is ruptured, while the protein is denatured. The purple color of the hemoglobin changes to reddish-brown and shows the rather indistinct two-banded spectrum in the green of heme (1276) protected by protein from flocculation (Holden, 1162; Keilin, 1475).

When oxygen is admitted the ferrous iron in the heme is oxidized

to ferric and "acid hematin" is formed which has a band in the red at $660\text{ m}\mu$ with a feeble band in the green. The same compound may be formed when any hemoglobin derivative is acidified, although there are slight differences in its rate of formation from different compounds; it is formed more slowly, for example, from carboxy-hemoglobin. When oxyhemoglobin is acidified, oxidation of the protein in addition to that of the iron atom takes place (1702,2279), and the freshly acidified oxyhemoglobin displays peroxidative properties, which are further dealt with in Chapter VIII, 6.3.6.

The band of the "acid hematin" in the red lies about $30\text{ m}\mu$ nearer the infrared than does the similar band of hematin dissolved in glacial acetic acid (1213). This may be due either to a different degree of dispersion of the hematin, the protein acting as protective colloid (1475), or to the hematin's still being attached to the protein. Although the iron is in the ferric state, it will not readily combine with substances such as hydrocyanic or hydrofluoric acid on account of the low pH .

2.4.4. Hemochrome Formation from Myohemoglobin. When hydrazine is added to oxyhemoglobin it first reduces the oxyhemoglobin to hemoglobin and then causes denaturation and forms a denatured globin hemochrome. Schumm (2498) and later Bechtold (197) observed that if myooxyhemoglobin is treated similarly it behaves differently. A spectrum with maxima at 565 , 552 , and $528\text{ m}\mu$ can be observed. A similar absorption spectrum appears if 0.1% pyridine + dithionite is added to a solution of myooxyhemoglobin. When the concentration of pyridine or hydrazine is raised, a typical proto-hemochrome spectrum with maxima at 558 and $524\text{ m}\mu$ appears. If the pyridine concentration does not exceed 2%, some myooxyhemoglobin can be regenerated from the compound by oxygenation. The compound of myohemoglobin with hydrazine and the first-mentioned compound with pyridine, which on reoxygenation yields myooxyhemoglobin, are substances of the structure A-Fe-B, where Fe represents the heme, A, native (myo)globin and B, hydrazine or pyridine (Gonella and Vannotti, 1019). They are thus allied to the mixed hemochromes discussed in Chapter V, 4.1.

In hemoglobin the heme probably lies between two imidazoles (*cf.* Section 3.2.2.) and it is therefore more difficult to form such compounds than in the case of myohemoglobin, where the heme is attached to only one imidazole and the other coordination point is free (compare the case of formation of cyanhemoglobin and myocyanhemoglobin, Section 2.2.5)..

Some observations of King and Delory (1535) on the extinction coefficient and band position of denatured globin hemochrome in 20% pyridine suggest that a mixed base hemochrome (denatured globin-Fe-pyridine) may be present, but the observation should be repeated by absolute spectrophotometric methods, particularly since it does not appear to agree with observations reported by Drabkin (621).

2.4.5. Protein Hemochromes Occurring in Nature. While heme is unable to combine with some native proteins such as egg albumin, some typical hemochromes with protein as nitrogenous base have been found to occur in nature. Cytochrome c, which will be discussed in Chapter VIII, belongs to this category. Another compound of this type is *helicorubin*, which was detected in 1876 by Sorby in the hepatopancreas of the snail *Helix*. *Helicorubin* has been studied by Krukenberg, MacMunn ("enterohematin"), Dastre and Floresco, Dhéré and Vegezzi (587; here the earlier literature is reviewed), Anson and Mirsky (67), and Roche and Morena (2320). *Helicorubin* is a protein protohemochrome with absorption bands at 571.5 and 533.8 μ . The ferric form is stable at pH 5-6. In alkaline solution (pH = 10) only the hemochrome form (absorption bands 562.6 and 530.2 μ) is stable; it does not combine with carbon monoxide.

Another example is the hemochrome observed by Wigglesworth (3081) in the hemolymph of blood-sucking insects (cf. also Fox, 937a).

A compound which appears to be a hemoprotein of somewhat similar nature is *urechrome*, a substance found in the eggs of *Urechis caupo*, a marine worm. While some of its properties deviate remarkably from those of the better known hemoproteins, the fact that pyridine, alkali, and dithionite produce a hemochrome spectrum with absorption bands at 548 and 515 μ indicates that the prosthetic group is of hematin nature, although not protohematin. The side chains may be saturated or of a nature similar to those in cytochrome c. *Urechrome* is reversibly oxidizable, one equivalent being required ($E'_{\%}(\text{pH} = 7.0, 25^{\circ} \text{C.}) = +0.185 \text{ v.}, -\Delta E/\Delta \text{pH} = 0.06$). It was extracted by 0.1 *N* hydrochloric acid in methanol and appeared to be of low molecular weight (1,700), although this is perhaps due to the breakdown of a larger chromoprotein during the extraction. It is also notable that it does not appear to possess a typical Soret band. Hence its nature cannot yet be considered sufficiently well established (1348).

With serum albumin, hematin combines to form a hemoprotein, methemalbumin (ferrihemalbumin), which can be reduced to ferrohemalbumin. This hemoprotein resembles hemochromes in being oxidized to the ferric state by atmospheric oxygen, but differs from hemochromes by its absorption spectrum. It will be further discussed in Section 3.3.5.

2.5. Summary of Spectroscopic Properties

In Table II the position of the maxima and magnitude of the extinction of the absorption bands of the more important hemoglobin compounds are summarized. It will be seen that with a few exceptions the agreement is as perfect as can be expected for data measured with different types of apparatus and with monochromatic light of different purity. Only in a few instances (cf. Table II, footnotes c and f; and 3099) is there any indication that differences in the species from which the hemoglobin was derived may have also played a role in causing differences in the strength of the bands,

while small differences in the position of the bands of the native protein compounds are known (*cf.* Chapter VII).

Figures 2 and 3* give the absorption spectra of oxyhemoglobin, carbon monoxide hemoglobin, hemoglobin, hemoglobin, and hemoglobin cyanide over the whole range from the infrared (1000 $m\mu$) to

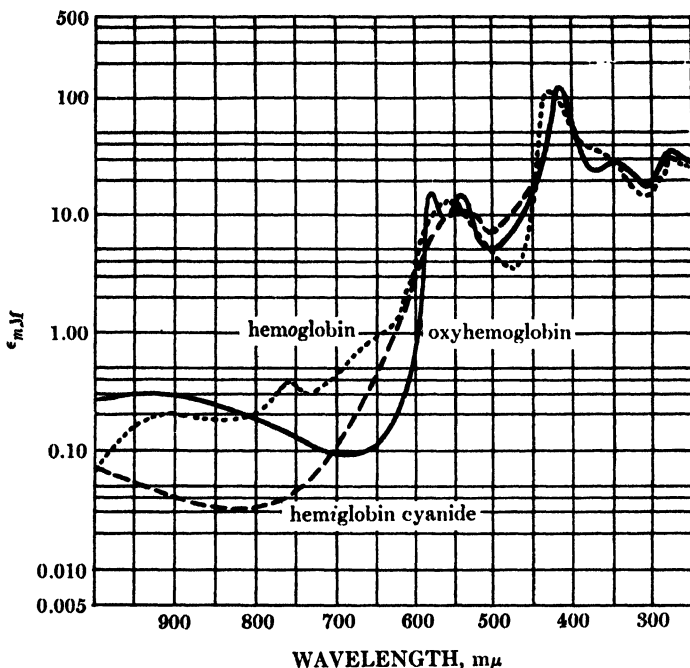

Fig. 2 Absorption spectra of oxyhemoglobin, hemoglobin, and hemoglobin cyanide drawn from data of B. L. Horecker.*

the ultraviolet (about 300 $m\mu$). These have been drawn principally from data kindly supplied to us by Dr. B. L. Horecker. They show clearly the remarkable transparency of carbon monoxide hemoglobin in the infrared, which was discovered by Eggert (649) and studied by Matthes and Gross (1884), Sidwell and co-workers (2549), and particularly by Horecker (1343). They also show that, in addition to the Soret band, hemoglobin and hemoglobin have only one band in the ultraviolet (270–280 $m\mu$), while oxy- and carboxyhemoglobins have a third band in the region of 330–340 $m\mu$. Drabkin has pointed out that these absorption bands in the ultraviolet are not derived from globin, though modified by it. As has been mentioned in Chapter

V, Holden considers a high Soret band evidence of an intact porphyrin ring structure as well as of the distribution of the absorbing molecules outside or nearly outside each other's radius of action as far as optics are concerned. The lower Soret band of acid hematin and (to a

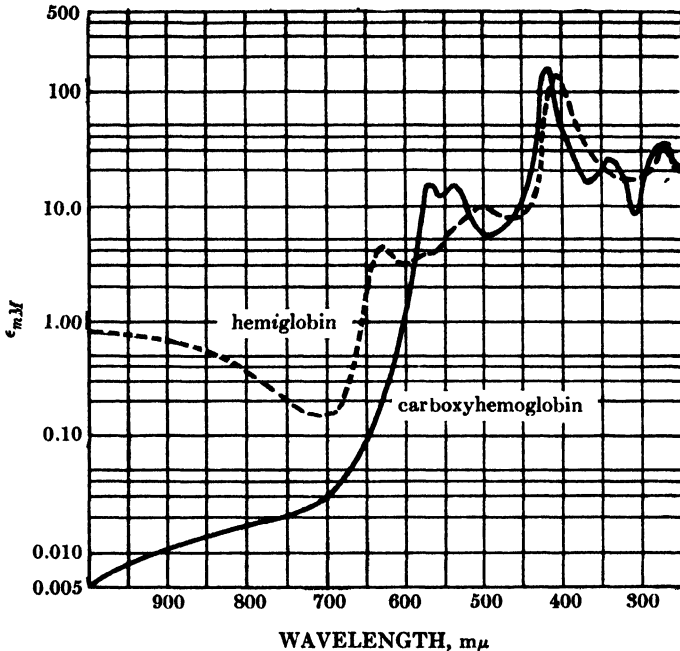

Fig 3. Absorption spectra of carboxyhemoglobin and hemoglobin drawn from data of B. L. Horecker.*

smaller extent) of hemoglobin hydroxide according to this view indicates less effective separation of the prosthetic groups and a certain degree of aggregation.

In an extension of the scheme of Theorell (2775), (cf. Chapter V) we may superficially classify the absorption spectra of these compounds in the visible part of the spectrum as follows:

Theorell's Class IV

1. Ferrous compounds with covalent bonds and with two absorption bands in the green, the longer wave band being referred to as the first.

*A composite graph of the absorption spectra shown schematically in Figures 2 and 3 will be found in the Appendix.

TABLE II

| Compound | Absorption bands | | Reference |
|---------------------------------------------------|------------------|-----------------|---------------------------------------------------------------------------------|
| | maxima, m μ | ϵ_{mM} | |
| Hb | 555 | 12.9 to 13.6 | 628,1343,1518,2549 ^a 628,2549 ^b |
| | 430 | 118 to 134 | |
| HbO ₂ | 576-578 | 15.1 to 16.2 | 627,628,1213,1343,1518,2549,3099 ^c 627,628,1343,3099 ^d |
| | 540-542 | 14.2 to 15.3 | |
| | 412-415 | 125 to 128.5 | |
| HbCO | 568-572 | 13.7 to 15.0 | 621,628,1213,1343,1518,3099 1270 |
| | 538-540 | 14.1 to 15.3 | |
| | 418 | 154 | |
| HbNO | 575 | 13.0 | 628 |
| | 545 | 12.6 | 628 |
| Hi ⁺ | 630 | 3.7 to 3.8 | 1343,1518,3099 |
| | 500 | 9.5 | 1343 |
| | 405-407 | 154,134 | 1270,1315 |
| HiOH ^e | (600) | | |
| | 577 | 8.5 | 1343 |
| | 540 | 9.7 | 1343 |
| | 411 | 90, 71 | 1270,1315 |
| HiCN | 540 | 10.8 | 1518 |
| | | 11.5 | 628 |
| | 412-416 | 92 to 104 | 1351 |
| Denatured globin hemochrome, pH 11.6 | 555-560 | 25 to 30.9 | 621,629 ^f 1323 |
| | 528-530 | 10.7 to 14.8 | |
| | 424 | 110 | |
| Denatured globin hemochrome in 20% pyridine | 558 | 26.9 to 29.1 | 621,2267 |
| | 528 | 15.6 | 621 |
| Denatured globin hemichrome | 575 | 9.1 | 629 |
| | 545 | 10.5 | |
| Denatured globin CO hemochrome | 571 | 11.8 to 12.5 | 621 |
| | 542 | 12.4 to 12.8 | |
| Denatured globin cyanide ferro- porphyrin | 568 | 10.7 | 621 |
| | 540 | 15.0 | |
| Acid hematin, hemoglobin in acetic acid. | 662 | 6.7 | 2048 |
| | 376-379 | 45 | 628,1315 |

^a Sidwell and co-workers (2549) found the maximum at 552.5 m μ . Heilmeyer's value (1213) ($\epsilon_{mM} = 12.4$) is certainly too low.

^b Sidwell and co-workers (2549) found the maximum at 421 m μ .

^c Heilmeyer's (1213) values ($\epsilon_{mM} = 14.6$ to 15.3) are certainly too low. In hemolyzed blood we find $\epsilon_{mM}^{576} = 15.8$, the same as Drabkin (628); Drabkin later (627) gives 15.35. Winegarden and Borsook (3099) found somewhat higher values in the fowl than in man and greater variation in the rabbit.

^d Sidwell and co-workers (2549) give a value of 14.2, which is certainly too low for human oxyhemoglobin.

^e Isosbestic points of Hi⁺ and HiOH: 615 and 520 m μ (628).

^f Human denatured globin hemochrome appears to absorb more strongly than that of the dog (621).

(a) Bands of roughly equal strength: HbO_2 , HbCO , HbNO , denatured globin carbon monoxide hemochrome.

(b) First band stronger; denatured globin hemochrome (other hemochromes).

(c) Second band stronger: denatured globin cyanide ferroporphyrin (dicyanide ferroporphyrin).

Class II

2. Ferric compounds with two bands in the green, covalent bonds: hemoglobin hydroxide (essentially), denatured globin hemochrome.
3. Ferric compounds with one band in the green, covalent bonds: hemoglobin cyanide.

Class III

4. Ferrous compounds with one band in the green, ionic bonds: hemoglobin (heme).

Class I

5. Ferric compounds with a band in the red, ionic bonds: hemoglobin and many hemoglobin compounds, acid hematin.

This classification as well as that of Theorell must be considered a scheme to memorize the main features of the absorption spectra rather than an expression of a natural law, although a deeper connection between absorption spectra and bond types undoubtedly exists. On closer examination, for instance, it becomes likely that the one absorption band in the green part of the spectrum shown by hemoglobin as well as by hemoglobin cyanide consists of two bands combined in one. This is indicated in hemoglobin by a slight bulge of the slope of the band toward longer wavelengths, which is more clearly visible in myohemoglobin (Kiese and Kaeske, 1927), and in hemoglobin cyanide only by the less steep fall of the curve from the absorption maximum toward longer wavelengths.

A more fundamental analysis of the absorption spectra of hemoglobin compounds as being composed of bands belonging to two different series has been attempted by Drabkin (1916, 1918). According to this interpretation the bands in the ultraviolet, the Soret bands, and some bands in the visible are derived from one series, and the typical bands of HbO_2 , HbCO , HbNO in the visible part of the spectrum from another; the spectra of ferrous compounds have an essentially similar pattern. This analysis still requires confirmation.

Beer's law is valid for most hemoglobin compounds, except for acid hematin, in a wide range of concentration (Butterfield, Heubner, and Rosenberg; Suhrmann and Kollath; cf. Drabkin, 1927).

3. LINKAGE OF PROTEIN TO PROSTHETIC GROUP

3.1. Introduction

Hemoglobin was the first conjugated protein investigated, and the mode of linkage of the prosthetic group to the protein, which is of equal interest for other hemoproteins, was first studied with hemoglobin. Progress may be divided into that made up to the mid-1920's and that made since, the dividing line being established by many important advances made at the beginning of the latter period. The molecular weight of hemoglobin was satisfactorily determined in 1925, while, in the same year, progress in spectroscopy cleared up the confusion between denatured globin hemichrome (kathemoglobin) and oxyhemoglobin (65,1475). In 1926, native globin was first prepared and hemoglobins were synthesized which carried prosthetic groups other than protoheme (1282). In 1928, the structure and shape of hemin was definitely established, and it became possible to envisage some of the steric considerations involved in the linkage.

In spite of lack of knowledge of these facts, the early workers made considerable progress. That hemoglobin could be split by acids was well known in the latter part of the nineteenth century and this fact, together with the large basic amino acid content of hemoglobin, suggested that the heme was bound to basic groups. Laidlaw's finding in 1904 (1632) that the iron was more readily split from hemoglobin than from oxyhemoglobin showed that the stability of the prosthetic group varied in different derivatives. The earlier work also clearly established the complexity of the interaction between oxygen, prosthetic group, and protein, which must be explained by any adequate hypothesis for the linkage. Bohr, Hasselbach, and Krogh (309a) showed in 1904 that carbon dioxide decreased the affinity of hemoglobin for oxygen (*cf.* Section 5.), while in 1914 Christiansen, Douglas, and Haldane (442a) showed the existence of the converse effect, oxygenation diminishing the amount of carbon dioxide bound by the blood. Later work (*cf.* Roughton, 2362) has shown that these effects are due both to the increased acidity of the oxyhemoglobin and to the diminished amount of carbon dioxide bound as carbhemoglobin.

At various times the prosthetic group has been considered as forming a molecular compound with the globin and as being linked through peptide, salt, or ester linkages formed by the heme carboxyl groups and groups in the globin or through coordinate linkage from the iron to some group in the protein. In the absence of definite

evidence as to the nature of the groups in the protein, they were called "hemaffine" groups.

Attempts have been made to degrade hemoglobin in the hope that a fragment could be isolated in which the original linkage between the heme and the hemaffine groups could be more readily investigated than in the original protein. Starting with the work of von Zeynek (3178) in 1906, all such attempts have been unsuccessful. Enzymic methods have generally been used for this since all other treatments detach the heme completely. Thus, Haurowitz (1160) subjected hemoglobin to tryptic digestion and isolated a "hemin proteose." He was unable, however, to detach hematin from this product, even by treatment with hydrobromic acid in acetic acid. The original linkage in the native protein was, therefore, no longer present in the pigment. Ross (2344) and Ross and Turner (2345) extended this approach with the investigation of the pancreatic digestion of carboxyhemoglobin. The outcome of their work was, however, as indecisive as that of Haurowitz so far as the original linkage was concerned.

Little support has been given to the view that the prosthetic group is bound to the protein by peptide or ester linkages; the ease with which the prosthetic group may be removed or recombined with the protein (*cf.* Section 4.3.) makes such linkages unlikely. Most of the work has suggested labile coordinate bonds between the iron atom and the protein or some type of feeble linkage between the protein and other parts of the prosthetic group. These possibilities will be discussed separately.

3.2. The Linkage of Heme Iron to Globin

3.2.1. Magnetochemical Evidence. The heme iron is involved not only in the attachment of heme to globin in hemoglobin, but also in the combination of hemoglobin with other molecules such as oxygen or carbon monoxide. While Haurowitz and Waelsch (1177) formulated the derivatives of hemoglobin as coordination compounds in 1929, the most direct evidence for this assumption has come later from the magnetochemical investigations of Pauling and co-workers. By combination with oxygen or carbon monoxide, the paramagnetic hemoglobin (with four unpaired electrons in its iron atom) is transformed to a diamagnetic compound (no unpaired electrons); the paramagnetic oxygen molecule also loses its unpaired electrons in its combination with hemoglobin. Such changes in the electronic configuration of the iron atom can be explained only if the globin as well as the molecules combining with hemoglobin are attached to the heme iron.

In order to account for some of the differences between oxyhemoglobin and carboxyhemoglobin, Holden (1317) has suggested that, in the former case, the oxygen is not combined with the iron atom but with some other

portion of the hemoglobin molecule. The change from ionic to covalent bonds on oxygenation of hemoglobin is assumed to be due to a secondary alteration of the linkages binding the heme to the protein when the oxygen combines. Now, although the existence of Hill's native globin hemochrome (*cf.* Section 4.3.3.1.) indicates that nitrogenous groups capable of forming covalent bonds with the iron atom lie in proximity to the heme, the spectrum of oxyhemoglobin is not that of a hemochrome and Holden's suggestion appears most unlikely.

3.2.2. Evidence That Heme Iron Combines with Imidazoles

3.2.2.1. Origin of the Imidazole Hypothesis. The recognition of the similarity between denatured globin hemochrome and the hemochromes containing simple bases (Chapter V) drew attention to the importance of the groups responsible for hemochrome formation in denatured globin. In view of the large amount of histidine in globin, Küster (1611) and later Langenbeck (1642,1643) suggested that histidine imidazoles were involved in the linkage of heme in hemoglobin. Haurowitz (1165) opposed this hypothesis because of the low affinity of histidine for heme; but histidine is present in peptide linkage in the protein and, though some histidine peptides have been prepared (1052), their affinity for heme has not been measured.

The histidine content, however, varies considerably among hemoglobins. In chlorocruorin (Chapter VII), an invertebrate oxygen carrier, about 2.5 moles of histidine are present per mole of heme, while Vickery gives 33 moles of histidine per mole (four hemes) of hemoglobin. While globin will combine with only one heme for an equivalent molecular weight of 16,700 (1232), denatured globin will combine with as many as six hemes per equivalent (1311,1322,3165), *i.e.*, more than the maximum possible if each heme binds two histidines. Holden and Freeman (1322) found that the ability of denatured ox globin to form hemochromes was diminished by treatment with nitrous acid, a procedure which leaves imidazoles unaffected, and concluded that imidazole was not solely responsible for hemochrome formation. Cytochrome c, which contains only three histidines, is also able to combine with additional hemes after denaturation (3165). The imidazole groups are therefore not the only groups in protein with which the heme iron can combine to form hemochromes.

Conant's discussion of the linkage between heme and globin in 1933 (471) marked an important advance, since he took into account the earlier work (*cf.* Section 3.1.), in which oxygenation had been shown to affect the properties of the protein. In Haurowitz's discussion of the linkage from the point of view of the Werner coordination theory, the sixth coordination valency of the iron in hemoglobin was occupied by a molecule of water, which was displaced on oxygenation. Conant considered that in hemoglobin the heme might

be bound to two "hemaffine" groups in the protein, one of these groups being displaced on oxygenation. He pointed out the improbability of the entry of oxygen affecting the dissociation of the carboxyl groups of the porphyrin and suggested that the oxylabile hydrogen ion might originate from the displaced "hemaffine" group. Although Conant spoke only of the probability that the histidine groups were involved, the recent developments of the imidazole hypothesis suggest that both of Conant's "hemaffine" groups are imidazoles. The imidazole hypothesis has been generally accepted, but recently a number of serious objections have been put forward. We shall consider these after presenting the evidence for the theory.

3.2.2.2. Present Status of the Imidazole Hypothesis. The investigations of van Slykè and co-workers (2140) had established the existence of an "oxylabile" group in hemoglobin whose dissociation in the region of pH 7 was increased when the pigment combined with oxygen. In 1937 Cohn, Green, and Blanchard (462) titrated crystalline horse carboxyhemoglobin and pointed out that between pH 5 and pH 9 the results could be accounted for by postulating thirteen histidines with apparent pK values of 5.7 and twenty histidines with apparent pK values of 7.5. The number of histidines indicated on the basis of the titration was identical with the value of 33 found analytically by Vickery and Leavenworth (2877). Below pH 4 and above pH 11 the ionizable groups found by titration do not agree so well with the analytical figures, perhaps due to denaturation. The groups, however, which are involved in the changes in acidity on oxygenation, are certainly present in native protein. German and Wyman (988), by using a wider pH range than had van Slyke, showed that between pH 4.5 and 6.1 oxyhemoglobin is a weaker acid than hemoglobin, while between pH 6.1 and 9.0 it is a stronger acid. Outside this limit, there was no difference between the two proteins. These data fitted well with the two pK values at which Cohn and co-workers had shown the histidines to dissociate.

Wyman next analyzed the heat of dissociation of hydrogen ions from oxyhemoglobin and its variation with pH and confirmed the conclusions drawn from the electrometric titrations (3134). The heats of dissociation found at pH less than 4.5 were characteristic of carboxyl groups. Between pH 6 and pH 8 a heat of dissociation of 6200 cal. was observed; this is of the right order for imidazole ionization; the dissociation of the hydrogen ion from the imidazole in histidine and histidylglycine requires 6900 and 7500 cal., respectively

(461, p. 89). Beyond pH 9.5 the heat of dissociation, 11,500 cal., corresponded to that expected for the terminal amino groups of lysine.

Wyman then investigated the heat of oxygenation of hemoglobin between pH 3 and pH 11 (3135). He says, "the results can be accounted for on the basis of the dissociation of the hydrogen ions which accompanies oxygenation if we assume a heat of dissociation of 6500 calories per equivalent." This value found on horse hemoglobin differed from that found by Roughton on ox hemoglobin (*cf.*, however, Section 3.2.2.4.).

Wyman interpreted his results in the light of Conant's model by assuming that the iron is situated between two imidazole groups, one of which is displaced when oxygen enters the molecule, with consequent changes in the ionization of the imidazoles. He attributed the opposite effects, which he found the introduction of oxygen to exert on the ionization on either side of pH 6.4, to the shift of one histidine pK from 5.25 to 5.75 and the other from 7.81 to 6.80, both changes being toward the pK value found for free histidine. Based on Wyman's investigation, Coryell and Pauling (499) have given an extremely interesting structural interpretation of the manner in which change of bond type affects the ionization of "oxylabile" groups. A modification of Conant's structure is taken, the heme being assumed to lie between two imidazoles and, after Wyman (3135), closer to one imidazole than to the other. We shall refer to these as the proximal and the distal imidazoles, respectively. Pauling and Coryell (499) discuss first the behavior of the proximal imidazole on the entry of oxygen into the molecule in the light of the influence of resonance on acid strength (2125).

The most important resonance structures assumed to be present are given below:

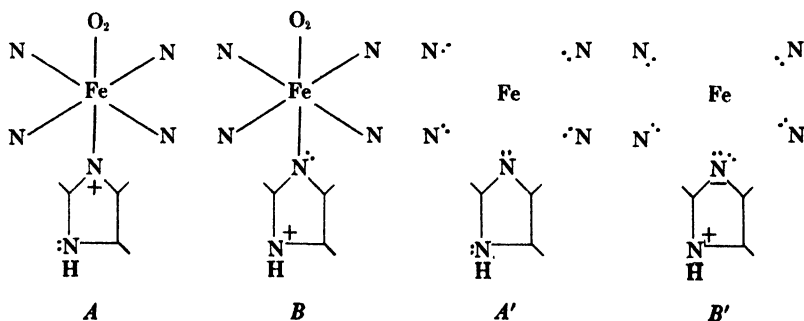

They say:

"If structure *A* alone represented the normal state of oxyhemoglobin the acidity* of the NH group of the imidazole ring would be very low, since the structure $\text{>}\ddot{\text{N}}-\text{H}$ is characteristic of amines (such as dimethylamine) which are basic rather than acidic. If structure *B* represented the normal state, the group would be rather strongly acidic; the group $\text{>}\overset{+}{\text{N}}-\text{H}$ in the pyridinium cation, for example, has $pK_A = 5.1$. With resonance between structures *A* and *B*, the group should be somewhat less acidic than the pyridinium cation. This is observed for imidazole derivatives of this type; thus the observed value (2964) of pK for the *N*-methylimidazolium cation is 7.35. For the imidazolium ion itself the observed value of pK , 6.95, becomes 7.25 when corrected by the amount of $\log 2$ to correct for the presence of two equivalent ionizable hydrogen atoms; and the imidazolium group in the histidine cation (1053) has $pK = 6.04$, which becomes 6.34 on correction, the change from the imidazolium value being attributable to interaction with the charges in the ionized amino and carboxyl groups of the amino acid. Some variation in substituted imidazoles is to be expected also because of the difference in electronegativity of the attached groups. We would predict on the basis of our postulate about the structure of oxyhemoglobin that pK_2 for this substance should lie in the region near 7; the observed value 6.80 is in satisfactory agreement with this prediction."

Coryell and Pauling discuss the change in bond type on oxygenation as follows:

"Structures *A* and *B* for oxyhemoglobin are seen to be closely similar, (they are equivalent in the imidazolium ion), and hence they contribute nearly equally to the normal state of the molecule. The decrease from large contribution of a structure of the type of structure *B* (pyridinium ion) to a contribution of about 50 per cent is accompanied by an increase in pK by about 2 units. Now in ferrohemoglobin itself structure *B'* makes a still smaller contribution than 50 per cent, because this structure, with separated electric charges, is less stable than structure *A'*, in which the nitrogen atoms have their normal covalence; hence it is predicted with certainty that *the change of bond type for the iron atom accompanying removal of the oxygen molecule must be accompanied by a decrease in the acidity of the attached imidazole group*. A quantitative prediction of the magnitude of the expected change in pK_2 from oxyhemoglobin to ferrohemoglobin cannot be made at present; but the observed change from 6.80 to 7.81 is reasonable in the light of the above discussion."

* The dissociation referred to is not that of a secondary amine as base:



The changes which take place in the distal imidazole group on oxygenation are discussed as follows:

"We assume that the 3-nitrogen atom of this ring is restrained by the configuration of the hemoglobin molecule to a relatively unfavorable position for electrostatic coordination with the iron atom so that a proton can be added, breaking the bond to the iron atom, at high enough acidity. These assumptions explain the occurrence of the low pK_1 value 5.25 in ferrohemoglobin for the imidazolium structure postulated for acid group I. The coordination of the iron atom with an oxygen molecule on the same side of the porphyrin ring would be expected to prevent the interaction with the iron atom and thus to make the imidazolium group show more nearly the same pK value as in histidine itself ($pK = 6.04$)."

3.2.2.3. Linkage in Hemoglobin. Further data on the heme-protein linkage became available on investigation of the hemoglobin-hemoglobin equilibrium. Taylor and Hastings (2751) showed that on oxidation of hemoglobin to hemiglobin the curve relating oxidation-reduction potential to pH showed no inflexion corresponding to the pK value of 8.1 found for the reaction $H_i^{2+} + OH^- \rightleftharpoons H_iOH$. Instead, the potential (E'_0) appeared to depend on an ionization with a pK value of 6.65.

Coryell and Pauling (499) then reinvestigated the pH dependence of the magnetic susceptibility of hemoglobin and were able to interpret the variation in magnetic susceptibility with pH in terms of a group with an approximate pK value of 5.3, and the pK value of 8.1 for the hemoglobin-hemoglobin hydroxide equilibrium. They assumed that the ionization corresponding to the pK value of 6.65 found by Taylor and Hastings from oxidation-reduction potential measurements had no effect on magnetic susceptibility. They explained the variation of potential with pH by assuming that the ionization of the group in hemoglobin with pK value 7.8 is replaced in hemiglobin by the ionization of the hematin (hemoglobin hydroxide \rightarrow hemiglobin) with pK value 8.1. There is therefore no measurable effect on the E'_0/pH dependence. While the group with a pK value of 6.65 appeared to influence the potential, there was no evidence for a spectral change of hemiglobin in this pH region. The group with a pK value of 5.3, which they found to influence the magnetic susceptibility, appeared to be without effect on the oxidation-reduction potential.

The heme-linked groups, the existence of which had been shown by various methods, were summarized by Coryell and Pauling (Table III). In the table the symbols following the pK values describe their

behavior. A certain simplification was introduced in this scheme by assuming that pK_2 of 6.65 in the hemoglobin represented the same group which shifts from the pK_2 of 7.8 in hemoglobin to a pK_2 of 6.8 in oxyhemoglobin. Wyman and Ingalls (3136) showed that this was

TABLE III
Heme-Linked Acid Groups^a in pH range 4.5 to 9^b

| Group | pK_1 | pK_2 | pK_3 |
|------------------|--------------------|------------------------|--------------------|
| Hi ⁺ | 5.3 <i>Mo</i> | 6.65 <i>Si, Mi, Po</i> | 8.10 <i>So, Mo</i> |
| Hb | 5.25 <i>Mi</i> | | 7.81 <i>Si, Mi</i> |
| HbO ₂ | 5.75 <i>Mi, Po</i> | 6.80 <i>Si, Mi, Po</i> | |

^a *S*, *M*, and *P* refer to spectrophotometric, magnetometric, and potentiometric measurement, respectively; *o* or *i* indicate whether the particular pK has been found operative or inoperative by the particular technique employed.

^b According to Coryell and Pauling (499).

probably the case, since they were able to describe adequately the difference between the base bound by hemoglobin and by oxyhemoglobin solely in terms of the pK_3 group in hemoglobin, to which they assign the value 8.05.

By an ingenious treatment (*cf.* Section 5.2.4.) of the data of Taylor and Hasting for the E_h of the hemoglobin \rightleftharpoons hemoglobin oxidation-reduction system and of the results of Ferry and Green (747) for the oxyhemoglobin \rightleftharpoons hemoglobin equilibrium, Wyman and Ingalls arrived at the following pK values for these systems at 25° C. and ionic strength 0.16:

| | Heme-linked acid groups | | |
|------------------|-------------------------|--------|--------|
| | pK_1 | pK_2 | pK_3 |
| Hi | 5.75 | 6.68 | 8.01 |
| HbO ₂ | 5.75 | 6.68 | |
| Hb | 5.25 | 7.93 | |

where pK_1 and pK_2 represent the ionization of the distal and proximal imidazole groups, respectively (Section 3.2.2.2.), and pK_3 , the dissociation of the hemein. The above pK values were not derived from the data of one experimental approach only, but represent those values which provide the best fit of the above data as well as the values they obtained from data on the differential titration systems. The way in which they did this is discussed in Section 5.2.5.

Coryell and Pauling (499) treat the behavior of the hemein-linked

imidazoles in hemoglobin in the same way as in the oxyhemoglobin-hemoglobin system (Section 3.2.2.4.). The chief effect of oxidation of hemoglobin to hemoglobin is the increase in the formal positive charge by one unit, the bond type remaining essentially ionic. Both oxidation and oxygenation decrease the dissociation of the proximal imidazole from a pK of 7.9 to 6.7, about one pH unit. They deduce from this the distance which separates the ionizing group from the iron atom:

"Assuming that the electrostatic interaction of the iron atom and the proton of the acid group is solely responsible for this change in pK_2 , we can estimate roughly the distance between acid group II and the iron atom from comparison with some dipositive acids such as the salts of the alkaline diamines. The first and second pK values of propylenediamine and butylenediamine differ by 2.04 and 1.54 units respectively. These values must be decreased by $\log 4$ or 0.60 for the symmetry effect, which does not operate between the chemically unlike second and third acid groups of ferrihemoglobin. The observed increase in pK_2 on oxidation of the iron atom lies between the corrected diamine differences (ΔpK) 1.44 and 0.94. The distance between the nitrogen atoms between the two diammonium salts, assuming extended configuration and the angles and distances given by Pauling (2125), are 4.94 and 6.27 Å., respectively. We conclude that acid group II of ferrohemoglobin and ferrihemoglobin is roughly 5 Å. from the iron atom, about the expected distance between an iron atom near one of the ring nitrogen atoms of a histidine residue and the second nitrogen atom of the ring."

The behavior of the distal imidazole is explained as follows:

"On oxidation of the iron to the ferric form, the pK_1 value would at first sight be expected to be lowered, as is the pK_2 value; instead, no appreciable change is observed. If, however, after addition of a proton to the imidazole group a water molecule coordinates (through dipole attraction) with the iron atom in the ferric state more strongly than with it in the ferrous state, the corresponding extra stabilization of the acid form by the water molecule will tend to offset the expected decrease in pK_1 when the iron atom is oxidized. The cancellation of these effects seems to be complete."

3.2.2.4. Objections to the Imidazole Hypothesis. While this hypothesis is able to account for a number of the properties of the heme-globin linkage, Roughton (2362) has pointed out that it is unable to account for at least one important reaction, the direct carbamino combination of carbon dioxide with oxylabile groups in the hemoglobin molecule. It has been established by a number of workers (745a,b;1882a;2586a) that more carbon dioxide is bound as the carbamino compound in the hemoglobin of the ox, horse, and human species than in the oxyhemoglobins. Now, only free amino

groups have been shown to form a carbamino compound according to the equation:

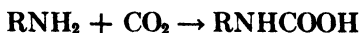

Imidazole as well as various other groups has been tested and found to be unable to form carbamino compounds. As a consequence of this fact Roughton has examined the evidence for the imidazole hypothesis and has made a number of criticisms. In addition to suggesting the possibility of certain technical errors in Wyman's technique, which might lead to an accuracy in his heats of reaction of only ± 1000 cal., Roughton points out that the heats of dissociation of hydrogen ions from horse hemoglobin in the pH range 6 to 8 are some 2000 cal. lower than the value found with ox hemoglobin, the latter value suggesting that both imidazole and amino groups are involved in buffering in this species.

Further he criticizes the lack of rigor in identification of a particular pK value in a protein with a particular dissociating group. Roughton points out that glycyglycine is able to form thirty times as many carbamino groups as glycine at pH 8, in agreement with the fact that the pK value of the free amino in the peptide lies about two pH units nearer neutrality than in the free amino acid. On the other hand, replacement of one of the postulated heme-linked imidazoles by a glycy residue, or by the terminal amino group of a lysyl residue will necessitate a re-examination of the mechanism by which the entry of oxygen affects the dissociation of hydrogen from the oxyliable groups. This problem is referred to again in Section 8.

3.3. Role of Hematin Side Chains in Linkage

3.3.1. Introduction. A number of the reactions of globin can be interpreted in terms of the linkage between the iron atom in the heme and the "hemaffine" groups in the protein. The evidence for linkage through iron, however, does not exclude the possibility that the side chains may be involved as well.

The ease with which the prosthetic group may be removed makes it unlikely that ester or peptide linkages are present. Only linkages of an electrostatic nature seem possible. These may be in the nature of weak van der Waals forces, or linkages involving the carboxyls or perhaps the vinyl side chains in the hematin. The latter possibility is excluded by consideration of synthetic hemoglobins.

3.3.2. Synthetic Hemoglobins. Hill and Holden (1982) prepared meso-hemoglobin and hematohemoglobin. Both were able to combine reversibly with oxygen. Warburg and Negelein (2954) prepared hemoglobins from

rhodohemin, diacetyldeuterohemin, and pheohemin-*b*, which combined reversibly with oxygen. The oxyhemoglobins of the first two showed a typical two-banded spectrum. These results show that the vinyl side chains in protohemin can be converted to ethyl groups in mesohemin, hydroxyethyl groups in hematohemin, and transformed to acetyl groups in diacetyldeuterohemin, without affecting the specific heme-globin linkage in the process.

Bile pigment hematins (Chapter X, 2.3.) and monazahematins (Chapter V, 8.2.), as well as pheophorbide-*b* hematin (2954), have been shown to combine with globin to form compounds which are unable to combine with oxygen. Further investigations are needed to decide whether this is due to their inability to form the same type of linkage with the globin as in protohemin, or whether it is due to the alteration in the structure of their resonance system.

All the above hemins, however, still possess carboxyl groups. No work has been reported on any of the hemins which do not carry carboxylic acid side chains, perhaps because of their insolubility. Haurowitz (1177) has reported that the dimethyl ester of mesohemin is able to form a hemoglobin; it is possible, however, that saponification of the ester occurred in the alkaline globin solution. Since Holden (1317) has recently revived the idea that the carboxyl groups are involved in the linkage, experiments with heme lacking these groups are urgently needed.

3.3.3. Compounds of Globin with Porphyrin and Nonferrous Metalloporphyrins. The possible role which the carboxylic acid side chains of the hematin might play in linkage to globin can be seen in the porphyrin globin compound. Hill and Holden (1282) observed that when protoporphyrin, mesoporphyrin, or hematoporphyrin are combined with globin, the color changes from brownish-red to pink and the absorption bands in the visible region become sharp. The Soret band also becomes stronger, indicating a change in the degree of aggregation of the porphyrin (1504) and the porphyrin is no longer adsorbed on calcium carbonate. While serum albumin (*cf.* Section 3.3.5.) causes slight spectral changes when added to an alkaline porphyrin solution (1177,1310), denatured globin (1282) and casein (1310) do not do so.

Native globin is able to combine with between four and eight porphyrin molecules (1282,1310); Hill and Holden (1282) were able to displace hematoporphyrin from combination with globin by the addition of hematin; hemoglobin was formed while the spectrum of alkaline porphyrin reappeared. The porphyrin is thus displaced from a position on the globin which is adjacent to, if not identical with, that occupied by hematin. This important experiment should be repeated, using spectrophotometric methods.

Globin combines with a number of nonferrous metalloporphyrins. The manganese, cobalt, nickel, copper, zinc, or tin mesoporphyrin compounds show sharpening and shifting of absorption bands when slightly alkaline solutions of these substances are allowed to stand with native globin (1282). Similar compounds of protoporphyrin with copper, nickel, cobalt, and zinc have been shown to combine with globin (1312). Taylor (2749) has shown that the cobalt and manganese mesoporphyrins are capable of combining

with base to form hemochromes; in the compounds which these metalloporphyrins form with globin, therefore, the metal atom may take part in the linkage (*cf.* Chapter V, and also peroxidase, Chapter IX). In the copper and zinc metalloporphyrins, however, it is unlikely that the valency shell of the metal atom would permit the formation of a stable metal protein bond. The insertion of the metal atom has also saturated the valencies of the pyrrole nitrogens.

In the copper or zinc mesoporphyrin globin compounds neither the metal atom nor the pyrrole nitrogens are able to take part in the linkage; this must therefore be either an electrostatic linkage between carboxyl groups in the porphyrin and basic groups in the protein or must be based on van der Waals forces between the flat aromatic porphyrin plate and the protein. The similarity between the spectral changes observed when the porphyrins combine with globin and when they combine with simpler substances (Section 3.3.4.) favor the former of these two possibilities. In this connection reference may be made to the observations of Granick and Gilder (1935), who found that porphyrins other than protoporphyrin, but not their esters, competitively inhibit the incorporation of protoporphyrin into the molecule of respiratory enzymes of hemoflagellates.

3.3.4. Compounds of Porphyrins and Metalloporphyrins with Simple Substances. Globin is not the only substance which causes sharpening of the bands in the visible region of the spectrum and the appearance of a well-marked Soret band on combination with porphyrins and metalloporphyrins. The rather indistinct spectra which are observed in aqueous solutions of porphyrins, nonferrous metalloporphyrins, and hematins are probably due to interference with the resonance of the porphyrin ring by formation of polymers (Chapters III and V).

The mechanism by which polymerization is prevented is not clear in all cases. In the porphyrins it is possible that polymerization takes place by the formation of hydrogen bonds between the carboxyl on one nucleus with one of the central hydrogens on another. Rupture of these intermolecular links by combination with solvent or with other substances may again establish the integrity of the resonance system within the single molecule.

The state of porphyrins and metalloporphyrins in organic solvents such as ethanol is irrelevant to the question of the linkage to globin. In aqueous solution, however, J. Keilin has shown that the spectrum is sharpened by the addition of surface-active substances such as bile salts or sodium dodecyl sulfate, or by bases such as caffeine, 1-methylimidazole, or pilocarpine (1904). While the former may exert their effect by van der Waals' interactions or by bond formation to the pyrrole nitrogens, the latter class of substances almost certainly combine with the carboxyl groups. The evidence for the change in the state of the porphyrin induced by caffeine does not rest solely on spectroscopic grounds, since the porphyrin was no longer precipitated by calcium carbonate.

Keilin's observations on turacin (copper uroporphyrin, *cf.* Chapter III) make it unlikely that van der Waals interactions are involved in these

phenomena. While caffeine, 1-methylimidazole, or pilocarpine cause sharpening of the absorption bands in the visible region of the spectrum, bile salts, digitonin, or sodium dodecyl sulfate are without effect. It is improbable that the presence of the copper atom or the side chain differences between uro- and protoporphyrin would affect the ability of the flat porphyrin plate to form van der Waals' compounds with the above-named substances. The copper atom would, however, prevent linkage of these substances to the pyrrole nitrogens.

While the carboxylic acid side chains may be involved in the formation of compounds of protoporphyrin and turacin with caffeine, there is evidence that in the formation of the caffeine heme compounds (1504) the iron atom is also involved. The caffeine heme compound is not a hemochrome, the spectral change on combination being similar to that observed when caffeine is added to porphyrin. Caffeine combines with heme and with carbon monoxide heme, but does not combine with hematin. The affinity of caffeine for heme is increased when the carbon monoxide compound is formed. If excess caffeine is added to pyridine hemochrome, the spectrum slowly changes to that of the caffeine heme compound, while addition of more pyridine re-forms the hemochrome.

It is difficult to understand this competition if the caffeine and the pyridine are not both attached to the iron atom. We do not believe that this possibility invalidates our earlier conclusions from the caffeine protoporphyrin and the caffeine turacin compounds that caffeine combines with the carboxyl side chains. In the caffeine heme compound the caffeine may be combined to both the iron and the carboxyl side chain. Keilin tested a number of purines, pyrimidines, imidazole derivatives, and several alkaloids. Besides caffeine only chlorocaffeine showed a simple "caffeine effect," while pilocarpine which is able to produce this effect, is also able to form a hemochrome.

As with the compounds of globin with the porphyrins and nonferrous metalloporphyrins, the combination of caffeine with mesoheme, hematoheme, and deuteroheme excludes the vinyl side chains from any active role.

Most of the evidence for combination with carboxylic acid side chains in this and in the previous sections is based on spectroscopic observations. The evidence is also indirect in that, with the exception of the caffeine heme compound, the carboxylic acid group is left as the most probable point of attachment, after linkage to other parts of the molecule has been excluded by working with different derivatives. The crucial experiments with porphyrins or metalloporphyrins lacking carboxyl groups have not yet been reported, probably owing to the difficulty of working with these substances in aqueous solution. On the other hand there is no evidence that in addition to the essential iron imidazole linkage in the hemoglobin, secondary carboxyl protein linkages may not be formed. The sharpening of the absorption bands, in consequence of the breaking up of polymers, by combination of

bases with the carboxylic acid side chains could not be detectable in the hemoglobin spectrum.

3.3.5. Methemalbumin (Ferrihemalbumin). The only compound of biological importance in which the linkage is probably from the carboxylic acid side chains of the hematin to basic groups in the protein is hemalbumin. Fairley (731) observed that a pigment was present in the plasma of patients with black water fever, which appeared to be similar to hemiglobin (methemoglobin) and which was originally named "pseudomethemoglobin" and later methemalbumin. J. Keilin used the term "hematin-albumin"; in accordance with the general principle of nomenclature used in this book we shall use the term ferrihemalbumin.

A positive reaction following Schumm's test for "hematin" in plasma (addition of ammonium hydrosulfide with consequent formation of ammonia hemochrome) indicates the presence of ferrihemalbumin, this compound reacting more readily than does free hematin. Heilmeyer indeed (1209) had observed that the spectrum of the compound in the serum of patients suffering from pernicious anemia and from hemolytic anemia differed from that of hematin in alkaline solution, but he did not follow up his observations. Fairley has shown (735) that the compound may be formed by the addition of hematin to human serum or plasma. In the case of other animals, the spectrum of hematin persists, but later experiments indicate that combination also occurs. He then showed that serum albumin was the protein responsible for the reaction.* The physiological role of hemalbumin will be discussed in Chapter XII. The spectrum of ferrihemalbumin has bands at 623, 540, and 500 $m\mu$, while reduction to ferrohemalbumin gives a two-banded spectrum, 570 and 530 $m\mu$. The latter compound is not a hemochrome but may be transformed by alkali into denatured albumin hemochrome with typical bands at 558 and 524 $m\mu$. Ferrohemalbumin combines with carbon monoxide to give carboxyhemalbumin, whose spectrum is similar to that of carboxyhemochrome or carboxyhemoglobin. The spectral change when ferrohemalbumin combines with carbon monoxide may be compared with the sharpening and shifting of the absorption bands observed when caffeine heme combines with carbon monoxide. J. Keilin considers that the increased affinity for nitrogenous base, which the iron atom in heme shows in combination with carbon

* It is not certain, however, whether the albumin is the only plasma protein able to combine with hematin (*cf.* Miller and Alling, 1949a).

monoxide, has led, in carboxyhemalbumin, to the establishment of an iron protein bond in addition to the other linkages.

No observations have as yet been reported on the combination of mesohematin with serum albumin but, in view of the ease with which the linkage between hematin and albumin may be formed or broken, it is unlikely that the vinyl groups play any role. In view of the discussion in Section 3.3.4. the evidence points to linkage from the carboxyl side chains of the hematin to the protein. Measurements are not available from which the dissociation constant of the compound may be calculated, nor has there been any quantitative investigation of the acid-base-binding power of methemalbumin which might throw light on the residues within the protein which are involved in the linkage.

It would be of interest to measure the relative affinities of caffeine and albumin for hematin. In view of the occurrence of bilirubin in the plasma as bilirubin albumin it is possible that both bilirubin and hematin may be combined with the same groups in albumin.

3.3.6. Differential Titration of Globin and Hemiglobin. The imidazole groups in the globin which combine with the iron atom in the heme have been called "heme-linked" groups because their ionization is affected by the changes in the character of the iron bonds. The groups in the protein involved in hematin carboxyl-protein linkage would not be "heme-linked" in this sense. The carboxyl groups, insulated from the resonance system of the porphyrin by being attached to propionic acid side chains, would be little affected by changes in the character of the iron bonds, and hence would be unable to affect the ionization within the protein.

Changes in the position of the heme could, of course, alter the strength of the carboxyl-protein bond. On entry of oxygen, the heme may be pushed toward the proximal imidazole ring, but in view of the configurations which the propionic acid side chain may take up it is most unlikely that appreciable alteration of bond length occurs between the carboxyl and the protein.

Differential electrometric titrations of hemoglobin and oxyhemoglobin (Sections 3.2.2.3. and 3.2.2.5.) would therefore not be expected to throw light on the groups within the protein which are linked to hematin carboxyls, but investigation of the changes which take place in the globin on combination with hematin might do so.

Theorell (2776) has investigated this important system. He titrated both globin and hemiglobin from pH 5.5 to pH 11.3, working at 0° C. on account of the instability of the globin. On completion of the titration of the globin at pH 11.3, the solutions were then immediately neutralized with hydrochloric acid and the globin was then coupled with heme. Theorell does not record the absence of denatured globin hemochrome after the procedure, but states that no precipitate appears on neutralization, from which it may be concluded that this difficult titration was carried out satisfactorily.

The interpretation of the difference between the base bound to globin and to hemoglobin is difficult, since (*cf.* Section 4.) the coupling of hematin to globin also involves the aggregation of two globin units, of molecular weight 34,000, into the hemiglobin molecule of molecular weight 68,000.

The minimum difference between the hemiglobin and the globin was two equivalents per Hüfner unit (molecular weight 17,000) at pH 11.33. The maximum difference was 2.67 equivalents at pH 9.5, falling to 2.2 equivalents at pH 7.7 and rising again to 2.6 equivalents at pH 5.5. Theorell did not attempt to interpret his results between pH 5.5 and pH 8. Between pH 8 and pH 11.3 he accounted for the difference in base bound between hemiglobin and globin by the presence in hemiglobin of two fully ionized carboxyls and the ionization of the iron taking place with a pK value of 8.5 at $0^{\circ}C.$, while in the globin he found evidence for the presence of a group which dissociated with a pK value of 10 at $0^{\circ}C.$ and which could not be detected in the hemiglobin.

In view of the difficulty in interpreting the pK value of 10 as well as the results obtained between pH 5.5 and 8, the results cannot be said to have provided unequivocal evidence for the presence of basic groups in the protein which form bonds with the hematin carboxyls.

3.4. Other Oxygen-Carrying Pigments

In the discussion of the problem of the linkage of prosthetic group to protein in hemoglobin it has been necessary to ignore the differences which exist between the globins of different species (Chapter VII). It would appear, however, that the general conclusions are applicable to most mammalian hemoglobins. There is evidence (*cf.* Sections 2.2.5., 6.2.8., and 7.2.) that the linkage between hematin and globin in myohemoglobin is different from that in hemoglobin in that the hematin iron appears to be attached to only one histidine imidazole. The invertebrate oxygen carriers (Chapter VII) have not been investigated in great detail but from the presence of the sigmoid dissociation curve (Section 5.1.9.) it may be concluded that "heme-linked" groups are present and that the heme may lie between two histidine imidazoles as in the mammalian hemoglobins.

4. GLOBIN AND HEMOGLOBIN AS PROTEINS

4.1. Molecular Weight

4.1.1. Hemoglobin. The iron content of hemoglobin established the equivalent weight on the basis of the iron atom as 16,700. This, however, provided only a minimum estimate of the size of the molecule. The early measurements of the osmotic pressure gave results in which the number of subunits of equivalent weight 16,700 in a molecule of hemoglobin varied.

In 1924 Adair (3,4) first succeeded in obtaining reproducible values

for the molecular weight. The value of 68,000 found for a salt-free 4% solution of hemoglobin agrees excellently with a molecule comprised of four subunits of weight 16,700. By working at low temperature, Adair was able to avoid bacterial contamination during the period necessary for the system to reach equilibrium; control of pH, careful purification of the protein, and recognition of the Donnan equilibrium enabled him to avoid the irregularities disturbing the results of the early workers. Adair's value for the molecular weight of mammalian hemoglobin was soon afterwards confirmed by Svedberg (2716,2720) with the ultracentrifuge. Other physical methods such as surface tension (1648), diffusion (1637,2045,2058,2809), and ultrafiltration (659) have subsequently given results for the size and molecular weight of hemoglobin which, within certain limits of pH and concentration, agree well with those obtained by the ultracentrifuge or by the measurement of osmotic pressure.

In a salt-free medium, Adair found the osmotic pressure to increase on either side of the isoelectric point, pH 6.8, but observed that in the presence of salt concentrations greater than 0.01 *M* the osmotic pressure remained unaltered between pH 5 and pH 11. The osmotic pressure is independent of the protein concentration up to 4%, but beyond this it steadily rises (?), probably due to the departure of the system from an ideal solution (382).

4.1.2. Dissociation of the Hemoglobin Molecule. When they reported on the molecular weight of hemoglobin, Svedberg and Nichols did not investigate the molecular weight of the dissociation products of hemoglobin found outside the pH stability zone, which they found to lie between pH 6.0 and pH 9.8, a somewhat narrower zone than that found by Adair.

In 1930 Burk and Greenberg (382) examined the osmotic pressure of purified horse hemoglobin in 6.66 *M* urea. Between pH 7.3 and 9, the molecular weight proved to be 34,300, half that found in the absence of urea. Below pH 7.3 the osmotic pressure of hemoglobin increased in a manner similar to the behavior of salt-free hemoglobin when the pH falls below 6.7. The protein was found to have the molecular weight of 68,000 when measured in strong glycerol solution. Wu and Yang (3131) confirmed Burk and Greenberg's results for horse hemoglobin, but found that the hemoglobin of sheep and dog did not dissociate in urea. The effect of urea and other amides has more recently been investigated by Steinhardt (2621), who deter-

mined the sedimentation and diffusion constants for the protein. He confirmed the results of the earlier workers and showed that on dialysis recombination of a considerable fraction of the protein could occur. Urea, however, slowly denatures hemoglobin (*cf.* 2775 and Section 4.3.).

The dissociation of the hemoglobin molecule into smaller units was further investigated by other methods. Tiselius and Gross (2809) and Lamm and Polson (1637) found a diffusion constant of 6.8 to 6.9×10^{-7} cm.² sec.⁻¹ for concentrations of horse carboxyhemoglobin between 0.8 and 3.8%, measured at pH 6.5 in 0.1 *M* potassium chloride. At lower concentrations (0.2 to 0.4%) somewhat higher values (7.3 to 7.4×10^{-7} cm.² sec.⁻¹) were obtained. In salt-free solutions, the diffusion constant slowly increased with time. Preliminary claims have recently been made (cited in 2711,2721) that hemoglobin dissociates into half molecules in strong salt solutions.

4.1.3. Myohemoglobin. Working in Svedberg's laboratory Theorell (2759) was able to show that a slowly sedimenting component (S_{10} of 1.9 to 2.1×10^{-13}) was present in the heart and kidney of horse and in the skeletal muscles in the cat. Some of his preparations had, in addition, a more rapidly sedimenting component S_{20} of 4×10^{-13}). Measurement of the diffusion constant and of the sedimentation equilibrium did not give reproducible values and Theorell concluded that the smallest particle he found had a molecular weight of about half that of hemoglobin and that the larger component had approximately the same molecular weight as hemoglobin (2760).

Subsequent work by Polson in the same laboratory (2166,2710,2721) confirmed Theorell's sedimentation constant for horse myohemoglobin and provided reproducible values for the diffusion constant and the sedimentation equilibrium, which indicated a molecular weight between 16,900 to 17,600. Roche and Vieil (2325) arrived at a figure of 16,850 for the molecular weight by measurement of osmotic pressure of myohemoglobin prepared from the skeletal muscle of the horse. Wyman and Ingalls (3137) have recently reviewed the data, and on a basis of additional measurements of viscosity and relaxation time of myohemoglobin (1869) conclude that, if the sedimentation constant of 2×10^{-13} is accepted, the maximum molecular weight must be approximately 19,000.

While it now appears certain that the smallest component in the preparation of myohemoglobin from horse heart muscle has a molecular weight one-quarter that of hemoglobin, Theorell's earlier results remain unexplained. He himself considered bacterial contamination as a possible cause of the irregular results obtained when the sedimentation equilibrium was measured.

In a personal communication to Taylor (cited in 2747) Svedberg suggests that one cause of the discrepancy between the results of Theorell and Polson was a species difference, the latter worker using myohemoglobin from cow heart muscle.

4.2. Shape of the Hemoglobin Molecule and Arrangement of the Hemes

4.2.1. Shape of the Hemoglobin Molecule. If the molecular weight of hemoglobin is determined from measurement of osmotic pressure or from measurement of the sedimentation equilibrium, the results may be used in conjunction with measurements of the sedimentation velocity or the diffusion constant to gain information as to the shape of the molecule. The sedimentation velocity or the diffusion constant, found by experiment, is compared with that calculated for a spherical molecule of the correct molecular weight. The difference between the predicted and found value has been interpreted in terms of the asymmetry of the molecule, and it has been concluded that hemoglobin may be an ellipsoidal molecule whose major axis may be three or four times as great as the minor axis (530,1622,2044,2167, 2721). This result has recently become suspect. The value for the partial specific volume used by Svedberg has been criticized by Adair and Adair (9), who concluded that, if allowance is made for hydration, the molecular volume in solution becomes some 46% greater than that calculated from the dry protein. In consequence the molecule becomes somewhat less asymmetric than was previously assumed.

By x-ray analysis of single crystals of hemoglobin and oxyhemoglobin, Perutz (325,2133,2135,2136) has produced data which go far to clear up the gross shape. He investigated wet and dry crystals and concluded that the molecule was 64 Å long, 48 Å wide and 36 Å thick. [Perutz recently, in a personal communication, revised his conclusions and now considers the molecule to be a circular disc, 57 Å diameter, 34 Å thick (cf. 324a)]. The molecule is symmetrical about a diad axis which is parallel to the *b* axis of the crystal. A similar structure was found for both oxyhemoglobin and hemoglobin. The protein molecules in the crystal form rigid and coherent layers which alternate with layers of liquid of crystallization. The actual molecules of hemoglobin appear to be impenetrable to liquid as their structure is not affected by shrinkage of the crystal. Each hemoglobin molecule seems to be made up of four layers which are spaced 9 Å apart; these intramolecular layers are parallel to the larger molecular

layers which extend throughout the crystal. The molecule is thus less asymmetric than was assumed, the ratio of the major to the minor axis being 1.6.

Perutz (2133) showed that by using the above dimensions for the molecule, and the value of 0.34 for the hydration, much of the data provided by other physical methods could be reconciled with his structure. The value for the wet radius in solution is, within the limits of experimental error, the same as that calculated by Polson (2166) from the diffusion constant. Using the volume for the hydrated protein, he showed that Polson's data (2167) for the viscosity of solutions of hemoglobin no longer lead to a result in disagreement with Einstein's equation.

More recently Oncley (2075) and Wyman and Ingalls (3137) have reviewed the problems of the determination of the shape of protein molecules, taking the correct values for the hydration into account. The following diagram (Fig. 4), taken from Oncley's paper illustrates the importance of the correct estimate of hydration in arriving at the shape of the molecule.

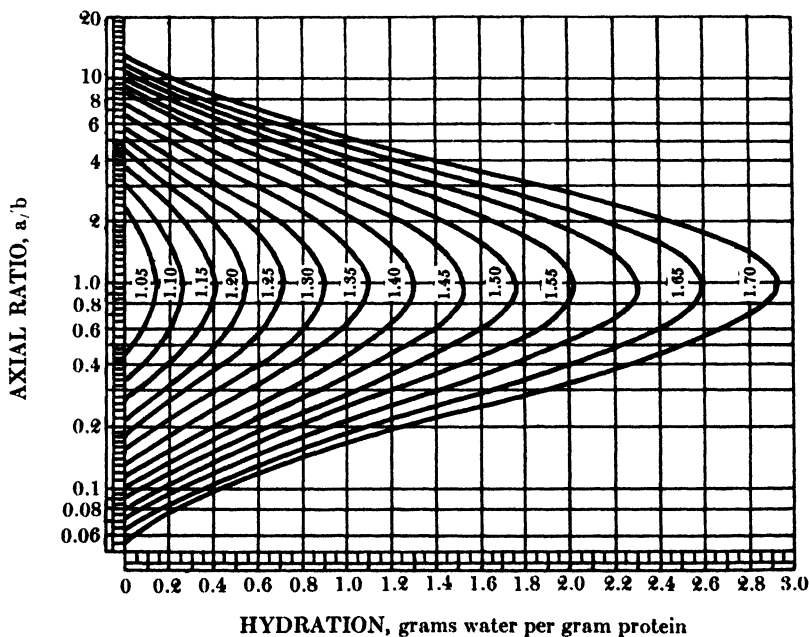

Fig. 4. Values of axial ratios and hydration in accord with frictional ratios (contour lines denote f/f_0 values), according to Oncley (2075).

4.2.2. Globin and Cleavage Products of Hemoglobin. Boyes-Watson and Perutz suggest that the four layers, 9 Å apart, which they observe in the crystal may each consist of four folded polypeptide chains extending in the direction of the b axis. The splitting of the hemoglobin molecule would therefore be unlikely to occur in the b plane, since this would involve the rupture of peptide bonds within the chain. Splitting is therefore most likely in the a or c planes, and would involve the breakage of bonds between the polypeptide chains. While cleavage in the b plane would have produced halves no more asymmetric than the original molecule, the half molecules produced by cleavage in the a or c planes would be more asymmetric. This is illustrated in the accompanying diagram (Fig. 5). If the molecule is, however, a circular disc, as now suggested by Perutz, splitting in the a plane would not yield a more asymmetric molecule.

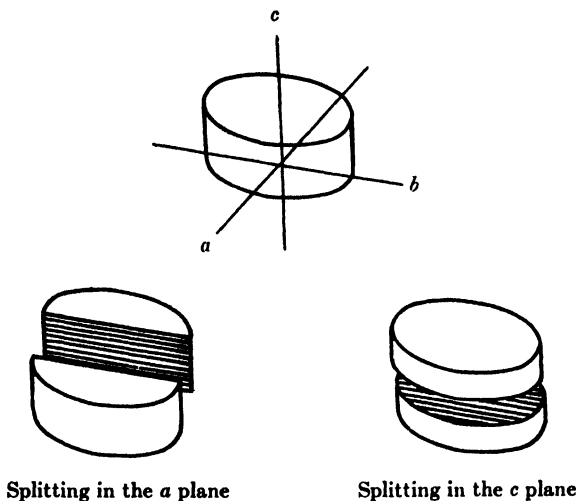

Fig. 5. Dissociation of the hemoglobin molecule into half-molecules.

Gralén (1028) subjected globin to analysis in the ultracentrifuge and in Lamm's diffusion cell. The results indicated the presence of fragments of different sizes, the largest of which corresponded to a molecular weight of 37,000. The frictional ratio was found to be greater than that of hemoglobin, which he interpreted as indication of a more asymmetric molecule. Neurath (2045), on the other hand, has interpreted Steinhardt's results (2437) on the dissociation of

hemoglobin in solutions of urea as indicating that the half molecules are slightly less asymmetric than the original. In view of the uncertainty which now attaches to the derivation of molecular dimensions from the frictional ratio if the degree of hydration is uncertain, and in view of the disagreement between these two workers, further experimental work is required.

4.2.3. Arrangement of the Hemes. The configuration within such a molecule is of great importance. The iron atom, in the center of the large flat plate of the heme molecule is able to coordinate with imidazole situated on either side (Section 3.2.), while the carboxyl groups give one edge of the molecule a hydrophilic character (Chapters III and V). The four hemes are indistinguishable from one another in any of the reactions of the pigment; this strongly suggests that they are arranged symmetrically with respect to one another as well as with respect to the protein.* Pauling put forward two alternatives for such an arrangement, the hemes being arranged at the corners of a square or of a tetrahedron (2123). He considered the former the more likely. Lemberg (1683) suggested the alternative possibilities that the heme lies flat on the surface, or is imbedded in the molecule between two imidazole groups; in the event that the imidazoles are firmly bound, a hemochrome structure would be expected. Theorell's investigations on cytochrome c confirm the latter possibility for this molecule (2785).

The optical properties of crystals of hemoglobin and oxyhemoglobin provide evidence of a more direct nature. Reichert and Brown (2224) observed that the crystals of oxyhemoglobin showed strong pleochroism, being dark red and almost opaque in two directions of extinction and light red and transparent in the third. Perutz (2134) examined the absorption spectra of the crystal in polarized light. When the electrical vector of the light was parallel to the α -direction of the crystal, the absorption band of hemoglobin in the red at 637 $m\mu$ was weak and diffuse, while the bands in the green were faintly visible. When the vector was parallel to the β - or γ -directions the band in the red was strong, broad, and sharply defined at the boundaries, while the absorption in the green was too strong for the bands to be distinguished. The sharpness and intensity of the oxyhemoglobin bands showed similar behavior when the crystal was examined in the appropriate directions. Since the light absorption is greatest when the electrical vector of the polarized light is parallel to the

* Compare footnote on page 266.

plane containing the conjugated double bonds of the heme, and least when the electrical vector is in a direction normal to this plane, it must be concluded that the hemes lie approximately parallel to the a plane of the crystal, the plane which contains the optic axes β and γ .

In the light of the x-ray structure of the crystal the hemes must be approximately in the a plane of the molecule. Two such arrangements are indicated in Figure 6, A and B, where a cross section in the c plane as seen from the direction of the c axis is shown. The heme plates, seen edgewise, are represented by rectangles. Of these A seems more likely since the hemes are more symmetrically placed with respect to the protein than in B. A third possibility is that all the four hemes lie in the same central a plane of the molecule. This

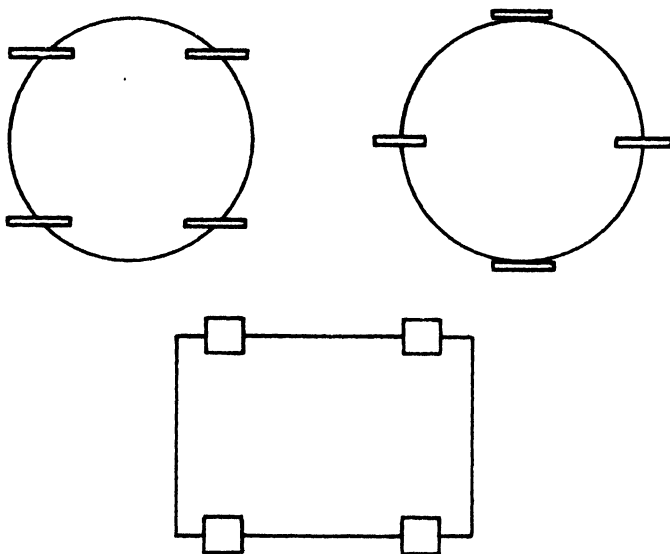

Fig. 6. Position of hemes in hemoglobin molecule.

is represented by C in Figure 6, where a cross section in this a plane is shown, the heme plates being represented by squares.

If the molecule A dissociates into halves in the c plane (or if C dissociates in the a plane), the configuration of the hemes with respect to the protein in their environment will be radically changed and they will become even more exposed. If, on the other hand the splitting of A occurs in the a plane (or of C in the c plane), the immediate environment of the hemes will undergo little change. In the

former case the heme-imidazole linkages on alternating sides of the hemes may be ruptured. So far, it is not known if the half molecules of hemoglobin can be made to dissociate still further to particles of the same weight as the myohemoglobin molecule. At the present time, no x-ray data are available for myohemoglobin crystals; this would be of great interest in view of the above problem.

4.3. Denaturation

4.3.1. Definition. Theoretically denaturation can be defined as a change in the structure of a native protein which involves the spatial arrangement of the peptide chain without breaking the chain itself. Various degrees of such changes are feasible, from the disarrangement of a few amino acids to a complete unfolding of the chain. This (denaturation in the proper sense) is apparently preceded by the breaking of hydrogen bonds or salt linkages (and possibly of disulfide bridges) between the side chains of the peptide backbone. These primary alterations cause, or at least facilitate, the disarrangement of the peptide chain, and it is therefore impossible to exclude them from the concept of denaturation. In this way a certain lack of preciseness is introduced into terminology but attempts to separate the preliminary reactions from denaturation under a separate name, such as "perturbation" (Holden, 1908), would appear to be premature at present.

Denaturation of a native protein usually involves the loss of its biological activity and of its crystallizability, a decrease of its solubility at a *pH* close to its isoelectric point, changes of molecular size and shape, and alterations in the accessibility of certain groups in the protein (*e.g.*, sulfhydryl groups) to chemical reagents. Some of these changes may not be found in a particular denaturation, while at least some of them may occur without denaturation (*cf.* Chapter VII, Section 4.4.). Oxyhemoglobin, for instance, forms an insoluble zinc salt, in which the oxygen is still held in reversible combination; or the biological activity of a protein may disappear by reactions involving the active center or prosthetic group, not the protein, as for instance in a conversion of hemoglobin to hemoglobin, by which the ability of reversible combination with oxygen is destroyed. While these should not be considered denaturations, in other instances the distinction may be more difficult. One and the same reagent may react with the prosthetic group as well as with the protein, as probably salicylate does in its reaction with hemoglobin (Roberts, 2280). It is

therefore not safe to rely on one criterion alone in establishing denaturation experimentally. The reader is referred to the review on denaturation by Neurath and co-workers (2046).

The two most readily observable alterations which hemoglobin suffers in denaturation are changes in solubility and loss of its ability to combine reversibly with oxygen. The latter change may be demonstrated directly by gas analysis or indirectly by spectroscopic identification as denatured globin hemochrome, which is unable to combine reversibly with oxygen. The other changes enumerated above have also been observed to occur on the denaturation of hemoglobin. There is no longer any doubt that denaturation as defined above can be reversed, though it has not been proved that a completely unfolded peptide chain can be rearranged to form the native protein.

Neurath and co-workers (2046) point out that it can never be proved that a renatured protein is absolutely identical with the native protein, but does this objection mean anything? If it is possible by the appropriate treatment to recover from a denatured protein a certain proportion of a protein which in most of its properties agrees with the native protein, the denaturation will have been, to that extent, reversible; the remainder of the denatured protein will have been irreversibly denatured.

While reversible denaturation of proteins had been described previously, the investigations of Anson and Mirsky on reversible denaturation of hemoglobin and other proteins have been of particular importance. In 1925 these workers succeeded in preparing crystalline oxyhemoglobin from heat-coagulated hemoglobin. Later they and other workers have shown that hemoglobin, myohemoglobin, and other proteins can be denatured by a variety of agents in such a way that the products can be reconverted to native proteins, denaturation and reversal being established by several criteria.

4.3.2. Bond Changes on Denaturation. Two types of linkage are present in a native protein in addition to the peptide linkage: those which may be ruptured by pH change alone and those linkages which require reduction for their rupture. The rupture of the latter linkage may be facilitated by changes in pH which in themselves are unable to bring it about (378). In the first group are placed salt linkages (728) or hydrogen bonds (1964) and, in hemoglobin, the linkages between the heme iron and the histidine imidazoles; in the second are the disulfide groups. Denaturation appears to involve the first type of linkages, although it may facilitate the attack on the sulfhydryl and disulfide groups by means of oxidizing or reducing substances. There is no evidence that peptide linkages are hydrolyzed.

The character of the bond changes on denaturation is at present the subject of controversy. This centers on the high energy of activation found

in kinetic studies. Stearn and co-workers (728,2616) interpret this as the reflection of the considerable entropy change which accompanies denaturation, the almost unique configuration in the native protein being displaced by a more disordered structure. Other workers, such as Steinhardt (2620) La Mer (1636), and Neurath and co-workers (2046) contest this interpretation, and suggest that, if proper allowance is made for the effect of pH , the energy of activation is found to be much smaller. The calculation of the actual number of bonds broken depends on the energy of activation assumed to be required for the rupture of a hydrogen bond or a salt linkage (*cf.* 461, p. 427; 2046, p. 204). Neurath concludes that denaturation by acid in the pH range 4.1 to 4.6 follows the breaking of only two essential hydrogen bonds.

While further work will doubtlessly establish accepted values for the energies of activation, this approach does not appear able to indicate whether the linkages broken on denaturation are hydrogen bonds or salt linkages. Mirsky and Pauling (1964) have given a qualitative explanation of some of the features of denaturation which, while not excluding the possible role of salt linkages, makes it appear likely that hydrogen bonds are involved. The action of acids and alkalis is explained by their ability to rupture the hydrogen bridge by supplying or removing protons from the bond; while urea, alcohol, and salicylate denature because of their ability to form hydrogen bonds themselves with one of the partners of the linkage, thus displacing the other. The effect of pH on the sensitivity of proteins to other reagents is interpreted as the rupture of a few of the hydrogen bonds with consequent loosening of the protein structure, so that the entry of the larger molecules is facilitated (*cf.* 2724, p. 146).

On denaturation the isoelectric point of hemoglobin and globin is shifted by about one pH unit toward higher values. Laporta (1649) showed by electrometric titrations on native and denatured ox globin that a dissociation with a pK value of 8.2 in the native protein was shifted to a pK value of 10.2 on denaturation.

4.3.3. Reversible Denaturation

4.3.3.1. Action of Alkali. Provided the ionic strength is low, the denaturation is probably proportional to the hydroxyl ion concentration (1162), although this would merit reinvestigation in the light of present theories of denaturation. Increase of the ionic strength above a certain optimum retards the rate of denaturation at a given pH (1727). Oxyhemoglobin is denatured by alkali more slowly than is hemoglobin. Differences are present both between the rates at which hemoglobins from adults of different species are denatured under identical conditions, as well as between the rates of denaturation of fetal and adult hemoglobin (see Chapter VII, Section 6.1.2. and 6.2.2.).

Roche and Chouaiech (2305,2310,2312) found that hemichrome formed by denaturing horse or ox hemoglobin at pH 11.6 to 11.8 could be renatured by dialysis at $0^\circ C$. They were able to renature 70 to 80% of the original pigment.

Hill (1275) has observed that in certain conditions the effect of alkali may

be immediately reversed. If oxyhemoglobin is added to 30% potassium or sodium hydroxide at -5°C ., the spectrum of hemoglobin changes to that of the hemochrome and the pigment precipitates. If the solution is then neutralized by ammonium sulfate and diluted, hemoglobin is re-formed and may be oxygenated to give oxyhemoglobin. If the temperature is allowed to rise above 0°C ., irreversible changes set in, and the native protein cannot be recovered. This phenomenon has received little attention. Holden (1920) has recently observed that a similar compound is formed by the action of strong ammonia on hemoglobin in nitrogen, while Legge (1667) found that if the reaction is carried out in potassium chloride solution (60% saturated) native protein can be recovered after treatment with 1% alkali. This finding may, perhaps, be associated with the increased resistance to denaturation by alkali which other workers have observed in strong salt solutions.

This behavior can be explained on the imidazole hypothesis by assuming that the distance between the imidazoles on either side of the heme may be lessened by a shrinkage of the protein in solutions of high ionic strength. The closer approach of the imidazoles may allow a firm hemochrome linkage to be established which may be strong enough to hold the structure of the protein during the denaturation, so that, on renaturation, the original linkages are formed. Zeynek (quoted by Haurowitz, 1165) observed a similar phenomenon when hemoglobin was dehydrated in a high vacuum, the hemochrome spectrum disappearing on admission of moisture.

In cytochrome c (Chapter VIII) the heme is not only firmly held between two imidazoles but in addition is bound to the protein through a thioether linkage in a side chain. The denaturation of cytochrome c is fully reversible, probably because of the stability of the heme protein linkage which prevents the unfolding of the molecule.

These experiments indicate that heme and its linkages to the protein stabilizes the structure of hemoglobin; this is also borne out by the fact that native globin is far less stable and more readily denatured than hemoglobin.

4.3.3.2. Action of Acid. At the same time as Hill provided spectroscopic evidence that hemoglobin might be recovered from denatured globin hemochrome, Anson and Mirsky (68) obtained crystalline oxyhemoglobin by renaturation of the protein after it had been denatured by a variety of procedures. Their renatured hemoglobin was able to combine with oxygen, although Hill (quoted in 1425) found the dissociation curve to be hyperbolic (*cf.* Section 5.). The results of Anson and Mirsky were confirmed in 1927 by Wu and Lin (3130) and by Holden and Freeman (1321). The reversible denaturation of hemoglobin derivatives in acid solutions, now more thoroughly

investigated, showed the following features: Below pH 5.7 hemoglobin dissociates into half molecules which in the pH range of 4.6 to 4.1 require a far lower energy for denaturation than above pH 5.7 (517). Ox hemoglobin, which is stable at pH 4, is completely converted to "acid hematin" at pH 3. If the pH is shifted back to 4 without precipitation of the protein, the renaturation is immediate. If, after denaturation at pH 3, the solution is neutralized, the denatured protein precipitates. Renaturation from the precipitated protein is slow, taking up to six hours if it is dissolved at pH 4. If dissolved in a slightly alkaline solution, the renaturation is complete in three hours. The rate at which renaturation proceeds is of importance in the preparation of native globin (Section 4.3.5.).

Oxyhemoglobin is more resistant to denaturation by acid than is hemoglobin; renaturation of only 60–70% of the pigment is possible. This is due to the irreversible oxidation of the protein (1702,2279). If the presence of oxygen is avoided, either by using carbon monoxide hemoglobin or hemoglobin, recoveries of 90–95% of native protein may be obtained. In the presence of ascorbic acid, the oxidation of globin by the oxygen liberated when oxyhemoglobin is acidified is prevented, the ascorbic acid being oxidized itself and protecting other oxidizable groups (Lemberg and Legge, 1702; cf. also Chapter VIII). Holden (private communication) has observed that, in the presence of ascorbic acid, up to 90% of denatured oxyhemoglobin may be renatured.

One aspect of the renaturation needs further investigation. Wu and Lin as well as Anson and Mirsky (71) have claimed that addition of dithionite and buffered cyanide increases the yield of native protein. The effect of cyanide appears to be on the protein. The yields which these workers have obtained, however, are rather low and without dithionite or cyanide they were able to obtain very little renatured protein at all. Since Holden is able to obtain virtually complete renaturation without the use of these reagents (1309, p. 48), their mode of action requires reinvestigation.

4.3.3.3. Other Reagents. Oxyhemoglobin may be denatured in neutral solution by organic solvents such as alcohol or acetone, anionic and cationic detergents, salicylate (1964,2280,2305,2310,2312), or amides such as urea, acetamide, and particularly guanidines (2621). Denaturation by urea is accompanied by splitting into half molecules with the hemoglobin of some, but not of all, species (93,1352,2621). Renaturation of a variable fraction can be obtained on dialysis; the reversal of denaturation by salicylate appears to yield hemoglobin indistinguishable from native hemoglobin (Roche, 2305, 2310,2312).

4.3.4. Chemical Changes on Denaturation. Anson and Mirsky (75), in contradiction to an earlier report (1901), found sulfhydryl groups in denatured globin. Their procedure was criticized by Meldrum (1899), but reinvestigation by different methods (1054, 1963) have confirmed their original finding. The sulfhydryl groups in the native protein do not reduce cystine or ferricyanide at pH 6.5, but react at pH 9.5, the protein structure altering sufficiently to allow the reaction to take place. At this pH, they will also react with iodoacetic acid. These reactions do not, in themselves, bring about denaturation of the protein (*cf.* Chapter VIII). On denaturation, however, sulfhydryl groups become reactive, irrespective of pH. In solutions of guanidine or methylguanidine hydrochlorides, 75% of the total alkali-labile sulfur in horse globin is estimated as cysteine by porphyrindine (1054). If, before globin is prepared by the acetone procedure, the sulfhydryl groups are oxidized, they can no longer be detected in the denatured protein.

Haurowitz and collaborators (1175) have shown that globin may react with iodine or small amounts of formalin and that groups may be inserted by diazotization without denaturation of the protein or loss of oxygen-combining power.

4.3.5. Reaction between Cephalin and Oxyhemoglobin. An interesting reaction between cephalin and oxyhemoglobin was discovered by Chargaff and co-workers (429). Addition of a dilute solution of cephalin to oxyhemoglobin causes the slow disappearance of the oxyhemoglobin bands and their replacement by a spectrum resembling that of heme. Carboxyhemoglobin reacts similarly, while the band of hemoglobin does not change. Additions of dithionite do not cause the appearance of the spectrum of denatured globin hemochrome, but, if a base is provided with which the heme can combine, by the use, for example, of ammonium hydrosulfide as reducer, the hemochrome spectrum appears.

On the evidence of spectroscopic change and altered solubility the reaction would be classed as one of denaturation. Yet the fact that no denatured globin hemochrome is formed speaks against this. Chargaff has not reported attempts to recover native hemoglobin from the compounds. A reinvestigation of this reaction would be of interest.

4.4. Preparation of Native Globin

In the light of present knowledge of the renaturation of denatured globin it is probable that both Bertin-Sans and de Moitessier (251) in 1892, and Schultz (2472a) in 1898, did in fact succeed in obtaining

some renatured globin in their preparations. Hill and Holden (1282), however, were the first to isolate native globin from hemoglobin, and to carry out the coupling of hematin to globin under controlled conditions. Their method gave poor yields of native globin. By a modification of the acid acetone procedure, which Hamsik (1119) used for the preparation of hemin, Anson and Mirsky (72) were ultimately able to recover up to 80% native globin from ox hemoglobin, but were less successful with the proteins from other species. The method, or slight modifications of it, remains in general use (625,2437).

Washed, laked corpuscles are cooled at 0° C. and added gradually to a tenfold volume of acetone containing 1% conc. hydrochloric acid also cooled to 0° C. The mixture is allowed to stand for two or three minutes and is filtered; the acid-denatured globin is washed with acetone and allowed to dry. All operations are carried out at low temperature. The mixture is then ground in a chilled mortar with water until it dissolves, and carefully titrated with 0.2 N sodium hydroxide until a slight permanent precipitate is formed. After standing for 15 minutes, it is titrated with alkali until the maximum precipitate of denatured protein is formed. The solution of native globin is filtered from the denatured protein after a further thirty minutes (if the neutralization is carried out rapidly, the protein is not renatured). Anson and Mirsky then add ammonium sulfate until the solution is 40% saturated to precipitate any denatured globin remaining in the solution, filter this off, precipitate the native protein by adding additional ammonium sulfate to 56% saturation, redissolve, and remove ammonium sulfate by dialysis at low temperature against distilled water. The protein may be further purified by repetition of the salting-out procedure (1418,2300). By freeze-drying, a stable preparation can be obtained.

Oxyhemoglobin, resynthesized from native globin and alkaline hematin, shows properties slightly different from those of the original hemoglobin (2314). Hill and Holden (1282) observed that the bands of the synthesized compound were shifted a few angstrom units to the blue in hemoglobin, oxyhemoglobin, and carboxyhemoglobin. Investigation of resynthesized carboxyhemoglobin in the ultracentrifuge showed that its molecular weight was unaltered, but electrophoretic measurements showed a tendency for the isoelectric point to become slightly more acid (1028).

Drabkin (625) has prepared denatured globin from crystalline horse myohemoglobin and has succeeded in renaturing it completely and in obtaining 100% yield of synthetic myohemoglobin, which crystallized in the same habit as the original protein.

5. HEMOGLOBIN EQUILIBRIA

5.1. Equilibria in Simple Systems — Interaction between Hemes

5.1.1. Introduction. Toward the end of the last century, knowledge of the reactions of hemoglobin had advanced sufficiently to be applied to many of the problems which technological progress had raised for human physiology. These included the toxic effects of carbon monoxide and other gases and the investigation of the physiological stresses involved in work under extremes of atmospheric pressure. The history of these investigations may be found in the works of Bert (249), J. S. Haldane (1101), Barcroft (141) and Henderson (1247). They accelerated the improvement of many valuable experimental methods, such as the modern technique of gas analysis and the microrespirometer, and led as well to many advances in spectroscopy. On the theoretical side, the need for quantitative data stimulated the rapid application of physical chemistry to this branch of physiology. Empirical answers were given to many practical problems far more rapidly than understanding was reached of the basic mechanism of the reaction. At the present time, indeed, the elucidation of the behavior of hemoglobin, the most thoroughly investigated protein, is probably of less importance for respiratory physiology than for the general advance of protein and enzyme chemistry.

Attempts at theoretical interpretations of the equilibrium between oxygen and hemoglobin have arisen alongside the experimental identification of the factors which influence the reactions. These may be divided into those factors which concern the structure of the hemoglobin, and those which concern the environment in which the equilibrium is measured. The former are dealt with in Chapter VII.

The environment influences the affinity of a given sample of hemoglobin for oxygen according to: (1) Temperature. Increase of temperature diminishes the affinity and vice versa. (2) *pH*. The affinity is a minimum at about *pH* 6.1; on either side of this *pH* value, it increases. (3) Ionic strength. The affinity is a maximum at zero ionic strength. (4) Specific ion effects are at present little investigated. (5) Concentration of hemoglobin. The more dilute the solution of hemoglobin, the greater the affinity.

The situation is further complicated by the presence of the four hemes in the hemoglobin molecule, which enables the affinity of

hemoglobin to oxygen to change as combination proceeds. Thus, the investigation of the affinity of hemoglobin for oxygen under all possible combinations of structural and environmental conditions is an impossible task. Most of our knowledge has been built up from relatively restricted data and although great progress has been made by assuming that the influence of a particular factor under one set of conditions may be extrapolated to other conditions, we shall see that the picture built up on this basis is incomplete, and the experimental investigation of a number of points is urgently required.

Different methods have been used for the determination of the oxygen dissociation curve of hemoglobin; Haldane, Barcroft, van Slyke, and Roughton have been chiefly concerned with the development of the refined gasometric methods now available; while Hüfner, Hartridge, Heilmeyer, Hill, Millikan, and Drabkin have developed spectroscopic and spectrophotometric methods. Some estimations, for example, that of small amounts of carbon monoxide in the presence of a large excess of oxyhemoglobin, can only be carried out accurately by gasometric methods. These methods are somewhat tedious and require a larger amount of manual skill than do other methods such as spectrophotometry or visual or photoelectric spectrophotometry. The most recent technique applied to the determination of the equilibrium has made use of the difference in magnetic susceptibility between the compounds (500).

The oxygen saturation (y) of hemoglobin, is defined by the equation:

$$y = [\text{HbO}_2]/[\text{Hb} + \text{HbO}_2]$$

Accurate measurement of the equilibrium is difficult in the regions of low and high oxygen saturation and the choice between one theoretical expression for the dissociation curve and the other must lie, therefore, on the accuracy with which they describe the dissociation curve between the limits $y = 0.1$ and $y = 0.95$. Outside this range, adequate experimental data are not available. This is unfortunate, since most of the equations put forward are able to describe the dissociation curve reasonably well over the middle range of values and the choice between one equation and another rests more on the general assumption from which they have been constructed, than on the accuracy with which they describe the curve.

Some of the theories developed apply equally to other equilibria in which hemoglobin is involved, such as the dissociation of carboxyhemoglobin or the oxidation-reduction system hemoglobin-hemi-

globin. The comparison between the behavior of different systems frequently provides a crucial test for a given theory. We shall not discuss all the theories put forward but only those still of interest today. Much of the early work has been dealt with by Barcroft (141).

5.1.2. Hufner's Equation. The first attempt to describe the dissociation curve was that of Hufner (1355). After satisfying himself that one molecule of oxygen combined with one atom of iron, he expressed the equilibrium in terms of the law of mass action:

$$K = \frac{[\text{HbO}_2]}{[\text{Hb}] [\text{O}_2]}$$

from which:

$$y = \frac{Kp}{1 + Kp}$$

may be derived, where y is defined as $[\text{HbO}_2]/[\text{HbO}_2 + \text{Hb}]$, p is the partial pressure of oxygen, and K , the equilibrium constant.

While Hufner's equation does not describe the type of dissociation found in blood or in concentrated hemoglobin solutions, it does describe the dissociation of denatured globin carbon monoxide hemochrome (66), the gaseous equilibria of myohemoglobin (1279,2762), and the equilibrium between oxygen and *Gastrophilus* hemoglobin, which has a molecular weight of 34,000 and contains two hemes (1503a). In addition, the well-known equation:

$$\frac{[\text{HbCO}]}{[\text{HbO}_2]} = K \frac{[\text{CO}]}{[\text{O}_2]}$$

where K represents the ratio of the affinity of hemoglobin for carbon monoxide and oxygen, is a special case of Hufner's equation (1103). This equation holds even for blood. The implications of the equation are further discussed in Section 6. The equilibrium between hemoglobin and either oxygen or carbon monoxide and ability of the equation to describe the behavior of the more complicated system when both gases are present will be discussed later.

5.1.3. Hill's Equation. The failure of the simple Hufner equation to describe the dissociation curve of HbO_2 led to a number of modified theories. In one of these, put forward by A. V. Hill (1274), the unit containing 1 atom of iron was capable of polymerization to a rather indefinite size. Hill's theory is no longer held in its original form,

since it has been shown to be incompatible with the kinetic data (*cf.* Section 6.), but his equation is still widely used, since it is convenient and has been shown to be formally related to the more modern theories. Hill assumed that the reaction could be described by the equation:

$$K = \frac{[\text{Hb}_n\text{O}_{2n}]}{[\text{Hb}_n] [\text{O}_2]^n}$$

from which the equation:

$$y = \frac{Kp^n}{1 + Kp^n}$$

may be obtained, where n is the average number of molecules in the polymer, and the remaining symbols are the same as before. It can be seen that, if $n = 1$, the equation becomes identical with that of Hufner.

A convenient method for deciding which of these two equations best fits a given set of data is by expressing the equation logarithmically. Hill's equation becomes:

$$-\log K = n \log [\text{O}_2] + \log \frac{[\text{Hb}_n]}{[\text{Hb}_n\text{O}_{2n}]}$$

and values for n and K may thus be obtained from a plot of the values of $\log [\text{Hb}_n]/[\text{Hb}_n\text{O}_{2n}]$ against $\log p_{\text{O}_2}$. For the dissociation of oxyhemoglobin in blood $n \doteq 2.5$. It should be noted that as far as fitting a curve to a number of points is concerned, Hill's equation with two constants gives more flexibility than does Hufner's with one. Between 10 and 90% saturation, a very good fit can be obtained with Hill's equation.

The development of these empirical equations facilitated the comparison of results obtained by different workers. This, in turn, accelerated the recognition of the importance of many of the factors discussed above, and between the years 1900 and 1925 the effects of salt concentration on $p\text{H}$ were recognized and controlled.

5.1.4. Adair's Equation. The equations so far described differ in the mean size of the unit of hemoglobin assumed to be present in solution. Hufner's equation assumed a molecular weight of 16,800, while Hill's equation suggested that the most frequently found particle contained between two and three Hufner units. By showing that four atoms of iron were present in a molecule of hemoglobin,

Adair (*cf.* Section 4.1.) created great difficulties for both the above theories. While Hill's equation can describe the dissociation curve of oxyhemoglobin if $n = 2.5$, it fails if $n = 4$.

Adair overcame this difficulty (5) by pointing out that, if four hemes were present in a molecule of hemoglobin, a number of species, Hb_4 , $Hb_4(O_2)$, $Hb_4(O_2)_2$, $Hb_4(O_2)_3$, $Hb_4(O_2)_4$, could be present on oxygenation. The four hemes were not assumed independent, the affinity of unoccupied hemes for oxygen being altered as the stepwise oxygenation proceeded.

Since we will frequently be referring to these intermediates, we will describe them by the symbols:

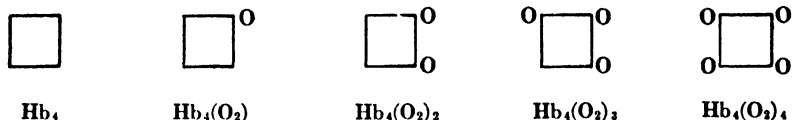

It can be seen that the concentration of any one of these species can be described by an equation such as:

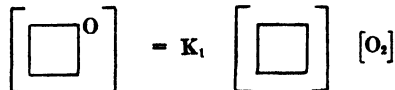

The oxygen saturation is defined by:

$$y = \frac{\Sigma(O_2 \text{ present in all species})}{\Sigma(O_2\text{-capacity of all species})}$$

whence:

$$y = \frac{K_1 p + 2 K_1 K_2 p^2 + 3 K_1 K_2 K_3 p^3 + 4 K_1 K_2 K_3 K_4 p^4}{4 (1 + K_1 p + K_1 K_2 p^2 + K_1 K_2 K_3 p^3 + K_1 K_2 K_3 K_4 p^4)}$$

It can be seen that Adair's hypothesis, while based on a more satisfactory theory than the earlier hypotheses, introduces four constants, making it even easier to fit a particular dissociation curve. Examples of the ability of the equation to fit HbO_2 dissociation data may be found in the papers of Adair (5,6), Ferry and Green (7,7), and Forbes and Roughton (9,18).

Adair's hypothesis marked a considerable advance. His postulate of the existence of intermediates gave rise to a number of attempts to prove their existence by methods independent of Adair's equation.

These will be discussed later. The most important step was, however, the recognition that interaction might take place between the hemes.

5.1.5. Pauling's Equation. In 1935, Pauling (2123) reinvestigated the problem and, by making certain simple assumptions, developed an equation which contained only two constants and which was able to describe the equilibrium satisfactorily. While Adair did not assume that the hemes were arranged in any particular way, Pauling considered certain steric arrangements, in one of which the hemes were assumed to lie at the corners of a square. He gave a quantitative meaning to Adair's conception of interaction between the hemes by assuming that this took place between oxygen molecules along the sides of the square so that the free energy of addition of oxygen to a heme, $RT \ln K$, is diminished by an amount $RT \ln \alpha$ by the presence of an adjacent oxygen atom. If a second oxygen combined with the heme diagonally opposite to one which held an oxygen atom, no interaction is assumed to occur. The number of possible intermediates on this basis is:



where a double line indicates interaction along the sides of the square. If account is taken of the number of ways the oxygen molecules can be arranged on the four hemes, the relative proportion of the six types is given by:

$$1 : 4Kp : 4\alpha K^2 p^2 : 2K^2 p^2 : 4\alpha^2 K^3 p^3 : \alpha^4 K^4 p^4$$

The oxygen saturation is then expressed by:

$$y = \frac{Kp + (2\alpha + 1)K^2 p^2 + 3\alpha^2 K^3 p^3 + \alpha^4 K^4 p^4}{1 + 4Kp + (4\alpha + 2)K^2 p^2 + 4\alpha^2 K^3 p^3 + \alpha^4 K^4 p^4}$$

Pauling assumed that the equilibrium constant, K , was dependent on the pH of the solution, but that the interaction constant was independent of pH . He concluded from a study of the data of Ferry and Green (747) that each heme was associated with two acid groups, of pK 7.9 in hemoglobin rather than with one "oxylabile" group as previous investigators had assumed (1148, 1154). By assuming an interaction constant β , which described the effect of oxygenation

on the pK values of the heme-linked acid group, he deduced the equation:

$$K = K' \frac{\left(1 + \beta \frac{A}{[H^+]}\right)^2}{\left(1 + \frac{A}{[H^+]}\right)^2}$$

to describe the variation of K with pH where $\beta = 4$, $-\log A = 7.94$ and $K' = 0.0035$. On these assumptions he was able to show that this equation with two constants could describe the Ferry and Green data very well with $K = 0.033$ at pH 8.3 and $\alpha = 12$.

It is frequently of interest to know the relative concentrations of the intermediates. Coryell, Pauling, and Dodson (500) prepared the diagram shown in Figure 7 from values of K which fit the data of Ferry and Green. It must be realized that with different values of K and α , a somewhat different distribution will be found, which can easily be calculated once the values of K and α have been determined for the system.

Pauling also considered the cases in which each heme interacted with one and with three other hemes, the latter suggesting a tetrahedral arrangement. Where no interaction occurs, the equilibrium is described by the Hufner equation. When the hemes interact in pairs, the equation:

$$y = \frac{Kp + \alpha K^2 p^2}{1 + 2Kp + \alpha K^2 p^2}$$

may be derived (Altschul and Hogness, 44), which may be approximated by the Hill equation when $1 \leq n \leq 2$ (2123). This equation should be applicable when the protein molecule splits into two particles.* The equation based on the tetrahedral arrangement of the hemes is able to describe the equilibrium as satisfactorily as the equation based on the square configuration. No use has been made of the derivation, however, on account of the difficulty of reconciling its assumptions with other evidence as to the structure of the molecule.

The essentially new feature of Pauling's contribution is the more precise physical meaning it gives to the conception of interaction between the hemes. In addition to this it may be considered an improvement on Adair's equation from an empirical point of view, since it has fewer constants and the labor (and arbitrariness) of fitting a dissociation curve with the equation is considerably lessened.

* Wyman, in an important communication (3138a), has produced evidence that in intact hemoglobin as well, intrapair interaction is stronger than interpair interaction.

Altschul and Hogness (44), Wyman and Ingalls (3136), and Coryell (498) discuss procedures which assist in the latter process.

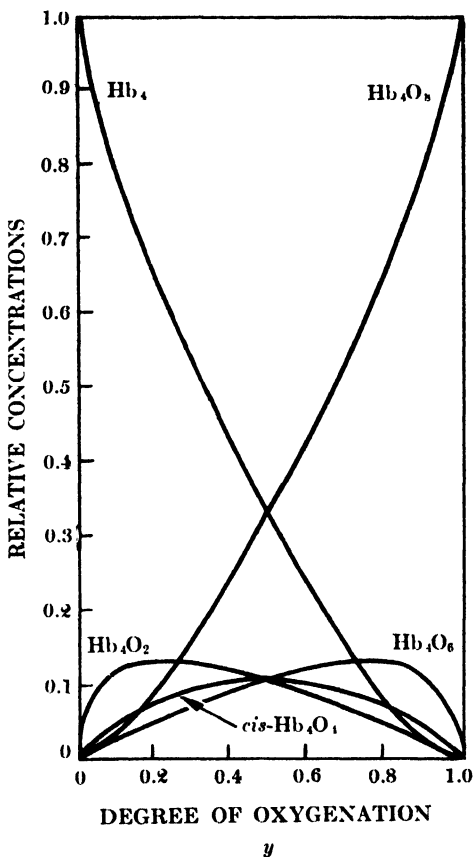

Fig. 7. Relative concentrations of intermediates between Hb_4 and $\text{Hb}_4(\text{O}_2)_4$ (after Coryell, Pauling, and Dobson, 500). The curve for $\text{trans-Hb}_4(\text{O}_2)_2$ is not given; it has $1/24$ the height of II throughout.

5.1.6. Present Status of the Equilibrium Problem. Pauling's equation was based on the behavior of horse hemoglobin which had been purified by the procedure of Ferry and Green (747) and which had been investigated at ionic strengths from $\mu = 0.2$ to $\mu = 0.4$. While it fitted these data adequately, difficulties arise when it is applied to other data. Thus Altschul and Hogness (44) reinvestigated the dissociation of HbO_2 and took into account the specific ionic effect, ionic strength, and pH . In addition, they purified

the hemoglobin by treatment with alumina cream. Under these conditions, they found that the value of α was very sensitive to variations in ionic strength. In salt-free preparations, $\alpha = 2$, while, in bicarbonate buffer, $\alpha = 12$. The dissociation constant, K , was similarly found to vary from 0.21 to 0.0057. They suggest that in salt-free solutions, the hemes might interact only in pairs and were able to fit their data equally well on this assumption. While Altschul and Hogness were able to fit a given dissociation curve by suitable choice of K and α , Roughton, in a personal communication, informs us that the data of Forbes and Roughton (918) cannot be fitted by Pauling's equation. In this work the dissociation curve was measured on solutions of hemoglobin within the concentration range in which Adair's work had shown the osmotic pressure to be proportional to concentration. Only in these cases, as Adair has stressed, is it possible to use concentrations of hemoglobin, rather than activities in applying the law of mass action; nevertheless this point has been frequently ignored even in the theoretical discussion of the data which have formed the basis for most of the recent work on the equilibrium.

Single values of K and α may be selected which enable the equation to fit the top of the dissociation curve, or the bottom of the curve but which will not fit the whole curve: Forbes and Roughton, indeed, were able to fit their data by a modified Adair equation in which only K_1 and K_4 were determined arbitrarily, while the values for K_2 and K_3 followed from that chosen for K_1 according to statistical considerations deduced from a recasting of the Adair equation in terms of Langmuir's adsorption theory.

These workers point out that when p is small in the Adair equation, it simplifies to:

$$y = \frac{K_1 p}{4(1 + K_1 p)}$$

since p^2 , p^3 , and p^4 can be neglected. When p is very large the equation becomes:

$$y = \frac{3K_1 K_2 K_3 p^3 + 4K_1 K_2 K_3 K_4 p^4}{4K_1 K_2 K_3 p^3 + 4K_1 K_2 K_3 K_4 p^4} = \frac{3 + 4K_4 p}{4 + 4K_4 p}$$

and by accurate determination of the values at the upper and lower ranges of the curve it might be possible to determine K_1 and K_4 separately, leaving only K_2 and K_3 to be determined arbitrarily. So far this has never been done.

A further problem is presented by the possibility that the dissociation curve may be affected by as yet unknown factors. An example of this may be found in the occasional reports of samples of mammalian hemoglobin whose dissociation curve has been found to be hyperbolic. Such instances are cited in Barcroft's monograph (141) and in papers by Hartridge and Roughton (1149) and Forbes (918). These results have never been explained.

No finality can therefore be said to have been reached on the choice of the most suitable equation to express the dissociation curve. The reader must bear this qualification in mind when we make use

of Pauling's equation, since in spite of doubts as to its generality it is a convenient expression and a suitable form in which to deal with the problem of the sigmoid dissociation curve.

5.1.7. Relation between n and α . In an extremely interesting analysis, Coryell (498) has succeeded in relating Hill's equation to Pauling's equation and has thereby facilitated the application of the heme-heme interaction to a number of systems which are generally described in terms of the former equation. The value of n may be rigorously defined by the equation:

$$n = \frac{\delta \log R}{\delta \log Kp}$$

where $R = y/(1 - y)$. Pauling's equation may be cast into a form where R is a function of α , K , and p . When $R = 1$, it can be shown that $Kp = 1/\alpha$ and the relation:

$$n = \frac{4\alpha^4 + 28\alpha^3 + 28\alpha^2 + 4\alpha}{\alpha^4 + 12\alpha^3 + 38\alpha^2 + 12\alpha + 1} = \frac{4\alpha^2 + 4\alpha}{\alpha^2 + 6\alpha + 1}$$

may be derived by partial differentiation. The relation between n and α is expressed graphically in the curve shown in Figure 8. The value of n represents the slope of the tangent to the curve obtained by plotting $\log R$ against $\log p$ when $R = 1$. This value, when substituted in Hill's equation is able to describe the dissociation curve of Ferry and Green with reasonable accuracy between 10 and 90% saturation.

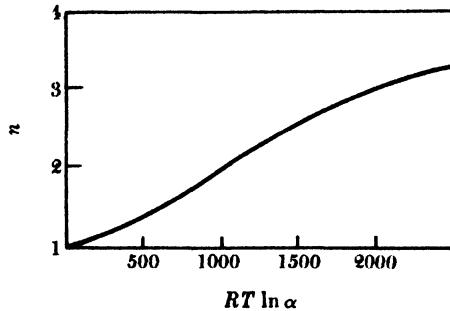

Fig. 8. Relation between n and α (after Coryell, 498).

In consideration of Keilin's data on the equilibrium between hemoglobin and hydrogen sulfide, Coryell finds that the slope of the plot of $\log \text{HiSH}/\text{Hi}$ against $\log (\text{H}_2\text{S})$, $n = 1.84$, corresponds to a value of α of 4.1 or to a heme-heme interaction of 840 cal. per mole. Similar treatment of the hemoglobin-hemoglobin hydroxide equilibrium as a function of $p\text{H}$ shows that $n = 1$ and that heme-heme interaction is absent.

5.1.8. Hemoglobin-Hemoglobin Equilibrium. The relation between \bar{n} and α has also found application to this system. Modern work on the equilibrium commences with the work of Conant and collaborators (479), who showed that the system was thermodynamically reversible. Subsequent work has measured the equilibrium under various conditions of pH , temperature, and ionic strength (171,477,479,1187,1190,2446,2750,2751) and in solutions of urea (2750), and in addition has investigated the related equilibrium between myohemoglobin and hemoglobin (2753). The system is electromotively sluggish, but stable potentials are reached on the addition of electroactive substances. The value of E'_0 at 30° C. and pH 7 lies between + 0.144 and + 0.152 v. $E'_0/pH = 0$ between pH 5 and 6, while, at pH 8 to 9, the slope is 0.06.

Difficulties are presented, however, by the interpretation of the electrode equation $E_h = E'_0 + RT/nF \ln (H_i/H_b)$. The value of n obtained from the experimental results lay between 1 and 2, and the equation could therefore be interpreted neither as a one-step oxidation of one iron atom nor on the basis of the oxidation of hemoglobin of molecular weight 68,000 containing four iron atoms. Conant (471) pointed out the similarity of this problem to the problem of the equilibrium between oxygen and hemoglobin, and suggested that the interpretation might be based on the existence of intermediate compounds between H_b , and H_i .

Coryell (498) reanalyzed the data on the equilibrium from the point of view of heme-heme interaction. He showed that the electrode equation was capable of interpretation in the same way as was the sigmoid coefficient in Hill's equation, and obtained values of α varying from 1.9 to 5.0, corresponding to a variation in the interaction energy from 1500 to 3800 cal. per mole.

The causes for the variations of the sigmoid coefficient have not as yet been specifically investigated. It would be of interest to see if the interaction constant for the hemoglobin-hemoglobin equilibrium is sensitive to changes in the method of preparation of the pigment, or to specific ion effects, in the same way as is the equilibrium between oxygen and hemoglobin (cf. 44). The value for E'_0 which Taylor and Hastings (2751) obtain on horse hemoglobin purified by recrystallization agrees excellently with those which Havemann (1187) obtained on the pigment from the same species after purification by electrodialysis. The former workers, however, find that the value of n increases from 1 to 2 as the oxidation proceeds (2750,2751), while Havemann finds a symmetrical curve throughout.

Taylor (2750) has recently investigated the hemoglobin-hemoglobin system when the pigments of horse and dog are dissolved in 4 *M* urea. E'_0 is found to be + 0.108 v. at 30° C., while n has a value of 2 throughout the oxidation. Under these conditions horse hemoglobin is known to be split into half molecules. Taylor and Morgan (2753) found that the E'_0 at pH 7.0 and 30° C. for horse myohemoglobin was + 0.046 v., and that n equalled 1, the value expected for a system containing only one heme. The system was

almost independent of pH within the region in which the redox potential of the hemoglobin-hemoglobin system shows marked changes (*cf.* Sections 5.2.5. and 6.2.8.).

5.1.9. Attempt to Discover Intermediates Directly. When Adair's hypothesis was first announced, a careful reinvestigation was made of the more obvious properties of hemoglobin in an endeavor to find discontinuities which would be accounted for by the existence of these intermediates. Spectroscopic observations failed to provide such evidence, since, as Hartridge and Roughton (1149) pointed out, the light absorption of partially oxygenated hemoglobin could be accounted for by the presence of only two species, fully oxygenated and fully reduced hemoglobin.

More recently the change in the magnetic properties of the pigment during reactions in which it changed from one bond type to another has been investigated (500). Certain anomalies in the values found for the magnetic susceptibility of a number of hemoglobin derivatives were provisionally attributed to the possibility that magnetic moments of the hemes were not independent but were coupled to give a resultant moment. Careful investigation of the susceptibility during such reactions failed to provide any evidence for this, and since similar anomalies were found in the magnetic moments of myohemoglobin derivatives they are now attributed to orbital contribution (2747).

The most ambitious attempt to gain direct experimental evidence for the existence of the intermediates was that of Conant and McGrew (476), on the basis of measurement of the solubility of fully oxygenated hemoglobin when the mother liquor was partially reduced. Their work was criticized by Roughton on experimental grounds (918, p. 257), while, later, Conant pointed out that subsequent work had probably rendered their initial assumptions incorrect.

In view of the rapidity with which equilibrium between the different intermediates would be expected to be established in comparison with the relatively slow manipulations involved in such experiments, it seems unlikely that such attempts will succeed.

5.2. Hemoglobin Systems Containing More Than Six Species of Intermediate

5.2.1. Introduction. If two compounds such as oxygen and carbon monoxide react with hemoglobin, we have 21 classes of intermediates, comprising all possible combinations in which the four hemes are free, or are combined with oxygen, carbon monoxide, or with both. The heme-heme interaction in such systems need not necessarily be the same as that found in the simple systems when the hemes are combined with only one type of molecule.

5.2.2. Haldane Effect. Long before Adair's intermediate compound hypothesis was presented, J. S. Haldane (1103) discovered a

phenomenon which could not be explained except in terms of interaction between hemes. He made the acute clinical observation that while miners succeeded in working when the hemoglobin content of their blood had been reduced by disease to less than 50%, the reduction of the oxygen capacity of their blood to the same extent by carbon monoxide often produced collapse. Haldane, Douglas, and Haldane (1102) reinvestigated the system oxygen-carbon monoxide-hemoglobin and were able to explain the phenomenon in an empirical fashion on the basis of the sigmoid shape of the dissociation curve. Their results were confirmed by Stadie and Martin in 1925 (2606) and by Roughton and Darling (2366) in 1944. Interest in the problem has recently been revived (*cf.*, for example, 438,1744) and observations have been extended to the analogous case in which large amounts of hemoglobin are present (532).

The phenomenon may be simply explained on the basis of the sigmoid dissociation curve, assuming this to be of the same shape for both oxyhemoglobin and carboxyhemoglobin. It has long been known that when hemoglobin is completely saturated with a mixture

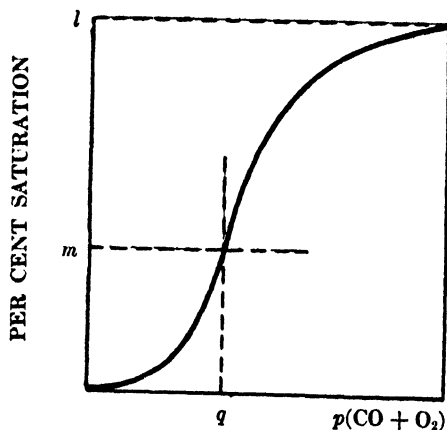
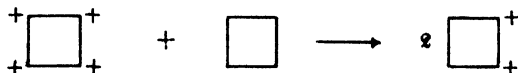

Fig. 9. The Haldane effect.

of oxygen and carbon monoxide, the relative amounts of the two pigments can be expressed by the equation $[\text{HbCO}]/[\text{HbO}_2] = K \times p_{\text{O}_2}/p_{\text{CO}}$. Consider the sigmoid dissociation curve given in Figure 9. The same degree of saturation of the pigment with oxygen will be obtained at Kq units of pressure as with carbon monoxide at q units

of pressure. If m is the degree of saturation of the pigment with carbon monoxide at a p_{CO} of q , the combination of the remainder of the pigment with oxygen will trace out the path taken by the dissociation curve as y increases from m to l . This curve is no longer of the original sigmoid shape, and the dissociation of the oxyhemoglobin for a given drop of partial pressure is less than that which would have taken place in the absence of carbon monoxide. It is possible to predict the saturation of the pigment if both the gases are present from a knowledge of the dissociation curve for one of them as well as of the value of the partition coefficient, K . Roughton and Darling (2366) point out that this would be expected on Pauling's theory only if the interaction constant α is the same for the combination of oxygen and carbon monoxide with hemoglobin.

The latter workers (532) also showed that the dissociation of oxygen from oxyhemoglobin was affected by the presence of hemoglobin in the same way as it was affected by carbon monoxide. They failed to find significant differences, however, between the dissociation curves of oxyhemoglobin-hemoglobin mixtures prepared by the oxidation of a certain fraction of the hemoglobin by nitrite or by ferricyanide or prepared by addition to oxyhemoglobin of a solution of hemoglobin. In the former case, intermediates containing both ferrous and ferric iron would be expected to be present, while in the latter, the solution would be expected to contain initially only molecules containing four ferrous or four ferric iron atoms, in which case the dissociation of the oxyhemoglobin should be uninfluenced by the hemoglobin. In explanation of this negative finding they suggested that equilibrium was established relatively rapidly between molecules containing only ferrous, or only ferric, iron atoms, and molecules containing both:



where the first square represents a molecule of hemoglobin.

Drabkin and co-workers (623) have recently attempted to differentiate physiologically between the effects produced by the presence in the blood of dogs of hybrid hemoglobin molecules containing both oxygen and carbon monoxide, and the effects produced by an equivalent mixture of hemoglobin molecules, each of which was homogeneous with respect to the gas with which it was combined. They were

unable to find a significant difference between these two cases, due, perhaps to the rapid establishment of equilibrium, or to the experimental difficulties.

5.2.3. Complex Oxidation-Reduction Systems. In Chapter V we have discussed the relations between the oxidation-reduction potential of the hemochromes and the relative affinity of the base for heme and hematin. As a by-product of their investigations into the reversibility of the hemoglobin-hemoglobin system, Conant and Scott (478,479) have dealt with the analogous effect that combination between oxygen or carbon monoxide and hemoglobin has on the oxidation-reduction potential. Conant treats the problem in the following way (471), which is similar to the more elaborate treatment accorded by W. M. Clark to the hemochrome systems (*cf.* Chapter II).

In the presence of the gas (oxygen or carbon monoxide) at partial pressure x , the saturation, y , is defined by the equation:

$$y = [\text{HbO}_2]/[\text{HbO}_2 + \text{Hb}]$$

and the fraction not combined with the gas, and therefore to be considered in the electrode equation, is equal to $(1 - y)$. The electrode equation at 30°C.:

$$E_h = E'_0 + \frac{0.0601}{n} \log \left(\frac{[\text{Hi}^+]}{[\text{Hb}]} \right)$$

becomes, in the presence of the gas at partial pressure x :

$$E_x = E'_0 + \frac{0.0601}{n} \log \frac{[\text{Hi}^+]}{(1 - y)[\text{HbO}_2 + \text{Hb}]}$$

When $[\text{Hi}^+] = [\text{HbO}_2 + \text{Hb}]$, the equation becomes:

$$E_x = E'_0 + \frac{0.0601}{n} \log \left(\frac{1}{1 - y} \right)$$

Now, the Hill equation (Section 5.1.3.) may be cast into the form $\log \left(\frac{1 - y}{y} \right) = \log K - n' \log x$, where y and x are defined above, K is the reciprocal of the dissociation constant used in Section 5.1.3., and n' is the sigmoid coefficient, which is written with a prime to distinguish it from the constant n in the electrode equation.

If the ferrous form of the pigment is almost completely saturated with the gas, $\log \left(\frac{1 - y}{y} \right)$ becomes nearly equal to $\log (1 - y)$, in which case the error is small in writing:

$$\log (1 - y) = \log K - n' \log x$$

At half saturation the equation becomes:

$$\log K = n' \log x_{1/2}$$

where $x_{1/2}$ is the pressure at half saturation; substituting for $\log K$:

$$\log (1 - y) = - n' (\log x - \log x_{1/2})$$

and by substitution in the electrode equation one obtains:

$$E_x = E'_0 + \frac{0.0601}{n} n' (\log x - \log x_{1/2})$$

Conant then uses this equation to obtain values for the E_x of oxyhemoglobin and carboxyhemoglobin at defined partial pressures of the gases. At 25° C. and pH 7 he calculates that at 735 mm. mercury E_x for oxyhemoglobin equals + 0.250 v., and at a similar pressure of carbon monoxide under the same conditions E_x is equal to + 0.410 v. While the value of oxyhemoglobin was inaccessible to experimental measurement, a value of + 0.417 v. was found when the equilibrium between hemoglobin and ferricyanide was measured in the presence of carbon monoxide at a pressure of 735 mm. mercury. It should be noticed that the values for the E_x of the oxyhemoglobin and the carboxyhemoglobin system are considerably higher than the E'_0 of + 0.15 v. found for the hemoglobin-hemoglobin system in the absence of oxygen or carbon monoxide. In arriving at these results Conant assumed that n equalled n' . While this is not always the case, the agreement between predicted values and those found for carboxyhemoglobin shows that the error, in this instance, was not large.

5.2.4. Variation of Oxygen Affinity and Oxidation-Reduction Potential with pH. Conant's treatment of the equilibrium between carboxy- or oxyhemoglobin, hemoglobin and hemoglobin, has not, so far, been extended to deal with the effects of variations of pH. Wyman's work (3134,3136) is a step in this direction. It is based, however, only in part on fresh experimental work and in part on a theoretical treatment of the results of other workers, including the rather over-worked data of Ferry and Green. We have previously pointed out the undesirability of relying solely on results obtained from one hemoglobin which is unique so far as species and preparation are concerned, and confirmatory experiments will probably lead to certain modifications in the general treatment.

This treatment is based on the finding of Ferry and Green that the dissociation curves of oxyhemoglobin, obtained at various pH values, can be reduced to a common pH by suitable adjustment of the p axis. We have seen that Pauling has made this the basis of his statement that the influence of pH is solely on the dissociation constant, and that the heme-heme interaction constant is independent of pH. Roughton and co-workers (2365) have pointed out that if pH is kept constant and temperature varied, a similar procedure may be used to reduce to a given temperature the oxygen pressure-saturation curves.

By a mathematical argument, Wyman and Ingalls (3136) have been able to develop equations expressing the interrelationship between the equilibria of oxidation-reduction, combination with oxygen, and dissociation of protons. For the hemoglobin-oxyhemoglobin system, they obtained the equation:

$$\log (1/p_x) = \frac{\log \left[\frac{(K_1 + H^+) \dots (K_g + H^+)}{(K'_1 + H^+) \dots (K'_g + H^+)} \right]}{4} + \text{constant}$$

where p is the oxygen pressure, x the ratio HbO_2/Hb , $K_1 \dots K_g$ the dissociation constants for ionization of protons from ionizable groups $1 \dots g$ assumed to be present in oxyhemoglobin, and $K'_1 \dots K'_g$ the corresponding constants for hemoglobin.

For the hemoglobin-hemiglobin system, they obtained a similar equation from the data of Taylor and Hastings:

$$- 16.63 E_z = \frac{\log \left[\frac{(K''_1 + H^+) \dots (K''_g + H^+)}{(K'_1 + H^+) \dots (K'_g + H^+)} \right]}{4} + \text{constant}$$

where E_z is the redox potential of the system when $z = \text{Hi}/\text{Hb}$, and $K'_1 \dots K'_g$ and $K''_1 \dots K''_g$ dissociation constants as defined above for ionizable groups in hemiglobin and hemoglobin, respectively.

These two equations can, if necessary, be combined to give a third equation which relates E_z and p_x to the dissociation constants of the ionizable groups in hemiglobin and oxyhemoglobin, respectively.

We have referred in Section 3.2.2. to the expression of the difference in base bound between oxyhemoglobin and hemoglobin in terms of the shifting the pK values of two imidazole groups (988) and to the description of the difference in base bound between hemiglobin and oxyhemoglobin solely in terms of the pK dissociation of proton from the heme (3136). The substitution of these pK values in the above equation gave a reasonable fit of the data for the variation of the half-saturation pressure with pH and for the variation of the oxidation-reduction potential with pH . By slight adjustment of the numerical values given to the pK values they were able to improve their equation further. The latter values, at 25° C. and μ of 0.16 are:

| | pK_1 | pK_2 | pK_3 |
|---------------|--------|--------|--------|
| Hemiglobin | 5.75 | 6.68 | 8.01 |
| Oxyhemoglobin | 5.75 | 6.68 | |
| Hemoglobin | 5.25 | 7.93 | |

The success with which they were able to describe the data can be seen from the curves in Figure 10. It should be noted that, while these deductions have been used to support the hypothesis that the "hemaffine" groups are histidine imidazoles, the derivation is essentially a formal one and is not necessarily dependent on this.

Further work is needed before Wyman's treatment can be extended to cover the effect variations in pH will have on the systems which

Conant has discussed. While this would be of interest, we can only emphasize our belief that these powerful mathematical methods should be applied in parallel with attempts to analyze the effect on

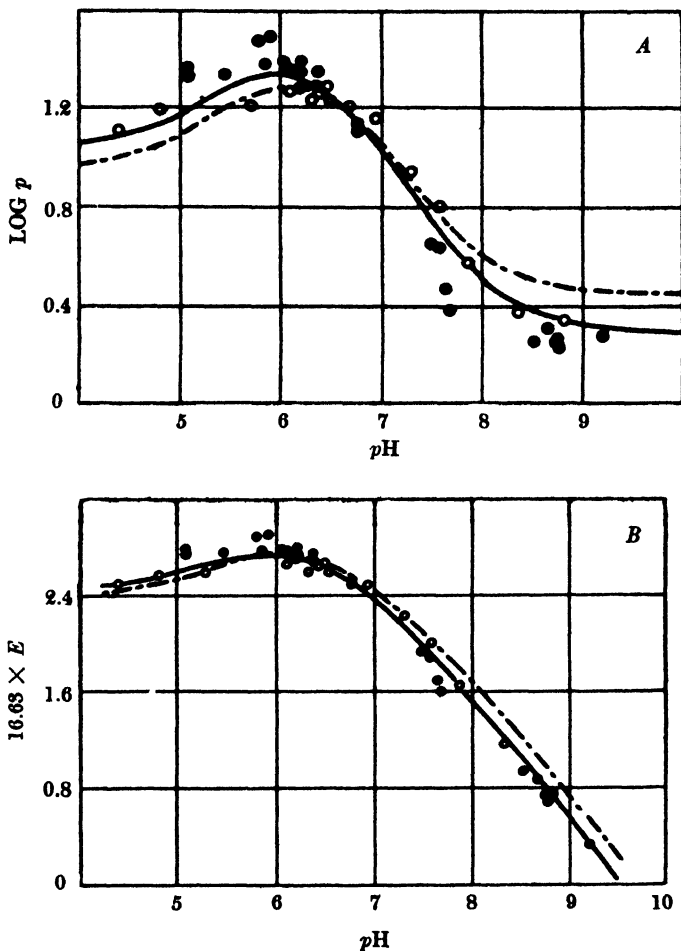

Fig. 10. Wyman's theory and fit of curves describing dependence of gas saturation and oxidation-reduction potential on pH with observed curves (after Wyman and Ingalls, 3136). A: O, values of $\log p$, the oxygen dissociation pressure at 50% saturation in relation to pH , from the data of Ferry and Green; ●, values of $\log p$ calculated from the oxidation-reduction potentials given by Taylor and Hastings. B: ●, oxidation-reduction voltages $\times 16.63$ for 50% oxidation, from the data of Taylor and Hastings; O, values of the same calculated from the oxygen dissociation pressures given by Ferry and Green. All curves are calculated on the basis of dissociation constants discussed in the text.

the dissociation curve and the redox potential of the mode of preparation and the species of animal used.

6. KINETICS OF HEMOGLOBIN REACTIONS

6.1. Methods

Not until Hartridge and Roughton commenced their work in 1923 did it become possible to approach the hemoglobin equilibria from the standpoint of their kinetics. The velocities of the reactions they set out to measure were extremely fast, and the original papers should be consulted to get a proper idea of the ingenuity with which they surmounted the technical difficulties. In principle, their method consisted of observing the spectrum of the compound in which they were interested, at various positions along a tube through which the hemoglobin solution was driven at a high velocity, a few milliseconds after it had been effectively mixed with an aqueous solution of the substance with which it was reacting. Their analyses were based on measurement of the position of the α band of a mixture of carboxy-hemoglobin and oxyhemoglobin with a Hartridge reversion spectroscope.

The early technique for measuring the kinetics of these fast reactions was subsequently altered by Roughton and Millikan (1928) by the replacement of the Hartridge reversion spectroscope by a differential photoelectric cell arrangement, when, by the use of proper wavelengths of light, a potential difference could be established which was proportional to the saturation of the pigment. While the earlier techniques required liters of blood, this improvement enabled a reduction to be made in the scale of the apparatus, and in Millikan's modification (1952a) the solutions are delivered by motor-driven syringes and a complete investigation of the kinetics of the pigment can be made with a few milliliters of solution.

The work on the kinetics of the hemoglobin and myohemoglobin systems was carried out during the period 1923 to 1936. This period was one in which great advances were made in the study of hemoglobin, some of which necessitated reinterpretation of the early kinetic investigations. In this chapter, we are concerned more with the mechanism of the reactions than with the absolute values obtained.

6.2. Kinetics of Individual Reactions with Carbon Monoxide and Oxygen

6.2.1. $\text{HbO}_2 \rightarrow \text{Hb} + \text{O}_2$. This was one of the earliest reactions investigated by Hartridge and Roughton (1149) and the technique they adopted was the measurement of the rate of disappearance of oxyhemoglobin in the absorption tube when, just prior to entering the tube, it was mixed with a solution of dithionite. When the partial pressure of the oxygen had been reduced sufficiently, the dissociation of the oxyhemoglobin commenced. This was independent of the concentration of reducer. The reaction was found to be of the first order and showed a marked dependence on pH ; see Figure 11.

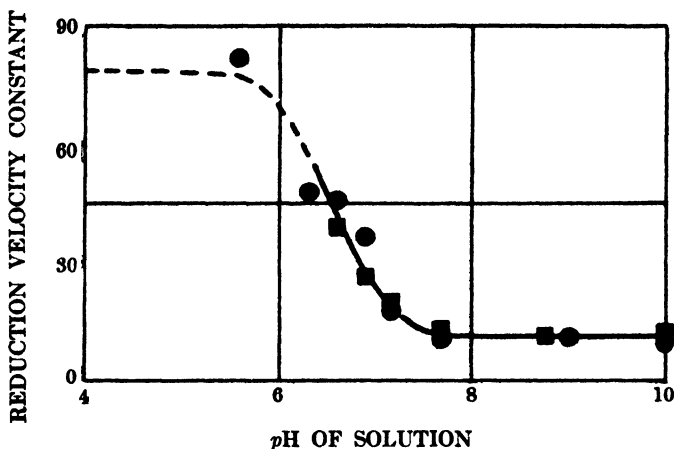

Fig. 11. pH dependence of rate of dissociation of oxyhemoglobin for two different blood samples (after Hartridge and Roughton, 1148).

The velocity below pH 5.6 was found to be approximately seven times that found above pH 7.7. The response to changes in pH was found to be virtually instantaneous, no difference being found between the rate of dissociation of oxyhemoglobin at pH 6.3, if the solutions were adjusted to this pH before mixing, or were mixed at different pH values chosen so that the final pH was 6.3. The significance of their finding a temperature coefficient of $Q_{10} = 3.8$ for the reaction is further discussed below.

6.2.2. $\text{Hb} + \text{O}_2 \rightarrow \text{HbO}_2$. This reaction is investigated by mixing hemoglobin with water containing a known concentration of oxygen

and following the rate of appearance of oxyhemoglobin (1149). Hemoglobin was prepared both by evacuation and by reduction with ammonium sulfide. Hartridge and Roughton found that the rate at which oxyhemoglobin was reduced by ammonium sulfide was so slow that the back reduction with this reagent could be neglected during the course of the reaction with oxygen. A twelvefold alteration in the concentration of ammonium sulfide used had no effect on the velocity of the association reaction, which was found to be much faster than the reverse reaction first investigated. The velocity was about 50% faster at *pH* 10 than at *pH* 5.6 and was unaffected by the presence or absence of 0.067 *M* sodium chloride. The rate is described by the equation:

$$d[\text{HbO}_2]/dt = k_2 [\text{Hb}] [\text{O}_2] - k_1 [\text{HbO}_2]$$

When the ratio of the hemoglobin to oxygen was increased fourfold, the rate increased likewise during the initial period of the reaction. This finding excludes Hill's hypothesis on which the first term on the right-hand side of the above equation would be $k_2 [\text{Hb}] [\text{O}_2]^n$. If this described the reaction, a fourfold variation in the ratio of oxygen to hemoglobin should alter the rate by a factor 4^n , where n is between 2 and 3.

Since from their previous work they had obtained a value for the rate of dissociation of oxyhemoglobin, they were able for the first time to put the kinetic basis of Hufner's theory to experimental test. They measured the dissociation curve and the rate constants on the same samples of hemoglobin. They found the dissociation curve to be hyperbolic and fitted it with the Hufner equation. The value of the equilibrium constant determined from the rate constants was then compared with that found experimentally.

| <i>pH</i> | Sample 1 | | Sample 2 | |
|-----------|-------------------|----------------------|-------------------|----------------------|
| | <i>K</i> (exper.) | <i>K</i> = k_2/k_1 | <i>K</i> (exper.) | <i>K</i> = k_2/k_1 |
| 7.7 | 218 | 164 | 112 | 148 |
| 10.0 | 730 | 700 | 336 | 438 |

In view of the experimental difficulties the agreement must be considered good, and under the conditions in which they worked the kinetic evidence, therefore, supported Hufner's theory, which, as we have seen, had been discarded because of the inability to predict the sigmoid dissociation curve obtained under most conditions. We shall examine this paradox in Section 7.1.1.

6.2.3. CO + Hb → HbCO. This reaction is much slower than the corresponding reaction with oxygen but is of the same type (2356). Up to 50% carboxyhemoglobin, the reaction is described by the equation:

$$d[\text{HbCO}]/dt = k_2[\text{Hb}][\text{CO}] - k_1[\text{HbCO}]$$

That the reaction is better described by this equation than by Hill's can be seen from the fact that 32-fold variation of the ratio $[\text{CO}]/[\text{Hb}]$ varies the rate proportionally and not 32^n times as would be expected on Hill's theory. Between pH 5.6 and 7.5, the rate remains unaltered, but is 50% faster at pH 10. The temperature coefficient Q_{10} is approximately 2. Hundred-fold variation in the intensity of the light did not affect the reaction, an indication that the back reaction was negligible. The effect varying salt concentration might have on the reaction was not investigated.

6.2.4. HbCO → CO + Hb. As has been well known, this is the slowest of the four reactions so far investigated, and, since the dissociation is slower than the association reaction, it is no longer permissible to neglect the second term in the equation:

$$-d[\text{HbCO}]/dt = k_1[\text{HbCO}] - k_2[\text{Hb}][\text{CO}]$$

Furthermore, it is impossible to utilize the same technique as was used in the measurement of the dissociation of oxyhemoglobin, no reagent being known which will combine with carbon monoxide without affecting the protein.

Roughton (2357) considered making use of the reaction:

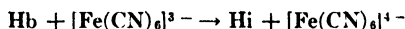

to remove the hemoglobin from the system as it was formed from carboxyhemoglobin. This should be compared with the removal of oxygen by means of dithionite in the analogous oxyhemoglobin reaction. The velocity found in using this device was however some 50% greater than that found by the method described in the succeeding section in which oxygen was used to combine with the hemoglobin.

While the dissociation of the first carbon monoxide molecule occurs under the same conditions in both methods, subsequent molecules dissociate from a different structure in the presence of ferricyanide; the structures:



and others will be present and there is no guarantee that the dissociation of molecules of carbon monoxide from such hybrid ferrous-ferric compounds can be directly compared with the dissociation from entirely ferrous compounds, such as:



Roughton removed the hemoglobin from the system by combining it with oxygen. Since a similar objection could be raised to this procedure, involving as it did the dissociation of molecules of carbon monoxide from hybrid carboxy-oxyhemoglobins of the structures:



he pointed out that the velocities measured under these conditions referred only to the rate of dissociation of the first of the four carbon monoxide molecules and that the results were not comparable with those obtained when the dissociation of oxyhemoglobin was measured with the aid of dithionite.

6.2.5. $\text{CO} + \text{HbO}_2 \rightarrow \text{HbCO} + \text{O}_2$. This reaction had been the first which Hartridge and Roughton had measured with their flow technique (1146). They found certain anomalies to be present in their earlier work and the reaction was reinvestigated by Roughton in 1934 (2357). The rate of appearance of carboxyhemoglobin is described by the equation:

$$d[\text{HbCO}]/dt = k_2 \frac{[\text{HbO}_2] [\text{CO}]}{[\text{O}_2]} - k_1 [\text{HbCO}]$$

On account of slow dissociation of carboxyhemoglobin the back reaction is neglected. Roughton initially^a kept the partial pressure of oxygen constant and varied the concentrations of carbon monoxide and oxyhemoglobin. The value of k_2 remained unaltered when the concentrations of carbon monoxide and oxyhemoglobin were varied 22-fold, $[\text{O}_2]$ remaining constant. This was found to be the case between $p\text{H}$ 6 and $p\text{H}$ 10 and between temperatures from 11°C . to 21°C . By keeping the concentrations of carbon monoxide and oxyhemoglobin constant, the reaction velocity varied inversely with the concentrations of oxygen when the latter was varied sixfold. The effect of temperature on the reaction was not thoroughly investigated

and more work was promised. The slight effect of varying pH was unexpected in view of the sensitivity of the oxyhemoglobin dissociation to alterations of this variable in the absence of carbon monoxide. We will postpone discussion of this anomaly until Section 7.3.1.

6.2.6. $HbCO + O_2 \rightarrow HbO_2 + CO$. This reaction was studied (2357) as far down as 30% carboxyhemoglobin. It is described by the equation:

$$-d[HbCO]/dt = -k_2 \frac{[CO][HbO_2]}{[O_2]} + k_1 [HbCO]$$

Roughton endeavored to reduce the effect of the back reaction by increasing the concentration of oxygen until it produced no further increase in the rate of reaction. This condition was not quite attained when the partial pressure of the oxygen reached one atmosphere, but the rate of alteration in velocity at this oxygen concentration was sufficiently slight for extrapolation to be made to the desired condition. He found the reaction to be of the first order with respect to $[HbCO]$. In spite of the sensitivity of the equilibrium between carbon monoxide, hemoglobin, and oxyhemoglobin to changes in the hydrogen ion concentration, the rate proved to be insensitive to changes in pH between 6.2 and 10, behaving in the same anomalous fashion as the reaction $CO + HbO_2 \rightarrow HbCO + O_2$.

In this instance the ratio of the association and dissociation reactions of carbon monoxide, k_2/k_1 , refers to the equation:

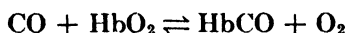

where K , the partition constant is defined by:

$$K = \frac{[HbO_2][CO]}{[HbCO][O_2]}$$

This equilibrium was measured for the samples of hemoglobin used in the kinetic experiments and the value found compared with those calculated from the two velocity constants.

| Sample 1 (18° C.) | | | Sample 2 (16° C.) | | |
|-------------------|--------------|---------------|-------------------|--------------|----------------------|
| pH | K (exper.) | $K = k_2/k_1$ | pH | K (exper.) | $K = k_2/k_1$ |
| 6.2 | 198 | 192 | 6.2 | 207 | 370 (?) ^a |
| 11.0 | 221 | 181 | 10.0 | 177 | 234 |

^aQuestion mark in original.

These results do not present the same paradox as is presented by the agreement between the equilibrium constant as found for the reaction $\text{HbO}_2 \rightleftharpoons \text{Hb} + \text{O}_2$ and that calculated from the velocity constants of the forward and back reactions (Section 6.2.2.), since the Hüfner equation is known to describe the behavior of the system $\text{CO} + \text{HbCO} \rightleftharpoons \text{HbCO} + \text{O}_2$.

6.2.7. Kinetics of Reactions within the Erythrocyte. In several papers Roughton (2355,2363) has approached the problem of the effect of the erythrocyte on the kinetics of the hemoglobin reactions. The influence of diffusion is not noticeable when slow reactions such as the dissociation of carboxyhemoglobin are measured, the rate of which appears to be the same in the erythrocyte as in solutions of hemoglobin. With faster reactions diffusion rates through the cell membrane and through the interior of the cell become progressively more important as limiting factors. Thus in the combination of carbon monoxide with hemoglobin the rate is about one-third as fast in the cell as in solution, and in the fastest reaction of all, the combination of oxygen with hemoglobin, the rate is reduced to one-twelfth. At partial pressures of oxygen above 400 mm. oxygen displaces carbon monoxide from carboxyhemoglobin as fast in cell suspensions as in solutions. If the value of k_2 (cf. Section 6.2.5.) was increased by further lowering the concentration of oxygen, Roughton considered that the velocity of diffusion into the cell would be detectable, so that at alveolar oxygen pressures the rate in the cell would be 87% of that in solution. So far, however, experimental confirmation of this figure is lacking (cf. Chapter VII, Sections 7.2.3. and 11.3.).

6.2.8. Kinetics of Myohemoglobin Reactions. This pigment has been less investigated than has hemoglobin. In particular, knowledge is lacking of the proton dissociation of myohemoglobin in the neighborhood of $\text{pH } 7$ when oxygen enters the molecule, although the insensitivity of the dissociation curve to changes in pH suggests that no ionization occurs.

The gaseous reactions of myohemoglobin were among the first investigated by the syringe modification of the Hartridge and Roughton rapid flow technique (2368). The reaction mechanisms were investigated in the usual way by altering the concentrations of the different components in the system and the essential data (1952,1953) are shown in Table IV (cf. Section 7.2.).

Since myohemoglobin contains only one heme, certain variations of the methods adopted for hemoglobin were possible in the study of the myohemoglobin reactions. Thus, Millikan's use of ferricyanide to remove the myohemoglobin formed by the dissociation of myocarboxyhemoglobin cannot introduce undesirable heme-heme interactions as in the case of the hemoglobin system. In the analogous dissociation reaction with oxyhemoglobin,

Millikan used dithionite as an acceptor for oxygen. The combination of oxygen with myohemoglobin, which is half complete in 0.4 millisecond, proved to be the fastest reaction of this type so far discovered. As would be expected, the dissociation of myocarboxyhemoglobin is sensitive to light. In view of the insensitivity of the equilibrium between oxygen and myohemoglobin to pH changes, the finding that the rate of dissociation remained unchanged between pH 6.2 and pH 8.6 was not unexpected. In contrast to the hemoglobin reactions, the comparison of the Hufner dissociation constant with the ratio of the velocity constants for the forward and back reactions is unexceptionable, since the dissociation curve may be described accurately by the Hufner equation. The data are summarized as follows for the system at $20^{\circ}C.$ and pH 7.4:

| | $K = k_2/k_1$ (calc.) | K (found) |
|--------------------------------|-----------------------|-------------|
| $MHb + O_2 \rightarrow MHbO_2$ | 520 | 495 |
| $MHb + CO \rightarrow MHbCO$ | 7000 | 9500 |

The affinity constant, $K = 9500$, for the equilibrium:

$$\frac{[MHbCO]}{[MHb][CO]}$$

was not measured by Millikan, but was calculated from the affinity constant he obtained by measurement of the oxygen equilibrium using Theorell's (2762) value for the partition constant K for the equilibrium:

$$\frac{[MHbO_2][CO]}{[MHbCO][O_2]}$$

Since the myohemoglobin reactions are adequately described by the Hufner equation this procedure gives a correct value.

6.3. Kinetics of Other Reactions

Some data are available on the kinetics of other rapid reactions of hemoglobin compounds. None of these have been investigated in the same detail as the reactions with oxygen and carbon monoxide. The photoelectric reaction meter has been used by Stern and DuBois (2658) for the measurement of the rate of reduction of hemoglobin by dithionite (*cf.* also Chapter VII, Section 11.3.). Roughton (2357) and Millikan (1952) have given data on the reactions between ferricyanide and hemoglobin. Havemann (1188) has analyzed the kinetics of the combination of cyanide with hemoglobin.

7. INTERPRETATION OF KINETIC DATA

7.1. Relation to Theories of Equilibrium

7.1.1. Anomalous Support for Hufner's Theory. In Sections 6.2.2. and 6.2.3., it has been pointed out that kinetic data exclude the earlier interpretation of A. V. Hill's equilibrium equation, since p -fold variations of the

concentrations of oxygen and carbon monoxide during the association reactions produce a p -fold variation in the rate and not a p^n -fold variation as would be expected from Hill's theory.

The kinetic data however, differentiate less obviously between the other three equilibrium equations. The fact that the ratio of the velocity constants for the forward and back reactions agrees with the original Hufner theory presents a paradox (Section 6.2.2.). Hartridge and Roughton (1149) determined the dissociation curve of a sample of the blood they were using for the kinetic measurements; they were restricted by the spectroscopic method they used for the measurement of the equilibrium to only four points on the curve between 40 and 70%, but were able to draw a hyperbolic dissociation curve through these points.

Although the dissociation curve has been observed to be sigmoid in shape in dilute solutions by a number of workers (*cf.* 1177, 1105), their measurements were not carried out in such great dilutions as were the kinetic measurements, and it is possible that under the latter conditions the dissociation curve is of hyperbolic shape. A second possibility is that the hemoglobin used for the kinetic experiments had been altered in some way (*cf.* Section 5.1.6.).

7.1.2. Reactivity of Freshly Reduced Hemoglobin. Further problems are presented by some experiments which Roughton carried out on freshly reduced hemoglobin (2358). The velocity of combination between carbon monoxide and hemoglobin was measured with hemoglobin which had been reduced some time before the commencement of the run, and with hemoglobin which was prepared from oxyhemoglobin by reduction immediately prior to its reaction with carbon monoxide. The velocity of the combination of carbon monoxide with the two samples of hemoglobin was identical at pH 6.6 and 15° C., and at pH 10 and 33° C. At pH 10 and 15° C. however, the reaction of carbon monoxide with the freshly reduced hemoglobin was found to be twice as fast as with the "old" hemoglobin. Under these conditions, high pH and low temperature, the velocity of the dissociation of oxyhemoglobin is many times slower than under the conditions in which his other experiments were carried out. Roughton suggested that the phenomenon might be related to the dissociation of the actual molecule of hemoglobin. Another possible explanation is that the reduction of oxyhemoglobin remained incomplete in the experiment with freshly reduced hemoglobin. Even if the saturation with oxygen is as low as 5%, this may have an effect on the rate of the association, if the combination of the first heme is the rate-determining step and the interaction between the hemes causes an acceleration for the remaining hemes. This would suggest that the whole burden of interaction between hemes as an explanation of the sigmoid equilibrium curve must be placed on the association reaction.* The dissociation of oxyhemoglobin has been shown to follow a logarithmic course down to 10% saturation; this is most easily understood by assuming no interaction as regards the rate of reaction of successive oxygens from the heme molecule.

* Recent work by Legge, Nicholson, and Roughton (1668a) has shown that this is not the case.

7.2. Comparison of Kinetics of Myohemoglobin and Hemoglobin

Roughton and Millikan (2368) raised several criticisms of Pauling's hypothesis on the basis of the kinetics of myohemoglobin. The basis for part of their criticism disappears if one takes the more generally accepted value of 17,000 for the molecular weight of myohemoglobin rather than the value 34,000 which they accepted; heme-heme interaction is therefore absent in myohemoglobin.

The ratio of the velocities with which oxygen and carbon monoxide react with myohemoglobin and hemoglobin are collected in Table IV, taken from the publications of Millikan (1952a). It can be seen that, with the exception of the dissociation of myooyhemoglobin, all the myohemoglobin reactions are faster than the corresponding hemoglobin reactions.

TABLE IV
Comparison of Myohemoglobin and Hemoglobin Kinetics^a

| Reaction | Velocity constants | | Dimensions |
|-----------------------------|--------------------|-------|---------------------------------------------|
| | MHb | Hb | |
| O ₂ association | 19,000 | 4,000 | Millimoles ⁻¹ sec. ⁻¹ |
| O ₂ dissociation | 37 | 40 | Sec. ⁻¹ |
| CO association | 300 | 130 | Millimoles ⁻¹ sec. ⁻¹ |
| CO dissociation | 0.04 | 0.004 | Sec. ⁻¹ |

^a According to Millikan (1952a).

Steric considerations might account for the increase in rate of association reactions. If the hemes are held between "hemaffine" groups on the surface of hemoglobin molecule, the effective target area may well be much less than in the case of myohemoglobin, where the heme is probably attached to only one hemaffine group. The insensitivity of myooyhemoglobin dissociation to *pH* changes between 6.2 and 8.6 indicates the absence of a heme-linked group whose *pK* value lies in this range. This would also be expected to influence the kinetic differences between the two compounds.

7.3. Differences between the Kinetics of Oxygen and Carbon Monoxide Reactions

7.3.1. Effect of *pH*. We have referred in Section 6.2.5. to the unexpected insensitivity of the replacement reactions to changes in *pH*. Since the

technique used in the measurement of these reactions made it unlikely that any of the less saturated intermediates were present, the reactions could be expressed as:

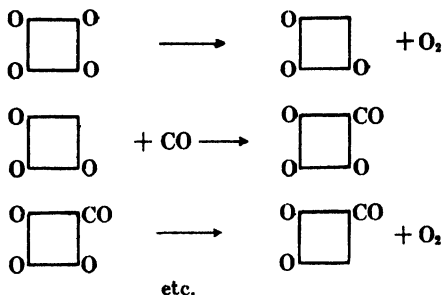

It has been shown above that if the dissociation of $\begin{array}{c} \text{O} \\ | \\ \square \\ | \\ \text{O} \end{array}$ is allowed to go to completion in the absence of carbon monoxide, the dissociation velocity constant diminishes approximately sevenfold on changing from pH 6 to pH 8. Roughton explained the anomalous lacking of pH sensitivity of the replacement reaction by assuming that the pH effect was only operative when the less saturated intermediates were formed (2357), *e.g.*:

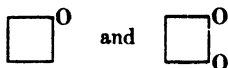

7.3.2. Differences in Heats and Entropies of Reaction. In an interesting contribution Eley (658) applies the transition state theory to the kinetics of these reactions, and evaluates the entropies and heats of activation, ΔS^* and ΔH^* , for these reactions and compares them with the over-all entropy and heat changes, ΔS and ΔH , obtained from the equilibrium data. He points out that the carbon monoxide reaction is "normal" and that the oxygen reaction is "abnormal" in that the difference between ΔS_{as}^* and ΔS_{dis}^* for the forward and back reactions agrees within experimental error with ΔS for the equilibrium in the former case, while in the latter there are very large quantitative discrepancies. The position is similar with respect to the differences between the heats of activation of the forward and back reactions and for the equilibrium. The reader is referred to Eley's paper for discussion of possible explanations for this peculiarity; Eley concludes that more data are required on the rates of reaction of the partially saturated intermediates.

With respect to the actual velocities of the reactions, he points out that, while similar heats of activation are found for the dissociation of HbO₂ and HbCO, the entropy of activation for the former is much larger than for the latter. This may explain why the dissociation of oxyhemoglobin is much faster than that of carboxyhemoglobin. The high velocities of the association

reactions are explained by the low heats of activation rather than by the entropies of activation, since the latter is small in the case of carbon monoxide reaction and negative in the case of the reaction with oxygen. He suggests that the negative entropy of activation of the association reaction with oxygen may be due to changes in the protein absent in the carbon monoxide reaction. If this is so, such changes apparently do not include changes in the ionization of the protein, since pH affects both reactions to approximately the same extent.

7.3.3. Spectroscopic Differences. The similarity between the type of spectrum of carboxy- and of oxyhemoglobin in the visible region (due to the fact that in both iron bonds are covalent) should not divert attention from the differences which exist in the infrared absorption spectrum.

In contrast to oxyhemoglobin, carboxyhemoglobin is photosensitive. Photosensitivity of complexes containing carbon monoxide is not peculiar, however, to the compound which this molecule forms with heme and its derivatives; it is a rather general property of iron-carbon monoxide compounds (*cf.*, *e.g.*, 512).

So far the investigation of the properties of the carbon monoxide-iron bond has not thrown light on this problem, or on the related problem of the effect of the protein on the quantum yield of the reaction. While in some of these compounds the absorption of one quantum of light of the appropriate wavelength is sufficient to dissociate the carbon monoxide complex, Bücher and Negelein (374) have recently claimed that the number of quanta required to produce dissociation depends on interaction between the hemes in the molecule. While one quantum was able to dissociate myocarboxyhemoglobin, two and four quanta, respectively, were required to produce dissociation of one mole of carbon monoxide from carboxyhemoglobin under conditions when it contained two and four hemes per molecule.

In emphasizing the differences between oxy- and carboxyhemoglobin Holden (1317) has recently even made the tentative suggestion that the oxygen and the carbon monoxide molecules are attached to different portions of the hemoglobin molecule. This idea could be criticized on a number of grounds.

It would, for example, be extremely difficult to interpret the similarity of behavior of the heme-linked proton dissociation groups in the two compounds if the gas molecules were not combined at the same position. In addition the work of Barcroft and collaborators (64) on the relation between band position and affinity for oxygen and carbon monoxide provides further data which make Holden's suggestion unlikely.

In the course of their investigations of the hemoglobins of a number of species Barcroft and co-workers found that the shift of the α band when oxygen was replaced by carbon monoxide was linearly related to the logarithm

of K , the constant of partition between oxygen and carbon monoxide. $\log K$ changes by about 0.05 per angstrom unit shift in the band (See Fig. 1, Chapter VII). Similar relations have been found to exist between the logarithms of the affinity constants of the hemoglobin of some species for carbon monoxide and the position of the α band of the carboxyhemoglobins, and between the variation of the affinity of hemoglobin for oxygen with temperature and the temperature variations of the positions of the α absorption band of oxyhemoglobin (Brown and Hill, 351, *cf.* Fig. 12).

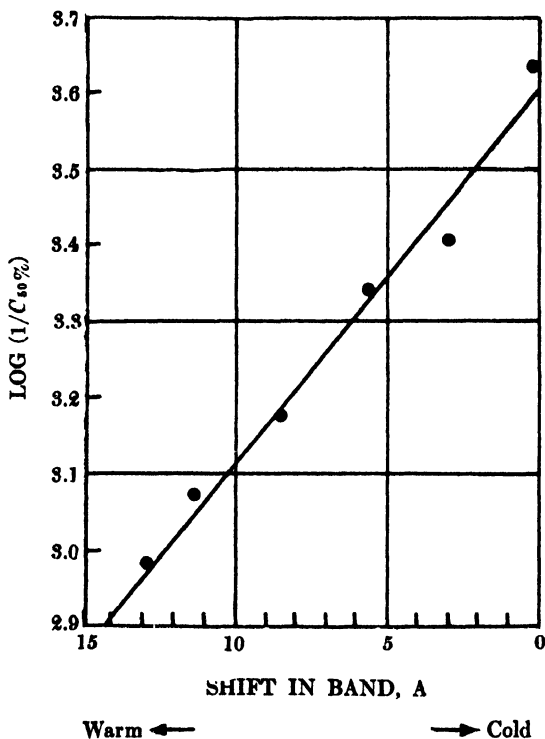

Fig. 12. Variations of band position and oxygen affinity with temperature (after Brown and Hill, 351). C is the concentration of O_2 .

Although this relationship between affinity and spectrum is not yet understood (*cf.* Chapter VII), it would seem extremely unlikely that such agreement between affinity and band shift for both the oxyhemoglobin and the carboxyhemoglobin compound would exist if the gases were combined at different places on the hemoglobin molecule.

8. STRUCTURAL BASIS OF HEME-HEME INTERACTION

8.1. Classification of Hemoglobin Equilibria

Coryell's demonstration of the relation between n and α (498) provides a useful criterion for the classification of hemoglobin reactions according to the degree of heme-heme interaction. He summarized data for a number of systems in order to see if the presence or absence of interaction could be correlated with the presence or absence of a change in the bond type. In Table V data are given for a number of these systems.

TABLE V
Classification of Hemoglobin Equilibria

| Reaction | n^a | Bond changes ^b | Change in H ⁺ ion activity on | |
|----------------------------------------------------------------------------------|-------------------|--------------------------------|------------------------------------------|-------------------|
| | | | Imidazole | Iron ^c |
| $\text{CO} + \text{HbO}_2 \rightleftharpoons \text{HbCO} + \text{O}_2$ | 1 | Cov. \rightarrow cov. | 0 | 0 |
| $\text{Hi} + \text{OH}^- \rightleftharpoons \text{HiOH}$ | 1 | Ion. \rightarrow partly ion. | ? | + |
| $\text{Hi} + \text{F}^- \rightleftharpoons \text{HiF}$ | 1 | Ion. \rightarrow ion. | ? | + |
| $\text{Hb} + \text{O}_2(\text{CO}) \rightleftharpoons \text{HbO}_2(\text{HbCO})$ | $2 \leq n \leq 3$ | Ion. \rightarrow cov. | + | 0 |
| $\text{Hb} - e \rightleftharpoons \text{Hi}^+$ | $1 \leq n \leq 2$ | Ion. \rightarrow ion. | + | + |
| $\text{HbCO} - e \rightleftharpoons \text{Hi} + \text{CO}$ | 2 | Cov. \rightarrow ion. | ? | + |
| $\text{Hi} + \text{SH}^- \rightleftharpoons \text{HiSH}$ | 1.8 | Ion. \rightarrow cov. | ? | + |
| $\text{Hi} + \text{N}_3^- \rightleftharpoons \text{HiN}_3$ | 1.7 | Ion. \rightarrow cov. | ? | + |

^a n is the sigmoid coefficient.

^b cov. = covalent, ion. = ionic.

^c Any reaction of hemoglobin or any reaction in which the valency of iron changes must be accompanied by such changes. 0 = no change, ? = undetermined, + = change present.

As Coryell pointed out, a change in the character of the iron bonds is not sufficient criterion for the presence or absence of interaction. This may be the basis for interaction in the combination of oxygen or carbon monoxide with hemoglobin, and the explanation for the absence of interaction in the replacement of oxygen by carbon monoxide, but fails to explain the behavior of the systems in which hemoglobin is present. It may be necessary to take into account the effect introduced by the charge on the iron atom. Even when there is no change in bond type, such as in the reaction $\text{Hb} - e \rightleftharpoons \text{Hi}^+$, the appearance of the positive charge on the iron atom of the first heme oxidized may be transmitted to the second heme (cf. Section 8.2.) and may there facilitate the removal of the second electron and so on. Further speculation on this aspect of the interaction problem is, however, unprofitable in view of the relatively small number of systems so far analyzed. There would seem to be no great difficulty in accumulating more data on other systems.

8.2. Pathway of the Interaction

Although the concept of interaction between hemes has been of great assistance in the quantitative expression of many of the reactions of hemoglobin, there has been little discussion of the interaction pathway. We put forward the following speculations on the problem in order to stimulate further work. As a basis, the imidazole hypothesis of the heme-protein linkage is taken, but attempts are made to extend this to include those facts which this hypothesis cannot yet explain (*cf.* Section 3.2.2.4.).

In hemoglobin the hemes are assumed to be held between two imidazole groups, with the possibility that electrostatic bonds might also be present between the ionized carboxyl side chains of the porphyrin and basic $-\text{NH}_3^+$ or $-\text{OH}$ groups in the protein. The latter linkages would not be expected to transmit changes in the energy levels of the resonance system of the porphyrin to the protein on account of the aliphatic carbon chain between porphyrin ring and carboxyl group in the propionic acid side chains. The interaction therefore takes place via the iron-imidazole linkage. The imidazole rings, however, are separated from the mesh of peptide linkages in the protein by aliphatic chains, which must insulate the resonance system of the iron porphyrin with its two satellite imidazoles from the protein. One heme must therefore be able to influence another along some pathway which lies between these "insulating" linkages. The only positions free to take part in interaction between the hemes are the imidazole groups with their two dissociable protons. It has been shown above how the proton-escaping tendency from these groups is affected by changes in iron bonding when groups combine with the heme, and it has generally been assumed that interaction is absent between the heme-linked groups of adjacent hemes. It seems to us, on the contrary, that interaction must occur between adjacent heme-linked groups, if any reasonable explanation is to be given of heme-heme interaction as the sharing between adjacent hemes of the energy required to bring about the alterations occurring in the dissociation of protons which accompany changes in bond type. $RT \log \alpha$ must therefore always be less than the change in free energy which occurs when the first heme in the molecule reacts with oxygen. In the data from which Pauling developed his equation $RT \log \alpha$ was in fact less than the value of $RT \log \beta$, which he defined as the energy of interaction between a single heme and its heme-linked groups.

Since the distance separating one heme from another is of the order of 40 Å, the interaction pathway must be at least this length, and we suggest that it consists of a pattern of electrostatic bonds between the charged side chains of the protein and other adsorbed molecules. If, for example, the amino groups which bind carbon dioxide as carbamino compounds are situated on this pathway, it becomes possible to reconcile the influence of oxygenation on the bonding of carbon dioxide and vice versa without having carbon dioxide actually bound to the same group which dissociates a proton on oxygenation.

Further, it may be of significance for this hypothesis that the imidazoles binding the heme suffer opposite shifts in their pK values. Our view that facilitation of the proton dissociation on the oxygenation of one heme may facilitate the proton dissociation of a second heme would be explained if interaction took place between those imidazoles which dissociate in the opposite sense.

The following may serve as an example of the suggested form of interaction: One of the hemes combines with an oxygen molecule and the proton-escaping tendency of the imidazole groups is altered. The pK value of the dissociation from the distal group changes from 5.3 to 5.7. This is associated with a shift in the equilibrium position of the proton, which, we assume, may be transmitted along the chain of hydrogen bonds and electrostatic linkages to the proton of the proximal imidazole of heme number 2. The interaction will therefore increase the proton-escaping tendency of this group, since the pK value of the proximal imidazole shifts from 7.8 to 6.8 when covalent bonds are formed on combination with oxygen. The free energy required to bring this change about, when combination with oxygen actually occurs with the second heme, will thus be diminished. Similarly, the behavior of the proximal imidazole group when the first heme combines with oxygen, involving a repulsion of the proton, is transmitted to the distal imidazole of heme number 4, diminishing the energy required for the proton attraction which takes place with the shift in the pK value from 5.3 to 5.7 when the heme combines with oxygen.

This hypothesis is illustrated in Figure 13. Im H^+ represents the imidazole proton, $\overset{\leftarrow}{\text{Im H}^+}$ and $\overset{\rightarrow}{\text{Im H}^+}$ representing the decrease and increase respectively of the escaping tendency of the proton. The hemes are numbered and are represented by the symbol FeO_2 , while the distal and proximal imidazoles are distinguished by the distance they lie from the heme and the position of the oxygen molecule. The interaction pathways are shown by dotted lines and distinguished by the symbols F_{12} , F_{14} . . . F_{41} etc., where the direction of the interaction is given by the sequence of the subscript. When oxygen combines with heme 1, interaction occurs along the pathways F_{12} , F_{14} to hemes 2 and 4. A second oxygen molecule, combining at heme 2, now

interacts reciprocally along F_{21} with heme 1 and sets up F_{23} to heme 3. The combination of oxygen with heme 4 takes place when pathways F_{14} and F_{44} have already been established, but the reciprocal affects along F_{41} and F_{43}

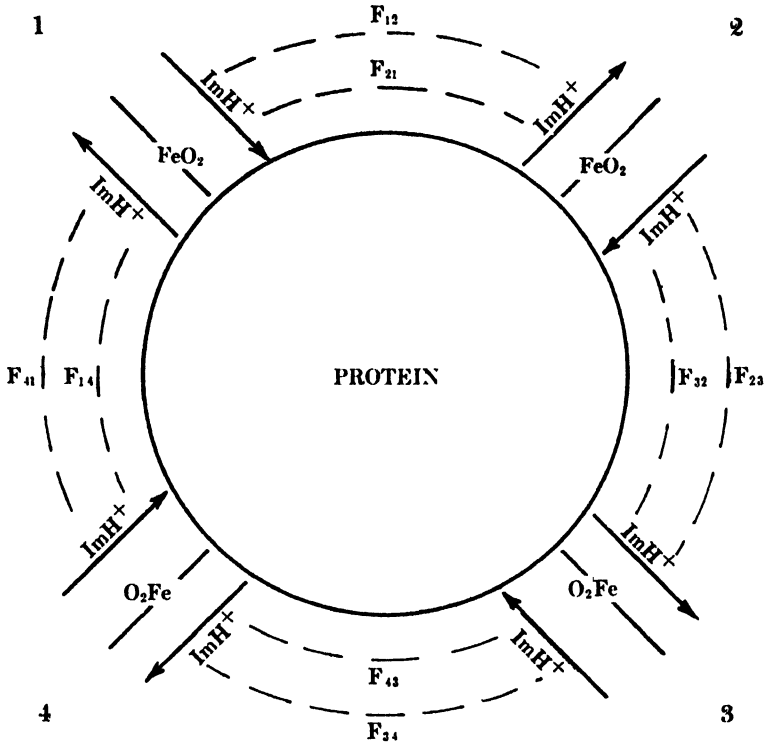

Fig. 13. Heme-heme interaction.

will lead to a further "settling in" of the oxygen molecule at 1 and 3. It may readily be seen that the result obtained is exactly the same as that obtained by Pauling when he first developed the concept of heme-heme interaction along the four sides of a square. If the interaction is formulated as taking place between both the imidazoles of heme 1 and both imidazoles of heme 2, interaction could only take place between pairs of hemes, since the transmission of the interaction could not be carried to the other hemes.

The transmission of a proton shift from one heme to another would be expected to be influenced by constitutional alterations in the molecule, and by the presence of anions bound to the protein. The effect which bicarbonate ion has on the oxygen affinity of hemoglobin, which is relatively greater than that shown by other ions, may be due to the fact that the resonating groups $O-C-O$ form part of the transmission mechanism. The heme-heme

interaction has also been assumed to be insensitive to changes in pH . If the transmission is carried along a chain of electrostatic linkages between $-\text{COO}^-$ and $-\text{NH}_3^+$, it should be unaffected between pH 4, where the carboxyl groups lose their proton, and pH 10, where the basic groups become uncharged. Hydrogen bond formation between one of the hydrogen atoms of the $-\text{NH}_3^+$ groups and two adjacent oxygen atoms might also be stable in this pH range, but such bifurcated hydrogen bonds are considered to occur only rarely (2125).

8.3. Hemoglobins of Different Molecular Weight

The reactions of myohemoglobin are of considerable importance for this hypothesis. So far, Kiese and Kaeske (1527) have been the only workers who have reported a reaction in which myohemoglobin departs from the behavior predicted for it by the Hüfner theory. Although inspection of their data reveals little reason for the sigmoid curve which they draw, a reinvestigation would be desirable.

Another problem is raised by the behavior of chlorocruorin. Fox (934) showed that its dissociation curve was sigmoid in shape and showed qualitatively the same type of pH sensitivity as does oxyhemoglobin. The molecular weight of chlorocruorin is of the order of three million, and the possibility exists of interaction between about two hundred hemes. In view of the dissociation of this pigment into smaller fragments (*cf.* Chapter VII) interaction may take place only between smaller groups of hemes. The scheme we have presented for the transmission of interaction is quite capable of extension to systems containing greater numbers of hemes than the four present in oxyhemoglobin. In this connection it is of interest that Ferry and Green (918) developed an empirical equation to describe the dissociation curve of oxyhemoglobin in which the affinity constant was related to the fraction of the hemoglobin combined with oxygen. Gaddum (964b) has also drawn attention to the use of the mathematical transformation known as the probit to describe the sigmoid dissociation curve of oxyhemoglobin. These approaches, depending, like the earlier Hill equation on the statistical behavior of a number of hemes may, perhaps, be capable of inclusion in a broader treatment of interaction between many hemes.

9. DETERMINATION OF HEMOGLOBIN

9.1. Estimation of Hemoglobin for Clinical Purposes

9.1.1. Specificity. Exact methods for determining oxyhemoglobin, carboxyhemoglobin, hemoglobin, sulfhemoglobin, and choleglobin in blood are available. A complete analysis involving all these procedures is laborious and requires special apparatus, such as a spectrophotometer, and hence cannot be applied for general routine purposes. As a rule, oxyhemoglobin forms so large a percentage of the total of all hemoglobin derivatives in aerated blood that its estimation will suffice for the clinical determination of total hemoglobin (*e.g.*, for gaging the intensity of an anemia). There are, however,

cases in which the content of hemoglobin and sulfhemoglobin cannot be neglected; these have recently increased in frequency due to the widespread use of sulfonamides and, in Australia, of phenacetin. In adopting a simple procedure of hemoglobin estimation to be recommended for general use, it must first be decided which of the above-mentioned pigments should be included under the term "hemoglobin."

The Medical Research Council Report of 1943 (1893) recommends as ideal methods which determine the sum of all the hemoglobin derivatives. In our opinion this is unjustified. Physiologically, the pigments fall into three classes: (1) Pigments able to function as oxygen carriers: hemoglobin, oxyhemoglobin. (2) Pigments unable to function, but reconvertible into functional hemoglobin: hemoglobin, carboxyhemoglobin. (3) Pigments unable to function, and not reconvertible to hemoglobins: sulfhemoglobin, choleglobin.

Obviously the third class should not be included in clinical hemoglobin analysis. According to whether the lack of hemoglobin is chronic or acute, the ideal method should give the sum of the pigments in the first two classes or of the first class only.

None of the methods in common use to-day fulfills either of these conditions and should therefore not be applied in cases in which the presence of much sulfhemoglobin is suspected without additional estimation of sulfhemoglobin. In describing various methods of hemoglobin estimation, we shall indicate which of the various hemoglobin derivatives are measured by the method in question.

9.1.2. Errors of Technique and Standardization. This lack of specificity is, however, only a minor weakness in hemoglobinometry; other defects are far more serious. In order of importance these are: the use of wrongly standardized instruments, incorrect sampling, lack of care for the instruments by poorly trained (though equally poorly paid) workers, failure to adhere to specified conditions (*e.g.*, with regard to illumination or timing), and, only in the last resort, the application of less exact methods.

A few examples may suffice: The fact that the acid hematin method has a variation of $\pm 5\%$ is of small significance, if individual hemoglobinometers vary $\pm 30\%$ in their standardization, if the pipets used for sampling are wrongly calibrated, the instrument dirty, the illumination varied from daylight to artificial light and if the prescribed timing is neglected. The fact that an error of 1 g. hemoglobin per 100 ml. blood (7%) in the standardization of British Haldane hemoglobinometers remained undetected for decades (1537, 1811) is a sad reflection on the state of clinical hemoglobinometry. This now explains why the "normal" English values were always far below those observed in the United States, Australia, and Germany.

The latter example emphasizes also the need for abandonment of the outmoded hemoglobin percentage scale. There is no unanimity on what

constitutes normal (100%) hemoglobin (with different hemoglobinometers 100% may mean anything between 13.8 and 17.3 g. hemoglobin per 100 ml.), and in any case this varies with sex and age. Values should, therefore, be given in grams hemoglobin per 100 ml. blood, not in per cent hemoglobin.

It is impossible and inadvisable to recommend one method of hemoglobinometry as ideal. The choice will depend a great deal on the availability of special apparatus and the training of the analyst (*cf.* here the remarks of Holden, 1317). Since diurnal variations in the hemoglobin content of one individual have been found, high precision is hardly needed in a method for clinical routine estimation. If carefully handled, a less exact method with simple apparatus may give more reliable results than one involving elaborate apparatus in the hands of a worker insufficiently trained in its use. It should be noted that cloudiness produces more serious errors in photoelectric and spectrophotometric estimations than in colorimetry, hence control measurements in a wavelength region of low absorption are advisable.

In order to improve clinical hemoglobinometry, the first task should be the standardization of all instruments by a laboratory particularly equipped for the purpose. Secondly, it should be recognized that hemoglobin estimation requires sound biochemical and physical training of the worker, as well as careful interpretation of the result by the doctor. Thirdly, there appears no reason why better, though somewhat more expensive, apparatus should not be used in this, one of the most commonly used and most badly neglected biochemical estimations. Exact estimations of hemoglobin and sulfhemoglobin, which are of importance in certain cases, cannot be carried out without such instruments. The hematologist should in any case have experience in spectroscopy and should be able to detect the presence of hemoglobin and sulfhemoglobin and to distinguish between them.

9.2. Manometric and Gasometric Methods

The manometric method is exact, but requires special apparatus and a good deal of experimental skill and is time consuming. It is therefore the ideal method for standardization of instruments or for research purposes rather than for clinical estimation. A simple microgasometric method, particularly suitable for the estimation of carboxyhemoglobin has been developed by Roughton and Scholander (2369,2370,2459). The manometric and gasometric methods have

been developed by van Slyke and are fully described in the book of Peters and van Slyke (2141).

The determinations of the oxygen capacity (*e.g.*, by the method of van Slyke and Neill (2531,2574) measure the sum of hemoglobin and oxyhemoglobin. In order to measure hemoglobin also, this must first be reduced to hemoglobin. Most reducers, however, interfere with the subsequent oxygen liberation by ferricyanide and only titanous tartrate has so far been shown to be applicable (480).

Determination of the carbon monoxide capacity without reduction give the sum of hemoglobin, oxyhemoglobin and sulfhemoglobin (2572). In the presence of dithionite (2573) hemoglobin, sulfhemoglobin, and choleglobin are also included (*cf.* Chapter X, Section 5.3.).

9.3. Spectrophotometric, Photoelectric, and Spectrocolorimetric Methods

These methods are little less exact than manometric methods. It is advisable, however, not to rely on the values of the extinction coefficient given in the literature, but to measure these under standard conditions with hemolyzed normal blood of a concentration known by manometric oxygen capacity determination. These methods require expensive apparatus, but the estimations are easy and rapid, and hence suitable for clinical use by well-trained workers. The particular advantage of spectrophotometry is its adaptability to a variety of problems, such as measuring the concentrations of hemoglobin, sulfhemoglobin, or carboxyhemoglobin in mixtures with oxyhemoglobin or even in more complex mixtures (*cf.* Section 9.6.). Clear solutions must be obtained and the absorption of the stroma is not entirely negligible, but even faint cloudiness can be detected by carrying out control measurements in regions in which the absorption of hemoglobin derivatives is small.

The direct spectrophotometric or photoelectric estimation of oxyhemoglobin in dilute hemolyzed blood is probably the best method for future clinical use. Practically clear solutions are easily obtained by the use of dilute ammonia (0.01 to 0.1%) or sodium carbonate (0.01 to 0.1%) as dilution liquid. 0.4% ammonia as suggested by some authors is less suitable (1878,2728). Phosphate buffer of pH 8 has been recommended (364). In our institute the measurement is carried out on a 1 : 100 dilution of blood in 0.01% sodium carbonate and the extinction is read at 576 m μ . This method has given results comparable in exactness with the manometric method, and similar

methods have been recommended by many other workers (206,376, 383,642;1213, p. 73; 1316,1517,2223,2425,2706,2728).

How large a proportion of hemoglobin and sulfhemoglobin are included in this estimation depends on the wavelength chosen for the analysis. At 520 $m\mu$ these two abnormal blood pigments have the same extinction coefficient as oxyhemoglobin (206). Calculation from their absorption curves shows that at 540 $m\mu$ 100% of the oxyhemoglobin, 50% of hemoglobin, and 65% of sulfhemoglobin would be measured, and at 576 $m\mu$ 100% of oxyhemoglobin, 33% of hemoglobin, and 55% of sulfhemoglobin.

The method is readily adaptable to use with photoelectric equipment. Provided filters are available with suitable transmission bands, any of the better quality commercial photoelectric colorimeters, or even simple ones of the Evelyn type, can with care be made to give satisfactory results. However, no permanent glass filter with maximum transmission in a narrow band corresponding to the α band of hemoglobin has yet been produced, most of those available having a rather broad transmission band in the 520 to 540 $m\mu$ region. Calibration is therefore on an empirical basis, and not necessarily linear. A decided improvement would be introduced by the production of a simple photoelectric spectrophotometer, using a fixed monochromator transmitting a 10 to 15 $m\mu$ band of center 576 $m\mu$; this would give greater specificity and sensitivity for oxyhemoglobin. As an alternative, a liquid filter transmitting in this region may be used with existing instruments; such a filter is obtained with saturated solutions of copper chloride in alcohol and cobaltous sulfate in water in separate 5-mm. vessels (393).

The sum of oxyhemoglobin and hemoglobin can be measured spectrophotometrically as hemoglobin cyanide (138,726,1947). Since the absorption curve of the compound does not depend on pH this is preferable to measuring the absorption of hemoglobin itself.

The first absorption band of pyridine hemochrome is so sharp that it lends itself well to the measurement of spectrophotometry, with pyridine hemochrome prepared from crystalline hemin as a standard. The method has been applied repeatedly for hematin estimation and has been recommended for hemoglobinometry by Rimington (2267).

It measures the sum of all hemoglobin derivatives, except choleglobin. It is simple, but not entirely reliable. Autoxidation of the dithionite produces hydrogen peroxide with consequent danger of oxidation of the hemochrome. This danger is avoided in the method of Lemberg and co-workers (1710) by saturation of the solution with carbon monoxide before conversion into denatured globin carbon monoxide hemochrome with dithionite and sodium hydroxide. This has been found more reliable than the transformation into pyridine hemochrome. The method measures the sum of all hemoglobin derivatives, including sulfhemoglobin, but not choleglobin. It can also be applied to measure the latter, by reading at 630 $m\mu$. The intensity of the

absorption band of pyridine hemochrome has been found rather variable (619,629), and various authors have reported different intensity ratios of the hemochrome absorption bands obtained from hemin and from hemoglobin by pyridine (*cf.* Section 2.2.4.).

An instrument for clinical use has been designed by Holiday, Kerridge, and Smith (1325), in which use is made of the Soret band of oxyhemoglobin. The spectral region from 380 $m\mu$ to 420 $m\mu$ is isolated by means of filters, and measurement is made by means of a potassium photocell. The method would include in the measurement hemoglobin and sulfhemoglobin, but not choleglobin.

9.4. Colorimetric Methods

While colorimetric methods are simple and cheap they are certainly less exact than those previously described. On account of the complicated absorption curves of most hemoglobin derivatives it is impossible to devise artificial standards of exactly the same color. One has therefore either to use solutions of hemoglobin derivatives such as carboxyhemoglobin as standards, or, in order to use artificial standards, the hemoglobin derivatives have to be transformed to hematin derivatives of less selective absorption. In the first method the stability of the standard is the weak point, and in the latter the weakness lies in the need for chemical reactions which are not yet perfectly understood (*cf.* Sections 2.4.2. and 2.4.3.) and which depend on external conditions.

The most commonly used method is the acid hematin method, in which hemoglobin is transformed to "acid hematin" by hydrochloric acid, and the brown color compared with that of a glass standard. It has been criticized by several authors (*cf.* 158,2169) for more than one reason. The solution is a colloidal one and the color development depends on time and temperature, the plasma exerts some influence, and the color varies with illumination. Nevertheless, although the method is not exact, it gives quite satisfactory results for clinical purposes, provided the conditions of color development and reading are carefully controlled.

Failure to maintain these conditions and the use of primitive and incorrectly standardized instruments and of the antiquated dilution method are far more frequently to blame for wrong results than the method itself. There is little excuse for this sloppy technique. As early as 1919 Newcomer (2048) developed a satisfactory color disk for use in a colorimeter and defined the conditions of color development. Recently a nomogram has been devised (207) for correcting readings at various times after the addition of the acid and at various temperatures to the value obtained after sixty minutes at

40° C. The sum of hemoglobin derivatives including sulfhemoglobin is determined.

It is doubtful whether the alkaline hematin method recently recommended (1536) is preferable to the acid hematin method. Since the method involves heating, it is less simple to carry out than the acid hematin method and in addition the color is weaker. The advisability of using hemin for standardization is open to question since the absorption spectrum of the alkaline hematin from hemoglobin differs from that of an alkaline hematin solution (*cf.* Section 2.4.2.). The use of this standard has also been found unsatisfactory by Gibson and Harrison (994), who devised an artificial standard composed of cobaltous sulfate, potassium bichromate, and chromium potassium sulfate. Horecker (1345), however, has recently suggested a method whereby the difficulties involved in using hemin as a standard can be overcome. (*cf.* also 1320a, 1534a).

The colorimetric estimation of carboxyhemoglobin (Haldane method) has been worked out as a British standard method. The Medical Research Council Report of 1943 (1893) has recommended this method, and a standard hemoglobinometer has been designed. A careful reading of the report, however, should convince everyone that the method is far from satisfactory. Quite apart from the fact that the stability of the carboxyhemoglobin solution is open to question, amazingly large errors were found, mainly due to faulty matching. While some of these errors were certainly due to avoidable faults, it has still to be shown that the method is superior to the acid hematin method. It has recently been shown that variation of the intensity of the light used for comparison exerts a marked influence on the exactness of the method, the smallest percentage of errors being obtained at from 5 to 10 foot candles (635). The carboxyhemoglobin method measures only part of any hemoglobin and sulfhemoglobin present.

The hemoglobin cyanide method is also applicable to the colorimeter (467). Hemin may be used for the preparation of the standard.

9.5. Other Methods and Estimation of Hemoglobin in Plasma, Urine, and Tissues

The estimation of total iron has frequently been used for hemoglobin determination in blood. There is, however, little doubt that blood contains some nonhemoglobin iron, although the amount of this is still a matter of controversy (*cf.* Chapter X, Section 5.2.). Plasma iron forms only a small part of this, far more nonhemoglobin iron being contained in the erythrocyte. While in normal blood the difference between total iron and hemoglobin iron is probably not significant, the values can be very different in pathological blood; here differences up to 50% have been observed. Sulfhemoglobin and choleglobin are, of course, also estimated as hemoglobin by this method.

While the determination of iron can be very exact in the hands of an experienced analyst, it is by no means simple and is time consuming. The great divergences in the findings of different authors for the differences between total iron and hemoglobin iron in normal blood (0-8%) raises serious doubts as to whether all investigators have been able to carry out correct

iron analyses. There is little to recommend this analysis for a routine estimation of hemoglobin.

The density of blood can be readily measured by the copper sulfate method; while this method is useful for screening blood donors and the discovery of anemia (326,1380), it cannot be used for the accurate estimation of hemoglobin (*cf.* 2169).

A determination of hemoglobin based on its peroxidative action on benzidine has been worked out (176,1274,1815). This method is probably more useful for measuring the small amounts of hemoglobin present in plasma, urine, or feces than for estimation of blood hemoglobin. For the former purpose, a photoelectric method measuring hemoglobin derivatives as pyridine hemochrome with a filter with maximum transmission at 550 $m\mu$ has been developed by Flink and Watson (909). Their use of blanks in which the hemochrome is destroyed by hydrogen peroxide can hardly be recommended, nor does the modification of this method by Greenberg and Erickson (1049) appear to be adequate. The turbidity of the solutions or extracts causes a difficulty which Lowry and Hastings (1782) have tried to overcome by subtraction, assuming that absorption of light due to turbidity increases linearly with decreasing wavelength; Cohn (463) measured changes in the light absorption produced by the conversion of oxyhemoglobin into hemoglobin or of hemoglobin into hemoglobin cyanide. The latter method presupposes that the degree of cloudiness is not altered by the reagents. It is therefore preferable to use methods in which the solutions are cleared before measurement, either by half saturation with ammonium sulfate (1544) or by sodium hydroxide (*cf.* the carbon monoxide hemochrome method of Lemberg and co-workers described above).

9.6. Special Estimations

Carboxyhemoglobin in mixture with oxyhemoglobin can be determined by measuring the positions of the α band in the Hartridge reversion spectroscopie (1143), or spectrophotometrically by measuring the ratio $\epsilon_{576\ m\mu} / \epsilon_{560\ m\mu}$ (1213, p. 91), this ratio being 1.72 for oxyhemoglobin and 0.875 for carboxyhemoglobin. Whether carboxyhemoglobin is the only accompanying pigment can be checked by the estimation of other absorption ratios such as $\epsilon_{555\ m\mu} / \epsilon_{568\ m\mu}$ in the reduced solution.

For the estimation of hemoglobin in the presence of oxyhemoglobin, Heilmeyer (1213, p. 103) uses the ratio $\epsilon_{576\ m\mu} / \epsilon_{590\ m\mu}$ in 0.4% ammonia. Since at 580 $m\mu$ the curve of oxyhemoglobin falls steeply, the ratio $\epsilon_{576\ m\mu} / \epsilon_{600\ m\mu}$ would probably be better. As an alternative the ratio $\epsilon_{575\ m\mu} / \epsilon_{560\ m\mu}$ after conversion of hemoglobin to hemoglobin cyanide may be determined.

Sulfhemoglobin and hemoglobin are measured spectrophotometrically (726) by determining the total pigments as hemoglobin cyanide

at $\epsilon_{540 \text{ m}\mu}$, with a small correction for the sulfhemoglobin not converted to this compound and having a slightly lower absorption at $540 \text{ m}\mu$. Hemoglobin is measured by the decrease of $\epsilon_{695 \text{ m}\mu}$ in phosphate buffer of pH 6.6 caused by the addition of cyanide. For modifications of this method see (138,1947).

In addition to methods using the visible region of the spectrum, a method of determination of total hemoglobin, oxyhemoglobin, hemoglobin, and carboxyhemoglobin has been published by Horecker (1343), in which the absorption of these compounds in the near infrared is utilized. The initial method (1346) was designed for the more elaborate type of photoelectric spectrophotometer, but a simplified type of instrument using filters has recently been described (57), suitable for use in clinical work. From the absorption spectra of the compounds (Section 2.5.) it may be seen that two measurements in the region 8000–10,000 Å, one before and one after the addition of cyanide, will give the concentration of hemoglobin. For determination of oxy- and carboxyhemoglobin a third reading suffices. In the original method this was made on the diluted solution, reading at 4965 Å; in the later method the compounds were converted to acid hematin and the absorption read in the same infrared region as before. While the method offers a comparatively simple means of estimating three hemoglobin derivatives on the same blood sample, it does not appear to have any advantage over reading in the visible region when only oxyhemoglobin is required.

CHAPTER VII

COMPARATIVE BIOCHEMISTRY OF HEMOGLOBINS

1. INTRODUCTION

In the previous chapter our attention has been chiefly directed toward building up a physicochemical picture of the structure and reactions of an idealized hemoglobin. The biological origin of the hemoglobin was considered only if it assisted in this task. In the present chapter, we propose to adopt the reverse procedure. Our knowledge of the structure and reactions of the idealized hemoglobin will be used as a basis for the critical consideration of individual differences.

In discussing hemoglobin, we distinguished between the respective influence of environmental and constitutional factors in its affinity for oxygen. It is convenient to retain a similar distinction when examining different hemoglobins. The crystal form, spectrum, oxygen affinity, and perhaps molecular weight, may be influenced by the treatment the pigment has received during extraction, as well as by the environment in which the observations are made. On the other hand, the structure of the prosthetic group or the amino acid composition of the protein are not subject to adventitious alterations and, together with the origins of the hemoglobins, provide a far more certain basis for classification.

Up to this point, our discussion of hematin compounds has proceeded from the point of view of structural and physical chemistry. The present chapter marks a shift in emphasis toward a more biological point of view, when we discuss the functional role played by the class of hemoglobins in living organisms. We do not attempt, at this juncture, to consider in detail the mode of evolution of hemoglobin, or the evolutionary importance of its functions.

2. BIOLOGICAL DISTRIBUTION

In this chapter we define hemoglobins as a class of ferroporphyrin protein compounds, able to combine reversibly with oxygen without oxidation of the iron to ferric. Hemoglobin was formerly thought to be synthesized only by the members of the animal kingdom, but recent work has shown that this is not so. In 1939, Kubo (1589) observed a hemoglobin-like compound in root nodules. This has been investigated by Burris and Haas (384), Keilin and Wang (1503), and by Virtanen and co-workers (2890,2891), and there is no doubt that it is a true hemoglobin; its relative affinity for carbon monoxide and oxygen, $K = 37$, is of the order of that found for myohemoglobin. The pigment is the product of symbiosis, since it is not found in pure cultures of *Rhizobium* or in the roots of the *Leguminosae* in the absence of nodule formation. Its function in nitrogen fixation is not discussed further in this chapter (cf. however Chapters IX and XIV).

Hemoglobin is distributed among a number of phyla in the animal kingdom, becoming increasingly important in the more highly evolved phyla. In these, the pigment is found as myohemoglobin in red muscle and as hemoglobin in erythrocytes. In the more primitive vertebrates, the heart muscle is practically the only muscle containing myohemoglobin. In none of the vertebrates is hemoglobin normally found free in the blood.

In the invertebrates, the presence of hemoglobin in muscle seems to be rare; so far it has been reported in only a few species (125,2206). In *Gastrophilus* larvae the pigment is found in special cells known as tracheal cells, which probably originate from fat-body cells (cf. for example 1503a). A variation is found in the circulatory system, in that hemoglobin is sometimes found in corpuscles and sometimes in physical solution like hemocyanin.

In 1839, Milne-Edwards (1956) first drew attention to the green blood of certain polychetes. The pigment was subsequently investigated by Lankester (1646) in the 1860's and by Krukenberg (1585) and MacMunn (1840) in the 1880's. Lankester named the pigment chlorocruorin. Although Sorby (2596) in 1876 first observed that the spectrum of the red invertebrate hemoglobin differed from that of mammalian hemoglobin, it was not until Svedberg (2708,2713-2715) investigated the physical properties of these pigments in the 1930's that their protein was shown to differ from mammalian globin. He revived the name erythrocrurins, first proposed in 1870 by Ray Lankester (1646), who subsequently dropped it in favor of invertebrate hemoglobin.

Table I shows the general distribution of hemoglobins throughout the animal kingdom. It can be seen that throughout the phyla the oxygen carrier may be found in a number of different tissues. The synthesis of the extracellular pigment takes place of course in certain cells: data referring to the annelids, for example, may be found in Stephenson's monograph (2630). While it may be convenient to qualify reference to the erythrocrurins by using the terms "intracellular" and "extracellular," the latter class have a large molecule which may well create a "microenvironment" similar to that found surrounding the intracellular pigments (cf. Section 7).

Some workers (1280,1483) still prefer to use the term "invertebrate

TABLE I
Biological Distribution of Hemoglobins

| Phylum | Pigment | Examples |
|-----------------------------|-------------------------------------------------------------------------------|--------------------------------------------------------------------------------------------------------------------------------------------------------------------------------------------------------------------------------------------------------------------------------------------------|
| Protozoans | Hemoglobin in cytoplasm. | Ciliate paramecia |
| Nematodes | Erythrocruorin in body cavity Myohemoglobin in body wall | Several species of <i>Ascaris</i> , intestinal parasitic worm in mammals. Two pigments different in character |
| Annelids | Erythrocruorin in plasma Erythrocruorin Chlorocruorin in plasma | Scattered throughout phylum, e.g., <i>Arenicola</i> , the lug worm, or <i>Lumbricus</i> , the earth worm Several species of order <i>Polychaeta</i> , e.g., <i>Glycera</i> , the blood worm Several species of order <i>Polychaeta</i> , e.g., <i>Spirographis</i> , a marine worm |
| Arthropods Crustaceans | Erythrocruorin in plasma | Found in several species, e.g., <i>Daphnia</i> , water flea, class <i>Branchiopoda</i> and, e.g., <i>Ernoecera</i> , parasite in fish, class <i>Copepoda</i> |
| Insects | Erythrocruorin in plasma | <i>Chironomus</i> , midges (order <i>Diptera</i>) |
| Molluscs | Erythrocruorin in plasma Erythrocruorin in corpuscles Myohemoglobin | <i>Planorbis</i> , fresh water snail (order <i>Gastropoda</i>) <i>Arca</i> , a mussel (order <i>Lamellibranchiata</i>) <i>Busycon</i> , a whelk (order <i>Gastropoda</i>) Pigment in heart and radula muscles (hemocyanin in circulation) |
| Echinoderms | Erythrocruorin | <i>Thyone</i> , sea slug (class <i>Holothuroidea</i>) |
| Chordates Protochordates | ? | So far, neither hemoglobin nor myohemoglobin reported present in members of this subphylum. Redfield (1922) reports absence of hemoglobin in <i>Amphioxus</i> |
| Vertebrates | Hemoglobin in corpuscles Myohemoglobin | Present throughout, including <i>Lampetra</i> (suborder <i>Cyclostomata</i>) Probably present throughout in lower orders, e.g., <i>Pisces</i> , <i>Amphibia</i> , and <i>Reptilia</i> , mostly in heart muscle |

hemoglobin" rather than erythrocrucorin. At the present time, however, the nomenclature of the oxygen carriers is becoming increasingly complicated from the point of view of phylogenetic origin; Virtanen and Laine (1931) suggest the term "leghemoglobin" for the root nodule pigment. There are in addition, certain chemical reasons which reinforce the desirability of revising the phylogenetic nomenclature. Pending such a revision, we shall use the term erythrocrucorin. Where we discuss the ferric derivatives of these pigments, we use the term ferrierythrocrucorin for metaerythrocrucorin, the ferric form of the native pigment (*cf.* Chapter VI).

3. CHEMICAL BASIS OF SPECTROSCOPIC DIFFERENCES

3.1. Classification

The diversity of hemoglobins in the animal kingdom was brought to light by spectroscopic methods. The spectrum depends on the derivative examined, on the structure of the prosthetic group, on the influence exerted by the protein, and perhaps on environmental factors. The influence of the different prosthetic groups is far greater than the influence of a different protein. If two pigments carry the same prosthetic group, the spectroscopic differences between them are almost abolished when the protein is denatured. A differentiation into green and red oxygen carriers, based on the prosthetic group, was soon recognized. The former class comprises the chlorocrucorins, the latter, the erythrocrucorins and hemoglobins. The variations between the spectra of chlorocrucorin from different species and between the spectra of the different members of the class of erythrocrucorins and hemoglobins are not greater than would be expected from variations in the protein.

3.2. Chlorocrucorin

Although the character of the spectrum of this compound is quite different from that of hemoglobin, the changes observed when different derivatives are formed, are familiar. It is capable of reversible oxygenation, it can form a ferrichlorocrucorin (metachlorocrucorin) and it forms hemochromes which can readily be distinguished from those containing protohematin. Table II summarizes Fox's observations (1931) on the spectroscopy of chlorocrucorin, the band position being measured with a Zeiss microspectroscope and in the case of oxychlorocrucorin and ferrochlorocrucorin, by spectrophotometry.

The porphyrin of the prosthetic group of chlorocrucorin is called

Spirographis porphyrin. Its structure has been fully elucidated by the work of Warburg (2954,2957), Fischer (880), and their co-workers. It is a type IX porphyrin, differing from protoporphyrin in that one vinyl group is replaced by formyl (*cf.* Chapter III).

TABLE II
Spectra of Chlorocruorin Derivatives^a

| Derivative ^b | Band position, m μ ^c |
|-------------------------|-------------------------------------|
| ChO ₂ | 604, 560 |
| ChCO | 600, 557 |
| Ch | 574 |
| Ch hemochrome | 569, 533 |
| CN-Ch hemochrome | 573, 538 |
| Ch ⁺ | 604, 569 |
| ChOH | Does not exist (?) |

^a According to Fox (931).

^b Ch = chlorocruorin; Ch⁺ = ferrichlorocruorin; and ChOH = ferrichlorocruorin hydroxide (alkaline metachlorocruorin).

^c The strongest bands are italicized.

3.3. Erythrocrucorin

The spectrum of the erythrocrucorins is similar in character to that of the hemoglobins, the difference in band position being attributed to the proteins. Salomon (2423) has prepared mesoporphyrin IX from the intracellular erythrocrucorin of *Glycera* while Kirmann (1539) has shown that the prosthetic group of the pigment from *Chironomus* is also type IX.

The erythrocrucorins differ from the hemoglobins in at least two reactions involving the prosthetic group. Vlès (2895) has shown spectroscopically that the acid and alkaline forms of the oxidized pigment, ferrierythrocrucorin and ferrierythrocrucorin hydroxide, resemble acid and alkaline hematins, rather than hemoglobin and hemoglobin hydroxide; while Salomon found that *Lumbricus* erythrocrucorin was unable to undergo a coupled oxidation with ascorbic acid in the same way as does hemoglobin (*cf.* Chapter X).

3.4. Hemoglobin and Myohemoglobin

So far, type IX protohemin is the only one prepared from mammalian hemoglobin, and up to the present time no one has reported spectra from the blood of any of the vertebrate species which would

suggest differences in the structure of the prosthetic group. Schönheimer's demonstration that the prosthetic group of myohemoglobin is a type IX protohematin (2457) enables us to say that, in all types of hemoglobin so far examined, only one arrangement of the side chains has been observed, and that, in only one case, that of *Spirographis* hemin, is there a difference in the composition of any of the side chains.

3.5. Influence of Protein on the Spectrum

Small differences have been observed in the position of the absorption bands of the oxyhemoglobins of various species. These differences disappear

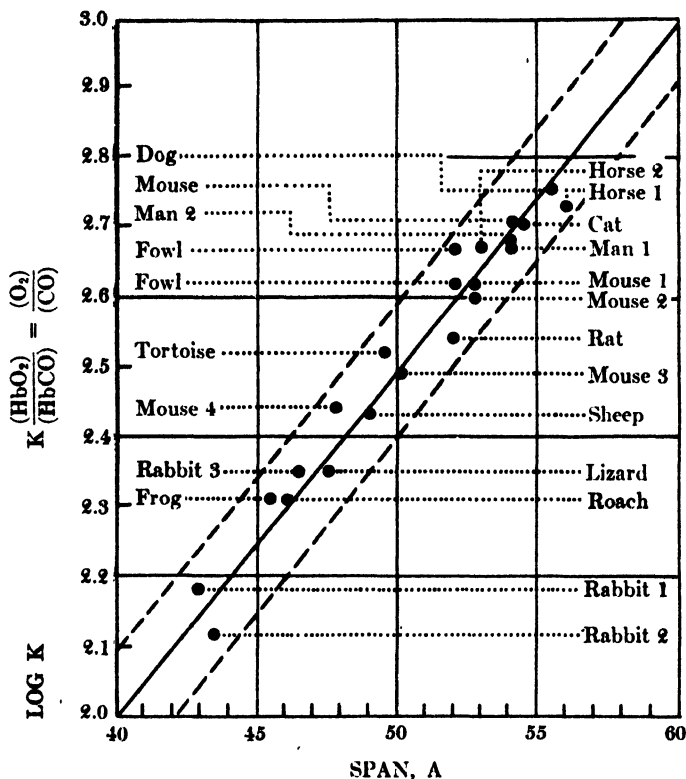

Fig. 1. Relation of log K to the span (after Anson, Barcroft, *et al.*, 64).

on denaturation of the globin and are no longer found in the denatured globin hemochromes. Barcroft's school (64,141) has related the shift in the band, when oxyhemoglobin is transformed into carboxyhemoglobin, to the

relative affinity of the pigments for oxygen and carbon monoxide. In the samples of hemoglobin they used, an approximately linear relationship was found between $\log K$ (K being the coefficient of partition between oxygen and carbon monoxide) and the "span" or shift in wavelength of the absorption band. Figure 1 shows the relationship between these two quantities in a number of different hemoglobins. Extension of the measurements to myohemoglobin by Roche (2321a) and Theorell (2761) showed that the point for myohemoglobin lies in the straight line given in Figure 1. The generality of the relationship has, however, been destroyed by the recent work of Keilin and Wang (1503a) on the hemoglobin of root nodules and of the tracheal cells of *Gastrophilus*. The latter pigment has a greater affinity for oxygen than for carbon monoxide.

4. MOLECULAR WEIGHT CLASSES OF RESPIRATORY PIGMENT

4.1. Classification

The comprehensive investigations of respiratory pigments carried out with the ultracentrifuge by Svedberg and co-workers (2711,2721) have shown a more complicated differentiation on the basis of molecular weight than have spectroscopic observations. In the main, these have been determinations of sedimentation velocity and in only a few cases has the sedimentation equilibrium been measured. This is probably due to the fact that the former requires only one milliliter of solution and can be used when several species of molecules are present in the solution, while the accurate determination of the sedimentation equilibrium requires purification which may be difficult with the invertebrate hemoglobins.

We will divide the respiratory pigments into two main classes, those which are contained within an erythrocyte and those which are found free in the vascular system. In the latter class are included chlorocruorin and a number of erythrochruorins. This step is further justified by the difference in isoelectric point found between intracellular and extracellular invertebrate pigments.

4.2. Extracellular Oxygen Carriers

Table III shows the distribution of the extracellular invertebrate oxygen carriers, grouped according to the values found for the sedimentation constants. They are compared with the value Svedberg and Hedenius derive (2717,2721) by assuming that the oxygen carriers are composed of a number of subunits containing one heme per

equivalent weight of approximately 17,000. This point is discussed further in Section 4.4.

TABLE III
Extracellular Oxygen Carriers

| Pigment ^a | Phylum ^b | $S_{20} \times 10^{13}$ range found | Mol. wt. range found ^c | Approx. no. of Hufner units | Calculated mol. wt. |
|----------------------|-------------------------|----------------------------------------|--------------------------------------|--------------------------------|------------------------|
| Ec and Ch | Annelids, 13 species | 53-63 | 3,000,000 3,040,000 | 192 | 3,360,000 |
| Ec | Arthropods 2 species | 2.0 | 31,400 | 2 | 34,500 |
| Ec | Molluscs | 34-36 | 1,500,000 | 96 | 1,680,000 |

^a Ec = erythrocrucorin, Ch = chlorocruorin.

^b Actual species investigated may be found in reference 2721, p. 360.

^c Mol. wt. inserted when diffusion constant or sedimentation equilibrium was measured.

4.3. Intracellular Oxygen Carriers

In Table IV the data from vertebrates and invertebrates are combined. As in the case of the extracellular respiratory pigments, we compare the weight distribution with that calculated by assuming that each pigment is composed of a number of subunits.

4.4. Dissociation of Erythrocrucorins

Svedberg and Erikson-Quensel (2714, cf. 2711) showed that certain of the erythrocrucorins of high molecular weight dissociated into smaller particles outside certain pH limits. Between pH 0.7 and 2.0 three components of the erythrocrucorin of *Planorbis* are found with molecular weights which are one-half, one-quarter, and one-sixth of that found between pH 2 and pH 8 (2721, p. 361).

The intracellular, low molecular weight pigment from *Petromyzon*, one of the *Cyclostomata*, behaves differently. Between pH 4 and pH 10 the sedimentation constant is 1.87×10^{-13} while outside these limits it commences to aggregate to larger particles.

4.5. Physiological Implication of Particle Size

There is a very striking difference between the range of molecular weights found among the intracellular and extracellular pigments. The ability of the extracellular invertebrate pigments to form large aggregates has been considered an adaptation which increases oxygen capacity without at the same time bringing in its train an undesirably high osmotic pressure in the plasma (cf., however, Roche and Chouaiech, 2310). The evolution of the

TABLE IV
Intracellular Oxygen Carriers

| Pigment ^a | Phylum ^b | $S_{20} \times 10^{13}$ | Mol. wt. range found ^c | Approx. no. of Hühner units | Calculated mol. wt. |
|----------------------|----------------------------------------------------------------|-------------------------|-----------------------------------|-----------------------------|---------------------|
| Ec | Annelids 2 species | 2.1 to 3.5 | 36,400 | 2 | 34,500 |
| Ec | Molluscs 1 species | 3.5 | 33,600 | 2 | 34,500 |
| Ec | Chordates Cyclostomes | 1.9 to 2.3 | 19,100-23,100 | 1 | 17,250 |
| Hb | Amphibia 4 species ^d | 4.5 to 4.8 | (68,000) | 4 | 69,000 |
| | | 7.0 to 7.7 | (150,000) | 8 | 138,000 |
| | | 12.5 | (290,000) | 16 | 280,000 |
| Hb | Reptiles 5 species ^d | 4.5 to 4.8 | (68,000) | 4 | 69,000 |
| | | 7.0 to 7.1 | (150,000) | 8 | 138,000 |
| Hb | Fish 12 species | 4.1 to 4.5 | (68,000) | 4 | 69,000 |
| Hb | Birds 7 species | 4.2 to 4.4 | (68,000) | 4 | 69,000 |
| Hb | Mammals 7 species Horse ^d Man ^d | 4.0 to 4.5 | (68,000) | 4 | 69,000 |
| | | 4.41 | 68,000 | 4 | 69,000 |
| | | 6.3 ^e | ? | | |
| | | 4.48 | 68,000 | 4 | 69,000 |
| | | 6.9 ^e | (150,000) | 8 | 138,000 |
| MHb | Mammals ^d | 2.0 | 17,500 | 1 | 17,250 |
| | | 4.0 | | | |

^a Ec = erythrocrurin, Hb = hemoglobin, MHb = myohemoglobin.

^b Actual species investigated may be found in reference 2721, pp. 357, 358, 360.

^c Mol. wt. inserted where diffusion constant or sedimentation equilibrium was measured.

Values given in brackets are those chosen from data on other proteins by Svedberg and Pedersen (2721, p. 362) as estimates of the molecular weight of the oxygen carrier where its sedimentation equilibrium has not yet been measured.

^d Where a species may contain several components with different sedimentation velocity constants, the range is that found within the order or genus for each component.

^e Data on the slower sedimenting components of horse and human hemoglobins have been obtained by Svedberg and co-workers, but are as yet unpublished, except in reference 2721.

Notes: The hemoglobin in the tracheal cells of *Gastrophilus* larvae has a molecular weight of about 34,000 (9a).

erythrocyte, with its high specific permeability, enables the development of high oxygen capacities without interfering with the osmotic pressure within the circulation. Parallel with this, we see the disappearance of respiratory proteins of large molecular weight.

5. PROTEIN DIFFERENCES

5.1. Isoelectric Points

This is the only other property investigated as systematically as the molecular weight distribution and the type of prosthetic group (2708, cf. also references in 2721). The division of the respiratory pigments in Table V on the basis of their isoelectric point corresponds roughly with the division into high and low molecular weight classes (2721).

TABLE V
Isoelectric Points^a

| Site of pigment | Phylum ^b | No. of Hufner units | Pigment | Isoelectric point | |
|-----------------|---------------------|---------------------|----------|-------------------|--------------|
| Extracellular | Annelids (6) | 192 | Ec Ch | 4.56 to 5.28 | |
| | Molluscs (1) | 96 | Ec | 4.77 | |
| | Arthropods (1) | 2 | Ec | 5.40 | |
| Intracellular | Annelids (1) | 2 | Ec | 6.0 | |
| | Molluscs (1) | 2 | Ec | Between 5 and 6 | |
| | Echinoderms (1) | 1 | Ec | 5.8 | |
| | Chordates | | | | |
| | | Cyclostomes (1) | 1 | Ec | 5.6 |
| | | Reptiles (1) | 4 | HbCO | 7.43 |
| | | Fish (4) | 4 | HbCO | 5.75 to 7.45 |
| | | Birds (4) | 4 | HbCO | 7.23 to 7.51 |
| | | Mammals (7) | 4 | HbCO | 6.9 to 7.5 |

^a With the exception of the isoelectric point of chlorocruorin (2301) the values are taken from those tabulated by Svedberg and Pedersen (2721, pp. 357, 358, 360).

^b Number of species examined given in parentheses.

It can be seen that the isoelectric points of the extracellular erythrocruorins so far examined lie in the range 4.56 to 5.4. The intracellular erythrocruorins fall in a somewhat higher range, 5.6 to 6.0, while, with the exception of one species, the isoelectric points of the carbon monoxide hemoglobins are in the region of 6.4 to 7.5. The distribution of isoelectric points found is not of much interest by itself, but corresponds to the phylogenetic differences found in amino acid composition.

5.2. Amino Acid Analysis

5.2.1. Invertebrate Oxygen Carriers. Detailed analysis of the amino acid composition of proteins is a task which is far more laborious than the determination of an isoelectric point or of the molecular weight of protein. For this reason, the data available for the amino acid composition of the different classes of respiratory pigments refer to a relatively small number of species.

TABLE VI
Percentage Amino Acid Content of Oxygen Carriers
of Some Invertebrates and the Horse

| Amino acid | Species ^a | | | | | |
|-------------|----------------------------|----------------------------|-------------------------------|--------------------------|-----------------------------|-----------------|
| | <i>Lumbricus</i> Ec (e) | <i>Arenicola</i> Ec (e) | <i>Spyrographus</i> Ch (e) | <i>Glycera</i> Ec (i) | <i>Petromyzon</i> Ec (i) | Horse Hb (i) |
| Arginine | 10.1 | 10.0 | 9.6 | 9.6 | 3.5 | 3.44 |
| Histidine | 4.7 | 4.1 | 2.4 | 5.4 | 3.4 | 7.82 |
| Lysine | 1.7 | 1.8 | 3.6 | 4.9 | 7.5 | 8.44 |
| Leucine | | 9.7 | | | | 19.15 |
| Valine | | 6.7 | | | | 9.74 |
| Tyrosine | 3.5 | 2.5 | 4.6 | | | 3.25 |
| Tryptophane | 4.4 | 1.6 | 4.5 | | | 2.3 |
| Cystine | 1.5 | 4.1 | 1.6 | 3.4 | 4.4 | 0.74 |

^a Ec = erythrocrurin, Ch = chlorocrurin. (e) = extracellular, (i) = intracellular.

So far Roche and co-workers (2313,2318,2319) have published the only amino acid analyses for the invertebrate pigments. These are given in Table VI, and for comparison data from the same laboratory for analyses on the erythrocrurin of *Petromyzon* and horse hemoglobin are included.

There is no doubt that as a class the invertebrate pigments differ considerably from horse hemoglobin while the pigment from *Petromyzon* stands between. Chlorocrurin has the lowest histidine content of any of the pigments so far examined. Since Fox (935) has shown that this pigment has the same iron content as has mammalian hemoglobin, the molar ratio of histidine to heme is 2.6. If heme-heme interaction takes place in the invertebrate pigments according to the hypothesis described in the previous chapter, and at least two mols of histidine per heme are required, this condition is fulfilled in chlorocrurin. In view of the incompleteness of the amino acid analyses of the invertebrate pigments it is difficult to give a satis-

factory explanation for the isoelectric points in the neighborhood of pH 4.5 to 5.3 found for these pigments. No data comparable to the acid-base titration figures obtained by Cohn and co-workers (462) for carboxyhemoglobin are available for the invertebrate pigments.

5.2.2. Vertebrate Oxygen Carriers. Recent work on the amino acid composition of the hemoglobins has been stimulated by the various theories of protein structure and by interest in the comparative biochemistry of the proteins. We are primarily interested here in the dependence of the reaction of hemoglobins on their amino acid content and in the essential nutritional character of certain amino acids for globin synthesis in some species. Most of the work

TABLE VII
Amino Acid Content of Vertebrate Oxygen Carriers

| Amino acid | Per cent in horse Hb | Ref. | Range found in other species, ^a per cent | Ref. |
|----------------|----------------------|------|-----------------------------------------------------|--------------------------------------|
| Arginine | 3.71 | 433a | 3.1 to 4.2 (r,g,p,d,s,o,m) | 244, 292, 434, 921, 2319, 2876, 2879 |
| Histidine | 8.45 | 433a | 7.4 to 8.6 (r,g,p,d,s,o,m) | 244, 292, 2319, 2879 |
| Lysine | 8.10 | 2881 | 8.0 to 9.2 (r,g,p,d,s,o,m) | 244, 292, 921, 2319 |
| Tyrosine | 3.15 | 912 | 2.1 to 3.7 (r,g,p,d,s,o,m) | 292, 921, 2319 |
| Tryptophane | 1.28 | 912 | 1.0 to 3.0 (r,g,p,d,s,o,m) | 292, 2319 |
| Phenylalanine | 6.68 | 433a | 6.8 to 7.8 (s,o) | 292 |
| Proline | (2.1 ox) | 244 | | |
| Hydroxyproline | (1.0 ox) | 1520 | | |
| Serine | 5.19 | 433a | | |
| Leucine | 15.1 | 921 | 7.3 to 24.7 (r,p,d,s,o,m) | 2321 |
| Isoleucine | 1.5 | 293 | 0.5 (m) | 32 |
| Valine | 8.85 | 433a | 3.4 to 10.1 (r,p,d,s,o,m) | 2321 |
| Alanine | 7.6 | 1520 | | |
| Glycine | 5.6 | 921 | | |
| Threonine | 3.82 | 433a | | |
| Cystine | 0.82 | 196 | 0.37 to 1.17 (p,d,s,o,m) | 196, 280 |
| Methionine | 0.72 | 196 | 0.27 to 1.19 (p,d,s,o,m) | 280, 462 |
| Aspartic acid | 10.3 | 921 | 8.0 (o) | 434 |
| Glutamic acid | 8.5 | 921 | 5.8 (o) | 434 |
| Amide nitrogen | 1.01 | 2877 | | |

^a Abbreviations are: r = rabbit, g = guinea pig, p = pig; d = dog, s = sheep, o = ox,

on the latter has been carried out with species (*e.g.*, rat and dog) whose hemoglobins have not received much attention.

Horse hemoglobin has been one of the most thoroughly analyzed proteins and, in Table VII, we compare the data in other species with the values found in this protein.

In view of the paucity of experimental data, detailed discussion of generic differences is impossible, although a better comparison may now be made with the invertebrate pigments. Their arginine, histidine, and lysine contents are seen to be far outside the range of generic variation in the highest phylum. In addition, the different annelid pigments vary much more than do the different vertebrate pigments. At one time Block (291,292) claimed that the ratio iron:histidine:lysine:arginine was 1:3:8:9 in the hemoglobins of horse, ox, sheep, and dog. Subsequent work (*cf.* Vickery, 2877) has indicated that this ratio can only be considered approximate; the arginine content of horse hemoglobin, for example, is nearer fourteen molecules per mole hemoglobin than the twelve molecules expected on Block's theory.

Generic differences in the content of the sulfur containing amino acids were first shown by analysis of total sulfur (*cf.* Valer, 2845). The earlier values obtained for cysteine must now be viewed with suspicion unless the prosthetic group was removed before hydrolysis, since Theorell (2770) has shown that cysteine may condense into the vinyl side chains of the heme during this process (*cf.* Chapter V). The variations in the estimates given in Table VII may be considered partly due to experimental error and partly to the presence within the animal of several hemoglobins of differing amino acid content. The latter is almost certainly the explanation for the significant departure from whole numbers found for the molar content of some amino acids (196,2052). Roche and Mourgue (2321) found that, while the total leucine + alanine + valine varied only from 46 to 52 molecules per Svedberg unit in six mammalian species, the content in the individual amino acids showed enormous variation, not only between species, but also between individuals of a given species, particularly the dog. They suggest that valine may, to some extent, be capable of being replaced by leucine and/or alanine. In view of these variations we shall not discuss the hypotheses of protein structure based on the frequency of occurrence of amino acids (378,433, 433a,461,2052,2070).

5.2.3. Myohemoglobin. The myohemoglobins have not been investigated as completely as the hemoglobins. Both class differences and generic differences are present. Thus Rossi (2346) finds that the iron:arginine:histidine:

lysine ratio is 1:1:5:9:15, or 4:6:36:60, in horse myohemoglobin, which should be compared with the ratio 4:14:33:37 which Vickery (2877) gives for horse hemoglobin. Roche and co-workers (2315,2316,2321) have investigated the myohemoglobin of a number of genera; values for valine, tryptophane, arginine, and cysteine are approximately the same in ox, horse, and dog, while variations are found in the tyrosine, leucine, alanine, lysine, and histidine contents. In comparison with the hemoglobin of the same genus, the muscle pigment is poorer in tyrosine, leucine, valine, and arginine and richer in tryptophane, lysine, histidine, and cysteine, thus confirming Rossi's findings. There are also immunologic differences between the myohemoglobins and the homologous hemoglobins (1522a).

5.3. Solubility

Roche and Combette (2313) have measured the solubility of the erythrocruorins of *Arenicola* and *Dasybranchus*. In spite of the fact that measurement of the osmotic pressure of the species with which they were working indicated that the molecular weight of the *Dasybranchus* erythrocruorin (intracellular) was only 26,200 and that of the *Arenicola* 362,000, there was little difference in the concentration of ammonium sulfate required to salt them out. The latter pigment was precipitated between 0.5 and 0.6 saturation and the former between 0.55 and 0.7.

Investigations of the mammalian pigments from erythrocytes and muscle show the existence of generic differences within each class of pigment as well as differences between the hemoglobins and the myohemoglobins. The data

TABLE VIII
Solubility Constants of Vertebrate Hemoglobins^a

| Pigment | Genus | pH | β | K'_s |
|------------------|-------|-----|---------|--------|
| HbO ₂ | Dog | 6.6 | 12.35 | 1.72 |
| HbO ₂ | Horse | 6.6 | 3.34 | 0.70 |
| HbO ₂ | Ox | 6.6 | 10.47 | 1.27 |
| MHb | Dog | 6.5 | 7.88 | 0.75 |
| MHb | Horse | 6.5 | 12.81 | 1.37 |
| MHb | Ox | 6.5 | 7.85 | 0.81 |

^a According to Roche and Derrien (2315). Determinations made in ammonium sulfate at 21° C.

of Roche and Derrien (2315) are shown in Table VIII. The solubility of the pigments is given as a function of ionic strength according to Cohn's equation:

$$\log S = \beta - K'_s \Gamma/2$$

where S is the solubility in grams protein nitrogen per 100 ml. solution, $\Gamma/2$ is the ionic strength in moles per liter, and K'_s is the apparent salting out constant, the numerical value of which varies with the nature of the protein

and salt, and β is the logarithm of the solubility in the absence of salt and reflects the amphoteric nature of the protein. The data included in Table VIII constitute the most extensive series carried out in one laboratory. Values are also available for the carboxyhemoglobins of ox (3138), man, and horse (1042) and for the myocarboxyhemoglobin of horse (1987).

5.4. Other Protein Reactions

A number of other reactions of the oxygen carriers are known which depend on the protein portion of the molecule and have been used to show generic differences. These include alkali resistance and oxygen affinity. We shall consider these in subsequent sections.

6. VARIATION OF PROTEIN WITHIN A SPECIES

6.1. Ontogenetic Variation

6.1.1. Fetal Hemoglobin. The existence of a difference between the oxygen affinity of fetal and maternal blood has been known for some time (*cf.* Barcroft, 143), and is of considerable functional importance (*cf.* Section 9.). Although the changes occurring in the maternal blood during pregnancy could be explained by changes in the pH of the blood, this was not possible with fetal blood and the existence of "fetal" hemoglobin was postulated (147). While the dissociation curve of the fetal hemoglobin could be described mathematically in terms of K and n in the Hill equation, this merely summarizes the integrated effects of the environment and the constitution of the pigment in the dissociation curve. As has been pointed out previously, the difference may be due to the influence of the micro-environment, or to differences in the actual protein.

6.1.2. Alkali Resistance. The measurement of the velocity of denaturation by alkali provided evidence that differences were present in the protein. The early observations of Körber in 1866 (1561), subsequently developed by von Krüger (1581) and other workers, showed that generic differences are found between the rates at which different hemoglobins are denatured by alkali. The investigations of von Krüger (1582), Bischof (282), Haurowitz (1158,1159), and Brinkman and co-workers (338) showed that similar differences were present between the pigments of the fetal and maternal human, the fetal hemoglobin being much more alkali resistant than the maternal pigment. The latter workers developed a photoelectric method which enabled them to work with mixtures of pigments of differing alkali resistance. Discontinuities in the rate of disappearance of

hemoglobin were analyzed graphically. Brinkman and Jonxis (336) showed that the difference between the fetal and adult pigments could also be detected by measuring the velocity with which monolayers of protein were formed at an air-water interface. This method is also applicable to mixtures.

6.1.3. Amino Acid Composition. The only work on differences in amino acid composition between fetal and adult animals is that of Vickery (2880) for the ox. The fetal pigment contained $6.43 \pm 0.04\%$ histidine, and the adult $6.1 \pm 0.05\%$ histidine, differences outside the experimental error. The content of histidine in the fetal and adult hemoglobin corresponds to 27.7 and 29.3 moles of histidine, respectively, per 66,700 g. hemoglobin.

6.1.4. Size and Shape. In view of the fact that myohemoglobin has a smaller molecular weight and greater oxygen affinity than hemoglobin, the possibility was considered that fetal hemoglobin may have a smaller molecular weight than the adult pigment. Measurement of the osmotic pressure of fetal hemoglobin of the sheep by McCarthy (1800), and of the human by McCarthy and Popjak (1803), gave values identical with those found in the adult pigment. Andersch and co-workers (50) investigated the difference between adult and fetal hemoglobin in the human species by other methods. Electrophoretic patterns were obtained which showed that the fetal pigment had a greater mobility than that of the adult. The sedimentation constant, $S_{20} \times 10^{13}$, of adult hemoglobin was found to be 4.73, while for the hemoglobin from a five-day-old and a nine-day-old infant, values of 2.5 and 2.9 were found. Since it is unusual although not unknown (*cf.* 2310,2313,2721), for the results with the ultracentrifuge to differ from those obtained by measurement of osmotic pressure, their results indicate that the fetal hemoglobin of the human may have the same molecular weight but a less asymmetric molecule. Measurement of the diffusion constant should confirm this.

That such differences in shape or in stability to dissociation might be present in other species is suggested by evidence from another direction. Wyman and co-workers (3138) measured the solubility of the fetal and adult carboxyhemoglobin of the cow. In strong phosphate buffers, pH 6.8, the fetal pigment was more than six times as soluble as that of the adult.

It is evident that the physical chemistry of the fetal pigment

requires further investigation. The present position, where data obtained with a particular experimental method cannot be compared with those obtained by other methods, in the same species, and vice versa, is unsatisfactory.

6.2. Intraspecific Variation — Adult Pigments

6.2.1. Methods. At least five independent lines of evidence have led to the conclusion that intraspecific differences exist. These are: (a) differing degrees of alkali resistance; (b) differences in elementary composition; (c) different affinities for oxygen or different equilibrium constants for the partition between carbon monoxide and oxygen; (d) significant spectroscopic differences; and (e) differences in electrophoretic mobility (1638,2229). It can be seen from the previous sections however, that the problem is more complicated than most workers have realized. If the blood pigment of an individual contains more than one species of hemoglobin, differences between individual bloods may be due to the mixture of the same components in different proportion, rather than to genuine differences between the composition of components that are homogeneous when tested by electrophoresis, amino acid composition, or solubility. Finally, intraspecific differences may be due to differences in the environment of the pigments, as discussed in Section 7.

6.2.2. Alkali Resistance. Investigation of the alkali resistance or of the spreading velocity during the growth of the young animal after birth has shown that considerable time may elapse before the complete disappearance of the fetal pigment. The method is hardly capable of doing more than this. Using these techniques, Brinkman and Jonxis (336) claimed that, while in the adults of other genera only one pigment is found after the disappearance of the fetal pigment, in humans two adult forms were present. The fetal pigment is replaced by the less resistant adult hemoglobin at seven months, while the resistant adult hemoglobin does not make its appearance until the third year and remains thereafter. Ramsey (2203), on the other hand, claimed that two hemoglobins, differing in alkali resistance, occurred in the blood of many vertebrate species, and that the more highly developed species contained a smaller proportion of the more resistant hemoglobin (*cf.* also Geiger, 985).

6.2.3. Differences in Composition. Many of the differences claimed between the chemical composition of the globins in different individuals

within a species (1456,2564,2807,2845) and in differences in amino acid content (50,121,1639,2303,2437) are based on dubious experimental grounds. In one case analysis was carried out on electrophoretically homogenous components; Reiner and co-workers (2229) found native globin to contain $0.61 \pm 0.02\%$ sulfur. On electrophoresis between pH 2.6 and 3.7, they found two components and succeeded in analyzing the faster. The sulfur content was $0.78 \pm 0.03\%$. Since the nitrogen contents of the original protein and of the faster fraction were identical, this difference in sulfur content is significant.

6.2.4. Spectroscopy and Affinity for Gases. During the first phase of the investigation of the dissociation curve of oxyhemoglobin, differences were claimed to exist between the affinities of the blood of different adult individuals for oxygen (141). There appears to be a slight, probably significant difference between the affinity of the blood of normal men and women (206,1811).^{*} Differences have also been claimed between the equilibrium constant, K , for the equation $(\text{HbCO})/(\text{HbO}_2) = K(p_{\text{CO}})/(p_{\text{O}_2})$. Sendroy, Liu, and van Slyke (2533) considered that earlier claims for such variations of the latter ratio (*cf.* 64,1101) were due to technical faults, since repetition of the work with manometric methods failed to show differences in human and ox blood, outside the experimental error. Killick (1531,1532) more recently found individual differences for K in mice. She used a Hartridge reversion spectroscope for the measurement of the band position of carboxyhemoglobin, a method which is less accurate than manometric methods. In addition, she worked with young mice in which fetal pigments may still be present.

The most recent claim that differences are found in the spectra of pigments from different individuals is that of Fox (936). By correctly controlled observations with the Hartridge reversion spectroscope, he found significant differences in the position of the α band of oxyhemoglobin from individual rabbits. No differences were found between the pigments from individual earthworms, frogs, or humans. Although Fox worked with the dilute hemolyzate from washed rabbit cells, this treatment is not sufficient to remove possible interfering substances from hemoglobin (*cf.* Section 7.).

7. MICROENVIRONMENT OF OXYGEN CARRIERS

7.1. Extracellular Carriers

The presence of a cell wall enables the pigment to exist in an environment differing considerably from that provided by the circulating fluid. We might also consider the possibility that the large molecules of the extracellular erythrocrucorins are similarly affected by the presence of other molecules which are more or less firmly bound to them, thus creating a special environment. The sedimentation constant, $S_{20} \times 10^{13}$, of the erythrocrucorin

^{*} This has, however, not been confirmed (*cf.* 995,1534b).

of *Planorbis* is found to be 33.7 between pH 3 and pH 8. At lower pH the molecule dissociates into smaller components (*cf.* Section 3.5.). The frictional ratio (2721, Table 48, p. 406) is about 1.4 and the partial specific volume, 0.745. Assuming that the hydration is approximately the same as that of hemoglobin, $w = 0.3$, the axial ratio a/b calculated from Oncley's diagram (2075, p. 131) is approximately equal to 5 or 0.18 according to whether the molecule is considered to be a prolate or an oblate ellipsoid. The molecular weight for a molecule containing 96 Hufner units is 1.69 million, the value found for erythrocrurin is 1.54 million. It is obvious that the units are not joined end to end to give a threadlike molecule since this would not agree with the value found for the frictional ratio and, moreover, might give rise to optical anisotropy, so the units must be packed in some relatively compact arrangement. Such a molecule would contain many "crevices" and "splits" into which the prosthetic group could fit, as well as salts or other substances.

7.2. Erythrocyte

7.2.1. Concentration of Hemoglobin. The concentration of hemoglobin found in erythrocytes is approximately 34% and the pH about 7.4. Once the hemoglobin is removed from the erythrocyte, it is certain that, at least in some species, concentrations as great as this cannot be obtained at the same pH . This fact is, of course, made use of in many of the methods for preparing hemoglobin since in several species hemolysis of the erythrocyte leads to spontaneous crystallization.*

7.2.2. Spectrum of Hemoglobin within the Erythrocyte. While the spectrum of the erythrocyte in the visible region and probably also in the infrared (1343) is the same as that of the hemoglobin prepared from it, Adams and co-workers (12) were not able to detect the Soret band in erythrocytes. They claimed that this was due to combination of hemoglobin with stromatin (11). Keilin and Hartree (1495) confirmed their finding that the Soret band was absent in suspensions of erythrocytes but were unable to find any spectroscopic change when hemoglobin was incubated with stromatin. They showed, however, that the Soret band disappears when olive oil was emulsified in a strong hemoglobin solution, and concluded that this was due, not to any alteration of the hemoglobin, but to the optical properties of the discontinuous medium. This conclusion has now been shown to be correct by several workers (464, 1381, 1428). There is no evidence therefore that the spectrum of the pigment within the cell is in any way abnormal.

7.2.3. Oxygen Affinity. Hemoglobin is associated with substances in the erythrocyte which affect its affinity for oxygen. Their action explains in part the increase in affinity found when laked cells are diluted. Hill and Wolvekamp (1286) observed that the effect was greater in the blood of some

* Recent investigations by Dervichian, Fournet, and Guinier (566a) and by Perutz (2136a) show that freely rotating hemoglobin molecules are arranged in the erythrocyte in a close-packed lattice, and that their arrangement is comparable to the order in a liquid metal, intermediate between that in a solid crystal and that in a dilute solution.

species than of others. A dialyzable, heat-labile substance was shown to be liberated from the cells on hemolysis which shifted the dissociation curve of the diluted hemoglobin back toward that found in the cell. The reaction takes place at pH 7.4, while at pH 9.2 no change in the affinity was observed. The authors excluded glutathione and bicarbonate as being responsible for the effect but did not study the substance further. Its properties seem to exclude both stromatin and cephalin (*cf.* Chapter VI, Section 4.3.5.).

Altschul, Sidwell, and Hogness (45) had observed that treatment with alumina cream increased the affinity of hemoglobin for oxygen. Washing the adsorbate with distilled water did not remove any substance decreasing the oxygen affinity. Addition of the neutral phosphate eluate to carefully purified hemoglobin, however, caused decrease in the saturation of some 30% at an oxygen pressure of 1 mm. The eluate was shown to contain hemoglobin which was readily denatured, but beyond this it was not investigated. Roughton's work on the relative rates of reaction in the erythrocyte and in solution have been discussed in Chapter VI, Section 6.2.7.

7.3. Myohemoglobin in the Muscle Cell

The microenvironment of myohemoglobin is much more complicated than that of hemoglobin in view of the much greater variety of substances within the muscle cell. The character of the visible spectrum of myohemoglobin in muscle is similar in character to that found in the purified substance (1279, 2220). There is no doubt that myohemoglobin does exhibit a great affinity for oxygen *in vivo* (1952, 1954, and Section 10.). The shape of the dissociation curve *in vivo*, however, has not yet been determined and the possibility of heme-heme interaction cannot be excluded. In view of the dilution of the pigment this would be unlikely if the pigment exists as particles of molecular weight 17,000. Theorell's results (Chapter VI), however, point to the existence of aggregates under some conditions.

8. BASES OF ADAPTATION

8.1. Environment of the Oxygen Carriers

The function of the oxygen-carrying pigments is to take up oxygen from the environment and transfer it to the tissues. The oxygen pressure at which the carrier is in equilibrium with the environmental oxygen is defined as the loading tension, while the oxygen pressure at which the carrier is in equilibrium with the tissues is defined as the unloading tension. These two oxygen tensions are not fixed but normally vary with changes in environment and in the physiological activity of the tissues. For the purposes of characterizing a pigment, two positions on the oxygen dissociation curve are rather arbitrarily selected, corresponding to these pressures. The loading tension is placed at an oxygen saturation of 95%, the unloading tension at 50%.

The amount of oxygen delivered between these two pressures is a measure of the biological efficiency of the pigment.

The efficiency of the adaptation of the pigment involves, in addition, kinetic considerations. Both must be considered in relation to the macroenvironment of the pigment, which itself is determined by the physiology of the organism and the environment in which the organism is found.

For the present purpose the most important factor in the environment of the aerobic organism is the partial pressure of oxygen; this may vary from that found in the intestines of mammals, where *Ascaris* lives, to that found in the free atmosphere at the surface of the earth. It is to the partial pressure of oxygen at the surface of the organism to which the loading tension of the first pigment in the oxygen-carrying chain must be adapted. We call this the initial loading tension. It may be subject to cyclic variation due to factors the organism cannot influence. This is seen in the case of *Arenicola*, the lugworm, which lives in a burrow in the sand just above the water mark, so that for the most of the time it is in well-oxygenated sea water but when the tide falls is cut off from external sources of oxygen (119). On the other hand, the organism may be a free-living form and be able to select an environment with a suitable initial loading tension.

The other partial pressure of great importance for aerobiosis is that required for the maximal action of the respiratory ferment. So long as the oxygen pressure at the surface of the oxidase is not a limiting factor for the metabolism of the animal, the functional adaptation at this point will be satisfactory. The oxygen carrier which delivers oxygen at the point must be capable of yielding it at a pressure, the final unloading tension, which satisfies this requirement. In some organisms we find only one oxygen carrier between the environmental oxygen and the respiratory ferment, while in others we may find two or even three, *e.g.*, maternal Hb → fetal Hb → fetal MHb → oxidase in fetal muscle. Where more than one pigment is present, we must consider their mutual loading and unloading tensions, and how well these are adapted to the initial loading tension and to the final unloading tension of the system.

Adaptation does not depend, however, solely on the thermodynamics of the pigment. Equally important is the rate at which oxygen is supplied to the tissues. This must be sufficient to enable the organism to withstand stresses caused by its own activity and by the

environmental changes which it cannot avoid. It is determined by several factors: the kinetics of the pigment, the concentration of the pigment in the circulation, the circulation rate, and the velocity of diffusion of gaseous oxygen across cell walls.

The oxygen-carrying pigments may differ in prosthetic group, in protein, and in microenvironment. These factors operate together to produce variations in the reaction between oxygen and the carrier. It is by means of these variations that the reaction is adapted to the variety of conditions met with in living organisms.

8.2. Mechanisms

8.2.1. Variation of the Heme. A heme which differs from protoheme IX is found only in the chlorocruorin in the blood of the *Sabellid* worms. The oxygen capacity of *Spirographis* blood is only 9 volumes per cent (119, p. 79). This is probably due to the fact that the pigment is extracellular rather than to the structure of the prosthetic group. Since this pigment is found only in a small group of worms which live in the same type of environment as do others containing erythrocrucorins with protoheme IX as prosthetic group, the peculiarity does not appear to be of adaptive importance and may be an evolutionary relic.

8.2.2. Variation of the Protein. A protein suitable for the formation of an oxygen carrier must be able to combine with heme, giving a compound able to bind oxygen without oxidation of the iron or catalytic destruction of the heme or the protein. This condition is fulfilled in its simplest form in the pigments of the type of myohemoglobin, which consist *in vitro* of single Hufner units. Even in its simplest form (which is not necessarily the most primitive), variation in the structure of protein affects the affinity of the pigment for oxygen.

On present hypothesis of hemoglobin structure, such simple pigments have a dissociation curve of hyperbolic shape; such a dissociation curve is disadvantageous for some oxygen carriers (Section 9.1.). In addition the attainment of high oxygen capacities with such pigments and their relatively small size would render necessary impermeable cell walls, since the high concentration of pigment required would entail a high osmotic pressure.

8.2.3. Variation of Microenvironment. The ability to form macromolecules is of great functional importance. In these macromolecules the combination with other substances, *e.g.*, salts, water, and stromatin, may not only solve the problem of the osmotic pressure and the problems raised by the ease of diffusion of the smaller molecules, but also may protect the molecule from destruction by reducing substances in the presence of oxygen. In the macromolecule, moreover, the phenomenon of heme-heme interaction appears, enabling the hyperbolic dissociation curve of the Hufner unit to be transformed into the sigmoid dissociation curve of hemoglobin. On the one hand, this gives the pigment a still greater power of functional adaptation

to its respective loading and unloading tensions than is conferred by the variation of structure of the Hüfner unit; on the other hand it makes it far more sensitive to change in its macroenvironment, such as pH or partial pressure of carbon dioxide (Chapter VI).

9. FUNCTIONAL ADAPTATION — MAMMALIAN RESPIRATION

9.1. Significance of Sigmoid Dissociation Curve

In view of the detail in which this has been discussed elsewhere (119,141), we will deal with it very briefly. As Barcroft has pointed out, the sigmoid dissociation curve enables a well-adapted pigment

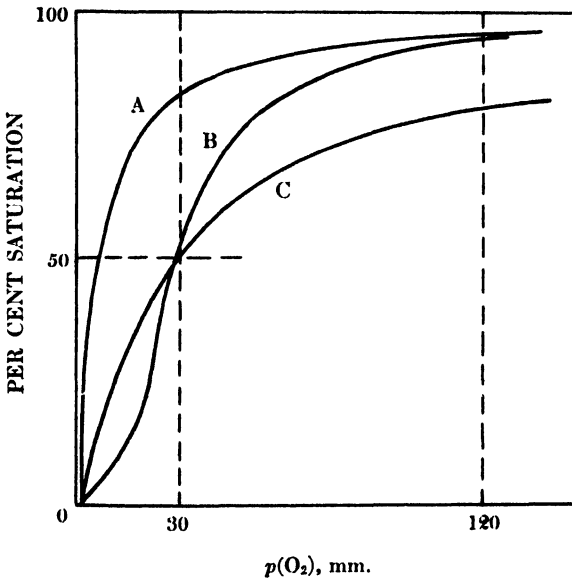

Fig. 2. Loading and unloading tensions of pigments with hyperbolic and sigmoid dissociation curves.

to deliver the maximum quantity of oxygen between limits of the loading and unloading tensions set by the environment of the pigment. This can be clearly seen from Figure 2, where a sigmoid dissociation curve is compared with two calculated on Hüfner's theory.

The loading and unloading tensions of the environment in which the pigment must function are 120 mm. and 30 mm., respectively.

At the loading tension pigments A and B are 95% saturated, but, where B delivers 45% of its oxygen, A only delivers 12%. Pigments B and C are both 50% saturated at the unloading tension, but on oxygenation at the loading tension the saturation of C rises to only 80%, while B is 95% saturated. The sigmoid curve delivers 45% of its oxygen between the loading and unloading tensions while the two hyperbolic curves A and C deliver only 12% and 30%, respectively.

In order to make up for the absence of the sigmoid dissociation curve, an organism would have either to increase its respiratory system relative to the rest of its body, or to increase the concentration of carrier in the circulation. Both these adaptations may have disadvantages which are avoided by a carrier with a sigmoid dissociation curve.

Since the sigmoid dissociation curve is determined not only by the structure of the protein, but also by the microenvironment, the variation in the position and shape of the curve which can be brought about by the different synthetic capacity of different species is greater than if variation were possible only in the structure of the protein (*cf.* Section 9.3.).

9.2. Interaction between Oxygen and Carbon Dioxide Transport

This problem has been thoroughly investigated by a number of workers and the reader is referred elsewhere for detailed discussion (1236,2140,2360). Hemoglobin not only assists in buffering the pH changes brought about by the cyclic variation in the carbon dioxide content of the blood, but in addition, as Henriques (1241) and Roughton (2360) have shown, forms carbamate compounds. The effect that diminishing pH has on the affinity of hemoglobin for oxygen has been discussed in Chapter VI. The slight diminution in pH facilitates the liberation of oxygen in the tissues and the reverse shift in the lungs facilitates the oxygenation of hemoglobin. The influence of shifts in pH of the cell, however, is probably of less importance than the actual combination of carbon dioxide with the hemoglobin molecule.

The importance of certain firmly bound substances in the transmission of heme-heme interactions has been discussed in Chapter VI. Sidwell and co-workers (2549) showed that, at constant pH, increase in the bicarbonate concentration from 0 to 0.02 moles per

liter, the $\text{CO}_2/\text{HCO}_3^-$ ratio being kept constant, caused the oxygen saturation to drop from 80 to 16%. A subsequent paper from the same school (41) showed that bicarbonate not only affected the equilibrium constant in Pauling's equation, but also the interaction constant (Chapter VI). Roughton (2362) considers that carbamate formation takes place on one of the heme-linked groups (cf. Chapter VI, Section 3.2.2.4.).

The aggregation of Hufner units within the mammalian erythrocyte makes possible, therefore, a much finer adjustment of the hemoglobin to cyclic changes in its microenvironment. Changes in the partial pressure of carbon dioxide and in the pH might still affect the oxygen affinity of a single Hufner unit, and conversely the buffer capacity of the latter would still be available to assist in carbon dioxide transport. The reciprocal influence of hydrogen ions, carbon dioxide, and oxygen on myohemoglobin is, however, almost negligible compared with that exerted on a system in which heme-heme interaction occurs.

9.3. Fetal Respiration

In Section 6.1. the differences between fetal and adult hemoglobin have been discussed. *In vivo*, however, differences in the composition of the proteins are modified in some species by the microenvironment of the cell. The reader is referred to other works (Needham, 2061; Barcroft, 147) for discussion of the nature of the placental circulation. For maximum oxygen carriage, the loading tension at which fetal blood approaches full saturation must be in the region of the unloading tension of the maternal blood in the placenta. This is achieved by shifting the dissociation curve of the fetal blood so that it lies above that of the mother. This has been shown by Haselhorst and Stromberger (1151,1152) and Liebson and co-workers (1742) to take place in the human species, by Barcroft and co-workers (147) in the goat, and by Roos and Romijn (2332) in the cow.

In the investigation of stroma-free dialyzed hemoglobins from the maternal and fetal blood of the goat, McCarthy (1800) showed by gasometric analysis that the difference in the dissociation curves was a property of the hemoglobin. Samples of fetal and maternal hemoglobin taken at the fifteenth week of pregnancy were saturated 58 and 33%, respectively, at 30 mm. oxygen, 37° C. and pH 6.8. The differences that Barcroft and co-workers (147) found on the analysis of the whole blood at 50 mm. carbon dioxide pressure and 38° C. were 35% and 10%, respectively for the goat at a similar stage of

pregnancy. The difference between the blood and the purified hemoglobin in fetus and mother is not only in the same direction but is of the same magnitude. Hall (1106), working with a spectroscopic method (1105) which enabled him to work with blood diluted hundred-fold, found that, at 32° C. and pH 6.8, the saturation of the fetal and maternal pigments in the goat at fifteen weeks' gestation was 72 and 53%, respectively at 30 mm. mercury. In addition, he found the fetal curve to be shifted to the left of the maternal curve in the rabbit. In comparison with McCarthy's data, Hall's results show that in dilute solution, both the maternal and the fetal pigment have a greater affinity for oxygen than in stronger solution. Haurowitz (1164) and Hill and Wolvekamp (1286), the latter workers using dilute solutions, found, however, that in the hemoglobin of the human species, the relative positions of the two curves were reversed, the fetal pigment having a smaller affinity for oxygen than the maternal pigment. The problem was reinvestigated by McCarthy (1801), who confirmed these results for both dilute and concentrated solutions of maternal and fetal hemoglobin. He also confirmed the earlier work done on the whole blood of mother and fetus.

The above results show the operation of generic factors in the functional adaptations of the fetus to its intrauterine existence. In the goat, the increased affinity of the fetal pigment is apparently determined by the structure of the hemoglobin; the microenvironment plays little or no role. In humans, the adaptation is achieved solely by the chemical influence of the erythrocyte on the hemoglobin. The chemical differences which exist between the maternal and fetal hemoglobins in humans are not able, by themselves, to produce the necessary functional adaptation.

10. FUNCTIONAL ADAPTATION — MYOHEMOGLOBIN

While the early work of Barcroft led to the division of the oxygen carriers into oxygen transporters and oxygen stores (139,141), it was not until the much greater affinity of myohemoglobin for oxygen was discovered that its function as an oxygen store rather than as an oxygen transporter was realized (142). Millikan (1954) summarizes the qualifications for an effective store as a pigment which has sufficient capacity, suitable loading and unloading tensions, and is able to load and unload its oxygen with sufficient speed.

In the dog, the myohemoglobin content of heart muscle is about

0.5%, and under normal conditions of activity the oxygen store would last for about seven seconds. In extreme activity the store would be used up in each contraction. Millikan's experiments (1953) have indeed shown that in this species, and probably in other terrestrial mammals, the storage function of myohemoglobin is related to the frequency with which a muscle is able to contract. The dissociation curve of myohemoglobin is admirably adapted to its function. At the oxygen tension of venous blood, myohemoglobin is 94% saturated (1279). The apparent loading tension of the respiratory ferment is low enough for it to operate at the pressure required to dissociate about 50% of the oxygen bound to myohemoglobin.

Actual measurement of the rate of reduction of myohemoglobin during tetanic contraction of the soleus muscle of the cat showed that the velocity of dissociation was of the same order as that of the increase of muscular tension during contraction. Oxygen consumption commenced less than 0.2 second (instrumental lag) after the application of the stimulus. Since within one second the myooxy-hemoglobin lost up to 40% of its oxygen, in spite of the fact that the circulation was left intact, the oxygen supply to the muscle is insufficient during the contraction. Millikan envisages the storage function of myohemoglobin as being able to provide a supply of oxygen when the need is greatest, as well as smoothing out the fluctuations in oxygen content during intermittent action.

In diving mammals, the myohemoglobin content of the muscles is particularly high (654,2288,2763) and in addition to the above role it probably enables the animals to stay under water for long periods. In the dolphin and seal, 3.5 and 7.7% are found, respectively, amounts which roughly correlate with the duration of their dives.

11. FUNCTIONAL ADAPTATION — SUBMAMMALIAN PIGMENTS

11.1. Diversity of Environments

In the two previous sections, the chemical bases of the adaptation of hemoglobin and myohemoglobin to their histological environment have been discussed. In the case of the submammalian oxygen-binding pigments, we are hampered not only by knowing less about the pigment, but also by knowing less about the functional role which the pigment plays in the particular species. Certain aspects

of the problem have been reviewed elsewhere (119,139,410,1853,2222,3080), but the position is still unsatisfactory. We have to reckon with much greater changes, in both the micro- and macroenvironment of the organism. Both intracellular and extracellular hemoglobin is found in the blood of the annelids. In other phyla, the pigment is found free in the circulation as well as in a variety of other cells, for instance in the tracheal cells of *Gastrophilus* larvae, in the adductor muscle of the whelk, and in the body wall of *Ascaris* — to name three.

The most important physiologic differences in the macroenvironment of the pigment are those related to the different respiratory systems in the lower phyla: as examples we cite the specialized epithelium in the gills of fish and certain other aquatic animals, tracheal respiration in insects, and finally, transfer of oxygen and carbon dioxide across unspecialized epithelium. The environment of the whole organism may be aquatic or aerial and in some species may be either. Some parasitic species may spend some portion of their life cycle in the moist, if not aqueous, environment of the host's intestine. Within these environmental ranges, we may find a variety of temperatures and partial pressures of oxygen and carbon dioxide. While in some cases the environment of a single species may remain relatively constant, in others the species must adapt itself to regular or irregular changes in one or other of the above-mentioned factors. We deal in detail only with certain aspects of these problems, since detailed discussion is outside the scope of this work.

11.2. Adaptation to Low Pressure of Oxygen

Table IX, taken from Carter (410), gives data for a number of oxygen carriers. The loading tension is taken as that giving 95% saturation and the unloading tension, 50% saturation. It can be seen that adaptation has taken place to the lower partial pressure of oxygen in marine environments, being reflected by the much higher affinity for oxygen found in the carriers.

The simplest form of adaptation is probably the production of a greater amount of pigment. Among mammals this is a normal physiologic response (Chapter XIII). Baldwin summarizes the oxygen capacities in the bloods of a number of species (119, p. 79). The values of those invertebrates which contain hematin oxygen carriers range from 1.5 volume per cent for the extracellular erythrocrurin in molluscs to 9.0 for the chlorocrurin of annelids. Fish, amphibia, and reptiles are found to have lower oxygen capacities than birds or

mammals. The actual amount of pigment carried and its affinity for oxygen appear to be independent.

The position is complicated by the greater prominence of anaerobic metabolism in certain species. Thus Wigglesworth (3080, p. 221) points out that *Gastrophilus* larvae are able to live under anaerobic

TABLE IX
Loading and Unloading Tensions of Oxygen Carriers^a

| Oxygen carrier | Temp., °C. | t_U , mm. O ₂ | t_L , mm. O ₂ | Authors |
|-------------------------------|------------|----------------------------|----------------------------|-----------------------------|
| Hemoglobin in corpuscles | | | | |
| Various mammals | 38 | ca. 27 | ca. 85 | |
| Fish | | | | |
| Marine (cod, plaice) | 17 | 12-15 | 30-40 | Krogh and Leitch (1580) |
| Fresh water (carp, pike, eel) | 15 | 2-3 | 10 | Krogh and Leitch (1580) |
| Hemoglobin in solution | | | | |
| Human | 38 | 9 | 100 | |
| Frog | 15 | 6-7 | 90 | Marcela and Seliskar (1868) |
| <i>Chironomus</i> | 20 | 0.17 | | Leitch (1669) |
| <i>Planorbis</i> | 20 | 7.0 | | Leitch (1669) |
| | 12 | 1-2 | 15 | Marcela and Seliskar (1868) |
| <i>Arenicola</i> | 20 | 1.7 | 5 | Barcroft and Barcroft (144) |

^aAccording to Carter (410). t_U = unloading tension, t_L = loading tension.

conditions; yet Keilin (1483) has shown that the hemoglobin in their tracheal cells is oxygenated if the larva comes in contact with a gas phase containing oxygen and is thereafter reduced by the organism. The extremely high affinity for oxygen of this pigment, of that contained in the species of *Planorbis* which prefers to live in still water with low oxygen pressure, or of that of the hemoglobin-containing species of *Chironomus* (1853), may represent an attempt to make the best of their environment. For further discussion of the latter species see Maluf (1853, p. 175) for references. A similar argument applies in the case of *Ascaris* (Davenport, 533). For discussions of how the adaptation to low oxygen pressure is related to the lower environmental temperature in many of these animals, the reader is referred to Barcroft (139,141) and to the work of Marcela and Seliskar (1868).

The relation of the partial pressure of carbon dioxide to the affinity of the pigment for oxygen is discussed by Carter (410) in consideration of Krogh and Leitch's data (1580) for the oxygen dissociation of hemoglobin of fish. The partial pressure of the carbon dioxide in the thin stationary layer of water surrounding the gills of animals living in an aqueous environment is much lower than that in the alveolar

air in mammals. At partial pressures of carbon dioxide even lower than that found in alveolar air, the oxygen saturation of these hemoglobins may be only of the order of 50% of that found at atmospheric pressure. Mammalian hemoglobin must, therefore, be considered as adapted not only to the temperature of 35–40° C. at atmospheric oxygen pressure, but also to the anatomy of the aerial respiratory system which requires that oxygen loading take place at relatively high partial pressure of carbon dioxide.

11.3. Role of Absolute Reaction Velocities

Salomon (2423) has measured the rates of dissociation of two annelid hemoglobins, while Davenport (533) has reported data on the pigments in *Ascaris*. The pigment of *Glycera*, carried in corpuscles, has the same dissociation rate as has human oxyhemoglobin, both measured in dilute solution by the reaction meter of DuBois (636). The extracellular high molecular weight pigment from *Lumbricus* dissociates about one-third as fast. The hemoglobin from the body wall of *Ascaris* has a dissociation rate 1/2500 and the hemoglobin of the parenteric fluid 1/10,000 of that of mammalian hemoglobin. If we consider the relatively sluggish movements of the annelids in the light of the absolute value for the half dissociation time for the pigment in *Lumbricus*, 70 milliseconds, it seems reasonable to conclude that, in the free living annelids, the velocity at which the gaseous reactions take place is not the limiting factor in their functional adaptation. In the case of *Ascaris*, which leads an even more inactive existence, the dissociation rate of the oxygenated carrier is probably still faster than its metabolic processes.

Myohemoglobin is present in invertebrates. It is found in the pharynx of *Limnaeus* and *Paludina* (1647), in the heart and adductor muscles of other molluscs (125,527,1910). Lankester (1647) pointed out the association between its distribution and the activity of the muscle. Unfortunately, it is not yet possible to decide whether this invertebrate myohemoglobin can be classed with mammalian myohemoglobin on the grounds of its affinity as distinct from its distribution. Even if its dissociation rate were slower than that of mammalian myohemoglobin, it is doubtful if it would become a limiting factor in the velocity of the heart beat or the contraction of the adductor muscles in the molluscs. Only in the vertebrates does muscle physiology approach the limits set by the velocity of the gaseous reactions of the oxygen carriers. In some species of insects,

the frequency of muscular contraction far exceeds that found in any other species. The limit is set by the diffusion of oxygen, which is brought directly to the neighborhood of the muscle by the respiratory system without intervention of other carriers. In the case of the lung, however, Roughton (2362-2364) has considered the velocity of the association reaction in the mammalian erythrocyte and its relation to the time taken for the erythrocyte to pick up oxygen on its way through the lung. In this organ, diminution in the velocity of the association reaction would probably require further anatomical adaptation. In *Lumbricus*, for example, even though the velocity of the oxygen uptake of its carrier may be slower than that of hemoglobin, it seems probable that the development of the anatomy of the primitive respiratory system has lagged behind the development of the pigment.

11.4. Store or Carrier?

Since Barcroft's (144) considerations of the possible storage function of the hemoglobin in *Arenicola*, and the demonstration that the amount of oxygen stored is sufficient to last the worm for the period between the tides, a number of organisms have been considered from a similar point of view. In the case of insects, Maluf (1853) reviews the data up to 1939 and concludes that the pigment functions as a carrier rather than as a store, since the total amount found is relatively slight. It seems that in relatively few instances have we enough data from which to draw very definite conclusions on this point. The cyclic changes in the oxygen pressure in the environment are extremely slow in comparison with the cyclic changes in mammalian muscle.

The concept of a store to tide the animal over a cyclic change in the oxygen pressure can only be considered a significant evolutionary adaptation if the animal is particularly sensitive to short periods of anaerobiosis. In these lower forms of life, the retention of the more primitive anaerobic metabolism seems a more profitable method of adaptation than the development of an oxygen store. The value of the latter is dependent on the probability that chance variations in the length of time during which the oxygen supply is short will never exceed the oxygen capacity of the store. Ewer and Fox (727) have shown that the chlorocruorin of *Sabella* acts as respiratory carrier, not as oxygen store (*cf.* also 1420).

CHAPTER VIII

HEMATIN ENZYMES, I. THE CYTOCHROME SYSTEM

INTRODUCTION

It is beyond the scope of this book to discuss the whole field¹ of biological oxidation, or even all known biological reactions in which hematin catalysts have been shown to take part. For this the reader is referred to special textbooks and reviews (1479,2079,2225,3160) and also to the chapters on biological oxidation and reduction in various volumes of the *Annual Review of Biochemistry*. In this and in the succeeding chapter we are mainly concerned with the respiratory catalysts as characteristic hematin compounds and as peculiar hemoproteins. We shall try to correlate the little we know about their structure with their biological function, and the chemical reactions on which this function is based with similar reactions of other hematin compounds. In a decade or so it may be necessary to give to each of the hematin enzymes as much space as to the hemoglobin; later again it may become possible to treat all hemoproteins together from one particular physicochemical aspect. At present the scantiness of the available data does not necessitate the first treatment and excludes the second.

Only the iron compounds of porphyrins have been shown to possess strong catalytic powers as oxidases, peroxidases, or catalases. Copper porphyrins, for instance, are not stronger oxidative catalysts than ionic copper (2422).

We shall discuss in this chapter the cytochrome system, and in Chapter IX the other hematin enzymes, particularly catalase and the peroxidases.

Role of the Specific Protein. The important role which hematin

compounds play as biological catalysts in respiratory processes is bound up with their ability to react with oxygen and hydrogen peroxide, or to undergo changes of iron valency. It has been shown in Chapter V that simple hematin compounds possess these abilities in a rudimentary way. In the chapters on hemoglobin it has been demonstrated how profoundly the properties of hematin are altered by combination with the protein globin. In this instance the alteration is of such a nature that the resulting compound, hemoglobin, has not the properties of an oxidative catalyst, nor is it greatly superior to hematin or hemochromes as a peroxidative or catalytic enzyme. The oxygen in oxyhemoglobin is less, rather than more, reactive than molecular oxygen; it is, as Warburg put it, transport oxygen, not activated oxygen. We shall see in Section 6.3.6 that certain alterations of the protein activate the chemically inert oxygen of oxyhemoglobin but such alterations have not yet been shown to occur *in vivo*. If an enzyme is defined as a *catalyst* of biological origin, hemoglobin is not an enzyme.

In the next chapter we shall find several instances of the same protoheme found as the prosthetic group of hemoglobin acquiring, when combined with other proteins, extremely powerful catalytic properties (horse-radish peroxidase, catalase). Similarly it has not been demonstrated, and is unlikely, that the related hematins which constitute the prosthetic groups of the oxidative enzymes (cytochromes, respiratory catalyst) are powerful catalysts in themselves; again they are certainly combined with specific proteins which modify and increase the catalytic activity of their prosthetic groups or active centers.

We must distinguish between several ways in which the protein exerts an influence on the catalytic efficiency of a hematin. First, it may alter the electronic configuration of the hematin iron atom, causing, for example, peroxidase to combine with hydrogen peroxide to a relatively stable compound, or catalase to form an explosively unstable compound; oxygen with hemoglobin results in a relatively inert oxygen compound, but with the respiratory enzyme presumably a very reactive one. Secondly, the protein alters the oxidation-reduction potential of the prosthetic groups. Thirdly, it will provide the point of combination with the specific substrate, for example between the hydrogen peroxide heme group and pyrogallol in peroxidase, or between cytochrome c and a suitable hydrogen donor. In order to make this distinction clear we shall restrict the use of the

term substrate to the hydrogen donor, and use the term acceptor (hydrogen acceptor) for oxygen or hydrogen peroxide, except in the case of catalase.

Considered from the general viewpoint of biological oxidation, there is no principal difference between substrates and acceptors, both forming a ternary system with the catalyst, except that the latter has a higher oxidation-reduction potential. In the cases we discuss, however, there is the additional difference that the substrate is bound to the protein, the acceptor to the heme iron of the reactive complex.

In general it can be observed that the catalytic activity (catalatic, peroxidative, or oxidative) of a free hematin or a simple hematin compound (*e.g.*, a hemochrome) is far lower than that of the specific hemoprotein enzymes found in the cell. The same holds if we compare the catalytic activity of a hemoprotein specially adapted to one kind of catalysis (*e.g.*, catalatic destruction of hydrogen peroxide) with a hemoprotein specially adapted to other reactions. Thus the combination of protoheme with globin or with the protein of horseradish peroxidase does not increase its catalatic activity to anything approaching that of catalase.

Reaction Velocities and Thermodynamics. In previous chapters we have been concerned mainly with problems of affinity. When discussing the catalytic activity of a substance, it must be realized first that we are dealing with reaction velocities, and that we must not expect to find a straightforward relationship between affinities and reaction velocities, except in certain reactions (179,3016). Affinity considerations will still be of importance, however, since they show us whether a reaction is thermodynamically possible, and give us indications in which direction it can be expected to proceed. Secondly, deductions from the true equilibrium conditions cannot always be applied to the false equilibrium that we find in the living cell. In a chain of oxidation-reduction processes of the kind observed in the cells, the system with the higher potential, E'_0 , will as a rule supply the oxidizing component, and the system with lower E'_0 the reducing component. In the cell, however, we find instances where the reverse occurs. In two systems $O_1 + R_1$ and $O_2 + R_2$, where O and R signify oxidized and reduced forms, and the potential of system 1 is assumed to be higher than that of system 2, the equilibrium:

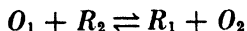

will normally lie toward the right and the reaction will proceed

predominantly in this direction. If, however, a reaction occurs by which O_1 is removed far more rapidly than O_2 , the equilibrium may be shifted toward the left, and the system with the lower potential will oxidize that with the higher one (*cf.* 2079, p. 91).

Inhibition of Hematin Enzymes. Developing from the early conception of Warburg of an iron-catalyzed respiration, the study of hematin catalysis by inhibitors such as cyanide and carbon monoxide has played a fundamentally important role in the development of our knowledge, and is still of considerable importance. Nevertheless it should be realized that an ideal inhibitor, which would be specific for all hematin-catalyzed reactions, and for them alone, does not exist. We have discussed the chemical basis of the reactions of hematin compounds with cyanide and carbon monoxide in Chapter V, and have seen that cyanide reacts with ferric hematin as well as with ferrous heme compounds, though not with all the latter (*e.g.*, little with hemoglobin; *cf.* Chapter VI); carbon monoxide, on the other hand, reacts only with the ferrous heme compounds. It will be seen in this chapter that the cytochromes do not react with carbon monoxide, but since the oxidase (which with them forms the cytochrome system) does so in its ferrous form, the failure of cytochrome to react is of little practical importance. Those hematin enzymes, however, which are ferric compounds and do not change their valency during the catalyzed reaction are not inhibited by carbon monoxide. These include peroxidase and probably catalase.

Cyanide inhibits a variety of nonhematin enzymes, *e.g.*, the copper-containing enzymes. Carbon monoxide is a more specific inhibitor, but is still not entirely so, since some copper catalysts (*e.g.*, polyphenoloxidase) are also inhibited by carbon monoxide. The carbon monoxide compound of the polyphenoloxidase is, however, not dissociated by light, and the light sensitivity of carbon monoxide inhibition is so far the best indirect evidence for the hematin nature of an enzyme. Some other iron systems such as ferrocysteine (512) and ferroglutathione (1591) are known, which are also able to form light-sensitive carbon monoxide compounds, but so far no evidence has been found that such compounds occur in the cell. In Chapter II we have discussed how, by combining carbon monoxide inhibition with irradiation in specific ranges of the spectrum, the heme nature of a catalyst can be established beyond doubt (*cf.* also this chapter, Section 3.6.1.). Finally, in some cases the conditions under which light sensitivity of the inhibition has been measured may not have been

sufficiently vigorous, since some carbon monoxide heme compounds may be less sensitive to irradiation than others.

2. SIMPLE HEMATIN COMPOUNDS AS OXIDATIVE CATALYSTS

The oxidation of a great variety of substrates can be catalyzed by simple hematin compounds. Among these are unsaturated fatty acids and fats (187,441,946,1176,1288,1618,1620,1621,2289,2563,3127), carotenoids (943), cysteine and glutathione (513,1135,1578,1579,1644,1794), hydrogen sulfide (1171), ascorbic acid (1697), benzaldehyde (1617,1927), pyruvic acid (1618,1928), and tertiary amino acids (219). Carbon monoxide cannot be oxidized by protohematin or related blood porphyrin iron compounds, but is oxidized to carbon dioxide by pheophorbid or pheophorphyrin hematins (2020).

As model experiments these reactions are very interesting, but there is so far no stringent evidence that any of these systems play a biological role. There is more likelihood that the oxidation of ascorbic acid and sulfhydryl compounds does so than in the case of the other substrates, but even here the issue is not yet clear (*cf.* Chapter XI). The catalytic effects of hemochromes on ascorbic acid and on cysteine are probably due to a valency change of the hematin iron, hemochromes oxidizing the substrate more rapidly than atmospheric oxygen, and hemochromes being more rapidly oxidized by it than the substrate (1579,1697). On the basis of cyanide inhibition experiments Krebs (1579) claimed that heme can catalyze the oxidation of cysteine by atmospheric oxygen without passing the ferric (hematin) stage. He observed that the cyanide inhibition of the oxidative action of hematin on ferrous cysteine was smaller than was to be expected from the combination with cyanide measured spectrophotometrically, and he concluded from this that part of the catalysis was not due to a valency change of the iron. This conclusion is not justified, since the potential of dicyanide iron porphyrin is higher than that of the free hematin (Chapter V, 6.3.) and there is thus no reason why dicyanide ferriporphyrin should not oxidize cysteine, though more slowly than hematin.

Krebs also used ferrocysteine as hydrogen donor, so that part of the observed inhibition may have been due to the reaction of cyanide with this, not with hematin. A further source of error may have been reaction of cyanide with the cystine, retransforming part of the latter into cysteine and removing cyanide from the reaction mixture. Thus Wright and Alstyne

(*3127*) observed that cystine did not take up oxygen in the presence of hematin, but did so if cyanide also was present. Haurowitz (*1171*), however, found also no evidence for a valency change in the hematin catalysis of hydrogen sulfide oxidation. The hemochrome-catalyzed oxidation of benzaldehyde is cyanide sensitive (*1617*).

The catalysis of fatty acid or linseed oil oxidation by hematin is still more obscure. It takes place in a heterogeneous system (oil-water emulsion). There is no evidence of a valency change; and the destruction which the hematin undergoes in the process points to a peroxidative reaction. It is often not easy to distinguish between a true oxidative and a peroxidative process. There is, however, in this case no independent evidence for peroxide formation.

Barron and Lyman (*187*) observed that cyanide inhibited this catalysis completely only in a narrow pH range (9.2 to 9.5). They tried to explain this by assuming that the inhibitor is free hydrocyanic acid (pK of 9.1) and that it inhibits the catalytic action of the cyanide ferroporphyrin-cyanide ferriporphyrin system, not that of the heme-hematin system. This explanation does not appear to be in accord with later findings on the pH stability of cyanide ferroporphyrin and cyanide ferriporphyrin (Chapter V, 6.3.). Hematin also catalyzes the oxidation of ergosterol (*1929*). Bergel (*219*) assumes the formation of peroxides of tertiary amino acids in the hematin-catalyzed oxidation of these substances.

Combination of hematin with bases to form hemochromes does not raise the oxidative efficiency to a very marked extent.

In hematin-catalyzed fatty acid oxidation, the effect of the bases is small and nicotine even inhibits the oxidation (*179*). The effect is also small in glutathione oxidation (*1794*) but somewhat larger in the oxidation of cysteine. Here pilocarpine hemochrome is about four times as active as free hematin (*1644*), pyridine hemochrome eleven times, and nicotine hemochrome twenty-eight times (*1579*). The catalytic effect of pyridine hemochrome on benzaldehyde oxidation was found to be about fifty times as strong as that of hematin (*1927*). Hemochrome systems are far more effective catalysts than free hematin for the oxidation of ascorbic acid, but this is due to the fact that they have the necessary high oxidation-reduction potential (*179*). As catalysts of the oxidation of ascorbic acid, hemochromes are only about half as effective as copper.

As is to be expected, hemoglobin has not been found to be a very effective oxidative catalyst (*1253, 2289, 2563*). It has been observed to catalyze the oxidation of phospholipides (*2563*)*; this reaction is not accelerated by cytochrome c. In Chapter X other reactions will be discussed in which hemoglobin acts as oxidative catalyst, being destroyed in the process (coupled oxidation).

* This is also true for unsaturated fats (Watts and Peng, *3004a*).

3. THE CYTOCHROME SYSTEM

3.1. Introduction

Fischer established the wide distribution of hematin compounds in the cells of plants, animals, and microorganisms (879). For the development of our knowledge on the biological role of these substances in cell respiration, however, chemical methods do not suffice. Rapid progress could only be made when other methods were applied to the problem which are far more sensitive, which do not damage the unstable cell compounds, and which interfere little with the life of the cell. Two such methods were used, both of general applicability at least in principle.

Spectroscopic investigation with refined methods led Keilin to a rediscovery of hemochrome-like substances in living cells which he called *cytochromes*. His method is based on the known spectroscopic properties of the simpler synthetic hemochromes, discussed in Chapter V, and particularly on the fact that the absorption bands of the hemochromes are sharper and more intense than those of the hemichromes. Thus it becomes possible to study reduction and oxidation of the cytochromes in the living cell.

In the second type of method use is made of the fact that the rate of a catalyzed reaction is in general proportional to the concentration of the catalyst. Warburg observed that cell respiration is inhibited by cyanide and carbon monoxide, substances which are known to combine with iron compounds. In Chapter V we have discussed the combination of these substances with hematin compounds. Warburg developed an ingenious method by which the absorption spectrum of the carbon monoxide compound of the *respiratory ferment* can be measured photochemically by studying the inhibitory effect of carbon monoxide on cell respiration in the dark and the diminution of this effect by irradiation (*cf.* Chapter II).

Both methods have complemented each other. We realize now that the study by inhibitors alone could not have thrown much light on the structure and role of the cytochromes, while the extremely small concentration of the respiratory ferment in most cells probably overtaxes the sensitivity of direct spectroscopic observation, except in the case of yeast and other microorganisms. Some recent developments give hope that it may become possible in the future to correlate spectra observed directly with those obtained by the photochemical method, but at present this cannot yet be done satisfactorily.

3.2. Spectroscopic Observations on Cytochromes

The first to observe the cytochromes spectroscopically was MacMunn (1833,1836-1838). He called them histohematin, or, since he also observed them in the muscle, myohematin. Premature attempts at isolation from the cell led to a confusion with myohemoglobin (1069,1725) and to criticism of the work by Hoppe-Seyler. MacMunn's observations remained practically forgotten for more than thirty years, when Keilin (1474,1475) confirmed and greatly extended them by careful microspectroscopic studies. Keilin's observations were immediately confirmed by Schumm's work (2498). In bakers' yeast Keilin found the following four-banded absorption spectrum, the fourth band having apparently three maxima: a, 604; b, 566; c, 550; and d, 532, 528, and 521 $m\mu$.

On vigorous aeration these bands disappeared, while on exclusion from air or reduction they reappeared. If the respiratory ferment is poisoned by cyanide, the cytochrome bands become strong; the dehydrogenase systems of the cells in conjunction with other non-hematin catalysts reduce the hemichromes to hemochromes. The disappearance of the bands on aeration is in fact no total disappearance, but the hemichrome absorption bands are too faint and indistinct to be seen in the usual manner in the microspectroscope. Occasionally the hemichrome bands of ferrocytochrome c (566.5 $m\mu$; stronger, 529 $m\mu$) may have been mistaken for hemochrome bands of cytochromes b (*cf.* 2079, p. 150; 2843).

The close relationship of the spectrum given above to the two-banded hemochrome spectrum is not immediately apparent. Keilin correlated the bands in the following manner (1476):

| Cytochrome | α , $m\mu$ | β , $m\mu$ |
|------------|-------------------|------------------|
| a | 604 | 532 |
| b | 566 | 528 |
| c | 550 | 521 |

This correlation was later proved to be correct for cytochrome c and probably for cytochrome b, although the β band of cytochrome c itself displays a light cancellation (597,1477). That cytochrome a has a second absorption band in the visible region is not clearly proved (*cf.* Sect. 3.5.). The close relationship of the absorption spectrum of ferrocytochrome c to that of hemochromes with saturated side chains such as mesohemochrome, of ferrocytochrome b to that of a proto-

hemochrome (shifted slightly toward the red), and the somewhat less distinct relationship of ferrocytochrome a to that of a hemochrome with carbonyl groups in the porphyrin side chains is evident from the following comparison of the position of the absorption maxima in $m\mu$:

| | | | | | |
|----------------|-----|-----------------|-----|---------------------|-----|
| Cytochrome c | 550 | Cytochrome b | 566 | Cytochrome a | 604 |
| | 521 | | 528 | | 532 |
| Pyridine | 547 | Protohemochrome | 558 | <i>Spirographis</i> | 582 |
| mesohemochrome | 518 | | 530 | hemochrome | 538 |

In addition to the above-mentioned absorption bands, three bands were found in the far violet at 448–449, 428–432, and 415–417 $m\mu$ (1479, 2951, 2956). These are ascribed to the cytochromes a, b, and c, respectively. It will be seen later that in the presence of carbon monoxide no such simple correlation is possible. Pyridine leaves the c band unaltered, but shifts the a and b bands to shorter wavelengths. These bands were designated a', b', and c' by Keilin. The a' band has now a position close to the first band of pyridine *Spirographis* hemochrome and the b' band to that of pyridine protohemochrome (1474, 1475).

Keilin (1474, 1476, 1479, 1481, 1484) and other workers, notably Fujita and Kodama (962), have studied a large number of cells of animals, plants, and microorganisms. Only in strict anaerobes and in a few facultative anaerobes (*Streptococcus lactis*, *Lactobacillus delbrueckii*, *L. acidophilus*) are the cytochrome bands entirely missing. While the absorption spectrum described above for bakers' yeast is the one most frequently found, some of the bands are lacking in some species (2625, p. 29) or are replaced by other bands which are ascribed to substances named cytochromes a₂, a₁, and b₁. These spectra are more commonly found in microorganisms, but also occur in some invertebrates, plants, and in the cells of a few mammalian tissues. It is necessary to keep in mind that with the exception of cytochrome c the various cytochromes are as yet spectroscopic phenomena rather than definite substances. The position of the bands is given by Fujita and Kodama as follows:

| Cytochrome | Band, $m\mu$ | Cytochrome | Band, $m\mu$ |
|----------------|--------------|----------------|--------------|
| a ₂ | 635–625 | b | 567–558 |
| a | 605'–600 | b ₁ | 563–552 |
| a ₁ | 595–587 | c | 555–547 |

It is evident from this that the spectroscopic distinction between b and b_1 , and to a smaller extent that between b_1 and c , is not always possible. Moreover, in a mixture of two compounds the absorption maxima of which are not far apart, the two bands can appear as one of intermediate position. Thus Yamaguchi (3146) claimed the presence of cytochrome c in *Escherichia coli*, while Keilin and Harpley (1484), using spectroscopy at the temperature of liquid air, established its absence.

Table I contains a classification of various microorganisms based on their cytochrome spectrum, which is mainly derived from the paper of Fujita and Kodama (962).

TABLE I
Cytochrome Spectra of Microorganisms

| Cytochrome | Microorganisms |
|----------------------------|-------------------------------------------------------------------------------------------------------------------------------------------------------------------------------------------------------------------------------------------------------------------------------------------|
| a, b, c | |
| c prevailing. | <i>Saccharomyces cerevisiae</i> (bakers' and aerobic brewers' yeast), <i>Neisseria gonorrhoeae</i> , <i>N. intracellularis</i> , <i>Hemophilus pertussis</i> , <i>Bacillus subtilis</i> , <i>Serratia marcescens</i> |
| $b = c$ | <i>Pseudomonas fluorescens</i> , <i>Ps. aeruginosa</i> (<i>pyocyanea</i>) |
| $b > c$ | <i>Corynebacterium diphtheriae</i> , <i>Mycobacterium tuberculosis</i> , <i>Hemophilus influenzae</i> , <i>Bacillus anthracis</i> , <i>Sarcina</i> |
| a, b_1 | <i>Staphylococcus</i> |
| a_1, b, c | <i>S. cerevisiae</i> (anaerobic brewers' yeast), <i>Vibrio cholerae</i> , <i>Alcaligenes faecalis</i> |
| a_2, a_1, b, c | <i>Acetobacter pasteurianum</i> , <i>A. aceti</i> , <i>Azotobacter</i> |
| a_2, a_1, b_1 | Many facultative anaerobes and most pathogenic intestinal bacteria. <i>Escherichia coli</i> , <i>E. metacoli</i> , <i>Shigella dysenteriae</i> , <i>S. paradysenteriae</i> , <i>Eberthella typhosa</i> , <i>Salmonella paratyphi</i> , <i>S. abortivoequina</i> , <i>Proteus vulgaris</i> |

Keilin (1480,1481) drew attention to the fact that the bacteria contain either cytochrome a or a_1 and a_2 . Later he showed, however, that "cytochrome a " is a mixture of two compounds, cytochromes a and a_3 , the latter resembling cytochrome a_1 more closely in its behavior than cytochrome a . Since these observations are of importance for the theory of the respiratory enzyme they will be discussed in this connection below. Cytochrome a_1 predominates in *Acetobacter* (*Bacterium*) *pasteurianum*, in which it was discovered by Warburg and Negelein (2955). It also occurs in brewers' yeast (660,766,2307,2954) and a somewhat similar band has been observed in bakers' yeast treated with caprylic alcohol (1480). Cytochrome a_2 was discovered

by Negelein and Gerischer (2024,2025) in *Azotobacter*. It predominates over cytochrome a₁ in *Azotobacter*, *Escherichia coli*, *Proteus* and *Shigella dysenteriae* (cf. also 962,1480,1481,3149).

Another cytochrome (c₁) with absorption bands lying slightly more toward the red has been found in heart muscle by Yakushiji and Okunuki (3144). This is confirmed by Theorell (2778). The oxidation-reduction potential is said to lie between those of cytochrome c and cytochrome b.

3.3. Cytochrome c

3.3.1. Isolation, Properties, and Estimation. *Isolation.* Of all these compounds only cytochrome c has so far been isolated from the cell and obtained in pure state. This is facilitated by its remarkable stability. Although of protein nature, it is not denatured by treatment with strong acids and is heat stable. Keilin (1284,1477) extracted cytochrome c from plasmolyzed yeast with sodium bisulfite and dithionite and precipitated it with sulfur dioxide in the presence of calcium chloride. Adsorption of cytochrome to kaolin was applied by Zeile and Reuter (3171). Oxidized cytochrome is readily adsorbed on kaolin, while reduced cytochrome is not; the enzyme can thus be easily eluted from the cytochrome adsorbate by reduction. This difference in adsorbability is not yet explained. Yakushiji (3141) reports an isolation from higher plants and from algae, and Goddard (1014) from commercial wheat germ. A purer cytochrome c was obtained from ox or horse heart by Theorell (2764,2766) and Keilin (1488,1500). Theorell used extraction with 0.1 N sulfuric acid, adsorption to barium sulfate, acetone precipitation, and adsorption on cellophane; while Keilin and Hartree extracted with trichloroacetic acid and purified by fractional ammonium sulfate precipitation. Both methods lead to a cytochrome c with 0.34% iron. This corresponds to a molecular weight of 16,500* (cf. Roche, Derrien, and Cahnmann, 2315a).

By submitting such preparations to electrophoresis, Theorell and Åkesson (2781,2782) found that below the isoelectric point of cytochrome c (pH 10.05) they appeared to be homogeneous, while at a higher pH (10.68) a colorless protein or peptide could be separated from the cytochrome c. The latter now contained more iron (0.43%). By fractional precipitation with ammonium sulfate at pH 10, Keilin and Hartree (1500) have recently obtained a cytochrome c with this iron content. The catalytic activity is increased by these procedures,

the activity per atom of iron remaining unaltered. Since cytochrome c is a rather strong base with an isoelectric point of 10.05 (2782), it may be combined in the cell with a protein or peptide of more acidic properties. It remains uncertain whether the cytochrome c with 0.34% iron still contains this original peptide, or a part of it, or whether the peptide has been introduced during the preparation. The constant iron content and the fact that the peptide group cannot be removed at a pH below the isoelectric point make it improbable that it is a mere admixture.

Properties. Cytochrome c is stable to dilute acids, even mineral acids, 0.1 N alkali, and boiling. At physiological pH it is not autoxidizable and does not react with carbon monoxide, hydrogen sulfide, azide,* or hydroxylamine (1479, 1488, 1493, 2782). The slight reversible spectral shift by carbon monoxide observed by Altschul and Hogness (43) was probably caused by impurities. Stotz, Altschul, and Hogness (2677) showed that in the complete system, only cytochrome oxidase, not cytochrome c, reacts with carbon monoxide. At pH above 11.5 and below 4, however, cytochrome c is modified to give autoxidizable compounds which react with carbon monoxide. In contradistinction to Keilin, Potter (2176) found a small effect of cyanide on the absorption spectrum of ferricytochrome c and an inhibition of the reduction of the latter by the succinic dehydrogenase system, though not under all conditions (2179). This has recently been confirmed by Horecker and Kornberg (1347), who have clearly demonstrated the formation of a dissociable cyanide compound. The absorption band at 692.5 m μ of ferricytochrome c is abolished by its combination with cyanide. The reaction is, however, much slower than that of the oxidase with cyanide, and, at least under normal conditions, plays no part in the cyanide inhibition of respiration (cf. 2677). Ferricytochrome c also combines with nitric oxide (1488) to form a compound with two equally strong absorption bands (563 and 527 m μ). Ferricyanide and cupric ions oxidize ferrocytochrome c to ferricytochrome, while hydrogen activated by platinum or palladium, dithionite, cysteine, *p*-phenylenediamine, ascorbic acid, catechol, pyrogallol, and succinic dehydrogenase reduce ferricytochrome to ferrocytochrome.

Molecular weight. Cytochrome c contains only one hematin group per molecule. Zeile and Reuter (3171) found a molecular weight of

* An easily dissociable azide compound of ferricytochrome c has recently been found by Horecker and Stannard (1347a).

about 18,000 by differential adsorption of ferrocytochrome and ferricytochrome on kaolin; by diffusion methods Theorell (2766) found 16,500 for cytochrome c with 0.34% iron. Ultracentrifuge and osmometric methods yield similar results (8,2131). The molecular weight of pure cytochrome c with 0.43% iron is 13,000, (Pedersen, quoted by Theorell, 2778).

Absorption spectra. Data on the absorption spectra of cytochrome c are summarized in Table II.

It is doubtful whether the band at 316 $m\mu$ is a genuine band of cytochrome c. Schales and Behrnts-Jensen (2435) conclude from it that cytochrome c contains a sulfoxide (SO) group. Dithionite however, which is frequently used in the preparation of cytochrome or for reduction, has a band in this region. This band was not observed in cytochrome c by Lavin and collaborators (1662).

TABLE II
Absorption Spectra of Cytochrome c

| Compound | Absorption maxima ^a | | Reference |
|-------------------|--------------------------------|-------------------------|------------------------|
| | $m\mu$ | ϵ mM | |
| Ferrocytochrome c | 550 | 26 to 28 | 619,621,1488,2061,2766 |
| | 522 | 15.5 to 16.9 | |
| | 415 | 143 | 597,2766 |
| | 345 | | |
| | 316 | | |
| Ferricytochrome c | 565 | No distinct maximum | 597,2766 |
| | 530 | 9.4 to 9.7 ^b | |
| | 407 | 112 | |
| | 346 | | |

^a On the basis of one gram equivalent iron per liter.

^b Theorell (2766) found a higher value (12.0).

Oxidation-reduction potentials. There is now little doubt that the potential found by Green (1043) for a cytochrome c prepared from yeast ($E'_0 = + 0.125$, pH 7.14) was far too low. The earlier value $+ 0.26$ found by Coolidge (486) in Conant's laboratory has been confirmed by several authors (123,1634,2680,3132,3133). Between pH 5 and 8 it does not vary with pH.

Estimation. Three methods are available for the estimation of cytochrome c in tissues. The first measures its catalytic effect on the oxidation of substrates such as hydroquinone in the presence of an excess of cytochrome oxidase and of semicarbazide, which combines with the quinone (1446,1447,2674). In the second, cytochrome c is extracted and freed from accompany-

ing hemoglobin and other impurities (960,2334,2768). In the resulting solution the absorption of ferrocytochrome c is determined spectrophotometrically. Finally cytochrome c may be extracted, and the difference of the absorption of ferrocytochrome c and ferricytochrome c in the extract may be determined spectrophotometrically (2179). This method, which is preferable to the second, uses a kidney preparation containing both cytochrome oxidase and dehydrogenases in excess. Without substrate ferrocytochrome is thus oxidized to ferricytochrome while in the presence of substrate and of cyanide to poison the oxidase, cytochrome c is fully reduced.

3.3.2. Nature of the Active Center of Cytochrome c and Its Linkage to Protein. By action of sulfur dioxide on cytochrome c, Hill and Keilin (1284) had obtained a water-soluble, ether-insoluble "porphyrin c." By treatment with hydrobromic acid in acetic acid this yielded hematoporphyrin, which Zeile and Reuter (3171) transformed to mesoporphyrin IX. The arrangement of the side chains on the porphin nucleus of cytochrome c is thus identical with that in protoporphyrin and hemoglobin. Theorell (2768,2769) showed that "porphyrin c" of Hill and Keilin still contained peptide groups. On further hydrolysis it lost much amino nitrogen, but not its sulfur. The new porphyrin c contained two sulfur atoms in thioether linkage and two primary amino groups. Two of the carboxylic acid groups (those of the propionic acid side chains) were found to have a pK 5.7, while two additional amino acid carboxyl groups of the cysteine were only weakly acid (pK 9.22). The compound split off by hydrobromic

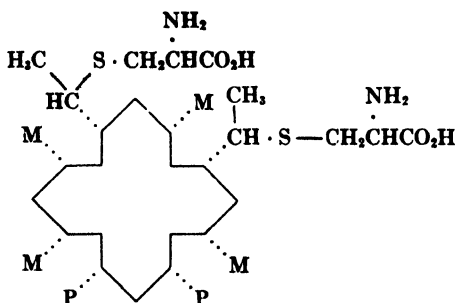

Fig. 1. Porphyrin c from cytochrome c.

acid in acetic acid was identified as *L*-cystine (2770). The position of the hemochrome bands of cytochrome c shows that it contains no vinyl side chains (*cf.* 621). Theorell concluded from these results

that porphyrin c has the structure of a protoporphyrin to each of whose vinyl groups one molecule of L-cysteine has been added (Fig. 1).

Theorell later came to doubt this structure, when he found that protoporphyrin under the conditions of the hydrolysis was able to add two molecules of cysteine and was transformed to porphyrin c (2770). Zeile and Meyer (3162,3167,3168) have shown, however, that porphyrin c can be obtained by hydrolysis of cytochrome c under conditions in which its synthesis from protoporphyrin and cysteine does not occur. The optical activity of the product from cytochrome c differs from that of the protoporphyrin cysteine adduct. It is therefore likely that the cysteine porphyrin of cytochrome c is not an artifact, although the observation of Theorell that, on short hydrolysis, compounds with less than two atoms of sulfur per atom of iron could be obtained is still difficult to explain.

In cytochrome c itself, the cysteine forms part of the protein in which it is bound by peptide linkages. It is evident from this that cytochrome c does not contain a separable prosthetic group, but an active hematin center combined by thioether linkage to the protein. The firm linkage between iron porphyrin and protein explains the great stability to acids and alkalis. It is even possible to remove the iron without breaking this linkage; this is achieved by treatment with 0.1 *N* hydrochloric acid in the presence of substances which keep the iron in the ferrous state, such as hydrogen activated by platinum (3162).

The hemochrome type of spectrum of cytochrome c must be accounted for by linkages between the iron atom of the heme and nitrogenous groups. These linkages are more easily broken than the thioether linkages attaching the heme to the protein, their rupture occurring below *pH* 3 and above *pH* 11. At *pH* 0 to 1, cytochrome c is transformed to an "acid hematin."

Theorell showed that the nitrogenous groups concerned in these linkages were part of the same protein as was involved in the thioether linkages to the vinyl side chains. Were they contained in bases of small molecular weight, these bases should be removed by dialysis of cytochrome c in acid solution; it is found, however, that if the dialyzed acid solution is neutralized, cytochrome c is re-formed. Were they parts of protein molecules, other than those attached firmly to the hematin side chains, the ultracentrifuge should separate two components in acid solution and indicate a decrease of molecular weight of the cytochrome; this however, was not found. The protein is thus bound to the hematin center by four linkages, two stable thioether linkages to the side chains and two less stable hemochrome

linkages to the iron. Lemberg (1683) pointed out that the hemochrome structure of cytochrome c can only be explained by assuming that the heme is bound in a crevice of the protein molecule, in which it is firmly anchored by the thioether linkages. Theorell assumes that this rigid structure explains why cytochrome c does not react with oxygen or carbon monoxide.

Zeile and Meyer (3167) showed that the iron-linked groups of the proteins might be the primary amino groups of the cysteine molecules whose sulfur atoms are attached to the side chains; on reduction, the hematin of the cysteine adduct of protoporphyrin yields a hemochrome without addition of other nitrogenous substances. Sterically a linkage such as is shown in Figure 2 is possible. This type of linkage does not appear to occur in cytochrome c, however.

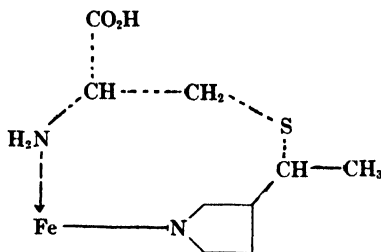

Fig. 2. Hemochrome c. The bonds indicated by dotted lines do not lie in the plane of the paper.

By spectrophotometric and magnetochemical investigations of ferricytochrome c and by differential titration of ferrocytochrome and ferricytochrome c from horse and ox heart, Theorell and Åkesson (2783-2785) conclude that two imidazole rings of histidine bound to the iron constitute the hemochrome linkage in cytochrome c. Cytochrome c contains three molecules of histidine. Two equivalents of ferricytochrome c are titrated between pH 5.5 and 8.5, the range in which the histidine imidazole is usually titrated, but the fact that the heat of dissociation is continually rising is interpreted by Theorell to indicate that only one of these two groups is histidine imidazole (*cf.* Chapter VI, 5.2.2.3.). In this range the relation between ferrocytochrome and ferricytochrome is normal, the solution becoming one equivalent more acid on reduction: $Fe^{3+} + H \rightarrow Fe^{2+} + H^+$. The titration curves of ferrocytochrome and ferricytochrome cross, however, at pH 9.6 (Fig. 3). Above this pH the solution becomes more alkaline on reduction. This indicates the presence in ferri-

cytochrome c of two hematin-linked acid groups with a pK close to 9.6, which is in good agreement with the pK of the imidazole group in imidazole hemoglobin, $pK = 9.5$ (2397). They cannot be α -amino acid groups as assumed by Zeile and Meyer. Evidently the pK of the same groups in ferrocyanochrome must be far higher and outside

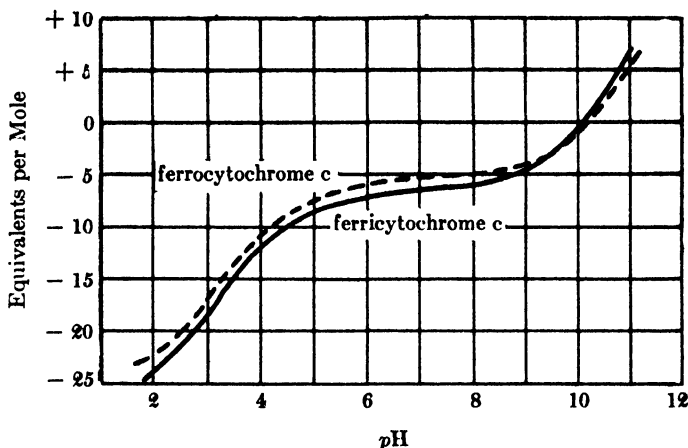

Fig. 3. Titration curves of ferrocyanochrome c and ferricytochrome c at 20°C. (after Theorell, 2778).







the range of the titration, which is rather remarkable. In this range spectrophotometry indicates only one pK of 9.35 for ferricytochrome c. In Table III the results of the investigations of Theorell are summarized together with his interpretation.*

There are several points in this scheme which require discussion. The magnetochemical results indicate that form V has only one free electron. In this it resembles hemichrome hydroxides (*cf.* Chapter V) rather than hemoglobin hydroxide, which has three free electrons. The absorption spectrum, however, differs from those of both hemichrome hydroxide and hemoglobin hydroxide.

Spectroscopic evidence was found for only one of the two dissociations III \rightarrow IVa and IVa \rightarrow IVb, the two forms IVa and IVb having apparently very similar spectra. The alterations in the spectra throughout the whole system are small and, being in the red region, must lie close to the limits of spectrophotometric procedure. The pK 9.35 is not considered that of the reaction $Fe^+ + OH^- \rightarrow FeOH$, since forms IVa and IVb do not react with cyanide (*cf.*, however, 1347).

* Recently, Theorell (2779a) found that measurements of the oxidation-reduction potential indicate another pK value of 6.86.

TABLE III
Forms of Ferricytochrome c at Various pH Values

| Form | I | II | III | IV _a | IV _b | V |
|---------------------------------------------------|-------------------------------------------------------------------------------------|------------------------------------------------------------------------------------|-----------------------------------------------------------------------------------|-----------------------------------------------------------------------------------|-----------------------------------------------------------------------------------|-----------------------------------------------------------------------------------|
| Assumed structure |  |  |  |  |  |  |
| Free electrons | 5 | 3-5 | 1 | 1 | 1 | 1 |
| Absorption bands, mμ | 685, (580), 590, 510 | 692, 595, 497 | 695, (655), (565), 590 | 565, 537 | 565, 536 | 565, 536 |
| Change of absorption | Isosbestic point 470 mμ | Isosbestic point 650 mμ | Isosbestic point 650 mμ | Isosbestic point 650 mμ | Isosbestic point 650 mμ | Isosbestic point 650 mμ |
| Similar compounds | Acid hematin | Hemiglobin | Hemichrome | Hemichrome | Hemichrome | Hemiglobin hydroxide |
| Compounds of Fe ²⁺ (Free electrons) | — | Fe ²⁺ F at pH 3 ^a (5) | — | — | — | Fe ²⁺ CN, Fe ²⁺ F (1) (5) |
| Compounds of Fe ³⁺ (Free electrons) | CO (None) | — | — | — | — | Fe ³⁺ CO (None) |

^a The fluoride exists only in a narrow pH range, since above pH 3 the concentration of form II decreases, while below pH 3, H₂F₂ is formed. It resembles hemoglobin fluoride, its absorption bands lying 5-7 mμ more toward the ultraviolet.

The lack in ferrocyclochrome c of the pK values ascribed to imidazole is not explained. It appears likely to us that in ferrocyclochrome c the resonance form *A* greatly prevails over *B* or intermediate forms.

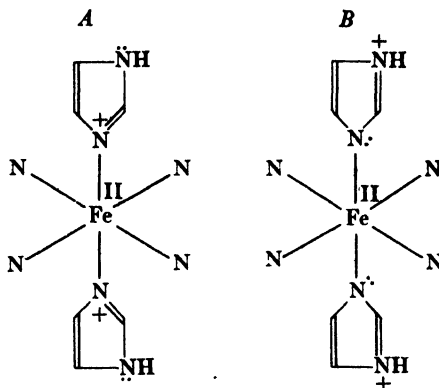

The dissociation of a proton from form *A* can be compared with that of pyrrole as acid, while that of a proton from form *B* is comparable to the dissociation of a pyridinium ion (*cf.* Chapter VI, 3.2.2.4.). If form *A* greatly prevails, the pK may become very high.

Form II resembles hemoglobin in its structure, its absorption spectrum (with the shift of the bands toward the ultraviolet caused by the saturation of the unsaturated side chains of the hematic) and its magnetic susceptibility. Like hemoglobin it forms a fluoride compound the absorption spectrum of which resembles that of hemoglobin fluoride.

Form III of ferricytochrome as formulated by Theorell would be expected to have the same high pK value as ferrocyclochrome c. Its lower pK value may be due to prevalence of the resonating forms IIIA and IIIB.

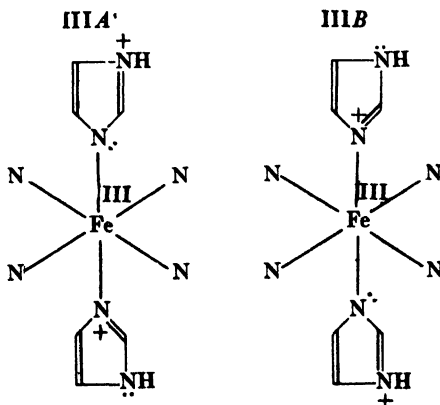

The dissociations III \rightarrow II and II \rightarrow I are not comparable with dissociations of imidazolium ions. They probably involve changes in the protein molecule comparable to those occurring when hemoglobin is transformed to "acid hematin"; these changes have not yet been studied potentiometrically. They are reversible even in hemoglobin; for cytochrome c, with its thioether linkages remaining intact, this reversibility is to be expected. The scheme does not explain why on reduction of forms I, II, and V the neutral hemochrome spectrum reappears, although changes in autoxidizability and reaction with carbon monoxide are found.

On heating, ferricytochrome c is reversibly dissociated. The hemochrome spectrum disappears, but returns on cooling.

In alkaline solution one molecule of cytochrome c is still able to combine with four additional molecules of protoheme giving mixed cytochrome c-protohemochromes (3165). Since the affinity between the thioether-linked heme and the hemochrome-forming histidines is too great to allow other hemes to compete, and since anyhow only three histidine imidazoles are present, it is evident that the additional protohemes must be bound by groups other than the histidine imidazoles.

Theorell (2776) has pointed out that the reaction of the ferric iron of ferricytochrome with hydrogen donors may be facilitated by the formation of semiquinoid structures in the covalently linked imidazole groups. Theorell formulates this:

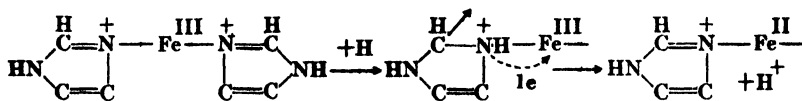

This can perhaps more clearly be put in the following way:

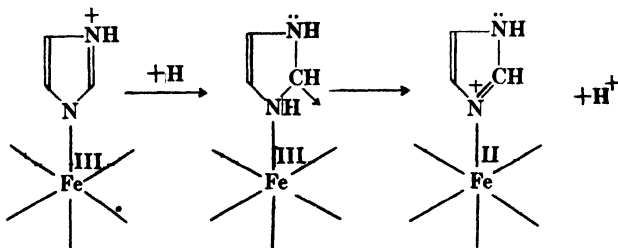

3.3.3. Protein of Cytochrome c. The amino acid composition of cytochrome c has been studied by Theorell and Åkesson (2787) and is given in Table IV. Cytochrome c contains six atoms of sulfur. The table shown

does not account for two of these, which are probably methionine; Åkesson (31) had found two molecules of this amino acid in cytochrome c. The protein of cytochrome c is remarkably high in lysine, which explains the high

TABLE IV
Amino Acid Composition of Cytochrome c^a

| Amino acid | Molecules | N atoms |
|----------------|-----------|----------------------------|
| (Porphyrin c) | 1 | 6 |
| Histidine | 3 | 9 |
| Arginine | 2 | 8 |
| Lysine | 22 | 44 |
| Cysteine | 1 | 2 |
| Tyrosine | 5 | 5 |
| Tryptophane | 1 | 2 |
| Glutamic acid | 19 | 19 |
| Aspartic acid | | |
| Amide nitrogen | 8 | 8 |
| Leucine | 9 | 9 |
| Isoleucine | | |
| Phenylalanine | | |
| Alanine | | |
| Glycine | 33 | 33 |
| Valine | | |
| Hydroxyvaline | | |
| <i>Total</i> | | 145 (101.5% of total N) |

^a According to Theorell and Åkesson (2782).

isoelectric point, and low in histidine and tryptophane. It is of interest that cytochrome c contains nine to ten free amino groups more than correspond to its lysine content; this indicates a branched arrangement of short polypeptide chains.

Neurath (2045) gives a frictional ratio of 5.4 for anhydrous, and 3.1 for hydrated cytochrome c.

On a water-air interface cytochrome c forms monolayers of 3.5 Å thickness at its isoelectric point (1128, 1425). Alterations below pH 3 and above pH 12 are indicated by greater compressibility of the films. The ferric form spreads more rapidly than the ferrous, while the opposite holds for hemoglobin and myohemoglobin.

Bechtold's (197, 198) erroneous claims that myohemoglobin can be reversibly transformed to cytochrome c are partly due to a confusion of cytochrome c and mixed hemochromes (*cf.* Chapter VI, Section 2.4.4.), partly to a reduc-

tion of the vinyl side chains of myohemoglobin by hydrazine, and partly to the formation of "hematin c" by the action of dithionite (*cf.* Chapter V, Section 8.4.).

3.4. Cytochromes b

The nomenclature of the cytochromes b (b, b₁) perhaps puts too much stress on small spectroscopic differences which may be due to the fact that the same heme (probably protoheme) is bound to different specific bearer proteins in different species. A variety of cytochromes b may thus exist with their absorption bands lying between those reported for cytochromes "b" and "b₁." So far none of the spectroscopically visible cytochromes b has been obtained pure; it is even dubious whether any has been extracted unmodified from the cell except the cytochrome b₁ from yeast.

Yakushiji and Mori (3142) claimed to have obtained cytochrome b in water-soluble form. These authors consider it a compound of protoheme with a flavoprotein. Von Euler and Hellström (715) extracted heart muscle with sodium cholate, and, by ammonium sulfate precipitation and elution of the precipitate with secondary phosphate, claimed to have obtained cytochrome b free from oxidase and cytochromes a and c. These claims have been disputed by Keilin and Hartree (1494).

Cytochromes b appear to be thermolabile, autoxidizable substances which do not combine with cyanide or carbon monoxide (257,1476, 1493,2681). The absorption band disappears at 65° C. (713). It is still doubtful whether the autoxidizability of cytochrome b plays a biological role. The fact that in the presence of cyanide the cytochrome b₁ band of *Escherichia coli* or *Proteus vulgaris* does not disappear on aeration (1481) indicates that cytochrome b does not act as an independent oxidase.

Cytochrome b is reduced by the succinic dehydrogenase system much faster than by *p*-phenylenediamine, ascorbic acid, or adrenaline (1494); it is not reduced by hydroquinone (2681). By spectroscopic observation in the cell, Ball (123) found the oxidation-reduction potential of cytochrome b to be far lower than that of cytochrome c ($E'_0 = 0.05$ at pH 7 and 30°). To judge from this cytochrome b may play a role as a hydrogen carrier between cytochrome c and dehydrogenase systems. Keilin and Hartree (1494) postulated such a role in succinic acid oxidation, and this is supported by experiments of von Euler (715). Von Euler found cytochrome b also necessary for the oxidation of the lactic acid dehydrogenase-diaphorase system (715) and Potter and Lockhart (2181) for the reaction between cytochrome c and diaphorase. Nevertheless decisive evidence for the function of cytochrome b is still required.

If respiration is inhibited by narcotics, the absorption band of reduced cytochrome b remains visible, while those of cytochromes a and c disappear (1491,1493,1943,2734). From this Tamiya and Ogura (2734) concluded that cytochrome b is normally oxidized by cytochrome a, acting as carrier between cytochrome c and cytochrome b; cytochrome a was assumed to react with the narcotics. Cytochrome b is, however, kept reduced in the presence of narcotics only by dehydrogenase systems, not by other reducing substances such as *p*-phenylenediamine. Keilin and Hartree (1491,1493) interpreted these results therefore by assuming that a complex between cytochrome b and dehydrogenase is formed, and by the action of narcotics is made inaccessible to ferricytochrome c. The position of cytochrome c between cytochromes a and b in the reaction chain is, indeed, in better agreement with the oxidation-reduction potentials of the cytochromes (*cf.* Section 5.2.).

In adrenal medulla Huszák (1377) has observed a cytochrome b_1 (absorption band at 559 $m\mu$) and a peroxidase with a broad indistinct absorption band at 559–553 $m\mu$ which, unlike the cytochromes, reacts with carbon monoxide (Chapter IX, Section 3.5.).

Cytochrome b_2 . A water-soluble cytochrome b has been found in purified yeast lactic acid dehydrogenase, which is quite different from the lactic acid dehydrogenase of mammals; it has been called cytochrome b_2 (Bach and co-workers, 112,113; Haas and co-workers, 1077). Its absorption bands lie at 560.5 $m\mu$ and 530 $m\mu$, but its concentration in the yeast cell is too small for spectroscopic observation. The Soret band lies at 420 $m\mu$ for the ferrous, at 410 $m\mu$ for the ferric enzyme.

Cytochrome b_2 appears to be an integral part of the yeast lactic acid dehydrogenase and does not contain a flavoprotein. With pyridine it gives pyridine protohemochrome. The same result had been found by Roche (2304) for the cytochrome b of *Actinia*. It is likely that the protohemin isolated by Fischer from various cells originated from cytochrome b.

Cytochrome b_2 oxidizes lactate, but does not react with cytochrome c (113). According to Haas and collaborators (1077) it is also reduced by the hexose-6-phosphate dehydrogenase system, while Gale (978) observed reduction by the formic acid dehydrogenase system in *Escherichia coli*. These claims have not been confirmed by Bach and co-workers. "Cytochrome b_2 " may be a mixture of cytochrome b_2 and lactic dehydrogenase, or it may contain protoheme bound to the dehydrogenase.

If the latter is found to be correct, "cytochrome b" may be a mixture of similar protoheme dehydrogenase compounds. The vari-

ations in the position of the absorption bands in different cells would then be a result of the presence of different protoheme dehydrogenase compounds, or of a mixture of them in different proportion. If these cytochromes b combine in *E. coli* with cytochrome a_2 , the latter acting as oxidase, the different sensitivities to carbon monoxide poisoning of succinate, lactate, and formate oxidation (Cook, Haldane, and Mapson, 485) would be explained in terms of different carbon monoxide affinities of the symplexes cytochrome a_2 -cytochrome b-succinic dehydrogenase, cytochrome a_2 -cytochrome b-lactic dehydrogenase, and cytochrome a_2 -cytochrome b-formic dehydrogenase. A similar explanation has already been suggested by Keilin (1484). So far this has been demonstrated as probable only for yeast and *E. coli*. In other cells, cytochromes b independent of dehydrogenases may exist.

3.5. Cytochrome a

Keilin had described cytochrome a as a compound which was not autoxidizable and did not combine with carbon monoxide or cyanide. Later Ball (123) found that the absorption band at 600-605 $m\mu$ did not behave homogeneously on oxidation with ferricyanide; the major part of the absorption disappeared, but a weaker band at 595 $m\mu$ remained. Keilin and Hartree (1492, 1493) found that the band at 600-605 $m\mu$ was due to two compounds, one of which (again called cytochrome a) was not autoxidizable and did not combine with carbon monoxide, while the other, called cytochrome a_3 , was autoxidizable and combined with carbon monoxide.

Using the observation of Keilin and Hartree (1493) that 2% sodium cholate clears the suspensions of cytochrome oxidase preparations, Straub (2684) and Yakushiji and Okunuki (3143, cf. 2655) have obtained solutions of the cytochromes a from heart tissue, using extraction with sodium cholate and secondary phosphate, followed by fractional precipitation with ammonium sulfate. Such solutions still show the Tyndall phenomenon. They contain both cytochromes a and a_3 (cf. Sections 3.6.4. and 3.6.5.).

Both cytochromes a and a_3 yield the same pyridine hemochrome, and this probably also holds for the cytochrome a of bacteria. Negelein (2021) obtained a porphyrin from pigeon muscle which gave a hemochrome with two absorption bands at 582 and 532 $m\mu$. This "cryptoporphyrin" was later (2022) claimed by Negelein to be an artifact,

arising from autoxidation of protoporphyrin in hydrochloric acid. It may perhaps contain one acetyl and one vinyl group as side chains. Later again Negelein (2023) isolated a different hematin from pigeon breast muscle and heart. The hematin solution in acetone-hydrochloric acid had an absorption band at 675 $m\mu$. After further treatment it was finally separated from protohematin, and its pyridine hemochrome, which was obtained crystalline, showed only one absorption band (587 $m\mu$) in the visible part of the spectrum. Like the *Spirographis* hematin the new hematin was converted by methanol treatment to a hemochrome with an absorption band at 558 $m\mu$; from this hemochrome it could be re-formed by treatment with acid acetone. Roche and Bénévent (2307) have repeated these experiments with somewhat different results. According to the conditions, they obtained either a hematin the hemochrome of which showed two absorption bands (582, 530 $m\mu$), or the hematin of Negelein, the hemochrome of which shows only the one band at 587 $m\mu$. They assume that the latter is an artifact, being formed from the former by secondary oxidation. On standing of the hemin in aqueous acetone, the 530- $m\mu$ band of the hemochrome decreased. If a two-banded hemochrome exists, it is certainly different from the "cryptohemochrome" Negelein obtained from protoporphyrin (1698a). *Spirographis* pyridine hemochrome has a very weak second absorption band 538 $m\mu$. In view of the importance of these hematins in relation to cytochrome a and the respiratory ferment, a reinvestigation, with special precautions to avoid autoxidative processes, is urgently required.

From spectroscopic observations on the cell, Ball (123) found the oxidation-reduction potential of cytochrome a to be + 0.29 (pH 7.4, 20°). This value is less certain than those for the cytochromes c and b.

In the cells of certain microorganisms, the cytochrome a band is absent and is replaced by bands described as those of cytochromes a_1 and a_2 (cf. Sections 3.6.3. and 3.6.6.). Because of this replacement Keilin (1479, 1480) considered these substances to be cytochromes, not respiratory ferments, but since he later discovered that his earlier cytochrome a was a mixture of nonautoxidizable cytochrome a with the respiratory ferment cytochrome a_3 , this argument has lost its validity. The biological significance of the cytochromes a_1 , a_2 , and a_3 is certainly different from that of the other cytochromes and these substances will therefore be discussed in greater detail in the next section dealing with the respiratory ferment.

3.6. The Respiratory Ferment and Cytochromes Related to It

3.6.1. The Respiratory Ferment. Shortly after the spectroscopic rediscovery of the cell hemochromes by Keilin, Warburg found evidence for the fundamental role played by a hematin compound in cell respiration. The idea that iron in some form was connected with cell respiration is very old. As early as 1843 von Liebig assumed that hemoglobin was the respiratory ferment, a theory which soon had to be abandoned. Inorganic iron was known to catalyze the autoxidation of cysteine and to be a peroxidative catalyst. After a series of model investigations by which he became convinced of the importance of heavy metal catalysis for the oxidation of biological substances, Warburg began the systematic study of the effect of inhibitors on the respiration of wild yeast (*Torula*) and other cells. He found it to be inhibited by cyanide (2917,2918,2920) and by carbon monoxide (2919) in the dark. Irradiation with light decreased the carbon monoxide inhibition. This was developed into an ingenious method for measuring the absorption spectrum of the carbon monoxide compound of the respiratory ferment (1592,2920-2922,2946-2950), the principle of which has been discussed in Chapter II. For reviews of these investigations see references 2924, 2928, and 2930.

Photochemical Absorption Spectrum of the Respiratory Ferment. In yeast and *Acetobacter pasteurianum* the following photochemical absorption spectrum was thus found: a very high (Soret) band at 432-433 $m\mu$ ($\epsilon_{mM} = 156$), a strong band at 283 $m\mu$ ($\epsilon_{mM} = 87$), and a fainter band at 590-593 $m\mu$ ($\epsilon_{mM} = 13.5$). There are also weak bands in the green which appear to be different for yeast and *Acetobacter* (cf. Section 3.6.3.). This absorption spectrum is very similar to that of carbon monoxide *Spirographis* hemoglobin, a hybrid hemoprotein synthesized from *Spirographis* hematin and globin (I, 594; II, 550 (weak); III, 434 $m\mu$, while that of carbon monoxide chlorocruorin, the naturally occurring hemoprotein, shows somewhat wider differences (I, 600; II, 552; III, 439 $m\mu$) (2954). The band at about 280 $m\mu$ is also found in carbon monoxide chlorocruorin, but not in carbon monoxide *Spirographis* hemoglobin. It is therefore unlikely that this band is due to the carbonyl group in the prosthetic group. While the position of the main band in the violet can be fairly accurately established by the photochemical method, this is unfortunately not so for the weak bands in the visible part of the spectrum. The

absorption coefficient, β , is given by Warburg as:

$$(1/cl) \ln (I/I_0)$$

with c in gram moles per gram; it must be multiplied by 2.3×10^{-6} in order to transform it to ϵ_{mM} , the unit used in this book. If this is done, the values are of the size usually found for hematin compounds. The concentrations of the catalyst is very small ($10^{-7} M$).

The photochemical spectrum of rat heart muscle oxidase was studied by Melnick (1907,1909) using succinate as substrate. The first absorption band (589 $m\mu$) was found in a position close to that of the yeast oxidase, but the Soret band was found at 450 $m\mu$. Another weak band at 510 $m\mu$ was observed.

While these results leave no doubt that these catalysts are hematin compounds of a nature somewhat different from that of protohematin, it must not be forgotten that the evidence is purely spectroscopic. The spectra suggest that the hematin is derived from a porphyrin with one or more carbonyl groups in the side chains. Not even this can be considered definitely proved. The unexpected spectra of the verdoperoxidase (Chapter IX, Section 3.6.), although not very similar to that of the respiratory ferment, are a warning that we do not yet know all types of hematin compounds. The reader should also refer to what has been said about "green" and "green-red" hemins in Chapter V. To draw conclusions from the spectrum as to the nature of these side chains, whether, for example, they are formyl or acetyl, or as to their position, is impossible; this should be clear, particularly if one remembers that the unknown protein bearer certainly has an influence on the spectrum.

3.6.2. Inhibitors. The distribution constant, K , of the respiratory ferment of yeast and acetic acid bacteria was found to be about 9. If this value is compared with the K of hemoglobin (0.01), it is seen that the relative affinity of the respiratory ferment for carbon monoxide is much smaller than that of hemoglobin. The toxicity of carbon monoxide for vertebrates is thus due to its combination with hemoglobin, not to its interference with tissue respiration.

Cyanide of the concentration $10^{-4} M$ inhibits the respiratory ferment completely.* In contrast to the inhibition by carbon monoxide, that by cyanide was found by Warburg to be independent of oxygen pressure (2920). Warburg explained this by assuming that only the

* In contrast to ferricytochrome c , hemoglobin, and other hematin compounds, cytochrome oxidase combines with undissociated hydrocyanic acid and hydrazoic acid, not with cyanide and azide ions; this was recently discovered by Stannard and Horecker (1347b).

ferric form of the enzyme reacts with cyanide. According to this view the catalytic cycle of the respiratory ferment and the action of inhibitors on it can be written diagrammatically as follows:

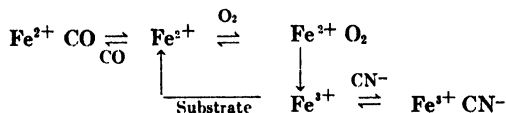

The substrate, as will be seen below, is generally cytochrome c.

If this is correct the enzyme behaves toward cyanide as does hemoglobin. It has been shown in Chapter VI, Section 2.2.5., that hemoglobin forms only a highly unstable compound with cyanide, while hemoglobin forms a very stable one. We have discussed in Chapter V (Section 6.3.), however, that this is by no means the general behavior of heme compounds to cyanide. Keilin and Hartree (1493) have, indeed, shown that cytochrome a_3 reacts with cyanide both in the ferrous and ferric form (*cf.* Section 3.6.5.), and the experiments of Tamiya and Kubo (2733) on the influence of cyanide on the distribution constant, K , of the respiratory ferment between oxygen and carbon monoxide are also not in agreement with Warburg's conception. Cyanide ferroporphyrins are autoxidizable, and cyanide ferriporphyrins are reduced only slowly by nascent hydrogen (Barron and Hastings, 186), although cyanide combines more firmly with ferroporphyrin than with ferriporphyrin. It is therefore likely that the inhibition of the respiratory ferment by cyanide must be explained kinetically, not thermodynamically.

Carbylamine does not inhibit the respiration of yeast (2918). Keilin (1482) found that azide inhibited the respiration of yeast only below pH 6.7, not at pH 7.5, while it inhibited cytochrome oxidase at both pH values. Keilin and Hartree (1498) have recently observed that red cells are permeable to azide at low pH values, but are impermeable at pH 7.5. This probably holds also for other cells and explains the difference between the azide inhibition of isolated cytochrome oxidase and intact cell respiration.* The probable identity of cytochrome oxidase with Warburg's respiratory ferment will be discussed under Section 3.6.5. Hydroxylamine, which also inhibits cytochrome oxidase, exerts marked inhibition on the respiration of kidney slices, but very little on that of testis (289).

* *Cf.*, however, Stannard and Horecker (1347b).

The inhibition of the respiration of different tissues raises complicated problems which are only partly solved today. This will be discussed further in Section 5.4.

3.6.3. Cytochrome a_1 . *Acetobacter pasteurianum* is a strongly respiring organism, which may be presumed to contain a relatively large concentration of respiratory ferment. For this reason it was studied by Warburg and his collaborators in the hope of finding the respiratory ferment bands by direct spectroscopy. A band at 589 $m\mu$ was indeed observed, which was shifted by carbon monoxide to 593 $m\mu$, approximately the position of the absorption band in the photochemical absorption spectrum of the respiratory ferment of yeast. The compound thus combines with carbon monoxide. The visible spectrum of the carbon monoxide compound tallied closely with the photochemical absorption spectrum of the respiratory ferment of this organism (1592,2953,2955,2958), while both definitely deviated from that of yeast:

Acetobacter: I, 589; II, 546; III, 524; IV, 430 $m\mu$ (1592)

Yeast: I, 589; II, 560; III, 510; IV, 430 $m\mu$ (1908,2954)

Keilin considered this compound a cytochrome and termed it cytochrome a_1 .

On aeration the band of ferrocytochrome a_1 disappears; according to Warburg there is also spectroscopic evidence of combination with cyanide. Cytochrome a_1 would thus appear to have all the properties demanded for a respiratory ferment.

The evidence for the combination with cyanide is, however, not clear. Warburg (2953) observed a band at 639 $m\mu$ which he ascribed at first to the cyanide compound of ferricytochrome a_1 . Later (2955,2958), however, the band was observed together with that of ferrocytochrome a_1 in the presence of alcohol, and an involved explanation was given assuming that the 639- $m\mu$ band was that of the cyanide compound of another hematin compound, the latter functioning as reducer of the respiratory ferment (cytochrome a_1) and as oxidizer of cytochrome a . In contrast to Warburg, Fujita, and Kodama (962) found that cyanide in the presence of air shifted the 589- $m\mu$ band slightly toward the red. The band observed by the Japanese authors is, however, probably the band of a ferrous cyanide compound rather than of a ferric cyanide compound, since Keilin (1492,1493) has found a similar band for the ferrous cyanide compound of cytochrome a_3 . As will be discussed below, the cytochrome a_1 of *A. pasteurianum* is, if not identical with, certainly closely related to Keilin's cytochrome a_3 .

Lemberg and co-workers (1698) pointed out that the formation of the 639- $m\mu$ band may be interpreted in another way. The cyanide may poison

the catalase of the bacterial cell, allowing hydrogen peroxide to oxidize the protoheme of cytochrome b to a hemichrome with an oxyporphyrin ring. The pyridine hemichrome of oxyporphyrin has a band at 639 $m\mu$.

Keilin and Harpley (1484) found no oxidation of cytochrome c by crushed *Escherichia coli*, although *E. coli* contains a trace of cytochrome a_1 . While the identity of cytochrome a_1 with the respiratory ferment of *A. pasteurianum* is probable, it cannot be considered definitely established.

3.6.4. Cytochrome Oxidase. In washed heart muscle and other tissues Keilin (1476) discovered an enzyme which catalyzed the oxidation of *p*-phenylenediamine, or a mixture of dimethyl-*p*-phenylenediamine with α -naphthol, the so-called Nadi reagent (653,2327). He called it indophenol oxidase. Later Keilin and Hartree (1477, 1491) and Stotz and co-workers (2681) recognized that cytochrome c was required for the oxidation of *p*-phenylenediamine, hydroquinone, and cysteine, ferricytochrome c oxidizing these substrates and ferrocyclochrome c being in turn oxidized by the oxidase. The enzyme was therefore renamed cytochrome oxidase. In fact, *p*-phenylenediamine is not a very suitable substrate for the cytochrome oxidase-cytochrome c system, since it is partly oxidized by cytochrome b without the oxidase (2681).

Cytochrome oxidase is a heat-labile enzyme destroyed by heating to 52° C. It is inhibited by cyanide, sulfide, azide, hydroxylamine, and by carbon monoxide. The distribution coefficient, *K*, of Keilin's cytochrome oxidase from sheep's heart (studied with cysteine as substrate) is not significantly different from that of Warburg's respiratory ferment in yeast or Melnick's oxidase from rat heart. Keilin found 5-10, Warburg, 9, and Melnick, 6.3.

For a time Keilin assumed that cytochrome oxidase was a copper-containing enzyme similar to polyphenol oxidase (1492). This view he later abandoned. Although decisive evidence is missing, it is likely that the photochemical absorption spectrum measured by Melnick (1907,1909) is that of cytochrome oxidase. Studies on the photochemical absorption spectrum of the reconstituted cytochrome oxidase-cytochrome system acting on substrates like hydroquinone or cysteine, and a comparison with the photochemical spectrum of Melnick would be of interest. In such experiments the oxidase should be prepared from rat heart, since this was used by Melnick. Too little attention has been paid hitherto to the possibility of species differences between the respiratory ferments

While the enzyme can be isolated from the cells, it is still doubtful whether homogeneous solutions have been obtained. The earlier preparations (1477, 1491) consisted of suspensions of washed cells. Later, turbid extracts with sodium phosphate were prepared. These can be liberated from accompanying

cytochrome *c* by precipitation with an equal volume of 0.2 *M* acetate buffer (*pH* 4.5) and resuspension in 0.1 *M* phosphate buffer, *pH* 7.4 (2681). Stern (2079, p. 264) found the enzyme in these preparations in relatively large particles of remarkably homogeneous size.* The extracts with sodium cholate and secondary phosphate have been mentioned above. Haas (1074) obtained a solution of cytochrome oxidase by grinding heart muscle with sand and toluene, or by treatment with ultrasonic waves followed by extraction, precipitation at *pH* 5.6, and redissolution at *pH* 9.5. All these solutions still show the Tyndall phenomenon, but Haas's preparation was not thrown out by short centrifugation at 12,000 *g*. In a later paper (1075) Haas described the separation of the enzyme into two fractions, which have full catalytic activity only in combination. The first is heat-labile and is precipitated on prolonged (two hours') centrifugation at 10,000 *g*. The second is heat-stable, slightly yellow, nondialyzable, and can be precipitated with ammonium sulfate; redissolved, it loses its activity on standing. Addition of the latter fraction to the former greatly increases its oxygen uptake.†

Stotz and co-workers (2677) showed that cytochrome oxidase unites with cytochrome *c* to form a complex for which the Michaelis-Menten equation holds (Michaelis constant of 5.8×10^{-6} *M*). By studying the influence of increased cytochrome *c* concentration on the system partly inhibited by cyanide or carbon monoxide, they confirmed that in this complex the oxidase, not cytochrome *c*, reacts with the inhibitors. Today the identity of cytochrome oxidase with the respiratory ferment of Warburg is accepted by most workers.

The claim of Japanese workers that the respiration of yeast and other organisms is catalyzed by two different enzymes, one of which reacts with carbon monoxide while the other reacts with cyanide, will be discussed in Section 6.4.

The estimation of cytochrome oxidase in tissues is not an easy task. It has been reviewed by Potter (2177). The tissue is homogenized and the concentration of the enzyme is measured in terms of oxygen uptake or substrate disappearance in the presence of excess cytochrome *c* and substrate. Several methods have been described (106,669,2475,2538,2674).

3.6.5. Cytochrome *a*₃. A spectroscopic investigation of cytochrome oxidase preparations for a long time failed to give any results indicating the presence of the absorption band at 589 *mμ* which was to be expected if cytochrome oxidase was identical or closely related to Warburg's respiratory ferment (*cf.* 2677). In 1938 Keilin (1492) found that on treatment of cytochrome oxidase preparations with

* In rats' liver cells the oxidase is present exclusively in the mitochondria (Schneider, Hogeboom, and co-workers, 2452a).

† According to Keilin and Hartree (1501a), the activation is, however, unspecific; the soluble fraction can be replaced by plasma proteins or hematin-free denatured globin.

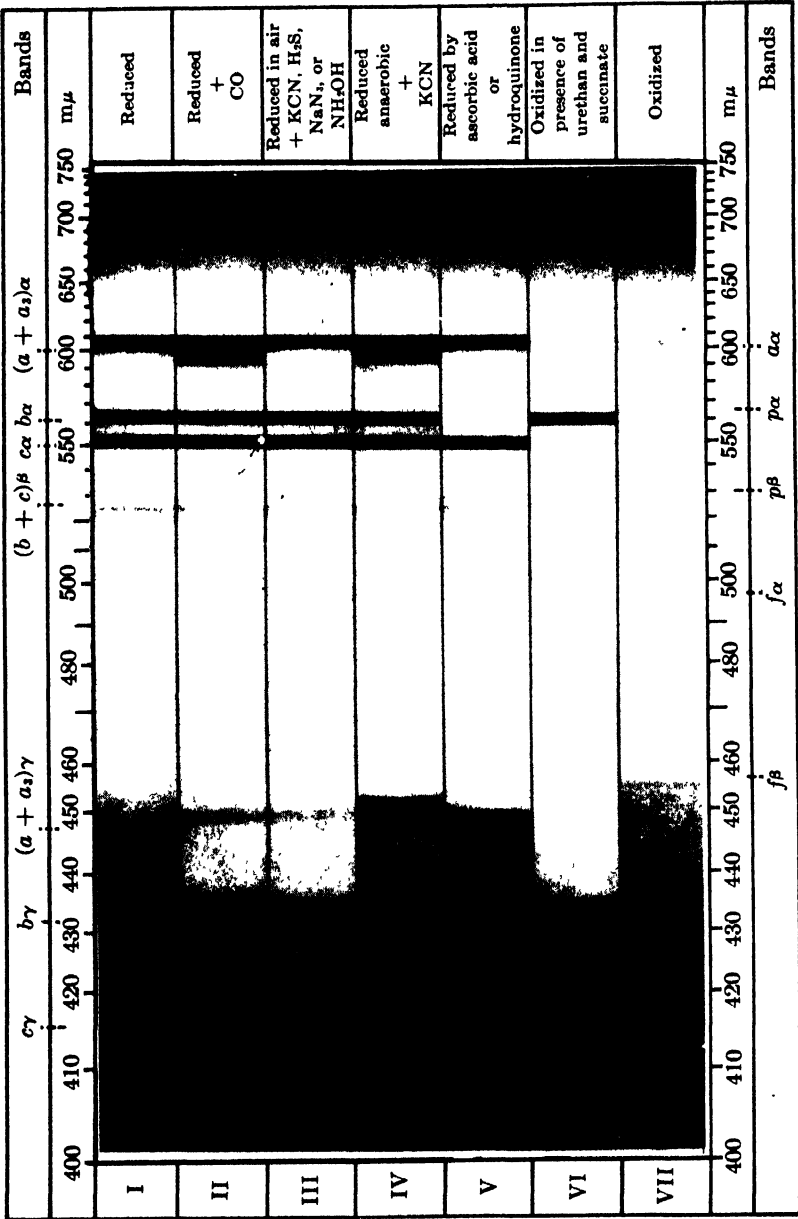

Fig. 4. Cytochromes a and a₃ (according to Keilin, 1953).

carbon monoxide the bands of cytochrome a did not appear to be homogeneous, and somewhat similar observations were made by Ball (123) in the same year. The experiments of Keilin and Hartree (1492, 1493) are more decisive. The band of cytochrome a is split in two by carbon monoxide; the main band remains unaltered, but another slight peak of absorption at $593\text{ m}\mu$ appears. Simultaneously the absorption band at $450\text{ m}\mu$ is decreased in strength, that of the $432\text{-m}\mu$ band is greatly increased. The diagram in Figure 4 gives the relations of the bands as found by Keilin. It is assumed that cytochrome a, which does not react with carbon monoxide, is accompanied by cytochrome a_3 , which has similar absorption bands but reacts with carbon monoxide. To the carbon monoxide compound of the latter, the bands at $590\text{--}593\text{ m}\mu$ and $432\text{ m}\mu$ are ascribed. In all cells studied the relative concentrations of cytochromes a and a_3 were found to be the same (*e.g.*, in the flight muscles of insects), and it is assumed that they are interconvertible. A similar position of the absorption bands in the presence and absence of carbon monoxide was later observed by Straub (2684) in solutions of cytochrome oxidase from heart, obtained by the cholate method; the band of ferrocytochrome a_3 was found, however, at $443\text{ m}\mu$ instead of at $450\text{ m}\mu$, the same position as that of the carbon monoxide compound.

Cyanide added to a completely reduced preparation causes a partial shift of the band of cytochrome a, similar to that caused by carbon monoxide. There is thus evidence of the formation of a cyanide compound of ferrocytochrome a_3 . On oxygenation in the presence of cyanide, this weak band disappears, while the main band at $600\text{ m}\mu$ remains slightly weaker than before the reaction with cyanide. Evidently cyanide ferrocytochrome a_3 is oxidized to cyanide ferricytochrome a_3 , while the nonautoxidizable cytochrome a remains reduced. Under these conditions the γ band at $450\text{ m}\mu$ almost disappears. From these observations it can be concluded that the greater part of the α band of $a + a_3$ (at $600\text{ m}\mu$) is due to ferrocytochrome a, while the greater part of the γ band (at $450\text{ m}\mu$) is due to ferrocytochrome a_3 . Cytochrome a_3 has thus a strong Soret band, like other heme compounds, while cytochrome a is abnormal in having a relatively weak Soret band.

The cytochrome a_3 occurring in heart muscle cytochrome oxidase preparations thus combines with carbon monoxide and cyanide, is autoxidizable, and as carbon monoxide compound has an absorption band similar to that of the carbon monoxide compounds of the res-

piratory ferment of Warburg and of cytochrome a_1 . It is thermolabile and easily destroyed by organic solvents, acid, and alkali. It also reacts with azide and hydroxylamine. The absorption band of ferrocyclochrome a_3 is given as about $600\text{ m}\mu$. This would make it different from cytochrome a_1 , the band position of which is $589\text{ m}\mu$, though not necessarily from the respiratory ferment, the band position of which in the reduced form, uncombined with carbon monoxide, is not known. Fujita and Kodama (962) have pointed out that the absorption band of cytochrome a falls off much more steeply toward the red than toward the green; we can therefore assume that a comparatively weak band of ferrocyclochrome a_3 , lying at $589\text{ m}\mu$, remains merged with the cytochrome a band, causing only a slight shift toward $600\text{ m}\mu$, while the band of the carbon monoxide compound of cytochrome a_3 , being stronger, appears as a separate band. There appears no need then to assume that cytochrome a_3 and cytochrome a_1 are really different.

There are, however, difficulties remaining which caused Keilin and Hartree at first to reject the idea of identity between cytochrome oxidase and cytochrome a_3 . Oxidation of cytochromes a , b , and c was observed while cytochrome a_3 still remained combined with carbon monoxide; it is probable, however, that a small proportion of uncombined cytochrome a_3 may have been present, sufficient to catalyze the oxidation. A reduction of ferricytochrome a_3 by ferrocyclochrome c has not yet been demonstrated, nor a light dissociation of the carbon monoxide compound of cytochrome a_3 . In their later paper, however, Keilin and Hartree no longer consider these difficulties sufficiently great to reject the assumption that cytochrome a_3 is identical with cytochrome oxidase.

There remains the difference in the position of the Soret band at $450\text{ m}\mu$ found by Melnick (1909) for the photochemical absorption spectrum of rat heart tissue and the $432\text{-m}\mu$ band found by Keilin for cytochrome a_3 . Melnick assumes that this may be due to an error of Keilin and Hartree in attributing the bands at 450 and $432\text{ m}\mu$ to carbon monoxide cytochrome a and carbon monoxide cytochrome a_3 , respectively. Stern (2656) and Melnick made the suggestion therefore of attributing the band at $450\text{ m}\mu$ to carbon monoxide cytochrome a_3 , that at $432\text{ m}\mu$ to carbon monoxide cytochrome a . This is, however, in contradiction to Keilin's and Straub's experiments, and the cause of the divergency is not clear.

3.6.6. Cytochrome a_2 . The absorption band of cytochrome a_2 at $628\text{--}632\text{ m}\mu$ was observed in bacteria by Japanese workers (2735, 2736, 3149; cf. also 962). It became of greater importance after Negelein and Gerischer (2024, 2025) had demonstrated that the cytochrome a_2

of *Azotobacter* has the properties expected for a respiratory ferment. Carbon monoxide shifts the absorption band to $634\text{ m}\mu$, oxygen to $645\text{ m}\mu$, while aeration in the presence of cyanide causes the band to disappear. This cytochrome is thus autooxidizable and reacts with carbon monoxide and cyanide. Pyridine produces a hemochrome with a band at $625\text{ m}\mu$ and a weaker band at $600\text{--}605\text{ m}\mu$, both rather diffuse (Roche, 2307). The hematin is thus certainly not a porphyrin hematin.

Lemberg and Wyndham (1716) have pointed out that cytochrome a_2 resembles certain bile pigment hemochromes in its spectroscopic behavior. These hemochromes were obtained by introducing iron into bilivolinoid bile pigments, followed by combination with pyridine. They are spectroscopically quite different from verdohemochromes (cf. Chapter X) and should not be called such. Carbon monoxide and oxygen shift their absorption bands toward the red like those of cytochrome a_2 , and ammonium sulfide causes the disappearance of the band in the orange; the same has been reported for cytochrome a_2 .

Cytochrome a_2 in crushed *Escherichia coli* cannot oxidize cytochrome c , but cytochrome c does not occur in *E. coli* (1484). It would be of great interest to study the photochemical absorption spectrum of *Azotobacter*, in which cytochrome a_2 prevails. The fact stressed by Keilin that respiratory activity of various microorganisms is not proportional to the cytochrome content is no serious objection to such a role of cytochrome a_2 as a respiratory catalyst, since the organism may contain varying amounts of cytochrome a_1 in addition to a_2 , and both may be respiratory catalysts; secondly the dehydrogenases may not have reached their maximum activity under the experimental conditions.

4. "PASTEUR ENZYME"

In 1879 Pasteur discovered that under aerobic conditions the alcoholic fermentation of yeast proceeds far less vigorously than under anaerobic conditions (2116). The same was found later to hold for the lactic acid fermentation (*glycolysis*) of many tissues. This suppression of the fermentation processes by aerobiosis is called the Pasteur effect. Its purpose is evidently to keep in check the substrate-wasting fermentation processes when substrate-saving oxidation of glucose can be performed.

We cannot here discuss fully the problem of the mechanism of the Pasteur effect. The reader is referred to the papers of Burk (381) and of Lipmann (1758) and the discussion of these papers in the symposium. The earlier hypothesis of Meyerhof which assumes aerobic resynthesis of glucose, had to be abandoned. It is still not certain whether the effect is due to higher oxygen pressure or to respiration.

The Pasteur effect is inhibited by substances which also inhibit respiration; carbon monoxide for instance causes an inhibition abolished by light (1654, 2920). It was therefore assumed that the Pasteur effect is due to respiration

and that the inhibitors react with the respiratory enzyme; thus Warburg (2925) measured what he assumed to be the photochemical absorption spectrum of the respiratory ferment of rat retina by the effect of carbon monoxide in the dark and under illumination on glycolysis.

Later, however, evidence for different effects of oxygen pressure and of inhibitors on respiration and Pasteur effects of certain tissues were discovered and a separate catalyst of the Pasteur reaction, the "Pasteur enzyme," was assumed. In fact, Warburg himself had noted as early as 1926 (2918) that carbylamine inhibited the Pasteur effect without inhibiting respiration. The same was found for carbon monoxide in rat retina by Laser (1654). Differences in oxygen affinity between respiratory enzyme and the assumed catalyst of the Pasteur reaction have also been noted by several authors (379, 1512, 1653). In general the respiratory ferment has a greater affinity for oxygen and a smaller one for carbon monoxide than the Pasteur enzyme in most tissues of higher animals, while for bacteria and for human myelocytes the reverse holds (1509-1512). For bone marrow (in both phosphate and bicarbonate medium) and for brain cortex and retina in phosphate (not in bicarbonate) medium, however, the changes in respiration and lactic acid fermentation produced by low oxygen tension and by carbon monoxide were always found reciprocal (509, 2961, 2962). The evidence from the inhibition experiments for a Pasteur enzyme distinct from the respiratory enzyme cannot, therefore, be considered conclusive.

The difficulties encountered in such inhibition experiments will be discussed in Section 5.4. Gaffron (972) has pointed out that the inhibition of the Pasteur enzyme by oxygen resembles the oxygen inhibition of hydrogenase.

More recently Stern and Melnick (1907-1909, 2660) have tried to solve the problem by comparing the photochemical absorption spectrum of both respiratory ferment and Pasteur enzyme of yeast on the one hand, and of mammalian tissue on the other. The respiration of rat retina is not inhibited by carbon monoxide, and hence the photochemical absorption spectrum of the respiratory enzyme in retina cannot be determined. The spectrum of the respiratory ferment of rat heart was therefore used for comparison with that of the Pasteur enzyme of rat retina. All these spectra show a weak band in the yellow-green, a still weaker one in the blue-green region, and a strong Soret band. No differences between the absorption spectra of Pasteur enzyme and respiratory enzyme were found with regard to the Soret band (430 μ in yeast, 450 μ in rat tissues) and the weak band in the blue-green (510 μ in both yeast and rat tissues). Small differences in the height of absorption of the enzymes of yeast at 560 μ were found, and a distinct difference in the position of the first absorption band in rat tissues (respiratory enzyme of rat heart, 589 μ ; Pasteur enzyme of rat retina, 578 μ). In view of the fact that the last-mentioned difference was found for enzymes from different tissues, and particularly in view of the great technical difficulties of such experiments and the low sensitivity in the visible part of the spectrum, we cannot consider these small differences of weak absorption bands as conclusive evidence for a difference between Pasteur enzyme and respiratory ferment.

There are thus at present some indications for the existence of a separate Pasteur enzyme, distinct from the respiratory ferment, but there is no conclusive evidence.

5. BIOLOGICAL FUNCTION OF THE CYTOCHROME SYSTEM

5.1. Introduction

There can be little doubt that the catalysis by hematin enzymes (the cytochrome system) provides the major pathway of respiration in the cells of higher animals; the same probably holds for lower animals, plants, and aerobic microorganisms. Respiration catalyzed by other enzyme systems, such as copper-containing enzymes or flavoproteins, is known to occur. To discuss to what extent the respiration in various organisms or tissues can be ascribed to the hematin enzymes and to what extent to such other enzyme systems is beyond the scope of this book. In some organisms the whole of the respiration is catalyzed by the cytochrome system. The oxygen consumption of baker's yeast, for instance, is fully accounted for by the rate of alternate reduction and oxidation of cytochrome *c* in the intact cell (1073). Even though flavoproteins are autoxidizable, in the yeast at least they are oxidized through the cytochrome system at the low oxygen pressure in the cell (2767).

The great difficulties in the study of the biological role of the hematin enzymes should be realized. While Warburg initially believed that only one respiratory ferment (in the earlier wider meaning) could reasonably be expected in all the different species, it is now certain that a variety of cytochrome systems exist, different species containing a variety of respiratory ferments (in the present narrower sense of cytochrome oxidase) as well as of cytochromes. The species specificity of the oxidase is proved by the differences found in the photochemical absorption spectra of yeast, *Acetobacter pasteurianum*, and rat heart, the few species so far studied. We have seen above that different organisms contain different cytochrome systems. It now appears very likely that the biochemistry of the hematin enzymes, when more completely known, will reveal species differences in the chemistry of their protein components and in some instances, of their prosthetic groups. This would be analogous to the species differences found for the oxygen-carrying pigments hemoglobin, erythrocruorins, and chlorocruorin (*cf.* Chapter VII), with the additional complication

that a series of hematin enzymes is required for the function of cellular respiration.

Equally great are the difficulties of quantitative estimation of hematin respiration. The distribution of cytochrome oxidase and cytochrome *c* in mammalian tissues has been studied carefully and quantitative data are known. We are not yet certain, however, how far results obtained by such studies are quantitatively representative of the whole of the respiration catalyzed by the cytochrome system in the intact cell. Inhibitors have been used to determine the part of the total respiration catalyzed by the hematin enzymes. Such data cover a wider range of organisms, but the interpretation of the inhibition experiments is uncertain (*cf.* Section 5.4.). For all these reasons an attempt at a comparative biochemistry of cellular respiration would be premature.

5.2. Pathways of Cellular Oxidation through the Cytochrome System

In Section 3. is summarized the evidence showing that atmospheric oxygen reacts with a hematin enzyme (respiratory ferment, cytochrome oxidase), which in turn oxidizes ferrous nonautoxidizable hematin compounds (cytochromes) to their ferric form. The problem of the autoxidation of the respiratory ferment will be discussed below (Section 7.). It is not yet definitely proved which cytochrome is the first to be oxidized by the oxidase. All oxidase preparations also contain cytochrome *a* and the ferrous cytochrome *a* is probably the one reacting directly with the ferric oxidase. This is also made likely by the fact that the oxidation-reduction potential of cytochrome *a* is slightly higher than that of cytochrome *c* (*cf.* below), although we have discussed in Section 1. that this in itself cannot be accepted as proof for the relative positions of cytochromes *a* and *c* in the reaction chain (*cf.* Ball, 124). We have also seen that the cytochrome oxidase-cytochrome *a* system does not react directly with the most important substrate dehydrogenase systems. Cytochrome *c* and, in some instances, cytochrome *b* are also required as intermediate electron carriers, until finally one of these cytochromes reacts with a monovalent hydrogen donor.

The way in which this reaction occurs has been formulated in Section 3.3.2. Of these monovalent hydrogen donors the flavoproteins are the most important and best known. Cytochrome reductase, an alloxazine mononucleotide protein, combines with cytochrome *c* to form a complex ($K = 10^{-7}$)

which mediates between cytochrome c and triphosphopyridine nucleotide (coenzyme II), the latter reacting with the glucose-6-phosphate dehydrogenase system. According to Ochoa (2062) cytochrome reductase also reacts with isocitric acid dehydrogenase. Similarly diaphorase (also called the coenzyme factor), an alloxazine adenine dinucleotide, mediates between cytochrome c and diphosphopyridine nucleotide (coenzyme I), the latter reacting with the lactic dehydrogenase of higher animals. The way in which the cytochrome system is linked with succinic dehydrogenase and also perhaps with diaphorase is not yet clear (*cf.* Slater, 2571a). The role of cytochrome b, which is probably required for this reaction, has been discussed in Section 3.4.

A turnover number of 3850 valency changes of cytochrome c per minute has been found by Keilin and Hartree (1494) in the yeast cell, a somewhat smaller figure — 1400 — in the isolated cytochrome oxidase-cytochrome c system. In those cells in which the complete cytochrome system has been observed spectroscopically, we thus probably have the system:

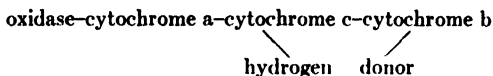

It is still doubtful whether similar systems are at work in organisms or tissues in which different cytochromes can be observed spectroscopically. Cytochrome a₂ can probably fully or partially replace the cytochrome oxidase in the microorganisms in which it occurs, for instance in *Azotobacter* (2025), but our knowledge of these systems is still so incomplete that there exists little more than speculation with regard to the pathways of hematin-catalyzed oxidation in such organisms.

The cytochrome system can probably react also with other metabolites in addition to those mentioned above. Caution is required, however, in attributing any reaction which can be shown to be accelerated by cytochrome c to the action of cytochrome oxidase. Green and Richter (1044) found a strong oxygen uptake by systems consisting of animal lactic and malic acid dehydrogenases, cyanide (which combines with the oxidation products, pyruvic or oxalacetic acid), adrenaline, and cytochrome c. Cytochrome c was found necessary for the production of adrenochrome from adrenaline. In this system it may be oxidized to ferricytochrome c by the hydrogen peroxide resulting from the autoxidation of leucoadrenochrome. Similarly Hermann and co-workers (1245) observed that cytochrome c increased the rate of oxidation of ascorbic acid in the presence of oxidized adrenaline.

In recent experiments carried out at this Institute by Mr. J. E. Falk, it was found that cytochrome c catalyzes the oxidation of ascorbic acid in the presence of adrenaline (or of some drugs of the acridine and quinoline series), by acting unspecifically as hematin peroxidase on adrenaline or the drugs. The quinoid systems thus produced then catalyze the oxidation of ascorbic acid by oxygen. The small amounts of hydrogen peroxide which initiate

the reaction are formed by autoxidation of adrenaline or ascorbic acid, while later more hydrogen peroxide is supplied by autoxidation of the reductant of the quinoid system. The system is thus a pseudo-oxidase.

Ames and Elvehjem (46, *cf.* also 259,3178a) described a glutathione oxidation by mouse kidney which required cytochrome c. The system was inhibited by diethyldithiocarbamate (a specific copper inhibitor), not by azide, and more stringent evidence is required before it can be accepted that cytochrome oxidase plays a role in it. These reactions resemble the coupled oxidation of hemoglobin (and other hematin compounds) with ascorbic acid and other hydrogen donors; they are probably of no significance in biological respiration, since they are accompanied by a destruction of the hematin catalyst (*cf.* Chapter X).

The stepwise lowering of the oxidation-reduction potential. Table V, taken from a paper of Ball (124), shows that the arrangement oxidase-cytochrome a-cytochrome c-cytochrome b postulated above for the complete system is in agreement with the oxidation-reduction potentials found for the different cytochromes and that about two-thirds of the total energy obtainable by the oxidation of substrate is released in the steps involving the cytochrome system.

TABLE V
Oxidation-Reduction Potentials^a in Cell Respiration

| E'_0 | System |
|--------|------------------------------------------------------------|
| + 0.81 | Oxygen |
| ? | Cytochrome oxidase |
| + 0.29 | Cytochrome a |
| + 0.25 | Cytochrome c |
| 0.00 | Succinate, fumarate |
| - 0.05 | Cytochrome b |
| - 0.07 | Flavoprotein |
| - 0.30 | Pyridine nucleotide; substrate dehydrogenases ^b |
| - 0.41 | Hydrogen |

^a According to Ball (124).

^b The potential of these systems varies from 0.00 to -0.41.

The stepwise lowering of the oxidation-reduction potential with specific interaction of several systems not greatly different in potential is probably required for the complete topochemical correlation of all the processes in the cell. If this correlation is disturbed, damage to the cell ensues. Respiration of sea urchin eggs, for example, is stimulated by very low concentrations of nitrophenols and other substituted phenols, but cell development and cell divisions are stopped, although the increased respiration is catalyzed by the cytochrome system (*cf.* 2017, p. 566, 570 ff.).

Dimethyl-*p*-phenylenediamine acts probably differently in so far as it replaces the normal substrates, while the phenols are considered carriers between the cytochromes and the normal substrate systems, but the effect is the same. It is interesting that this amine produces liver tumors and that

there is probably a connection between its damaging effect on the cytochrome system and its carcinogenic effect.

5.3. The Cytochrome System in Various Organisms

5.3.1. Cytochrome c and Cytochrome Oxidase in Animal Tissues. While the distribution of cytochrome c in mammalian tissues has been studied thoroughly, only a few quantitative data are avail-

TABLE VI
Concentration of Cytochrome c in Vertebrate Tissues^a

| Tissue | Animal | Concentration, mg./100 g. wet weight |
|----------------------------|---------------|-----------------------------------------|
| Heart | Rat | 53, 37 |
| | Pigeon | 55 |
| | Horse | 32 |
| | Ox | 21 |
| | Frog | 2.6 |
| Muscle | Rat | 16, 9.7 |
| | Pigeon breast | 69 |
| | Horse | 7.5 |
| | Hen, red | 15.1 |
| | Hen, white | 8.5 |
| | Rabbit | 1.3 |
| Liver | Rat | 6.8, 9.0 |
| | Ox | 1.0 |
| Kidney cortex ^b | Rat | 33, 25 |
| | Ox | 15 |
| Kidney medulla | Ox | 9.4 |
| Brain, whole | Rat | 7.5, 5.0 |
| | Ox | 3.1 |
| | Ox | 1.7 |
| Spleen | Rat | 4.8, 4.3 |
| Lung | Rat | 2.9, 2.1 |
| | Ox | 0.9 |
| Adrenal cortex | Ox | 0.8 |
| Embryos, 2-4 weeks | Rat | 0.5 |
| | Rat | 3.1 |
| | 6 days | 0 |
| | 10 days | 0.3 |
| | 12-17 days | 0.6 |
| | Tumors | Rat |
| Various animals | | 0 to 6.8 |

^a According to Stotz (2674), Potter and DuBois (2179), Fujita and collaborators (960).

^b Keilin and Hartree (1494) found no evidence for the presence of cytochrome c in the kidney cortex of the pig, although a similar cytochrome (c_1 ?) with an absorption band at 551 $m\mu$ in liquid air was observed. The band of cytochrome c under the same conditions was found at 547 $m\mu$.

^c Huszák (1377) found no cytochrome c in adrenal medulla.

able on the tissues of other vertebrates and none on those of invertebrates. Table VI summarizes the results of quantitative estimations of cytochrome c obtained by Stotz (2674), Potter and Du Bois (2179), and Fujita and co-workers (960). These results are so similar that a compilation in one table is justifiable.

Heart muscle is usually rich in cytochrome c, but some other red muscles contain even more; Fujita reported very high values for the red muscles of some Japanese fish. White muscles often contain less cytochrome c, but as Hill (1279) has pointed out, the correlation is rather between cytochrome content and rapidity of movement of the muscle than between cytochrome and myoglobin contents. The cytochrome spectrum is particularly strong in the rapidly moving flight muscles of insects. In Australia both drum and flight muscles of the cicadas lend themselves well to a demonstration of the cytochrome system.

Nerve cells are rich in the cytochrome system (1328,1976,2866), but nerve fibers and central nervous system contain little. No cytochrome spectrum has been observed in the white matter of the brain and no oxidase in the peripheral ganglia, but cerebral cortex and central nuclei contain both (1376). The substantia nigra is particularly rich in oxidase and cytochromes b and c. Adrenal cortex shows the normal cytochrome spectrum; with regard to adrenal medulla the findings are contradictory. Cohen and Elvehjem (459) observed only cytochrome c in the medulla of ox adrenals, while Huszák (1377) reports only cytochrome b.

Stotz investigated a variety of rat tissues and found a remarkable correlation between their content of cytochrome c and of cytochrome oxidase (2674). Exceptions from this rule have been reported. Early embryos of rats and chicken (2179,2674), some tumors (705,716,960,1055,1327,1446,2178,2674), and also unfertilized sea urchin eggs (*cf.* below) have been reported to contain oxidase but no cytochrome c. In some instances, however, such disproportion between cytochrome oxidase and cytochrome c has not been found by other investigators.

In early embryo of rats and chicken cytochrome c is very low (2179,2674) and Stotz has claimed that cytochrome c may be absent in the presence of the oxidase. A comparison of the papers of Albaum and Worley (35) and Yaoi (3148) indicates, however, that both oxidase and cytochrome c appear at the same time in chicken embryos, on about the fourth day. The oxidase content increases rapidly after the eighth day, perhaps more rapidly than the cytochrome c content.

While cytochrome c was not found spectroscopically in unfertilized eggs of *Arbacia* or during the diapause of the grasshopper embryo, its presence there appears to be indicated by various facts discussed below. Cytochrome oxidase has been observed in bull spermatozoa; cytochrome c had been claimed to be absent, but has now been shown also to be present (Mann, 1864). *Arbacia* sperm also contains cytochrome c (Ball and Meyerhof, 125).

The occurrence of cytochrome c and cytochrome oxidase in tumors has been reviewed by Potter (2177). In general, cytochrome oxidase and partic-

ularly cytochrome c appear to be decreased. In tissues with normally high cytochrome c content neoplasms occur far less frequently than in those poor in cytochrome c. Not all tumors, however, lack cytochrome c (Rosenthal and Drabkin, 2335; cf. also the discussion remarks of Stern and Ball, 2675), and while many authors (cf. above) reported a disproportion between cytochrome oxidase and cytochrome c in tumor tissue, Potter states that in general both are present in roughly proportional concentration.

Our knowledge of the cytochrome system in invertebrates is scanty. The spectroscopic observations in insect muscles have been mentioned; observations on the occurrence of cytochromes in other invertebrates have been reported by Ball and Meyerhof (125). The "actiniohematin" of MacMunn (1833) has been reinvestigated by Roche (2304), who found it to consist of a mixture of the cytochromes a₁, b₁, and c, with b₁ prevailing.

5.3.2. The Cytochrome System of Plants. The distribution of the cytochrome system in plants has been recently reviewed by James (1409). The presence of cytochrome oxidase in germinating seeds has been established by Hill and Bhagvat (255,1281). The rate of oxidation of succinate was increased by the addition of cytochrome c. These investigations confirm the earlier observations of Keilin that plant cells contain the normal a, b, c cytochromes, though in much smaller concentration than yeast, and hence difficult to observe spectroscopically. Cytochrome c has been isolated from plants (cf. Section 3.3.1.). Possibly the concentration of cytochrome c is lower than that of cytochromes b. Thus Roche (2307) observed only the cytochromes a₁ and b₁ in the onion; cytochromes b, not a and c, were also observed in tea and carrot leaves (543,1374,1635,1872) and in the flavedo (white part) of the orange (1374); cf. also the cytochrome f of Hill (1280a).

The occurrence of the cytochrome system is also indicated by observations on its role in the "salt respiration" (cf. Section 5.5.) and by certain inhibition experiments (Section 5.4.). Nevertheless it is not yet certain whether all plants contain the cytochrome system (cf. 1409). In this regard it is of interest that by growing yeast in cyanide solution a strain can be produced which lacks cytochrome oxidase (Pett, 2146; Stier and Castor, 2668).

The distribution of cytochromes in bacteria has been discussed under Section 3.2. (cf. Table I; cf. also 2736).

5.4. Study of Respiration by Inhibitors

The cytochrome system is inhibited by cyanide, azide, and carbon monoxide. If the presence of other enzymes sensitive to these inhibitors can be reasonably excluded, one may study the relative proportion of respiration catalyzed by the cytochrome system by measuring the degree of inhibition. It was assumed that the respiratory ferment would behave in all cells in the same manner toward the inhibitors, provided it was saturated with substrate.

It could indeed be established that the respiration of some cells behaved as if it were entirely catalyzed by the respiratory ferment.

In other tissues or under other conditions, this was not found, however, and the number of exceptions has gradually increased. By some workers this has been accepted as proof for the existence of alternative pathways of respiration, *e.g.*, through the autoxidation of flavoproteins (*cf.*, *e.g.*, Commoner, 469). Such systems are assumed particularly to catalyze the oxidation of protoplasmic protein, in the absence of suitable substrates, or of fats and proteins. While there can be little doubt that such alternative pathways exist in some organisms and tissues, insensitivity of the respiration to inhibitors of the cytochrome system cannot be accepted as reliable evidence.

Inhibition by carbon monoxide. Carbon monoxide inhibition of the respiration of the whole organism can, of course, only be studied in animals in which no oxygen carrier reacting with carbon monoxide is present, otherwise tissue slices must be investigated. In the first way the carbon monoxide sensitivity of the respiration not only of microorganisms, such as yeast, but also of insects (1097,3118) could be established. The respiration of plant cells (548,1374,1508,1871) is also inhibited by carbon monoxide and the affinity ratio of the respiratory ferment for oxygen and carbon monoxide is of the same order as that of the respiratory ferment in yeast or of the cytochrome oxidase of heart muscle.

No inhibition of the respiration was found, however, in rat retina, allantois, chorion, and liver (1654) and in liver, skin, and spleen of frogs (745); in frog muscle even an apparent stimulation of the respiration by carbon monoxide was observed (403,745,2451,2610). 95% carbon monoxide inhibits the respiration of all bacteria which contain cytochromes, with the exception of *Pseudomonas aeruginosa* (*pyocanea*), *Serratia marcescens*, and *Corynebacterium diphtheriae* (962), but Keilin (1479) found little or no effect of light on the carbon monoxide inhibition of the respiration of *Escherichia coli* and *Bacillus subtilis*.

Lack of carbon monoxide inhibition does not prove, however, that the respiratory enzyme is absent in such tissues, or even that it does not catalyze their respiration. The apparent stimulation of the respiration of frog muscle by carbon monoxide is explained by Stannard (2610,2611) as due to an oxidation of carbon monoxide to carbon dioxide by the tissue, superimposed upon a carbon monoxide inhibition of the cytochrome system. A catalytic oxidation of carbon monoxide by certain chlorophyll iron and chlorophyll porphyrin iron compounds had been observed by Negelein (2020). Fenn and Cobb

(745), who originally observed this phenomenon in frog muscles, also found it in skeletal and heart muscle of the rat. So far, their experiments in this species have not been repeated, but in man recovery of radioactive carbon monoxide after inhalation is within experimental error (2811).

The inhibition by carbon monoxide may be also negligible if there is a great excess of respiratory enzyme over the dehydrogenase systems, *i.e.*, if the respiratory enzyme is not saturated with substrate or if the reaction of the oxidase with the cytochrome *c* is not the slowest, rate-determining, step. Finally the particular tissue may contain a different respiratory enzyme of hematin nature with much lower affinity for carbon monoxide.

Cyanide and azide inhibition. The assumption that an alternative pathway of respiration exists in which the respiratory enzyme does not function is supported by other evidence, although this evidence is again not considered to be entirely conclusive.

The respiration of resting frog muscle is not inhibited by azide (2609), which inhibits the respiration of the muscle stimulated by electricity, potassium, acetylcholine, or caffeine. Cyanide inhibits both the respiration of the resting as well as of the stimulated muscle, but in a somewhat different manner. The respiration of the stimulated salivary mammalian gland is inhibited by cyanide, that of the resting gland is not (1572). Similarly the respiration of the unfertilized sea urchin egg is not inhibited by cyanide, while that of the fertilized egg is inhibited (1572,1576,2393,2394).*

Ball (124) suggested that cyanide, in contrast to azide, may decrease the oxidation-reduction potential of the respiratory enzyme sufficiently to prevent it from interacting with cytochrome *c* (potential + 0.25 v.), to which it is geared in fertilized eggs. The decrease of potential of the oxidase by combination with cyanide may, however, in the unfertilized egg, still permit its interaction with flavoproteins, which have a lower potential (about - 0.07 v.). The cyanide-insensitive respiration in the unfertilized egg is assumed to be due to this direct reaction of cyanide-combined ferric oxidase with flavoproteins, while the great increase of respiration on fertilization in the absence of cyanide together with the cyanide sensitivity is assumed to be due to the "gearing" of the oxidase to the cytochrome system. Azide, however, is assumed to inhibit incompletely, combining with both ferric and ferrous enzyme. There is, however, as yet no evidence for the direct reaction of oxidase with flavo-proteins. The explanation of Ball fails to account for

* While azide certainly does not inhibit the respiration of unfertilized sea urchin eggs (*cf.* Fisher, Henry, and Low, 903a), the noninhibition by cyanide has become doubtful (Robbie, 2279a).

the lack of carbon monoxide inhibition, and there is no sound theoretical basis for the assumptions made by Ball in calculating the potential of the oxidase in the presence of cyanide. A similar explanation is given by Ball for the azide-resistant respiration of resting frog muscle, while Stannard (2608) had assumed different enzymes at work in resting and stimulated muscle.* Since we know very little about the affinity of azide for ferrous and ferric hematin compounds, Ball's hypothesis is entirely speculative. It appears more likely that the cyanide-resistant respiration is due to other cyanide noninhibitable enzyme systems. Another possibility which must be considered, at least in some cases, is that cytochrome oxidase is present in so large an excess over either cytochrome c, the substrate, or another intermediate component of the reaction chain that one of these remains the limiting factor even when a large part of the oxidase is inactivated by the inhibitor.

Whether the cyanide-insensitive respiration is catalyzed by the cytochrome oxidase or not, there is important evidence to show that the enzyme is present in such cells, as is probably cytochrome c.

Runnström (2394) found that, in the presence of dimethyl-*p*-phenylenediamine as substrate, the respiration of unfertilized sea urchin eggs was inhibited by carbon monoxide; Runnström and Öström (2066, 2393, 2394) measured the affinity ratio of the enzyme for carbon monoxide and oxygen under these conditions and found it to be of the same magnitude as that of cytochrome oxidase. The enzyme system is therefore present in the cell, but not "geared in." While Korr (1572) stresses the availability of cytochrome c, Runnström considers it more likely that the availability of a suitable substrate is of greater importance (cf. 1576). In this connection, experiments of Keilin and Hartree (1494) are of interest. By damaging cytochrome oxidase from heart by treatment with acids or pancreatin, they obtained preparations which contained active oxidase and cytochrome c (to judge from the catalytic effect on *p*-phenylenediamine) as well as succinic dehydrogenase (methylene blue oxidation of succinate). Nevertheless such preparations did not oxidize succinic acid. As in sea urchin eggs, the addition of dimethyl-*p*-phenylenediamine to grasshopper egg brei in the diapause causes the appearance of a cyanide-sensitive respiration. The cytochrome system in the diapause (cf. below) appears thus to be present though normally not active. Again no cytochrome c has been observed spectroscopically, but it is difficult to believe that cytochrome c present in the prediapause would disappear afterward. For further discussion the reader is referred to Needham's book (2017, p. 566 ff.).

In plant tissues a carbon monoxide-sensitive respiration has often been encountered, which is inhibited by cyanide or azide only at high concentrations (10^{-2} to 10^{-3} *M*) (548, 1374, 1401, 1508, 1871). The fact that the carbon monoxide inhibition is light-sensitive indicates that the cytochrome system is nevertheless the catalyst. The respira-

* Cf. Horecker and Stannard (1347b).

tion of bacteria which contain cytochromes is inhibited by cyanide though little in the case of *Corynebacterium diphtheriae* and *C. pseudodiphthericum* (962).

The degree of cyanide inhibition of the respiration of retina has been claimed to depend markedly on the medium (phosphate or bicarbonate) (1652). Similar observations have been made with other mammalian tissues (39,596), but presence or absence of substrate (glucose) was probably the decisive factor (cf. 469,1479,1541).

5.5. Importance of the Cytochrome System for Supply of Energy and Cell Function

Whether the respiration of the resting cell is always catalyzed by the cytochrome system or not, it has become increasingly clear that the functional activity of the cells depends on this system.

The respiration of fertilized *Arbacia* eggs, abolished by cyanide, can be restored by methylene blue or pyocyanine, but the ability of the cell to develop and to divide is not restored (1572). Another instructive example is the development of grasshopper eggs, in which a cyanide and CO-sensitive cytochrome respiration is correlated with the prediapausal and postdiapausal development, while during the diapause the lower residual respiration is cyanide and CO-insensitive (304-306; cf. also 2017, p. 578 ff.). Needham (2017) concludes: "It almost looks as if nonferrous respiration cannot be geared to morphogenesis."

Similar results were obtained with regard to the respiration of the frog nerve by Schmitt (2447,2450). The cyanide-suppressed respiration of frog nerve is restored by methylene blue, but not its action potential. Cyanide and carbon monoxide inhibition abolish the potential together with the respiration, while illumination of carbon monoxide inhibited nerve restores both. "Spike" and "after potential" are maintained by the same respiratory catalyst (2448). Sustained tonic contraction of smooth muscles also requires the active cytochrome system (2449).

The embryologic studies of Flexner and Stiehler (906-908,2431, 2664) are of particular interest in this connection. In the chorioid plexus of the fetal pig, in the presecretory phase when the spinal fluid is still an ultrafiltrate, not a secretion, there is no differentiation in the distribution of the cytochrome oxidase system between epithelium and stroma and no potential difference. Later in the secretory phase, the oxidase system is concentrated in the epithelium and a positive

potential develops. The functional changes occurring with the onset of secretion are correlated with the selective development of the oxidase system in the epithelium. If the oxidase is inhibited by cyanide, the potential difference and the selective transport of anionic or cationic dyes across the plexus is abolished. Similar observations were made with the ciliary body of the eye (953).

In the developing kidney of the fetal pig a correlation between the ability to perform thermodynamic work in secretion on the one hand, and the higher oxidation-reduction potential and the concentration of the cytochrome oxidase system on the other, was shown to exist with regard to the development in time and space. The secretory portion of the nephron had a much higher concentration of oxidase and oxidation-reduction potential than Bowman's capsule and collecting tubules, but this difference developed only with the onset of secretory activity.

A parallel in the plant kingdom is the correlation between the cyanide-inhibitable oxidase system and accumulation of salts in plants in the so-called salt (anion) respiration (1788,2286).

The cytochrome system has been claimed to play a more specific role in the formation of thyroxine, particularly in the incorporation of inorganic iodine in the tyrosine molecule. This was studied by Schachner and collaborators (2431) with surviving thyroid tissue and radioactive iodine, I^{131} . Oxygen was found necessary, though 0.6% oxygen in nitrogen sufficed. The incorporation of iodine was inhibited by cyanide, azide, sulfide, and carbon monoxide, and with the last-mentioned substance the inhibition was reversed by light. Several workers (1720,2111,2431) have claimed inhibition of the cytochrome system by thiourea or thiouracil, substances which are known to inhibit thyroxine formation in the thyroid, but these results have not been confirmed (1012,1845). Nor do sulfonamides which have a similar though less intense action on the thyroid, inhibit cytochrome oxidase (1865).

6. THEORY OF MODE OF ACTION OF THE RESPIRATORY FERMENT

6.1. Autoxidation

On first view one may be inclined to believe that the mode of action of the cytochrome system can be perfectly understood on the basis of the facts discussed in the preceding sections of this chapter. An

autoxidizable hematin compound of relatively high oxidation-reduction potential, the respiratory ferment or cytochrome oxidase, is oxidized by atmospheric oxygen to its ferric form via an unstable intermediate compound of oxygen with its ferrous form. Its ferric form then oxidizes a ferrous cytochrome and similar reactions between various cytochromes are repeated until finally a ferricytochrome is reduced by a hydrogen donor. The way in which the primary oxygen compound of the ferrous respiratory enzyme is transformed to its ferric form has not received any special consideration. It is well known of course, that ferrous heme compounds are autoxidizable, but, from the fact that the reduction of a molecule of oxygen to two molecules of water involves a tetravalent change, it can be expected that the reaction is complicated.

The theory of the reaction of ferrous compounds with molecular oxygen has been developed by Haber and Weiss (1078,1079,3016-3018,3020). The following scheme is suggested by Weiss:

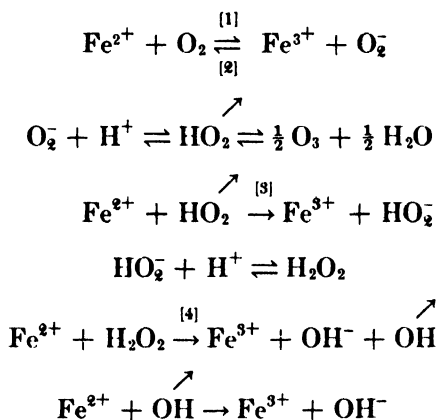

Both the velocity of reaction 3 and the oxidation-reduction potential will depend on the ratio of the velocity constants of reactions 1 and 2. This is in harmony with the observations of Barron (179) on the relation of rates of autoxidation and oxidation-reduction potentials of hemochromes. The speed of reaction 4 will determine whether hydrogen peroxide formation can be observed in such systems or not.

This theory gives an excellent account of the autoxidation of inorganic iron compounds and the simple hemochromes but fails to explain satisfactorily the mode of action of the respiratory enzyme.

First, it leaves unexplained the formation of an oxygen compound in which carbon monoxide could compete with oxygen for the heme iron. Second, it postulates the formation of free reactive radicals which, for reasons discussed in the next subsection, we do not consider likely to occur in biological reactions.

While Smythe (2582) claimed that only iron complex salts were autoxidizable, Weiss assumed first that on the contrary only iron compounds with incompletely filled electron orbits were subject to autoxidation, and that iron complexes could only be oxidized by atmospheric oxygen, if the ferric complex were more stable than the ferrous. The autoxidizable hemochromes have however a completely filled electron shell, and the complex is more stable in its ferrous form. Later Weiss explained the ready autoxidizability of hemochromes in the following way; first, the resonance system facilitates rapid conduction of the inner electrons, and second, the valency change is not connected, as it is in the oxidation of ionic iron, with changes in hydration, requiring movement of water molecules.

In the scheme of Haber and Weiss free radicals occur, but no radical chain is postulated. Haber and Willstätter (1080) had previously postulated a more complicated reaction mechanism for the autoxidation of the ferrous enzyme in which the substrate H_2A was assumed to be involved. This may be formulated as:

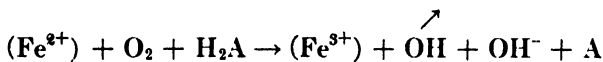

It will be seen below that this formulation, in a modified form, describes the autoxidation of cytochrome oxidase probably more correctly than the scheme of Haber and Weiss.

6.2. Radical Chain Theory

In 1931 Haber and Willstätter (1080) published a universal theory of the reaction mechanism of enzymes and other catalysts, which has been widely discussed and is still of importance, although it had to be modified to a great extent. Actually the theory comprises two different though connected ideas, namely, first, the monovalent reaction of a catalyst with a hydrogen donor, with the formation of a radical, *e.g.*, $Fe^{3+} + H_2A \rightarrow Fe^{2+} + HA$, where H_2A is the substrate, Fe^{3+} the enzyme, and Fe^{2+} the "desoxyenzyme"; second is the formation of radical chains, *e.g.*:

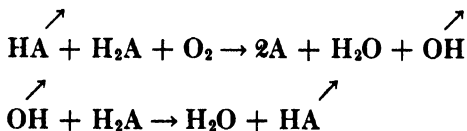

In these chains a large number of substrate molecules are transformed, in our case hydrogen donors of an oxidase. Finally the ferrous desoxygenzyme is retransformed to the ferric enzyme by a chain-breaking reaction, such as:

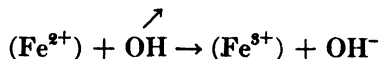

or the latter is re-formed by autoxidation of the former. In a similar way the actions of catalase and peroxidase were explained (*cf.* Chapter IX).

The first idea, *i.e.*, that of monovalent dehydrogenation, is now well proved for the reaction of cytochromes with their substrates. We now know that the flavoproteins which react with cytochrome c (as well as the pyridine coenzymes which react with the flavoproteins) are able to form radicals which are stabilized by resonance (*cf.* Michaelis, 1935,2516; Pauling and Wheland, 2128,3042). It is almost certain that all the reactions of the hematin enzymes are such monovalent reactions.

The second proposition, that of oxidation of the substrate by radical chains, however, is certainly not correct for the cytochrome

system. The substrate radical HA (*e.g.*, dehydrogenated flavoprotein) is stabilized by resonance and is unable to initiate radical chains of the kind postulated by Haber and Willstätter. In Chapter IX it will be shown that even with catalase and peroxidase, where such radical chains are more likely, the radical chain theory has been subjected to a well-founded criticism on kinetic, thermodynamic, and specificity grounds (250,709,1099). Some of these objections have been met by Weiss by adjustments of the theory, for instance by the assumption of short radical chains.

There are, however, even more fundamental biological reasons against the radical chain theory as the explanation of the function of respiratory enzymes. It appears impossible to bring into harmony with the formation of highly diffusible, indiscriminately reacting free radicals the remarkable correlation between the various enzymes, which has been demonstrated lately in numerous instances. In this connection it is significant that Haber and Willstätter had to assume a rather improbable trimolecular reaction between a radical, hydrogen donor, and hydrogen peroxide in order to account for the fact that peroxidase has no catalatic activity (*cf.* Chapter IX).

It is therefore necessary to replace these theories by a theory which allows monovalent reactions to occur, but does not postulate the formation of free radicals or radical chains. The fundamentals of such a theory can be found in the work of Michaelis on autoxidation of metal-cysteine complexes (1934) and in the emphasis of Szent-Györgyi on the biological importance of intracomplex reactions (2726). In addition to the long-known fact that enzymes unite with their substrates, there is now evidence for the formation of even more complicated complexes such as oxygen-cytochrome oxidase-cytochrome c, or hydrogen peroxide-peroxidase-ascorbic acid. Monovalent electron transfers can be assumed to occur in such complexes, but there is no evidence and no need to assume that the radical thus

formed (*e.g.*, HO₂ from oxygen) leaves the complex before it has reacted a second time. It is obvious that if the reaction mechanism consists of such intracomplex rearrangements, the formation of radicals as intermediates within the complex, while quite likely, cannot be proved and need not be considered any further. The formation of radical chains is thus excluded, since no free radicals occur.

It must be emphasized that this criticism of the radical chain theory applies only to the explanation of the biological function of the hematin enzymes, and does not minimize its value for illuminating the mechanism of reactions of inorganic and organic molecules with oxygen or hydrogen peroxide outside the cells. It is quite possible that radical chains also play a role in some unphysiologic reactions catalyzed by hematin enzymes under certain conditions outside their normal environment.

6.3. Hemoglobin as a Cytochrome Oxidase Model

6.3.1. Introduction. Before attempting an explanation of the mode of action of cytochrome oxidase on the basis of the conception developed in the preceding section, we will study certain reactions of hemoglobin which are of interest in this regard. In Chapter VI and in the first section of this chapter the differences between hemoglobin and the respiratory enzymes has been stressed, but it has been mentioned that they are important but not absolute. In this section we discuss such reactions of hemoglobin in which the similarity is more important than the difference, *i.e.*, mainly the autoxidation of hemoglobin and the activation of oxygen by modified hemoglobin.

While the autoxidation of hemoglobin is slow, it can under certain conditions play a catalytic role (*cf.* Chapter XI, Section 4.). Like the respiratory ferment, hemoglobin combines with oxygen and carbon

monoxide. Hence the autoxidation of hemoglobin and the formation of hemiglobin can be assumed to be a reasonably good model for the autoxidation of the oxidase.

6.3.2. Hemiglobin Formation. For certain reasons which will become clear later on, we discuss here not only the formation of hemiglobin from hemoglobin by autoxidation, but also other modes of hemiglobin formation. We shall only consider the physicochemical mechanism of the reaction and not its physiologic importance, which will be discussed later in conjunction with the biochemistry of the red cell (Chapter XI, Section 4.).

Hemiglobin can be formed from hemoglobin in three different ways: (1) by the direct action of oxidants, (2) by the coaction of hydrogen donors and atmospheric oxygen, and (3) by autoxidation.

Direct oxidation of the ferrous iron of hemoglobin. The ferrous iron of hemoglobin can be oxidized directly by such reagents as ferric tartrate, ferricyanide, bivalent copper, chlorate, nitrate, quinones, alloxan (359), and dyes of high oxidation-reduction potential such as indigo sulfonates or phenol-indophenol. It will be seen below, however, that even some of these reagents do not simply oxidize the hemoglobin iron.

Warburg and Kubowitz (2940) have claimed that hematins oxidize hemoglobin in the red cell and in this way catalyze an increased cell respiration. Their evidence is partly based on erroneous interpretation of the action of phenylhydrazine, which will be discussed in Chapter XI, Section 2.3. They have obtained this increase, however, also by addition of hematins. Whatever is the correct interpretation of these effects, it is unlikely that it is due to the oxidation of the ferrous iron of hemoglobin by the ferric hematin iron since the oxidation-reduction potential of the heme-hematin system is several hundred millivolts below that of the hemoglobin-hemiglobin system.

Hemiglobin is formed by chlorate and nitrate, but these reactions are more complicated. The hemiglobin formation by chlorate is an autocatalytic process (1258). Since compounds combining with hemiglobin such as cyanides, azide, cyanate, and thiocyanate inhibit the reaction, it is likely that hemiglobin chlorate acts as an oxidative catalyst. Myohemiglobin chlorate is less effective (1528).

The oxidation of hemoglobin by nitrite and nitrite esters, *e.g.*, amylnitrite, is a still more complex process, which in spite of numerous investigations (99, 172, 343, 1050, 1104, 1144, 1489, 1895, 2068) is not yet fully explained. It is complicated by the formation of nitrosohemoglobin and nitrosohemiglobin (*cf.* Chapter VI, Sections 2.2.4. and 2.3.6.) and by the oxidation of nitric oxide to higher nitrogen oxides in the presence of air.

Brooks (343) and Heubner (1254) formulate the over-all process of the formation of hemiglobin from oxyhemoglobin by nitrite:

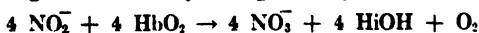

and the reaction between hemoglobin and nitrite in the absence of oxygen:

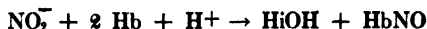

6.3.3. Oxidation of Groups in Globin. The oxidant may, in some instances, not only oxidize the ferrous iron of hemoglobin to ferric iron, but may also oxidize groups in the globin. While Conant and co-workers (479), in their investigations of the reaction between hemoglobin and ferricyanide, did not find evidence for any other reaction but the oxidation of the hemoglobin iron by one equivalent of ferricyanide (at pH 7 or below) (*cf.* also 1941), Schüler (2471) found that in the reaction between guinea pig carbon monoxide hemoglobin and ferricyanide at pH 9.5 more ferricyanide is reduced than corresponds to the oxidation of four atoms of iron per mole — 64,000 — of hemoglobin; two additional moles of ferricyanide are used for the oxidation of the sulfhydryl groups of the globin (2471). Mirsky and Anson (1963) found that at a pH above 7 maximally two active sulfhydryl groups are present in hemoglobin, which disappear by oxidation with ferricyanide. At a pH below 7, however, the sulfhydryl groups are nonreactive and ferricyanide oxidizes only the iron. According to this two different hemoglobins exist, one of which, produced by ferricyanide at pH 6–8, contains unaltered globin, while the other, produced by ferricyanide in more alkaline solution, contains a dehydroglobin. It will be shown below that these observations are of particular interest for the theory of autoxidation of hemoglobin to hemiglobin.

On the basis of differences in the catalytic effect on glucose oxidation in the erythrocyte, Warburg and his school (2941, 2942, 2944) claimed that different hemoglobins existed. The hemiglobin formed in the erythrocyte by amyl nitrite caused only an induced oxidation of glucose, the hemoglobin being then converted by oxygen to oxyhemoglobin which did not react further. The hemiglobin produced by phenylhydroxylamine, however, was found to cause a true catalysis, many moles of glucose being oxidized per mole of phenylhydroxylamine. Warburg assumed that in the latter case an abnormal hemiglobin was reduced by glucose to an abnormal hemoglobin which with oxygen, instead of yielding oxyhemoglobin, was reconverted to the hemiglobin. The investigations of Jung (1443) and of Keilin and Hartree (1496) have shown, however, that the catalytic effect is one of phenylhydroxylamine rather than of hemiglobin. Phenylhydroxylamine in reacting with oxyhemoglobin is itself oxidized to nitrosobenzene in a coupled oxidation (*cf.* Chapter X). Nitrosobenzene can unite with hemoglobin to nitrosobenzene hemoglobin, which Keilin and Hartree believed to be autoxidizable. The catalytic effect is better explained by the observation of Jung that nitroso-

benzene is reduced back to phenylhydroxylamine by reducing systems present in the erythrocyte (*cf.* Chapter XI).

There is, however, more recent evidence confirming the existence of different hemoglobins. Darling and Roughton (532) have observed differences between the hemoglobin produced by ferricyanide and that produced by autoxidation in their effect on the dissociation curves of oxyhemoglobin. An alteration of the globin in one of the reactions leading to hemoglobin was suggested as an explanation. Vestling (2873) found that hemoglobin formed with nitrite is reduced much more slowly and less completely by ascorbic acid at *pH* 7 and 0° C. than the hemoglobin formed with ferricyanide. This was assumed to be due to a difference of the two hemoglobins. Doubt was cast on this explanation by Gibson (993), since the addition of ferrocyanide to the nitrite-hemoglobin-ascorbic acid system increased the rate of reduction to that found for ferricyanide hemoglobin. The author himself, however, points out that it is impossible to assume that ferrocyanide reacts by reducing the ferric iron of hemoglobin directly. The catalytic effect of ferrocyanide thus remains unexplained.

6.3.4. Formation of Hemoglobin by Reducing Substances in the Presence of Oxygen. A number of dyes oxidize hemoglobin to hemoglobin in the presence of oxygen, but it is clear from a consideration of the oxidation-reduction potentials that only a few (*e.g.*, phenolindophenol with a potential of + 0.250 v. at *pH* 7) oxidize hemoglobin (potential + 0.150 v.) directly. The most important of the hemoglobin-forming dyes and substances, however, have a potential considerably below that of hemoglobin, *e.g.*, methylene blue (potential + 0.010 v. at *pH* 7.0); dyes of a still lower potential fail to form hemoglobin (1941).

It has been assumed that methylene blue, for example, catalyzes hemoglobin formation by oxidizing hemoglobin and by being constantly re-formed from leucomethylene blue by autoxidation. Although the oxidation reduction potentials of methylene blue-leucomethylene blue and hemoglobin-hemoglobin show that the reaction methylene blue + hemoglobin → leucomethylene blue + hemoglobin can each time proceed only very slightly toward the right-hand side, it is theoretically not impossible that a catalysis of hemoglobin formation may be brought about in this manner (*cf.* Michaelis and Salomon, 1941; De Meio, Kissin, and Barron, 552).

It is usually overlooked, however, that hydrogen peroxide is formed in the autoxidation of the reduced dye, and that hydrogen peroxide is a powerful former of hemoglobin. The objection has been raised that catalase present in such systems would destroy hydrogen peroxide (2421), but this is invalid. First, Keilin and Hartree (1499) have found that hydrogen peroxide formed gradually in small concentrations can oxidize hemoglobin in the erythrocytes in the presence of an abundance of catalase. Second, a hydrogen donor such as leucomethylene blue may react directly with oxyhemoglobin with formation of an unstable hydrogen peroxide-hemoglobin complex (Lemberg and coworkers, 1708):

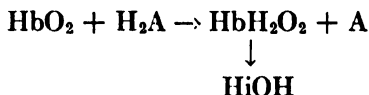

The latter type of reaction, which has been shown to be the mechanism of the complex oxidation of ascorbic acid with oxyhemoglobin (Chapter X), is incompletely inhibited by catalase. Similarly phenylhydroxylamine reacts with oxyhemoglobin (1259). With other hydrogen donors the first mechanism (oxidation of hemoglobin by hydrogen peroxide formed by autoxidation of the hydrogen donor), the second (direct reaction of oxyhemoglobin with the hydrogen donor), or both may be at work.

A large number of hydrogen donors (*e.g.*, aminophenols, phenylhydroxylamine, phenylhydrazine, hydrazobenzene, ascorbic acid, metabolic products of bacteria and tissues) are thus able to form hemoglobin. These reactions will be discussed further in Chapters X and XI since they cause irreversible as well as reversible oxidation of hemoglobin.

6.3.5. Autoxidation of Hemoglobin. After having shown in a series of papers (102,1986,2028,2030) that the hemoglobin-forming principle of bacteria consists of reducing substances in the presence of atmospheric oxygen, Neill and collaborators found that autoxidation of hemoglobin with formation of hemoglobin also proceeds with maximal velocity at a remarkably low partial pressure of oxygen (20 mm. mercury) (2027,2031). They explained this as Brooks did later, by assuming that only hemoglobin reacted with oxygen to form hemoglobin. Speaking of oxygen activation comparable to that obtained with reducing substances, they vaguely suggested a similar-

ity in the mode of hemoglobin formation by autoxidation of hemoglobin to that by oxygen in the presence of reducing substances.

The kinetics of hemoglobin autoxidation were closely studied by Brooks (341,342), who found the following law to hold:

$$\frac{dx}{dt} = k [\alpha (a - x)] \frac{bp_{O_2}}{1 + bp_{O_2}} \quad (1)$$

where k and b are constants, a is the initial hemoglobin concentration, α is the quotient [hemoglobin]/[total hemoglobin], and x is the hemoglobin concentration.

Brooks claimed therefore that only hemoglobin reacts with oxygen (hence the proportionality to α) and that oxygen caused an additional inhibition expressed in the term $b/(1 + bp_{O_2})$. He rejected the idea that intermediates between Hb_4 and $Hb_4(O_2)_4$ played a role, since his equation did not fit the assumption of a reaction of any one of the intermediates, *e.g.*, Hb_4O_2 or $Hb_4(O_2)_2$, with oxygen. The inhibiting action of oxygen expressed in the term $b/(1 + bp_{O_2})$ remained unexplained. As Brooks pointed out, an alternative explanation, in harmony with equation 1, would be that the rate of autoxidation is proportional to the concentration of unoxxygenated heme and to a $Fe^{3+} O_2$ compound acting as oxidative catalyst. The latter explanation is preferable to the first.

In a theoretical study Legge (1666) reinterpreted Brooks' results as indicating the spontaneous breakdown of the intermediate compound $Hb_4(O_2)_2$ to form hemoglobin.* This fails to explain, however, why the autoxidation of myohemoglobin, which has only one heme group per molecule, has also a maximal rate at low oxygen pressure (Brooks, 340).

It remains to explain how the $Fe^{2+}O_2$ group can become an oxidative catalyst and why in the hemoglobin molecule with four heme groups just the intermediate $Hb_4(O_2)_2$ gives rise to hemoglobin. From the fact that the reduction of oxygen involves four equivalents, one would have rather expected the compound $Hb_4(O_4)$ to be the one to undergo a spontaneous transformation to hemoglobin. (This has erroneously been given as the result of Legge's study in Holden's review (1317).) With $Hb_4(O_2)_2$ such a reaction is stoichiometrically possible only if hydrogen donors participate in it:

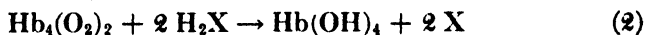

* In a private communication Dr. Brooks has informed us that the rate of hemoglobin formation at high oxygen pressures is not in agreement with Legge's theory.

In conformity with the hypothesis that Fe^{2+}O_2 acts as an oxidative catalyst we can write this:

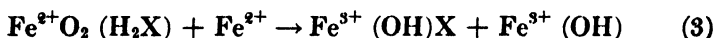

It will be shown in Chapter X that a similar reaction between Fe^{2+}O_2 and H_2X may occur when oxyhemoglobin reacts with hydrogen donors, the intermediate stage being the formation of an Fe^{2+} hydrogen peroxide compound. In these cases, the hydrogen donor is another molecule perhaps bound to hemoglobin; in the present instance the hydrogen donor must be a group in the globin part of hemoglobin (or myohemoglobin) itself. As early as 1924 Baudisch and Welo (192) discussed the possibility of an FeO_2 compound acting as hydrogen acceptor. This hypothesis brings into close relationship the formation of hemoglobin from hemoglobin by the action of reducing substances in the presence of oxygen and that by autoxidation. We have seen above that Neill had been impressed by the similarity between these reactions. If equation 3 represents the autoxidation of myohemoglobin one should expect to find the latter dimolecular with regard to total myohemoglobin concentration; this has been assumed to be the case by Brooks (340), but still requires experimental verification.

Equation 2 postulates the existence in the globin of hydrogen donor groups able to supply four atoms of hydrogen per Hb_4 molecule, while we have seen above that so far only two such groups have been discovered. The formula is, however, well supported by the observation that acid or pyridine, on denaturing oxyhemoglobin, liberate only two of the four oxygen molecules, a third one being evidently required for the oxidation of four iron equivalents, while the fourth must be used in oxidizing two H_2X groups of the globin (*cf.* next section).

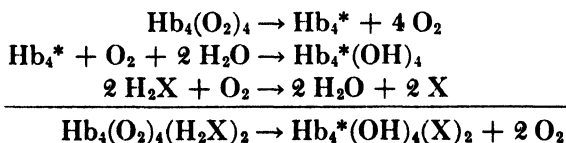

The asterisk represents denaturation of the globin.

This working hypothesis is amenable to experimental verification. It is generally assumed that the preparation of hemoglobin by autoxidation is particularly mild. Our hypothesis demands that the globin of hemoglobin produced by autoxidation should differ from that of

hemoglobin, while in the formation of hemoglobin with ferricyanide at a *pH* below 7 the globin remains unaltered. We have mentioned above that Darling and Roughton (532) observed, indeed, differences between the hemoglobins produced by these methods.

These considerations have a very important bearing on the problem of the reaction mechanism of respiratory hematin enzymes. So far very little attention has been paid to the role hydrogen donor or hydrogen acceptor groups in the protein part of these enzyme molecules may play in their reaction mechanism. Nevertheless scattered evidence is available which indicates that here the key to many unsolved problems may be found. Such groups may very well be the mediators of intracomplex reactions, which make it possible for the reactions to proceed without the formation of free radicals.

6.3.6. Oxidizing Action of Oxygen Liberated from Oxyhemoglobin. Before returning to the respiratory enzymes proper, we consider once more hemoglobin as a model system in a somewhat different aspect. Warburg stressed the important difference between the inactive transport oxygen of oxyhemoglobin and the activated oxygen of the respiratory ferment. While this is perfectly correct, it can be shown that a comparatively mild alteration of the globin, *e.g.*, reversible denaturation by acid or denaturation by pyridine, transforms the oxygen into "active" oxygen.

It has frequently been observed that ascorbic acid disappears almost instantaneously when a solution of this substance containing oxyhemoglobin or hemolyzed blood is deproteinized with trichloroacetic acid. Similar observations had been made with adrenaline (390). Some authors (218,390,896,964) tried to explain the phenomenon by assuming adsorption of ascorbic acid or adrenaline to the "acid hematin" precipitate, but others (961,1506,1549,1702) found that transformation of oxyhemoglobin into hemoglobin or carboxyhemoglobin prevented the destruction of ascorbic acid by the ensuing deproteinization. The disappearance of the ascorbic acid was thus recognized as oxidation.

The phenomenon has been studied more closely by Lemberg (1686, *cf.* also 1668,1702,1710,1712). Only 40% instead of the 75% of the oxygen expected theoretically is evolved, if an oxyhemoglobin solution is acidified with metaphosphoric acid. The remainder is used up in oxidative reactions. Hydrogen donor groups in the globin are oxidized (*cf.* also 1308,1309,1963,2218) and a small part of the

hematin also undergoes oxidation with liberation of its iron (1668). The alteration of the globin part by the acid alters the oxygen-heme linkage in such a way that the oxygen becomes activated and an intramolecular oxidation of the globin ensues. If ascorbic acid is present, it is oxidized instead of the globin. The oxidation occurs instantaneously on acidification (1686); if ascorbic acid is added shortly after acidification, much less of it is oxidized. The activated oxygen reacts directly with ascorbic acid in an oxyhemoglobin-ascorbic acid complex and the globin is thus protected.

Other substances such as bilirubin (690) and biliverdin (1686, 1712) are oxidized in a more complicated way by the system. Here there is no immediate decay of the active system after acidification. The reaction of the activated oxygen with the globin leads to formation of hydrogen peroxide, which oxidizes these substances, the "acid hematin" acting as peroxidase. These experiments reveal once more the importance of hydrogen donor groups in the protein molecule.

The activation of oxygen is not restricted to the effects of acidification. Oxygen acting on dried oxyhemoglobin causes not only formation of hemoglobin but also oxidative denaturation of the globin (1293). If oxyhemoglobin is denatured by pyridine, again only 50% of its oxygen is liberated instead of the 75% theoretically expected. The reaction between cupric ions and oxyhemoglobin has been studied by Rawlinson (2218). The oxidation of the iron of oxyhemoglobin is accompanied by an oxidative denaturation of the globin by activated oxygen. There is also a direct denaturation of the globin if hemoglobin or hemoglobin react with cupric ions, but this requires a greater excess of copper than the denaturation of oxyhemoglobin. In contradistinction to ferricyanide, bivalent copper thus causes the formation of active oxygen, and intramolecular oxidation of the globin by it. It is still unexplained why the oxygen liberated from oxyhemoglobin by ferricyanide is unable to react with the hydrogen donor groups of the globin, at least under certain conditions, whereas it is able to react with added hydrogen donors such as ascorbic acid (2873) or cysteine (2940).

Whatever may be the explanation of the mode of action of the activated oxygen, it has been demonstrated that the inactive transport oxygen of oxyhemoglobin is readily converted into activated oxygen, and that this is able to react with hydrogen donor groups in the protein part of the molecule.

6.4. Mode of Action of the Respiratory Enzyme

When we attempt to apply the experiences gained with the autoxidation of hemoglobin to the main unsolved problem of the mode of action of the respiratory enzyme, the transformation of the form Fe^{2+}O_2 to Fe^{3+} , we are quite conscious of entering the realm of speculation. Clark stated in 1939 (450): "It is not unlikely that the activation of oxygen . . . is within a co-ordination complex and by a specific channel that removes the action from the general field."

Cytochrome oxidase and cytochrome c form such a complex, in which at least two molecules of hematin iron are present (*cf.* Section 3.6.4.). We assume that, as in the autoxidation of hemoglobin, a hydrogen donor group H_2X is present in the protein of the oxidase or bound to it, and plays a role in the autoxidation of both ferrous heme iron atoms in the complex of cytochrome oxidase (Fe_{ox}) with cytochrome c (Fe_{cyl}):

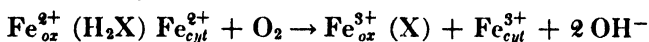

It is possible that the second component of cytochrome oxidase, recently isolated by Haas (1075) contains the hydrogen donor group H_2X . Figure 5 shows the assumed catalytic cycle. In this scheme

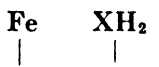

represents the oxidase, and

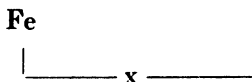

represents cytochrome c, the cross in the latter indicating the point at which the hydrogen donor, HA (*e.g.*, cytochrome reductase) is attached to cytochrome c.

The oxidase is written on the left side, cytochrome c on the right side, both forming the complex; whether this complex dissociates at certain stages of the cycle or not is of no significance for the scheme. Step 1 in Figure 5 represents the autoxidation as discussed above. Ferricytochrome c is then reduced by the substrate in steps 2 and 3. Step 4 represents the oxidation of ferrocycytochrome c by the ferric oxidase. This is the slowest rate-determining reaction (Warburg, 2929) and is inhibited by cyanide, the cyanide combining with the ferric oxidase. The ferrous oxidase now combines with oxygen (step 5). This reaction is inhibited by carbon monoxide. In

this form (containing X, not XH_2) the ferrous oxygen compound of the oxidase is relatively stable. Only after X has been reduced to H_2X by means of substrate, in a reaction probably mediated by

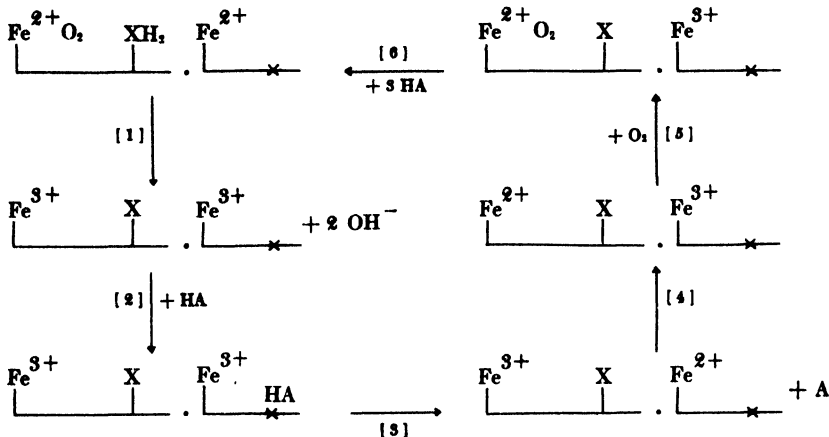
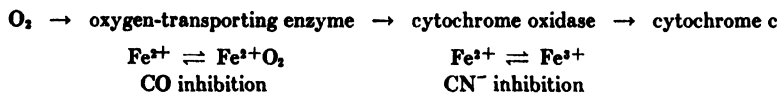

Fig. 5. Mode of action of cytochrome oxidase.

cytochrome c, and the iron of the latter has been reduced to ferrous (step 6), is the stage set once more for the autoxidation and the cycle begins once again. In this way the oxygen is transformed to water without the formation of free reactive radicals or hydrogen peroxide. Reactions 1 and 6 probably involve several monovalent steps, but the radicals formed in them do not leave the complex before the reaction proceeds. It is of historical interest to note that this theory uses a combination of Warburg's and Wieland's theories of respiration even at the level of the first "oxygen-activating" enzyme.

The school of Shibata and Tamiya (2733) holds that cytochrome c is oxidized by two enzymes acting in succession, a ferrous oxygen-transporting enzyme, which reacts with oxygen and carbon monoxide, and a cytochrome oxidase, the ferrous form of which is oxidized to ferric by the oxygen-transporting enzyme. The ferric form of the second enzyme is assumed to combine with cyanide (2733, cf. also 2656, p. 7):



A large part of the evidence brought forward to support this theory has not been confirmed by Keilin and Hartree (1491, cf. also 2677). It is now

mainly supported by the observation of Tamiya (2733) that inhibition of the respiration of yeast and other organisms by cyanide has an effect on the distribution coefficient of the oxidase, similar to that caused by a decrease of substrate concentration ("unsaturation" of the oxidase with substrate). It would indeed be difficult to explain these observations on the basis of Warburg's original theory of cyanide inhibition without postulating that cyanide and carbon monoxide react with two different catalysts. It has been shown, however, in Section 3.6.2. that cyanide probably reacts with both ferrous and ferric oxidase, and that the cyanide inhibition of respiration requires a different interpretation. There is therefore no need for assuming more than one enzyme.

There is, moreover, no indication whatsoever of the occurrence of a reaction:

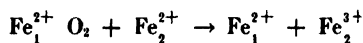

which is assumed in the dualistic theory, while the autoxidation of hemoglobin appears to us a reasonably good model for the reaction:

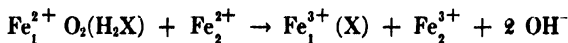

assumed in our scheme above.

CHAPTER IX

HEMATIN ENZYMES, II

1. INTRODUCTION

1.1. Historical

This chapter will be concerned mainly with the enzymes catalase and peroxidase. In contrast to the cytochrome system these do not react with molecular oxygen, but with hydrogen peroxide, although with certain substrates, peroxidases may behave as oxidases.

A decomposition of hydrogen peroxide by plant and animal tissue, as well as by certain finely divided metals, was discovered by Thénard in 1811. For many years catalase was confused with peroxidase until the decomposition of hydrogen peroxide into oxygen and water was known to be due to a specific enzyme, which was called catalase by Loew (1772). The similarity of the names catalase and catalyst is not accidental. Bredig's model experiments (333) on the catalytic action of colloidal platinum have been of fundamental importance for the development of the theory of catalysis and have stimulated work on the enzymes and the use of inhibitors for enzyme studies in general. The similarity between the mode of action of the enzyme and that of the colloidal metal is, however, probably not as close as was then assumed.

Peroxidative action of biological material was first observed in 1863 by Schönbein (2454). The name peroxidase was first applied in 1898 by Linossier (1750), but a clear distinction between oxidases and peroxidases was not made until later (439,521), and in the case of the peroxidase of leucocytes only recently (26).

In addition to catalases and peroxidases, this chapter will deal with

certain enzymes the hematin nature of which cannot yet be considered as established, such as hydrogenase, and with other biologically important catalyses in which hematin compounds probably play a role.

1.2. Model Reactions with Simple Hematin Compounds

1.2.1. Catalatic Activity. Hematin compounds are the only porphyrin metal complexes to catalyze the decomposition of hydrogen peroxide (1168); iron phthalocyanine is also active. Studies on the catalatic action of hematin and hematin compounds have been carried out by Kuhn, von Euler, Zeile, Langenbeck and Stern (328,723,724, 1614,1615,1620,1644,3157). The affinity of hematin for hydrogen peroxide is not smaller than that of catalase (721), but the hematin-hydrogen peroxide complex breaks down much more slowly, and the whole reaction is therefore much slower. Haldane (1098) calculated that at 0° C. the activity in moles per liter per second is 10^{-5} for ionic iron, 10^{-2} for hematin, but 10^5 for catalase.

A comparison of hematin with mesohematin, coprohemin, and deuterohematin showed that the nature of the porphyrin side chain exerts a certain influence on the catalatic activity of the hematin. The pH optimum (1614) and the stability of the hematin to hydrogen peroxide (3157) are also influenced by the side chains, which explains contradictory statements with regard to the relative efficiency of various hematins (cf. 1614 and 1644). Hematins are much more rapidly destroyed by hydrogen peroxide than is catalase.

The state of dispersion and adsorption of the hematin has a considerable influence on its catalatic activity. Adsorption to charcoal increases, adsorption to alumina decreases, it (1620). No similar effect of adsorption has been found with hemichromes (2649). Cyanide inhibits the activity at pH 7-9 under conditions under which dicyanide ferriporphyrin is formed, but does not inhibit it at pH 6, where it even activates (3157); the solutions at the latter pH are probably colloidal. Smaller concentrations of cyanide (0.001 M) at pH 8-9 have the remarkable effect of increasing the initial activity, but cause rapid destruction of the catalyst. These observations of Zeile deserve further study. Imidazole hemichromes are slightly more active catalysts (1644) for the destruction of hydrogen peroxide than is hematin, but other hemichromes are not. Hemoglobin has a catalatic activity of the same order as that of free hematin (1161,2215,2650).

1.2.2. Peroxidative Activity. Peroxidative activity is also restricted to the iron compounds of porphyrins and to the related iron phthalocyanine (1168, 1169). For more than one reason it is difficult to compare the peroxidative activities of different hematin compounds. First, the activity depends on the substrate: although one hematin compound is a more active peroxidase than another with one substrate, it may nevertheless be weaker with a

different substrate. Second, peroxidative activity depends more markedly on pH than does catalatic activity (1614) and again the pH optimum varies with the substrate. It may also vary with the solvent. Haurowitz (1168) gives the following values, in moles of hydrogen peroxide used per mole of hematin per hour: with iodide (pH 5.7), 2; with pyrogallol in aqueous solution of pH 6.8, 15; with pyrogallol in acetic acid or in methanol, 1000; with benzidine in 20% acetic acid, 11,000. This illustrates both points.

In the studies on peroxidative activity of hematin compounds a variety of substrates have been used, such as pyrogallol, which is oxidized to purpurogallin (129,1644,3090), phenolphthalin and other leuco dyes (717,723,724), benzidine (2232), hydriodic acid (328,1614,1615), and ascorbic acid (897,1411, 2163). For the peroxidative oxidation of hydrogen sulfide, inorganic iron is a better catalyst than hematin, while horse-radish peroxidase is entirely inactive (2965,2966). Of the substrates mentioned, only pyrogallol (as a polyphenol) and possibly ascorbic acid are of biological interest.

With benzidine as substrate, protohematin and other hematins closely related to it are stronger peroxidases than hematins derived from chlorophyll porphyrins (2232).

With pyrogallol as substrate, hemochromes are only slightly, hemoglobin derivatives ten to twenty times, more active peroxidases than hematin (129). Bancroft and Elliot give the following values for the purpurogallin number (PZ) (*cf.* Section 3.2.4.) per mg. iron: hematin 1.6, pyridine-hemichrome 4.5, hemoglobin 16, denatured globin hemichrome 35. Compared with horse-radish peroxidase activity, which in these units would be of the order of 10^4 , all these values are very small. With iodide as substrate, similar observations were made by Kuhn and Brann (1614,1615). Imidazole hemichromes were found to be about twice as active as other hemichromes (1644). The peroxidative activity of hemoglobin was first shown by Moitessier (1968) and studied by Bach (110); carbon monoxide does not inhibit the reaction. Jayle (1411)* found hemoglobin at pH 4-5.5 a strong peroxidase with ascorbic acid as substrate, while at pH 7.2, in contrast to Fischer (897), he found little activity. The studies of Polonovski on the peroxidative action of hemoglobin are of some interest with regard to the mechanism of peroxidase action and will be discussed in this connection.

2. CATALASE

2.1. Isolation

Catalase is best prepared from the mammalian liver or from erythrocytes, both of which contain the enzyme in comparatively high concentrations. The preparation from erythrocytes is more difficult, since it requires separation of the enzyme from a large excess of hemoglobin, but leads to preparations of greater purity and higher activity.

* More recent publications of this author (1411a) have not been available.

Considerable progress in the purification of catalase was made by von Euler and his co-workers (720,725,1239,1240). These authors also studied the kinetics of the enzyme carefully and developed methods for its estimation. It is now evident that some of von Euler's preparations were not far from purity.

In 1930, Zeile and Hellström (3166) prepared hemoglobin-free catalase from horse liver, using the method of Tsuchihashi (2832). The hemoglobin is removed by precipitation with alcohol and chloroform. The enzyme is then adsorbed to alumina C or calcium phosphate and elutriated with secondary phosphate. They showed that the catalatic activity was proportional to the hematin content of the preparation, and thus proved catalase to be a hemoprotein. Similar methods were used by Keilin and Hartree (1487).

Agner (24) showed that one of the impurities of liver catalase is ferritin. Since ferritin contains a much larger percentage of iron than catalase, even small amounts of this impurity greatly influence the iron content of catalase preparations. Hence no correlation between iron content and activity had been observed in earlier preparations (1239,1240). Agner removed ferritin by fractional precipitation with ammonium sulfate.

For the preparation of catalase from horse liver, Lemberg and Legge (1705) used the method of Zeile, followed by removal of phosphate by dialysis and then by removal of the ferritin according to Agner. Still better is the use of ammonia instead of phosphate for elution of the enzyme. Another method in which no adsorption is used, has been described by Agner (27).

Sumner and Dounce (2698) prepared ox liver catalase by a greatly simplified procedure using fractional precipitation with dioxane, digestion of glycogen by salivary amylase, and crystallization by addition of ammonium sulfate or dialysis against ammonium sulfate solution. Dioxane can be replaced by acetone (612).

Ox liver catalase and catalases from the livers of other animals were obtained as well-formed crystals by Sumner and his collaborators (2698-2700,612). Erythrocyte catalase was prepared by Agner (28) and crystallized by Laskowski and Sumner (1657). The isolation and chemistry of catalase has been reviewed by Sumner (2697).*

Catalase is readily adsorbed on alumina, calcium phosphate, silica gel, and also on cellulose (2742). The catalase adsorbed on alumina or silica gel is still active (2333,2651).

* Recently, Bonnicksen (311a) crystallized human erythrocyte catalase; Herbert and Pinsent (1244a) crystallized the catalase of *Micrococcus lysodeiaticus*.

2.2. Spectroscopic and Magnetochemical Properties of Catalase and Compounds of Catalase

The absorption bands of liver catalase have been found by various authors (24,1390,1487,2653,2659,2697,3166) in somewhat different positions, varying with the method used. By visual spectroscopy the centers of the unsymmetrical bands are found to be shifted toward the red as compared with the true position of the absorption maxima (Theorell, 2778). The spectrum was found as follows:

| | | |
|---------------------------------------|---------------------------------------|----------------|
| I, 629-622 ($\epsilon_{mM} = 10.8$) | II, 544-536 | III, 506.5-500 |
| IV, 409-400 ($\epsilon_{mM} = 145$) | V, 280-266 $m\mu$ (IV > III > I > II) | |

The quantitative extinction values are those given by Stern (2659).

Agner (24) reports a much lower value for the extinction of the Soret band IV ($\epsilon_{mM} = 78.5$). Itoh (1390) made the queer observation that the absorption band at 406 $m\mu$ disappears when the enzyme is treated with carbon monoxide. The band at about 270 $m\mu$ is remarkably high; Stern and Lavin (2659) explain this by the relatively greater contribution of the protein in catalase as compared with hemoglobin.

It should be noted that most of the spectroscopic studies were carried out with liver catalase which, as will be seen below, contains a somewhat varying amount of bile pigment hematin, differing in this respect from erythrocyte catalase.

Keilin and Hartree (1487) observed a shift of the absorption bands caused by ammonia, not by other alkalis; catalase is thus evidently able to form an ammonia compound. Theorell and Agner (28, p. 7; 2780) found that, at a lower pH, catalase becomes more greenish, the absorption band in the orange shifting to 618 $m\mu$ and becoming narrower and higher. By measurements of the effect of anions on the intensity of the absorption at 610 $m\mu$, Agner and Theorell (29) have recently shown that at a pH above 4 the hematin iron of erythrocyte as well as of liver catalase has a hydroxyl ion bound to it as has the iron of hemoglobin hydroxide. Anions can replace the hydroxyl group:

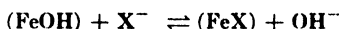

While relatively high concentrations of phosphate are required for this reaction to proceed to a noticeable degree, acetate and particularly fluoride and formate react at much lower concentrations. If

$$K = \frac{[\text{FeOH}][\text{X}^-][\text{H}^+]}{[\text{FeX}]}$$

the following pK values were found: phosphate 4.83, acetate 6.27, fluoride 7.66, formate 9.15. In the absence of anions ($FeOH$) is half-dissociated at pH 3.8.

Catalase cannot be reduced by dithionite, the absorption spectrum remaining unaltered. After denaturation of the protein by alkali the spectrum becomes that of a hemichrome (575, 545 $m\mu$) and dithionite now reduces it to a protohemochrome. The bands of this are not altered by pyridine. According to Zeile and co-workers (3164) catalase can be reduced by dithionite after treatment with hydrogen sulfide or in the presence of washed liver slices; Keilin (1499) could not confirm this observation. Recently Dounce and Howland (615) observed that crystalline ox liver catalase after being dried in the frozen state can be reduced by dithionite to a compound with two absorption bands (594, 560 $m\mu$). This absorption spectrum resembles that of reduced peroxidase. This catalase preparation was, however, largely inactive.

TABLE I

Spectroscopic and Magnetochemical Data on Compounds of Catalase

| Compound of catalase with | Color | Position of absorption maxima, $m\mu$ | Reference | Unpaired electrons |
|---------------------------|----------------|---------------------------------------|------------------|--------------------|
| Cyanide | Red | 589, 557 595 ^a , 557 | (3166) (1487) | 1 |
| Fluoride | Orange-red | 622 (weak), 597 | (1487) | 5 |
| Hydrogen sulfide | Green | 640, 587, 548 | (1487, 3166) | 1 ^d |
| Ethyl hydrogen peroxide | | 570, 534.5 | (2650) | |
| Nitric oxide | | 576, 541 577, 538.5 | (1487) | |
| Azide | Greenish brown | 624 ^b , 544, 506.5 | (1487) | 5 |
| Azide + hydrogen peroxide | Red | 588, 547 590, 554 ^c | (1487) | 1 ? |

^a In the spectrophotometer the absorption spectrum shows only an inflection at 580 $m\mu$.

^b Band higher than that of uncombined catalase.

^c If hydrogen peroxide is added more slowly.

^d Somewhat higher than would correspond to one unpaired electron.

Table I gives the absorption spectra of various compounds of catalase together with the numbers of unpaired electrons found by Theorell and Agner (2780) by magnetochemical investigation of

horse liver catalase. The iron of catalase itself has five unpaired electrons.

Earlier studies of Michaelis and Granick (1938) had indicated three unpaired electrons per iron atom, but these results were later withdrawn (1937). Magnetochemical studies on liver catalase are complicated by the large diamagnetic contribution of the protein which forms 99% of the molecule, and also by the fact that only about three quarters of the total iron is hematin iron. The remaining quarter is bile pigment hematin iron, which does not form covalent bonds with any of the reagents. The paramagnetic contribution of this iron has to be subtracted in order to determine the magnetochemical properties of the hematin iron in liver catalase.

The absorption spectra of catalase and fluoride catalase are those expected for compounds with an ionic type of linkage (*cf.* Chapter V, Section 1.3.). The band of hydrogen sulfide catalase at 640 $m\mu$ may be due to a partially ionic character of this compound. This is supported by its magnetic susceptibility which is somewhat larger than would be expected for a compound with covalent linkages. The absorption spectra have also been measured spectrophotometrically and the data of Keilin and Hartree (1499) are given in Figure 1. Catalase also reacts with hydroxylamine, the first band becoming more diffuse and a shading at 580 $m\mu$ more noticeable (2654).

The azide compound of catalase is quite different from that of hemoglobin. While hemoglobin azide is a substance with covalent linkages and a two-banded absorption spectrum, azide catalase has ionic linkages and an absorption spectrum of the same type as that of catalase itself.

Of peculiar interest is the reaction of the azide compound with hydrogen peroxide (Keilin, 1487, 1499). The red, two-banded absorption spectrum and the decrease in magnetic susceptibility prove that hydrogen peroxide produces a compound with covalent linkages, while in azide catalase the linkage is ionic. The absorption spectrum of the red compound is shifted by carbon monoxide 10 $m\mu$ toward the blue; this was confirmed by Theorell and Agner (2780). The compound is stable under nitrogen, and is reconverted into azide catalase by atmospheric oxygen, but not by ferricyanide. It does not react with cyanide. Keilin therefore assumes that the compound contains ferrous iron, hydrogen peroxide reducing the ferric iron of azide catalase.

While Keilin and Hartree previously spoke of azide-hydrogen peroxide-carbon monoxide catalase, they avoid this term in their latest paper (1499). Such compounds would require coordination

of heme with seven or eight groups; there is in fact no evidence that hydrogen peroxide is bound in the ferrous azide compound, nor is there any need to assume a linkage to peroxide or azide in the carbon

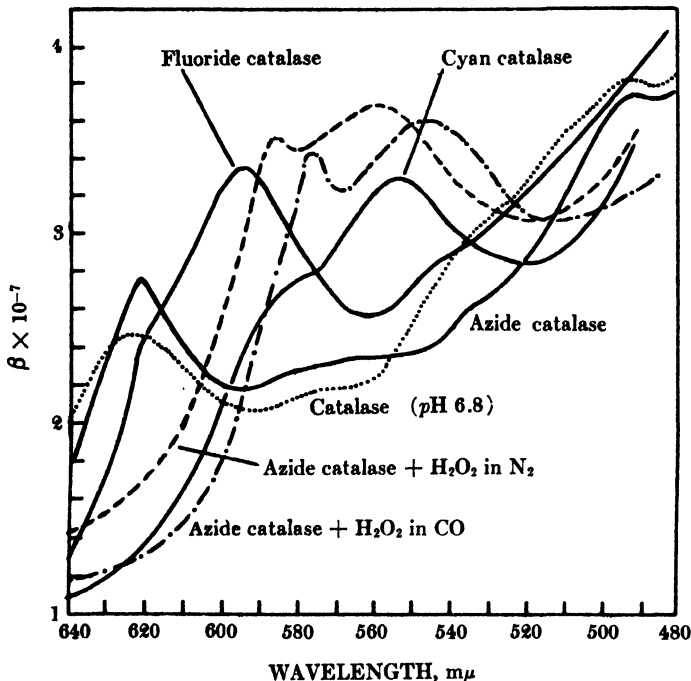

Fig. 1. Absorption spectra of catalase and its derivatives determined with the Hilger-Nutting spectrophotometer (after Keilin and Hartree, 1499). $\beta = (1/cl) \ln (I_0/I)$, where c = concentration of catalase in gram moles hematin per milliliter, l = depth of liquid layer in centimeters, and I_0 and I = intensities of incident and transmitted light, respectively.

monoxide compound, since carbon monoxide may replace azide. The main point is that hydrogen peroxide in some way reduces azide catalase to a ferrous compound, which dithionite is unable to do. This will be discussed further in Section 4.

The magnetochemical results of Theorell and Agner (2780) indicated the presence of one free electron in the red azide compound produced by hydrogen peroxide. Keilin and Hartree (1499) have pointed out, however, that the instability of the compound renders the magnetochemical studies inconclusive. The magnetic susceptibility can be explained by assuming that during preparation for

analysis a 20% oxidation of the diamagnetic ferrous compound to the fully ionic ferric azide compound takes place. The results of Keilin and Hartree add further convincing evidence for the ferrous nature of the red azide compound.

2.3. Inhibitors

The substances which have been shown to combine with catalase also inhibit its catalytic activity. This is also true of the anions. Only the (FeOH) form is active, not the (FeX) compounds. The inhibition by anions previously observed by Michaelis and Pechstein (1939), by Santesson (2426), and by Agner (28) is thus explained. Ethyl hydrogen peroxide inhibits the action of catalase on hydrogen peroxide competitively (2647);* 50% inhibition is caused by 8×10^{-7} M cyanide (3166), and by 3×10^{-5} M sodium hydrosulfide (2647). According to Zeile the dissociation constant of the cyanide compound agrees with this value for 50% inhibition, but a smaller degree of inhibition by cyanide (50% inhibition at about 5×10^{-6} M) has been reported by Stern (2647) and Keilin and Hartree (1499). It has also been claimed that the cyanide inhibition does not depend on hydrogen peroxide concentration, which it should do if hydrogen peroxide and cyanide were to compete for the iron. Zeile concludes from this that cyanide combines with a group other than the hematin iron, but this appears to be in contradiction to his earlier experiments quoted above.

TABLE II

Comparison between Effectiveness and Affinity of Inhibitors for Catalase

| Inhibitor | Inhibitor concentration at 50% inhibition, M | Dissociation constant |
|--------------------|--------------------------------------------------|-----------------------|
| KCN | 4.3×10^{-6} (8×10^{-7}) ? | 8×10^{-7} |
| NaN ₃ | 6.3×10^{-8} | 1.2×10^{-4} |
| NH ₂ OH | 6.3×10^{-7} to 1×10^{-8} | 2×10^{-4} |

The inhibition by azide and hydroxylamine, on the other hand, is far stronger than would be warranted by their affinity for catalase as determined spectrophotometrically (289,1403,1487,1499,2535). Table II gives the values for the concentrations of inhibitors causing 50% inhibition, together with those at which half-dissociation occurs

* Cf., however, Chance (425b).

according to spectrophotometric estimation. The values for the latter were calculated from the relative affinities given by Keilin and Hartree (1499), on the assumption that the dissociation constant of the cyanide catalase is $8 \times 10^{-7} M$. The problem of accounting for this divergence will be discussed below and in Section 4. Phenylhydroxylamine and *o*-aminophenol (2528) as well as *p*-hydroxylaminobenzene sulfonamide (2535) are also strong catalase inhibitors.

An inhibition of catalase by carbon monoxide has been claimed by Califano (391). Several authors were unable to confirm this (*cf.* 2079, p. 156); it is now clear that pure catalase is not inhibited by carbon monoxide, but Keilin and Hartree (1490,1499) found a light-sensitive inhibition by this reagent in the presence of such substances as glutathione, cysteine, and azide.

2.4. Estimation and Enzyme Kinetics*

Estimation. Highly purified catalase is best determined oxidimetrically by the method developed by von Euler and his collaborators and extended by Zeile and Hellström (3166). For impure preparations the iodometric method of Jolles (1423) has been recommended. Finally, the oxygen development can be determined manometrically: although this method is the only one available for the estimation of catalase in some tissues, it cannot be recommended for pure catalase (*cf.* below).

If the disappearance of hydrogen peroxide is estimated oxidimetrically it is found that the reaction does not follow a strictly monomolecular course with regard to hydrogen peroxide. This is largely explained by a slow destruction of the enzyme by hydrogen peroxide, accompanying its catalatic action.

Sizer (2570) has claimed that the initial rate of development of oxygen from hydrogen peroxide, measured manometrically, is of zero order. His claim that he measured a more truly initial stage of the hydrogen peroxide decomposition than is measured by the oxidimetric methods is not correct. The deviation of his results from those obtained by oxidimetric methods is probably due to a fault in the manometric method. It has been shown by Theorell and Agner (2780) that it cannot be used for the activity estimation of pure catalase solutions, since the oxygen evolution lags behind the disappearance of hydrogen peroxide as measured oxidimetrically (*cf.* also Roughton, 2361).

The kinetics of the destruction of hydrogen peroxide by catalase are

* The important papers of Chance (425a, 425b; *cf.* also 314b) appeared too late for inclusion in this discussion, but should be consulted.

described by the two formulas:

$$-dC = kEC dt \quad \text{and} \quad -dE = k'CE dt$$

where C and E are the concentrations of hydrogen peroxide and catalase, respectively, k is the reaction constant of the hydrogen peroxide decomposition, and k' is that of the enzyme destruction. The mathematics of this process have been worked out by Yamazaki (3147), Nosaka (2059), and Maximowitsch and Antonomova (1889) (cf. also Lemberg and Legge, 1705).* The constants k and k' can thus be calculated from the data observed experimentally. Usually $k_0 (= kE_0)$, the initial activity, is determined by graphical extrapolation from the monomolecular pseudoconstants k_1 , k_2 , and k_3 observed at times t_1 , t_2 , and t_3 under conditions under which the destruction of the enzyme plays only a small role (von Euler, Zeile). The specific activity of catalase (*Katalase-Fähigkeit*, Kat.f.) is defined as k_0 per gram of enzyme in 50 milliliters (3161, p. 557), where k_0 is measured in minutes and with decadic logarithms. Unfortunately Kat.f. was given by Hennichs (1238, cf. also 718) as k per gram of enzyme, although it was pointed out in a footnote that this was to refer henceforth to 50 ml., not to 1000 ml. This incorrect definition has been perpetuated in the literature right up to date (cf. 2697, 2705), and has led many authors to the erroneous belief that the enzyme concentration to which Kat.f. refers is grams per liter (cf., for example, 2570). This is of importance since the activity of the enzyme per mole per second calculated on this basis is twenty times too high. Only Haldane's calculation (1098) is free of this error. It is also present in most calculations on the enzyme concentration in liver and blood (including those of Haldane). The use of natural instead of decadic logarithms (1482) has also led to Kat.f. values which are not directly comparable with those of other authors.

Enzyme activity. For horse liver catalase (extrapolated for a catalase free from inactive bile pigment hematin catalase, cf. below), Sumner (2697) found a value of Kat.f. of 60,000, Lemberg (1705) 52,000, and Keilin and Hartree (1499) 54,000-55,000, while Agner (27) reports 80,000. The value of k per milligram of hematin iron per liter (k/Fe_p) for horse liver catalase was found by Zeile (3166) to be between 2500 and 3400. On the basis of our knowledge of the composition of catalase, Agner's value would correspond to a k/Fe_p value of 4250. Agner's value therefore would appear to be too high to be correct. While Agner and Theorell (29) again find this high value for Kat.f. of liver catalase, they now report a lower value (65,000-70,000) for erythrocyte catalase. Agner (28) had previously given the value of 100,000, while Laskowski and Sumner (1657) found only 48,000 for crystalline erythrocyte catalase.

From a value 46,000 for Kat.f., which is probably about three-fourths of the true value, Haldane (1098) calculated for the velocity constant of hydrogen peroxide decomposition $k = 2 \times 10^5$ liter mole⁻¹ sec.⁻¹ at 0° C., and for the velocity constant of combination between enzyme and hydrogen peroxide

*Recently, George (986a) found, in manometric studies, an initial rapid decay of the enzyme activity, which is claimed to be reversible and is assumed to be due to the rapid partial transformation of catalase into a less active state by hydrogen peroxide. The initial rapid decay has been confirmed by Lemberg and Foulkes (1698a) with the oxidimetric technique.

a minimal velocity of 8×10^6 liter mole⁻¹ sec.⁻¹. Still higher values have been estimated by Brdička and co-workers (332) on the basis of polarographic experiments.

Between pH 6 and 8 the activity of catalase is not affected by pH, but below pH 6 it decreases rapidly with decreasing pH, particularly in acetate buffer (cf. Section 2.3.).

The Michaelis constant was found to be about 0.03 *M* (721,2647). Large concentrations of hydrogen peroxide inhibit the action of the enzyme; 0.4 *M* hydrogen peroxide, for instance, inhibits 50% (2647). It is to be noted that the oxidimetric estimation of catalase is carried out at a substrate concentration (0.005 *M*) somewhat below the optimal concentration (0.07 *M*). The greater *k*/*Fep* found by Zeile for pumpkin catalase (3158), as compared with liver catalase, may thus be due to the greater substrate affinity of the former.

Inhibition by destruction of catalase. A form of inhibition of catalase exists which differs essentially from inhibition by cyanide. Lemberg and Legge (1705) have shown that the inhibition of the catalatic action by ascorbic acid (2829) is due not to a decrease of *k* but to an increase of *k'*, *i.e.*, to faster inactivation of catalase by hydrogen peroxide. This also holds for inhibition by sulfhydryl compounds, which inhibit at rather high concentrations — about 10^{-3} *M* (Stern, 2647). Waldschmidt-Leitz (2913) found the cysteine inhibition to be irreversible. It has been shown by Lemberg and Legge that the destruction of catalase in the presence of ascorbic acid is due to the action of hydrogen peroxide on ferrous heme iron and the peroxidative autodestruction of catalase, with formation of bile pigment hematin (cf. Chapter X).* Keilin and Hartree (1490) have observed that, in the presence of cysteine, glutathione, and azide, the action of catalase is inhibited by carbon monoxide, and that this inhibition is abolished by light. The inhibition by BAL (2,3-dimercapto-1-propanol) is also increased by carbon monoxide (1699).† There is thus definite evidence for a change of valency of the catalase iron under these conditions.

Some "anticatalase" preparations of Battelli and Stern (191, 2237, 2662) evidently contained reducing substances. In liver extracts catalase is activated by —S—S— compounds such as cystine and oxidized glutathione and by other oxidants (Balls and Hale, 126). Such effects have been described

* This does not hold, however, for the effect of ascorbic acid on catalase in the presence of dilute hydrogen peroxide. Under these conditions, there is no evidence that the catalase iron is reduced (Foulkes and Lemberg, 921a). Carbon monoxide does not increase the ascorbic acid inhibition; on the contrary, it decreases it by binding copper.

† BAL does not remove the hematin iron, as postulated by Webb and van Heyningen (3005a).

as due to "philocatalase." In Section 4. these phenomena will be discussed in relation to the theory of the mode of action of catalase. They deserve a reinvestigation with modern methods.

2.5. Nature of the Prosthetic Group

Zeile and Hellström (3166) demonstrated that alkali, pyridine, and dithionite transform horse liver catalase into a hemochrome which is spectroscopically indistinguishable from pyridine protohemochrome. By treatment with hydrazine and acetic acid this was transformed into protoporphyrin. Crystalline hemin was isolated from catalase by Stern (2652) and transformed into mesoporphyrin dimethyl ester. By mixed melting point determinations it was shown that this was mesoporphyrin IX ester. The prosthetic group of catalase is thus the same as that of hemoglobin.

Bile pigment in catalase. From a fraction of Stern's preparation, Lemberg (cf. 2652) isolated biliverdin. This later became of interest when Summer and Dounce (2699) showed that their crystalline ox liver catalase did not contain four hematin groups per molecule, as had been claimed by Stern and Wyckoff (2661), but only two, the remainder of the iron (two atoms per molecule) being accompanied by a blue substance after treatment with acetone-hydrochloric acid. The blue substance was again identified as biliverdin by Lemberg and co-workers (1705,1714). They showed that biliverdin was not present in the catalase as such but was detached from a bile pigment hematin by treatment with acid. The presence of this hematin was also revealed by the absorption curves of the hemochrome obtained from the catalase by treatment with alkali and dithionite.

Lemberg and Legge as well as Agner (27) found about three of the four iron atoms of the molecule of ox and horse liver catalase to be protohematin groups. The fourth iron was ascribed by Lemberg to the bile pigment hematin group, while Theorell (2771,2778) and Agner (27) considered the proportionality of iron and biliverdin to be accidental. Lately, however (29), these authors have themselves found additional evidence for the presence of a hematin group different from protohematin in liver catalase.*

There is no conclusive evidence today to show whether protohematin and bile pigment hematin groups occur in one and the same molecule, or whether liver catalase is a mixture of active catalase — containing four protohematin

* Human liver catalase apparently does not contain this group (unpublished experiments cited by Theorell, 2779a).

groups — with inactive oxidized catalase — containing four bile pigment hematin groups. Sumner and Lemberg have both shown that the ratio of protohematin to bile pigment hematin varies (*cf., e.g., 614*), although usually within rather narrow limits, and that the catalase activity decreases with increased bile pigment hematin content. Hybrids may exist, but then interaction between dissimilar hematins has not been demonstrated. If the mixture contains active and inactivated catalase, the proteins to which the different prosthetic groups are attached must be the same. The rather constant proportion must then be conditioned physiologically rather than chemically. This is supported by the fact that erythrocyte catalase does not contain any bile pigment hematin (Laskowski and Sumner, *1657*; Agner, *28*). These observations are of interest with regard to the role of catalase *in vivo*. This aspect will receive consideration in a later section. A claim of Agner (*24*) that copper is an essential part of the catalase molecule was withdrawn (*25*).

2.6. Protein of Catalase

Catalase is not as stable as cytochrome c, but is not as readily denatured as hemoglobin. At 0° C. it can be kept for a long time. It has been claimed, however, that very dilute solutions soon lose their activity. By means of ultracentrifuge experiments the molecular weight of ox and horse liver catalase was found to be 225,000 (*2700, 2702*); Stern and Wyckoff (*2661*) had previously reported a similar, but somewhat higher value of 250,000 to 300,000. From the iron content — 0.094% of horse liver catalase (*27*), 0.087% of erythrocyte catalase (*28*) — a molecular weight of 238,000 can be calculated for the former, and of 257,000 for the latter — assuming four atoms of iron per molecule. At pH 9.9 the molecule splits into smaller units.

The isoelectric point of crystalline ox liver catalase is 5.7 (*2698*); for horse liver catalase values between 5.4 and 5.6 have been reported (*25,2645,2646*). Theorell and Åkesson (*2786*) have studied the hydrolyzate of horse liver catalase with a new electro-dialytic micro-method, and have investigated the content of basic amino acids. The results are given in Table III. The asymmetry ratio of 4.8 was observed for anhydrous, that of 3.4 for hydrated, catalase (*2045*).

Catalase is an antigen; the antibody-catalase precipitate is catalytically inactive (*399*). Horse liver catalase differs immunologically to a greater extent from ox liver catalase than does sheep liver catalase (*2828*).

Practically nothing is known as yet about the linkage of the prosthetic group to the protein, which confers an extraordinary stability on the ferric form of the former. Agner (*23*) had claimed that catalase could be split reversibly if the enzyme was dialyzed

against 0.1 *N* hydrochloric acid. Several authors (2699,2744) have, however, been unable to confirm this observation. Evidently it is impossible to renature the denatured protein.

TABLE III
Fractions of Catalase Hydrolyzate^a

| Fraction | Per cent of nitrogen | Nitrogen atoms per iron atom |
|-------------------------------------------|----------------------|------------------------------|
| Humin nitrogen | 1.3 | 4 (porphyrin) + 6 |
| Amide nitrogen | 10.4 | 75 |
| Anode nitrogen (dicarboxylic amino acids) | 15.4 | 112 |
| Neutral nitrogen | 43.5 | 315 |
| Cathode nitrogen (basic amino acids) | 29.5 | 213 |

| Fraction | Per cent of weight | Moles | Nitrogen atoms per iron atom |
|------------------------|--------------------|-------|------------------------------|
| Histidine (determined) | 3.87-4.12 | 15-16 | 48 |
| Arginine (determined) | 7.72 | 27 | 108 |
| Lysine (calculated) | 7.70 | 32 | 64 |

^a According to Theorell and Åkesson (2786).

2.7. Biological Function of Catalase

2.7.1. Occurrence of Catalase. Catalase is ubiquitous in aerobic cells and is lacking only in strict anaerobes and in a few facultative anaerobes. In general, the organisms possessing a cytochrome system also contain catalase; (the converse is also true). An exception is *Acetobacter peroxydans* which shows cytochrome bands, but does not contain catalase. It is likely that its cytochrome bands are due to the presence of a peroxidase which protects the organism against hydrogen peroxide (3073). *Shigella dysenteriae* has also been reported to contain no catalase. In yeast cytochrome and catalase contents have been found to vary in parallel (708).

While catalase is ubiquitous in aerobic cells, it is highly concentrated in a few animal tissues (liver, red cells). Assuming a Kat.f. of 60,000 for pure catalase, the concentration in horse liver is about 0.03% and in blood, 0.05%, i.e., 10^{-6} to $10^{-7}M$ (2697). These are minimal values which neglect the presence of inhibitors in the tissues. In all other tissues the concentration of the enzyme is far smaller. Liver cell nuclei do not contain catalase (613).

In general, the catalase content of human blood is approximately but not completely parallel to its red cell content (51,2483). Further references are given in the papers quoted. In general, anemia is frequently associated with reduced blood catalase activity but on recovery catalase rises more rapidly than does hemoglobin, young red cells being perhaps particularly rich in catalase. During the first months of life the catalase activity is relatively smaller than later.

Needham (2017, p. 604) states: "Contrary to a persistent belief it is not possible to show any relation between catalase activity and respiratory intensity." If, however, the activity of catalase is compared with the amount of cytochrome system which can be shown to be present, the experiments of Williams (3084) on grasshopper egg development appear to make a rather good case for correlation, except that in the first days of prediapausal development catalase appears more slowly than the cytochrome system. In the development of the embryo the ratio of catalase to unit weight increases and the increase of catalase is inversely proportional to anaerobic glycolysis (cf. 2017, p. 604).

2.7.2. Protection against Hydrogen Peroxide. Until quite recently it has been generally assumed that catalase serves the biological purpose of protecting the cell from the deleterious effects of hydrogen peroxide.

It has been shown in Chapter VIII that the autoxidation of ferrous cytochrome oxidase produces no hydrogen peroxide, but it is well known that several enzyme systems, such as amino acid oxidase, amine oxidase, polyphenol oxidase, glucose oxidase, xanthine and aldehyde oxidase, and uricase (aerobic dehydrogenases), produce hydrogen peroxide, and that the latter may be also formed by the autoxidation of flavoproteins, sulfhydryl compounds, and ascorbic acid. Dixon (595) showed that catalase, in fact, protects xanthine oxidase from destruction by the hydrogen peroxide which it forms. L. Stern (2662) found a certain proportionality between the concentration of the aerobic dehydrogenases in organisms and their catalase content. Hydrogen peroxide has not been observed, however, in strongly respiring cells of aerobic organisms, even if catalase was inhibited by hydroxylamine. Keilin believes that the small oxygen affinities of the aerobic dehydrogenase systems make it questionable whether these systems actually function in the cells of higher organisms, in which the oxygen pressure is low.

In this connection it is of some interest that *Ascaris* contains but little catalase and cytochrome c (1655); this worm lives under nearly anaerobic conditions and is damaged by higher oxygen pressure.

In plants, hydrogen peroxide has been shown to be formed, although

it should be noted that the frequently used cerous hydroxide method gives misleading results if ascorbic acid is present (1697). Peroxidase is widespread in plants and in the presence of this enzyme, whose action is not inhibited by catalase (*cf.* Section 3), the protective action of catalase can only be of minor importance. An interesting biological role of the competition between peroxidase and catalase for hydrogen peroxide has, however, been reported by Hurst (1371). According to his observations peroxidase plays a role in the hardening of the insect cuticle and this is counteracted and controlled by catalase.

In strictly anaerobic bacteria, hydrogen peroxide is probably not formed inside the cell. The experiments of McLeod and Gordon (1822-1825), which appear to prove the contrary, have to be interpreted in a different manner (*cf.* Chapter X). Some facultative anaerobes, *e.g.*, *Pneumococcus*, lactic acid bacteria, and certain streptococci, do not contain catalase but form hydrogen peroxide. In the case of the lactic acid bacteria and *Alcaligenes faecalis* there is evidence of the deleterious effect of hydrogen peroxide on the organism, while in *Pneumococcus* the peroxide may be used up in a direct reaction with substrate (pyruvic acid).

2.7.3. Catalase as a Peroxidative Enzyme. Keilin and Hartree (1500) have recently come to doubt the theory of the biological role of catalase as a safety valve against accumulation of hydrogen peroxide. Hydrogen peroxide, they believe, is not formed *in vivo* as frequently as is often assumed; if it is formed, catalase is frequently found to be unable to exert the postulated protective function, and consequently a peroxidative rather than a catalytic function is postulated as the role of catalase in the cell. Similar ideas had been expressed in 1927 by L. Stern (2662).

Keilin's objections against the protection theory are based on the following observations:

(a) Keilin and Hartree (1486) have shown that, in the presence of catalase, ethyl alcohol and its homologues, as well as ethanolamine, can be oxidized by hydrogen peroxide formed by such systems as xanthine oxidase, glucose oxidase, and α -amino acid oxidase. In this "coupled oxidation of alcohol" catalase behaves as a peroxidase. Later Marsh and Carlson (1873) and Keilin and Hartree (1500) demonstrated that alcohol is also oxidized if hydrogen peroxide itself is added very gradually in small concentrations to a solution containing catalase in a concentration much higher than that needed for catalytic activity. The mechanism of this reaction will be dis-

cussed in Section 4. In the liver, catalase is present in a sufficiently high concentration to act in this manner.

(b) The catalase present in some facultative anaerobes, e.g., *E. coli*, *Proteus vulgaris*, *Bacillus subtilis*, or *Staphylococcus*, appears to afford no protection against the toxic effects of hydrogen peroxide, if the latter is added to the medium or formed in it by such systems as xanthine oxidase, glucose oxidase or autoxidation of ascorbic acid (281,506,1760,1791).*

(c) The high concentration of catalase present in erythrocytes fails to protect hemoglobin against oxidation to hemiglobin, if hydrogen peroxide is gradually produced in small concentrations by the action of notatin, the glucose oxidase of *Penicillium notatum*.† Bingold (270) and others had ascribed to the erythrocyte catalase the role of protector of hemoglobin against oxidation by hydrogen peroxide. Finally, Keilin points out that the retransformation of hydrogen peroxide into oxygen would be a wasteful process.

Keilin's hypothesis of the peroxidative function of catalase is of great interest and deserves further close study. At present, however, the matter is far from being clear. So far no biological substrate of major importance has been found to undergo this coupled oxidation. While the conditions for the peroxidative action of catalase may be present in the mammalian liver and erythrocytes, where its concentration is exceptionally high, this does not hold for the majority of cells in which catalase is found. Here its concentration is so small that catalatic action, not peroxidative action, is more likely to occur.

The fact that liver catalase always contains inactive bile pigment hematin catalase (cf. Chapter X, Section 8.2,) while erythrocyte catalase is free from it, speaks (in our opinion) strongly in favor of a catalatic function of the enzyme in the mammalian liver. Lemberg and Legge (1705) have shown that the action of hydrogen peroxide on catalase in the presence of ascorbic acid oxidizes the enzyme to inactive bile pigment hematin catalase under conditions that would be expected in the liver. The fact that alcohol acts as a philocatalase makes it appear doubtful that the peroxidative action of catalase could lead to a similar autodestruction of catalase.‡

Keilin's theory fails to explain the function of catalase in the erythrocyte. The coupled oxidation of alcohol does not afford protection of hemoglobin against oxidation. If one can conclude from his experiments with notatin that catalase does not protect hemoglobin from oxidation by hydrogen peroxide at all, one must assume that hydrogen peroxide never reaches the red cell. If this is true, the catalase in the erythrocyte is functionless. It will be shown in Chapter XI that there is, nevertheless, good evidence for catalase playing a role in the protection of hemoglobin against oxidation —

* Herbert and Pinsent (1244a) found *Micrococcus lysodeieticus* to contain about 2% catalase, and doubt whether destruction of hydrogen peroxide can provide a teleological reason for such a high concentration of the enzyme.

† Catalase protects, however, against hydrogen peroxide formed by D-amino acid oxidase or ascorbic acid (1699).

‡ Bonnichsen (314a) has recently shown that horse liver catalase contains the same protein as horse erythrocyte catalase.

at least against irreversible oxidation — in the red cell, although Bingold's evidence is of little value.

The inability of intracellular catalase to protect bacteria against hydrogen peroxide formed in the medium does not prove that the enzyme is unable to protect the cell against hydrogen peroxide formed internally. While in a sense it is true that the catalatic destruction of hydrogen peroxide is a waste of energy, so is every safety valve; the oxygen is not lost but can recombine with hemoglobin or the respiratory enzyme.

In spite of these reservations it appears likely that catalase functions *in vivo* as an oxidative catalyst, in a manner still unknown. This may at least be so under special conditions. Stannard (2610) considered it possible, although not proven, that catalase functions as an oxidase in the system in frog muscle which oxidizes carbon monoxide to carbon dioxide.

3. PEROXIDASES AND DIHYDROXYMALEIC ACID OXIDASE

3.1. Introduction

One of the richest sources of peroxidase is horse-radish. Horse-radish peroxidase was investigated in the pioneer enzyme studies of Willstätter (3089,3093). A relationship to iron was suspected, but no parallelism of activity and iron content was found. In 1931 Kuhn and collaborators (1123,1616) discovered that the activity of the enzyme was proportional to its light absorption at $420\text{ m}\mu$ (Soret band) and concluded from this that the enzyme was a hematin compound. This was first doubted by Elliot and Keilin (670), who found, in peroxidase solutions containing far more hematin than those used by Kuhn, no proportionality between activity and the protohemochrome bands which appeared upon reduction with sodium dithionite. They mistook the $640\text{ m}\mu$ absorption band of the enzyme for that of acid hematin. Later, however, Keilin and Mann (1502) found that the strength of this band was always proportional to the activity of the enzyme. They isolated hemin crystals and found that the spectroscopic properties of peroxidase and of its compounds resembled those of other hemoproteins. Meanwhile a similar peroxidase containing 1% hematin had been isolated from fig sap by Sumner and Howell (2703).

Horse-radish peroxidase and the peroxidases of milk and leucocytes were further purified and the first two were crystallized by Theorell and his collaborators. Horse-radish peroxidase can be split into protohemin and a protein, and resynthesized from them (2772,2788). There is little doubt that the prosthetic group of peroxidase is protohemin IX, the same as in hemoglobin and catalase.

3.2. Horse-radish Peroxidase

3.2.1. Isolation. Methods for the isolation of peroxidase from horse-radish have been developed by Bach and Chodat, Willstätter, Kuhn, Elliot, Keilin, and Theorell (109,668,670,1502,1616,2772,3093,3094). Fractional precipitation with ammonium sulfate and alcohol, purification by dialysis and filtration, adsorption to alumina A, precipitation by tannin or picric acid, and electrophoresis have been applied. By electrophoresis at pH 7.5 (2772) a paraperoxidase migrating toward the cathode can be separated from peroxidase which migrates anodically. The former was first called peroxidase I, the latter, peroxidase II. Peroxidase I has now been recognized to be an alteration product of peroxidase (peroxidase II) (2786) and is called paraperoxidase (Theorell, 2778). While the isoelectric point of peroxidase is 7.2, that of paraperoxidase is 10.45. Peroxidase crystallizes from ammonium sulfate solutions of 48–62% saturation, while paraperoxidase requires more than 58%. Paraperoxidase is precipitated by acid at pH 4.5. It is not always found and is rather unstable. Enzymically it is almost as active as peroxidase.

3.2.2. Absorption Spectra and Magnetochemical Properties of Peroxidase and Its Compounds. An absorption spectrum with four bands in the visible part of the spectrum was observed by Keilin and Mann (1502) for horse-radish peroxidase in neutral solution: (I) 645, (II) 583, (III) 548, and (IV) 498 $m\mu$. At pH 10 only bands (II) and (III) are seen. According to Theorell (2772) bands (II) and (III) of the neutral peroxidase solution are not bands of peroxidase, but of paraperoxidase, and only bands (I) (640 $m\mu$) and IV are those of peroxidase. Chance found $\epsilon_{mM}^{640} = 12$ (424).

The Soret band lies at 400–402 $m\mu$ ($\epsilon_{mM} = 78$) according to Theorell (2772) and Itoh (1391), at 410 $m\mu$ ($\epsilon_{mM} = 125$) according to Chance (424), and at 415–420 $m\mu$ according to Kuhn and co-workers (1616).

By means of dithionite, peroxidase is reduced to ferropoxidase with an absorption band at 558 $m\mu$ and a weaker band at 594 $m\mu$ (1502). This combines with carbon monoxide.

Table IV gives the absorption spectra of compounds of peroxidase together with the number of free electrons found magnetochemically (Theorell, 2775).

Peroxidase forms three different compounds with hydrogen peroxide. I, observed by Theorell, is green and in the absence of hydrogen

donors passes readily into II, red compound; according to Theorell, the former is the catalytically active hydrogen peroxide-enzyme complex. Compounds II and III are both considered ferric by Keilin, since carbon monoxide does not alter the position of the

TABLE IV
Spectroscopic and Magnetochemical Data on Compounds
of Horse-radish Peroxidase

| Compound of peroxidase | Position of absorption maxima, $m\mu$ | Reference | Unpaired electrons ^a |
|-------------------------------------------------------------------|---------------------------------------|-------------------------|---------------------------------|
| Fe ³⁺ -H ₂ O ₂ (compound I) | 658 | (Theorell, 2772, 2777) | |
| Fe ³⁺ -H ₂ O ₂ (compound II) | 561, 530.5 | (Keilin and Mann, 1502) | |
| Fe ³⁺ -H ₂ O ₂ (compound III) | 583, 545.5 | (1502) | |
| Fe ³⁺ CN | (581.5), 542 | (1502) | 1 |
| Fe ³⁺ SH | (587), 549 | (1502) | 1 |
| Fe ³⁺ F | 615, 561, 529.5, 496 | (1502) | 5 |
| Fe ³⁺ NO | 570, 539.5 | (1502) | |
| Fe ³⁺ CO | 578, 545.5 | (1502) | 0 |

^a According to Theorell (2775).

absorption bands; compare, however, Abrams and co-workers (1). Hydroquinone restores peroxidase. It is not impossible that III, which arises with an excess of peroxide of at least 15-25 moles, is ferrous, since its absorption spectrum happens to coincide with that of the ferrous carboxy compound. The formation of compound III may explain the inhibition of the enzyme activity by an excess of hydrogen peroxide. It is of interest that only compound III has been observed by Keilin (1502) to cause catalytic decomposition of hydrogen peroxide (*cf.* Section 4.). According to Chance (424), the Soret band is shifted to about 390 $m\mu$ by hydrogen peroxide combination. Azide does not combine if peroxide is present (1502). In weakly acid solution peroxidase also combines with phosphate and picrate if these are present in high concentrations. The absorption spectrum of the compounds resembles that of fluoride peroxidase (2776).

3.2.3. Inhibitors. Both cyanide and sulfide strongly inhibit peroxidase at concentrations of 10^{-5} to 10^{-6} M (989, 1502, 3074). While Wieland and Sutter (3074) found both inhibitions to be irreversible, Keilin (1502) observed that hydrogen peroxide replaced cyanide

from the enzyme and Chance (425) showed the inhibition to be reversible and competitive. The enzyme combines with one mole of cyanide ($K = 4 \times 10^{-6} M$). Whereas the affinities for cyanide and hydrogen peroxide are of the same order, the rate of combination with cyanide is about 100 times slower than that with hydrogen peroxide (cf. Section 3.2.4.). Fluoride, azide, hydroxylamine, and hydrazine (1482,1502) are also strong inhibitors, although in somewhat higher concentration, ($10^{-3} M$), while carbon monoxide has no inhibitory effect (671,2777). Balls and Hale (127), measuring the disappearance of hydrogen peroxide iodometrically, claimed that peroxidase is inactivated by sulfhydryl compounds which act on it in the absence of peroxide, while aniline, phloroglucinol, resorcinol, and toluidines inhibit the enzyme in the presence of peroxide. Randall (2204) has recently shown, however, that the method used by Ball and Hale cannot be applied in the presence of sulfhydryl compounds, and that the latter do not really inhibit peroxidase. They are themselves oxidized as substrates of the hydrogen peroxide-peroxidase system.

3.2.4. Kinetics and Estimation. The enzyme has a double specificity, which we shall call hydrogen donor and hydrogen acceptor specificity, whereas some authors speak of hydrogen peroxide as the substrate and of the hydrogen donors as "acceptors." Peroxidase combines with hydrogen peroxide through the hematin iron and with the hydrogen donor through a group in the protein molecule (1862). It can oxidize a variety of hydrogen donors, of which polyphenols (particularly pyrogallol), leuco dyes such as leucomalachite green, and ascorbic acid are used frequently. The *pH* optimum varies with the hydrogen donor used (127). As hydrogen acceptors hydrogen peroxide and (less effectively) monoalkylperoxides are active, but not dialkylperoxides (3075). Catalase does not inhibit peroxidase effectively (1375). Horse-radish peroxidase can also catalyze the oxidation of *p*-aminobenzoic acid by hydrogen peroxide (1759). The reaction is inhibited by sulfanilamide, but has no correlation with the antibacterial activity of the latter substance.

For quantitative estimations, the purpurogallin method of Willstätter is commonly used. The "Purpurogallin Zahl" (PZ) is defined as the number of milligrams of purpurogallin, an orange pigment, produced per milligram of enzyme preparation (dry weight) in five minutes at 20° C. when 12.5 mg. of hydrogen peroxide and 1.25 g. of pyrogallol in 500 cc. of water are employed. It now appears that this method was not fortunately chosen. Several authors

(*cf.* 2079, p. 179) have drawn attention to the fact that the PZ values of Willstätter and Kuhn were far higher than any reported by later workers. For pure crystalline horse-radish peroxidase (and also for paraperoxidase), Theorell (2775) gives a PZ value of 900-1200, while Willstätter found one value of 4700 and Kuhn and co-workers (1616), a PZ of 3400, for a preparation containing only 0.009% hemin, *i.e.*, 1/150 of the hematin content of pure peroxidase. The tendency has been to dismiss the values of Willstätter and Kuhn as erroneous (*cf.* Theorell, 2778). If we transform them into molecules of hydrogen donor oxidized per liter per second by one mole of enzyme, we find, from Kuhn's values, a value of about 3×10^6 moles liter⁻¹ sec.⁻¹, which agrees much better with the values found by Chance (424) for the oxidation of leucomalachite green (3×10^6 to 4×10^6) or of ascorbic acid (1.8×10^6), than the values for pyrogallol oxidation by the pure enzyme (about 10^5); Willstätter (3094) found pyrogallol to be oxidized more rapidly than leucomalachite green. This suggests that a mediator for the oxidation of pyrogallol may be removed during the purification. On the other hand, the necessity of a mediator for the peroxidative oxidation of ascorbic acid, claimed by Szent-Györgyi (1375, 2725, *cf.* also 2743), is not evident from the experiments of Chance (424) or Keilin and Mann (1502).

In an interesting investigation Chance (422, 424) has shown that peroxidase action with a low concentration of hydrogen peroxide proceeds as postulated by the Michaelis-Menten theory of enzyme action:

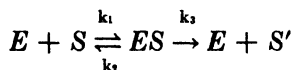

according to the equation:

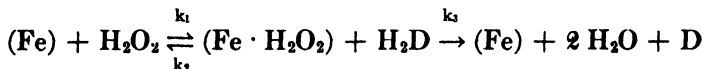

H_2D = hydrogen donor = leucomalachite green. The rates of formation and breakdown of the hydrogen peroxide compound with and without hydrogen donor were measured directly by a modified Hartridge-Roughton flow technique (423, 426). The shift of the Soret band caused by the formation of the hydrogen peroxide compound was measured by means of mirror oscillograph recordings, compensation being made for a rather high absorption of malachite green in this region by using two filters with maxima of transmission at 370 and 430 $m\mu$, respectively, the transmissions of which were affected equally by the malachite green absorption. The formation of the malachite green was measured at 570 $m\mu$. The following values were found: $k_1 = 1 \times 10^7$ moles liter⁻¹ sec.⁻¹, $k_2 = 0.2$ sec.⁻¹, k_2/k_1 (true dissociation constant) = 2×10^{-8} M, $k_3/(H_2D) = 1.8 \times 10^5$ moles liter⁻¹ sec.⁻¹ for ascorbic acid, 3×10^5 moles liter⁻¹ sec.⁻¹ for leuco-

malachite green, $(k_2 + k_3)/k_1$ (over-all Michaelis constant) = 0.5×10^{-6} , whereas experimentally (*cf.* 1862) 5×10^{-6} was found. The combination with hydrogen peroxide is thus very rapid and practically irreversible; k_3 is greater than k_2 . It could be measured more readily with ascorbic acid than with leucomalachite green, since the formation of the dye is not a straightforward bimolecular reaction (*cf.* 1470). No evidence for a chain reaction could be discovered, the induction period being no longer than that required for the formation of the peroxidase-hydrogen peroxide compound. The main difference between peroxidase and catalase is the rapid irreversible breakdown of the hydrogen peroxide catalase compound.

3.2.5. Protein of Peroxidase. Peroxidase contains one protohematin group (1.48%) in a molecule of molecular weight 44,000, as established by measurement in the ultracentrifuge (2773). The frictional ratio, f/f_0 , is 1.36, corresponding to a prolate ellipsoid with an axial ratio of 7. Theorell and Åkesson (2786) have studied the amino acid composition of horse-radish peroxidase by the electro-dialytic micromethod and by estimation of the basic amino acids (Table V).

TABLE V
Fractions of Horse-radish Peroxidase Hydrolyzate^a

| Fraction | Per cent of nitrogen | Moles | Nitrogen |
|-------------------|----------------------|-------|-------------------|
| Humin nitrogen | 1.1 | | 4 (porphyrin) + 1 |
| Amide nitrogen | 13.0 | | 54 |
| Anodic nitrogen | 16.2 | | 68 |
| Neutral nitrogen | 45.1 | | 188 |
| Cathodic nitrogen | 24.2 | | 101 |
| Histidine | 0.71 | 2 | 6 |
| Arginine | 6.91 | 18 | 72 |
| Lysine | 4.06 | 12 | 24 |

^a According to Theorell and Åkesson (2786).

There is much less histidine in peroxidase (2 moles) than in catalase. Peroxidase contains six atoms of sulfur. The nitrogen (13.2%) and carbon contents are low. These data, the positive Molisch reaction, and the fact that on hydrolysis no less than 18.4% of the weight of the peroxidase yielded humin substances of low nitrogen content,

indicate that peroxidase contains carbohydrate. This carbohydrate is probably present in the form of a uronic acid. If 18.4% is subtracted from the molecular weight, a molecular weight of 35,900 is obtained, which corresponds to about 288 moles of amino acids; a figure of 287 is obtained by subtracting 5 humin nitrogen, 54 amide nitrogen, 4 histidine nitrogen, 54 arginine nitrogen, and 12 lysine nitrogen atoms from 415, the total number of nitrogen atoms. Only 14 nonamidized aminodicarboxylic acids + 2 hematin carboxylic acids are present, as against 30 basic groups of arginine and lysine, while the isoelectric point is 7.2. Therefore, acidic groups in the carbohydrate fraction must neutralize some of the basic groups. On transformation of peroxidase into paraperoxidase the greater part of the carbohydrate is removed, with a resulting shift of the isoelectric point to the alkaline side. At the same time an increase of nitrogen content occurs, while the distribution of the nitrogen in the various fractions remains unaltered.

3.2.6. Linkage of Prosthetic Group and Protein. Theorell (2772) found that peroxidase can be split reversibly into protein and hemin with acetone-hydrochloric acid at -15°C . After neutralization, the protein recombines slowly with added protohematin, giving active enzyme. Under certain conditions the activity can be fully restored (2788). This was confirmed by Gjessing and Sumner (1008). They found that mesohematin and deuterohematin also combine with the peroxidase protein to form active catalysts, while porphyrin iron complexes which do not have the two propionic acid side chains, such as rhodo- and pyrrohematin, combined, but yielded inactive compounds; hematohematin did not combine. Their claims that the compound with mesohematin was an even more active peroxidase than that with protohematin, and that manganese porphyrins also gave an active peroxidase, have not been confirmed by Theorell (2779).

The problem of the mode of linkage of hematin to the protein has been studied by Theorell (2776) and by Theorell and Paul (2789). By differential titration of the enzyme and apoenzyme (hematin-free protein), by study of the dissociation of fluoride peroxidase, and by spectrophotometry, they arrive at the conclusion that the hematin is bound to a carboxylic group of the protein, and that at the same time one of the carboxylic acid groups of the hematin is bound to a basic group of the protein of pK value 10.2. The latter is probably a

tyrosine hydroxyl group, the linkage, an ester linkage. The structure of peroxidase at pH 7 would thus be that given in Figure 2.

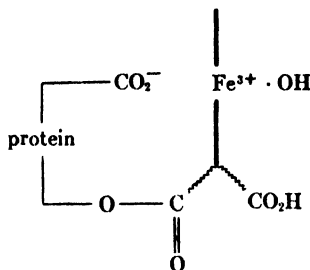

Fig. 2. Structure of peroxidase (for explanation of figure *cf.* Section 3.3, Chapter V).

An alternative possibility envisages linkage of the heme iron to a hydroxyl group of the protein, with two ester linkages of the carboxyl groups to protein hydroxyl groups.

Spectrophotometric evidence was adduced for dissociation, with inactivation of the enzyme, at pH 4.0 and for a pK of 5.0. The latter is in agreement with the pK value of 5.0 for the dissociation of $(FeOH) \rightarrow (Fe)^+ + (OH)^-$ found from dissociation experiments on fluoride peroxidase. Finally in peroxidase another pK value of about 11.0 replacing a pK value of 10.2 in the apoenzyme, is found from differential titration of enzyme and apoenzyme (*cf.* Table VI) and of ferro- and ferriperoxidase. This is supported by magnetochemical evidence showing transformation of peroxidase with ionic type of linkages into an alkaline peroxidase with covalent type of linkages. Theorell and Paul (2789) arrive at the scheme in Figure 3. This is supported by the following evidence:

(1) Peroxidase has only two moles of histidine per mole and both imidazole groups are titrated within their normal range of 5.5 to 8.

(2) Between pH 8 and 9.5 there is a titration difference of one equivalent between ferric and ferrous enzyme.

(3) There is no difference between the titration curves of ferriperoxidase and carbon monoxide ferriperoxidase, although the type of linkage changes from ionic to covalent. In hemoglobin, in which the iron is linked to imidazole groups, the combination with carbon monoxide influences the titration curve.

(4) Between pH 5.5 and 9 the differential titration between enzyme and apoenzyme indicates a difference of two equivalents per mole. In his first paper Theorell (2776) claimed that a difference of three equivalents should be found, if the pK of the acid group of the protein before combination was above 4.5 — leaving out of consideration the $(FeOH)$ formation. Later he stressed that the difference should be three, in consideration of the dissocia-

tion $(\text{FeOH}) \rightleftharpoons (\text{Fe})^+ + \text{OH}^-$. This supports covalent linkage of one of the carboxylic acid groups of the hematin to a protein group.

The combination of the hematin with apoenzyme is slow and, on treatment of the enzyme with normal hydrochloric acid, slow changes of absorption

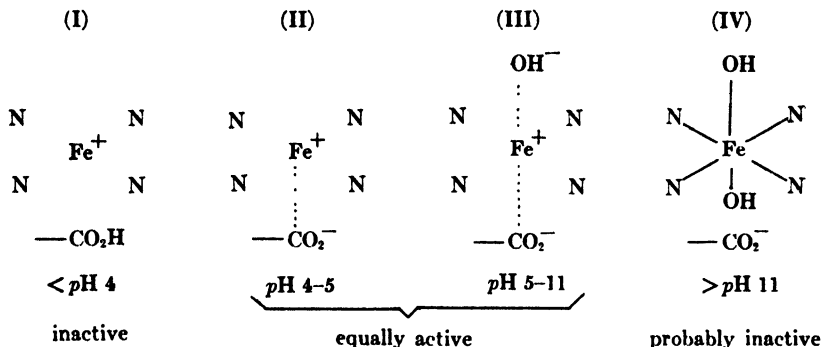

Fig. 3. Forms of horse-radish peroxidase, according to Theorell and Paul (2789).

were found by spectrophotometric measurements. This speaks in favour of an ester linkage, broken slowly at low pH values.

Theorell's arguments have a number of weak points and the results of the two papers do not appear to have been correlated satisfactorily. Thus, in the first paper (before the discovery of the formation of the hydroxyl compound at $\text{pH } 5$), a difference of one equivalent between ferriperoxidase and ferroperoxidase between $\text{pH } 8$ and 9.5 was found, which now remains unexplained. No clear evidence for a change of one equivalent at $\text{pH } 5$ was found, but the results of this differential titration were not reliable below $\text{pH } 7.5$. It is difficult to see why a difference of three equivalents should be expected if the pK value of the acidic hematin-linked protein group is above 5 (*cf.* point 4 above).

Part of the reaction $(\text{Fe})^+ + \text{OH}^- \rightarrow (\text{FeOH})$ will be titrated in the pH range of 5.5 to 8 (*cf.* point 1); since, however, 2.5 equivalents are titrated, 2 may still be normal histidine imidazoles.

Theorell showed that the titrated apoenzyme could be reunited with hematin to fully active enzyme after neutralization. This excludes, however, only irreversible, not reversible, denaturation. Perhaps the large differences found at low pH values (*cf.* Table VI) are due to reversible denaturation of the apoenzyme which does not occur as long as hematin remains combined with the apoenzyme by ester linkage.

Another difficulty, stressed by Theorell himself, is the structure ascribed to alkaline peroxidase (compound IV of Fig. 3). This compound is magnetochemically (covalent linkage) and spectroscopically very different from alkaline hematin; the linkage of the hematin carboxyl to protein cannot explain this difference, since there is no resonance between the porphyrin-iron system and this carboxylic acid group. It must not be forgotten, however,

that the properties of alkaline hematin are largely due to polymerization which cannot occur in the alkaline peroxidase, and that Rawlinson's magnetochemical investigations (*cf.* Chapter V, Section 3.) indicate the presence of a covalently linked compound in alkaline hematin solutions.

TABLE VI

Differential Titration of Peroxidase (Enzyme) and Protein (Apoenzyme)^a

| pH | Δ , equiv./mole | Calculated ^b | pH | Δ , equiv./mole | Calculated ^b |
|------|------------------------|-------------------------|-------|------------------------|-------------------------|
| 4.25 | 4.84 | | 8.0 | 2.00 | 2.0 |
| 4.5 | 3.45 | | 8.5 | 1.97 | 1.98 |
| 5.0 | 2.30 | | 9.0 | 2.02 | 1.95 |
| 5.5 | 1.99 | 2.0 | 9.5 | 1.85 | 1.86 |
| 6.0 | 1.88 | 2.0 | 10.0 | 1.69 | 1.70 |
| 6.5 | 1.89 | 2.0 | 10.5 | 1.56 | 1.57 |
| 7.0 | 1.92 | 2.0 | 11.0 | 1.80 | 1.64 |
| 7.5 | 1.95 | 2.0 | 11.34 | 1.99 | 1.74 |

^a According to Theorell (2776).

^b On the basis that apoenzyme has a pK value of 10.2 and peroxidase a pK value of 11.0.

It is rather unexpected that compounds II and III (Fig. 3) should have the same catalytic activity, unless hydrogen peroxide replaces the hydroxyl group in form III very effectively. Finally, the combination of ferrous heme compounds with carboxylic anions, which would have to be assumed for ferroperoxidase, has so far not been demonstrated.

While the evidence of Theorell cannot thus be considered as fully conclusive and is even partly contradictory, the linkage of the hematin iron to a carboxylic acid group of the protein* seems to be more likely than the linkage to an imidazole group, and there is rather good evidence for a second linkage between a propionic acid side chain and a basic group in the protein, which may be a tyrosine-ester linkage.

The different mode of linkage between hematin and protein in peroxidase and hemoglobin may explain the great difference between the pK value $[(FeOH) \rightarrow (Fe)^+ + OH^-]$ of peroxidase (5.0) and that of hemoglobin (8.1). The inactivity of the compounds of the apoenzyme with rhodo- and pyrrohematin is explained by the lack of a suitably placed carboxyl group in the side chains of these hematins, which is able to combine with a basic group of the apoenzyme.

3.3. Other Plant Peroxidases

From the sap of the fig, which is an extremely rich source of peroxidase, Sumner and Howell (2703) isolated a peroxidase of PZ 700-1000, which

* This is no longer upheld in Theorell's recent review (2779a).

contained 1% hematin. After removal of some less active hematin compound the absorption band was at 640 μ . This peroxidase appears to be closely related to horse-radish peroxidase.

The peroxidase of *Asclepias syriaca* L. (milkweed) was studied by Sumner and Gjessing (2701). The enzyme works with a much higher optimal hydrogen peroxide concentration than horse-radish or turnip peroxidase and is rapidly destroyed by peroxide in the absence of pyrogallol, as well as by pyrogallol in the absence of peroxide. For the estimation of such peroxidases the purpurogallin method must therefore be modified.

3.4. Milk Peroxidase

The peroxidase in milk was discovered by Arnold in 1881 (81) and studied by Elliot (667), who separated it from caseinogen by fractional ammonium sulfate precipitation. More recently it has been purified further and studied thoroughly by Theorell and collaborators (2786, 2789, 2790).

Impurities were removed by heating for fifteen minutes at 70° C., followed by basic lead acetate precipitation and precipitation at pH 5.9 by acetone. By electrophoresis at pH 5.9 the enzyme was separated from an accompanying red iron-containing substance. The enzyme moved cathodically, its isoelectric point being at pH 7.7. Further purification was effected by isoelectric precipitation with ammonium sulfate. It was thus obtained in thin, indistinctly crystalline leaflets. The yield is low (2% of the total enzyme present), and the preparation does not work during certain seasons.

Its molecular weight was found to be 92,700 and the frictional ratio, 1.18 (ratio of axes in prolate ellipsoid would be 4.1 for the nonhydrated, less than 4 for the hydrated, enzyme). The pure enzyme with one hematin group per mole would be expected to contain 0.06% iron, while the best preparations gave 0.076%.

The absorption spectra of lactoperoxidase and its compounds (cf. Table VII) show that it is not a protohematin compound. The brown-green ferriperoxidase is reduced by dithionite to the green ferropoxidase.

Theorell classes this enzyme with the leucocyte peroxidase as a "verdoperoxidase," but it differs in its properties as much from the green leucocyte peroxidase as from horse-radish peroxidase. It appears possible that the hematin group is monoazahematin (cf. Chapter V, Section 8.2.).

With a small excess of hydrogen peroxide the enzyme gives a reddish hydrogen peroxide compound, which decomposes to yield the free enzyme, while a larger excess (10 moles of peroxide per mole of enzyme) produces a brownish compound. Combination with fluoride decreases the absorption

at 640 $m\mu$ and increases absorption at 620, 595, and 557 $m\mu$. A pK value of 1.82 for the reaction $(Fe^{3+}) + (F)^- \rightarrow (Fe^{3+}F)$ was determined in this way spectrophotometrically.

For the reaction:

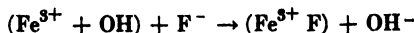

a pK value of 10.15 was found. The $(FeOH)$ compound is thus half-dissociated at a pH of 3.85, showing that the affinity of lactoperoxidase for hydroxyl (as for fluoride) is greater than that of horse-radish peroxidase. Phosphate of rather high concentrations also combines with the enzyme at pH 5.5.

The solubility curve of lactoperoxidase in ammonium sulfate solution shows that the enzyme is practically uniform.

TABLE VII
Absorption Spectra of Lactoperoxidase and Its Compounds^a

| Compound | Color | Absorption maxima ^b , $m\mu$, and ϵ_{mM} (in parentheses) |
|--------------------------------------------|---------------|-----------------------------------------------------------------------------------|
| Ferriperoxidase | Brown-green | 640 (low), 600 (7.6), 500 (11.4), 412 (109), 280 (142) |
| Ferropoxidase | Emerald-green | <i>[645]</i> , 600, <i>566</i> |
| H ₂ O ₂ -compound I | Reddish | 570, 538 |
| H ₂ O ₂ -compound II | Brownish | 617, <i>594</i> , [540] |
| Fe ³⁺ CN | Yellow-green | [595], <i>560</i> |
| Fe ³⁺ F | Blue-green | [620], 590 |
| Pyridine hemochrome | Red | 565, 530 |

^a According to Theorell (2787, 2790).

^b Main absorption bands are italicized, weak bands are in brackets.

Its PZ is rather low (71.5), but pyrogallol may not be a suitable substrate. The activity decreased rapidly and the determination could only be carried out with a lower hydrogen peroxide concentration than usual, and corrected by calculation.

3.5. Peroxidase of Adrenal Medulla

In adrenal medulla, Huszák (1377) found a peroxidase, which was particularly active against *p*-phenylenediamine. In reduced form it showed a broad band at 559–553 $m\mu$ and a second band at 528 $m\mu$. Carbon monoxide shifted the first band to 570 $m\mu$. Cyanide (50% inhibition by 10 M), azide, hydroxylamine, and fluoride inhibited its activity.

3.6. Peroxidase of Leucocytes (Myeloperoxidase, "Verdoperoxidase")

The strong peroxidative activity of pus has long been known. It was observed by Klebs (1543) in 1868 and shown by Linossier (1750) in 1898 to be caused by a peroxidase. After fig sap, leucocytes are

the material which is richest in peroxidase. It is now evident that the "indophenol oxidase" activity of leucocytes is not due to cytochrome oxidase but to myeloperoxidase, hydrogen peroxide being produced by autoxidation of the Nadi reagent. The literature is fully reviewed in Agner's paper (26).

Agner isolated the enzyme from the leucocytes of empyema and from the blood of patients with myeloid leukemia. Because of its green color, he first used the term "verdoperoxidase," and later the term "myeloperoxidase," because of its origin. The preparation involves precipitation in a layer between ether and ammonium sulfate solution, removal of impurities by adsorption to barium sulfate, fractional alcohol and ammonium sulfate precipitations (the enzyme being precipitated at two-thirds saturation of the latter), dialysis, and electrophoresis. At pH 6.8 the enzyme, which has an isoelectric point above pH 10, migrates to the cathode, while a red impurity moves to the anode. If sufficiently pure, the enzyme is soluble in salt-free solution. Agner calculates that the leucocytes contain 1 to 2% of the enzyme.

Myeloperoxidase contains about 0.1% iron. It is resistant to alcohol-formalin treatment. In the cells it is partly bound by acidic proteins.

The absorption spectra of the enzyme and its compounds (*cf.* Table VIII) show clearly that its prosthetic group is not a porphyrin

TABLE VIII
Absorption Spectra of Myeloperoxidase and of Its Compounds^a

| Compound | Absorption spectra Position of bands, m μ , and ϵ_{mM} (in parentheses) |
|------------------------------------------------|-----------------------------------------------------------------------------------------|
| Fe ²⁺ | 690 (3.5), 625 (6.5), 570 (11.0), 495 (weak), 430 (70) |
| Fe ³⁺ | 637 (17.3), 590 (11.0), 475 (65-80) |
| Fe ²⁺ CN | 634, 438 |
| Fe ²⁺ OH | 628, 460 |
| Fe ²⁺ N ₃ | = Fe ²⁺ |
| Fe ²⁺ N ₃ (?) | 615, 460, slow reaction |
| Fe ²⁺ H ₂ O ₂ | 625, unstable |

^a According to Agner (26).

hematin; the prosthetic group is firmly attached to the protein.* This, together with the absorption spectra make it appear likely that this peroxidase is related to choleglobin (*cf.* Chapter X). The visible absorption spectra somewhat resemble those of choleglobin and also those of biladienone hemochromes (*cf.* Chapter IV, Section 5.4.2.), but the data are not sufficient to prove a close chemical relationship to either. The band at 475 m μ may be considered as a rather low

*Recent investigations (1699) have shown that, like choleglobin, verdoperoxidase yields protohemochrome on heating in alkali in the presence of dithionite.

Soret band, shifted toward the red; choleglobin does not possess a similar band. Verdohemochrome (*cf.* Chapter X) is reduced by dithionite to a yellow compound with a similar band ($\epsilon_{mM} = 50$), but its absorption in the visible part of the spectrum is quite different. Fluoride and carbon monoxide do not cause any spectroscopic changes. The reduced enzyme is not autoxidizable in neutral or alkaline solutions, but is autoxidizable below pH 5. The enzyme is inhibited by 10^{-4} *M* cyanide (86%), 10^{-3} *M* hydroxylamine (30%), and 10^{-3} *M* azide (86%); it is not inhibited by carbon monoxide. The PZ is 75, if calculated from the initial reaction velocity, but the latter drops rapidly. Polyphenols, *p*-phenylenediamine, and ascorbic acid can serve as substrates. Hydroquinone reacts rapidly with the green hydrogen peroxide compound, restoring the ferriperoxidase.

Agner believes that myeloperoxidase may be the compound with absorption band at $639 m\mu$ observed by Warburg in *Acetobacter pasteurianum* (Chapter VIII, Section 3.6.3.), when the latter is aerated in the presence of cyanide. There is, however, no indication of a band in the red in the reduced state in the organism, which should be the case if the band were due to a substance similar to myeloperoxidase.

3.7. Cytochrome c Peroxidase

An interesting enzyme has been discovered in bakers' yeast by Hogness and his collaborators (1,41,42). It was first believed to be water-soluble cytochrome c oxidase, but later it was found that its activity depended on the presence of hydrogen peroxide in the reduced cytochrome c preparation; hence catalase prevented its action. The peroxide probably owed its presence to the use of dithionite as reducer in the preparation of cytochrome c.

The enzyme is isolated from yeast by toluene autolysis, followed by ammonium sulfate-trichloroacetic acid precipitation, solution of the precipitate in water, fractional alcohol precipitation, and adsorption to γ -aluminum hydroxide. On reduction with dithionite in the presence of pyridine it yields pyridine protohemochrome; a spectrophotometric estimation of this showed that the enzyme contained about 0.3% protohematin.

The ferric enzyme has weak absorption bands at $620 m\mu$ ($\epsilon_{mM} = 5.0$) and $500 m\mu$ ($\epsilon_{mM} = 10.5$) and a strong Soret band ($\epsilon_{mM} = 92$). Dithionite reduces it to the ferrous compound which has an absorption band at $560 m\mu$, a Soret band at $437.5 m\mu$, and possibly also a weak band at $670 m\mu$.

The absorption spectrum of the hydrogen peroxide complex resembles that of the horse-radish peroxidase-hydrogen peroxide compound II of

Theorell (*cf.* Table IV): I, $\epsilon_{mM}^{560} = 12.9$; II, $\epsilon_{mM}^{530} = 11.5$; and III, $\epsilon_{mM}^{420} = 89$. One mole combines with one mole of hydrogen peroxide, the dissociation constant of the complex being 10^{-6} ; $3 \times 10^{-4} M$ cyanide inhibits its action completely.

The enzyme catalyzes only the peroxidative oxidation of cytochrome c, and is inactive toward pyrogallol, while horse-radish peroxidase does not oxidize cytochrome c. The kinetics of the cytochrome c oxidation are described by the equation:

$$-\frac{d(\text{Fe}^{2+})}{dt} = k(\text{Fe}^{2+})(\text{E})$$

where (Fe^{2+}) is the concentration of ferrocytochrome c and (E) is that of the enzyme. The amount of enzyme which gives the value 1 for the expression $(-d \log \text{Fe}^{2+})/dt$, where t is in minutes, is taken as the unit. The number of units per milligram of enzyme was found to be 700–800.

While Barron believes that this peroxidase may only arise during the prolonged autolysis of yeast during the preparation, the specificity of the enzyme makes a biological function probable. Hogness and collaborators find about 250 times more cytochrome peroxidase than catalase in yeast, so that, in this organism at least, the enzyme may compete with catalase for the substrate. One must also keep in mind the possibility of structurally organized reactions.

3.8. Dihydroxymaleic Acid Oxidase

Banga, and Szent-Györgyi and collaborators (133–135, 2287) have discovered an enzyme in horse-radish, as well as in a great number of other plants, which catalyzes the oxidation by atmospheric oxygen of dihydroxymaleic acid, $\text{HO}_2\text{CC}(\text{OH})=\text{C}(\text{OH})\text{CO}_2\text{H}$. Dihydroxymaleic acid is of some interest because of the chemical similarity of its oxidizable $-\text{C}(\text{OH})=\text{C}(\text{OH})-$ group to the same group in ascorbic acid, (*cf.* also Wieland and Franke, 3071). The occurrence of dihydroxymaleic acid in grapes is probable (984).

Robežnieks (2287) has shown that the enzyme also works with hydrogen peroxide as hydrogen acceptor. The reaction was accelerated by hydroquinone and benzidine, but not by benzopyrane dyes with two vicinal hydroxyl groups or by catechol. According to Huszák (1375), these latter substances accelerate the peroxidative oxidation of ascorbic acid as hydrogen carriers.

Theorell and collaborators (26,2722,2772,2775,2786) (*cf.* also 422) then showed that animal and plant peroxidases can act as oxidases with dihydroxymaleic acid, although horse-radish peroxidase (in contradistinction to horse-radish paraperoxidase) occasionally required hydroquinone as mediator. While dihydroxymaleic oxidase is generally strongly inhibited by 10^{-5} *M* cyanide, the horse-radish peroxidase-hydroquinone-dihydroxymaleic acid system is not inhibited. The enzyme of some plants is not cyanide sensitive; in others it is inhibited by cyanide (134). Manganese increases the activity of the enzyme.

Dihydroxymaleic acid oxidase is strongly inhibited by catalase. Its action has therefore been explained by assuming that hydrogen peroxide is formed by autoxidation of dihydroxymaleic acid and that the peroxidase catalyzes the oxidation of the acid by the hydrogen peroxide. It will be shown in Section 4 that the mechanism of its action cannot be thus sufficiently explained.

It is of particular importance that carbon monoxide, which does not inhibit peroxidases, inhibits dihydroxymaleic acid oxidase and that the carbon monoxide inhibition is reversed by light (2722,2778). There is thus definite evidence that the valency of the hematin iron in the peroxidases undergoes a change when they react with dihydroxymaleic acid. As should be expected from this (*cf.* Chapter X), the prosthetic group undergoes irreversible oxidation under these conditions (2791). Ascorbic acid also inhibits the oxidase; it can evidently combine with it without being oxidized itself.

3.9. Biological Function of Peroxidases

About the biological function of peroxidases even less is known than about that of catalase. In addition to the problem of hydrogen peroxide formation in the cell, we have to find the biological hydrogen donors which react with peroxidase. The study is further complicated by the presence of heat-stable hematin compounds in the tissues which are able to catalyze the oxidation of benzidine by hydrogen peroxide.

3.9.1. Plant Peroxidases. The presence of peroxidase in plants has been demonstrated by Bach and Chodat (109) and by Onslow (2077).

Plants can be divided into two classes: polyphenol oxidase plants and peroxidase plants. The tissues of the first group become brown to black if damaged by the oxidation of polyphenol to quinoid pigments by the action of the copper-containing enzyme polyphenol oxidase, while the tissues of the

second group remain colorless. The division is, however, by no means sharp, and plant tissues are known which contain both polyphenol oxidase and peroxidase. So far peroxidase has been studied only in plant juices and breis. The Szent-Györgyi school assumes that hydrogen peroxide, produced, for example, by the action of ascorbic acid oxidase on ascorbic acid, reacts at first with polyphenols of the benzopyrane class (such as quercetin or eriodictyol), oxidizing these with the help of peroxidase to quinones which in turn oxidize ascorbic acid (1375). The scheme raises several unsolved problems, such as competition of ascorbic acid oxidase and quinones for ascorbic acid, competition of polyphenol oxidase (if present) and peroxidase for the polyphenols, and competition of peroxidase and catalase for hydrogen peroxide. While it is known that catalase does not prevent peroxidative action, no carefully controlled quantitative experiments have been carried out. We have mentioned the fact that the interaction of pure peroxidase with ascorbic acid is rapid and does not appear to need mediators.

It is not certain that such systems are major pathways of respiration, they may serve rather for the removal of hydrogen peroxide. Kursanov and Kryukova (1624) have found that polar plants with high respiration contain more peroxidase than plants of the warm southern districts of Russia.

A biological role of peroxidases as dihydroxymaleic acid oxidases is still more questionable. Catalase inhibits this reaction and the enzyme is destroyed in it.

The cytochrome peroxidase of yeast also can only function if it is in great excess over catalase. In yeast this appears to be so, but it is still unknown whether other tissues contain cytochrome peroxidase in sufficiently high concentrations to compete with catalase.

3.9.2. Animal Peroxidases. The biological significance of peroxidases in animal cells is still more uncertain. It appears unlikely that milk oxidase plays any biological role. Elliot (667) found nitrite, tryptophane, and tyrosine to be the only substances of biological interest in the animal body which are attacked by the enzyme; the first two are not attacked by horse-radish peroxidase. It is of interest to note that this peroxidase cannot be derived from the peroxidase of leucocytes from which it differs chemically.

No biological substrate has yet been found for myeloperoxidase. In infections this enzyme is liberated from leucocytes and is found in the serum (1966) or in empyema fluid (26). Singer (2567) has observed a decrease in the "oxidase," *i.e.*, myeloperoxidase (*cf.* Agner, 26), of polymorphonuclear leucocytes in infections. It is not impossible, although still unproven, that the system plays a role in the detoxication of bacterial toxins.*

A substance catalyzing the oxidation of ascorbic acid by the peroxidase system more powerfully than adrenaline has been reported to be present in the adrenals by Tauber (2743).

The peroxidase system catalyzes the formation of thyroxine from diiodo-tyrosine *in vitro* (Harington and Rivers, 1127). *In vivo* it may not only form the diphenyl ether linkage, but also liberate iodine from iodide and thus

* Agner (28a) has recently shown that diphtheria and tetanus toxins are destroyed by peroxidase systems.

catalyze the iodination. It has therefore been assumed that peroxidase plays an important role in the formation of thyroxine in the thyroid gland (1521, 3040). Inhibitors of thyroxine formation *in vivo*, such as thiourea and thiouracil, have indeed been shown to inhibit peroxidase and the *in vitro* synthesis of thyroxine from diiodotyrosine (420,553,557,1011,2204,3040). The inhibitory action of these substances appears to be due, not to a direct effect on the enzyme, but rather to competition with tyrosine for hydrogen peroxide or for iodine. While Glock (1011) did not detect peroxidase in the thyroid gland, De Robertis and Grasso (557) found a heat-labile peroxidase in rat thyroid. The possible role of cytochrome oxidase in thyroxine formation has been discussed in Chapter VIII.

Hurst (1371) found that peroxidase plays a role in the hardening of the insect cuticle.

Peroxidase is said to appear before hemoglobin in the development of the hen's egg (*cf.*, however, 129). It is widely distributed in eggs. In the development of grasshopper eggs it appears only in the diapause and rises rapidly after the diapause (307). Since these findings are, however, based on histological evidence, it is not certain whether they prove the presence of a true heat-labile peroxidase.

4. MODE OF CATALATIC AND PEROXIDATIVE ACTION

4.1. Peroxidase and Dihydroxymaleic Acid Oxidase

4.1.1. Mode of Action of Peroxidase. The mode of the action of peroxidase was explained by Haber and Willstätter (1080,3020) by assuming radical chains:

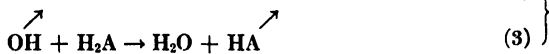
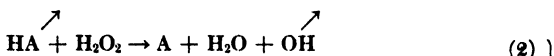
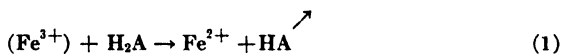

Since the hydroxyl radical was also assumed to initiate the radical chain causing catalatic destruction of hydrogen peroxide, while peroxidases do not destroy hydrogen peroxide in the absence of hydrogen donors, Willstätter had to make the assumption that reactions 2 and 3 proceeded together in a threefold collision:

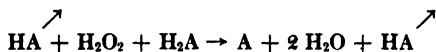

This explanation is improbable, and later research has not found any evidence either for a valency change of the hematin iron or for radical chains taking part in the mechanism of normal peroxidative action.

According to Theorell (Section 3.2.6.), the hematin iron of peroxidase at physiological *pH* carries a hydroxyl group. The hydrogen peroxide compound probably has, therefore, the structure (FeOOH)

and can be considered as an iron peroxide. The formation of iron peroxides had been assumed many years ago by Manchot to play a role in the peroxidative action of ionic iron, and more recently by Polonovski and Jayle (1411,2163) as the explanation of the peroxidative action of hemoglobin. In the reaction schemes discussed below, the peroxidase hydrogen peroxide compound is therefore formulated as (FeOOH), but this makes no essential difference from the earlier formulation as (Fe⁺ · H₂O₂).

The investigations of Chance (*cf.* Section 3.2.4.) lead to the following simple picture of peroxidase function shown by Figure 4. The

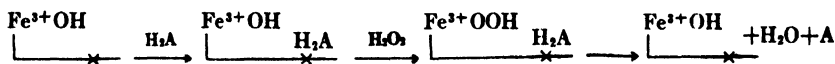
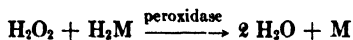
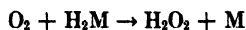

Fig. 4. Mechanism of action of peroxidase.

enzyme unites with hydrogen peroxide through its ferric heme iron and with a hydrogen donor through a group in its protein. The reduction of hydrogen peroxide to water by the hydrogen donor then takes place as an intracomplex reaction. Finally, the oxidized substrate dissociates and is replaced by a fresh molecule of substrate.

4.1.2. Mode of Action of Dihydroxymaleic Acid Oxidase. It remains to deal with the ability of peroxidases to function as oxidases of dihydroxymaleic acid with molecular oxygen. This is a much more complex problem. Any theory which could claim to be considered as satisfactory must explain: first, the increase of oxygen uptake on addition of peroxidase to dihydroxymaleic acid, second, the inhibition by carbon monoxide, and third, the inhibition by catalase.

The only theory so far discussed (422,2287,2722) assumes that hydrogen peroxide is formed by autoxidation of dihydroxymaleic acid and that the peroxidase accelerates the oxidation of the acid by the peroxide thus formed. If H₂M is written for dihydroxymaleic acid:



This theory explains the inhibition by catalase, but fails to account for the increased uptake of oxygen and for the carbon monoxide inhibition.

The following theory appears to be in better accordance with the known facts (Fig. 5).

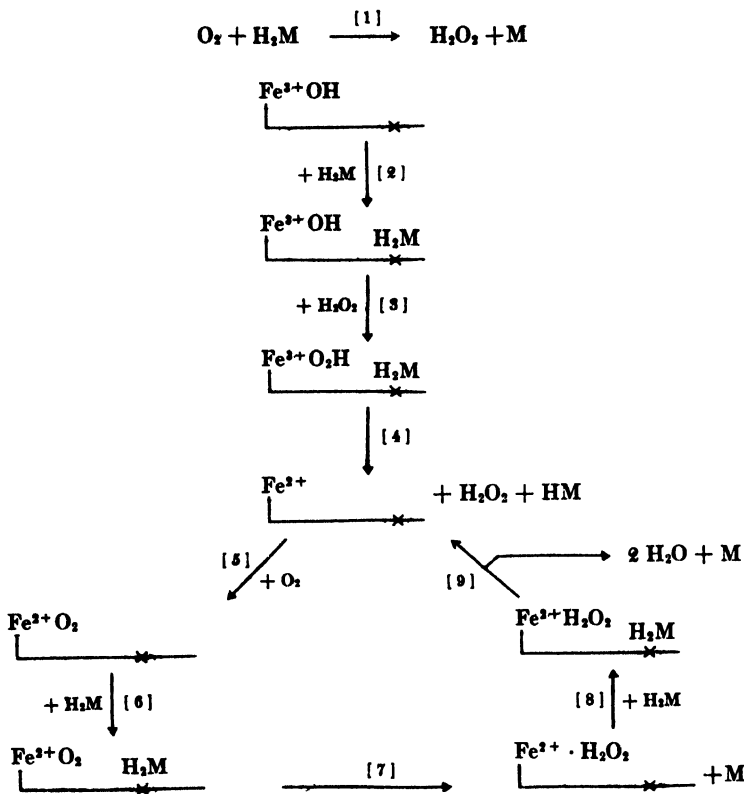

Fig. 5. Mechanism of action of dihydroxymaleic acid oxidase.

Step 1. The reaction begins with the autoxidation of dihydroxymaleic acid, which provides the hydrogen peroxide required for the initiation of the reaction. If catalase is present this is destroyed and no catalysis takes place.

Steps 2 and 3. Hydrogen peroxide and dihydroxymaleic acid unite with the peroxidase to a complex.

Step 4. Unlike the normal peroxidative reaction which leads back to ferric peroxidase, the ferric iron in the hydrogen peroxide ferriperoxidase is reduced by the dihydroxymaleic acid. It is assumed that this reaction does not take place in the ferriperoxidase-dihydroxymaleic acid complex without the peroxide bound to the iron. The hydrogen peroxide may be liberated, or, more likely, disposed of in a peroxidative reaction with a second molecule of dihydroxymaleic acid.

Steps 5-9. The ferropoxidase now acts as oxidase. This reaction is inhibited by carbon monoxide. The substrate is oxidized in an intracomplex reaction without valency change and several such cycles are completed before ferropoxidase is oxidized back to ferriperoxidase in side reactions and the cycle is thus broken. The intermediate formation of a ferropoxidase-hydrogen peroxide compound in steps 4 and 7 destroys part of the enzyme irreversibly.

4.2. Catalase

4.2.1. Radical Chain Theory. It is still impossible to explain the action of catalase satisfactorily in spite of inorganic models and painstaking research on the enzyme itself. Research in this field began early with Bredig's work on the catalatic action of colloidal metals, which revealed a surprising similarity with phenomena observed with the enzyme (*e.g.*, cyanide inhibition). The radical chain theories of Haber and Willstätter and of Weiss have continued this line of attack on the problem.

The catalatic activity of platinum metal is initiated by one of the reactions (Weiss, 3017,3019):

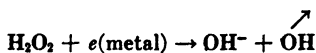

or:

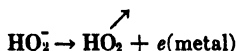

The destruction of hydrogen peroxide is then caused by the following radical chain:

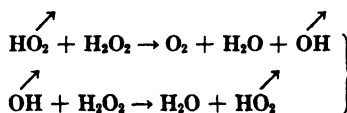

Similarly the action of catalase was explained by Haber and Willstätter (1080) by the initiation of the same radical chain by the reaction:

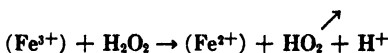

Haldane raised the objection that this theory would demand the reaction velocity of hydrogen peroxide decomposition to be proportional to a higher power of enzyme concentration.

The theory was modified by Weiss (3020) in order to meet this objection. It is now assumed that the following reactions are involved:

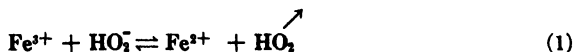

and that the radicals formed in reactions 1 and 2 initiate only short chains, while reaction 3 breaks the chains. Thus the concentration of the radicals is assumed to remain so small that no noticeable oxidation of hydrogen donors takes place. In fact, platinum metal acting catalytically on hydrogen peroxide likewise does not act as a peroxidase. An unexpected specificity of the action of substances added to act as "chain-breakers" on the catalytic and photolytic destruction of hydrogen peroxide was, however, found by Schwab and collaborators (2511). Their experiments are occasionally quoted as supporting the radical chain theory, but in fact they supply evidence against it, since the radical chain theory fails to explain the observed specificity of these inhibitors.

Our general objections to the radical chain theory as an explanation of enzymic reactions has been discussed in Chapter VIII, Section 6.2.

The radical chain theories all presuppose a valency change of the iron in the catalase. While we have seen that there is now general agreement that the iron of peroxidase remains ferric during its action, there is some evidence to support the assumption that the iron of catalase changes its valency. A definite proof, however, that during the normal uninhibited action of catalase such a change occurs, is still lacking.

4.2.2. Keilin's Theory. It has been shown in Section 2.2. that Keilin and Hartree (1487,1499) have produced strong evidence that, in the presence of azide or hydroxylamine and hydrogen peroxide, a reduction of catalase to a ferrous compound occurs. They assumed that azide ferricatalase is reduced by hydrogen peroxide, but not by dithionite, and that the reduction product is an azide ferrocatalase, which is oxidized by atmospheric oxygen but not by hydrogen peroxide.

The same mechanism is postulated for the action of catalase on hydrogen peroxide in the absence of azide or hydroxylamine. The inhibitory action of these compounds is explained by their combination with ferrocatalase.

The reaction mechanism of catalytic action is formulated as follows:

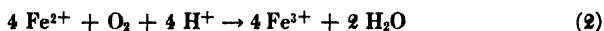
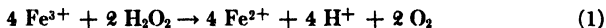

There are several weak points in this theory. First, carbon monoxide, although it inhibits catalytic action in the presence of small amounts of azide (1499) or in the presence of sulfhydryl compounds (1490), does not produce an inhibition with pure catalase; second, the mode of action of an enzyme may be drastically modified by compounds which can react with it. Theorell

and Agner (2780) have drawn attention to the somewhat related conversion of peroxidases into oxidases by dihydroxymaleic acid. This has been discussed above. Third, the earlier claim of Keilin and Hartree (1487) that the presence of small amounts of atmospheric oxygen is necessary for the activity of catalase was later abandoned (1497, cf. also 1419, 2654, 2697, 3021). This is not conclusive evidence against Keilin's theory since oxygen required for reaction 2 is formed in reaction 1, but Weiss and Weil-Malherbe (3021) have pointed out that the scheme of Keilin necessitates the assumption of a radical chain mechanism. Unless the unlikely assumption is made that the reduction of oxygen to water in reaction 2 does not proceed *via* hydrogen peroxide, the hydrogen peroxide decomposed in reaction 1 is re-formed in reaction 2. Unless a radical is formed during the reduction of ferricatalase in reaction 1, which initiates a decomposition of peroxide by a radical chain, no destruction of hydrogen peroxide could result. Finally, no other ferrous heme compounds are known to combine with azide except perhaps myeloperoxidase.

A strong argument in favour of Keilin's theory is the fact that azide and hydroxylamine inhibit the activity of catalase at much smaller concentrations than those at which they combine with ferricatalase (cf. Table II). Keilin explains these results by assuming that azide combines much more strongly with ferrocatalase. Were it not for the possibility that azide may also combine or react with the protein part of catalase without visible spectroscopic alteration, these observations would indeed prove that the reaction of uninhibited catalase also proceeds over the ferrous state. In Keilin's experiments combination of azide or hydroxylamine with catalase was measured by alteration of the absorption spectrum. Such measurements do not give us any information about reactions which may occur between the catalase protein and azide, nor about more complex reactions occurring only in the presence of hydrogen peroxide.

Lemberg and Foulkes (1699) have studied the azide inhibition by the oxidimetric method. They found that, unlike the cyanide inhibition, the azide inhibition develops only gradually; for technical reasons this is not revealed in manometric experiments. Since this inhibition can be largely reversed by dilution, its gradual appearance cannot be due to irreversible destruction as in the instances mentioned in Section 2.4. According to Keilin's theory one might assume that it is caused by a gradually established equilibrium involving the reduction of the catalase iron. Against this, however, speaks, first, the observation that oxygenation after disappearance of the hydrogen peroxide did not reactivate the enzyme, and, second, that after catalase in the presence of carbon monoxide and azide had been completely inactivated, reoxygenation caused no reappearance of the enzyme activity (1699); according to Keilin the ferrous azide catalase, with or without carbon monoxide, is very autoxidizable. These findings do not appear to be in agreement with Keilin's theory.*

* Some recent observations (Lemberg and Foulkes, 1698a) suggest that the "ferrous azide catalase" and "ferrous hydroxylamine catalase" may be nitric oxide ferrocatalase, the nitric oxide being produced by an enzyme-catalyzed oxidation of azide or hydroxylamine.

Although they show that in the presence of azide and hydrogen peroxide a reduction of the hematin iron occurs, Keilin's experiments do not provide convincing evidence that the same holds for uninhibited catalase.

4.2.3. Theories of Stern and Sumner. Two theories have been suggested in order to explain catalatic action without recourse to valency change. Stern (2647) has assumed that hydrogen peroxide unites with two molecules of hematin and is transformed into two

↑
OH radicals:

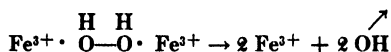

For thermodynamic as well as for stereochemical reasons this theory has little to recommend it.

The theory of Sumner (2700) is apparently simple and straightforward. He formulates the reactions as follows:



The combination of hydrogen peroxide with the hematin iron of the enzyme is made very likely by the reaction of other hematin compounds, such as hemoglobin or peroxidase, with hydrogen peroxide, as well as by the formation of a compound of catalase with ethyl hydrogen peroxide. Theorell has shown that at physiological *pH* the hematin iron of catalase is in the form (FeOH) rather than (Fe⁺) and that the former is the active form (*cf.* Section 2.2.); he has thus lent support to equation 1 of Sumner (above). There is no evidence yet for a reaction of the type assumed in equation 2.

The main weakness of the theory, however, is its failure to account for catalase specificity, which is undoubtedly based on the protein part of the enzyme. The catalatic activity of peroxidase is negligibly small if compared with that of catalase, and so is that of hemoglobin hydroxide; the latter does not appear to combine with hydrogen peroxide, however.

4.2.4. Attempts at a New Theory. In putting forward a new theory of catalase action we are aware of the fact that it contains an unproven assumption, an assumption, however, which is not entirely unsupported by facts and which is amenable to experimental verification.

Since the transformation of hydrogen peroxide into oxygen involves a dehydrogenation of hydrogen peroxide, and since the specific protein is obviously of fundamental importance, a dehydrogenating group (X) is assumed in the protein part of the catalase molecule. The action of catalase in the absence of reducing substances or azide is assumed to proceed as shown in Figure 6, without valency change of the iron.

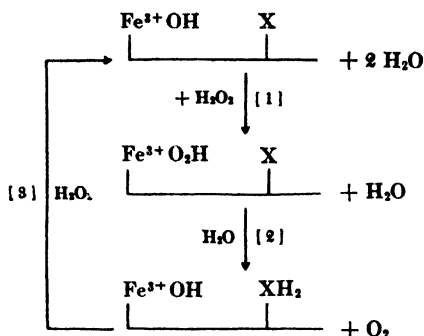

Fig. 6. Assumed mode of action of catalase.

Step 1 is formulated as by Sumner and Theorell.

Step 2 represents the rapid break-down of the catalase-hydrogen peroxide compound with liberation of oxygen. The hydrogen peroxide is dehydrogenated to oxygen by the specific hydrogen acceptor group X of the protein. The presence of this group in catalase and its absence in other hemoproteins would explain the lack of catalase activity of the latter. This type of intracomplex reaction can be assumed to be more rapid than the bimolecular reaction assumed as step 2 in Sumner's theory.

Step 3. Finally the active catalyst is restored by oxidation of the XH₂ group by a second molecule of hydrogen peroxide.

It would be premature to make special assumptions about the nature of the hydrogen acceptor group, X, in the catalase protein. It may be mentioned that catalase is not inhibited by iodoacetic acid (Barron and Singer, 189); this was confirmed by Lemberg and Foulkes (1699).*

4.2.5. Anticatalases and Philocatalases. In Section 2.4. we have seen that some reducing substances, such as sulfhydryl compounds and ascorbic acid, cause an apparent inhibition of catalase which is actually due to irreversible destruction of the enzyme. They thus

* Cf. also Gordon and Quastel (1023a), Barron and co-workers (183a); cf., however, Cook and co-workers (485a).

behave as "anticatalases." A closely related phenomenon is probably the destruction of catalase by oxygen in the presence of such substances (Marks, 1870). Here the hydrogen peroxide which initiates the reaction is formed by the slow autoxidation of the reducing substance.

There is obviously some similarity between this action of reducing substances on catalase and the action of dihydroxymaleic acid on peroxidase. In both instances there is evidence for a valency change of the hematin iron. First, carbon monoxide inhibits the action of catalase in the presence of sulfhydryl compounds as well as dihydroxymaleic acid oxidase; second, the enzymes undergo a more rapid destruction than in the absence of reducing substances.

The latter is explained by the destructive action of hydrogen peroxide on ferrous heme compounds which leads to bile pigment hematin compounds (cf. Chapter X). In the case of catalase there is no evidence as yet that the enzyme can act as oxidase on reducing substances to any greater extent than the equivalent reduction of the ferricatalase to ferrocatalase, nor is this necessarily demanded by the theory. Here the reactions 1 to 4 of Figure 5 may occur without the oxidative cycle, reactions 5 to 9, being initiated. It must be left to further research to demonstrate whether or not the oxidative cycle also occurs with catalase in the presence of reducing substances.

Previously Lemberg and Legge (1705) had considered that the effect of ascorbic acid on the activity of catalase supported Keilin's theory, but it appears more likely that the reduction to the ferrous state is only caused by some reducing substances, and in their absence occurs only to a very slight extent if at all.

We have seen that certain substances are able to protect catalase from the action of anticatalases (cf. Section 2.4.). Some of these substances included in the term "philocatalases" are oxidizing substances which may either oxidize the reducing anticatalase or may prevent its action by competition with the anticatalase binding group in the catalase protein molecule.

Another group of substances, such as alcohols, may act as philocatalases in the second way.

4.2.6. "Coupled Oxidation" of Alcohol. In Section 2.7.2. we have discussed the discovery of Keilin and Hartree that catalase can oxidize certain alcohols with hydrogen peroxide, acting as peroxidase. The conditions under which this reaction occurs are the presence of high concentrations of catalase and very low concentrations of hydrogen peroxide, otherwise catalytic destruction of the hydrogen peroxide occurs. We explain the transformation of catalase into a peroxidase in this system in the way described diagrammatically in Figure 7.

Reactions 1 and 2 proceed as normally, except that alcohol is bound to the catalase. After reaction 2 the symplex is in a form in which no catalatic reaction can occur before its XH_2 group has been reoxidized by hydrogen peroxide. In the absence of alcohol this reaction occurs practically simultaneously with the addition of the hydrogen peroxide to the hematin iron and catalatic reaction ensues. Alcohol bound in the complex is assumed to

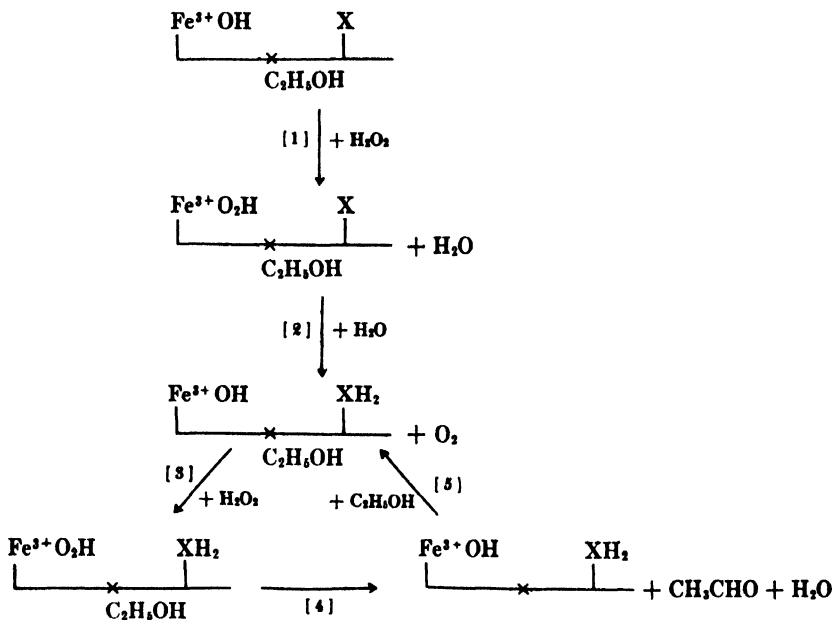

Fig. 7. Mode of action of catalase as alcohol peroxidase.

delay the reoxidation of the XH_2 group by hydrogen peroxide, so that the enzyme now behaves as peroxidase — reactions 4 and 5. This occurs, however, only when the concentration of hydrogen peroxide is very low and that of catalase, exceptionally high. Under other conditions the XH_2 group is oxidized by hydrogen peroxide even in the presence of alcohol before the peroxidative reaction can proceed. Since reactions 1 and 2 only initiate the cycle of reactions 3 to 5, the oxygen development due to reaction 2 is not measurable.

A corollary to this action of catalase as peroxidase may be the fact observed by Keilin and Mann (1502) that in the presence of a large excess of hydrogen peroxide, when the peroxidative action of peroxidase is inhibited, peroxidase destroys hydrogen peroxide catalatically. Peroxidase may contain a XH_2 group in its protein which, after dehydrogenation by an excessive amount of hydrogen peroxide, may turn the enzyme into a catalase.

5. ENZYMES POSSIBLY OF HEMOPROTEIN NATURE

5.1. Hydrogenase

A very interesting enzyme, hydrogenase, which catalyzes reactions with molecular hydrogen has been found in a variety of microorganisms, *E. coli*, *Proteus*, *Acetobacter peroxydans*, *Azotobacter*, lactic acid bacteria, root nodule bacteria (1665), and organisms isolated from river mud (cf. 2625). It also occurs in butyric acid fermenters and *Clostridium welchii* and participates in the photosynthetic processes.

The primary reaction which it catalyzes is: $H_2 \rightleftharpoons 2 H^+ + 2 e$ (1045). A bright metal electrode in contact with a suspension of *E. coli* and hydrogen acts as a hydrogen electrode; Green and Stickland (1045) have measured the oxidation-reduction potential of the enzyme of *E. coli* in the presence of hydrogen with methylviolinogen as oxidation-reduction indicator and have found $E_0' = -0.40$ at pH 7, 30° C. Molecular hydrogen activated by this enzyme is able to reduce a great variety of hydrogen acceptors, e.g., molecular oxygen, catalyzing the "Knallgas" reaction:

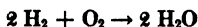

(2626,3073); carbon dioxide to formic acid as well as to methane (2626,2629, 3119); acetic acid (3079); nitrate to nitrite (2626); sulfate to hydrogen sulfide; phosphate; and organic hydrogen acceptors such as fumarate and methylene blue (1045), although the latter perhaps not directly (1297). For a review of the older literature the reader is referred to the papers of Stephenson and Stickland, and particularly to Stephenson's book (2625).

Farkas and collaborators (738) and Hoberman and Rittenberg (1297) have studied the hydrogenase-catalyzed reaction: $H_2 + D_2O \rightleftharpoons HD + DOH$ (D = deuterium). It is of interest to note that colloidal platinum is perhaps even a better model for the reactions catalyzed by hydrogenase than for the catalytic decomposition of hydrogen peroxide; thus it catalyzes the equilibrium: $CO_2 + H_2 \rightleftharpoons HCO_2H$ (Bredig and Carter, 334), as well as the "Knallgas" reaction.

It is to be expected that the enzyme also catalyzes the inverse reactions, e.g., the splitting of formic acid; $HCO_2H \rightarrow CO_2 + H_2$. Stephenson and Stickland (2629,2663) have assumed that this reaction is caused by a distinct enzyme, hydrogenlyase, but it is now probable that this is identical with hydrogenase (898,1297,2080). It is also very likely that the development of molecular hydrogen in fermentations, e.g., butyric acid fermentation, is catalyzed by hydrogenase (1507,1513,1590,2105).

Enzyme preparations. Crude cell-free extracts of hydrogenase have been obtained by Wilson and collaborators (1665) from *Azotobacter vinelandii* by grinding with powdered glass in M/15 phosphate buffer of pH 7, and from *E. coli* by Kalnitsky and Werkman (1460,1461) and by Still and co-workers (115). By freezing and drying *in vacuo* the enzyme was obtained in a stable form. Inhibition experiments, supported by studies on the iron metabolism of microorganisms and on certain models, suggest that the enzyme may be a hematin compound or a closely related substance.

Inhibitors. Carbon monoxide inhibits the action of hydrogenase (2628,2629). Hoberman and Rittenberg (1297) observed a reversal of this inhibition by light. This could not be confirmed by other workers (2651,3096), but insufficiently strong intensities of light may have been applied.

At a partial pressure of 0.07 atmosphere, carbon monoxide inhibits the butyric acid fermentation about 50%; this is also completely inhibited by 10^{-2} *M* cyanide (Kempner and Kubowitz, 1507,1513, 1590). Strong light reversed the inhibition by carbon monoxide, and a few points of the photochemical absorption spectrum were plotted. Too few points were taken, however, to allow the construction of the curve; a maximum of absorption at about 560 $m\mu$ and a strong band in the ultraviolet are indicated.

The inhibition by carbon monoxide does not interfere with the initial stage of the reaction in which glucose is split into C_3 compounds. In an atmosphere containing carbon monoxide, lactic acid is the end product, while the formation of butyric acid and gaseous hydrogen are completely inhibited. The enzyme apparently splits pyruvic acid into acetic acid, carbon dioxide, and molecular hydrogen according to the equation:



Hydrogenase must be an essential part of this enzyme system, which is also reversibly inhibited by molecular hydrogen.

Hydrogenase is inactivated by oxygen, the "Knallgas" reaction only occurring when hydrogen is in excess, although some bacteria (*Bacillus pycnoticus*) can react in mixtures of two parts of hydrogen with one part of oxygen. The inactivated enzyme is reactivated by molecular hydrogen as well as by hydrogen donors, glucose, pyruvate, formate, fumarate, and succinate (1297); the action of succinate could not be confirmed by Lascelles and Still (2651). Cyanide blocks this reactivation and 10^{-3} *M* cyanide therefore inhibits when added to the aerobic, but not when added to the anaerobic, system (1297,2626).

Still and co-workers (115,2651) found that the pure enzyme was not inhibited by azide, which even accelerated the "Knallgas" reaction. They found that with bacteria, the azide inhibition of the reaction with methylene blue was small, and was unaffected by the state of oxidation of the enzyme. On the other hand, with hydroxylamine and hydrazine, there was a clear difference between the inhibition of the oxidized and the reduced enzyme, the reduction of the former to the active reduced state evidently being inhibited. These two substances also inhibited the "Knallgas" reaction much less than the methylene blue reaction.

Models. Resonant systems similar to porphyrins, as well as their metal complexes, can act as activators of molecular hydrogen at temperatures above 200° C. Calvin, Polanyi, and co-workers (396) have shown that phthalocyanine and copper phthalocyanine: (a) enable deuterium to interchange with the hydrogen of water; (b) exchange part of their own hydrogen for deuterium; and (c) catalyze the "Knallgas" reaction. Not all preparations were found to be active, however (2158a).

Phthalocyanines as well as porphyrins and hematins also catalyze the transformation of para- into orthohydrogen (657). The activation energy of the disruption of the H—H bond in the presence of these catalysts is so small that the process might be observable at physiological temperatures if the catalysts were spread over a large surface area.

Chemical nature of hydrogenase. These observations and the inhibitor experiments indicate that the enzyme is a ferrous heme compound, which functions without a change of valency and is inactive in its ferric form.

There can be no doubt that it is an iron compound. Waring and Werkman (2960) have recently shown that *Aerobacter indologenes*, made deficient in iron by cultivation in a medium freed from iron by treatment with 8-hydroxyquinoline, had a very low hydrogenase activity. 8-Hydroxyquinoline removes copper as well as iron, but on replacement of adequate amounts of the former the organism is still unable to produce the enzyme. In a medium poor in iron, *Clostridium welchii* develops a pure lactic acid fermentation and becomes unable to produce acetic acid, butyric acid, and hydrogen gas (2105), reactions for which hydrogenase is necessary.

Nevertheless, its nature as a heme compound cannot yet be considered proved, particularly since Gaffron (974) has shown that the hydrogenase of green algae is inhibited by *o*-phenanthroline.* While this substance is an excellent complex former with iron and can remove iron even from ferricyanide, it does not react with normal heme compounds, in which the iron is inaccessible to the chelating influence of such reagents. There remains the possibility that hydrogenase is a bile pigment heme compound, since the iron of these is loosely bound.

5.2. Nitrogen Fixation

In 1928 Meyerhof and Burk (1933) observed an inhibition of nitrogen fixation by high oxygen pressure. Later, Wilson and collaborators (1746, 2149, 3095-3098, 3139) demonstrated that root nodule bacteria as well as *Azotobacter*, i.e., nitrogen-fixing organisms, contain hydrogenase which is inhibited by oxygen. Hydrogenase activity was measured by the "Knallgas"

* The methylene blue reduction by molecular hydrogen in the presence of hydrogenase is, however, not inhibited by *o*-phenanthroline (Still, private communication).

reaction. If root nodule bacteria from nodules of the pea are grown on artificial media, they lose both their ability to fix nitrogen and their hydrogenase, although this was not always found to be the case. The nitrogen fixation by *Rhizobium trifolii* and *Azotobacter* was found to be inhibited by hydrogen and also by carbon dioxide, both of which react with hydrogenase. Carbon monoxide inhibits the nitrogen fixation in the root nodules (1745) as well as in *Azotobacter* (1746).

The nitrogenase and hydrogenase activities of *Azotobacter* differ in their sensitivity to carbon monoxide and in the effect on them of pH. Thus nitrogenase is much more effectively inhibited by carbon monoxide than hydrogenase. Nitrogenase was inactive at pH 6, at which hydrogenase still possessed 70% of its optimal activity; the optimal pH was the same for both (about 7.5). The activities of hydrogenase measured by the "Knallgas" reaction and by methylene blue reduction are, however, also differently affected by pH (2651). Since nitrogenase action may require the formation of a complex with another enzyme activating the nitrogen, these differences cannot be taken as proof of the existence of two independent enzymes.*

Hemoglobin in the root nodules. An interesting correlation between the content of hemoglobin in the root nodules (cf. Chapter VII) and their ability to fix nitrogen has been described recently by Virtanen (2890,2891). The root nodules which are effective for nitrogen fixation are red and contain hemoglobin in the nodule, while those which are inactive are green. The latter contain a bile pigment hemoglobin, from which hydrochloric acid splits off iron, the green substance being thus closely related to or identical with choleglobin (Chapter X). Red nodules are transformed into green nodules by keeping the plants in the dark. This transformation is irreversible and accompanied by an irreversible loss of nitrogen-fixing power. In addition to red and green nodules, brown nodules were observed which contain hemoglobin. Fluoride shifts the absorption band in the brown nodules to 610 mμ, the position of the band of hemoglobin fluoride.

The equilibrium between hemoglobin and hemiglobin is said to depend on light intensity. On bright days the oxaloacetic acid content of the nodules is highest and the influence of oxaloacetic acid on the reduction of hemiglobin to hemoglobin is explained as a shift of the equilibrium between hemiglobin (Hi) + nitrogen and hemoglobin (Hb) + hydroxylamine

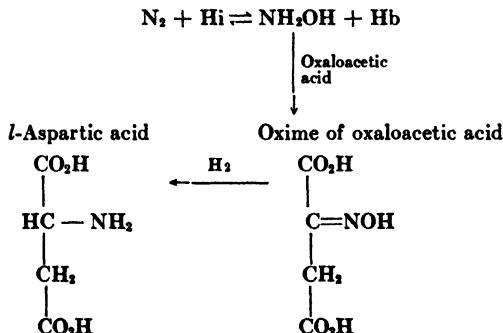

* Cf. the recent review of Burris and Wilson (384a).

by the removal of hydroxylamine by oxime formation with oxaloacetic acid. Hydroxylamine is known to form hemoglobin and choleglobin from hemoglobin. The role of oxaloacetic acid is to prevent this back reaction which destroys the effective hemoglobin catalyst, but it is interesting to note that this is evidently not done very efficiently. The nitrogen fixation according to Virtanen's theory is thus due to a reversal of the action of hydroxylamine on hemoglobin. This reaction is normally not reversible and must certainly still require the presence of another factor activating the nitrogen.*

Virtanen has assumed a relation between hemoglobin and hydrogenase in the root nodules. At present it is difficult to see a connection between the hydrogenase in root nodule bacteria and the role of hemoglobin in the nitrogen fixation, or between these two phenomena in root nodules and the same phenomena in *Azotobacter*. No hemoglobin has been found in *Azotobacter*. These experiments are of importance with regard: first, to the appearance of hemoglobin at an early stage of evolution for a purpose not connected with its oxygen-carrier role; and second, to the mode of breakdown of hemoglobin to bile pigment, in a way which evolution has not essentially changed. These aspects will receive further discussion in later chapters.

5.3. Possible Hematin Nature of Catalysts in Photosynthetic Processes

A full treatment of this subject would require a detailed discussion of many aspects of photosynthesis which cannot be given in this book. The reader is referred to the excellent monograph of Rabinowitch (2198), as well as to reviews by Franck, Gaffron, van Niel, and French (940,951,974,2050,2051).

Photocatalase (oxygen-liberating enzyme, deoxidase). It is well known that the carbon dioxide assimilation of green plants consists of photochemical and "dark" reactions. This was revealed by the studies of Blackman (286) on the factors limiting the rate of photosynthesis, and by Warburg's investigations with intermittent light (2923). Willstätter and Stoll (3092) assumed that the dark reaction consisted in the liberation of oxygen from a peroxide formed in the photochemical reaction, and was catalyzed by an enzyme which, because of this catalase-like action, was called photocatalase. The observations of Warburg and others that the dark reaction was inhibited by cyanide, sulfide, azide, and hydroxylamine (Shibata and Yakushiji, 2545), indicated that the enzyme was possibly a hematin compound.

Later investigations have shown that several different reactions and catalysts are involved in the dark reaction, and that some of the above-mentioned inhibitors, notably cyanide, interfere primarily with reactions other than the liberation of oxygen. Hill and Scarisbrick (1285) have even constituted a system with isolated chloroplasts and ferric oxalate which developed oxygen without being inhibited by cyanide, azide, or hydroxylamine. Nevertheless,

* Keilin and Smith (1502a) have been unable to confirm the results of Virtanen and Laine.

a good deal of evidence remains which indicates that in the intact cell the oxygen is liberated with the help of a catalyst which is inhibited by hydroxylamine and, although to a smaller degree, by cyanide and azide (942,951,974, 2198,3029). The system of Warburg and Lüttgens (2945) which resembles that of Hill but uses quinone instead of ferric oxalate, was inhibited by *o*-phenanthroline.

Hydrogenase in photoreduction of carbon dioxide in bacteria and algae. The photoreduction of carbon dioxide in bacteria was discovered by Roelefsen (2326) and Gaffron (987) in 1934, and has been studied extensively by van Niel and Gaffron. Green bacteria and purple bacteria are able to reduce carbon dioxide by a photochemical process using hydrogen sulfide (*Thiorhodaceae*) or simple organic compounds such as lower fatty acids (*Athiorhodaceae*) as hydrogen donors. In the purple bacteria bacteriochlorophyll fills the role played by chlorophyll in the green algae and higher plants.

Molecular hydrogen can be used as hydrogen donor for the photoreduction of carbon dioxide by some species of purple bacteria (950,968,2326,3038). In the dark the following reactions can be observed: in nitrogen molecular hydrogen is developed (2007,2326), while in the presence of hydrogen and oxygen (of low pressure) the "Knallgas" reaction is catalyzed (968). It can therefore be assumed that hydrogenase takes part in these reactions and also in the photoreduction of carbon dioxide, light being required solely for the reduction of carbon dioxide (2050).

Similar observations have been made with certain green algae by Gaffron (969,970,972,975). If *Scenedesmus* is exposed to several hours of anaerobiosis, in hydrogen as in nitrogen, its metabolism becomes similar to that of purple bacteria. On illumination with weak light intensities, the alga reduces carbon dioxide with molecular hydrogen. In the dark hydrogen is taken up or evolved (in nitrogen); the "Knallgas" reaction is catalyzed and, if carbon dioxide is present, is coupled with a dark reduction of this substance (Gaffron, 971). The latter reaction has also been observed to occur in some bacteria (Ruhland, 2392).

Adaptation and deadaptation. If the anaerobically adapted alga (in the "reduced state") is subjected to intense light in the presence of carbon dioxide, normal photosynthesis with oxygen development returns, and photochemical reduction with hydrogen will now not reappear if the light is dimmed again. This is known as deadaptation. Exposure to oxygen in the dark also causes deadaptation, but requires a higher oxygen pressure; in the "Knallgas" reaction oxygen disappears without abolishing the reduced state.

The study of the effect of inhibitors on adaptation and deadaptation gives further support to the assumption that valency changes of hematin-like enzymes are involved in these reactions. Carbon monoxide not only inhibits the photoreduction of carbon dioxide (*i.e.*, the hydrogenase), but also deadaptation. Cyanide and hydroxylamine, on the other hand, which hardly inhibit the photoreduction

and (in low concentrations) do not inhibit photosynthesis, prevent the adaptation of the algae to the "reduced state" (972).

The simplest explanation would be that a hematin enzyme, acting as photocatalase, acts as hydrogenase when reduced to the ferrous state; when the photocatalase is inactivated, the hydrogenase becomes active, and conversely. Inhibitors which inhibit photocatalase also inhibit adaptation; both photocatalase and hydrogenase are inhibited by *o*-phenanthroline. The photocatalase of higher plants, however, is not reduced to a hydrogenase nor is the hydrogenase of purple bacteria oxidizable to a photocatalase. Other observations (*cf.* 940,972-975,2198) also indicate that the photocatalase and hydrogenase of the algae are independent catalysts, not only differing in the valency of their iron. According to Gaffron (974,972) and Rabinowitch (2198), the photocatalase is transformed by anaerobiosis into an enzyme which, acting as peroxidase or oxidase, plays a role in the oxidation of hydrogenase to the inactive ferri-state (deadaptation).

The discussion on the mode of action of catalase in Section 4. makes it indeed likely that the reduction of a hydrogen donor group in the protein part of photocatalase might convert this enzyme into a peroxidase, or, if combined with reduction of its iron to the ferrous state, into an oxidase. It may well be that the dehydrogenation of this group is one of the series of dehydrogenation reactions which are now postulated in the photosynthetic process (*cf.* Rabinowitch, 2198). This would also explain the fact observed by Weller and Franck (941,3029) that hydroxylamine inhibits photosynthesis even in weak light, when the dark reaction is not normally the limiting factor. Activation of the photocatalase by illumination was assumed by these workers as a possible explanation of the phenomenon; the conversion of the XH_2 into an X group by the photosynthetic chain of reactions may be the way in which this occurs.

CHAPTER X

CHEMICAL MECHANISM OF BILE PIGMENT FORMATION AND OTHER IRREVERSIBLE ALTERATIONS OF HEMOGLOBIN

1. INTRODUCTION AND NOMENCLATURE

In this chapter we discuss the chemical mechanism of bile pigment formation from hemoglobin and other hematin compounds and a number of irreversible alterations of hemoglobin, which may be closely related to the formation of intermediates between hemoglobin and bile pigments.

That bile pigments arise in the animal body by a breakdown of hemoglobin, has been generally accepted for a long time (*cf.* Chapter XI). The mechanism of this transformation, however, remained mysterious. The direction of the search was wrong, first, in assuming that hematin and porphyrin could be considered as likely intermediates, and, second, in attempting to find a conversion to bilirubin, which was assumed to be the primary bile pigment.

In 1935 Lemberg (1681) described the transformation of hematin into biliverdin. As intermediates in this process he found green complex iron compounds, previously described by Warburg and Negelein (2952) as "green hemin," which he called "verdohemochromogens," and which we shall now call verdohemochromes, in conformity with the nomenclature suggested in Chapter V. They are hemochromes (*e.g.*, pyridine hemochromes) which contain a tetrapyrrolic compound closely related to and easily convertible into

TABLE I
Verdohemochromes and Green Hemoglobin Derivatives

| Names suggested | Process by which substance is obtained | Author and reference | Absorption Spectra, m μ | | Stability of iron to acid | Bile pigments | Other names |
|--------------------|-----------------------------------------------------------------------------------------|-------------------------------------------------------|-----------------------------|--------------------------|---------------------------|---------------|------------------------------------|
| | | | Hemoglobin derivative | Hemochrome | | | |
| Sulfhemoglobin | Hemoglobin + H ₂ S + O ₂ | Various authors | 617-623 CO: 612-618 | Protohemochrome | Split little if at all | - | Verdoglobin S (1527) |
| Pseudo-hemoglobina | Hemoglobin + cyanide + H ₂ O ₂ | Barkan and Schales (161,163); Kiese and Kaeske (1527) | 630 (1527) | 626 (163), 618 (4527) | Split little if at all | +? | Verdoglobin CN (1527) ^b |
| Cruoralbin | Hemoglobin + cyanide + Na ₂ S ₂ O ₄ + O ₂ | Holden (1315) | 624 CO: 625 | 628? CO: 628? | Split little if at all | - | |
| Choleglobin | Coupled oxidation of hemoglobin with ascorbic acid | Lemberg (1668,1707-1710,1712) | 629 CO: 628 | 619 CO: 628 | Split to 66% | + | Verdoglobin A (1527) |
| Verdohemochrome | Coupled oxidation of pyridine and other hemochromes with hydrazine, ascorbic acid, etc. | Lemberg (1681,1697) | 660 | 655,(530),(498) | Split | +++ | Green.hemin (2952) |

^a The "pseudo-hemoglobin" of Barkan (161,163) was prepared without buffering and its globin is partly denatured.

^b The "verdoglobin-CN" of Kiese and Kaeske (1527) was prepared with buffered cyanide.

biliverdin; since their structure is not yet established in every detail, no systematic nomenclature can be applied.

Lemberg restricted the use of the prefix "verdo" expressly to this type of compound. Unfortunately, it was extended by other authors, particularly the Heubner school* (1527) to cover a variety of green compounds which are formed from hemoglobin under conditions similar to those under which verdohemochrome arises from hemochrome.

This group of irreversibly altered green hemoglobins comprises a variety of substances, such as sulfhemoglobin, the "choleoglobin" of Lemberg, the "pseudohemoglobin" of Barkan, the "cruoralbin" of Holden, and other similar substances. While the spectroscopic properties (not, however, other properties) of these substances resemble each other, they are quite distinct from those of verdohemochromes. This dissimilarity persists if the pigments obtained from hemoglobin are converted to hemochromes, or if verdoheme is combined with globin. The verdohemochromes have their main absorption band at 660–640 $m\mu$, the hemochromes derived from green hemoglobins at 630–610 $m\mu$, with the exception of sulfhemoglobin which is reconvertible to protohemochrome. The use of the same name to cover all these substances is, therefore, misleading and should be avoided. Until we know more about their structure they are adequately described as green hemoglobins or hemochromes.

Again, Barkan on the basis of assumptions which were later known to be partly erroneous classified all the pigments under the terms pseudohemoglobin and pseudohemochromogen.

While the structure of verdoheme is established except for minor details, that of the other compounds is still unknown. It has become increasingly clear that they differ in their constitution more from each other than their spectroscopic similarity would suggest. None of the names in use, including our name "choleoglobin," is very satisfactory, but at the present stage it appears to be best to describe them by the name given to them by the various authors who first obtained them by a particular procedure. They have been summarized in Table I. It must be left to further research to establish their constitution and the greater or lesser degree of structural similarity between them. At present one can only say with certainty

* Kiese and Kaeske (1527) state that in adopting this nomenclature Heubner followed the example of Lemberg. This is in error; compare also (622).

that sulfhemoglobin appears to be most closely related to hemoglobin, since it is reconvertible to protohemochrome, while choleglobin appears to be most closely related to the verdoheme compounds, since its iron — like that of verdoheme compounds — is easily detached. Research in this field is complicated by the fact that none of these pigments have yet been obtained in a pure state, that most of them are unstable, and that the prosthetic group is attached more firmly to the protein than in hemoglobin.

2. MODEL EXPERIMENTS ON BILE PIGMENT FORMATION. VERDOHEMOCHROMES

2.1. Introduction

When hemochromes are exposed to atmospheric oxygen in the presence of a great variety of reducing substances, such as polyhydric phenols, adrenaline, ascorbic acid (1469), sulfhydryl compounds, extracts of yeast or minced animal or plant tissues (850), green compounds are obtained. The complete literature is given in the papers of Fischer and Lindner (850) and of Lemberg (1681). Several workers had speculated on a relationship of these substances to bile pigments, but Fischer and Lindner found the green pigments to contain iron and to possess an absorption spectrum different from that of any known bile pigment. Warburg and Negelein (2952) obtained the green compound by coupled oxidation of pyridine hemochrome with hydrazine and, under the name "green hemin," related it to the green hematin compounds of chlorophyll derivatives.

By the action of methanolic hydrochloric acid on their green hemin, these authors obtained a crystalline ester of the composition $C_{36}H_{40}O_6N_4FeCl_4$, which they considered to be a green hemin ester.

On incubation of hemoglobin or hematin with liver brei or liver extracts at 70° C. and pH 7–8, Schreus and Carrié (2470) obtained a green, ether-soluble pigment, which the authors considered, however, to be a secondary oxidation product of bilirubin.

In 1935 Lemberg (1681), realizing the fact that the bilatrienes (biliverdins) were more closely related in structure to the porphyrins than the biladienes-(a,c) (bilirubins) (Fig. 1), reinvestigated this problem. He identified the "green hemin ester" of Warburg and Negelein as the "double salt" of biliverdin dimethyl ester hydrochloride and ferric chloride — bilatriene dimethyl ester ferrichloride, $C_{36}H_{38}O_6N_4 \cdot FeCl_4$ — which he had previously obtained from bili-

verdin (1676); cf. Chapter IV, Section 3.2.1. Similarly, pyridine mesohemochrome was shown to be transformed into the corresponding mesobiliverdin compound, the "ferrobilin" of Fischer and his collaborators (803).

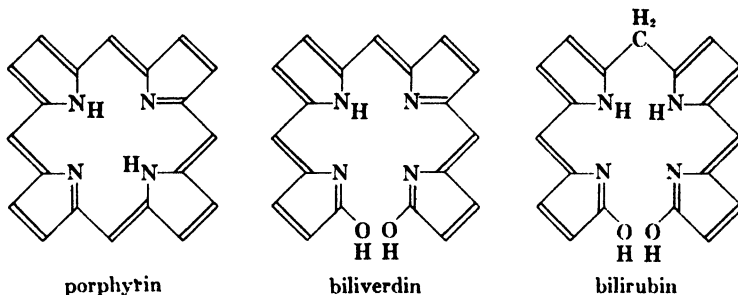

Fig. 1. Relationship of biliverdin and bilirubin to porphyrin.

It has been shown in Chapter IV that these compounds do not contain their iron in complex combination with the tetrapyrrolic system. By neutralization they are easily converted into biliverdins. In fact, they are formed only under the conditions of the acid esterification and would not be stable under physiological conditions.

In this way pure crystalline bile pigments were first obtained from hematin compounds in a reaction which could be considered as a model of their formation from hemoglobin in the animal body.* Since hemin had been synthesized by Fischer (cf. Chapter III), the total synthesis of the bile pigments had also been achieved.†

* The significance of these experiments was overlooked for several years. For example, Watson, in his contribution to Downey's *Handbook of Hematology*, published in 1938 (2989), still discussed only the old theory which assumed that hemoglobin is transformed into bilirubin with hematin and porphyrin as intermediate products; Lemberg's 1935 paper is not mentioned; cf. also Fischer (861, p. 628). In 1938 Fischer and Libowitzky (846), transforming coprohemin into coprobiliverdin by coupled oxidation with ascorbic acid, claimed: "*Damit ist . . . zum ersten Male mit guter Ausbeute auf einem Wege wie er in der lebenden Zelle ohne weiteres denkbar ist, in vitro aus einem Haemin ein einheitlicher Gallenfarbstoff erhalten worden.*" (Italics in original.) In fact, their paper contained nothing new in principle. Crystalline bile pigments had been obtained from hemins by Lemberg in 1935 (1681), and the fact that ascorbic acid could be used for this reaction had been known since the work of Karrer and co-workers in 1933 (1469). The verdohemochrome formation by coupled oxidation with ascorbic acid had been carefully investigated by Lemberg and co-workers (1687, 1696; cf. also 647, 162), who had shown that it could be carried out at physiological conditions of pH and temperature. In the same year Lemberg and co-workers transformed hemoglobin into crystalline biliverdin by coupled oxidation with ascorbic acid (1707).

† Stier (2666) made the objection against this claim that a total synthesis should also provide an unequivocal proof of the structure; in our opinion the term has no such connotation.

In contradistinction to these esters, the "green hemin" itself was found to contain iron in complex combination, which was not removable by alkali. It was found to be a pyridine hemochrome which in many ways behaved similarly to a pyridine hemochrome of the porphyrin type. There was, however, the remarkable difference that its iron could be much more readily detached, *e.g.*, by acids. The course of reaction shown in Figure 2 was postulated.

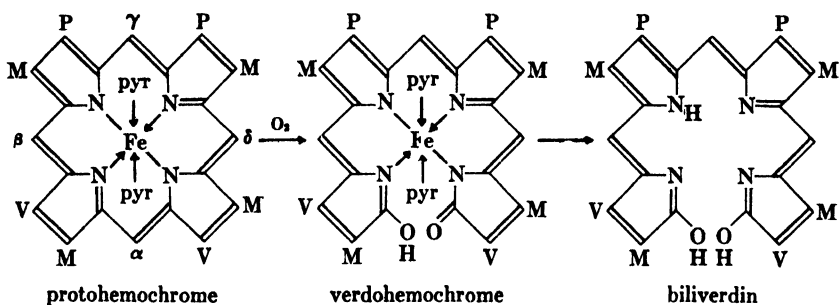

Fig. 2. Formation of verdohemochrome and biliverdin from protohemochrome.

It was suggested by Lemberg (1681,1682) that the formation of bile pigments in the animal body proceeded in a similar way. The oxidative opening of the porphyrin ring occurs before the removal of iron and of the nitrogenous substance bound to it. In this way the iron becomes easily detachable and biliverdin is formed. This is subsequently reduced to bilirubin by enzyme systems of the cell, which were studied by Lemberg and Wyndham (1715).

The oxidation of the porphyrin ring begins with the replacement of a methene group by $\geq C-OH$ leading to the hemichrome of an oxyporphyrin (*cf.* Chapter III, Section 8.2., and Chapter V, Section 8.3.). This was discovered by Lemberg and co-workers (1696,1698) and later confirmed by Libowitzky and Fischer (1732).

In the first preliminary note of Lemberg and co-workers (1695), the oxyporphyrin hemichrome had been assumed to be a hydrogen peroxide compound of protohemochrome. The error was rectified when the difference between oxyporphyrin hemochrome and protohemochrome was discovered (1698).

In the presence of ascorbic acid and the absence of atmospheric oxygen, very dilute hydrogen peroxide formed oxyporphyrin hemochrome from pyridine hemochrome; hemochromes more stable to

autoxidation, such as coprohemochrome, can be transformed into oxyporphyrin hemochrome by hydrogen peroxide in the absence of ascorbic acid (1732).

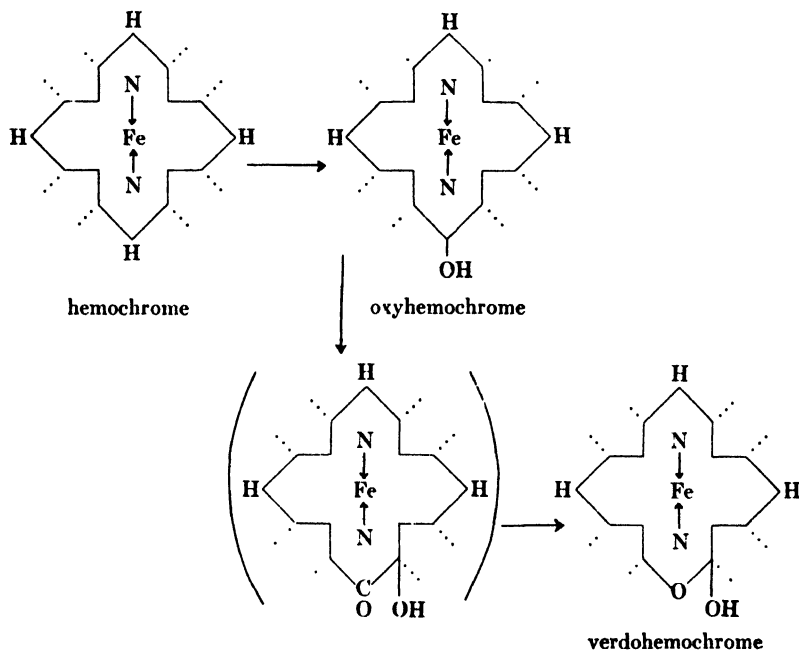

Fig. 3. Formation of verdohemochrome.

With the modification in the structure of verdohemochrome suggested below, the reactions leading to its formation are represented by the scheme shown in Figure 3.

2.2. Bile Pigments Formed from Verdohemochrome

Figure 3 (*cf.* also Chapter IV, Fig. 7) shows that, theoretically, the fission of the protoporphyrin ring can occur at any one of the four methene groups, α , β , γ , or δ .

The *biliverdin dimethyl ester*, obtained from pyridine hemochrome by coupled oxidation with hydrazine hydrate, had a melting point of 208° and gave no melting point depression with biliverdin dimethyl ester (m.p. 215° C.) prepared from bilirubin. The mother liquor of this ester contained hemato-biliverdin ester. Two molecules of water had thus been added to the vinyl groups of some of the molecules during the process. It proved difficult to

split off water from the side chains of hematobiliverdin by the methods used for preparing protoporphyrin from hematoporphyrin, but partial success was achieved. This difficulty was later also observed by Stier (2666). No isomeric protobiliverdin esters could be detected in the mother liquor.

The *mesobiliverdin dimethyl ester* obtained in the same way from mesohemochrome had a melting point of 218–219° and gave no depression with the ester (m.p. 220°) prepared from mesobilirubin; similarly, the ferrichloride of the ester obtained from mesohemochrome melted at 261° and gave no depression with the ester prepared from mesobilirubin (265°). In this case, however, there was evidence for the presence of isomerides in the mother liquor from which an ester of lower melting point (179–180°) was obtained.

These experiments show that the methene bridge α is removed preferentially. No evidence was found that the ester formed from protohemochrome was a mixture of isomerides, whereas with mesohemochrome there was evidence that other isomerides were formed.

In the case of biliverdin ester (m.p. 218°) obtained from hemoglobin by coupled oxidation with ascorbic acid, Lemberg and collaborators (1707) again found no evidence for the formation of a mixture of isomerides.

Although there is thus some evidence that methene groups other than the group α are attacked if mesohemochrome is oxidized, such evidence is absent for the oxidation of protohemochrome.

Whether or not, in the case of protoheme, the group α alone is attacked in the reaction, there is no evidence whatsoever for a greater specificity of the bile pigment formation *in vivo* than *in vitro*. During the isolation of bilirubin from gall stones or bile, a large proportion of the compound remains in the mother liquors and more easily soluble isomerides may thus escape detection. In other words, selection of the most readily crystallizable bile pigments may indicate a specificity of the removal of the α group *in vivo* as well as *in vitro*, which in fact may not be complete. It may or may not be significant that the melting points of mesobilene-(b) hydrochloride preparations obtained from natural bilirubin (3001) vary widely and are far below that of the synthetic substance of Siedel (2550).

Nevertheless, we believe that there is a directive influence which makes the methene group α especially likely to undergo oxidative removal. This can be partly ascribed to the carboxylic acid groups on the opposite side of the molecule which give it a polar character and make the methene group furthest away from them the most readily attacked. The neighborhood of a vinyl group may enhance this effect. It is also probable that the specific effect is larger for hemoglobin than for hemochrome.

2.3. Preparation and Properties of Verdohemochromes

Preparation. For the preparation of pyridine verdohemochromes on a large scale the coupled oxidation of pyridine hemochromes with hydrazine gives good results. Great care is required, however, in order to avoid contamination with by-products; so far only amorphous preparations have been obtained.*

The original method of Warburg and Negelein has been modified by Lemberg (1681,1687). A rapid current of oxygen is passed through a vigorously stirred solution of hemin in 20% pyridine at 60° C.; the addition of a mixture of hydrazine sulfate and sodium hydroxide starts a rapid reaction with change of the color to green (both the total amount of hydrazine and the ratio of hydrate to sulfate are critical). This reaction is complete in a few minutes. It is essential to control the course of the reaction by examining samples reduced with dithionite under the spectroscope every thirty seconds.

At first the green hemichrome of oxyporphyrin is formed (absorption band at 640 $m\mu$)†; on reduction with dithionite this yields a red-brown hemochrome with absorption bands similar to those of porphyrin hemochromes. The reaction must be continued until, after dithionite reduction, no trace of the first hemochrome band in the green (557 $m\mu$ for proto) is any longer visible, but only the strong band in the red and the two weak bands in the green (530 and 500 $m\mu$), which are those of protoverdohemochrome. If this precaution is neglected mixtures of verdohemochromes with hemochromes of oxyporphyrin or intermediate oxidation products of the latter are obtained.

After extraction of brown by-products with ether, the verdohemochrome is extracted with chloroform, together with some pyridine. The extract is dried, concentrated to a small volume *in vacuo*, and the verdohemochrome is precipitated with light petroleum. The precipitate is once more dissolved in dry chloroform containing 1% pyridine and reprecipitated with light petroleum.

Analysis proves that the ratio of nitrogen to iron is 6:1, *i.e.*, that the substance contains two moles of pyridine; the carbon values, however, were always found too low (about 61% instead of the 65% expected from theory). The preparation also contains a small amount (1.85%, far less than one atom) of chlorine, which may be due to occluded chloroform.

Verdohemochromes are rather unstable substances. In the presence of atmospheric oxygen they soon lose their solubility in chloroform.

* Recently a crystalline verdohemin was obtained (1688). The chloroform solution of verdohemochrome is washed with dilute hydrochloric acid to remove the pyridine. After concentration of the chloroform solution *in vacuo*, verdohemin crystallizes in green prisms.

† This compound is possibly the hemochrome of the intermediate oxidation product postulated in Figure 3, not the hemichrome of oxyporphyrin, *i.e.*, dithionite reduces the pyrrolic nucleus, but not the iron.

Absorption spectrum. A solution of protoverdohemochrome in dilute pyridine or chloroform shows a typical three-banded spectrum. In 20% pyridine the position of the bands is: I, 657 $m\mu$ ($\epsilon_{mM} = 19.6$); II, 530 $m\mu$ ($\epsilon_{mM} = 9.8$); III, 498 $m\mu$ ($\epsilon_{mM} = 8.15$). There is also a weak and indistinct absorption band in the ultraviolet at 350 $m\mu$, while the Soret band is absent (1324). In the absence of alkali, dithionite does not alter the spectrum.

Valency of the iron. The solution of the problem as to whether the compound is ferrous (a hemochrome) or ferric (a hemichrome) met unexpected difficulties (1688), which do not yet permit a clear decision. In neutral pyridine solution evidently only one form is stable. The following experiments are in favor of its being a hemochrome:

(a) If ferricyanide is added to the neutral pyridine solution, the typical bands disappear and are replaced by a diffuse absorption in the red; dithionite restores the bands.

(b) If verdohemochrome is treated with ammonia in the absence of atmospheric oxygen, azahemochrome results (*cf.* below) without a reducer being present.

(c) If verdohemochrome is dissolved under coal gas in a mixture of 66% acetic acid with a little pyridine, a carbon monoxide compound with an absorption band at 611 $m\mu$ similar to that of carbon monoxide verdoheme (*cf.* below) is observed. If more pyridine is added, the typical verdohemochrome spectrum is restored. Previously the same experiment had been carried out with the addition of some ascorbic acid (1712), but in the absence of air this can be dispensed with.

(d) In a weaker aqueous pyridine solution the absorption bands can be made to disappear by shaking with air and can be restored by dithionite. This can be expected, since the dissociability of hemichromes is usually greater than that of hemochromes.

On the other hand the following experiments indicate trivalent iron:

(e) If dithionite is added to a pyridine solution of verdohemochrome made alkaline with sodium hydroxide, the solution becomes yellow and the absorption bands disappear. If the solution is at once shaken with air the green color and the spectrum are restored. If cyanide is added to the green alkaline solution, dithionite does not alter its color. In the first paper of Lemberg (1681), it had been reported that the reduction to a yellow compound could only be observed with proto- and not with mesoverdohemochrome. This was in error; evidently an alkaline pyridine solution of the proto, and a neutral one of the meso, compound had been studied. The explanation then given, based on the assumption of a specific influence of the vinyl group, is therefore not correct. The yellow reduction product has a rather high absorption maximum at 455 $m\mu$ ($\epsilon_{mM} = 57.5$) which may be mistaken for a Soret band. The experiments must be carried out with fresh solutions in alkaline pyridine; on standing such solutions turn yellow without reducer, and then turn green if dithionite is added.

(f) Verdohemochrome arises from oxyporphyrin hemichrome by further oxidation in the presence of hydrazine. *Cf.*, however, the footnote on p. 461.

(g) Magnetochemical investigations of Mellor (1906) indicate the presence of one free electron. This proves that the linkages are covalent, but the evidence with regard to the valency is not decisive, since verdohemochrome readily forms a fully paramagnetic chloroform-insoluble substance with five free electrons, so that a partial transformation of diamagnetic verdohemochrome into this substance may explain the paramagnetism found.

(h) Libowitzky and Fischer (1731,1732) assume ferric iron since their compound was not readily split by acids. It is uncertain, however, whether their compound was really verdohemochrome; under some conditions at least verdohemochrome is very easily split by acids (*cf.* below).

It is evident from a comparison of experiments (a) and (e) that either the ferricyanide or the dithionite reaction must involve an alteration of the tetrapyrrolic system. Were it not for the inhibition of this reduction by cyanide, it would be certain that the ferricyanide alters the valency of the iron, while the dithionite reacts with the tetrapyrrolic system. It will be seen below that the action of cyanide may perhaps be explained, not as reaction with iron, but on the basis of the tetrapyrrolic system.

On the whole we believe that the evidence in favor of the ferrous state of verdohemochrome is stronger.

Verdohematin is obtained as a black powder on removal of the pyridine by washing solid verdohemochrome or its chloroform solution with water. Apparently oxidation occurs in this process. Verdohematin can be dissolved in dilute sodium carbonate or phosphate buffer, giving a dark olive solution which absorbs light in the red but shows no distinct absorption bands. On cautious reduction with a small amount of dithionite the green verdoheme is obtained. Its absorption band in the red is indistinct. On passing coal gas through this solution a band at $610\text{ m}\mu$ appears, in addition to a band at $665\text{ m}\mu$ (carboxyverdoheme).

In dilute sodium carbonate, verdohematin undergoes an irreversible alteration, even in the absence of oxygen (1638). The product is now no longer reconvertible to verdohemochrome and is easily split to biliverdin by dilute acetic acid (*cf.* also 1731). Reduction yields a green compound which has also been obtained from biliverdin by introduction of iron and is probably its ferrous iron complex. The ease of conversion of verdohemochrome into biliverdin in this manner provides additional evidence against the assumption of a carbon-closed ring in verdohemochromes and supports the semiacetal formula suggested below.

Verdohematin combines with native globin giving the olive-green verdohemoglobin (indistinct absorption in the red, absorption bands at 532 and $505\text{ m}\mu$). With a small amount of dithionite the solution

turns a pure green (verdohemoglobin) with a sharp absorption band at $665 \text{ m}\mu$, while an excess of dithionite transforms it into a yellow compound. The absorption spectrum of verdohemoglobin does not differ from that of denatured globin verdohemochrome, and when a solution of verdohemoglobin is oxygenated verdohemoglobin results. There is thus no evidence for the formation of a compound comparable to oxyhemoglobin (1716,2309).

2.4. Structure of Verdoheme

The verdohemochrome formula shown in Figure 2 assumes it to be an isobiliverdin iron complex in which pyrrole ring IV is in a tautomeric form. This assumption was based on the facts that treatment with acids yielded biliverdin and that sodium amalgam reduced it to mesobilane.

The latter experiment excluded the possibility that verdoheme contained a tetrapyrrolic ring system closed by a carbonyl (CO) group. Such a compound might perhaps have given bile pigments on being split with acids, but would have given porphyrinogen, not mesobilane on complete reduction. Nevertheless, Libowitzky and Fischer (1731,1732) later assumed this structure again for verdohemochrome. This was finally disproved by the conversion by Lemberg (1687) of verdohemochrome into monoazahemochrome (cf. Chapter V). This could be well understood with the verdohemochrome formula as an isobiliverdin iron compound (Fig. 4). In spite of this

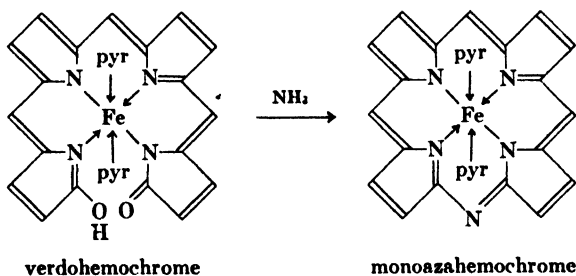

Fig. 4. Reaction of verdohemochrome with ammonia.

the assumption of a carbon closed ring was not abandoned by the Fischer school (2666,2667).^{*} The iron, which is so labile in verdoheme

^{*} Pure verdohemochrome yielded no trace of porphyrin when treated with formic acid, palladium, and hydrogen in the manner by which Stier and Gangl (2667a) obtained a small amount of coproporphyrin from "coproverdohemin" (1688).

compounds, is extremely firmly bound in azaheme compounds — which is in agreement with the reclosure of the ring.

Nevertheless, the structure suggested by Lemberg for verdoheme requires a modification. We have seen in Chapter IV, Section 3.3. that a formula similar to that given in Figure 2 for verdohemochrome has to be assumed for the zinc complex salt of biliverdin (which is readily obtained from biliverdin), whereas all attempts to form verdohemochrome from biliverdin have failed; the two compounds, biliverdin zinc and verdohemochrome, also have rather different absorption spectra. That they must nevertheless be closely related to each other is not only supported by the conversion of verdohemochrome to biliverdin by acids, but also by other observations. Oxidation of the zinc or copper complexes obtainable from verdohemochrome by exchange of iron with these metals leads to complexes of biliviolinoid type, spectroscopically indistinguishable from the biliviolinoid complexes obtained by oxidation of biliverdin zinc (1681). The structure of these biliviolinoid pigments (bilipurpurins) has been discussed in Chapter IV, Section 5.4.

These facts and (compare page 463) a number of other observations are best accounted for by the assumption that verdoheme contains a cyclic anhydride of biliverdin with a ring system closed by a labile oxygen bridge. Formulas such as *A* and *B* in Figure 5 are suggested

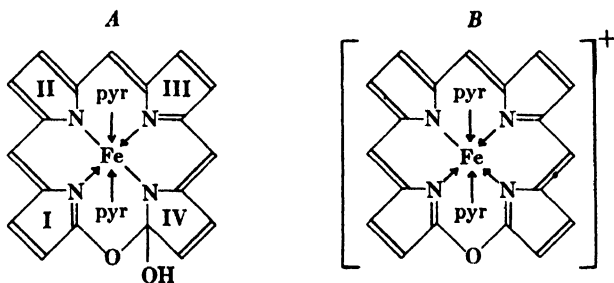

Fig. 5. Structure of verdohemochrome.

for verdohemochrome. Formula *B* was suggested by Lemberg (1687) in 1943, but formula *A* appears to be more likely.

By the action of acid on the yellow dithionite reduction product of verdohemochrome a yellow compound is obtained which differs from all known bile pigments. This may be explained in the way suggested

in Figure 6. Cyanide prevents this reduction, perhaps by replacing the hydroxyl group in A.

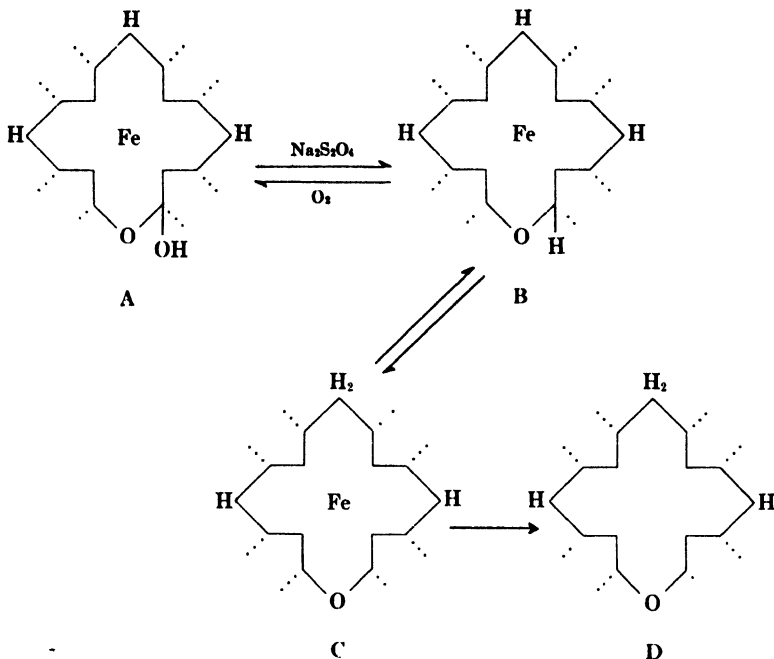

Fig. 6. Conversion of verdohemochrome into yellow compounds.

As by-products of the formation of verdohemochrome peculiar brown iron-containing substances are obtained which do not appear to form hemochromes. One would expect ring IV in formula A, Figure 5, to be labile, and its hydrolysis may lead to the brown compounds.

It is still uncertain whether the compounds isolated by Libowitzky (1731) actually were verdoheme compounds or compounds with a ring closed by a carbonyl group, in spite of the fact that the absorption spectrum in pyridine was that of verdohemochrome. These compounds were obtained by the autoxidation, not the coupled oxidation, of oxycoproporphyrin hemichrome, and appear to be more stable to acid than verdohemochrome. Thus Libowitzky isolated a crystalline green hemin containing two atoms of chlorine by methods which would split verdohemin.

A compound of the structure given in Figure 7:

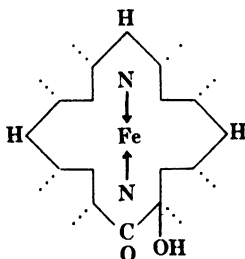

Fig. 7. Possible intermediate.

may have an absorption spectrum quite similar to that of verdohemochrome. It is not impossible that it occurs as a stage of the formation of verdohemochrome (*cf.* Fig. 3) and may be present as an impurity in verdohemochrome preparations in which the reaction has not gone to completion. (Stier, 2666-2667*a*).

The varying yield of biliverdin obtained by the action of acids on verdohemochromes can perhaps be understood in this way. Certain preparations lost all their iron readily when treated with acids and gave a yield of almost 100% of biliverdin (1716), while others showed signs of incomplete splitting and gave rather poor bile pigment yields (1712). This cannot be explained by the observation of Stier (2666,2667) who found that diacetylhemo-verdohemochrome in the presence of an excess of hydrazine is slowly oxidized further to a hemochrome with a similar absorption spectrum; on treatment with acid, the latter yields a bilipurpurin, not a biliverdin. Lemberg and co-workers (1712) often found small recoveries in spite of the fact that they measured total bile pigment yield (biliverdin + bilipurpurin). The process

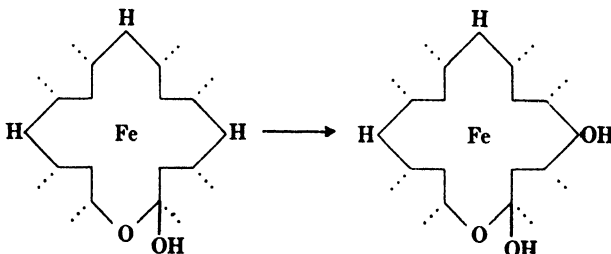

Fig. 8. Further oxidation of verdohemochrome.

observed by Stier can be largely avoided by careful technique in the preparation of verdohemochrome. It consists evidently in the oxidation of methene

group β or δ to a \geq COH group (Fig. 8). This is a repetition of the process which occurs at methene group α before it is removed (*cf.* Fig. 3).

In spite of the transformation of verdohemochrome into azahemin, it is unlikely from these experiments that the conversion of hematin into bile pigment is a reversible process. Neither a conversion of biliverdin into verdohemochrome nor a reconversion of the latter into a porphyrin compound by formic acid or formaldehyde has been observed.

2.5. Mechanism of Formation of Verdohemochromes

The mechanism of the formation of verdohemochromes has been thoroughly studied by Lemberg and co-workers (1697,1698).

Role of hydrogen peroxide. It has been mentioned above that hydrogen peroxide (in high dilution) acting on pyridine hemochrome in the absence of oxygen produces oxyporphyrin hemochrome, which is a precursor of verdohemochrome. The conversion of oxyporphyrin hemochrome to verdohemochrome is probably also caused by hydrogen peroxide, not by molecular oxygen, although — as we saw above — oxyporphyrin hemochrome is autoxidizable to a substance having the verdohemochrome type of absorption spectrum (1732). It is not yet certain whether the latter reaction leads to verdohemochrome, and in any case the coupled oxidation with ascorbic acid is much faster than the autoxidation. The verdohemochrome formation is partly inhibited by catalase.

For verdohemochrome formation to occur it is essential that the hydrogen peroxide act on the ferrous heme compound. Oxidation of ferric hematin compounds by hydrogen peroxide leads only to decoloration. To keep the hematin iron in the ferrous state is one of the functions of the hydrogen donor in the reaction, but not the only one. In the coupled oxidation with some hydrogen donors the hydrogen peroxide may be produced by the autoxidation of the hydrogen donor. With ascorbic acid, under the conditions of the experiment, the autoxidation is, however, too slow to account for the reaction velocity; catalase only partially inhibited this reaction, while the action of added peroxide was completely blocked by catalase. Lemberg and co-workers, therefore, assumed the following reaction mechanism:

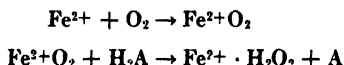

In the presence of catalase the hydrogen peroxide thus formed in the

complex has time to cause some intramolecular oxidation before it dissociates and is destroyed by catalase.

If the primary compound of hemochrome with oxygen is to react with ascorbic acid its lifetime cannot be infinitesimally small. The concept that an Fe^{2+}O_2 compound may be able to act as a dehydrogenating agent has been discussed in Chapter VIII.

Coupled oxidation of hemochrome and ascorbic acid. The catalysis of the oxidation of ascorbic acid by hemochromes has been studied by Barron and co-workers (184), but they failed to notice the accompanying oxidation of the hemochrome, which had previously been observed by Karrer and co-workers (1469). In fact, under the conditions of their experiments a great part of the catalytic action on ascorbic acid oxidation must have been due to the resulting verdohemochrome (1697). Lemberg and co-workers (1697) confirmed the view of Barron that ascorbic acid is oxidized by the hemichrome formed by the autoxidation of hemochrome. The whole coupled oxidation can thus be formulated as follows (where H_2A denotes ascorbic acid and A, dehydroascorbic acid):

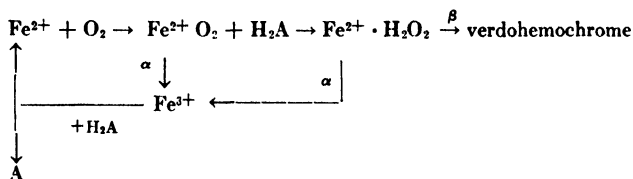

It can be considered as a peroxidative destruction of the porphyrin nucleus in the ferrous hydrogen peroxide heme compound. Each time only a small part of the oxygen compound reacts in this direction (β), the major part being transformed into hemichrome (α) and reduced again by ascorbic acid.*

* I use the occasion to correct several printing errors in two papers of Lemberg and co-workers (1697,1698) that may have obscured the meaning. In *Biochemical Journal*, 32, 152 (1938), Table II, the headings of the columns under "B. Method 2" differ from those under "A. Method I." They were erroneously omitted and should read: Column 1, Ascorbic acid, mg.; column 2, Hemin, mg.; column 3, Ratio, ascorbic acid : hematin; column 4, Mg. ascorbic acid oxidised; column 5, Mg. ascorbic acid which should be oxidised provided the ratio be 1:2; column 6, ditto, provided the ratio be 1:1; and column 7, % reaction of theoretical (1:2).

Page 149, line 7 read: "the methene group α " instead of "one of the α -methene groups." Page 180, line 13: read "with the theory that," instead of "with the second theory mentioned in the introduction, that."

In the same journal, page 180, line 25: read "557 $m\mu$ " instead of "527 $m\mu$ " and line 29: read "ferrous" instead of "ferric." A few other misprints should be readily corrected.

The oxidation product is dehydroascorbic acid; in the later stages of the coupled oxidation, however, irreversible oxidation of ascorbic acid beyond the dehydro stage takes place. Reduced glutathione protects ascorbic acid from oxidation and is oxidized instead, verdohemochrome being formed with small concentrations of ascorbic acid in the presence of an excess of glutathione. Pure glutathione alone was not found by Lemberg and co-workers (1697) to form verdohemochrome. The formation of a green compound in the reaction with glutathione has been observed by Lyman and Barron (1794), but this was not verdohemochrome.

Other hemochromes, such as a nicotine hemochrome, are also oxidized to verdohemochromes. Denatured globin hemochrome is oxidized very slowly and hematin not at all, their oxidation-reduction potentials being so low that the ferric compound is not reduced by ascorbic acid to a large extent. The optimal *pH* for the oxidation of pyridine hemochrome to verdohemochrome is 7.6. In air at 37°C. about twenty molecules of ascorbic acid are oxidized for one mole of hemochrome oxidized to verdohemochrome. At a lower oxygen pressure the ratio is smaller, since the rate of oxidation of ascorbic acid is roughly proportional to the oxygen pressure, while verdohemochrome formation, at least to a pressure as low as 30 mm. of mercury, is almost independent of it.

Other hydrogen donors which form verdohemochrome are hydrazine, pyrogallol, and adrenaline (850). The verdohemochrome formed by oxidation of pyridine hemochrome with hydrogen peroxide in the presence of pyrogallol was again mistaken for a chlorophyll derivative by Haurowitz (1169). Veer (2863) has found that adrenochrome converts hemochrome into verdohemochrome. This author assumes that adrenochrome oxidizes hemochrome first directly and later by means of hydrogen peroxide formed by autoxidation of leuoadrenochrome. A direct oxidation of hemochrome to verdohemochrome by a quinone appears unlikely. It is more probable that the solution of pyridine hemochrome prepared by pyridine treatment of erythrocytes contained reducing substances; adrenochrome is reduced by reduced pyridine nucleotides to leuoadrenochrome (1044).

Cysteine in the presence of copper was also found to yield verdohemochrome, while copper-free cysteine, and glutathione (with and without copper) led to the formation of a little of a hemochrome with an absorption band at 585 $m\mu$, perhaps a hemochrome with carbonyl side chains (1698).

3. PHOTOCHEMICAL FORMATION OF BILE PIGMENTS FROM PORPHYRIN METAL COMPLEXES

While free porphyrins have never been converted into bile pigments, Fischer and Bock (804,805) found a photochemical oxidation of the sodium metal complex of etioporphyrin to bile pigments (etiobiliverdin and biliviolinoid pigments) as well as to an α -formyl- α' -hydroxypyrrromethene, if the pyridine solution of the complex salt was exposed to strong light in the presence of atmospheric oxygen.

The mechanism of the reaction is not yet clear in all its phases, but can be formulated as addition of oxygen to a double bond between one methene group and a pyrrole nucleus, followed by the formation of a tetrapyrrotriene with a formyl group at one end (Fig. 9). The latter is ultimately replaced

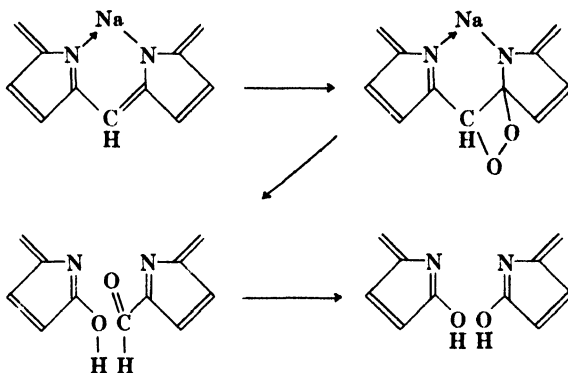

Fig. 9. Photochemical formation of bile pigments (only the lower halves of the molecules in which the alterations occur are shown).

by a hydroxyl group, yielding the bilatriene etiobiliverdin. If the reaction occurs on two opposite methene groups, dipyrrolic substances are formed and the formyl group remains attached.

An alternative explanation was first preferred, but was later (805) withdrawn because it was based on an erroneous assumption of the nature of a presumed intermediate.

It is not impossible that chlorophyll may be converted into bile pigments by such a photochemical oxidation.

4. FORMATION OF BILIVERDIN FROM HEMOGLOBIN *IN VITRO*. CHOLEGLOBIN

4.1. Introduction

The formation of green pigments from hemoglobin has been frequently observed. In 1901 Lewin (1726) obtained "hemoverdin" from the blood of animals poisoned with phenylhydrazine. Schott-

müller (in 1903) first observed the discoloration of hemoglobin by bacteria, the so-called "α" or "viridans effect" (2461). Parisot (2106) obtained a green pigment by the action of adrenaline on hemoglobin. The transformation of hemoglobin into a green, ether-soluble bile pigment by incubation with liver brei and liver extract (Schreus and Carrié, 2470) has been mentioned above. Hart and Anderson (52, 1141) found, not only bacterial autolysates, but also a variety of hydrogen donors able to form an insoluble green pigment if hemoglobin solutions were incubated with these extracts or substances in the presence of air. Among these was ascorbic acid. Edlbacher and von Segesser (647) later obtained a green, amyl alcohol-soluble substance by acid treatment of the green pigment obtained by coupled oxidation of hemoglobin and ascorbic acid. At the same time the reaction was studied in detail by Lemberg and co-workers (492, 1668, 1707-1710, 1712).

In the first stages hemoglobin is partly transformed into a green water-soluble compound, which was called choleglobin. Later, when the choleglobin concentration reaches about 20% of the initial hemoglobin, free biliverdin is found in the solution, while the globin becomes denatured, and a green surface scum and precipitate appear. This is the "green pigment" of Anderson and Hart. It is essentially denatured choleglobin, but differs from the substance obtained by denaturation of choleglobin with alkali by having its prosthetic group firmly attached to the denatured protein. Finally, 10-15% of the prosthetic group of hemoglobin can be obtained in the form of biliverdin. These results were confirmed later by other workers (691, 1527).

4.2. Properties of Choleglobin

4.2.1. Spectroscopic Properties. Choleglobin has so far been obtained only in mixtures with a great excess of hemoglobin. Its spectroscopic properties can, therefore, only be studied in regions of the spectrum in which hemoglobin has little absorption. The "green pigment," however, could be obtained practically free from denatured globin hemochrome. Table II shows the position of the typical absorption bands of choleheme compounds. Despite the identity of position of the bands of carboxycholeglobin and choleglobin, the formation of a carboxy compound could be established; its absorption band is higher than that of choleglobin. Attempts to demonstrate a reversible combination with oxygen failed, since

ascorbic acid could not be removed without secondary alterations (1709).

Choleglobin can be distinguished from sulfhemoglobin by its conversion to cholehemochrome with alkali and dithionite. Sulfhemo-

TABLE II
Absorption Bands of Choleheme Compounds^a

| Choleglobin | Absorption band, m μ | Cholehemochromes | Absorption bands, m μ |
|-------------------------|-----------------------------|--------------------------------------------------|-----------------------------------------------------------------------|
| Ferrocholeglobin | 629 | Denatured globin hemo- chrome (green pigment) | In alkali, 619 In dilute acid, 628 |
| Ferricholeglobin | 674, (630) ^b | Denatured globin carboxyhemochrome | 628 |
| Carboxyferrocholeglobin | 628 | Pyridine hemochrome Hydrazine hemochrome | 619 617 ^c |
| | | Hydrazine carboxyhemochrome | 633 ^c |
| | | Hemichromes | |
| | | Denatured globin hemi- chrome | In 0.1 N NaOH, 646; in 1% Na ₂ CO ₃ , 595 |
| | | Pyridine hemichrome | 612, (665) ^b |

^a According to Lemberg and co-workers (1709).

^b Values in parentheses are weak bands. It is doubtful whether this band is that of ferricholeglobin; it may be due to accompanying hemoglobin or to ferrocholeglobin, ascorbic acid being still present.

^c According to Kiese and Kaeske (1527).

globin yields protohemochrome under these conditions, with disappearance of the band in the orange part of the spectrum.*

The absorption spectra are quite different from those of verdohemoglobin. Like the latter, however, choleglobin does not absorb strongly in the ultraviolet. Conversion of 20% of hemoglobin into choleglobin is accompanied by a corresponding decrease of the Soret band (1324).

Kiese and Kaeske (1527) have shown that myohemoglobin forms corresponding myocholeglobin compounds. Their absorption bands

* Whereas Liébecq (1738b) noted a partial reconversion of pseudohemoglobin into protohemochrome, but in later experiments (1738e) could not obtain conclusive evidence for this, we have recently found (1699) that, under more vigorous conditions (in hot alkaline solution in the presence of reducing agents), cholehemochrome (not, however, verdohemochrome) can be reconverted to protohemochrome.

lie 5–10 $m\mu$ closer to the red than those of the choleglobin compounds from hemoglobin. Since a similar difference is known to exist between analogous myohemoglobin and hemoglobin compounds, it seems unlikely that the globin part of the molecule is altered. This holds only for the initial stage of the reaction; later, alterations of the globin — and particularly of the type of linkage between globin and prosthetic groups — occur, accompanied by denaturation of the globin. Holden (1317) suggests that the protein of choleglobin may be no longer unaltered globin; his evidence is based, however, on the properties and mechanism of formation of a green compound, which is only spectroscopically similar to choleglobin, but which belongs to a different class of pigments (*cf.* under Section 6.).

4.2.2. Spectrophotometric Analysis. The solutions obtained by the coupled oxidation of hemoglobin and ascorbic acid contain hemoglobin, oxyhemoglobin, hemoglobin, and ferro- and ferricholeglobin. Nevertheless, a spectrophotometric analysis was worked out by Lemberg and co-workers (1710). By means of carbon monoxide, alkali, and dithionite the hemoglobin derivatives are converted into carbon monoxide-denatured globin hemochrome, and the choleglobin derivatives into carbon monoxide-denatured globin cholehemochrome. By measurement of the absorptions at 630 and 570 $m\mu$ the concentration of total hemoglobin and choleglobin compounds can be found. The extinction coefficients of the carboxycholehemochrome were obtained from measurements on almost pure denatured globin cholehemochrome (green pigment), as well as on mixtures of choleglobin and hemoglobin in the initial stages of the reaction, from the ratio:

$$+ \Delta \epsilon_{630 \text{ } m\mu} / - \Delta \epsilon_{570 \text{ } m\mu}$$

Since this ratio remains constant during the first stage of the reaction, it can be assumed that no other pigments are formed.

In the later stages, however, the ratio decreases — indicating the disappearance of hemoglobin with conversion into other pigments. Under the conditions of the analysis, both biliverdin and verdoheme compounds would be transformed by alkaline dithionite into yellow compounds which do not absorb strongly at either 630 or 570 $m\mu$.

4.3. Structure of the Prosthetic Group

The structure of the prosthetic group of choleglobin is not yet clear. It is not identical with verdoheme, as shown by the difference

of the absorption spectra. Also, denatured globin or pyridine cholehemochrome does not yield azahemochrome with ammonia.* The similar mode of its preparation, the lack of the Soret band, the ease with which iron is detached, and the fact that the same bile pigments (biliverdin and biliviolinoid substances) are obtained in this way, however, all indicate a close relationship.

If choleglobin or "green pigment" is incubated for sixteen hours at 37° in 66% acetic acid, two thirds of its iron is removed. The bile pigment yields from choleglobin are small, however, only about 10% of the theoretical. Very little bile pigment is obtained from "green pigment," the prosthetic group remaining firmly attached to the denatured protein, in spite of the removal of iron.

From the fact that a constant proportion of choleglobin is transformed to bile pigment, and from the constant ratio, $+\Delta\epsilon_{630\text{ m}\mu}/-\Delta\epsilon_{570\text{ m}\mu}$, Lemberg *et al.* concluded that the bile pigments are derived from choleglobin by the action of the acetic acid. It is not impossible, however, that choleglobin is a precursor of verdohemoglobin, and that the latter is unstable under the conditions of the experiment and breaks down to yield free biliverdin. There are some indications for this. Compounds similar to verdohemochrome, although apparently not identical with it, were obtained by coupled oxidation of "green pigment" with ascorbic acid in 20% pyridine, and also during the late stages of the coupled oxidation of hemoglobin with ascorbic acid. By splitting of green pigment with acid, a very small amount of an oxyporphyrin-like substance was obtained in addition to bile pigments; this compound could not, however, be obtained from choleglobin solutions (1709). Finally, the ratio $\epsilon_{665\text{ m}\mu}/\epsilon_{630\text{ m}\mu}$ is 0.6 for choleglobin — higher than that for "green pigment" (0.32) — which might indicate an admixture of a verdohematin derivative in the former. If the ratio of choleglobin to verdohemoglobin formations remains constant during the initial stages of the action of ascorbic acid, a small amount of verdohemoglobin formation may be difficult to detect spectroscopically.

The problem of the constitution of the prosthetic group of choleglobin must remain open.

4.4. Mechanism of Choleglobin Formation

4.4.1. Principle of the Mechanism. Hydrogen peroxide acting on hemoglobin in the presence of ascorbic acid produces choleglobin (1708). Even in the absence of ascorbic acid, hydrogen peroxide transforms hemoglobin, and also to a smaller extent oxyhemoglobin and hemoglobin, into choleglobin (1710).

* Liébeq (1738c) has recently claimed that choleglobin as well as pseudo-hemoglobin yields azahemochrome with ammonia; a small azahemochrome band appeared in ammonia, but the band in the orange of choleglobin or pseudo-hemoglobin did not disappear.

Keilin and Hartree (1501) have recently found that hydrogen peroxide produced by notatin, the glucose dehydrogenase of *Penicillium notatum*, formed small amounts of choleglobin as well as hemoglobin from oxyhemoglobin.

Substances which in the presence of oxygen yield hydrogen peroxide can thus cause the formation of choleglobin or similar substances (cf. Section 6.2.). One of these substances is dithionite, which is frequently used as a reducer of blood pigments. After several reductions of oxyhemoglobin by dithionite, followed by reoxygenation, an absorption band similar to that of ferrocholeglobin can always be observed. No choleglobin is formed by repeated deoxygenation of oxyhemoglobin by evacuation, followed by reoxygenation (691; cf. also 1698).

For the coupled oxidation of hemoglobin and ascorbic acid, Lemberg and co-workers (1708) showed that the hydrogen peroxide formed by the autoxidation of ascorbic acid can play only a minor role. This autoxidation is a copper-catalyzed reaction; its complete inhibition by specific reagents which combine with copper, such as diethyl dithiocarbamate, did not reduce the rate of the coupled oxidation.* The latter is also not prevented, although it is slowed down, by catalase (cf. also 52,691). The reaction is, therefore, initiated by a direct reaction of oxyhemoglobin with ascorbic acid and its mechanism is similar to that described above for the formation of verdohemochrome from pyridine hemochrome. In this connection it is of interest that Kiese has found evidence for the formation of a compound of hemoglobin with ascorbic acid (1526; cf. Chapter XI, Section 3.3.2.).

The coupled oxidation can be formulated as follows:

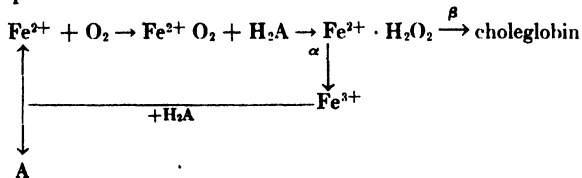

In this case the Fe^{2+}O_2 compound is stable (oxyhemoglobin) and yields hemoglobin directly only at a negligible velocity. Again the major part of the reaction proceeds in the direction (α) so that the formation of choleglobin is completed only after several cycles. The

*According to recent observations (1699), however, diethyldithiocarbamate does not act on the system merely as copper inhibitor.

ratio α/β is somewhat smaller than in the verdohemochrome formation, roughly 10 moles of ascorbic acid being oxidized per mole of choleglobin formed.

Hemoglobin is an intermediate of the cycle. By coupled oxidation with ascorbic acid it is converted into choleglobin at the same rate as oxyhemoglobin (1710). Cyanide, by transforming hemoglobin into hemoglobin cyanide which ascorbic acid cannot reduce, inhibits choleglobin formation (1315); by this it is shown that the process of choleglobin formation is different from that of pseudohemoglobin and cruoralbin formation for which a high concentration of cyanide is required (*cf.* Section 6.).

The reaction proceeds rapidly under physiological conditions of pH, temperature, oxygen pressure, and concentrations of ascorbic acid and reduced glutathione. At an oxygen pressure of 15 mm. of mercury it is about four times faster than at 150 mm. pressure (1666, 1710); these optimal conditions are the same as those for the formation of hemoglobin from hemoglobin in the presence or absence of reducing substances (*cf.* Chapter VIII).

There is no need to assume that specific enzymes play a role in the oxidation of hemoglobin to choleglobin and bile pigments; hemoglobin is rather the catalyst of its own destruction. Enzyme systems may play a role as hydrogen donors similar to that of ascorbic acid (*cf.* Sections 4.4.4. and 4.4.5.); the enzyme systems which reduce hemoglobin to hemoglobin in the erythrocyte (*cf.* Chapter XI, Section 4.) do not form choleglobin, but the reduction of hemoglobin may be of importance for the formation of choleglobin.

4.4.2. Stroma Factor. In a solution of hemolyzed red cells choleglobin formation proceeds at only one third of the rate observed in destromatized oxyhemoglobin solutions of the same concentration (1710). The stroma thus contains a factor which protects hemoglobin.* In intact red cells choleglobin is formed very slowly if at all. Erythrocytes containing choleglobin can best be prepared if a small hypotonicity is used in conjunction with a large ascorbic acid concentration (Lemberg and Callaghan, 1694). Such cells are unstable

* Recent experiments (1699) indicate that the rapid choleglobin formation in acid-destromatized hemolyzates of mammalian red cells can be partly explained by a combination of lowered catalase content and increased rate of catalase destruction. A stroma effect can, however, also be observed in duck erythrocytes which do not contain catalase. Oxyhemoglobin solutions, exposed to a pH of 5 or below and reneutralized, are thereby sensitized toward ascorbic acid + oxygen, whereas no such sensitization was found on acidification of oxygen-free hemoglobin solutions (*cf.* also Vladimirov and Kolotilova, 2893a).

and are easily hemolyzed, *e.g.*, by centrifugation. Still more unstable choleglobin cells were prepared with phenylhydrazine. The intracorpuseular formation of biliverdin by phenylhydrazine *in vivo* and the small amount of biliverdin obtainable from normal erythrocytes will be discussed in the next chapter.

4.4.3. Green Pigment. Under the conditions of *pH* and temperature used for the coupled oxidation, hemoglobin itself (in the absence of atmospheric oxygen) is not denatured. Even while the reaction proceeds in air, at first only the choleglobin is denatured and precipitated; at this stage the green precipitate is alkali-soluble. Only later is hemoglobin also denatured, the precipitate acquiring a less purely green color and becoming insoluble in alkali. The denaturation appears to be due to an oxidation of globin, to which choleglobin is apparently more sensitive than hemoglobin. It is probably due to hydrogen peroxide formed in the reaction. This oxidative denaturation is accompanied by a change to an irreversible type of linkage between prosthetic groups and protein. which we shall also find in pseudohemoglobin, cruoralbin (prepared at room temperature), and sulfhemoglobin — in these cases without the protein becoming insoluble at neutral *pH*. For this reason the "green pigment" of Anderson and Hart yields little ether-soluble substance on treatment with acid.

4.4.4. Various Hydrogen Donors Producing Choleglobin. In addition to ascorbic acid and ascorbic acid plus reduced glutathione, a variety of other hydrogen donors produces choleglobin from hemoglobin. Reductone is quite as active as ascorbic acid (Lemberg and co-workers, 1710). Adrenaline and phenylhydrazine have been mentioned above. The hemoverdin of Lewin was probably impure biliverdin, resulting from the treatment of choleglobin with acid. A great variety of substances and systems was found by Anderson and Hart (52) to form green pigment, *e.g.*, dihydroxyacetone with ammonia or glycine, glucose in phosphate with cysteine or glutathione, or with much glycine, or with glycine and ammonia.

Lemberg and co-workers (1710) found cysteine and glutathione alone almost inactive, Barkan and Schales (163), only occasionally active. This probably depends on the purity of the glutathione. With hydrogen peroxide, cysteine and reduced glutathione have been found to yield green oxidation products of hemoglobin (2164). Thioglycolic acid is not only able to form choleglobin or a similar green pigment (163), but also to detach its iron (2547). Dimercaptopropanol rapidly reduces hemoglobin and causes coupled oxidation (2968).

Dialuric acid and alloxanthine as reducing substances form choleglobin, while alloxan, an oxidizing substance, forms only hemoglobin (359).

In the presence of oxygen, hydrogen sulfide acting on hemoglobin produces choleglobin in addition to sulfhemoglobin, particularly if the reaction is

carried out in weakly alkaline solutions (1701; cf. also 2054, 2863). The identification of sulfhemoglobin with choleglobin or "verdohemochromogen" is, however, unjustified and confusing. In Jung's paper (1439) "verdohemochromogen" stands at different times for sulfhemoglobin, for choleglobin, and for pseudo-hemoglobin (cf. Sections 6 and 7.).

The compound produced from hemoglobin by the action of arsine and oxygen is probably choleglobin (Lemberg, 1684).* This reaction had first been observed by Hoppe-Seyler in 1877 (1338); it was later studied by several other workers (1156, 1762, 1896, 2758). The assumption of Haurowitz and of Thauer (1156, 2758) that only hemoglobin is formed is erroneous. Oxygen is required for the hemolysis of the erythrocytes by arsine (2013) as well as for the transformation of hemoglobin into choleglobin. Henze (1244) found that arsine and oxygen yielded hydrogen peroxide. The reaction is a coupled oxidation, arsine being oxidized to arsenite (cf. 1027), while in the absence of oxygen hemoglobin is reduced to hemoglobin (Wolff, 3117; Jung, 1440). The easily detachable iron in blood is increased by treatment with arsine.

Finally, certain enzyme systems are evidently able to react in the same manner as reducing substances. Such enzyme systems have been found in bacteria (cf. Section 4.4.5.). Recently Keszyüs and Kiese (1522) have found that enzyme systems of liver pulp and liver extracts transform hemoglobin into biliverdin (cf. also Schreus and Carrié, 2470). The heat-stable substrate could be removed by dialysis, the enzyme, by ammonium sulfate precipitation. A green hemoglobin is an intermediate product; it is more readily converted into biliverdin than is hemoglobin, and at pH 5.2 it yields biliverdin while hemoglobin does not do so. Enzyme systems producing hydrogen sulfide are indeed known to occur in the liver. Polonovski (2162) has recently claimed that in the spleen choleglobin is formed, whereas in the liver sulfhemoglobin arises as an intermediate product.† In the circulating erythrocyte, however, sulfhemoglobin is quite stable and is not broken down to bile pigments (cf. Chapter XI, Section 3.2.3. and Chapter XII).

Urine contains a substance which forms choleglobin (1688, 1867), not only hemoglobin (2252), from oxyhemoglobin.

The identity with choleglobin of the green hemoglobins formed in these reactions has not yet been proved. The mode of their formation, however, their properties, and in some instances their transformation into bile pigments, make it appear far more likely that they are choleglobin than that they are pseudo-hemoglobins (Section 6.) or sulfhemoglobin (Section 7.). The green hemoglobin formed by phenylhydrazine has spectroscopic properties differing slightly from those of choleglobin (1527, 1529), but, like the latter, yields biliverdin with acids.

Other substances which form green hemoglobins *in vivo* are 2,4-diaminotoluene, *m*-dinitrobenzene, hydroxylamine, hydrazine, glycol

* Kiese (1526a) claims that it is sulfhemoglobin.

† Cited from abstracts only.

dinitrate, and sodium chlorate; but, as in the instance of the green hemoglobin formed by nitrite and hydrogen peroxide (*cf.* Section 6.3.), some of these are perhaps of different nature.

4.4.5. The "Viridans" Effect. If some microorganisms, *e.g.*, *Strep. viridans* and *Pneumococcus (D. pneumoniae)* are grown on blood agar plates, a zone of green discoloration is found around the colonies. This was previously explained as due to the formation of hemoglobin from oxyhemoglobin, but it is now clear that the green color is due to choleglobin, not to hemoglobin, although the same systems probably produce both pigments from oxyhemoglobin. The effect was discovered by Schottmüller in 1903 (2461) and the literature is reviewed in the textbook of Topley and Wilson, page 433 (2998; *cf.* also 350).

Oxyhemoglobin solutions are transformed into green pigment by the same bacteria and, to a lesser degree, also by other bacteria such as β -streptococci (*Streptococcus pyogenes*), *S. faecalis*, *Staphylococcus aureus*, and *Escherichia coli* (1141). Hart and Anderson (1141) obtained the system responsible for the formation of this pigment in cell-free autolysates. We have seen above that the green color is due to choleglobin and denatured choleglobin.

The pigment-producing system in pneumococci and streptococci is apparently identical with the hemoglobin-forming system of bacteria studied in detail by Avery, Morgan, and Neill (101-102, 1985-1986, 2027-2030). They established the presence in bacterial autolysates of a dehydrogenase system which, under anaerobic conditions, decolorized methylene blue and, in the presence of oxygen, oxidized oxyhemoglobin to hemoglobin. Thermostable diffusible hydrogen donors, probably derived from carbohydrate metabolism, and a thermolabile factor, probably enzymic in nature, were found to play a role. The latter factor is released from the cell only by autolysis and is labile to oxygen and small amounts of hydrogen peroxide, but is protected by the reducing thermostable factor. Hydrogen peroxide is formed by a dehydrogenase system able to react with molecular oxygen; the formation of hydrogen peroxide was demonstrated by distillation and the starch-iodine reaction (*cf.* also 1422, 1266).

The formation of green rings by bacteria (pneumococci and streptococci, but also anaerobes, such as *Clostridium welchii* and *C. tetani*) in deep-shake cultures in heated blood agar has also been explained by McLeod and Gordon (1824) as due to hydrogen peroxide formation, but here the hydrogen peroxide may be formed by the autoxidation of diffusible hydrogen donors produced by the bacteria. It has been discussed above that, in addition to hydrogen

peroxide, hydrogen donors are required for the formation of choleglobin and verdohemochrome. Hydrogen peroxide alone destroys ferric hematin compounds with complete decoloration, and a colorless ring above the green zone has, indeed, been occasionally observed by McLeod and Gordon. A colorless, hemolyzed ring further away from the colony and surrounding the green zone is also often observed on unhemolyzed blood agar plates.

The system in bacterial autolysates which forms green pigment was studied by Hart and Anderson (1141). They found that the system is destroyed by aeration, that added hydrogen peroxide destroys the green pigment, and that added catalase does not prevent the formation of green pigment; they concluded from this that hydrogen peroxide does not play a role. This does not necessarily exclude hydrogen peroxide, however, as a factor in the formation of green pigment. An excess of reducing substances, able to react with hemoglobin and to reduce it back to hemoglobin, is required, in addition to hydrogen peroxide in small concentrations; catalase does not prevent formation of choleglobin by hydrogen peroxide formed by notatin (1501).

If the viridans effect (on unhemolyzed cells in blood agar) is due to the same enzyme system, hydrogen peroxide formed by it must enter into the reaction, since the enzyme does not leave the bacterial cell, nor would it readily penetrate the erythrocyte membrane. It is nevertheless possible that diffusible bacterial products, similar to ascorbic acid, react directly with intracorpuseular oxyhemoglobin. The hydrogen peroxide formed by notatin transformed intracorpuseular oxyhemoglobin only into hemoglobin, not into choleglobin (1501).

The viridans effect is thus due in principle to the primary formation of a hemoglobin-hydrogen peroxide compound, and to the presence of reducing substances which keep the heme iron in the ferrous state. The hemoglobin-hydrogen peroxide compound may be formed either by the action on hemoglobin of free hydrogen peroxide — produced by a system reacting with oxygen — or by direct interaction of diffusible reducing substances with oxyhemoglobin. It is influenced by a variety of factors: the relative rates of reaction of reducing substances with oxygen or oxyhemoglobin, the permeability of the erythrocyte membrane, partial hemolysis (which often accompanies the viridans effect), diffusion rates of reducing substances and oxygen, and the killing of the bacteria by aerobiosis. These factors decide whether oxyhemoglobin is transformed into hemoglobin (as in the initial stages of the action of *E. coli* in bulk solutions, or by anaerobic bacteria in the deeper layers), into hemoglobin, or into choleglobin, or is completely destroyed with the formation of colorless products. *Pneumococcus*, for example, reduces hemoglobin less rapidly in the presence of glucose, than strict anaerobes (2027).

From the investigations of Neill and Avery as well as those of Petherick

and Singer (2144,2145), it appears likely that the same systems cause destruction of bacterial toxins in the presence of hematin compounds; this may be of physiological importance.

5. "EASILY DETACHABLE IRON" AND NONHEMOGLOBIN IRON IN BLOOD

5.1. Easily Detachable Iron

In several papers Barkan and co-workers (150,153,155,157,159,161, 163) have shown that a part of the iron in erythrocytes and also in crystalline oxyhemoglobin is split off by dilute hydrochloric acid. In ox blood, for example, 4-6% of the total blood iron can be set free in this way, in horse and dog blood more, in man and rabbit perhaps somewhat less. No free porphyrin is formed. The plasma iron forms only a small percentage of this "easily detachable iron" (0.1-0.2%), and the contribution of the stroma is still smaller. Barkan's results were confirmed by several other authors, although the percentages of "easily detachable iron" found by different methods varied a good deal. Barkan assumed the easily detachable iron to be derived from a bile pigment hemoglobin which was assumed to be present in erythrocytes and even to accompany oxyhemoglobin in the crystals. Lintzel (1753,1755), however, believed it to be derived from oxyhemoglobin itself, since less acid hematin color was developed on acidification from oxyhemoglobin than from carboxyhemoglobin solutions; this was confirmed but differently interpreted by Barkan.

Barkan and co-workers (157) observed that the presence of carbon monoxide and also reduction to hemoglobin prevented the setting free of about two thirds of the easily detachable iron. This was confirmed by Legge and Lemberg (1668). The iron of choleglobin, however, is removed in the presence of carbon monoxide as well as in its absence. From this and from a critical discussion of Barkan's experiments, they arrived at the conclusion that only about one third of the easily detachable iron which could be removed in the presence of carbon monoxide is derived from a bile pigment hemoglobin present in the erythrocytes, while the remaining two thirds is formed from oxyhemoglobin by the action of the acid.

It has been shown in Chapter VIII, Section 6.3.6., that on acidification the oxygen of oxyhemoglobin becomes strongly active and able to oxidize parts of the hemoglobin molecule. Several authors, including later Barkan himself (165,333,2613,2965), have shown that the amount of easily detachable

iron set free is variable and depends on the strength of the acid used, stronger hydrochloric acid liberating less than weak acid; weaker acid probably leaves the "acid hematin" a stronger intramolecular peroxidase than does strong acid.* Barkan (165) has now accepted this explanation. As a result of this many of the physiological deductions drawn from an estimation of easily detachable iron now need revision. Some of the reagents which have been used for the estimation of iron, particularly thioglycolic acid (2814), liberate iron from hemoglobin (2547).

Nevertheless, Barkan's assumption of the occurrence of a hemoglobin derivative with easily detachable iron and closely related to bile pigments, is probably correct, although this forms a much smaller percentage of the erythrocyte iron than had been assumed. 1 to 2% of the erythrocyte iron is set free in the presence of carbon monoxide. Small amounts of biliverdin (a few micrograms per milliliter of erythrocytes) were obtained by Lemberg and co-workers (1704,1712) from hemolyzed erythrocytes, even if ascorbic acid was added to the acid (66% acetic acid) used for the liberation of the iron†; it has been shown (cf. Chapter VIII, Section 6.) that ascorbic acid prevents the intramolecular oxidation in the acidified oxyhemoglobin-molecule. The biliverdin obtained from the erythrocytes can hardly have been present as such in the cells, since the erythrocyte contains systems able to reduce biliverdin to bilirubin (cf. Chapter XI, Section 8.). Barkan and Walker (166) have observed an increase in plasma iron and bilirubin when blood containing an anticoagulant was incubated at 37° C. Iron and bilirubin are probably derived from a precursor present in the erythrocytes. Although under pathological conditions, *e.g.*, in animals receiving phenylhydrazine, choleglobin can be demonstrated in the cells (cf. Chapter XI), Lemberg and collaborators (1707,1716) observed in the normal erythrocyte only a weak absorption band at 660 m μ after reduction with dithionite.

It is clear that conclusions drawn from the estimation of easily detachable iron can be interpreted only with the utmost caution. Large increases in easily detachable iron can be considered as significant, but small variations cannot. In experiments with radioactive iron, for example, Miller and Hahn (1950) found that young, newly formed erythrocytes contained the same amounts of easily detachable iron as the average of red cells of varying age. They concluded from this that "easily detachable iron" is an artifact, and that it cannot be formed by a gradual degradation progressing in the circulating erythrocyte. While the former is true for the major portion of the easily detachable iron, the latter has not been proved. In view of the large variations in total easily detachable iron and the fact that the really interest-

* According to Liébecq, Delbrouck, and Prijot (1738c), more iron is liberated with small amounts of acid, when hemoglobin is formed, than with large ones, when the product is acid hematin.

† Gardikas, Kench, and Wilkinson (979a) have recently claimed that no bile pigment can be obtained from erythrocytes after acid treatment in the absence of ascorbic acid if oxygen is excluded. It can be shown, however, that acid treatment of corpuscles after saturation with carbon monoxide or anaerobically, in the absence of ascorbic acid, gives the same yield of bile pigment (7-9 μ g. per ml. of human or sheep cells). In this instance the major part of the bile pigment is not biliverdin but a weakly basic bilipurpurin found in the extracts with 20% hydrochloric acid (Lemberg, 1687a).

ing fraction forms only a small part of it, the results are not significant. The subject will be discussed further in Chapter XI.

5.2. Nonhemoglobin Iron

If a bile pigment precursor with easily detachable iron exists in the red cells, their total iron content must be higher than their hemoglobin iron content. It might be expected that this difference should be easily established, but this is not so, as the widely different results of such investigations show.

First, the iron content of hemoglobin itself can only be considered as established within a possible error of $\pm 1\%$. The method used for the estimation of hemoglobin may include other substances, as would, for example, the acid hematin method or the estimation of the carbon monoxide capacity in the presence of dithionite. Choleglobin would be at least partially included in the hemoglobin value determined by the first, and fully in that by the second, method. On the other hand, estimation by oxygen capacity or carbon monoxide capacity without reduction does not include hemoglobin. A comparison of the values for nonhemoglobin iron obtained by these different methods by different workers reveals greater differences between the results obtained by different investigators than between those obtained by different methods. Great accuracy of both total iron and hemoglobin estimations is necessary if the small difference is to be significant; it is doubtful whether this accuracy has been achieved in the hands of the investigators concerned (*cf.* 1431,1435). Peters, working in Barcroft's laboratory, found a difference of 2.5% (2142) between the iron content of erythrocytes and their oxygen capacity, while Barcroft and Burn (145) found none (*cf.* 141). Of later studies one group of workers finds nonhemoglobin iron to form 6-8% of the total iron (1417,1812), sometimes even more (2184); others find no difference, or even less iron than corresponds to the hemoglobin(!) (1081,1235,2005, 2589,3013); and a third group finds intermediate values, mostly of the order of about 2-3% (136,383,994,995,1811); the last values appear to be the most trustworthy ones. Gibson and Harrison (995) recently found a difference of 2.0% between total iron and iron calculated from oxygen capacity in human blood; of this difference only 0.6% was due to hemoglobin. The remaining 1.4% may be due to choleglobin.

Some of these investigations have been carried out with the blood of species such as the horse, the blood of which may contain more hemoglobin than that of man. Different values have, however, also been found by different investigators in one and the same species, or by methods in which hemoglobin would be measured as hemoglobin.

Bell and co-workers (206) and Macfarlane and O'Brien (1811) have observed that men's blood has slightly, but significantly, higher nonhemoglobin iron than women's blood; this was not confirmed by Gibson and Harrison (995). Josephs (1431,1435) found nonhemoglobin iron in the blood of the newborn. The latter observation may explain the findings of Lemberg and co-workers (1704) who obtained a rather high biliverdin yield from the erythrocytes of a newborn with icterus gravis neonatorum; the etiology of

this disease does not explain this finding, and no normal blood of the newborn was studied.

There is no doubt that in some anemias the nonhemoglobin iron is greatly increased (741,1417). While Jenkins and Thomson concluded, from the low nonhemoglobin iron values often found in recovery from anemia, that young erythrocytes contained a smaller nonhemoglobin iron content than the average, Burmester (383) found very high nonhemoglobin iron values in immature turkey and chicken erythrocytes. This difference is perhaps due to the fact that bird blood contains nucleated red cells.

5.3. Differences between Carbon Monoxide Capacities before and after Reduction

These differential estimations are a measure of all ferric hematin compounds which are reducible to ferrous heme compounds and may be present in the blood, such as ferricholeglobin, sulfhemiglobin, verdohemichromes, but also hemiglobin. Carbon monoxide capacity in the presence of dithionite is estimated by the method of Van Slyke and Hiller (2573; also 2141, p. 349); the gas capacity without reduction can be measured as either carbon monoxide or oxygen capacity.

A difference between carbon monoxide capacities with and without reduction was first observed by Klumpp (1550) in 1935. It was confirmed by Taylor and Coryell (2748) and particularly by Ammundsen (47-49). The difference for healthy humans varied from 0 to 14.5%, with an average of 3.5%; in two thirds of all cases the difference was below 5% and in only a few, above 10%. The close agreement of the average figure with Barkan's figure for "easily detachable iron" in blood is certainly accidental, since the larger part of the latter is, as we saw, derived from oxyhemoglobin; these results were later confirmed by several workers. Nevertheless, it is not yet quite certain whether the difference is not, at least partially, due to inaccuracies in analytical procedure. Thus Kallner (1458) explains the results of Ammundsen on the basis of insufficient saturation with carbon monoxide in the estimation without reduction by the method of Van Slyke and Hiller.

Similarly Ramsay (2202) at first found large differences between oxygen capacity before and after titanous citrate reduction (Conant's method, 480), but later showed that these largely disappeared with more efficient oxygenation.

In comparing carbon monoxide capacity after reduction with oxygen capacity of blood one has to bear in mind the possibility that ferricyanide may not develop the oxygen from oxyhemoglobin quantitatively in the presence of certain substances in the plasma (cf. Chapter VIII, Section 6.3.6.; 141;49) So far, no differences between oxygen and carbon monoxide capacities (without reduction) have been found (2531,2532,2572), but the agreement might be accidental, if the carbon monoxide method also gives too low values.

How great a part of any difference between the carbon monoxide capacities before and after reduction can be ascribed to hemiglobin is still a matter of dispute. Differences as high as 10 to 20% of the total capacity have been

found without hemoglobin being observed spectroscopically. Hemoglobin, which forms such a percentage of the blood pigment, should be readily found in the spectroscope. In normal human blood its concentration is less than 1% of the total blood pigment (*cf.* Chapter XI, Section 5.).

If the differences between carbon monoxide capacities before and after reduction can be confirmed, it appears unlikely that they can be due to hemoglobin; a part at least must be due to the presence of choleglobin or similar compounds.*

6. PSEUDOHEMOGLOBIN AND CRUORALBIN

6.1. Pseudohemoglobin

Green compounds with absorption spectra very similar to those of choleglobin were obtained by Barkan and Schales (161,163) by treating oxyhemoglobin or hemolyzed red cells with hydrogen peroxide in the presence of cyanide; rather large concentrations of cyanide (0.3 *M*) and hydrogen peroxide (about 0.1 *M*) were used in this reaction, and alkalinity of the cyanide was not neutralized by buffering. The green solution had an absorption band at 617–620 $m\mu$ which was shifted by carbon monoxide to 625.5 $m\mu$. By incubation with 0.1 *N* hydrochloric acid, 15.6% of the iron could be removed, while with carbon monoxide only 2% was detached. This compound was termed "pseudohemoglobin," on the assumption that the porphyrin ring had been opened (*cf.* pseudouric acid, although in this case the opening of the ring is due to hydrolysis, not to oxidation).

Upon dialysis or on allowing the compound to stand, the properties were found to be somewhat altered; 9% of its iron could now be detached with or without carbon monoxide; carbon monoxide also no longer shifted the absorption band of the reduced compound in the presence of cyanide. The authors attributed this to an alteration of "pseudohemoglobin" to "pseudohemochromogen."

Lemberg and co-workers (1709) showed that under the conditions used by Barkan the globin is denatured by the alkalinity of the cyanide; on dialysis the "pseudohemoglobin" precipitates completely. They failed to confirm Barkan's spectroscopic observations; provided that *pH* and cyanide concentration were identical, the green pigment behaved in the same way toward carbon monoxide before and after dialysis. By buffering the cyanide they obtained a pseudohemoglobin, soluble at neutral *pH*, which showed an absorption band at 630 $m\mu$ after reduction with dithionite. From these experiments they concluded that pseudohemoglobin was a choleheme deriva-

* According to Van Slyke and co-workers (2574a) the average difference between the carbon monoxide capacities of normal human blood before and after reduction was 1.3% of the total, whereas hemoglobin was only 0.4%. The difference, however, decreased on standing of the blood more than the 0.4% due to the hemoglobin.

tive, probably ferricholeglobin cyanide, while Barkan's compound was the corresponding denatured compound.

Kiese and Kaeske (1527), while confirming the great spectroscopic similarity between pseudohemoglobin (or, as they call it, verdoglobin-CN) and choleglobin (or, as they call it, verdoglobin-A), found differences in the position of the absorption band of the hydrazine and particularly the carboxy hydrazine hemochromes (Table III).

TABLE III

Absorption Spectra of Choleheme and Pseudoheme Compounds^a

| Compound | Position of absorption bands, $m\mu$ | |
|-----------------------------|--------------------------------------|------------|
| | Choleheme | Pseudoheme |
| Pyridine hemochrome | 620 | 618 |
| Pyridine carboxyhemochrome | 632 | 629 |
| Hydrazine hemochrome | 617 | 615 |
| Hydrazine carboxyhemochrome | 633 | 624 |

^a According to Kiese and Kaeske (1527).

Holden (1319) obtained a "pseudohematin" which resembled cruoratin (see below), except that the absorption bands of its compounds were 10–11 $m\mu$ closer to the infrared. Carboxypseudoheme showed a moderately strong Soret band ($\epsilon_{mM}^{410} = 50$). Pseudohemoglobin cyanide, produced by the action of hydrogen peroxide and buffered cyanide on hemoglobin, has an absorption band at 590–600 $m\mu$.*

Kiese and Kaeske used high concentrations of both peroxide and buffered cyanide; a large part of the product was denatured, but the experiments were carried out with the part which remained in solution after dialysis, and which was almost free from unaltered hemoglobin. Liébecq (1738a) separated the

* Liébecq and co-workers (1738c, 1738d) have recently come to the same conclusions as Lemberg and co-workers (*cf.* above). Their observation that the cyanide is removed on reduction agrees with our findings and does not contradict the observations of Lemberg and co-workers (1709) that the hemochrome is able to combine with cyanide. It is well known that hemoglobin cyanide dissociates on reduction, while hemochrome forms a cyanide compound.

According to the Belgian workers, pseudohemoglobin (as well as choleglobin) contains a small admixture of an oxyporphyrin compound, to which the absorption band at 670–680 $m\mu$ of cyanide-free pseudohemoglobin and of ferricholeglobin is ascribed. Evidence for partial conversion of pseudohemoglobin into a monoazahemochrome by ammonia was obtained.

The contradictory findings with regard to the Soret band, the liberation of iron, and the yield of bile pigment — compare Liébecq's findings with those of Kiese (1526a) and also the next subsection — and recent observations of Lemberg and Callaghan (1694) suggest that slight variations of the same method may lead to different compounds, as in the instance of sulfhemoglobin (see below).

native from the denatured protein by fractional precipitation with phosphate.

Myohemoglobin was converted into similar products. The position of the absorption band of reduced myopseudohemoglobin (myoverdoglobin-CN) was 640 $m\mu$, that of its carboxy compound, 636 $m\mu$. These bands thus agree with those of myocholeglobin.

6.2. Cruoralbin and Cruoratin

Holden (1915,1918) has prepared compounds similar to pseudo-hemoglobin by exposing hemoglobin cyanide to oxygen in the presence of a large concentration (0.5 M) of well-buffered cyanide and by keeping the iron partially reduced with dithionite. In this way complete conversion into a green compound ("cruoralbin") is obtained which remains in solution after dialysis. On the other hand, the use of dithionite in the presence of oxygen entails the danger of conversion into compounds of the "hematin c" type (cf. Chapter V, Section 8.4.) and cruoralbin is possibly a "hematin c" compound corresponding to pseudo-hemoglobin.

Properties. The absorption spectrum of ferricruoralbin resembles that of pseudo-hemoglobin rather than of ferricholeglobin; the absorption band at 670 $m\mu$ of the latter is lacking. The band of ferrocruoralbin was at 624 $m\mu$, that of the carboxy compound at 620-625 $m\mu$. Holden gives position of the absorption band of the alkali-denatured reduced compound as 628 $m\mu$; Lemberg and Callaghan find it at 618 $m\mu$ (1694). Cruoralbin differs from choleglobin not only by the stability of its iron toward acid, but also by having a distinct Soret band ($\epsilon_{mM}^{410} = 77$). Holden made the interesting observation that hemochrome linking groups, masked in hemoglobin, are free in cruoralbin. One additional mole of protoheme can be bound by cruoralbin, as indicated by a large increase of the Soret band (ϵ_{mM}^{410} rising from 77 to 160). The protein, though soluble at pH 7, is therefore assumed to be no longer unaltered globin, hence the not quite happy name cruoralbin was chosen.

Cruoratin. Cruoralbin still contains almost the same amount of iron as hemoglobin and binds one molecule of carbon monoxide per atom of iron. If cruoralbin is prepared at 0° C., a substance soluble in organic solvents can be separated from the protein by treatment with acetic acid and amyl alcohol (1918,1919). This is called cruoratin (using the suffix "atin" applied by Schumm for hematin compounds), and considered to be the prosthetic group of cruoralbin. Its ferrous form is called "cruoraem." The yield of this substance from cruoralbin prepared at 18-20° C. is negligible. It is an unstable substance, which is irreversibly oxidized to other substances by ferricyanide and dilute hydrogen peroxide. Cruoraem in ammonia has an absorption band at 610 $m\mu$, shifted by carbon monoxide to 620.5 $m\mu$; and it still has a rather high Soret band ($\epsilon_{mM} = 70$). The fact that the position of this band differs from that of carboxycruoralbin indicates that cruoraem is not the exact prosthetic group of cruoralbin. According to Holden, cruoraem

does not appear to combine with cyanide or pyridine, nor cruoratin with cyanide, imidazole, or pyridine. The solutions of cruoratin in sodium hydroxide are, however, brown, with an indistinct absorption band at 650 μ , and differ from those in ammonia in color and light absorption. The facts that cruoratin cannot be extracted with ether, that it contains eight atoms of nitrogen per iron atom, and that the absorption maxima of its compounds are shifted toward shorter wavelengths in comparison with pseudohematin compounds, all indicate that cruoratin is a "hematin c"-like compound. It apparently contains amino acid residues (cysteine?) bound to the side chains and, under certain conditions, may thus be able to form a hemochrome with its own amino groups, as does the protoheme-cysteine adduct of Zeile (*cf.* Chapter VIII).

Neither cruoralbin nor cruoratin yielded more than traces of bile pigment with acid.

6.3. Formation of Similar Green Hemoglobins without Cyanide

Cyanide is not the only substance which promotes the formation of green hemoglobins of pseudohemoglobin or cruoralbin types, although none of the others causes such a striking reaction. It has been mentioned above that the action of dithionite and atmospheric oxygen alone on hemoglobin slowly produces an absorption band in the orange part of the spectrum. Riedel (2253) observed that pyridine in a concentration of 3-6% accelerated this reaction. Nitrite is able to replace cyanide in the formation of pseudohemoglobin from hemoglobin by hydrogen peroxide, though not effectively (1186, 1876, 1895).^{*} Recently, Holden (1320) has found that a large number of substances, *e.g.*, hydrogen ions, ammonia, alcohol, urea, pyridine, iodide, sodium benzoate and salicylate, and phenol, promote the formation of both cruoralbin and pseudohemoglobin (*cf.* also Jung, 1439). Some of these substances cause irreversible, but the majority reversible, denaturation ("perturbation") of hemoglobin. The absorption bands of the carboxy compounds of the cruoralbins thus produced were found at wavelengths 3 to 11 μ shorter than those of the corresponding pseudohemoglobins. This indicates that in the formation of cruoralbins the vinyl side chains are attacked by dithionite with formation of "hematin c" like substances.

6.4. Reaction Mechanism

The experiments of Holden (1320) indicate the importance of the protein for the reaction. The release of groups in the globin able to bind additional protoheme with formation of hemochrome (*cf.* above) also shows that a profound alteration of the type of linkage between protein and prosthetic group occurs. Holden assumes that this change takes place during the reversible denaturation (perturbation).

^{*} Kiese (1526b) found this green hemoglobin, however, to be of a distinctly different nature, since it yielded a porphyrin with a carbonyl side chain, and not a bile pigment, on acid decomposition.

The irreversible alteration of the type of linkage may occur, however, only in an oxidation reaction facilitated by a less far-reaching change of the hemoglobin structure, such as, for example, the removal of the loosely bound histidine imidazole from the sphere of action of the heme iron by a reversible change of structure in the protein. The nature of the irreversible changes which follow and which probably also involve the porphyrin ring is still obscure.

The role of cyanide is certainly not due to its inhibiting action on catalase, an explanation first given by Barkan, but later withdrawn. Cyanide is needed in a concentration far in excess of that needed for catalase inhibition, and is needed, also, in the absence of catalase. The spectroscopic similarity of pseudohemoglobin to sulfhemoglobin, and the fact that cyanide reacts with disulfide linkages producing sulfhydryl and thiocyanate groups, led Lemberg and Callaghan to an investigation of whether cysteine sulfhydryl groups of the globin played a part in the reaction. The role of cyanide could possibly be understood as reformation of sulfhydryl groups from disulfide groups produced by hydrogen peroxide. It has indeed been found that hematin, when exposed to the action of hydrogen peroxide in the presence of cysteine and cyanide, yielded hematin compounds somewhat resembling cruoratin; by acid treatment of these, an alkali-soluble porphyrin has been obtained which, according to the analysis, contained one molecule of cysteine (1694). Iodoacetic acid, however, did not inhibit the production of either cruoralbin or choleglobin. The problem is, therefore, still open.

There is no evidence whatsoever that compounds of the type of pseudohemoglobin or cruoralbin play a physiological role. Their interest lies mainly in their similarity to choleglobin on the one hand and to sulfhemoglobin on the other.

7. SULFHEMOGLOBIN

7.1. Historical

In 1863 Hoppe-Seyler (1336) observed the formation of a greenish hemoglobin derivative which he called "Schwefelmethämoglobin," resulting from the action of hydrogen sulfide on oxyhemoglobin. The substance was later renamed "sulfhemoglobin," and Keilin has shown that the substance arising from hemoglobin and hydrogen sulfide is different (*cf.* Chapter VI). Sulfhemoglobin was subsequently studied

by many authors (79,454,1129,1156,1394,1478,1945). Haurowitz (1156) obtained crystals, but in the light of later research it must be considered very doubtful whether these contained unaltered sulfhemoglobin. In many instances the preparations probably contained sulfhemoglobin together with choleglobin or choleglobin-like substances (*cf.* Section 7.6.). Sulfhemoglobin is found in blood under pathological conditions (*cf.* Chapter XII).

7.2. Properties of Sulfhemoglobin

Sulfhemoglobin has an absorption band at $620\text{ m}\mu$; some observers have found it at $623\text{--}626\text{ m}\mu$ (1156,164), but this is probably due to an admixture of choleglobin. Sulfhemoglobin does not combine reversibly with oxygen but is oxidized to sulfhemiglobin, although the ferrous form appears to be rather stable. On oxygenation a shift of the band from 620 to $632\text{--}633\text{ m}\mu$ has been observed (1156, 164); this band is, however, probably due to hemiglobin, formed from the accompanying hemoglobin under the conditions of the experiment.

Sulfhemiglobin has been produced by Keilin (1478) and Nijveld (2054) by oxidation of sulfhemoglobin with ferricyanide and can be reduced again to sulfhemoglobin. If the absorption due to accompanying hemiglobin is subtracted, it is found that sulfhemiglobin does not have a distinct absorption band in the red part of the spectrum (2054). It appears to be a rather unstable compound (1945,2054). Sulfhemoglobin combines with one mole of carbon monoxide, the absorption band being shifted to shorter wavelengths ($612\text{--}618\text{ m}\mu$).

A complete conversion of hemoglobin into sulfhemoglobin has never been achieved, but Drabkin and Austin (628) have extrapolated its absorption curve, assuming that in the initial stages of the reaction no other compound is formed. They found $\epsilon_{\text{mM}}^{620} = 11$. There appears also to be a somewhat lower and indistinct absorption band at about $540\text{ m}\mu$. Lemberg and co-workers (1701) found for carboxy-sulfhemoglobin $\epsilon_{\text{mM}}^{617} = 16$; from this value Jope (1427) calculates a somewhat higher value for $\epsilon_{\text{mM}}^{620}$ of sulfhemoglobin (13.0) than that found by Drabkin.

Crystals of oxyhemoglobin containing up to 9% sulfhemoglobin have been obtained by Michel (1945).

7.3. Protein of Sulfhemoglobin

The globin of sulfhemoglobin is apparently essentially unchanged (1945); its molecular weight is 68,000. The rate of alkali denaturation of human and bovine sulfhemoglobin is the same as that of the corresponding hemoglobins, and so are the solubilities in water and phosphate buffer, the isoelectric points, and the cataphoretic mobilities. Michel was unable to obtain a separation of mixtures prepared *in vitro* as well as from the blood of rats fed sulfur and phenacetin. Lemberg and co-workers (1701), however, observed an enrichment of sulfhemoglobin in the mother liquors of the crystals obtained from hemolyzed rats' blood.

7.4. "Sulfhemoglobin" as a Mixture of Sulfhemoglobin and Choleglobin

Clarke and Hurlley (454) stated that sulfhemoglobin is unstable and, even at 0° C., yields a compound with the absorption band of hemoglobin, but not identical with it. Michel (1945) observed a drop of only 3.6% in the absorption of protohemochrome, obtained from sulfhemoglobin with alkali and dithionite, accompanying a 30% conversion of hemoglobin into sulfhemoglobin, while a proportionately far greater drop (30%) accompanied a 75% conversion. In the course of the conversion to sulfhemoglobin the oxygen uptake went on even when the rate of increase in sulfhemoglobin concentration had become small.

Lemberg and co-workers (1701) have shown that sulfhemoglobin prepared *in vitro* is a mixture of true sulfhemoglobin, reconvertible into protohemochrome, and choleglobin or a choleglobin-like substance, which on denaturation by alkali yields a compound spectroscopically identical with denatured globin cholehemochrome (absorption band at 618 $m\mu$). In human blood containing sulfhemoglobin, no choleglobin was detected, and the sulfhemoglobin prepared by brief action of hydrogen sulfide on oxyhemoglobin is also almost free from choleglobin. On prolonged action, however, and particularly with alkali or ammonium sulfides (at higher pH), choleglobin is predominant. This was also found by Barkan and Walker (168) and by Haurowitz (1171); Nijveld (2054) showed that the compound formed from hemoglobin with hydrogen sulfide and hydrogen peroxide is mainly choleglobin.

The claim of Jung (1439) and von Restorff (2230) that sulfhemoglobin is usually nothing but "verdohemochromogen" is erroneous, apart from the incorrect use of the term "hemochromogen" for an undenatured protein. The confusion may have been caused by a faulty spectrophotometer which

was used for three years (1939-1941) at the Pharmacological Institute of Berlin University and which reported 636 $\mu\mu$ as 650 $\mu\mu$ (*cf.* Kiese and Kaeske, 1527).

The experiments of Lemberg and co-workers throw some light on the divergencies between the experiments of different authors on the detachment of iron from "sulfhemoglobin." Barkan and Schales (164), who prepared their "sulfhemoglobin" by repeated alternate introduction of hydrogen sulfide and oxygen, found that 20-30% of the sulfhemoglobin iron is split off by acid; carbon monoxide does not inhibit the detachment. Evidently their "sulfhemoglobin" contained much choleglobin and the iron was derived from the latter, not from sulfhemoglobin (*cf.* also 2054). Haurowitz (1170) who prepared sulfhemoglobin in a milder way by exposure of hemoglobin for ten hours to mixtures of hydrogen sulfide and oxygen, found no easily detachable iron. It is still unexplained, however, why he did not find it in his first experiments, in which sulfhemoglobin was prepared in a manner even more drastic than that used by Barkan. Under these conditions the presence of some choleglobin would be expected; even under the conditions of his later experiments some, though far less, should be present. Barkan and Walker (168) found later that sulfhemoglobin obtained *in vivo* in rabbit blood did not yield easily detachable iron. The yield from sulfhemoglobin obtained by the action of hydrogen sulfide on oxyhemoglobin was still high; this is probably due to the well-known ease with which the iron of hemoglobin is removed by hydrochloric acid.

Clarke and Hurtle (454) claimed that a compound similar to sulfhemoglobin can be produced by hydrogen selenide. This was not confirmed by Meissner (1896) and Haurowitz (1156), but the latter worked in the absence of atmospheric oxygen. Even if a green compound with an absorption band similar to that of sulfhemoglobin can be produced by hydrogen selenide, it would still have to be shown that the compound is not choleglobin.

7.5. Sulfur Content of Sulfhemoglobin and Mode of Formation

Sulfhemoglobin contains one more sulfur atom than hemoglobin (Michel, 1945). This was confirmed by Nijveld (2054). The extra sulfur is oxidized to sulfate by bromine, as is the sulfur of thiohistidine, thiourea, and thioamides, and, according to Nijveld, is set free by cyanide and ferricyanide, but not by alkali or acid.

Harnack (1129) claimed that sulfhemoglobin can be obtained in the absence of oxygen, but Keilin found that oxygen is required and this was confirmed by all later investigators. Since hydrogen peroxide is formed by autoxidation of hydrogen sulfide (2434), Michel (1945) assumed the following reaction mechanism:

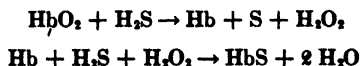

This was supported by the observation that hydrogen peroxide or perborate also formed "sulfhemoglobin." It has been shown above, however, that these reagents cause the formation mainly of choleglobin, not of sulfhemoglobin. Nijveld has also pointed out that Michel's formulation does not agree with this statement that at low sulfide concentrations only one mole of sulfide is required for the formation of one mole of sulfhemoglobin.* Nijveld formulates the reaction as follows:

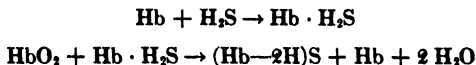

According to him, sulfhemoglobin would contain two atoms of hydrogen less and one atom of sulfur more than hemoglobin. The fact that no more than 75% sulfhemoglobin can be obtained in the reaction is explained by Nijveld by the assumption that the complex:

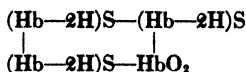

can no longer react with H_2S according to the second of the above equations, at least not intramolecularly.

While this explanation is in agreement with Nijveld's own experiments, it still fails to explain the results of Michel. At least a second mole of sulfide would be required for the formation of the hemoglobin from oxyhemoglobin, with which the reaction of Nijveld as well as that of Michel begins. Also, interaction between hemes does not appear necessary for sulfhemoglobin formation (*cf.* Section 7.7.).

If Michel's results are correct the over-all equation must be written



Nijveld suggests that the two hydrogen atoms removed from hemoglobin in the reaction are derived from the prosthetic group. In the discussion on the structure of the latter it will be seen that this is hardly possible. It is much more likely that the hydrogen is taken from a hydrogen donor group in the globin, and that the reaction is to be written:



In spite of the fact that hydrogen peroxide *in vitro* forms pre-

* We have not found any clear-cut experimental proof for this in the papers of Michel or Nijveld. Neither mentions sulfide analyses. How Michel arrived at his conclusion is not evident from his publication; Nijveld only showed that one molecule of oxyhemoglobin yielded one molecule of sulfhemoglobin as long as hemoglobin was also present.

dominantly choleglobin, not sulfhemoglobin, the formation of the hemoglobin-hydrogen peroxide complex from oxyhemoglobin and hydrogen donors such as phenylhydroxylamine and phenylhydrazine catalyzes not only the formation of choleglobin but also that of sulfhemoglobin, *in vivo* as well as *in vitro* (80,454,1010,1394,1439,1945, 1946,2264,2587). Lemberg and co-workers (1701) have shown that phenylhydrazine *in vitro* initially accelerates the formation of sulfhemoglobin, while at a later stage of the reaction more choleglobin is formed. In these reactions the hydrogen donor probably takes over the role of the XH_2 group in globin:

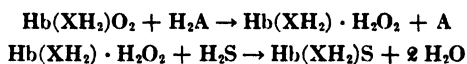

7.6. Reconversion of Sulfhemoglobin to Protoporphyrin Derivatives and Nature of Its Prosthetic Group

In spite of earlier claims to the contrary (454), it has later been shown that sulfhemoglobin cannot be reconverted to hemoglobin. Nijveld (2054) has recently claimed a conversion by cyanide and ferricyanide into hemoglobin cyanide, accompanied by removal of the extra sulfur atom. The identity of the resulting compound with hemoglobin cyanide has, however, not been proven.

It is certain, on the other hand, that by alkali or pyridine denaturation sulfhemoglobin is transformed into protohemochromes (628, 1701,1945), in spite of claims to the contrary by Barkan and Schales (164) which were based on the study of products consisting mainly of choleglobin. The band in the orange part of the spectrum disappears and the visible band of protohemochrome and the Soret band reappear in original strength; carboxysulfhemoglobin has only a weak absorption at $415 \text{ m}\mu$. The transformation by pyridine or hydrazine is not extremely rapid. Apparently unstable sulfhemochromes are first formed; with pyridine a band at $612 \text{ m}\mu$ was observed (carboxy compound, $624 \text{ m}\mu$), with hydrazine, at $610 \text{ m}\mu$ (carboxy compound, $618 \text{ m}\mu$). These are then more slowly transformed into protohemochromes (1527).

Protoporphyrin has been obtained from sulfhemoglobin solutions by List (1783), but only Nijveld (2054) has proven that it is derived from sulfhemoglobin, and not from the splitting by acid of accompanying hemoglobin.

Haurowitz (1156,1170) obtained a sulfur-containing porphyrin from sulfhemoglobin. In spite of the fact that in his second study Haurowitz

prepared his sulfhemoglobin in a more cautious manner than in his first, the long exposure (ten hours) to mixtures of hydrogen sulfide and oxygen, and particularly the subsequent digestion of the protein by pepsin in hydrochloric acid, may well have produced secondary changes, with an alteration of the type of linkage of the prosthetic group. The "sulfhemin proteose" obtained by the action of pepsin was converted into a porphyrin by heating at 100° C. with concentrated hydrochloric acid. The elementary analysis of this ether-insoluble porphyrin gave $C_{34}H_{36}N_4O_4S_2$. Since, upon titration, no free acid (SO_2H) groups were found to be present, Haurowitz assumes that the sulfur and the additional oxygen atoms are present as sulfone groups in rings between the vinyl side chains and the methene group (Fig. 10). This is,

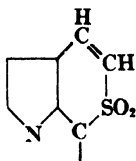

Fig. 10. Porphyrin from sulfhemin proteose (Haurowitz).

however, in contradiction to his observation that the vinyl groups can be removed by the resorcinol melt. Moreover, a sulfhemoglobin is also formed from mesohemoglobin with saturated side chains (1170) and from hemato-hemoglobin (1945). According to Haurowitz, the prosthetic group of sulfhemoglobin is not detached from the protein by boiling acetic acid or by oxalic acid in acetone. There can be little doubt that Haurowitz's porphyrin is not closely related to the original prosthetic group.

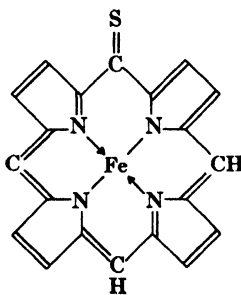

Fig. 11. Structure of sulfhemoglobin suggested by Nijveld (2054).

Nijveld suggests the structure of Figure 11 for sulfhemoglobin and a similar structure with CO instead of CS for choleglobin. Such structures with allene carbon ($=C=$) in the ring are stereochemically impossible. This formula for sulfhemoglobin also fails to explain the

reconversion into protoporphyrin derivatives by acid and alkali and the fact that the extra sulfur is not removed in these reactions.

It appears more likely that the heme group is bound to a thiol-histidine by a sulfur linkage between the heme iron and the imidazole

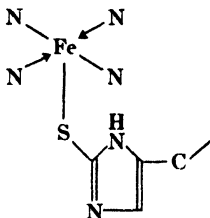

Fig. 12. Structure of sulfhemoglobin (?).

ring, which replaces the normal iron-imidazole linkage in hemoglobin (Fig. 12); or sulfur may be added to a methene bridge double bond.

7.7. Myosulfhemoglobin

From myoxyhemoglobin a sulfhemoglobin is formed even faster than from oxyhemoglobin. The formation of sulfhemoglobin cannot, therefore, be due to interaction between the heme groups in hemoglobin. Kiese and Kaeske (1527) found the absorption band of myosulfhemoglobin and that of its carboxy compound in the same position as those of sulfhemoglobin and its carboxy compound. This is in contrast to the difference between hemoglobin and myohemoglobin derivatives observed for the choleglobins and pseudohemoglobins. Michel (1945), however, reports an absorption band at $617\text{ m}\mu$ ($\epsilon_{\text{mM}} = 17$) for myosulfhemoglobin, *i.e.*, at somewhat shorter wavelengths than that of sulfhemoglobin. Ferricyanide and mercuric chloride oxidize myosulfhemoglobin to the ferric state; the band disappears and can be restored by reduction with dithionite. Like myohemoglobin, myosulfhemoglobin is far more stable toward alkali than sulfhemoglobin.

7.8. Distinction between Sulfhemoglobin and Compounds with Similar Absorption Spectra

Sulfhemoglobin, hemoglobin, ferrihemalbumin (methemalbumin), and ferrocholeoglobin all have absorption bands in the orange between 620 and $635\text{ m}\mu$ which cannot be distinguished from one another with a hand spectroscope, although the Hartridge reversion spectroscope allows the distinction between the bands of hemoglobin and sulfhemoglobin. It is preferable to rely for differentiation on reactions of the pigments, in which case a hand spectroscope can be used. The

TABLE IV
Distinction between Compounds Having Absorption Bands in Orange Part of Spectrum

| Compound | Absorption band, $m\mu$ | Dithionite ^a | Carbon monoxide and dithionite | Dithionite and sodium hydroxide | Other reagents |
|---------------------------------|-------------------------|--------------------------------------------------------------------|---------------------------------------------------------------|-------------------------------------------------------------------------------|------------------------------------------------------------------|
| Hemoglobin | 630-634 ^b | Band disappears; one diffuse band in the green (hemoglobin) | Band disappears; two bands in the green (570 and 540 $m\mu$) | Band disappears; one strong and one weak band in the green (protohemo-chrome) | Band disappears with cyanide or an excess of 1% sodium carbonate |
| | | Band disappears; two diffuse bands in the green (ferrohem-albumin) | | | |
| Methemalbumin (ferrihemalbumin) | 622-624 | | | | |
| Sulfhemoglobin | 618-622 | No change or band becoming stronger | Band shifted toward the blue (614-618 $m\mu$) | | Band persists with cyanide and sodium carbonate |
| Ferrochologlobin | 628-632 | | No change | Band shifted to 618-620 $m\mu$ | Band persists with cyanide and sodium carbonate |

^a Care must be taken to avoid oxygenation after reduction with dithionite, otherwise some chologlobin may be formed.

^b The pH should be below 7.

^c If this band is obtained, the test should be repeated with preliminary saturation with carbon monoxide (see footnote a). The band then appears at 630 $m\mu$.

reactions most useful for this purpose are collected in Table IV. If one also remembers that hemoglobin and sulfhemoglobin (except in severe anaerobic septicemia) and also choleglobin occur intracellularly, while ferrihemalbumin is found only in the plasma, the differentiation is still easier.

8. VERDOHEME AND CHOLEHEME COMPOUNDS IN HEMATIN ENZYMES

8.1. Verdohemochrome Formed from Cytochrome c

Bigwood and Thomas (258) observed two absorption bands at 675 and 645 $m\mu$ in solutions of cytochrome c. The first band disappeared on reduction, but the second remained. These bands are probably due to a substance related to choleglobin. Lemberg and Wyndham (1716) isolated small amounts of verdohemochrome from preparations of cytochrome c. These substances are not present in cytochrome c, but were formed from it during the isolation, which involved reduction with dithionite and reoxidation. Even the purest preparation of cytochrome c, however, contains a small percentage (1-4%) of easily detachable iron (Theorell and Åkesson, 2782). Dihydroxymaleic acid in the presence of manganese destroys cytochrome c rapidly with the formation of verdohemochrome (2791). The dihydroxymaleic acid reduces ferricytochrome to ferrocytochrome and at the same time by its autoxidation — catalyzed by manganese — yields hydrogen peroxide, which oxidizes cytochrome c to a verdohemochrome. The reaction is completely inhibited by catalase.

8.2. Bile Pigment Hematin in Liver Catalase

The isolation of biliverdin from horse liver catalase has been discussed in Chapter IX. Evidence has been given that an inactive bile pigment catalase is formed from the active protohematin catalase by the action of hydrogen peroxide in the presence of reducing substances and that this bile pigment catalase is the precursor of the biliverdin. It remains to discuss the nature of the bile pigment hematin catalase more closely.

Lemberg and Wyndham found that strong solutions of horse liver catalase, after treatment with pyridine and dithionite, showed an absorption at 651 $m\mu$ in addition to the bands of protohemochrome. The same band was observed if alkali-denatured horse liver catalase was cautiously reduced by dithionite (Lemberg and Legge, 1705). Carbon monoxide formed a carboxy hemochrome which showed an absorption band at 630 $m\mu$ with a minimum at 690 $m\mu$ and rising absorption toward the infrared. Removal of the carbon monoxide

failed to reproduce the band at $651\text{ m}\mu$, but yielded a hemochrome with absorption band at $618\text{ m}\mu$. The positions of this band and that of the carboxy compound at $630\text{ m}\mu$ are the same as those of cholehemochrome and carboxycholehemochrome, respectively, but the absorption in the infrared is not a property of choleglobin. The position of the band before treatment with carbon monoxide and the fact that acid yields almost 100% of biliverdin make it appear more likely that the hemochrome is a compound of the verdohemochrome type. The nature of the irreversible alteration by carbon monoxide is not yet understood.

9. BREAKDOWN OF HEMOGLOBIN AND MYOHEMOGLOBIN TO DIPYRROLIC COMPOUNDS

In Chapter IV we mentioned pentdyopent and the bilifuscins, two types of dipyrrolic pigments which are products of the metabolic breakdown of hemoglobin and myohemoglobin. Pentdyopent (or rather propentdyopent) is formed by the action of strong hydrogen peroxide solutions on hemoglobin or hematin (Bingold, 272,273,277). It does not occur physiologically and its formation under pathological conditions may be due to an intensified mechanism of hemoglobin destruction, which is different in principle from that which leads to

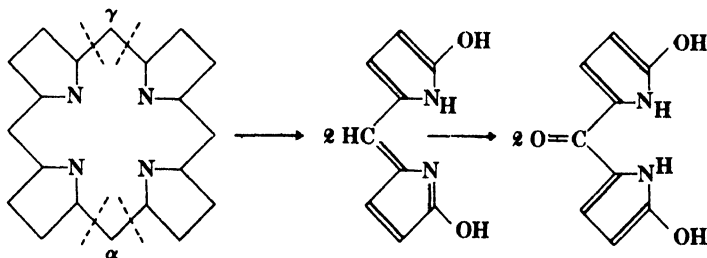

Figure 13

bile pigment formation only in that the oxidative opening of the porphyrin nucleus occurs simultaneously at two opposite methene groups (Fig. 13). Such a reaction might lead first to bilifuscins (*cf.* Chapter IV) which, on further oxidation of the central methene group, would yield propentdyopent. Fischer and von Dobeneck (807) found far higher concentrations of hydrogen peroxide necessary for the formation of pentdyopent than for bile pigment formation.

Catalase prevents the formation of pentdyopent and it is therefore doubtful whether the reaction can occur physiologically, except under certain conditions which will be discussed in Chapter XI.

It is also possible that pentdyopent is a product of secondary oxidation of bilirubin or mesobilane, from which it is also formed by hydrogen peroxide (273). In fact, it is not impossible that pentdyopent may be an artifact, small amounts of it arising from the action on bilirubin or mesobilane (but not on tetrahydromesobilane) of hydrogen peroxide formed by autoxidation of dithionite, which is used in the test. It has been found in some instances in urine which did not contain bilirubin, but such urines may have contained mesobilane.

CHAPTER XI

HEMOGLOBIN CATABOLISM, I. BREAKDOWN TO BILE PIGMENTS

1. INTRODUCTION

1.1. Formation of Bile Pigments from Hemoglobin

The conception that bile pigment is derived from hemoglobin is probably very old (Virchow ascribes it to Breschet, 2889), but the first clear indication came from the observations of Virchow (2889) in 1847. He produced evidence showing that "hematoidin," the orange pigment found at the site of old blood extravasations was similar to bilirubin. Although a long controversy (*cf.* 2240) took place as to whether hematoidin was identical with bilirubin, Fischer and Reindel (868) in 1923 identified the hematoidin from a liver cyst as bilirubin. The last doubt was removed, when Rich and Bumstead (2242) obtained the same result with hematoidin from a hemorrhagic cyst of the omentum; in this case the bile was excluded as the source of bilirubin.

The transformation of hemoglobin into bilirubin in animal experiments was probably first observed by Frerichs and Städeler (952) in 1850, when they observed bilirubin excretion in the urine after injection of bile acids. For a short time (*cf.* 2240) it was thought that the bile acids were necessary for the formation of bilirubin, although Kühne (1595) had drawn attention to the fact that bile acids cause hemolysis. When Herrmann (1246) in 1859 obtained bilirubinuria after injection of distilled water, the bile acids were eliminated as possible precursors. It was not until Tarchanoff (2739), working

with bile fistula animals, demonstrated that the introduction of pure hemoglobin into the circulation led to increased excretion of bile pigment by the liver, that the ability of the animal body to convert hemoglobin into bilirubin became generally accepted. The latter has been confirmed by a number of workers (371,372,998,2605), and Whipple and his collaborators (*cf.* Section 8.1.) later showed that the prosthetic group of hemoglobin is almost quantitatively converted into bilirubin.

Bilirubin is excreted by the liver into the bile and thus reaches the intestine, in which it is transformed into urobilinogen and urobilin (*cf.* Chapter IV). Jaffé (1407), who, in 1868, first discovered urobilin in urine, considered that it was related to the bile pigments. In view of the fact that bilirubin is present in much greater concentration in the bile than at the end of the alimentary canal, where only traces exist, urobilin was always considered to be a further breakdown product of bilirubin. Müller (1994) confirmed this by demonstrating the presence of urobilin in the urine after feeding bile to a patient with an occluded bile duct. A part of the intestinal urobilin is reabsorbed from the intestine and excreted again by the liver (enterohepatic circulation). Normally only small amounts of urobilin and only traces of bilirubin appear in the urine.

1.2. Earlier Theories of the Mechanism

With the recognition that the transformation of hemoglobin to bile pigment involved the removal of iron and protein, and the profound alteration of the structure of the prosthetic group, theories were formulated as to the possible steps. Almost all hypotheses ignored obvious physiological and histological hints as to the chain of reactions, and envisaged the transformation almost solely in terms of chemical steps which could be carried out at that time in the test tube. As a result of the isolation of hematin and hematoporphyrin the steps were considered to be hemoglobin, hematin, hematoporphyrin, bilirubin (371,372,697,1859). While Brugsch's school (370-372) claimed that they had observed increases in bilirubin excretion after injection of hematin, and in this received some support from Van de Velde (2864),* these findings have not been confirmed by Gitter and Heilmeyer (1007) or by Duesberg (639). Intravenous injection of hemoglobin is followed by large increases in serum bilirubin and rapid excretion of bilirubin in the bile, but the

*And more recently by Bénard and co-workers (211).

clinical observations of Schottmüller (2462), Schumm (2490), and Watson (2989) failed to show increases in serum bilirubin after injection of hematin. Duesberg therefore supported the earlier views of Bingold (265,267,269) that hematin was not an intermediate in the breakdown. The metabolism of hematin is dealt with in the next chapter.

The last step, transformation of hematoporphyrin or of any other porphyrin into bilirubin, has never been carried out directly *in vitro*, while the clinical observations of Meyer-Betz (1931) showed only that the injection of hematoporphyrin gave rise to a dangerous photosensitization.

This theory of the mechanism, therefore, while it still appears in most modern textbooks and reviews, has extremely little to recommend it from a biochemical point of view. In view of the ease with which many tissues (*cf.* 2240) are able to carry out the transformation of hemoglobin to bile pigment, the exact mechanism was envisaged rather vaguely as an enzymic process.

1.3. Importance of Biliverdin

The earliest observers of bile pigment formation noted the appearance of biliverdin together with bilirubin. In 1870, Langhans published his classical description of the hemoglobin breakdown in hematomas. He found biliverdin in phagocytic cells entering the outer zone of the blood extravasation, while hematoidin crystals appeared further inside in the blood clot. Lignac (1743) later confirmed these observations and concluded that bilirubin had diffused into the inner necrotic zone. Rich (2238) found biliverdin in phagocytic wandering cells ingesting red corpuscles in tissue cultures, and Stein (2618), in cultures of chicken embryo liver incubated with hemolyzed blood. In the classic experiments of Minkowsky and Naunyn (1959) much biliverdin was seen in the phagocytic Kupffer cells of geese after arsine poisoning; this was confirmed by McNee (1842) and Lepehne (1717) who also observed biliverdin in the Kupffer cells of normal pigeons and geese. Auld (98) found it in the endothelial cells of the rabbit spleen after phenylhydrazine administration.

In view of these observations and the obvious appearance of the blue-green stage in a bruise before the yellow stage, it seems astonishing that most workers relegated biliverdin to the status of a secondary oxidation product of bilirubin. An exception was MacMunn

(1834), who in 1885 assumed a direct transformation of hemoglobin into biliverdin. This failure to interpret observed facts correctly — an interesting example is the paper of Auld (98) — is due to historical facts. While bilirubin had been obtained in a pure crystalline state, biliverdin was then known only as the green stage of the Gmelin reaction and as a product of the autoxidation of bilirubin, for instance, in bile standing exposed to the air. The analysis of the very impure products then available indicated a higher oxygen content for biliverdin than for bilirubin. This was rectified when Lemberg (1676) succeeded in crystallizing biliverdin; the proof that it differed by only two hydrogen atoms from bilirubin made it possible to explain most of the earlier physiological observations on the basis of the hypothesis that bilirubin is formed in the body by a reduction of biliverdin. This was finally proven by Lemberg and Wyndham (1715), when they investigated the actual reducing systems responsible for the reduction (*cf.* Section 8.).

Biliverdin formation in animal tissues had actually been observed very early. In 1830, Breschet (335) gave an account of the green pigment of the dog's placenta. Toward the end of the last century this was studied by a number of outstanding histologists (314,644, 1229,1739,2682,2730). The green pigment (and also bilirubin) has occasionally been found in the placenta of other species (1875). Its close relationship to biliverdin was suspected for some time but its identity with the latter was not finally proved until the investigations of Lemberg and Barcroft (1691) in 1932.

In 1858 Wicke (3068) described a green-blue pigment in bird egg shells, which Sorby (2595) named oocyan. Its chemical structure remained uncertain (848,1587,1674,1740,2802) until Lemberg (1676, 1680) finally confirmed its identity with biliverdin.

Fresh human or ox bile is usually yellow and contains only bilirubin; the bile of some other species contains only biliverdin, *e.g.*, that of amphibia (1681,2055,2399) and of birds (2341). Nisimaru (2055) found excretion of green-blue bile when the liver of the giant frog was perfused through the hepatic artery with solutions of horse hemoglobin. The claim of von Recklinghausen (2221) that biliverdin is formed in sterile frog blood has not been confirmed (2240).

In frogs' blood serum, biliverdin was observed in 1850 by Kunde (1623) after liver extirpation. McNee (1842) found it in the serum of hepatectomized geese. While it does not occur in normal human sera, Moleschott (1970) found it in pathological serum in 1852. Biliverdin

regularly accompanies bilirubin in the serum of patients with carcinomatous obstruction of the common bile duct, and frequently in that of patients with liver cirrhosis, catarrhal jaundice, and bile duct occlusion by gall stones (1650,2199,2990).

Some of the hitherto unexplained facts in bile pigment physiology are probably due to the neglect to search for biliverdin when no bilirubin could be found. As far back as 1882, Neumann observed that hemosiderin formation preceded the appearance of hematoidin crystals. This has recently been confirmed by Muir and Niven (2002). Since the organic moiety of the prosthetic group must become free when iron is split off, the most likely explanation is that diffuse biliverdin has escaped notice at the stage when iron is removed and deposited as hemosiderin.

1.4. Modern Views on the Mechanism of Hemoglobin Breakdown

The demonstration of the conversion of hematin compounds to bile pigments (Chapter X), without either free hematin or free porphyrin occurring as intermediates, provides the basis for an hypothesis of hemoglobin breakdown which entirely supersedes the earlier hypothesis discussed in Section 1.2. The mechanism of the reaction involves the oxidative rupture of the porphyrin ring of hemoglobin before separation of the prosthetic group from iron and globin. The fact that biliverdin is the bile pigment most closely allied to the choleglobin or verdoheme compounds, which occur as intermediates, provides the key to the correct assessment of the numerous observations which have just been discussed as to the occurrence of biliverdin.

The new hypothesis is based on experiments in which substances found *in vivo* are allowed to react with hemoglobin under physiological conditions of temperature, concentration, and *pH* to give products which are also found *in vivo*. Its extension, however, to the problem of hemoglobin metabolism *in vivo* requires the elaboration of the basic mechanisms of the reaction at biochemical and physiological levels of cell organization. The conversion of the prosthetic group of hemoglobin into bile pigment appears to be quantitative *in vivo*, while *in vitro* so far only a 15% conversion has been achieved.

In their simplest form, the conditions required for the oxidative disruption of the hematin ring — the presence of oxygen and of an appropriate reducing system — are so generally present in living cells that one would expect bile pigment formation to occur wherever

hemoglobin is found. There is little doubt that the bile pigment found in nature mostly originates from hematin compounds (*cf.* Chapter X). Choleglobin and biliverdin have been found in situations in which hemoglobin is in the process of destruction, not only in the vertebrates but also in members of the invertebrate phyla (*cf.* Section 11.). The breakdown of hemoglobin in the leguminous root nodules appears to follow a similar course (Virtanen and Laine, 2891).

In spite of the almost universal presence of potentially harmful systems, however, hemoglobin is a relatively stable compound in the living animal. The actual mechanism of hemoglobin breakdown is no longer difficult to understand; the problem is, rather, to explain why it does not occur more rapidly.

The most important factor in the conservation of hemoglobin among vertebrates is probably its inclusion in the red cell, the biochemistry and physiology of which we must therefore discuss.

2. LIFE SPAN OF THE ERYTHROCYTE

2.1. Introduction

Since the balance between the formation and destruction of erythrocytes is under physiological control, information as to the normal life must be obtained under conditions which interfere as little as possible with the controlling mechanism. For this reason, measurements of the rate of decrease of the erythrocyte count during abolition of cobalt polycythemia (540) are unlikely to give normal results. Furthermore, the clinical condition of the subject is of the greatest importance. It is doubtful, therefore, how much reliance should be placed on the estimate of the lifetime of the red cell, which Eppinger (697) deduced from the excretion of bilirubin in human subjects with bile fistulae. In spite of this and other difficulties, the results for normal breakdown, which have now been obtained by a variety of completely independent methods, show relatively good agreement. The experimental errors, however, are still too great for the results to show how far the life span in one species differs from that in another. There seems to be no reason to assume that differences will not exist, unless in most species a common process limits the life. At the present time one can only speculate, since with the exception of man different methods have generally been used in different species. Many reviews are available on this problem (*e.g.*,

1384,2444,2989). Only a small part of the data can be considered here.

2.2. Life Span of the Cell Deduced from Pigment Metabolism

2.2.1. Bilirubin Excretion. Eppinger concluded from measurements of bilirubin excretion in humans with bile fistulae that the normal life span of the erythrocyte was about forty days, while the experiments of earlier workers had indicated a period of between thirteen and fifty days. The earlier values are certainly vitiated by lack of a pure bilirubin standard. Eppinger's own value was calculated on the basis of a blood volume of 3.5 liters and a hemoglobin content of 14 g. per 100 ml. The blood volume was undoubtedly assumed too low; the average blood volume of men is about 5.5 liters (*cf.* 992). Eppinger's figures indicate the daily excretion of about 300–350 mg., rather than of 400 mg., of bilirubin per day which was the basis of his calculation. Assuming a blood volume of 5.5 liters and 15 g. of hemoglobin per 100 ml., the total circulating hemoglobin is 825 g., corresponding to 29 g. of bilirubin. An excretion of 300–350 mg. per day thus indicates a lifetime of 87–97 days, a figure in far better agreement with modern results. Similar average values were obtained by Adler (18) and With (3112).

In the hands of Whipple and his co-workers, the quantitative measurement of bile pigment excretion in dogs with bile fistulae may be regarded as a more reliable index of hemoglobin destruction, although Drill and co-workers (633) have recently also found signs of liver damage in these animals. The bile is collected either in a sterile bag (method of Rous and McMaster, 2374) or is diverted into the bladder by the formation of a renal gall bladder fistula (method of Kapsinow, Engle, and Harvey, 1466). By being fed bile salts, the animals may be kept in excellent condition for many years after the operation. In nonanemic dogs Shribishaj, Hawkins, and Whipple (2548) found a bilirubin excretion of 4–6 mg. per kg. per day, closely corresponding to the values quoted above for human bilirubin excretion. The experiments of Whipple and his school have shown that the bile pigment excreted in the bile almost exactly corresponds to the amount of hemoglobin broken down. This will be discussed in Section 8.

The excretion of bilirubin has been used more accurately for measuring the life span of the erythrocyte by Hawkins and Whipple (1196). As will be seen later, all the erythrocytes live for a fixed period and are destroyed within a few days of the average life. If a large number of new cells are suddenly put into circulation, as after severe bleeding or destruction of cells by acetylphenylhydrazine, a second peak of excretion of bilirubin will appear when these cells reach their natural span of life. The bilirubin excretion was measured regularly over a period of several months and a highly significant rise was observed 112 to 113 days after the stimulus to new cell

formation had been given. A mean value of 124 days was obtained on four dogs. This gives a value for the normal daily bilirubin excretion of 83 mg. The value actually found by Whipple during control periods on the same dogs was 85 mgs. As Hawkins and Whipple point out: first, it is unlikely that this agreement is fortuitous; and second, the contribution made to the normal daily excretion of bilirubin by myohemoglobin seems to be slight (*cf.* Section 9.3.3.). Similar values (94–117 days) were obtained by Harne and collaborators (1130) by measuring the time between the first and second reticulocyte shower in monkeys.

2.2.2. Urobilin Excretion. Measurement of the excretion of urobilinogen in feces and urine has the advantage that it can be carried out on normal individuals. There is, however, little doubt that the values for urobilinogen excretion are lower than those for bilirubin excretion; bilirubin is either not quantitatively converted into urobilinogen, or the latter is destroyed in the body. The figures obtained for the average life of the human erythrocyte by measurement of urobilinogen excretion are, therefore, too high. A number of workers have used the urobilinogen excretion to measure hemoglobin turnover (208, 1219, 1736, 2109, 2110, 2112, 2594, 2987; *cf.* also 1949, 2566). Large variations of daily urobilinogen excretion have been found by one and the same worker. Thus Watson (2987) found values of 40–280 mg. per day; these are probably at least in part due to the irregularities of fecal excretion. The values of Heilmeyer and Oetzel (1219) and Watson (2987) give a life span varying from 160–300 days with an average somewhat above 200 days; the values of other workers fall mostly into the same range. The values are probably still 25% too high owing to losses in the urobilinogen estimation (Watson, 2984). If this is taken into account, it will be seen that the lowest values agree with those deduced by other methods for the average lifetime of the red cell.

2.2.3. Other Methods. Two quite different methods, based on pigment metabolism, have given results for man which agree with the data of Hawkins and Whipple for the dog. The slow disappearance of sulfhemoglobin from the circulating blood has been known for some time. The erythrocyte is unable to reconvert sulfhemoglobin into hemoglobin (*cf.* Chapter XII). Jope (1427) measured the rate of disappearance of sulfhemoglobin over four months and found complete disappearance of sulfhemoglobin-containing cells in about 114 days. These cells have therefore the same lifetime as normal erythrocytes. A lifetime of the hemein, and therefore of the erythrocyte, of about 127 days was obtained by Shemin and Rittenberg (2543) by measuring the excess of the N¹⁵ isotope in hemein prepared from blood, at various periods after one of these workers had ingested

glycine in which one third of the nitrogen was present as this isotope. Maximum isotope concentration in the hemin was reached in thirty days after the glycine was fed. This remained constant for many weeks and then declined rapidly. In this experiment there was certainly a minimum of interference with normal metabolism.

Fundamental to the deduction of the life of the cell from the excretion of bilirubin or urobilinogen, or from the rate of disappearance of cells containing sulfhemoglobin, is the assumption that breakdown products of the iron-free prosthetic group are not used in the synthesis of new hemoglobin. The work of Whipple and his collaborators, discussed in Chapter XIII, fully justifies this assumption. Although radioactive iron has been used by Hahn (1087,1092,1095) and his collaborators for the study of hemoglobin formation, it could not be used for the determination of the life of the cell, since iron liberated by hemoglobin breakdown is used again for the synthesis of new hemoglobin (Cruz, Hahn, and Bale, 515; cf. also Chapter XIII).

The data we have so far discussed refer to the nonnucleated erythrocytes of mammals. Hevesy and Ottesen (1265) have used the fact that nucleoprotein is present in avian corpuscles to determine the life of these in the hen by means of radioactive phosphorus. No exchange reactions were observed between the nucleic acid of corpuscles and sodium phosphate, so they assume that the radioactive phosphorus enters the cell during its synthesis. Radioactive phosphate was fed in amounts sufficient to keep its concentration in the plasma at a constant level. They measured the time taken for the desoxyribose nucleic acid to reach a constant level of radioactivity, and found a linear increase from the 5th to the 33d day after the commencement of feeding, giving a lifetime of 28 days for the cell. It is unlikely that the normal synthesis or breakdown is interfered with by the labelled phosphate, and one must therefore assume that the length of life of erythrocytes in the hen is of a different order from that found in dog or

2.3. Life Span of the Cell Deduced from Histological and Immunological Evidence

Here again, two quite different types of experiment have given reasonable concordance in their results. One approach has been the deduction of the life span of the red cell from the maturation time of reticulocytes. Heilmeyer (1206) found a maturation time for the reticulocyte of 24 hours, in agreement with earlier workers (554,2449,2537). If the erythrocytes leave the

* This has meanwhile been confirmed (Hevesy, 1262b). Shemin, London, and Rittenberg (2542a) have recently found, however, that the mature avian erythrocyte continues to synthesize hemoglobin. The problem in this phylum is thus quite different from that in mammals.

bone marrow as reticulocytes (1206,1339;2989,p.2508) and have a constant maturation time, the reticulocyte level can be used to determine the life of the erythrocyte. The number of reticulocytes found in normal individuals varies between 0 and 2% (2086,2186). The mean value is frequently given as 0.7 to 0.8%. Heilmeyer and Oetzel (1219) found an average of 1% reticulocytes, which would give a lifetime of 100 days. While the reticulocyte count itself is not very reliable, it seems likely that the exact maturation time of reticulocytes is known with even less certainty. The recent experiments of Plum (2155; cf. Chapter XIII) indicate that the maturation of the reticulocyte is under the control of reticulocyte-ripening substances, and that the reticulocyte percentage is proportional to the content of these substances in the plasma (2157). This probably explains the results of Baar and Lloyd (108). These workers found a maturation time of 11 hours for reticulocytes which, taken with the average content of 0.7% in the circulation, gives a value of 65 days for the life of a mature cell. The deduction of the life of the cell from such data seems, therefore, to be relatively inaccurate in comparison with other methods.

The use of blood groups to determine the life of the mature cell, was first carried out by Ashby (90,91). By transfusing group O blood into recipients of group A or group B, and by subsequently agglutinating the recipient's cells, the number of surviving donor cells of group O may be counted. By this method, Ashby found a lifetime varying from 30 to 100 days, with an average of 82 days. Wearn and his co-workers (3005) found values varying from 59 to 113 days and Wiener (3078), from 80 to 120 days.

2.4. Significance of the Mortality Curve

There is thus now good agreement between reliable methods showing that the life span of the mammalian cell is of the order of 120 days under normal conditions. Of the methods which we have considered, some, like those based on the bile pigment excretion, give a figure for the average number of cells destroyed per day, as well as the end point of the life of a population of new cells formed during the experiment. Other methods, involving cells labeled with sulf-hemoglobin, with hemin containing the N¹⁵ isotope or with a specific agglutinin, enable an actual mortality curve to be calculated. The agreement between these independent methods increases the weight to be attached to the results of a recent mathematical analysis by Witts and co-workers (349,395) which have been derived from data obtained by the third of these methods.

Normal individuals were used, and blood was withdrawn and was immediately replaced by the same amount of group O blood. In

some cases, the surviving donor cell count fell linearly when plotted against time, while in other cases an initial period of rather more rapid destruction was observed, after which the decay was linear. The linear decay leads to a value of about 120 days for the true average life of the erythrocyte. In their earlier work, these authors measured the decay in a number of anemias and found that in some it was linear while in others there was a more rapid decay in which the donor cell count fell exponentially.

Where a linear mortality curve is obtained, the destruction of the erythrocytes must depend primarily on some characteristic of the erythrocyte, which reaches a critical value after a certain period. Where the factor responsible for hemolysis affects cells irrespective of their age, the decay curve will have an exponential component as well as a linear component. Hemolytic mechanisms (discussed in Section 6.) are of this type, as would be a mechanism dependent on the mechanical fragmentation of cells in the circulation. Since the normal breakdown is not exponential, the rate-determining factor must be sought in some characteristic of the aged cell, while factors external to this can only be secondary.

If this conception is correct, it is clearly inadequate to view the erythrocyte simply as a dying cell. It must be looked on as a special cell which is able to live for about 120 days without a nucleus, at the end of which time it enters a stage in which it dies relatively rapidly. Callender, Powell, and Witts (395) are not able to attach a numerical value to the variation between the life of one cell and another, but they conclude, in agreement with Schiødt (2442), that most cells are destroyed within a few days of their average life span. Shemin and Rittenberg (2543) found 50% to live 127 ± 7 days.

3. ENZYME SYSTEMS OF THE ERYTHROCYTE

3.1. Origin and Possible Function

In view of the evidence given in the previous section that the lifetime of the erythrocyte is primarily controlled by some internal process, it becomes of great interest to try to identify the system or systems responsible. At the present stage of knowledge it is not possible to carry such an analysis much further than to suggest a number of avenues for further work, but since the problem appears to be closely linked with the preservation of functional hemoglobin within the cell, it appears desirable to make such an attempt.

Although the mature mammalian erythrocyte has been shown to contain

some nuclear material (2560), its capacity, in the absence of a nucleus, for synthesis of new enzymes is probably very low and the biochemical repairs must be carried on by enzymes inherited from the more immature cell. Since the structure of the cell cannot be considered as static, its maintenance during life must involve an expenditure of energy together with the provision of the necessary metabolites. In view of the selective permeability of the cell wall some of these may have been accumulated during an earlier stage in development. Although the cell contains proteins, lipides, and carbohydrates, evidence that it contains enzymes connected with the metabolism of the first two types of substances is lacking. Although ketone bodies and amino acids may be found in the cell, they appear to be accumulated in the mature cell only in a passive fashion, determined by the permeability of the cell wall.

The function of those enzymes which have been found in the erythrocyte has been elucidated only in a few cases, such as carbonic anhydrase and some of the enzymes concerned with the reduction of hemoglobin. In other cases, such as catalase or true choline esterase, the reactions which are catalyzed may be well known, but the biological function in the cell is not yet clear. Finally, the copper protein which Keilin and Mann isolated in a crystalline form has not yet been shown to possess any catalytic power. Some of these substances, indeed, may be of little importance in the physiology of the mature cell, being merely relics from the reactions carried out in the immature cell (*cf.* 1020).

3.2. Carbohydrate Metabolism of the Erythrocyte

The physiological importance of the reducing systems in the erythrocyte was clearly demonstrated by the classic experiments of Haldane, Makgill, and Mavrogordato (1104) in 1897 on the reduction of hemoglobin *in vivo* (*cf.* Section 4). The actual systems involved were little investigated until Barron and Harrop (185,1137) observed the increased respiration of the mammalian erythrocyte in the presence of methylene blue and glucose.

In the absence of substances capable of inducing an acceptor respiration, the oxygen uptake of the mammalian erythrocyte is small. Ramsey and Warren (2201), after allowing for the relatively much greater respiration of reticulocytes, arrived at a figure for rabbit cells of 8 μ l. of oxygen per gram of moist cells per hour, while a figure of about twice this may be derived from the experiments of Jacobsen and Plum (1400). The respiration may be inhibited by carbon monoxide (2940,2942) and by lowering the oxygen pressure. Kempner (1511) found, however, that the respiration of human erythrocytes remained uninhibited down to a concentration of 4% oxygen in the gas phase, while the respiration of nucleated avian erythrocytes was 40% inhibited under the same conditions. This may indicate either an unsaturation of the oxidase by hydrogen-transporting enzymes in the case of the nonnucleated cells, whose respiration is much less than that of avian cells, or the oxidase in the former cell may have a much greater affinity for oxygen than that of the latter.

There is, however, little evidence that the mature mammalian erythrocyte contains any cytochrome oxidase at all. The evidence apparently rests on

the carbon monoxide and cyanide sensitivity of the respiration. Negelein (2018) found that cyanide caused an increased production of lactic acid, and Kiese and Schwartzkopff (1528a) found that hemoglobin inhibits glycolysis. The behavior of the oxidase toward inhibitors could also be explained on the basis of the hypothesis that the oxidase is not cytochrome oxidase, but oxyhemoglobin, undergoing autoxidation to hemoglobin; the latter is reduced to hemoglobin by the reducing systems and is thus able to re-enter the cycle. This hypothesis is supported by the work of Heubner and Kiese (1262a, 1526, 1528a). Certain facts relating to it will be discussed in Section 4. It must be pointed out here, however, that the presence of a complete respiratory system in the erythrocyte would enable the erythrocyte to engage in a wasteful and useless oxidation of large quantities of glucose. The magnitude of the respiration under the influence of substances such as methylene blue indicates that, as far as the dehydrogenases and coenzymes are concerned, the cell is relatively well equipped. It would seem a useful adaptation to make use of the full capacity of these enzymes only when the physiologically desirable reduction of hemoglobin is to be brought about.

Nonnucleated erythrocytes display aerobic glycolysis, the glycolytic power varying considerably in different species. The breakdown of glucose seems to follow a relatively normal path through phosphorylated intermediates (706, 1046, 1264, 1848, 1932a, 2208, 2209). Coenzymes I and II are present. Adenosine triphosphate has long been known to be present (904); reticulocytes contain more of it than mature erythrocytes (2210). In the absence of glucose, or when glycolysis is prevented by fluoride or by the hemolysis of the cell, inorganic phosphate is set free (695). In the nucleated avian erythrocyte, with an efficient respiratory system, there is no aerobic glycolysis.

In the presence of methylene blue or hemoglobin (methemoglobin) glucose is broken down by the oxidation of hexose monophosphate to phosphohexonic acid, according to the work of Lipmann (1757), Warburg and Christian (2934, 2935), and Dickens (588). The last author also showed that phosphohexonic acid and ribose phosphate were further broken down. Warburg and co-workers (2936, 2942) showed that triphosphopyridine nucleotide and a specific protein were required for the hexose monophosphate system, but Kiese (1526) found that hemoglobin could not be reduced by reduced triphosphopyridine nucleotide except in the presence of an additional protein, which he named hemoglobin reductase, and which appears to be a flavoprotein.

This is not the only system in the red cell which is able to reduce hemoglobin. Wendel (3032, 3033) and Shapot (2539) found a system which metabolizes lactate in dog erythrocytes, while Kiese (1526) has found it to be present in guinea pig and horse erythrocytes. The hexose phosphate and lactate reductions are probably caused by separate systems. Cox and Wendel (508) consider that between 25 and 50% of the intracorporeal reduction of hemoglobin is caused by lactate.*

* Recently the reduction of hemoglobin in the red cell has been studied extensively (cf. 993a, 1071a, 1262a, 1530a, 1530b, 2528a, 2834a).

The reduction of hemoglobin caused by glucose is mainly due to the oxidation of

In connection with the carbohydrate metabolism of the erythrocyte, mention should also be made of the increase in respiration known as the "Michaelis-Salomon effect," which is observed in the presence of glucose when extracts of liver and other tissues are present (1940). This increase is apparently not due to hemoglobin formation, and is inhibited by 10^{-4} *M* cyanide, but not by carbon monoxide. The substance present in the extracts is destroyed by acetone. The system has been further studied by Overbeck (2095,2096) who concluded that the effect was due neither to a copper-ascorbic acid-glutathione mechanism nor to the coupled oxidation of oxy-hemoglobin. Instead he suggested that a flavoprotein was responsible. This seems unlikely in view of the permeability of the cell wall and of the cyanide sensitivity of the system.

3.3. Other Reducing Systems in the Erythrocyte

3.3.1. Glutathione. The erythrocytes of many species contain considerable quantities of glutathione, the major part being in the reduced state (2194,3120). Investigation has been stimulated by finding increases in blood glutathione under conditions under which blood regeneration takes place (111,254,963,1764,2026, in rabbit; 137,963,607, in man). The relation of glutathione to nutritional anemia due to lack of copper (2180,2480) is discussed in Chapter XIII.

The metabolism of glutathione in the erythrocyte was first investigated by Meldrum (1900). He found that aeration of washed corpuscles results in a slow diminution in the amount of reduced glutathione. The experiments of Oberst and Woods (2060a) actually show the same effect, although a disappearance of total glutathione independent of aeration was also noticed on incubation of cells. On storage of blood the reduced glutathione is even slightly increased, while the glucose content diminishes (Bick, 256).

Meldrum found that on aerobic incubation of washed cells a number of sugars, among them glucose, were able to donate hydrogen for the reduction of glutathione. He later (1902) showed that oxidized glutathione could be reduced by the reconstructed hexose monophosphate dehydrogenase system.

The actual function of glutathione in the mature erythrocyte is still obscure. A powerful glyoxalase system is present in the erythrocytes (1436, 1437), but in view of the fact that methylglyoxal is no longer considered to play any role in the breakdown of carbohydrate, the function of the glyoxalase system remains unexplained. Since reduced glutathione is able to reduce a number of protein disulfide linkages and, in addition, is able to protect enzyme sulfhydryl groups from iodoacetate or trivalent arsenic compounds (2143), it has been suggested that glutathione may be a general activator for the oxidizable sulfhydryl groups in enzymes. The fact that triosephosphate dehydrogenase contains such groups (2207) suggests that glutathione protects it in the erythrocyte.

triose phosphate to phosphoglyceric acid, mediated by coenzyme I. Only in the presence of methylene blue does the reduction by hexosemonophosphate, mediated by coenzyme II, become of major importance. Lactate is also oxidized by hemoglobin to pyruvate; the proportion of hemoglobin reduction due to this reaction differs widely in different species (cf. 1530).

Reduced glutathione may be necessary for the stability of the erythrocyte. Keilin and Hartree (1498) found that cells in which hemoglobin had been formed by nitrite commenced to hemolyze in 11 hours. They found all the glutathione in such nitrite cells in the oxidized state. Glutathione reduces hemoglobin (1991), as does cysteine (641,1526,2854).

Reduced glutathione has been shown by a number of workers (1710), (*cf.* also Section 3.3.2.) to reduce dehydroascorbic acid. In ascorbic acid saturation tests, Prunty (2191) found a significant negative correlation between the ascorbic acid content of the blood and the reduced glutathione in the corpuscles, with indications of an increase of oxidized glutathione accompanying the decrease of reduced glutathione. If the factors (Chapter X, 4.4.2.), which normally prevent hemoglobin from undergoing oxidative destruction by coupled oxidation with ascorbic acid, became inactive, even the traces of ascorbic acid which are probably present in the erythrocyte would be able to function together with the glutathione - hexose monophosphate mechanism as the coenzyme for hemoglobin destruction. Under certain conditions glutathione is also able to assist in the destruction of catalase (*cf.* Chapter IX, Section 2.4. and 2398). No evidence is available on the question of whether this reaction takes place in the erythrocyte or whether philocatalases are present in the erythrocyte. Jowett and Quastel (1436) could find no evidence that the erythrocyte was permeable to reduced glutathione. Since it is unlikely that the mature cell is able to synthesize this compound, the quantity present must be regarded as having originated at some stage in the cell synthesis. During the increased blood destruction after birth, the total blood glutathione falls, while its concentration in the remaining erythrocytes is increased (1841).

3.3.2. Ascorbic Acid. Unless special precautions are taken (1702), the determination of reduced ascorbic acid in hemolyzed blood and perhaps also in total blood is likely to give erroneous values owing to the peroxidative action of acidified oxyhemoglobin, although Kassan and Roe (1471) and Heinemann (1227) claim that if the protein precipitant is added to the intact erythrocyte the destruction of ascorbic acid does not take place (*cf.*, however, Borsook *et al.*, 320). Van Eekelen (648) found 0.34 mg. ascorbic acid per 100 ml. present in erythrocytes (using reduction of the protein-free filtrate with hydrogen sulfide), while Stevens and Hawley (2624), who apparently added trichloroacetic acid to intact erythrocytes, found the normal range to lie between 0.7 and 1.0 mg. per 100 ml. Borsook and co-workers (320) added ascorbic acid to the defibrinated or oxalated bloods of seven species, and concluded from their recoveries in plasma that, with the exception of pig and sheep, the erythrocytes of the other species, including man, were almost impermeable to ascorbic acid. If proper precautions are taken, however, the direct analysis would be expected to give rather more reliable results; Heinemann and Hald (1228) have observed a slow uptake of ascorbic acid by the erythrocytes. In agreement with the finding of van Eekelen and of Stevens and Hawley, Lemberg and co-workers (1710) found 0.35 mg. per 100 ml. in rabbit erythrocytes, while Heinemann (1227) also confirms the presence of small amounts of ascorbic acid in human erythrocytes.

Dehydroascorbic acid can be reduced by reduced glutathione (320,1710, 2485). Schultze, Stotz, and co-workers (2482,2485,2678,2679) have shown that the oxygen uptake of liver and kidney tissue is not increased by the ascorbic acid - glutathione system. This, however, proves only that this system does not play a major part in normal tissue respiration. In erythrocytes in which the respiration is much smaller, the system may be of relatively greater importance. Davis, indeed, has assumed that ascorbic acid is involved in red cell respiration on the basis of experiments on cobalt polycythemia (539, cf. Chapter XIII), but definite evidence is not yet available.

The reduction of hemoglobin in solution by ascorbic acid has been studied by Lemberg and co-workers (1710), Vestling (2873), Gibson (993), and Kiese (1526). Kiese found the rate of reduction proportional to the hemoglobin concentration, but reaching a limiting value with increasing ascorbic acid concentration; from this he concluded that a complex is formed and that the reduction of the hemoglobin iron in this complex is the limiting velocity.

4. HEMIGLOBINEMIA (METHEMOGLOBINEMIA)

4.1. Hemoglobin as Normal Component of the Erythrocyte

In the previous section it has been shown that the erythrocyte is well supplied with reducing systems, and it has been suggested that they are concerned in part with the reduction of hemoglobin within the cell. While this view is generally accepted, little evidence is available concerning the mode of formation of the hemoglobin under normal conditions.

The hemoglobin concentration in normal blood is still a matter of dispute. Claims that 15-20% of the total hemoglobin can be in the form of hemoglobin without being spectroscopically detectable (48,1254,1388) are certainly incorrect (508). Drabkin and Schmidt (632) found that hemoglobin concentrations of above 1% can be readily detected by spectrophotometry and that normal human blood must contain a smaller concentration (cf. also Chapter X, Section 5.3.). Jope (1427) found 3% hemoglobin readily detectable in the Hartridge reversion spectroscope. Heubner (1254) gives the following average values for the hemoglobin content of normal blood (in per cent of total hemoglobin): man, 1.7 (1.1-2.4); dog, 0.6; rabbit, 1.5 (0.9-1.8); cat, 1.9; horse blood may contain more hemoglobin. Lower values have been found by Paul and Kemp (2122): man, 0.6 (0-2.5).*

From the figure of Ramsey and Warren (2201) for the respiration

* Cf. also Kiese (1530a), Heubner and co-workers (1262a), Van Slyke and co-workers (2574a).

of rabbit erythrocytes (8 μ l. oxygen per gram moist cells per hour) and by assuming that the oxygen is activated via the autoxidation of hemoglobin, one can calculate the rate of hemoglobin formation to correspond roughly to 8% per hour. The fact that hemoglobin during the physiological cycle of oxygen carriage spends an appreciable fraction of its life at oxygen tensions close to those optimal for hemoglobin formation, might increase the rate of autoxidation *in vivo* over that *in vitro*, so that the figure may well be a minimum estimate. Cox and Wendel (508) found that high concentrations of hemoglobin in the erythrocyte of the dog were reduced at a rate corresponding to 10–12% of the total pigment per hour. At lower concentrations of hemoglobin the rate of reduction is slower, and, if we can compare this set of data, the reducing systems are adapted to keep all but a small percentage of the total pigment functional. This neglects the possibility of hemoglobin formation by oxidizing substances other than oxygen. An increased amount of hemoglobin in the circulation would be expected to follow an increased rate of formation or a diminished efficiency of reduction.*

4.2. Hemoglobin Formation by Foreign Substances

A great variety of substances have been shown to produce clinical hemoglobinemia. These include the chlorate and nitrite ions and various organic nitrites; among commonly used drugs phenacetin, acetylsalicylic acid (357), and the sulfonamides (929,1142,1768,2264, 2265,2271,2577,3007,3036), and among the industrial poisons aromatic nitro and amino compounds are extremely active. The physiology and toxicology of the latter class of substances have been carefully reviewed by Von Oettingen (2067,2069) and by Heubner (1254).

In spite of the fact that the formation of hemoglobin is a reversible alteration, its detrimental effect has probably been underestimated. Recent observations have shown that its effect on the oxygen-carrying capacity of hemoglobin is greater than corresponds to the amount of hemoglobin transformed into hemoglobin. This is caused by the influence of hemoglobin on the dissociation curve of oxyhemoglobin (532,1722a), cf. Chapter VI. Increase

* Both factors are evidently of importance in familial hemoglobinemia. Evidence for lack of reducing systems has been found (King, White, and Gilchrist, 1537a; Gibson, 993a). On the other hand, Fishberg (902a) shows that in this disease, as well as in scurvy, tyrosine is incompletely metabolized with the formation of benzoquinone acetic acid. This quinone oxidizes hemoglobin to hemoglobin; ascorbic acid diminishes the hemoglobinemia by preventing the formation of the benzoquinone acetic acid.

in the rate of hemoglobin formation may be due to direct oxidation of oxyhemoglobin, to the formation of hemoglobin by coupled oxidation, and to the formation of hydrogen peroxide within the cell in such a way that it can act on hemoglobin in spite of the presence of catalase.

Nitrite and chlorate undoubtedly oxidize hemoglobin to hemoglobin without affecting the rate of reduction of hemoglobin (Section 4.3.).

The mechanism is more complicated in the case of the aromatic nitro and amino compounds; they are primarily converted either into phenylhydroxylamines or into aminophenols, both of which readily form hemoglobin from oxyhemoglobin (*cf.* Heubner, 1254,1255; Von Oettingen, 2067; Wendel and Cox, 508). Ellinger (661) and Lipschitz (1761) obtained evidence to show that aromatic amino as well as nitro compounds are converted first into phenylhydroxylamines. Heubner and his school, however, attributed the hemoglobin formation by aromatic amines to the formation of aminophenols, particularly *p*-aminophenol (246,1259,1261,2517). Both hydroxylamino compounds and aminophenols can be formed by reduction of aromatic nitro compounds, *e.g.*, trinitrotoluene (Lemberg and Callaghan, 1693) *in vivo*, and may contribute to hemoglobin formation.

The formation of hemoglobin by these compounds is a true catalysis, eight equivalents of hemoglobin being formed, for example, per mole of *p*-aminophenol. To explain the catalytic effect of *p*-aminophenol Heubner assumed that the product of its autoxidation, *p*-iminoquinone, is the actual oxidizer of hemoglobin. Alcohol, which is known to enhance the toxicity of aromatic nitro compounds (*cf.* 2517), delays the removal of the iminoquinone system, while it does not interfere with the reduction of hemoglobin (*cf.* 1254). Against the correctness of the hypothesis of Heubner doubts have been raised by Williams (3085); the glucuronides of aminophenols which cannot readily yield iminoquinones were also found to be active hemoglobin formers.

Heubner (1254,1255) discusses as an alternative explanation the formation of hydrogen peroxide by autoxidation (or reaction with oxyhemoglobin) of the hydrogen donor and oxidation of hemoglobin to hemoglobin by the hydrogen peroxide thus formed. This hypothesis can be applied for phenylhydroxylamine as well as for aminophenols. With regard to the latter, the hypothesis is actually not alternative, but complementary to the first, since both the hydrogen peroxide and the iminoquinone are able to oxidize hemoglobin. Phenylhydroxylamine and also hydroquinone (1254) are more rapidly oxidized by oxyhemoglobin than by atmospheric oxygen; the primary reaction in these instances must be assumed to be:

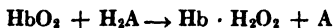

rather than:

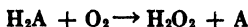

The secondary reaction depends on the nature of A; if it is a quinone, it will oxidize hemoglobin to hemoglobin, while nitrosobenzene formed from phenylhydroxylamine unites with hemoglobin. Finally, hemoglobin may be reduced back to hemoglobin by the hydrogen donor and, after recombination of hemoglobin with oxygen, the cycle begins once more; in this case irreversible oxidation of hemoglobin to choleglobin is the final result (*cf.* Chapter X,

Section 4.4.1.). In this connection it is of interest that Seide (2528) found phenylhydroxylamine to produce a 50% inhibition of catalase at $5 \times 10^{-5} M$, and *p*-aminophenol, at $4 \times 10^{-6} M$ concentration.

The mechanism of hemiglobin formation by the sulfonamides must remain open.* On the basis of the theory that the antibacterial effects were to be explained by an anticatalase action due to the formation of hydroxylamine derivatives, hemiglobin formation was thought to be due to a mechanism analogous to that proposed by Ellinger and Lipschitz for other aromatic amino compounds. There is little evidence, however, that such derivatives are formed *in vivo* (2800) and it is more likely that hydroxysulfonamides are involved. On the other hand, Clyman (458) observed an inhibition of the erythrocyte catalase *in vivo*, so the possibility that the hemiglobin is formed by hydrogen peroxide under conditions under which the catalase is inhibited cannot be excluded; Seide (2528) found sulfanilamide to inhibit catalase only at rather high concentrations. Finally, the existence of an inhibitory effect on the cell dehydrogenases and on the activity of hydrogen carriers cannot be excluded.

The strong increase in the respiration of the mammalian erythrocyte in the presence of methylene blue was originally explained by Warburg and Christian (2941,2942) as due to the oxidation of hemoglobin to hemiglobin and to the catalytic action of the latter compound on the oxidation of glucose (cf. Section 3.2.). While methylene blue can be shown to form hemiglobin cyanide in the presence of cyanide (1728), and thus like nitrite or *p*-aminoacetophenone (2846) can be used to bind cyanide in the blood — thereby protecting the respiratory ferment (cf. also 1254,1965,3034) — the methylene blue catalysis of erythrocyte respiration is independent of hemiglobin formation. Wendel (3033) has shown that hemiglobin cyanide does not oxidize lactic acid in the erythrocyte, while the oxidation of lactate to pyruvate by oxygen and methylene blue in the presence of the appropriate dehydrogenases is not inhibited by cyanide. This view was later accepted by Warburg and Christian (2932).†

The increase of erythrocyte respiration by pheophorbid hemins observed by Warburg and Kubowitz (2940) has been explained by these authors as due to hemiglobin formation. In view of the fact that their oxidation-reduction potential is far lower than that of the hemoglobin-hemiglobin system, the explanation appears unlikely.

Hemiglobin formation is also accelerated by pyridine (2251,2253), by a substance present in the urochrome fraction in urine (2252) and a quinoid substance present in pathological urine (902), naphthoquinones (1566,2525), the D-amino acid oxidase system of kidney (245,247), and substances present in liver extracts (567,641). Since most of the experiments on these substances were carried out on hemolyzates, it is doubtful whether they have any physiological significance.‡

* According to Kallner (1458a) the cyanosis is due to the formation of a compound of carbhemoglobin with sulfanilamide, rarely to hemiglobin.

† Cf. also Kiese (1530b).

‡ With reference to quinones, see, however, Fishberg (902a).

4.3. Reduction of Hemoglobin *in Vivo*

In addition to the work on the mechanism of hemoglobin reduction in erythrocytes discussed in Section 3.2., there exist a number of investigations into the reduction *in vivo* (986,1108,1254,1260-1262,1438,1526,2173,2415). One of the best is that of Cox and Wendel (508) who found a rate of reduction of hemoglobin formed by intravenous injection of nitrite in dogs, corresponding to 11 to 12% of total hemoglobin per hour.

This was independent of total hemoglobin and of hemoglobin concentration (as long as hemoglobin formed more than 20% of the blood pigment), and independent of the way in which hemoglobin had been formed (unless substances were used which are only gradually transformed into active catalysts). In contrast to Brooks (344) no influence of the glucose content of blood on the rate of reduction was found. The rate was decreased by low body temperature. Methylene blue increased the rate of reduction (*cf.* also 1178,1526), but successive doses were less and less effective. Methylene blue has found clinical application in the abolition of hemoglobinemia caused by sulfonamides (398,1142). The differences in sensitivity of various animal species to hemoglobin-forming drugs depend largely on the efficiency of the reducing systems (986,1254,1260,1438,1530,1722).

It is uncertain what role substances such as ascorbic acid and glutathione (*cf.* Sections 3.3. and 3.3.2.) play in the normal reduction of hemoglobin. The fact that ingestion of ascorbic acid has been shown to bring about a significant reduction in the hemoglobin level in idiopathic familial hemoglobinemia (551,1040,1728) speaks in favor of the assumption that this compound might also be involved under normal conditions, but the point is far from settled (*cf.* the footnote on p. 519).

Glutathione reduces hemoglobin (1991) as does cysteine (641,1526,1991). Cox and Wendel (508) found, however, no diminution of the rate of hemoglobin reduction after repeated doses of nitrite *in vivo*, which were sufficient to oxidize the total blood hemoglobin to hemoglobin four times. To judge from the work of Keilin and Hartree (1498), quoted in Section 3.3.1., all glutathione should have been oxidized by this procedure.

The inhibition of reduction of hemoglobin by drugs and poisons possibly contributes to their effect of causing hemoglobinemia. Nitrophenols inhibit cytochrome reductase (1076,1575; *cf.* also Kensler and co-workers, 1519).

5. INTRACORPUSCULAR ALTERATIONS PRECEDING DESTRUCTION OF THE ERYTHROCYTE AND HEMOLYSIS

5.1. Introduction

The existence in the erythrocyte of an oxidation-reduction cycle with intracellular hemoglobin formation and reduction, even if slow, may be assumed ultimately to bring about the destruction of the reducing enzyme systems. Since most of these are also concerned

in the energy transfers required for the maintenance of the structure of the cell, their inactivation would have serious consequences for the cell.

It has been shown, however, in Chapter X that hemiglobin formation and reduction in the presence of oxygen is closely allied to choleglobin formation. This hypothesis of slow irreversible hemoglobin destruction as initiating erythrocyte disintegration was put forward independently by Lemberg and by Barkan.

In favor of the former hypothesis one may adduce the experiments of Richardson (2245), who found that ingestion of 1 to 4% nitrite in the diet caused mice to develop anemia in which spectroscopic observations showed hemiglobin to be the only abnormal pigment. In the absence of reducing substances nitrite forms only hemiglobin, but in their presence it catalyzes irreversible oxidation by H_2O_2 (cf. Chapter X). Cells containing only irreversible breakdown products would readily disintegrate so that the detection of these compounds in the corpuscle might be difficult. The same considerations hold for all substances able to form hemiglobin in the intact red cell.

Heubner (1255), Jung (1444), and van Loon and Clark (1780) conclude that hemiglobin formation *per se* does not damage the erythrocyte; while this is probably correct, a frequent repetition of the cycle might cause a premature destruction of the cell enzymes.

At present it is therefore impossible to decide which of the two mechanisms causes the normal death of the erythrocyte. It will be seen below, however, that the balance of evidence favors the second theory, which certainly accounts for the shortening of the normal life span in a variety of pathological or experimental conditions.

5.2. Sulfhemoglobinemia

Not all irreversible changes in intracorpuseular pigment result in deleterious effects on cell stability. It suffices to recall that cells containing true sulfhemoglobin may be used as indicators of the normal life span of the cell (cf. Section 2.).

Sulfhemoglobin is found in the blood after administration of drugs of the aromatic amine class, such as phenacetin and acetanilide (2216,2584,2813,1139), pyridium (phenylazoaminopyridine) (236,240,2121), or sulfonamides (466,593,929,2121,2245,2577,3007); after dosage with sulfur; in severe constipation; in cases of septicemia, particularly in severe *Clostridium welchii* bacteremia; occasionally also in trinitrotoluene workers (1427), although in this case far more

rarely than hemoglobin. Blood rarely contains more than 10% of sulfhemoglobin. It is usually present only in the corpuscles, but in severe bacteremia it may be found in the plasma; so far it has never been reported in the urine. Large amounts can frequently be found in cases of phenacetin misuse, and have been observed by us in one case of quack therapy with sulfur.

The actual agent of sulfhemoglobin production is always hydrogen sulfide, produced in the intestine by the action of bacteria on food residues and absorbed from the large intestine. Normally this is excreted in the lungs or destroyed, but if present in excess, or in the presence of catalysts which accelerate its action on hemoglobin, sulfhemoglobin is produced. Of all sulfur compounds only elementary sulfur, sulfides, or thiosulfates produce sulfhemoglobin directly (2245). Cysteine is inactive, and in the action of magnesium sulfate or sulfonamides their sulfur content is of no significance. Magnesium sulfate may cause hydrogen sulfide production in the intestine, and the sulfonamides act as catalysts of sulfhemoglobin formation like other aromatic amino compounds. The catalytic action of phenylhydrazine and other amino compounds on sulfhemoglobin formation *in vitro* was first observed by van den Bergh and Wieringa (240). Smith (2577) found 0.1–1.5 g. of sulfhemoglobin per 100 ml. of blood after sulfanilamide, while sulfapyridine produced little or none.

The distinction between sulfhemoglobin and hemoglobin is of clinical importance (*cf.* Chapter X, Section 7.2.), since the conversion of hemoglobin into sulfhemoglobin is irreversible and the pigment loses its oxygen-carrying function, while hemoglobin is reduced in the blood (*cf.* 398,1427,2121,2617,3003) and becomes again functionally active. The sulfhemoglobin-containing cells are not destroyed in the circulation more rapidly than normal erythrocytes (1427) and persist for several months.

The intracorpuseular sulfhemoglobin cannot therefore be a precursor of intracorpuseular bile pigment formation and erythrocyte breakdown.

5.3. Intracellular Changes after Phenylhydrazine

The earlier literature on the action of phenylhydrazine has been reviewed by Von Oettingen (2067). The formation of a characteristic, hitherto unknown, brown pigment with well-defined absorption by the action of phenylhydrazine on oxyhemoglobin was first noticed by Hoppe-Seyler (1340) in 1885. The brown pigment in the cells

was erroneously considered as hemoglobin by Warburg and collaborators (2944), who were forced to assume that it was a peculiar kind of hemoglobin, since the erythrocytes remained brown on reduction. The significance of their finding that denatured globin was also present is discussed below. Lemberg and Legge (1704) showed, however, that after an injection of 50 mg. per kg. phenylhydrazine into a rabbit, choleglobin could be detected in greatly increased amounts and biliverdin could be isolated from the cells. The biliverdin concentration reached a maximum value of 11.7 mg. per 100 ml. of cells after 4 hours, and reached normal levels between the second and sixth day after injection. The real biliverdin concentration in the cells was probably about twice as high since the recovery is not quantitative. During the experiment the hemoglobin level fell by about one third. Cruz (514) has observed a considerable decrease in the mean corpuscular hemoglobin in the dog one day after injection of acetylphenylhydrazine. The choleglobin-containing erythrocytes are rapidly removed from circulation (1527).

Phenylhydrazine and aromatic amino and nitro compounds have long been known to form inclusion bodies in the erythrocyte, known as Heinz bodies after their discoverer (1230). They were associated with the breakdown of the hemoglobin which occurs under these conditions and, more specifically, with hemoglobin formation (1967), "verdohemochromogen" formation (1439), and with Warburg's discovery of the presence of intracorpuseular denatured globin. Heubner (1255,1256), Jung (1445), and Kiese and Seipelt (1529) conclude that they are due to the denaturation of stroma protein. It appears more likely, however, that they contain denatured globin. This is well supported by Horecker's observation (1344) that the formation of Heinz bodies in dog erythrocytes after trinitrotoluene administration coincides with the appearance of a precipitate of denatured globin in hemolyzed blood; by dialysis this is reconvertible into native globin. Denatured globin cholehemochrome has also been found (1529). The claim of Heubner that there is no correlation between formation of choleglobin ("verdoglobin") and Heinz bodies is based on the erroneous equation of sulfhemoglobin and choleglobin (cf. Section 5.4.).

The appearance of denatured globin within the cell is probably to be associated with the observations made by Lemberg and Legge (1704) that more biliverdin was found in rabbit cells after phenylhydrazine than could be accounted for by their choleglobin content.

Similar observations were made during the later stages of the reaction between oxyhemoglobin and ascorbic acid (Chapter X, Sections 4.2.2. and 4.3.), while Liébecq (1738) has produced spectrophotometric evidence for the presence of a colorless protein which still contains iron as one of the reaction products during the formation of pseudohemoglobin.

A third line of evidence as to intracorpuseular hemoglobin breakdown after phenylhydrazine comes from Case's investigations on the siderocyte (*cf.* this chapter, Section 10.3.1.). This is an erythrocyte which contains granules which may be stained by the Prussian blue or analogous histochemical reactions for free iron. *In vitro* up to 20% of the cells were found to be siderocytes 2 hours after 0.5 mg. acetylphenylhydrazine had been added to 100 ml. citrated blood, while 10% siderocytes were observed in a human subject after 4 days' treatment with 0.1 g. acetylphenylhydrazine per day.

It is apparent from these results that the changes which are observed in erythrocytes after phenylhydrazine treatment are entirely consonant with choleglobin formation. The spectroscopic evidence, the isolation of free biliverdin, the appearance of denatured globin in the Heinz bodies, and the presence of labile iron all represent aspects of a single process. In the remainder of this section any one of these abnormalities will be taken as indicating intracorpuseular breakdown.

This view is now supported by the majority of workers in the field (415,416,1031,1034,1525,1529).

5.4. Alteration of Erythrocyte Stability

Many other substances will produce similar effects. Thus Case (416) observed siderocytes after treatment of blood *in vitro* with potassium dichromate, silver nitrate, lead nitrate, carbon tetrachloride, and carbon disulfide. The frequent occurrence of Heinz bodies in intoxications has been referred to above; in addition to hemoglobin and sulfhemoglobin, choleglobin has occasionally been detected after administration of sulfonamides (1701,3007). "Verdoglobin" which Kiese and Seipelt (1529) observed in dogs after dosage with hydroxylamine and aromatic amino and nitro compounds, as well as in rats when sulfur or thiosulfate was given in conjunction with sulfonamides, was probably principally choleglobin and not sulfhemoglobin, since the pigment disappeared from the cells after 2 to 3 days.

The fact that Heinz bodies are generally observed on the periphery of the red cell led to the suggestion that they might be due to some change in the cell wall, thus explaining the instability of the cells. Bratley and co-workers (329) conclude, however, from a study of the effect of acetylphenylhydrazine on red cells in hanging drops that the change in the stability of the cell is secondary to the pigment changes. Erythrocytes treated with ascorbic acid in hypotonic phosphate buffer contain choleglobin (1694). On being brought back to isotonic conditions they are found to be very fragile, and even centrifugation may produce hemolysis. More recently, Gajdos and Tiprez (977) found that treatment of washed cells with ascorbic acid under more physiological conditions caused Heinz bodies to appear. Cruz observed abnormal fragility in red cells after administration of acetylphenylhydrazine (514) and also the fact that the cells were ingested by phagocytes like foreign bodies from the circulating blood in a few days. More easily detachable iron is to be found in those erythrocytes which are more readily hemolyzed by hypotonic solutions (Barkan and Walker, 167).

A number of points arise from Case's experiments on siderocytes (416). The integrity of the cell is apparently necessary for the reaction between acetylphenylhydrazine and oxyhemoglobin to give rise to siderocytosis, since he could not observe hemoglobin destruction in hemolyzed cells. Cells in 3.8% citrate are able to react only once, a second addition of acetylphenylhydrazine being neither able to break down any more hemoglobin, nor to form siderocytes. The iron-containing granules were extruded from the intact cell and could be observed in the extracellular fluid, the cell in the post-siderocyte stage being histologically indistinguishable from the normal erythrocyte. The cells in the siderocyte or post-siderocyte stage were phagocytosed by leucocytes, mainly mononuclears, while the polymorphs present were found to contain many iron granules. The evaluation of the siderocyte experiments is difficult. It is doubtful whether the position of iron granules inside or outside the cell can be established with certainty. Iron granules outside the cell may be artifacts; with some techniques, at least, particularly those applying ammonium sulfide for "unmasking" the iron, there is also the danger that iron may be set free from hemoglobin during the processes of preparation of the slides. The fact that there is no satisfactory agreement on the siderocyte counts in normal adult human blood (*cf.* below) also indicates that a reliable technique has not yet been developed.

It is clear from the fact that neither the Heinz bodies nor the deposits of stainable iron occupy the entire erythrocyte that the altered stability of the cell, predisposing it to hemolysis or to phago-

cytosis, is brought about when only a part of the pigment is destroyed. This is in agreement with the direct analyses made of intracorpuseular biliverdin after phenylhydrazine (1704). The remainder of the hemoglobin is destroyed outside the red cell (*cf.* Sections 7 and 8).

While choleglobin is found in arsine poisoning, it is still doubtful whether the extreme rapidity of the hemolysis by this substance is due to the rapidity of choleglobin formation, or whether oxidation products of arsine, formed by the coupled oxidation, have a specific hemolyzing action (*cf.* Chapter X, Section 4.4.4.).

5.5. Changes in Stored Blood

Although red cells stored in the presence of an anticoagulant cannot be considered as being under truly physiological conditions, they are undoubtedly nearer such conditions than when in the presence of phenylhydrazine *in vitro* or *in vivo*. However, most of the chemical and histological changes discussed in the previous sections have been observed in stored blood.

Case (416) has carried out siderocyte counts in blood stored under a number of conditions. In human blood in 3.8% citrate, stored at 20°C., without shaking, the siderocyte count increased from 0.5 to 5% in 24 hours, the count remaining above the original level for about 17 days. Similar observations were made with cats' and dogs' blood. Shaking the blood produced irregular cyclic changes. The highest siderocyte count recorded in the series (25%) was obtained in an experiment in which blood was stored under paraffin. It is tempting to assume that this may be due to the greater rate of coupled oxidation of hemoglobin with hydrogen donors under lowered oxygen tension (*cf.* Chapter X, Section 4.4.1.), particularly since carbon monoxide inhibited the formation of siderocytes. Control experiments showed that siderocytes appeared at approximately the same rate in heparinized or oxalated blood as in citrated blood, as well as in clots in the presence and absence of leucocytes.

In view of the influence of glucose on prolonging the life of stored blood, Case attaches considerable importance to experiments in which blood stored in glucose citrate at 4°C. showed the first siderocyte peak at 15 days, as against 5 days in blood stored in citrate without glucose.

That the extrusion of the iron granules took place under these conditions is shown by the increase in the plasma iron, which took place steadily during the experiment. Such an increase had been observed previously by Barkan and Walker (166).

Moeschlin (1967) was apparently the first to observe the appearance of Heinz bodies in human blood maintained in citrate, and to

show that at low temperature they could not be found. His experiments have been extended by Gajdos and Tipez (977), who found significant quantities of "verdoglobin" in addition to Heinz bodies in citrated human blood stored at 37°C. for 3 days.

So far only a very faint absorption band at about 660 $m\mu$ has been noticed after reduction of normal blood with dithionite (1707,1716), although Kiese (1524) concluded from spectrophotometric studies that normal human blood contains 0.4% "verdoglobin." Since this method depends ultimately on the absorption curve of a sample of hemoglobin which completely lacks choleglobin, it is worth referring to the difficulty which Lemberg and Legge experienced in preparing such a sample (1706). Although there is little doubt that traces of choleglobin are present, the changes observed in stored blood merit quantitative reinvestigation.

Small amounts of biliverdin, up to 0.7 mg. per 100 ml. of cells, have been isolated from the normal washed erythrocytes of man, sheep, horse, and rabbit (1704,1712; cf. also Chapter X, Section 5.). It is of interest to compare this value with the normal level of siderocytes in human blood, 0.5%. It can be accounted for on the basis of 10% of the hemoglobin in siderocytes being transformed into biliverdin. So far, no measurements have been reported on the biliverdin concentration in stored blood.

Increase in bilirubin in citrated or hirudinized blood which was allowed to stand was first observed by von Czike (520) in 1929. Ernst and Hallay (1700) tried to explain it by a change in cell volume, but von Czike's results have been largely confirmed by a number of workers (151,154,161,166,167,416,681). Both Barkan and Walker, and Case measured the plasma iron at the same time. The latter was found to increase much more than the bilirubin; six equivalents of iron per equivalent of bilirubin was found in one case, and about eleven in the other. In Barkan's experiments, carried out at 37°C., the increase in bilirubin was equal to about 6% of the daily human bilirubin production. Taken in conjunction with the biliverdin content of the erythrocytes, the increase in bilirubin indicates that some intracorpuseular reduction of biliverdin takes place (cf. Section 8.2.).

5.6. The Dying Cell *in Vivo*

No reason is apparent why the changes observed in stored blood should not also take place normally *in vivo*. The fact that freshly transfused blood has as long a life in a compatible recipient as his

normal cells is decisive evidence for the physiological nature of the operation. Measurement of the *in vivo* life of cells after transfusion is therefore an excellent physiological measurement of the extent by which their "normal" life has been shortened by particular treatments *in vitro*. There can be little doubt that glucose prolongs the life of stored cells as a chemical metabolite rather than as a physical agent (1974,1975). Its influence in delaying the appearance of siderocytes (416) or visible hemolysis *in vitro* is paralleled by the longer life of such cells *in vivo*, measured by Ashby's method (*cf.* also 204,205). This is confirmed by measurements of the urobilinogen excretion in the feces, or of the transitory increase of serum bilirubin which occurs after the transfusion of blood which has been stored long enough for degenerative changes to have taken place (*cf.* above and 2861,2967).

There is evidence, however, that the changes discussed in the previous section do not represent the whole story. It has been reported, for example, that the spherocytosis observed in blood stored for a sufficient length of time disappears when the cells are transfused, a process of regeneration apparently taking place in the fresh serum. Whether this is due to the removal *in vivo* of metabolic products which accumulate or to some other mechanism *in vitro* is not certain. It seems possible from the irregular cyclical occurrence of the siderocytes which Case observed in stored blood which was inverted daily, that some interaction between cells and plasma is of importance. This is unlikely to be due to the Berghem-Fähræus mechanism (*cf.* Section 6.), which has not been entirely confirmed by other workers (*cf.* 1109), and which is apparently without influence on the lifetime of the cell (1975). The appearance of a peak in the siderocyte level which occurred in blood stored in citrate-glucose after 15 days is indicative of a critical change at this period which is not found from measurement of the decay rate *in vivo* (*cf.* Section 2.).

The normal level of siderocytes in humans is found by Case to be 0.50-0.25% (417), while Greenberg (1065) found far less (below 0.1%).

It can be concluded, as far as the normal breakdown is concerned, that the hypothesis of intracorpuseular hemoglobin breakdown as the factor initiating the death of the cell is completely in harmony with the shape of the normal decay curve. Knowledge of the factors initiating this process is still in an unsatisfactory state, although there is evidence that they are bound up with the physiological stresses to which the cell is subjected during the performance of its function, while much work remains to be done on detailed biochemical analysis of the relation between intracellular metabolism and cell stability.

5.7. Protection of Hemoglobin in the Erythrocyte

There can be little doubt that in vertebrates hemoglobin is protected from rapid irreversible destruction by its incorporation in the red cell. The limited permeability of the cell wall prevents hemoglobin from diffusing into the intracellular spaces, where it would come into contact with potentially harmful systems, and may also prevent harmful substances from diffusing into the cell. It is well known that oxyhemoglobin injected intravenously or set free from the corpuscles by hemolysis carries oxygen only for a few hours and is broken down to bile pigment. It is of interest in this connection that Mouchet (1993) observed that certain blood-sucking parasites of fish (*Gnathidae*) were able to form bile pigments only when they are able to hemolyze cells of the particular animal to which they are attached.

The red cell wall does not appear completely impermeable, however, to harmful substances, *e.g.*, ascorbic acid. Of equal importance is probably the presence of factors which Lemberg and co-workers (1710) found to inhibit the reaction between oxyhemoglobin and ascorbic acid in laked horse erythrocytes (*cf.* Chapter X, Section 4.4.2.).

A similar factor may protect the hemoglobins of certain invertebrate species (erythrocruorins) which contain extracellular hemoglobin. Thus, Salomon (2423) has shown that the erythrocruorin of *Lumbricus* is unable to undergo coupled oxidation with ascorbic acid. It is also possible, however, that the inability to react in this manner is a specific property of erythrocruorins (*cf.* Chapter VII).

In view of the role which hydrogen peroxide can play in the breakdown of hemoglobin (*cf.* Chapter VIII, Section 6.3.4.; Chapter X, Sections 4.4.1., 4.4.5., and 2.5.), the presence of catalase in the erythrocyte in high concentrations suggests that this enzyme may function as the protective agent.

Bingold (270-273), particularly, has attempted to prove that the function of catalase in the red cell is the protection of hemoglobin against destruction by hydrogen peroxide. His experiments, however, were carried out with hydrogen peroxide in unphysiologically high concentrations, which causes an unphysiological breakdown of hemoglobin to colorless products. These experiments do not lend strong support to his hypothesis. Still less convincing is his assumption that separation of catalase from hemoglobin in the kidney causes hemoglobin breakdown.

According to Shapot (2540) hydrogen peroxide oxidizes hemoglobin to hemoglobin in avian corpuscles, which are poor in catalase, but not in mam-

malian erythrocytes. As has been discussed in Chapter IX, Section 2.7.2., Keilin and Hartree (1500) found however that hydrogen peroxide, slowly formed by certain enzyme systems in small concentrations, produced hemoglobin in the mammalian erythrocyte in spite of the presence of catalase in large amounts. The fact that erythrocyte catalase does not contain bile pigment hematin is also in agreement with the assumption that hydrogen peroxide does not normally reach the erythrocyte.

Nevertheless, it would be premature to rule out a protection of hemoglobin by catalase under physiological conditions. Lemberg and co-workers (1697) and Engel (689,692) have shown that the formation of verdohemochrome from pyridine hemochrome and the formation of choleglobin from hemoglobin are not prevented by catalase, but that the rate of the reaction is decreased. In the intact erythrocyte, Keilin and Hartree found no irreversible oxidation of hemoglobin to choleglobin by hydrogen peroxide formed by notatin, while this occurred in hemolyzed blood.*

The possibility that irreversible destruction of hemoglobin may be accelerated by drugs which inhibit catalase is therefore still more likely than that hemoglobin formation may be increased in this manner (*cf.* Section 4.2.). It should be noted, however, that the hypothesis of catalase inhibition has been erroneously used to explain the effect of cyanide on pseudo-hemoglobin formation *in vitro* (Chapter X, Section 6.1.) or the effect of sulfide on sulfhemoglobin formation.

5.8. Disintegration of the Dying Cell

The normal destruction of the erythrocyte has been discussed so far in the literature (*cf.* the reviews 1384,2371,2989,3116) generally with regard to the final mechanism of disintegration of the cell rather than with regard to the changes which presage its destruction and end its life. The former may now be regarded in its proper perspective, as acting under normal conditions on cells which are doomed to die. Under abnormal conditions, the mechanisms of disintegration may, however, act on normal living cells, *i.e.*, cells whose metabolism has not yet reached its terminal phase. An exponential decay curve may then be found.

Rapid hemolysis *in vitro* is brought about by a large number of agents, such as hypotonic solutions, organic solvents, saponins, and hemolysins.

* Recent evidence (1699; *cf.* Chapter X, Section 4.4.2.) strongly supports the assumption that catalase protects hemoglobin in the erythrocyte.

In vivo such a rapid hemolysis is a rather rare phenomenon. If the concentration of hemoglobin dissolved in the plasma reaches 100–140 mg. per 100 ml. corresponding roughly to 0.4% of the total circulating hemoglobin, hemoglobin is excreted in the urine (3153). Hemoglobinemia has been observed after intoxication with arsine, in blackwater fever, in paroxysmal hemoglobinuria, in a few other hemoglobinurias, and in some cases of hemolytic anemia. It has not been observed, however, in a great number of hemolytic anemias or after administration of phenylhydrazine, in spite of the rapid breakdown of corpuscles under these conditions. Fairley (735) distinguishes three groups which indicate the degree of rapidity of hemolysis: (a) hemoglobinuria, methemalbuminemia, and hyperbilirubinemia; (b) methemalbuminemia and hyperbilirubinemia; and (c) hyperbilirubinemia alone. In the last case all the damaged corpuscles are phagocytized before hemolysis occurs.

It is not known if the cells in the reticuloendothelial system (*cf.* Section 7.) ever phagocytose erythrocytes which have not been damaged, either by their normal catabolic processes or by the action of external agents. If intravascular hemolysis occurs, it appears certain that the greater part of the pigment is destroyed by these cells, provided that the hemoglobin level does not exceed the renal threshold, when the pigment is excreted.

Corpuscles may undergo mechanical destruction by being thrashed to bits in the circulation (for a review of the literature *cf.* Mellgren, 1903). Many physiologists have assumed that this is the normal method of destruction. Hemoglobinemia has, indeed, been observed in a large proportion of young athletes after long cross-country runs (1001). It is not known, however, whether the cells which are destroyed are a random fraction of the cell population or whether they consist of aged cells. Hemolysis by fragmentation would only be compatible with the shape of the normal decay curve if the cells destroyed were, in fact, of the latter type.

Soaps are hemolytic agents. It has been known for some time that ingestion of high fat diets causes an increase of the excretion of urobilinogen (1009, 1433, 1434, 2420). In a number of papers (948, 949, 1421, 1774, 1778, 1779) Johnson and co-workers have brought forth evidence for the hemolytic action of fat *in vivo*. In dogs with bile fistulae bilirubin excretion was found to be increased by high fat diet and also after intravenous injection of fatty acids or soaps (8 mg. per kg. injected over a period of one hour). Samples collected from the lacteals and thoracic ducts of dogs after fat absorption were found to have marked hemolytic properties. Hemolysis was not observed when the red cells were mixed with lipemic serum although the cell fragility increased. Davis (541) also observed a diminution of red cells and hemoglobin in dogs fed lard and 10 mg. of choline per day. No studies of the life span of the erythrocytes on these high fat diets are yet available and would appear to be necessary before the significance of fat hemolysis can be properly assessed.

Considerable importance has been attributed to hemolysins arising from the Bergenhem-Fähræus effect (220; *cf.* also 729, 1903 and Section 7.4.) in normal erythrocyte destruction, while Laser (1656) has shown the presence, in an inactive form, of a strongly lytic substance in normal plasma. It seems

most unlikely that these mechanisms are of primary importance for erythrocyte destruction, since the linearity of the decay curve speaks against the random destruction of erythrocytes by lysins. They may be of importance in pathological conditions, or perhaps by their action on dying cells. Lysins may also be produced by tissue slices (360,1846,2170) but it is unlikely that they are of importance in the normal erythrocyte breakdown.

Aged erythrocytes may be destroyed both by intravascular fragmentation and by phagocytosis, the reticuloendothelial system being of major importance in the latter process (*cf.* Section 7.).

5.9. Renal Excretion of Extracorpuseular Hemoglobin

When the rate of liberation of hemoglobin from the erythrocyte greatly exceeds the rate at which it can be broken down, the concentration of hemoglobin in the plasma may exceed the renal threshold and hemoglobinuria may ensue. The literature on experimental hemoglobinuria has been reviewed by Manwell and Whipple (1867) and by Yuile (3153). The human threshold for hemoglobin is 100–140 mg. per 100 ml. of plasma (2093). Whipple and collaborators (1737) found that above a certain glomerular threshold hemoglobin passed the glomerulus but was reabsorbed by the tubules. This subject was studied by several workers (117,987,1548,1573,1977,2093,2243). The tubular reabsorption was confirmed, but no glomerular threshold was found; about 3% of the pores of the glomerular membrane appear to be large enough to pass hemoglobin molecules. The rate of clearance of hemoglobin above the threshold increases proportionally to the hemoglobin concentration in the plasma, but reaches a maximum when the latter is about 250 mg. per 100 ml.

Incompatible blood transfusion or the hemoglobinemia of blackwater fever are often accompanied by renal damage and anuria, while no such effects have been observed in the hemoglobinurias which in some individuals are caused by exposure to cold or to long marches. Baker and Dodds (117) explained this by assuming that acid hematin, formed in acid urine from hemoglobin which passes the kidney, causes a blockage of the tubules; this has led to the alkaline therapy of such conditions. The theory and the suggestions of treatment based on it have been attacked by de Nevasquez (2047), who was unable to detect renal damage in a patient with cold hemoglobinuria and a large degree of hemolysis, whose urine was acid. Kidney damage rarely results from injections of hemoglobin solutions (551a,551b,1359,2091). The frog kidney excretes hemoglobin even more readily if the urine pH is 5.5 than if it is 7.8 (3008). Bing (263) found renal damage in acidotic dogs after intravenous injection of hemoglobin, but not of oxyhemoglobin.* The cause of the renal damage is not yet fully understood and it is certainly not due to mechanical blockage of the tubules. Anderson (54) believes that it is due to the toxic action of hematin. Yuile and co-workers (3155) produced renal damage in rabbits, when the urine was kept acid and

* *Cf.*, however, Flink (908a).

the renal tubules had been previously damaged to a moderate degree.* The subject has been reviewed by Foy and co-workers (938).

The position is very similar with regard to the renal damage in "crush syndrome" which had been noticed during the war of 1914-1918 (1958), but was more fully studied on the victims of the air-blast in England during the last war (386). If large muscles are crushed for a prolonged period, but to a minor degree also without prolonged crush (1018), myohemoglobin is found in the urine, and the kidneys show the same signs of damage as after incompatible transfusion. Bywaters has been able to produce renal damage by injections of myohemoglobin into rabbits (388), while Bing (263) did not find it after injections into acidotic dogs. Some observations (cf. 1018, 1096a, 2673)† indicate the importance of breakdown of ATP as causal factor of the renal damage. The clearance of myohemoglobin from plasma is 25 times as fast as that of hemoglobin and about 60% of the creatinine clearance. The renal threshold is far lower (15-20 mg. per 100 ml. plasma) (401, 1867, 3154) than that of hemoglobin.

Spontaneous myohemoglobinuria occurs in a paralytic myohemoglobinuria of the horse and in humans in the so-called Haff disease (387, 2854).

6. ANEMIAS

6.1. Introduction

A full discussion of anemias is beyond the scope of this book. From a physiological point of view we can divide anemias into four classes. (a) Anemias with decreased production of red cells, of hemoglobin, or of both. These will be of interest to us mainly in connection with the anabolism of hemoglobin (Chapter XIII). (b) Production of faulty erythrocytes, which are broken down more readily. Idiopathic hemolytic anemia as well as pernicious anemia belong to this class. (c) Anemias due to increased destruction of normal erythrocytes. (d) Anemias due to loss of blood by external or internal hemorrhage.

It is possible to distinguish between classes (a) and (b) by measuring the life span of the erythrocyte or the rate of hemoglobin disintegration, but in many instances complete evidence is not yet available. Where the causal agent is unknown, it may be difficult to distinguish between (b) and (c).

Probably too much attention has been paid so far to the "fragility" of the red cell, *i.e.*, its osmotic resistance. *In vivo* the erythrocyte is not subject to the action of hypotonic solutions, and while a high sensitivity to hypotonicity may indicate a decreased resistance

* Cf. also Lalich (1634a).

† Cf. also Meyer and co-workers (1930a).

to other conditions, this need not necessarily be so. It is quite possible that some erythrocytes of increased fragility will be found to have a normal span of life, as well as that erythrocytes of normal fragility have a shorter span of life. Only a few investigations of the life span of erythrocytes in anemias have yet been carried out. Witts and co-workers (349,395) have shown that in some anemias, *e.g.*, in idiopathic hypochromic anemia, the linear decay curve of transfused normal cells (*cf.* Section 3.3.) remains unaltered. In others, *e.g.*, hemolytic anemia, there is an exponential decay, indicating the working of a random process; there is thus evidence for an external lytic factor. In addition to the exponential decay, the linear decay is also more rapid. Since the transfused cells were normal, this is ascribed to a decrease of the protective factor in the plasma (*cf.* 1846).

6.2. Hemolytic Anemias

The relative importance of external hemolytic factors and of internal faults of construction of the erythrocyte in the different hemolytic anemias is not yet clear. In sickle cell anemia and in acholuric jaundice, Case found a large proportion of siderocytes, even up to 100% of the red cell count (415). In these instances there is thus definite evidence for increased intracorpuscular hemoglobin breakdown. The fact that the increased fragility of the cells in acholuric jaundice remains after the clinical picture of anemia has been symptomatically cured by splenectomy is an example of the interaction of both internal and external factors.

Spherocytosis has been assumed to be a factor which predisposes to hemolysis (220,1083,1109), although it is not found in paroxysmal hemoglobinuria (375,1881), cold hemoglobinuria, or march hemoglobinuria (1002). Hemoglobinuria is, however, a rare phenomenon in hemolytic anemia.

Bergenheim and Fähræus (220) observed that when plasma was incubated at 37°C. the sedimentation rate of added corpuscles diminished and spherocytosis finally ensued. These changes were not observed in flowing blood. They obtained a crude fraction from incubated plasma which showed some of the characteristics of lysolecithin, and suggested that the process might occur in the spleen, where Knisely (1554) observed the separation of cells from plasma in the sinusoids. Mellgren (1903) found detectable hemoglobinemia in the reservoir blood of the spleen, which was greatly increased by allowing the splenic blood to stand *in vitro* (*cf.* also Ham and Castle, 1109). Mason (1881) has assumed that a factor is present in abnormal erythrocytes which causes prolonged stasis in the spleen. It has not been shown, however, that the latter observations are related to the phenomenon investigated by Bergenheim and Fähræus. Laser (1656) has isolated a lytic substance from blood which shows properties quite different from those reported for their crude substance by Bergenheim and Fähræus. It is present in an inactive form in normal plasma and may well be of significance in hemolytic anemia.

There is no doubt of the importance of the spleen, for Mellgren's experi-

ments have been confirmed by other workers. Heilmeyer (1210,1212) assumes that the spleen is a contributory factor in idiopathic hemolytic anemia and that in acquired hemolytic anemias it causes the breakdown of apparently normal erythrocytes.*

6.3. Pernicious Anemia

Since before the discovery of the antipernicious anemia principle in the liver by Minot and Murphy and by Castle pernicious anemia had been erroneously assumed to be caused by a hemolytic toxin, there has been a tendency to disregard the evidence for increased hemoglobin breakdown in this disease. Some workers went so far as to assume that the increased excretion of urobilinogen in the feces (740,1209,2969) and the raised bilirubin content of the plasma (1955) during relapse were due to the inability of the bone marrow to use the "pyrrole body store" for hemoglobin synthesis, and to the excretion of the bile pigments from this store. Whipple's later experiments (*cf.* Chapter XIII), however, have forced him to abandon the assumption of such a store. There is now no biochemical evidence for its existence, for the assumed ability of the bone marrow to utilize bile pigment for hemoglobin synthesis, or for an independent synthesis of bile pigment from pyrrole precursors. The lifetime of the red cell is decreased in pernicious anemia; in the untreated disease it is only 9-19 days and the erythrocytes are destroyed by a random process (2082). The erythrocytes are more sensitive to small concentrations of saponin (2171; *cf.* also 2755). There can be little doubt that pernicious anemia is due to faulty construction of the erythrocyte stroma and membrane; see class (b) of our classification.† The permeability of the membrane to glucose is greater than that of normal cells (132a); erythrocyte respiration is abnormally low and no Michaelis-Salomon effect (*cf.* Section 3.2.) is found (528). The increase of coproporphyrin I excretion indicates an increased, rather than a decreased, hemopoietic activity of the bone marrow (*cf.* Chapters XII and XIII).

6.4. Physiological Hemolysis of the Newborn

The explanation of the polycythemia of the newborn and the rapid decrease of erythrocyte and hemoglobin contents of the blood after birth is still a matter of controversy. It is accompanied by an increase of bilirubin in the plasma (Yllpö, 3150) which is evidently due to the increased hemoglobin

* By studies of the life span of erythrocytes of patients transfused into normal recipients, and of normal cells transfused into the patient's blood, Loutit and Mollison (1781a) have recently found that in familial hemolytic anemia the cells are abnormal and undergo a rapid breakdown in the (normal) spleen, whereas in acquired hemolytic anemia the cells are normal and are hemolyzed intravascularly by a hemolysin.

† In a recent review of work on the life span of the erythrocyte, Ashby (91a) states that the erythrocytes have a normal life span in this disease. The data on which this statement is based (91,3005) refer, however, to the life span of normal cells in the blood of patients suffering from pernicious anemia; thus they do not contradict the view put forward here. Recent findings of London and co-workers (1777a) on the appearance of N¹⁵ in stercobilin after ingestion of glycine containing N¹⁵ may, however, necessitate a revision.

breakdown, although even this has been doubted (675,2241,2844). Vahlquist (2844) found a decrease, not an increase, of plasma iron after birth (cf. Section 10.3.2.) and concludes that there is no reliable evidence for increased blood destruction. Several workers (Wintrobe, 3104,3106; Sachs and co-workers, 2407) were unable to find a true polycythemia. Wintrobe found only macrocytosis which he explains as due to the belated appearance of the antipernicious anemia principle. Sachs and co-workers found the cell count increased in the peripheral, not in the cord, blood, while others found no polycythemia in infants delivered by Caesarean section. They assume that the polycythemia is caused by traumatic shock at birth. The maximum of the polycythemia occurs, indeed, 48 hours after birth (30,919). Polycythemia has, however, also been observed in hatching chicks (1326; cf. 2017, p. 648), in which the explanation in terms of a traumatic shock is unlikely.

Another point which is still unsettled is the storage of iron in the liver of the fetus. While the nonhematin iron content of the fetal liver has been found to be higher than that of the adult liver by many workers, others have been unable to confirm this (cf. the discussion by Needham, 2017, p. 651; and 361).

The polycythemia of the newborn has been explained as an adaptation to the life of the fetus at low oxygen pressures (Anselmino and Hoffmann, 59-62; cf. also 1015;2017, p. 648) or as adaptation to the poor iron supply in the milk (Bunge, Abderhalden), but in view of the uncertainty of the experimental findings a discussion appears unprofitable.

7. SITE OF BILE PIGMENT FORMATION

7.1. The Reticuloendothelial System

In Section 5. the main emphasis has been on the factors leading to the disintegration of the corpuscle. The amount of hemoglobin destroyed within the corpuscle during the normal breakdown amounts only to about 10% of the daily breakdown, the remaining 90% being transformed to bile pigment elsewhere. The site of this breakdown must now be discussed.

In 1886 Minkowski and Naunyn (1959) observed that arsine no longer produced a marked jaundice in geese after hepatectomy. They concluded that bilirubin is formed in the epithelial cells of the liver. This theory has been superseded by that of Löwit (1773), McNee (1843), Eppinger (697), Lepehne (1717), and Aschoff (85-88) (cf. the review of Rich, 2240), according to which bile pigment is formed in the cells of the reticuloendothelial system. This system consists of a widely distributed variety of cells of mesenchymic origin which possess phagocytic properties and are able to change readily from a sessile to an amoeboid state and back again. Such

cells are the endothelial and reticulum cells of the spleen, the capillary endothelial cells of the liver (Kupffer or stellate cells), and of the adrenals and bone marrow, the macrophages of the connective tissue and migratory cells derived from them. Thus, attempts were made to block bile pigment formation by filling the reticuloendothelial cells with colloids. These were at first without conspicuous success, but thorium dioxide was found to be effective (1024,2834). Hence the causation of severe jaundice by arsine or phenylhydrazine can be prevented by injections of thorium dioxide as well as by extirpation of liver or spleen (85-88,1393,2340,2591,2850). The observations of Minkowski and Naunyn are now explained by the fact that in birds the reticuloendothelial cells are more concentrated in the liver than in mammals; in fact, Minkowski noted biliverdin in the cells of the spleen and bone marrow of the geese. The evidence for and against the importance of the reticuloendothelial system has been summarized by Aschoff and his pupils, by Rosenthal, who adhered to Minkowski's theory, and by other workers (85-88,303,1717,1718, 1842,1844,2240,2338,2989).

Extrahepatic bilirubin formation, *e.g.*, in hematomata, cysts, and transudates, has long been known and can occasionally reach large proportions (*cf.* below). More important was the demonstration that bile pigment is formed in hepatectomized animals. Dog's blood usually does not contain bilirubin, but after liver extirpation the bile pigment formed extrahepatically accumulates since it is no longer excreted by the liver (Mann and co-workers, 1857,1858,1861; Makino, 1847; Rich, 2239,2240; Taniguchi, 2737; Royer, 2388). The increase of bilirubin in the plasma after hepatectomy is not striking, particularly in view of the fact that part of the yellow pigment was found to be different from bilirubin ("xanthorubin," "hemorubin," 687, 1897,2337; *cf.* Chapter IV, Section 8.1.).

The formation of bile pigments in the cells of the reticuloendothelial system is now no longer in question, but it has not yet been proved that they are not also formed in other cells and there is no certainty about the relative role which various organs — liver, spleen, and bone marrow — play in it. Lepehne (1718) supported a dualistic theory, assuming both types of cells to form bilirubin. Rosin and Doljanski observed that the epithelial liver cells of rats treated with allyl formate or urethane take up red cells (2342); see also the observations of Stein on tissue cultures under Section 7.3. Aschoff, while denying that the epithelial liver cells played any other role than that

of excreting bilirubin into the bile, admitted the possibility of bile pigment formation in circulating blood by humoral factors. We have seen above that some bile pigment is formed even in normal erythrocytes.

It may ultimately turn out that the biochemical conditions in the cell together with its ability to take up hemoglobin are the decisive factors, and that the histological origin is only of secondary importance. Wigglesworth (3081) noted bile pigment formation in the epithelial intestinal cells of *Rhodnius*, as well as in its pericardial cells which may be considered as precursors of reticuloendothelial cells.

7.2. Bile Pigment Formation in Body Fluids and Tissue Cultures

In the earlier experiments on hemoglobin disintegration by tissue extracts *in vitro* (92,397,1252) the products of the disintegration were not investigated. The claims of Leschke (1721) that bilirubin formation in the cerebrospinal fluid continues *in vitro* was not confirmed by Duesberg (639). Other early claims of bile pigment formation by extracellular enzymes have been discussed by Rich (2240), who showed that they were not convincing and found no evidence of bile pigment formation by dead tissue or tissue extracts.

Doljanski and Koch (609), however, claimed that chicken embryo extracts converted hemoglobin to bilirubin, and in the light of subsequent work, and of the ease with which oxyhemoglobin can be broken down by coupled oxidation, it is possible that some of the earlier claims were correct.

Reticuloendothelial cells cause the formation of bile pigments in hemorrhagic transudates and hematmata; this occurs in mesothelial-lined cavities, only rarely in epithelial-lined cavities (2989, p. 2473). The bile pigment present in the sputum is probably of this origin. Occasionally large amounts of bile pigments are thus formed pathologically (238,239,2238) and, in the placenta of the dog, also physiologically (1691). Practically nothing is known about the mode of formation of biliverdin in birds' egg shells.

Tissue culture experiments have given partly contradictory results and should perhaps be repeated with more modern methods of isolation and with greater attention to the formation of biliverdin. Rich, Sümegi, and co-workers, and Niven (2056,2238,2694,2695) found formation of bilirubin and hematoidin crystals in explanted tissue of mesenchymic origin, *e.g.*, spleen tissue of chicken embryo and frog, when hemolyzed blood was added. Although Doljanski and Koch (609) observed bilirubin formation in the embryonic

extracts which did not contain living tissue, they found no bilirubin but "xanthorubin" in tissue culture. Stein (2618) found no bile pigment formation in cultures of pure mesenchymic cells, e.g., of the chick embryo spleen or heart muscle fibroblasts, while biliverdin was formed (?) in cultures of chick embryo liver.

7.3. Role of Liver, Spleen, and Bone Marrow in Bile Pigment Formation

Liver. In spite of the certainty of bile pigment formation outside the liver, this organ is still considered by many as the principal site of this process, even in mammals and man (1349,1847,2336). Blood in the hepatic vein was found to contain more bilirubin than in the hepatic arteries (Mann and co-workers, 311). Removal of the liver decreases not only the jaundice produced by arsine in geese (1959), but also that caused by phenylhydrazine in dogs (2340). If Ringer solutions containing 0.2% dissolved hemoglobin are perfused through the frog liver, biliverdin is excreted in the bile (2055).

Spleen. In his 1925 review Rich (2240) still concluded that there was no satisfactory evidence for bile pigment formation in the spleen under normal conditions. Since that time a large number of papers has been published on this subject which have made the evidence far more convincing (634,699,701,1395,1567,1568,1777,1787,1859,2006,2541,2834,3010), but Lauda (1659) still considers it doubtful whether the spleen removes or destroys normal erythrocytes. Mann and co-workers and others found much more bilirubin in the splenic vein than in the splenic artery and this has been confirmed repeatedly. Urobilin excretion is decreased by splenectomy (1949, 2566), particularly in hemolytic anemia (697,1016,1412,2109,2988), but Singer (2566) found no decrease of bilirubin formation nor an increase in the average lifetime of erythrocytes after splenectomy in dogs. The interpretation of the results of splenectomy in animals is complicated by the development of *Bartonella* infection, and by the possibility that other parts of the reticuloendothelial system may take over the function of the spleen.

Adrenaline causes a contraction of the spleen and the increase of bilirubin in the blood after administration of adrenaline therefore indicates its formation in the spleen, since blood which has been stagnant in the spleen is expelled into the circulation. It is of interest that Watson and Paine (2996) found that the mean corpuscular hemoglobin concentration of the erythrocytes expelled from the spleen was decreased. Immediately after splenectomy adrenaline no longer produced hyperbilirubinemia in rabbits, but Fernandez (746) found that after several weeks hyperbilirubinemia could be produced again by adrenaline; it appears doubtful whether this can be explained by assuming an action of adrenaline on the compensatory blood-destroying organs which take over the function of the spleen after its removal; in this instance a direct chemical action of adrenaline on hemoglobin (coupled oxidation) is the more probable explanation.

There is no doubt that under pathological conditions the spleen con-

tributes greatly to hemoglobin breakdown as the beneficial effect of splenectomy in some forms of hemolytic anemia shows (*cf.* Section 6.2.). It is not yet clear, however, whether a normal spleen acts on abnormal red cells, as supported by some workers (522,2566), or whether an abnormal mechanism is active in the spleen, at least in acquired hemolytic anemia (Heilmeyer, 1210,1212,1214).* The role of the spleen in toluylene diamine jaundice may be rather indirect (1294,1392).

The importance of the spleen for hemolytic processes has been referred to in Sections 5.8. and 6.2. Granick (1031) found a high nonhematin iron content in erythrocytes from the teased spleens of various animals (*cf.*, however, the criticism of the technique by Case, 416). It is particularly interesting to note that splenectomy causes an increase of the siderocyte count in humans (611); this indicates that the spleen removes the damaged cells.

As far back as 1926 Mann and co-workers (1859) observed the appearance of an absorption band at 630 $m\mu$ in oxyhemoglobin solutions after their perfusion through the dog spleen. This band was ascribed to "acid hematin," not hemiglobin. Among other possibilities, it may have been due to choleglobin, although Lemberg and Legge (1705) in similar experiments with rabbit spleen found a scarcely significant choleglobin formation.

Bone marrow. Mann and co-workers (311,1859) and London and Kryzanowskaja (1777) have shown that bile pigment is also formed in the bone marrow. Even after excision of abdominal organs, bilirubin appeared in the plasma, and the bilirubin content of the femoral vein was higher than that of the femoral artery, though the difference was not as marked as in the spleen.

The increased bile pigment formation in pernicious anemia perhaps occurs largely in the bone marrow.

7.4. Observations on Formation and Occurrence of Choleglobin and Sulfhemoglobin in Tissues Other Than Blood

One to two hours after intravenous injection of hemoglobin into the dog, Kiese (1525) analyzed the blood, the spleen, and the liver for "verdoglobin." The amount of verdoglobin found in these tissues accounted for 5, 12, and 20% of the injected blood pigment, respectively. It is open to doubt whether the choleglobin formation occurring readily in tissue extracts *in vitro* has been obviated in these experiments. Kiese considered the pigment to be verdoglobin S (*i.e.*, sulfhemoglobin) on account of the position of the absorption band of the carboxy compound.

Since it has been shown that a variety of reducing substances and systems present in organs are able to form choleglobin from oxyhemoglobin, the mere demonstration of choleglobin formation by tissue breis or extracts adds little to our knowledge. The same holds for the formation of sulfhemoglobin in the liver, the liver being known to contain enzymes which produce hydrogen sulfide from cysteine. Such experiments have been carried out by Kiese (1522) and by Polonovski and co-workers (210). Kiese's observa-

* *Cf.* footnote on p. 537.

tion that the liver can transform sulfhemoglobin to bilirubin is, however, of interest (*cf.* Chapter X).

Observations of Brückmann and Zondek (362) indicate that occasionally abnormal amounts of bile pigment hematins occur in organs. Extracts with methanolic hydrochloric acid normally show a brown color due to hematin, but in these instances they were green owing to the presence of biliverdin. The green color of the chloroma tumor has been ascribed to the protoporphyrin which is found in it (*cf.* Chapter XIII), but this is not correct. Treatment with carbon monoxide and dithionite produces an absorption band at 630 $m\mu$ (1706). This cannot be due to myeloperoxidase (Chapter IX, Section 3.6.) since the chloroma tissue is known to contain little peroxidase (*cf.* Thomas, 2798) and is probably the band of carboxycholeoglobin.*

7.5. Breakdown of Myohemoglobin

It is still doubtful to what extent if at all the myohemoglobin of the muscle is normally metabolized. The increased bilirubin excretion after exercise, observed by McMaster and co-workers in the bile fistula dog (1826), is due to increased hemolysis, not to greater destruction of myohemoglobin (345). Whipple and co-workers (2548,3058) found increase of urobilinuria in the dog after intravenous, intraperitoneal, or intramuscular injection of myohemoglobin and a prompt conversion of it into bilirubin if given intravenously. Myohemoglobin is transformed into myocholeoglobin by coupled oxidation with ascorbic acid, and is thus a potential source of bile pigment. These experiments do not prove, however, that myohemoglobin suffers destruction in the intact muscle cell. Whipple (3047) found a rapid decrease of myohemoglobin in the muscle after its nerve supply was cut. Heilmeyer (1206) has suggested that the urobilinuria in apoplexy, paralysis, and encephalitis may be due to release and destruction of myohemoglobin, but Watson (2989, p. 2499) suggests a temporary dysfunction of the liver as the explanation. In pathological myohemoglobinuria, jaundice occurs (408), but again the bilirubin is probably derived from myohemoglobin in the circulating blood. In progressive muscular dystrophy and also during the early stages of puerperal involution, Meldolesi and co-workers (1898) found no increase of bile pigment excretion but an increase of the fecal excretion of myobilin, the peptide of the dipyrrolic compound mesobilifuscin (*cf.* Chapter IV, Section 5.5.1.). This pigment was also observed in small amounts in normal serum and

* Humble (1367a) also identified the pigment with choleglobin, although he found strong peroxidative activity of the tumor tissue. The absence of the Soret band supports the assumption that the pigment is choleglobin and not myeloperoxidase.

feces. Myohemoglobin, when destroyed in the muscle, may therefore undergo a more thorough decomposition than hemoglobin or myohemoglobin in the blood (*cf.* 2162).

There is, however, evidence that myohemoglobin in the muscle is certainly more stable than hemoglobin. In anemias caused by hemorrhage or lack of iron and copper no decrease of myohemoglobin in the muscle occurs (507,917). It is also not converted into myohemoglobin by nitrite or *m*-dinitrobenzene (1527). The fact that Meldolesi and Siedel isolated only 30 mg. of mesobilifuscin from 100 feces of myopathics also indicates that the metabolism of myohemoglobin is very slow (*cf.* also the experiments of Hawkins and Whipple, 1196, quoted in Section 2.2.1.).

8. BILIRUBIN

8.1. Quantitative Transformation of Prosthetic Group of Hemoglobin to Bile Pigment

Earlier attempts to determine how much of the prosthetic group of hemoglobin is converted into bilirubin when hemoglobin is broken down gave contradictory results, since neither the method of measuring hemoglobin breakdown nor that of determining bile pigment were adequate. Only the development of the technique of Whipple (3057, 3059) ultimately supplied the answer. Dogs with renal bile fistulae are kept on a salmon-bread diet with iron-free salt mixture which allows only a small degree of extra hemoglobin synthesis (1-3 g. hemoglobin per week). They are constantly bled to keep up a certain level of anemia (about one-third of the normal hemoglobin). The iron reserves of the body are thus exhausted in 2 to 3 weeks, and the dogs then may be kept constantly for several months on a steady anemia level, before the experiments are performed. If the dogs are fed bile acids they remain healthy for many years. Estimation of the newly formed hemoglobin is carried out by measuring the amount of blood which must be withdrawn in order to maintain the anemia level. Bile pigments are determined in the combined bile and urine by the oxidation method (*cf.* Chapter IV, Section 9.1.). This method also includes biliverdin.

Even under these conditions of the maximum effort of the body to prevent anemia, 80-100% of the prosthetic group of hemoglobin is excreted as bile pigments (516,1193,1195).

The amounts of daily excretion of bilirubin in man and dog have been discussed in Section 2.2.1.

8.2. Reduction of Biliverdin to Bilirubin

In a preliminary note Barry and Levine (190) mention the reduction of biliverdin to bilirubin by liver enzymes and the increase of this reduction by glucose. We have been unable, however, to find the publication of the evidence. In 1936 the subject was studied by Lemberg and Wyndham (1715). If biliverdin solutions are incubated with liver slices, typical "hematoidin" crystals appear in the liver cells. The reducing power of the liver of starved animals was smaller than that of normal animals; in the frog, which excretes biliverdin in its bile, the reducing power of the liver was small. Anaerobically all tissues were able to reduce biliverdin; aerobically, liver, kidney, brain, spleen, and skin, and particularly the hair sheath, but not lung, muscle, or heart. All tissues except heart prevented the oxidation of bilirubin by atmospheric oxygen. The observation of Sumner and Nyman (2704) that milk peroxidase catalyzes the oxidation of bilirubin to biliverdin is therefore unlikely to be of physiological interest. Several enzyme systems were shown to use biliverdin as hydrogen acceptor *in vitro*, particularly lactic acid dehydrogenase and systems acting with glucose as substrate; ascorbic acid reduced biliverdin more slowly than these enzyme systems.

Biliverdin added to blood was not reduced, but since enzyme systems reacting with biliverdin occur in the intact erythrocyte, they reduce intracorpuseular biliverdin to bilirubin. The small amounts of biliverdin obtainable from normal erythrocytes are derived from choleglobin or a verdohemochrome, while phenylhydrazine exhausts the reducing systems and biliverdin is therefore no longer reduced.

The reduction of biliverdin to bilirubin by liver enzymes has been confirmed by Baumgärtel (194); the reductases of intestinal bacteria which reduce bilirubin to urobilinogen are unable to reduce the central CH group of biliverdin and to form bilirubin. Biliverdin is therefore not transformed into urobilinogen in the intestine. These observations explain why in animals in which biliverdin is normally found, *e.g.*, in frog bile (2055), in *Rhodnius* (3081), or under pathological conditions in human bile (1462), glucose causes the formation of bilirubin, and, on the other hand, why the excretion of biliverdin in the bile is observed under conditions of starvation (1342) or necrosis

of the liver in animals and man which normally excrete bilirubin (534,944,1462,1650). The biliverdin icterus in regurgitation jaundice (2290) must be explained as due to liver damage.

It is possible that in the animal body biliverdin still combined with globin is reduced to bilirubin globin (*cf.* below).

8.3. Bilirubin in Blood Plasma

8.3.1. Normal Concentrations of Plasma Bilirubin. The presence of bilirubin in human blood serum was first noted by Gilbert and co-workers (999) in 1903 and was proven by van den Bergh and his co-workers (221,225,233,237) by the reaction with diazotized sulfanilic acid (Ehrlich's diazo reaction, *cf.* Chapter IV, Section 4.3.) and other diazonium compounds, as well as by isolation of bilirubin. Bilirubin has not been found in the sera of some animals (such as dog, rabbit, guinea pig, hare, and rat) (*cf.* 1226,1232); it would be of interest to search for biliverdin in these sera.

While earlier estimations gave a bilirubin content of below 0.5 mg. per 100 ml. of normal human serum, estimation with modern methods indicates a somewhat higher median value of about 0.75 mg. per 100 ml. (3109) and values up to 1.5 mg. per 100 ml. have been found in healthy persons (2160). While the earlier methods gave too low values, the modern methods tend perhaps to give somewhat too high values (*cf.* Chapter IV, Section 6.1.). Horse serum contains 1.9 to 3.1 milligram per cent (1039).

The discussion between Heilmeyer (*cf.* 1213, p. 185) and Müller (1997) as to whether bilirubin or hemoglobin contributes more to the yellow color of the normal serum is rather pointless. The bilirubin content varies physiologically and the hemoglobin content depends on the method of isolation which usually causes a slight hemolysis. With (3111) has recently claimed that the yellow color of normal and pathological sera is partly due to bilifuscins (*cf.* Section 9.3.3.).

The bilirubin content of blood depends on the degree of hemoglobin breakdown and on the excretory power of the liver; of the two factors the second is of more decisive influence. Blood bilirubin is therefore increased in diseases in which a very rapid hemoglobin breakdown occurs, as well as in those in which the liver is damaged or the excretion of the bile blocked by a stone or tumor.

8.3.2. "Direct" and "Indirect" Bilirubin. Van den Bergh discovered that the bilirubin in normal sera, in sera of patients suffering from hemolytic anemia, and in hemorrhagic fluids behaved to diazo-

tized sulfanilic acid in a manner different from that of bilirubin in patients with obstructive jaundice. In obstructive jaundice the red azo dye was formed with the reagent alone — the bilirubin reacted “directly” — while in the first-mentioned cases it was formed only after the addition of alcohol (“indirect reaction”). On the basis of these experiments and of those of McNee and Lepehne (1719), Aschoff (85–88) suggested that “indirect bilirubin” is produced by the breakdown of hemoglobin in reticuloendothelial cells, and is changed to “direct bilirubin” by the excreting liver cell; in cases of obstruction of the bile duct the latter is dammed back into the blood stream.

This hypothesis has led to a veritable flood of investigations and hypotheses to explain the difference between “direct” and “indirect” bilirubin. There are few fields in biochemistry in which so much work has been done with so little success. The subject has been reviewed repeatedly (178,1913,3031; 2989, p. 2474). We still have no exact knowledge of the mechanism of the coupling reaction (cf. Chapter IV, Section 4.3.), nor of the basis of the difference between the two types of reaction. Watson's assumption that the coupling occurs in a furan ring of bilirubin (2989, p. 2476) was based on an erroneous formula of Fischer, long abandoned by Fischer himself.

“Indirect bilirubin” is made to react with the diazo reagent not only by alcohol, but also by caffeine (1414,1415,1719; cf. also Chapter IV, Section 9.1.), while directly reacting sera or urine become indirectly reacting on standing or boiling.

The two types of bilirubin also differ in other properties, although the coordination of these differences with the manner of reaction with the diazo reagent is not always straightforward, and there are contradictory claims. “Indirect bilirubin” is more readily extracted from the serum by chloroform (56,534,1066,1203,2590), while ether and butanol extract “direct bilirubin” preferentially (487,2858). The “indirect bilirubin” of hemolytic anemia is less readily excreted into the urine in large amounts than the “direct bilirubin” of obstructive jaundice (1843,2199,2339,3037,2989, p. 2559).

These differences have been variously explained by assuming two chemically different bilirubins, two tautomeric forms of bilirubin, different amounts of bilirubin, a different kind of solution of bilirubin, influences of pH and of substances present in the plasma such as lipoids, cholesterol, or bile acids. All these hypotheses have been contradicted in turn.

It is certain that the bilirubin in both forms is one and the same, and is identical with the bilirubin from bile, and there is also no evidence for the existence of tautomerism (cf. Chapter IV, Section 2.). The absorption spectrum of serum bilirubin differs from that of a solution of bilirubin in phosphate buffer of the same pH, the maximum of the absorption of the latter being at 425 $m\mu$, while the maximum in human serum is 460 $m\mu$, in horse serum, 470 $m\mu$ (1213, p. 153; 1223). The absorption spectra of “direct” and “indirect” bilirubin in serum are very similar; slight differences have

been noted by Heilmeyer and Krebs (1216) and by Davis and Sheard (537), but these are given as being in the opposite direction in the two papers.

It is not even certain how bilirubin itself reacts under the conditions present in the serum. Davies and Dodds (534) found a solution of bilirubin in phosphate buffer added to serum to react directly, while Barron (178) found sodium bilirubinate to react directly, but indirectly if added to serum. The former has also been found by Fiessinger and co-workers (see below).

"The confusion has been somewhat cleared by the proof that both "direct" and "indirect" bilirubin of the blood are protein compounds of bilirubin (213,215,487,920,2132). This proof is based on ultrafiltration, ultracentrifugation, and cataphoresis experiments. Combination of bilirubin with globin had, without evidence, already been assumed by several authors (233,639,1331,1742,1223,2623); it has now been supported by experimental evidence by Fiessinger and co-workers (748-750,2162). They observed that a solution of sodium bilirubinate when added to globin and neutralized with acid, reacted "indirectly" and that the bilirubin could be extracted with chloroform. If serum albumin was used instead of globin, a direct reaction was obtained, and the bilirubin could not be extracted with chloroform. Direct bilirubin (from the serum of a patient with cancer of the pancreas) could be made chloroform-extractable by being incubated with globin. The protein, obtained after chloroform extraction from sera giving an indirect reaction, could be shown to be globin by coupling it with hematin to hemoglobin. If these observations can be confirmed, "indirect bilirubin" is bilirubin still combined with globin, while "direct bilirubin" is bilirubin which, after having been set free in the liver, has recombined with serum albumin, in the same way as hematin set free from hemoglobin recombined with serum albumin to form methemalbumin.

Pedersen and Waldenström have provided evidence against this view (2132). They found no difference between the variation of electrophoretic mobilities of "direct" and "indirect" bilirubin with pH, both behaving in the same way as serum albumin and not as globin. Recently, Robscheit-Robbins and co-workers (2292), studying the electrophoretic mobility pattern of the plasma proteins, came to the conclusion that a modified globin is present in the plasma after intraperitoneal injection of hemoglobin (cf. Section 10.4.). It may well be this protein which, combined with bilirubin, constitutes the "indirect" bilirubin of normal and hemolytic sera.*

* While Watson (2991a) has come to the same conclusion as the French workers, our own experiments have failed to confirm important points of their evidence. Recently,

Most biochemists who have had experience with the clinical application of the distinction between "direct" and "indirect" bilirubin agree that it is of some value for the distinction between hemolytic and obstructive jaundice, although very high bilirubin values in hemolytic jaundice may make the reaction also appear to be "direct." A rough observation of whether the reaction is predominantly direct or indirect is probably all that is required, and little more is likely to be learned by quantitative measurements, or ill-defined and arbitrary distinctions such as between delayed, biphasic, and indirect reactions (*cf.* Chapter IV, Section 7.2.).

8.4. Excretion of Bilirubin

8.4.1. Excretion by Liver into Bile. Injected bilirubin is rapidly removed from the blood stream by the liver (78,1847,2174,2460). Bilirubinemia with a normally functioning liver is therefore rather low, even if much blood pigment is destroyed, *e.g.*, in paroxysmal hemoglobinuria (3115), after administration of phenylhydrazine (1393), or in hemolytic anemia, as long as the excretory function of the liver has not been damaged (2071). The human gall bladder contains 12–40 mg. bilirubin. The capacity of the liver to remove injected bilirubin from the blood stream provides a more sensitive measurement of liver function than the level of serum bilirubin. A bilirubin clearance test has been worked out on this basis by von Bergmann and his co-workers (241,656,1138,1457,2592,2683,2686,2691,3009).

8.4.2. Enterohepatic Circulation. Bilirubin passes with the bile into the intestine and is found in the duodenum. In the intestine and occasionally in infected bile passages, bilirubin is transformed into urobilin and urobilinogen (*cf.* the next section). In the first days of life the newborn excretes bilirubin (2741) while the meconium contains biliverdin. Reabsorption of bilirubin from the intestine and re-excretion from the blood stream through the liver (enterohepatic circulation) were first assumed by Wertheimer on the basis of experiments with phylloerythrin of sheep bile, which is however a porphyrin, not a bile pigment. While enterohepatic circulation of bilirubin was supported by the experiments of McMaster and other workers (346,1828,1925,2231,2385), most of the later workers have been unable to confirm these results and to find any evidence for reabsorption of bilirubin from the intestine (287,311,1533,1847,2412,2460,2548,2737,3044,3052). Against the experiments of Scholderer (2460) and Sackey and co-workers (2412), who found no

Cohn (460a) reported that the Harvard workers have isolated the protein which "alone of adequately purified plasma proteins" combines with bilirubin to give "indirect bilirubin." (*cf.* also Martin (1877a).

absorption of bilirubin injected into isolated intestinal loops, Watson (2989, p. 2481) raised the objection that pure, not "natural," bilirubin had been injected; this objection is hardly justified. Watson's own experiments (2979) cannot be considered as evidence in favor of the enterohepatic circulation of bilirubin.

8.4.3. Excretion of Bilirubin in Urine. According to Rabinowitch (2199) and Naumann (2011) normal urine contains small amounts of bilirubin (about 0.3 mg. per 100 ml.) which can be demonstrated by adsorption to talc and application of the Fouchet test to the adsorbate (*cf.* Chapter IV, Section 9.1.). With (3108) found urine to contain usually one quarter to one half of the bilirubin concentration of the plasma, and occasionally the same concentration. The "threshold" is therefore no true threshold, but depends on the sensitivity of the method used for testing the urine for bilirubin. According to Pollock (2160) and Watson (2991a), increase of bilirubin in the urine can be noted in the pre-icteric stage of infective hepatitis earlier than increase of serum bilirubin.

9. END PRODUCTS OF HEMOGLOBIN CATABOLISM

9.1. Transformation of Bilirubin to Urobilin in the Animal Body

9.1.1. Introduction. We have shown in Chapter IV, Section 6.1., that both urobilin and stercobilin (or the corresponding leuco compounds, urobilinogen and stercobilinogen) actually consist of mixtures of tetrahydromesobilene-(b) and mesobilene-(b) (or the corresponding mesobilanes), while urobilin and stercobilin are probably identical in composition. The recognition of the complex nature is of comparatively recent date, and has so far received little attention in physiological investigations. Urobilins and urobilinogens are readily intraconvertible and physiologically only the sum of the two is of interest. We shall therefore for most purposes in this section simply speak of urobilin, meaning the sum total of all urobilins and urobilinogens, whether in urine or feces. Since we now know that urinary urobilin is derived from fecal urobilin, the use of different names, at least for physiological purposes, is illogical.

The conversion of bilirubin into tetrahydromesobilane, the substance usually predominating in urobilinogen (Chapter IV, Section 6.1.), consists in a reduction, eight hydrogen atoms being added to the tetrapyrrolic system and four to the vinyl side chains of bili-

rubin. Theoretically, mesobilirubin (with reduction of the side chains only) and mesobilane (with reduction of the side chains and addition of four hydrogen atoms to the tetrapyrrolic system) may be intermediates. Watson (2989, p. 2486) found some evidence for mesobilirubin occurring in the small intestine and assumed that it was formed there and further reduced in the large intestine; he also assumed mesobilane to be an intermediate of the reduction to tetrahydromesobilane in the intestine. From the investigations of Baumgärtel (193,194), there is little doubt, however, that intestinal bacteria reduce bilirubin directly to tetrahydromesobilane, while mesobilane is formed by enzymic reduction of bilirubin in the liver.

9.1.2. Formation of Urobilin in the Intestine. It is now generally agreed that the transformation of bilirubin into urobilin occurs mainly in the intestine. In his classical experiments von Müller (1994) showed that urobilin disappears from the intestine after obstruction of the bile duct, but reappears if pig's bile is fed by stomach tube. Pig bile contains bilirubin, not urobilin, though urobilinogen may have been overlooked (3030). Müller's results were confirmed by McMaster and Elman (673,1827) with the bile fistula technique of Rous and McMaster (2374). Heilmeyer and co-workers (260) found that, after removal of the intestine, intravenous injection of hemoglobin failed to produce urobilinuria in the dog. Salén and Enochsson (2417) showed that laxatives decrease urobilinuria in hemolytic jaundice, while constipation increases it (209,1206,1829,2109,2110,2112,2380,2384,2565,3082; 2989, p. 2500). The site of urobilin formation is largely the large intestine. The theory of urobilin formation has been discussed in numerous reviews (14,697,981,1301,1829,1932,2380,2384,2416,2417,2989,3082).

Action of Intestinal Bacteria. As early as 1871 Maly (1854) assumed that urobilin is formed by the action of intestinal bacteria on bilirubin. In 1892 von Müller found that the transformation could be carried out with feces in peptone solution in an atmosphere of hydrogen. The bacterial systems in feces which are responsible for the reaction have been studied by Kämmerer and Miller (1450, 1453,1454), Passini (2114,2115) and Baumgärtel (193).

Kämmerer found that a synergism of the anaerobic *Bacillus putrificus* Bienstock* with facultative aerobes (*Escherichia coli* or *Vibrio*) was required which was active at a pH between 6.5 and 7.6; Passini found that *B. putrificus*

* *Clostridium lentoputrescens* (?). The identity has not been ascertained.

Bienstock destroyed bilirubin without forming urobilin, but that other strict anaerobes such as *Clostridium welchii* effected the transformation. These early experiments, particularly those of Passini, were unsatisfactory for chemical as well as for bacteriological reasons. Instead of pure bilirubin, bile was used, which may have contained some urobilinogen, and the samples were not always tested for both urobilin and urobilinogen. Hoesch (1901) claimed that the synergism of Kämmerer also oxidized urobilinogen to urobilin. At that time no distinction was made between the mesobilane and the tetrahydromesobilane series.

Recently Baumgärtel (193,194) has taken up the study of this problem. He confirmed Kämmerer's results in so far as he found that a synergism of the anaerobic *Bacillus verrucosus** (a component of Kämmerer's "*B. putrificus*") and the facultative anaerobe *E. coli* was required for the reduction of bilirubin to tetrahydromesobilane. Metabolites of protein putrefaction were also necessary. He established the fact that the strict anaerobe was only required for the formation of cysteine from protein and the reduction of cystine to cysteine; this occurs in the caecum. Dehydrogenases of *E. coli* then transfer the hydrogen of cysteine to bilirubin in the lower parts of the alimentary canal. The bacterial reductases primarily add hydrogen to the pyrrole rings I and IV and then to the methene groups a and c (cf. Chapter IV, Section 6.3.), also reducing the vinyl side chains. Thus tetrahydromesobilane is formed. Liver enzymes, in contradistinction to the bacterial enzymes, reduce only to mesobilane (cf. below). The feces of breast-fed infants lack the bacteria necessary for the reduction of bilirubin, whereas these bacteria occur in the feces of the bottle-fed infant, together with urobilin. The age at which bilirubin disappears from the infant's feces varies widely, but after the seventh month no bilirubin is found (2741). Nevertheless, the fecal urobilin excretion remains low in infancy and childhood (2-7 mg. at 3-11 years of age); it is still unknown whether this is due to a destruction of bilirubin with formation of other compounds, or to a slower hemoglobin catabolism. A trace of unaltered bilirubin is found in normal feces (cf. also 2989, p. 2501), the feces of vegetarians containing more, since their acid reaction inhibits the bacterial reduction.

The bacterial enzyme systems are unable to reduce biliverdin to bilirubin, in contrast to those of the liver (cf. Section 8.2.). Garrod (191) reviewed the evidence showing that herbivorous animals with green bile excrete less urobilin.

* *Clostridium verrucosum*.

able to find a later publication of this evidence in detail. It is claimed that even fresh bile (sterile?) can transform mesobilane into *d*-urobilin. Mesobilane administered *per os* or intraduodenally, or incubated with normal feces or with acholic feces plus bile, was found to yield *l*-tetrahydromesobilene, while acholic feces alone were inactive. The experiments with acholic feces, however, do not appear decisive; Watson assumes that for the conversion of mesobilane into *l*-tetrahydromesobilane a bile factor and a fecal factor are required. Bacterial reduction is postulated for the reduction of bilirubin to mesobilane, but not for the conversion of mesobilane to *d*-urobilin, nor apparently for its conversions to *l*-tetrahydromesobilane. We have seen above that according to Baumgärtel, on the contrary, liver enzymes can perform the reduction of bilirubin to mesobilane, but not its further reduction to tetrahydromesobilane; the optical activity of the latter and of *d*-urobilin indicate bacterial formation. The difference between *d*-urobilin and *l*-tetrahydromesobilene may well be due to the activity of bacteria in the bile which are different from those active in the intestine.

Formation of mesobilane in the liver. Lemberg and co-workers (1713) found mesobilane as the prevalent urobilinogen in some cases of liver disease, although it usually forms only a small part of the urobilinogen. From this they concluded that mesobilane may be formed by the diseased liver. Baumgärtel (194) has shown that the liver enzymes can reduce not only biliverdin to bilirubin (*cf.* above), but also the latter to mesobilane. It is thus likely that the small amount of mesobilane present in normal urobilinogen is formed in this way in the liver. Baumgärtel estimates this as 20% of the total urobilinogen, while Lemberg and co-workers (1713) found no more than 10%. Further investigations on the conditions which cause an increased formation of mesobilane would be of interest.

Urobilin in the fetus and newborn. Urobilin is found in the liver and gall bladder of the fetus or the stillborn, and in the urine of the newborn, before bacteria and urobilin are present in the intestine (373,1017,2114,2387,2741,3101). This is, however, no proof of extraintestinal formation of urobilin, since Winternitz (3101; *cf.* also 1273) has shown that urobilin of the mother passes the placenta and is found in the umbilical cord. Urobilin is less readily removed from the circulation of the newborn than from that of the adult. On the other hand, the urobilinuria in icterus neonatorum is explained by Royer (2387) as due to extraintestinal urobilin formation.

9.2. Endogenous Urobilin Metabolism

9.2.1. Enterohepatic Circulation. While we have seen that there is no convincing evidence for the reabsorption of bilirubin from the intestine, the enterohepatic circulation of urobilin has been established beyond doubt. It was first demonstrated by von Müller

(1994), proved by McMaster and Elman (673,1827,1828) and confirmed by Royer (490,2379).

The urobilin reabsorbed from the intestine is carried by the blood of the portal vein to the liver. The greater part is evidently taken up by the liver and re-excreted in the bile, while a small amount passes the liver, enters the general circulation, and is excreted in the urine. This endogenous metabolism of urobilin is very complicated and is not yet entirely understood.

9.2.2. Absorption from the Intestine. Urobilin is mainly absorbed from the ascending colon, less from the sigmoid colon (2332). Urobilinuria is increased by injection of urobilin into the portal vein (2381). The amount of the reabsorption is thought to be considerable, since in liver disease more urobilinogen is occasionally excreted in the urine than in the feces (2989, p. 2500; 2988); it is usually estimated to be between 30 and 70%, but this is based on guesswork rather than on experiment. If the pathological liver is able to form mesobilane, some of it may find its way directly into the general circulation. Watson (2990) assumes that the preponderance of mesobilane over tetrahydromesobilane in some urines has to be explained by an unusually rapid absorption of the former from the intestine, but so far there is no evidence that the feces in these cases do not also contain an abnormal proportion of the two urobilinogens. This problem is not easy to solve experimentally, particularly since mesobilane is rather unstable and may undergo further alterations in the intestine (*cf.* below).

9.2.3. Re-excretion of Urobilin by the Liver. By far the greater part of the urobilin is normally reabsorbed by the liver. Its later fate is still far from certain. Some of it may again reach the intestine with the bile; Garrod (981) always found some urobilin in the bile (*cf.* also 2417). Watson found urobilin and urobilinogen in the bile half an hour after intravenous injection of *l*-tetrahydromesobilene. Royer (2386) found about half of the biliary urobilin to disappear from the gall bladder, but since he determined only urobilin, not urobilinogen, this may have been due quite as well to reduction to urobilinogen, as to absorption or to destruction. The fact, however, that strong urobilinuria is observed only if the gall bladder remains connected indicates that absorption of urobilin from it occurs.

We have seen above (Section 2.2.2.) that the total amount of urobilin excreted in feces and urine is distinctly smaller than the amount of bilirubin formed by the breakdown of hemoglobin, or the amount which can be calculated from total circulating hemoglobin and the lifetime of the erythrocyte. Although Heilmeyer (1206) came to the conclusion that after ingestion of bilirubin the corresponding amount of urobilin is excreted with a delay of three to five days, there is little doubt that a part of the urobilin is destroyed (792,1219,1736,2281,2969,3046).

Watson (2989) found an average daily excretion by healthy men of 180 mg. of urobilin, the values varying between 40 and 280 mg., usually between 100 and 200 mg. Assuming a total circulating hemoglobin content of 825 g. (*cf.* Section 2.2.) and a lifetime of the red cell of 120 days, about 250 mg. should be excreted per day, or to judge from the bilirubin excretion, rather more. According to this calculation, from 0 to 85% (on the average 30%) of the urobilin is destroyed, unless the corresponding amount of bilirubin is transformed to substances other than urobilin.

Figures similar to those of Watson can be calculated from the "hemolytic index," *i.e.*, the amount of fecal urobilinogen excreted per day in mg. per 100 g. circulating hemoglobin. Heihäeyer and Oetzel (1219), Miller and co-workers (1949), and Singer (2566) found a hemolytic index of about 10–25. Belonogowa (208) found the higher value of 30, but assumed a value for the blood volume which is probably too low. The hemolytic index is high in pernicious anemia (50–230) and in hemolytic jaundice (up to 800). Evidence for the destruction of mesobilane in the liver has been found by Brulé and Garban (373) and Felix and Moebus (743), but tetrahydromesobilane or -bilene are probably more stable. Perhaps the loss of urobilin is mainly due to the destruction of mesobilane and mesobilene. Baumgärtel (194) found that, in the presence of cysteine, liver reduction can lead to a complete destruction of pyrrole rings. Urobilin may also be absorbed from the circulating blood and destroyed in muscles and organs (*cf.* below).

Small amounts of bilirubin remain unaltered in the intestine (*cf.* above), but the quantity is hardly large enough to account for the loss. Reconversion of urobilin to bilirubin has been assumed repeatedly, without a shred of evidence (370–372, 697, 2989). The chemical constitution of urobilin as now known makes this assumption still less likely. On the basis of Whipple's hypothesis of a pyrrole body complex (3044), it has been assumed that the excretion of urobilin is proportional to the amount of hemoglobin destruction only when the individual is in the state of blood balance (346, 1593, 1984). The later work of Whipple and co-workers has clearly shown that this assumption is unjustified; even in a state of severe anemia the prosthetic group of hemoglobin is quantitatively excreted as bile pigment (*cf.* Chapter XIII).

The diet, particularly a meat diet, exerts an influence on urobilin excretion. The smaller amount of urobilin in vegetarian feces is perhaps due to the less complete conversion of bilirubin to urobilin (*cf.* above).

9.2.4. Physiological and Clinical Value of Estimation of Total Urobilin Excretion. The disappearance of a varying proportion of urobilin and the possibility of incomplete conversion of bilirubin into urobilin introduce a large margin of error into attempts to deduce the degree of hemoglobin destruction from estimations of total urobilin excretion. The results of Watson and Schwartz (2989, p. 2502) make one rather sceptical of the value of the method for measuring the degree of hemoglobin breakdown in a single case. In one instance 800 mg. pure *l*-tetrahydromesobilene, given *per os*

over a period of four days, produced much too small an excretion of urobilin on the days it was given, and none afterward, while in a second instance the increase of urobilin excretion in the period following its administration was much too large.

Nevertheless, the consistent finding of abnormally high urobilin excretion in a particular disease establishes increased hemoglobin breakdown beyond doubt; the method has been used by many workers and all agree that it supplies a rough measure of hemoglobin breakdown (1007, 2969, 2987, 2988, 2989, p. 2509). The increase of urobilin excretion in relapse in pernicious anemia (638, 740, 2969) must be considered as evidence for increased hemoglobin destruction in this disease; the same holds for aplastic anemia (2235). The destruction of erythrocytes need not necessarily occur in the circulating blood — it may involve young hemoglobin-containing bone marrow cells before their escape into the circulation — but destruction there is. The results cannot be explained, as has been tried by Patek and Minot (2118), by Isaacs (1384), and by others, by assuming that urobilin is formed from an unused precursor of blood pigment synthesis (*cf.* Section 6.3.).

Conversely, increase of red cell destruction is unlikely if no abnormally high urobilin excretion is found, *e.g.*, in anemia of sepsis (2862). After hemorrhage the urobilin excretion is diminished (503).

9.2.5. Urobilin in Blood Plasma. So far we have discussed the fate of urobilin which is reabsorbed by the liver and finally excreted in the intestine; it remains to discuss the fraction which enters the general circulation and which is finally excreted in the urine. Normally this fraction is much smaller, at least as far as can be judged from the urinary excretion; in liver diseases, however, 50% or more of the urobilin may appear in the urine.

The concentration of urobilin in normal blood is so small that it cannot be demonstrated by the fluorescence of its zinc salt (1220, 2378, 3100), although the contrary has repeatedly been claimed. If the liver is traumatized in liver diseases, and in severe infections and in moribund patients, urobilinemia develops (3100; *cf.* 2989, p. 2523).

By spectrophotometry Heilmeyer and Ohlig (1220) established the presence of urobilin in the plasma in liver disease, but the concentration never reaches high values (maximal 0.46 milligram per cent). Heilmeyer (1213, p. 198) and Farmer-Loeb (739) found urobilinogen in the plasma of patients with severe urobilinuria. Watson (2983) observed that the Ehrlich aldehyde reaction of the plasma became positive 20–30 minutes after the intravenous injection of *l*-tetrahydromesobilene, while the urobilin band disappeared. Probably, therefore, urobilinogen, not urobilin, is present in the blood.

Urobilin injected intravenously disappears rapidly from the blood (2350,

2443). Royer (2379,2380,2384,2387) studied this phenomenon in dogs. By estimations of urobilin by the zinc salt fluorescence method in the arterial and venous blood, he found that not only the liver and kidney, but also spleen, pancreas, and muscles absorbed urobilin from the blood stream; even after removal of all abdominal organs the greater part of the injected urobilin disappeared. Forty-five minutes after the injection of 10 mg. urobilin per kg., 60% of it could be found in the liver, kidney, and muscles. Later it disappeared from the viscera, but apparently not from the muscles. Injection of India ink retarded the removal of the last traces of urobilin from the blood, indicating that reticuloendothelial cells played a part in the removal of urobilin (*cf.* also 2983,3101).

Royer did not determine urobilinogen and it is therefore uncertain whether the observed disappearance of urobilin from the organs and also partly from the blood might not have been due to reduction. Watson (2983) found 50 mg. injected *l*-tetrahydromesobiline to disappear from the blood of the dog in 40 minutes (both urobilin and urobilinogen); he does not assume absorption by tissues other than liver or kidney. It is questionable whether these experiments have a physiological significance. Even if exceptionally large amounts of urobilin are reabsorbed from the intestine, its concentration in the blood would hardly reach a level comparable to that after a sudden injection. Normal muscles have not been found to contain urobilin, and the effect of liver damage on urobilinuria would be difficult to understand, if the muscles had a great potentiality for absorbing urobilin under physiological conditions. It is also hardly justifiable to draw conclusions from such experiments, with regard to the rate of removal of urobilin from the blood stream by the liver.

In urobilinemia urobilin passes into transudates and exudates (3100,3101).

After extirpation of the liver urobilinemia develops, but the excretion of urobilin in the urine is not increased; neither is the increase of urobilinuria, after creating a by-pass from the portal vein to the vena cava (Eck fistula) thus short-circuiting the liver, as high as would be expected (490,2379); since urobilin injected intravenously into dogs so treated also does not cause an increase of urobilinuria, the absence of such increase must be due to renal damage.

9.2.6. Urobilinuria. The normal daily urinary excretion of urobilin varies between 0 and 3.5 mg. per day and is usually between 0.5 and 1.5 mg. (2990), *i.e.*, below 1% of the total urobilin excretion. It is subject to large diurnal variations and is increased after meals (2417) or by constipation, and decreased by laxatives (*cf.* Section 9.1.2.). Royer and Solari (2389) found that both glomerulus and tubules excrete urobilin in man, while in the dog only the glomerulus did so. Kidney disease can decrease or prevent urobilin excretion in the urine.

Damage of the liver causes an increase of the excretion of urobilin in the urine; this is probably the most sensitive sign of liver damage, appearing in jaundice before bilirubinuria can be noticed, although

it has been observed that this is not true in the pre-icteric stage of infective jaundice (2160,2991a,3110). Urobilinuria disappears when bilirubin no longer reaches the intestine, to reappear once more in the early stage of recovery. The use of quantitative urobilin estimations for diagnosis of jaundice and other liver diseases has frequently been discussed and reviewed (1206,1207,2109,2110,2112, 2151,2984,2988,2990,3082; cf. also Chapter IV, Section 9.2.). In liver diseases the ratio of urinary to fecal urobilin is greatly increased and may exceed unity (2989, p. 2500; 2988).

9.3. Other End Products of Hemoglobin Catabolism

9.3.1. Fecal Pigments. Watson found mesobiliviolin in the feces (cf. Chapter IV, Section 5.2., and 2989, p. 2487). It is probable that this is a secondary oxidation product of mesobilane, and is formed during the extraction of the feces; occasionally appreciable amounts of final end products of hemoglobin metabolism may escape determination in this form.

"Stercofulvin" and "stercorubin" have been observed in the feces by Baar and Hickmans (107); little is known about their properties and nothing about their constitution.

9.3.2. Urinary Pigments. According to Heilmeyer (1007,1208,1209,1225, 2094) and Bingold (274,276), "urochrome B" is also derived from hemoglobin. For the earlier literature on urochrome see Garrod (980,981). Urochrome B is an ill-defined fraction of the yellow pigment of the urine which can be precipitated by ammonium sulfate. It probably contains urobilin as well as uroerythrin (2989,3024). Heilmeyer found it increased in hemolytic anemia, after administration of phenylhydrazine, and after hemoglobin injections. From the fact that injections of hematin and bilirubin also increased its excretion, he concluded that it is a breakdown product of the prosthetic group of hemoglobin. Fischer and Zerweck (891), however, found no pyrrole in urochrome, nor did Weiss (3024) in uroerythrin. Nothhaas obtained a compound resembling urochrome B by the action of 30% hydrogen peroxide on hemoglobin; on this slender basis Bingold assumes that urochrome B is formed from hemoglobin by the action of hydrogen peroxide in the kidney, after the protective catalase has been left behind (cf. pentdyopent, below). It has been pointed out by Watson (2989) that, unlike pentdyopent, urochrome B occurs in normal urine. Uroerythrin does not occur in feces; Weiss assumes that the cause of uroerythrin and increased urochrome B excretion is liver dysfunction rather than increased hemoglobin breakdown. None of these urinary pigments can represent more than an insignificant proportion of the total sum of excretory products derived from hemoglobin.

9.3.3. Dipyrrolic Compounds. Pentdyopent. In a series of papers Bingold (269-273,278) has claimed that pentdyopent (cf. Chapter IV, and Chapter X, Section 9.) plays an important part as an end product of hemoglobin catabolism.

Pentdyopent does not occur in feces, duodenal contents, or normal urine.

Bingold has claimed that it occurs in normal plasma, but this has not been confirmed by Fischer and von Dobeneck (807). It is found in the urine in most liver diseases, in hemolytic anemia, severe heart discompensation, high fever, and in other diseases (1366) — mostly together with urobilin and bilirubin, but occasionally without these bile pigments. On the other hand, it is not found in the urine of pernicious anemia in spite of the presence of urobilin. Bingold assumes that it is formed by the action of hydrogen peroxide on hemoglobin in the kidney, after the hemoglobin has been freed from catalase which prevents its oxidation in the erythrocyte. It is known that the kidney contains enzyme systems which produce hydrogen peroxide. Nevertheless the theory has many weak points. Normally no significant amount of hemoglobin ever passes the glomerulus, and it is doubtful whether it does so in many of the instances in which pentdyopent was found in the urine. If the theory were correct one should expect to find much pentdyopent in hemoglobinuric urine, but no claim to this effect has been found. Bingold observed that hemoglobin in such urines is destroyed *in vitro* by high concentrations of hydrogen peroxide, but this can hardly be considered as sufficient evidence. Later Bingold (274,276) and Hulst and Grotepass (1366) assumed that pentdyopent is formed from bilirubin in the kidney, again by the action of hydrogen peroxide.

There is little evidence that pentdyopent, even in pathological conditions, contributes much to the products of hemoglobin destruction. The example brought by Watson (2989) shows only the normal picture, urobilin accounting for no more than two-thirds of the hemoglobin destruction. This normal divergency between bilirubin and urobilin cannot be accounted for by the formation of pentdyopent, since pentdyopent does not occur in normal urine.

We have pointed out in Chapter X, Section 9., that in some cases pentdyopent may have been an artefact formed from bilirubin or mesobilane. While there can be no doubt that pentdyopent occurs occasionally as a pathological breakdown product of hemoglobin, its importance has been exaggerated.

Bilifuscins. It is not yet certain whether bilifuscins (*cf.* Chapter IV, Section 8.1., and this chapter, Section 7.5.) occur normally in bile, as Siedel assumes, or are artefacts formed from bilirubin, as Fischer is inclined to believe, and whether they are derived solely from myohemoglobin, or also from hemoglobin. Mesobilifuscin was found in normal feces by Meldolesi (2558) (as the chromoprotein myobilin), but in insignificantly small amounts compared with the bilirubin or urobilin excretion. The experiments of Meldolesi, Siedel, and Möller make it appear more likely that myohemoglobin, not hemoglobin, is the source, but Siedel himself leaves the question open.

Recently With (3111,3113) has claimed that bilifuscins occur in normal sera and are increased in pathological conditions. In certain cases of biliary obstruction and yellow atrophy of the liver, in which no jaundice was found, it was assumed that hemoglobin is transformed into bilifuscins instead of into bilirubin.*

* *Cf.* also With (3113a) and Lups and Meijer (1788a).

The small margin between the bilirubin excretion, as calculated from the lifetime of the erythrocytes or from disappearing hemoglobin in Whipple's experiments, and that found experimentally (*cf.* Section 3.) makes it appear unlikely that any catabolism of hemoglobin which does not lead to bilirubin is of major significance. This excludes for instance the possibility that the coupled oxidation of hemoglobin and fatty acids (Haurowitz and co-workers, 1176), which leads to colorless products, occurs physiologically on a large scale.

10. LIBERATION OF HEMATIN IRON AND FATE OF GLOBIN

10.1. Introduction

The human body contains between 3 and 5 g. iron, significantly more in men than in women. Of this about 60% (2.8 g. in man, 1.9 g. in woman) is present as hemoglobin in the erythrocytes. Of the remainder 0.3 g. or more has been estimated to be present in the tissues, as myohemoglobin in the muscles, and in much smaller amounts as respiratory enzymes in all tissues. About 1.3 g. is present as storage iron in organs, mainly in the liver and spleen, while a few milligrams represent the transport iron of the plasma.

Iron is found in the animal body principally in two chemical forms: hematin iron and nonhematin iron. The former is represented by hemoglobin, myohemoglobin, and the respiratory catalysts. Wherever one of these compounds, mainly of course hemoglobin, is broken down to bile pigment, iron is set free.

A third form of iron exists which is intermediate between hematin and nonhematin iron. This is the bile pigment hematin iron, which is easily detached by acids (*cf.* Chapter X). So far no method has been found by which it would be possible to distinguish directly between it and nonhematin iron; the evidence is indirect and based on the spectroscopic properties of the compounds.

The nonhematin iron again comprises a variety of iron compounds. The iron may be in the ferrous or in the ferric state. It may be present as an inorganic compound, *e.g.*, as pyrophosphate, or bound to protein, probably in more than one way.

Knowledge of iron metabolism has recently begun to make rapid progress, largely due to the use of radioactive iron (Fe^{59}) (*cf.* the reviews 1034, 1086, 1199, 1765, 2129a) and still more recently, of Fe^{55} . Using Fe^{59} , Ruben and co-workers (2389a) have shown that there is no exchange between hematin iron and ionic iron. Many erroneous ideas have had to be abandoned.

These researches have shown that iron of broken-down hemoglobin is carefully husbanded and used for synthesis of fresh hemoglobin, that both the absorption of iron from the gastrointestinal tract and its excretion are slow, and that the former is more readily adjusted to the needs of the organism than the latter. The absorption of iron and its incorporation in the hemoglobin molecule will be discussed in Chapter XIII.

10.2. Excretion of Iron

Contrary to earlier assumptions, Widdowson and McCance (1797,1798, 3070) found by careful studies of the iron balance that of injected iron little was excreted in urine and none in feces, and also that excretion was not raised after large doses of iron had led to its accumulation in the body. Lintzel (1573), who reviewed the earlier literature, had also found only a small fecal excretion of iron in men (less than 0.9 mg. per day). These results were confirmed and extended by experiments of Hahn, Whipple, and co-workers with radioactive iron, Fe^{59} (1092,1093,1191), and of Copp and Greenberg (489) with Fe^{55} (cf. Chapter XIII, Section 4.2.3.). The dog excretes 0.05–0.4 mg. of its body iron per day in the feces, showing no influence by feeding and little by injection of iron. Normally only 0.01 mg. iron was excreted in the bile. After increased hemoglobin destruction, *e.g.*, by phenylhydrazine, this rose to 0.1–1.0 mg. per day. The increase was proportional to the increase of bilirubin excretion, but represented only 3% of the hemoglobin which underwent destruction. The remainder was stored, even when excess iron was available in the body. Similarly only a small fraction (2–8%) of radioactive iron was excreted in feces and urine for a few days after intravenous injection (1093) and the excretion in the bile was also little increased (1047). Little or none was excreted in the urine (1093,925,926) in the rat. Only a small and variable percentage of Fe^{56} is excreted in bile, feces, and urine.

10.3. Nonhematin Iron in Tissues

10.3.1. Bile Pigment Iron. Probably all the iron entering the iron stores via catabolic processes passes through the bile pigment iron stage. While the catabolism of hemoglobin provides the greatest part of the iron liberated by catabolic processes, it is uncertain how much of the total bile pigment iron in the body (if this could be determined at any one moment) is actually derived from hemoglobin, since some compounds containing bile pigment iron, *e.g.*, inactivated catalase, seem much more stable than choleglobin.

Within the erythrocyte, however, the nonhemoglobin hematin compounds may be neglected, and the bile pigment iron may be considered as solely deriving from hemoglobin. The high concentration

of hemoglobin iron in the erythrocyte made it difficult to detect the presence of other forms of iron, and the chemical pitfalls in the interpretation of "easily detachable iron" have been discussed in Chapter X. The normal level of bile pigment iron in the erythrocytes is probably about one per cent of the total iron, and may be increased under pathological conditions.

It may be considered almost certain that this iron fraction is identical with that found histologically in the erythrocyte by the appropriate methods. Iron granules were first reported in erythrocytes at the end of last century (*cf.* 416), but their significance has recently been established by the work of Grüneberg (1065) and Case (416). The former of these two workers found that their occurrence was under genetic control in mice (*cf.* Chapter XIII), and concluded that the cells containing iron were young cells. Case has provided good evidence, however, that they are aged cells (*cf.* Sections 5.2. and 5.3.) although there is evidence that an easily detachable iron fraction may exist in immature avian erythrocytes (*cf.* Chapter XIII, Section 4.).

The significance of bile pigment iron in tissues other than the circulating blood must be related to the role these tissues play in the catabolism of hemoglobin as well as to their content of other heme compounds. Thus, the catalase content of the liver would make some contribution to the bile pigment iron content of this organ although this may be negligible.

In view of the fact that analytical methods which are able to distinguish between bile pigment iron and the various forms of storage iron are lacking, the most accurate value for this fraction can best be obtained by calculation from the content of bile pigment hematin determined spectrophotometrically or perhaps by estimation of pigments such as biliverdin. In the presence of complex mixtures, such methods are only able to give very approximate results. At present the histochemical methods for iron (*cf.* 416,1034) suffer from similar defects although they enable histological differentiation of cells of importance for iron metabolism.

10.3.2. Transport Iron. Normal human plasma contains 50–250 $\mu\text{g.}$ iron per 100 ml., the average value for men (120–140 $\mu\text{g.}$) being significantly higher than for women (90–115 $\mu\text{g.}$) (149,151,928,1221, 2409,2814,2844,2938). In the plasma of various animals quite similar values have been found (152,915,1242,2180).

The importance of the plasma iron as transport iron has been correctly stressed by Moore and co-workers (1979,1982); the assumption

that the "easily detachable iron" of the erythrocytes plays this role has been disproved.

Moore and co-workers found the plasma iron low in iron deficiency (*cf.* also 2180) and during rapid hemoglobin synthesis, and high in aplastic anemia and in relapse in pernicious anemia, when hemoglobin synthesis is considered as being retarded. The level is, however, not always passively controlled by the rate of hemoglobin synthesis in the bone marrow. McKibbin and co-workers (1820) found high plasma iron levels associated with rapid regeneration of hemoglobin, and concluded that an active principle in the liver mobilizes the storage iron; this is assumed to be impaired by liver damage. The level of the plasma iron must be considered as a composite effect regulated by the balance of iron absorption from the gastrointestinal tract, mobilization of iron from the body reserves, and formation of iron by hemoglobin breakdown on the one hand, and hemoglobin synthesis and storage of iron in liver and spleen on the other; the excretion of iron plays only an insignificant role (1350,2409); except during growth, the tissue iron (hematin enzymes and myohemoglobin) can be considered as fixed (Fig. 1).

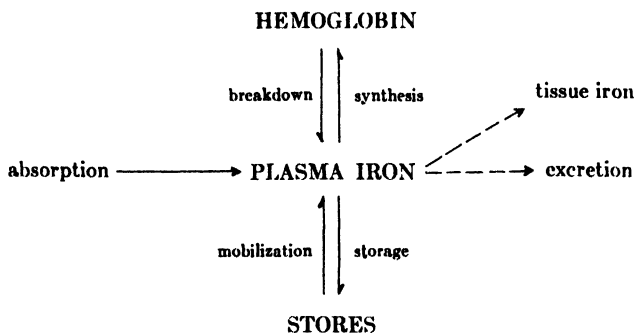

Fig. 1. Plasma iron.

Heilmeyer and Plötner (1221) assumed that the breakdown of hemoglobin was of no importance with regard to plasma iron. This was based on experiments with Stüwe (1222) who showed that plasma iron decreased in sepsis; the evidence for increased hemolysis in sepsis is, however, doubtful, since the total urobilinogen excretion is not increased (*cf.* Section 9.2.4.). Phenylhydrazine (411,2844) causes a strong increase of the plasma iron *in vivo*. The increase of plasma iron resulting from intracorporeal hemoglobin breakdown in standing blood has been discussed in Section 5. The decrease

of the plasma iron by blockage of the reticuloendothelial system with thorium dioxide (156,2795) may be due to the decrease of hemoglobin breakdown.

Vahlquist (2844) found the plasma iron in the fetus to increase gradually to about 150 $\mu\text{g.}$ per 100 m., followed by a sharp drop after birth and a slow gradual rise later. The plasma iron life curve thus follows closely that of the hemoglobin content of blood.

In infections, a drop of plasma iron is often accompanied by an increase of copper (1222). This countermovement of iron and copper has also been found by several observers, but does not occur invariably (*cf.* Chapter XIII, Section 3.3.4.). Houghton and Doan (1350) suggest that the rapid fall of plasma iron in remission from pernicious anemia may be used for measuring the activity of the antipernicious anemia principle in liver extracts.

The plasma iron is nonhematin iron, ferric (2613), and is set free by trichloroacetic acid (928). Tompsett (2816) assumed that it may be iron pyrophosphate, but it is nondialyzable and bound to protein (2409,2844,3152). Vahlquist (2844) found some bound to serum albumin, some to globulins; even at a low pH some remained undialyzable. By using the precipitin reaction for the detection of apoferritin, Granick (1032) has shown the absence of this protein from plasma. Ferritin is thus of no importance in iron transport.

10.3.3. Storage Iron. The iron found in tissues is either a continuous and essential part of the tissue, or is storage iron, which can be mobilized if required for the synthesis of hemoglobin. Most of the latter iron is stored in the liver, the kidney (361), and the spleen. Tissue iron consists mostly of hematin iron (respiratory ferments, myohemoglobin), but also apparently of some nonhematin iron, while storage iron is entirely nonhematin iron, probably largely ferritin (*cf.* below).

Of the large number of studies on the iron content of organs we can mention only a few. Different methods and different animals have been used by the investigators, which makes a short summary difficult.

The liver is the organ in which most of the iron is stored. According to Brückmann and Zondek (361) the human liver contains on the average 1080 mg. iron (800 mg. per kg.) of which 75% is nonhematin iron; the kidney contains 410 mg. (160 mg. per kg., 40% nonhematin iron). While the amount of hematin iron in both organs is about the same, the liver contains five times as much nonhematin iron, most of which is storage iron. The spleen contains less iron than either of these organs (2613), but the concentration of nonhematin iron in this organ equals that in the liver (2817). In rats' liver Tompsett (2817) found about 50% of the iron as nonhematin iron, which does not agree well with the observations of Scott and McCoy (2520), who found that the storage iron of the liver contributed 75% of its total iron. These workers found 800 $\mu\text{g.}$ iron in rat liver, 135 $\mu\text{g.}$ in the spleen, and about 20 $\mu\text{g.}$ in the bone marrow. They tried to estimate the amount of storage iron by studying the iron contents of these organs in normal and iron-defi-

cient rats, and concluded that 75% of the liver iron, 40% of the spleen iron, and 15% of the bone marrow iron was mobilizable storage iron, while 15–25% constituted tissue iron, the remainder being due to hemoglobin.

Radioactive iron, injected intravenously as ferric ammonium citrate, is readily converted into liver ferritin by the dog (Hahn and co-workers, 1089; Granick and Hahn, 1036). Thirteen days after the injection, 80% of the injected Fe^{59} could be recovered from the ferritin fraction of the dog's liver. About 50% of the iron set free by destruction of hemoglobin by means of phenylhydrazine was stored in the liver (1089, 1729). The spleen, which before the injections contained relatively large amounts of ferritin, did not take up much of the injected ferric citrate iron, but took up more of the broken down hemoglobin iron, although less than the liver.

Greenberg and co-workers (100,489) studied the storage of radioactive iron in the organs of young (normal and anemic) rats, after removal of blood by viviperfusion. The liver is the chief storage organ, the spleen the next in importance. A considerable amount is also stored in the intestinal mucosa. Far more iron is stored in the liver after intravenous administration of the iron than after feeding; the storage of iron by the liver is evidently controlled by the plasma iron concentration. Only a small amount (2–6%) is stored in muscles and this is not influenced by the degree of anemia; (in the earlier paper of Austoni and Greenberg a much larger uptake by the muscles had been claimed). After oral application the highest specific activity ($\text{Fe}^{55}/\text{total Fe}$) was found in the bone marrow, although the experiments indicated a preliminary passing storage in liver and spleen; after intraperitoneal application, particularly in anemic rats, the specific activity in the liver was higher than that of the bone marrow.*

Under pathological conditions, large amounts of iron can be stored in the liver and spleen; in hemochromatosis the liver can contain up to 30 g. of iron. The life curves of nonhematin iron in the liver and kidney and of hemoglobin in the blood are closely parallel, except that little evidence was found for a sex difference in storage iron (361).

10.3.4. Estimation of Nonhematin and Hematin Iron. A number of methods for the estimation of nonhematin iron have been worked out, some of which have been discussed in the sections on nonhemoglobin iron in the blood in Chapter X, Section 5. For the estimation of nonhematin iron in tissues the best method available is probably the modification of that of Tompsett (2817), by Brückmann and Zondek (362). The tissue is boiled for seven minutes with a mixture of trichloroacetic acid and pyrophosphate, which removes the iron from ferritin, and the iron in the extract is determined colorimetrically as the *o*-phenanthroline complex, after neutralization and reduction. A small part of hemoglobin iron (probably about 2%) may be split off by this procedure, but this is usually of no significance. Hematin iron is found as the difference between total and nonhematin iron.

A direct estimation of hematin iron has been suggested by Yabusoe (3140) who extracts the hematin with methyl alcohol containing hydrochloric acid, removes proteins by magnesium sulfate precipitation, and determines

* Cf. also Dubach, Moore, and Minnich (635a) and Vannotti (2850a).

the hematin colorimetrically; it is doubtful whether this method gives reliable values.

10.3.5. Chemical Nature of Nonhematin Iron. Ferritin. The chemical nature of nonhematin iron is not yet fully understood. The only well investigated compound which forms a large part of the storage iron in the spleen, the intestinal mucosa, and probably also in the liver, is ferritin, a crystallizable protein containing 20–24% iron. Ferritin was first isolated from horse spleen by Laufberger (1660) as a crystalline protein, by the use of cadmium sulfate. It was later studied by Kuhn and co-workers (1619) and particularly by Granick and Michaelis (1034, 1030, 1037, 1038, 1937). It is precipitated by trichloroacetic acid and in this way little of its iron is removed; the iron is removed, however, by pyrophosphate in trichloroacetic acid, or by reduction of the ferric to ferrous iron with dithionite. According to Scott (2519) 23% of ferritin iron is removed by thiocyanate in dilute hydrochloric acid.

Ferritin contains 1.2–2% phosphorus which Kuhn assumed to be present as nucleic acid; Granick, however, found no evidence for this. Ferritin is stable at pH 4–10, but its iron is removed at pH 4.6 by dithionite and dipyridyl. By removal of the iron the colorless apoferritin is obtained which crystallizes with cadmium sulfate in the same form and shape as ferritin. The x-ray powder diagrams of ferritin and apoferritin crystals show the same structure and identical cell size, the packing of the protein molecules not being disturbed by the iron (737). This, together with the fact that the iron can also be removed by ultracentrifugation, indicates that ferritin contains micelles of colloidal ferric hydroxide in the interstices of apoferritin. The conception of Behrens and Asher (202) that the iron is present in the spleen as ferric hydroxide embedded in protein has thus reappeared in modern dress.

Michaelis and co-workers (1937) have shown that ferritin contains three unpaired electrons per iron atom. In colloidal ferric hydroxide different forms having from one to five free electrons per iron atom were found to exist. This is interpreted as being due to partial dehydration which establishes oxygen bridges between iron atoms and causes neighboring octahedra to share corners and edges. According to the valency angle on the oxygen atom, the linkages may be covalent or ionic, the former if, for example, one edge with two corners is shared. Such micelles of partly dehydrated ferric hydroxide must be present in ferritin. Holden (1317) has criticized the magnetochemical evidence on the ground that the iron content of ferritin varies. This criticism is unjustified, since the estimation of the paramagnetism was based on the iron content.

While apoferritin is entirely homogenous, ferritin is dishomogeneous in the ultracentrifuge and in solubility experiments, but homogeneous in electrophoresis. Ferritin can be regenerated from apoferritin.

In rat liver and spleen Scott found a much smaller percentage of the storage iron removable by means of thiocyanate in dilute hydrochloric acid than was the case with ferritin, and concluded that the storage iron in the rat is not ferritin. To judge from McFarlane's results (1813), it is more likely that rats' liver contains a mixture of ferritin with another ferric ion compound;

about 60% of the nonhematin iron of rats' liver can be precipitated by trichloroacetic acid, while 40% is found in the solution; the latter reacts completely with thiocyanate. Libet and Elliot (1729) claim that a protein iron compound, "ferrin," distinct from ferritin, is present in the liver of various animals, but "ferrin" may be heat-denatured ferritin. In dogs' liver the storage iron is certainly largely ferritin (Granick and Hahn, 1036). In addition the liver also contains some ferrous iron not bound to protein (2613). Bull spermatozoa contain 40% hematin and 60% nonhematin iron (3181). The importance of ferritin for the absorption of iron from the intestine will be discussed in Chapter XIII, Section 4.2.

It is still not proved that all forms of histologically observed "hemosiderin" are identical with ferritin. Ferritin has been found in the erythrocytes (Agner, 28).

10.4. Fate of Globin

Little is still known about the fate of globin set free from hemoglobin. Recently, Robscheit-Robbins and collaborators (2292) have studied the electrophoretic mobility pattern of the plasma proteins after intraperitoneal injection of hemoglobin. They found a prompt increase of the peaks corresponding to β -globulins and "fibrinogen," followed by a decrease after discontinuation of hemoglobin administration. "Modified human globin" had a mobility between those of β -globulins and fibrinogen. It is unlikely that fibrinogen itself is increased, as had been assumed by Fagerberg and co-workers (729); rise of fibrinogen after tissue injury is accompanied by an increase of α_3 globulin, which was not found after hemoglobin injection.

If the indirect bilirubin of the serum is bilirubin-globin (*cf.* Section 8.3.2.), globin is only removed from bilirubin in the liver.

The occasional formation of denatured globin in erythrocytes, its relation to the Heinz bodies, and the possible effects of this denaturation on hemolysis have been discussed previously. The use which is made by the body of the protein part of catabolized hemoglobin in resynthesizing hemoglobin will be discussed in Chapter XIII.

11. CATABOLISM OF HEMATIN ENZYMES

Practically nothing is known about the catabolism of the respiratory ferment. From the fact that copper is needed for its maintenance (*cf.* Chapter XIII) one may conclude that it undergoes a continuous destruction and synthetic replacement.

Since cytochrome c is not autoxidizable and does not combine with oxygen, it is unlikely that it is transformed to bile pigments.

The verdohemochrome found in certain cytochrome c preparations is an artefact, probably derived from altered, autoxidizable cytochrome c (Lemberg and Wyndham, 1716).

There is more evidence for catalase undergoing a breakdown to bile pigments, which has been discussed in Chapter IX, Section 2.3. and Chapter X, Section 8.2.

The breakdown of myoglobin has been discussed in this chapter (*cf.* Sections 7.4. and 9.3.3.). The formation of porphyrins from myohemoglobin in pathological conditions, and possibly from cytochrome c, will be discussed in Chapter XII.

12. DISTRIBUTION OF BILE PIGMENTS IN NATURE

Thus far we have discussed the formation of bile pigments from hemoglobin in vertebrates, mainly in mammals. Far less is known about the formation of bile pigments in other living forms, but the few isolated observations when pieced together indicate that bile pigments are widespread in nature. Often we have no knowledge of their origin, as for example with regard to the bile pigments forming the prosthetic groups of the algae chromoproteins phycoerythrin and phycocyanin or of the chromoprotein of butterfly wings (*cf.* Chapter IV, Section 7.2.). Metcalf (1917) has recently claimed that chlorophyll is broken down to a green bile pigment in the squash bug (*Anasa tristis*), but the claim is based merely on a positive Gmelin reaction. In other instances, however, it is evident that the bile pigments originate from hematin compounds by the same kind of mechanism which transforms hemoglobin into bile pigment.

In Section 2.3. we referred to the observation of Virtanen and Lane (2891) on choleglobin formation in root nodules, and to the observations of Wigglesworth (3081) on the breakdown of hemoglobin in several blood-sucking insects, *e.g.*, the louse, but particularly in the reduviid bug *Rhodnius* (*cf.* also Mouchet, 1993). In *Rhodnius* small amounts of hemoglobin pass into the hemolymph, where hematin is found in the form of a hemichrome. This has evidently no biological function in the insect, but nevertheless it is metabolized in a manner closely akin to the catabolism of hemoglobin in vertebrates. Choleglobin and biliverdin are observed, biliverdin is excreted in the intestine and is partly transformed into urobilin, while injected hemoglobin is excreted as biliverdin in the Malpighian tubes, a primitive kidney. Biliverdin has also been observed in the peritoneal cells of the leech (2604) and in the digestive tract of invertebrates (594), although in the leech as well as in *Rhodnius* the greater part of the hematin is excreted as such. Similarly Raphael (2206) found biliverdin accompanying large amounts of

hematin in the marine polychaete worm *Aphrodite*, "the sea mouse"; this animal contains myohemoglobin and there is some evidence for the presence of hematin compounds acting as respiratory pigments. In the larvae ("blood-worms") of *Chironomus*, which contains hemoglobin, biliverdin was also found (468).

The biliverdin found in a protozoan living within the frog's intestine (1661) is almost certainly absorbed as such from the host. The green pigment of some oysters is probably derived from the phycocyanin of a diatom ingested by the oyster (2428).

MacMunn's early observations (1831, 1832, 1834) bring good evidence for the presence of biliverdin in sea anemones. The occurrence of bile pigments in Coelenterata has been reviewed by Fox and Pantin (930). The calliactin of *Calliactis effoeta* ($C_{22}H_{20}O_8N_4$) is possibly a tetrapyrrolic pigment (Lederer and co-workers, 1664). From *Heliopora caerulea*, biliverdinoid pigments have been isolated by Tixier and Tixier-Durivault (2809b, 2810).

The presence of biliverdin in some members of the Annelida has been mentioned above (990, 2206, 2604).

Biliverdin has also been found in the digestive tract of crustaceans (327), and perhaps in molluscs (958, 2278). The sea-snail *Aplysia* contains biliviolinoid and erythrinoid bile pigments as chromoproteins (563, 914, 1663). The orange pigments of *Arion* and various pigments of *Haliotis* and *Turbo* have been assumed to be bile pigments, but no convincing evidence had been produced (575-577, 1559, 1586, 1675, 2473, 2474). The pigment of *Arion* is probably not a pyrrole pigment, while the blue pigment of *Haliotis californiensis* has been claimed to be indigo by Schulz and Becker (1213, 2474). Recently, however, Tixier and Lederer (2809d) confirmed Lemberg's view (1675) that the blue *Haliotis* pigment is a tetrapyrrolic derivative, while Tixier (2809c) isolated a crystalline biliverdinoid pigment, "turboglucobilin," from *Turbo* species. According to Webb (3006) the "vanadium chromogen" of *Ascidians* is a pyrrole pigment, perhaps related to biliverdin.

Several instances of the occurrence of bile pigment in insects have been mentioned above (468, 1993, 3072, 3081). The rather confused claims of von Linden (1747) on the occurrence of bile pigments in the butterfly *Vanessa* should be reinvestigated. Okay (2073) found red and blue chromoproteins resembling the algae chromoproteins phycoerythrin and phycocyanin, in the green integument of *Mantis*.

The green pigment of the bones and scales of the needlefish *Belone* has been claimed to be biliverdin (389); cf., however (913a). According to Fontaine (913a) the blue and blue-green pigments of *Cyclopteridae* are bile pigment chromoproteins related to the phycochromoproteins.

13. THE PHYSIOLOGICAL FUNCTION OF BILE PIGMENTS

Bile pigments are mainly excretory products of hemoglobin breakdown, which appear in nature occasionally as ornamental pigments, as in butterfly wings or birds' egg shells. Whether they have any

function in the synthesis of hemoglobin is still a matter of conjecture; this aspect will be discussed in Chapter XIII. Bilirubin in blood is in itself innocuous even in high concentration.

The only established function of bile pigment compounds in biological processes is the role of phycoerythrin and phycocyanin (*cf.* Chapter IV, Section 7.1.) as photosensitizers in the assimilation of carbon dioxide by red and blue algae. The absorption curves of these compounds are complementary to that of chlorophyll a (chlorophyll b is missing in these algae), since they absorb in the green region of the spectrum, just where the absorption of chlorophyll is weak (*cf.* Fig. 2).

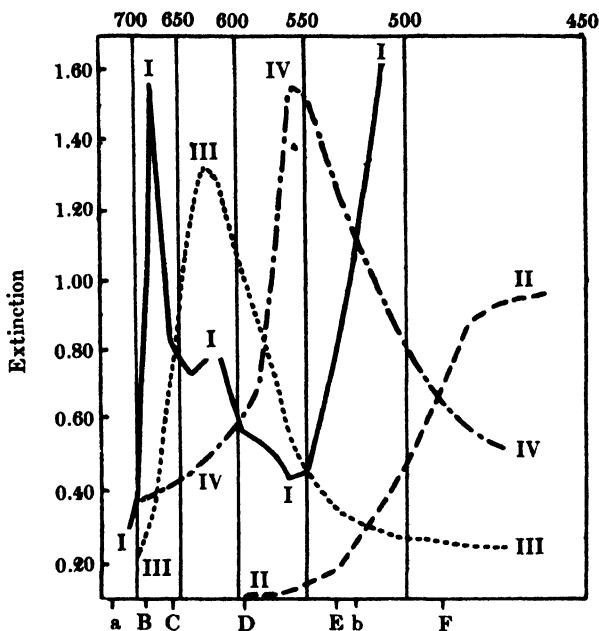

Fig. 2. Absorption curves of chlorophyll a (I), carotenoids (II), phycocyanin (III) and phycoerythrin (IV) (after Borech, 316).

This additional absorption of light energy not only enables the algae to grow in weaker light (2074, 2429), but also permits the *Rhodophyceae* to use more efficiently the green light which is found in the deeper layers of the sea or the *Cyanophyceae* to use the filtered light under a surface vegetation of green algae. The maximum of assimilation of *Rhodophyceae* lies in the green, whereas that of green plants and algae is found in the red.

In addition to this phylogenetic adaptation an ontogenetic adaptation of one and the same species occurring at various depths of the sea has been observed. Gaidukov added additional interest by the discovery that some *Cyanophyceae*, for instance *Oscillaria*, on irradiation with colored light took on a color complementary to that of the light, adjusting their pigments so as to absorb the light more fully (976). This theory of complementary chromatic adaptation has been discussed by many workers (316,318,1126,1785,1978) and has been confirmed. The mechanism of the adaptation is not yet clear. According to Boresch (315,316) the color change is due to an alteration of the ratio of phycocyanin to phycoerythrin, which are now recognized as chromoproteins of two isomeric bile pigments (cf. Chapter IV, Section 5.3.). It is not caused by a bleaching of the absorbing chromoprotein, but on the contrary by its increased formation ("autosensitization").

Some of the algae (e.g., *Ceramium rubrum*) contain large amounts of these chromoproteins (2%) and the absorption coefficients of the latter are extraordinarily high, much higher than those of the prosthetic groups. The subject has been recently reviewed by Cook (483) and Rabinowitch (2198, p. 418 ff.).

CHAPTER XII

HEMOGLOBIN CATABOLISM, II. HEMATIN AND PORPHYRINS

1. INTRODUCTION

In this chapter we deal with substances which arise during pathologic catabolism of hemoglobin but which are not formed in normal hemoglobin breakdown. Hematin and porphyrins have in the past been, and by some workers are still, held to be products of hemoglobin catabolism or intermediates in bile pigment formation, but we shall show that the evidence in favor of such an assumption is unconvincing. Other substances which occur pathologically, such as increased amounts of hemoglobin, and also sulfhemoglobin, have been discussed in the preceding chapter (Chapter XI, 5.).

2. METABOLISM OF HEMATIN

2.1. Hematin and Methemalbumin in Blood Plasma

"Hematin" was first found in human plasma by Schumm in 1912 (2488,2490,2500) by the sensitive hemochrome test (*cf.* Chapter VI, Section 3.3.5.). It has subsequently been found by several workers in a variety of pathologic conditions.

These include hemolytic anemia (232,239,742,1201,2488,2490,2500,2507), nocturnal hemoglobinuria (733,735), icterus neonatorum (267,269,1150, 1233), pernicious anemia, particularly before treatment (265,267,638,735, 742;1213, p. 191; 2488,2490,2500,2507), and occasionally also after the beginning of remission (2939), malarial hemolytic anemia (638,735,736,2488,2490, 2500,2507), septicemia (269,638,735,2452,2488,2490,2500,2507), acute yellow

atrophy of the liver and other cases of severe liver damage (232,639,735), eclampsia (2488,2490,2500,2507), after drugs and poisons such as acetanilide, pamaquin (592), phenylhydrazine, aromatic nitro compounds (2488,2490,2500,2507), and occasionally also porphyria and lead poisoning (638,735,2491,2507). With the possible exception of the last-named conditions, one can say that "hematinemia" occurs under conditions of rapid hemolysis or severe liver damage, generally only in traces, but more strongly if the two factors are combined (*cf.* 232). In such cases Schumm speaks of "hematin icterus," although pure hematin icterus is probably restricted to severe sepsis.

Physiologically hematinemia has been found in the second half of the fetal period and in the blood of the umbilical cord (638,1150); it has also been claimed that hematin is present in the plasma of normal bird blood (268,271).

After intravenous hemoglobin injection "hematinemia" has been observed by Fairley (733), while according to Duesberg (639) hematin is only formed from injected hemoglobin if the liver is damaged. This probably also holds for the hematinemia of pernicious anemia. Vaughan (2861) did not find hematinemia in increased blood destruction following the injection of long-stored blood.

According to Fairley (*cf.* Chapter VI, Section 3.3.5.), hematin is not present in the blood as such, but in combination with serum albumin as methemalbumin (ferrihemalbumin), although the absorption band of methemalbumin in the orange part of the spectrum could not be observed in all instances in which the Schumm test was positive.

If hemoglobin sufficient to cause a concentration of 200–230 mg. per 100 ml. in the plasma is injected intravenously, methemalbumin is found after four to ten hours and persists for 27–34 hours (733).

2.2. Hematin in Blood Extravasations and in the Malarial Red Cell

Hematin has been found in large blood extravasations, particularly in ruptures of ectopic pregnancies (266,2452,2490; 2989, p. 2462). If hematin is present, hemorrhagic transudates contain less bilirubin than usual.

The brown pigment in the erythrocytes in malaria is free hematin (89,352,353,402,1988,2299,2569,3014) or hematin combined with a protein different from serum albumin (997; 1213, p. 117). It can be extracted with 0.5% sodium carbonate solution, which does not alter hemoglobin (1988). Only after having been set free by the disinte-

gration of the erythrocyte does it combine with serum albumin to form methemalbumin.

2.3. Metabolism of Hematin

While hematin is considered by Duesberg (639), Bingold (265,267, 269) and Fairley as an abnormal breakdown product of hemoglobin, and by Duesberg and Bingold as a blind alley of hemoglobin metabolism, some other workers believe that it is a normal intermediate in bile pigment formation.

Brugsch (370-372) claimed that the excretion of bilirubin in bile fistula dogs was increased by intravenous injections of hematin, and although neither Duesberg (639), Fairley (733,735), or Watson and co-workers could find increased bilirubin formation under these conditions,* Brugsch's claim has recently been confirmed by Bénard, Gajdos, and co-workers (211). Gitter and Heilmeyer (1007) found the urobilinogen excretion to be increased after hematin injection in only one case out of many, but Watson and co-workers (2113,2990) found this effect in humans and concluded that hematin is quantitatively converted to bile pigment.

As will be shown below, direct observation of the fate of the hematin does not support the view that it is rapidly metabolized. Although many factors may be involved in producing increased urobilinogen excretion (*cf.* Chapter XI) the balance of the evidence quoted above seems to indicate a real increase of bilirubin excretion after hematin injection. It does not follow, however, that this is due to metabolism of hematin. Brugsch (370) found increases in bilirubin excretion in bile fistula dogs after urobilin injection, when, as has been shown in Chapter XI, there is absolutely no evidence that the transformation of urobilin to bilirubin can be brought about in the body. The increase of bile pigment excretion is therefore probably caused indirectly, the excretion of bilirubin in the bile being variable and depending on other factors (*cf.* With, 3111-3113).

Lemberg (1688) injected solutions of mesohematin into rabbits. This caused bilirubinuria and urobilinuria, but the effect was not due to increased bile pigment formation from mesohematin. The bile did not contain bile pigments with saturated side chains, but only bilirubin and biliverdin; this was established by the position of

* Watson and co-workers (2113) claim an occasional increase of serum bilirubin after injection of hematin in humans; the presence of unaltered hematin in the serum may, however, cause the findings of erroneously high bilirubin values with the Jendressik method which was used for the estimation.

the absorption band of the bilipurpurin zinc compound which was found at 638 $m\mu$, not at 623 $m\mu$, the position of the band of the zinc compound of mesobilipurpurin. From these experiments it must be concluded that very little or no conversion of mesohematin to bile pigment has taken place. Unaltered mesohematin was found in the bile and in the organs of the animals.

The latter is in agreement with the observations of other workers. Anderson and co-workers (54,55) found that hematin injected into dogs and monkeys was taken up by reticuloendothelial cells, but not metabolized. Brown (352,353) showed that hematin remains for weeks with but slight and slowly progressing alterations. Rigdon (2254) observed a slow breakdown of malarial hematin to an iron pigment in the tissues.* We have mentioned above the long persistence of methemalbuminemia after a single hemoglobin injection. It is possible that hematin is finally converted into bile pigment but this reaction is far slower than that of hemoglobin.

Nothing definite is known yet about the mechanism of the formation of hematin and methemalbumin from hemoglobin. Duesberg assumes that the damaged liver converts hemoglobin to hematin, while Fairley and Watson ascribe to the liver only the function of absorbing methemalbumin and converting it to bile pigment. Fairley believes in a conversion of hemoglobin to methemalbumin in the circulating blood as an additional pathway to its normal conversion to bile pigment in the reticuloendothelial cells. This is supported by the occurrence of methemalbumin in hemolytic conditions in which there is little evidence of liver damage, and in hemoglobinemia. Methemalbuminemia is found in rapid hemolysis, but is not necessarily accompanied by hemoglobinemia.

In hemolytic anemia splenectomy causes a simultaneous decrease of methemalbumin and bilirubin in the blood. Fairley found formation of methemalbumin from hemoglobin and hemoglobin on incubation with plasma at 37° (734). These experiments cannot be considered, however, as a satisfactory model of methemalbumin formation, since the conversion occurred only at an unphysiologically high pH, caused by the loss of carbon dioxide from the plasma *in vitro*. Methemalbumin in the plasma is found without hemoglobin being observed in the corpuscles (*cf.* 2254).

Sight should not be lost of the fact that the amount of hematin or methemalbumin found is usually very small if compared with the

* Plumier (2158aa) found no increase of plasma iron after injection of hematin.

amount of prosthetic group destroyed even in normal hemoglobin catabolism. It may be of importance with regard to porphyrin metabolism (*cf.* Section 3.), which is also small, but can play no significant role in the balance of hemoglobin catabolism.

If given *per os* hematin undergoes a partial decomposition. Of 100 mg. hematin given *per os* 10% was recovered unaltered, while the rest was broken down, a small part by the stomach acid, the remainder by intestinal bacteria (Bing and co-workers, 262). A part of its iron became free and was absorbed, since a negative iron balance was converted to a positive one; other workers, however, found hematin a very inferior source of nutritional iron (*cf.* Chapter XIII).

2.4. Toxicity of Hematin

In 1912 Brown and co-workers (353-356) found that intravenous injections of alkaline hematin solutions into rabbits caused a paroxysm similar to that observed in malaria, and concluded that hematin was the cause of the malarial paroxysms. They found also similar changes in the blood picture and effects on the vascular system, *i.e.*, vasoconstriction followed by vasodilation. These results have recently been confirmed by Anderson and co-workers (55), who found the pathologic changes in the blood vessels and the kidney caused by hematin injection to resemble those in malaria. The renal lesions associated with hemoglobinemia are also ascribed to the toxic effects of hematin on the kidney (54).*

Lemberg and Goldsworthy (1700) confirmed the observations of Kämmerer (1452) that mesohematin has a powerful bactericidal action in concentrations as low as 1/100,000 to 1/1,000,000. The substance turned out, however, to be toxic, 80 mg. in 5 ml. 1% sodium carbonate solution injected intravenously causing the death of a rabbit.

The toxicity of hematin is one more argument against assuming it to be a normal breakdown product of hemoglobin.

3. PORPHYRIN METABOLISM

3.1. Introduction

In this section we shall discuss porphyrin metabolism excluding the synthesis of porphyrin in the animal body, which is inseparable from

* In this connection it may be of interest that Keilin and Hartree (1501b) found that hematin inhibits the oxidation of succinate by heart muscle preparations.

the synthesis of hemoglobin and will be discussed in the following chapter. A large number of books and reviews are available on this subject (322,367,406,603,981,982,1070,1822,2255,2464,2506,2848,2850,2908,2983,3028).

From a physiologic point of view, porphyrins have perhaps received an unduly large amount of attention. This is due to the fact that their characteristic spectroscopic properties and their strong fluorescence make their detection and estimations in tissues and excreta relatively easy. This has made many workers overlook the fact that the occurrence and excretion of porphyrins is measured in micrograms, while the metabolism of the prosthetic group of hemoglobin and the formation and excretion of bile pigments is measured in milligrams. For example, Watson (2989, p. 2498) and Kench and co-workers (1515) have rightly stressed the improbability of a direct causal connection between the anemia and the increased porphyrin excretion in lead intoxication. In this condition many grams of hemoglobin disappear from the blood, while the excess excretion of porphyrin amounts only to a few micrograms. With the exception of a few rare congenital diseases (porphyrias, *cf.*, *e.g.*, Löffler, 1771) the formation and excretion of free porphyrin never approaches the magnitude even of normal metabolism of the prosthetic group of hemoglobin.

In spite of an enormous amount of work by many investigators many important problems of porphyrin metabolism remain unsolved. The distinction between porphyrins with different side chains (proto, uro, copro) and with different arrangements of the side chains (types I and III of the fundamental etio series) has somewhat facilitated the unravelling of the complicated picture. The most important result of these studies has been the recognition that, in most instances at least, porphyrins must be considered intermediates in hemoglobin synthesis rather than products of hemoglobin breakdown.

3.2. Endogenous Porphyrin Metabolism

3.2.1. Introduction. The endogenous metabolism of porphyrins is extraordinarily complicated and very little is known about it. This is due partly to the fact that so small amounts are involved, partly to the fact that porphyrins are formed in the intestine by bacterial synthesis and by the action of bacteria on hemoglobin and other hematin compounds of the food, and that they are probably partially reabsorbed from the intestine together with traces of por-

phyrin present in the food as such. A scheme of porphyrin metabolism is given in Figure 1.

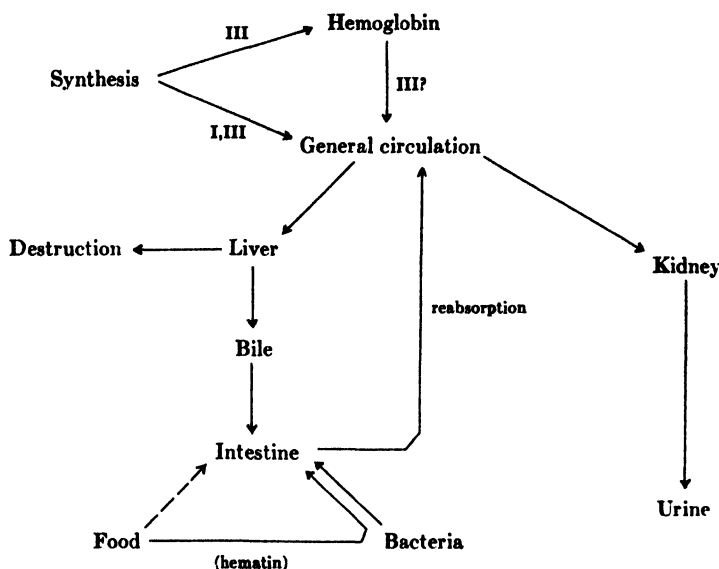

Fig. 1. Endogenous porphyrin metabolism.

The amounts of porphyrins that can be found in the animal body under normal conditions are so small that the study of porphyrin metabolism is mainly based on the study of porphyrins in disease.

3.2.2. Distribution of Porphyrins in the Human Body. *Porphyrin in erythrocytes.* The presence of protoporphyrin in erythrocytes was demonstrated by van den Bergh and co-workers (229) and has been confirmed by many investigators (223,794,1451,1631,2347,2464,2496a,2508,2850,2883). Normal erythrocytes contain 2–20 μg . per 100 ml*; the much higher values reported by Lageder (1631) are probably erroneous. The porphyrin is protoporphyrin IX, identical with that of the prosthetic group of hemoglobin (Grotepass, 1061).

Watson and Clarke (2993; cf. also Grotepass, 1061,1640) and Burmester (383) assumed that reticulocytes were the cells which contained protoporphyrin. This was later partly withdrawn (2991a, 2994), after Keller and Seggel (1505,1996,2526, cf. 443) demonstrated that the

* Cartwright and co-workers (412) find 20–50 μg . per 100 ml.

porphyrin-containing cells were not identical with the reticulocytes, and could be recognized by their fluorescence. These "fluorescytes" normally form 0.1% of the red cells. No parallelism exists between the reticulocytosis in remission from pernicious anemia and the concentration of porphyrin in the erythrocytes, which reaches its maximum after the reticulocyte peak. This was confirmed by Watson and collaborators (2994). In pathological conditions up to 5% of the erythrocytes can consist of fluorescytes. In pernicious anemia the maximum porphyrin concentration reached during the response to liver therapy was 20–60 μg . per 100 ml., which then fell to 8–30 μg . per 100 ml. on continued treatment (2527). Similar observations were made by Vigliani and Sonzini (2886; cf. also 1631,2850).

In lead intoxication Vigliani and co-workers (2883,2884,2887, cf. 2582) found the protoporphyrin content of the erythrocytes to rise to very high values (200–1,000 μg . per 100 ml.), while Kench and co-workers (1515) found only 50–60 μg . per 100 ml., there being more protoporphyrin in the plasma than in the corpuscles. In fevers and catarrhal jaundice the protoporphyrin content of the corpuscles is also raised (229,2886). High values are also found in iron deficiency (2991a) and in chronic infections (412).

Borst and Königsdörffer (321,322) and Duesberg (638,639) observed porphyrin fluorescence in the erythroblasts and megaloblasts of the embryonic bone marrow, as well as in the bone marrow in pernicious anemia. While the former has been confirmed by later investigators, Seggel (2527) found no fluorescent cells and Stacey and McCord (2615) no protoporphyrin in the megaloblastic marrow of pernicious anemia; the latter workers showed, however, that protoporphyrin appeared when the marrow became normoblastic in response to liver therapy. Turner (2836) found porphyrin fluorescence in the megaloblasts of the fox squirrel. According to Fischer and co-workers (833), coproporphyrin is increased in the pernicious anemia marrow, but this cannot be observed regularly (cf. Vannotti, 2850). In the bone marrow of the six-month-old human fetus, Borst and Königsdörffer observed copro- and uroporphyrins in addition to protoporphyrin.

Porphyrin in the plasma. The concentration of coproporphyrin in the plasma, where it must be assumed to be present, is evidently very small. Fischer and Zerweck (890) found traces, but none was detected by other workers (2101,2466,2496a,2508,2850). It occurs, however, in the plasma in porphyria, obstructive jaundice, nephritis, and lead intoxication (2850), and also in the plasma of the fetus and newborn (Fikentscher, 758). In heavy lead intoxication it may be accompanied by protoporphyrin (2883), in porphyria by uroporphyrin (2494).

Occurrence of porphyrins in other parts of the human body. Until recently there was little evidence of the occurrence of free porphyrin in the human body as a normal constituent, with the exception of that of erythrocytes and excreta (cf. Section 3.3.). In the fresh muscle Schumm (2494) found no porphyrin, although it is formed in autolysis. The traces of porphyrin observed

by their fluorescence on teeth, in the saliva, on the tongue, the openings of the sebaceous glands of the nasolabial region, and on the genitalia of women (230,313,405-407,2850) are probably bacterial products. Porphyrin fluorescence has been observed in corpora lutea.

Recently Klüver (1551) discovered coproporphyrin and probably small amounts of protoporphyrin in the white matter of the nervous system of men and warm-blooded animals by fluorescence spectroscopy *in situ* and by the investigation of extracts. The porphyrin is not present at birth but is found in the spinal cord after three weeks in rats and eight weeks in ducks, while it develops later in the brain. It appears to be chiefly a characteristic of sensory nerves and is found only in regions in which little or no cytochrome c is present.

Pathologically, coproporphyrin and uroporphyrin are widely distributed in the body in congenital porphyria (Fischer, 833,876; Schumm, 2493; Borst and Königsdörffer, 322; Rimington, 922) and also in acute porphyria (Prunty, 2193). Uroporphyrin has not been observed in plasma and bile, coproporphyrin not in the bones. Protoporphyrin has been found in the liver in porphyria (833,2193) and in acute pellagra (1004), but also in normal animal livers (833, 2260). Its presence in chloroma and myeloid leukemia has been established by Thomas (2796,2798, cf. also 3172). The green color of the tumor is, however, not due to the presence of the porphyrin (cf. Chapter XI, Section 7.4.).

Porphyrin in the bile. In human fistula bile only coproporphyrin, and perhaps mesoporphyrin (1063), has been found, while neither Watson (2986), nor Vigliani (2882) could detect protoporphyrin. Rabbit bile also contains coproporphyrin, dog bile none or very little (406). After administration of lead, protoporphyrin has been found in the bile (2912). Ox bile contains in addition porphyrins derived from chlorophyll, such as phylloporphyrin (2351,2354) and phylloerythrin. In man chlorophyll probably gives rise only to weakly basic porphyrins, such as phylloerythrin, which is also found in the feces (Brugsch, 366).

Deposition of uroporphyrin in bones. Uroporphyrin is normally deposited in fetal bones (Fikentscher, 758) in small amounts; in much larger amounts it is found in the bones in congenital porphyria of man and animals (cf. Sec. 3.3.4.). This was first observed in the case of a patient, Petry, by Fischer (779,781,782,784,785,833,845) and Schumm (2506) and confirmed by other workers (447,755,922,923, 2257). Fränkel (939, cf. also 759,767,772,2148) found that uroporphyrin injected into guinea pigs is deposited in young growing bones and teeth, and also in new bone formation after fractures.

Uroporphyrin III if injected is deposited in the same manner as uroporphyrin I (264; *cf.*, however, Section 3.3.4.).

3.2.3. Destruction of Porphyrins. Injected uroporphyrin or protoporphyrin is destroyed to a large extent (Günther, 1070; Schreus and Carrié, 406,2467; Vigliani, 2882), but some uroporphyrin appears in the urine (1070). If the kidney is perfused with porphyrin solutions, uroporphyrin passes rapidly into the urine, coproporphyrin more slowly and protoporphyrin not at all (Grotepass and Hulst, 1064). Earlier claims of Schreus and Carrié (2467) that protoporphyrin is converted by the liver into bile pigment, have been abandoned by these workers (406). Watson and co-workers (2424,2997) also found no increase of bile pigment in the bile, when the liver of dogs or rabbits was perfused with protoporphyrin solutions, although 98% of the porphyrin disappeared. It has been reported (2137) that normal liver bile, not that of liver damaged by sulfonal, destroys coproporphyrin rapidly. Dobriner (601), however, recovered 70% of injected coproporphyrin I in the bile of fistula dogs, and Vigliani (2882) 50% of coproporphyrin I and 20% of coproporphyrin III in the human fistula bile. Coproporphyrin is thus less readily destroyed than protoporphyrin. The difference in recovery of coproporphyrins I and III supports the suggestion of Watson (2986) that the former is more readily excreted by the liver.

3.2.4. Conversions of One Porphyrin to Another. No evidence for conversion of protoporphyrin to uroporphyrin has been found when the former is destroyed in the liver (Schreus and Carrié, 2467; van den Bergh, 229).

It would be of great importance to know whether protoporphyrin can be converted into coproporphyrin in animal metabolism, but the evidence available can at best be considered as suggestive and has been considerably weakened by more recent experiments.

As will be seen in Section 3.3.5. there is also no reliable evidence for conversion of protoporphyrin into coproporphyrin by intestinal bacteria. Several workers (Papendieck, 2101; Schumm, 2492,2493,2495,2499,2503,2506; Fischer, 788,793; Brugsch, 365) have observed that meat diet increased coproporphyrin excretion in the urine and Papendieck (2103) that it increased fecal coproporphyrin excretion. According to Fischer and co-workers (832, 848), the excretion of coproporphyrin in the urine was increased by injections of protoporphyrin. An increase in the coproporphyrin content of organs as the result of absorption of protoporphyrin from the rectum was claimed by Kämmerer and Weisbecker (1455).

In no instance is there evidence, however, that the coproporphyrin thus formed was of type III. In fact it was apparently considered to be coproporphyrin I by Fischer (*cf.* 861, p. 479). In some instances the porphyrin classified as coproporphyrin was probably deuterio-, hemato-, or mesoporphyrin. This possibility was suggested later by Fischer himself (832; 861, p. 480) in explanation of the increase of "coproporphyrin" excretion

after protoporphyrin ingestion, as well as of the transformation of protoporphyrin to "coproporphyrin" by the liver, claimed by van den Bergh (*cf.* below). The influence of meat diet may be indirect, for instance, by an alteration of bacterial flora synthesizing coproporphyrin. The investigations quoted in the preceding paragraph were carried out in the years 1923-1926, at a time when the distinction between the various porphyrins was just being worked out, and when Fischer still assumed coproporphyrin to be the iron-free prosthetic group of myohemoglobin. It is evident that he later considered the results doubtful. In recent experiments, Zeligman (3173) found no evidence for an increase of urinary coproporphyrin excretion in the rat after injection of protoporphyrin.

Van den Bergh and co-workers (222,229) found that lead, arsphenamine, and mercury increased the protoporphyrin content of erythrocytes in parallel with the coproporphyrin excretion in the urine. Chalmers and co-workers (421) suggest that formic acid formed from methyl chloride may cause the transformation of uroporphyrin to coproporphyrin, and thus cause the increased coproporphyrin III excretion in this disease; this can, however, be interpreted differently (*cf.* Chapter XIII).

Finally van den Bergh and co-workers (229) found coproporphyrin in addition to protoporphyrin in rabbit bile, after perfusion of the liver with defibrinated blood containing protoporphyrin. This important experiment of van den Bergh could, however, not be confirmed by several workers. Vigliani (2882) found only protoporphyrin to be excreted in the human fistula bile. Watson and co-workers (2997) recovered only 2% of the protoporphyrin (injected intravenously or subcutaneously) in the coproporphyrin fraction of dog bile, and this consisted of coproporphyrin I and some "pseudodeutero-porphyrin." After injection of protoporphyrin into the portal vein of rabbits Salzburg and Watson (2424) found no coproporphyrin in bile or feces.

The parallelism of erythrocyte protoporphyrin and urinary coproporphyrin has also not been confirmed by Seggel (2527). In remission from pernicious anemia, for instance, a high protoporphyrin content of the erythrocytes goes hand in hand with a decrease of coproporphyrin excretion in urine and feces (Dobriner and Barker, 601). The coproporphyrin in pernicious anemia and other diseases is of type I and could not have been derived from protoporphyrin (*cf.* below).

The question of the ultimate fate of the protoporphyrin in the corpuscles must be left open; it may be excreted as such, converted into coproporphyrin, or destroyed.

3.2.5. Influence of Liver and Kidney on Urinary Porphyrin Excretion. Urinary porphyrin excretion has more often been determined quantitatively

than fecal excretion. This is not only due to the greater ease with which urinary porphyrin can be estimated, but also to the fact that the fecal porphyrin is not solely derived from endogenous metabolism (cf. Section 3.3.) and depends on the diet.

Unfortunately urinary porphyrin excretion cannot be considered a safe measure of porphyrin formation, since it is influenced by the state of liver and kidney, particularly of the former. A damaged liver excretes the porphyrin less readily into the bile and hence more passes into the general circulation and is excreted in the urine. The normal ratio of urinary to fecal porphyrins was found to be 0.07 to 0.24 by Nesbitt and Snell (2039) and somewhat higher (0.2 to 0.6) by other workers (367,1767). In liver diseases it is increased to 0.8 to 22.0. It is, for instance, increased in biliary obstruction and returns to normal after relief by operation. Conversely, a badly diseased kidney is unable to excrete porphyrin (Nesbitt, 2037). Since porphyrinuria is often absent in pernicious anemia (Hopkins, 1333; Garrod, 981) and, when it occurs, is often accompanied by urobilinuria (890,2985), Watson believes that liver disturbance plays a role in causing porphyrinuria in this disease. Liver disturbance is also the cause of the porphyrinuria in alcoholic pellagra (2272).

There is, however, a real increase of porphyrin formation in liver diseases in addition to the proportionally larger excretion through the kidney (cf. 406,1630,2798,2976).

3.2.6. Porphyrin Metabolism in Other Species. Some mammals have a porphyrin metabolism very different from that of man. This seems to be particularly true of rodents. In the fox squirrel, *Sciurus niger*, for instance, porphyrin metabolism is similar to that of a patient with congenital porphyria rather than to the normal human metabolism (Turner, 2836). More attention should be paid to the fact that the porphyrin metabolism of rats and mice is also remarkably different from that in humans.

Comparatively large amounts of porphyrin (about 300 $\mu\text{g.}$) are found in the Harderian gland of the rat eye (561,2798,2821), the gland of the female rat being richer in porphyrin than that of the male (2688). According to the careful study of Thomas (2798) the porphyrin is synthesized in the gland itself, while in anemia it acts as a reserve store for hemoglobin synthesis. The protoporphyrin which is always found in rat feces (1379,1713,2270,2478) may originate in the Harderian gland.

"Blood-caked whiskers" is another phenomenon of porphyrin metabolism connected with the Harderian gland; the relation of this to protoporphyrin formation in the gland is not yet clear. Chick and co-workers (436) and Tashiro and co-workers (2740) found that the "blood-caked whiskers" of the rat are not due to hemoglobin as was previously assumed, but to por-

phyrin. The last-named authors termed the phenomenon "chromodacryorrhoea," the flow of colored tears. The phenomenon could be caused by feeding rats a diet lacking in vitamin B factors. The missing factor was later found to be pantothenic acid by Figge and Salomon (754) and Smith (2581). Since Ellinger and co-workers (664) had observed, several years before the investigation of Chick, that coproporphyrin excretion in the rat was increased in the urine of rats deprived of B vitamins, chromodacryorrhoea appeared to be further evidence of an increase of porphyrin formation. Figge and Salomon showed, however, that pantothenic acid affects the gland locally (*cf.* also Smith). The direct effect of the vitamin lack is on water metabolism, and the phenomenon can also be caused by withholding water. The excretion of the gland, which normally finds its way via the nasolacrimal duct into the alimentary canal, becomes gluey, remains around the eyes and nose, and is smeared over the face in the efforts of the animal to clean itself.

A difficult problem is raised by the observation of McElroy and co-workers (1807) that the porphyrin in chromodacryorrhoea is predominantly coproporphyrin, not protoporphyrin, as Chick and co-workers had assumed. This appears to be neither in harmony with the interpretation of the action of pantothenic acid given by Figge and Salomon, nor with the claim of Thomas that the porphyrin metabolism of the gland is not affected by an increase of coproporphyrin formation in the animal. If the protoporphyrin of the gland is normally excreted in the feces, it should be found in the red smear of chromodacryorrhoea, when the normal way is blocked; if the blocking of this way leads to an accumulation of coproporphyrin in the smear, this porphyrin must be either formed in the gland or accumulated from the general circulation, and should normally pass into the excreta.

Protoporphyrin is also found in the placenta of rats and mice in the later part of the period of gestation (Thomas, 2798).

The occurrence of protoporphyrin in the shells of bird eggs has been mentioned in Chapter III, Section 1.2. Little is yet known about the formation of the porphyrin in the mother bird and the way it is deposited in the egg shells. Giersberg (997) found that the porphyrin is conveyed in wandering cells which penetrate the uterine epithelium in the final stages of calcification of the shell. Derrien and Turchini (560,561,2835) observed red fluorescence in the uterus of the laying hen and porphyrin granules in the uterine epithelium; these were not found, however, by Richardson (2246). According to van den Bergh and Grotepass (228) glands of the uterus excrete the porphyrin together with calcium albuminate. Possibly the mode of deposition of protoporphyrin in hen eggs, in which the whole of the shell is impregnated with a small amount of porphyrin, differs from that in other bird eggs, in which blotches of a porphyrin protein compound are found only on the surface of the shell. In bird feathers coproporphyrin III has been found (2898).

Other isolated observations on the occurrence of porphyrins in nature have been discussed in Chapter III; nothing is known about their physiological significance. The formation of porphyrins by microorganisms will be discussed below (Section 3.3.5.).

3.3. Excretion of Porphyrins

3.3.1. Introduction. Porphyrin was first observed in the human urine by Baumstark in 1874 (195). In 1891 Salkowsky found it in the urine after sulfonal administration (2418). Soon afterward Garrod published his classic studies on what we now call porphyrias, congenital diseases in which large amounts of porphyrin are excreted in the urine. Among the pioneers were Saillet (2414) and Stockvis (2671). Saillet and Garrod were the first to discover small amounts of porphyrin in the normal human urine.

At that time hematoporphyrin was the only porphyrin known, and the term "hematoporphyrinuria" is still used in many medicine and physiology textbooks (*cf.* 2614). We now know from the work of H. Fischer and Schumm that the porphyrin predominant in both feces and normal urine is coproporphyrin. This is accompanied in the urine by traces of uroporphyrin (2494). Protoporphyrin does not occur in the urine. One claim that it does so, by Boas (299), is evidently due to a confusion with mesobiliviolin.

3.3.2. Excretion of Porphyrins of Isomeride Types I and III. We have discussed the isomerism of porphyrins in Chapter III and have seen that of the four possible types of isomerides of porphyrins which contain four each of two different kinds of side chains, such as copro- and uroporphyrins, only two are found in nature, type I with alternating arrangement and type III with dissymmetrical arrangement. The protoporphyrin of hemoglobin and that found free in nature have always been of type IX (*cf.* above), which on conversion to coproporphyrin would yield coproporphyrin III. From the structure of the porphyrins of type I and type III it is clear that a conversion of one to the other cannot occur without far-reaching decomposition and resynthesis, which is unlikely (dualism of the porphyrins, H. Fischer).

It is of historical interest and necessary for the understanding of Fischer's earlier papers to note that his term "dualism of the porphyrins" had at first a different meaning. It referred to the difference between proto- and coproporphyrins, and it was then assumed that a similar dualism of hemoglobins existed, protoporphyrin being derived from hemoglobin, coproporphyrin from myohemoglobin (*e.g.*, Fischer and Schneller, 876). This idea had later to be abandoned, but the same term was then used in the new meaning.

In 1930 Fischer (795) claimed to have obtained evidence for a type II mesoporphyrin occurring in hemoglobin. This evidence,

however, was of the weakest kind, being based on a difference of the melting point depression obtained on mixing natural and synthetic mesoporphyrin IX methyl esters with mesoporphyrin II ester. The claim was later withdrawn in a somewhat obscure way (*cf.* 796,877; also Rimington, 2268).

A coproporphyrin derived from hemoglobin by decomposition can, therefore, be only coproporphyrin III, while both coproporphyrin I and coproporphyrin III may result as by-products of hemoglobin synthesis (*cf.* Chapter XIII). The isomeride type of the porphyrins found in the excreta is thus of physiologic interest, and has been studied by a large number of workers; in fact perhaps a disproportionately large amount of energy has been spent in the attempt to elucidate this problem.

We have already discussed the experimental difficulties of the separation of coproporphyrins I and III in Chapter III (Section 4.8.). The result depends on melting point determinations of crystals obtained by fractional crystallization. The uncertainties of the melting point determinations have been discussed in Chapter III, Section 3.4.1. The success of the fractional crystallization evidently depends a good deal on the amount of material available, the skill of the operator, on the presence of impurities, and the thoroughness with which mother liquors have been worked up. It is rather significant that no exact estimations of the porphyrin remaining in the mother liquor have been given, and that later investigators often found coproporphyrin III in addition to coproporphyrin I where earlier workers had only reported the latter (*cf.* below). While, on the one hand, the final evidence for the presence of coproporphyrin I is more certain than that for III, the latter may have escaped detection in the mother liquors.

With regard to uroporphyrin the difficulties are even greater. The investigations of Watson and co-workers (1056,3002) and of Prunty (2193) make it appear very doubtful whether the "uroporphyrin III" of Waldenström can be considered a uniform substance (*cf.* Chapter III, Section 3.4.2.); it probably contains a mixture of type I and type III porphyrins. The solubility of type III uroporphyrin in ethyl acetate does not appear to be always a reliable guide (*cf.* 2838), and there is no complete certainty about the melting points of uroporphyrins, which may be lowered by impurities or raised by complex salt formations with traces of metal.

Moreover, if, as Waldenström found, and as we have also observed in one case, the uroporphyrin is predominantly formed *in vitro* from dipyrrolic porphobilinogen (*cf.* Chapter IV, Section 8.3.), it is very unlikely that a single isomeride (particularly of the dissymmetrical type III) could arise. The claim of Waldenström and Wendt (2912) that porphyrin is formed in rabbit liver from injected porphobilinogen, has not been confirmed by Prunty (2192). It is possible that the porphyrin mixture formed by the action of acid on porphobilinogen *in vitro* differs from the uroporphyrin,

which in other instances of acute porphyria is certainly present as such in the body and in the urine (*cf.*, *e.g.*, Rau, 2213).

It should also be mentioned that the study of the isomerides has given some contradictory results and others which are hard to explain. We have mentioned in Chapter III that Fischer obtained coproporphyrin I on decarboxylation of the uroporphyrin of turacin, while Rimington obtained coproporphyrin III. Coproporphyrin I, not III, was found by Watson and co-workers (2997) after perfusion of protoporphyrin through the liver (*cf.* Section 3.2.4.).

3.3.3. Porphyrins in Normal Excreta. *Urine.* According to the most reliable modern estimations, between 0 and 120 μg . porphyrins per day are normally excreted in the urine (600,603,2039).

At first only coproporphyrin I was isolated from normal human urine (771,1298); later Watson (2985) and Fink (766) suspected an admixture of coproporphyrin III, and the latter was finally isolated in almost equal amounts by Grotepass (1062) from 10,000 liters of mixed urine. Dobriner and Rhoads (603) suspected that the mixed urines may have contained some pathologic urines, but, in view of the rarity of pathologic urines in which coproporphyrin III predominates, this can hardly explain the results of Grotepass.*

Feces. Between 150 and 400 μg . porphyrins per day are normally excreted in human feces (367,600,603,2039,2850). The meconium contains 2 μg . per 100 g. (980,2098,2099). The amount varies with the diet and part of it is not derived from endogenous metabolism, but is formed in the intestine from hematin compounds of the food or by microbial synthesis (*cf.* Section 4.5.). Hence, the study of fecal porphyrin excretion does not supply reliable evidence with regard to endogenous porphyrin formation in health, and gives also no clear indications of slightly increased porphyrin formation in disease unless the diet is carefully controlled. This has so far not been done, and the value of these studies on fecal porphyrin excretion is therefore limited. Coproporphyrin and traces of protoporphyrin are excreted in the feces even on a vegetarian diet (Fischer and Hilmer, 834), but their excretion is increased by ingestion of meat and blood (200,2506). Deuteroporphyrin occurs only after ingestion of blood or after hemorrhages into the gastrointestinal tract (297,298,1367). In the human feces coproporphyrin predominates, but protoporphyrin (2098,2099,2986), deuteroporphyrin (2970), and mesoporphyrin (1063,3170) have also been found. In normal human

* According to Watson and co-workers (3004aa), coproporphyrin III forms 8-35% of the total coproporphyrins.

feces (600,2986), meconium (2907,2908) and normal bile (2986) so far only the type I isomeride of coproporphyrin has been isolated. Uroporphyrin does not occur in normal feces and has also not been found in the feces in porphyria, unless the ester of melting point 208°C., isolated by Watson and co-workers (3002) from feces in acute porphyria is a uroporphyrin ester (*cf.* Chapter III). Uroporphyrin, being hydrophilic, is evidently not taken up by the liver, but passes into the urine. By subcutaneous injection of coproporphyrin, the coproporphyrin content of bile and feces was increased (Fischer and Hilmer, 832), while only traces of injected uroporphyrin are excreted in the feces (832,1070).

3.3.4. Porphyrins in Pathologic Excreta. *Porphyrinuria.* A distinction is now drawn between porphyrinuria and the porphyrias. Porphyrinuria is a symptom accompanying a variety of diseases, or is caused by the intake of certain drugs and poisons. The coproporphyrin content of the urine is moderately increased, rarely above 1 mg. per day, in lead poisoning occasionally up to several mg. per day. Porphyrias are rather rare congenital diseases in which the excretion of porphyrin (or its precursor) is greatly increased and is counted in milligrams rather than in micrograms. Here the porphyrin consists predominantly of uroporphyrin. The classic patient of congenital chronic porphyria, Petry, excreted no less than 200–600 mg. uroporphyrin per day.

Occasionally complex salts of porphyrins have been found in the urine. Porphyrins easily combine with traces of metal, but there is reliable evidence that the zinc salts of coproporphyrin and of uroporphyrin occur in the urine (201,427,559,1464,1465,1915,2040,2506,2837). The two absorption bands of zinc coproporphyrin at 577 and 541 $m\mu$ can be mistaken for the bands of oxyhemoglobin, but are easily differentiated by acidification with hydrochloric acid, which splits the zinc complex and develops the typical absorption spectrum of the porphyrin hydrochloride.

Porphyrin excretion in the urine is increased in a large number of diseases, in fever, liver diseases, anemias, polycythemia, pellagra, and skin and mental diseases (*cf.* the review of Dobriner and Rhoads, 603). In pernicious anemia this was first observed by Taylor (2746) in 1897. The porphyrinuria in lead intoxication was discovered early by Garrod (980) and Stokvis (2671). Francke and Litzner (945) found the porphyrin excretion to parallel the degree of lead intoxication so exactly that they suggested porphyrin estimations as a means of studying progress in lead poisoning.

The porphyrinogenic action of sulfonal and related drugs was discovered even before that of lead by Salkowsky (2418; *cf.* also 383,2041,2464). Bar-

biturates, chloral, cinchophen, and thiosinamine also have occasionally been found to cause porphyrinuria.

The large number of data on the excretion of porphyrins in diseases or after administration of drugs and poisons have been summarized in Tables I and II. It should be noted that so far only coproporphyrin III has been found in normal rabbit urine, while the isomeride type of the coproporphyrin

TABLE I
Excretion of Coproporphyrins in Disease and after Administration
of Drugs and Poisons

| Condition | Excreted in ^a | Isomeride type | References |
|---------------------------------------|---------------------------------------------------------|--------------------------------------------------------|---------------------------------------------------------------------------------------------------------|
| Hemolytic anemia | Urine Feces } | I | 599,2977,2985,2986 |
| Pernicious anemia | Urine Feces } | { I I > III | 600,601,2977,2978,2986 2885 |
| Aplastic anemia | Urine | I | 603 |
| Various diseases, fever | Urine | I + III (I occa- sionally missing) | 604 |
| Congenital chronic porphyria | Urine Feces } Urine (cattle) | { I I + III I + III (in vary- ing proportion) | 599,600,603,771,1733, 2975,2985 602,606,2257,2259 235,598,808,1025,1916 2257-2259,2261,2274 |
| Acute porphyria | Urine Feces } | { III III + I | 235,808,1302,2908,3022 427,845,2193 |
| Liver diseases | Urine | Usually I (+ III) | 599,600,604,605,2038, 2885,2976,2985 |
| Arsphenamines | Urine | Occasionally ^b III only | 599,600,604,605,1300, 2038,2885 |
| Aromatic amino and nitro compounds | Urine (rat) | III | 222,368,603,1299,1300, 2465 |
| Sulfonamides | Urine ^c Feces Urine (rat) ^d | III (+ I) No adequate study III | 752,2270,3004 2262,2271,2561,2577, 3077 |
| Mercury | Urine | III or type not established | 229,231,638,686,1515, 1741,2348,2885 |
| Lead | Urine | III (rarely I) | 600,808,1060,1062, 1299,1915,2885,2887, 2985 |
| Sulfonal | Feces ^e Urine (rabbit) Urine (rabbit) | I I (?) Type (?), not established | 604,2885,2986 2908 2912 |
| Methyl chloride | Feces (rabbit) Urine Feces } | Coprc (?) ^f III | 808,2424 421 |

^a Human excreta unless specified. ^b Mostly in alcoholic cirrhosis or after arsphenamines. ^c Not regularly increased. ^d Not always increased (1810,1667). ^e No adequate studies (cf. 603). ^f Probably a deuteroporphyrin, not coproporphyrin.

in normal rat urine is unknown. Observation of the predominance of coproporphyrin III in the urine of these animals has therefore not the same significance as it has in humans.

Porphyrinuria is usually, but not always (2842), accompanied by an increased excretion of coproporphyrin in the feces; this is usually of type I even when type III coproporphyrin is found in the urine, except in methyl

TABLE II
Excretion of Uroporphyrins in Diseases

| Condition | Excreted in ^a | Type | References |
|----------------------------------------|-----------------------------|-----------------------|---------------------------------------------------------------------------------------------------------|
| Congenital chronic porphyria | Urine (human, cattle, pigs) | { I I + III III | Fischer <i>et al.</i> , many papers (861) 835,2258,2261 427,835,1302,1914,2905,2906, 2908,2910 |
| Acute porphyria | Urine | | |
| Pernicious anemia ^b | Urine | III + I | 845,1299,1914,2193,2837 |
| Alcoholic liver cirrhosis ^b | Urine | (?) | 892,893 |
| Sulfonal ^c | Urine | (?) | 1300 |
| | | I | 808 |
| | | III | 665 |

^a Human urine unless specified. ^b Porphyria may have also been present. ^c In sensitive individuals.

chloride poisoning, where the fecal coproporphyrin is also of type III (421). Apparently the liver excretes coproporphyrin I more readily into the bile than coproporphyrin III (2986).

One may summarize these observations by stating that usually a mixture of the two isomerides is excreted, with type I prevailing in most diseases particularly in those in which blood pigment destruction is increased (Dobriner, Watson), type III prevailing only in some toxic porphyrinurias.* The physiologic significance of these observations will be discussed below.

Porphyrias. Chronic congenital porphyria is a disease inherited as a Mendelian recessive and characterized by the formation and excretion of enormous amounts of uroporphyrin and coproporphyrin in the urine, deposition of uroporphyrin in the bones, and light sensitization of the skin. The classic experiments of Garrod (982,1818) were followed by those of Günther (1070,1071), Borst and Königsdörffer (322), H. Fischer, Schumm, and many other investigators. Uroporphyrin was first isolated in the Petry case (see Sec. 3.2.2.) by Fischer (779,781,782,784,785,833,845) and Schumm (2506). In animals a disease of the same kind was first described as "ochronosis." Poulsen (2182) and Schmey (2445) discovered porphyrin in affected cattle, Tappeiner (2738) in pigs. Fink (764,767,772) and Fikentscher (755) established the essential similarity of this animal disease to chronic congenital

* Also in poliomyelitis (Watson and co-workers, 3004aa).

porphyria of men; this was confirmed by the work of Fourie, Rimington, and Clare (447,922,923,2257).

The so-called "acute porphyria" consists of recurrent attacks of another idiopathic, actually also chronic, disease, which is inherited as a Mendelian dominant (1070,2908). The typical skin lesions of chronic porphyria are absent, and the symptoms are nervous, neuromuscular, and abdominal. It is not so rare, particularly in women, and is frequently misdiagnosed. The urine contains varying amounts of uroporphyrin together with the dipyrrolic compound porphobilinogen (*cf.* Chapter IV, Section 5.3.). The test for the latter substance (Watson and Schwartz, 3000) is of diagnostic value. The coproporphyrin content of the urine is also occasionally, but not regularly, high.* No uroporphyrin is found in the bones (1914,2908).

Data on uroporphyrin excretion are summarized in Table II, while Table I gives data on the coproporphyrin excretion in porphyrias. In congenital chronic porphyria at first only uroporphyrin I was found, in acute porphyria only the "uroporphyrin III" of Waldenström. Later, however, both types were discovered to occur in both diseases, although type I appears to predominate in chronic, type III in acute porphyria.

3.3.5. Formation of Porphyrins by Bacterial Decomposition of Hematin Compounds. The formation of porphyrin in the intestine from hemoglobin of the diet has been studied by many workers (*cf.* Schumm, 2492,2493,2495,2499,2503,2506; Papendieck, 2098,2099,2103; Snapper, 2583,2585; Boas, 298-300; Fischer, 788,834; Hauowitz, 1160,1163). Protoporphyrin and deuteroporphyrin are the main products. Boas (297) claimed that finding deuteroporphyrin is of diagnostic value for the detection of hemorrhages in the gastrointestinal tract, but according to Häcker (1084) the test is of little value. Agreement has not yet been reached as to the microorganisms or groups of microorganisms which transform hemoglobin to protoporphyrin (1396,1424,1449).

By prolonged putrefaction of meat Schumm and Mertens (2510) and Fischer and Lindner (851) obtained deuteroporphyrin in addition to protoporphyrin. Bacteria are thus able to remove the two vinyl side chains of protoporphyrin. Coproporphyrin has also been found in traces, but not always (2494).

The autolysis of meat has been investigated by Hoagland (1296), Schumm (2494) and Fischer and co-workers (840,848,876). In acid autolysis much protoporphyrin was found, in autolysis in alkaline buffer much less. Coproporphyrin has only been found after several weeks of autolysis, particularly in alkaline buffers. In such experiments of long duration bacterial infection is hard to exclude and the coproporphyrin may have been formed by bacterial synthesis.

* The porphyrins are often excreted as zinc complexes.

There is one objection which may be raised against the methods applied in all these studies. If bacteria reduce oxyhemoglobin to hemoglobin, a small part of the latter may be split by the acetic acid used in the isolation of the porphyrin. This danger has been emphasized by Schumm (2496) as well as by Fischer (848), *cf.* also the study of the equilibrium between hemochrome and porphyrins by Vestling (2872).

The synthesis of porphyrins by microorganisms will be discussed in Chapter XIII. In a number of instances porphyrins observed in the human body or on the skin can be ascribed to such a synthesis. In others a formation by the action of bacteria on hemoglobin appears more likely. Figge and co-workers (751,753,1424) found several porphyrins in the exudates of female genitalia.

3.4. Is Pathological Porphyrin Formation Due to Deranged Breakdown of Hemoglobin?

3.4.1. Introduction. In Chapters X and XI it was shown that the normal catabolism of hemoglobin leads to bile pigment without free porphyrin appearing at any stage. This does not rule out the possibility that, particularly under pathologic conditions, a small fraction of hemoglobin may be catabolized in a series of reactions which lead to porphyrin.

Earlier workers (Garrod, Günther) assumed that the porphyrin formed in the human body in health as well as in disease arises by breakdown of hemoglobin. This theory is still held by several workers, particularly European workers (Schreus, 2464,2469; Carrié, 406, 1302; Vannotti, 2850; Vigliani, 2882; Paschkis, 2110). The investigations of Dobriner, Rhoads, Watson, Rimington, and Turner have, however, clearly demonstrated that the normal porphyrin formation as well as that in most diseases occurs during hemoglobin synthesis, not during hemoglobin breakdown. The evidence for this will be more fully discussed in Chapter XIII.

There is, however, reliable evidence (*cf.* Section 3.4.6.) that protoporphyrin can be formed by hemoglobin breakdown under certain conditions, although the protoporphyrin found in the erythrocytes is certainly not formed in this way.

3.4.2. Porphyrin in Hemolytic Diseases. The theory of porphyrin formation by hemoglobin breakdown was based partly on the finding of increased porphyrin formation in diseases in which an increased breakdown of hemoglobin was known to occur, such as

hemolytic anemia or pernicious anemia. We have seen, however, in Section 3.3.4. that in all these cases the coproporphyrin is of type I and thus cannot be derived from hemoglobin breakdown.

In the anemia of chronic infections both types I and III have been found, but the porphyrin formation is due to derangement of hemoglobin synthesis, not to hemoglobin breakdown (*cf.* Chapter XIII).

If we collect some of the arguments brought forward in support of the theory of porphyrin formation by hemoglobin breakdown, it is not difficult to recognize their speciousness. An abnormally high bile pigment excretion accompanying increased porphyrin excretion is accepted as evidence in favor of the theory; but so is an exceptionally low bile pigment excretion, which is assumed to be due to a competition between bile pigment and porphyrin formation from hemoglobin (Hoesch and Carrié, 1302). Increased hemoglobin breakdown is usually accompanied by increased hemopoiesis and the latter, not the hemoglobin breakdown, causes the increased porphyrin formation in hemolytic anemia or after phenylhydrazine (*cf.* Chapter XIII). Evidence in favor of porphyrin formation by hemoglobin breakdown, derived from parallel increase of bile pigment formation, is therefore of little value. Herold (1248) found the postnatal porphyrin excretion maximal at the third day of life, together with the peak of bilirubin excretion, but again the coproporphyrin is probably of type I (*cf.* Waldenström, 2908). The porphyrin of the chick embryo is formed during a stage at which little hemoglobin and probably no bile pigment is present and can hardly be formed by hemoglobin breakdown (Schönheyder, 2458); in the frequently quoted paper of Sendju (2530), bile pigment formation in the chick embryo had been studied by the entirely unreliable method of iodine titration.

Schreus and Carrié (2469) claimed that intravenous injection of hemoglobin caused porphyrinuria, but Duesberg (639) found no increase of porphyrin excretion after hemoglobin injection or after hemolysis caused by injection of distilled water or saponin. Thomas (2798) also failed to notice any increase of total porphyrin excretion in the rat by hemoglobin injection or intravascular hemolysis. Maugeri (1885) found the fecal protoporphyrin, but not the urinary porphyrin, increased by hemolysis.

3.4.3. Porphyrin in Liver Diseases and Porphyrria. Liver diseases, particularly yellow atrophy and carcinoma, are frequently accompanied by an increase of porphyrin excretion, not only in the urine (*cf.* Section 3.3.4.), but also in the feces. The hypothesis of a disturbed hemoglobin breakdown in the diseased liver leading to porphyrin formation has been supported particularly by Schreus and Carrié (406,2470), their evidence being based mainly on the demonstration of a decrease in erythrocyte numbers in the blood parallel with an increase in porphyrin excretion. Most of their experiments were carried out with arsenenamines (salvarsan) as a liver-damaging agent. Their claim to have demonstrated the formation of protoporphyrin from hemoglobin by the liver *in vitro*, is open to criticism; the porphyrin may have been set free from reduced hemoglobin by the action of acid (*cf.*

Section 3.3.5.). Their hypothesis has been supported by experiments of Thomas (2798). Not only was the total porphyrin excretion of rats increased by damaging the liver with manganese chloride or phosphorus, but in such animals it could be further increased by intravenous injection of hemoglobin, which left the porphyrin excretion of normal animals unaltered. The porphyrin metabolism of the rat differs, however, from that in men in that most of its excretory porphyrin is protoporphyrin, not coproporphyrin.

The porphyrin in the majority of human liver diseases cannot be derived from hemoglobin breakdown, since it is coproporphyrin I. Only in a few cases of alcoholic cirrhosis or after salvarsan, where coproporphyrin III has been found, can the mechanism assumed by Schreus and Thomas be at work.

The investigations on the isomeride type of porphyrins have thus restricted to a few diseases the possibility of assuming that porphyrin is formed from hemoglobin, these being a few cases of liver disease, aplastic anemia, acute porphyrias, and particularly toxic porphyriurias. There are, however, other reasons for rejecting the theory even in the majority of these diseases.

It appears improbable that porphyrin formation in aplastic anemia can be due to hemoglobin breakdown, since here it is the hemopoiesis which is affected. In acute porphyria, the nature of the breakdown products makes much more likely their formation by faulty hemoglobin synthesis than by faulty breakdown (*cf.* Chapter XIII). If the latter were correct, one would have to assume a special carboxylation of protoporphyrin to uroporphyrin combined with decomposition of a tetrapyrrolic to a dipyrrolic compound (porphobilinogen). Porphobilinogen has occasionally been mistaken for urobilinogen, since it also gives the Ehrlich aldehyde reaction, and the presumptive formation of urobilinogen has been taken as evidence of increased hemoglobin breakdown. On the other hand, Rau (2213) has claimed that urobilinogen is low where porphyrin is high, and conversely, and has explained this on the basis of the theory of competition between two modes of breakdown, which was first assumed by Garrod and later by Hoesch and Carrié (1302). Again Rau's "urobilinogen" was certainly porphobilinogen, and since this is the precursor of uroporphyrin in acute porphyria, the inverse ratio of porphyrin and porphobilinogen is only to be expected. If there were any competition between porphyrin and bile pigment formation, it should be found in chronic porphyria, where still larger amounts of porphyrin are formed; in this disease, however, the anemia is slight and normal bile pigment formation is observed.

3.4.4. Porphyrin in Lead Intoxication. In spite of the fact that the porphyrin excreted in lead poisoning is predominantly of type III, there is clear evidence that lead causes porphyrin formation by a derangement of hemoglobin synthesis.

Van den Bergh and Hyman (231) assumed that the porphyrin was formed from hemoglobin in the liver. Schreus and Carrié (2469) and Vigliani (2882, 2883) found a parallel between erythrocyte destruction and porphyrin formation.

Vigliani and Angeleri (2883) assume that the plasma porphyrin found in lead poisoning is derived from hemolysis, and that the porphyrin is protoporphyrin if the hemolysis is rapid, coproporphyrin if it is slow and the liver has time to convert proto- to coproporphyrin. It has been claimed that lead acts on the erythrocyte membrane increasing hemolysis by changing the permeability of the red cell wall (95,2081).

Hemolysis is, however, by no means a general feature of lead poisoning (cf. Vannotti, 2850; Maugeri, 1886); Francke and Litzner (945), Watson (2986) and Rimington (2259) found no increase of urobilinogen excretion by lead. According to Francke and Litzner, porphyrin excretion still remains high after the disappearance of the anemia, and becomes normal only a few weeks afterward, when increased hemopoiesis slows down. If hemoglobin is injected intravenously in patients with lead poisoning, the excretion of bilirubin is increased, while that of porphyrin is not affected (Kark and Meiklejohn, 1468). On the other hand, bleeding strongly increases the porphyrinemia and also the proto- and coproporphyrin content of the bone marrow (de Langen and Grotepass, 1641).

The theory of the hemolytic origin of the plasma porphyrin does not account for the presence of protoporphyrin in increased amounts in the erythrocytes, and postulates the conversion of protoporphyrin into coproporphyrin for which there is no evidence. Emminger and Battistini (686) found fluorescent erythroblasts in the bone marrow (cf. also 1641). In Chapter XIII it will be shown that the porphyrin in the fluorescytes is formed during hemoglobin synthesis.

Duesberg (638) and Rimington (2259) assume that the incorporation of iron into hemoglobin is inhibited by lead; cf. also Watson (2989, p. 2498). This theory will be discussed further in Chapter XIII.

3.4.5. Porphyrin Formation by Aromatic Amino Compounds. Rimington (2264,2271) and Brownlee (357) have studied the influence of a large number of aromatic amino compounds, *e.g.*, acetanilide, phenacetin, amidopyrine, aspirin, *p*-aminophenol, sulfonamides, and a few nitro compounds on porphyrin metabolism, and have found that the ability of these substances to cause formation of hemoglobin from hemoglobin is parallel to their ability to cause porphyrinuria in rats. 2-Methyl-1,4-naphthoquinone is another substance which causes hemoglobinemia as well as porphyrinuria (1566). Exceptions

have been noted, however; thus aspirin does not form hemoglobin, but causes porphyrinuria. The porphyrin was found to be coproporphyrin III, but this is of no great evidential value since the normal urinary porphyrin in rats may also be coproporphyrin III, but is not derived from hemoglobin breakdown (Thomas, 2798).

An increased fecal porphyrin excretion after injection of hematin in man, monkeys, and rabbits has also been mentioned, without full experimental data, by Rimington and Hemmings (2265,2271); the fecal porphyrin was found to consist of proto- and coproporphyrin. Rimington points out the repeated observations of "hematinemia" together with porphyrinuria; but in hemolytic anemia as well as in pernicious anemia, for which this is true, the porphyrin is of type I. It would appear a matter of interest to establish the nature of the excess coproporphyrin in the feces, which ought to be of type III, while so far only type I has been found in normal feces.

Rimington and, independently, Brownlee conclude that the aromatic amines, or substances derived from them, probably aminophenols, cause a deranged hemoglobin catabolism, in which hemoglobin, as a ferric hematin compound, is not converted to bile pigment but to porphyrin.

Quantitatively the porphyrin formation is on a small scale, and it is therefore certainly an exaggeration when Brownlee states: "Where hemoglobin is oxidised to methaemoglobin, the normal conversion into bilirubin cannot occur, but is replaced by degradation to coproporphyrin III."

No chemical explanation for the formation of porphyrin from hemoglobin is apparent. *In vitro*, ferrous heme compounds are transformed far more readily than ferric to porphyrin. Hemoglobin can thus hardly be considered a direct precursor of porphyrin. Rimington and Brownlee postulate an inhibition of bile pigment formation by hemoglobin formation, but so far there is no evidence for this. On the contrary, van Loon, Clark, and collaborators (448,1780) found that acetanilide and phenacetin increase serum bilirubin, and urobilin excretion is increased by sulfonamides (1667,3004). Many hemoglobin-forming substances also cause irreversible breakdown of hemoglobin to bile pigment, and we have met hemoglobin as an intermediate of choleglobin and biliverdin formation from hemoglobin (*cf.* Chapter X, Section 4.4.1.).

It is true that methemalbumin and hematin are transformed very slowly to bile pigment, if at all. There is, however, no relationship between hemoglobinemia and methemalbuminemia; there is no reliable evidence for increase of porphyrin formation under all conditions

under which methemalbuminemia would be expected (*cf.* Section 3.4.2.); and where methemalbuminemia is accompanied by increased porphyrin excretion, the nature of the porphyrin proves that it is not derived from methemalbumin or hemoglobin (*cf.* above). Our scepticism with regard to the theory of Rimington and Brownlee is shared by Heubner (1254).

An alternative hypothesis is that the aromatic amino compounds derange hemoglobin breakdown in the liver, as perhaps the arsphenamines do.

Finally, the possibility must be considered that the effect is on hemopoiesis rather than on hemoglobin breakdown. Van Loon, Clark, and collaborators (448,1780) found that acetanilide and phenacetin cause a marked increase of hemopoiesis in the bone marrow. They consider the reduced venous oxygen saturation in hemoglobinemia a stimulant of erythropoiesis. On the other hand, Watson and Spink (3004) found sulfonamides to cause a lowered color index of the blood, indicative of interference with hemoglobin synthesis. This will be further discussed in Chapter XIII.

3.4.6. Porphyrin Formation by Hemoglobin Breakdown. Summarizing the evidence discussed in Sections 3.4.2. to 3.4.5. one can state that only in a few instances (some cases of liver disease and toxic porphyrinurias caused by aromatic amino compounds) is porphyrin formation by hemoglobin breakdown likely and that even in these it has not been proved. To these instances may be added the porphyrinuria caused by methyl chloride for which another explanation will be suggested in Chapter XIII.

The term "hematoporphyrinuria" is, therefore, not only misleading with regard to the chemical nature of the porphyrin in the urine, but is also incorrect from a physiologic point of view since it implies formation of porphyrin from hemoglobin.

There can be no doubt that protoporphyrin can be formed in the animal body by hemoglobin breakdown without bacterial action. The protoporphyrin in bird egg shells and in the rat placenta (*cf.* Section 3.2.6.) are certainly derived from hemoglobin, and Thomas (2798) has shown that the damaged liver of the rat transforms hemoglobin to porphyrin, probably again protoporphyrin. The protoporphyrin found by Thomas (2798) in chloroma and in myeloid leukemia may also be derived from hemoglobin, although Thomas came to the conclusion that it was synthesized in the cells of the tumor (*cf.* Section 3.4.7.). There is at present no proof, however, that coproporphyrin or uroporphyrin can be formed in hemoglobin breakdown.

The mode of the transformation of hemoglobin to protoporphyrin is not yet fully understood. Thomas (2798) believes that a hematin c-like compound is an intermediate of porphyrin formation, since its iron is more readily removed by acid than that of protohematin. This hypothesis is unlikely for several reasons. First, the mode of formation of hematin c is not a simple reduction followed by oxidation as Thomas assumed, but involves irreversible changes of the side chains and, in some instances, also of the nucleus; in these changes the dithionite (used by Thomas as reducer) is involved. Second, the porphyrin obtainable from hematins c is ether insoluble; no transformation of porphyrin c to protoporphyrin in the body has been demonstrated, nor is it a reaction likely to occur. Third, ferrous heme compounds yield their iron quite as readily as hematins c; their formation *in vivo*, particularly in anoxic necrotic tissue, is to be expected. *In vitro* an unphysiologically low pH is required for the removal of the iron, but in the body the reaction is probably facilitated by chelating compounds which bind the iron in complex form (*cf.* the formation of biliverdin from choleglobin with ascorbic acid, Chapter X).

3.4.7. Porphyrin Formation from Other Hematin Compounds.

There is little evidence in favor of the assumption that porphyrin is derived from myohemoglobin. Fischer, who in earlier papers supported this assumption, later abandoned it (790). Weiss (3022) and Vannotti (2847,2848) believe it to be supported by the involvement of muscles in acute porphyria; and Vannotti (2847,2848) found porphyrinuria in a case of myositis, with porphyrin in heart muscle cells, kidneys, and bones, but not in the marrow. As we have seen above, the chemical findings in acute porphyria do not support this hypothesis.

Porphyrin formation from respiratory enzymes has also been assumed (599,1004,1474,2798,2908), but there is no real evidence in its favor (1516). We have mentioned that the porphyrin of yeast is certainly not derived from its cytochrome since it is mainly of type I. Thomas noted that cytochrome c injected intradermally was converted to a porphyrin, but the porphyrin was ether insoluble.

The presence of protoporphyrin in chloroma or myeloid leukemia has been explained by Thomas (2798) as due to a disturbance of peroxidase synthesis. While the cells from which the tumor is derived are rich in peroxidase, the tumor contains remarkably little, and Thomas assumes a hyperactivity of the synthesis of porphyrin normally used for peroxidase synthesis.

3.5. Pharmacology and Toxicology of Porphyrins

3.5.1. Photosensitization. If animals after injection of porphyrin solutions, or animals and patients suffering from chronic porphyria,

are exposed to sunlight or ultraviolet light, the skin is locally destroyed and death in shock may result. This photosensitizing action of porphyrins was discovered by Hausmann (1179,1180). A number of reviews on this subject are available (294,322,662,1070,1181,1182, cf. also 295,296). This dangerous action of porphyrins was also demonstrated in a self-experiment by Meyer-Betz (1931). Gaffron (966), Harris (1132), and Smetana (2575) showed that it consists in a photooxidation of proteins in the skin (cf. also 324,1351), while Thomas (2798) demonstrated the destruction of enzyme systems by photooxidation. Comparatively long-wave ultraviolet radiation of about 400-m μ wavelength is most effective. All these experiments were carried out with hematoporphyrin, but the photosensitizing action of physiologically important porphyrins on white mice was studied by Fischer and Zerweck (891). Uroporphyrin I was strongly active, coproporphyrin somewhat less, and proto- and hematoporphyrins only slightly; in man no sensitization by protoporphyrin has been found (875). Bingel (cf. 1914) found uroporphyrin III inactive in contradistinction to uroporphyrin I, and coproporphyrin III less active than coproporphyrin I. The embryo, in which uroporphyrin occurs, is not exposed to light, while the fox squirrel, in which it occurs physiologically, is protected against photosensitization by its black fur. Serum was observed to afford protection against photosensitization *in vitro* (2212,2546) but only with coproporphyrin, not with uroporphyrin (Gildemeister, 1000). It is not yet quite clear whether the lack of the photosensitization in acute porphyria is due to the smaller activity of uroporphyrin III or to the presence of the porphyrin in the body as an inactive, colorless precursor. Porphyrin formed from chlorophyll in the gastrointestinal tract of sheep has been found to be the cause of some animal diseases accompanied by photosensitization (445,446,519,2196,2256,2273).

3.5.2. Other Toxic Actions. The symptoms of acute porphyria and perhaps also of lead poisoning (Schreus, 2464) are due to different toxic actions of porphyrin, which do not depend on light. Porphyrins have been found to cause vascular spasms (1025,2212,2348,2469,2707, 2850) as well as intestinal spasms (2229,2464,2707,2850). They also probably cause the psychiatric disorders which frequently accompany acute porphyria (406,556,655,1070,1552,2349,2848,2850,2908); Baker and Watson (116) observed pathologic alterations of the myelin sheath in this disease.

It is, however, still unexplained why these toxic effects are not found in chronic porphyria, or, if found, at least occur far less strongly.

There is a suspicion that porphyrins are carcinogenic agents (Figge and co-workers, 751,753,1424; Strong, 2689).*

3.5.3. Physiologic Action. Hematoporphyrin has been used therapeutically by Hühnerfeld (775,1358) in nervous depressions and melancholia. He observed that it depressed blood calcium and increased hemopoiesis (cf. also 370). Two milligrams daily for fourteen days did not produce any damage (406). Klüver (1552) found that hematoporphyrin was not taken up by the white matter of rabbits, which normally contained some porphyrin (1551), but was accumulated in the pituitary gland.

According to Hinsberg and co-workers (1287,1289,1290) injections of proto- and hematoporphyrins increase protein metabolism and raise the secretion of melanophore-dispersing hormone from the pituitary in rabbits, and cause premature follicle formation in mice ovaries.

Based on their discovery that porphyrins other than protoporphyrin can competitively inhibit the formation of respiratory enzymes from protoporphyrin in *Hemophilus influenzae*, Granick and Gilder (1035) have advanced the interesting hypothesis that these porphyrins may be of physiologic importance as regulators of the formation of respiratory enzymes and of the consumption of oxygen.

* Cf., however, Bittner and Watson (283a).

CHAPTER XIII

FORMATION OF HEMOGLOBIN AND SYNTHESIS OF PORPHYRINS IN THE ANIMAL BODY

1. INTRODUCTION

Little is known about the formation of the hematin enzymes or of those hemoglobins (erythrocruorins) which are found circulating free in the plasma of some invertebrates. The bulk of our knowledge of the biochemistry and physiology of hematin synthesis is drawn from studies on the formation of hemoglobin in higher animals, in which hemoglobin is formed inside the erythrocytes. This introduces a complication, since it is often difficult to decide whether a substance with hemopoietic activity is required for the synthesis of hemoglobin, be it as building stone or as catalyst of the synthetic process ("hemopoiesis" in the narrower sense of the term), or for the building up of the red cell architecture, the "stroma," and the formation of a stable erythrocyte ("erythrocytopoiesis" or "cytopoiesis"). In more primitive organisms, however, it may be more difficult to separate the synthesis of hematin compounds from general cell synthesis than in the case of higher animals where considerable interference with the processes of hemoglobin synthesis is possible without endangering the life of the organism.

2. SOME HEMATOLOGIC DATA

Although it is beyond the scope of this book to give an introduction to hematology, certain essential anatomic and histologic facts are necessary for understanding the biochemistry of hemoglobin synthesis in the animal body.

2.1. Development of the Red Cell

In normal adult man erythrocytes are formed only in the red bone marrow. In periods of abnormal strain on the hemopoietic system, in certain anemias, foci of erythrocyte formation arise in liver, spleen, and lymph nodes (*cf.*, *e.g.*, 1112,2065).

Embryonically red blood cells are first formed in small blood islands in the yolk sac and possibly also in the body stalk, chorion, and embryo itself. These ultimately coalesce to form the circulatory system, and the primitive red cells multiply intravascularly. Next, hemopoiesis begins in the liver and, later still, to a small extent in the spleen and in other parts of the embryo (1005; *cf.* also Needham, 2017, pp. 590,599). In this period intravascular cell division stops. The red cells arise from mesodermic cells of undifferentiated potentialities; these hemocytoblasts develop into megaloblasts (nucleated) and later into megalocytes (nonnucleated), except in some species (cat, rabbit), where normoblastic formation is found during intravascular red cell formation (1888). In the period of hepatic red cell formation the smaller normoblasts begin to replace the megaloblasts. In the bone marrow of the normal adult, the normoblasts and normocytes are the only hemoglobin-containing cells found, while only normocytes are found in the circulating blood. The earlier idea that the megaloblast is a precursor of the normoblast in the development of the red cell in the adult has been abandoned (1385). In some pathologic conditions, such as pernicious anemia, a reversion to the embryonic mode of red cell formation occurs, with megaloblasts and megalocytes in the bone marrow and circulating blood.

While in birds the cells retain their nucleus, the nucleus of the mammalian cell disintegrates before the cell is released from the intrasinusoidal capillaries of the bone marrow into the circulating blood. Only in pathologic conditions with hastened hemopoiesis are nucleated red cells found in the blood. Normally the cell enters the circulation as a reticulocyte. This no longer contains a nucleus, but a network of basophilic nature and unknown chemical structure is present, which is stained by brilliant cresyl blue. Reticulocytes number less than 1% of the erythrocytes of the circulating blood under normal conditions, but in periods of accelerated hemopoiesis the percentage may rise to 100.

The relationship of the various cell forms is briefly summarized below:

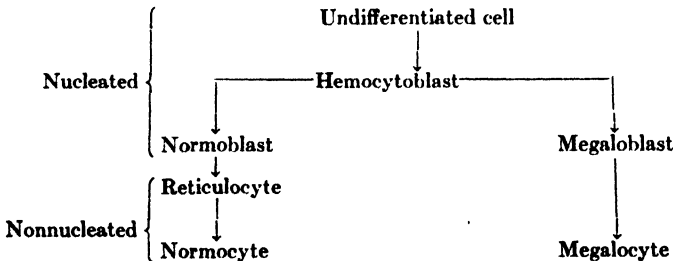

The maturation of reticulocytes proceeds in the circulating blood (1023, 1198,1224,1523,2249) in the course of 24-96 hours. Recent observations of

Jacobsen and Plum (1398-1400,2155-2158) have shown that the velocity of this process depends on the presence of a reticulocyte-ripening principle in the plasma. The nature of this principle is not yet fully elucidated. Liver and particularly stomach extracts contain a heat-labile substance, probably of purine character, which is activated by tyrosine and (more strongly) by hallachrome, the latter being assumed to be formed from tyrosine by tyrosinase, probably in the erythrocyte. The gastric factor appears to be combined with the activator in the reticuloendothelial system.

The appearance of hemoglobin in the red cell has been studied histologically by observing the change of the basophilic material of the cytoplasm into eosinophilic (orthochromatic) material. Some workers assume that the chromatin of the cell nucleus develops into hemoglobin (1796,2072,2250). This hypothesis needs modification in the light of modern knowledge on the role of nucleoproteins in protein synthesis.* In the embryo or when the megaloblastic red cell formation is found pathologically, hemoglobin appears early in the development of the cell, but in the normoblastic development in the normal adult it appears only in the later stages when the nucleus becomes pyknotic. Hemoglobin formation appears to be completed before the nucleus is extruded. Under conditions of hastened hemopoiesis, hemoglobinization may be almost completed in the nucleated and still dividing cells of the adult bone marrow (1386).

2.2. Quantitative Hematologic Data

In adult men the number of erythrocytes per mm.³ is about 5.4 million, in women about 4.8 million. The diameter of the normal mature erythrocyte is 7-8 μ , its average thickness 2 μ , its mean corpuscular volume 75-95 μ^3 . There are roughly 25×10^{12} erythrocytes in the circulating blood. According to modern estimations, the average hemoglobin content of the blood of adult men is 15.5 to 16 g. per 100 ml. blood. For women a figure of 14.0 to 14.5 g. per 100 ml. can be considered normal; frequently, however, smaller values for hemoglobin and erythrocyte count are found, since the larger physiologic demands for replacement of iron, due to blood loss in menstruation and pregnancy, are not completely met. By iron therapy, Widdowson and McCance (3069) were able to raise the hemoglobin content of the blood of women from 13.8 to 15.3 g. per 100 ml., while that of men remained unaltered. There is a definite need to distinguish between the average level of "healthy" women and a "normal" level, which should be obtained from individuals living under optimal conditions (*cf.* 646). This is a matter of social importance. The hemoglobin content of the blood of other omnivorous or

* B. Thorell (2799a) has recently shown that hemoglobin — at least its prosthetic group — is synthesized, after the protein synthesis from cytoplasmic ribose polynucleotides has been practically completed.

carnivorous mammals is about the same as that of man, while that of herbivorous animals is lower, 11–12 g. per 100 ml. (2234). There is a slight diurnal variation of the hemoglobin concentration, probably caused by excitement and splenic contraction (1802,1969).

The “*color index*,” which has been obtained by rather uncertain assumptions about what constitutes a “normal” hemoglobin content and erythrocyte count, should be discarded and replaced by the *mean corpuscular hemoglobin*, which is obtained by dividing the grams of hemoglobin per 1000 ml. of blood by the number of millions of erythrocytes per mm.³ of blood. It states the number of micrograms (10⁻¹² g.) of hemoglobin in a single erythrocyte and is normally about 30.

The *mean corpuscular hemoglobin* does not indicate whether an abnormally small or high value is due to a change of hemoglobin concentration in the cell, or to a variation in cell size. The concentration of hemoglobin in the cell is given as *mean corpuscular hemoglobin concentration*, which is obtained as a percentage by dividing the number of grams of hemoglobin per 100 ml. of blood by the volume of packed red cells per ml. of blood. The normal value is 35%. The mean corpuscular hemoglobin concentration is remarkably constant even in animals of different species, in spite of variations in size and number of erythrocytes (3102). Hyperchromicity of cells in the true sense of increased mean corpuscular hemoglobin concentration does not exist; the increased mean corpuscular hemoglobin of erythrocytes found, for instance, in pernicious anemia is simply due to the larger size of the cells. “Hypochromicity” may be due to a small cell size, or may be due to a smaller concentration of hemoglobin in the cell (true hypochromicity), or to both. The finding of an abnormally small mean corpuscular hemoglobin concentration is of importance since it indicates that hemoglobin formation is impaired to a greater extent than red cell formation.

At birth the hemoglobin content of the blood is very high (20–22%). While most workers assume that this is due to polycythemia, Wintrobe (3103,3104,3106) finds the erythrocyte count not above five million, and believes that the high hemoglobin content is largely due to the presence of large cells (cf. also Chapter XI, Section 6.5.). In Australia, Hicks (1271) found the average hemoglobin content at birth 22.3% and the average erythrocyte count 6.95 million.* During the first months or the first year of life the hemoglobin falls to a minimum of about 11 gram per cent, partly owing

* Smith (2575a), in the United States, gives somewhat lower values: hemoglobin, 20 g. per 100 ml.; erythrocytes, 5.5 million.

to a physiologically increased breakdown of hemoglobin (*cf.* Chapter XI, Section 6.5.) and partly owing probably to an exhaustion of iron reserves and a poor supply of iron in the milk. It seems to be significant that the time at which the minimum occurs has been found consistently shorter in more recent researches (2405,2408) than previously, probably because of the earlier supply to the baby of food rich in iron. Later the hemoglobin rises gradually to the adult level, the sex difference appearing only in the period of puberty.

3. REQUIREMENTS FOR HEMOGLOBIN SYNTHESIS IN THE ANIMAL BODY

3.1. Introduction

It is a difficult task to establish with certainty the significance of a given factor for hemoglobin synthesis. What is usually measured is the variation in hemoglobin concentration in the blood caused by the lack of a certain factor in the food or by its administration in excess. The difficulties involved in altering the supply of one factor without simultaneously altering others, some of which may be still unknown, have only gradually been overcome. If we neglect possible alterations in blood volume, the hemoglobin concentration depends on the balance of formation and destruction of hemoglobin; consequently before the absence of a factor can be said to diminish hemoglobin synthesis, it must be shown by measurement of bile pigment excretion that a decrease of hemoglobin is not due merely to increased destruction.

Even if all this has been accomplished, the problem is far from being solved. In Section 1. we have pointed out the difficulty of deciding whether a certain factor is required for the synthesis of hemoglobin or for the formation of the erythrocyte. It is also often difficult to decide whether a factor which by its chemical structure may be supposed to be required as a building stone of the hemoglobin molecule is actually required for this purpose, or whether it influences hemoglobin synthesis in an indirect way. There are varying degrees of indirectness in such a stimulating action. The substance may act as a catalyst of the intracellular hemoglobin synthesis itself, or of the formation of precursors in the cell or elsewhere. It may act upon another factor necessary for this synthesis, such as iron, by influencing mobilization from the depots or absorption from the intestine. Even more indirectly, it may influence the oxygen supply of the bone

marrow, which as we shall see exerts an influence on hemoglobin formation.

It is therefore not surprising that many substances are known which exert an influence on hemoglobin formation, but that we know very little about the way in which this action occurs.

3.2. Building Stones of Hemoglobin

3.2.1. Iron. It is obvious that iron is a building stone necessary for the synthesis of hemoglobin. The iron treatment of anemias was known to Hippocrates, but its practical use goes further back to sympathetic magic, the iron of rusted arms being imbibed in order to obtain its strength (1082). Iron is saved in the body with meticulous care; very little of the iron set free in hemoglobin breakdown is excreted (cf. Chapter XI, Section 10.2.), the remainder is stored and used once more for hemoglobin synthesis. It is still claimed by some workers that iron given intravenously or in the food, in addition to being a building stone of hemoglobin, acts as a stimulus (cf. Section 4.3.). The absorption of iron from the intestine and its incorporation in the hemoglobin molecule will be further discussed in Section 4.

3.2.2. The Porphyrin Nucleus. Neither preformed porphyrin nor pyrrole compounds are required for the synthesis of hemoglobin, and the potentialities of most organisms for synthesizing porphyrins are far in excess of the requirements. Lwoff and Lwoff (1789-1793) have discovered that most trypanosomes, some flagellates, and bacteria of the *Hemophilus influenzae* type require protohematin as growth substance for the synthesis of their respiratory ferment. This cannot be replaced by other blood or chlorophyll hematins, not even by cytochrome c. Granick and Gilder (1035) have shown that these organisms can combine iron with protoporphyrin, but lack the power of synthesizing the latter. Other porphyrins inhibit the synthesis of the respiratory ferments competitively, while porphyrin esters are neither useful, nor inhibitory. Many other microorganisms are, however, able to synthesize porphyrins and respiratory hematin enzymes (cf. Section 6.).

In mammals hematin in the food is useless as a source of the porphyrin nucleus of hemoglobin and is a poor source of iron. This was observed in 1895 by Cloetta (457) and confirmed by many workers (677,680,681,1257,1313,1753,3056). Only 10-25% of hemoglobin given by mouth is used for the formation of new hemoglobin (284,

1758,2544,3049) and this is not due to its pyrrole content, but to the fact that part of its iron is removed in the intestine (*cf.* Section 4.) and that use is made of the amino acids of the globin part. The small porphyrin content of the food is obviously insufficient for hemoglobin synthesis.

Claims that feeding porphyrins or chlorophyll increases hemoglobin formation have been made by Hughes and co-workers (1965) and by Kirkman (1938), although the experiments of the last-mentioned worker actually give very little support to his claim. Kohler, Elvehjem, and Hart (1962) found that chlorophyll, protoporphyrin, and bilirubin did not increase hemoglobin formation in rats made anemic by lack of copper, but supplied with iron. Robschey-Robbins and Whipple (2296) found that pyrrole compounds were unable to increase hemoglobin formation in dogs made anemic by bleeding and kept on standard salmon-bread diet. Zih (3180) also failed to observe any effect of chlorophyll on hemoglobin formation in humans.

Many workers (Brown, McMaster, Rous, Morawitz, Duesberg, Heilmeyer, Witts, Watson, and Whipple) assumed that bilirubin or other breakdown products of the prosthetic group of hemoglobin (the "pyrrole body complex" of Whipple) could be retained in the body and utilized for hemoglobin synthesis or even for bilirubin formation (3045,3053; but *cf.* 2372). This was partly based on experimental work of Brown, McMaster, and Rous (346) and Patek and Minot (2117,2118), and was partly due to lack of distinction between re-utilization of the globin and of the prosthetic group (Whipple). The later experiments of Whipple and his co-workers (516,1192,1193,1195, 1196,1584,1951,2548, *cf.* also Seyderhelm and Tammann, 2536) have clearly shown that the protein and iron of catabolized hemoglobin are carefully husbanded in the body and re-utilized for hemoglobin synthesis, while the prosthetic group is quantitatively excreted as bilirubin, even under conditions of severe anemia in dogs. These experiments prove that the ability of the animal body to synthesize the porphyrin nucleus is far in excess of its normal need. So far no conditions have been discovered in which the synthesis of the porphyrin nucleus becomes the limiting factor of hemoglobin formation (3061). From this it can be concluded that the actual precursors from which the porphyrin ring is formed must be relatively simple compounds, universally present in the animal body in large amounts. This does not necessarily exclude the possibility that breakdown products of the prosthetic group of hemoglobin, such as bilirubin, may stimulate hemoglobin formation in an indirect way; this will

be discussed in Section 5. The problem of the mode of porphyrin synthesis will be further discussed in later sections.

3.2.3. Globin. The metabolism of globin is intimately connected with the general protein metabolism of the body. Like iron and unlike the prosthetic group, the protein part of the catabolized hemoglobin is used once more in the synthesis of hemoglobin (Whipple and co-workers, 1090,1951,2291,2293,2298,3049,3051,3061-3063a). In aplastic anemia hemoglobin-forming factors, probably building stones of globin, are accumulated in the liver (3049). There is a ready exchange between protein reserve stores in the liver, plasma protein, and the protein used for hemoglobin synthesis (3054,3055). Whipple speaks of a protein pool, and considers the plasma protein as a medium of exchange, in physiologic equilibrium with red cell hemoglobin and stroma protein. Even the starved anemic dog produces considerable amounts of hemoglobin from tissue protein (523). A dog weighing 16 kg., which produces 60 g. hemoglobin per week on salmon-bread diet, can produce up to 100 g. if protein and iron are added to the diet. Plasma protein given intravenously is incorporated in hemoglobin if iron is available. When both plasma protein and hemoglobin are low, the protein synthesis is partitioned in the ratio of 2-4 g. hemoglobin per g. plasma protein. While additional protein has no effect on the copper deficiency anemia of rats (Pearson, Elvehjem, Hart, 2130), a protein lack anemia in rats can be produced (Orten and Orten, 2084).

Individual amino acids. It has often been reported that individual amino acids are of importance for hemopoiesis, but there is little satisfactory evidence.

Tryptophane has been claimed by several workers to be essential for hemoglobin formation (33,1110,1133), but Alcock (37) found no evidence that lack of tryptophane was able to produce anemia in rats or that tryptophane accelerated the recovery of rats from anemia produced by a milk diet. There is no valid evidence to support the assumption that tryptophane is required for the formation of the prosthetic group of hemoglobin. Thomas (2798) found that the porphyrin content of the Harderian glands of adult or growing rats was independent of tryptophane supply.*

Drabkin and Miller (630,631) found that several amino acids, particularly glutamic acid and arginine, cause recovery of milk-anemic rats fed additional iron, but no copper, while other amino acids were found inactive. They

* Cf. also Robscheit-Robbins, Miller, and Whipple (2294a), who found tryptophane to favor the formation of plasma protein rather than of hemoglobin in doubly depleted dogs, whereas arginine, lysine, and histidine favored hemoglobin formation.

believe that these amino acids are required for the synthesis of the prosthetic group. In view of the fact that glutamic acid is a building stone of folic acid and in view of the possible role of α -ketoglutaric acid in porphyrin synthesis (cf. Sections 3.3. and 8.) this observation is of some interest, but Elvejhem and co-workers (2130) have been unable to confirm it; they ascribe the results of Drabkin and Miller to contamination of the amino acids with copper (683).

Lack of lysine slows down the development of the hemopoietic system of growing rats, but causes no real anemia (1133). Deaminated casein, in which the ϵ -amino groups of lysine are replaced by hydroxyl, causes anemia in rats (1305), and this may well be another instance of competition by structural analogs.

Orten, Bourque, and Orten (2088) found that if ox globin, which contains little isoleucine, was the only protein fed to young rats, an anemia developed which could be abolished by feeding small amounts of this amino acid (cf. also 32,33). Rat hemoglobin is probably equally poor in isoleucine, but the isoleucine may be used predominantly for growth. Hemoglobin is also rather poor in methionine. In adult anemic dogs Whipple and co-workers (2292) found increase of hemoglobin synthesis and of plasma protein formation by addition of methionine, but not of isoleucine, to a hemoglobin diet. The difference between the results found with isoleucine is probably due to the fact that in Whipple's experiments the amino acid was required only for maintenance, not for growth.

In hemoglobin-depleted dogs, Whipple and Robscheit-Robbins (3061) found no large differences between the hemopoietic activity of various amino acids. The unphysiologic D-forms were quite as active as the L forms. Similarly none of the ten essential amino acids was found to be a key substance for hemopoiesis in rats anemic from lack of protein (Orten and Orten, 2085). Metcoff, Favour, and Stare (1918), studying the formation of total circulating hemoglobin in rats deficient in protein, found that inadequate hemoglobin synthesis is probably not wholly responsible for the anemia. The diminution of the erythrocyte volume was the predominant factor. Casein (perhaps due to its higher methionine content) was more effective in restoring hemoglobin than was lactalbumin.

According to Jacobson and Williams (1406) arginine is the only amino acid which may conceivably play a role in the effect of the antipernicious anemia principle. Jacobson and SubbaRow (1401,1402,2691) had claimed that tyrosine and perhaps tryptophane were of importance, but these amino acids were missing in other active preparations studied by Dakin and Karrer. Tyrosine is probably a factor in the reticulocyte-ripening principle (cf. above).

3.3, Factors Necessary for Hemopoiesis

3.3.1. Antipernicious Anemia Principle and Folic Acid. The principle is necessary for the correct maturation of the erythroblast to the normoblast in the bone marrow and the formation of a stable erythrocyte. It serves the building up of the architecture of the red

cell rather than hemoglobin synthesis; in recovery from pernicious anemia the increase of the erythrocyte count outstrips the increase in hemoglobin, while in relapse the cell is not hypochromic. It has also been suggested that the principle is required for the detoxication of endogenous aromatic (benzene) derivatives.

The nature of the liver principle is still unknown. It is formed by the action of an intrinsic factor, probably aminopolypeptidase on an extrinsic food factor. Castle (419) excluded all known vitamin B factors, including riboflavin and xanthopterin from identity with the extrinsic factor. On the other hand, according to recent investigations of Jacobson and collaborators (1404,1406), the gastric principle contains leucopterin or a similar pterin, perhaps in conjunction with another factor; xanthopterin appears to be less active than leucopterin. The opinion of SubbaRow and Jacobson (2690,2691) that the antipernicious anemia principle is of multiple nature is probably correct.* A polypeptide, L-tyrosine and a purine (pterin?) substance were found to play a role (1401), although tyrosine was not found in other preparations (cf. below). SubbaRow and co-workers (2692) isolated a "complex pterin" in the form of a crystalline salt of intense blue fluorescence, and Mazza and Penati (1892) found pterins in liver extract.

It appears likely that certain compounds isolated from the liver by West, Howe, and Dakin (525,526,3039) may also form part of the complex principle. These are a dipeptide of β -hydroxyglutamic acid with γ -hydroxyproline and a pyrrolidonecarboxylic acid, the former producing a strong, the latter a much smaller, reticulocytosis in pernicious anemia. The possible connection between these, particularly the latter, and porphyrin synthesis will be discussed in Section 8. The dipeptide may perhaps contribute to the glutamic acid part of folic acid.

Folic acid. Vitamin B₁₂, the lack of which causes macrocytic anemia of the chick (400,1304,1570,1786,2064,2147,2523), a similar factor required for hemopoiesis in the rat, particularly in rats treated with sulfasuxidine (103,279,285,524,1272,1569,1570,2205), but also without this drug (409), and the vitamin M necessary for blood formation in monkeys (546,2819) have now all been shown to be closely related to folic acid. The lack of other factors may also contribute to the macrocytic anemia of monkeys.

The chemical structure of the folic acid of the liver as pteroylglutamic acid has been elucidated by Angier and co-workers, who also achieved its synthesis (58). Pteric acid is pteridyl-*p*-aminobenzoic acid, pteridines being closely related in structure to pterins.

The effectiveness of folic acid in curing both pernicious anemia and macrocytic nutritional anemia has recently been demonstrated by

* Cf., however, the vitamin B₁₂ of Smith (2575b) and Rickes and co-workers (2248a), a cobalt compound.

Spies and co-workers (2600,2601), Watson (2991), Darby and co-workers (531), and Moore and co-workers (1981); *cf.* the review of Berry and Spies (248). The antipernicious anemia factor of the liver is not able to cure macrocytic nutritional anemia. Scott, Norris, and Heuser (2524) found that folic acid increases the speed of recovery from hemorrhagic anemia of the chick, but according to Spies microcytic anemia is not benefited by folic acid.

Liver extracts contain folic acid, but not in sufficient quantity to explain the action of the antipernicious anemia factor of liver. Comparatively large amounts (10–20 mg. daily) of folic acid are required to cure pernicious anemia. Macrocytic nutritional anemia is not due to lack of intrinsic factor (Spies and Payne, 2603), nor can folic acid be identical with the extrinsic factor, since it is active in the absence of normal gastric juice and when given parenterally. Spies suggested that the antipernicious anemia factor may liberate folic acid from a conjugate present in food and yeast. This is supported by recent experiments of Welch and co-workers (3027).^{*} Normal individuals, but not patients with pernicious anemia, convert the conjugate pteroylpolyglutamate of yeast to folic acid, which is excreted in the urine. Liver extract given to pernicious anemia patients increased their folic acid excretion, while normal gastric juice did not convert the conjugate to folic acid. Fresh rat liver is able to synthesize folic acid from pterins (Wright and Welch, 3128).

Nevertheless, the exact relationship between the actions of the liver factor and folic acid in pernicious anemia require further study. It is of interest that cure can also be effected by treatment with very large doses of thymine (2602), which suggests that the factors are required for nucleic acid synthesis. According to Davis (542) acetylcholine produces a macrocytic anemia and folic acid increases the acetylcholine esterase in the plasma.

3.3.2. Vitamins. It can now be considered reasonably established that the following vitamins are required for cytopoiesis or hemopoiesis: riboflavin (428,488,547,610,1013,1072,1563,1571,1948,2175,2599,2803,2904); pyridoxine (319,411,428,435,610,924,1364,1571,1819,1821,2579,3105); nicotinic acid (428,547,610,1013,1124,2235a); pantothenic acid (2745,2803); folic acid (*cf.* above); pterins (1820,2562,2819,2831,3128); vitamin D (53,545,959,1432,1547; *cf.*, however, 1806); ascorbic acid (428,643,722,911,1387,1814,1919,1920,1924,2331,

^{*} *Cf.* Heinle and Welch (1228a) and Bethell and co-workers (254a).

2860); with regard to ascorbic acid the evidence is still considered contradictory by some (1894,3103, cf. also 82,511,1784).

There is suggestive, but not conclusive, evidence for the hemopoietic activity of other vitamins. Mason and Mason (1880) found lack of thiamine to cause a macrocytic hypochromic anemia in man (cf. also 428), but Elvehjem and co-workers (1795) observed no impairment of hemoglobin synthesis in dogs bled regularly and supplied with the other vitamins of the B class. According to Kornberg, Tabor, and Sebrell (2803) thiamine has only a very slight effect on anemic rats. These workers found biotin inactive, but Sydenstricker, Isbell, and co-workers (2723) cured the anemia caused by egg white injury in man by biotin administration. Elvehjem and co-workers (2391) increased the hemoglobin content of the blood of anemic dogs to 11-14 gram per cent by a synthetic diet containing other vitamins of the B class without biotin, but found the latter able to cause a further increase. Scott and co-workers (2523,2524) found pyracins in addition to folic acid to hasten the recovery of the chicken from macrocytic anemia; this was not confirmed by Luckey, Elvehjem, and co-workers (1736). A correlation of *p*-aminobenzoic acid to hemopoiesis has been postulated by Vannotti (2853); this substance is a constituent of folic acid. It has also been claimed that vitamins A and P are required for hemopoiesis.

Some of the data on the significance of the vitamins of the B class must be treated with reserve. Recent work has drawn attention to the importance of bacterial synthesis of vitamins in the intestine, and the effect of a given vitamin on hemopoiesis may be due to its function as an essential growth factor for intestinal bacteria which produce some other vitamin actually required for hemopoiesis. Some of the work will probably have to be repeated when the interrelationships of the vitamins in the physiology of the host, the microorganisms, and the symbiosis between the two are better understood.

General inanition consequent upon vitamin deficiency may cause inhibition of hemopoiesis, and the effect of a particular vitamin on hemopoiesis may have been caused in some instances by abolition of inanition rather than by a particular effect on hemopoiesis.

About the way in which the vitamins act on hemopoiesis and cytopoiesis we have little certain knowledge.

Nicotinic acid, probably riboflavin, and possibly ascorbic acid act on the respiration of red cells and are required for the maturation of the erythrocyte rather than for the synthesis of hemoglobin. *Nicotinic acid* is required directly for the synthesis of the coenzyme in the erythrocyte, for which nicotinamide is far less effective (105,1124,1125,1295,1565,2427). According to Handler and Featherstone (1124) the lack of coenzyme in the immature red cell causes arrest of its maturation at the primitive erythroblast stage. The anemia is macrocytic; the mean corpuscular hemoglobin is slightly increased, but the mean corpuscular hemoglobin concentration is decreased. The total circulating hemoglobin is only 15% of the normal. Macrophages in the spleen are filled with hemosiderin and iron-containing cells are also found in the bone marrow.

The anemia caused by lack of *riboflavin* is hypochromic and microcytic (1072,2599); cf however (488). György and co-workers (1072) have speculated that the function of riboflavin is the production of the correct arrangement of amino acids for globin synthesis, but its necessity for respiration of the primitive red cell appears to be a more likely explanation.

In the case of *ascorbic acid*, its effect on red cell respiration and maturation is only one of several attempted explanations of the microcytic anemia of scurvy (Mettier and Chew, 1919; Minot and Castle, 1961; Menshikov, 1911). Barron and Barron (177) showed that ascorbic acid given together with cobalt prevents the appearance of polycythemia, and that it depresses the polycythemia produced by previous cobalt administration. They found that the respiration of the red cells of cobalt-polycythemic rabbits was greater than normal, and that addition of cobalt to the same cells *in vitro* depressed the respiration. They explained this by assuming that in consequence of the cobalt inhibition of the respiration of the immature cells in the bone marrow, these are thrown into the circulation at an earlier stage of development than normal; when removed from the influence of cobalt, the respiration is that of immature cells, and is subject to inhibition once again by *in vitro* addition of cobalt. The effect of ascorbic acid on cobalt polycythemia was explained by assuming that ascorbic acid binds cobalt and thus prevents its action.

Davis (539) confirmed the results of Barron and Barron, but suggested an alternative explanation for the action of ascorbic acid; he considers that this substance has a normal action in increasing the respiration of the red cells, this action being prevented by cobalt.

Other authors consider ascorbic acid a regulator of hemoglobin synthesis rather than of red cell maturation (Deeny, 550; Israels, 1892; MacFarlane, 1814; Fokina, 911). This is supported by studies on iron metabolism, and also by observations showing that deficiency of ascorbic acid and its subsequent replacement both affect the hemoglobin content of the blood more rapidly than they do the erythrocyte count. Heilmeyer and Plötner (1221) found that intravenous injection of iron ascorbate caused a greater increase of hemoglobin formation than corresponded to its iron content. A mobilization of iron from its depots may be assumed to account for this. MacFarlane (1814) assumes that this mobilization in turn may be due to a reduction by ascorbic acid of a ferric iron protein compound in the liver. This view agrees with the more general scheme put forward by Granick (1034), in which he assumes that the shift of ferric iron from ferritin is dependent on the $\text{Fe}^{2+} \rightleftharpoons \text{Fe}^{3+}$ equilibrium in the cell. In ascorbic acid deficiency the plasma iron, but not the liver iron, is decreased (de Braganza and Saka, 327a). All these investigations indicate that the primary action of ascorbic acid is on the mobilization of depot iron; this may also occur in the mucosa of the gastrointestinal tract, facilitating iron absorption.

Harrer and King (1131) found a moderate decrease of cytochrome oxidase in guinea pig heart and muscle in scurvy, in spite of the increased metabolism and tissue respiration; the significance of this observation is not yet clear.

The predominant feature of the anemia caused by *pyridoxine* deficiency is the hemosiderosis in spleen, liver, and bone marrow and the elevated plasma iron (411,1821,3105). The lack of hemoglobin formation alone does

not sufficiently explain the high plasma iron level; iron is absorbed from the intestine in increased amounts, or at least not in amounts decreased in accord with the increased plasma level. There are some similarities of the anemia caused by pyridoxine deficiency to pernicious anemia, in the increased storage of iron, in the hyperplasticity of the bone marrow, and in neurologic lesions. There is, however, no macrocytosis and no evidence for the increased hemoglobin breakdown, which are found in pernicious anemia. In addition, pernicious anemia is not cured by pyridoxine nor is the anemia of pyridoxine deficiency cured by the antipernicious anemia principle. It appears that an inhibition of hemoglobin synthesis and a failure of coordination between hemoglobin synthesis and iron absorption both play a part. The prevention of hemoglobin synthesis is evidently not due to an effect on iron mobilization, nor does it appear to be due to an indirect effect on copper metabolism (1821). Pyridoxine appears thus to be directly concerned with hemoglobin synthesis.

Pantothenic acid injected into eggs, or supplied to the hen, increases the rate of hemoglobin formation in the chick (2745).

Vitamin D improves the absorption of iron from the food, while it may also act in part indirectly through an influence on the calcium and phosphorus metabolism (545,959; cf. Section 3.3.4.). Bile fistula dogs become anemic unless *bile acids* are fed to them (2536,2731). Whipple and co-workers (1194) found that the bile fistula dog used iron fed *per os* inadequately for hemoglobin synthesis, while iron injected parenterally was fully used. They concluded from these experiments that bile acids were required for the absorption of iron from the intestine. Feeding of bile acids did not restore fully the ability of the animals to synthesize hemoglobin, and an additional disturbance of liver function was assumed. Smith and Crandall (510,2578), however, found no evidence for decreased absorption of iron from the intestine. They attributed the anemia to a failure to absorb the reticulocyte-ripening principle from the intestine. Recently Scott (2518) has shown that fistula dogs receiving fat-soluble vitamins parenterally can be kept free from anemia without bile therapy. Bile acids are therefore required for the absorption of these vitamins from the intestine.

The "secondary anemia liver factor." Whipple and co-workers (2295,3064) found that liver fed by mouth greatly increased the ability of their standard anemic dogs to synthesize hemoglobin. This liver fraction (the "secondary anemia liver factor") was different from the antipernicious anemia principle. Its activity could also not be attributed to its iron content alone (cf. also 114,170,1473,2859), although in human cases of vitamin deficiencies Moore and co-workers (1980) found that iron alone was sufficient to cure the anemia. The hemopoietic activity of the liver is clearly the sum of the activity of iron, copper, various vitamins of the B class and probably still unknown factors. Elvehjem and co-workers (1820) found liver almost, though not fully, replaceable by synthetic vitamins of the B class (*e.g.*, thiamine + riboflavin + pyridoxine + pantothenate + choline + inositol) together with bile salts, cysteine, xanthopterin, and asparagine. The riboflavin deficiency of monkeys was cured much more effectively by liver than by riboflavin (488), but Day and co-workers (547) found a combination of riboflavin,

nicotinamide, ascorbic acid, and thiamine rather effective in preventing anemia in monkeys on the Goldberger diet.

Summarizing, one may say that, with the possible exception of pyridoxine, pantothenic acid, and perhaps fractions of the anti-pernicious anemia principle, none of these substances exert a direct influence on the synthesis of hemoglobin in the bone marrow.

3.3.3. Minerals. There is a large literature on the effect of metals on hemopoiesis. We can only quote a few of these papers and refer the reader to the reviews of Schultze (2476), of McCance and Widdowson (1799), of Maynard and Loosli (1891) and of Elvehjem (678).

Copper. In 1928, Hart, Steenbock, Waddell, and Elvehjem (1140) found that rats on a milk diet developed an anemia which was not abolished by addition of iron, although this element was absorbed and stored in liver and spleen. Only when small amounts of copper were added to the diet did hemoglobin formation become possible. A rat requires 0.3 mg. iron and 0.01 mg. copper per day. In spite of findings to the contrary, it can now be considered as proved that small amounts of copper are needed for the synthesis of hemoglobin in the mammalian body (*cf.* 214,2015,2180,2481); this also holds for man (440,679,1378), although there is little evidence that copper deficiency is important in the etiology of microcytic anemia in the adult.

The erythrocytes in the anemia of copper deficiency are only slightly hypochromic, and copper has occasionally been observed to produce a marked rise in erythrocyte numbers with little increase of the hemoglobin concentration in the blood. This has led several workers to assume that copper is necessary for cytopoiesis rather than for hemopoiesis. The effect on hemoglobin formation is certainly of greater importance (*cf.* the discussion by Schultze, 2476, as well as 2580). Copper has little effect on the absorption of iron (681,1430,2520), but affects iron mobilization from the stores (Elvehjem and Sherman, 681; Sachs and co-workers, 2409; Copp and Greenberg, 439). Copper produces the typical reticulocyte response only in the presence of iron (2479). Cunningham (518) observed that copper decreases the inorganic iron content of the liver, while leaving its hematin iron content practically unaltered. He assumed that copper stimulates the synthesis of "hemochromogen" precursors of hemoglobin in the liver, but such an explanation is not acceptable in view of the fact that plasma iron is nonhematin iron and there is no evidence for a transport of preformed hematin from the liver to the bone marrow. In fact, his results are satisfactorily explained by mobilization of nonhematin iron from the liver by the action of copper.

In spite of the fact that the liver contains far more copper than the bone marrow, it appears more likely that it is within the latter that

copper acts on hemoglobin synthesis. This is supported by several observations. In many instances a decrease of the hemoglobin content of the blood is accompanied by an increase of the copper content of the plasma, and conversely an increase of hemoglobin by a decrease of plasma copper (2402, 2404, 2409). If hemopoiesis is stimulated by hemorrhage or phenylhydrazine, the iron content of the plasma decreases while the copper content increases (Sachs and co-workers, 2406; Heilmeyer, 1222; cf. Chapter XI, Section 10.3.2.). If the primary effect of copper were on the mobilization of iron in the liver, a high plasma iron should be expected. Normally plasma contains 0.10 to 0.13 mg. copper per 100 ml. The low copper content of fetal plasma and the high copper content of the fetal liver is attributed by Sachs and co-workers (2404) to the fact that in the fetus hemopoiesis proceeds in the liver rather than in the bone marrow; after birth the blood hemoglobin decreases, while the copper content of the plasma rises.

Copp and Greenberg (489) found that copper increases the rate of utilization of radioactive iron in the bone marrow. Schultze and Simmons (2484), studying the absorption of radioactive Cu^{64} in copper-deficient rats, found most of it to be retained in the kidney and liver, while less than 0.1 mg. entered the bone marrow in 24 hours. Nevertheless, a great increase of its cytochrome oxidase content could be observed, together with increased hemopoiesis (McCoy and Schultze, 1804). Copper is necessary for the maintenance and formation of cytochrome oxidase, and also of cytochrome a, in rat liver and heart (Cohen and Elvehjem, 459; Schultze, 2475). The cytochrome oxidase content of the bone marrow as well as the rate of hemopoiesis is higher in young rats, and is increased by low oxygen pressure or in recovery from severe anemia if copper is available.

It is not clear, however, whether copper acts directly on hemoglobin synthesis, or affects this only indirectly by its effect on the synthesis of the respiratory ferment. Cohen and Elvehjem (459) found that the synthesis of cytochrome a in the liver was affected by a degree of copper deficiency, which did not seriously affect hemopoiesis, and Schultze (2477) observed that the increase of the oxidase in the bone marrow by copper preceded the reticulocytosis; on the other hand Schultze (2475) found the synthesis of hemoglobin more sensitive to lack of copper than that of the respiratory ferment in the bone marrow.

Two different copper protein compounds, hemocuprein and hepatocuprein, have been isolated from erythrocytes and liver by Mann and Keilin (1866), but there is at present no evidence for their physiologic activity.* Hemocuprein completely accounts for the copper in the erythrocytes. Tompsett (2815) had suggested that the copper in the red cell may be present in the form of a mercaptide of glutathione. Elvehjem and co-workers (2180, 2480) were unable, however, to detect clear-cut relations between the effect of copper on hemopoiesis and the glutathione content of the erythrocytes.

Cobalt. The causation of anemia in sheep by cobalt deficiency was discovered by Filmer (961) and Marston (1877) in Australia, and is also found in cattle (2014); *cf.* the reviews of Huffmann and Duncan (1360) and Russell (2398).

Horses are not affected by it. Recently it has been found (*cf.* 1799) that cobalt prevents or cures the disease only if given by mouth and not if injected parenterally. It has been suggested that the metal acts on the bacteria of the rumen rather than on the host. In milk-anemic rats Frost and Elvehjem (957) found cobalt, in addition to iron and copper, necessary for the full restoration of hemoglobin, although under certain conditions an excess of cobalt had an opposite effect in young dogs (Elvehjem and co-workers, 956, 1820); it has also been found that cobalt stimulates hemopoiesis in the salamander (428).

Excess of cobalt causes a polycythemia and erythremia which was discovered by Waltner and Waltner (2915) and has been confirmed by many workers with different animals. It is accompanied by hyperplasia of the bone marrow and reticulocytosis. Cobalt certainly does not cause a decrease of hemoglobin catabolism, the blood bilirubin being higher than normal (2087), at least in the initial stages; in the later stages decreased phagocytosis has been observed (544, *cf.* also 1472).

The way in which the metal produces the polycythemia is still unknown. Since dilator drugs such as choline abolish it, Orten (2087) believed that cobalt caused primarily a vasoconstriction in the bone marrow with resulting anoxia. Barron and Barron (177) and Davis (538, 539), on the other hand, came to the conclusion that cobalt acted upon the respiration and maturation of the immature red cells (*cf.* Section 3.3.2.). Warren, Schubmehl, and Wood (2963) were unable to confirm either of these hypotheses and assume an action on the liver. Kato and Iob (1472) found no mobilization of liver iron by cobalt, but observed an increase of the nonhemoglobin

* *Cf.*, however, Holmberg and Laurell (1325a).

iron of the blood. Copp and Greenberg (489) showed, however, in experiments with radioactive iron that cobalt accelerates the rate of hemoglobin formation in the bone marrow and mobilizes liver iron.*

Other substances. The need of other trace metals for hemopoiesis or cytopoiesis has been claimed repeatedly, but there is little certain evidence. A small amount of manganese appears to be necessary for hemopoiesis in rats. This was first claimed by Titus and Cave (2806); while at first in doubt, it has more recently been confirmed (2571,2900). Arsenic, given in addition to manganese, is claimed to increase hemopoiesis still further (2571). A high calcium diet depresses hemoglobin formation (53,959,1547,2542), probably by interfering with iron absorption. On the other hand, Day and Stein (545, cf. also 53,2542) observed mild anemia (and polycythemia) caused by an excess of phosphorus over calcium. An extreme salt restriction increases the erythrocyte count but decreases hemoglobin formation; there is no evidence of increased breakdown of hemoglobin (Orten and Smith, 2089).

3.4. Control of Hemopoiesis by Endocrine Factors

According to Wintrobe (3103) a clear-cut relationship of endocrine factors to the development of anemia in man remains to be established. While there are some observations on the effect of hormones on hemopoiesis, there is no evidence that they act directly upon hemoglobin synthesis. The subject has been reviewed by Querido (2195).

Thyroxine and thyroid have been claimed to increase hemopoiesis. No immediate effect of thyroidectomy is, however, noticeable.† Wintrobe (3103) assumed that in some cases of myxedema the anemia may be caused by achlorhydria and lack of antipernicious anemia principle but the anemia is not benefited by the administration of liver extract (118). Thyroxine has been found to increase the blood copper level (2009).

Hypophysectomy causes anemia (1930,2395). Flaks and co-workers (905) observed reticulocytosis after feeding pituitary gland to rats, and assume the existence of a hemopoietic hormone in the pituitary. After hypophysectomy the stimulus of anoxia (cf. below) was found to be no longer effective in increasing hemopoiesis (1930). Anemia is found in pituitary hypoplasia — polycythemia and erythremia in diseases with pituitary hypertrophy (cf. 543). Witts and co-workers (2586) assume that the cause of the anemia may be achlorhydria. Prolan stimulates hemopoiesis (1574), while injections of large doses of pituitrin depress it (1003,1816).

Androgens stimulate hemopoiesis while estrogens depress it (762,1805, 2463,2619,2729). Insulin causes only a passing decrease, but animals chronically treated with insulin develop hyperplasia of the bone marrow (1658). Vagotonin has been found to increase hemopoiesis (1029). Adrenaline produces an increase of hemoglobin and erythrocyte number mainly by causing

* Cf. also Wintrobe and co-workers (3105a).

† Gordon and co-workers (1023b) found, however, hemoglobin synthesis after bleeding inhibited by thyroidectomy.

contraction of the spleen, but this may not be the only cause of the increase (*cf.* 543). According to Davis (542), acetylcholine produces a hyperchromic anemia, and the effects on the oxygen supply of the bone marrow hitherto ascribed to choline (*cf.* Section 5.2.) are actually due to acetylcholine.

4. ABSORPTION OF IRON AND ITS INCORPORATION IN THE HEMOGLOBIN MOLECULE

4.1. Iron Requirements

The normal daily food contains 10–30 mg. iron, but this is partially in a combined form which is not, or is very poorly, absorbed. Widdowson and McCance (3069) found the average daily intake of iron by men 16.8 mg., by women 11.4 mg. The latter was too small and caused a slight microcytic anemia cured by iron. 15–16 mg. is considered an adequate iron supply for adults (Medical Research Council Report, 1894), 5–6 mg. as the minimum. The iron loss in menstruation is about 50 mg. (higher in menorrhagia), in pregnancy about 900 mg., in lactation 1 to 1.5 mg. per day (Witts, 3114). The amounts actually required for hemoglobin synthesis are far smaller and decrease considerably after puberty, more so in men than in women (*cf.* 1197,3103). Absorption and utilization of 25 mg. iron causes 1% increase in the hemoglobin concentration of the blood.

Iron given intravenously is quantitatively transformed to hemoglobin by anemic dogs (Whipple and Robscheit-Robbins, 3060). The iron set free by hemoglobin breakdown is also retained for the synthesis of fresh hemoglobin with the exception of a small part (2–8%) which is excreted (*cf.* Chapter XI, Section 10.2.). Iron given by mouth, however, is only partly absorbed, and even the absorbed iron is incompletely used for hemoglobin synthesis, the remainder being stored in liver and spleen.

4.2. Absorption of Iron from the Gastrointestinal Tract

By experiments with radioactive iron (Fe^{59}) Whipple, Hahn, and co-workers have shown that the degree of absorption of iron from the gastrointestinal tract by dogs depends upon the amount of iron stored in the organs (120,1092). Nonanemic dogs absorb very little, anemic ones much more. Most of the iron is absorbed from the small intestine, some also from the stomach and duodenum (2290). The iron absorption depends on the presence or absence of iron stores rather than on the degree of anemia; while it takes several days to produce iron desaturation, physiologic iron saturation is produced in

a few hours and only small amounts of iron are absorbed. The experiments of Austoni and Greenberg (100) with Fe^{59} and those of Copp and Greenberg (489) with Fe^{55} on normal and irondeficient rats confirm the influence of the iron stores on the degree of iron absorption. The larger absorption of iron in anemic rats is due to the slower passage through the intestines, which is probably due to the lowered intestinal tone. Relatively more iron (30% of 0.05 mg.) was absorbed by the nonanemic rats than by nonanemic dogs; this was increased to over 90% in anemic rats (489).

The mechanism of the absorption of iron through the intestinal mucosa has been studied by Granick (1033) with interesting results. The saturation of the mucosa with iron is accompanied by an accumulation of ferritin which can be demonstrated by the observation of ferritin crystals in the mucosa after immersion in 10% cadmium sulfate. In normal growing guinea pigs ferritin can only be found in traces in the duodenal region (*cf.* also 308); nor is there any evidence for the presence of the iron-free apoferritin, which crystallizes as readily as ferritin in cadmium sulfate. When 10 mg. iron is fed, there is a marked increase of ferritin all along the gastrointestinal tract, on continued feeding even in the stomach. An equilibrium:

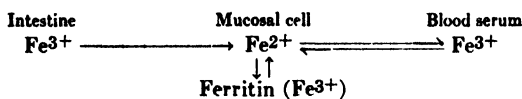

is postulated. Only when the ferritin in the mucosa cell is lowered by giving off iron to the blood can more iron be absorbed. Apparently the formation of apoferritin in the mucosal cell is the limiting factor of the rate of absorption.

It is still uncertain to what degree the absorption of large doses of iron given *per os* is subject to the same control. The use of high doses of iron in hypochromic anemia has been reintroduced into medical treatment by Lichtenstein (1734) and Meulengracht (1923), and its value is now generally recognized. Fowler and Barer (926) have, however, pointed out the danger of iron cirrhosis of the liver which may be incurred if large doses of iron are given over long periods.

4.3. Incorporation of Iron in the Hemoglobin Molecule

Experiments of Hahn, Whipple, and collaborators with radioactive iron (1091,1092,1094) fed to anemic dogs or man have shown that the

iron is incorporated in the hemoglobin of new red cells with remarkable speed. After four hours it was detected in the erythrocytes; after 24 hours one-third of the absorbed iron was incorporated in hemoglobin and in a few days the utilization was complete. The radioactive iron in the blood is in the form of hemoglobin not in that of inorganic or easily detachable iron (Miller and Hahn, 1950). In the human fetus, the formation of hemoglobin appears to be even faster than in the mother; more of the radioactive iron given to the mother shortly before termination of pregnancy was taken up by the fetal erythrocytes than by those of the mother (2168).

Similar results have been obtained with rats by Copp and Greenberg (489). They demonstrated the great rapidity with which the bone marrow takes up radioactive iron, given *per os* or intravenously. The maximum of iron concentration in the marrow is reached in less than one day and is followed by a fast decline due to the removal of the iron in form of erythrocyte hemoglobin, with a half-time of one to two days. In the recovery of rats from anemia the hemoglobin synthesis is still faster (489,1804). Scott and McCoy (2520) calculate that the total iron of rat bone marrow can be transformed to hemoglobin in one to two hours, the rate being perhaps even faster at the height of hemopoiesis.

In humans, however, the rate of hemoglobin synthesis in recovery from a mild degree of anemia, for instance in blood donors, is far less rapid (*cf.*, *e.g.*, 927). Evidently only a small part of the iron absorbed from the intestine is used for hemoglobin synthesis; a large part is stored (339,926,2226). The conditions under which the storage iron in the organs is released for hemoglobin synthesis in the bone marrow, and the transformation it undergoes before it is incorporated in the hemoglobin molecule in the red cells of the bone marrow are still incompletely understood. From studies with radioactive iron, Fe⁵⁹, Greenberg and Wintrobe (1048) conclude that in man about 130 mg. of iron constitute a metabolic iron pool which is readily available for hemoglobin synthesis.

Barer and Fowler (148,926) observed that the initial increase of hemoglobin in blood donors or anemic patients on iron therapy is followed by a decrease even if iron therapy is continued. Also iron fails to accelerate recovery of hemoglobin in blood donors after repeated bleedings followed by iron therapy. These observations have been taken as evidence for assuming that iron stimulates hemoglobin formation in addition to supplying a building stone for hemoglobin synthesis. It is, however, not clear why the iron stimulus should cease. Similar conclusions were drawn by Heilmeyer and Plötner

(1921) from the observation that iron ascorbate produced a greater hemoglobin formation than corresponded to its iron content. As has been pointed out, this may be explained more readily by assuming a mobilization of iron stores by ascorbic acid through reduction of ferritin iron.

There is an apparent lack of iron utilization for hemoglobin synthesis in the anemia of chronic infections, in which there is no evidence for increased hemolysis, lack of iron in the body, or aplasia of the bone marrow (2297, 2413). Cartwright, Wintrobe, and co-workers (412) and Schäfer (2432) have shown that the anemia is nevertheless, in a sense, an anemia of iron deficiency. The iron is accumulated in the inflamed (not necessarily infected) tissues* and not available for hemoglobin formation. Serum iron is very low and serum copper abnormally high. According to Hahn, Bale, and Whipple (1088) there may also be a decreased iron absorption.

5. RELATIONS BETWEEN HEMOGLOBIN FORMATION, HEMOGLOBIN CONCENTRATION IN THE BLOOD, AND HEMOGLOBIN DESTRUCTION

5.1. Introduction

The number of erythrocytes and the hemoglobin concentration in blood are to be considered as governed by the equilibrium between the processes of hemopoiesis and blood destruction. In anemias, of course, a sufficiently great alteration in the rate of hemopoiesis or breakdown may lead to a new equilibrium. In hemolytic anemia, for instance, increased blood destruction, being the cause of the disease, is found together with low hemoglobin concentration in the blood and increased hemopoiesis.

The equilibrium appears to be self-regulatory, a low hemoglobin content of the blood causing an increase of hemopoiesis, and conversely a high hemoglobin concentration a decrease of hemopoiesis (*cf.* 1962). Provided that the lifetime of the erythrocytes remains unaltered, the hemoglobin breakdown in the normal individual will be proportional to the number of cells in the circulation. If, after hemorrhage, newly formed blood with young erythrocytes replaces blood with erythrocytes of average age, the daily breakdown of cells will be diminished until the new cells have reached the end of their life span. These factors are, however, not the only ones involved in the regulation.

* Recent evidence indicates, however, that the incorporation of iron in the hemoglobin molecule is inhibited and that iron is stored in the liver (Greenberg and co-workers, 1050a) and in the bone marrow (Rath and Finch, 2212a).

5.2. Influence of Oxygen Tension and Anoxia of the Bone Marrow on Hemopoiesis

In 1890 Viault (2875) observed an increase of hemoglobin after ascent to high altitudes. It was later studied extensively by Barcroft (140), *cf.* also Hurtado and co-workers (1372,1373). This effect is due to the lowered oxygen tension, incomplete saturation of the hemoglobin with oxygen, and anoxia of the bone marrow acting as a stimulus to hemopoiesis. It can be produced experimentally in low-pressure chambers. The polycythemia of patients with pulmonary or cardiac diseases, that caused by administration of vasoconstrictor drugs (*cf.* 543), and perhaps also that caused by cobalt are also due to anoxia of the bone marrow. Polycythemia vera, a disease in which both red cell numbers and hemoglobin are greatly increased, has also been explained as due to the effect of arteriosclerosis on the oxygen supply of the bone marrow. The mechanism by which the anoxia of the bone marrow increases hemopoiesis is still unknown.* It has been suggested that hemopoiesis is sensitive to alteration in oxygen tension rather than to its absolute value (2285). This does not appear to be correct since dwellers at high altitudes show higher average hemoglobin concentrations and red cell counts than dwellers at sea level. The primary stimulus appears to be on hemoglobin formation rather than cytopoiesis, since the mean corpuscular hemoglobin increases before the erythrocyte count (2665). This is also supported by the observation of Hurtado and co-workers (1372), who observed an increase of myohemoglobin in dogs exposed to low oxygen tension. Conversely bone marrow activity and reticulocyte number are depressed by high oxygen pressure, by vasodilation caused by acetylcholine, or by raising the hemoglobin level above normal by blood transfusions (261,542,1369,2285), but some workers have been unable to find an effect of increased oxygen tension on hemoglobin regeneration.

5.3. Direct Relations between Hemoglobin Breakdown and Hemopoiesis

In addition to an indirect stimulus to hemopoiesis via anoxia in the bone marrow when abnormal hemoglobin breakdown occurs, the

* Anoxia *in vivo* may cause an "anoxic hyperoxia" by increase of respiration, arterial pressure, and cardiac rate. Rosin and Rachmilewitz (2342a) found that low oxygen tension decreased, and high oxygen tension increased, the rate of cell maturation and multiplication in bone marrow explants.

products of the breakdown themselves may act as stimulants. Since iron and globin are utilized for hemoglobin synthesis (*cf.* Sections 3.2.1. and 3.2.3.), there is good reason to believe that they accelerate hemopoiesis. With regard to the breakdown products of the prosthetic group, however, the evidence can only be considered suggestive. In a large number of papers (212,744,1787,2693,2867,2868,2870,2871,3015,3179) Verzár and his school have claimed that bilirubin acts as a hemopoietic hormone. This claim is based partly on increases in erythrocyte numbers caused by small amounts of bilirubin fed by mouth (1-2 mg. in rats, 3-5 mg. in rabbits, 5 mg. in dogs, 50 mg. in men) and partly on parallel increases of serum bilirubin and hemoglobin after ascent to high altitudes. The latter, confirmed by Talbot and Dill (2732), can hardly be considered sufficient evidence, since the increases of bilirubin as well as that of hemoglobin may be caused by contraction of the spleen (Drouet, 634). In the experiments in which bilirubin was ingested, the erythrocyte numbers varied greatly, and it is doubtful whether a statistical analysis would show the increase by bilirubin ingestion to be significant. It is also difficult to understand how ingestion of amounts of bilirubin much smaller than those normally excreted with the bile could increase hemopoiesis. Larger amounts of bilirubin had the opposite effect (3179). Finally most workers have come to the conclusion that bilirubin is not absorbed from the intestine. Patek and Minot (2118) noted a second reticulocyte response when large doses of bilirubin (of doubtful purity) were fed in iron therapy. More convincing are the experiments of Bomford (312), who measured hemoglobin formation in anemic dogs by the technique of Whipple, and injected large doses of bilirubin (50 mg.) intravenously. He observed an increase in the rate of hemoglobin formation and a prolonged reticulocyte response following the administration of bilirubin. This occurred only when iron was also given by mouth or subcutaneously; Bomford considers the hypothesis that bilirubin acts as a hemopoietic hormone as attractive, but so far unproved.

Conversely, Boycott and Oakley (323) have claimed that blood transfusion causes an active process of red cell destruction, and Robertson (2285) found that by repeated blood transfusions animals could be trained to destroy injected erythrocytes more rapidly. It is doubtful, however, whether these results cannot be explained partly on the basis of decreased resistance of blood subjected to

temperature changes outside the body, or aging by storage, and partly to immunologic factors.

6. SYNTHESIS OF RESPIRATORY ENZYMES

So far we know very little about the synthesis of the respiratory enzymes. Since protoporphyrin or protohematin are required as nutrients for the synthesis of respiratory enzymes and cytochromes in certain microorganisms (*cf.* Section 3.2.2.), the former porphyrins can be assumed to be intermediates in the synthesis of the enzymes. Cytochrome c cannot replace protohematin. The hematin enzymes of *Hemophilus influenzae* differ, however, from the usual cytochrome oxidase system (1035).^{*} Protoporphyrin is the only porphyrin into which iron can be introduced by the organism; but mesohematin can be used for the formation of the respiratory enzyme, although not for that of a nitrate-reducing system for which protoporphyrin is essential.

Crandall and Drabkin (510a) found a rapid formation of cytochrome c in regenerating rat liver tissue after partial hepatectomy, but transport of the cytochrome from the skeletal muscle has not yet been excluded. Benkö (213a) found the cytochrome c content of skeletal muscle, and to a smaller extent that of heart muscle, depressed by factors inhibiting hemopoiesis, and Tissières (2809a) found the same after thyroidectomy or administration of thiouracil.

Iron deficiency decreases the catalase content of mammalian organs, except that of the heart (Schultze and Kuiken, 2483). On recovery the catalase is restored more rapidly than is hemoglobin. No decrease of the cytochrome oxidase content of mammalian organs in iron deficiency has been observed, but in bacteria cytochrome oxidase is diminished, together with other hematin enzymes, such as catalase and peroxidase, though to a smaller degree than the latter.

Waring and Werkman (2960) found that the cytochrome absorption bands of *Aerobacter indologenes* disappear, if the organism is made deficient in iron. They removed the iron with 8-hydroxyquinoline, a reagent which also removes copper, but could show by readdition of iron that the observed effects were due to iron, not to copper deficiency. The iron-deficient bacteria contained less catalase (only 1/20), peroxidase, hydrogenase, cytochromes, and cytochrome

^{*} The hematin enzyme formed from porphyrin, iron, and toxin in *Corynebacterium diphtheriae* is cytochrome b, according to Pappenheimer (2104b).

oxidase, the lastmentioned enzyme being less decreased than the others, and evidently synthesized preferentially. Iron deficiency has also been found to decrease the formation of hydrogenase in *Clostridium welchii* (2105), and that of catalase in yeast (3151).

In addition to iron and the simple building stones required for the synthesis of porphyrins (*cf.* Section 7.), copper is also required for the synthesis of the cytochromes a and cytochrome oxidase in yeast, liver, and bone marrow (459,676,2475,2477,3151). Since cytochromes b and c are far less affected by the lack of copper (459), copper probably plays a role in the oxidation of the vinyl side chains of proto-hematin. In addition, it appears to be required also for the synthesis of catalase (2483) and of hemoglobin, unless cytochrome oxidase is necessary for the synthesis of these hemoproteins and the inhibition of their formation by copper deficiency is indirectly caused by a lack of the oxidase (*cf.* Section 3.3.3.).

7. SYNTHESIS OF PORPHYRINS BY THE LIVING CELL

7.1. Porphyrins as Intermediates and By-Products of Hemoglobin Synthesis

In Chapter XII, Section 3.4. (particularly Section 3.4.6.) it has been shown that there is little evidence suggesting a derivation of porphyrins in the animal body from preformed hemoglobin, and that their formation as intermediates or by-products of hemoglobin synthesis is far more likely. The porphyrin which is excreted under conditions in which hemopoiesis is increased is of type I. Rimington, Dobriner, and Rhoads have developed the theory according to which the synthesis of the porphyrins is never completely specific, and that in addition to type III porphyrin, which is used for hemoglobin synthesis, some type I porphyrin which does not combine with iron is always produced and excreted. Hence every increase in hemopoiesis will be accompanied by a corresponding increase in excretion of coproporphyrin I. The theory of porphyrin formation in the animal body will be discussed in the next section. Here we add some further evidence to that mentioned already in Chapter XII, Section 3.4.

After phenylhydrazine administration the increase of porphyrin excretion occurs not when the bile pigment formation is maximal, but at a later stage when hemopoiesis and reticulocyte formation is maximal (Dobriner and co-workers, 601,605). After hemorrhage, coproporphyrin I excretion is increased and reaches its maximum after about ten days, at the same time as the maximal reticulocyte

response (604). In pernicious anemia the fecal coproporphyrin I excretion is high in relapse and during the response to liver therapy, but declines sharply after the reticulocyte crisis to remain normal in remission; it is found to be roughly parallel to the degree of hemopoiesis (Dobriner and co-workers, 601,603,604; Watson, 2976). In refractory anemias, too, fecal coproporphyrin I excretion is found to be correlated with the state of the bone marrow as revealed by biopsy (604). Libowitzky and Scheid (1733) found increased hemopoietic activity in febrile episodes of schizophrenia associated with increased excretion of coproporphyrin I.

In addition to this increase of porphyrin formation associated with a general increase of hemopoiesis, there is, however, in other diseases evidence of a more specific derangement. This is found, first, in chronic porphyria, in which large amounts of predominantly type I porphyrin are excreted (2258), and, second, in acute porphyria, aplastic anemia, and porphyrinurias caused by lead, methyl chloride, and perhaps also aromatic amino compounds in which there is increased formation of type III porphyrin.

Duesberg (638) and later Rimington (2259; cf. also Vannotti, 2849) explained the increased excretion of coproporphyrin in lead intoxication by assuming that the combination of iron and protoporphyrin in the immature cell was inhibited and that the increased protoporphyrin in the blood was ultimately excreted as coproporphyrin. In addition the lead inhibited hemopoiesis.

Against this theory Kench, Gillam, and Lane (1515) have raised several objections. First, they found the porphyrin formation much too small to account for the anemia and found no constant relationship between the degree of anemia and porphyrin excretion. This is certainly correct, but is no argument against the hypothesis of Duesberg and Rimington, unless the assumption is made that the inhibition of hemopoiesis by lead is solely due to the inhibition of iron incorporation (cf. Section 8.2.2.). Second, they find no correlation between stippled cells and porphyrin excretion. Since the fluorescytes and not the stippled cells are the porphyrin-containing cells, this is not surprising. Third, they do not find the constant relationship between protoporphyrin content of the blood and coproporphyrin excretion, which might be expected were the coproporphyrin III derived from the protoporphyrin. There is no evidence (cf. Chapter XII) that protoporphyrin IX can be transformed *in vivo* to coproporphyrin III, and an alternative explanation for its formation in lead intoxication as well as in other conditions in which hemopoiesis is inhibited will be given in Section 8.

The increase of coproporphyrin excretion in infections, which had been explained by Schreus (2465) as due to increased hemoglobin breakdown, is also due to inhibited hemoglobin synthesis (2862; cf. also Section 4.3.).

It is now generally agreed that the protoporphyrin in the erythrocytes is formed as an intermediate of hemoglobin synthesis. The

observations of Seggel, showing that the number of fluorescytes increases with absolute or relative iron deficiency (Chapter XII, Section 3.2.2.), are good evidence for this.

Porphyryns are frequently found at the site of hemopoiesis, *i.e.*, the bone marrow in the adult, for instance in pernicious anemia. The evidential value of these observations has been emphasized by Thomas (2798), and they certainly support the hypothesis of porphyrin formation in hemoglobin synthesis. Nevertheless, as isolated facts, they do not completely rule out porphyrin formation by abnormal hemoglobin breakdown, since hemoglobin breakdown to bile pigments occurs in the bone marrow. In pathologic conditions, porphyryns have been observed in the liver (322,558,685,2839,2850). In some instances, this may be connected with extramedullary hemopoiesis, which has been observed by Fischer in the porphyria patient Petry.

7.2. Porphyrin Formation in the Embryo

The formation of porphyrin in the incubated egg was first studied by van den Bergh and Grotepass (228). The protoporphyrin of the egg shell does not penetrate into the interior. An increase of the porphyrin in the albumin, not in the yolk, was observed after about five days. Van den Bergh concludes that the porphyrin cannot be derived by breakdown of hemoglobin from the small amount of blood present at this period. Although this conclusion is undoubtedly correct, it was based on a dubious comparison between the ratio of porphyrin to hemoglobin in the egg and that in normal adult blood.

In a later study Schönheyder (2458) comes to conclusions similar to those of van den Bergh. A simultaneous rise of coproporphyrin and hemoglobin begins at the third day of incubation, hemoglobin rising to 19 mg., coproporphyrin to 7.5 μ g. on the ninth day. These data show that the quantitative relations do not actually exclude formation of porphyrin by breakdown of hemoglobin; the fact that the coproporphyrin is of type I, however, shows that this assumption cannot be correct. Schönheyder concludes that his results indicate an entirely independent synthesis of coproporphyrin and of hemoglobin. This assumption is, however, unnecessary; his results are equally well met by a theory in which coproporphyrin is derived as a by-product of hemoglobin synthesis, but which provides for a variation of the ratio of the isomerides (*cf.* Section 8.).

Porphyryns do not enter the mammalian fetus from the mother (Fränkel, 939; Hammer, 1111; *cf.* also 1691). Porphyrin is found in blood and bone marrow of fetuses (Borst and Königsdörffer, 322). The porphyrin content of the fetal serum is 8-10 microgram per cent, and decreases to 1-3 microgram per cent at birth. Fetal red cells also contain 2-3 times as much protoporphyrin as the adult erythrocyte (van den Bergh and Hijmans, 231). Fikentscher's finding (758) that the porphyrin deposited in the fetal bones is

uroporphyrin has not received the attention it deserves (*cf.* Section 8.2.). In the adult of the human and most other mammalian species, no uroporphyrin is deposited in the bones and only traces are formed, while in the fox squirrel formation of uroporphyrin and deposition in the bones is a normal occurrence (Turner, 2886).

These studies, particularly the finding of coproporphyrin I in the developing egg, show that the increased porphyrin formation in embryonic and fetal tissue is due to a still incomplete coordination of hemoglobin synthesis rather than to a breakdown of hemoglobin to porphyrin occurring before the normal breakdown to bile pigments has been established. The latter had been assumed by Garrod and other workers.

7.3. Porphyrin Synthesis in Microorganisms

7.3.1. Porphyrin Synthesis in Bacteria. A variety of anaerobic or facultative anaerobic bacteria and fungi possess the ability to synthesize porphyrin. The porphyrin is mostly coproporphyrin; occasionally traces of protoporphyrin have been found. The findings on porphyrin synthesis by intestinal bacteria are still contradictory. Vannotti believes that the synthesis of porphyrin by intestinal bacteria contributes little to the porphyrin metabolism in humans. Mallinckrodt-Haupt (1849) assumes that all the coproporphyrin I may be formed in this way, while Jacob (1896) found the intestinal bacteria to form coproporphyrin III, not I. Mallinckrodt-Haupt found a great variety of intestinal bacteria able to form coproporphyrin with asparagine as source of nitrogen. The intestinal porphyrin formation may be influenced by dyspepsia and changes in the intestinal flora. Gram-negative bacteria are considered to be the stronger porphyrin formers by Mallinckrodt-Haupt. *Escherichia coli* is said to produce more porphyrin when carbohydrates are present in the intestine, which may occur in dyspepsia. Urbach (2841), however, believes that Gram-positive organisms form more porphyrin. He describes cases of light dermatoses with increased porphyrin in the feces, not in the urine, which could be cured by abolishing the bacterial imbalance in the intestine by replacement of the bacteria with *E. coli*.

Porphyrin-producing bacteria have been observed in the mouth and on the tongue as well as on the skin (405,491). Pathogenic fungi also produce porphyrin (Carrié and co-workers, 405-407,1849; Cortese, 491).

Coproporphyrin* and its complex zinc salt have been observed in *Corynebacterium diphtheriae* (Coulter and Stone, 504,505,2672; Dhéré, 583). The latter was first erroneously believed to be a hemochrome. The identity of porphyrin and bacterial toxin has also been suggested, but this has been disproved (2901,3041). Coproporphyrin copper has been claimed to occur in *Pseudomonas phospharescens*.

* Whereas Pappenheimer (2104a) assumed the porphyrin to be hematoporphyrin, Gray and Holt (1039a) have shown that it is coproporphyrin III.

7.3.2. Porphyrin Synthesis in Yeast. The study of the porphyrin synthesis in yeast was commenced by Fischer and co-workers (811-813,830,875,876). Other fungi, such as *Aspergillus oryzae*, also synthesize porphyrin. No preformed porphyrin, hematin, or pyrrole compound is required in the medium (834), which contained ammonia or urea, glucose, and salts. A correlation between rate of fermentation and porphyrin synthesis has been found by Fischer and Fink, and Carrié and Mallinckrodt-Haupt (407; but cf. 1516). The porphyrin formation is not due to an iron deficiency, since iron even increased porphyrin formation, while hematin did not do so. Copper, lead, arsenic, and vanadium were also found to cause an acceleration of porphyrin synthesis. Under normal conditions the porphyrin is coproporphyrin I and, hence, cannot be derived from the cell hematin or cytochrome c (cf. 707,708,834,1516). Mayer (1890) found that porphyrin synthesis proceeds in the press juice of yeast, and concluded from the observed inhibition by cyanide that the process is enzymic. Sulfonal increases porphyrin formation by yeast (Thomas, 2799).

More recently the process has been studied by Rimington (2269) and by Kench and Wilkinson (1516). Rimington found that yeast soon loses its ability to synthesize porphyrins. Press juices obtained after incubation with toluene at 48°C. formed some porphyrin and, by the addition of boiled extract of active yeast, the yield could be increased sevenfold. Kench and Wilkinson (1516) found that more porphyrin was formed when the autolysis of yeast at 19-22°C. proceeded in the presence of an ammonium salt. When glucose or other carbohydrate was added, the porphyrin formation remained high. In the presence of sugar, coproporphyrin I was formed, while starved autolyzing yeast yielded predominantly coproporphyrin III. Sodium fluoride or toluene inhibited the synthesis. From these results it can be concluded that the synthesis of porphyrins is intimately linked up with carbohydrate metabolism.

8. SYNTHESIS OF THE PORPHYRIN NUCLEUS

8.1. Previous Theories

No convincing theory of the way in which the porphyrin nucleus is synthesized in the animal or yeast cell has yet been devised. A number of earlier suggestions are no more than speculations, not supported by evidence. Tryptophane has often been assumed to be

the mother substance, since by splitting of the benzene nucleus and removal of the amino group one can, on paper, arrive at a pyrrole substituted with the right kind of side chains: ,

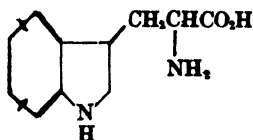

We have seen above (Section 3.2.3.) that there is no evidence that tryptophan is needed for the synthesis of porphyrin. Other theories leave the side chains out of account. Abderhalden suggested ring

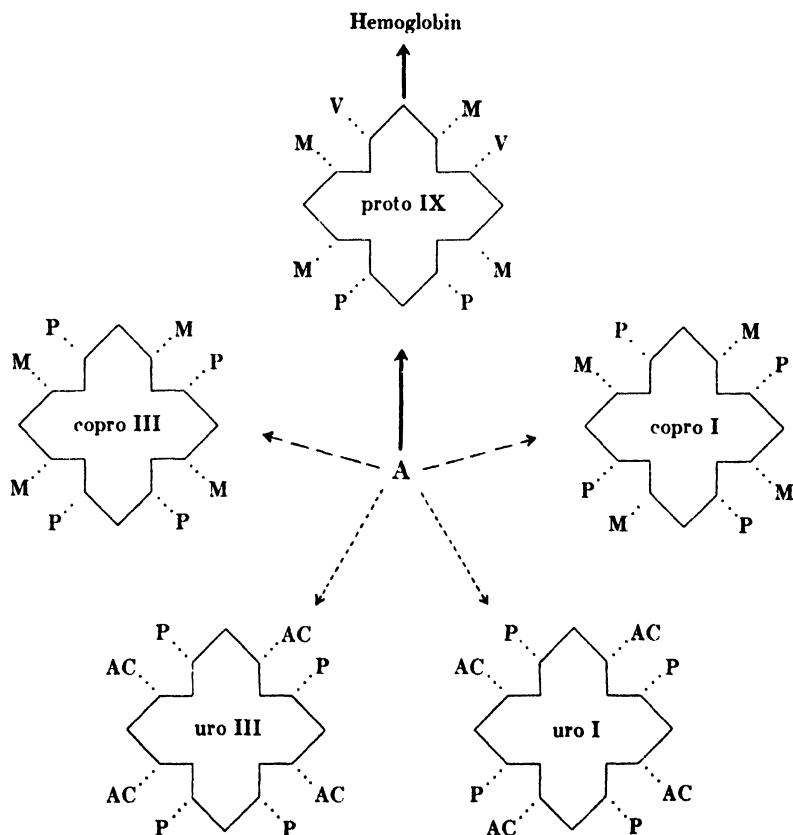

Fig. 1. Porphyrins occurring in the animal body: broken lines, small amount of formation normally; dotted lines, mainly pathological.

closure of glutamic acid to pyrrolidonecarboxylic acid, von Euler (704) the condensation of isoprene or methylcrotonaldehyde with

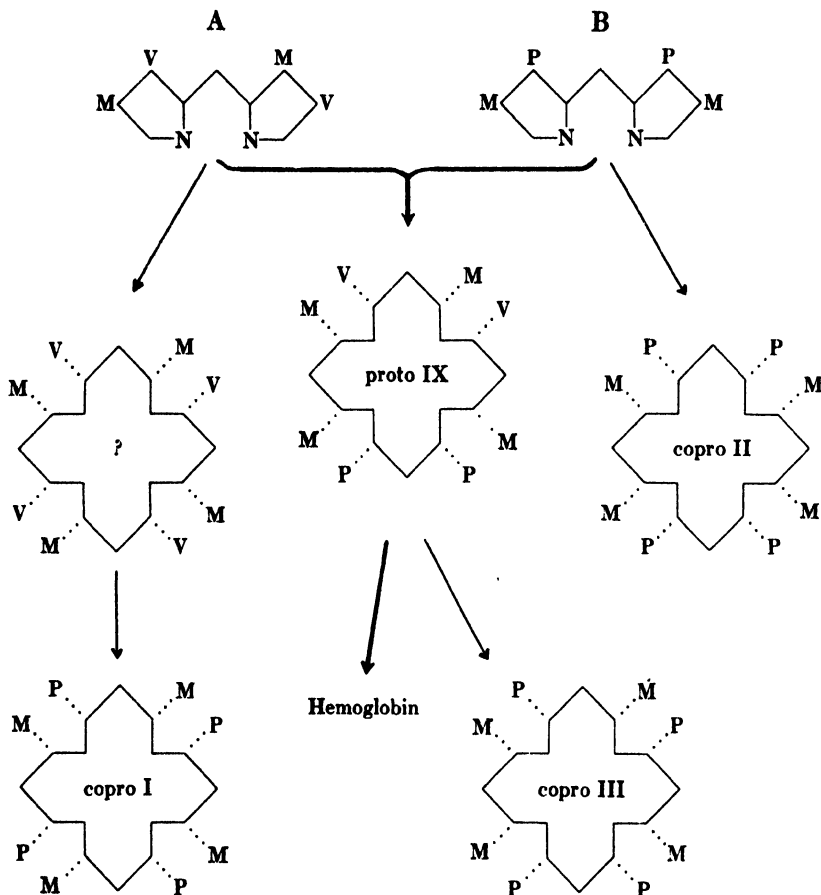

Fig. 2. Theory of porphyrinogenesis of Rimington and Dobriner (1936).

ammonia or (712) the ring closure of polyenes with ammonia, Emde (684) condensation of ammonia with furfuraldehyde, Whipple and Robscheit-Robbins (3062) ring-closure of straight-chain amino acids. Glucosamine has been tested by Kench (1514), who found large amounts, given to patients with acute porphyria, unable to increase porphyrin formation.

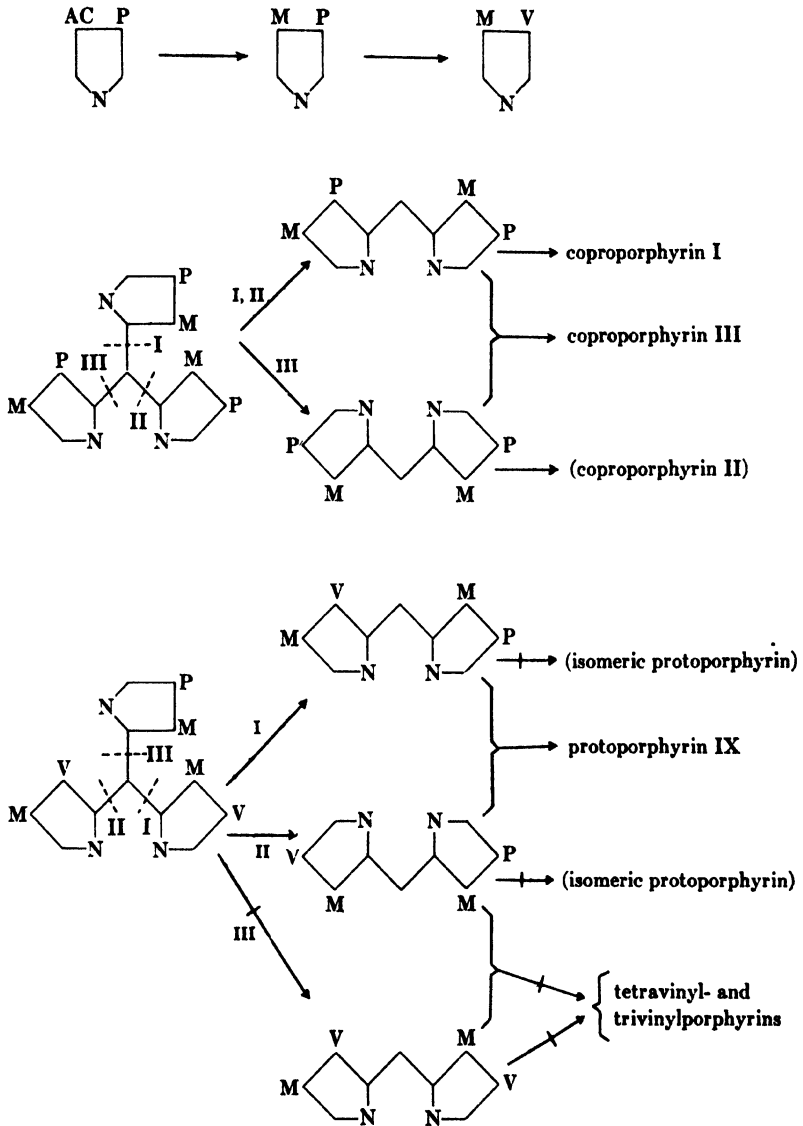

Fig. 3. Theory of porphyrinogenesis of Turner (1940); (→) possibilities not taken into account.

Later theories are concerned only with the explanation of the synthesis of the various porphyrins from postulated pyrromethene precursors. A sound theory of porphyrinogenesis should explain the formation of the variety of porphyrins which have been summarized in Figure 1, and the nonoccurrence of other isomerides. In this the present theories of porphyrin formation still fail to a large extent. In 1936 Rimington (2257-2259) and Dobriner and co-workers (601, 602, 604) independently suggested the following theory, assuming two pyrromethenes A and B as precursors (Fig. 2). By condensation with one another they yield protoporphyrin IX which is largely converted into hemoglobin. This is the main reaction, probably under enzymic control. A small amount of A (about 1 part in 10,000) condenses with itself to yield a (hypothetical) type I porphyrin with four vinyl side chains. This is assumed to be converted to coproporphyrin I by addition of formic acid to its vinyl side chains, and under pathologic conditions, by further carboxylations (methyl \rightarrow acetic acid side chains) to uroporphyrin I. Coproporphyrin III may be assumed to be derived by the reaction of protoporphyrin IX with formic acid. Autocondensation of pyrromethene B should yield coproporphyrin II, but this has not been found. The theory necessitates the assumption that vinyl side chains can be transformed to propionic acid side chains; we have seen in Chapter XII, Section 3.2.4., that there is no reliable evidence for this reaction. The carboxylation of a methyl to an acetic acid side chain, which is necessary for the explanation of the formation of uroporphyrin under pathologic conditions and in the embryo, is still less likely. The greatest weakness of the theory is, however, that the assumption of the two precursor pyrromethenes A and B is an *ad hoc* hypothesis which begs the question.

The same criticism can be raised against the theory of Turner (2839). Turner, however, was the first to suggest that the primary precursor contains acetic acid and propionic side chains, like uroporphyrins, and that the precursors of coproporphyrin and protoporphyrin are derived from it by decarboxylation (Fig. 3).

The primary precursor was assumed to condense to tripyrrylmethanes which by splitting at different linkages yielded the pyrromethenes required for the porphyrin synthesis (*cf.* Fig. 3).

Not only are the particular tripyrrylmethanes arbitrarily chosen, but so also are the linkages which are ruptured to form pyrromethenes. The formation of such tripyrrylmethanes could only increase the number of possible porphyrins in excess of the number actually

found. At that time, however, Fischer's evidence for the occurrence of a protoporphyrin of type II had not yet been withdrawn.

8.2. Attempts at a New Theory of Porphyrinogenesis

8.2.1. Precursors and Mechanism. Before a new theory of porphyrinogenesis is attempted we sum up once more the most important experimental results. The studies on porphyrin formation in yeast (*cf.* Section 7.3.2.) as well as the investigation on the porphyrin of the Harderian gland of the rat by Thomas (2798) indicate a close relationship between carbohydrate metabolism and porphyrin formation. They show that the precursors must be sought among compounds which occur as metabolites in carbohydrate metabolism and simple nitrogen compounds, either ammonia or compounds easily formed from ammonia in the animal body or the yeast cells, such as glutamic acid or glycine. Schoenheimer, Rittenberg, and co-workers (290,2276,2277,2453,2543) have attempted to solve the problem by making use of nitrogen compounds containing an excess of N^{15} . They found that the N^{15} of ammonia, leucine, and particularly of glycine was incorporated in the hematin of rat erythrocytes in the course of a few (9–18) days and was found in hemin crystals prepared from them. Similarly the carbon-bound deuterium of deuterioacetate was found in the hemin crystals. After feeding N^{15} -labeled glycine, the N^{15} content of hemin was so high that only glycine itself could be considered to be the precursor. While there is no proof that acetic acid is used directly for porphyrin synthesis, the actual precursor must be a metabolic product readily formed from acetic acid, such as succinic, α -ketoglutaric or glutamic acid.*

Secondly we have seen (*cf.* Chapter XII, Section 3.2.3.) that there is no reliable evidence for conversion of protoporphyrin into coproporphyrin by ascending carboxylation. There is no evidence whatsoever for ascending carboxylation of coproporphyrin to uroporphyrin, which is not a reaction likely to occur in the animal body (transformation of methyl to acetic acid side chains). Fischer's assumption that the occurrence of uroporphyrin in porphyria is due to a detoxication reaction taking place in the kidney to aid excretion (732) is disproved by the facts that, in chronic porphyria, uroporphyrin is deposited in

* According to Orten and Keller (2088a), young rats on a protein-deficient diet excrete far less protoporphyrin than on a normal diet. Compounds such as glutamic acid and α -ketoglutaric acid are of importance in protein as well as in carbohydrate metabolism.

the bones, that it is more toxic than coproporphyrin, and that, in acute porphyria porphobilinogen, a dipyrrolic precursor of uroporphyrin is excreted. The facts that uroporphyrin is formed in the normal megaloblastic hemopoiesis of the embryo, and occurs as a physiologic product in the fox squirrel make it appear more likely that the primary precursor of all porphyrins is a substance with the acetic acid and propionic side chains which we find in uroporphyrin. This was first suggested by Turner (2839), but without reference to supporting evidence. Normally the primary precursor would undergo decarboxylation to yield the precursors of coproporphyrin and protoporphyrin, while in porphyrias this decarboxylation is incomplete owing to an inborn error of metabolism. It appears more reasonable to explain the porphyrias in this way, than by assuming that a special carboxylation process, not occurring under normal conditions, is at work in the porphyrias.*

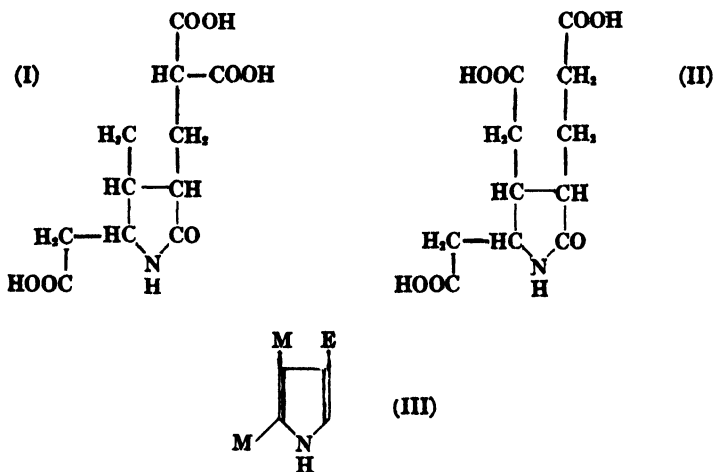

Finally there is one important piece of evidence which has received little attention. In 1931 Dakin and West (525) isolated from powdered liver the tribasic acid $\text{C}_{11}\text{H}_{15}\text{O}_7\text{N} \cdot \text{H}_2\text{O}$ with a yield of up to 1%. Formula I was assumed for this acid, the β -side chains being formulated like those then assumed to be the side chains of uroporphyrin, but formula II with acetic and propionic acid side chains is

* The decarboxylation of a precursor of coproporphyrin to one of protoporphyrin is now supported by the fact that coproporphyrin is formed by *Corynebacterium diphtheriae* when the synthesis of cytochrome b is inhibited by lack of iron (cf. Sections 6. and 7.3.1.). Similarly, coproporphyrin is formed in yeast under conditions in which the synthesis of the cytochromes appears to be deranged.

equally probable. We have seen in Chapter III that acetic acid side chains in β -position of pyrroles are easily decarboxylated. On heating with baryta first a dicarboxylic acid, then a pyrrolemonocarboxylic acid and finally hemopyrrole (III) were obtained.

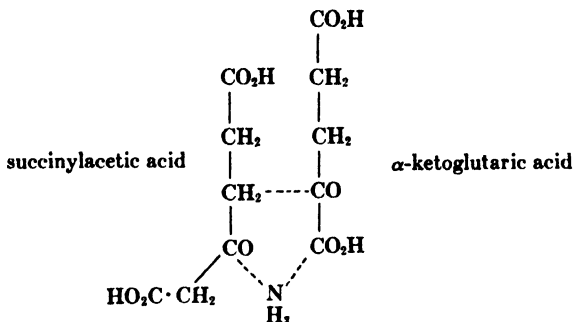

Fig. 4. Possible synthesis of Dakin and West acid.

A number of possibilities can be suggested for the synthesis of a compound of the structure of formula II in the animal body. It could, for example, be formed by a condensation of α -ketoglutaric acid, succinylacetic acid, and ammonia (Fig. 4).

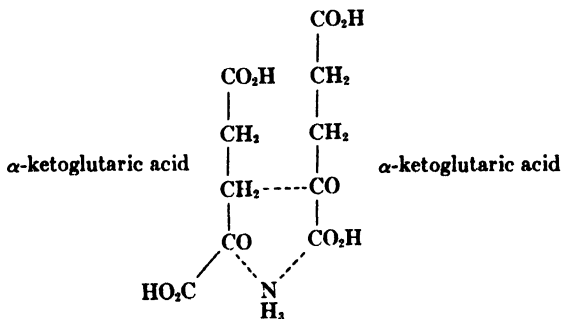

Figure 5

The porphyrin precursor need not necessarily have an acetic group in the α -position, but might have, for example, a carboxyl or formyl group. A compound of this type may be readily formed by condensation of two molecules of α -ketoglutaric acid with ammonia (Fig. 5). The significance to be attached to this substituent in the α -position will become apparent below.

Alternatively the synthesis might take place by condensation of glutamic acid with ketoglutaric acid, by intramolecular condensation of a dipeptide of β -hydroxyglutamic acid and glutamic acid, or by oxidation of a dipeptide of glutamic acid alone (Fig. 6). A dipeptide

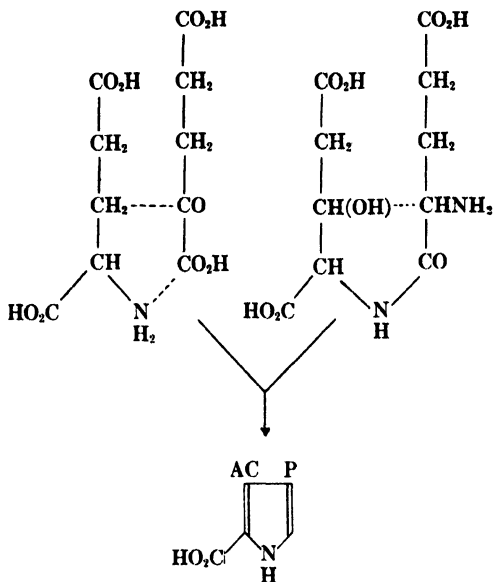

Figure 6

of hydroxyglutamic acid with proline has been isolated from the liver by West and Howe (3039). Finally glycine may be condensed with the semialdehyde of succinic acid (Fig. 7).

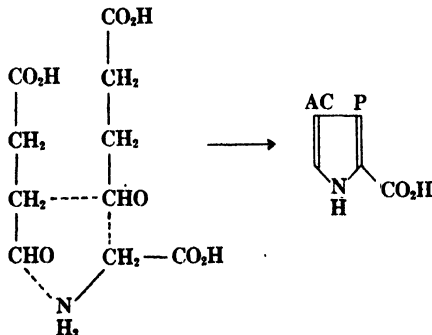

Figure 7

Whatever may be the merit of these schemes, the starting products are chosen from substances which have been shown to be related to the synthesis of the porphyrin nucleus, and their condensations to the primary precursor would be reactions of a type likely to occur in the animal metabolism. Utilizing a substituted pyrrole of this type as primary precursor, the remainder of the biosynthesis of the porphyrin nucleus may be envisaged in the form shown in Figure 8.

In normal hemopoiesis the monopyrrolic precursor *A* is decarboxylated in the β -substituent, the acetic acid side chain being transformed to a methyl group, and giving precursor *B* (reaction 1). By autocondensation, *B* yields the unsymmetrically substituted dipyrrolic substance *C* with the side chain in the α -position, whether $-\text{CH}_2\text{COOH}$, $-\text{COOH}$, or some similar group, supplying the bridge (reaction 2). By condensation of *B* with a monocarbon compound such as formaldehyde or with a short-chain compound, which can later be readily degraded to a single carbon, the symmetrically substituted dipyrrolic compound *D* is obtained (reaction 3). The latter, being substituted in both α -positions, cannot give rise to a porphyrin by autocondensation, the nonoccurrence of type II porphyrin being thus explained.

It is now assumed that the pyrromethene or dipyrrylmethane *C*, but not *D*, undergoes an oxidative decarboxylation transforming its propionic acid side chains to vinyl groups, and that the pyrromethene *E*, resulting from this reaction, combines with *D* to form protoporphyrin IX and hemoglobin.* The decarboxylation of *C* to *E*, the condensation of *E* with *D*, and the incorporation of iron and globin

* Although two molecules of the α, α' -disubstituted dipyrrolic compound *D* cannot readily condense to a type II porphyrin with elimination of two α -carbon substituents, a condensation of *D* with *C* or *E* to a type III porphyrin can readily occur. By condensation first an open-ring tetrapyrrolic body is formed.

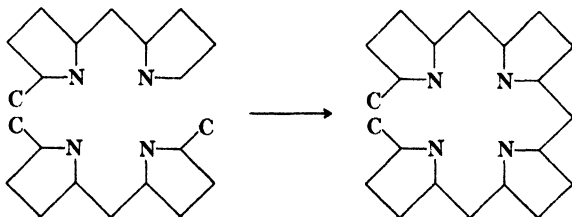

In the latter the rotational possibilities are restricted, and this together with the great tendency of formation of the porphyrin ring allows an expulsion of one of the α -substituents and ring closure. Numerous examples for reactions of this type occurring *in vitro* are found in Fischer's syntheses.

to form hemoglobin, are supposed to constitute one coordinated process of hemoglobin synthesis; this has also been assumed by Rimington. A slight excess of reaction 2 over reaction 3 allows a

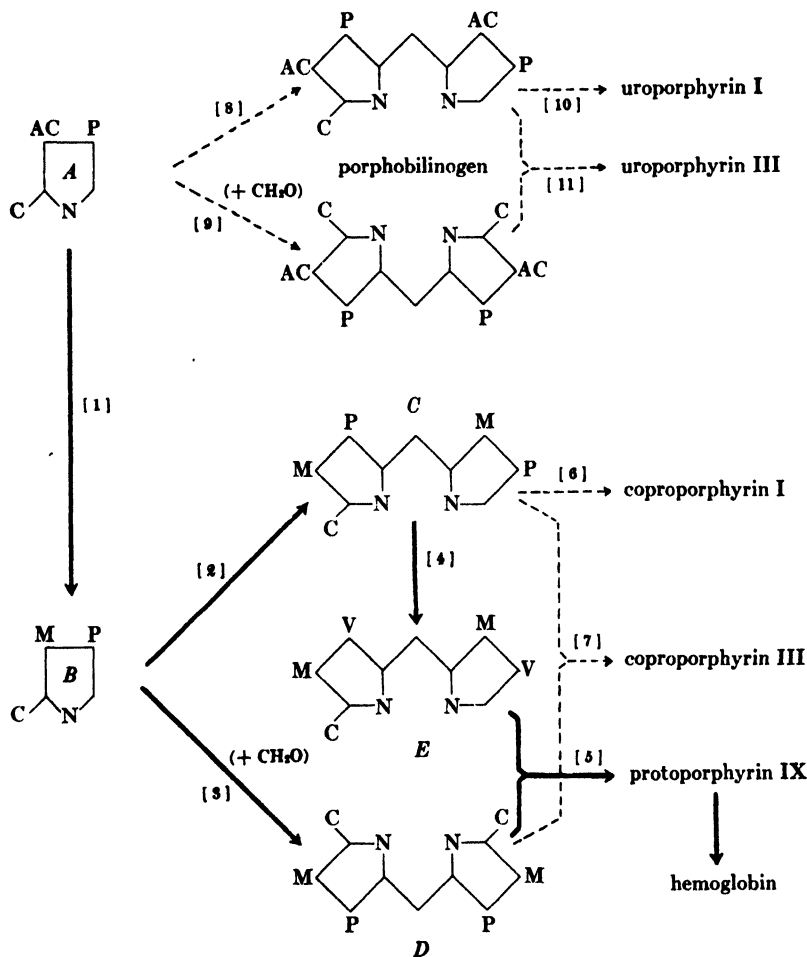

Figure 8

slight formation of coproporphyrin I by autocondensation of C, while a still smaller amount of coproporphyrin III is synthesized by condensation of a small fraction of D with C.

In the megaloblast — *i.e.*, hemopoiesis of the embryo — and also in porphyria, the decarboxylation of *A* is incomplete. In reaction 8 and 9, which correspond to reactions 2 and 3 of the decarboxylated series, two dipyrrolic compounds are formed which yield the uroporphyrins I and III. The formation of uroporphyrin II is again excluded by α, α' -disubstitution of one of the dipyrrolic compounds. Reaction 4 is admittedly an *ad hoc* assumption, but it allows a great simplification of the scheme.

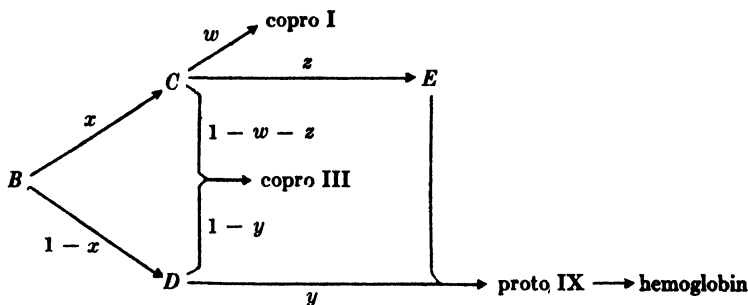

Fig. 9. Relation between coproporphyrin I and III formation and hemopoiesis.

8.2.2. Ratio of Type I to Type III Porphyrins. It is now of interest to investigate the consequences of this theory. By an approximate mathematical treatment one can predict that hemopoiesis will influence the ratio of coproporphyrin I formation to that of the III isomere (*cf.* Fig. 9).

Assume that a fraction x of *B* is transformed to *C* and $(1-x)$ to *D*, that of *D* a fraction y is used for the synthesis of protoporphyrin IX and hemoglobin, while $(1-y)$ is used for the synthesis of coproporphyrin III; of *C* a fraction z is used for synthesis of protoporphyrin IX and hemoglobin, a fraction w for the synthesis of coproporphyrin I, leaving $1-w-z$ for the synthesis of coproporphyrin III. It is assumed that the other reactions (*e.g.*, $E \rightarrow$ protoporphyrin IX) proceed to 100%. Hence one molecule of *D* reacts with one molecule of *E* derived from one molecule of *C*. From this stoichiometry of the formation of protoporphyrin IX, it follows that:

$$Dy = Cz$$

or:

$$B(1-x)y = Bxz$$

i.e.:

$$z = \frac{y(1-x)}{x} \quad (1)$$

From the stoichiometry of the formation of coproporphyrin III it follows that:

$$D(1 - y) = C(1 - w - z)$$

or: $B(1 - x)(1 - y) = Bx(1 - w - z)$

i.e.:
$$\frac{(1 - x)(1 - y)}{x} = 1 - w - z \quad (2)$$

From equations 1 and 2 follows:

$$w = \frac{2x - 1}{x} \quad (3)$$

We can now give the ratio of coproporphyrin I to coproporphyrin III (I/III) as a function of x and y :

$$I/III = \frac{Bxw}{B(1 - x)(1 - y)} = \frac{2x - 1}{2(1 - x)(1 - y)} \quad (4)$$

substituting the value of w from equation 3.

Now, x must be slightly greater than 0.5, since if $x = 0.5$, $w = 0$, and no coproporphyrin I will be formed. Since the daily excretion of bile pigment is 300 mg., and that of coproporphyrin less than 300 μ g., w must normally be of the order of 0.001, and somewhat higher in pathologic conditions. Values of x of the order of 0.5001 to 0.5005 are thus indicated. If we put $x = 0.5005$, I/III becomes 1.0 with $y = 0.999$, but 0.17 with $y = 0.994$.

A slight decrease of hemoglobin formation, *i.e.*, of the coordinated reactions 4 and 5 of Figure 8, will thus have a large influence on the ratio of the two coproporphyrins. Assuming x to remain constant we shall expect to find the ratio I/III to be either unaltered or increased by increased hemopoiesis, according to whether only the primary synthesis of precursor B or also y and z are increased. This indeed has been found by Dobriner and Watson. A derangement of hemopoiesis on the other hand, with decrease of y and z , will lead to a preponderance of coproporphyrin III.

In lead poisoning the increased protoporphyrin content of the corpuscles can be explained by inhibition of iron incorporation, but the anemia is much larger than can be due to this. The whole hemopoiesis must be decreased, *i.e.*, the formation of B ; but it is also probably deranged by decrease of the fractions y and z . The theory requires in such a case a preponderance of coproporphyrin III, which has been observed. The action of methyl chloride in causing a porphyrinuria in which coproporphyrin III is excreted may be understood as partly due to a similar derangement of hemopoiesis; but here in addition the formation of formic acid may perhaps play

a specific role in increasing reaction 3, for which a monocarbon compound is needed, and decreasing reaction 2 correspondingly. We have seen that a decrease of x from 0.5003 to 0.50 eliminates coproporphyrin I formation. With the possible exception of the last-mentioned case no alteration of the fraction x need be assumed in order to explain variations in the ratio of the two coproporphyrins. It is clear that a derangement of hemopoiesis can explain an increased excretion of coproporphyrin III, quite as well as an increased hemopoiesis explains that of coproporphyrin I. There is thus no necessity to assume that coproporphyrin III is derived from hemoglobin breakdown.

The assumptions made hitherto on porphyrin formation have been too simple, and did not take into account these complicated relationships to hemopoiesis. The fact that the ratio of the coproporphyrin isomerides in various pathologic conditions can be correctly predicted by the present theory is strong evidence that it represents a step forward.

CHAPTER XIV

PYRROLE PIGMENTS IN EVOLUTION

1. INTRODUCTION

The color of substances arises from their ability to absorb selectively energy of certain wavelengths in the visible spectrum. Physico-chemically this is due to resonance in the absorbing molecule. The pyrrole pigments are at the same time the most highly resonant and the most deeply colored biological compounds, and their absorption reaches far into the region of the longer wavelengths of the red, in bacteriochlorophyll even into the infrared.

For the functional importance of hematin derivatives and other catalysts in respiration, only the resonance, not the color, is of fundamental importance (1685). The resonance confers on the molecule sufficient stability to permit the existence of free radicals in aqueous solution. In conjunction with the monovalent change of the iron valency, this is of fundamental importance for the catalysis of respiration (1942,2516; cf. Chapter VIII), for the activation of hydrogen by hydrogenase and probably also for the action of chlorophyll as hydrogen donor in photoassimilation (940). Though neither the role of bivalent iron in hydrogenase nor that of magnesium in chlorophyll is as yet understood, it would appear that the most important property which led to the selection of these pyrrole pigments for biological catalysis was their high degree of resonance.

At the present time, indeed, pyrrole pigments are found almost universally, in the most advanced as well as in very primitive organisms.

In the green plant a highly complex pyrrole pigment system exists — chlorophylls a and b as well as probably a hematin enzyme in the

chloroplasts acting in photosynthesis, the cytochrome system, catalase and peroxidases, and perhaps the "Pasteur enzyme," acting in respiration. In yeast and many bacteria, free porphyrins are synthesized, but the cytochrome system and catalase are also present. Fischer and Borst and Königsdörffer (322,334) considered that the formation of free porphyrin in yeast and in porphyria patients was an evolutionary atavism. There is no sound evidence for this theory, since the synthesis of free porphyrins of type I, or of porphyrins, such as the coproporphyrins which do not combine *in vivo* with iron, is always accompanied by the formation of hematin compounds containing protoporphyrin IX.

2. PALEONTOLOGY OF PORPHYRINS

In 1933 Fikentscher (756) isolated porphyrin derivatives from the fossilized excrements (coprolites) of crocodiles. Treibs (2824-2826) found porphyrins of chlorophyll (*e.g.*, desoxophylloerythrin) as well as of hemoglobin derivation (meso-, mesoetio-, and deuterioetio-porphyrins, *i.e.*, largely decarboxylated porphyrins) in petroleum, oil shales, earth waxes, asphalts, and coals. While the crocodile coprolites are of early eocene age (beginning of the tertiary period) and thus about 25-30 millions of years old, porphyrins have also been extracted from far older deposits, the oldest being the lower silurian. Only free porphyrins have been preserved; the more sensitive hematin compounds of the blood seem to have largely undergone destruction. Vanadium complexes have been found, but they are of secondary origin, vanadium frequently occurring in these deposits. It may be mentioned that the so-called "vanadium-hemochromogen" of the *Tunicata* has no relation to porphyrin compounds, though it may be related to bile pigments (3006).

These findings are of interest for the theory of formation of these deposits, both with regard to the organisms from which the deposits originated (*e.g.*, plants for petroleum) and to the conditions to which the deposits have been exposed. The presence of decarboxylated porphyrins, for instance, gives a clue with regard to the temperature of the process, while that of desoxophylloerythrin indicates reducing conditions. They are also of interest as proof that the nature of the essential biological catalysts many millions of years ago did not differ from that of the pyrrole compounds found in present-day organisms.

For hypotheses on the evolution of these cell catalysts and on the role of pyrrole pigments in evolution, we have thus to go back into the dim past of the history of life on earth; any theory thus becomes necessarily speculative. The soundest procedure is perhaps to base such a speculation on geochemical considerations, as Oparin (2078) has done (without our necessarily subscribing to this author's theories on the origin of life).

3. PRIMITIVE PYRROLE PIGMENTS

At an early period in the earth's history, according to Oparin, little free oxygen was present,* the first form of living organisms being anaerobic heterotrophs. The atmosphere contained, among other constituents, a relatively high percentage of hydrogen. Hydrogenase, which activates molecular hydrogen, occurs in present-day primitive organisms. The butyric acid fermenters (anaerobic heterotrophs), in which it is found, can certainly be considered primitive; they have a poor energy metabolism, and contain a little-integrated mixture of a variety of enzymes. Hydrogenase can thus be considered an important primitive enzyme. If it can be shown to be a hematin compound, it is probably the most ancient hematin compound known today (*cf.* Chapter IX).

In the next stage of the earth's history, abundant carbon dioxide is assumed in the atmosphere, but still little oxygen. Hydrogen sulfide, as well as molecular hydrogen, may also have been atmospheric constituents. It may be assumed (*cf.* below) that the shortage at this stage of easily assimilable organic material necessitated the first attempts of the primary heterotrophic organisms to use sulfur energy. Hydrogenase catalyzes some reactions which may have been of importance at this time, including the "Knallgas" reaction, and the reduction of carbon dioxide to methane (Soehngen, *cf.* 2198, p. 121), the latter supplying not only energy, but also cell material (169). In some bacteria (purple bacteria), the "Knallgas" reaction proceeds only at low oxygen pressure.

Hydrogenase is found in some green bacteria, in *Thiorhodaceae* and *Athiorhodaceae* and in primitive green algae, all of which absorb and utilize light energy.

The investigations of van Niel and Gaffron (*cf.* Chapter IX) lend

* This is not generally accepted (*cf.* Tammann, 2736a; Wildt, 3082a), but is supported by Vernadsky and V. M. Goldschmidt.

support to the hypothesis that the photosynthesis of the green plants, using water as hydrogen donor and evolving oxygen, had its precursor in this period in the photoreduction of carbon dioxide by hydrogen sulfide, molecular hydrogen (974,2326), and other hydrogen donors. This is supported particularly by the experiments of Gaffron, who showed that the photoreduction of carbon dioxide, which occurs alone in purple bacteria, is found side by side with normal photosynthesis in some green algae (974,2050); the same has been found for some *Cyanophyceae* and *diatoms* (2008).

There is a parallel to be seen between the presence of anaerobic sulfur metabolism with hydrogenase and bacteriochlorophyll in the more primitive organisms and of aerobic oxygen metabolism with photocatalase and chlorophyll in the green plants. Bacteriochlorophyll and the pigment of green bacteria which is probably also related to chlorophyll (Fischer and co-workers, 844) may thus be considered evolutionary precursors of chlorophyll.

Bacteriochlorophyll is a tetrahydroporphyrin compound with an acetyl side chain, chlorophyll a dihydroporphyrin compound with a vinyl side chain instead of the acetyl side chain. Warburg (2928) divided the hematin compounds into three types, red (porphyrin) hemins, green (chlorophyll) hemins, and green-red hemins (derived from porphyrins with carbonyl groups in the side chains). This division has been criticized on chemical grounds in Chapter V, Section 8.1. Warburg assumed that the green-red hemins (to which the prosthetic group of chlorocruorin and perhaps that of the respiratory ferment belong) were the evolutionary prototype of both red and green hemins. In this general form the theory is certainly not correct. There is little likelihood that the respiratory ferment or chlorocruorin has preceded catalase or cytochrome c on the one hand, or bacteriochlorophyll on the other. The relation of chlorophyll and bacteriochlorophyll indicates, however, that the presence of carbonyl groups in the side chain (at least in that which later becomes a vinyl group) is a primitive characteristic. This is probably also correct in the porphyrin (hematin) series, in which chlorocruorin can be considered an evolutionary relic (cf. Chapter VII, Section 8.2.1.). It must not be forgotten, however, that chlorophyll b has also a formyl group as side chain, the latter standing in place of a methyl group, not a vinyl, of chlorophyll a; chlorophyll b is absent in some algae, but present in all higher plants, and that it is an early evolutionary product is thus improbable. It may be mentioned that according to Fischer only one bacteriochlorophyll exists.

From the geochemical point of view, according to Oparin, the oxygen of the atmosphere was produced in the next period of the earth's history, by the introduction of water as hydrogen donor in photosynthesis. Photoassimilation thus preceded respiration, and

hence chlorophyll, or at least bacteriochlorophyll, preceded the development of the respiratory catalysts of the hematin series. Catalase is, however, present in purple bacteria (Gaffron, 1968), though photocatalase is lacking. It is, therefore, possible that bacteriochlorophyll and catalase appeared simultaneously.

Certain chemical relationships can be pointed out which may have been of evolutionary significance. Bacteriochlorophyll is related to chlorophyll a in a way which may be expressed by:

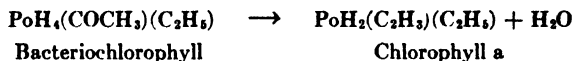

where Po signifies the porphyrin nucleus, and where only two side chains are shown. It is not impossible that chlorophyll a has evolved from bacteriochlorophyll by a dismutation, two atoms of hydrogen being transferred from the tetrahydroporphin nucleus to the acetyl side chain. Fischer and Bub (1906) have observed such hydrogen transfers between nucleus and side chain in chlorophyll derivatives under the influence of hydriodic acid *in vitro*. Similar dismutations may have been of importance in the conversion of chlorophyll to hematin compounds, such as catalase, or inversely hematin into the former, or in their origin from a common precursor. Protoporphyrin, for instance, has in its nucleus two hydrogen atoms less than chlorophyll a and also two less in its second vinyl group (ethyl in chlorophyll), but the opening of the isocyclic ring in chlorophyll (with formation of the second propionic acid side chain of protoporphyrin) requires the addition of six hydrogen atoms. This relation can be written:

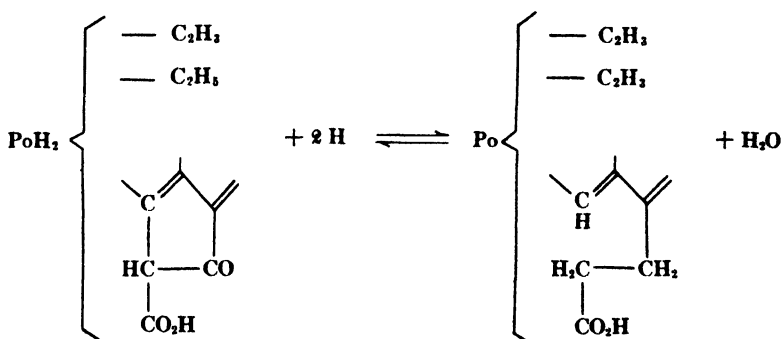

4. RESPIRATORY HEMATIN ENZYMES

As soon as photosynthetic organisms developed with the capacity to use water as hydrogen donor for the assimilation of carbon dioxide

and evolution of oxygen, need may have arisen for the protection of the oxygen-sensitive anaerobic enzyme systems. As we have discussed in Chapter IX, the role of catalase as protective enzyme is not beyond doubt. It is also necessary to keep in mind that catalase could only protect anaerobic enzyme systems against the action of hydrogen peroxide, produced indirectly from oxygen, but not against the action of oxygen itself. Another possible early evolutionary precursor of the hematin enzymes, in particular of the cytochrome system, is an enzyme which according to Vogler and co-workers (2899) is probably present in *Thiobacillus thiooxidans*. This enzyme oxidizes sulfur to sulfate; it is inhibited by carbon monoxide, the inhibition being reversed by light. This enzyme deserves further study.

The evolution of the hematin enzymes is largely a matter of the development of suitable proteins. With the exception of the respiratory ferment and cytochrome a, the other more important hematin enzymes all contain the same prosthetic group, protohematin; for our present purpose we may also include cytochrome c in this group, considering it a protohematin compound having the prosthetic group in a peculiar kind of combination with the protein. We know also, from the synthesis of hybrid enzymes with nonbiological hematin and globin or the peroxidase protein, that it is the protein not the prosthetic group which determines the nature of the enzyme. The unique role of the proteins for biological processes holds in this field as in many others, and the problem of adaptation of the hematin enzymes to their function becomes largely one of protein adaptation.

It has been shown in Chapter VIII that the specific proteins greatly increase, for one specific catalytic action, the rudimentary catalytic potentialities residing in the hematin, and that they are also of great importance for the protection of the enzyme against destruction in the catalytic process itself. This decrease in lability may have been of importance in the evolution of the present-day enzymes, which unite a very high turnover number with a remarkable stability. They may have evolved from much less stable hemoproteins by adaptation of the protein, the prosthetic group having already reached the maximum degree of resonance and thus the limit of its adaptation.

This assumption cannot be supported by evidence demonstrating differences of stability of enzymes in forms now living. We can only summarize once more the various mechanisms by which such a protection is achieved. Ferrous heme compounds are particularly likely to undergo autodestruction (cf. Chapter X). Hence enzymes which are reactive in the ferric form, such as catalase and peroxidase, are stabilized in this form and do not undergo

valency change. This protection is not absolute; dihydroxymaleic acid in the case of peroxidase, and to a minor degree other reducing substances in the case of catalase cause reduction and destruction. Destruction of peroxidase by dihydroxymaleic acid and oxygen probably does not occur biologically, less dangerous hydrogen acceptors normally being bound in the region of the hematin. The destruction of catalase by coupled oxidation occurs in the mammalian liver (*cf.* Chapter IX).

Such protection is obviously impossible for substances which are reactive in the ferrous form, such as hemoglobin, or whose function depends on a change of valency, such as cytochrome *c*. In the case of hemoglobin we have discussed a variety of protective mechanisms (*cf.* Chapters VII and X). Either the region in which reducing substances are bound by the protein is removed from proximity to the heme group, or hemoglobin is combined with substances which block the dangerous zone. Nevertheless the protection is only partial, as the large catabolism of hemoglobin shows. This is counterbalanced by the powers of the organism for porphyrin and hemoglobin synthesis.

In the case of the cytochromes the heme protein-hydrogen donor interaction is an essential part of the mechanism of its function and hence unavoidable. Here the protection is through prevention of direct combination of the heme iron with oxygen by the peculiar type of linkage between protein and hematin; this, on the other hand, necessitates the assistance of an oxidase for the catalytic function.

The increase of size of organisms makes the supply of oxygen by diffusion impossible, and necessitates the development of special oxygen carriers and oxygen stores. The adaptation for these functions has been discussed in Chapter VII.

5. HEMATIN PIGMENTS OF UNKNOWN FUNCTION

In addition to the hematin compounds the function of which is known, the hematin enzymes, and the oxygen carriers, a number of hematin compounds have been observed which do not appear to possess any metabolic function, or whose function is still unknown.

It has been mentioned that yeast and other cells contain a hematin compound which on reduction does not give a hemochrome, while on reduction in the presence of pyridine it yields pyridine protohemochrome. This compound has been called "free cell hematin" by Keilin (1474), although it is probably also a hemoprotein. Its evolutionary role is uncertain. It may be a relic of the time before the hematin compounds became adapted to their specific enzymic or metabolic functions, or it may be a reserve store of hematin for the formation of metabolically active compounds, or have a still unknown function.

As Wigglesworth (3081) has pointed out, the hematin compounds of hemichrome nature which are found in hemolymph and salivary glands of certain blood-sucking insects are derived from the hemoglobin of host and prey and are apparently metabolically functionless. The fact, however, that they are passed on in the egg yolk indicates that they are nevertheless of biological significance. Perhaps they serve as reserve food for the construction of the hematin enzymes before the nymph receives blood. If this is correct, these animal species require hematin as a growth factor in the same way as the flagellates or *Hemophilus influenzae* (cf. Chapter XIII, Section 3.2.2.). Perhaps the urechrome found in the eggs of the pacific marine worm *Urechis caupo* serves a similar purpose (1348).

Other hematin compounds may be unsatisfactory cul-de-sacs of evolution. Helicorubin does not appear to possess any physiologic function and may be considered an excretory product, particularly in view of the fact that *Helix* does not require hematin for the formation of its oxygen carrier (hemocyanin). It should be noted, however, that hemocyanin animals possess the cytochrome system and that some of them have even myohemoglobin in their heart and adductor muscles (125).

The hemoglobin of root nodules poses an interesting evolutionary problem, since neither the host plant nor the bacteria (*Rhizobium*) alone are able to produce it. Its physiologic role is perhaps connected with nitrogen assimilation (cf. Chapter IX, Section 5.2.).*

In conclusion it will have been observed that the tentative hypotheses put forward in the earlier sections of this chapter by no means solve the problem of the origin and evolutionary role of the pyrrole pigments. The present state of knowledge is insufficient to make this possible. It demonstrates, on the contrary, the difficulties which face the worker in the field of chemical aspects of evolution, where the guidance of the fossil record is denied him in the most crucial stages of his search. It would seem that further progress will be slow, and will derive its main impetus from further comparative studies of primitive types of organisms, as representative, at least in approximation, of those which lived in the, even geologically, distant past.

* The hemoglobin found occasionally in some species of *Daphnia* (Fox, 937aa) does not appear to have an essential physiologic function, although, like the hematin compounds mentioned above, it is passed on in parthenogenetic eggs. Even the chlorocruorin or erythrocrucorin of serpulimorphid worms does not appear to be essential (Fox, 937a).

BIBLIOGRAPHY

1. Abrams, R., A. M. Altschul, and T. R. Hogness, *J. Biol. Chem.*, **142**, 303 (1942).
2. Abramson, H. A., L. S. Moyer, and M. H. Gorin, *Electrophoresis of Protein and the Chemistry of Cell Surfaces*, Reinhold, New York (1942).
3. Adair, G. S., *Proc. Cambridge Phil. Soc.*, **1**, 75 (1924).
4. Adair, G. S., *Proc. Roy. Soc. London*, **108A**, 627 (1925).
5. Adair, G. S., *Proc. Roy. Soc. London*, **109A**, 292 (1925).
6. Adair, G. S., *J. Biol. Chem.*, **63**, 529 (1925).
7. Adair, G. S., *Proc. Roy. Soc. London*, **120A**, 573 (1928).
8. Adair, G. S. Quoted in D. Keilin and E. F. Hartree, *Proc. Roy. Soc. London*, **122B**, 298 (1937).
9. Adair, G. S. and M. E. Adair, *Proc. Roy. Soc. London*, **120B**, 422 (1936).
- 9a. Adair, G. S., A. G. Ogston, and J. P. Johnston, *Biochem. J.*, **40**, 867 (1946).
10. Adams, G. A., *Biochem. J.*, **30**, 2016 (1936).
11. Adams, G. A., *Biochem. J.*, **32**, 646 (1938).
12. Adams, G. A., R. C. Bradley, and A. B. Macallum, *Biochem. J.*, **28**, 482 (1934).
13. Adler, A., *Deut. Arch. klin. Med.*, **138**, 309 (1922).
14. Adler, A., *Klin. Wochschr.*, **1**, 1787, 2505 (1922).
15. Adler, A., *Deut. med. Wochschr.*, **48**, 1442 (1922).
16. Adler, A., *Deut. Arch. klin. Med.*, **140**, 302 (1922).
17. Adler, A., *Biochem. Z.*, **144**, 64 (1924).
18. Adler, A., *Z. ges. exptl. Med.*, **46**, 371 (1925).
19. Adler, A. and M. Sachs, *Z. ges. exptl. Med.*, **31**, 370, 398 (1923).
20. Adler, A. and E. Schubert, *Biochem. Z.*, **134**, 539 (1923).
21. Adler, A. and L. Strauss, *Z. ges. exptl. Med.*, **44**, 1 (1924).
22. Adler, A. and G. Tützer, *Klin. Wochschr.*, **3**, 1318 (1924).
23. Agner, K., *Z. physiol. Chem.*, **235**, II (1925).
24. Agner, K., *Biochem. J.*, **32**, 1702 (1938).
25. Agner, K., *Naturwissenschaften*, **27**, 418 (1939).
26. Agner, K., *Acta Physiol. Scand.*, **2**, Suppl. VIII (1941).
27. Agner, K., *Arkiv. Kemi Mineral. Geol.*, **16A**, No. 6 (1942).
28. Agner, K., *ibid.*, **17B**, No. 9 (1943).
- 28a. Agner, K., *Nature*, **159**, 271 (1947).
29. Agner, K. and H. Theorell, *Arch. Biochem.*, **10**, 321 (1946).
- 29a. Aharoni, J. and Ch. Dhéré, *Compt. rend.*, **190**, 1499 (1930).
30. Aitken, J., *J. Obstet. Gynaecol. Brit. Empire*, **1**, 414 (1902).
31. Åkesson, Å., *Acta Physiol. Scand.*, **4**, 362 (1932).
32. Albanese, A. A. and T. M. Barnes, *J. Biol. Chem.*, **157**, 613 (1945).
33. Albanese, A. A., and co-workers, *ibid.*, **148**, 299 (1943).
34. Albaum, H. G., J. Tepperman, and O. Bodansky, *ibid.*, **164**, 45 (1946).
35. Albaum, H. G. and L. G. Worley, *ibid.*, **144**, 697 (1942).

36. Albers, V. M. and A. V. Knorr, *J. Chem. Phys.*, **4**, 422 (1936).
37. Alcock, R. C., *Biochem. J.*, **27**, 754 (1933).
38. Alexander, A. E., *J. Chem. Soc.*, 1937, 1813.
39. Alt, H. L., *Biochem. Z.*, **231**, 493 (1929).
40. Alt, H. L., *Am. J. Diseases Children*, **56**, 975 (1938).
41. Altschul, A. M., R. Abrams, and T. R. Hogness, *J. Biol. Chem.*, **130**, 427 (1939).
42. Altschul, A. M., R. Abrams, and T. R. Hogness, *ibid.*, **136**, 777 (1940).
43. Altschul, A. M. and T. R. Hogness, *ibid.*, **124**, 25 (1938).
44. Altschul, A. M. and T. R. Hogness, *ibid.*, **129**, 315 (1939).
45. Altschul, A. M., A. E. Sidwell, and T. R. Hogness, *ibid.*, **127**, 123 (1939).
46. Ames, S. R. and C. A. Elvehjem, *ibid.*, **159**, 549 (1945).
47. Ammundsen, E., *Science*, **90**, 372 (1939).
48. Ammundsen, E., *J. Biol. Chem.*, **138**, 563 (1941).
49. Ammundsen, E. and M. Trier, *Acta Med. Scand.*, **101**, 451 (1939).
50. Andersch, M. A., D. A. Wilson, and M. L. Menten, *J. Biol. Chem.*, **153**, 301 (1944).
51. Andersen, B., *Skand. Arch. Physiol.*, **79**, 240 (1938).
52. Anderson, A. B. and P. D'A. Hart, *J. Path. Bact.*, **39**, 465 (1934).
53. Anderson, H. D., K. B. McDonough, and C. A. Elvehjem, *J. Lab. Clin. Med.*, **25**, 464 (1940).
54. Anderson, W. A. D., *Urol. and Cutaneous Rev.*, **47**, 139 (1943).
55. Anderson, W. A. D., D. B. Morrison, and E. F. Williams, Jr., *Arch. Path.*, **33**, 589, 677 (1942).
56. Andrewes, *Brit. J. Exptl. Path.*, **5**, 213 (1924).
57. Andrews, H. L. and B. L. Horecker, *Rev. Sci. Instruments*, **16**, 148 (1945).
58. Angier, R. B., and co-workers, *Science*, **102**, 227 (1945); **103**, 667 (1946).
59. Anselmino, K. J. and F. Hoffmann, *Arch. Gynäk.*, **143**, 477 (1931).
60. Anselmino, K. J. and F. Hoffmann, *ibid.*, **147**, 69 (1931).
61. Anselmino, K. J. and F. Hoffmann, *Klin. Wochschr.*, **10**, 97 (1931).
62. Anselmino, K. J. and F. Hoffmann, *Münch. med. Wochschr.*, **79**, 1226 (1932).
63. Anson, M. L., *J. Gen. Physiol.*, **23**, 239 (1939-40).
64. Anson, M. L., J. Barcroft, A. E. Mirsky, and S. Oinuma, *Proc. Roy. Soc. London*, **97B**, 61 (1925).
65. Anson, M. L. and A. E. Mirsky, *J. Physiol. London*, **60**, 50 (1925).
66. Anson, M. L. and A. E. Mirsky, *ibid.*, **60**, 63 (1925).
67. Anson, M. L. and A. E. Mirsky, *ibid.*, **60**, 161, 222 (1925).
68. Anson, M. L. and A. E. Mirsky, *J. Gen. Physiol.*, **9**, 169 (1925).
69. Anson, M. L. and A. E. Mirsky, *ibid.*, **12**, 273 (1928).
70. Anson, M. L. and A. E. Mirsky, *ibid.*, **13**, 121 (1930).
71. Anson, M. L. and A. E. Mirsky, *ibid.*, **13**, 133 (1930).
72. Anson, M. L. and A. E. Mirsky, *ibid.*, **13**, 469 (1930).
73. Anson, M. L. and A. E. Mirsky, *ibid.*, **13**, 477 (1930).
74. Anson, M. L. and A. E. Mirsky, *ibid.*, **14**, 43 (1930-31).
75. Anson, M. L. and A. E. Mirsky, *ibid.*, **14**, 597, 605 (1931).
76. Anson, M. L. and A. E. Mirsky, *ibid.*, **17**, 399 (1934).
77. Anson, M. L. and A. E. Mirsky, *ibid.*, **19**, 451 (1935).
78. Appelmans, R. and J. P. Bouckaert, *Arch. Intern. méd. exptl.*, **2**, 259 (1926).
79. Araki, T., *Z. physiol. Chem.*, **14**, 405 (1890).
80. Archer, H. E. and G. Discombe, *Lancet* II, 432 (1937).
81. Arnold, *Arch. exptl. Path. Pharmacol.*, **219**, 41 (1881).
82. Aron, H. C. S., *J. Nutrition*, **18**, 375 (1939).
83. Aronsohn, A. G. and J. E. Hudson, *Proc. Soc. Exptl. Biol. Med.*, **39**, 271 (1938).
84. Arrhenius, S., *Physik. Z.*, **40**, 534 (1939).

85. Aschoff, L., *Münch. med. Wochschr.*, **69**, 1352 (1922).
86. Aschoff, L., *Acta Path. Microbiol. Scand.*, **5**, 339 (1928).
87. Aschoff, L., *Klin. Wochschr.*, **3**, 961 (1924); **11**, 1620 (1932).
88. Aschoff, L., *Med. Klin.*, **28**, 1553 (1932).
89. Ascoli, V., *Münch. med. Wochschr.*, **57**, 2315 (1910).
90. Ashby, W., *J. Exptl. Med.*, **29**, 267 (1919).
91. Ashby, W., *ibid.*, **34**, 127 (1921).
- 91a. Ashby, W., *Blood*, **3**, 486 (1948).
92. Asher and Ebnöth, *Biochem. Z.*, **72**, 416 (1916).
93. Astbury, W. T. and R. Lomax, *J. Chem. Soc.*, 1935, 846.
94. Aszódi, Z., *Biochem. Z.*, **252**, 212 (1932).
95. Aub, J., D. E. Smith, and P. Reznikoff, *J. Exptl. Med.*, **40**, 151 (1924).
96. Aubertin, E., *Compt. rend. soc. biol.*, **132**, 129, 132, 135, 137, 139, 141 (1939).
97. Auché, A., *ibid.*, **64**, 297, 299 (1908).
98. Auld, A. G., *Brit. Med. J.*, **I**, 1896, 137.
99. Austin, J. H. and D. L. Drabkin, *J. Biol. Chem.*, **112**, 67 (1935).
100. Austoni, M. E. and D. M. Greenberg, *ibid.*, **134**, 27 (1940).
101. Avery, O. T. and H. J. Morgan, *J. Exptl. Med.*, **39**, 275, 289 (1924); **42**, 347 (1924).
102. Avery, O. T. and J. M. Neill, *ibid.*, **39**, 347, 357, 543, 745 (1924).
103. Axelrod, A. E. and co-workers, *J. Biol. Chem.*, **148**, 721 (1943).
104. Axelrod, A. E. and C. A. Elvehjem, *Nature*, **143**, 281 (1939).
105. Axelrod, A. E., T. D. Spies, and C. A. Elvehjem, *J. Biol. Chem.*, **138**, 667 (1941).
106. Axelrod, A. E., K. F. Swingle, and C. A. Elvehjem, *ibid.*, **145**, 297 (1942).
107. Baar, H. S. and E. M. Hickmans, *J. Physiol. London*, **100**, *Proc. Physiol. Soc.*, **3P**, 4P (1941).
108. Baar, H. S. and T. W. Lloyd, *J. Physiol., London*, **98**, 12P (1940); *Arch. Disease Childhood*, **18**, **1**, 124 (1943).
109. Bach, A. and co-workers, *Ber.*, **36**, 600 (1903); **37**, 1342, 2434, 3785 (1904); **41**, 2345 (1908); **47**, 2122 (1914).
110. Bach, A. and A. Kultjugin, *Biochem. Z.*, **167**, 227, 238, 241 (1926).
111. Bach, I. and B. Korpássy, *Ber. ges. Physiol. u. exptl. Pharmakol.*, **73**, 285 (1933).
112. Bach, S. J., M. Dixon, and D. Keilin, *Nature*, **149**, 21 (1942).
113. Bach, S. J., M. Dixon, and L. G. Zervas, *ibid.*, **149**, 48 (1942); *Biochem. J.*, **40**, 229 (1946).
114. Bacharach, A. L. and H. E. Glynn, *Nature*, **140**, 896 (1937).
115. Back, K. J. C., J. Lascelles, and J. L. Still, *Austral. J. Sci.*, **9**, 25 (1946).
116. Baker, A. B. and C. J. Watson, *J. Neuropathol. Exp. Neurol.*, **4**, 68 (1945).
117. Baker, S. L. and E. C. Dodds, *Brit. J. Exptl. Path.*, **6**, 247 (1925).
118. Baldridge, C. W. and J. A. Greene, *Proc. Soc. Exp. Biol. Med.*, **31**, 1035 (1934).
119. Baldwin, E., *Introduction to Comparative Biochemistry*, Macmillan, New York, 1937.
120. Balfour, W. M. and co-workers, *J. Exptl. Med.*, **76**, 15 (1942).
121. Bálint, P. and M. Bálint, *Biochem. Z.*, **308**, 82 (1941).
122. Ball, E. G., *J. Biol. Chem.*, **118**, 219 (1937).
123. Ball, E. G., *Biochem. Z.*, **295**, 262 (1938).
124. Ball, E. G., *Symposium on Respiratory Enzymes*, Univ. Wisconsin Press, Madison, p. 21, 1942; *Ann. N. Y. Acad. Sci.*, **45**, 357 (1944).
125. Ball, E. G. and B. Meyerhof, *J. Biol. Chem.*, **134**, 483 (1940).
- 125a. Ball, R. H., G. D. Dorough, and M. Calvin, *J. Am. Chem. Soc.*, **68**, 2278 (1946).
126. Balls, A. K., *J. Am. Chem. Soc.*, **54**, 2133 (1932).
127. Balls, A. K. and W. S. Hale, *J. Biol. Chem.*, **107**, 767 (1934).

128. Balthazard, V. and M. Philippe, *Ann. méd. légale criminol. police sci.*, **6**, 137 (1926).
129. Bancroft, G. and K. H. C. Elliot, *Biochem. J.*, **28**, 1911 (1934).
130. Bandow, F., *Z. physik. Chem.*, **34B**, 323 (1936).
131. Bandow, F., *ibid.*, **42B**, 155 (1939).
132. Bandow, F. and E. J. Klaus, *Z. physiol. Chem.*, **238**, 1 (1936).
- 132a. Bang, O. and S. L. Ørskov, *J. Clin. Investigation*, **16**, 279 (1937).
133. Banga, I., E. Philippot, and A. Szent-Györgyi, *Nature*, **142**, 874 (1938).
134. Banga, I. and E. Philippot, *Z. physiol. Chem.*, **258**, 147 (1939).
135. Banga, I. and A. Szent-Györgyi, *ibid.*, **255**, 57 (1938).
136. Bansi, H. W. and M. Rohrich, *Verhandl. deut. Ges. inn. Med.*, **45**, 350 (1933).
137. Barbaro-Forleo, G. and F. Cattaneo, *Ber. ges. Physiol. u. exptl. Pharmacol.*, **91**, 33 (1936).
138. Barcroft, H., A. H. Gibson, D. C. Harrison, and J. McMurray, *Clin. Sci.*, **5**, 145 (1945).
139. Barcroft, J., *Physiol. Revs.*, **5**, 596 (1925).
140. Barcroft, J., "The respiratory function of the blood," Part I, Cambridge Univ. Press, London, 1928.
141. Barcroft, J., "The respiratory function of the blood," Part II — Hemoglobin, Cambridge Univ. Press, London, 1928.
142. Barcroft, J., *Features in the Architecture of Physiological Function*, Cambridge Univ. Press, London, 1934.
143. Barcroft, J., *Physiol. Revs.*, **16**, 103 (1936).
144. Barcroft, J. and H. Barcroft, *Proc. Roy. Soc. London*, **96B**, 28 (1924).
145. Barcroft, J. and J. H. Burn, *J. Physiol. London*, **45**, 493 (1913).
146. Barcroft, J. and co-workers, *Philos. Trans.*, **B211**, 351 (1923).
147. Barcroft, J. and co-workers, *J. Physiol. London*, **83**, 192 (1935).
148. Barer, A. P. and W. M. Fowler, *Am. J. Med. Sci.*, **205**, 9 (1943).
149. Barkan, G., *Klin. Wochschr.*, **6**, 1615 (1927).
150. Barkan, G., *Z. physiol. Chem.*, **171**, 179 (1927).
151. Barkan, G., *ibid.*, **171**, 190 (1927).
152. Barkan, G., *ibid.*, **177**, 205 (1928).
153. Barkan, G., *ibid.*, **221**, 241 (1936).
154. Barkan, G., *ibid.*, **239**, 97 (1936).
155. Barkan, G., *Klin. Wochschr.*, **16**, 300 (1937).
156. Barkan, G., *ibid.*, **17**, 671 (1938).
157. Barkan, G. and E. Berger, *Arch. exptl. Path. Pharmacol.*, **136**, 278 (1928).
158. Barkan, G. and J. Olesk, *Biochem. Z.*, **289**, 251 (1937).
159. Barkan, G. and O. Schales, *Z. physiol. Chem.*, **244**, 81 (1936).
160. Barkan, G. and O. Schales, *ibid.*, **246**, 181 (1937).
161. Barkan, G. and O. Schales, *ibid.*, **248**, 96 (1937).
162. Barkan, G. and O. Schales, *Naturwissenschaften*, **25**, 667 (1937).
163. Barkan, G. and O. Schales, *Z. physiol. Chem.*, **253**, 83 (1938).
164. Barkan, G. and O. Schales, *ibid.*, **254**, 241 (1938).
165. Barkan, G. and O. Schales, *Proc. Soc. Exptl. Biol. Med.*, **50**, 74 (1942).
166. Barkan, G. and B. S. Walker, *J. Biol. Chem.*, **131**, 447 (1939).
167. Barkan, G. and B. S. Walker, *ibid.*, **135**, 803 (1940).
168. Barkan, G. and B. S. Walker, *Science*, **96**, 66 (1942).
169. Barker, H. A., S. Ruben, and M. D. Kamen, *Proc. Natl. Acad. Sci. U.S.*, **26**, 426 (1940).
170. Barker, W. H. and D. K. Miller, *Am. J. Med. Sci.*, **195**, 287 (1938).
171. Barnard, R. D., *J. Gen. Physiol.*, **16**, 657 (1922-3).
172. Barnard, R. D., *J. Biol. Chem.*, **120**, 177 (1937).

173. Barnard, R. D. and W. Nietzel, *Proc. Soc. Exptl. Biol. Med.*, **39**, 171 (1929).
 174. Barrenscheen, H. K. and O. Weltmann, *Biochem. Z.*, **140**, 273 (1923).
 175. Barret, P. A., C. E. Dent, and R. P. Linstead, *J. Chem. Soc.*, 1936, 1717.
 176. Barrett, J. F., *Brit. J. Exptl. Path.*, **21**, 22 (1940).
 177. Barron, A. G. and E. S. G. Barron, *Proc. Soc. Exptl. Biol. Med.*, **35**, 407 (1936).
 178. Barron, E. S. G., *Medicine*, **10**, 77 (1931).
 179. Barron, E. S. G., *J. Biol. Chem.*, **97**, 287 (1932).
 180. Barron, E. S. G., *ibid.*, **121**, 285 (1937).
 181. Barron, E. S. G., *Cold Spring Harbor Sympos. Quant. Biol.*, **7**, 154 (1939).
 182. Barron, E. S. G., *J. Biol. Chem.*, **133**, 51 (1940).
 183. Barron, E. S. G., *Ann. Rev. Biochem.*, **10**, 1 (1941).
 183a. Barron, E. S. G. and co-workers, *Biochem. J.*, **41**, 69 (1947).
 184. Barron, E. S. G., R. H. DeMeio, and F. Klemperer, *J. Biol. Chem.*, **112**, 625 (1935).
 185. Barron, E. S. G. and G. A. Harrop, *ibid.*, **79**, 65 (1928).
 186. Barron, E. S. G. and A. B. Hastings, *ibid.*, **109**, iv (1935).
 187. Barron, E. S. G. and C. M. Lyman, *ibid.*, **123**, 229 (1938).
 188. Barron, E. S. G., R. Munch, and A. E. Sidwell, *Science*, **86**, 39 (1937).
 189. Barron, E. S. G. and T. P. Singer, *J. Biol. Chem.*, **157**, 221, 241 (1945).
 190. Barry, W. B. and V. E. Levine, *ibid.*, **59**, lii (1924).
 191. Battelli, F. and L. Stern, *Soc. de biol.*, **57**, 46, 405 (1904); *Arch. fsiol.*, **2**, 471 (1905); *J. physiol. et path. gén.*, **7**, 919 (1905).
 192. Baudisch, O. and L. A. Welo, *J. Biol. Chem.*, **61**, 261 (1924).
 193. Baumgärtel, T., *Klin. Wochschr.*, **22**, 92 (1943).
 194. Baumgärtel, T., *Z. ges. exptl. Med.*, **112**, 459 (1943); *Klin. Wochschr.*, **22**, 416 (1943).
 195. Baumstark, *Arch. ges. Physiol.*, **9**, 568 (1874).
 196. Beach, E. F., S. S. Bernstein, F. C. Hummel, H. H. Williams, and I. G. Macy, *J. Biol. Chem.*, **130**, 115 (1939).
 197. Bechtold, E., *Der Muskelfarbstoff*, Stuttgart (1935); *Biochem. Z.*, **311**, 426 (1942).
 198. Bechtold, E. and K. Pfeilsticker, *Biochem. Z.*, **307**, 194 (1941).
 199. Beck, A., *Wien. klin. Wochschr.*, **8**, 617 (1895).
 200. Beckermann, F. and H. Schülke, *Klin. Wochschr.*, **16**, 1311 (1937).
 201. Belk, W., P. Ellinger, and T. D. Spiess, *J. Soc. Chem. London*, **56**, 97 (1937); *Quart. J. Med.*, **6**, 305 (1937).
 202. Behrens, M. and T. Asher, *Z. physiol. Chem.*, **220**, 97 (1933).
 203. Belk, W. P. and B. C. Barnes, *Am. J. Med. Sci.*, **201**, 838 (1941).
 204. Belk, W. P. and F. Rosenstein, *ibid.*, **201**, 841 (1941).
 205. Belk, W. P. and F. Rosenstein, *ibid.*, **204**, 504 (1942).
 206. Bell, G. H., J. W. Chambers, and M. B. R. Waddell, *Biochem. J.*, **39**, 60 (1945).
 207. Bell, G. H. and M. L. McNaught, *Lancet I*, 784 (1944).
 208. Belonogowa, N. S., *Deut. Arch. klin. Med.*, **162**, 297 (1928).
 209. Belonogowa, N. S., *ibid.*, **170**, 436 (1931).
 210. Bénard, H. and co-workers, *Compt. rend. soc. biol.*, **138**, 356, 798 (1944); **139**, 346 (1944).
 211. Bénard, H. and co-workers, *ibid.*, **140**, 51 (1946).
 212. Bencsik, F., A. Gáspár, F. Verzár, and A. Zih, *Biochem. Z.*, **225**, 278 (1930).
 213. Bendien, W. M. and I. Snapper, *Acta brevia Neerland Physiol. Pharmacol. Microbiol.*, **1**, 4 (1931); *Biochem. Z.*, **261**, 1 (1933).
 213a. Benkő, S., *Chem. Zentr.*, 1944, II, 767.
 214. Bennets, W. H. and co-workers, *J. Dept. Agr. W. Australia*, **16**, 156 (1939); *Australian Vet. J.*, **17**, 85 (1941); **18**, 50 (1942).

215. Bennhold, H., *Ergeb. inn. Med. u. Kinderheilk.*, **42**, 273 (1932).
216. Bensley, E. H., *J. Lab. Clin. Med.*, **21**, 1195 (1936).
217. Bensley, E. H., L. J. Rhea, and E. S. Mills, *Quart. J. Med.*, **7**, 325 (1938).
218. Berend, N. and M. Fischer, *Biochem. Z.*, **291**, 211 (1937).
219. Bergel, F. and K. Bolz, *Z. physiol. Chem.*, **215**, 25 (1933); **220**, 201 (1933); **223**, 66 (1934).
220. Bergenhem, B. and R. Fähræus, *Z. ges. exptl. Med.*, **97**, 555 (1936).
221. Bergh, A. A. H. van den, *Der Gallenfarbstoff im Blute*, 2d ed., Van Doesburgh, Leyden, 1928.
222. Bergh, A. A. H. van den, *Nederland. Tijdschr. Geneesk.*, **76**, 120 (1932).
223. Bergh, A. A. H. van den, *Klin. Wochschr.*, **12**, 586 (1933).
224. Bergh, A. A. H. van den and H. Engelkes, *ibid.*, **1**, 1932 (1922).
225. Bergh, A. A. H. van den and J. J. de la Fontaine-Schluiter, *Kon. Akad. Wetenschap. Verhand. Wisk. Natuurk.*, **23**, 733 (1914).
226. Bergh, A. A. H. van den and W. Grotepass, *Klin. Wochschr.*, **12**, 586 (1933).
227. Bergh, A. A. H. van den and W. Grotepass, *Nederland. Tijdschr. Geneesk.*, **78**, 259 (1934).
228. Bergh, A. A. H. van den and W. Grotepass, *Compt. rend. soc. biol.*, **121**, 1253 (1936).
229. Bergh, A. A. H. van den, W. Grotepass, and F. E. Revers, *Klin. Wochschr.*, **11**, 1534 (1932).
230. Bergh, A. A. H. van den and A. J. Hijman, *Deut. med. Wochschr.*, **54**, 586 (1928).
231. Bergh, A. A. H. van den and A. J. Hijman, *ibid.*, **54**, 1492 (1928).
232. Bergh, A. A. H. van den and A. W. C. G. Kamerling, *Nederland. Tijdschr. Geneesk.*, **78**, 4432 (1934); *Ann. méd.*, **38**, 309 (1935).
233. Bergh, A. A. H. van den and P. Muller, *Biochem. Z.*, **77**, 90 (1916).
234. Bergh, A. A. H. van den and P. Muller, *Handb. d. biol. Arbeitsmeth.*, *Abt. IV*, **TI**, 1, 901 (1927).
235. Bergh, A. A. H. van den, R. Regniers, and W. Muller, *Arch. Verdauungs-Krankh.*, **42**, 302 (1928).
236. Bergh, A. A. H. van den, and F. E. Revers, *Deut. med. Wochschr.*, **57**, 706 (1931).
237. Bergh, A. A. H. van den, and I. Snapper, *Deut. Arch. klin. Med.*, **110**, 540 (1913).
238. Bergh, A. A. H. van den, and I. Snapper, *Berlin. klin. Wochschr.*, **51**, 1109, 1180 (1914).
239. Bergh, A. A. H. van den, and I. Snapper, *ibid.*, **52**, 1081 (1915).
240. Bergh, A. A. H. van den, and A. Wieringa, *Z. Physiol.*, **59**, 407 (1925).
241. Bergmann, G. v., *Klin. Wochschr.*, **6**, 776 (1927).
242. Bergmann, M. and C. Niemann, *J. Biol. Chem.*, **118**, 301 (1937).
243. Bernard, Cl., *Compt. rend.*, **48**, 393 (1858).
244. Bernard, Cl., quoted by D. Burk in *Cold Spring Harbor Sympos. Quant. Biol.*, **7**, 420 (1939).
245. Bernheim, F., M. L. C. Bernheim, and A. G. Gillaspie, *J. Biol. Chem.*, **114**, 657 (1936).
246. Bernheim, F., M. L. C. Bernheim, and H. O. Michel, *J. Pharmacol. Exptl. Therap.*, **61**, 311 (1937).
247. Bernheim, F. and H. O. Michel, *J. Biol. Chem.*, **118**, 743 (1937).
248. Berry, L. J. and T. D. Spies, *Blood*, **1**, 271 (1946).
249. Bert, Paul, *La Pression Barométrique*, Masson, Paris, 1877.
250. Bertho, A., in C. Oppenheimer, *Handbuch d. Biochemie des Menschen u. d. Tiere, Ergänzungswerk*, Vol. 1, Fischer, Jena, 1933, p. 723.
251. Bertin Sans, H., and I. de Moitessier, *Compt. rend.*, **114**, 923 (1892).
252. Bertrand, G. and L. de Saint-Rat, *Acta Microchim.*, **1**, 5 (1937).

253. Berzelius, J., *Ann.*, **33**, 139 (1840).
254. Besozzi, G. C. and R. Zanini, *Arch. sci. biol., Italy*, **18**, 497 (1933).
- 254a. Bethell, F. H. and co-workers, *J. Lab. Clin. Med.*, **32**, 3 (1947).
255. Bhagvat, K., *doctoral dissertation*, Cambridge, London, 1939.
256. Bick, M., *Australian J. Exptl. Biol. Med. Sci.*, **17**, 321 (1939).
257. Bierich, R. and A. Rosenbohm, *Z. physiol. Chem.*, **196**, 87 (1931).
258. Bigwood, E. J. and J. Thomas, *Compt. rend. soc. biol.* **117**, 220 (1934).
259. Bigwood, E. J. and J. Thomas, *ibid.*, **120**, 69 (1935).
260. Billi, A., L. Heilmeyer, and F. Pfothenauer, *Z. ges. exptl. Med.*, **91**, 726 (1933).
261. Binet, L., M. Bochet, and A. Guiraud, *Compt. rend. soc. biol.*, **130**, 1249 (1939).
262. Bing, F. C., F. A. Benes, and D. G. Remp, *J. Biol. Chem.* **114**, x (1936).
263. Bing, R. J., *Bull. Johns Hopkins Hosp.*, **74**, 161 (1944).
264. Bingel, A., *Z. ges. Neurol. Psychiat.*, **158**, 79 (1937).
265. Bingold, K., *Z. klin. Med.*, **97**, 257 (1923).
266. Bingold, K., *Deut. Arch. klin. Med.*, **154**, 53 (1923).
267. Bingold, K., *Folia Haematol.*, **42**, 192 (1930).
268. Bingold, K., *Klin. Wochschr.*, **11**, 1423 (1932).
269. Bingold, K., in H. Hirschfeld and A. Hittmair, *Handbuch d. allg. Hämatologie*. Hälfte 1, Urban und Schwarzenberg, Berlin, 1932, p. 601.
270. Bingold, K., *Klin. Wochschr.* **12**, 1201 (1933).
271. Bingold, K., *Verhandl. deut. Ges. inn. Med.*, **45**, 75 (1933).
272. Bingold, K., *Klin. Wochschr.*, **13**, 1451 (1934).
273. Bingold, K., *ibid.*, **14**, 1237 (1935).
274. Bingold, K., *Deut. Arch. klin. Med.*, **177**, 230 (1935).
275. Bingold, K., *Z. ges. exptl. Med.*, **99**, 325 (1936).
276. Bingold, K., *Deut. Arch. klin. Med.*, **199**, 325 (1936).
277. Bingold, K., *Klin. Wochschr.*, **17**, 239 (1938).
278. Bingold, K., *ibid.*, **20**, 331 (1941).
279. Binkley, S. B. and co-workers, *Science*, **100**, 36 (1944).
280. Birkhofer, L. and A. Taurins, *Z. physiol. Chem.*, **265**, 94 (1940).
281. Birkinshaw, J. H. and H. Raistrick, *J. Biol. Chem.*, **148**, 459 (1943).
282. Bischoff, H., *Z. ges. exptl. Med.*, **43**, 161 (1926).
283. Bischoff, H., *ibid.*, **48**, 472 (1926).
- 283a. Bittner, J. J. and C. J. Watson, *Cancer Rev.*, **6**, 337 (1946).
284. Black, D. A. K. and J. F. Powell, *Biochem. J.*, **36**, 110 (1942).
285. Black, S. and co-workers, *J. Biol. Chem.*, **145**, 137 (1942); *Proc. Soc. Exptl. Biol. Med.*, **47**, 308 (1941).
286. Blackman, F. F., *Ann. Botany*, **19**, 23 (1905).
287. Blankenhorn, M. A., *J. Exptl. Med.*, **45**, 195 (1927).
288. Blankenhorn, M. A., *J. Biol. Chem.*, **80**, 477 (1923).
289. Blaschko, H., *J. Physiol., London*, **84**, 52P (1935).
290. Bloch, K. and D. Rittenberg, *J. Biol. Chem.*, **159**, 45 (1945).
291. Block, R. J., *ibid.*, **105**, 663 (1934).
292. Block, R. J., *Cold Spring Harbor Symposia Quant. Biol.*, **6**, 79 (1938).
293. Block, R. J. and D. Bolling, *Arch. Biochem.*, **3**, 217 (1944).
294. Blum, H. F., *Physiol. Revs.*, **12**, 23 (1932).
295. Blum, H. F. and N. Pace, *Brit. J. Dermatol. Syphilis*, **49**, 465 (1937).
296. Blum, H. F. and I. C. Schumacher, *Ann. Internal Med.*, **11**, 548 (1937).
297. Boas, I., *Klin. Wochschr.*, **10**, 2311 (1931); **11**, 1051, 1496 (1932).
298. Boas, I., *Deut. med. Wochschr.*, **59**, 126 (1933).
299. Boas, I., *Klin. Wochschr.*, **12**, 589 (1933).
300. Boas, I., *Arch. Verdauungs-Krankh.*, **53**, 87 (1933).

301. Bocat, L., *Compt. rend. soc. biol.*, **62**, 1078 (1907).
 302. Bocat, L., *ibid.*, **64**, 101 (1908).
 303. Bock, E., *Klin. Wochschr.*, **3**, 587, 638 (1924).
 304. Bodine, J. H., *J. Cellular Comp. Physiol.*, **4**, 397 (1934).
 305. Bodine, J. H. and E. J. Boell, *ibid.*, **4**, 475 (1934).
 306. Bodine, J. H. and E. J. Boell, *ibid.*, **5**, 97 (1934).
 307. Bodine, J. H. and E. J. Boell, *Proc. Soc. Exptl. Biol. Med.*, **32**, 783 (1935).
 308. Bogniard, R. P. and G. H. Whipple, *J. Exptl. Med.*, **55**, 653 (1932).
 309. Bohr, Ch., *Zentr. Physiol.*, **17**, 682 (1903).
 309a. Bohr, Ch., K. Hasselbach, and A. Krogh, *Skand. Arch. Physiol.*, **16**, 402 (1904).
 310. Bois, E., *Recherches spectrochimiques sur quelques porphyrines animales*, Dissertation, Fribourg, Switzerland, 1927.
 311. Bollman, J. L., Ch. Sheard, and F. C. Mann, *Am. J. Physiol.*, **78**, 384, 658 (1926).
 312. Bomford, R. R., *Brit. Med. J.*, **II**, 1940, 549.
 313. Bommer, *Klin. Wochschr.*, **6**, 1145 (1927).
 314. Bonnet, R., *Deut. med. Wochschr.*, **45** (1899); *Anat. Hefte*, **20**, 327 (1903).
 314a. Bonnichsen, R. K., *Arch. Biochem.*, **12**, 83 (1947).
 314b. Bonnichsen, R. K., B. Chance, and H. Theorell, *Acta Chem. Scand.*, **1**, 685 (1947).
 315. Boresch, K., *Biochem. Z.*, **119**, 167 (1921).
 316. Boresch, K., *Arch. f. Protistenk.*, **44**, 1 (1922).
 317. Boresch, K., *Ber. deut. botan. Ges.*, **40**, 288 (1922).
 318. Boresch, K., in G. Klein, *Handbuch der Pflanzenanalyse*, Bd. 3, Springer, Berlin, 1932, p. 1395.
 319. Borson, H. J. and S. R. Mettler, *Proc. Soc. Exptl. Biol. Med.*, **43**, 429 (1940).
 320. Borsook, H. and co-workers, *J. Biol. Chem.*, **117**, 237 (1936).
 321. Borst, M. and H. Königsdörffer, *Strahlentherapie*, **28**, 132 (1928).
 322. Borst, M. and H. Königsdörffer: *Untersuchungen über Porphyrin*, Hirzel, 1929.
 323. Boycott, A. E. and C. L. Oakley, *J. Path. Bact.*, **36**, 205 (1933).
 324. Boyd, M. J., *J. Biol. Chem.*, **103**, 249 (1933).
 324a. Boyes-Watson, J., E. Davidson, and M. F. Perutz, *Proc. Roy. Soc. London*, **191A**, 83 (1947).
 325. Boyes-Watson, J. and M. F. Perutz, *Nature*, **151**, 714 (1943).
 326. Boynton, M. H., *J. Lab. Clin. Med.*, **31**, 40 (1946).
 327. Bradley, H. C., *J. Biol. Chem.*, **4**, xxxvi (1908).
 327a. Braganca, B. de M. and K. C. Saha, *Ann. Biochem. Exptl. Med., India*, **3**, 47 (1943).
 328. Brann, L., *doctoral dissertation*, Zürich, 1927.
 329. Bratley, F. G. and co-workers, *Am. J. Med. Sci.*, **182**, 597 (1931).
 330. Brdička, R. and C. Tropp, *Biochem. Z.*, **289**, 301 (1937).
 331. Brdička, R. and K. Wiesner, *Naturwissenschaften*, **31**, 247 (1942).
 332. Brdička, R., K. Wiesner, and K. Schäferna, *ibid.*, **31**, 390 (1943).
 333. Bredig, G. and M. v. Berneck, *Z. physiol. Chem.*, **31**, 258 (1899); *Physik. Z.*, **1**, 259 (1900); **2**, 1 (1901).
 334. Bredig, G. and S. R. Carter, *Ber.*, **37**, 541 (1914).
 335. Breschet, G., *Ann. sci. nat.*, **19**, 379 (1830).
 336. Brinkman, R. and J. H. P. Jonxis, *J. Physiol.*, **85**, 117 (1935).
 337. Brinkman, R. and J. H. P. Jonxis, *ibid.*, **88**, 162 (1937).
 338. Brinkman, R., A. Wildschut, and H. Wittermans, *ibid.*, **80**, 377 (1934).
 339. Brock, J. F. and D. Hunter, *Quart. J. Med.*, **6**, 5 (1937).
 340. Brooks, J., *Biochem. J.*, **23**, 1391 (1929).
 341. Brooks, J., *Proc. Roy. Soc. London*, **109B**, 35 (1931).

342. Brooks, J., *ibid.*, **118B**, 560 (1935).
343. Brooks, J., *ibid.*, **123B**, 368 (1937).
344. Brooks, M. M., *Proc. Soc. Exptl. Biol. Med.*, **32**, 63 (1934).
345. Broun, G. O., *J. Exptl. Med.*, **36**, 481 (1922).
346. Broun, G. O., P. D. McMaster, and P. Rous, *ibid.*, **37**, 699, 733 (1923).
347. Brown, A. and A. Goodall, *J. Physiol.*, **104**, 404, 408 (1946).
348. Brown, A. H. and D. R. Goddard, *Am. J. Botany*, **28**, 319 (1941).
349. Brown, G. M., O. C. Hayward, E. O. Powell, and L. J. Witts, *J. Path. Bact.*, **56**, 81 (1944).
350. Brown, J. H., in *Monograph No. 9*, Rockefeller Institute for Medical Research, New York, 1919.
351. Brown, W. E. L. and A. V. Hill, *Proc. Roy. Soc. London*, **94B**, 297 (1924).
352. Brown, W. H., *J. Exptl. Med.*, **13**, 290 (1910).
353. Brown, W. H., *ibid.*, **14**, 612 (1911).
354. Brown, W. H., *ibid.*, **15**, 580 (1912).
355. Brown, W. H., *ibid.*, **18**, 96 (1913).
356. Brown, W. H. and A. S. Loevenhart, *ibid.*, **18**, 107 (1913).
357. Brownlee, G., *Biochem. J.*, **33**, 697 (1933).
358. Brücke, *Wien. med. Wochschr.*, **4**, Heft 44 (1859).
359. Brückmann, G. and E. Wertheimer, *Nature*, **155**, 268 (1945).
360. Brückmann, G. and E. Wertheimer, *Brit. J. Exptl. Path.*, **26**, 217 (1945).
361. Brückmann, G. and S. G. Zondek, *Biochem. J.*, **33**, 1845 (1939).
362. Brückmann, G. and S. G. Zondek, *J. Biol. Chem.*, **135**, 23 (1940).
363. Brückner-Mortensen, K., *Acta Med. Scand.*, **47**, 759 (1931).
364. Bruggen, J. T. Van, *J. Lab. Clin. Med.*, **30**, 611 (1945).
365. Brugsch, J., *Z. ges. exptl. Med.*, **95**, 471 (1935).
366. Brugsch, J., *ibid.*, **98**, 49, 57 (1936).
367. Brugsch, J. T., *Ergebn. inn. Med. u. Kinderheilk.*, **51**, 86 (1936).
368. Brugsch, J. T., *Proc. Staff Meetings Mayo Clin.*, **12**, 609 (1937).
369. Brugsch, J. T. and A. Keys, *Proc. Soc. Exptl. Biol. Med.*, **38**, 557 (1938).
370. Brugsch, T. and K. Kawashima, *Z. exptl. Path. Therap.*, **8**, 645 (1911).
371. Brugsch, T. and K. Retzlaff, *ibid.*, **9**, 508 (1912).
372. Brugsch, T. and Yoshimoto, *ibid.*, **8**, 639 (1911).
373. Brulé, M. and H. Garban, *Comp. rend. soc. biol.*, **84**, 482 (1921).
374. Bücher, T. and E. Negelein, *Biochem. Z.*, **311**, 163 (1942).
375. Buell, A. and S. R. Mettler, *J. Lab. Clin. Med.*, **26**, 1434 (1941).
376. Bürker, H., *Arch. ges. Physiol.*, **247**, 194 (1943).
377. Bull, H. B., *Cold Spring Harbor Symposia Quant. Biol.*, **6**, 140, 146 (1938).
378. Bull, H. B., in F. F. Nord and C. H. Werkman, *Advances in Enzymology*, Vol. I, Interscience, New York, 1941.
379. Bumm, E., H. Appel, and K. Fehrenbach, *Z. physiol. Chem.*, **223**, 207 (1934).
380. Burger, G. C. E. and B. H. Stockmann, *Nederland. Tijdschr. Geneesk.* **76**, 1369 (1932).
381. Burk, D., *Cold Spring Harbor Symposia Quant. Biol.*, **7**, 420 (1939).
381a. Burk, D. and co-workers, *J. Biol. Chem.*, **165**, 723 (1946).
382. Burk, N. F. and D. M. Greenberg, *J. Biol. Chem.*, **87**, 197 (1930).
383. Burmester, B. R., *Folia Haematol.*, **56**, 372 (1937).
384. Burris, R. H. and E. Haas, *J. Biol. Chem.*, **155**, 227 (1944).
384a. Burris, P. W. and R. H. Wilson, *Bact. Rev.*, **11**, 41 (1947).
385. Butler, A. M. and M. Cushman, *J. Clin. Invest.*, **19**, 459 (1940).
386. Bywaters, E. G. L., G. E. Delory, C. Rimington, and J. Smiles, *Biochem. J.*, **35**, 1164 (1941).

387. Bywaters, E. G. L. and J. H. Dibble, *J. Path. Bact.*, **55**, 7 (1943).
388. Bywaters, E. G. L. and J. K. Stead, *Quart. J. Exptl. Physiol.*, **33**, 53 (1944).
389. Caglar, M., *Nature*, **155**, 670 (1945).
390. Cahen, A., *Compt. rend. soc. biol.*, **127**, 221 (1938).
391. Califano, L., *Naturwissenschaften*, **22**, 249 (1934).
392. Callaghan, J. P., Unpublished data.
393. Callaghan, J. P., *Nature*, in press.
394. Callaghan, J. P. and R. Giovanelli, Unpublished data.
395. Callender, S. T., E. O. Powell, and L. J. Witts, *J. Path. Bact.*, **57**, 129 (1945).
- 395a. Calvin, M. and co-workers, *J. Am. Chem. Soc.*, **68**, 2254, 2263, 2267, 2612 (1946).
396. Calvin, M., E. G. Cockbain, and M. Polanyi, *Trans. Faraday Soc.*, **32**, 1436 (1936); D. D. Eley, and M. Polanyi, *ibid.*, **32**, 1443 (1936).
397. Calvo-Criado, V., *Biochem. Z.*, **164**, 61 (1925).
398. Campbell, D. and T. N. Morgan, *Lancet* **II**, 123 (1939).
399. Campbell, D. H. and L. Fourt, *J. Biol. Chem.*, **129**, 385 (1939).
400. Campbell, R. J., R. A. Brown, and A. D. Emmett, *ibid.*, **152**, 483 (1944).
401. Camus, J. and P. Pagniez, *Compt. rend.*, **135**, 1010 (1902).
402. Carbone, T., *Giorn. reale accad. med. Torin*, **39**, 901 (1891).
403. Carleton, B. H. and W. O. Fenn, *J. Cell. Comp. Physiol.*, **11**, 91 (1938).
404. Carrié, C., *Arch. Dermatol. u. Syphilis*, **163**, 523 (1931).
405. Carrié, C., *Dermatol. Z.*, **70**, 189 (1934).
406. Carrié, C., *Die Porphyrine*, Thieme, Leipzig, 1936.
407. Carrié, C. and A. S. v. Mallinckrodt-Haupt, *Arch. Dermatol. u. Syphilis*, **170**, 521 (1934).
408. Carlström, B., *Skand. Arch. Physiol.*, **62**, 1 (1931).
409. Carter, C. W. and co-workers, *Biochem. J.* **39**, 339 (1945).
410. Carter, G. S., *Biol. Revs. Biol. Proc. Cambridge Phil. Soc.*, **6**, 1 (1931).
411. Cartwright, G. E., M. M. Wintrobe, and S. Humphreys, *J. Biol. Chem.*, **153**, 171 (1944).
412. Cartwright, G. E. and co-workers, *Science*, **103**, 72 (1946); *J. Clin. Invest.*, **25**, 65, 81 (1946).
413. Case, R. A. M., *Nature*, **152**, 599 (1943).
414. Case, R. A. M., *J. Physiol.*, **103**, Proc. Soc., 14P (1944).
415. Case, R. A. M., *J. Path. Bact.*, **57**, 271 (1945).
416. Case, R. A. M., *Proc. Roy. Soc. London*, **133B**, 235 (1946).
417. Case, R. A. M., V. N. Laden, and M. E. Nutt, *Nature*, **155**, 270 (1945).
418. Castle, W. B., *Harvey Lectures*, **34-35**, 37 (1936).
419. Castle, W. B. and co-workers, *Science*, **100**, 81 (1944).
420. Chaikoff, I. L., H. Schachner, and A. L. Franklin, *J. Biol. Chem.*, **151**, 191 (1943).
421. Chalmers, J. N. M., A. E. Gillam, and J. E. Kench, *Lancet*, **II**, 806 (1940).
422. Chance, B., *J. Biol. Chem.*, **140**, xxiv (1941).
423. Chance, B., *J. Franklin Inst.*, **229**, 455 (1940); *Rev. Sci. Instruments*, **13**, 158 (1942).
424. Chance, B., *J. Biol. Chem.*, **151**, 553 (1943).
425. Chance, B., *J. Cell. Comp. Physiol.*, **22**, 33 (1943).
- 425a. Chance, B., *Acta Chem. Scand.*, **1**, 236 (1947).
- 425b. Chance, B., *Nature*, **161**, 914 (1948).
426. Chance, B., E. N. Harvey, F. Johnson, and G. A. Millikan, *ibid.*, **15**, 195 (1940).
427. Chandler, F. G., G. A. Harrison, and C. Rimington, *Brit. Med. J.* **II**, 1939, 1173.
428. Chang, Y. T., J. M. Chen, and T. Shen, *Arch. Biochem.*, **3**, 235 (1944).
429. Chargaff, E., *Advances in Protein Chem.*, **1**, 1 (1944).
430. Chargaff, E., M. Ziff, and B. M. Hogg, *J. Biol. Chem.*, **131**, 95 (1939).

431. Charnas, D., *Biochem. Z.*, **20**, 401 (1909).
432. Charnas, D., *Mitt. d. Ges. f. inn. Med. u. Kinderheilk.*, **12**, 70 (1913).
433. Chibnall, A. C., *Proc. Roy. Soc. London*, **131B**, 136 (1942-3).
433a. Chibnall, A. C., *J. Intern. Soc. Leather Trades' Chemists*, **30**, 1 (1946).
434. Chibnall, A. C. and co-workers, *Biochem. J.*, **37**, 354, 360, 372 (1943).
435. Chick, H., T. F. Macrae, A. J. P. Martin, and C. J. Martin, *ibid.*, **32**, 2207 (1944).
436. Chick, H., T. F. Macrae, and A. V. Warden, *ibid.*, **34**, 580 (1940).
437. Chick, H. and C. J. Martin, *Kolloid chem. Behefte*, **5**, 49 (1913).
438. Chiodi, H. and co-workers, *Am. J. Physiol.*, **134**, 683 (1941).
439. Chodat, R. and A. Bach, *Ber.*, **36B**, 606 (1903).
440. Chou, T. P. and W. H. Adolph, *Biochem. J.*, **29**, 476 (1935).
441. Chow, B. F., *J. Am. Chem. Soc.*, **56**, 894 (1934).
442. Christenson, E. H., and D. B. Dill, *J. Biol. Chem.*, **109**, 443 (1935).
442a. Christiansen, J., C. G. Douglas, and J. S. Haldane, *J. Physiol.*, **48**, 244 (1914).
443. Chytrek, F., *Klin. Wochschr.*, **19**, 1321 (1940).
444. Clar, E. and F. Haurowitz, *Ber.*, **66B**, 331 (1933).
445. Clare, N. T., *New Zealand J. Sci. Tech.*, **25A**, 205 (1942).
446. Clare, N. T., *ibid.*, **27A**, 23 (1945).
447. Clare, N. T. and E. H. Stephens, *Nature*, **153**, 252 (1944).
448. Clark, B. B., E. J. van Loon, and W. L. Adams, *Am. J. Physiol.*, **139**, 64 (1943).
449. Clark, W. M., *The Determination of Hydrogen Ions*, Williams and Wilkins, Baltimore (1928).
450. Clark, W. M., *Cold Spring Harbor Symposia Quant. Biol.*, **7**, 1 (1939).
451. Clark, W. M. and M. E. Perkins, *J. Biol. Chem.*, **135**, 643 (1940).
452. Clark, W. M., J. F. Taylor, T. H. Davies, and C. S. Vestling, *Cold Spring Harbor Symposia Quant. Biol.*, **7**, 18 (1939).
453. Clark, W. M., J. F. Taylor, T. H. Davies, and C. S. Vestling, *J. Biol. Chem.*, **135**, 543 (1940).
454. Clarke, T. W. and W. H. Hurlley, *J. Physiol. London*, **36**, 32 (1907-8).
455. Clegg, J. W. and E. J. King, *Brit. Med. J. II*, **1942**, 329.
456. Cliffoern, L. E., V. W. Meloche, and C. A. Elvehjem, *J. Biol. Chem.*, **111**, 399 (1935).
457. Cloetta, N., *Arch. exptl. Path. Pharmacol.*, **37**, 69 (1895).
458. Clyman, M., *Ann. Internal Med.*, **14**, 406 (1940).
459. Cohen, E. and C. H. Elvehjem, *J. Biol. Chem.*, **107**, 97 (1934).
460. Cohn, E. J., *Cold Spring Harbor Symposia Quant. Biol.*, **6**, 8 (1938).
460a. Cohn, E. J., *Blood*, **3**, 471 (1948).
461. Cohn, E. J. and J. T. Edsall, *Proteins, Amino Acids and Peptides*, Reinhold, New York, 1943.
462. Cohn, E. J., A. A. Green, and M. H. Blanchard, *J. Am. Chem. Soc.*, **59**, 509 (1937).
463. Cohn, W. E., *J. Biol. Chem.*, **148**, 219 (1943).
464. Cole, P. A. and F. S. Brackett, *Rev. Sci. Instruments*, **12**, 419 (1940).
465. Cole, S. W., *Practical Physiological Chemistry*, 8th ed., Hefter, Cambridge, 1928.
466. Colebrook, L. and M. Kenny, *Lancet*, **I**, 1279 (1936).
466a. Collander, R., *Ann. Rev. Biochem.*, **6**, 1 (1937).
467. Collier, H. B., *Can. Med. Assoc. J.*, **50**, 550 (1944).
468. Comas, M., *Compt. rend. soc. biol.*, **96**, 866 (1926).
469. Commoner, B., *Biol. Revs. Cambridge Phil. Soc.*, **15**, 168 (1940).
470. Conant, J. B., *J. Biol. Chem.*, **57**, 401 (1923).
471. Conant, J. B., *Harvey Lectures*, **28**, 159 (1933).
472. Conant, J. B., G. A. Alles, and C. O. Tongberg, *J. Biol. Chem.*, **79**, 89 (1928).
473. Conant, J. B. and C. F. Bailey, *J. Am. Chem. Soc.*, **55**, 798 (1933).
474. Conant, J. B., B. F. Chow, and E. M. Dietz, *J. Am. Chem. Soc.*, **56**, 2185 (1934).

475. Conant, J. B. and S. E. Kamerling, *ibid.*, **53**, 3522 (1931).
476. Conant, J. B. and R. V. McGrew, *J. Biol. Chem.*, **85**, 421 (1929-30).
477. Conant, J. B. and A. W. Pappenheimer, *ibid.*, **98**, 57 (1932).
478. Conant, J. B. and N. D. Scott, *ibid.*, **69**, 575 (1926).
479. Conant, J. B. and N. D. Scott, *ibid.*, **76**, 207 (1928).
480. Conant, J. B., N. D. Scott, and W. F. Douglas, *ibid.*, **76**, 223 (1928).
481. Conant, J. B. and C. O. Tongberg, *ibid.*, **86**, 733 (1930).
482. Conrad-Billroth, H., *Ber.*, **66B**, 639 (1933).
483. Cook, A. H., *Biol. Revs. Cambridge Phil. Soc.*, **20**, 115 (1944).
484. Cook, A. H. and R. P. Linstead, *J. Chem. Soc.*, 1937, 929.
485. Cook, R. P., J. B. S. Haldane, and L. W. Mapson, *Biochem. J.*, **25**, 534 (1931).
- 485a. Cook, E. S. and co-workers, *J. Biol. Chem.*, **162**, 43 (1946).
486. Coolidge, T. B., *J. Biol. Chem.*, **98**, 755 (1932).
487. Coolidge, T. B., *ibid.*, **132**, 119 (1940).
488. Cooperman, J. M., H. A. Waisman, K. B. McCall, and C. A. Elvehjem, *J. Nutrition*, **30**, 45 (1945).
489. Copp, D. H. and D. M. Greenberg, *J. Biol. Chem.*, **164**, 377, 389 (1946).
490. Cornejo-Saravia, E. and M. Royer, *Compt. rend. soc. biol.*, **99**, 171 (1928).
491. Cortese, F., *Boll. soc. ital. biol. sper.*, **6**, 572 (1931).
492. Cortis-Jones, B. and R. Lemberg, *Congressber. d. 16th Internat. Physiol. Congress*, No. 2, 251 (1938).
493. Corwin, A. H. and J. S. Andrews, *J. Am. Chem. Soc.*, **58**, 1086 (1936).
494. Corwin, A. H. and J. S. Andrews, *ibid.*, **59**, 1937 (1937).
495. Corwin, A. H. and J. S. Andrews, *ibid.*, **62**, 418 (1940).
- 495a. Corwin, A. H. and J. G. Erdman, *ibid.*, **68**, 2473 (1946).
496. Corwin, A. H. and R. H. Kriebel, *ibid.*, **63**, 1829 (1941).
497. Corwin, A. H. and W. M. Quattlebaum, *ibid.*, **58**, 1081 (1936).
498. Coryell, C. D., *J. Phys. Chem.*, **43**, 841 (1939).
499. Coryell, C. D. and L. Pauling, *J. Biol. Chem.*, **132**, 769 (1940).
500. Coryell, C. D., L. Pauling, and R. W. Dodson, *J. Phys. Chem.*, **43**, 825 (1939).
501. Coryell, C. D. and F. Stitt, *J. Am. Chem. Soc.*, **62**, 2942 (1940).
502. Coryell, C. D., F. Stitt, and L. Pauling, *ibid.*, **59**, 633 (1937).
503. Cotti, L. and F. Balestri, *Minerva med.*, 1936 I, 234.
504. Coulter, C. B. and F. M. Stone, *J. Gen. Physiol.*, **14**, 583 (1930-31).
505. Coulter, C. B. and F. M. Stone, *Proc. Soc. Exptl. Biol. Med.*, **38**, 423 (1938).
506. Coulthard, C. E., H. Raistrick, and co-workers, *Nature*, **150**, 634 (1942).
507. Cowan, D. W. and L. C. Bauguess, *Proc. Soc. Exptl. Biol. Med.*, **34**, 636 (1936).
508. Cox, W. W. and W. B. Wendel, *J. Biol. Chem.*, **143**, 331 (1942).
509. Craig, F. N., and H. K. Beecher, *J. Neurophysiol.*, **6**, 135 (1943); *J. Gen. Physiol.*, **26**, 467 (1943).
510. Crandall, L. A., Jr., C. O. Finne, and P. W. Smith, *Science*, **93**, 549 (1941).
- 510a. Crandall, M. W. and D. L. Drabkin, *J. Biol. Chem.*, **166**, 653 (1946); *Am. J. Med. Sci.*, **213**, 123 (1947).
511. Crandon, J. H., C. C. Lund, and D. B. Dill, *New Engl. J. Med.*, **223**, 353 (1940).
512. Cremer, W., *Biochem. Z.*, **194**, 231 (1928); **201**, 490 (1928); **206**, 228 (1929).
513. Cremer, W., *Biochem. Z.*, **192**, 428 (1928).
514. Cruz, W. O., *Am. J. Med. Sci.*, **202**, 781 (1941).
515. Cruz, W. O., P. F. Hahn, and W. F. Bale, *Am. J. Path.*, **135**, 595 (1941-2).
516. Cruz, W. O., W. B. Hawkins, and G. H. Whipple, *Am. J. Med. Sci.*, **203**, 848 (1942).
517. Cubin, H. K., *Biochem. J.*, **23**, 25 (1929).
518. Cunningham, I. J., *ibid.*, **25**, 1267 (1931).

519. Cunningham, I. J., C. S. M. Hopkirk, and I. J. Tilmer, *New Zealand J. Sci. Technol.*, **25A**, 185 (1942).
520. Czike, A. v., *Dew. Arch. klin. Med.*, **164**, 236 (1929).
521. Czylarz, E. v. and O. v. Fürth, *Beitr. chem. Physiol. Path.*, **10**, 358 (1907).
522. Dacie, J. V., and P. L. Mollison, *Lancet*, **I**, 550 (1943).
523. Daft, F. S., F. J. Robscheit-Robbins, and G. W. Whipple, *J. Biol. Chem.*, **103**, 495 (1933).
524. Daft, F. S. and W. H. Sebrell, *U. S. Publ. Health Repts.*, **58**, 1542 (1943).
525. Dakin, H. D. and R. West, *J. Biol. Chem.*, **92**, 117 (1931).
526. Dakin, H. D., R. West, and M. Howe, *Proc. Soc. Exptl. Biol. Med.*, **28**, 2 (1930).
527. Dakin, W. J., *Memoir, Marine Biol. Station, Port Erin, Liverpool Univ.*, **XX**, 1911-1912; *Proc. and Trans. Liverpool Biol. Soc.*, **26**, 253 (1911-12).
528. Damblé, K., *Z. ges. exptl. Med.*, **86**, 595, 608 (1933).
529. Dameshek, W. and S. O. Schwartz, *Am. J. Med. Sci.*, **196**, 769 (1938); *Medicine*, **19**, 231 (1940).
530. Daniel, J. A. and E. J. Cohn, *J. Am. Chem. Soc.*, **58**, 415 (1936).
531. Darby, W. J., E. Jones, and H. C. Johnson, *Science*, **103**, 108 (1946).
532. Darling, R. C. and F. J. W. Roughton, *Am. J. Physiol.*, **137**, 56 (1942).
- 532a. Darling, R. C. and co-workers, *J. Chn. Invest.*, **20**, 739 (1941).
533. Davenport, H. E., *Nature*, **155**, 516 (1945).
534. Davies, D. T. and E. C. Dodds, *Brit. J. Exptl. Path.*, **8**, 316 (1927).
535. Davies, T. H., *J. Am. Chem. Soc.*, **62**, 447 (1940).
536. Davies, T. H., *J. Biol. Chem.*, **135**, 597 (1940).
537. Davis, G. E. and C. Sheard, *J. Lab. Clin. Med.*, **23**, 22 (1937).
538. Davis, J. E., *Am. J. Physiol.*, **122**, 397 (1938); *Proc. Soc. Exptl. Biol. Med.*, **40**, 445 (1939).
539. Davis, J. E., *Am. J. Physiol.*, **129**, 140 (1940).
540. Davis, J. E., *J. Lab. Clin. Med.*, **28**, 848 (1943).
541. Davis, J. E., *Am. J. Physiol.*, **142**, 213 (1944).
542. Davis, J. E., *Science*, **104**, 37 (1946); *Am. J. Physiol.*, **147**, 404 (1946).
543. Davis, J. E. and A. M. Harris, *Am. J. Physiol.*, **137**, 94 (1942).
544. Davis, J. E., A. W. McCollough, and H. R. Rigdon, *J. Lab. Clin. Med.*, **30**, 327 (1945).
545. Day, H. G. and H. J. Stein, *J. Nutrition*, **16**, 525 (1938).
546. Day, P. L. and co-workers, *ibid.*, **9**, 637 (1935); *J. Exptl. Med.*, **68**, 923 (1938); *J. Biol. Chem.*, **157**, 423 (1945); **161**, 45 (1945).
547. Day, P. L. and co-workers, *J. Exptl. Med.*, **72**, 463 (1940).
548. Deb, S. B. and E. A. H. Roberts, *Biochem. J.*, **34**, 1507 (1940).
549. De Castro, U., *Arch. pat. e clin. med.*, **8**, 543 (1929); *Presse Méd.*, **1929** II, 1151.
550. Deeny, J., *Brit. Med. J.*, **II**, 864 (1940).
551. Deeny, J., E. T. Murdock, and J. J. Rogan, *Brit. Med. J.*, **I**, 721 (1943).
- 551a. De Gowin, E. L., H. F. Osterhagen, and M. Andersch, *Arch. Internal Med.*, **59**, 432 (1937).
- 551b. De Gowin, E. L., E. D. Warner, and W. L. Randall, *Arch. Internal Med.*, **61**, 609 (1938).
552. De Meio, R. H., M. Kissin, and E. S. G. Barron, *J. Biol. Chem.*, **107**, 579 (1934).
553. Dempsey, W., *Endocrinology*, **34**, 27 (1944).
554. Denecke, G., *Z. ges. exp. Med.*, **36**, 179 (1923).
555. Denigès, G., *Compt. rend.*, **215**, 9 (1942).
556. Denny-Brown, O. and D. Sciara, *Brain*, **68**, 1 (1945).
557. De Roberts, E. and R. Grasso, *Endocrinology*, **38**, 137 (1946).

558. Derrien, E. and C. Benoit, *Arch. soc. sci. med. et biol. Montpellier et Languedoc*, **8** 456 (1929).
559. Derrien, E. and P. Cristol, *Compt. rend. soc. biol.*, **103**, 126 (1930).
560. Derrien, E. and J. Turchini, *Bull. soc. chim.*, **35**, 687 (1924).
561. Derrien, E. and J. Turchini, *Compt. rend. soc. biol.*, **91**, 637 (1924).
562. Derrien, E. and J. Turchini, *ibid.*, **92**, 1028 (1925).
563. Derrien, E. and J. Turchini, *ibid.*, **92**, 1030 (1925).
564. Derrien, E. and J. Turchini, *Bull. soc. chim. biol.*, **8**, 218 (1926).
565. Derrien, E. and J. Turchini, *Bull. soc. chim.* **43**, 522, 936 (1928).
566. Derrien, E. and J. Turchini, *ibid.*, **45**, 689 (1929).
- 566a. Dervichian, D. G., G. Fournet, and A. Guinier, *Compt. rend.*, **224**, 1848 (1947).
567. Deutsch, W. and J. F. Wilkinson, *Brit. J. Exptl. Path.*, **16**, 33 (1935).
568. Dhéré, Ch., *Compt. rend.*, **158**, 64 (1914).
569. Dhéré, Ch., *Compt. rend. soc. biol.*, **97**, 1660 (1927).
570. Dhéré, Ch., *Arch. Intern. de Pharmacodynamie*, **38**, 134 (1930).
571. Dhéré, Ch., *Compt. rend.*, **195**, 1436 (1932).
572. Dhéré, Ch., *Handb. d. biol. Arbeitsmeth.*, Abt. 2, Teil 3, Urban und Schwarzenberg, Berlin, 1933.
573. Dhéré, Ch. and J. Aharoni, *Compt. rend.*, **190**, 1499 (1930).
574. Dhéré, Ch., L. Baudoux, and A. Schneider, *ibid.*, **165**, 515 (1917).
575. Dhéré, Ch. and C. Baumeler, *Compt. rend. soc. biol.*, **102**, 756 (1929).
576. Dhéré, Ch., C. Baumeler, and A. Schneider, *ibid.*, **99**, 492, 722, 726 (1928).
577. Dhéré, Ch., C. Baumeler, and A. Schneider, *Arch. intern. physiol.*, **32**, 73 (1930).
578. Dhéré, Ch. and O. Biermacher, *Compt. rend. soc. biol.*, **120**, 1162 (1935).
579. Dhéré, Ch. and O. Biermacher, *Compt. rend.*, **202**, 442 (1936).
580. Dhéré, Ch. and E. Bois, *ibid.*, **183**, 321 (1926).
581. Dhéré, Ch. and M. Fontaine, *ibid.*, **192**, 1131 (1931).
582. Dhéré, Ch. and M. Fontaine, *Ann. inst. Océanog.*, **10**, 249 (1931).
583. Dhéré, Ch., P. Meunier, and V. Castelli, *Compt. rend. soc. biol.*, **127**, 564, 1050 (1938).
584. Dhéré, Ch. and J. Roche, *Bull. soc. chim. biol.*, **13**, 987 (1931).
585. Dhéré, Ch. and J. Roche, *Compt. rend.*, **193**, 673 (1931).
586. Dhéré, Ch., H. Schneider, and Th. van der Bom, *ibid.*, **179**, 1356 (1924).
587. Dhéré, Ch. and G. Vegezzi, *J. physiol. et path. gén.*, **17**, 44, 53 (1917); **18**, 239 (1921).
588. Dickens, F., *Biochem. J.*, **32**, 1626 (1938).
589. Dickens, F. and F. Simer, *Biochem. J.*, **23**, 936 (1929).
590. Dieckmann, W. J., *Arch. Internal Med.*, **50**, 574 (1932).
- 590a. Diehl, H., *Iowa State College J. Sci.*, **21**, 271, 278, 287 (1947).
591. Dietz, E. M. and T. H. Werner, *J. Am. Chem. Soc.*, **58**, 2180 (1934).
592. Dimson, S. B. and R. B. Martin, *Quart. J. Med.*, **15**, 25 (1946).
593. Discombe, G., *Lancet*, **I**, 626 (1937).
594. Diwany, H. F., *Étude histologique de l'embryotrophe hématique des mammifères et du tube digestif de quelques invertébrés hématophages*, Le François, Paris, 1919.
595. Dixon, M., *Biochem. J.* **19**, 507 (1925).
596. Dixon, M. and K. A. C. Elliott, *ibid.*, **23**, 812 (1929).
597. Dixon, M., R. Hill, and D. Keilin, *Proc. Roy. Soc. London*, **109B**, 29 (1932).
598. Dobriner, K., *Proc. Soc. Exptl. Biol. Med.*, **35**, 175 (1936).
599. Dobriner, K., *J. Biol. Chem.*, **113**, 1 (1936).
600. Dobriner, K., *ibid.*, **120**, 115 (1937).
601. Dobriner, K. and co-workers, *Proc. Soc. Exptl. Biol. Med.*, **36**, 752, 755, 757, 864 (1937).

602. Dobriner, K., S. A. Localio, and W. H. Strain, *J. Biol. Chem.*, **114**, xxvi (1936).
603. Dobriner, K. and C. P. Rhoads, *Physiol. Revs.*, **20**, 416 (1940).
604. Dobriner, K., C. P. Rhoads and L. E. Hummel, *J. Clin. Invest.*, **17**, 95, 105, 125 (1938).
605. Dobriner, K., W. H. Strain, and S. A. Localio, *Proc. Soc. Exp. Biol. Med.*, **38**, 748 (1938).
606. Dobriner, K., W. H. Strain, H. Guild, and S. A. Localio, *J. Clin. Invest.*, **17**, 761 (1938).
607. Dogliotti, G. C. and T. Castellani, *C. A.*, **29**, 8121 (1935).
608. Dole, M., *The Glass Electrode*, Wiley, New York, 1941.
609. Doljanski, I. and O. Koch, *Arch. path. Anat. Physiol. (Virchow's)*, **291**, 379, 390 (1935).
610. Dollchen, H., *Klin. Wochschr.*, **19**, 220 (1940).
611. Doniach, I., H. Grüneberg, and J. E. G. Pearson, *J. Path. Bact.*, **55**, 23 (1943).
612. Dounce, A. L., *J. Biol. Chem.*, **143**, 497 (1942).
613. Dounce, A. L., *ibid.*, **147**, 685 (1943).
614. Dounce, A. L. and O. D. Frampton, *Science*, **89**, 300 (1939).
615. Dounce, A. L. and J. W. Howland, *ibid.*, **97**, 21 (1943).
616. Drabkin, D. L., *Proc. Soc. Exptl. Biol. Med.*, **32**, 456 (1934); *J. Biol. Chem.*, **114**, xxvii (1936); *ibid.*, **119**, xxvi (1937).
617. Drabkin, D. L., *ibid.*, **123**, xxxi (1938).
618. Drabkin, D. L., *Proc. 7th Summer Conference on Spectroscopy and Its Applications*, 1939, 116 (1940).
619. Drabkin, D. L., *J. Biol. Chem.*, **140**, 373, 387 (1941).
620. Drabkin, D. L., *ibid.*, **142**, 855 (1942).
621. Drabkin, D. L., *ibid.*, **146**, 605 (1942).
622. Drabkin, D. L., *Ann. Rev. Biochem.* **11**, 531 (1942).
623. Drabkin, D. L., *Am. J. Med. Sci.*, **205**, 755 (1943).
624. Drabkin, D. L., *ibid.*, **209**, 268 (1945).
625. Drabkin, D. L., *J. Biol. Chem.*, **158**, 721 (1945).
626. Drabkin, D. L., *Science*, **101**, 445 (1945).
627. Drabkin, D. L., *J. Biol. Chem.*, **164**, 703 (1946).
628. Drabkin, D. L. and J. H. Austin, *ibid.*, **112**, 51 (1935-6).
629. Drabkin, D. L. and J. H. Austin, *J. Biol. Chem.*, **112**, 89 (1935-6).
630. Drabkin, D. L. and H. K. Miller, *ibid.*, **90**, 531 (1931).
631. Drabkin, D. L. and H. K. Miller, *ibid.*, **93**, 39 (1931).
632. Drabkin, D. L. and C. F. Schmidt, *ibid.*, **157**, 69 (1945).
633. Drill, V. A., J. H. Annegers, F. E. Snapp, and A. C. Ivy, *J. Clin. Invest.*, **24**, 97 (1945).
634. Drouet, L. and P. Florentin, *Compt. rend. soc. biol.*, **102**, 9, 845 (1929).
635. D'Silva, J. L. and F. M. G. Stammers, *J. Physiol.*, **104**, 215 (1945).
- 635a. Dubach, R., C. V. Moore, and V. Minnich, *J. Lab. Clin. Med.*, **31**, 1201 (1946).
636. Du Bois, D., *J. Biol. Chem.*, **137**, 123 (1940).
637. Ducci, H. and C. J. Watson, *J. Lab. Clin. Med.*, **30**, 293 (1945).
638. Duesberg, R., *Arch. exptl. Path. Pharmacol.*, **162**, 249 (1931).
639. Duesberg, R., *ibid.*, **174**, 305 (1933-34).
640. Duesberg, R., *Klin. Wochschr.*, **17**, 533 (1938).
641. Duesberg, R. and W. Koll, *Arch. exptl. Path. Pharmacol.*, **162**, 296 (1931).
642. Duffie, D. H., *J. Am. Med. Assoc.*, **126**, 95 (1944).
643. Dunlop, D. M. and H. Scarborough, *Edinburgh Med. J.*, **42**, 476 (1935).
644. Duval, M., *J. Anat. Physiol.*, **29**, 341, 633, 425 (1893).

645. Edelman, M. H., L. Halpern, and J. A. Killian, *Am. J. Diseases Children*, **39**, 711 (1930).
646. Editorial. *Lancet I*, 1943, 52.
647. Edlbacher, S. and A. v. Segesser, *Naturwissenschaften*, **25**, 461, 557, 667 (1937).
648. van Eekelen, M., *Biochem. J.*, **30**, 2291 (1936).
649. Eggert, J., *Naturwissenschaften*, **23**, 281 (1935).
650. Ehrisman, O. and W. Noethling, *Biochem. Z.*, **284**, 376 (1936).
651. Ehrlich, P., *Zentr. Kliniken*, **45**, 721 (1883); *Z. anal. Chem.*, **22**, 301 (1883); *ibid.*, **23**, 275 (1884).
652. Ehrlich, P., *Med. Wochschr.*, **1**, 151 (1901).
653. Ehrlich, P., *Das Sauerstoff-Bedürfnis im Organismus*, Berlin, 1885.
654. Eichelberger, L. and co-workers, *Science*, **90**, 443 (1939).
655. Eichler, P., *Z. ges. Neurol. Psychiat.*, **141**, 363 (1932).
656. Eilbott, W., *Z. klin. Med.*, **106**, 529 (1927); *ibid.*, **120**, 95 (1927).
657. Eley, D. D., *Trans. Faraday Soc.*, **36**, 500 (1940).
658. Eley, D. D., *ibid.*, **39**, 172 (1943).
659. Elford, W. J., *Proc. Roy. Soc. (London)*, **112B**, 384 (1932-33).
660. Elion, E., *Bull. soc. chim. biol.*, **18**, 165 (1936).
661. Ellinger, P., *Z. physiol. Chem.*, **111**, 86 (1920).
662. Ellinger, F., *Die biologischen Grundlagen der Strahlenbehandlung (Sonderband zur Strahlentherapie)*, Urban und Schwarzenberg, Berlin, 1935.
663. Ellinger, P., *Biochem. J.*, **36**, xiii (1942).
664. Ellinger, P., C. E. Edgar, and N. S. Lucas, *J. Soc. Chem. Ind. London*, **54**, 269 (1935).
665. Ellinger, A. and O. Riesser, *Z. physiol. Chem.*, **98**, 1 (1916).
666. Ellingson, R. C. and A. H. Corwin, *J. Am. Chem. Soc.*, **68**, 1112 (1946).
667. Elliott, K. A. C., *Biochem. J.*, **26**, 10 (1932).
668. Elliott, K. A. C., *ibid.*, **26**, 1281 (1932).
669. Elliott, K. A. C. and M. E. Greig, *ibid.*, **32**, 1407 (1938).
670. Elliott, K. A. C. and D. Keilin, *Proc. Roy. Soc. (London)*, **114 (B)**, 210 (1934).
671. Elliott, K. A. C. and H. Sutter, *Z. physiol. Chem.*, **205**, 147 (1932).
672. Elman, R. and P. D. McMaster, *J. Exptl. Med.*, **41**, 503 (1925).
673. Elman, R. and P. D. McMaster, *ibid.*, **42**, 99, 619 (1925).
674. Elman, R. and P. D. McMaster, *ibid.*, **43**, 753 (1926).
675. Elton, N., *J. Lab. Clin. Med.*, **20**, 817 (1935).
676. Elvehjem, C. A., *J. Biol. Chem.*, **90**, 111 (1931).
677. Elvehjem, C. A., *J. Am. Med. Assoc.*, **98**, 1047 (1932).
678. Elvehjem, C. A., *Physiol. Revs.*, **15**, 471 (1935).
679. Elvehjem, C. A., D. Duckles and D. R. Mendenhall, *Am. J. Diseases Children*, **53**, 785 (1937).
680. Elvehjem, C. A., E. B. Hart, and W. C. Sherman, *J. Biol. Chem.*, **103**, 61 (1938).
681. Elvehjem, C. A. and W. C. Sherman, *ibid.*, **98**, 309 (1932).
682. Elvehjem, C. A., H. Steenbock, and E. B. Hart, *ibid.*, **83**, 21 (1929).
683. Elvehjem, C. A., H. Steenbock, and E. B. Hart, *ibid.*, **93**, 197 (1931).
684. Emde, H., *Naturwissenschaften*, **17**, 690 (1929).
685. Emminger, E., *Klin. Wochschr.*, **12**, 1840 (1933).
686. Emminger, E. and G. Battistini, *Arch. path. Anat. Physiol. (Virchow's)*, **290**, 492 (1933).
687. Enderlen, E., S. J. Thannhauser, and M. Jenke, *Arch. exptl. Path. Pharmacol.*, **120**, 16 (1927).
688. Endermann, F. and H. Fischer, *Ann.*, **538**, 172 (1939).
689. Engel, M., "Die plasmatische Bilirubin-Bildung," *doctoral dissertation*, Zürich, 1935.

690. Engel, M., *Z. physiol. Chem.*, **259**, 75 (1939).
691. Engel, M., *ibid.*, **266**, 135 (1940).
692. Engel, M., *Klin. Wochschr.*, **19**, 1177 (1940).
693. Engelhardt, V. A., *Biochem. Z.*, **227**, 16 (1930); **251**, 343 (1932).
694. Engelhardt, V. A. and A. P. Barkhash, *Biokhimiya*, **3**, 500 (1938).
695. Engelhardt, V. A. and M. Ijubimowa, *Biochem. Z.*, **227**, 6 (1930).
696. Engelmann, T. W., *Botan. Ztg.*, **39**, 442 (1881); **40**, 419, 633 (1882); **41**, 1 (1883); **42**, 81 (1884).
697. Eppinger, H. and E. Ranzi, *Die hepatolienalen Erkrankungen*, Springer, Berlin, 1920.
697a. Erdman, J. G. and A. H. Corwin, *J. Am. Chem. Soc.*, **68**, 1885 (1946).
698. Eriksson-Quensel, I. B., *Biochem. J.*, **32**, 585 (1938).
699. Ernst, Z. and E. Hallay, *Biochem. Z.*, **228**, 354 (1930).
700. Ernst, Z. and E. Hallay, *Z. ges. expit. Med.*, **78**, 325 (1931).
701. Ernst, Z. and Szappanyos, *Biochem. Z.*, **157**, 16, 30 (1925).
702. Esenbeck, N. von, *Ann.*, **17**, 75 (1836).
703. Ettisch, G. and G. Groscurth, *Biochem. Z.*, **266**, 441 (1933).
704. Euler, H. v., *Z. physiol. Chem.*, **183**, 103 (1929).
705. Euler, H. v., *Deut. med. Wochschr.*, **64**, 1712 (1938).
706. Euler, H. v., and K. M. Brandt, *Z. physiol. Chem.*, **240**, 215 (1936).
707. Euler, H. v., and H. Fink, *ibid.*, **164**, 69 (1927).
708. Euler, H. v., H. Fink, and H. Hellström, *ibid.*, **169**, 10 (1927).
709. Euler, H. v., W. Franke, R. Nilsson, and K. Zeile, *Chemie d. Enzyme*, **1**, **2**, Bergmann, München 1934, p. 3.
710. Euler, H. v., G. Günther, and N. Forsman, *Z. Krebsforsch.*, **49**, 46 (1939).
711. Euler, H. v., and H. Hellström, *Z. physiol. Chem.*, **169**, 10 (1927).
712. Euler, H. v., and H. Hellström, *ibid.*, **183**, 183 (1929).
713. Euler, H. v., and H. Hellström, *ibid.*, **190**, 189 (1930).
714. Euler, H. v., and H. Hellström, *ibid.*, **255**, 159 (1938).
715. Euler, H. v., and H. Hellström, *ibid.*, **260**, 163 (1939).
716. Euler, H. v., H. Hellström, and N. Forsman, *Arkiv Kemi Mineral. Geol.*, **13B**, No. 2 (1939).
717. Euler, H. v., and B. Jansson, *Monatsh.*, **53/54**, 1014 (1929).
718. Euler, H. v., and K. Josephson, *Ber.* **56B**, 1749 (1923).
719. Euler, H. v., and K. Josephson, *Ann.* **452**, 158 (1927).
720. Euler, H. v., and K. Josephson, *ibid.*, **455**, 1 (1927).
721. Euler, H. v., and K. Josephson, *ibid.*, **456**, 111 (1927).
722. Euler, H. v., and M. Malmberg, *Z. physiol. Chem.*, **249**, 85 (1937); **252**, 24 (1938).
723. Euler, H. v., H. Nilsson, and D. Runnehjelm, *Svensk. Kem. Tid.*, **41**, 85 (1929).
724. Euler, H. v., D. Runnehjelm, and S. Steffenberg, *Arkiv. Kemi Mineral. Geol.*, **10B**, No. 1 (1929).
725. Euler, H. v., K. Zeile and H. Hellström, *Svensk. Kem. Tid.*, **42**, 74 (1930).
726. Evelyn, K. A. and H. T. Malloy, *J. Biol. Chem.*, **126**, 655 (1938).
727. Ewer, R. F. and H. M. Fox, *Proc. Roy. Soc. (London)*, **129** (B), 137 (1940).
728. Eyring, H. and A. E. Stearn, *Chem. Revs.*, **24**, 253 (1939).
729. Fagerberg, E., S. E. Fagerberg, and R. Fåhræus, *Acta. Med. Scand.*, **108**, 1 (1941).
730. Fåhræus, R., *Lancet* II, 1939, 630.
731. Fairley, N. H., *Nature*, **139**, 588 (1937).
732. Fairley, N. H., *Proc. Roy. Soc. Med.*, **32**, 1278 (1939).
733. Fairley, N. H., *Brit. Med. J.*, **II**, 213 (1940).
734. Fairley, N. H., *Brit. J. Exptl. Path.*, **21**, 231 (1940).

735. Fairley, N. H., *Quart. J. Med.*, **10**, 95 (1941).
736. Fairley, N. H. and R. J. Bromfield, *Trans. Roy. Soc. Trop. Med. Hyg.*, **28**, 307 (1934).
737. Fankuchen, I., *J. Biol. Chem.*, **150**, 57 (1943).
738. Farkas, A., L. Farkas, and J. Yudkin, *Proc. Roy. Soc. (London)*, **115** (B), 373 (1934).
739. Farmer-Loeb, L., *Biochem. Z.*, **244**, 426 (1932).
740. Farquharson, R. F., H. Borsook, and A. M. Goulding, *Arch. Int. Med.*, **48**, 1156 (1931).
741. Fehlow, W., K. Wolff, and F. Steinkamp, *Klin. Wochschr.*, **17**, 1435 (1938).
742. Feigl, J., *Biochem. Z.*, **85**, 171 (1918).
743. Felix, K. and H. Moebus, *Z. physiol. Chem.*, **236**, 230 (1935).
744. Fellingner, K., *Z. ges. exp. Med.*, **85**, 369 (1932).
745. Fenn, W. O. and D. M. Cobb, *Am. J. Physiol.*, **102**, 379, 393 (1932).
- 745a. Ferguson, J. K. W., *J. Physiol.*, **38**, 40 (1937).
- 745b. Ferguson, J. K. W. and F. J. W. Roughton, *J. Physiol.*, **83**, 68 (1935).
746. Fernandez, M., *Istit. di Pat. Clin. Modena*, **5**, 163 (1936).
747. Ferry, R. M. and A. A. Green, *J. Biol. Chem.*, **81**, 175 (1929).
748. Fiessinger, N., A. Gajdos, and M. Polonovski, *Compt. rend. soc. biol.*, **135**, 1572 (1941).
749. Fiessinger, N., A. Gajdos, and M. Polonovski, *ibid.*, **136**, 224, 714 (1942).
750. Fiessinger, N., A. Gajdos, and M. Polonovski, *Bull. soc. chim. biol.*, **24**, 221 (1942).
751. Figge, F. H. J., *Cancer Research*, **4**, 465 (1944).
752. Figge, F. H. J., T. N. Carey, and G. S. Weiland, *J. Lab. Clin. Med.*, **31**, 752 (1946).
753. Figge, F. H. J., E. G. Jones and G. F. Wolfe, *Cancer Research*, **4**, 483 (1944).
754. Figge, F. H. J. and K. Salomon, *J. Lab. Clin. Med.*, **27**, 1495 (1942).
755. Fikentscher, R., *Arch. path. Anat. Physiol. (Virchow's)*, **279**, 731 (1931).
756. Fikentscher, R., *Zool. Anz.*, **103**, 20 (1933).
757. Fikentscher, R., *Biochem. Z.*, **249**, 257 (1933).
758. Fikentscher, R., *Klin. Wochschr.*, **14**, 569 (1935).
759. Fikentscher, R., H. Fink, and E. Emminger, *ibid.*, **10**, 206 (1931); *Arch. path. Anat. Physiol. (Virchow's)*, **287**, 764 (1933).
760. Fikentscher, R. and K. Franke, *Klin. Wochschr.*, **12**, 285 (1933).
761. Filmer, J. F. and E. J. Underwood, *Australian Vet. J.*, **9**, 163 (1933); **10**, 83 (1934); **11**, 84 (1935).
762. Filo, E., *Folia Haematol.*, **50**, 21 (1933).
763. Fink, H., *Naturwissenschaften*, **17**, 388 (1929).
764. Fink, H., *Z. physiol. Chem.*, **197**, 193 (1931).
765. Fink, H., *ibid.*, **210**, 197 (1932).
766. Fink, H., *Ber.* **70B**, 1477 (1937).
767. Fink, H. and W. Hoerbürger, *Z. physiol. Chem.*, **202**, 8 (1931).
768. Fink, H. and W. Hoerbürger, *ibid.*, **218**, 181 (1933).
769. Fink, H. and W. Hoerbürger, *ibid.*, **220**, 123 (1933).
770. Fink, H. and W. Hoerbürger, *ibid.*, **225**, 49 (1934).
771. Fink, H. and W. Hoerbürger, *Naturwissenschaften*, **22**, 292 (1934).
772. Fink, H. and W. Hoerbürger, *Z. physiol. Chem.*, **232**, 77 (1935).
773. Fink, H. and W. Hoerbürger, *ibid.*, **232**, 28 (1935).
774. Fink, H. and K. Weber, *Naturwissenschaften*, **18**, 16 (1929).
775. Fischel, W. and J. Hühnerfeld, *Z. ges. exp. Med.*, **101**, 425 (1937).
776. Fischer, H., *Z. physiol. Chem.*, **73**, 204 (1911).
777. Fischer, H., *Munch. med. Wochschr.*, **47**, 2555 (1912).
778. Fischer, H., *Z. Biol.*, **65**, 163 (1915).
779. Fischer, H., *Z. physiol. Chem.*, **95**, 34 (1915).

780. Fischer, H., *ibid.*, **95**, 55 (1915).
781. Fischer, H., *ibid.*, **96**, 148 (1915).
782. Fischer, H., *ibid.*, **96**, 309 (1915).
783. Fischer, H., *Ergeb. Physiol.*, **15**, 185 (1916).
784. Fischer, H., *Z. physiol. Chemie*, **97**, 109, 148 (1916).
785. Fischer, H., *ibid.*, **98**, 14, 78 (1916).
786. Fischer, H., *Oppenheimer's Handbuch der Biochemie*, Jena, 2d ed., Bd. I, 1923, 351.
787. Fischer, H., *Z. angew. Chem.*, **38**, 891 (1925).
788. Fischer, H., *Z. physiol. Chem.* **155**, 96 (1926).
789. Fischer, H., *Handbuch der biologischen Arbeitsmethoden*, Abt. I, Teil II, Urban und Schwarzenberg, Berlin, 1926, p. 170.
790. Fischer, H., *Ber.* **60B**, 2612 (1927).
791. Fischer, H., *Naturwissenschaften*, **17**, 611 (1929).
792. Fischer, H., *ibid.*, **18**, 1026 (1930).
793. Fischer, H., in A. Bethe, G. v. Bergmann, G. Emden, and A. Ellinger, *Handbuch der normalen und pathologischen Physiologie*, Vol. 6, 1930, Springer, Berlin, p. 1.
794. Fischer, H., *Verhandl. deut. Ges. inn. Med.*, **45**, 1 (1933).
795. Fischer, H., *Z. physiol. Chem.*, **259**, 1 (1939).
796. Fischer, H., *ibid.*, **259**, 96 (1939).
797. Fischer, H., *Organic Syntheses*, Vol. 21, Wiley, New York, 1941, p. 53.
798. Fischer, H. and E. Adler, *Z. physiol. Chem.*, **197**, 237 (1931).
799. Fischer, H. and E. Adler, *ibid.*, **200**, 209 (1931).
800. Fischer, H. and E. Adler, *ibid.*, **206**, 187 (1932).
801. Fischer, H. and H. Andersag, *Ann.*, **458**, 117 (1927).
802. Fischer, H. and H. Baumgartner, *Z. physiol. Chem.*, **216**, 260 (1933).
803. Fischer, H., H. Baumgartner and R. Hess, *ibid.*, **206**, 201 (1932).
804. Fischer, H. and H. Bock, *ibid.*, **251**, 85 (1938).
805. Fischer, H. and H. Bock, *ibid.*, **255**, 1 (1938).
806. Fischer, H. and K. Bub, *Ann.* **530**, 213 (1937).
806a. Fischer, H., and K. O. Deilmann, *Z. physiol. Chem.*, **280**, 186 (1944).
807. Fischer, H. and H. F. v. Dobeneck, *Z. physiol. Chem.*, **263**, 125 (1940).
808. Fischer, H. and R. Duesberg, *Arch. exper. Path. Pharmacol.*, **166**, 95 (1932).
809. Fischer, H. and F. Endermann, *Ann.* **531**, 245 (1937).
810. Fischer, H., L. Filser, and E. Plötz, *Ann.* **495**, 1 (1932).
811. Fischer, H. and H. Fink, *Z. physiol. Chem.*, **144**, 107 (1925).
812. Fischer, H. and H. Fink, *ibid.*, **150**, 243 (1925).
813. Fischer, H. and H. Fink, *ibid.*, **152**, 144 (1926).
814. Fischer, H. and W. Friedrich, *Ann.*, **523**, 155 (1936).
815. Fischer, H. and W. Fröwis, *Z. physiol. Chem.*, **195**, 45 (1931).
816. Fischer, H., H. Gebhardt and A. Rothhaas, *Ann.*, **482**, 1 (1930).
817. Fischer, H. and H. Gibian, *ibid.*, **548**, 183 (1941).
818. Fischer, H., and W. Gleim, *ibid.*, **521**, 157 (1935).
819. Fischer, H. and E. Haarer, *Z. physiol. Chem.*, **204**, 101 (1932).
820. Fischer, H. and H. W. Haberland, *ibid.*, **232**, 236 (1935).
821. Fischer, H., H. W. Haberland and A. Müller, *Ann.*, **521**, 122 (1935).
822. Fischer, H. and H. Halbach, *Z. physiol. Chem.*, **238**, 59 (1936).
823. Fischer, H., H. Halbach, and A. Stern, *Ann.*, **519**, 254 (1935).
824. Fischer, H. and P. Hartmann, *Z. physiol. Chem.*, **226**, 116 (1934).
825. Fischer, H. and P. Heisel, *Ann.*, **457**, 99 (1927).
826. Fischer, H. and R. Hess, *Z. physiol. Chem.*, **194**, 193 (1931).
827. Fischer, H. and J. Hierneis, *ibid.*, **196**, 155 (1931).
828. Fischer, H. and J. Hilger, *ibid.*, **138**, 49 (1924).
829. Fischer, H. and J. Hilger, *ibid.*, **138**, 271 (1924).

830. Fischer, H. and J. Hilger, *ibid.*, 138, 288 (1924).
831. Fischer, H. and J. Hilger, *ibid.*, 138, 297 (1924).
832. Fischer, H. and H. Hilmer, *ibid.*, 143, 1 (1925).
833. Fischer, H., H. Hilmer, F. Lindner, and B. Pützer, *ibid.*, 150, 44 (1925).
834. Fischer, H. and H. Hilmer, *ibid.*, 153, 167 (1926).
835. Fischer, H. and H. J. Hofmann, *ibid.*, 246, 15 (1937).
836. Fischer, H. and E. v. Holt, *ibid.*, 229, 98 (1934).
837. Fischer, H. and G. Hummel, *ibid.*, 181, 124 (1929).
838. Fischer, H., G. Hummel, and A. Treibs, *Ann.*, 471, 248 (1929).
839. Fischer, H. and K. Jordan, *Z. physiol. Chem.*, 190, 75 (1930).
840. Fischer, H., H. Kämmerer, and A. Kühner, *ibid.*, 139, 107 (1924).
841. Fischer, H. and F. Kögl, *ibid.*, 131, 241 (1923).
842. Fischer, H. and F. Kögl, *ibid.*, 138, 267 (1924).
843. Fischer, H. and A. Kürzinger, *ibid.*, 196, 213 (1931).
844. Fischer, H., R. Lambrecht, and H. Mittenzwei, *ibid.*, 253, 1 (1938).
845. Fischer, H. and H. Libowitzky, *Z. physiol. Chem.*, 241, 220 (1936).
846. Fischer, H. and H. Libowitzky, *ibid.*, 251, 198 (1938).
847. Fischer, H. and F. Lindner, *ibid.*, 142, 141 (1925).
848. Fischer, H. and F. Lindner, *ibid.*, 145, 202 (1925).
849. Fischer, H. and F. Lindner, *ibid.*, 145, 213 (1925).
850. Fischer, H. and F. Lindner, *ibid.*, 153, 54 (1926).
851. Fischer, H. and F. Lindner, *ibid.*, 161, 17 (1926).
852. Fischer, H. and P. Meyer, *ibid.*, 75, 339 (1911).
853. Fischer, H. and F. Meyer-Betz, *ibid.*, 75, 232 (1911).
854. Fischer, H. and A. Müller, *Ann.*, 528, 1 (1937).
855. Fischer, H. and A. Müller, *Z. physiol. Chem.*, 246, 31 (1937).
856. Fischer, H. and A. Müller, *ibid.*, 246, 43 (1937).
857. Fischer, H. and F. W. Neumann, *Ann.*, 494, 225 (1932).
858. Fischer, H. and G. Niemann, *Z. physiol. Chem.*, 137, 293 (1924).
859. Fischer, H. and G. Niemann, *ibid.*, 146, 196 (1925).
860. Fischer, H. and H. Orth, "Animal pigments." *Ann. Rev. Biochem.* 3, 413 (1934).
861. Fischer, H. and H. Orth, *Die Chemie des Pyrrols, Pyrrolfarbstoffe, II. Erste Hälfte*, Akadem. Verlagsgesellschaft, Leipzig, 1937.
862. Fischer, H., K. Platz, and K. Morgenroth, *Z. physiol. Chem.*, 182, 265 (1929).
863. Fischer, H. and H. Plieninger, *ibid.*, 274, 231 (1942); *Naturwissenschaften*, 30, 382 (1942).
864. Fischer, H., H. Plieninger, and O. Weissbarth, *ibid.*, 268, 197 (1941).
865. Fischer, H., E. Plötz, and L. Filser, *Ann.*, 495, 10 (1936).
866. Fischer, H. and B. Pützer, *Z. physiol. Chem.*, 154, 17 (1926).
867. Fischer, H. and B. Pützer, *ibid.*, 154, 39 (1926).
868. Fischer, H. and F. Reindel, *ibid.*, 127, 299 (1923).
869. Fischer, H. and H. Reinecke, *ibid.*, 258, 9 (1939).
870. Fischer, H. and H. Reinecke, *ibid.*, 265, 9 (1940).
871. Fischer, H. and H. Reinecke, *ibid.*, 265, 83 (1940).
872. Fischer, H. and F. Röse, *Ber.*, 45B, 1579 (1912).
873. Fischer, H. and F. Röse, *Z. physiol. Chem.*, 82, 391 (1912).
874. Fischer, H., F. Röse, and E. Bartholomäus, *ibid.*, 84, 262 (1913).
875. Fischer, H. and K. Schneller, *ibid.*, 130, 302 (1923).
876. Fischer, H. and K. Schneller, *ibid.*, 135, 253 (1924).
877. Fischer, H. and C. G. Schroeder, *Ann.* 451, 196 (1939).
878. Fischer, H. and M. Schubert, *Ber.*, 56B, 1202 (1923).
879. Fischer, H. and F. Schwerdtel, *Z. physiol. Chem.*, 175, 248 (1928).

880. Fischer, H. and C. v. Seemann, *ibid.*, **242**, 133 (1936).
881. Fischer, H. and R. Siebert, *Ann.*, **483**, 1 (1930).
882. Fischer, H. and A. Treibs, *Tabulae biologicae*, **3**, 339 (1926)
883. Fischer, H. and A. Treibs, *Oppenheimer's Handbuch der Biochemie*, 2d ed., Ergänzungsb., Jena, 1930, p. 72; *ibid.*, *Erganzungswerk*, **1**, Jena, 1933, p. 247.
884. Fischer, H., A. Treibs, and G. Hummel, *Z. physiol. Chem.*, **185**, 38 (1929).
885. Fischer, H., A. Treibs, and K. Zeile, *ibid.*, **193**, 138 (1931).
886. Fischer, H., A. Treibs, and K. Zeile, *ibid.*, **195**, 1 (1931).
887. Fischer, H., B. Walach, and P. Halbig, *Ann.*, **452**, 268 (1927).
888. Fischer, H. and G. Wecker, *Z. physiol. Chem.*, **272**, 1 (1941).
889. Fischer, H., T. Yoshioka, and P. Hartmann, *ibid.*, **212**, 146 (1932).
890. Fischer, H. and W. Zerweck, *ibid.*, **132**, 12 (1924).
891. Fischer, H. and W. Zerweck, *ibid.*, **137**, 176 (1924).
892. Fischer, H. and W. Zerweck, *ibid.*, **137**, 188 (1924).
893. Fischer, H. and W. Zerweck, *ibid.*, **137**, 242 (1924).
894. Fischer, H. and W. Zerweck, *ibid.*, **137**, 209 (1924).
895. Fischer, H. and H. Zischler, *ibid.*, **245**, 123 (1937).
896. Fischer, M., *Biochem. Z.*, **292**, 16 (1937).
897. Fischer, M., *ibid.*, **292**, 271 (1937).
898. Fischer, M., R. Lieske, and K. Winzer, *ibid.*, **236**, 247 (1931).
899. Fischler, F., *Physiologie und Pathologie der Leber*, Springer, Berlin, 1916.
900. Fischler, F., *Deut. Arch. klin. Med.*, **146**, 305 (1925).
901. Fischler, F. and F. Ottensooser, *ibid.*, **93**, 427 (1908).
902. Fishberg, E. H., *Proc. Soc. Exptl. Biol. Med.*, **56**, 24 (1944).
- 902a. Fishberg, E. H., *J. Biol. Chem.*, **172**, 155 (1948).
903. Fisher, K. C., *J. Cellular Comp. Physiol.*, **15**, 122 (1940).
- 903a. Fisher, K. C., R. J. Henry, and E. Low, *J. Pharm. Exptl. Therap.*, **81**, 58 (1944).
904. Fiske, C. H., *Proc. Natl. Acad. Sci. U. S.*, **20**, 25 (1934).
905. Flaks, J., I. Himmel, and A. Zlotnik, *Presse méd.*, **45**, 1261 (1937); **46**, 1506 (1938).
906. Flexner, L. B., *J. Biol. Chem.*, **131**, 703 (1939).
907. Flexner, L. B., J. B. Flexner, and W. L. Strauss, Jr., *J. Cell. Comp. Physiol.*, **18**, 355 (1940).
908. Flexner, L. B. and R. D. Stiehler, *J. Biol. Chem.*, **126**, 619 (1938).
- 908a. Flink, E. B., *J. Lab. Clin. Med.*, **32**, 223 (1947).
909. Flink, E. B. and C. J. Watson, *J. Biol. Chem.*, **146**, 171 (1942).
910. Floren, W. and H. Heite, *Arch. exptl. Path. Pharmacol.*, **197**, 338 (1941).
911. Fokina, T. V., *Pediatrics*, No. 2, **1944**, 13.
912. Folin, O. and A. D. Marenzi, *J. Biol. Chem.*, **83**, 89 (1929).
913. Fontaine, M., *Compt. rend. soc. biol.*, **117**, 420 (1934).
- 913a. Fontaine, M., *Bull. inst. océanog.*, Nos. 792, 793 (1941).
914. Fontaine, M., and A. Raffy, *Bull. soc. zool. France*, **61**, 49 (1936); *Compt. rend. soc. biol.*, **121**, 735 (1936).
915. Fontès, G. and L. Thivolle, *Compt. rend. soc. biol.*, **93**, 687 (1925).
916. Fontès, G. and L. Thivolle, *ibid.*, **105**, 965, 969 (1930); *Compt. rend.*, **191**, 1088 (1930); *Le Sang*, **6**, 658 (1930).
917. Fontès, G. and L. Thivolle, *Le Sang*, **10**, 144 (1937).
918. Forbes, W. H. and F. J. W. Roughton, *J. Physiol. (London)*, **71**, 229, 261 (1931).
919. Forkner, C. E., *Am. J. Diseases Children*, **22**, 525 (1924); *Bull. Johns Hopkins Hosp.*, **45**, 75 (1929).
920. Forrai, E. and R. Sivó, *Biochem. Z.*, **189**, 162 (1927).

921. Foster, G. L., *J. Biol. Chem.*, **159**, 431 (1945).
- 921a. Foulkes, E. C. and R. Lemberg, *Australian, J. Exptl. Biol. Med. Sci.*, **26**, 307 (1948).
- 921b. Foulkes, E. C. and R. Lemberg, *unpublished experiments*.
922. Fourie, P., *Onderstepoort J. Vet. Sci. Animal Ind.*, **7**, 535 (1936); **13**, 383 (1939).
923. Fourie, P. and C. Rimington, *Nature*, **140**, 68 (1937).
924. Fouts, P. J. and co-workers, *J. Nutrition*, **16**, 197 (1938); *Proc. Soc. Exptl. Biol. Med.*, **40**, 4 (1939); *Am. J. Med. Sci.* **199**, 163 (1940).
925. Fowler, W. M. and A. P. Barer, *Ann. Internal Med.*, **14**, 378 (1940).
926. Fowler, W. M. and A. P. Barer, *Arch. Internal Med.*, **59**, 561, 1024 (1937); **61**, 401 (1938); *Am. J. Med. Sci.*, **201**, 642 (1941).
927. Fowler, W. M. and A. P. Barer, *J. Am. Med. Assoc.*, **118**, 421 (1942).
928. Fowweather, F. S., *Biochem. J.*, **28**, 1160 (1934).
929. Fox, C. L., *J. Clin. Invest.*, **19**, 123 (1940).
930. Fox, D. L. and C. F. A. Pantin, *Biol. Revs. Cambridge Phil. Soc.*, **19**, 121 (1944).
931. Fox, H. M., *Proc. Cambridge Phil. Soc., Biol. Sci.*, **1**, 204 (1924).
932. Fox, H. M., *Proc. Roy. Soc. (London)*, **99** (B), 199 (1925).
933. Fox, H. M., *ibid.*, **100** (B), 129 (1926).
934. Fox, H. M., *ibid.*, **111** (B), 356 (1932).
935. Fox, H. M., *ibid.*, **115** (B), 378 (1934).
936. Fox, H. M., *Nature*, **145**, 781 (1940).
937. Fox, H. M., *ibid.*, **156**, 18 (1945).
- 937a. Fox, H. M., *ibid.*, **160**, 431 (1947).
- 937a. Fox, H. M., *ibid.*, **160**, 825 (1947).
938. Foy, H., A. Altmann, H. D. Barnes, and A. Kondi. *Trans. Roy. Soc. Trop. Med. Hyg.*, **36**, 197 (1943).
939. Fränkel, E., *Arch. path. Anat. Physiol. (Virchow's)*, **248**, 125 (1923).
940. Franck, J. and H. Gaffron, *Advances in Enzymology*, Vol. I. Interscience, New York, 1941, p. 199.
941. Franck, J. and K. F. Herzfeld, *J. Phys. Chem.*, **45**, 978 (1941).
942. Franck, J., P. Pringsheim, and D. T. Lad, *Arch. Biochem.*, **7**, 103 (1945).
943. Franke, K., *Z. physiol. Chem.*, **212**, 34 (1932).
944. Franke, K., *Z. klin. Med.*, **130**, 193 (1936).
945. Franke, K. and S. Litzner, *Z. klin. Med.*, **129**, 115 (1935).
946. Franke, W., *Ann.*, **498**, 129 (1932).
947. Franklin, A. W., *Proc. Soc. Exptl. Biol. Med.*, **35**, 680 (1942).
948. Freeman, L. W. and V. Johnson, *Am. J. Physiol.*, **130**, 723 (1940).
949. Freeman, L. W., A. Loewy, and V. Johnson, *ibid.*, **140**, 556 (1944).
950. French, C. S., *J. Gen. Physiol.*, **20**, 711 (1937).
951. French, C. S., *Ann. Rev. Biochem.*, **15**, 397 (1946).
952. Frerichs, F. Th. and G. Städeler, *Müller's Arch. Anat. Physiol.*, **1850**, 55.
953. Friedenwald, J. A. and R. D. Stiehler, *Arch. Ophthalmol. (New York)*, **20**, 761 (1938).
954. Friedli, H., *Bull. soc. chim. biol.*, **6**, 908 (1924).
955. Fromholdt, G. and Nersessov, *Z. ges. exptl. Path. Therap.*, **9**, 404 (1912).
956. Frost, D. V. and co-workers, *Am. J. Physiol.*, **134**, 746 (1941).
957. Frost, D. V. and C. A. Elvehjem, *J. Biol. Chem.*, **128**, xxxi (1939).
958. Fürth, O. v., *Vergleichende Chemie und Physiologie niederer Tiere*, Jena, 1903.
959. Fuhr, I. and H. Steenbock, *J. Biol. Chem.*, **147**, 59, 65, 71 (1943).
960. Fujita, A. and co-workers, *Biochem. Z.*, **301**, 376 (1939).
961. Fujita, A., T. Ebihara, and I. Numata, *ibid.*, **301**, 245 (1939).
962. Fujita, A. and T. Kodama, *ibid.*, **273**, 186 (1934).

963. Gabbe, E., *Klin. Wochschr.*, **8**, 2077 (1929).
964. Gabbe, E., *ibid.*, **15**, 292 (1936); **16**, 483 (1937).
- 964a. Gad, I., E. Jacobsen, and C. M. Plum; *Acta Physiol. Scand.*, **7**, 244 (1944).
- 964b. Gaddum, J. H., *Proc. Roy. Soc. (London)*, **121** (B), 601 (1936-7).
965. Gaetano, R., *Pubblicazioni della Stazione Zool. di Napoli*, **7**, 78 (1925).
966. Gaffron, H., *Biochem. Z.*, **179**, 157 (1926).
967. Gaffron, H., *ibid.*, **269**, 447 (1934).
968. Gaffron, H., *ibid.*, **275**, 301 (1935).
969. Gaffron, H., *ibid.*, **280**, 337 (1935).
970. Gaffron, H., *Am. J. Botany*, **27**, 204, 273 (1940).
971. Gaffron, H., *Science*, **91**, 529 (1940).
972. Gaffron, H., *J. Gen. Physiol.*, **26**, 195 (1942).
973. Gaffron, H., *ibid.*, **26**, 241 (1942).
974. Gaffron, H., *Biol. Revs., Cambridge Phil. Soc.*, **19**, 1 (1944).
975. Gaffron, H. and J. Rubin, *J. Gen. Physiol.*, **26**, 219 (1942).
976. Gaidukov, N., *Abhandl. preuss. Akad. Wiss., Math.-naturw. Klasse*, **5**, 927 (1902); *Ber. deut. botan. Ges.*, **21**, 484, 517 (1903); **22**, 23 (1904); **24**, 1 (1906); *Univ. Petrograd., Scripta botan.*, **22**, (1903); *Hedwigia*, **43**, 96 (1904).
977. Gajdos, A. and G. Tirprez, *Compt. rend. soc. biol.*, **139**, 545 (1945).
978. Gale, E. F., *Biochem. J.*, **33**, 1012 (1939).
979. Gamgee, A., *Z. Biol.*, **34**, 505 (1897).
- 979a. Gardikas, C., J. E. Kench, and J. F. Wilkinson, *Nature*, **161**, 607 (1948).
980. Garrod, A. E., *J. Physiol. (London)*, **13**, 598 (1892); **15**, 108 (1893); **17**, 349 (1894); *Proc. Roy. Soc. (London)*, **55**, 394 (1894).
981. Garrod, A. E., "Bradshaw Lecture," *Lancet II*, 1900, 1923.
982. Garrod, A. E., *Inborn Errors of Metabolism*, 2d ed., H. Frowde, London (1923).
983. Garrod, A. E. and F. G. Hopkins, *J. Physiol. (London)*, **20**, 112 (1896).
984. Gatet, M. L., *Enzymologia*, **6**, 375 (1939).
985. Geiger, A., *Proc. Roy. Soc. (London)*, **107** (B), 369 (1931).
986. Gelinsky, G., *Arch. exptl. Path. Pharmacol.*, **195**, 460 (1940).
- 986a. George, P., *Nature*, **160**, 41 (1947).
987. Gérard, P., *J. Anat. Physiol.*, **70**, 354 (1936).
988. German, B. and J. Wyman, *J. Biol. Chem.*, **117**, 533 (1937).
989. Getchell, R. W. and J. H. Walton, *ibid.*, **91**, 419 (1931).
990. Gheorghiu, G., *Bull. soc. chim. biol.*, **15**, 522 (1935).
991. Gibb, T. R. P., Jr., *Optical Methods of Chemical Analysis*, McGraw-Hill, New York, 1942.
992. Gibson, J. G. and W. A. Evans, *J. Clin. Invest.*, **16**, 317 (1937).
993. Gibson, Q. H., *Biochem. J.*, **37**, 615 (1943).
- 993a. Gibson, Q. H., *ibid.*, **42**, 13 (1948).
994. Gibson, Q. H. and D. C. Harrison, *ibid.*, **39**, 490 (1945).
995. Gibson, Q. H. and D. C. Harrison, *ibid.*, **40**, 247 (1946).
996. Gibson, Q. H. and R. C. Lowe, *J. Biol. Chem.*, **123**, xli (1938).
997. Giersberg, H., *Biol. Zentr.*, **43**, 167 (1923); *Z. wiss. Zool.*, **120**, 1 (1923).
998. Gilbert, A., E. Chabrol, and H. Bénard, *Presse méd.*, **20**, 113 (1912).
999. Gilbert, A., M. Herscher, and S. Posternack, *Compt. rend. soc. biol.*, **55**, 530 (1903).
1000. Gildemeister, H., *Z. ges. exptl. Med.*, **102**, 58 (1937).
1001. Gilligan, D. R., M. D. Altschul, and E. M. Katersky, *J. Clin. Invest.*, **22**, 859 (1943).
1002. Gilligan, D. R. and H. L. Blumgart, *Medicine*, **20**, 341 (1941).
1003. Gilman, A. and L. Goodman, *Am. J. Physiol.*, **118**, 241 (1937).

1004. Gillman, J., T. Gillman, and S. Brenner, *Nature*, **156**, 689 (1945).
1005. Gilmour, J. R., *J. Path. Bact.*, **52**, 25 (1941).
1006. Giordano, C. and L. Griva, *Boll. soc. ital. biol. sper.*, **2**, 784 (1927).
1007. Gitter, A. and L. Heilmeyer, *Z. ges. exptl. Med.*, **77**, 594 (1931).
1008. Gjessing, E. C. and J. B. Sumner, *Arch. Biochem.*, **1**, 1 (1945).
1009. Glanzmann, E., *Schweiz. med. Wochschr.*, **59**, 1001 (1929).
1010. Gley, P., *Bull. acad. méd. (Paris)*, **118**, 377 (1937).
1011. Glock, G. E., *Nature*, **154**, 460 (1944).
1012. Glock, G. E., *ibid.*, **158**, 169 (1946).
1013. Gobell, O., *Klin. Wochschr.*, **18**, 1319 (1939).
1014. Goddard, D. R., *Am. J. Botany*, **31**, 270 (1944).
1015. Goldbloom, A. and R. Gottlieb, *J. Clin. Invest.*, **8**, 375 (1930).
1016. Goldschmidt, A., O. H. Pepper, and R. M. Pearce, *Arch. Internal Med.*, **16**, 437 (1925).
1017. Goldschmidt-Schulhoff, L. and A. Adler, *Arch. f. Gynaekol.*, **48**, 1526 (1924).
1018. Gollan, K. R., R. Lemberg, and R. A. Money, *Med. J. Australia*, **II**, 212 (1945).
1019. Gonella, A. and A. Vannotti, *Z. ges. exptl. Med.*, **112**, 405 (1948).
1020. Goodhart, R. S. and H. M. Sinclair, *Biochem. J.*, **33**, 1099 (1939).
1021. Goodman, E. G. and L. Iverson, *Am. J. Med. Sci.*, **211**, 205 (1946).
1022. Goodson, W. H. and Ch. Sheard, *Proc. Staff Meetings Mayo Clinic*, **15**, 421 (1940).
1023. Gordon, A. S. and W. Kleinberg, *Proc. Soc. Exptl. Biol. Med.*, **38**, 360 (1938).
- 1023a. Gordon, J. J. and J. W. Quastel, *Nature*, **159**, 97 (1947).
- 1023b. Gordon, A. S. and co-workers, *Am. J. Med. Sci.*, **212**, 385 (1946).
1024. Gottlieb, R., *Can. Med. Assoc.*, **30**, 512 (1934).
1025. Gottron, H. and F. Ellinger, *Arch. Dermat. u. Syphilis*, **164**, 11, 167 (1931); **167**, 325 (1938).
1026. Graff, S., E. Maculla, and A. M. Graff, *J. Biol. Chem.*, **121**, 81 (1937).
1027. Graham, A. F., T. B. Crawford, and G. F. Merriam, *Biochem. J.*, **40**, 256 (1946).
1028. Gralén, N., *ibid.*, **33**, 1907 (1939).
1029. Grandpierre, R. and P. Grognot, *Compt. rend. soc. biol.*, **121**, 398 (1936).
1030. Granick, S., *J. Biol. Chem.*, **146**, 451 (1942).
1031. Granick, S., *Proc. Soc. Exptl. Biol. Med.*, **53**, 255 (1943).
1032. Granick, S., *J. Biol. Chem.*, **149**, 157 (1943).
1033. Granick, S., *Science*, **103**, 107 (1946); *J. Biol. Chem.*, **164**, 737 (1946).
1034. Granick, S., *Chem. Revs.*, **38**, 379 (1946).
1035. Granick, S. and H. Gilder, *Science*, **101**, 540 (1945); *J. Gen. Physiol.*, **30**, 1 (1946).
1036. Granick, S. and P. F. Hahn, *J. Biol. Chem.*, **155**, 661 (1944).
1037. Granick, S. and L. Michaelis, *Science*, **95**, 440 (1942).
1038. Granick, S. and L. Michaelis, *J. Biol. Chem.*, **147**, 91 (1943).
1039. Grassnickel, W., *Arch. wiss. u. prakt. Tierheilk.*, **54**, 479 (1926).
- 1039a. Gray, C. H. and L. B. Holt, *J. Biol. Chem.*, **169**, 235 (1947).
1040. Graybiel, A., J. L. Lilienthal, Jr., and R. L. Riley, *Bull. Johns Hopkins Hosp.*, **76**, 155 (1945).
1041. Greco, A., *Diagnost. e tec. lab. (Napoli), Riv. mens.*, **2**, 925 (1931); *J. Am. Med. Assoc.*, **98**, 1123 (1931).
1042. Green, A. A., E. J. Cohn, and M. H. Blanchard, *J. Biol. Chem.*, **309**, 631 (1935).
1043. Green, D. E., *Proc. Roy. Soc. (London)*, **114(B)**, 423 (1934).
1044. Green, D. E. and D. Richter, *Biochem. J.*, **31**, 596 (1937).
1045. Green, D. E. and L. H. Stickland, *ibid.*, **28**, 898 (1934).

1046. Green, H. H. and E. A. Macaskill, *J. Agr. Sci.* **18**, 384 (1928).
1047. Greenberg, D. M., D. H. Copp, and E. M. Cuthbertson, *J. Biol. Chem.*, **147**, 749 (1943).
1048. Greenberg, G. R. and M. M. Wintrobe, *ibid.*, **165**, 397 (1946).
1049. Greenberg, A. and D. Erickson, *ibid.*, **156**, 679 (1944).
1050. Greenberg, L. A., D. Lester, and H. W. Haggard, *ibid.*, **151**, 665 (1943).
- 1050a. Greenberg, G. R. and co-workers, *J. Clin. Invest.*, **26**, 114, 121 (1947).
1051. Greenblatt, I. J. and A. P. Greenblatt, *Arch. Biochem.*, **7**, 87 (1945).
1052. Greenstein, J. P., *J. Biol. Chem.*, **93**, 479 (1931).
1053. Greenstein, J. P., *ibid.*, **101**, 603 (1933).
1054. Greenstein, J. P., *ibid.*, **128**, 233 (1939).
1055. Greenstein, J. P., A. B. Eschenbrenner, and F. M. Leuthardt, *J. Natl. Cancer Inst. U. S.*, **5**, 55 (1944).
1056. Grinstein, M., S. Schwartz, and C. J. Watson, *J. Biol. Chem.*, **157**, 323 (1945).
1057. Grinstein, M. and C. J. Watson, *ibid.*, **147**, 667 (1943); **167**, 515 (1947).
1058. Grinstein, M. and C. J. Watson, *ibid.*, **147**, 671 (1943).
1059. Grinstein, M. and C. J. Watson, *ibid.*, **147**, 675 (1943).
1060. Grotepass, W., *Z. physiol. Chem.*, **205**, 193 (1932).
1061. Grotepass, W., *Nederland. Tijdschr. Geneesk.*, **81**, 362 (1937).
1062. Grotepass, W., *Z. physiol. Chem.*, **253**, 276 (1938).
1063. Grotepass, W. and A. Defalque, *ibid.*, **252**, 155 (1938).
1064. Grotepass, W. and Z. Hulst, *Nederland. Tijdschr. Geneesk.*, **79**, 1780 (1935).
1065. Grüneberg, H., *Nature*, **148**, 114, 469 (1941); *J. Genetics*, **43**, 45 (1942).
1066. Grunenberg, K., *Z. ges. exptl. Med.*, **35**, 123 (1923).
1067. Gubler, C. J. and C. L. A. Schmidt, *Arch. Biochem.*, **8**, 211 (1945).
1068. Günther, H., *Deut. Arch. klin. Med.*, **105**, 89 (1911).
1069. Günther, H., *Arch. path. Anat. Physiol. (Virchow's)*, **230**, 146 (1921).
1070. Günther, H., in Lubarsch-Ostertag, *Ergebnisse der allgemeinen Pathologie und pathologischen Anatomie des Menschen und der Tiere*. Vol. 20, Abt. II, Tl. II, Bergmann, München, 1922.
1071. Günther, H., in Schittenhelm, *Handbuch der Krankheiten des Blutes und der blutbildenden Organe, Enzyklopadie der klinischen Medizin*, Springer, Berlin, Vol. 2, 1925, p. 622.
- 1071a. Gutmann H. R., B. J. Jandorf, and O. Bodansky, *J. Biol. Chem.*, **169**, 145 (1947).
1072. György, P., F. S. Robscheit-Robbins, and G. H. Whipple, *Am. J. Physiol.*, **122**, 154 (1938).
1073. Haas, E., *Naturwissenschaften*, **22**, 207 (1934).
1074. Haas, E., *J. Biol. Chem.*, **148**, 481 (1943).
1075. Haas, E., *ibid.*, **152**, 695 (1944).
1076. Haas, E., C. J. Harrer, and T. R. Hogness, *ibid.*, **143**, 341 (1942).
1077. Haas, E., B. L. Horecker, and T. R. Hogness, *Science*, **95**, 406 (1942).
1078. Haber, F. and J. Weiss, *Naturwissenschaften*, **20**, 948 (1932).
1079. Haber, F. and J. Weiss, *Proc. Roy Soc. (London)*, **147**(A), 332 (1934).
1080. Haber, F. and R. Willstätter, *Ber.*, **64B**, 2844 (1931).
1081. Haden, R. L., *J. Lab. Clin. Med.*, **18**, 1062 (1933).
1082. Haden, R. L., *J. Am. Med. Assoc.*, **111**, 1059 (1938).
1083. Haden, R. L., *Symposium on the Blood and Blood-Forming Organs*, Univ. of Wisconsin Press, Madison, 1939, p. 83.
1084. Häcker, W., *Arch. Verdauungs-Krankh. Stoffwechselpath. u. Diätetik*, **58**, 263 (1935).

1085. Hagenbach, A., F. Auerbacher, and E. Wiedemann, *Helv. Chim. Acta*, **9**, 1 (1936).
1086. Hahn, P. F., *Medicine*, **16**, 249 (1937).
1087. Hahn, P. F., W. F. Bale, and W. M. Balfour, *Am. J. Physiol.*, **135**, 600 (1942).
1088. Hahn, P. F., W. F. Bale, and G. H. Whipple, *Proc. Soc. Exptl. Biol. Med.*, **61**, 405 (1946).
1089. Hahn, P. F., L. Michaelis, and co-workers, *J. Biol. Chem.*, **150**, 407 (1943).
1090. Hahn, P. F. and G. H. Whipple, *J. Exptl. Med.*, **69**, 315 (1939).
1091. Hahn, P. F. and G. H. Whipple, *Am. J. Med. Sci.*, **191**, 24 (1936).
1092. Hahn, P. F., G. H. Whipple, and co-workers, *J. Exptl. Med.*, **69**, 739 (1939).
1093. Hahn, P. F., G. H. Whipple, and co-workers, *ibid.*, **70**, 443 (1939).
1094. Hahn, P. F., G. H. Whipple, and co-workers, *ibid.*, **71**, 731 (1940).
1095. Hahn, P. F., G. H. Whipple, and co-workers, *Science*, **92**, 131 (1940).
1096. Hahn, P. F., G. H. Whipple, and co-workers, *J. Exptl. Med.*, **78**, 169 (1943).
- 1096a. Haist, R. E. and J. I. Hamilton, *J. Physiol.*, **102**, 471 (1944).
1097. Haldane, J. B. S., *Nature*, **119**, 352 (1927).
1098. Haldane, J. B. S., *Proc. Roy. Soc. (London)*, **108(B)**, 559 (1931).
1099. Haldane, J. B. S., *Nature*, **130**, 61 (1932).
1100. Haldane, J. S., *J. Physiol.*, **25**, 230 (1899).
1101. Haldane, J. S. and C. G. Douglas, *Respiration*, Yale Univ. Press, New Haven, (1922).
1102. Haldane, J. S., C. G. Douglas, and J. B. S. Haldane, *J. Physiol. (London)*, **44**, 275 (1913).
1103. Haldane, J. S. and J. Lorraine-Smith, *ibid.*, **22**, 231 (1897).
1104. Haldane, J. S., M. B. Makgill, and A. E. Mavrogordato, *ibid.*, **21**, 160 (1897).
1105. Hall, F. G., *ibid.*, **80**, 502 (1934).
1106. Hall, F. G., *ibid.*, **82**, 33 (1934); **83**, 222 (1934).
1107. Hall, F. G., *J. Biol. Chem.*, **130**, 573 (1939).
1108. Halpern, B. W. and P. Dubost, *Bull. soc. chim. biol.*, **21**, 717 (1939).
1109. Ham, T. H. and W. B. Castle, *Proc. Am. Phil. Soc.*, **82**, 411 (1940).
1110. Hamada, T., *Z. physiol. Chem.*, **243**, 258 (1936).
1111. Hammer, H., *Arch. path. Anat. Physiol. (Virchow's)*, **277**, 159 (1930).
1112. Hamre, C. J. and C. D. Miller, *Am. J. Physiol.*, **111**, 578 (1935).
1113. Hamsik, A., *Z. physiol. Chem.*, **80**, 35 (1912).
1114. Hamsik, A., *ibid.*, **178**, 67 (1928).
1115. Hamsik, A., *ibid.*, **180**, 308 (1929).
1116. Hamsik, A., *Z. physiol. Chem.*, **182**, 117 (1929).
1117. Hamsik, A., *ibid.*, **186**, 263 (1930).
1118. Hamsik, A., *ibid.*, **187**, 234 (1930).
1119. Hamsik, A., *Compt. rend. soc. biol.*, **104**, 243 (1930).
1120. Hamsik, A., *Z. physiol. Chem.*, **190**, 199 (1930).
1121. Hamsik, A., *ibid.*, **196**, 195 (1931).
1122. Hamsik, A., *ibid.*, **241**, 156 (1936).
1123. Hand, D. B., in F. F. Nord and R. Weidenhagen, *Ergebnisse der Enzymforschung*. Vol. II, Akadem. Verlagsgesellschaft, Leipzig, 1933, p. 272.
1124. Handler, P. and W. P. Featherston, *J. Biol. Chem.*, **151**, 395 (1943).
1125. Handler, P. and H. I. Kohn, *J. Biol. Chem.*, **150**, 447 (1943).
- 1125a. Hanson, E. A. and Ketelaar, *Rec. trav. botan. néerland.*, **36**, 180 (1939).
1126. Harder, R., *Ber. deut. bot. Ges.*, **40**, 26 (1922). *Z. Botan.*, **15**, 305 (1923).
1127. Harington, C. R. and R. V. P. Rivers, *Biochem. J.*, **39**, 157 (1945).
1128. Harkins, W. D. and T. F. Anderson, *J. Biol. Chem.*, **125**, 369 (1938).
1129. Harnack, E., *Z. physiol. Chem.*, **16**, 558 (1898-9).

1130. Harne, O. G., J. F. Lutz, G. I. Zimmermann, and C. L. Davis, *J. Lab. Clin. Med.*, **30**, 247 (1945).
1131. Harrer, C. J. and C. G. King, *J. Biol. Chem.*, **138**, 111 (1940).
1132. Harris, D. T., *Proc. Roy. Soc. (London)*, **98(B)**, 178 (1925); *Biochem. J.*, **20**, 280 (1926).
1133. Harris, H. A., A. Neuberger, and F. Sanger, *Biochem. J.*, **37**, 508 (1943).
1134. Harris, J. S. and H. O. Michel, *J. Clin. Invest.*, **18**, 507 (1939).
1135. Harrison, D. C., *Biochem. J.*, **18**, 1009 (1924).
1136. Harrison, D. C., *ibid.*, **27**, 382 (1933).
1137. Harrop, G. A. and E. S. G. Barron, *J. Exptl. Med.*, **48**, 207 (1928).
1138. Harrop, G. A. and G. Barron, *J. Clin. Invest.*, **9**, 577 (1931).
1139. Harrop, G. A. and R. L. Waterfield, *J. Am. Med. Assoc.*, **95**, 647 (1930).
1140. Hart, E. B., H. Steenbock, J. Waddell, and C. A. Elvehjem, *J. Biol. Chem.*, **77**, 777, 797 (1928); **83**, 251 (1929).
1141. Hart, P. D'A. and A. B. Anderson, *J. Path. Bact.*, **37**, 91 (1933).
1142. Hartmann, A. F., A. M. Perley, and H. L. Barnett, *J. Clin. Invest.*, **17**, 699 (1938).
1143. Hartridge, H., *J. Physiol.*, **44**, 1 (1912).
1144. Hartridge, H., *ibid.*, **54**, 253 (1920).
1145. Hartridge, H. and A. V. Hill, *J. Physiol.*, **48**, LI (1914).
1146. Hartridge, H. and F. J. W. Roughton, *Proc. Roy. Soc. (London)*, **94(B)**, 336 (1923).
1147. Hartridge, H. and F. J. W. Roughton, *ibid.*, **104(A)**, 376 (1923).
1148. Hartridge, H. and F. J. W. Roughton, *ibid.*, **104(A)**, 395 (1923).
1149. Hartridge, H. and F. J. W. Roughton, *ibid.*, **107(A)**, 654 (1925).
1150. Haselhorst, G. and A. Papendieck, *Klin. Wochschr.*, **3**, 979 (1924).
1151. Haselhorst, G. and K. Stromberger, *Z. Geburtshülfe u. Gynäkol.*, **98**, 49 (1930).
1152. Haselhorst, G. and K. Stromberger, *ibid.*, **100**, 48 (1931).
1153. Haslewood, G. A. D. and E. J. King, *Biochem. J.*, **31**, 920 (1937).
1154. Hastings, A. B. and co-workers, *J. Biol. Chem.*, **60**, 89 (1924).
1155. Haurowitz, F., *Z. physiol. Chem.*, **138**, 68 (1924).
1156. Haurowitz, F., *ibid.*, **151**, 130 (1926).
1157. Haurowitz, F., *ibid.*, **169**, 235 (1927).
1158. Haurowitz, F., *ibid.*, **183**, 78 (1929).
1159. Haurowitz, F., *ibid.*, **186**, 141 (1930).
1160. Haurowitz, F., *ibid.*, **188**, 161 (1930).
1161. Haurowitz, F., *ibid.*, **189**, 9 (1931).
1162. Haurowitz, F., *ibid.*, **194**, 98 (1931).
1163. Haurowitz, F., *Arch. Verdauungs-Krankh. Stoffwechselfath. u. Diätetik*, **50**, 33 (1931).
1164. Haurowitz, F., *Z. physiol. Chem.*, **232**, 125 (1935).
1165. Haurowitz, F., *ibid.*, **232**, 146 (1935).
1166. Haurowitz, F., *ibid.*, **232**, 159 (1935).
1167. Haurowitz, F., *Ber.*, **68B**, 1795 (1935).
1168. Haurowitz, F., *Enzymologia*, **2**, 9 (1937).
1169. Haurowitz, F., *ibid.*, **4**, 139 (1937).
1170. Haurowitz, F., *J. Biol. Chem.*, **137**, 771 (1940).
1171. Haurowitz, F., *Enzymologia*, **10**, 141 (1941).
1172. Haurowitz, F., R. Brdička, and F. Kraus, *ibid.*, **2**, 9 (1937).
1173. Haurowitz, F. and H. Kittel, *Ber.*, **66B**, 1046 (1933).
1174. Haurowitz, F. and W. Klemm, *Ber.*, **68B**, 2312 (1935).
1175. Haurowitz, F., F. Kraus, and A. Winkler, *Z. physiol. Chem.*, **232**, 146 (1935).
1176. Haurowitz, F., P. Schwerin, and M. M. Yenson, *J. Biol. Chem.*, **140**, 353 (1940).

1177. Haurowitz, F. and H. Waelsch, *Z. physiol. Chem.*, **182**, 82 (1929).
1178. Hauschild, F., *Arch. exptl. Path. Pharmacol.*, **184**, 458 (1937).
1179. Hausmann, W., *Wien. klin. Wochschr.*, **109**, 1820 (1909).
1180. Hausmann, W., *Biochem. Z.*, **30**, 276 (1910).
1181. Hausmann, W., *Strahlentherapie*, **28**, 81 (1928).
1182. Hausmann, W., *Grundzüge der Lichtbiologie (Sonderband zur Strahlentherapie)*, Urban und Schwarzenberg, Berlin, 1923.
1183. Hausmann, W. and O. Krumpel, *Biochem. Z.*, **186**, 203 (1927).
1184. Hausser, K. W. and co-workers, *Z. physik. Chem.*, **29B**, 363 (1935).
1185. Hausser, K. W., R. Kuhn, and G. Seitz, *ibid.*, **29B**, 391 (1935).
1186. Havemann, R., *Biochem. Z.*, **308**, 1 (1941).
1187. Havemann, R., *ibid.*, **314**, 118 (1943).
1188. Havemann, R., *ibid.*, **316**, 138 (1943).
1189. Havemann, R., F. Jung, and B. v. Issekutz, *Biochem. Z.*, **301**, 116 (1939).
1190. Havemann, R. and K. Wolff, *ibid.*, **293**, 399 (1937).
1191. Hawkins, W. B. and P. F. Hahn, *J. Exptl. Med.*, **80**, 31 (1944).
1192. Hawkins, W. B. and G. H. Whipple, *Am. J. Physiol.*, **122**, 418 (1938).
1193. Hawkins, W. B. and A. C. Johnson, *ibid.*, **126**, 326 (1939).
1194. Hawkins, W. B., F. S. Robscheit-Robbins, and G. H. Whipple, *J. Exptl. Med.*, **67**, 89 (1938).
1195. Hawkins, W. B., and co-workers, *Am. J. Physiol.*, **96**, 463 (1931).
1196. Hawkins, W. B. and G. H. Whipple, *ibid.*, **122**, 418 (1938).
1197. Heath, C. W., *Symposium on the Blood and Blood-forming Organs*, Univ. of Wisconsin Press, 1939, p. 41.
1198. Heath, C. W. and G. A. Daland, *Arch. Internal Med.*, **46**, 533 (1930).
1199. Heath, C. W. and A. S. Patek, *Medicine*, **16**, 267 (1937).
1200. Hecht, G., *Biochem. Z.*, **305**, 290 (1940).
1201. Hegler, *Münch. med. Wochschr.*, **59**, 2924 (1912).
1202. Heidelberger, M., *J. Biol. Chem.*, **53**, 31 (1922).
1203. Heilbrun, N. and R. S. Hubbard, *J. Lab. Clin. Med.*, **26**, 576 (1940).
1204. Heilmeyer, L., *Z. ges. exptl. Med.*, **76**, 220 (1931).
1205. Heilmeyer, L., *Biochem. Z.*, **232**, 229 (1931).
1206. Heilmeyer, L., *Deut. Arch. klin. Med.*, **171**, 121, 515 (1931).
1207. Heilmeyer, L., *ibid.*, **172**, 341 (1932).
1208. Heilmeyer, L., *ibid.*, **172**, 628 (1932).
1209. Heilmeyer, L., *ibid.*, **173**, 128 (1932).
1210. Heilmeyer, L., *ibid.*, **179**, 292 (1936).
1211. Heilmeyer, L., *Biochem. Z.*, **296**, 383 (1938).
1212. Heilmeyer, L., *Klin. Wochschr.*, **18**, 661 (1939).
1213. Heilmeyer, L., *Spectrophotometry in Medicine*, Hilger, London, 1943.
1214. Heilmeyer, L. and L. Albus, *Deut. Arch. klin. Med.*, **178**, 89 (1935).
1215. Heilmeyer, L. and P. Beickert, *Z. physiol. Chem.*, **244**, 99 (1936).
1216. Heilmeyer, L. and W. Krebs, *Biochem. Z.*, **223**, 352 (1930).
1217. Heilmeyer, L. and W. Krebs, *Biochem. Z.*, **231**, 393 (1931).
1218. Heilmeyer, L. and W. Krebs, *Z. physiol. Chem.*, **228**, 33 (1934).
1219. Heilmeyer, L. and W. Oetzel, *Deut. Arch. klin. Med.*, **171**, 365 (1931).
1220. Heilmeyer, L. and W. Ohlig, *Klin. Wochschr.*, **15**, 1124 (1936).
1221. Heilmeyer, L. and H. Plötner, *ibid.*, **15**, 1669 (1936).
1222. Heilmeyer, L. and H. Stüwe, *ibid.*, **17**, 925 (1938).
1223. Heilmeyer, L. and H. Toop, *Z. ges. exptl. Med.*, **80**, 603 (1932).
1224. Heilmeyer, L. and R. Westhauser, *Z. klin. Med.*, **121**, 361 (1932).

1225. Heilmeyer, L. and G. Will, *Z. ges. exptl. Med.*, **67**, 111 (1929).
1226. Heimann, F., *Biochem. Z.*, **263**, 316 (1933).
1227. Heinemann, M., *J. Clin. Invest.*, **20**, 467 (1941).
1228. Heinemann, M. and P. M. Hald, *J. Clin. Invest.* **17**, 751 (1938); **19**, 469 (1940).
- 1228a. Heinle, R. W. and A. D. Welch, *Ann. N. Y. Acad. Sci.*, **48**, 343, 347 (1946).
1229. Heinrichius, G., *Arch. Mikroskop. Anat. Entwicklungsmech.*, **33**, 419 (1899).
1230. Heinz, R., *Arch. path. Anat. Physiol. (Virchow's)*, **122**, 112 (1890); *Berlin klin. Wochschr.*, **27**, 47 (1890).
1231. Helberger, J. H., *Ann.*, **529**, 205 (1937).
1232. Heller, R., *Z. ges. exptl. Med.*, **87**, 17 (1933).
1233. Hellmuth, K., *Z. Geburtshilfe u. Gynäkol.*, **54**, 321 (1921).
1234. Hellström, H., *Z. physik. Chem.*, **12B**, 353 (1931); *ibid.*, **14B**, 9 (1931); *Arkiv Kemi Mineral. Geol.*, **12B**, No. 13 (1936).
1235. Helmer, O. M. and C. P. Emerson, *J. Biol. Chem.*, **104**, 157 (1934).
1236. Henderson, L. J., *Blood, a Study in General Physiology*, Yale Univ. Press, New Haven, 1928.
1237. Henderson, Y., *Adventures in Respiration*, Williams & Wilkins, Baltimore, 1938.
1238. Hennichs, S., *Biochem. Z.*, **145**, 286 (1924).
1239. Hennichs, S., *ibid.*, **171**, 314 (1926).
1240. Hennichs, S., *Ber.*, **59B**, 218 (1926).
1241. Henriques, O. M., in L. Asher and K. Spiro, *Ergebnisse der Physiologie*, Vol. 28, Bergmann, München, 1929, p. 628.
1242. Henriques, O. M. and J. Roche, *Bull. soc. chim. biol.*, **9**, 501 (1927).
1243. Henry-Cornet, J., *Bull. Acad. roy. Belg., Classe des Sciences*, **22**, 553 (1936).
1244. Henze, C., *Klin. Wochschr.*, **17**, 24 (1938).
- 1244a. Herbert, D. and A. J. Pinsent, *Nature*, **160**, 125 (1947); *Biochem. J.*, **43**, 193 (1948).
1245. Hermann, H., M. B. Boss, and J. S. Friedenwald, *J. Biol. Chem.*, **164**, 773 (1946).
1246. Hermann, M., *Arch. path. Anat. Physiol. (Virchow's)*, **17**, 451 (1859).
1247. Hermann, M., *Arch. Anat. Physiol. u. wiss. Med.*, **1865**, 469
1248. Herold, L., *Arch. Gynäkol.*, **158**, 213 (1934).
1249. Herzog, A., *Biochem. Z.*, **280**, 156 (1935).
1250. Herzfeld, E., *ibid.*, **251**, 394 (1932).
1251. Herzfeld, E. and R. Klinger, *ibid.*, **100**, 64 (1919).
1252. Hess, L. and P. Saxl, *ibid.*, **19**, 274 (1909); *Deut. Arch. klin. Med.*, **108**, 180 (1912).
1253. Heubner, W., *Naturwissenschaften*, **16**, 515 (1928).
1254. Heubner, W., "Methaemoglobin bildende Gifte," *Ergebnisse der Physiologie*, Vol. 43, Bergmann, München, p. 9, 1940.
1255. Heubner, W., *Klin. Wochschr.*, **20**, 137 (1941).
1256. Heubner, W., *ibid.*, **21**, 520 (1942).
1257. Heubner, W. and M. Frerichs, *Arch. exptl. Path. Pharmacol.*, **186**, 671 (1937).
1258. Heubner, W. and F. Jung, *Ber.*, **75B**, 1636 (1942).
1259. Heubner, W., R. Meier, and W. Rhode, *Arch. exptl. Path. Pharmacol.*, **100**, 149 (1923).
1260. Heubner, W. and H. Moebus, *ibid.*, **190**, 223 (1938).
1261. Heubner, W. and G. Schwedtke, *ibid.*, **184**, 1, 80 (1936).
1262. Heubner, W. and M. Stuhlmann, *ibid.*, **199**, 1 (1942).
- 1262a. Heubner, M. and co-workers, *ibid.*, **204**, 313 (1947).
- 1262b. Hevesy, G., *Nature*, **160**, 247 (1947).

1263. Hevesy, G. and A. H. W. Aten, *Kgl. Danske Videnskab. Selskab Biol. Medd.*, **14**, No. 5 (1939).
1264. Hevesy, G. and L. Hahn, *ibid.*, **15**, No. 7 (1940).
1265. Hevesy, G. and J. Ottesen, *Nature*, **156**, 534 (1945).
1266. Hewitt, L. F., *Biochem. J.*, **24**, 1551 (1930).
1267. Hewitt, L. F., *Oxidation-Reduction Potentials in Bacteriology and Biochemistry*, 4th ed., King, London, 1936.
1268. Heynsius, A., *Arch. ges. Physiol. (Pflügers)*, **10**, 246 (1875).
1269. Heynsius, A. and F. F. Campbell, *ibid.*, **4**, 497 (1871).
1270. Hicks, C. S. and H. F. Holden, *Australian J. Exptl. Biol. Med. Sci.*, **6**, 175 (1929).
1271. Hicks, J. D., *Med. J. Australia*, **1942**, 117.
1272. Higgins, G. M., *Proc. Staff Meetings Mayo Clinic*, **19**, 329 (1944).
1273. Hildebrandt, W., *Deut. med. Wochschr.*, **34**, 489, 2161 (1908).
1274. Hill, A. V., *J. Physiol. (London)*, **40**, 4P (1910).
1275. Hill, R., *Biochem. J.*, **19**, 341 (1925).
1276. Hill, R., *Proc. Roy. Soc. (London)*, **100**(B), 419 (1926).
1277. Hill, R., *ibid.*, **105**(B), 112 (1930).
1278. Hill, R., *ibid.*, **107**(B), 205 (1931).
1279. Hill, R., *ibid.*, **120**(B), 472 (1936).
1280. Hill, R., in *Perspectives in Biochemistry*, Cambridge Univ. Press, 1937, p. 127.
- 1280a. Hill, R., *Biochem. J.*, **37**, Proc. Soc. xxiii (1943).
1281. Hill, R. and K. Bhagvat, *Nature*, **143**, 726 (1939).
1282. Hill, R. and H. F. Holden, *Biochem. J.*, **20**, 1326 (1926).
1283. Hill, R. and H. F. Holden, *ibid.*, **21**, 625 (1927).
1284. Hill, R. and D. Keilin, *Proc. Roy. Soc. (London)*, **107**(B), 286 (1930).
1285. Hill, R. and R. Scarisbrick, *Nature*, **139**, 881 (1937); **146**, 61 (1940); *Proc. Roy. Soc. (London)*, **127**(B), 192 (1939); **129**, 238 (1940).
1286. Hill, R. and H. P. Wolvekamp, *Proc. Roy. Soc. (London)*, **120**(B), 484 (1936).
1287. Hinsberg, K., *Klin. Wochschr.*, **18**, 180 (1939).
1288. Hinsberg, K. and G. Lahn, *Biochem. Z.*, **300**, 301 (1939).
1289. Hinsberg, K. and R. Merten, *ibid.*, **302**, 103 (1939).
1290. Hinsberg, K. and W. Rodewald, *Arch. exptl. Path. Pharmacol.*, **191**, 1 (1939).
1291. Hirasawa, S., *Jap. Med. World*, **3**, 250 (1923); *J. Osaka Med. Soc.*, **21**, 9 (1922).
1292. Hirsch, M., doctoral dissertation, Heidelberg (1934).
1293. Hisey, A. and D. B. Morrison, *J. Biol. Chem.*, **130**, 763 (1939).
1294. Hiyeda, K., *Beitr. path. Anat. u. allgem. Path.*, **78**, 389 (1927).
1295. Hoagland, C. L., S. M. Ward, and R. E. Shank, *J. Biol. Chem.*, **151**, 369 (1949).
1296. Hoagland, R., *J. Agr. Research*, **7**, 41 (1916); *Chem. Zentr.*, **1**, 1917, 76.
1297. Hoberman, H. D. and D. Rittenberg, *J. Biol. Chem.*, **147**, 211 (1943).
1298. Hoerburger, W., doctoral dissertation, Erlangen (1933).
1299. Hoerburger, W. and H. Fink, *Z. physiol. Chem.*, **236**, 136 (1935).
1300. Hoerburger, W. and W. Schulze, *Arch. Dermatol. u. Syphilis*, **175**, 671 (1937).
1301. Hoesch, K., *Biochem. Z.*, **167**, 107 (1926).
1302. Hoesch, K. and C. Carrié, *Z. klin. Med.*, **129**, 214 (1935).
1303. Hoffmann, O. D. and E. F. Beath, *J. Biol. Chem.*, **128**, xlv (1939).
1304. Hogan, A. G. and E. M. Parrot, *J. Biol. Chem.*, **132**, 507 (1940).
1305. Hogan, A. G., E. L. Powell, and R. E. Guerrant, *ibid.*, **137**, 41 (1941).
1306. Hogness, T. R., *Cold Spring Harbor Symposia Quant. Biol.*, **7**, 121 (1939).
1307. Hogness, T. R., F. P. Zscheile, Jr., A. E. Sidwell, Jr., and E. G. S. Barron, *J. Biol. Chem.*, **118**, 1 (1937).
1308. Holden, H. F., *Australian J. Exptl. Biol. Med. Sci.*, **14**, 291 (1936).
1309. Holden, H. F., *ibid.*, **15**, 43 (1937).

1310. Holden, H. F., *ibid.*, **15**, 409 (1937).
 1311. Holden, H. F., *ibid.*, **16**, 153 (1938).
 1312. Holden, H. F., *ibid.*, **19**, 1 (1941).
 1313. Holden, H. F., *ibid.*, **19**, 89 (1941).
 1314. Holden, H. F., *ibid.*, **21**, 9 (1943).
 1315. Holden, H. F., *ibid.*, **21**, 159 (1943).
 1316. Holden, H. F., *ibid.*, **21**, 169 (1943).
 1317. Holden, H. F., *Ann. Rev. Biochem.*, **14**, 599 (1945).
 1318. Holden, H. F., *Australian J. Exptl. Biol. Med. Sci.*, **23**, 255 (1945).
 1319. Holden, H. F., *ibid.*, **24**, 107 (1946).
 1320. Holden, H. F., *ibid.*, **25**, 47 (1947).
 1320a. Holden, H. F., *Australian J. Exptl. Biol. Med. Sci.*, **25**, 57 (1947).
 1321. Holden, H. F. and M. Freeman, *ibid.*, **5**, 213 (1928).
 1322. Holden, H. F. and M. Freeman, *ibid.*, **6**, 79 (1929).
 1323. Holden, H. F. and C. S. Hicks, *ibid.*, **10**, 219 (1932).
 1324. Holden, H. F. and R. Lemberg, *ibid.*, **17**, 133 (1939).
 1325. Holiday, E. R., P. M. T. Kerridge, and F. C. Smith, *Lancet*, **229**, 661 (1925).
 1325a. Holmberg, C. G. and C. B. Laurell, *Nature*, **161**, 236 (1948).
 1326. Holmes, A. D., M. G. Pigott, and P. A. Campbell, *J. Biol. Chem.*, **105**, xli (1934); *Poultry Sci.*, **14**, 183 (1935).
 1327. Holmes, B. E., *Biochem. J.*, **20**, 812 (1926).
 1328. Holmes, E. G., *Biochem. J.*, **24**, 914 (1930).
 1329. Hooper, C. W. and G. H. Whipple, *Am. J. Physiol.*, **40**, 332 (1916); **42**, 264 (1917); **43**, 275 (1917).
 1330. Hooper, C. W. and G. H. Whipple, *ibid.*, **45**, 573 (1918).
 1331. Hoover, C. F. and M. A. Blankenhorn, *Arch. Internal Med.*, **18**, 289 (1916).
 1332. Hopkins, F. G., *Guy's Hosp. Repts.*, **50**, 349 (1893).
 1333. Hopkins, F. G., *ibid.*, **50**, 363 (1893).
 1334. Hopkins, F. G. and A. E. Garrod, *J. Physiol. (London)*, **22**, 452 (1897).
 1335. Hoppe-Seyler, F., *Arch. path. Anat. Physiol. (Virchow's)*, **23**, 446 (1862).
 1336. Hoppe-Seyler, F., *Centr. med. Wiss.*, **1866**, 436.
 1337. Hoppe-Seyler, F., *Medizin.-chem. Untersuchungen.*, Heft 1-4 (1871).
 1338. Hoppe-Seyler, F., *Z. physiol. Chem.*, **1**, 134 (1877).
 1339. Hoppe-Seyler, F., *ibid.*, **3**, 339 (1879); **4**, 193 (1880); **5**, 75 (1881).
 1340. Hoppe-Seyler, F., *ibid.*, **9**, 34 (1885).
 1341. Hoppe-Seyler, F., *ibid.*, **13**, 477 (1889).
 1342. Hoppe-Seyler, F. and H. Thierfelder, *Handbuch d. physiologisch-u. pathologisch-chem. Analyse für Ärzte u. Studierende*, 9th Ed., 1924, p. 417.
 1343. Horecker, B. L., *J. Biol. Chem.*, **148**, 173 (1943).
 1344. Horecker, B. L., *U. S. Pub. Health Service, Pub. Health. Bull.*, **285**, 46 (1944).
 1345. Horecker, B. L., *J. Lab. Clin. Med.*, **31**, 589 (1946).
 1346. Horecker, B. L. and F. S. Brackett, *J. Biol. Chem.*, **152**, 669 (1944).
 1347. Horecker, B. L. and A. Kornberg, *ibid.*, **165**, 11 (1946).
 1347a. Horecker, B. L. and J. N. Stannard, *ibid.*, **172**, 589 (1948).
 1347b. Horecker, B. L. and J. N. Stannard, *ibid.*, **172**, 599 (1948).
 1348. Horowitz, N. H. and J. P. Baumberger, *ibid.*, **141**, 407 (1941).
 1349. Horsters, H., *Ergeb. Physiol.*, **34**, 494 (1932).
 1350. Houghton, B. C. and C. A. Doan, *Am. J. Clin. Path.*, **11**, 144 (1941).
 1351. Howell, W. H., *Arch. internat. physiol.*, **18**, 269 (1921).
 1352. Huang, T. and H. Wu, *Chinese J. Physiol.*, **4**, 221 (1930).
 1353. Hüfner, G., *Arch. ges. Physiol. (Pflügers)*, **1894**, 180.
 1354. Hüfner, G., *Arch. Anat. Physiol., Anat. Abt.*, **5**, 187 (1901).

1355. Hüfner, G., *Arch. ges. Physiol. (Pfügers)*, **1903**, 217.
1356. Hüfner, G. and W. Küster, *Arch. Anat. Physiol., Physiol. Abt., Suppl.*, **1904**, 387.
1357. Hüfner, G. and J. Otto, *Z. physiol. Chem.*, **7**, 65 (1882).
1358. Hühnerfeld, J., *Psychiat. Neurol. Wochschr.*, **35**, No. 23 (1933); *Z. ges. Neurol. Psychiat.*, **154**, 799 (1936).
1359. Hueper, W. C., *J. Lab. Clin. Med.*, **29**, 623 (1944).
1360. Huffmann, C. F. and C. W. Duncan, *Ann. Rev. Biochem.*, **13**, 467 (1944).
1361. Huggins, M. L., Cited by A. H. Corwin and W. M. Quattlebaum, *J. Am. Chem. Soc.*, **58**, 1081 (1936).
1362. Huggins, M. L., *J. Chem. Phys.*, **5**, 527 (1937).
1363. Hughes, A., *Proc. Roy. Soc. (London)*, **155A**, 710 (1937).
1364. Hughes, E. H. and R. L. Squibb, *J. Animal Sci.*, **1**, 320 (1942).
1365. Hughes, J. H., and A. L. Latner, *J. Physiol. (London)*, **89**, 403 (1937).
1366. Hulst, L. A. and W. Grotepass, *Klin. Wochschr.* **15**, 201 (1936).
1367. Hulst, Z., *Doctoral Dissertation*, Utrecht, 1933.
1367a. Humble, J. G., *Quart. J. Med.*, **15**, 299 (1946).
1368. Hunter, G., *Brit. J. Exptl. Path.*, **11**, 407 (1930).
1369. Hunter, W., *J. Anat. Physiol.*, **21**, 138, 264, 450 (1887).
1370. Huppert, H., *Arch. Heilkunde*, **8**, 351, 476 (1869).
1371. Hurst, H., *Nature*, **156**, 194 (1945).
1372. Hurtado, H. and co-workers, *Am. J. Med. Sci.*, **194**, 708 (1937).
1373. Hurtado, H., C. Herino, and E. Delgado, *Arch. Internal Med.*, **75**, 284 (1945).
1374. Hussein, A. A., *J. Biol. Chem.*, **155**, 201 (1944).
1375. Huszák, S., *Z. physiol. Chem.*, **247**, 239 (1937).
1376. Huszák, S., *Biochem. Z.*, **298**, 137 (1938).
1377. Huszák, S., *ibid.*, **312**, 330 (1942).
1378. Hutchinson, J. H., *Quart. J. Med.*, **7**, 397 (1938).
1379. Hutschenreuter, R., *Z. physiol. Chem.*, **222**, 161 (1933).
1380. Hynes, M. and H. Lehmann, *J. Physiol. (London)*, **104**, 305 (1946).
1381. Ilna, A. A. and co-workers, *Compt. rend. acad. sci. U.R.S.S.*, **48**, 325 (1945).
1382. Ingrarson, G., *Biochem. Z.*, **294**, 407 (1937).
1383. Irving, L., *Physiol. Revs.*, **19**, 112 (1939).
1384. Isaacs, R., *ibid.*, **17**, 291 (1937).
1385. Israels, M. C. G., *Lancet II*, **1941**, 207.
1386. Israels, M. C. G., *J. Path. Bact.*, **52**, 361 (1941).
1387. Israels, M. C. G., *Lancet I*, **1943**, 170.
1388. Issekutz, B., Jr., *Arch. exptl. Path. Pharmacol.*, **193**, 567 (1939).
1389. Istomowa, T. S., *Z. ges. exptl. Med.*, **52**, 140 (1926).
1390. Itoh, R., *J. Biochem. (Japan)*, **22**, 139 (1935).
1391. Itoh, R., *ibid.*, **23**, 125 (1935).
1392. Itoh, T., *Beitr. path. Anat. u. allgem. Path.*, **86**, 498 (1931).
1393. Itoh, T., *ibid.*, **89**, 513 (1932).
1394. Ivens, W. H. J. and J. H. van Vollenhofen, *Nederland. Tijdschr. Geneesk.*, **69**, 44 (1925).
1395. Iwao, C. and H. Nakamura, *Japan. J. Gastroenterol.*, **3**, 43 (1929).
1396. Jacob, A., *Klin. Wochschr.*, **18**, 507, 1024 (1939).
1397. Jacobi, M., R. Finkelstein, and R. Kurlen, *Arch. Internal Med.*, **47**, 759 (1931).
1398. Jacobsen, E., *Acta Physiol. Scand.*, **7**, 342 (1944).
1399. Jacobsen, E. and C. M. Plum, *ibid.*, **4**, 272, 280 (1942); **5**, 1 (1945).

1400. Jacobsen, E. and C. M. Plum, *ibid.*, 7, 168 (1944).
1401. Jacobson, B. M. and Y. Subbarow, *J. Clin. Invest.*, 16, 573 (1937).
1402. Jacobson, B. M. and Y. Subbarow, *J. Am. Med. Assoc.*, 116, 367 (1941).
1403. Jacobson, J., *Z. physiol. Chem.*, 16, 340 (1892).
1404. Jacobson, W., *J. Path. Bact.*, 49, 1 (1939).
1405. Jacobson, W. and D. M. Simpson, *Biochem. J.*, 40, 3, 9 (1946).
1406. Jacobson, W. and S. M. Williams, *J. Path. Bact.*, 57, 423 (1945).
1407. Jaffé, M., *Centr. med. Wiss.*, 6, 24 (1868).
1408. Jaffé, N., *ibid.*, 7, 177 (1869).
1409. James, W. O., *Ann. Rev. Biochem.*, 15, 417 (1946).
1410. James, W. O. and F. B. Hora, *Ann. Bot.*, N.S., 4, 107 (1940).
1411. Jayle, M. F., *Bull. soc. chim. biol.*, 21, 14 (1939).
- 1411a. Jayle, M. F., *ibid.*, 28, 63, 80 (1946).
1412. Jedlicka, V. and S. Varadi, *Z. klin. Med.*, 118, 286 (1931).
1413. Jendrassik, L. and R. H. Cleghorn, *Biochem. Z.*, 289, 1 (1936).
1414. Jendrassik, L. and A. v. Czike, *Deut. med. Wochschr.*, 54, 430 (1928).
1415. Jendrassik, L. and A. v. Czike, *Z. ges. expth. Med.*, 60, 554 (1928).
1416. Jendrassik, L. and P. Gróf, *Biochem. Z.*, 297, 81 (1938).
1417. Jenkins, C. E. and M. L. Thomson, *Brit. J. Exptl. Path.*, 18, 175 (1937); 19, 417 (1938).
1418. Johnson, C. H. and W. M. Bradley, *J. Infectious Diseases*, 57, 70 (1935).
1419. Johnson, F. H. and K. L. van Schouwenburg, *Nature*, 144, 634 (1939).
1420. Johnson, M. L., *J. exptl. Biol.*, 18, 266 (1942).
1421. Johnson, V. and W. Freeman, *Am. J. Physiol.*, 124, 466 (1938).
1422. Johnstone, K. I., *J. Path. Bact.*, 51, 59 (1940).
1423. Jolles, A., *Münch. med. Wochschr.*, 51, 2083 (1904).
1424. Jones, E. G., F. H. J. Figge, and J. M. Hundley, Jr., *Cancer Research*, 4, 472 (1944).
1425. Jonxis, J. H. P., *Biochem. J.*, 33, 1743 (1939).
1426. Jope, E. M. and J. R. P. O'Brien, *ibid.*, 39, 239 (1945).
1427. Jope, E. M., *Brit. J. Ind. Med.*, 3, 136 (1946).
1428. Jope, E. M., *private communication*.
1429. Jorpes, E., *Biochem. J.*, 26, 1488 (1932).
1430. Josephs, H. W., *J. Biol. Chem.*, 96, 559 (1932).
1431. Josephs, H. W., *Bull. Johns Hopkins Hosp.*, 56, 50 (1935).
1432. Josephs, H. W., *ibid.*, 65, 145 (1939).
1433. Josephs, H. W. and co-workers, *J. Clin. Invest.*, 17, 532 (1938).
1434. Josephs, H. W. and co-workers, *Bull. Johns Hopkins Hosp.*, 71, 84 (1942).
1435. Josephs, H. W. and P. Winocur, *ibid.*, 61, 75 (1937).
1436. Jowett, M. and J. H. Quastel, *Biochem. J.*, 27, 486 (1933).
1437. Jowett, M. and J. H. Quastel, *ibid.*, 28, 162 (1934).
1438. Jung, F., *Arch. exptl. Path. Pharmakol.*, 192, 464 (1939).
1439. Jung, F., *ibid.*, 194, 16 (1939).
1440. Jung, F., *Naturwissenschaften*, 27, 318 (1939).
1441. Jung, F., *ibid.*, 28, 264 (1940).
1442. Jung, F., *Biochem. Z.*, 304, 37 (1940).
1443. Jung, F., *ibid.*, 305, 248 (1940).
1444. Jung, F., *Klin. Wochschr.*, 19, 1016 (1940).
1445. Jung, F., *Naturwissenschaften*, 30, 472 (1942).
1446. Junowicz-Kocholatry, R. and T. R. Hogness, *J. Biol. Chem.*, 129, 569 (1939).
1447. Junowicz-Kocholatry, R. and T. R. Hogness, *ibid.*, 131, 187 (1939).

1448. Kämmerer, H., *Arch. exptl. Path. Pharmacol.*, **88**, 247 (1920).
 1449. Kämmerer, H., *Deut. Arch. klin. Med.*, **145**, 257 (1924).
 1450. Kämmerer, H., *Klin. Wochschr.*, **3**, 724 (1924).
 1451. Kämmerer, H., *Verhandl. deut. Ges. inn. Med.* **45**, 28 (1933).
 1452. Kämmerer, H., *ibid.*, **45**, 338 (1933).
 1453. Kämmerer, H. and K. Miller, *Wien. klin. Wochschr.*, **35**, 640 (1922).
 1454. Kämmerer, H. and K. Miller, *Deut. Arch. klin. Med.*, **141**, 318 (1923).
 1455. Kämmerer, H. and H. Weisbecker, *Arch. exptl. Path. Pharmacol.*, **111**, 263 (1925).
 1456. Kaiser, E., *Biochem. Z.*, **192**, 58 (1928).
 1457. Kalk, H., *Deut. med. Wochschr.*, **58**, 1078, 1119, 1160 (1932).
 1458. Kallner, S., *J. Physiol. (London)*, **104**, 6 (1945).
 1459a. Kallner, S., *Acta Med. Scand.*, Suppl. **130**, 1 (1942).
 1459. Kalmus, E., *Z. physiol. Chem.*, **70**, 217 (1910).
 1460. Kalnitsky, G., M. F. Utter, and C. H. Werkman, *J. Bact.*, **49**, 595 (1945).
 1461. Kalnitsky, G. and C. H. Werkman, *Arch. Biochem.*, **2**, 113 (1943).
 1462. Kanasaki, K., *Japan. J. Gastroenterol.*, **5**, 91 (1933).
 1463. Kane, J. J., *Ulster Med. J.*, **6**, 144 (1937).
 1464. Kapp, E. M., *Brit. J. Exptl. Path.*, **20**, 33 (1939).
 1465. Kapp, E. M. and A. F. Coburn, *ibid.*, **17**, 255 (1936).
 1466. Kapsinov, R., L. P. Engle, and S. C. Harvey, *Surg. Gynecol. Obstet.*, **39**, 62 (1924).
 1467. Karczag, L., *Deut. med. Wochschr.*, **62**, 969 (1936).
 1468. Kark, R. and A. P. Meiklejohn, *J. Clin. Invest.*, **21**, 91 (1942).
 1469. Karrer, P., H. v. Euler, and H. Hellström, *Arkiv Kemi Mineral. Geol.*, **11B**, No. 6 (1933).
 1470. Karush, F., *J. Biol. Chem.*, **140**, lxvi (1941).
 1471. Kassan, R. J. and J. H. Roe, *J. Biol. Chem.*, **133**, 579 (1940).
 1472. Kato, K. and V. Iob, *Am. J. Clin. Path.*, **10**, 751 (1940).
 1473. Keefe, C. S. and C. S. Yang, *J. Am. Med. Assoc.*, **93**, 575 (1929).
 1474. Keilin, D., *Proc. Roy. Soc. London*, **98B**, 312 (1925).
 1475. Keilin, D., *ibid.*, **100B**, 129 (1926).
 1476. Keilin, D., *ibid.*, **104B**, 206 (1929).
 1477. Keilin, D., *ibid.*, **106B**, 418 (1930).
 1478. Keilin, D., *ibid.*, **113B**, 393 (1933).
 1479. Keilin, D., *Ergeb. Enzymforsch.*, **2**, 239 (1933).
 1480. Keilin, D., *Nature*, **132**, 783 (1933).
 1481. Keilin, D., *ibid.*, **133**, 290 (1934).
 1482. Keilin, D., *Proc. Roy. Soc. London*, **121B**, 165 (1936).
 1483. Keilin, D., *Parasitology*, **36**, 1 (1944).
 1484. Keilin, D. and C. H. Harpley, *Biochem. J.*, **35**, 688 (1934).
 1485. Keilin, D. and E. F. Hartree, *Proc. Roy. Soc. London*, **117B**, 1 (1935).
 1486. Keilin, D. and E. F. Hartree, *ibid.*, **119B**, 141 (1936).
 1487. Keilin, D. and E. F. Hartree, *ibid.*, **121B**, 173 (1936).
 1488. Keilin, D. and E. F. Hartree, *ibid.*, **122B**, 298 (1937).
 1489. Keilin, D. and E. F. Hartree, *Nature*, **139**, 548 (1937).
 1490. Keilin, D. and E. F. Hartree, *Proc. Roy. Soc. London*, **124B**, 397 (1938).
 1491. Keilin, D. and E. F. Hartree, *ibid.*, **125B**, 171 (1938).
 1492. Keilin, D. and E. F. Hartree, *Nature*, **141**, 870 (1938).
 1493. Keilin, D. and E. F. Hartree, *Proc. Roy. Soc. London*, **127B**, 167 (1939).
 1494. Keilin, D. and E. F. Hartree, *ibid.*, **129B**, 277 (1940).
 1495. Keilin, D. and E. F. Hartree, *Nature*, **148**, 75 (1941).
 1496. Keilin, D. and E. F. Hartree, *ibid.*, **151**, 390 (1943).

1497. Keilin, D. and E. F. Hartree, *ibid.* **152**, 626 (1943).
 1498. Keilin, D. and E. F. Hartree, *ibid.*, **157**, 210 (1945).
 1499. Keilin, D. and E. F. Hartree, *Biochem. J.*, **39**, 148 (1945).
 1500. Keilin, D. and E. F. Hartree, *ibid.*, **39**, 289 (1945).
 1501. Keilin, D. and E. F. Hartree, *ibid.*, **39**, 293 (1945).
 1501a. Keilin, D. and E. F. Hartree, *ibid.*, **41**, 500 (1947).
 1501b. Keilin, D. and E. F. Hartree, *ibid.*, **41**, 503 (1947).
 1502. Keilin, D. and T. Mann, *Proc. Roy. Soc. London*, **122B**, 119 (1937).
 1502a. Keilin, D. and J. D. Smith, *Nature*, **159**, 692 (1947).
 1503. Keilin, D. and Y. L. Wang, *Nature*, **155**, 227 (1945).
 1503a. Keilin, D. and Y. L. Wang, *Biochem. J.*, **40**, 855 (1946).
 1504. Keilin, J., *Biochem.*, **37**, 281 (1943); *Nature*, **154**, 20 (1944).
 1505. Keller, Ch. J. and K. A. Seggel, *Folia Haematol.*, **52**, 241 (1934)..
 1506. Kellie, A. E. and S. S. Zilva, *Biochem. J.* **29**, 1028 (1935).
 1507. Kempner, W., *Biochem. Z.*, **257**, 41 (1933).
 1508. Kempner, W., *Plant Physiol.*, **11**, 605 (1936).
 1509. Kempner, W., *J. Cell. Comp. Physiol.*, **10**, 339 (1937).
 1510. Kempner, W., *Am. J. Tuberculosis*, **2**, 157 (1939).
 1511. Kempner, W., *Cold Spring Harbor Symposia on Quantitative Biology*, **7**, 269 (1939).
 1512. Kempner, W. and M. Gaffron, *Am. J. Physiol.*, **126**, 553 (1939).
 1513. Kempner, W. and F. Kubowitz, *Biochem. Z.*, **265**, 245 (1933).
 1514. Kench, J. E., *Nature*, **154**, 117 (1944).
 1515. Kench, J. E., A. E. Gillam, and R. E. Lane, *Biochem. J.*, **36**, 384 (1942).
 1516. Kench, J. E. and J. F. Wilkinson, *Nature*, **155**, 579 (1945); *Biochem. J.*, **40**, 660 (1946).
 1517. Kennedy, R. P., *Am. J. Physiol.*, **78**, 56 (1926).
 1518. Kennedy, R. P., *ibid.*, **79**, 346 (1927).
 1519. Kensler, C. J., S. O. Dexter, and C. P. Rhoads, *Cancer Research*, **2**, 1 (1942).
 1520. Kestner, O., *Chemie d. Eiweisskorper*, 4th ed., Vieweg, Braunschweig, (1925).
 1521. Keston, A. S., *J. Biol. Chem.* **153**, 335 (1944).
 1522. Keszytis, L. and M. Kiese, *Klin. Wochschr.*, **22**, 746 (1943).
 1522a. Keszytis, L. and V. Vartéresz, *Z. Immunitätsforsch.*, **105**, 383 (1945).
 1523. Key, J. A., *Arch. Internal Med.*, **28**, 511 (1921).
 1523a. Keys, A. and J. Brugsch, *J. Am. Chem. Soc.*, **60**, 2135 (1938).
 1524. Kiese, M., *Klin. Wochschr.*, **21**, 565 (1942).
 1525. Kiese, M., *Naturwissenschaften*, **30**, 587 (1942).
 1526. Kiese, M., *Biochem. Z.*, **316**, 264 (1943).
 1526a. Kiese, M., *Arch. expl. Path. Pharmacol.*, **204**, 385 (1947).
 1526b. Kiese, M., *ibid.*, **204**, 439 (1947).
 1527. Kiese, M. and H. Kaeske, *Biochem. Z.*, **312**, 121 (1942).
 1528. Kiese, M., E. Savini, and W. Schwartzkopf, *ibid.*, **317**, 32 (1944).
 1528a. Kiese, M. and W. Schwartzkopf, *Arch. expl. Path. Pharmacol.*, **204**, 267 (1947).
 1529. Kiese, M. and L. Seipelt, *ibid.*, **200**, 648 (1943).
 1530. Kiese, M. and B. Weiss, *ibid.*, **202**, 493 (1943).
 1530a. Kiese, M. and co-workers, *Klin. Wochschr.*, **24-25**, 81 (1946).
 1530b. Kiese, M. and co-workers, *Arch. expl. Path. Pharmacol.*, **204**, 267, 288, 451 (1947).
 1531. Killick, E. M., *J. Physiol.*, **91**, 279 (1937).
 1532. Killick, E. M., *Physiol. Revs.* **20**, 313 (1940).

1533. Kim, M. S., *J. Lab. Clin. Med.*, **17**, 1223 (1932).
1534. King, A., *Ann. Repts. on Progress, Chem. Soc. London*, 1933, 178; 1934, 226.
- 1534a. King, E. J., *Brit. Med. J.*, **II**, 1947, 349.
- 1534b. King, E. J. and co-workers, *Lancet*, **II**, 1947, 789.
1535. King, E. J. and G. E. Delory, *Biochem. J.* **39**, 111 (1945).
1536. King, E. J., M. Gilchrist, and G. E. Delory, *Lancet*, **246**, 239 (1944).
1537. King, E. J., M. Gilchrist, and A. Matheson, *Brit. Med. J.*, **I**, 1944, 250.
- 1537a. King, E. J., J. C. White, and M. Gilchrist, *J. Path. Bact.*, **59**, 181 (1947).
1538. Kirkman, N. F., *J. Physiol.*, **95**, 508 (1939).
1539. Kirrmann, A., *Bull. soc. chim. biol.*, **12**, 1146 (1930).
1540. Kirstahler, A., *Tabulae Biologicae*, **1**, 48 (1931).
1541. Kisch, B., *Biochem. Z.*, **263**, 75 (1933).
1542. Kitasato, Z., *Acta Phytochim. (Japan)*, **2**, 75 (1925).
1543. Klebs, *Centr. med. Wiss.*, **6**, 417 (1868).
1544. Klein, J. R., *Arch. Biochem.*, **8**, 421 (1945).
1545. Klemm, L. and W. Klemm, *J. prakt. Chem.*, **143**, 82 (1935).
1546. Klemm, W., *Angew. Chem.*, **48**, 617 (1935).
1547. Kletzien, S. W., *J. Nutrition*, **9**, suppl. 9 (1935); **15**, suppl. 16 (1938); **19**, 187 (1940).
1548. Klingmüller, K., *Z. ges. exptl. Med.*, **103**, 106 (1938).
1549. Klodt, W., *Klin. Wochschr.*, **15**, 1637 (1936); *Z. ges. exptl. Med.*, **99**, 738 (1936).
1550. Klumpp, T. G., *J. Clin. Invest.* **14**, 351 (1935).
1551. Klüver, H., *Science*, **99**, 482 (1944).
1552. Klüver, H., *J. Psychol.*, **17**, 209 (1944).
1553. Knall, W., *Folia Haematol.*, **44**, 310 (1931).
1554. Knisely, M. H., *Anat. Record*, **65**, 23, 131 (1936).
1555. Knorr, H. and H. Albers, *J. Chem. Phys.*, **4**, 422 (1936).
1556. Knorr, H. and H. Albers, *ibid.*, **9**, 197 (1941).
1557. Knutti, R. E., W. B. Hawkins, and G. H. Whipple, *J. Exptl. Med.*, **61**, 127 (1935). See also reference 1584 on page 691.
1558. Kobert, R., *Arch. Gen. Physiol.*, **82**, 603 (1900).
1559. Kodzuka, T., *Tohoku J. Exptl. Med.*, **2**, 287 (1921).
1560. Kögl, F., in G. Klein, *Handbuch der Pflanzenanalyse*, Bd. III, Springer, Berlin, 1932, p. 1443.
1561. Körber, E., *doctoral dissertation*, Dorpat, 1866.
1562. Köhler, G. O., C. A. Elvehjem, and E. B. Hart, *J. Biol. Chem.*, **128**, 501 (1939).
- 1562a. Königsdörffer, H., *Strahlentherapie*, **28**, 132 (1928).
1563. Kohls, C. L., *Anat. Record*, **52**, 62 (1932).
1564. Kohn, H. I. and W. J. Dann, *Am. J. Physiol.*, **126**, 557 (1939).
1565. Kohn, H. I. and J. R. Klein, *J. Biol. Chem.*, **130**, 1 (1939); **135**, 685 (1940).
1566. Koller, F., *Schweiz. med. Wochschr.*, **69**, 1159 (1939).
1567. Komori, Y. and C. Iwao, *J. Biochem. (Japan)*, **8**, 195 (1927).
1568. Komori, Y., C. Iwao, and H. Nakamura, *ibid.*, **10**, 11 (1929).
1569. Kornberg, A., F. S. Daft, and W. H. Sebrell, *Science*, **98**, 20 (1943).
1570. Kornberg, A., H. Tabor, and W. H. Sebrell, *Am. J. Physiol.*, **142**, 604 (1944); **143**, 434 (1945).
1571. Kornberg, A., H. Tabor, and W. H. Sebrell, *ibid.*, **145**, 54 (1945).
1572. Korr, I. M., *Cold Spring Harbor Symposia Quant. Biol.*, **7**, 74, 120 (1934).
1573. Koster, H., *Beitr. path. Anat. u. allgem. Path.*, **100**, 100 (1937).
1574. Kotake, Y., *Folia Endocrinol. Japon.*, **17**, 2, 3 (1941).
1575. Krahl, M. E., A. K. Keltch, and G. H. A. Clowes, *J. Biol. Chem.*, **136**, 563 (1940).

1576. Krahl, M. E., A. K. Keltch, C. E. Neubeck, and G. H. A. Clowes, *J. Gen. Physiol.*, **24**, 597 (1941).
1577. Krall, W., *Folia Haematol.*, **44**, 310 (1931).
1578. Krebs, H., *Biochem. Z.*, **193**, 347 (1928).
1579. Krebs, H., *ibid.*, **204**, 322 (1929).
1580. Krogh, A. and I. Leitch, *J. Physiol. (London)*, **52**, 288 (1919).
1581. Krüger, F. v., *Z. Biol.*, **24**, 318 (1888).
1582. Krüger, F. v., *Z. ges. exptl. Med.*, **54**, 653 (1927).
1583. Krüger, F. v. and H. Bischoff, *Ber. ges. Physiol. exptl. Path.*, **32**, 696 (1925).
1584. Knutti, R. E., W. B. Hawkins, and G. H. Whipple, *J. Exptl. Med.*, **61**, 127 (1935).
1585. Krukenberg, C., *Vergleichende physiologische Studien*, Heidelberg (1880, 1882).
1586. Krukenberg, C., *Centr. med. Wiss.*, **21**, 785 (1889).
1587. Krukenberg, C., *Verhandl. Wurzluriger phys. med. Ges.*, **17**, 109 (1883).
1588. Krupski, A. and F. Almasy, *Biochem. Z.*, **279**, 424 (1935).
1589. Kubo, H., *Acta Phytochim. (Japan)*, **11**, 195 (1939).
1590. Kubowitz, F., *Biochem. Z.*, **274**, 285 (1934).
1591. Kubowitz, F., *ibid.*, **282**, 277 (1935).
1592. Kubowitz, F. and E. Haas, *ibid.*, **255**, 247 (1932).
1593. Kühl, S., *Arch. exper. Path. Pharmokol.*, **103**, 247 (1924).
1594. Kühling, G., *Klin. Wochschr.*, **16**, 1503 (1937).
1595. Kühne, W., *Arch. Path. Anat. Physiol. (Virchow's)*, **14**, 310 (1858).
1596. Küster, W., *Ber.*, **45**, 1945 (1912).
1597. Küster, W., *Arch. Pharm.*, **253**, 457 (1915).
1598. Küster, W., *Z. physiol. Chem.*, **94**, 136 (1915).
1599. Küster, W., *ibid.*, **99**, 86 (1917).
1600. Küster, W., *ibid.*, **109**, 117 (1920).
1601. Küster, W., in *Handb. d. biol. Arbeitsmeth.*, Abt. I, Teil VIII, 200 (1921).
1602. Küster, W., in *ibid.*, Abt. I, Teil II, 335 (1921).
1603. Küster, W., *Z. physiol. Chem.*, **121**, 80 (1922).
1604. Küster, W., *ibid.*, **138**, 21 (1924).
1605. Küster, W., *Z. angew. Chem.*, **37**, 200 (1924).
1606. Küster, W., *Z. physiol. Chem.*, **141**, 40 (1924).
1607. Küster, W., *ibid.*, **149**, 30 (1925).
1608. Küster, W., *ibid.*, **149**, 452 (1925).
1609. Küster, W. and H. Deihle, *ibid.*, **82**, 463 (1913).
1610. Küster, W. and R. Haas, *ibid.*, **141**, 279 (1924).
1611. Küster, W. and G. F. Koppenhöfer, *ibid.*, **170**, 106 (1927).
1612. Küster, W., K. Reihling, and R. Schmiedel, *ibid.*, **91**, 58 (1914).
1613. Kützing, F. T., *Phycologia Generalis, oder Anatomie, Physiologie und Systemkunde der Tange*, 1843, p. 20.
1614. Kuhn, R. and L. Brann, *Ber.*, **59B**, 2370 (1926).
1615. Kuhn, R. and L. Brann, *Z. physiol. Chem.*, **168**, 27 (1927).
1616. Kuhn, R., D. B. Hand, and M. Florkin, *ibid.*, **201**, 255 (1931); *Naturwissenschaften*, **19**, 771 (1931).
1617. Kuhn, R. and K. Meyer, *ibid.*, **16**, 1023 (1928).
1618. Kuhn, R. and K. Meyer, *Z. physiol. Chem.*, **185**, 193 (1929).
1619. Kuhn, R., N. A. Soerehsen, and L. Birkofer, *Ber.*, **73B**, 823 (1940).
1620. Kuhn, R. and A. Wassermann, *ibid.*, **61B**, 1550 (1928).
1621. Kuhn, R. and A. Wassermann, *Ann.*, **503**, 203 (1933).
1622. Kuhn, W., *Z. physik. Chem.*, **161A**, 1 (1932).
1623. Kunde, "De hepatis ranarum extirpatione," *dissertation*, Berlin, 1850.
1624. Kursanov, A. L. and N. N. Kryukova, *Biokhimiya*, **10**, 97 (1945).

1625. Kylin, H., *Z. physiol. Chem.*, **69**, 169 (1910).
1626. Kylin, H., *ibid.*, **74**, 105 (1911).
1627. Kylin, H., *ibid.*, **76**, 396 (1912).
1628. Kylin, H., *ibid.*, **197**, 1 (1931).
1629. Laemmer, M. and J. Beck, *Compt. rend. soc. biol.*, **113**, 166 (1933).
1630. Lageder, K., *Arch. Verdauungs-Krankh.*, **56**, 237 (1934).
1631. Lageder, K., *Klin. Wochschr.*, **15**, 296 (1936).
1632. Laidlaw, P. P., *J. Physiol.*, **31**, 464 (1904).
1633. van Lair, C. F. and J. B. Masius, *Centr. med. Wiss.*, **9**, 369 (1871).
1634. Laki, K., *Z. physiol. Chem.*, **254**, 27 (1938).
1634a. Lalich, J. J., *J. Exptl. Med.*, **86**, 153 (1947).
1635. Lamb, J. and E. A. H. Roberts, *Nature*, **144**, 867 (1939).
1636. La Mer, V. K., *Science*, **86**, 614 (1937).
1637. Lamm, O. and A. Polson, *Biochem. J.*, **30**, 528 (1936).
1638. Landsteiner, K., L. G. Longworth, and J. van der Sheer, *Science*, **88**, 83 (1938).
1639. Lang, K., *Arch. exptl. Path. Pharmacol.*, **174**, 63 (1934).
1640. de Langen, C. D. and W. Grotepass, *Acta Med. Scand.*, **97**, 29 (1938).
1641. de Langen, C. D. and W. Grotepass, *ibid.*, **106**, 168 (1941).
1642. Langenbeck, W., *Naturwissenschaften*, **20**, 124 (1932).
1643. Langenbeck, W., *Ber.*, **65B**, 842 (1932).
1644. Langenbeck, W., R. Hutschenreuter, and W. Rottig, *ibid.*, **65B**, 1750 (1932).
1645. Langhans, Th., *Arch. path. Anat. Physiol. (Virchow's)*, **49**, 66 (1870).
1646. Lankester, E. Ray, *J. Anat. Physiol.*, **2**, 114 (1867); **3**, 119 (1870).
1647. Lankester, E. Ray, *Arch. ges. Physiol. (Pflügers)*, **4**, 315 (1871).
1648. Laporta, M., *Arch. sci. biol. Italy*, **16**, 198 (1931).
1649. Laporta, M., *Australian J. Exptl. Biol. Med. Sci.*, **9**, 69 (1932).
1650. Larson, E. A. and G. T. Evans, *J. Lab. Clin. Med.*, **30**, 384 (1945).
1651. Lascelles, J. and J. L. Still, *Australian J. Exptl. Biol. Med. Sci.*, **24**, 37 (1946).
1652. Laser, H., *Nature*, **136**, 184 (1935).
1653. Laser, H., *Biochem. J.*, **31**, 1671 (1937).
1654. Laser, H., *ibid.*, **31**, 1677 (1937).
1655. Laser, H., *ibid.*, **38**, 333 (1945).
1656. Laser, H., *Nature*, **157**, 301 (1946).
1657. Laskowski, M. and J. B. Sumner, *Science*, **94**, 615 (1942).
1658. Latta, J. S. and J. W. Henderson, *Folia Haematol.*, **57**, 206 (1937).
1659. Lauda, E., *Die normale u. pathol. Physiologie d. Milz*, Urban & Schwarzenberg, Berlin, 1933.
1660. Laufberger, M., *Bull. soc. chim. biol.*, **19**, 1375 (1937).
1661. Lavier, G., *Compt. rend. soc. biol.*, **124**, 1206 (1937).
1662. Lavin, G. I., C. L. Hoaglund, and S. M. Ward, *Proc. Soc. Exptl. Biol. Med.*, **43**, 757 (1940).
1663. Lederer, E. and Ch. Hutterer, *Trav. membres soc. chim. biol.*, **24**, 1055 (1942).
1664. Lederer, E., G. Teissier, and C. Hutterer, *Bull. soc. chim.*, **7**, 603 (1940).
1665. Lee, S. B., J. B. Wilson, and P. W. Wilson, *J. Biol. Chem.*, **144**, 273 (1942).
1666. Legge, J. W., *J. Proc. Roy. Soc. N. S. Wales*, **76**, 47 (1942).
1667. Legge, J. W., *unpublished experiments*.
1668. Legge, J. W. and R. Lemberg, *Biochem. J.*, **35**, 353 (1941).
1668a. Legge, J. W., P. Nicholson, and F. J. W. Roughton, *unpublished experiments*.
1669. Leitch, I., *J. Physiol.*, **50**, 370 (1916).
1670. Lemberg, R., *Ann.*, **461**, 46 (1928).

1671. Lemberg, R., *Naturwissenschaften*, **17**, 541, 878 (1929).
1672. Lemberg, R., *Biochem. Z.*, **219**, 255 (1930).
1673. Lemberg, R., *Ann.*, **477**, 195 (1930).
1674. Lemberg, R., *ibid.*, **488**, 74 (1931).
1675. Lemberg, R., *Z. physiol. Chem.*, **200**, 173 (1931).
1676. Lemberg, R., *Ann.*, **499**, 25 (1932).
1677. Lemberg, R., *Nature*, **134**, 422 (1934).
1678. Lemberg, R., *J. Soc. Chem. Ind. London*, **53**, 179 (1934).
1679. Lemberg, R., *ibid.*, **53**, 1024 (1934).
1680. Lemberg, R., *Biochem. J.*, **28**, 978 (1934).
1681. Lemberg, R., *ibid.*, **29**, 1322 (1935).
1682. Lemberg, R., "The disintegration of haemoglobin in the animal body," *Perspectives in Biochemistry*, Cambridge Univ. Press, London, 1937.
1683. Lemberg, R., *Ann. Rev. Biochem.*, **7**, 421 (1938).
1684. Lemberg, R., *Australian Chem. Inst. J. & Proc.*, **6**, 170 (1939).
1685. Lemberg, R., *Rept. Australian & New Zealand Assoc. Advance. Sci.*, **24**, 303 (1939).
1686. Lemberg, R., *Australian J. Exptl. Biol. Med. Sci.*, **20**, 111 (1942).
1687. Lemberg, R., *ibid.*, **21**, 239 (1943).
1687a. Lemberg, R., *Nature*, **163**, 97 (1949).
1688. Lemberg, R., *unpublished experiments*.
1689. Lemberg, R. and G. Bader, *Naturwissenschaften*, **21**, 206 (1933).
1690. Lemberg, R. and G. Bader, *Ann.*, **505**, 151 (1933).
1691. Lemberg, R. and J. Barcroft, *Proc. Roy. Soc. London*, **110B**, 362 (1932).
1692. Lemberg, R., J. Barcroft, and D. Keilin, *Nature*, **128**, 967 (1931).
1693. Lemberg, R. and J. P. Callaghan, *Australian J. Exptl. Biol. Med. Sci.*, **23**, **1**, 6, 13 (1945).
1694. Lemberg, R. and J. P. Callaghan, *unpublished experiments*.
1695. Lemberg, R., B. Cortis-Jones, and M. Norrie, *Nature*, **139**, 1016 (1937).
1696. Lemberg, R., B. Cortis-Jones, and M. Norrie, *ibid.*, **140**, 65 (1937).
1697. Lemberg, R., B. Cortis-Jones, and M. Norrie, *Biochem. J.*, **32**, 149 (1938).
1698. Lemberg, R., B. Cortis-Jones, and M. Norrie, *ibid.*, **32**, 171 (1938).
1698a. Lemberg, R. and E. C. Foulkes, *Nature*, **161**, 131 (1948).
1699. Lemberg, R. and E. C. Foulkes, *unpublished experiments*.
1700. Lemberg, R. and N. E. Goldsworthy, *unpublished experiments*.
1701. Lemberg, R., H. F. Holden, J. W. Legge, and W. H. Lockwood, *Australian J. Exptl. Biol. Med. Sci.*, **20**, 161 (1942).
1702. Lemberg, R. and J. W. Legge, *J. Proc. Roy. Soc. N. S. Wales*, **72**, 62 (1938).
1703. Lemberg, R. and J. W. Legge, *Australian J. Exptl. Biol. Med. Sci.*, **18**, 95 (1940).
1704. Lemberg, R. and J. W. Legge, *ibid.*, **20**, 65 (1942).
1705. Lemberg, R. and J. W. Legge, *Biochem. J.*, **37**, 117 (1943).
1706. Lemberg, R. and J. W. Legge, *unpublished experiments*.
1707. Lemberg, R., J. W. Legge, and W. H. Lockwood, *Nature*, **142**, 148 (1938).
1708. Lemberg, R., J. W. Legge, and W. H. Lockwood, *Biochem. J.*, **33**, 754 (1939).
1709. Lemberg, R., J. W. Legge, and W. H. Lockwood, *ibid.*, **35**, 328 (1941).
1710. Lemberg, R., J. W. Legge, and W. H. Lockwood, *ibid.*, **35**, 339 (1941).
1711. Lemberg, R. and W. H. Lockwood, *J. Proc. Roy. Soc. N. S. Wales*, **72**, 69 (1938).
1712. Lemberg, R., W. H. Lockwood, and J. W. Legge, *Biochem. J.*, **35**, 363 (1941).
1713. Lemberg, R., W. H. Lockwood, and R. A. Wyndham, *Australian J. Exptl. Biol. Med. Sci.*, **16**, 169 (1938).
1714. Lemberg, R., M. Norrie, and J. W. Legge, *Nature*, **144**, 551 (1939).

1715. Lemberg, R. and R. A. Wyndham, *Biochem. J.*, **30**, 1147 (1936).
1716. Lemberg, R. and R. A. Wyndham, *J. Proc. Roy. Soc. N. S. Wales*, **70**, 343 (1937).
1717. Lepehne, G., *Beitr. path. Anat. u. allgem. Path.*, **64**, 55 (1917).
1718. Lepehne, G., *Folia Haematol.*, **39**, 277 (1930).
1719. Lepehne, G., *Deut. Arch. klin. Med.*, **132**, 96 (1920).
1720. Lerner, S. R. and I. L. Chaikoff, *Endocrinology*, **37**, 362 (1945).
1721. Leschke, E., *Deut. med. Wochschr.*, **47**, 376 (1921).
1722. Lester, D., *J. Pharmacol.*, **77**, 154 (1945).
- 1722a. Lester, L. and L. H. Greenberg, *J. Pharmacol. Exptl. Therap.*, **81**, 182 (1944).
1723. Levene, P. A. and R. Schormüller, *J. Biol. Chem.*, **93**, 571 (1931).
1724. Levi-Craillsheim, P., *Z. ges. exptl. Med.*, **32**, 468 (1923).
1725. Levy, L., *Z. physiol. Chem.*, **13**, 309 (1889).
1726. Lewin, L., *Compt. rend.*, **133**, 599 (1901).
1727. Lewis, P. S., *Biochem. J.*, **20**, 984 (1926).
1728. Lian, C., P. Frumusan, and M. Sassier, *Bull. mém. soc. méd. hôp. Paris*, **55**, 1194 (1939).
1729. Libet, B. and K. A. C. Elliott, *J. Biol. Chem.*, **152**, 613 (1933).
1730. Libowitzky, H., *Z. physiol. Chem.*, **263**, 267 (1940).
1731. Libowitzky, H., *ibid.*, **265**, 191 (1940).
1732. Libowitzky, H. and H. Fischer., *ibid.*, **255**, 209 (1938).
1733. Libowitzky, H. and K. F. Scheid, *Klin. Wochschr.*, **17**, 156 (1938).
1734. Lichtenstein, A., *Jahrb. Kinderheilk.*, **88**, 387 (1918).
1735. Lichtenstein, A. and A. J. L. Terwen, *Deut. Arch. klin. Med.*, **149**, 72 (1925).
1736. Lichtenstein, A. and A. J. L. Terwen, *ibid.*, **149**, 113 (1925).
1737. Lichty, J. A., Jr., W. H. Havill, and G. H. Whipple, *J. Exptl. Med.*, **55**, 603 (1932).
1738. Liébecq, C., *Bull. acad. roy. méd. Belg.*, **9**, 130 (1944).
- 1738a. Liébecq, C., "Conception actuelle du catabolisme de l'hémoglobine," *Actualités Biochimiques*, Vol. 7, Masson, Paris, 1946.
- 1738b. Liébecq, C. *Compt. rend. soc. biol.*, **140**, 561 (1946).
- 1738c. Liébecq, C. and co-workers, *Bull. soc. chim. biol.*, **29**, 52, 54, 71 (1947).
- 1738d. Liébecq, C. and J. Collette, *ibid.*, **28**, 523 (1946).
- 1738e. Liébecq, C. and J. Collette, *Compt. rend. soc. biol.*, **140**, 1171 (1946).
1739. Lieberkühn, N., *Arch. Anat. u. Physiol.*, **1889**, 196.
1740. Liebermann, C., *Ber.*, **11**, 606 (1878).
1741. Liebig, H., *Arch. exptl. Path. Pharmacol.*, **125**, 96 (1927).
1742. Liebson, R. G., I. I. Likhnitzky, and M. G. Sax, *J. Physiol.*, **87**, 97 (1936).
1743. Lignac, G. O. E., *Arch. path. Anat. Physiol. (Virchow's)*, **243**, 273 (1923).
1744. Lilienthal, J. L., Jr. and co-workers, *Am. J. Physiol.*, **145**, 351 (1946).
1745. Lind, C. J. and P. W. Wilson, *J. Am. Chem. Soc.*, **63**, 3511 (1941).
1746. Lind, C. J. and P. W. Wilson, *Arch. Biochem.*, **1**, 59 (1943).
1747. Linden, M. v., *Arch. ges. Physiol. (Pflüger's)*, **98**, 1 (1905).
1748. Lindenfeld, K., *Roczniki Chem.*, **11**, 532 (1931); **13**, 645, 660 (1933).
1749. Lindenfeld, K., *ibid.*, **15**, 516 (1935).
1750. Linossier, M. G., *Compt. rend. soc. biol.*, **50**, 373 (1898).
1751. Linstead, R. P., *J. Chem. Soc.*, **1934**, 1016.
1752. Lintzel, W., *Z. Biol.*, **83**, 289 (1925); **87**, 97 (1928).
1753. Lintzel, W., *Ergeb. Physiol.*, **31**, 844 (1931).
1754. Lintzel, W., *Biochem. Z.*, **263**, 173 (1933).
1755. Lintzel, W. and T. Radeff, *ibid.*, **203**, 212 (1928).
1756. Lipmann, F., *ibid.*, **206**, 171 (1929).
1757. Lipmann, F., *Nature*, **138**, 588 (1936).

1758. Lipmann, F., *Symposium on Respiratory Enzymes*, Univ. Wisconsin Press, 1942, p. 48.
1759. Lipmann, F., *J. Biol. Chem.*, **139**, 977 (1944).
1760. Lipmann, F. and C. R. Owen, *Science*, **98**, 246 (1934).
1761. Lipschitz, W., *Z. physiol. Chem.*, **109**, 189 (1920).
1762. Lipschitz, W. and J. Weber, *ibid.*, **132**, 251 (1924).
1763. List, P., *ibid.*, **135**, 95 (1924).
1764. Litarzyczek, G., H. Aubert, I. Cosmulesco, and B. Nestoresco, *Compt. rend. soc. biol.*, **107**, 111 (1931).
1765. Livingood, J. J. and G. T. Seaborg, *Phys. Rev.*, **54**, 51 (1938).
1766. Lloyd, T. W., "On the Etiology of Acholuric Familial Jaundice," *doctoral dissertation*, Oxford University, 1941
1767. Localio, S., S. Schwartz, and C. Gammon, *J. Clin. Invest.*, **20**, 7 (1941).
1768. Lockwood, J. S., A. F. Coburn, and H. E. Stokinger, *J. Am. Med. Assoc.*, **111**, 2259 (1938).
1769. Loeb, R. F., A. V. Bock, and R. Fitz, *Am. J. Med. Sci.* **161**, 539 (1921).
1770. Loebisch, W. F., and M. Fischler, *Sitzber. Akad. Wiss. Wien. Math. naturw. Klasse Abt. IIB*, **112**, 335 (1903).
1771. Löffler, W., *Biochem. Z.*, **98**, 105 (1919).
1772. Loew, O., *U. S. Dep. Agr. Repts.*, No. 68, 47 (1901).
1773. Löwit, M., *Beitr. z. path. Anat. u. allgem. Path.*, **4**, 225 (1889).
1774. Loewy, A. and co-workers, *Am. J. Physiol.*, **138**, 230 (1942).
1775. Lohmann, K., *Biochem. Z.*, **222**, 324 (1930).
1776. Lohmann, K. and O. Meyerhof, *ibid.*, **273**, 60 (1934).
1777. London, F. S. and L. J. Kryzanowskaja, *Z. physiol. Chem.*, **227**, 229 (1934).
- 1777a. London, I. M. and co-workers, *Federation Proc.*, **7**, 169 (1948).
1778. Longini, J., L. W. Freeman, and V. Johnson, *ibid.*, **1**, 51 (1942).
1779. Longini, J. and V. Johnson, *Am. J. Physiol.*, **140**, 349 (1943).
1780. van Loon, E. J. and B. B. Clark, *J. Lab. Clin. Med.*, **29**, 942 (1944).
1781. Lothian, F. G., *J. Soc. Chem. Ind. London*, **61**, 58 (1942).
- 1781a. Loutit, J. F. and P. L. Mollison, *J. Path. Bact.*, **58**, 711 (1946).
1782. Lowry, O. H. and A. B. Hastings, *J. Biol. Chem.*, **143**, 257 (1942).
1783. Lowry, O. H., C. A. Smith, and D. L. Cohen, *ibid.*, **146**, 519 (1942).
1784. Luzner, E. L., *New Engl. J. Med.*, **224**, 265 (1941).
1785. Lyubimenko, V. N., *Compt. rend.*, **181**, 730 (1925).
1786. Luckey, T. D. and co-workers, *Science*, **103**, 682 (1946).
1787. Lúdany, G. v. and F. Verzár, *Biochem. Z.*, **257**, 130 (1933).
1788. Lundegårdh, H., *Nature*, **157**, 575 (1946).
- 1788a. Lups, S. and F. G. D. Meijer, *Acta Med. Scand.*, **126**, 85 (1946); *Nederland. Tijdschr. Geneesk.*, **90**, 1445 (1946).
1789. Lwoff, A., *Compt. rend. soc. biol.*, **113**, 231 (1936); *ibid.*, **122**, 1041 (1936).
1790. Lwoff, A. and M. Lwoff, *Compt. rend.*, **204**, 1510 (1937).
1791. Lwoff, A. and M. Morel, *Ann. inst. Pasteur*, **68**, 323 (1942).
1792. Lwoff, A. and I. Pirovsky, *Compt. rend. soc. biol.*, **124**, 1169 (1937).
1793. Lwoff, M., *Compt. rend. soc. biol.*, **121**, 419 (1936); *Compt. rend.*, **206**, 540 (1938); *Ann. inst. Pasteur*, **51**, 55 (1933).
1794. Lyman, C. M. and E. S. G. Barron, *J. Biol. Chem.*, **121**, 275 (1937).
1795. Maass, À. R. and co-workers, *Arch. Biochem.*, **4**, 105 (1944).
1796. Macallum, A. B., *Ergeb. Physiol.*, **7**, 552, 579 (1908).
1797. McCance, R. A. and E. M. Widdowson, *Lancet II*, 1937, 680.
1798. McCance, R. A. and E. M. Widdowson, *J. Physiol.*, **94**, 148 (1938).
1799. McCance, R. A. and E. M. Widdowson, *Ann. Rev. Biochem.*, **13**, 315 (1944).

1800. McCarthy, E. F., *J. Physiol.*, **80**, 206 (1938).
1801. McCarthy, E. F., *ibid.*, **102**, 55 (1943).
1802. McCarthy, E. F., *Brit. Med. J.*, *II*, **1943**, 362.
1803. McCarthy, E. F. and G. Popjak, *Biochem. J.*, **37**, *Proc. Soc. XVIII* (1943).
1804. McCoy, R. H. and M. O. Schultze, *J. Biol. Chem.*, **156**, 479 (1944).
1805. McCullagh, E. P. and R. Jones, *Cleveland Clinic Quart.*, **8**, 79 (1941).
1806. McDonough, K. B. and D. R. Borgen, *J. Lab. Clin. Med.*, **22**, 819 (1937).
1807. McElroy, L. W. and co-workers, *Science*, **94**, 467 (1944).
1808. McEwen, W. K., *J. Am. Chem. Soc.*, **58**, 1124 (1936).
1809. McEwen, W. K., *J. Am. Chem. Soc.*, **68**, 711 (1946).
1810. McFarland, A. R. and W. H. Strain, *Arch. Dermatol. Syphilol.*, **38**, 727 (1938).
1811. MacFarlane, R. G. and J. R. P. O'Brien, *Brit. Med. J. I*, **1944**, 248.
1812. MacFarlane, W. D., *Biochem. J.*, **26**, 1034 (1932).
1813. MacFarlane, W. D., *J. Biol. Chem.*, **106**, 245 (1934).
1814. MacFarlane, W. D., *Biochem. J.*, **30**, 1472 (1936).
1815. MacFarlane, W. D. and R. C. McKenzie Hamilton, *Biochem. J.*, **26**, 1050 (1932).
1816. MacFarlane, W. D. and M. K. McPhail, *Am. J. Med. Sci.*, **193**, 385 (1937).
1817. McHargue, J. S., D. J. Healy, and E. S. Hill, *J. Biol. Chem.*, **78**, 637 (1923).
1818. Mackey, L. and A. E. Garrod, *Quart. J. Med.*, **19**, 357 (1926).
1819. McKibbin, J. M. and co-workers, *Am. J. Physiol.*, **128**, 102 (1939).
1820. McKibbin, J. M. and co-workers, *J. Biol. Chem.*, **145**, 107 (1942).
1821. McKibbin, J. M. and co-workers, *ibid.*, **142**, 77 (1942).
1822. McLeod, J. W. and J. Gordon, *Biochem. J.*, **16**, 499 (1922).
1823. McLeod, J. W. and J. Gordon, *J. Path. Bact.*, **26**, 326 (1923).
1824. McLeod, J. W. and J. Gordon, *ibid.*, **26**, 332 (1923).
1825. McLeod, J. W. and J. Gordon, *ibid.*, **28**, 147 (1925).
1826. McMaster, P. D., G. O. Broun, and P. Rous, *J. Exptl. Med.*, **37**, 395 (1923).
1827. McMaster, P. D. and R. Elman, *ibid.*, **41**, 513 (1925).
1828. McMaster, P. D. and R. Elman, *ibid.*, **41**, 719 (1925).
1829. McMaster, P. D. and R. Elman, *Ann. Internal Med.*, **1**, 68 (1927).
1830. MacMunn, C. A., *Proc. Roy. Soc. London*, **31**, 206 (1881).
1831. MacMunn, C. A., *Nature*, May 21st (1885).
1832. MacMunn, C. A., *Phil. Trans. Roy. Soc. London*, **176**, 641 (1885).
1833. MacMunn, C. A., *ibid.*, **176**, 661 (1885).
1834. MacMunn, C. A., *J. Physiol.*, **6**, 22 (1885).
1835. MacMunn, C. A., *ibid.*, **7**, 240 (1886).
1836. MacMunn, C. A., *Phil. Trans. Roy. Soc. London*, **177**, 267 (1886).
1837. MacMunn, C. A., *J. Physiol.*, **8**, 57 (1887).
1838. MacMunn, C. A., *Z. physiol. Chem.*, **13**, 497 (1889).
1839. MacMunn, C. A., *J. Physiol.*, **10**, 71 (1889).
1840. MacMunn, C. A., *Quart. J. Microscop. Sci.*, **25**, 469 (1885); **30**, 51 (1889).
1841. McNamara, H. and M. J. E. Senn, *Am. J. Diseases Children*, **59**, 97 (1940).
1842. McNee, J. W., *J. Path. Bact.*, **18**, 315 (1913).
1843. McNee, J. W., *Quart. J. Med.*, **16**, 390 (1922-3).
1844. McNee, J. W., *Brit. Med. J.*, *II*, **1924**, 495.
1845. McShan, W. H., R. K. Meyer, and D. R. Johansson, *Endocrinology*, **38**, 152 (1946).

1846. Maegraith, B. G., N. H. Martin, and G. M. Findlay, *Nature*, **151**, 252 (1943); *Brit. J. Exptl. Path.*, **24**, 58 (1943).
1847. Makino, J., *Beitr. path. Anat. u. allgem. Path.*, **72**, 808 (1924).
1848. Malan, A. I., *J. Agr. Sci.*, **18**, 397 (1923).
1849. Mallinckrodt-Haupt, A. St. v., *Radiologica Berlin*, **3**, 74 (1938).

1850. Mallinckrodt-Haupt, A. St. v., *Klin. Wochschr.*, **18**, 153 (1939).
1851. Malloy, H. T. and K. A. Evelyn, *J. Biol. Chem.*, **119**, 481 (1937).
1852. Malloy, H. T. and K. A. Evelyn, *ibid.*, **122**, 597 (1937).
1853. Maluf, N. S. R., *Quart. Rev. Biol.*, **14**, 149 (1939).
1854. Maly, R., *Centr. med. Wiss.*, **9**, 849 (1871).
1855. Maly, R., *Ann.*, **161**, 368 (1871).
1856. Maly, R.; *ibid.*, **163**, 77 (1872).
1857. Mann, F. C., L. J. Bollmann, and T. B. Magath, *Am. J. Physiol.*, **69**, 393 (1924).
1858. Mann, F. C. and co-workers, *ibid.*, **74**, 497 (1925).
1859. Mann, F. C. and co-workers, *ibid.*, **76**, 306 (1926).
1860. Mann, F. C. and T. B. Magath, *Ergeb. Physiol.*, **1**, 23, 212 (1924).
1861. Mann, F. C., Ch. Sheard, and L. J. Bollmann, *Am. J. Physiol.*, **74**, 749 (1925).
1862. Mann, P. J. G., *Biochem. J.*, **25**, 918 (1931).
1863. Mann, P. J. G., *ibid.*, **26**, 785 (1932).
1864. Mann, T., *ibid.*, **39**, 451 (1945).
1865. Mann, T. and D. Keilin, *Nature*, **146**, 164 (1938).
1866. Mann, T. and D. Keilin, *Proc. Roy. Soc. London*, **126B**, 303 (1938-9).
1867. Manwell, E. J. and G. H. Whipple, *Am. J. Physiol.*, **88**, 420 (1929).
1868. Marcela, I. and A. Seliskar, *J. Physiol.*, **60**, 428 (1925).
1869. Marcey, H. O. and J. Wyman, *J. Am. Chem. Soc.*, **64**, 638 (1942).
1870. Marks, G. W., *J. Biol. Chem.*, **115**, 299 (1936).
1871. Marsh, A. and D. R. Goddard, *Am. J. Botany*, **26**, 724 (1939).
1872. Marsh, A. and D. R. Goddard, *ibid.*, **26**, 767 (1939).
1873. Marsh, G. and I. Carlson, *J. Biol. Chem.*, **136**, 69 (1940); *Am. J. Physiol.*, **133**, 235 (1941).
1874. Marshall, E. K. and E. M. Walzl, *Bull. Johns Hopkins Hosp.*, **61**, 140 (1937).
1875. Marshall, F. H. A., *The Physiology of Reproduction*, Longmans, Green, London, 1922, pp. 440, 449.
1876. Marshall, W. and Ch. R. Marshall, *J. Biol. Chem.*, **158**, 187 (1945).
1877. Marston, H. R., *J. Council Sci. Ind. Research*, **8**, 111 (1935).
- 1877a. Martin, H. N., *Biochem. J.*, **42**, xv (1948).
1878. Martin, P. and B. Schuler, *Z. ges. exptl. Med.*, **83**, 1 (1932).
1879. Mason, H. L. and S. Nesbitt, *J. Biol. Chem.*, **152**, 19 (1944).
1880. Mason, R. D. and H. L. Mason, *Proc. Staff Meetings Mayo Clin.*, **16**, 493 (1941).
1881. Mason, V. R., *Arch. Internal Med.*, **72**, 471 (1943).
1882. Mason, V. R., C. B. Courville, and E. Ziskind, *Medicine*, **12**, 355 (1933).
1883. Matsuoka, Z. and S. Hirasawa, *Japan. Med. World*, **3**, 250 (1923).
1884. Matthes, K. M. and F. G. Gross, *Arch. exptl. Path. Pharmacol.*, **191**, 706 (1939).
1885. Maugeri, S., *C. A.*, **34**, 7377 (1940).
1886. Maugeri, S., *ibid.*, **36**, 3259 (1942).
1887. Maurer, H., *Abderhalden's Biochemisches Handlexikon*, **14**, Ergänzungsbd. 7, Springer, Berlin, 1933, p. 776.
1888. Maximow, A. in Möllendorf, *Handb. mikrosk. Anatomie*, Band 2, Springer, Berlin, 1927.
1889. Maximowitsch, S. M. and E. S. Awtonomova, *Z. physiol. Chem.*, **174**, 233 (1928).
1890. Mayer, R. M., *ibid.*, **177**, 47 (1928); **179**, 99 (1928).
1891. Maynard, L. A. and J. K. Loosli, *Ann. Rev. Biochem.*, **12**, 251 (1943).
1892. Mazza, F. P. and F. Penati, *Arch. sci. biol. Italy*, **23**, 443 (1937-38).
1893. Medical Research Council, *Brit. Med. J.*, **1**, 1943, 209.
1894. Medical Research Council, *Med. Research Council Brit. Special Rept. Ser. No.* **252** (1945).
1895. Meier, R., *Arch. exptl. Path. Pharmacol.*, **100**, 117, 241 (1923).

1896. Meissner, R., *Z. exptl. Path. Therap.*, **13**, 284 (1913).
1897. Melchior, E., F. Rosenthal, and H. Licht, *Arch. exptl. Path. Pharmacol.*, **107**, 238 (1925).
1898. Meldolesi, G., W. Siedel, and H. Möller, *Z. physiol. Chem.*, **259**, 137 (1939).
1899. Meldrum, N. U., *Biochem. J.*, **26**, 162 (1932).
1900. Meldrum, N. U., *ibid.*, **26**, 817 (1932).
1901. Meldrum, N. U. and M. Dixon, *ibid.*, **24**, 472 (1930).
1902. Meldrum, N. U. and H. L. A. Tarr, *ibid.*, **29**, 108 (1935).
- 1902a. Meldrum, N. U. and F. J. W. Roughton, *J. Physiol.*, **80**, 143 (1933).
1903. Mellgren, J., *ibid.*, **94**, 483 (1939).
1904. Mellon, R. R., A. P. Locke, and L. E. Shinn, *Am. J. Med. Sci.*, **199**, 749 (1940).
1905. Mellor, D. P. and D. P. Craig, *J. Proc. Roy. Soc. N. S. Wales*, **74**, 475 (1940).
1906. Mellor, D. P. and D. P. Craig, *ibid.*, **78**, 258 (1945); Mellor, D. P. and W. H. Lockwood, *ibid.*, **74**, 141 (1940).
1907. Melnick, J. L., *Science*, **94**, 118 (1941).
1908. Melnick, J. L., *J. Biol. Chem.*, **141**, 269 (1941).
1909. Melnick, J. L., *ibid.*, **146**, 385 (1942).
1910. Mendel, L. B. and H. C. Bradley, *Am. J. Physiol.*, **13**, 17 (1905); **17**, 167 (1906).
1911. Menshikov, F. K., *Klin. Med. U.S.S.R.*, **16**, No. 1, 55 (1938); *C. A.*, **34**, 5127 (1940).
1912. Merkelbach, O., *Schweiz. med. Wochschr.*, **65**, 1142 (1935).
1913. Mertens, E., "Farbstoffe des Serums" in H. Hirschfeld and H. Hittmair, *Handbuch der allgemeinen Hamatologie*, Band 2, Hälfte 2, Urban and Schwarzenberg, Berlin, 1934, p. 923.
1914. Mertens, E., *Z. physiol. Chem.*, **250**, 57 (1937).
1915. Mertens, E., *Klin. Wochschr.*, **16**, 61 (1937).
1916. Mertens, E., *ibid.*, **258**, I (1939).
1917. Metcalf, R. L., *Ann. Entomol. Soc. Am.*, **38**, 397 (1945).
1918. Metcalf, J., C. B. Favour, and F. J. Stare, *J. Clin. Invest.*, **24**, 82 (1945).
1919. Mettler, S. R. and W. B. Chew, *J. Exptl. Med.*, **55**, 971 (1932).
1920. Mettler, S. R., G. R. Minot, and W. C. Townsend, *J. Am. Med. Assoc.*, **95**, 1089 (1930).
1921. Metzger, W. and H. Fischer, *Ann.*, **527**, 1 (1936).
1922. Meulengracht, E., *Deut. Arch. klin. Med.*, **132**, 285 (1920).
1923. Meulengracht, E., *Acta Med. Scand.*, **58**, 594 (1923).
1924. Meyer, A. W. and L. M. McCormick, *Stanford Univ. Pubs. Univ. Ser. Med. Sci.*, **2**, No. 2, 199 (1928).
1925. Meyer, E. C. and H. Heinelt, *Deut. Arch. klin. Med.*, **142**, 94 (1923).
1926. Meyer, E. C. and H. Knüpfner, *ibid.*, **138**, 321 (1922).
1927. Meyer, K., *J. Biol. Chem.*, **103**, 25 (1933).
1928. Meyer, K., *ibid.*, **103**, 39 (1933).
1929. Meyer, K., *ibid.*, **103**, 807 (1933).
1930. Meyer, O. and co-workers, *Folia Haematol.*, **57**, 99 (1937).
- 1930a. Meyer, R. K. and co-workers, *Am. J. Physiol.*, **147**, 66 (1946).
1931. Meyer-Betz, F., *Deut. Arch. klin. Med.*, **112**, 476 (1913).
1932. Meyer-Betz, F., *Ergeb. inn. Med. u. Kinderheilk.*, **12**, 733 (1913).
- 1932a. Meyerhof, O., *Biochem. Z.*, **246**, 247 (1932).
1933. Meyerhof, O. and D. Burk, *Z. physiol. Chem.*, **139**, 117 (1928).
1934. Michaelis, L., *J. Biol. Chem.*, **84**, 777 (1929).
1935. Michaelis, L., *Chem. Revs.*, **16**, 243 (1935).
1936. Michaelis, L., Discussion remark, *Cold Spring Harbor Symposia Quant. Biol.*, **7**, 33. (1939).

- 1936a. Michaelis, L., *Arch. Biochem.*, **14**, 17 (1947).
1937. Michaelis, L., C. D. Coryell, and S. Granick, *J. Biol. Chem.*, **148**, 463 (1943).
1938. Michaelis, L. and S. Granick, *J. Gen. Physiol.*, **25**, 325 (1941).
1939. Michaelis, L. and H. Pechstein, *Biochem. Z.*, **53**, 320 (1913).
1940. Michaelis, L. and K. Salomon, *J. Gen. Physiol.*, **13**, 683 (1930).
1941. Michaelis, L. and K. Salomon, *Biochem. Z.*, **234**, 107 (1931).
1942. Michaelis, L. and C. V. Smythe, *Ann. Rev. Biochem.*, **7**, 1 (1938).
1943. Michaelis, M. and J. H. Quastel, *Biochem. J.*, **35**, 518 (1941).
1944. Michel, H. O., *J. Biol. Chem.*, **119**, lxi (1937).
1945. Michel, H. O., *ibid.*, **123**, lxxxv (1938); **126**, 323 (1938).
1946. Michel, H. O., *J. Lab. Clin. Med.*, **25**, 445 (1940).
1947. Michel, H. O. and J. S. Harris, *ibid.*, **25**, 445 (1940).
1948. Miller, D. K. and C. P. Rhoads, *Proc. Soc. Exptl. Biol. Med.*, **30**, 540 (1932).
1949. Miller, E. B., K. Singer, and W. Dameshek, *Arch. Internal Med.*, **70**, 722 (1942).
- 1949a. Miller, L. L. and E. L. Alling, *J. Exptl. Med.*, **85**, 55 (1947).
1950. Miller, L. L. and P. F. Hahn, *J. Biol. Chem.*, **134**, 585 (1940).
1951. Miller, L. L., F. S. Robschheit-Robbins, and G. H. Whipple, *J. Exptl. Med.*, **81**, 405 (1945).
1952. Millikan, G. A., *Proc. Roy. Soc. London*, **120B**, 366 (1936).
- 1952a. Millikan, G. A., *ibid.*, **155A**, 277 (1936).
1953. Millikan, G. A., *ibid.*, **123B**, 218 (1937).
1954. Millikan, G. A., *Physiol. Revs.*, **19**, 503 (1939).
1955. Mills, J. and C. A. Mason, *Lancet II*, **1938**, 1455.
1956. Milne-Edwards, H., *Ann. sci. nat.*, **10**, 212 (1938).
1957. Milroy, J. A., *J. Physiol.*, **38**, 384, 392 (1909).
1958. Minami, S., *Arch. path. Anat. Physiol. (Virchow's)*, **245**, 247 (1923).
1959. Minkowski, O. and B. Naumyn, *Arch. exptl. Path. Pharmacol.*, **21**, 1 (1886).
1960. Minot, G. R., in *Symposium on the Blood and Blood-Forming Organs*, Univ. Wisconsin Press, Madison, 1939, p. 52.
1961. Minot, G. R. and W. B. Castle, *Lancet II*, **1935**, 319.
1962. Minot, G. R. and C. W. Heath, *J. Am. Med. Sci.*, **183**, 116 (1932).
1963. Mirsky, A. E. and M. L. Anson, *J. Gen. Physiol.*, **19**, 439 (1936).
1964. Mirsky, A. E. and L. Pauling, *Proc. Natl. Acad. Sci. U. S.*, **22**, 439 (1936).
1965. Moeller, K. O., *Skand. Arch. Physiol.*, **73**, 267 (1936).
1966. Mollerstrom, J., *Compt. rend. soc. biol.*, **98**, 1361 (1928).
1967. Moeschlin, S., *Folia Haematol.*, **65**, 345 (1941).
1968. Moitessier, I. de, *Compt. rend. soc. biol.*, **56**, 373 (1904).
1969. Mole, R. H., *J. Physiol.*, **104**, 1 (1945).
1970. Moleschott, *Arch. Physiol. Heilk.*, **11**, 479 (1852).
1971. Molisch, H., *Botan. Ztg.*, **52**, 179 (1894).
1972. Molisch, H., *ibid.*, **53**, 131 (1895).
1973. Molisch, H., *Sitzber. Akad. Wiss. Wien. Math. naturw. Klasse, Abt. I*, **115**, 795 (1906).
1974. Mollison, P. L. and I. M. Young, *Quart. J. Exptl. Physiol.*, **30**, 313 (1940).
1975. Mollison, P. L. and I. M. Young, *ibid.*, **31**, 359 (1942).
1976. Monaghan, B. R. and F. D. Schmitt, *Proc. Soc. Exptl. Biol. Med.*, **28**, 705 (1931).
1977. Monke, J. V. and Ch. L. Yuile, *J. Exptl. Med.*, **72**, 149 (1940).
1978. Montfort, C., *Jahrb. wiss. Botan.*, **71**, 52, 106 (1929); *Biochem. Z.*, **261**, 179 (1933); *Protoplasma*, **19**, 385 (1933).
1979. Moore, C. V., *J. Clin. Invest.*, **16**, 613 (1937).
1980. Moore, C. V. and co-workers, *J. Am. Med. Assoc.*, **121**, 245 (1942).

1981. Moore, C. V. and co-workers, *J. Lab. Clin. Med.*, **30**, 1056 (1945); *Federation Proc.*, **5**, 236 (1946).
1982. Moore, C. V., C. A. Doan, and W. R. Arrowsmith, *J. Clin. Invest.*, **16**, 627 (1937).
1983. Morawitz, P., *Arch. exptl. Path. Pharmacol.*, **60**, 298 (1909).
1984. Morawitz, P., "Die Messung des Blutumsatzes," *Handb. d. norm. path. Physiol.*, Bd. 6, Hälfte 2, Springer, Berlin, 1928, p. 202.
1985. Morgan, H. J. and O. T. Avery, *J. Exptl. Med.*, **39**, 335 (1924).
1986. Morgan, H. J. and J. M. Neill, *ibid.*, **40**, 269 (1924).
1987. Morgan, V. E., *J. Biol. Chem.*, **112**, 557 (1935-6).
1988. Morrison, D. B. and W. A. D. Anderson, *U. S. Pub. Health Service. Pub. Health Repts.*, **57**, 90 (1942).
1989. Morrison, D. B. and A. Hisey, *J. Biol. Chem.*, **109**, 233 (1935).
1990. Morrison, D. B. and E. F. Williams, *ibid.*, **123**, lxxxvii (1938).
1991. Morrison, D. B. and E. F. Williams, *Science*, **87**, 15 (1938).
1992. Moseley, H. N., *Quart. J. Microscop. Sci.*, **17**, 1 (1877).
1993. Mouchet, S., *Bull. soc. zool. France*, **53**, 442 (1928).
1994. Müller, F. v., *Z. klin. Med.*, **12**, 45 (1887); *Kongr. inn. Med.*, **11**, 118 (1892); *Verhandl. schles. Ges. vaterl. Kultur. Med., Abt. I*, **70**, 1 (1892).
1995. Müller, F. v., *Arch. path. Anat. Physiol. (Virchow's)*, **131**, 106 (1893).
1996. Müller-Neff, H., *Folia Haematol.*, **56**, 18 (1937).
1997. Müller, P., *Klin. Wochschr.*, **11**, 189, 1352 (1932).
1998. Müller, P. and L. Engel, *ibid.*, **9**, 2304 (1930).
1999. Müller, P. and L. Engel, *Z. physiol. Chem.*, **199**, 177 (1931).
2000. Müller, P. and L. Engel, *ibid.*, **200**, 145 (1931).
2001. Müller, P. and L. Engel, *ibid.*, **202**, 56 (1931).
2002. Muir, R. and J. S. F. Niven, *J. Path. Bact.*, **41**, 183 (1935).
2003. Mulder, and van Goudoever, *J. prakt. Chem.*, **32**, 186 (1844).
2004. Muller, G. L., *New Engl. J. Med.*, **213**, 1221 (1935).
2005. Murphy, W. P., R. Lynch, and I. M. Howard, *Arch. Internal Med.*, **47**, 883 (1931).
2006. Naegeli, T. and F. Meythaler, *Arch. exptl. Path. Pharmacol.*, **165**, 571 (1932).
2007. Nakamura, H., *Acta. Phytochim., Japan*, **10**, 211 (1937).
2008. Nakamura, H., *ibid.*, **9**, 189 (1937); **10**, 259, 271 (1938).
2009. Narasaka, S., *Japan. J. Med. Sci., II. Biochem.*, **3**, 273 (1937); **4**, 1, 25, 33, 97 (1938).
2010. Naumann, H. N., *Biochem. J.*, **30**, 347 (1936).
2011. Naumann, H. N., *ibid.*, **30**, 762 (1936).
2012. Naumann, H. N., *J. Lab. Clin. Med.*, **23**, 1127 (1938).
2013. Naunyn, B., *Arch. Anat. Physiol.*, **1868**, 401.
2014. Neal, W. M. and C. F. Almann, *J. Dairy Sci.*, **20**, 741 (1937).
2015. Neal, W. M., R. B. Becker, and A. L. Shealy, *Science*, **74**, 418 (1931).
2016. Needham, J., *Chemical Embryology*, Vol. I, Cambridge Univ. Press, London, 1931.
2017. Needham, J., *Biochemistry and Morphogenesis*, Cambridge Univ. Press, London, 1942.
2018. Negelein, E., *Biochem. Z.*, **158**, 121 (1925).
2019. Negelein, E., *ibid.*, **165**, 122 (1925).
2020. Negelein, E., *ibid.*, **243**, 386 (1931).
2021. Negelein, E., *ibid.*, **248**, 243 (1932).
2022. Negelein, E., *ibid.*, **250**, 577 (1932).

2023. Negelein, E., *ibid.*, **266**, 412 (1933).
2024. Negelein, E. and W. Gerischer, *Naturwissenschaften*, **21**, 884 (1933).
2025. Negelein, E. and W. Gerischer, *Biochem. Z.*, **268**, 1 (1934).
2026. Negri, C., *Ber. ges. Physiol. u. exptl. Pharmakol.*, **77**, 468 (1934).
2027. Neill, J. M., *J. Exptl. Med.*, **41**, 299, 535, 561 (1925).
2028. Neill, J. M. and O. T. Avery, *ibid.*, **39**, 757 (1924).
2029. Neill, J. M. and O. T. Avery, *ibid.*, **40**, 405, 423 (1925).
2030. Neill, J. M. and O. T. Avery, *ibid.*, **41**, 285 (1925).
2031. Neill, J. M. and A. B. Hastings, *J. Biol. Chem.*, **63**, 479 (1925).
2032. Nencki, M., *Arch. exptl. Path. Pharmakol.*, **24**, 430 (1888).
2033. Nencki, M., *Z. physiol. Chem.*, **30**, 423 (1900).
2034. Nencki, M. and N. Sieber, *Arch. exptl. Path. Pharmakol.*, **18**, 401 (1884).
2035. Nencki, M. and J. Zaleski, *Z. physiol. Chem.*, **30**, 384 (1900).
2036. Nencki, M. and J. Zaleski, *ibid.*, **34**, 997 (1901).
2037. Nesbitt, S., *Arch. Internal Med.*, **71**, 62 (1943).
2038. Nesbitt, S., *ibid.*, **71**, 483 (1943).
2039. Nesbitt, S. and A. M. Snell, *ibid.*, **69**, 573, 582 (1942).
2040. Nesbitt, S. and C. H. Watkins, *Am. J. Med. Sci.*, **203**, 74 (1942).
2041. Neubauer, O., *Arch. exptl. Path. Pharmakol.*, **43**, 456 (1900).
2042. Neubauer, O., *Munch. med. Wochschr.*, **50**, 1846 (1903).
2043. Neumann, E., *Arch. path. Anat. Physiol. (Virchow's)*, **111**, 25 (1888).
2044. Neurath, H., *Cold Spring Harbor Symposia Quant. Biol.*, **6**, 196 (1938).
2045. Neurath, H., *J. Am. Chem. Soc.*, **61**, 1841 (1939).
2046. Neurath, H. and co-workers, *Chem. Revs.*, **38**, 157 (1944).
2047. Navasquez, S. de, *J. Path. Bact.*, **51**, 413 (1940).
2048. Newcomer, H. S., *J. Biol. Chem.*, **37**, 465 (1919).
2049. Newman, W. V. and G. H. Whipple, *J. Exptl. Med.*, **55**, 637 (1932).
2050. van Niel, C. B., *Advances in Enzymology*, Vol. 1. Interscience, New York, 1941, p. 263.
2051. van Niel, C. B., *Bact. Revs.*, **8**, 1 (1944).
2052. Niemann, C., *Cold Spring Harbor Symposia Quant. Biol.*, **6**, 58 (1938).
2053. Niemann, G., *Z. physiol. Chem.*, **146**, 181 (1925).
2054. Nijveld, H. A. W., *Rec. trav. chim.*, **62**, 293 (1943).
2055. Nisimaru, Y., *Am. J. Physiol.*, **97**, 654 (1931).
2056. Niven, J. S. F., *J. Path. Bact.*, **41**, 177 (1935).
2057. Nobel, C. le, *Arch. ges. Physiol. (Pflugers)*, **40**, 501 (1887).
2058. Northrop, J. H. and M. L. Anson, *J. Gen. Physiol.*, **12**, 543 (1929).
2059. Nosaka, K., *J. Biochem. Japan*, **8**, 275, 301 (1927).
2060. Nothhaas, R., *Klin. Wochschr.*, **12**, 1438 (1933).
- 2060a. Oberst, F. W. and E. B. Woods, *J. Biol. Chem.*, **111**, 1 (1935).
2061. Ochoa, S., *ibid.*, **155**, 87 (1944).
2062. Ochoa, S., *ibid.*, **160**, 373 (1945).
2063. O'Daniel, H. O. and A. Damaschke, *Z. Krist.*, **104**, 114 (1942).
2064. O'Dell, B. L. and H. G. Hogan, *J. Biol. Chem.*, **149**, 323 (1943).
2065. Oehlbeck, L. W. F., F. S. Robschert-Robbins, and G. H. Whipple, *J. Exptl. Med.*, **56**, 425 (1932).
2066. Örström, A., *Protoplasma*, **15**, 566 (1932).
2067. von Oettingen, F. W., *U. S. Pub. Health Service. Pub. Health Bull.*, No. **271**, 158 (1941).
2068. von Oettingen, F. W., *ibid.*, No. **272** (1941).
2069. von Oettingen, F. W., *ibid.*, No. **285** (1944).
2070. Ogston, A. G., *Trans. Faraday Soc.*, **39**, 151 (1943).

2071. Ohno, Y., *Klin. Wochschr.*, **8**, 2188 (1929); *Münch. med. Wochschr.*, **78**, 1639 (1931).
2072. Okamoto, K., *Acta Schol. Med. Univ. Imp. Kioto*, **20**, 413 (1937).
2073. Okay, S., *Nature*, **155**, 635 (1944).
2074. Oltmanns, F., *Jahrb. wiss. Botan.*, **23**, 349 (1908).
2075. Oncley, J. L., *Ann. N. Y. Acad. Sci.*, **41**, 121 (1941).
2076. Oncley, J. L., J. D. Ferry, and J. Shack, *Cold Spring Harbor Symposia Quant. Biol.*, **6**, 21 (1938).
2077. Onslow, M. W., *Biochem. J.*, **13**, 1 (1919); **14**, 535, 541 (1920); **15**, 107, 113 (1921).
2078. Oparin, A. I. and S. Morgulis, *The Origin of Life*, Macmillan, New York, 1938.
2079. Oppenheimer, C. and K. G. Stern, *Biological Oxidations*, W. Junk, The Hague, 1939.
2080. Ordal, E. J. and H. O. Halvorson, *J. Bact.*, **38**, 199 (1939).
2081. Orkov, S., *Biochem. Z.*, **279**, 250 (1935).
2082. Ornstein, L. S. and J. F. Schouten, *Nederland. Tijdschr. Geneesk.*, **81**, 1717 (1937).
2083. Orru, A., *Atti reale accad. Italia, Rend. classe sci. fis. mat. e nat.*, **1**, No. 7, 74 (1939); *Atti accad. naz. Lincei, Classe sci. fis. mat. e nat.*, **29**, 333 (1939).
2084. Orten, A. U. and J. M. Orten, *J. Nutrition*, **26**, 21 (1943).
2085. Orten, A. U. and J. M. Orten, *ibid.*, **30**, 137 (1945).
2086. Orten, J. M., *Yale J. Biol. Med.*, **6**, 519 (1934-35).
2087. Orten, J. M., *Am. J. Physiol.*, **114**, 414 (1936).
2088. Orten, J. M., J. E. Bourque, and A. U. Orten, *J. Biol. Chem.*, **160**, 435 (1945).
- 2088a. Orten, J. M. and J. M. Keller, *ibid.*, **165**, 167 (1946).
2089. Orten, J. M. and A. H. Smith, *Proc. Soc. Exptl. Biol. Med.*, **34**, 72 (1936).
2090. Osgood, E. E., *Arch. Internal Med.*, **56**, 849 (1935).
2091. O'Shaughnessy, L., H. E. Mansell, and D. Slome, *Lancet II*, 1939, 1068.
2092. Oshima, M., *Japan. J. Gastroenterol.*, **4**, 100, 102 (1932).
2093. Ottenberg, R. and C. L. Fox, *Am. J. Physiol.*, **123**, 516 (1938).
2094. Otto, W. and I. Heilmeyer, *Z. ges. exptl. Med.*, **77**, 144 (1931).
2095. Overbeck, G. A., *Rec. trav. chim.*, **58**, 1018, 1033 (1939).
2096. Overbeck, G. A., *ibid.*, **59**, 14, 21 (1940).
2097. Paic, W., *Compt. rend.*, **203**, 933 (1936).
2098. Papendieck, A., *Z. physiol. Chem.*, **128**, 109 (1923).
2099. Papendieck, A., *ibid.*, **133**, 97 (1924).
2100. Papendieck, A., *ibid.*, **134**, 158 (1924).
2101. Papendieck, A., *ibid.*, **136**, 293 (1924).
2102. Papendieck, A., *ibid.*, **139**, 262, 267 (1924).
2103. Papendieck, A., *ibid.*, **140**, 16 (1924).
2104. Papendieck, A. and K. Bonath, *ibid.*, **144**, 60 (1925).
- 2104a. Pappenheimer, A. M., Jr., *J. Biol. Chem.*, **167**, 251 (1946).
- 2104b. Pappenheimer, A. M., Jr., *ibid.*, **166**, 653 (1946); **171**, 701 (1947).
2105. Pappenheimer, A. M., Jr. and E. Shaskan, *ibid.*, **155**, 265 (1944).
2106. Parisot, J., *Compt. rend.*, **153**, 1518 (1911).
2107. Parsons, L. G., E. M. Hickmans, and E. Finch, *Arch. Disease Childhood*, **12**, 369 (1937).
2108. Partos, A., *Biochem. Z.*, **129**, 89 (1922).
2109. Paschkis, K. E., *Z. klin. Med.*, **114**, 765 (1931); **116**, 680 (1931).
2110. Paschkis, K. E., *Ergeb. inn. Med. u. Kinderheilk.*, **45**, 682 (1933).

2111. Paschkis, K. E., A. Cantarow, and E. K. Tillson, *Proc. Soc. Exptl. Biol. Med.*, **60**, 148 (1945).
2112. Paschkis, K. E. and M. Diamant, *Deut. Arch. klin. Med.*, **169**, 180 (1930).
2113. Pass, I. J., S. Schwartz, and C. J. Watson, *J. Clin. Invest.*, **24**, 283 (1945).
2114. Passini, F., *Wien. klin. Wochschr.*, **35**, 217 (1922).
2115. Passini, F. and J. Czaczkes, *ibid.*, **36**, 657 (1923).
2116. Pasteur, L., *Studies on Fermentation* (English translation), London, 1879.
2117. Patek, A. J., *Arch. Internal Med.*, **57**, 73 (1936).
2118. Patek, A. J. and G. R. Minot, *Am. J. Med. Sci.*, **188**, 206 (1934).
2119. Patent, U. S., **2,166,073**.
2120. Patent, U. S., **2,386,716**.
2121. Paton, J. P. J. and J. C. Eaton, *Lancet I*, **1937**, 1159.
2122. Paul, W. D. and C. R. Kemp, *Proc. Soc. Exptl. Biol. Med.*, **56**, 55 (1944).
2123. Pauling, L., *Proc. Natl. Acad. Sci. U. S.*, **21**, 186 (1935).
2124. Pauling, L., *J. Am. Chem. Soc.*, **58**, 94 (1936).
2125. Pauling, L., *The Nature of the Chemical Bond*, 2d ed., Cornell Univ. Press, Ithaca, 1944.
2126. Pauling, L. and C. D. Coryell, *Proc. Natl. Acad. Sci. U. S.*, **22**, 159 (1936).
2127. Pauling, L. and C. D. Coryell, *ibid.*, **22**, 210 (1936).
2128. Pauling, L. and G. W. Wheland, *J. Chem. Phys.*, **1**, 362 (1933).
2129. Pauling, L., W. B. Whitney, and W. A. Felsing, *J. Am. Chem. Soc.*, **59**, 633 (1937).
- 2129a. Peacock, W. C. and co-workers, *J. Clin. Invest.*, **25**, 605 (1946).
2130. Pearson, P. B., C. A. Elvehjem, and E. B. Hart, *J. Biol. Chem.*, **119**, 749 (1937).
2131. Pedersen, K. O., Quoted by H. Theorell, *Biochem. Z.*, **285**, 207 (1936).
2132. Pedersen, K. O., and J. Waldenström, *Z. physiol. Chem.*, **245**, 152 (1937).
2133. Perutz, M. F., *doctoral dissertation*, Cambridge, 1939.
2134. Perutz, M. F., *Nature*, **143**, 731 (1939).
2135. Perutz, M. F., *ibid.*, **149**, 491 (1942).
2136. Perutz, M. F., *ibid.*, **150**, 324 (1942).
- 2136a. Perutz, M. F., *Nature*, **161**, 204 (1948).
2137. Perutz, A., *Arch. Dermatol. u. Syphilis*, **124**, 531 (1917).
2138. Peter, J. R., *Biochem. Z.*, **262**, 432 (1933).
2139. Peterman, E. A. and T. B. Cooley, *J. Lab. Clin. Med.*, **19**, 723, 743 (1933).
2140. Peters, J. P. and D. D. Van Slyke, *Quantitative Clinical Chemistry*, Vol. 1, Baillière, Tindall and Cox, London, 1931.
2141. Peters, J. P. and D. D. Van Slyke, *loc. cit.*, Vol. 2.
2142. Peters, R. A., *J. Physiol.*, **44**, 131 (1912).
2143. Peters, R. A., L. A. Stocken, and R. H. Thompson, *Nature*, **156**, 616 (1945).
2144. Petherick, M. H. and E. Singer, *Australian J. Exptl. Biol. Med. Sci.*, **21**, 221 (1943).
2145. Petherick, M. H. and E. Singer, *ibid.*, **22**, 21, 285 (1944).
2146. Pett, L. B., *Biochem. J.*, **30**, 1438 (1936).
2147. Piffner, J. J. and co-workers, *Science*, **97**, 404 (1943); **102**, 228 (1945).
2148. Pflüger, H., *Klin. Wochschr.*, **10**, 572 (1931).
2149. Phelps, A. S. and P. W. Wilson, *Proc. Soc. Exptl. Biol. Med.*, **47**, 473 (1941).
2150. Philippe, M., *Z. vergl. Physiol.*, **18**, 459 (1933).
2151. Piersol, G. M. and M. M. Rothman, *J. Am. Med. Assoc.*, **91**, 1768 (1928).
2152. Piettre, M., *Compt. rend.*, **147**, 1492 (1908).
2153. Piloty, O. and J. S. Thannhauser, *Ann.*, **390**, 191 (1912).
2154. Pincussen, L., *Deut. med. Wochschr.*, **48**, 1074 (1922).
2155. Plum, C. M., *Acta Physiol. Scand.*, **4**, 259 (1942).
2156. Plum, C. M., *ibid.*, **5**, 165 (1943).

2157. Plum, C. M., *Acta Med. Scand.*, **112**, 151 (1942).
 2158. Plum, C. M., *ibid.*, **117**, 43 (1944).
 2158aa. Plumier, M., *Compt. rend. soc. biol.*, **140**, 589 (1946).
 2158a. Polyani, M., *Trans. Faraday Soc.*, **34**, 1191 (1938).
 2159. Policard, A., *Compt. rend.*, **179**, 1287 (1924).
 2160. Pollock, M. R., *Lancet II*, **1945**, 626.
 2161. Polonovski, M. and co-workers, *Compt. rend. soc. biol.*, **137**, 363 (1943).
 2162. Polonovski, M. and A. Gajdos, "De l'Hémoglobine a la Bilirubine et l'Urobiline,"
Exposés Ann. de Biochim. Méd., Masson, Paris, 1945, **5**, p. 152.
 2163. Polonovski, M. and M. Jayle, *Compt. rend. soc. biol.*, **128**, 1076 (1938).
 2164. Polonovski, M., M. Jayle, and G. Glotz, *ibid.*, **128**, 1072 (1938).
 2165. Polonovski, M., D. Santenoise, and E. Stankoff, *ibid.*, **137**, 365 (1943).
 2166. Polson, A., *Kolloid-Z.*, **87**, 149 (1939).
 2167. Polson, A., *ibid.*, **88**, 51 (1939).
 2168. Pommerenke, W. T. and co-workers, *Am. J. Physiol.*, **137**, 164 (1942).
 2169. Ponder, E., *J. Biol. Chem.*, **144**, 339 (1942).
 2170. Ponder, E., *J. Gen. Physiol.*, **27**, 483 (1944).
 2171. Ponder, E. and C. P. Rhoads, *Proc. Soc. Exptl. Biol. Med.*, **38**, 540 (1938).
 2172. Porter, C. R., *J. Chem. Soc.*, **1938**, 368.
 2173. Posner, I., N. W. Guthrie, and M. R. Mattice, *J. Lab. Clin. Med.*, **23**, 804 (1938).
 2174. Potick, D., *Compt. rend. soc. biol.*, **109**, 324 (1932).
 2175. Potter, R. L., A. E. Axelrod, and C. A. Elvehjem, *J. Nutrition*, **24**, 449 (1942).
 2176. Potter, V. R., *J. Biol. Chem.*, **137**, 13 (1941).
 2177. Potter, V. R., *Advances in Enzymology*, Vol. 4, Interscience, New York, 1944,
 p. 201.
 2178. Potter, V. R. and K. P. DuBois, *J. Biol. Chem.*, **140**, cii (1941).
 2179. Potter, V. R. and K. P. DuBois, *ibid.*, **142**, 417 (1942).
 2180. Potter, V. R., C. A. Elvehjem, and E. B. Hart, *ibid.*, **126**, 155 (1938).
 2181. Potter, V. R. and E. E. Lockhart, *Nature*, **143**, 942 (1943).
 2182. Poulson, V., *Beitr. path. Anat. u. allgem. Path.*, **48**, 346 (1910).
 2183. Powell, W. N., *Am. J. Clin. Path.*, **14**, 55 (1944).
 2184. Prados, J. L., *Science*, **103**, 406 (1946).
 2185. Pregl, F., *Z. physiol. Chem.*, **44**, 173 (1905).
 2186. Price-Jones, C., J. M. Vaughan, and H. M. Goddard, *J. Path. Bact.*, **40**, 503
 (1935).
 2187. Proger, S., D. Dekaneas, and G. Schmidt, *J. Clin. Invest.*, **24**, 864 (1945).
 2188. Pruckner, F., *Z. physik. Chem.*, **190A**, 101 (1942).
 2189. Pruckner, F. and A. Stern, *ibid.*, **177A**, 387 (1936).
 2190. Pruckner, F. and A. Stern, *ibid.*, **180A**, 25 (1937).
 2191. Prunty, F. T. G., *Biochem. J.*, **37**, 506 (1943).
 2192. Prunty, F. T. G., *ibid.*, **39**, 446 (1945).
 2193. Prunty, F. T. G., *Arch. Internal Med.*, **77**, 623 (1946).
 2194. Quensel, W. and K. Wachholder, *Z. physiol. Chem.*, **231**, 65 (1935).
 2195. Querido, A., *Chem. Weekblad*, **37**, 175 (1940).
 2196. Quin, J. I., *Onderstepoort J. Vet. Sci. Animal Ind.*, **1**, 505 (1933).
 2197. Quin, J. I., C. Rimington, and G. C. S. Roets, *ibid.*, **4**, 463 (1935).
 2198. Rabinowitch, E. I., *Photosynthesis*, Vol. I, Interscience, New York, 1945.
 2198a. Rabinowitch, E. I., *Rev. Modern Phys.*, **16**, 226 (1944).
 2199. Rabinowitch, I. M., *J. Biol. Chem.*, **97**, 163 (1932).

2200. Radley, J. A. and J. Grant, *Fluorescence Analysis in Ultraviolet Light*, 2d ed., Chapman & Hall, London, 1935.
2201. Ramsey, R. and C. O. Warren, Jr., *Quart. J. Exptl. Physiol.*, **20**, 213 (1930).
2202. Ramsay, W. N. M., *Biochem. J.*, **38**, 470 (1944); **40**, 286 (1946).
2203. Ramsey, H. J., *J. Cellular Comp. Physiol.*, **18**, 369 (1941).
2204. Randall, L. O., *J. Biol. Chem.*, **164**, 521 (1946).
2205. Ransone, B. and C. A. Elvehjem, *ibid.*, **151**, 109 (1943).
2206. Raphael, C., *Compt. rend.*, **202**, 588 (1936).
2207. Rapkine, L., *Biochem. J.*, **32**, 1729 (1938).
2208. Rapoport, S. and D. M. Guest, *J. Biol. Chem.*, **138**, 269 (1941).
2209. Rapoport, S. and D. M. Guest, *ibid.*, **143**, 671 (1942).
2210. Rapoport, S., D. M. Guest, and M. Wing, *Proc. Soc. Exptl. Biol. Med.*, **57**, 344 (1944).
2211. Rappaport, F. and F. Eichhorn, *Lancet I*, **1943**, 62.
2212. Rask, E. N. and W. H. Howell, *Am. J. Physiol.*, **84**, 363 (1928).
- 2212a. Rath, C. E. and C. A. Finch, *J. Lab. Clin. Med.*, **33**, 81 (1948).
2213. Rau, L., *Lancet II*, **1940**, 647.
2214. Raudnitz, H., *Naturwissenschaften*, **21**, 518 (1933).
2215. Raudnitz, R. W., *Z. Biol.*, **42**, 91 (1901).
2216. Raven, M. O., *Guy's Hosp. Repts.*, **78**, 275 (1928).
2217. Rawlinson, W. A., *Australian J. Exptl. Biol. Med. Sci.*, **16**, 303 (1938).
2218. Rawlinson, W. A., *ibid.*, **17**, 53 (1939).
2219. Rawlinson, W. A., *ibid.*, **18**, 185 (1940).
2220. Ray, G. B. and G. H. Paff, *Am. J. Physiol.*, **94**, 521 (1930).
2221. Recklinghausen, F. v., *Handb. d. allgem. Path. d. Kreislaufs u. d. Ernährung*, Enke, Stuttgart, 1883.
2222. Redfield, A. C., *Quart. Rev. Biol.*, **8**, 31 (1933).
2223. Reeve, E. B., *J. Path. Bact.*, **56**, 95 (1944).
2224. Reichert, E. T. and A. P. Brown, *The Crystallography of Hemoglobin*, Pub. No. 116, Carnegie Inst. Washington, Washington, D. C., 1909.
2225. Reid, A., *Ergeb. Enzymforsch.*, **1**, 325 (1932).
2226. Reimann, F., F. Fritsch, and K. Schick, *Z. klin. Med.*, **131**, 1 (1936).
2227. Reinhold, B. v., *Z. physiol. Chem.*, **85**, 250 (1913).
2228. Reiner, L., D. H. Moore, E. H. Lang, and M. Green, *J. Biol. Chem.*, **146**, 583 (1942).
2229. Reitlinger, K. and P. Klee, *Arch. exptl. Path. Pharmacol.*, **127**, 277 (1928).
2230. Restorff, H. v., *ibid.*, **196**, 10 (1940).
2231. Retzlaff, K., *Z. ges. exptl. Med.*, **34**, 133 (1923).
2232. Reuter, F., H. Willstaedt, and K. Zirm, *Biochem. Z.*, **261**, 353 (1933).
2233. Reznikoff, P., in *Symposium on the Blood and Blood-Forming Organs*, Univ. Wisconsin Press, Madison, 1939, p. 207.
2234. Rhiel, J., *Arch. ges. Physiol. (Pflügers)*, **246**, 709 (1943).
2235. Rhoads, C. P., in *Symposium on the Blood and Blood-Forming Organs*, Univ. Wisconsin Press, Madison, 1939, p. 31.
- 2235a. Rhoads, C. P. and D. K. Miller, *J. Exptl. Med.*, **58**, 585 (1933).
2237. Riakhina, E. M. and S. R. Zubkova, *Compt. rend. soc. biol.*, **97**, 479 (1927).
2238. Rich, A. R., *Bull. Johns Hopkins Hosp.*, **35**, 415 (1924).
2239. Rich, A. R., *ibid.*, **36**, 233 (1925).
2240. Rich, A. R., *Physiol. Revs.*, **5**, 182 (1925).
2241. Rich, A. R., *Bull. Johns Hopkins Hosp.*, **47**, 338 (1930).
2242. Rich, A. R. and J. H. Bumstead, *ibid.*, **36**, 225 (1925).
2243. Richards, A. N. and A. M. Walters, *Am. J. Med. Sci.*, **190**, 727 (1935).

2244. Richardson, A. P., *J. Pharmacol. Exptl. Therap.*, **59**, 101 (1937).
2245. Richardson, A. P., *ibid.*, **71**, 203 (1941).
2246. Richardson, K. C., *Trans. Roy. Soc. London*, **225B**, 149 (1935).
2247. Richter, A. F., *Z. physiol. Chem.*, **190**, 21 (1930).
2248. Richter, A. F., *ibid.*, **253**, 193 (1938).
2249a. Rickes, E. L. and co-workers, *Science*, **107**, 396 (1948).
2249. Riddle, M. C., *Arch. Internal Med.*, **46**, 417 (1930).
2250. Riecker, H. H., *J. Exptl. Med.*, **49**, 937 (1929).
2251. Riedel, H., *Arch. exptl. Path. Pharmacol.*, **190**, 224 (1938).
2252. Riedel, H., *ibid.*, **191**, 609 (1939).
2253. Riedel, H., *ibid.*, **192**, 39 (1939).
2254. Rigdon, R. H., *Am. J. Clin. Path.*, **15**, 489 (1945).
2255. Rimington, C., *Ergeb. Physiol.*, **35**, 712 (1933).
2256. Rimington, C., *Onderstepoort J. Vet. Sci. Animal Ind.*, **3**, 137 (1934).
2257. Rimington, C., *ibid.*, **7**, 567 (1937).
2258. Rimington, C., *Nature*, **140**, 105, 584 (1937).
2259. Rimington, C., *Compt. rend. trav. lab. Carlsberg, Sér. chim.*, **22**, 454 (1938).
2260. Rimington, C., *Biochem. J.*, **32**, 460 (1938).
2261. Rimington, C., *Z. physiol. Chem.*, **259**, 45 (1939).
2262. Rimington, C., *Biochem. J.*, **34**, 78 (1939).
2263. Rimington, C., *Proc. Roy. Soc. London*, **127B**, 106 (1939).
2264. Rimington, C., *Proc. Roy. Soc. Med.*, **32**, 351 (1939).
2265. Rimington, C., *ibid.*, **32**, 1268 (1939).
2266. Rimington, C., *Biochem. J.*, **37**, 137 (1943).
2267. Rimington, C., *Brit. Med. J. I.*, **1942**, 177.
2268. Rimington, C., *Ann. Rev. Biochem.*, **12**, 425 (1943).
2269. Rimington, C., *Nature*, **151**, 393 (1943).
2270. Rimington, C. and A. W. Hemmings, *Lancet I*, **1938**, 770.
2271. Rimington, C. and A. W. Hemmings, *Biochem. J.*, **33**, 960 (1939).
2272. Rimington, C. and Z. A. Leitner, *Lancet II*, **1945**, 494.
2273. Rimington, C. and J. I. Quin, *S. African J. Sci.*, **32**, 142 (1935).
2274. Rimington, C., G. Roets, and P. Fourie, *Onderstepoort J. Vet. Sci. Animal Ind.*, **10**, 421, 431 (1938).
2275. Rimington, C. and A. M. Stewart, *Proc. Roy. Soc. London*, **110B**, 75 (1932).
2276. Rittenberg, D., R. Schoenheimer, and A. S. Keston, *J. Biol. Chem.*, **128**, 603 (1939).
2277. Rittenberg, D. and D. Shemin, *Ann. Rev. Biochem.*, **15**, 258 (1946).
2278. Roaf, H. E., *Biochem. J.*, **1**, 397 (1906).
2279. Roaf, H. E. and W. A. N. Smart, *Biochem. J.*, **17**, 579 (1923).
2279a. Robbie, W. A., *J. Cell. Comp. Physiol.*, **28**, 305 (1946).
2280. Roberts, R. M., *J. Am. Chem. Soc.*, **64**, 1472 (1942).
2281. Robertson, O. H., *Arch. Internal Med.*, **15**, 1072 (1915).
2282. Robertson, J. M., *J. Chem. Soc.*, **1936**, 1195.
2283. Robertson, J. M., *ibid.*, **1935**, 615.
2284. Robertson, J. M. and I. Woodward, *ibid.*, **1937**, 219; **1940**, 36.
2285. Robertson, O. H., *J. Exptl. Med.*, **26**, 221 (1917).
2286. Robertson, R. N. and J. S. Turner, *Australian J. Exptl. Biol. Med. Sci.*, **23**, 63 (1945).
2287. Robeznieks, I., *Z. physiol. Chem.*, **255**, 255 (1938).
2288. Robinson, D., *Science*, **90**, 276 (1939).
2289. Robinson, M. E., *Biochem. J.*, **18**, 255 (1924).
2290. Robschheit-Robbins, F. S., *Physiol. Revs.*, **9**, 666 (1929).
2291. Robschheit-Robbins, F. S. and co-workers, *J. Exptl. Med.*, **72**, 479 (1940).

2292. Robscheit-Robbins, F. S. and co-workers, *ibid.*, **83**, 355 (1946).
2293. Robscheit-Robbins, F. S., L. L. Miller, and G. H. Whipple, *ibid.*, **77**, 375 (1943).
2294. Robscheit-Robbins, F. S., L. L. Miller, and G. H. Whipple, *ibid.*, **82**, 311 (1945).
- 2294a. Robscheit-Robbins, F. S., L. L. Miller, and G. H. Whipple, *ibid.*, **85**, 243 (1947).
2295. Robscheit-Robbins, F. S. and G. H. Whipple, *Am. J. Physiol.*, **83**, 76 (1927).
2296. Robscheit-Robbins, F. S. and G. H. Whipple, *ibid.*, **92**, 400 (1930).
2297. Robscheit-Robbins, F. S. and G. H. Whipple, *J. Exptl. Med.*, **63**, 767 (1936).
2298. Robscheit-Robbins, F. S. and G. H. Whipple, *ibid.*, **66**, 565 (1937).
2299. Rocchi, F., *Arch. ital. anat. istol. patol.*, **1**, 613 (1930).
2300. Roche, J., *Compt. rend. trav. lab. Carlsberg, Sér. chim.*, **18**, No. 4 (1930).
2301. Roche, J., *Bull. soc. chim. biol.*, **14**, 1032 (1932).
- 2301a. Roche, J., *Compt. rend.*, **110**, 1084 (1932).
2302. Roche, J., *Arch. phys. biol.*, **10**, 91 (1933).
2303. Roche, J., *Bull. soc. chim. biol.*, **16**, 794 (1934).
2304. Roche, J., *ibid.*, **18**, 825 (1936).
2305. Roche, J., *Compt. rend. trav. lab. Carlsberg, Sér. chim.*, **22**, 465 (1938).
2306. Roche, J. and M. T. Bénévnt, *Bull. soc. chim. biol.*, **17**, 1473 (1936).
2307. Roche, J. and M. T. Bénévnt, *ibid.*, **18**, 1650 (1936).
2308. Roche, J. and M. T. Bénévnt, *Compt. rend. soc. biol.*, **123**, 18 (1936).
2309. Roche, J. and M. T. Bénévnt, *Bull. soc. chim. biol.*, **19**, 642 (1937).
2310. Roche, J. and M. S. Chouaiech, *ibid.*, **22**, 263 (1940); *Compt. rend. soc. biol.*, **130**, 562 (1939).
2311. Roche, J. and R. Combette, *Compt. rend.*, **205**, 1011 (1935).
2312. Roche, J. and R. Combette, *Compt. rend. soc. biol.*, **126**, 950 (1937).
2313. Roche, J. and R. Combette, *Bull. soc. chim. biol.*, **19**, 613 (1937).
2314. Roche, J. and R. Combette, *ibid.*, **19**, 627 (1937).
2315. Roche, J. and Y. Derrien, *Compt. rend. soc. biol.*, **136**, 41 (1942).
- 2315a. Roche, J., Y. Derrien, and J. Cahnmann, *ibid.*, **140**, 146 (1946).
2316. Roche, J., Y. Derrien, and H. Vieil, *Bull. soc. chim. biol.*, **24**, 1016 (1942).
2317. Roche, J. and P. Dubouloz, *Compt. rend. soc. biol.*, **113**, 317 (1933).
- 2317a. Roche, J. and M. Fontaine, *Ann. inst. océanog. Paris*, **20**, 77 (1940).
2318. Roche, J. and G. Jean, *Compt. rend. soc. biol.*, **116**, 1304 (1934).
2319. Roche, J. and G. Jean, *Bull. soc. chim. biol.*, **16**, 769 (1934).
2320. Roche, J. and J. Morena, *Compt. rend. soc. biol.*, **123**, 1215, 1218 (1936).
2321. Roche, J. and M. Mourgue, *Compt. rend.*, **212**, 773 (1941).
- 2321a. Roche, J. and M. Mourgue, *Bull. soc. chim. biol.*, **23**, 1329 (1941).
2322. Roche, J. and A. Roche, *Compt. rend. soc. biol.*, **97**, 804 (1927).
2323. Roche, J. and A. Roche, *Bull. soc. chim. biol.*, **11**, 549 (1929).
2324. Roche, J., A. Roche, G. S. Adair, and M. E. Adair, *Biochem. J.*, **26**, 1811 (1932).
2325. Roche, J. and H. Vieil, *Compt. rend.*, **210**, 314 (1940).
2326. Roelofsen, P. A., *Proc. Koninkl. Nederland. Akad. Wetenschap.*, **37**, 660 (1934); "On Photosynthesis of the Thiorhodaceae," *doctoral dissertation, Utrecht, 1935*.
2327. Röhmann, F. and W. Spitzer, *Ber.*, **28**, 567 (1895).
2328. Roets, G. C. S., *Onderstepoort J. Vet. Sci. Animal Ind.*, **11**, 385 (1938).
2329. Rogers, C. G., *Textbook of Comparative Physiology*, McGraw-Hill, New York (1938).
2330. Rogers, M. A. T., *Nature*, **151**, 504 (1943).
2331. Rohmer, P. and co-workers, *Compt. rend. soc. biol.*, **127**, 1279 (1938).
2332. Roos, J. and C. Romijn, *J. Physiol.*, **92**, 249 (1938).
2333. Rosenblum, L. A., *J. Biol. Chem.*, **109**, 635 (1935).
2334. Rosenthal, O. and D. L. Drabkin, *ibid.*, **149**, 437 (1943).

2335. Rosenthal, O. and D. I. Drabkin, *ibid.*, **150**, 131 (1949).
2336. Rosenthal, F., *Handb. d. norm. u. pathol. Physiol.*, Band 3, Springer, Berlin, 1927, p. 876.
2337. Rosenthal, F., *Ergeb. inn. Med. u. Kinderheilk.*, **33**, 63 (1928).
2338. Rosenthal, F., *Klin. Wochschr.*, **11**, 441 (1932).
2339. Rosenthal, F. and P. Holzer, *Deut. Arch. klin. Med.*, **135**, 257 (1921).
2340. Rosenthal, F. and H. Licht, *Arch. exper. Path. Pharmacol.*, **115**, 198 (1926).
2341. Rosenthal, F. and E. Melchior, *ibid.*, **94**, 28 (1922).
2342. Rosin, A. and A. Doljanski, *Brit. J. Exptl. Path.*, **25**, 111 (1944).
- 2342a. Rosin, A. and M. Rachmilewitz, *Blood*, **3**, 165 (1948).
2343. Ross, E., *Am. J. Botany*, **25**, 458 (1938).
2344. Ross, W. F., *J. Biol. Chem.*, **127**, 169, 179 (1939).
2345. Ross, W. F. and R. B. Turner, *ibid.*, **139**, 603 (1941).
2346. Rossi, A., *Arch. sci. biol. Italy*, **26**, 244 (1940).
2347. Roth, E., *Deut. Arch. klin. Med.*, **178**, 185 (1935).
2348. Roth, E., *Z. klin. Med.*, **129**, 123 (1935).
2349. Roth, N., *Psychosomat. Med.*, **7**, 291 (1945).
2350. Roth, O. and E. Herzfeld, *Deut. med. Wochschr.*, **46**, 2129 (1911).
2351. Rothemund, P., *J. Am. Chem. Soc.*, **57**, 2179 (1935).
2352. Rothemund, P., *ibid.*, **58**, 625 (1936).
2353. Rothemund, P., *ibid.*, **61**, 2912 (1939).
2354. Rothemund, P., R. R. McNary, and O. I. Inman, *ibid.*, **56**, 2400 (1934).
2355. Roughton, F. J. W., *Proc. Roy. Soc. London*, **111B**, 1 (1932).
2356. Roughton, F. J. W., *ibid.*, **115B**, 464 (1934).
2357. Roughton, F. J. W., *ibid.*, **115B**, 473 (1934).
2358. Roughton, F. J. W., *ibid.*, **115B**, 495 (1934).
2359. Roughton, F. J. W., *Biochem. J.*, **29**, 2604 (1935).
2360. Roughton, F. J. W., *Physiol. Revs.*, **15**, 241 (1935).
2361. Roughton, F. J. W., *J. Biol. Chem.*, **141**, 129 (1941).
2362. Roughton, F. J. W., *Harvey Lectures*, **39**, 96 (1944).
2363. Roughton, F. J. W., *Am. J. Physiol.*, **143**, 609 (1945).
2364. Roughton, F. J. W., *ibid.*, **143**, 621 (1945).
2365. Roughton, F. J. W. and co-workers, *Biochem. J.*, **30**, 2117 (1936).
2366. Roughton, F. J. W. and R. C. Darling, *Am. J. Physiol.*, **141**, 17 (1944).
2367. Roughton, F. J. W., R. C. Darling, and W. S. Root, *ibid.*, **142**, 708 (1944).
2368. Roughton, F. J. W. and G. A. Millikan, *Proc. Roy. Soc. London*, **155A**, 258 (1936).
2369. Roughton, F. J. W. and W. S. Root, *J. Biol. Chem.*, **160**, 123, 135 (1945).
2370. Roughton, F. J. W. and P. F. Scholander, *J. Biol. Chem.*, **148**, 541 (1943).
2371. Rous, P., *Physiol. Revs.*, **3**, 75 (1923).
2372. Rous, P., G. O. Broun, and P. D. McMaster, *J. Exptl. Med.*, **37**, 421 (1923).
2373. Rous, P. and P. D. McMaster, *ibid.*, **34**, 47 (1921).
2374. Rous, P. and P. D. McMaster, *ibid.*, **37**, 11 (1923).
2375. Roy, M. and A. Boutaric, *Compt. rend.*, **215**, 425 (1942).
2376. Royer, M., *Compt. rend. soc. biol.*, **99**, 1003 (1928).
2377. Royer, M., *ibid.*, **99**, 1006 (1928).
2378. Royer, M., *ibid.*, **99**, 1419 (1928).
2379. Royer, M., *ibid.*, **102**, 422, 424, 448, 451 (1929).
2380. Royer, M., *L'urobiline a l'état normal et pathologique*, Masson, Paris, 1930.
2381. Royer, M., *Compt. rend. soc. biol.*, **111**, 408 (1932).
2382. Royer, M., *ibid.*, **111**, 466 (1932).
2383. Royer, M., *ibid.*, **111**, 825 (1932).

2384. Royer, M., *Klin. Wochschr.*, **14**, 374 (1935).
 2385. Royer, M., *Compt. rend. soc. biol.*, **123**, 76 (1936).
 2386. Royer, M., *Arch. Internal Med.*, **64**, 445 (1939).
 2387. Royer, M. and C. F. Bertrand, *Compt. rend. soc. biol.*, **100**, 130 (1929).
 2388. Royer, M. and H. Bogetti, *ibid.*, **133**, 718 (1940).
 2389. Royer, M. and A. V. Solari, *Rev. soc. argentina biol.*, **17**, 329 (1941).
 2389a. Ruben, S. and co-workers, *J. Am. Chem. Soc.*, **64**, 2297 (1942).
 2390. Rudert, H. and L. Heilmeyer, *Biochem. Z.*, **261**, 336 (1932).
 2391. Ruegamer, W. R. and co-workers, *Am. J. Physiol.*, **145**, 23 (1945).
 2392. Ruhland, W., *Jahrb. wiss. Botan.*, **63**, 32 (1924).
 2393. Runnström, J., *Protoplasma*, **10**, 106 (1930).
 2394. Runnström, J., *ibid.*, **15**, 532 (1932).
 2395. Rusch, H. P., *Folia Haematol.*, **57**, 99 (1937).
 2396. Ruska, H., *Ergeb. Physiol.*, **34**, 253 (1932).
 2397. Russel, Ch. D. and L. Pauling, *Proc. Natl. Acad. Sc. U. S.*, **25**, 517 (1939).
 2398. Russell, F. C., *Imp. Bur. Animal Nutrition, Aberdeen, Scotl., Commun.*, **15**,
 May (1944).
 2399. Ruz, J. C., *Rev. soc. argentina biol.*, **19**, 17, 31 (1943).
 2400. Ryan, F. J. and E. Brand, *J. Biol. Chem.*, **154**, 161 (1944).

 2401. Sabin, F. R., *Physiol. Revs.*, **8**, 191 (1928).
 2402. Sachs, A., *Am. J. Digestive Diseases Nutrition*, **4**, 803 (1937).
 2403. Sachs, A., V. E. Levine, and A. Appelsis, *Arch. Internal Med.*, **52**, 366 (1933).
 2404. Sachs, A., V. E. Levine, and A. A. Fabian, *ibid.*, **55**, 227 (1935).
 2405. Sachs, A., V. E. Levine, and A. A. Fabian, *ibid.*, **58**, 523 (1936).
 2406. Sachs, A., V. E. Levine, and W. O. Griffiths, *Proc. Soc. Exptl. Biol. Med.*, **35**,
 6 (1936).
 2407. Sachs, A., V. E. Levine, W. O. Griffith, and C. H. Hansen, *Am. J. Diseases
 Children*, **56**, 787 (1938).
 2408. Sachs, A., V. E. Levine, and R. Hughes, *Arch. Internal Med.*, **71**, 489 (1943).
 2409. Sachs, A., V. E. Levine, F. C. Hill, and R. Hughes, *Arch. Internal Med.*, **71**,
 489 (1943).
 2410. Sachs, P., *Z. klin. Med.*, **119**, 381 (1932).
 2411. Sachs, P., and H. Kloss, *ibid.*, **119**, 551 (1932).
 2412. Sackey, M. S., C. G. Johnston, and I. S. Ravdin, *J. Exptl. Med.*, **60**, 189 (1934).
 2413. Saifi, M. F., and J. M. Vaughan, *J. Path. Bact.*, **56**, 189 (1944).
 2414. Sallet, *Rev. méd. Paris*, **16**, 542 (1896).
 2415. Sakura, K., *Arch. exptl. Path. Pharmakol.*, **107**, 287 (1925); **109**, 198 (1925).
 2416. Salén, E. B., and B. Enocksson, *Acta Med. Scand.*, **65**, Suppl. No. 16, 595
 (1926).
 2417. Salén, E. B., and B. Enocksson, *ibid.*, **66**, 366 (1927).
 2418. Salkowsky, E., *Z. physiol. Chem.*, **15**, 286 (1891).
 2419. Salmon, U. J., *Surg. Gynecol. Obstet.*, **56**, 621 (1933).
 2420. Salomon, H., *Arch. Verdauungs-Krankh.*, **42**, 572 (1928).
 2421. Salomon, K., *Cold Spring Harbor Symposia Quant. Biol.*, **7**, 301 (1939).
 2422. Salomon, K., *Enzymologia*, **6**, 173 (1939).
 2423. Salomon, K., *J. Gen. Physiol.*, **24**, 367 (1941).
 2424. Salzburg, P. and C. J. Watson, *J. Biol. Chem.*, **139**, 593 (1941).
 2425. Sanford, A. H. and Ch. Sheard, *J. Lab. Clin. Med.*, **15**, 483 (1930).
 2426. Santesson, C. G., *Skand. Arch. Physiol.*, **44**, 262 (1923).
 2427. Saunders, F., A. Dorfman, and S. A. Koser, *J. Biol. Chem.*, **138**, 69 (1941).
 2428. Sauvageau, C., *Compt. rend. soc. biol.*, **62**, 919 (1907).

2429. Sauvageau, C., *ibid.*, **64**, 95 (1908).
2430. Sauvageau, C., *Utilisation des Algues Marines*, Paris, 1920.
2431. Schachner, H., A. L. Franklin, and I. L. Chaikoff, *J. Biol. Chem.*, **151**, 191 (1943).
2432. Schäfer, H. K., *Klin. Wochschr.*, **22**, 98 (1943).
2433. Schales, O., *Z. physiol. Chem.*, **257**, 121 (1938).
2434. Schales, O., *Ber.*, **71B**, 447 (1938).
2435. Schales, O. and H. Behrnts-Jensen, *Z. physiol. Chem.*, **257**, 106 (1938).
2436. Schälfejeff, M., *J. Russ. Physiol. Chem. Soc.*, **1885**, 30; *Ber.*, **18**, 232 (1885).
2437. Schenk, E. G., *Arch. exptl. Path. Pharmacol.*, **150**, 160 (1930).
2438. Scherer, J., *Ann.*, **53**, 377 (1845).
2439. Scherer, J., *Chemische und mikroskopische Untersuchungen zur Pathologie*, 1843.
2440. Scherer, J., *Ann.*, **40**, 1 (1841).
2441. Schjødt, E., *Am. J. Med. Sci.*, **193**, 313 (1937).
2442. Schjødt, E., *Acta Med. Scand.*, **95**, 49 (1938).
2443. Schlesinger, W., *Deut. med. Wochschr.*, **29**, 561 (1903).
2444. Schlossmann, H., *Ergeb. Physiol.*, **34**, 741 (1932).
2445. Schmey, H., *Frankfurt. Z. Path.*, **12**, 218 (1913).
2446. Schmidt, O., *Biochem. Z.*, **296**, 210 (1938).
2447. Schmitt, F. O., *Am. J. Physiol.*, **95**, 650 (1930).
2448. Schmitt, F. O. and H. S. Gasser, *ibid.*, **104**, 320 (1933).
2449. Schmitt, F. O. and P. A. Nicoll, *ibid.*, **106**, 225 (1933).
2450. Schmitt, F. O. and O. H. A. Schmitt, *ibid.*, **97**, 302 (1930).
2451. Schmitt, F. O. and M. G. Scott, *ibid.*, **107**, 85 (1934).
2452. Schmitt, H., *Munch. med. Wochschr.*, **76**, 1129 (1929).
- 2452a. Schneider, W. C., G. H. Hogeboom, and co-workers, *J. Biol. Chem.*, **165**, 585, 615 (1946); **172**, 451, 619 (1948).
2453. Schoenheimer, R., S. Ratner, and D. Rittenberg, *ibid.*, **130**, 703 (1939).
2454. Schönbein, C. F., *Verhandl. naturforsch. Ges. Basel*, **1**, 339 (1863).
2455. Schönberger, S., *Biochem. Z.*, **278**, 428 (1935).
2456. Schönberger, S. and P. Balint, *ibid.*, **283**, 210 (1936).
2457. Schönheimer, R., *Z. physiol. Chem.*, **180**, 144 (1929).
2458. Schönheyder, F., *J. Biol. Chem.*, **123**, 491 (1938).
2459. Scholander, P. F. and F. J. W. Roughton, *J. Med. Hyg. Toxicol.*, **24**, 218 (1942).
2460. Scholderer, H., *Biochem. Z.*, **257**, 137, 145 (1933).
2461. Schottmüller, H., *Munch. med. Wochschr.*, **50**, 849, 909 (1903).
2462. Schottmüller, H., cited by C. J. Watson in Downey's *Handbook of Hematology*, Vol. 4, Hoeber, New York, 1938, p. 2461.
2463. Schrade, W., *Folia Haematol.*, **61**, 145 (1938).
2464. Schreus, H. T., *Klin. Wochschr.*, **13**, 121, 334 (1934).
2465. Schreus, H. T., *ibid.*, **14**, 1717 (1935).
2466. Schreus, H. T. and C. Carrié, *Dermatol. Z.*, **62**, 347 (1931).
2467. Schreus, H. T. and C. Carrié, *Strahlentherapie.*, **40**, 340 (1931).
2468. Schreus, H. T. and C. Carrié, *Klin. Wochschr.*, **12**, 146 (1933).
2469. Schreus, H. T. and C. Carrié, *Z. klin. Med.*, **125**, 330 (1933).
2470. Schreus, H. T. and C. Carrié, *Klin. Wochschr.*, **13**, 1670 (1934).
2471. Schüller, H., *Biochem. Z.*, **255**, 474 (1932).
2472. Schütz, F., *Nature*, **155**, 759 (1945).
2473. Schulz, F. N., *Z. allgem. Physiol.*, **3**, 91 (1903).
2474. Schulz, F. N. and M. Becker, *Z. physiol. Chem.*, **203**, 157 (1931); *Biochem. Z.*, **236**, 157 (1931).
2475. Schultze, M. O., *J. Biol. Chem.*, **129**, 729 (1939).

2476. Schultze, M. O., *Physiol. Revs.*, **20**, 37 (1940).
2477. Schultze, M. O., *J. Biol. Chem.*, **138**, 219 (1941).
2478. Schultze, M. O., *ibid.*, **142**, 89 (1942).
2479. Schultze, M. O. and C. A. Elvehjem, *ibid.*, **102**, 357 (1933).
2480. Schultze, M. O. and C. A. Elvehjem, *ibid.*, **116**, 711 (1936).
2481. Schultze, M. O., C. A. Elvehjem, and E. B. Hart, *ibid.*, **116**, 107 (1936).
2482. Schultze, M. O., C. J. Harrer, and C. G. King, *ibid.*, **131**, 5 (1939).
2483. Schultze, M. O. and K. A. Kuiken, *ibid.*, **137**, 727 (1940).
2484. Schultze, M. O. and S. J. Simmons, *ibid.*, **142**, 97 (1941).
2485. Schultze, M. O., E. Stotz, and C. G. King, *ibid.*, **122**, 395 (1937).
2486. Schultze, M. O., *ibid.*, **128**, lxxxviii (1939).
2487. Schulz, A., *Arch. Anat. Physiol. Suppl.*, **1904**, 271.
2488. Schumm, O., *Z. physiol. Chem.*, **80**, 1 (1912); **87**, 171 (1913); **97**, 1 (1916).
2489. Schumm, O., *ibid.*, **96**, 183 (1915).
2490. Schumm, O., *ibid.*, **97**, 32 (1916).
2491. Schumm, O., *ibid.*, **98**, 123 (1916).
2492. Schumm, O., *ibid.*, **126**, 169 (1923).
2493. Schumm, O., *ibid.*, **132**, 34 (1923).
2494. Schumm, O., *ibid.*, **133**, 309 (1924).
2495. Schumm, O., *ibid.*, **139**, 247 (1924).
2496. Schumm, O., *ibid.*, **139**, 219 (1924).
2496a. Schumm, O., *ibid.*, **142**, 209 (1925).
2497. Schumm, O., *ibid.*, **144**, 272 (1925); **147**, 228 (1925); **149**, 1 (1925).
2498. Schumm, O., *ibid.*, **149**, 111 (1925).
2499. Schumm, O., *ibid.*, **150**, 48 (1925).
2500. Schumm, O., *ibid.*, **152**, 1 (1926).
2501. Schumm, O., *ibid.*, **152**, 8 (1926).
2502. Schumm, O. and A. Papendieck, *ibid.*, **152**, 219 (1926).
2503. Schumm, O., *ibid.*, **153**, 225 (1926).
2504. Schumm, O., *ibid.*, **153**, 246 (1926); **159**, 194 (1926); **169**, 3 (1927); *Ber.*, **61B**, 784 (1928).
2505. Schumm, O., *Z. physiol. Chem.*, **178**, 1 (1928).
2506. Schumm, O., *Die spectrochemische Analyse natürlicher organischer Farbstoffe*, Fischer, Jena, 1927.
2507. Schumm, O., "Chemie der Erythrocyten und des Haemoglobins," *Handbuch der allgemeinen Hamatologie*, Band 1, Hälfte 1, Urban & Schwarzenberg, Berlin, 1932, p. 98.
2508. Schumm, O., *Arch. exper. Path. Pharmacol.*, **191**, 529 (1939).
2509. Schumm, O., *Z. ges. exper. Med.*, **106**, 252 (1939).
2510. Schumm, O. and E. Mertens, *Z. physiol. Chem.*, **156**, 64 (1926).
2511. Schwab, G. M., B. Rosenfeld, and L. Rudolph, *Ber.*, **66B**, 661 (1933).
2512. Schwartz, S., V. E. Hawkinson, S. Cohen, and C. J. Watson, *Science*, **103**, 338 (1946); *J. Biol. Chem.*, **168**, 133 (1947).
2513. Schwartz, S., V. Shorov, and C. J. Watson, *Proc. Soc. Exper. Biol. Med.*, **49**, 643 (1942).
2514. Schwartz, S., V. Shorov, and C. J. Watson, *Am. J. Clin. Path.*, **14**, 598 (1944).
2515. Schwartz, S. and C. J. Watson, *Proc. Soc. Exper. Biol. Med.*, **49**, 641 (1942).
2516. Schwarzenbach, G. and L. Michaelis, *J. Am. Chem. Soc.*, **60**, 1667 (1938).
2517. Schwedtke, G., *Arch. exper. Path. Pharmacol.*, **188**, 130 (1938).
2518. Scott, C. C., *Am. J. Physiol.*, **144**, 626 (1945).
2519. Scott, E. M., *Arch. Biochem.*, **6**, 27 (1945).
2520. Scott, E. M. and R. H. McCoy, *ibid.*, **5**, 349 (1944).

2521. Scott, L. D., *J. Lab. Clin. Med.*, **18**, 399 (1936).
2522. Scott, L. D., *Brit. J. Exptl. Path.*, **22**, 17 (1941).
2523. Scott, M. L. and co-workers, *J. Biol. Chem.*, **154**, 713 (1944); **158**, 291 (1945).
2524. Scott, M. L., C. L. Norris, and G. F. Heuser, *Science*, **103**, 303 (1946).
2525. Scudi, J. V. and R. P. Buhs, *J. Biol. Chem.*, **144**, 599 (1942).
2526. Seggel, K. A., *Folia Haematol.*, **52**, 250 (1934); **54**, 374 (1936); *Klin. Wochschr.*, **15**, 574 (1936); *Ergeb. inn. Med. Kinderheilk.*, **58**, 582 (1940).
2527. Seggel, K. A., *Klin. Wochschr.*, **16**, 382 (1937).
2528. Seide, G., *Biochem. Z.*, **308**, 175 (1941).
- 2528a. Seits, I. F. *Biokhimiya*, **12**, 123 (1947).
2529. Selwood, P. W., *Magnetochemistry*, Interscience, New York, 1943.
2530. Sendju, Y., *J. Biochem. Japan*, **7**, 191 (1927).
2531. Sendroy, J., Jr., *J. Biol. Chem.*, **91**, 307 (1931).
2532. Sendroy, J., Jr., R. T. Dillon, and D. D. Van Slyke, *ibid.*, **105**, 597 (1934).
2533. Sendroy, J., Jr., S. H. Liu, and D. D. Van Slyke, *Am. J. Physiol.*, **90**, 511 (1930).
2534. Sepulveda, B. and A. E. Osterberg, *J. Lab. Clin. Med.*, **28**, 1359 (1943).
2535. Sevag, M. G., M. Shelburne, and M. Ibsen, *J. Biol. Chem.*, **144**, 711 (1942).
2536. Seyderhelm, R., H. Tammann, and W. Baumann, *Z. ges. exptl. Med.*, **57**, 641 (1927); **66**, 539 (1929).
2537. Seyfarth, C., *Folia Haematol.*, **34**, 7 (1927).
2538. Shack, J., *J. Natl. Cancer Inst.*, **3**, 389 (1943).
- 2538a. Shack, J. and W. M. Clark, *J. Biol. Chem.*, **171**, 143 (1947).
2539. Shapot, V. S., *Biokhimiya*, **3**, 430 (1938).
2540. Shapot, V. S., *ibid.*, **10**, 130 (1945).
2541. Sheard, Ch., E. J. Baldes, F. C. Mann, and J. L. Bollmann, *Am. J. Physiol.*, **76**, 577 (1926).
2542. Shelling, D. H. and H. W. Josephs, *Bull. Johns Hopkins Hosp.*, **55**, 309 (1934).
- 2542a. Shemin, D., I. M. London, and D. Rittenberg, *J. Biol. Chem.*, **173**, 799 (1948).
2543. Shemin, D. and D. Rittenberg, *ibid.*, **159**, 567 (1945); **166**, 627 (1946).
2544. Sherman, W. C., C. A. Elvehjem, and E. B. Hart, *ibid.*, **107**, 383 (1934).
2545. Shibata, K. and E. Yakushiji, *Naturwissenschaften*, **21**, 267 (1933).
2546. Shibuya, H., *Strahlentherapie*, **17**, 412 (1924).
2547. Shorland, F. B. and E. M. Wall, *Biochem. J.*, **30**, 1049 (1936).
2548. Shribhishaj, K., W. B. Hawkins, and G. H. Whipple, *Am. J. Physiol.*, **96**, 449 (1931).
2549. Sidwell, A. E., R. H. Munch, E. S. G. Barron, and T. R. Hogness, *J. Biol. Chem.*, **123**, 335 (1938).
2550. Siedel, W., *Z. physiol. Chem.*, **237**, 8 (1935).
2551. Siedel, W., *ibid.*, **245**, 257 (1937).
2552. Siedel, W., *Angew. Chem.*, **52**, 98 (1939).
2553. Siedel, W., *Ber.*, **77A**, 21 (1944).
2554. Siedel, W. and H. Fischer, *Z. physiol. Chem.*, **214**, 145 (1933).
2555. Siedel, W. and W. Fröwis, *ibid.*, **267**, 37 (1940).
2556. Siedel, W. and E. Grams, *ibid.*, **267**, 49 (1940).
2557. Siedel, W. and E. Meier, *ibid.*, **242**, 101 (1936).
2558. Siedel, W. and H. Möller, *ibid.*, **259**, 113 (1939).
2559. Siedel, W. and H. Möller, *ibid.*, **264**, 64 (1940).
2560. Sigurdsson, B., *J. Exptl. Med.*, **77**, 315 (1943).
2561. Silver, B. and M. Elliott, *J. Am. Med. Assoc.*, **112**, 723 (1939).
2562. Simmons, R. W. and E. R. Norris, *J. Biol. Chem.*, **140**, 679 (1941).
2563. Simon, F. P., M. K. Horwitt, and R. W. Gerard, *ibid.*, **154**, 421 (1944).
2564. Simonovits, S. and G. Balassa, *Biochem. Z.*, **281**, 186 (1935).

2565. Singer, K., *Wien. Arch. inn. Med.*, **20**, 59 (1930).
 2566. Singer, K., *J. Lab. Clin. Med.*, **30**, 784 (1945).
 2567. Singer, E., *Australian J. Exptl. Biol. Med. Sci.*, **23**, 41 (1945).
 2568. Singer, K. and R. Kubin, *J. Lab. Clin. Med.*, **28**, 1042 (1945).
 2569. Sinton, J. A. and B. N. Ghosh, *Records Malaria Survey India*, **4**, 205 (1934).
 2570. Sizer, I. W., *J. Biol. Chem.*, **154**, 461 (1944).
 2571. Skinner, J. T. and J. S. McHargue, *Am. J. Physiol.*, **145**, 500 (1946).
 2571a. Slater, E. C., *Nature*, **161**, 405 (1948).
 2572. Slyke, D. D. Van and A. Hiller, *J. Biol. Chem.*, **78**, 807 (1928).
 2573. Slyke, D. D. Van and A. Hiller, *ibid.*, **84**, 205 (1929).
 2574. Slyke, D. D. Van and J. M. Neill, *ibid.*, **61**, 523 (1924).
 2574a. Slyke, D. D. Van and co-workers, *ibid.*, **166**, 121 (1946).
 2575. Smetana, H., *J. Exptl. Med.*, **47**, 593 (1928); *J. Biol. Chem.*, **124**, 667 (1938); **125**, 741 (1939).
 2575a. Smith, C. H., *J. Am. Med. Assoc.*, **134**, 992 (1947).
 2575b. Smith, E. L., *Nature*, **161**, 638 (1948).
 2576. Smith, L. and G. G. L. Wolf, *J. Med. Research*, **12**, 451 (1904).
 2577. Smith, P. K., *Am. J. Med. Sci.*, **200**, 183 (1940).
 2578. Smith, P. W. and L. A. Crandall, *Am. J. Physiol.*, **135**, 259 (1942).
 2579. Smith, S. E. and co-workers, *J. Elisha Mitchell Sci. Soc.*, **59**, 117 (1943).
 2580. Smith, S. E. and M. Medicott, *Am. J. Physiol.*, **141**, 354 (1944).
 2581. Smith, S. G. and D. H. Sprunt, *J. Nutrition*, **10**, 481 (1935); *Proc. Soc. Exptl. Biol. Med.*, **49**, 691 (1942).
 2582. Smythe, C. V., *J. Biol. Chem.*, **90**, 251 (1931).
 2583. Snapper, I., *Arch. Verdauungs-Krankh.*, **25**, 230 (1919).
 2584. Snapper, I., *Nederland. Tijdschr. Geneeskunde*, **66**, 2541 (1922).
 2585. Snapper, I. and S. van Crefeld, *Ergeb. inn. Med. u. Kinderheilk.*, **32**, 1 (1927).
 2586. Snapper, I., J. Groen, D. Hunter, and L. J. Witts, *Quart. J. Med.*, **6**, 1951 (1937).
 2587. Snapper, I., *Deut. med. Wochschr.*, **51**, 648 (1925).
 2588. Snell, F. D. and C. T. Snell, *Colorimetric Methods of Analysis*, Van Nostrand, New York, 1936-37.
 2589. Sobel, I. P. and I. J. Drechter, *Am. J. Diseases Children*, **45**, 486 (1933).
 2590. Soejima, R., *Arch. klin. Chir.*, **149**, 206 (1927).
 2591. Soejimba, *Nisshia-Jgaku*, **16**, 1723 (1937).
 2592. Soffer, L. J. and M. Paulson, *Arch. Internal Med.*, **53**, 809 (1934).
 2593. Somogyi, M., *J. Biol. Chem.*, **103**, 665 (1933).
 2594. Sonnenfeld, A., *Klin. Wochschr.*, **2**, 2124 (1923); *Z. klin. Med.*, **100**, 508 (1924).
 2595. Sorby, H. Q., *Proc. Zool. Soc. London*, **1875**, 351.
 2596. Sorby, H. Q., *Quart. J. Microscop. Sci.*, **16**, 76 (1876).
 2597. Soret, J. L., *Compt. rend.*, **97**, 1267 (1883).
 2598. Sparkman, R., *Arch. Internal Med.*, **63**, 858 (1939).
 2599. Spector, H. and co-workers, *J. Biol. Chem.*, **150**, 75 (1943).
 2600. Spies, T. D. and co-workers, *Southern Med. J.*, **38**, 707, 781 (1945); **39**, 30 (1946); *J. Lab. Clin. Med.*, **31**, 227 (1946).
 2601. Spies, T. D. and co-workers, *Lancet I*, **1946**, 225; *J. Am. Med. Assoc.*, **130**, 474 (1946).
 2602. Spies, T. D. and co-workers, *Southern Med. J.*, **39**, 269 (1946); *Blood*, **1**, 85 (1946).
 2603. Spies, T. D. and W. J. Payne, *J. Clin. Invest.*, **12**, 229 (1933).
 2604. Spiess, C., *Compt. rend.*, **141**, 333, 506 (1905).
 2605. Stadelmann, E., *Der Icterus u. seine verschiedenen Formen, nebst. Beiträgen z. Physiol. u. Pathol. der Gallensekretion*, Enke, Stuttgart, 1891.

2606. Stadie, W. C. and K. A. Martin, *J. Clin. Invest.*, **2**, 77 (1925-6).
 2606a. Stadie, W. C. and H. O'Brien, *J. Biol. Chem.*, **112**, 723 (1935); **117**, 429 (1937).
 2607. Städeler, F., *Ann.*, **132**, 323 (1864).
 2608. Stannard, J. N., *Cold Spring Harbor Symposia Quant. Biol.*, **7**, 394 (1939).
 2609. Stannard, J. N., *Am. J. Physiol.*, **126**, 196 (1939).
 2610. Stannard, J. N., *ibid.*, **129**, 195 (1940).
 2611. Stannard, J. N., *ibid.*, **135**, 238 (1941-42).
 2612. Stark, I. E. and M. Somogyi, *J. Biol. Chem.*, **147**, 319, 721, 731 (1943).
 2613. Starkenstein, E. and H. Weden, *Arch. exptl. Path. Pharmacol.*, **134**, 274 (1928).
 2614. Starling, E. H., *Principles of Human Physiology*, 6th ed., Churchill, London, 1933.
 2615. Stasney, J. and W. M. McCord, *Proc. Soc. Exptl. Biol. Med.*, **51**, 340 (1943).
 2616. Stearn, A. E., *Ergeb. Enzymforsch.*, **7**, 1 (1938).
 2617. Steigmann, F. and J. M. Dymiewicz, *Gastroenterology*, **1**, 743 (1943).
 2618. Stein, J., *Arch. exptl. Zellforsch. Gewebezucht*, **20**, 78 (1937).
 2619. Steinglass, P., A. J. Gordon, and H. A. Charipper, *Proc. Soc. Exptl. Biol. Med.*, **48**, 169 (1941).
 2620. Steinhardt, J., *Kgl. Danske Videnskab. Selskab, Mat. fys. Medd.*, **14**, No. 11 (1937).
 2621. Steinhardt, J., *J. Biol. Chem.*, **123**, 543 (1938).
 2622. Stenhagen, E. and E. K. Rideal, *Biochem. J.*, **33**, 1591 (1939).
 2623. Stenhagen, E. and T. Teorell, *Nature*, **141**, 415 (1938).
 2624. Stephens, D. J. and E. E. Hawley, *J. Biol. Chem.*, **115**, 653 (1936).
 2625. Stephenson, M., *Bacterial Metabolism*, 2nd ed., Longmans, Green, London, New York, Toronto, 1939.
 2626. Stephenson, M. and L. H. Stickland, *Biochem. J.*, **25**, 205 (1931).
 2627. Stephenson, M. and L. H. Stickland, *ibid.*, **25**, 215 (1931).
 2628. Stephenson, M. and L. H. Stickland, *ibid.*, **26**, 712 (1932).
 2629. Stephenson, M. and L. H. Stickland, *ibid.*, **27**, 1517, 1528 (1933).
 2630. Stephenson, J., *The Polychaeta*, Oxford Univ. Press, London, 1930.
 2631. Stern, A., *Z. physik. Chem.*, **174A**, 332 (1935); **175A**, 434 (1936); *Angew. Chem.*, **49**, 55 (1936).
 2632. Stern, A. and M. Deželic, *Z. physik. Chem.*, **176A**, 40 (1936).
 2633. Stern, A. and M. Deželic, *ibid.*, **179A**, 275 (1937).
 2634. Stern, A. and M. Deželic, *ibid.*, **180A**, 131 (1937).
 2635. Stern, A. and G. Klebs, *Ann.*, **500**, 91 (1932); **504**, 287 (1933); **505**, 295 (1933).
 2636. Stern, A. and H. Molvig, *Z. physik. Chem.*, **177A**, 55 (1936).
 2637. Stern, A. and H. Molvig, *ibid.*, **175A**, 38 (1936); **176**, 209 (1936).
 2638. Stern, A. and H. Molvig, *ibid.*, **177A**, 365 (1936).
 2639. Stern, A. and F. Pruckner, *ibid.*, **178A**, 420 (1937).
 2640. Stern, A. and H. Wenderlein, *ibid.*, **170A**, 337 (1934).
 2641. Stern, A. and H. Wenderlein, *ibid.*, **174A**, 81 (1935).
 2642. Stern, A. and H. Wenderlein, *ibid.*, **175A**, 405 (1936); **176**, 81 (1936).
 2643. Stern, A., H. Wenderlein, and H. Molvig, *ibid.*, **177A**, 40 (1936).
 2644. Stern, A., E. F. Beach, and I. G. Macy, *J. Biol. Chem.*, **130**, 733 (1939).
 2645. Stern, K. G., *Z. physiol. Chem.*, **204**, 259 (1932).
 2646. Stern, K. G., *ibid.*, **208**, 86 (1932).
 2647. Stern, K. G., *ibid.*, **209**, 176 (1932).
 2648. Stern, K. G., *ibid.*, **215**, 35 (1933).
 2649. Stern, K. G., *ibid.*, **219**, 105 (1933).
 2650. Stern, K. G., *Nature*, **136**, 335 (1935).
 2651. Stern, K. G., *Science*, **83**, 190 (1936).
 2652. Stern, K. G., *J. Biol. Chem.*, **112**, 661 (1936).

2653. Stern, K. G., *ibid.*, **121**, 561 (1937).
2654. Stern, K. G., *J. Gen. Physiol.*, **20**, 631 (1937).
2655. Stern, K. G., *Cold Spring Harbor Symposia Quant. Biol.*, **7**, 312 (1939).
2656. Stern, K. G., *Ann. Rev. Biochem.*, **9**, 1 (1940).
2657. Stern, K. G., *Symposia on Respiratory Enzymes*, Univ. Wisconsin Press, Madison, 1942, p. 74.
2658. Stern, K. G. and D. DuBois, *J. Biol. Chem.*, **116**, 575 (1936).
2659. Stern, K. G. and G. I. Lavin, *Science*, **88**, 263 (1938).
2660. Stern, K. G., L. Melnick, and D. DuBois, *ibid.*, **91**, 436 (1940).
2661. Stern, K. G. and R. W. Wyckoff, *J. Biol. Chem.*, **124**, 573 (1938).
2662. Stern, L., *Biochem. Z.*, **182**, 139 (1927).
2663. Stickland, L. H., *Biochem. J.*, **23**, 1187 (1929).
2664. Stiehler, R. D. and L. B. Flexner, *J. Biol. Chem.*, **126**, 603 (1938).
2665. Stickney, J. C. and E. J. van Liere, *J. Aviation Med.*, **13**, 170 (1942).
2666. Stier, E., *Z. physiol. Chem.*, **273**, 47 (1942).
2667. Stier, E., *ibid.*, **275**, 155 (1942).
- 2667a. Stier, E. and K. Gangl, *ibid.*, **272**, 239 (1942).
2668. Stier, T. J. B. and J. G. B. Castor, *J. Gen. Physiol.*, **25**, 229 (1941).
2669. Stitt, F. and C. D. Coryell, *J. Am. Chem. Soc.*, **61**, 1263 (1939).
2670. Stokvis, B. J., *Centr. inn. Med.*, **11**, 211 (1873).
2671. Stokvis, B. J., *Z. klin. Med.*, **28**, 1 (1895).
2672. Stone, F. M. and C. B. Coulter, *J. Gen. Physiol.*, **15**, 629 (1932).
2673. Stoner, H. B. and H. N. Green, *J. Path. Bact.*, **56**, 343 (1944).
2674. Stotz, E., *J. Biol. Chem.*, **131**, 555 (1939).
2675. Stotz, E., *Cold Spring Harbor Symposia Quant. Biol.*, **7**, 111 (1939).
2676. Stotz, E., *Symposia on Respiratory Enzymes*, Univ. Wisconsin Press, Madison, 1942, p. 149.
2677. Stotz, E., A. M. Altschul, and T. R. Hogness, *J. Biol. Chem.*, **124**, 745 (1938).
2678. Stotz, E., C. J. Harrer, M. O. Schultze, and C. G. King, *ibid.*, **120**, 129 (1937).
2679. Stotz, E., C. J. Harrer, M. O. Schultze, and C. G. King, *ibid.*, **122**, 407 (1937).
2680. Stotz, E., A. E. Sidwell, Jr., and T. R. Hogness, *ibid.*, **124**, 11 (1938).
2681. Stotz, E., A. E. Sidwell, Jr., and T. R. Hogness, *ibid.*, **124**, 733 (1938).
2682. Strahl, H., *Arch. Anat. u. Physiol. Suppl.*, **1890**, 118; *Anat. Hefte*, **5**, 337 (1895).
2683. Strasser, U., *Wien. Arch. inn. Med.*, **31**, 267 (1937).
2684. Straub, F. B., *Z. physiol. Chem.*, **268**, 227 (1941).
2685. Strauss, M. B., *J. Clin. Invest.*, **12**, 345 (1933).
2686. Stroebe, F., *Z. klin. Med.*, **120**, 95 (1932).
2687. Strong, F. M., *Science*, **100**, 287 (1943).
2688. Strong, L. C., *Proc. Soc. Exptl. Biol. Med.*, **50**, 123 (1942).
2689. Strong, L. C., *ibid.*, **57**, 78 (1944).
2690. Subbarow, Y. and B. M. Jacobson, *J. Biol. Chem.*, **114**, cii (1936).
2691. Subbarow, Y., B. M. Jacobson, and C. H. Fiske, *New Engl. J. Med.*, **212**, 663 (1935).
2692. Subbarow, Y., B. M. Jacobson, and V. Prochownik, *J. Am. Chem. Soc.*, **58**, 2234 (1936).
2693. Sullmann, V. H. and A. Vischer, *Biochem. Z.*, **274**, 7 (1934).
2694. Sümegi, G. and M. Csaba, *Arch. exptl. Zellforsch.*, **11**, 339 (1931).
2695. Sümegi, G., M. Csaba, and E. v. Balogh, *Arch. path. Anat. Physiol. (Virchow's)*, **293**, 320 (1934).
2696. Sullivan, C. F., W. P. Few, and E. M. Watson, *J. Obstet. Gynaecol. Brit. Empire*, **41**, 347 (1934).

2697. Sumner, J. B., in *Advances in Enzymology*, Vol. I, Interscience, New York, 1941, p. 163.
2698. Sumner, J. B. and A. L. Dounce, *J. Biol. Chem.*, **121**, 417 (1937).
2699. Sumner, J. B. and A. L. Dounce, *ibid.*, **127**, 439 (1939).
2700. Sumner, J. B., A. L. Dounce, and V. L. Frampton, *J. Biol. Chem.*, **136**, 343 (1940).
2701. Sumner, J. B. and E. C. Gjessing, *Arch. Biochem.*, **2**, 295 (1943).
2702. Sumner, J. B. and N. Gralén, *J. Biol. Chem.*, **125**, 33 (1938).
2703. Sumner, J. B. and S. F. Howell, *Enzymologia*, **1**, 133 (1936).
2704. Sumner, J. B. and M. C. Nymon, *Science*, **102**, 208 (1945).
2705. Sumner, J. B. and G. F. Somers, *Chemistry and Methods of Enzymes*, Academic Press, New York, 1943.
2706. Sunderman, F. W., *Am. J. Clin. Path. Tech. Sect.*, **7**, 1 (1943).
2707. Supniewski, J. V., *J. Physiol.*, **64**, 30 (1927).
2708. Svedberg, T., *J. Biol. Chem.*, **103**, 311 (1933).
2709. Svedberg, T., *Chem. Revs.*, **20**, 81 (1937).
2710. Svedberg, T., *Nature*, **139**, 1051 (1937).
2711. Svedberg, T., *Proc. Roy. Soc. London*, **127B**, 1 (1939).
2712. Svedberg, T. and I. B. Ericksson, *J. Am. Chem. Soc.*, **54**, 3938 (1932).
2713. Svedberg, T. and I. B. Ericksson, *ibid.*, **55**, 2834 (1933).
2714. Svedberg, T. and I. B. Ericksson-Quensel, *ibid.*, **56**, 1700 (1934).
2715. Svedberg, T. and I. B. Ericksson-Quensel, *Tabulae Biol.*, **11**, 351 (1936).
2716. Svedberg, T. and R. Fåhræus, *J. Am. Chem. Soc.*, **48**, 430 (1926).
2717. Svedberg, T. and A. Hedenius, *Biol. Bull.*, **66**, 191 (1934).
2718. Svedberg, T. and T. Katsurai, *J. Am. Chem. Soc.*, **51**, 3573 (1929).
2719. Svedberg, T. and N. B. Lewis, *ibid.*, **50**, 525 (1928).
2720. Svedberg, T. and J. B. Nichols, *ibid.*, **49**, 2920 (1927).
2721. Svedberg, T. and K. O. Pedersen, *The Ultracentrifuge*, Oxford Univ. Press, London, 1940.
2722. Swedin, B. and H. Theorell, *Nature*, **145**, 71 (1940).
2723. Sydenstricker, V. P. and co-workers, *J. Am. Med. Assoc.*, **118**, 1199 (1942).
2724. Symposium, *Cold Spring Harbor Symposia Quant. Biol.*, **6** (1938).
2725. Szent-Györgyi, A. v., *Biochem. J.*, **22**, 1387 (1928).
2726. Szent-Györgyi, A. v., *Z. physiol. Chem.*, **254**, 147 (1937).
2727. Szent-Györgyi, A. v., *Nature*, **148**, 157 (1941); *Science*, **93**, 609 (1941).
2728. Szigeti, B., *Biochem. J.*, **34**, 1460 (1940).
2729. Taber, E., D. E. Davis, and L. V. Domm, *Am. J. Physiol.*, **138**, 479 (1943).
2730. Tafani, A., *Biol. Zentr.*, **6**, 613 (1886).
2731. Takasu, M., *Deut. Z. Chir.*, **224**, 240 (1930).
2732. Talbot, J. H. and D. B. Dill, *Am. J. Med. Sci.*, **192**, 626 (1936).
2733. Tamiya, H. and H. Kubo, *Acta Phytochim. Japan*, **10**, 317 (1938); *Studies Tohokagawa Inst.*, **5**, No. 1 (1939).
2734. Tamiya, H. and Y. Ogura, *Acta Phytochim. Japan*, **9**, 123 (1937).
2735. Tamiya, H. and K. Tanaka, *ibid.*, **5**, 182 (1930).
2736. Tamiya, H. and S. Yamagutchi, *ibid.*, **7**, 233 (1933).
- 2736a. Tammann, G., *Z. physik. Chem.*, **110**, 17 (1924).
2737. Taniguchi, K., *Arch. exptl. Path. Pharmacol.*, **130**, 37 (1928).
2738. Tappeiner, H., *Fortschr. Med.*, **4**, 21 (1904).
2739. Tarchanoff, J. F., *Arch. ges. Physiol.*, **9**, 53 (1874).
2740. Tashiro, S., E. Badger, and W. Younker, *Proc. Soc. Exptl. Biol. Med.*, **45**, 377 (1940).

2741. Tat, R., T. J. Greenwalt, and W. Dameshek, *Am. J. Diseases Children*, **65**, 558 (1943).
2742. Tauber, H., *J. Biol. Chem.*, **113**, 753 (1936).
2743. Tauber, H., *Enzymologia*, **1**, 209 (1936).
2744. Tauber, H. and J. Kleiner, *Proc. Soc. Exptl. Biol. Med.*, **33**, 391 (1935).
2745. Taylor, A., J. Thacker, and D. Pennington, *Science*, **96**, 342 (1942).
2746. Taylor, A. E., *Centr. inn. Med.*, **18**, 873 (1897).
2747. Taylor, D. S., *J. Am. Chem. Soc.*, **61**, 2150 (1939).
2748. Taylor, D. S. and C. D. Coryell, *J. Am. Chem. Soc.*, **60**, 1177 (1938).
2749. Taylor, J. F., *J. Biol. Chem.*, **135**, 569 (1940).
2750. Taylor, J. F., *ibid.*, **144**, 7 (1942).
2751. Taylor, J. F. and A. B. Hastings, *ibid.*, **131**, 649 (1939).
2752. Taylor, J. F. and A. B. Hastings, *ibid.*, **144**, 1 (1942).
2753. Taylor, J. F. and V. E. Morgan, *ibid.*, **144**, 15 (1942).
2754. Teichmann, L., cf. M. Nencki, and J. Zaleski, *Z. physiol. Chem.*, **30**, 384 (1900).
2755. Tempka, and B. Braun, *Folia Haematol.*, **45**, 269 (1931).
2756. Terwen, A. L. J., *doctoral dissertation*, Amsterdam, 1924.
2757. Thannhauser, J. S. and E. Andersen, *Deut. Arch. klin. Med.*, **137**, 179 (1921).
2758. Thauer, R., *Arch. exptl. Path. Pharmacol.*, **176**, 531 (1934).
2759. Theorell, H., *Biochem. Z.*, **252**, 1 (1932).
2760. Theorell, H., *ibid.*, **268**, 46 (1934).
2761. Theorell, H., *ibid.*, **268**, 64 (1934).
2762. Theorell, H., *ibid.*, **268**, 73 (1934).
2763. Theorell, H., *ibid.*, **268**, 81 (1934).
2764. Theorell, H., *ibid.*, **279**, 463 (1935).
2765. Theorell, H., *Nature*, **138**, 687 (1936).
2766. Theorell, H., *Biochem. Z.*, **285**, 207 (1936).
2767. Theorell, H., *ibid.*, **288**, 312 (1936).
2768. Theorell, H., *Enzymologia*, **4**, 192 (1937).
2769. Theorell, H., *Biochem. Z.*, **298**, 242 (1938).
2770. Theorell, H., *ibid.*, **301**, 201 (1939).
2771. Theorell, H., *Ann. Rev. Biochem.*, **9**, 663 (1940).
2772. Theorell, H., *Arkiv. Kemi Mineral. Geol.*, **14B**, No. 20 (1940).
2773. Theorell, H., *ibid.*, **15B**, No. 24 (1940).
2774. Theorell, H., *ibid.*, **16A**, No. 2 (1942).
2775. Theorell, H., *ibid.*, **16A**, No. 3 (1942).
2776. Theorell, H., *ibid.*, **16A**, No. 14 (1942).
2777. Theorell, H., *Enzymologia*, **10**, 250 (1943).
2778. Theorell, H., *Ergeb. Enzymforsch.*, **9**, 239 (1943).
2779. Theorell, H., *Nature*, **156**, 474 (1945).
- 2779a. Theorell, H., *Advances in Enzymology*, Vol. VII, Interscience, New York, 1947, p. 265.
2780. Theorell, H. and K. Agner, *Arkiv Kemi Mineral. Geol.*, **16A**, No. 7 (1942).
2781. Theorell, H. and Å. Åkesson, *Science*, **90**, 67 (1939).
2782. Theorell, H. and Å. Åkesson, *J. Am. Chem. Soc.*, **63**, 1804 (1941).
2783. Theorell, H. and Å. Åkesson, *ibid.*, **63**, 1812 (1941).
2784. Theorell, H. and Å. Åkesson, *ibid.*, **63**, 1818 (1941).
2785. Theorell, H. and Å. Åkesson, *ibid.*, **63**, 1820 (1941).
2786. Theorell, H. and Å. Åkesson, *Arkiv Kemi Mineral. Geol.*, **16A**, No. 8 (1942).
2787. Theorell, H. and Å. Åkesson, *ibid.*, **17B**, No. 7 (1943).
- 2787a. Theorell, H. and de Duve, *Arch. Biochem.*, **12**, 113 (1947).

2788. Theorell, H., S. Bergström, and Å. Åkesson, *ibid.*, **16A**, No. 13 (1942).
2789. Theorell, H. and K. G. Paul, *ibid.*, **18A**, No. 12 (1944).
2790. Theorell, H., in A. Tiselius and K. O. Pedersen, *Svedberg, 1884-1944*, Almqvist & Wicksells, Uppsala, 1944.
2791. Theorell, H. and B. Swedin, *Naturwissenschaften*, **27**, 95 (1939).
2792. Thiel, A., *Biochem. Z.*, **298**, 436 (1938).
2793. Thiel, A. and H. Logemann, *Biochem. Z.*, **284**, 347 (1936).
2794. Thiel and O. Peter, *ibid.*, **271**, 1 (1934).
2795. Thoenes, F. and R. Aschaffenburg, *Der Eisenstoffwechsel des wachsenden Organismus*, Karger, Berlin, 1934.
2796. Thomas, J., *Compt. rend. soc. biol.*, **118**, 381 (1934).
2797. Thomas, J., *ibid.*, **125**, 386 (1937).
2798. Thomas, J., *Bull. soc. chim. biol.*, **20**, 471, 635, 878, 1058 (1938); *Contribution à l'étude des porphyrines en biologie et pathologie*, M. Declume, Lons-Le-Saunier, 1938.
2799. Thomas, J., *Bull. soc. chim. biol.*, **21**, 1053 (1939).
- 2799a. Thorell, B., *Studies on the Formation of Cellular Substances during Blood Cell Production*, Kimpton, London, 1947.
2800. Thorpe, W. V. and R. T. Williams, *Biochem. J.*, **35**, 52, 61 (1941).
2801. Thudichum, J. L., *10th Report of the Medical Officer of the Privy Council, Appendix, London*, 1868, p. 228.
2802. Thudichum, J. L., *Ann. Rev. Chem. Med.*, **1**, 93 (1879); *Grundzüge anat. klin. Med.*, 1886, 321.
2803. Thunison, A. V. and co-workers, *N. Y. State Conservation Dept. Fisheries Research Bull.*, **5**, *Cortland Hatchery Rept.*, 12 (1943).
2804. Thurlow, S., *Biochem. J.*, **19**, 175 (1925).
2805. Tiedemann, F. and L. Gmelin, *Die Verdauung nach Versuchen*, **1**, 80 (1826).
2806. Titus, R. W., H. W. Cave, and J. S. Hughes, *J. Biol. Chem.*, **80**, 565 (1928).
2807. Timar, E., *Biochem. Z.*, **202**, 365 (1928).
2808. Tiselius, A., *Nova Acta Regiae Soc. Sci. Upsaliensis*, **7**, No. 4 (1930).
2809. Tiselius, A. and D. Gross, *Kolloid-Z.*, **66**, 12 (1934).
- 2809a. Tissières, A., *Arch. intern. physiol.*, **54**, 305 (1946).
- 2809b. Tixier, R., *Ann. inst. océanog.*, **22**, 343 (1945).
- 2809c. Tixier, R., *Compt. rend.*, **225**, 508 (1947).
- 2809d. Tixier, R., and E. Lederer, *Commun. 13th Intern. Congr. Zool. Paris*, 1948.
2810. Tixier, R. and A. Tixier-Durivault, *Bull. soc. chim. biol.*, **25**, 98 (1943).
2811. Tobias, C. A. and co-workers, *Am. J. Physiol.*, **145**, 253 (1945).
2812. Tobie, W. C., *Proc. Soc. Exptl. Biol. Med.*, **34**, 620 (1936).
2813. Todd, A. T., *Am. J. Med. Sci.*, **171**, 635 (1926).
2814. Tompsett, S. L., *Biochem. J.*, **28**, 1536 (1934).
2815. Tompsett, S. L., *ibid.*, **28**, 1544 (1934).
2816. Tompsett, S. L., *ibid.*, **28**, 1802 (1934).
2817. Tompsett, S. L., *ibid.*, **29**, 480 (1935).
2818. Topley, W. M. and G. S. Wilson, *The Principles of Bacteriology and Immunology*, 2nd ed., Arnold, London, 1936, p. 433 ff.
2819. Totter, J. R. and co-workers, *Science*, **100**, 223 (1944); *J. Biol. Chem.*, **152**, 147 (1944).
2820. Toverud, K. U., *Acta Paediat.*, **22**, 91 (1937).
2821. Towbin, E. J., P. E. Fanta, and H. C. Hodge, *Proc. Soc. Exptl. Biol. Med.*, **60**, 228 (1945).
2822. Treibs, A., *Z. physiol. Chem.*, **168**, 68 (1927).
2823. Treibs, A., *ibid.*, **212**, 26 (1932).
2824. Treibs, A., *Ann.*, **510**, 42 (1934).
2825. Treibs, A., *Angew. Chem.*, **47**, 725 (1934).

2826. Treibs, A., *ibid.*, **49**, 551, 682 (1936).
 2827. Treibs, A. and E. Wiedemann, *Ann.*, **471**, 150, 222 (1929).
 2828. Tria, E., *J. Biol. Chem.*, **129**, 377 (1939).
 2829. Tria, E., *Ricerca Sci.*, **11**, 345 (1940).
 2830. Tropp, C. and H. Hofmann, *Biochem. Z.*, **292**, 74 (1937).
 2831. Tschesche, R. and H. T. Wolf, *Z. physiol. Chem.*, **244**, I (1936); **248**, 34 (1937).
 2832. Tsuchihashi, M., *Biochem. Z.*, **140**, 63 (1923).
 2833. Tsuchiya, I., *Z. ges. exptl. Path. Therap.*, **7**, 352 (1910).
 2834. Tsunoo, S. and H. Nakamura, *J. Biochem. Japan*, **12**, 133 (1930).
 2834a. Tulin, M. and co-workers, *J. Physiol. U. S. S. R.*, **31**, 191 (1945).
 2835. Turchini, J., *Compt. rend. assoc. anat.*, **19**, 255 (1924).
 2836. Turner, W. J., *J. Biol. Chem.*, **118**, 519 (1937).
 2837. Turner, W. J., *Arch. Internal Med.*, **61**, 762 (1938).
 2838. Turner, W. J., *Arch. Dermatol. and Syphilol.*, **37**, 549 (1938).
 2839. Turner, W. J., *J. Lab. Clin. Med.*, **26**, 323 (1940).
 2840. Twyman, F. and C. B. Allsopp, *Spectrophotometry*, Hilger, London, 1934.
2841. Urbach, E., *Klin. Wochschr.*, **17**, 304 (1938).
 2842. Urbach, E., *ibid.*, **17**, 1435 (1938).
 2843. Urban, F., *J. Biol. Chem.*, **109**, xciii (1935).
 2844. Vahlquist, B. C., *Acta Paediat.*, **28**, Suppl. 5 (1941).
 2845. Valer, J., *Biochem. Z.*, **190**, 444 (1927).
 2846. Vandenbelt, J. M. and co-workers, *J. Pharmacol. Exptl. Therap.*, **80**, 31 (1941).
 2847. Vannotti, A., *Z. ges. exptl. Med.*, **97**, 377 (1935).
 2848. Vannotti, A., *Ergeb. inn. Med. u. Kinderheilk.*, **49**, 337 (1935).
 2849. Vannotti, A., *Klin. Wochschr.*, **16**, 583 (1936.)
 2850. Vannotti, A., *Porphyrine u. Porphyrinrankheiten*, Springer, Berlin, 1937.
 2850a. Vannotti, A., *Schweiz. Akad. Med. Wiss.*, **2**, 90 (1946).
 2851. Vannotti, A. and E. Neuhaus, *Z. ges. exptl. Med.*, **97**, 398 (1935).
 2852. Vannotti, A. and A. Imholz, *ibid.*, **106**, 597 (1939).
 2853. Vannotti, A. and V. de Kalbermatten, *Helv. Med. Acta*, **11**, 189 (1944).
 2854. Vogt, H. and G. Geisler, *Deut. Arch. klin. Med.*, **189**, 44 (1942).
 2855. Varela, B., E. Apolo, and C. Viana, *Compt. rend. soc. biol.*, **108**, 1014 (1931).
 2856. Varela, B. and J. Esculies, *ibid.*, **107**, 884 (1931).
 2857. Varela, B., P. Recarte, and J. Esculies, *ibid.*, **108**, 1009 (1931).
 2858. Varela, B. and C. Viana, *ibid.*, **114**, 786, 789 (1933); **115**, 1567 (1934).
 2859. Vaughan, J. M., *Quart. J. Med.*, **23**, 213 (1930).
 2860. Vaughan, J. M., *Trans. Roy. Soc. Trop. Med. Hyg.*, **27**, 533 (1933-34).
 2861. Vaughan, J. M., *Brit. Med. J.* I, **1942**, 548.
 2862. Vaughan, J. M. and M. F. Saifi, *J. Path. Bact.*, **49**, 69 (1939).
 2863. Veer, W. L. C., *Rec. trav. chim.*, **61**, 638, 646 (1942).
 *2864. Van de Velde, quoted by C. J. Watson in Downey's *Handbook of Hematology*, Vol. 4, Hoeber, New York, 1938., p. 2463
 2865. Vennndt, H., *Z. physiol. Chem.*, **263**, 162 (1940).
 2866. Vernon, H. M., *J. Physiol.*, **42**, 402 (1911); **44**, 150 (1912).
 2867. Verzár, F., *Z. ges. exptl. Med.*, **68**, 475 (1929).
 2868. Verzár, F. and co-workers, *Biochem. Z.*, **257**, 113 (1933).
 2869. Verzár, F., H. Süllmann, and A. Vischer, *Biochem. Z.*, **274**, 7 (1934).
 2870. Verzár, F. and E. Fischer, *Z. ges. exptl. Med.*, **80**, 385 (1932).
 2871. Verzár, F. and A. Zih, *Klin. Wochschr.*, **7**, 1031 (1928); *Biochem. Z.*, **205**, 388 (1929).
 2872. Vestling, C. S., *J. Biol. Chem.*, **135**, 623 (1940).

* In general, names with "von" and "van" will be found under the part of the name following the connective.

2873. Vestling, C. S., *ibid.*, **143**, 439 (1942).
 2874. Vestling, C. S. and J. R. Downing, *J. Am. Chem. Soc.*, **61**, 3511 (1939).
 2875. Viault, F., *Compt. rend.*, **111**, 917 (1890).
 2876. Vickery, H. B., *J. Biol. Chem.*, **132**, 325 (1940).
 2877. Vickery, H. B., *Ann. N. Y. Acad. Sci.*, **41**, 87 (1941).
 2878. Vickery, H. B., *J. Biol. Chem.*, **143**, 77 (1942).
 2879. Vickery, H. B., *ibid.*, **144**, 719 (1942).
 2880. Vickery, H. B., *ibid.*, **156**, 283 (1944).
 2881. Vickery, H. B. and C. S. Leavenworth, *ibid.*, **79**, 377 (1928).
 2882. Vigliani, E. C., *Arch. sci. med.*, **65**, 391 (1938).
 2883. Vigliani, E. C. and C. Angeleri, *Clin. med. ital.*, **65**, 1 (1934); *Klin. Wochschr.*, **15**, 700 (1936).
 2884. Vigliani, E. C., C. Angeleri, and M. Sand. *Arch. sci. med.*, **65**, 423 (1938).
 2885. Vigliani, E. C. and H. Libowitzky, *Klin. Wochschr.*, **16**, 1243 (1937).
 2886. Vigliani, E. C. and B. Sonzini, *Arch. sci. med.*, **65**, 363 (1938).
 2887. Vigliani, E. C. and J. Waldenström, *Deut. Arch. klin. Med.*, **180**, 182 (1937).
 2888. Villa, L., *Arch. path. Anat. Physiol. (Virchow's)*, **277**, 380 (1930).
 2889. Virchow, R., *ibid.*, **1**, 379 (1847).
 2890. Virtanen, A. I., *Nature*, **155**, 747 (1945).
 2891. Virtanen, A. I. and T. Laine, *ibid.*, **157**, 25 (1946).
 2892. Vischer, A., *Biochem. Z.*, **268**, 116 (1934).
 2893. Vitolo, A. E., *Giorn. batteriol. immunol.*, **30**, 141 (1943).
 2893a. Vladimirov, G. E. and A. I. Kolotilova, *Biokhimiya*, **12**, 321 (1937).
 2894. Vles, F., *Arch. phys. biol.*, **1**, 1 (1921).
 2895. Vles, F., *ibid.*, **2**, No. 6 (1923).
 2896. Völker, O., *Z. physiol. Chem.*, **258**, 1 (1939).
 2897. Völker, O., *J. Ornithol.*, **86**, 436 (1938); **88**, 604 (1940).
 2898. Völker, O., *Z. physiol. Chem.*, **273**, 277 (1942).
 2899. Vogler, K. G., G. A. Le Page, and W. Umbreit, *J. Gen. Physiol.*, **26**, 89 (1942).
 2900. Wachtel, L. W., C. A. Elvehjem, and E. B. Hart, *Am. J. Physiol.*, **140**, 72 (1943).
 2901. Wadsworth, A., M. O'L. Crowe, and L. A. Smith, *Brit. J. Exptl. Path.*, **16**, 201 (1935).
 2902. Waelsch, H., *Z. physiol. Chem.*, **188**, 161 (1930).
 2903. Wagenaar, M., *Z. anal. Chem.*, **103**, 417 (1935).
 2904. Waisman, H. A., *Proc. Soc. Exptl. Biol. Med.*, **55**, 69 (1944).
 2905. Waldenström, J., *Acta Med. Scand.*, **83**, 281 (1934).
 2906. Waldenström, J., *Deut. Arch. klin. Med.*, **178**, 38 (1935).
 2907. Waldenström, J., *Z. physiol. Chem.*, **239**, IV (1936).
 2908. Waldenström, J., *Acta Med. Scand. Suppl.*, **82**, (1937).
 2909. Waldenström, J., *Acta Psychiat. et Neurol.*, **14**, 375 (1939).
 2910. Waldenström, J., H. Fink, and W. Hoerburger, *Z. physiol. Chem.*, **233**, 1 (1935).
 2911. Waldenström, J. and B. Vahlquist, *ibid.*, **260**, 189 (1939).
 2912. Waldenström, J. and S. Wendt, *ibid.*, **259**, 157 (1939).
 2913. Waldschmidt-Leitz, E., *ibid.*, **214**, 75 (1933).
 2914. Wallace, G. B. and J. S. Diamond, *Arch. Internal Med.*, **35**, 698 (1925).
 2915. Waltner, K. and K. Waltner, *Klin. Wochschr.*, **8**, 313 (1929).
 2916. Warburg, O., *Ergeb. Physiol.*, **14**, 264 (1914).
 2917. Warburg, O., *Biochem. Z.*, **165**, 196 (1925).
 2918. Warburg, O., *ibid.*, **172**, 432 (1926).
 2919. Warburg, O., *ibid.*, **177**, 471 (1926).
 2920. Warburg, O., *ibid.*, **189**, 354 (1927).
 2921. Warburg, O., *Naturwissenschaften*, **15**, 546 (1927).

2922. Warburg, O., *ibid.*, **16**, 345 (1928).
2923. Warburg, O., *Katalytische Wirkungen der Lebendigen Substanz*, Springer, Berlin, 1928.
2924. Warburg, O., *Z. Elektrochem.*, **35**, 549 (1929).
2925. Warburg, O., *Biochem. Z.*, **214**, 101 (1929).
2926. Warburg, O., *ibid.*, **233**, 486 (1932).
2927. Warburg, O., *ibid.*, **244**, 239 (1932).
2928. Warburg, O., *Z. angew. Chem.*, **45**, 1 (1932).
2929. Warburg, O., *Naturwissenschaften*, **22**, 441 (1934).
2930. Warburg, O., *Ergeb. Enzymforsch.*, **7**, 210 (1938).
2931. Warburg, O. and W. Christian, *Biochem. Z.*, **238**, 131 (1931).
2932. Warburg, O. and W. Christian, *ibid.*, **242**, 206 (1931).
2933. Warburg, O. and W. Christian, *ibid.*, **254**, 438 (1932).
2934. Warburg, O. and W. Christian, *ibid.*, **287**, 302 (1936).
2935. Warburg, O. and W. Christian, *ibid.*, **292**, 287 (1937).
2936. Warburg, O., W. Christian, and A. Griese, *Biochem. Z.*, **282**, 157 (1935).
2937. Warburg, O. and E. Haas, *Naturwissenschaften*, **22**, 207 (1934).
2938. Warburg, O. and H. Krebs, *Biochem. Z.*, **190**, 143 (1927).
2939. Warburg, O. and F. Kubowitz, *ibid.*, **203**, 95 (1928).
2940. Warburg, O. and F. Kubowitz, *ibid.*, **227**, 184 (1930).
2941. Warburg, O., F. Kubowitz, and W. Christian, *ibid.*, **221**, 499 (1930).
2942. Warburg, O., F. Kubowitz, and W. Christian, *ibid.*, **227**, 245 (1930).
2943. Warburg, O., F. Kubowitz, and W. Christian, *ibid.*, **233**, 240 (1930).
2944. Warburg, O., F. Kubowitz, and W. Christian, *ibid.*, **242**, 170 (1931).
2945. Warburg, O. and W. Lüttgens, *Naturwissenschaften*, **32**, 161, 301 (1944); *Biokhimiya*, **11**, 303 (1946).
2946. Warburg, O. and E. Negelein, *Biochem. Z.*, **193**, 334, 339 (1928).
2947. Warburg, O. and E. Negelein, *ibid.*, **200**, 414 (1928).
2948. Warburg, O. and E. Negelein, *ibid.*, **202**, 202 (1928).
2949. Warburg, O. and E. Negelein, *ibid.*, **204**, 495 (1929).
2950. Warburg, O. and E. Negelein, *ibid.*, **214**, 64 (1929).
2951. Warburg, O. and E. Negelein, *ibid.*, **233**, 486 (1930).
2952. Warburg, O. and E. Negelein, *Ber.*, **63B**, 1816 (1930).
2953. Warburg, O. and E. Negelein, *Biochem. Z.*, **238**, 135 (1931).
2954. Warburg, O. and E. Negelein, *ibid.*, **244**, 9 (1932).
2955. Warburg, O. and E. Negelein, *ibid.*, **262**, 237 (1933).
2956. Warburg, O., E. Negelein, and W. Christian, *ibid.*, **214**, 26 (1929).
2957. Warburg, O., E. Negelein, and E. Haas, *ibid.*, **227**, 171 (1930).
2958. Warburg, O., E. Negelein, and E. Haas, *ibid.*, **266**, 1 (1933).
2959. Warburg, O. and A. Reid, *ibid.*, **242**, 149 (1931).
2960. Waring, W. S. and C. H. Werkman, *Arch. Biochem.*, **4**, 75 (1944).
2961. Warren, C. O., *J. Cellular Comp. Physiol.*, **19**, 193 (1942).
2962. Warren, C. O. and C. F. Carter, *J. Biol. Chem.*, **150**, 267 (1943).
2963. Warren, C. O., Q. D. Schubmehl, and I. R. Wood, *Am. J. Physiol.*, **142**, 173 (1944).
2964. Washburn, E. W., *Intern. Crit. Tables*, **6**, 266 (1929).
2965. Wassermann, A., *Ber.*, **65B**, 704 (1932).
2966. Wassermann, A., *Ann.*, **503**, 249 (1933).
2967. Wasserman, L. R., M. Volterra, and N. Rosenthal, *Am. J. Med. Sci.*, **204**, 356 (1942).
2968. Waters, L. L. and C. Stock, *Science*, **102**, 601 (1945).
2969. Watson, C. J., *Arch. Internal. Med.*, **47**, 698 (1931).
2970. Watson, C. J., *Z. physiol. Chem.*, **204**, 57 (1932).

2971. Watson, C. J., *ibid.*, **208**, 101 (1932).
2972. Watson, C. J., *ibid.*, **221**, 145 (1933).
2973. Watson, C. J., *Proc. Soc. Exptl. Biol. Med.*, **30**, 1207 (1933).
2974. Watson, C. J., *J. Biol. Chem.*, **105**, 469 (1934).
2975. Watson, C. J., *J. Clin. Invest.*, **14**, 104 (1935).
2976. Watson, C. J., *ibid.*, **14**, 106 (1935).
2977. Watson, C. J., *ibid.*, **14**, 110 (1935).
2978. Watson, C. J., *ibid.*, **14**, 116 (1935).
2979. Watson, C. J., *J. Am. Med. Assoc.*, **104**, 247 (1935).
2980. Watson, C. J., *Proc. Soc. Exptl. Biol. Med.*, **32**, 1508 (1935).
2981. Watson, C. J., *Z. physiol. Chem.*, **233**, 39 (1935).
2982. Watson, C. J., *J. Biol. Chem.*, **114**, 47 (1936).
2983. Watson, C. J., *Proc. Soc. Exptl. Biol. Med.*, **34**, 377 (1936).
2984. Watson, C. J., *Am. J. Clin. Path.*, **6**, 458 (1936).
2985. Watson, C. J., *J. Clin. Invest.*, **15**, 327 (1936).
2986. Watson, C. J., *ibid.*, **16**, 383 (1937).
2987. Watson, C. J., *Arch. Internal Med.*, **59**, 196 (1937).
2988. Watson, C. J., *ibid.*, **59**, 206 (1937).
2989. Watson, C. J., "The Pyrrole Pigments," quoted in Downey's *Handbook of Hematology*, Vol. 4, Hoeber, New York, 1938, p. 2447.
2990. Watson, C. J., *New Engl. J. Med.*, **227**, 665 (1942).
2991. Watson, C. J. and co-workers, *Am. J. Med. Sci.*, **210**, 463 (1945).
2991a. Watson, C. J., *Blood*, **1**, 99 (1946).
2992. Watson, C. J. and E. Bilden, *Arch. Internal Med.*, **68**, 740 (1941).
2993. Watson, C. J. and W. O. Clarke, *Proc. Soc. Exptl. Biol. Med.*, **36**, 65 (1937).
2994. Watson, C. J., M. Grinstein, and V. Hawkinson, *J. Clin. Invest.*, **23**, 69 (1944).
2995. Watson, C. J. and Hochmann, quoted in Downey's *Handbook of Hematology*, Vol. 4, Hoeber, New York, 1938, p. 2447.
2996. Watson, C. J. and J. R. Paine, *Am. J. Med. Sci.*, **205**, 493 (1943).
2997. Watson, C. J., I. J. Pass, and S. Schwartz, *J. Biol. Chem.*, **139**, 583 (1941).
2998. Watson, C. J., V. Sborov, and S. Schwartz, *Proc. Soc. Exptl. Biol. Med.*, **49**, 647 (1942).
2999. Watson, C. J. and S. Schwartz, *ibid.*, **44**, 7 (1940).
3000. Watson, C. J. and S. Schwartz, *ibid.*, **47**, 393 (1941).
3001. Watson, C. J. and S. Schwartz, *ibid.*, **49**, 636 (1942).
3002. Watson, C. J., S. Schwartz, and V. Hawkinson, *J. Biol. Chem.*, **157**, 345 (1945).
3003. Watson, C. J., S. Schwartz, V. Sborov, and E. Bertie, *Am. J. Clin. Path.*, **14**, 605 (1944).
3004. Watson, C. J. and W. W. Spink, *Arch. Internal Med.*, **65**, 825 (1940).
3004aa. Watson, C. J. and co-workers, *Proc. Soc. Exptl. Biol. Med.*, **64**, 73 (1947).
3004a. Watts, B. M. and Da-Hwejn Peng, *J. Biol. Chem.*, **170**, 441 (1947).
3005. Wearn, J. T., J. Warren, and O. Ames, *Arch. Internal Med.*, **29**, 527 (1922).
3005a. Webb, E. C. and R. van Heyningen, *Biochem. J.*, **41**, 74 (1947).
3006. Webb, D. A., *J. Exptl. Biol.*, **16**, 499 (1939).
3007. Webb, T. J. and M. Kniazuk, *J. Biol. Chem.*, **128**, 511 (1939).
3008. Webster, M. D. and co-workers, *J. Cellular Comp. Physiol.*, **5**, 399 (1934).
3009. Weech, A. A., D. Vann, and A. A. Grillo, *J. Clin. Invest.*, **20**, 323 (1941).
3010. Wehrle, H., *Arch. Path.*, **25**, 514 (1938).
3011. Weil, L., *J. Franklin Inst.*, **238**, 145 (1944).
3012. Weinberger, E., *Z. physiol. Chem.*, **238**, 124 (1936).
3013. Weise, W., *Biochem. Z.*, **292**, 64 (1937).

3014. Weise, W., *Arquiv. inst. biol. São Paulo*, **11**, 595 (1940).
3015. Weiss, G. and L. Hollos, *Ber. ges. Physiol. u. exptl. Pharmacol.*, **54**, 479 (1929).
3016. Weiss, J., *Nature*, **133**, 648 (1934).
3017. Weiss, J., *Naturwissenschaften*, **23**, 64 (1935).
3018. Weiss, J., *Trans. Faraday Soc.*, **31**, 668 (1935).
3019. Weiss, J., *ibid.*, **31**, 1547 (1935).
3020. Weiss, J., *J. Phys. Chem.*, **41**, 1107 (1937).
3021. Weiss, J. and H. Weil-Malherbe, *Nature*, **144**, 866 (1939).
3022. Weiss, M., *Deut. Arch. klin. Med.*, **149**, 255 (1925).
3023. Weiss, M., *Wien. Arch. inn. Med.*, **20**, 39 (1930).
3024. Weiss, M., *Deut. Arch. klin. Med.*, **166**, 331 (1930); **177**, 97 (1934).
3025. Weiss, M., *Biochem. Z.*, **233**, 354 (1931).
3026. Weissberger, A., ed., *Physical Methods of Organic Chemistry*, Interscience, New York, 1945.
3027. Welch, A. D. and co-workers, *J. Biol. Chem.*, **164**, 787 (1946).
3028. Welcker, M. L., *New Engl. J. Med.*, **232**, 11 (1945).
3029. Weller, S. and J. Franck, *J. Phys. Chem.*, **45**, 1359 (1941).
3030. Weltmann, O., *Wien. klin. Wochschr.*, **36**, 389 (1923).
3031. Weltmann, O. and H. Hüchel, *Med. Klin. Munich*, **24**, 1393 (1928); **25**, 560 (1929).
3032. Wendel, W. B., *J. Biol. Chem.*, **102**, 373 (1932).
3033. Wendel, W. B., *ibid.*, **102**, 385 (1932).
3034. Wendel, W. B., *J. Pharmacol. Exptl. Therap.*, **54**, 283 (1935).
3035. Wendel, W. B., *J. Clin. Invest.*, **18**, 179 (1939).
3036. Wendel, W. B., N. M. Wendel, and W. W. Cox, *J. Biol. Chem.*, **131**, 177 (1939).
3037. Wespi, H., *Klin. Wochschr.*, **14**, 1820 (1935).
3038. Wessler, S. and C. S. French, *J. Cellular Comp. Physiol.*, **13**, 327 (1939).
3039. West, R. and M. Howe, *J. Biol. Chem.*, **88**, 427 (1930).
3040. Westerfeld, W. W. and C. Lowe, *ibid.*, **145**, 463 (1942).
3041. Wheeler, M. W. and M. O'L. Crowe, *J. Bact.*, **31**, 519 (1936).
3042. Wheland, G. W., *Ann. N. Y. Acad. Sci.*, **40**, 77 (1940).
3043. Whidborne, J. and C. H. Gray, *Biochem. J.*, **39**, xi, xii (1945); *ibid.*, **40**, 81 (1946).
3044. Whipple, G. H., *Arch. Internal Med.*, **29**, 711 (1922).
3045. Whipple, G. H., *Physiol. Revs.*, **2**, 440 (1922).
3046. Whipple, G. H., *Harvey Lectures*, **17**, 103 (1921-2).
3047. Whipple, G. H., *Am. J. Physiol.*, **76**, 693 (1926).
3048. Whipple, G. H., *ibid.*, **76**, 708 (1926).
3049. Whipple, G. H., *J. Am. Med. Assoc.*, **104**, 791 (1935).
3050. Whipple, G. H., *Am. J. Med. Sci.*, **196**, 609 (1938).
3051. Whipple, G. H., *ibid.*, **203**, 477 (1942).
3052. Whipple, G. H. and C. W. Hooper, *Am. J. Physiol.*, **42**, 256 (1917).
3053. Whipple, G. H. and C. W. Hooper, *ibid.*, **43**, 258 (1917).
3054. Whipple, G. H., C. W. Hooper, and F. S. Robscheit-Robbins, *Am. J. Physiol.*, **53**, 167 (1920).
3055. Whipple, G. H. and C. S. Madden, *Medicine*, **23**, 215 (1944).
3056. Whipple, G. H. and F. S. Robscheit-Robbins, *Arch. Internal Med.*, **27**, 591 (1921); *Proc. Soc. Exptl. Biol. Med.*, **21**, 554 (1924).
3057. Whipple, G. H. and F. S. Robscheit-Robbins, *Am. J. Physiol.*, **72**, 395 (1925).
3058. Whipple, G. H. and F. S. Robscheit-Robbins, *ibid.*, **78**, 675 (1926).
3059. Whipple, G. H. and F. S. Robscheit-Robbins, *ibid.*, **92**, 362 (1930).
3060. Whipple, G. H. and F. S. Robscheit-Robbins, *Am. J. Med. Sci.*, **191**, 11 (1936).
3061. Whipple, G. H. and F. S. Robscheit-Robbins, *J. Exptl. Med.*, **71**, 569 (1940).

3062. Whipple, G. H. and F. S. Robscheit-Robbins, *ibid.*, **76**, 283 (1942).
3063. Whipple, G. H., F. S. Robscheit-Robbins, and W. B. Hawkins, *ibid.*, **81**, 171 (1945).
- 3063a. Whipple, G. H., F. S. Robscheit-Robbins, and L. L. Miller, *Ann. N. Y. Acad. Sci.*, **47**, 317 (1946).
3064. Whipple, G. H., F. S. Robscheit-Robbins, and G. B. Walden, *Am. J. Med. Sci.*, **179**, 628 (1930).
3065. Whipple, G. H., K. H. Shribishaj, and W. B. Hawkins, *Am. J. Physiol.*, **96**, 440 (1931).
3066. Whitby, L. E. H. and C. J. C. Britton, *Disorders of the Blood*, 3rd ed., Churchill, London, 1939.
3067. White, F. W. and co-workers, *Am. J. Digestive Diseases Nutrition*, **8**, 346 (1941).
3068. Wicke, *J. Ornithol.*, **1858**, 393.
3069. Widdowson, E. M. and R. A. McCance, *J. Hyg.*, **36**, 13 (1936).
3070. Widdowson, E. M. and R. A. McCance, *Biochem. J.*, **31**, 2029 (1937).
3071. Wieland, H. and W. Franke, *Ann.*, **457**, 1 (1927).
3072. Wieland, H. and A. Kotschmar, *ibid.*, **530**, 152 (1937).
3073. Wieland, H. and J. Pistor, *ibid.*, **522**, 116 (1936).
3074. Wieland, H. and H. Sutter, *Ber.*, **61B**, 1060 (1928).
3075. Wieland, H. and H. Sutter, *ibid.*, **63B**, 66 (1930).
3076. Wieland, H. and A. Tartter, *Ann.*, **545**, 197 (1940).
3077. Wien, R., *Quart. J. Pharm. Pharmacol.*, **11**, 217 (1938).
3078. Wiener, A. S., *J. Am. Med. Assoc.*, **102**, 1779 (1934); *Blood Groups and Transfusions*, 3rd ed., C. C. Thomas, Springfield, 1943.
3079. Wieringa, K. T., *Antonie van Leeuwenhoek, J. Microbiol. Serol.*, **3**, 88, 263 (1936).
3080. Wigglesworth, V. B., *Biol. Rev. Biol. Proc. Cambridge Phil. Soc.*, **6**, 181 (1931).
3081. Wigglesworth, V. B., *Proc. Roy. Soc. London*, **131B**, 313 (1943).
3082. Wilbur, R. L. and T. Addis, *Arch. Internal Med.*, **13**, 235 (1914).
- 3082a. Wildt, R., *Rev. Modern Phys.*, **14**, 151 (1942).
3083. Wille, N., *Ber. deut. botan. Ges.*, **40**, 188 (1922).
3084. Williams, M. E., *Physiol. Zool.*, **9**, 231 (1936).
3085. Williams, R. T., *Biochem. J.*, **37**, 329 (1943).
3086. Willstätter, R., *Ber.*, **47**, 2831 (1914).
3087. Willstätter, R. and M. Fischer, *Z. physiol. Chem.*, **87**, 430, 488 (1912).
3088. Willstätter, R. and M. Mieg, *Ann.*, **400**, 147 (1913).
3089. Willstätter, R. and A. Pollinger, *ibid.*, **430**, 269ff. (1923).
3090. Willstätter, R. and A. Pollinger, *Z. physiol. Chem.*, **130**, 281 (1932).
3091. Willstätter, R. and A. Stoll, *Untersuchungen über das Chlorophyll*, Springer, Berlin, 1913.
3092. Willstätter, R. and A. Stoll, *Untersuchungen über die Assimilation der Kohlen-säure*, Berlin, 1918.
3093. Willstätter, R. and A. Stoll, *Ann.*, **416**, 21 (1918).
3094. Willstätter, R. and H. Weber, *ibid.*, **449**, 156 (1926).
3095. Wilson, J. B., S. B. Lee, and P. W. Wilson, *J. Biol. Chem.*, **144**, 265 (1942).
3096. Wilson, J. B. and P. W. Wilson, *J. Gen. Physiol.*, **26**, 277 (1942).
3097. Wilson, P. W., *Ergeb. Enzymforsch.*, **8**, 13 (1939).
3098. Wilson, P. W., *The Biochemistry of Symbiotic Nitrogen Fixation*, Univ. Wisconsin Press, Madison, 1942.
3099. Winegarden, H. M. and H. Borsook, *J. Cellular Comp. Physiol.*, **3**, 437 (1933).
3100. Winternitz, W., *Z. ges. expul. Med.*, **47**, 634 (1925).
3101. Winternitz, W., *Klin. Wochschr.*, **5**, 938 (1926).
3102. Wintrobe, M. M., *Folia Haematol.*, **51**, 32 (1933).

3103. Wintrobe, M. M., *Clinical Hematology*, Lea & Febiger, Philadelphia, 1942.
3104. Wintrobe, M. M. and co-workers, *J. Clin. Invest.*, **16**, 667 (1937).
3105. Wintrobe, M. M. and co-workers, *Bull. Johns Hopkins Hosp.*, **72**, 1 (1943).
3105a. Wintrobe, M. M. and co-workers, *Blood*, **2**, 323 (1947).
3106. Wintrobe, M. M. and A. B. Shumaker, *J. Clin. Invest.*, **14**, 837 (1935); *Am. J. Anat.*, **58**, 313 (1936).
3107. With, T. K., *Z. physiol. Chem.*, **278**, 120 (1943).
3108. With, T. K., *Acta Med. Scand.*, **114**, 426 (1943).
3109. With, T. K., *ibid.*, **115**, 542 (1943).
3110. With, T. K., *ibid.*, **119**, 214 (1944).
3111. With, T. K., *ibid.*, **122**, 501 (1945).
3112. With, T. K., *ibid.*, **122**, 513 (1945).
3113. With, T. K., *ibid.*, **123**, 166 (1946).
3113a. With, T. K., *Nature*, **158**, 310 (1946).
3114. Witts, L. J., *Lancet I*, 1936, 1.
3115. Witts, L. J., *Lancet II*, 1936, 115.
3116. Witts, L. J. and M. D. Manch, *Lancet I*, 1932, 495.
3117. Wolff, K., *Biochem. Z.*, **288**, 79 (1936).
3118. Wolsky, A., *J. Exptl. Biol.*, **15**, 225 (1938).
3119. Woods, D. D., *Biochem. J.*, **30**, 515 (1936).
3120. Woodward, G. E. and E. G. Fry, *J. Biol. Chem.*, **97**, 465 (1932).
3121. Woodward, I., *J. Chem. Soc.*, 1940, 601.
3122. Wrede, F., *Z. physiol. Chem.*, **210**, 125 (1932).
3123. Wrede, F. and O. Hettche, *Ber.*, **62B**, 2678 (1929).
3124. Wrede, F. and A. Rothaas, *Z. physiol. Chem.*, **215**, 67 (1933); **222**, 203 (1933); **226**, 95 (1934).
3125. Wrede, F. and A. Rothaas, *ibid.*, **223**, 113 (1934).
3126. Wright, G. P., *J. Gen. Physiol.*, **14**, 179, 201 (1930).
3127. Wright, G. P. and M. van Alstyne, *J. Biol. Chem.*, **93**, 71 (1931).
3128. Wright, L. D. and A. D. Welch, *Science*, **98**, 179 (1943).
3129. Wu, H., *J. Biochem. Japan*, **2**, 189 (1923).
3130. Wu, H. and K. H. Lin, *Chinese J. Physiol.*, **1**, 219 (1927).
3131. Wu, H. and E. F. Yang, *ibid.*, **6**, 51 (1932).
3132. Wurmser, R. and S. Filitti-Wurmser, *Compt. rend. soc. biol.*, **127**, 471 (1938).
3133. Wurmser, R. and S. Filitti-Wurmser, *J. chim. phys.*, **35**, 81 (1938).
3134. Wyman, J., *J. Biol. Chem.*, **127**, 1 (1939).
3135. Wyman, J., *ibid.*, **127**, 581 (1939).
3136. Wyman, J. and E. N. Ingalls, *ibid.*, **139**, 877 (1941).
3137. Wyman, J. and E. N. Ingalls, *ibid.*, **147**, 297 (1943).
3138. Wyman, J., J. A. Rafferty, and E. N. Ingalls, *ibid.*, **153**, 275 (1944).
3138a. Wyman, J., in *Advances in Protein Chemistry*, **4**, 407 (1948).
3139. Wyss, O. and P. W. Wilson, *Proc. Natl. Acad. Sci. U. S.*, **27**, 162 (1941).
3140. Yabusoe, M., *Biochem. Z.*, **157**, 388 (1925).
3141. Yakushiji, E., *Acta Phytochim. Japan*, **8**, 325 (1935).
3142. Yakushiji, E. and T. Mori, *ibid.*, **10**, 113 (1937).
3143. Yakushiji, E. and K. Okunuki, *Proc. Imp. Acad. Tokyo*, **17**, 38 (1941).
3144. Yakushiji, E. and K. Okunuki, *ibid.*, **16**, 229 (1940).
3145. Yamagutchi, S., *Acta Phytochim. Japan*, **8**, 166 (1934).
3146. Yamagutchi, S., *Shokubutsu-Gaku Zasshi, Botan. Mag. Tokyo*, **51**, 457 (1937).
3147. Yamazaki, E., *Science Repts. Tohoku Imp. Univ., First Ser.*, **9**, 13-59 (1920).
3148. Yaoi, H., *Japan J. Exptl. Med.*, **7**, 135 (1928).
3149. Yaoi, H. and H. Tamiya, *Proc. Imp. Acad. Tokyo*, **4**, 436 (1928).

3150. Yllpö, A., *Z. Kinderheilk.*, **9**, 208 (1919).
 3151. Yoshikawa, H., *J. Biochem. Japan*, **25**, 627 (1937).
 3152. Yoshikawa, H., P. F. Hahn, and W. F. Bale, *Proc. Soc. Exptl. Biol. Med.*, **49**, 284 (1942).
 3153. Yuile, C. L., *Physiol. Revs.*, **22**, 19 (1942).
 3154. Yuile, C. L. and W. F. Clark, *J. Exptl. Med.*, **74**, 187 (1941).
 3155. Yuile, C. L., M. A. Gold, and E. G. Hinds, *ibid.*, **82**, 361 (1945).
3156. Zaleski, J., *Z. physiol. Chem.*, **43**, 11 (1904-5).
 3157. Zeile, K., *ibid.*, **189**, 127, 255 (1930).
 3158. Zeile, K., *ibid.*, **195**, 39 (1931).
 3159. Zeile, K., *ibid.*, **207**, 35 (1932).
 3160. Zeile, K., *Ergeb. Physiol.* **35**, 498 (1933).
 3161. Zeile, K., in Oppenheimer *Handbuch d. Biochemie des Menschen u. d. Tiere*, 2nd Ergänzungswerk, I, Fischer, Jena, 1933, p. 544.
 3162. Zeile, K., *Ber.*, **76A**, 99 (1943).
 3163. Zeile, K. and H. v. Euler, *Z. physiol. Chem.*, **195**, 35 (1931).
 3164. Zeile, K., G. Fawaz, and V. Ellis, *ibid.*, **263**, 181 (1940).
 3165. Zeile, K. and G. Gnant, *ibid.*, **263**, 147 (1940).
 3166. Zeile, K. and H. Hellström, *ibid.*, **192**, 171 (1930).
 3167. Zeile, K. and H. Meyer, *Naturwissenschaften*, **27**, 596 (1939).
 3168. Zeile, K. and H. Meyer, *Z. physiol. Chem.*, **262**, 178 (1939).
 3169. Zeile, K. and P. Piutti, *ibid.*, **218**, 52 (1933).
 3170. Zeile, K. and B. Rau, *ibid.*, **250**, 197 (1937).
 3171. Zeile, K. and F. Reuter, *ibid.*, **221**, 101 (1933).
 3172. Zeldenrust, J., W. L. C. Veer, and J. H. W. Nota, *Nederland. Tijdschr. Geneesk.*, **87**, 875 (1943).
 3173. Zeligman, I., *Proc. Soc. Exptl. Biol. Med.*, **61**, 350 (1946).
 3174. Zeynek, R. v., *Z. physiol. Chem.*, **25**, 492 (1898).
 3175. Zeynek, R. v., *ibid.*, **70**, 224 (1910).
 3176. Zeynek, R. v., and S. Kittel, *ibid.*, **224**, 233 (1934).
 3177. Zeynek, R. v., *ibid.*, **33**, 426 (1901).
 3178. Zeynek, R. v., *ibid.*, **49**, 472 (1906).
 3178a. Ziegenhagen, A. J., S. R. Ames, and C. A. Elvehjem, *J. Biol. Chem.*, **167**, 129 (1947).
 3179. Zih, A., *Z. ges. exptl. Med.*, **104**, 675 (1939).
 3180. Zih, A., *Schweiz. med. Wochschr.*, **69**, 577 (1939).
 3181. Zittle, C. A. and B. Zitin, *J. Biol. Chem.*, **144**, 99, 105 (1942).
 3182. Zumbusch, L. R. v., *Z. physiol. Chem.*, **31**, 446 (1901).

SUBJECT INDEX

A

- Absorption (light)**
bands, influence of side chains on, 75,
90, 117, 121, 176
curves, 14
spectrophotometric estimations, 14
spectrophotometric titrations, 15
spectroscope, direct vision, 10
reversion, 10
symbols and units, 12 (table)
- Actinohematin, 359, 379**
- Adaptation of algae, complementary
chromatic, 572**
- Adrenaline**
coupled oxidation with
cytochrome c, 375
and hyperbilirubinemia, 541
and verdohemochrome formation, 470
- Adrenochrome, 375, 470**
- Adsorption and surface properties, 70,
123**
- Aminophenols**
catalase inhibition by, 410
hemoglobin formation by, 520
- Anemia, 535, 578. See also Lead poisoning.**
catalase in, 416
erythrocyte mortality curve in, 512, 536
hemolytic, 536, 542, 556, 573, 576,
590 (table)
from infections 557, 624
iron (nonhemoglobin) in, 485
pernicious, 537, 556, 557, 565, 573, 580,
583, 584, 590 (table), 591 (table),
597, 611, 629
from vitamin deficiency, 613
- Antipernicious anemia principle, 538, 611**
- Aplysiorhodin, 148**
- Aplysioviolet, 148**
- Arbacia eggs. See Eggs.**
- Aromatic amino and nitro compounds.**
See also *Aminophenols, Nitrophenols,*
Phenylhydrazine, Phenylhydroxylam-
ine, Sulfonamides.
choleglobinemia by, 526
hemoglobinemia by, 519
porphyrin formation by, 596
sulfhemoglobinemia by, 523
- Arsine**
bile pigment formation by, 538
choleglobin formation by, 479, 528
hemoglobin formation by, 479
hemolysis by, 533
- Ascorbic acid**
anticatalase action of, 443
in choleglobin formation, 472, 475
destruction by acidified oxyhemo-
globin, 395, 517
in erythrocyte, 517
and hemoglobin, 391, 477, 517, 522
in hemopoiesis, 613ff., 624
inhibition of dihydroxymaleic acid
oxidase, 434
as substrate of oxidation by hematin
compounds, 341, 375, 469
as substrate of peroxidase, 422, 433, 435
in verdohemochrome formation, 456,
469
- Autoxidation, 384, 388, 391, 392**
- Azahematin compounds, 202**
monazahemochrome, occurrence in
nature, 203, 429
preparation from verdohemochrome,
202, 464
monazahemoglobin, 203, 208, 240
- Azaporphyrins, 89. See also Phthalocyanins.**
- Azide**
hematin compounds, 381
hemoglobin, 221, 407
inhibition of catalase, 409, 440
of hydrogenase, 447
of peroxidases, 421, 422, 432
of photocatalase, 450
of respiratory ferment and cyto-
chrome oxidase, 363, 381

B

- Bacteriochlorophyll, 451, 650**
- Bergh, van den. See Bilirubin (diazo
reaction, estimation).**

Bile pigments

- biological role, 5, 570
- classes, 96, 103, 106 (table), 112 (table)
- bilanes, 105, 134ff. See also *Mesobilane*, *Tetrahydromesobilane*.
- biladienes-(a, c), 108, 110, 118ff. See also *Bilirubin*, *Mesobilirubin*.
- biladienes-(a, b), 108, 124, 125ff. See also *Mesobiliviolin*, *Mesobilerythrin*.
- biladienones and biladiene-diols, 111, 124, 130ff. See also *Biliviolinoid*, *Bilerythrinoid*, *Bilichrysin*.
- bilenediones and bilenetetrols, 111, 144. See also *Choletelin*.
- bilatrienes, 108, 110, 113ff. See also *Biliverdin*, *Mesobiliverdin*.
- bilenes-(a), 109, 138. See also *Mesobilene-(a)*.
- bilenes-(b), 134ff., 140ff., 143
- definition, 95
- estimation, 153ff.
- isomerism, 96, 100, 460
- metal complexes, 108, 118, 123, 131, 199. See also *Bile pigment hematin*.
- nomenclature, 103, 105, 124, 128, 134
- physical properties, 102, 107, 123
- stereochemistry, 100
- structure, 3, 95, 100
- synthesis *in vitro*, 99, 457
- Bile pigment chromoproteins**
 - of algae, 145. See also *Phycocyanin*, *Phycocerythrin*.
 - of animals, 148, 569
- Bile pigment formation**
 - in invertebrates and plants, 569
 - in vitro*, from hematin, 453, 456, 459
 - from hemoglobin, 460, 471
 - photochemical, 471
 - in vivo*, earlier theories, 504
 - from hematin, 504, 575
 - from hemoglobin, 503, 525, 544. See also *Biliverdin*, *Choleglobin*.
 - and hemoglobin formation, 597
 - and porphyrin formation, 594, 595
 - site of, 538ff.
 - in tissue cultures, 540
- Bile pigment hematin**. See also *Verdohematin*, *Choleglobin*.
 - in catalase, 405, 413, 499

- in cytochrome a₂, 371
- in organs, 543
- Bilichrysin, 112 (table), 131, 133
- Bilerythrinoid oxidation products of bilatrienes, 133
- Bilifuscins, 149. See also *Mesobilifuscin*, *Myobilin*, *Lanaurin*, *Copronigrin*.
 - in blood plasma, 546, 560
 - mode of formation, 500
- Bilin, 104, 105
- Bilipurpurins, 112 (table), 130ff.
- Bilirubin**, 106 (table), 120
 - absorption (light), 121, 122 (table), 547
 - in bile, 549
 - in blood plasma, 148, 546ff.
 - clearance tests, 549
 - diazo reaction, 121
 - "direct" and "indirect" bilirubin, 148, 154, 546
 - estimation, 153ff.
 - excretion, 549ff.
 - in bile fistula, 549
 - increase by hematin injection, 504, 575
 - increase by high fat diet, 533
 - and life span of erythrocyte, 509
 - Whipple technique, 544
 - in feces, 551
 - in urine, 550
- and hemopoiesis, 609, 626
- hyperbilirubinemia, 537, 546, 549
- preparation, 120
- protein compounds, 123, 148, 244, 547
- side chains, 119
- in stored blood, 529
- synthesis, 100 (table), 101
- Bilirubinic acid**, 98
- Biliverdin**, 106 (table), 114
 - absorption spectra, 116, 117 (table)
 - in bile, 505
 - from catalase (liver), 413
 - dimethyl ester ferrichloride, 113, 115
 - as "green hemin ester," 456
 - in feces, 552
 - formation, from bilirubin, 113, 114
 - from normal erythrocytes, 483, 529
 - from hemin, 99, 456, 459
 - from hemoglobin, 471, 505, 507
 - by coupled oxidation, 456, 460, 472
 - in invertebrates, 569, 570
 - in jaundice, 507, 546
 - in meconium, 549
 - and mesobiliverdin, 115

Biliverdin (contd.)

- oocyan, in bird egg shells, 115, 506, 540
- oxidation by acidified oxyhemoglobin, 396
- reduction to bilirubin, 99, 545
- synthesis, 99, 100 (table), 101
- and urobilin, 545, 552
- uteroverdin, in dog placenta, 114, 506

Biliviolinoid substances, 107, 123, 570**Blood. See also Erythrocytes.**

- carbon monoxide capacity, 485
- changes in stored, 528
- color index, 606
- iron, easily detachable, 482
 - nonhemoglobin, 484
- oxygen capacity, 485

C**Caffeine**

- compounds with heme, 242, 244
- with porphyrins, 241
- with turacin, 241

Calliactin, 570**Carboxyhemoglobin, 215**

- absorption spectrum, 226, 227, 228 (table)
- infrared, 289
- bond type, 215
- dissociation, 261ff., 285, 286, 322
- estimation, 302
- kinetics, of association, 281, 285, 286, 287 (table)
- of dissociation, 281, 287 (table)
- of reaction with O₂, 283
- light sensitivity, 216, 289
- span, 289, 310

Catalase, 401, 403ff.

- anabolism, 627
- and anions, 405, 442
- and compounds, absorption spectra, 405, 406 (table)
- as antigen, 414
- anticatalase, 412, 443
- azide catalase, reaction with hydrogen peroxide, 406 (table), 407, 412, 440ff.
- bile pigment hematin in liver catalase, 405, 413, 418, 499, 563
- biological function, as peroxidative enzyme, 417, 444
 - protection against H₂O₂, 416, 417, 652
- catabolism, 569
- coupled oxidation of alcohol, 418, 444

Catalase (contd.)

- and dithionite, 406
- in erythrocyte, 418, 531
- estimation, 410ff.
- in evolution, 650, 651
- inhibition, by destruction, 412
 - of choleglobin formation, 476, 477
 - of hemiglobin formation *in vivo*, 418, 521
 - of pseudo-hemoglobin formation, 490
 - of verdohemochrome formation, 468
- inhibitors, 409
- isolation, from erythrocytes, 404
 - from liver, 404
- Katalasefähigkeit (Kat.f.), 411
- kinetics, 411
- magnetochemistry, 405, 406 (table)
- mode of action, 439ff.
- models, 401, 402
- molecular weight, 414
- occurrence, 415
 - and peroxidase, 401
- philocatalase, 413, 443
- protein, 414, 415 (table)
- and respiration, 415, 416
- transformation into protohemochrome, 406, 413

Chlorocruorins, 306, 308, 326

- absorption spectrum, 186 (table), 309 (table)
- biological function, 335
- dissociation of oxychlorocruorin, 295
- distribution, 307 (table)
- in evolution, 326, 650
- ferrichlorocruorin, 308, 309 (table)
- protein, 314 (table), 315
- and respiratory ferment, 362

Chloroma. See Choleglobin, Peroxidase (verdo-peroxidase), Protoporphyrin.**Chlorophyll**

- chlorophyll b, 63, 571, 650
- hemins derived from, 201, 403, 521, 608
- in hemoglobin synthesis, 609
- in photosynthesis, 1, 647, 650
- porphyrins derived from, 648. See also *Etioporphyrin, Phylloerythrin, Phyllobiporphyrin, Pyrroporphyrin, Rhodoporphyrin.*
- and protoporphyrin, 651
- structure, 5, 52

Choleglobin, 454 (table), 455, 472ff.

- absorption spectra, 454 (table), 472, 473 (table)

- Choleglobin** (*contd.*)
 in chloroma, 543
 denatured, 472, 473 (table)
 distinction from other blood pigments,
 497, 498 (table)
 "green pigment," 472, 475, 478
 in insects, 569
 iron, 475
 myocholeoglobin, 473
 prosthetic group of, 473, 474
 in root nodules, 449
 spectrophotometric analysis, 474
 and sulfhemoglobin, 473, 498 (table)
- Choleglobin formation**, 475ff.
 in bacteria, 480
 by coupled oxidation, 478
 by enzyme systems, 479, 480
 and erythrocyte destruction, 482, 523.
 See also *Erythrocytes*.
 intracorporeal, 525, 526, 527, 529
 in organs, 479, 542
 oxygen pressure, effect on, 477
 stroma factor inhibition, 477
 by sulfides and oxygen, 478, 492, 493
- Cholehematin compounds**, 474
 cholehemochromes, 454 (table), 473
 (table), 487 (table)
- Choletelin**, 111, 144. See also *Bile pigments (bilenediones, bilenetetrols)*.
- Chromodacryorrhoea**, 585
- Chromoproteins**. See *Bile pigments*.
- Cobalt**
 in hemopoiesis, 619
 polycythemia, 615, 619
 porphyrin complexes. See *Porphyrin metal complexes*.
- Colorimetry**, 17
- Conchoporphyrin**, 50 (table), 68
- Copper**
 and cytochrome oxidase, 618
 and cytochromes, 618, 628
 in hemoglobin synthesis, 617 ff.
 in porphyrin synthesis, 632
 in serum, 565, 618
- Coprohematin**, 402
- Coprohemochromes**, 177 (table), 178,
 182 (table), 194 (table), 457
- Copromesobiliviolin**, 104, 127. See also *Mesobiliviolin*.
- Copronigrin**, 150
- Coproporphyrin**, 50 (table), 51 (table), 53
 (table), 63 ff., 69 (table), 74 (table),
 Coproporphyrin (*contd.*)
 75 (table), 76 (table). See also
Porphyrin metabolism.
 in chromodacryorrhoea, 585
 excretion in disease, 589 ff., 590 (table),
 628 ff.
 and drugs and poisons, 590 (table),
 644
 fate of injected, 582, 589
 isolation, 85 ff.
 isomerides, 64, 582, 583, 586, 588, 590
 (table), 591, 594 ff., 628 ff., 631, 632,
 643
 and hemopoiesis, 643 ff.
 in meat autolysis, 592
 occurrence, in bird feathers, 50 (table)
 in mammals, 579
 in plants, 49
 synthesis, by bacteria, 631
in vivo, theory of, 637 ff.
- Coupled oxidation**
 of alcohol, 418, 444
 of hemochromes and ascorbic acid, 456,
 467
 and other hydrogen donors, 470
 of hemoglobin
 and adrenaline, 472
 and ascorbic acid, 472, 476
 and fatty acids, 561
 and hydrogen donors, 391, 471, 478,
 519 ff., 541
- Crenilabrus pigment**, 148
- Cruoralbin**, 454 (table), 488
 prosthetic group, 488
- Crush syndrome**, 535. See also *Myo-hemoglobinuria*.
- Cryptoporphyrin**, 62, 361
- Cyanide**
 and cytochrome a₃, 364
 detoxification by hemoglobin, 521
 hematin compounds, 7, 187. See also
Dicyanide ferriporphyrins.
 absorption spectra, 189 (table), 191
 bond type, 191
 cyanide base iron porphyrins, 189
 (table), 190
 cyanide ferroporphyrins, 188, 189
 (table)
- hemoglobin compounds**. See *Hemoglobin, Hemoglobin*.
- inhibition, of catalase**, 409
 of catalatic action of hematin, 402
 of choleglobin formation, 477

- Cyanide (*contd.*)
of dihydroxymaleic acid oxidase, 434
of erythrocyte respiration, 515
of hydrogenase, 447
of oxidative action of hematin, 134
of peroxidases, 421, 430, 432, 433
of photocalase, 450
of respiratory enzymes, 340, 348, 381
of respiratory ferment, 362, 363, 364
oxidation-reduction potentials of, hematin compounds, 194
influence of pH on, 199, 381
and pseudohemoglobin formation, 490
- Cyanide hemochromogen, dicyanide ferroporphyrin. See *Cyanide (hematin compounds)*.
- Cyanmethemoglobin. See *Hemoglobin (compounds)*.
- Cysteine
in green hematin formation, 490
linkages in cytochrome c and porphyrins c, 350 ff.
oxidation by hematin, 341, 342
and urobilinogen formation, 552
- Cytochrome system, 343. See also *Cytochromes, Cytochrome oxidase, Respiratory ferment*.
in animals, 377, 379 ff.
biological function, 373 ff.
cytochromes in, 358, 374 ff., 376 (table)
importance for cell function and energy supply, 376, 383
in respiration, 373, 374, 379 ff.
inhibition experiments, 374, 379 ff.
in nerve function, 383
in plants, 379, 380, 382, 384
in resting muscle, 381
in sea urchin eggs, 381
in thyroxine formation, 384
- Cytochromes, 343. See also specific cytochromes.
as hemochromes, 343
in microorganisms, 344 ff., 346 (table), 380, 383
oxidation reduction-potentials, 195, 374, 376 (table)
reaction with hydrogen donors, 374 ff.
spectroscopic data, 344 ff.
- Cytochrome a, 344 ff., 360
and cryptohemochrome, 360, 361
as mixture of a and a₂, 346, 360
- Cytochrome a₁, 345, 346, 361, 365
absorption band at 639 m μ , 365, 432
cyanide compound, 365
and cytochrome oxidase, 370
as respiratory ferment of *Acetobacter*, 366
- Cytochrome a₂, 345, 346 (table), 370
and bile pigment hemochromes, 371
as respiratory ferment in bacteria, 370, 375
- Cytochrome a₃, 360, 367
CO-compound, 369
and cyanide, 364, 369
in cytochrome a preparations, 369
relations to cytochrome oxidase, respiratory ferment, and cytochrome a₁, 370
- Cytochrome b, 344, 345, 358
autoxidizability, 358
biological function, 358, 374 ff.
complexes with dehydrogenases, 360
and narcotics, 359
oxidation-reduction potential, 358
in plants, 379
reduction by hydrogen donors, 358
transformation into protohemochrome, 345
- Cytochrome b₁
in actinia. See *Actiniohematin*.
in adrenal medulla, 359
in microorganisms, 344 ff., 346 (table)
in plants, 379
- Cytochrome b₂, isolation from yeast, 359
and yeast lactic acid dehydrogenase, 359
- Cytochrome c, 347
absorption spectrum, 177 (table), 344 ff., 348, 349 (table), 351, 354 (table)
in adrenaline oxidation, 375
anabolism, 627
in *Ascaris*, 416
catabolism, 568
cyanide compound, 348
and cytochrome oxidase, 377 (table), 378, 379 ff.
electrometric titration, 352, 353
estimation, 349
ferricytochrome c, different forms, 352, 354 (table)
in glutathione oxidation, 376
and hydrogen donors, 356
iron content, 347
isolation, 347
linkage of prosthetic group, 251, 256, 350, 354 (table)

Cytochrome c (*contd.*)
 magnetochemistry, 352, 354 (table)
 molecular weight, 347
 and myohemoglobin, 357
 oxidation-reduction potential, 349
 in plants, 347, 379
 porphyrin c, 350
 properties, 347 ff.
 protein, 356, 357 (table)
 in spermatozoa, 378
 surface properties, 357
 in tumors, 377 (table), 378
 turnover number, 375
 in vertebrate tissues, 377 ff.

Cytochrome c₁, 347

Cytochrome oxidase, 366
 anabolism, 627. See also *Copper*.
 in animals, 373, 377 ff.
 catabolism, 568
 complex with cytochrome c, 367, 397
 estimation, 367
 fractions, 367
 in glutathione oxidation, 376
 mode of action, 397
 partition (CO/O₂) constant. See
Partition constants.
 in plants, 379
 preparations, 366
 and respiratory ferment, 366, 398
 in scurvy, 615
 in yeast (cyanide-resistant), 379
Cytochrome reductase, 374, 522

D

Dehydrobilirubin. See *Biliverdin*.
Denaturation, 253
 bond changes in, 254
 of hemoglobin, 222, 223, 253 ff.
 by acid, 256
 by alkali, 255, 319, 321
 by amides, 257
 by salicylate, 257
 reversible, 254, 255, 256, 257, 259
Deuterohematin, 53 (table), 56, 61, 402, 425
Deuteroporphyrin, 51 (table), 53 (table), 61, 69 (table), 74-76 (tables)
 in feces, 61, 588
 and gastrointestinal hemorrhage, 592
 in putrefying meat, 592
 synthesis, 56
Diacetyldeuterohemoglobin, 240
Diacetyldeuteroporphyrin, 56, 62

Diaphorase, 375

Dicyanide ferriporphyrin, 187
 absorption spectrum, 189 (table), 191
 bond type, 191
 and cysteine oxidation, 341
 dissociation constant, 189 (table)
Dihydrimesobilirubin. See *Mesobilene-(a)*.
Dihydroxymaleic acid oxidase, 433, 435, 653
 mode of action, 437
Dipyrrylmethanes, hydroxylated, 125, 128, 138. See also *Bilirubinic acid*.
Dithionite, as reducing agent, 476

E

Eggs. See also *Embryo*.
 bird, hemoglobin in, 604, 616
 oocyan, 114
 ooporphyrin, 50 (table), 60, 585
 peroxidase in, 436
 porphyrin in, 630
 invertebrate, grasshopper, catalase in, 416
 cytochrome system in, 378, 382, 383
 peroxidase in, 436
 sea urchin, cytochrome system in, 378, 381, 382, 383
Ehrlich aldehyde reaction, 137. See also *Mesobilane*, *Tetrahydrimesobilane*, *Porphobilinogen*.
 green reaction, 158
Ehrlich diazo reaction in urine, 151
Embryo. See also *Eggs*, *Fetus*.
 catalase in, 416
 cytochrome system in, 377 (table), 378, 383
 hemopoiesis in, 580, 604, 623
 porphyrin in, 580, 594, 630
Enterohepatic circulation
 of bilirubin, 549
 of urobilin, 504, 554, 555
Erythrocruorins, 306, 307 (table), 309.
 See also *Hemoglobin*.
 adaptation (functional) of, 332.
 amino acid composition, 315
 and ascorbic acid, 309, 531
 biological function, 335
 distribution, 307 (table)
 ferrierythrocruorin, 309
 of *Gastrophilus*, 262
 isoelectric point, 314, 316

Erythrocruorins (contd.)

- linkage of prosthetic group with protein, 245
- loading and unloading tensions, 332, 333 (table)
- microenvironment, 322 ff.
- molecular weight, 312, 313, 322
- shape of molecule, 322
- solubility, 318
- span, 289, 310
- Erythrocyte, 323 ff., 512, 513 ff., 605.**
 - See also *Hemoglobin, Hemiglobin, Hemolysis, Hemopoiesis, Oxyhemoglobin, Reticulocytes, Siderocytes.*
 - bile pigment hemoglobin in normal, 483, 529, 562
 - breakdown, intracorporeal, alterations preceding, 522, 524-532
 - normal, 512, 529 ff.
 - by phenylhydrazine, 524
 - in stored blood, 528
 - carbohydrate metabolism, 514
 - chologlobin in, 477, 483, 526, 527
 - count, 605
 - disintegration of dying, 532
 - enzyme systems in, 513 ff.
 - erythrocytopoiesis, 603, 604, 614
 - faulty, 535, 536, 537
 - fluorescytes. See *Porphyryns.*
 - fragility, 535
 - fragmentation, 513, 533
 - hemoglobin, concentration in, 323, 606
 - protection in, 531
 - spectrum in, 323
 - hyper- and hypochromic, 606
 - life span, from bilirubin excretion, 509
 - from maturation of reticulocytes, 511
 - from N¹⁵ in hemin, 510
 - from radioactive P, 511
 - from sulfhemoglobin disappearance, 510
 - from transfusion experiments, 512, 513
 - from urobilin excretion, 510
 - mean corpuscular hemoglobin, 606
 - mean corpuscular hemoglobin concentration, 606
 - mortality curve, significance, 512, 532
 - in disease, 536, 537
 - permeability of membrane, 514, 517, 537, 596
 - phagocytosis, 533
 - porphyrin in, 579 ff., 3, 59856, 629

Erythrocyte (contd.)

- respiration, 514 ff., 519, 521, 537, 614, 615
 - Michaelis-Salomon effect, 516, 537
- spherocytosis, 536
- Etioporphyrin**
 - mesoetioporphyrin, 51 (table), 59
 - chlorophyll etioporphyrins, 53 (table), 59
- Evolution, 647.** See also individual compounds.
 - "atavism of porphyrins," 648
 - paleontology of porphyrins, 648
 - primitive pyrrole pigments, 649
 - resonance and color, 647
 - of respiratory enzymes, 651

F

- Ferritin, 565-568**
 - apoferritin, 567
 - in catalase preparations, 404
 - ferrin, 568
 - and iron metabolism, 615, 622
- Ferrobilins, 113, 456**
- Fetus.** See also *Embryo.*
 - hematinemia in, 574
 - hemoglobin in. See *Hemoglobin (fetal).*
 - liver iron in, 538
 - plasma iron in, 565
- Fluorescence methods, 18**
- Fluorescytes.** See *Porphyryns.*
- Fluoride compounds**
 - of catalase, 406 (table), 407
 - of cytochrome c, 354 (table), 355
 - of hemiglobin, 219
 - of peroxidases, 421 (table), 422, 430, 432
- Folic acid, 611, 612**

G

- Glucobilin.** See *Mesobiliverdin.*
- Globan, 211.** See also *Globin (denatured).*
- Globin, denatured, 240, 258**
 - combination with heme, 232
 - electrometric titration, 255
 - in erythrocytes, 255
 - isoelectric point, 255
 - renaturation, 259
- Globin, native, 230, 258, 568**
 - amino acids. See *Hemoglobin.*
 - combination, with hematins, 239
 - with metalloporphyrins, 240
 - with porphyrins, 240
 - denaturation, 255 ff.

- Globin native (*contd.*)
 electrometric titration, 255
 differential of globin and hemoglobin, 244
 fate in hemoglobin breakdown, 548, 568
 frictional ratio, 250
 isoelectric point, 255
 molecular weight, 250
 oxidation, in autoxidation of hemoglobin, 390
 in denaturation, 395, 478
 preparation, 258
 specificity, 321. See also *Hemoglobin*.
 synthesis *in vivo*, 610
- Glutathione
 as anticalase, 412
 and choleglobin formation, 477, 478, 517
 and dehydroascorbic acid, 470, 517, 518
 in erythrocyte, 516, 522, 619
 and hemoglobin, 522
 as substrate of cytochrome c, 376
- Glycine, in porphyrin synthesis, 637
- Gmelin reaction, 109, 112 (table), 116, 138
- Green hemins, 201, 456, 490. See also *(chlorophyll hemins, Pheophorbide hemin, Verdochemochrome)*.
- Green hemoglobins, 455, 489. See also *(Choleglobin, Pseudohemoglobin, Cruoralbum, Sulfhemoglobin, Pheophorbide-b hemoglobin, Verdohemoglobin)*.
 formation of, and perturbation, 489, 490
- Green pigment. See *(Choleglobin ("green pigment"))*.
- Green-red hemins, 201, 650. See also *(Spirographis hemin, Pheohemins)*.
- H**
- Haldane effect, 217, 271
- HCl number. See also *(Porphyrins)*.
 of bile pigments, 115
- Heinz bodies, 525, 527, 528
- Helicorubin, 225, 654
- Hemaffine groups, 231
- Hemalbumin, 225, 243
 carboxyhemalbumin, 243
 linkage of heme to albumin, 243
- Hematin compounds
 biological role, 2, 6
 catalatic action, 402
 detection as hemochromes, 176
 distribution, 343
- Hematin compounds (*contd.*)
 green. See *(Green hemins)*.
 green-red. See *(Green-red hemins)*.
 iron, removal from, 167
 magnetochemistry, 160
 nomenclature, 163, 164 (table)
 oxidation-reduction potential, 193 ff., 194 (table)
 influence, of pH on, 197
 of buffer anions, 201
 oxidative action, 341
 peroxidative action, 402
 reaction with O₂ and H₂O₂, 184
 red, 201
 surface properties, 70, 172
 valency change, 6
- Hematin, 164 (table), 169
 absorption spectra, 172, 173 (table)
 acid hematin, 170-172, 173 (table)
 "acid hematin" from hemoglobin, 223, 228 (table), 256, 296, 300
 alkaline hematin, 169 ff., 173 (table)
 "alkaline hematin" from hemoglobin, 223
 β-hematin and ψ-hematin, 171, 172
 in blood extravasations, 574
 borate compound, 172, 201
 catabolism, 575
 cyanide compounds, 187 ff. See also *(Cyanide (hematin compounds))*.
 free cell hematin, 653
 as growth factor, 608, 654
 hydroxyhemin, 170, 171
 iron. See *(Iron)*.
 magnetochemistry, 160, 161, 173
 in malarial cell, 574
 polymerization, 171, 172, 194
 Schumm's test, 243, 574
 toxicity, 534, 577
- Hematin c, 203, 488, 489, 599
- Hematinemia, 574. See also *(Methemalbumin)*.
- Hematobiliverdin, 459
- Hematohe moglobin, 239, 496
- Hematoidin, 503, 545
- Hematoma, 505, 574. See also *(Bile pigment formation (extrahepatic))*.
- Hematoporphyrin, 47, 48, 51 (table), 61, 69 (table)
 from cytochrome c, 350
 occurrence, 61
 synthesis, 56

- "Hematoporphyrinuria," 586, 598.
 See also *Porphyrinuria*.
- Heme, 164 (table), 166, 223
 absorption spectrum, 166
 CO-heme, 185, 186 (table)
 magnetochemistry, 160, 161
 reaction, with acetonitrile, 191
 with caffeine, 242
 with cyanide, 188
 with methylcarbylamine, 191
- Hemins, 167. See also *Green hemins*,
Green-red hemins, *Hematin*.
 acetone hemin, 169
 β - and ψ -hemins, 168
 magnetochemistry, 160, 161
 synthesis, 56, 57
- Hemin protease, 231
- Hemochromes, 7, 174 ff.
 denatured globin hemochromes, 222
 hemochromes c, 352
 imidazole hemochromes, 179, 181,
 182, 232
 magnetochemistry, 161, 174, 178
 occurrence, 225
 oxidation-reduction potentials, 36 ff.,
 193, 194-200
 and constitution, 195
 and pH, 197
 oxidative action, 341, 342
 polymerization, 175
- hemichromes, 164 (table), 165, 177-
 184, 569
 absorption spectra, 183
 affinity of hematin for bases, 177, 182
 catalatic action, 402
 cyanide base ferriporphyrins, 190
 denatured globin hemichrome, 223,
 228 (table), 230
 effect of pH on stability, 177
 hemichrome hydroxides, 178-181
 hydrogen peroxide compound of
 pyridine hemichrome, 185
 in insects, 654
 peroxidative action, 403
 stereochemistry, 180
- hemochromes, 164 (table), 165, 174-
 177
 absorption spectra, 176, 177 (table)
 affinity of heme for bases, 174, 175
 (table)
 autooxidation, 184, 386
 CO-hemochromes, 185, 186 (table),
 262
- hemochromes (*contd.*)
 light dissociation, 185
 cyanide base ferriporphyrins. See
Cyanide (hematin compounds).
 denatured globin hemochrome, 174,
 176, 177 (table), 222, 228 (table)
 individual, 175 (table), 177 (table),
 202, 228 (table), 243
 mixed, 174, 224
 from myohemoglobin, 224
 stereochemistry, 176
- Hemochromogens. See *Hemochromes*.
- Hemocuprein, 619
- Hemoglobin. See also *Carboxyhemoglobin*,
Erythrocyruorins, *Oxyhemoglobin*.
 absorption spectra, 225-227, 228
 (table), 229
 alkali resistance, 222, 319, 321
 amino acid composition, 315 ff., 316
 (table), 320, 321, 610
 anabolism. See below.
 carbhemoglobin, 230, 238, 328, 521
 catalatic action, 337, 402
 definition, 207
 denaturation. See *Denaturation*.
 distribution, 306, 307 (table)
 diurnal variations, 297, 606
 electrophoretic behavior, 320, 321
 equilibria, 260 ff., 291
 estimation, clinical, 295 ff.
 estimation methods, as acid hematin,
 296, 300
 as alkaline hematin, 301
 colorimetric, 300
 as CO hemochrome, 299, 302
 as CO hemoglobin, 301
 as hemoglobin cyanide, 299, 301,
 302
 as iron, 301
 manometric and gasometric, 297,
 485
 as oxyhemoglobin, 298
 by peroxidative action, 302
 in plasma, urine and organs, 301
 as pyridine hemochrome, 299
 spectrophotometric, photoelectric
 and spectrophotometric, 298
 by infrared spectrophotometry,
 303
 standardization, 296
 fetal, 319, 320, 325, 329
 frictional ratio, 248

Hemoglobin (contd.)

- hemes, arrangement in, 251
- interaction between hemes, 260, 263-270, 286, 291-295
 - constant α , 265, 268, 270, 292
 - functional importance of, 326, 328
 - pathway of, 292
- intermediates, attempts of direct discovery, 271
 - between hemoglobin and hemoglobin, 270
 - between hemoglobin and oxyhemoglobin, 263-269
 - between oxyhemoglobin and sulfhemoglobin, 494, 497
- in complicated systems, 271 ff.
- iron content, 213
- isoelectric point, 246
- kinetics, methods, 278. See also individual compounds.
 - of hemoglobin reactions in erythrocyte, 284
- linkage, of iron to O₂ and CO, 231
 - of hemein carboxyls to protein, 240-242, 244, 245
 - of iron to globin, 231
 - of iron to imidazole, 217, 224, 232-239, 256, 276, 292-294
 - of prosthetic group and protein, 230
- methemoglobin and its compounds. See *Hemoglobin* below.
- molecular weight, 245, 246, 311, 312, 313 (table), 314, 320
 - dissociation of molecule into halves, 246, 250, 252
- nomenclature, 208, 209 (table)
- normal, 297, 605
 - life curve of, 606
- as oxidase, 338, 339, 342, 388, 392-396, 482, 515
- oxidation-reduction equilibria, 261, 270, 274
 - effect of pH on, 275
- oxygen capacity, 213
- oxylabile groups, 232, 233, 237 (table), 238, 275-277
- as peroxidase, 338, 403, 437
- of *Petromyzon*, 312, 313 (table), 315
- proteolytic degradation, 231
- reduced hemoglobin and its compounds. See *Hemoglobin* below.
- in root nodules, 306, 311, 449, 654
- shape of molecule, 248, 320

Hemoglobin (contd.)

- solubility, 318, 320
- specificity, 305, 308, 315 ff., 321 ff.
 - See also *Erythrocytes*, *Myohemoglobin*, *Hemoglobin (fetal)*.
 - and absorption spectra, 308, 322
- sulfhydryl groups, 254, 258
- surface properties, 320
- synthetic hemoglobins, 239
- transformation, into methemalbumin, 574, 576
 - into porphyrins, 592, 593 ff.
- and urea, 246
- x-ray analysis, 248, 252
- hemoglobin anabolism and catabolism, 625
- from nuclear material, 605, 613
- rate of, 623
- requirements for, 607 ff.
 - amino acids, 610
 - minerals, 617 ff.
 - pyrrole compounds, 608, 609
 - vitamins, 612, 613 ff.
- self-regulation, 624 ff.
- theory of, 637 ff.
- hemoglobinemia, 533, 534, 536
- hemoglobinuria, 533-535
 - and kidney damage, 534, 535
- hemoglobin, 218, 394. See also *Hemoglobin formation*.
 - absorption spectra, 227, 228 (table)
 - compounds. See below.
 - differential titration of hemoglobin and globin, 244
 - dissociation constants, 236 ff., 237 (table), 276
 - effect on oxyhemoglobin dissociation, 273, 519
 - in normal erythrocyte, 518
 - estimation, 297-299, 302
 - kinetics, of combination with cyanide, 285
 - of reduction, 285
 - linkage imidazole-iron in, 236-239
 - magnetochemistry, 218
 - in oxyhemoglobin preparations, 211
 - pleochroism of crystals, 251
 - reduction, in erythrocyte, 515-518, 522
 - by ascorbic acid, 517
 - by glutathione, 516
 - in root nodules, 449

- hemiglobin (contd.)**
 and salicylate, 253
 variety of hemoglobins, 390, 391, 395, 525
hemiglobin compounds
 with azide, 221, 407
 with cyanide, 219
 absorption spectrum, 226, 228 (table)
 and cytochrome oxidase, 220
 equilibrium, 220
 reduction of, 216
 with fluoride, 219
 with hydrogen peroxide, 221
 with hydroxide, 218
 absorption spectrum, 218, 228 (table), 229
 dissociation, 219, 236, 269
 magnetochemistry, 219
 reaction with ammonia, 222
 reaction with ethanol, 222
 with hydrosulfide, 221, 269
 with imidazole, 222
 with nitric oxide, 221
 with other anions, 222
hemiglobinemia, 518
 by drugs and poisons, 519
 idiopathic, 519, 522
hemiglobin formation, 389-394, 519
 by aromatic amino and nitrocompounds, 519
 by autoxidation. *See Hemoglobin.*
 by bacteria, 480
 and choleglobin formation, 476, 477, 480 ff.
 in erythrocytes, 518
 and erythrocyte destruction, 522
 hydrogen donors in, 391, 393, 480
 hydrogen peroxide and catalase in, 392, 417, 481, 520, 521
 kinetics, 285, 393
 by methylene blue, 391, 521
 by nitrite, 389
hemoglobin, 215
 absorption spectrum, 226, 228 (table)
 autoxidation, 388, 392
 bond type, 215
 compounds. *See below.*
 dissociation constants, 236 ff., 237 (table), 276
 iron, removal from, 230
 linkage imidazole-iron in, 233 ff.
 and methylene blue, 391
hemoglobin (contd.)
 and phenylhydroxylamine, 390
 reactivity of freshly reduced, 236
hemoglobin compounds. *See also Carboxyhemoglobin, Oxyhemoglobin.*
 with carbylamines, 217
 with cyanide, 216
 with hydrogen peroxide, 392, 476
 with nitric oxide, 216, 228 (table)
 with nitrosobenzene, 217, 390, 520
Hemolysis, 532
 Bergenhem-Fähraeus mechanism, 530, 533, 536
 and mortality curve of erythrocytes, 513
 in newborn, 537
 by a plasma factor, 533, 536
 and porphyrin formation, 593, 596
 by soaps and fatty acids, 533
 by spleen in hemolytic anemias, 537
 by tissue factor, 534
Hemolytic index, 556
Hemopoiesis, 603, 607 ff. *See also Antipernicious anemia principle, Copper, Erythrocytes, Folic acid, Hemoglobin (anabolism), Pterins.*
 and bile acids, 616
 and endocrine factors, 620
 and liver, 611, 616
 megaloblastic. *See Embryo.*
 and oxygen pressure, 625
Hemoproteins, 7, 337
 electrometric titrations, 27, 28
 oxidation-reduction potentials. *See Oxidation-reduction potentials.*
 protein specificity and enzymic activity, 338, 339
Hemorubin, 539
Hemosiderin, 507, 568, 614, 615
Hemoverdin, 471, 478
Hepatocuprein, 619
Hepta-coordination, 180, 181, 220
Histidine
 in cytochrome c, 232, 352, 357 (table)
 hemochromes, 232
 imidazole and protein-iron linkage, 232-238
 objections to imidazole hypothesis, 238
 in peroxidase, 424 (table), 426, 427
 in respiratory pigments, 232, 315 (table), 316 (table), 317

- Histoheatin**, 344
- Hydrobilirubin**, 135. See also *Meso-*
bilene-(b).
- Hydrogenase**, 446, 647
adaptation and deadaptation of algae,
451
in evolution, 649
inactivation by oxygen, 447
inhibitors, 447
models, 448
in nitrogen fixation, 449
in photoreduction of bacteria and
algae, 451
preparations, 446
- Hydrogen peroxide**
in acidified oxyhemoglobin solution, 396
in choleglobin formation, 476, 481
in cytochrome c preparations, 432
formation in organisms, 416-419, 480,
481
hematin compounds, 184, 185, 444, 468
hemoglobin compound, 221
in hemoglobin formation, 392, 520, 521
in pentdyopent formation, 500, 560
peroxidase compounds, 420, 421 (table)
429, 430 (table), 431 (table), 432
in sulfhemoglobin formation, 493-495
in verdohemochrome formation, 468
- Hydroxylamine**
inhibition, of catalase, 409, 440
of cytochrome oxidase, 366
of hydrogenase, 447, 451
of peroxidase, 422, 432
of photocatalase, 450
in nitrogen fixation, 449

I

- Icterus index**, 153
- Imidazole**. See also *Histidine*.
hemochromes, 195, 232
- Imidoporphyrins**. See *Azaporphyrins*.
- Indophenol oxidase**, 366. See also
Cytochrome oxidase.
"indophenol oxidase" of leucocytes,
431
- Iron**. See also *Ferritin*.
absorption, 615, 616, 617, 621
bile pigment hematin, 561, 562
in bone marrow, 565, 566
easily detachable, 458, 475, 482, 486,
493, 562, 564, 623
from erythrocytes in stored blood,
527

- Iron (contd.)**
excretion, 562
from hematin in digestive tract,
577, 608
hematin-iron, 561, 565, 566, 617
hemoglobin-iron, 561
and hemoglobin synthesis, incorpor-
ation in hemoglobin, 622
requirements for. See below.
as stimulus, 623
in intestinal mucosa, 566
in man, 561
mobilization, 564, 615-620
nonhematin iron, 542, 561, 565-568
nonhemoglobin, 484
in liver, 538, 565, 566, 567, 568
radioactive, in iron metabolism, 561,
562, 566, 618, 620, 622, 623
requirements, for hemoglobin forma-
tion, 605, 608, 621
for hydrogenase formation, 448, 628
for synthesis of respiratory enzymes,
627
in serum, 561, 563
in disease, 538, 565
in spleen, 565-567
storage, 561, 564, 565, 567, 615-620,
623, 624
tissue, 561, 564, 565
transport, 563

K

- Kathemoglobin**. See *Hemichromes (de-*
natured globin hemichrome), *Denaturation of hemoglobin*.
- α -Ketoglutaric acid**, in porphyrin syn-
thesis, 639, 640

L

- Lanaurin**, 150
- Lead poisoning**, 578, 580, 581, 589, 590
(table), 596, 600, 629, 643. See also
Porphyrin formation.
- Loading and unloading tensions**, 324.
See also *Oxyhemoglobin*, *Erythro-*
cruorins.

M

- Magnetochemistry**, 21
magnetochemical titrations, 25
- Mesobilane**, 106 (table), 136, 137 (table),
138 ff.

- Mesobilane** (*contd.*)
 absorption from intestine, 555
 Ehrlich aldehyde reaction, 139
 formation from bilirubin by liver enzymes, 551, 552, 553, 554
 occurrence in urine and feces, 134
- Mesobilene-(a)**, 106 (table), 138
- Mesobilene-(h)**, 100 (table), 106 (table), 136, 137 (table)
 absorption spectra and complex salts, 139, 140 (table)
 occurrence in urine and feces, 134
 oxidation, 137
- Mesobilierythrin**, 106 (table), 128, 130 (table)
 as prosthetic group of phycoerythrin, 128
- Mesobilifuscin**, 150
 prosthetic group of myobilin, 148
- Mesobilirhodin**. See *Mesobilierythrin*.
- Mesobilirubin**, 97, 98, 100 (table), 106 (table), 120 ff.
 absorption spectrum, 122 (table)
 dimethyl ester, 121
 distinction from bilirubin, 120
 in intestine, 551
- Mesobilirubinogen**. See *Mesobilane*.
- Mesobiliverdin**, 100 (table), 106 (table), 115 ff.
 absorption spectra, 116, 117 (table)
 dimethyl ester, 116, 460
 ferrichloride, 116, 457
 distinction from biliverdin, 115, 116
 as prosthetic group of pterobilin, 148
- Mesobiliviolin**, 106 (table), 124-128
 absorption spectra and complex salts, 126
 in feces, 104, 127, 559
 as prosthetic group of phycocyanin, 127
- "**Mesobiliviolinogen**," 126
- Mesohematin**
 catabolism, 575
 catalatic action, 402
 dimethyl ester, 169
 hemoglobin from, 240
 oxidation-reduction potentials, 193, 194 (table)
 peroxidase, 425
- Mesohemochromes**, 175 (table), 176, 177 (table), 182 (table), 196
- Mesohemoglobin**, 208, 239, 496
- Mesoporphyrin "II,"** from hemoglobin, 586
- Mesoporphyrin IX**, 47, 51 (table), 59, 69 (table), 74 (table), 75 (table), 76 (table)
 in bile, 581
 from catalase, 413
 from cytochrome c, 350
 from erythrocruorins, 309
 in feces, 588
- Methemalbumin**, 243. See also *Hemalbumin*.
 in blood, 243, 533, 573, 576
 distinction from other blood pigments, 497, 498 (table)
 formation from hemoglobin, 576
 and porphyrin formation, 597
- Methemoglobin**. See *Hemoglobin*.
- Methylene blue**, 391, 514, 515, 521, 522
- N-Methylporphyrin**, 82
- Monazahematin compounds**. See *Azahematin compounds*.
- Myeloperoxidase**. See *Peroxidases*.
- Myobilin**, 148, 543. See also *Mesobilifuscin*.
- Myohematin**, 344
- Myohemoglobin**, 213, 306, 307 (table), 309, 317, 326
 adaptation to oxygen pressure, 625
 amino acid composition, 317
 biological function, 325, 330, 334
 breakdown, 543, 599
 cholemyohemoglobin, 473
 cyanmyohemoglobin, 216
 dissociation of oxy-myohemoglobin, 262, 295
 hemochromes from, 224
 in invertebrates, 307 (table), 334, 654
 kinetics of reactions with gases, 284, 287
 light sensitivity of carboxy-myohemoglobin, 289
 linkage of heme with protein in, 217, 245, 284, 287
 molecular weight, 247, 287
 in muscle, 324
 oxidation-reduction equilibrium, 270
 preparation, 213
 pseudomyohemoglobin, 488
 solubility, 319
 span, 311
- Myohemoglobinuria**, 535

N

- "Nitrite body," 119
 Nitrogen fixation
 hemoglobin in, 449
 hydrogenase in, 448
 Nitrophenols
 effect on cytochrome system, 376
 inhibition of cytochrome reductase, 522

O

- Oocyan. See *Biliverdin*.
 Ooporphyrin, 50 (table), 60. See also *Protoporphyrin*.
 Oxidases. See *Cytochrome oxidase*, *Cytochromes a₁, a₂, a₃*, *Hematin compounds*, *Hematin*, *Hemochromes*, *Hemoglobin*, *Respiratory ferment*.
 distinction from peroxidases, 342, 431, 432
 Oxidation-reduction potentials, 28 ff., 193 ff.
 effect of change in aggregation on, 35
 effect of combination of oxidant or reductant with other substances, 36
 effect of pH on, 32, 197
 of hematin systems, 193 ff.
 of hemochrome systems, 194 ff.
 interaction between systems, 44
 of Mn and Co porphyrins, 192, 193 (table)
 Oxorhodin, 134. See also *Biliverthrinoid oxidation products of bilatrienes*.
 Oxourobilin, 134
 Oxyhemoglobin, 214. See also *Erythrocruorins*, *Hemoglobin*, *Myohemoglobin*.
 absorption spectrum, 226, 228 (table)
 in infrared, 226, 229
 effect of protein on, 310
 active oxygen from, 257, 395
 bond type, 214
 and cephalin, 258
 crystals, 212, 248, 251
 denaturation, 257
 dissociation and association equilibria, 207, 260-269, 305
 effect, of CO on, 271
 of erythrocyte substances on, 323, 329
 of hemoglobin on, 273
 of pH on, 275

Oxyhemoglobin (*contd.*)

- of temperature on absorption band position, 290
 equation, of Adair, 263
 of Hill, 262, 280, 281
 of Hüfner, 262, 268, 280, 285
 of Pauling, 265
 functional importance of sigmoid curve, 326, 327
 methods of investigation, 260
 electrometric titration, dissociation constants, 233, 237 (table), 276
 differential between oxyhemoglobin and hemoglobin, 236
 kinetics, of association and dissociation, 279, 287 (table)
 of reaction with CO, 282
 anomaly in pH sensitivity, 283, 287
 linkage, imidazole-iron, 233 ff.
 of oxygen, 231, 239
 heats and entropies, 288
 loading and unloading tension, 324, 327, 329, 332, 333 (table)
 preparation, 211
 purity, criteria of, 213
 zinc salt, 253
 Oxyprophyrins, 91
 Oxyprophyrin hemochromes, 201, 203, 366
 transformation into verdohemochromes, 203, 458, 461, 468

P

- Parahematin. See *Hemichromes*.
 Partition constants (CO/O₂)
 of cytochrome oxidase, 366, 380
 of hemoglobin, 262, 271, 283, 287 (table), 306
 of myohemoglobin, 285, 287 (table), 306
 relation to "span," 289, 310
 of respiratory ferment, 363
 Pasteur enzyme, 371
 Pentdyopent, 150, 559
 mode of formation, 500
 Peroxidase, 401, 419
 of adrenal medulla, 359, 430
 anabolism, 627
 in animals, 435
 biological function, 434
 and catalase, competition between, 422
 catalatic action of, 445

- Peroxidase** (*contd.*)
 cytochrome c-peroxidase, 432, 435
 distinction from oxidases, 401, 431, 432
 estimation, 422
 hemin from, 419
 of horse-radish, 419, 420 ff.
 absorption spectra, 420, 421 (table)
 alkaline peroxidase, 427
 compounds, 420, 421 (table)
 electrometric titration
 of enzyme and apoenzyme, 425, 426, 428 (table)
 of ferro- and ferriperoxidase, 426, 427
 glucuronic acid in, 425
 isolation, 420
 linkage between protein and prosthetic group, 425
 magnetochemistry, 421 (table), 426, 427
 paraperoxidase, 420, 425
 protein, 424
 reversible splitting, 425
 inhibitors, 421
 kinetics, 422
 lactoperoxidase, 429, 430 (table), 435, 545
 mode of action, 436
 myeloperoxidase of leucocytes, 430, 431 (table), 435
 in plants, 419, 428, 434
 Purpurogallin-Zahl (PZ), 422
 specificity, 422 ff.
 and thyroxine formation, 435
 verdo-peroxidase. See *Myeloperoxidase*, *Lactoperoxidase*.
- Perturbation**, 253, 439
- p-Phenylenediamine** and cytochrome system, 376, 382
- Phenylhydrazine**
 and bile pigment formation, 524, 527, 539
 and porphyrin formation, 628
- Phenylhydroxylamine**
 and hemoglobin, 390, 520
 inhibition of catalase, 410, 521
- Pheohemins**, 201
- Pheohemoglobins**, 240
- Pheophorbide-b hemoglobin**, 240
- Photocatalase**. See *Photosynthesis*.
- Photoreduction of CO₂**, 451. See also *Hydrogenase*.
 in evolution, 650
- Photosynthesis**. See also *Chlorophyll*, *Bacteriochlorophyll*.
 algae chromoproteins in, 571
 hematin catalysts in, 450, 647
 photocatalase, 450, 651
 pyrrole pigments in, 1, 647
- Phthalocyanins**, 80, 89, 448
 complex salts, 160, 161, 402, 448
- Phycocyanins**, 145 ff., 146 (table)
 in photosynthesis, 571
 prosthetic group (phycocyanobilin), 127. See also *Mesobilinolin*.
- Phycocerythrins**, 145 ff., 146 (table)
 in photosynthesis, 571
 prosthetic group (phycocerythrobilin), 128. See also *Mesobilierythrin*.
- Phyllins**, 93
- Phylloerythrin**, 125, 549, 581
- Phylloporphyrin**, 53 (table), 581
 and oxyporphyrin, 92
- Polycythemia**, 615, 619, 620, 625
 of newborn, 537, 606
- Porphin**, 49, 58, 69 (table), 74 (table), 76 (table)
 "isoporphin," 69 (table), 83
- Porphin polycarboxylic acids**, 68. See also *Conchoporphyrin*, *Coproporphyrin*, *Uroporphyrin*.
- Porphobilin**, 144
- Porphobilinogen**, 144, 151, 157, 587, 595, 638
 Ehrlich aldehyde reaction, 151
- Porphyrias**, 580, 581, 586, 589, 590 (table), 591 (table), 592, 595, 599, 600, 601, 629, 630, 637, 638, 643
- Porphyrinogens**, 77
- Porphyrins**. See also individual porphyrins.
 absorption spectra, 71, 74 (table), 75 (table), 76 (table)
 and nuclear structure, 84
 adsorption and surface properties, 70
 aggregation, 73, 241
 in bile, 581
 in bone marrow, 580, 630
 competition between, *in vivo*, 608
 destruction *in vivo*, 582
 dualism, 586 ff., 648
 in erythrocyte. See *Erythrocyte*.
 esterification, 70
 estimation, 87
 excretion, 586 ff.
 in feces, 588, 590 (table), 597, 631

- Porphyrins (contd.)**
 fluorescence, 76, 88. See also *Erythrocyte*.
 pH curves, 77
 formation *in vivo*. See *Porphyrin formation*.
 HCl-number, 68, 69 (table)
 historical, 47
 isolation, 85
 isomerism, side chain, 6, 54
 nuclear, 83
 in liver, 581, 630. See also *Protoporphyrin*.
 metabolism, 577 ff. See also *Porphyrin formation*.
 in animals, 584
 in man, 578 ff.
 metal complexes. See *Porphyrin metal complexes*.
 in nervous system, 581
 nomenclature and symbols, 53
 occurrence, 48, 50 (table)
 paleontology, 648
 pH number, 69
 pharmacology, 601
 photosensitization, 599
 protein compounds, 71, 240, 241
 resonance, 78 ff.
 separation, 85, 86 (table)
 in serum, 580
 solubility and acid base character, 59, 68
 stereochemistry, 80
 structure, of ring system, 3, 48, 49 ff.
 side chains, 6, 49, 51-3 (tables), 62
 synthesis, 7, 56
 toxicity, 600
 in urine, 47, 583, 586, 588. See also *Porphyriuria*.
Verteilungszahl, 69
- Porphyrins c**, 204, 350
 from cytochrome c, 350
- Porphyrin formation *in vivo***
 by aromatic amines, 590 (table), 596
 by bacteria, 581, 631
 from hematin compounds, 592
 and bile pigment formation, 594, 595
 from hematin and hemoglobin, 597
 by hemoglobin breakdown, 598
 in hemoglobin synthesis, 628
 in hemolytic diseases, 593
 in lead poisoning, 578, 596. See also *Porphyrins (excretion)*.
 in liver disease, 583, 590 (table), 591 (table), 594
 from myohemoglobin, 599
 from respiratory enzymes, 599, 627
 synthesis of nucleus, 608, 610, 632 ff.
 and carbohydrate metabolism, 632, 637-641
 decarboxylation of precursor, 636, 637, 638, 641, 642
 and hemopoiesis, 643-645
 nitrogen precursor, 637
 theory of, 632 ff., 637 ff.
 in yeast, 632
- Porphyrin metal complexes**, 6, 48, 93, 94 (table), 159 ff., 192. See also *Hematin compounds*.
 absorption spectra and bond type, 162, 192
 in bacteria, 631
 copper, as oxidases, 337
 and globin, 240
 magnetochemistry, 21, 22 (table), 24, 25, 160, 192
 of Mn, Co, Ni, 192, 193 (table)
 stereochemistry, 159
 in urine, 589
- Porphyriuria**, 589, 590 (table), 591 (table)
- Potentiometry**, 25
 dissociation constants, 26
 electrometric titration curves of proteins, 27, 28
 oxidation-reduction potentials, 28 ff.
- Prodigiosin**, 152
- Propentdyopent**, 149, 150, 151
- Protoporphyrin**, 48, 50 (table), 51 (table), 53 (table), 60, 69 (table), 70, 72, 74 (table), 75 (table), 76 (table)
 in chloroma, 581, 598, 599
 and coproporphyrin, 582, 583, 596, 629, 637, 641
 in earthworm, 50 (table)
 in erythrocytes, 579. See also *Erythrocyte*.
 fate of injected, 582, 583
 formation from hemoglobin, 598
 in putrefying blood, 60
 as growth factor, 608
 in Harderian gland, 50 (table), 584
 isolation from erythrocytes, 86
 in meat autolysis and putrefaction, 592
 ooporphyrin, 50 (table), 60, 585
 in placenta, 585

- Protoporphyrin** (*contd.*)
 synthesis, 56
in vivo, theory of, 637
 and uroporphyrin, 595, 637, 638
Pseudohematin, 487
Pseudohemochrome, 454 (table), 487 (table)
Pseudohemoglobin, 454 (table), 455, 486
 mechanism of formation, 489
 similar compounds, 489
Pseudoverdoporphyrin, 53 (table), 83
Pterins in hemopoiesis, 612, 613
Pterobilin, 148
Pyrrole body store hypothesis, 537, 556, 557, 609
Pyromethenes
 bile pigments similar to, 106 (table), 108, 112 (table), 122
 hydroxy-, 98, 125, 129, 149. See also *Bilifuscins*, *Mesobilifuscins*.
 metal complexes, 162
 as precursors of porphyrin synthesis *in vivo*, 634-636, 641-643
 as resonance structures, 79
 synthesis, 56-58, 100 (table)
Pyroporphyrin, 53 (table)
- R**
- Radical chain theory**
 of catalatic action, 439, 442
 of peroxidative action, 436
 of oxidative action, 386
Radicals in respiration and photosynthesis, 647
Resonance in bile pigments, 107, 108, 110, 129
 biological importance, 647
 in cytochrome c, 355
 in hemoglobin compounds, 214, 215, 234-238
 in porphyrins, 78, 241
 in pyrrole, 78
 in pyromethenes, 79
Resorcinol melt
 of bilirubin and biliverdin, 97
 of hemin, 61
 of mesobilirubin, 97, 98
 of spirographis hemin, 63
Respiratory enzymes. See also *Catalase*, *Cytochromes*, *Cytochrome oxidase*, *Peroxidases*, *Respiratory ferment*.
 anabolism, 627
 catabolism, 568
 in evolution, 651
 inhibitors, 340, 379
 kinetics and thermodynamics, 339
 protein specificity, 338, 652
 stabilization, 652
Thiobacillus hematin enzyme, 652
Respiratory ferment, 343, 362, 365, 372, 373, 384 ff. See also *Cytochromes a₁*, *a₂*, *a₃*, *Cytochrome oxidase*.
 autoxidation of ferrous, 184, 384, 397
 constitution, 201, 363
 and cyanide, 190, 200, 362-364
 inhibitors, 363, 379
 loading tension, 325
 partition constant (CO/O₂). See *Partition constants*.
 photochemical absorption spectrum, 18, 185, 340, 343, 362, 366, 373
 reversible combination with oxygen, 184, 397, 398
 specificity, 373
Respiratory pigments. See also *Chlorocruorins*, *Erythrocrucorins*, *Hemoglobin*, *Myohemoglobin*.
 adaptation to environment, 324 ff., 331, 332, 335, 652
 in mammalian respiration, 327 ff., 332
 of myohemoglobin, 330
 in submammalian respiration, 331
 to low oxygen pressure, 332
 by variation of heme, 326
 by variation of protein, 326
 extracellular, 311, 312 (table)
 in fetal respiration, 329
 intracellular, 312, 313 (table)
 microenvironment, 306, 321, 322, 324, 326, 328, 329, 330, 653
 molecular weight, classes, 311 ff., 312 (table), 313 (table)
 biological implication of, 312
 nomenclature, 308
 oxygen capacity of bloods, 332
 store, 330, 335
 transport and CO₂-transport, 328, 333
 reaction velocities and function, 334
Reticulocytes, 604
 maturation, 511, 605
 porphyrin in, 579
Rhodohemoglobin, 240
Rhodoporphyrin, 53 (table), 83
Rubrobilin, 142

S

Sedimentation equilibria, 246, 311, 312
(table), 313 (table), 320, 322, 357

Sex differences
in nonhemoglobin iron, 484
in oxygen affinities of blood, 322

Siderocytes, 526, 527, 528, 529, 530, 536,
542, 563

Soret band
of azaheme, 90, 202
of bile pigments, 118
of catalase, 405
of choleglobin, 473
of cruoralbin, 488
of cytochromes, 349 (table), 359, 369
in erythrocytes, 323
of hematin compounds, 167, 172, 173
(table), 186 (table), 241
in hemoglobin estimation, 300
of hemoglobin compounds, 226, 227,
228 (table), 229
of oxyporphyrin heme, 203
of peroxidases, 419, 421, 423, 430
(table), 431 (table), 433
of porphyrins, 72, 73, 74 (table), 75, 76
(table), 88, 240
of pseudo-heme compounds, 487
of respiratory ferment, 362, 363, 365,
369
of verdoheme, 462

Spectrocolorimetry, 17
in hemoglobin estimation, 299
in porphyrin estimation, 87

Spirographis hematin, 169, 201, 309.
See also *Chlorocruorins*.
absorption spectra, 186 (table), 189
(table)
oxidation-reduction potentials, 194
(table), 195

Spirographis hemochromes, 177 (table),
309 (table), 345

Spirographis hemoglobin, 208, 362

Spirographis porphyrin, 63, 309

Stercobilinogens, 134 ff., 137 (table).
See also *Mesobilane*, *Tetrahydro-*
mesobilane.
estimation, 156 ff.

Stercobilins, 104, 134 ff., 137 (table).
See also *Mesobilene-(b)*, *Tetrahydro-*
mesobilene-(b).
estimation, 156 ff.

Stercofulvin and stercorubrin, 559

Stromatin. See also *Erythrocyte*.
effect on choleglobin formation, 477, 531
effect on hemoglobin, 323, 326

Sulfhemiproteose, 204, 496

Sulfhemoglobin, 295, 454 (table), 455, 490
absorption spectra, 454 (table), 491
in blood. See *Sulfhemoglobinemia*.
and choleglobin, 492
distinction from other blood pigments,
497, 498 (table), 524
in erythrocyte, 510, 524. See also
Erythrocyte (life span).
estimation, 297, 302
ferric (sulfhemoglobin), 491
formation *in vivo*, catalysts, 495, 523
in liver, 479, 542
in hemoglobin estimation, 295, 298, 299
iron, 493
mode of formation, 493
prosthetic group, 494, 495
protein, 492
sulfur, 493
transformation, into protoporphyrin
derivatives, 456, 492, 495
into bile pigment by liver, 542

Sulfhemoglobinemia, 523

Sulfmyohemoglobin, 497

Sulfonamides
and choleglobinemia, 526
and hemoglobinemia, 519, 521
inhibition, of catalase, 410
of peroxidase, 422
and porphyrin formation, 590 (table),
596-598
and sulfhemoglobinemia, 523, 524
and urobilin excretion, 553

T

Tautomerism in bile pigments, 108, 109,
119, 123, 132

Tetrahydromesobilane, 106 (table), 137
(table), 140, 141
differentiation from mesobilane, 134,
140
Ehrlich aldehyde reaction, 141
formation from bilirubin by intestinal
bacteria, 550-552
occurrence in urine and feces, 134
optical activity, 141

Tetrahydromesobilene-(b)
absorption spectra and complex salts,
142, 143
hydrochloride, 142

- Tetrahydromesobilene-(b)** (*contd.*)
 separation from mesobiliviolin, 141
 spectroscopic differentiation from mesobilene-(b), 143
- Tetrapyrrenes**, 105
- Tripyrrenes**, resembling biliviolins, 106 (table), 126
- Tripyrrylmethanes**, in pyromethene synthesis, 58, 635, 636
- Tryptophane**, in hemoglobin synthesis, 610, 633
- Tumors**, cytochrome system in, 376, 377 (table), 378
- Turacin**, 6, 50 (table), 68, 241, 588
- U**
- Urechrome**, 225, 654
- Urobilins**, 184, 137 (table). See also *Mesobilene-(b)*, *Tetrahydromesobilene-(b)*.
 absorption from intestine, 555
 destruction in body, 555
 enterohepatic circulation, 504, 554, 555
 excretion, 510, 541, 551, 555, 556, 558
 and bilirubin formation, 510, 555
 in disease, 537, 541, 557, 558
 after hematin injection, 575
 and life span of erythrocyte, 510
 in urine, 555, 558
 formation in man, 504, 545, 550 ff.
 by bacteria, 551, 553
 enzymes in, 552, 554
 extraintestinal, 553
 in fetus and newborn, 554
 intestinal, 551
 in serum, 557
- d*-Urobilin, 137 (table), 143, 553
- Urobilin IX α . See *Mesobilene-(b)*.
- Urobilinogens**. See also *Mesobilane*, *Tetrahydromesobilane*.
 estimation, 156
- Urobilinoid substances**, 107. See also *Bile pigment classes*, *Choletelin*, *Porphobilin*.
- Urochrome B**, 559
- Uroporphyrin**, 50 (table), 51 (table), 53 (table), 66, 69 (table), 74 (table), 75 (table), 76 (table). See also *Turacin*.
- Uroporphyrin** (*contd.*)
 in bones, 50 (table), 581, 630, 631
 excretion in disease, 589 ff., 591 (table)
 fate of injected, 581, 582, 589
 isolation, 86
 isomerides, 66-68, 587, 591 (table)
 in *Pteria* mussel, 50 (table), 66
 in porphyria, 66, 591, 592
 in *Sciurus niger*, 50 (table), 584, 638
 synthesis, theory of, 637 ff.
- Uteroverdin**. See *Biliverdin*.
- V**
- Vanadium**
 chromogen of *Ascidians*, 570, 648
 complexes of porphyrins, 648
- Verdins** (closed ring), 114
- "Verdoglobins," 454 (table), 455. See also *Choleglobin*, (*ruoralbin*), *Pseudo-hemoglobin*, *Sulphemoglobin*.
- Verdohematin**, 455 ff., 461, 463, 464 ff.
 nomenclature, 453, 455
 structure, 464
- Verdohemochromes**, 454 (table), 456-470
 absorption spectrum, 454 (table), 462
 from catalase, 499
 from cytochrome c, 499
 formation from hemochromes, 456-459, 467-470
 iron valency, 462
 magnetochemistry, 463
 mechanism of formation, 468
 oxidation of, 467
 preparation, 461
 reduction to yellow compounds, 462, 465
 transformation into monazahemochromes, 202, 464
- "Verdohemochromogens," 453, 479, 492
- Verdohemoglobin**, 208, 240, 454 (table), 455, 463
- Verdoperoxidase**. See *Peroxidases*.
- Violacein**, 153
- Viridans effect**, 480
- X**
- Xanthorubin**, 150, 539

APPENDIX

Absorption spectra data for oxy-hemoglobin, hemoglobin, hemoglobin, carboxyhemoglobin, and hemoglobin cyanide.

Courtesy B. L. Horecker

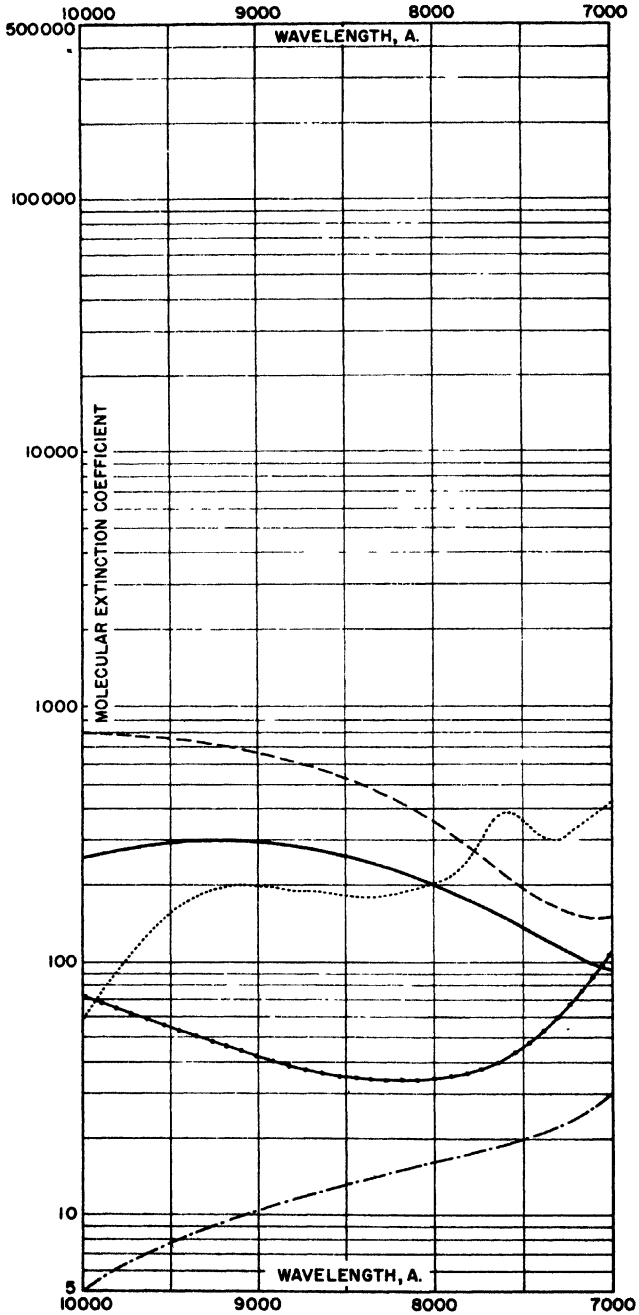

Absorption spectra: oxyhemoglobin, hemoglobin, hemoglobin, carboxyhemoglobin, hemoglobin cyanide. All spectra 10,000-2500 A.

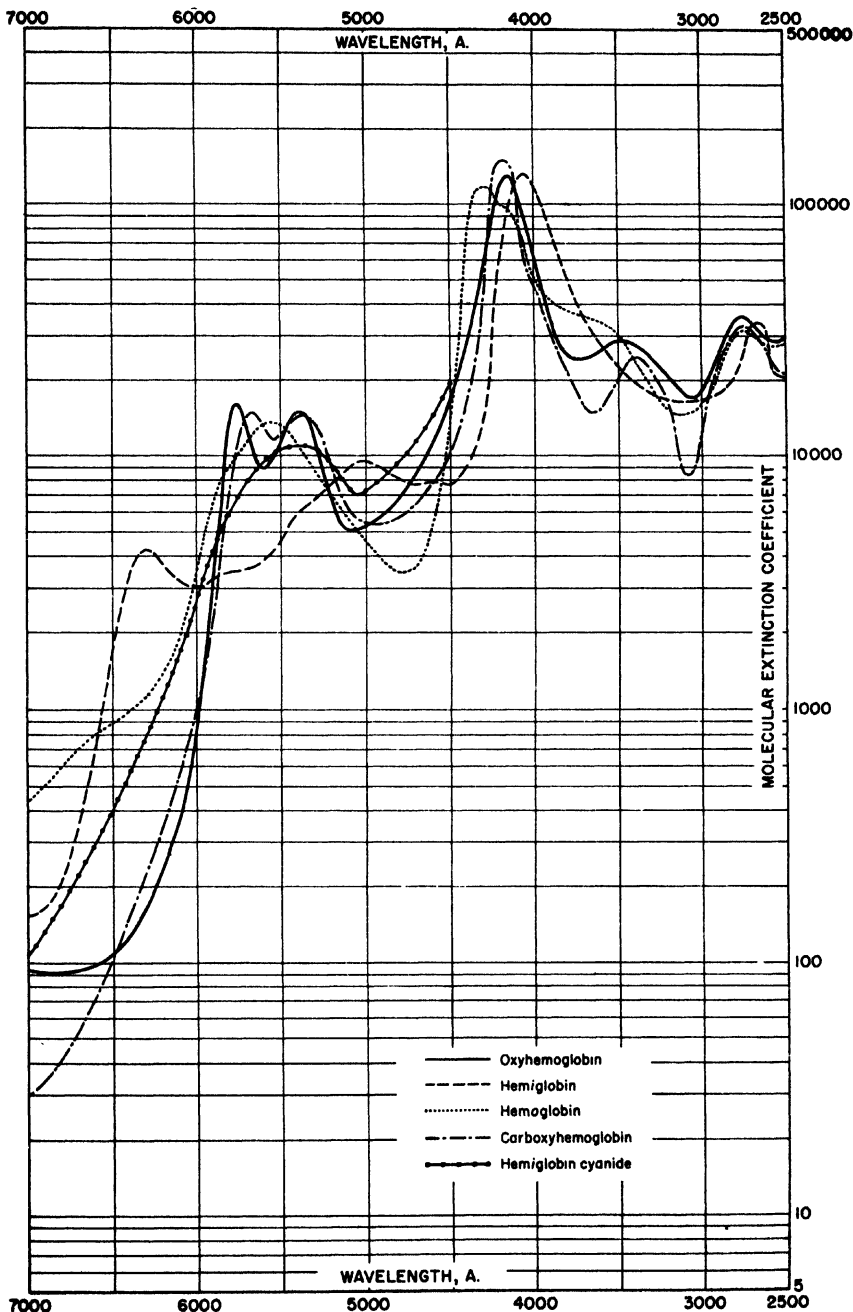

Data for oxyhemoglobin and hemoglobin, ultraviolet, from Sidwell, Munch, Barron, and Hogness (1949). Data for carboxyhemoglobin and hemoglobin from Hicks and Holden (1970).

11 APR 1961

DATE OF ISSUE

This book must be returned within 37,14 days of its issue. A fine of ONE ANNA per day will be charged if the book is overdue.

| | | | | | |
|--|--|--|--|--|--|
| | | | | | |
|--|--|--|--|--|--|

