

# Birla Central Library

PILANI (Jaipur State)

Engg College Branch

Class No :- 696.9

Book No - P634 P.V.2

Accession No :- 32268

Acc. No. . . . .

**ISSUE LABEL**

***Not later than the latest date stamped below.***

--	--	--



**PLUMBING PRACTICE**  
*and* **DESIGN**

**PLUMBING PRACTICE  
AND DESIGN**

**VOLUME I.** 308 pages; 6 × 9¼; cloth.

**VOLUME II.** 329 pages; 6 × 9¼; cloth.

(  
PLUMBING PRACTICE  
*and* DESIGN /

*Volume II*

By  
Svend Plum  
~

NEW YORK • JOHN WILEY & SONS, INC.

*London* • CHAPMAN & HALL, *Limited*

COPYRIGHT, 1943  
BY  
SVEND PLUM

*All Rights Reserved*

*This book or any part thereof must not  
be reproduced in any form without the  
written permission of the publisher.*

*Fourth Printing, November, 1948*

696.5  
P 635  
32268  
P  
✓

● 1/87

C/87

## PREFACE

Plumbing, an ancient and useful craft, has had difficulty finding its proper place in a modern world of engineering technique. Treated as a stepchild, it has not been properly acknowledged by any particular group, whether architects or mechanical, sanitary, and civil engineers.

Good plumbing actually combines the sciences and arts of all these groups. Consequently, the technical data concerning plumbing are scattered among them and among the plumbers and the manufacturers, and have been interpreted by all in their particular language and for their individual benefit.

Every home, apartment, office building, institution, or work shop receives daily supplies for the sake of general conveniences and for the maintenance of food and sanitary services. To furnish these services, to handle them efficiently within the building, and to dispose of the wastes and refuse can be classified as the problem of domestic sanitation.

Plumbing is, more specifically, the domestic services which depend on supply and disposal through a system of pipes. In its more extensive phase as a pipe craft it includes, besides water piping and drains, various other systems, as piping for gas, air, etc.

This book is an attempt to consolidate the scattered data on the subject and to present them in a uniform terminology. Where data were available, no attempt has been made to alter their presentation. In many cases, however, for the sake of proper sequence and uniformity, it has been necessary to modify the information and fill in missing parts with new text.

I have tried to make this book, in so far as it is a handbook, usable for solving the many problems in design of plumbing systems. Certain practical limits, however, have to be adopted in all such work. A number of illustrative examples can be worked out, and yet only a small fraction of the possible cases can be analyzed. Rather than encourage the growth of any class of "handbook experts" or "catalog engineers," the users of this book are urged to adopt a spirit of intellectual pioneering by becoming interested in the underlying principles which govern the design and then, with this handbook as a guide, to use their own ingenuity in working out their ideas.

Even at this date plumbing practice and design can by no means be said to be an established and generally recognized set of rules. While much research has been done, we still cling to old notions. The old methods are often unscientific, and the new theories unfortunately are very often impractical. To bring these two extremes together is not an



easy task, and I do not even pretend to have accomplished it. This book is only a wholehearted attempt to do so.

I found that to make this book complete in all details and to elaborate on all the necessary subjects would make it too large for convenient use. Specifications are included only where they aid in describing the particular mode of installation. Without a description of materials to be used and the methods of construction a good design may become nullified. The size of the book, however, placed limitations on this phase of the work. Because the specifications are not extensive, and also to overcome the difficulty in discussing work which is filled with an excess of terms overlapping each other or duplicating themselves, I have given a great number of definitions. The definitions also take the place of more extensive text on borderline subjects.

I am especially indebted to two men who initiated me into the mysteries of plumbing: Major Carl Richard Stephany of the firm of Gordon and Kaelber in Rochester, N. Y., and the late Oscar J. Miller, plumbing contractors superintendent.

I wish to thank Harry E. Jordan, Secretary, American Water Works Association, for editing Chapter 5 on Water Supply and C. George Segeler, Engineer of Utilization, American Gas Association, for editing Chapter 10 on Gas Piping and preparing the text for sizing of gas pipes.

SVEND PLUM

*March, 1943*

## CONTENTS

CHAPTER	PAGE
1. DEFINITIONS OF PHYSICAL AND CHEMICAL TERMS.....	1
Standard Terms. Pressure Terms. Cross-Connections in Plumbing Systems. Prevention of Backflow in Supply Branches. Properties of Water. Flow of Water in Pipes. Chemical Terms. Compressed Air. Heat. Electric Terms.	
2. CODES AND REGULATIONS.....	32
Code Requirements.	
3. ARCHITECTURAL PRACTICE.....	36
General Design. Drawings. Costs.	
4. PIPE WORK.....	49
Piping. Underground Work. Pipe Tests. Insulations. Painting.	
5. WATER SUPPLY.....	69
Standards. Water Supply. Water Analysis. Treatments.	
6. WATER PIPING.....	94
Piping Systems. Materials and Construction. Meters. Water Consumption. Storage and Pumps. Hot-Water Systems. Sizing of Pipes.	
7. DRAINAGE.....	163
General Terms. Elements of Waste. Soil and Waste Pipes. Storm Drains. Vents and Venting. Materials and Construction.	
8. SEWERS.....	199
General Terms. Sanitary Sewers. Storm Sewers and Combined Sewers. Construction.	
9. SEWAGE DISPOSAL AND TREATMENT.....	212
Sewage. Screening and Separation. Tank Treatments. Clarification of Effluent. Disinfection.	
10. GAS PIPING AND APPLIANCES.....	237
Gas Services. Gas Piping. Gas Appliances.	

11. WATER HEATING..... 255  
Types. Gas Heaters. Other Heaters. Tanks and Heating  
Coils. Operating and Emergency Controls for Automatic  
Storage Systems. Selection of Heaters.

APPENDIX..... 309  
National Institutions. Abbreviations and Symbols. References.

INDEX..... 319

## CHAPTER 1

### DEFINITIONS OF PHYSICAL AND CHEMICAL TERMS

This chapter states in brief form the various physical and chemical terms used in plumbing, and, where considered necessary, gives more detailed explanations of their direct application to plumbing systems.

#### ART. 1-A. STANDARD TERMS

##### Definitions

*Gage.* A device for registering water levels, flow, velocity, pressure, etc.; a gage (45).

*Intensity of Pressure.* The pressure per unit area.

*Negative Pressure.* Pressure below atmospheric pressure. Sometimes called "vacuum." (4).

*Positive Pressure.* Pressure above atmospheric pressure. Sometimes called "back pressure." (4).

*Pressure.* Total load or force acting upon a surface; also appropriately used to indicate intensity of pressure or force per unit area (45).

*Siphon.* A pipe bent in the form of a U or acting on the principle of the hydrostatic balance so that the pressure of water in one leg always tends to equalize that in the other.

A bent tube or pipe with limbs of unequal length for transferring liquids from a barrel or other receptacle. The action of the instrument is due to the difference in weight of the liquid in the two legs (12).

*Siphonage.* A suction created by the flow of liquid in pipes. A pressure less than atmospheric (4).

#### ART. 1-B. PRESSURE TERMS

##### Absolute Pressure and Gage Pressure

Pressures are usually stated as "gage pressures"; that is, the registered pressure above atmospheric pressure (normal atmospheric pressure at sea level, or about 14.7 psi absolute pressure).

The actual or "absolute pressure" is the combined atmospheric and gage pressures.

##### Pressure Units

Many combinations are used in the expression of pressure units, the most common for water and air being pounds per square inch.

Water pressures are also expressed as the height of feet of water, inches of water, or millinches of water.

Atmospheric pressures are also expressed as the height in inches of a column of mercury.

In this book, wherever possible, pressures have been expressed in pounds per square inch (abbreviated psi).

### **Vacuum and Vapor Pressure**

A vacuum is usually defined as space devoid of matter. This is the hypothetical perfect vacuum, in which, if it were obtainable, the pressure in the evacuated space would be zero on an absolute scale of pressures. Actually, an absolute-zero pressure cannot be produced over water, since some water vaporizes into the space over the water and continues to vaporize until equilibrium is established. This equilibrium pressure is called the *vapor pressure of water*, and its value depends on the temperature and purity of the water. At 0 C, the vapor pressure of water is small; but it increases rapidly with increase in temperature, and at 100 C it is equal to standard atmospheric pressure, approximately 34 ft of water at sea level (47).

Similarly, if the water contains dissolved air or other gases, as is usually the case, some of the gases will come out of solution into the evacuated space until equilibrium is established, and each gas will exert a pressure independently of the vapor pressure and of the partial pressures of the other gases present (47).

The total pressure in an inclosed vacuum in equilibrium with water containing air or other gases in solution is equal to the sum of the partial pressures of the water vapor, air, and other gases at the existing temperature. This total pressure varies with the temperature, and, for dissolved gases, also with the saturation and the ratio of the evacuated volume of water remaining in the system when the latter comes to equilibrium. The equilibrium pressure, which will be referred to as the *limiting vacuum pressure* and designated by the symbol  $h_e$ , is small in cold-water systems, but in hot-water systems its value may equal or exceed the atmospheric pressure  $h_a$  if the temperature equals or exceeds the boiling temperature at atmospheric pressure (47).

### **Definition of a Vacuum.**

*A vacuum* is any space in a water-supply system from which water has been displaced by water vapor, air, or other gases, and in which the pressure is less than the prevailing atmospheric pressure (47).

*A limiting vacuum* is a vacuum in an inclosed space in which the absolute pressure is equal to the equilibrium pressure  $h_e$  (47).

*A partial vacuum* is any vacuum in which the pressure lies between the prevailing atmospheric pressure  $h_a$  and the limiting pressure  $h_e$  (47).

### **Atmospheric Pressure and Siphon Action**

The atmosphere at sea level exerts a pressure of approximately 14.7 psi, equivalent to the pressure at the base of a column of water 34 ft in height or at the base of a column of mercury 30 in. in height. Therefore, the atmosphere at sea level will support a column of water approxi-

mately 34 ft in height in a tube against a perfect vacuum (zero absolute pressure). Actually, at any given time and place, the height of the water column, illustrated by a simple water barometer in Fig. 1, will be given by the equation  $h_b = h_a - h_e$ . If there are no dissolved gases in

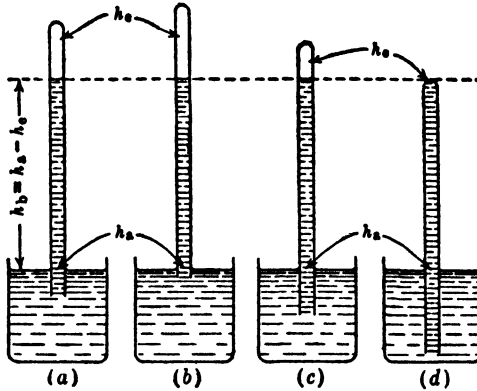

FIG. 1. Simple Liquid Barometer.

the water, then, when the barometer tube is raised and lowered successively, Fig. 1 (b, c, and d), the evacuated volume over the column of water increases or decreases correspondingly, and the length of the column of water  $h_b$  will be the same in each case, once the system has come to equilibrium. If the water contains air in solution, the system will come to equilibrium with slightly different values of the equilibrium pressure  $h_e$  in the cases illustrated, since the change in the relative volumes of vacuum and water exposed produces a change in the partial pressure due to the dissolved air, as explained in the preceding section. In any case,  $h_e$  represents the limit in the height that water can be lifted from an open vessel by siphon action in a completely filled siphon tube, since the atmospheric pressure supplies the entire lifting force. This limit, as defined here, refers to atmospheric pressure at sea level, and it decreases proportionately as the atmospheric pressure decreases with elevation above sea level (47).

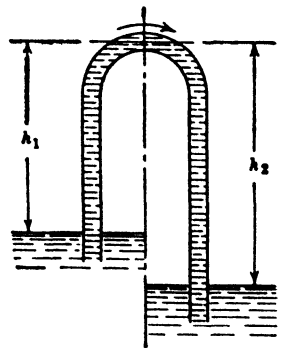

FIG. 2. Simple Siphon.

Since the pressure exerted at the base of a liquid column varies directly as its density, the maximum height to which a liquid can be lifted by siphon action varies inversely as the density of the liquid. Therefore, the limit in the height to which a mechanical mixture of air and water, such as may flow into a partially submerged inlet, can be lifted will be approximately equal to  $h_b(\rho_w/\rho_m)$ , where  $\rho_w$  is the density of the water and  $\rho_m$  is the density of the mixture, provided

the velocity of flow through the siphon is sufficient to prevent the air from separating from the mixture in the siphon tube (47).

There is a head of  $h_2 - h_1$  available to produce flow in the tube, and the velocity at any time will be such that this available head is exactly equal to the friction loss in the tube plus the entrance and exit losses (47).

It should be pointed out that the sole functions of the outlet leg are: (1) to reduce the pressure at the top of the siphon tube so that the atmospheric pressure can lift the water in the inlet leg and (2) to provide a passage for flow (47).

TABLE 1  
PRESSURE EQUIVALENTS (27)

Units	Pounds per Square Inch	Pounds per Square Foot	Kilograms per Square Centimeter	Inches of Mercury at 32 F	Feet of Water at 39.2 F	Feet of Water at 62 F	Atmospheres
1 pound per square inch =	1.	144.	0 0703067	2 0 360	2 30671	2 30934	0 068044
1 pound per square foot =	0 0069444	1.	0 0004882	0 014139	0 016019	0 016037	0 0004725
1 ounce per square inch =	0 0625	9.	0 0043942	0 12725	0 144169	0 144334	0 0042528
1 kilogram per square centimeter =	14 2234	2048 17	1.	28 9582	32 8092	32 8467	0 967820
1 kilogram per square meter =	0 0014223	0 204817	0 0001	0 0028958	0 0032809	0 0032847	9 678 × 10 <sup>-5</sup>
1 inch of mercury at 32 F =	0 49117	70 7285	0 034533	1	1 13299	1 13428	0 033421
1 inch of water at 39.2 F =	0 036127	5 20222	0 0025399	0 073552	0 083333	0 083428	0 0024582
1 inch of water at 62 F =	0 036085	5 19628	0 0025370	0 073468	0 083238	0 083333	0 0024554
1 foot of water at 39.2 F =	0 43352	62 4266	0 030479	0 88262	1	1 00114	0 029498
1 foot of water at 62 F =	0 43302	62 3554	0 030444	0 88162	0 99886	1	0 029465
1 atmosphere =	14 6963	2116 27	1 03325	29 9210	33.9001	33 9388	1

### ART. 1-C. CROSS-CONNECTIONS IN PLUMBING SYSTEMS

#### Definitions

*Air gap* in a water-supply system for plumbing fixtures is considered as the vertical distance between the supply fitting outlet (spout) and the highest possible water level in the receptor (when flooded). The air gap (see *A* in Fig. 3) required to prevent

backflow through a water-supply opening (faucet or valve) under the action of atmospheric pressure and a vacuum in the water-supply system depends principally on the effective opening. (See definition of *Effective Opening*) [39].

*Backflow* means the flow of impure (non-potable) water into a pure (potable) water system. The flow may be caused by gravity, vacuum, or other pressure differential (39).

*Backflow connection* is any arrangement whereby backflow can occur (39).

*Back siphonage* is one form of backflow caused by a vacuum in the water-supply pipes (39).

*Back-siphonage preventer* (sometimes called *vacuum breaker*) is a device for installation in a water-supply pipe to prevent back siphonage of water into the water-supply system from the connections on its outlet end (39).

*Control valve* is the valve that is operated each time water is supplied to, or shut off from, a receptacle or plumbing fixture (39).

*Critical level* of a back-siphonage preventer, when a vacuum of 15 in. of mercury or greater exists in the supply line to the fixture, is the highest horizontal plane through the preventer at which the preventer can be immersed in water, open to the atmosphere, before siphonage begins through the preventer. Conversely, the critical level may be defined as the highest horizontal plane to which the flood level of a fixture can be raised relative to a back-siphonage preventer before siphonage begins, when a vacuum of 15 in. of mercury exists in the supply line (39).

*Definition and Classification of Cross-Connections.* A cross-connection may be defined as any physical connection or arrangement of pipes between two water-piping systems whereby water may flow from one system to the other, the direction of flow depending on the direction of the pressure differential between the two systems. A cross-connection becomes a hazard to health when one system carries a water used for human consumption and the other carries an impure or contaminated water. It will be convenient for purposes of discussion and analysis to divide cross-connections into two general classes, direct and indirect, although there is no sharp demarcation between the two in principle (47).

*A direct cross-connection* may be defined as a continuous inclosed interconnection between two piping systems, such that the flow of water from one system to the other may occur whenever a pressure differential is set up in the connection between the two systems. *Examples:* Interconnections between dual water-distributing systems, completely submerged inlets from water-supply lines to closed plumbing fixtures, tanks and vats, continuous water connections between the supply and drain systems, priming lines to pumps, etc. (47).

*An indirect cross-connection*, frequently referred to as a potential cross-connection, is one in which the interconnection is not continuously inclosed and the completion of the cross-connection depends on the occurrence of one or more abnormal conditions. *Examples:* Water closets with direct flush-valve supply, bathtubs, and lavatories with faucet openings that may become submerged, and other plumbing fixtures and equipment whose supply inlets may become partially or wholly submerged (47).

Among the abnormal conditions, using the term to include all conditions not contemplated or intended, as well as in the sense of unusual, the following are the conditions that may occur or may be necessary to complete the cross-connection: (1) a drop in the static pressure in the supply system to such a point that a pressure differential acting in the direction of the supply system is produced in the supply connection to the fixture; (2) the formation of a vacuum by displacement of water from the supply line; (3) a flooding of the fixture by stoppage or other causes; and (4) an open or leaking faucet or valve. In general, the simultaneous occurrence of two and sometimes all of these conditions is necessary to produce flow from the fixture into the supply line (47).

*Direct flushing valve* is a self-closing type of valve used primarily to supply water direct from a water-supply pipe to flush a water closet, urinal, etc. It is one type of control valve (39).

*Effective opening* (see *B* in Fig. 3) is the minimum cross-sectional area between the



end of the supply fixture outlet (spout) and the inlet to the controlling valve or faucet. (See *X* in Fig. 3.) The basis of measurement is the diameter of a circle of equal cross-sectional area. If two or more lines supply one outlet, the effective opening is the sum of the effective openings of the individual lines, or the effective opening of the combined outlet, whichever is the smaller (39).

*Flood level* is the highest horizontal plane to which water can rise in a plumbing fixture or receptacle (usually the rim) before water will overflow onto the floor. Connections below rim which are called "overflows," to carry water from a certain level to the waste or soil pipes, are not recognized as flood level, except under special conditions, for example:

1. A tank or vat fitted with overflow connections and piping of sufficient capacity to keep the water level below the critical level of a back-siphonage preventer, if one is used, or below the end of the supply spout or nozzle that has the required safe air-gap elevation for the piping involved—when water is entering the tank at the maximum rate of flow. In such cases, the top of the overflow opening in the tank is rated as flood level, provided that there is a safe air-gap break in the overflow piping as close to the tank as possible, to allow overflow water

to spill onto the floor if the waste pipe line becomes clogged.

2. A closet tank, because the overflow water from it runs down into the closet, and, if the soil pipe is stopped, the water will overflow from the closet rim onto the floor. Therefore, the top of the overflow opening is rated as flood level, provided that the edge at the top end of the wall is well rounded (not cut square) and the overflow channel has an internal area not less than 0.78 sq in. (1 in. in diameter) at all points (39).

*Outlet end of back-siphonage preventer* is the end where the pipe connection is made to carry the discharge from the back-siphonage preventer (39).

*Safe air gap* is any gap greater than the maximum gap across which backflow can occur under any condition of service (39).

*Air inlet* of a back-siphonage preventer is a passage or series of passages leading through the body of the device from the surrounding atmosphere to the water passage (39).

*Water lift* of a back-siphonage preventer is the maximum rise of water (in inches) in the flush pipe (*a*) when its open end is immersed in water open to atmospheric pressure, (*b*) when a vacuum of 15 in. of mercury, or greater, exists on the supply side of the preventer, and (*c*) when the critical level is 4 in. above the water level (39).

#### ART. 1-D. PREVENTION OF BACKFLOW IN SUPPLY BRANCHES

If no provision for controlling the minimum pressure that may occur in water-supply systems is assumed, there are three ways in which backflow into the system can be restricted or prevented: (1) by safe air gaps; (2) by siphon breakers; and (3) by check valves (47).

##### Safe Air Gap

In open-top plumbing fixtures that do not require a direct connection from the water-supply system, the obvious and economical means of preventing backflow is to provide a safe air gap (47).

This method may be used effectively in any cross-connection where a direct connection is not essential for the proper functioning of the fixture (47).

**Recommended Air Gaps**

The air gaps recommended for the ordinary-type plumbing fixtures by Subcommittee 12 of the ASA Sectional Committee A-40 are given in Table 2.

**TABLE 2**  
**RECOMMENDED AIR GAPS FOR COMMON PLUMBING FIXTURES \***

Fixture and Fitting	Diameter of Effective Opening Not Greater Than	Minimum Air Gaps
Lavatories	0.50 in.	1 in.
Sinks, laundry trays, and gooseneck bath faucets	0.75 in.	1½ in.
Overrim bath fillers	1.00 in.	2 in.

\* If the effective opening is greater than specified in Table 2, the minimum air gap shall be equal to twice the diameter of the effective opening.

The minimum air gaps recommended in Table 2 and its footnote apply when no wall extending to or above the level of the spout opening is close to the supply outlet. If any vertical wall extending to or

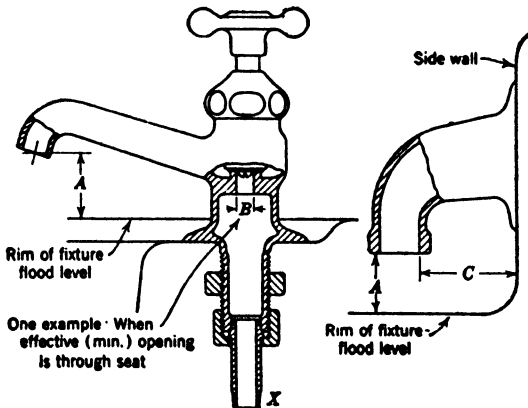

**FIG. 3. Air Gap for Supply Fixtures.**

above the horizontal plane of the spout opening is closer to the nearest inside wall of the supply opening than four times the diameter of the effective opening, the air gap shall be at least three times the diameter of the effective opening, but, in no case, less than the air gap specified in Table 2. (See C, Fig. 3.) Should the plane of the end of the spout

be at an angle to the surface of the water, the mean gap is to be the basis for measurement (39). (See Fig. 3.)

### Siphon Breakers

Where a clear air gap between the fixture and the water-supply branch is impractical, for example, in water-closet bowls with flush-valve supply, a siphon breaker can be installed to prevent backflow (47).

There has been considerable rivalry in the past between the advocates of the two general types of siphon breakers (moving-part and non-moving-part) and some controversy regarding their relative merits. Questions of this nature can be answered best by stating the general characteristics of the two types for consideration in regard to their effectiveness in preventing backflow, dependability, and general serviceability. For each pattern or design of either type there is a definite minimum limit to the distance  $A$  (see Fig. 3) which the device may be set above the top of a water-closet bowl and give 100 per cent effectiveness in preventing backflow (47).

The *non-moving-part siphon breaker* must be suited in design to the flushing characteristics of the closet bowl with which it is installed, and it is impossible to design a single model, without an adjustment feature, suitable for use with water-closet bowls distinctly different in their flushing characteristics or to design a single model, whether adjustable or not, that will be completely effective in preventing backflow when  $A$  is small. There is no assurance that a siphon breaker suitable for the closet bowl at the time of installation will be suitable later if the flushing characteristics of the closet bowl change after a period of service. Also the non-moving-part siphon breaker is inherently noisy in operation (47).

The design of a *moving-part siphon breaker* is not dependent on the characteristics of the water-closet bowl, so it can be designed to make it completely effective for very low values of  $A$  and quiet in operation (47).

Objections to the moving-part siphon breaker have been made on the grounds that the moving part may get out of order in service and cease to function and that it does not permit a rapid relief of vacua in water-supply systems. Whether the former objection is a valid one or not can probably be most convincingly answered by the history of these devices in actual service. In reference to the latter objection, it may be pointed out that there is no logical reason for relieving the vacuum in a water-supply system if all supply outlets from the system are protected against backflow. Also it will be a distinct service disadvantage if the water-supply system is permitted to fill with air every time a sub-atmospheric pressure occurs, since the air has to be let out before the system can refill (47).

A *check valve* alone cannot be regarded as positive protection against backflow through a cross-connection because of possible failure to operate. However, in any existing direct cross-connection, it may be less

hazardous to permit the use of a check valve or combination of check valves than to remove the cross-connection, if its removal would introduce a different hazard or increase one already existing, as, for example, the fire hazard. Control of such conditions is more a matter of judgment, based on a knowledge of the local conditions, such as pressure

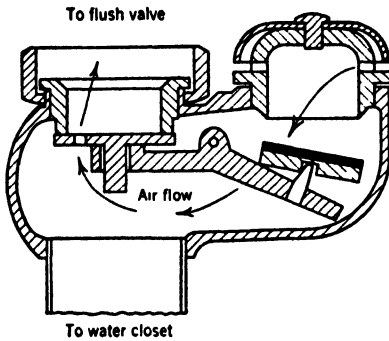

FIG. 4.

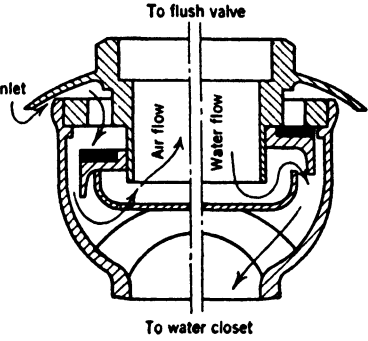

FIG. 5.

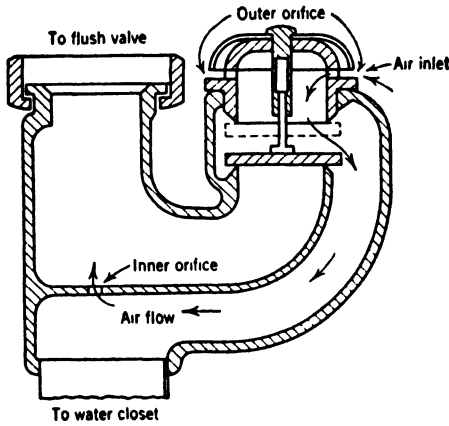

FIG. 6.

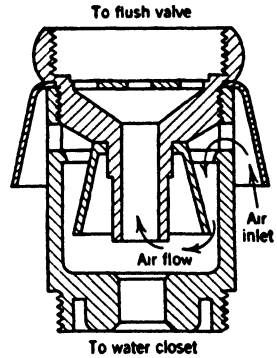

FIG. 7.

Siphon Breakers.

variations, nature of the cross-connection, character of the waters in the two systems, etc., than of facts of general analysis. The only certain way to prevent flow through a direct cross-connection is to remove the cross-connection or convert it into one that can be controlled positively (47).

Protection of Closed Fixtures

Since there is no means of determining the maximum back pressure which a closed fixture may exert on a direct-supply connection, there

is no apparent means of positively preventing backflow through a cross-connection of this type. If the direct-supply connection is essential, the only certain way of preventing pollution of the main water supply of the building is by means of a separate or auxiliary water-distributing system to fixtures of this type. If the direct-supply connection is not essential for satisfactory service, then the obvious way of preventing backflow is to convert the cross-connection to one in which a safe air gap may be employed (47).

**Auxiliary Supply Systems**

An auxiliary water-distributing system for water closets and urinals has been advocated and used to some extent as a means of preventing contamination of the main water supply. If such an auxiliary system has no connection or branch through which water might be drawn for drinking or domestic purposes, and if the main system is fully protected against backflow from the auxiliary system by a safe air gap between the two, the method is perfectly safe, so long as the system remains unaltered by structural changes. Objections to this method of protecting the main water supply are principally on the basis of cost and on the assumption that the system may be altered without the knowledge or consent of the health authorities. However, in some cases, the cost of installing an auxiliary supply system may not exceed the cost of installing siphon breakers for individual fixtures, and it is impossible to estimate or weigh the chance of unauthorized alterations (47).

**Recommendations**

(Recommendations for Protection of Water Supplies and Fixtures against Contamination through Interconnections and Unprotected Waste Lines, New York State Department of Health, *Bulletin* 23.)

- Aspirator-filter pumps* . . . . . Use siphon-preventer check valve on water line to fixture.
- Baths: tub-, seat-, foot-* . . . . . Use overrim inlets discharging above flood line.
- Baths: continuous-flow* . . . . . Use air inlet valve on water lines to fixture.
- Bed-pan washers* . . . . . Use venturi air break on water line between control valve and fixture. Whenever possible existing fixtures should be provided with venturi air break between the water-supply valve and fixture. Where this is not possible because of fixture design, a siphon-preventer check valve should be used.
- Bidets* . . . . . Use siphon-preventer check valve or air inlet valve on water lines to fixture.
- Dental cuspidors* . . . . . Use siphon-preventer check on water line to fixture.

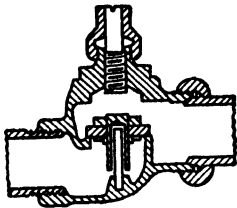

FIG. 8. Siphon-Preventer Check Valve.

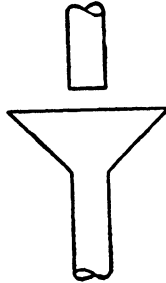

FIG. 9. Funnel Air Break.

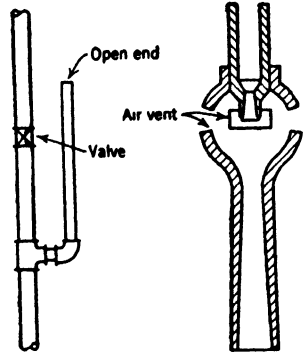

FIG. 10. Air Inlet.

FIG. 11. Venturi Air Break.

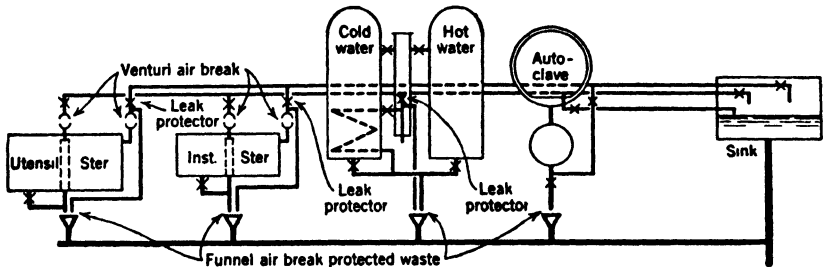

FIG. 12. Satisfactory Sterilizer Plumbing.

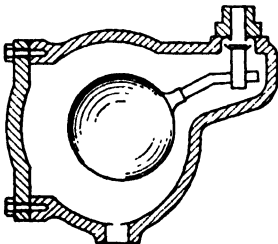

FIG. 13. Air Inlet Valve.

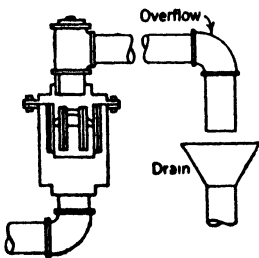

FIG. 14. Air Inlet Valve.

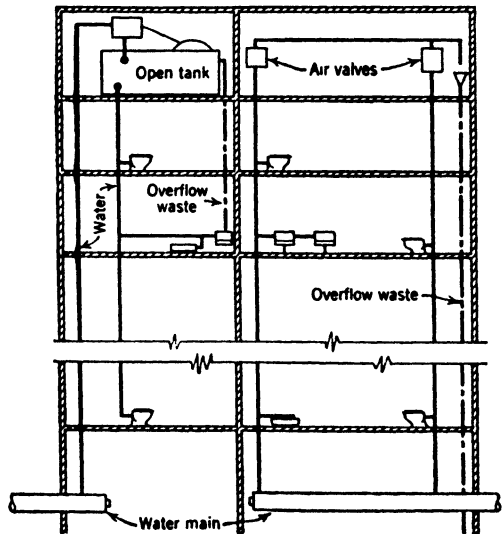

FIG. 15. Arrangement for Vented Risers.

<i>Drinking fountains</i> . . . . .	Use fixture complying with recommendations of the American Public Health Association. (See Vol. I, page 171).
<i>Floor drain, flush rim</i> . . . . .	Avoid use where possible. Where used, provide venturi air break, air inlet valve, or siphon-preventer check valve on water line to fixture.
<i>Kitchen and pantry fixtures</i> . . . . .	Use fixtures having inlets discharging above flood line or provide break on water line to fixture with air breaks on all waste connections.
<i>Laundry trays</i> . . . . .	Use fixtures with overrim inlets discharging above flood line.
<i>Laundry washing machines</i> . . . . .	Use air break or air vent or air inlet valve on water lines to submerged inlets. Use air break on all waste connections.
<i>Lavatories</i> . . . . .	Use fixtures with overrim inlets discharging above flood line.
<i>Photodeveloping tanks</i> . . . . .	Use air breaks on water lines to fixture (Fig. 69, Vol. I).
<i>Pump primers</i> . . . . .	Use air break on priming line to pump.
<i>Sinks, slop</i> . . . . .	Use fixtures with overrim inlets discharging above flood line.
<i>Sinks, flush rim</i> . . . . .	Use siphon-preventer check valve or air inlet valve on water line to rim.
<i>Spray heads, movable</i> . . . . .	Use siphon-preventer check valve or air inlet valve on water line to fixture.
<i>Sterilizers</i> . . . . .	Use leak-protected valve and air break on water line to fixture. Use air break on all waste lines.
<i>Urinals with flush valves</i> . . . . .	Use siphon-preventer check valve on water line to flush valve.
<i>Water closets with flush valves</i> . . . . .	Same as above.
<i>Water closets, flush tank</i> . . . . .	Use vented top inlet valve in tank.
<i>Water-distributing system.</i> . . . . .	Use elevated tank or air relief valve on cold-water risers. Connect laterals to risers above top of fixtures served by lateral. Air relief valves on risers are not considered necessary in ordinary residential or small institutional installations (Fig. 15).

#### ART. 1-E. PROPERTIES OF WATER

##### Definitions

*Evaporation.* Vaporization of moisture from a wet surface (41).

*Saturation.* The condition of a liquid when it has taken into solution the maximum possible quantity of a given substance at a given temperature and pressure, as water saturated with oxygen (41).

### Composition of Water

The chemical composition of pure water is two parts hydrogen and one part oxygen ( $H_2O$ ).

Water contains in addition to the molecules of  $H_2O$  a number of un-associated or free ions, the positive hydrogen ions (H) and the negative hydroxyl ions (HO). Further discussion of this will be found in Chapter 1 of Volume I, under Corrosion.

*Hydrogen-ion concentration* (written pH) is an expression of the acidity of water. Values of pH below 7 indicate acidity and values above 7 indicate alkalinity.

### Absorption by Water

Water is never found in a pure state. When exposed in the least degree, it absorbs other elements.

*Absorption of Gases.* At any certain temperature the volume of any gas absorbed by a given amount of liquid is constant regardless of pressure. As the volume of gas is smaller with increasing pressure, the total weight of gas absorbed increases with pressure.

Water can absorb its own volume of carbonic acid gas, 430 times its volume of ammonia;  $2\frac{1}{3}$  times its volume of chlorine; and about  $\frac{1}{20}$  times its volume of oxygen (12).

### Free Oxygen

Most water contains dissolved oxygen. The amount of oxygen which can be held in solution increases with the pressure and decreases with the temperature. The dissolved oxygen is invisible while any excess oxygen will form air bubbles.

### Water Pressure

*Weight.* Water is practically incompressible. Its greatest variation in volume is due to temperature difference. Its weight at 39.2 F (4 C) is 62.425 lb per cu ft. Its specific gravity at 39.2 F equals 1. (This is not an accepted standard, the temperature used being 0 C in some cases or even 60 F.)

*Hydrostatic pressure,* the pressure of still water, is due to its weight. Pressure at a distance  $h$  from the surface of a fluid of weight  $w$  is

$$P = hw$$

The total force on an area,  $A$ , due to hydrostatic pressure, is

$$F = PA = Ahw$$

*Pascal's Law.* Pressure exerted at any point upon the mass of a liquid is transmitted undiminished in all directions.

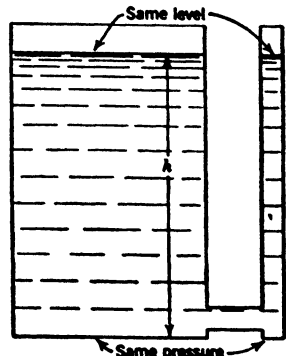

FIG. 16. Problem in Hydrostatics.



TABLE 3

## WEIGHT OF WATER AT DIFFERENT TEMPERATURES

(Circular of the Bureau of Standards No. 19, 6th Edition, 1924) (5)

Temperature		Weight in Pounds		Temperature		Weight in Pounds	
Degrees C	Degrees F	Cubic foot	U. S. gallon	Degrees C	Degrees F	Cubic foot	U. S. gallon
0	32	62.4183	8.34412	50	122	61.682	8.2457
5	41	62.4261	8.34515	55	131	61.536	8.2261
10	50	62.4096	8.34295	60	140	61.380	8.2054
15	59	62.3720	8.33793	65	149	61.215	8.1832
15½	60	62.3667	8.33722	70	158	61.041	8.1600
16¾	62	62.3554	8.33571	75	167	60.859	8.1357
20	68	62.3164	8.33049	80	176	60.668	8.1101
25	77	62.2441	8.32083	85	185	60.470	8.0836
30	86	62.1568	8.30915	90	194	60.263	8.0560
35	95	62.0558	8.29566	95	203	60.049	8.0274
40	104	61.9428	8.28054	100	212	59.828	7.9979
45	113	61.817	8.2638				

TABLE 4

VOLUME OF WATER (CORRESPONDING TO DENSITY IN GRAMS PER MILLILITER)  
AT DIFFERENT TEMPERATURES

(Circular of the Bureau of Standards No. 19, 6th Edition, 1924) (5)

Temperature		Density in Grams per Milliliter	Temperature		Density in Grams per Milliliter
Degrees C	Degrees F		Degrees C	Degrees F	
0	32	0.99987	50	122	0.98807
4	39.2	1.00000	55	131	0.98573
5	41	0.99999	60	140	0.98324
10	50	0.99973	65	149	0.98059
15	59	0.99913	70	158	0.97781
20	68	0.99823	75	167	0.97489
25	77	0.99707	80	176	0.97183
30	86	0.99567	85	185	0.96865
35	95	0.99406	90	194	0.96534
40	104	0.99224	95	203	0.96192
45	113	0.99024	100	212	0.95838

TABLE 5  
 PRESSURE OF WATER AT DIFFERENT HEADS  
 TABLE OF EQUIVALENTS

Inches of Mercury	Feet of Water	Lb per Sq In.	Feet of Water	Lb per Sq In.	Inches of Mercury
1	1.13	0.49	1	0.43	0.89
2	2.26	0.98	2	0.87	1.77
3	3.39	1.47	3	1.30	2.66
4	4.52	1.95	4	1.73	3.54
5	5.65	2.44	5	2.17	4.43
6	6.78	2.93	6	2.60	5.31
7	7.91	3.42	7	3.03	6.20
8	9.04	3.91	8	3.40	7.09
9	10.17	4.40	9	3.90	7.97
10	11.30	4.89	10	4.33	8.85

Lb per Sq In.	Feet of Water	Inches of Mercury
1	2.31	2.05
2	4.62	4.09
3	6.93	6.14
4	9.24	8.19
5	11.54	10.23
6	13.85	12.28
7	16.16	14.32
8	18.47	16.37
9	20.78	18.42
10	23.09	20.46

*Example:* To find pressure of 136 ft of water

$$\begin{array}{r}
 100 \text{ ft} = 43.3 \text{ psi} \\
 30 \text{ " } = 13.0 \text{ " } \\
 6 \text{ " } = 2.6 \text{ " } \\
 \hline
 136 \text{ ft} = 58.9 \text{ psi}
 \end{array}$$

ART. 1-F. FLOW OF WATER IN PIPES

**Definitions**

*Air Bound.* The condition of a pipe line wherein air entrapped in a summit prevents the free flow of water through it (45).

*Coefficient of Roughness.* A factor in the Kutter, Manning, Bazin, and other formulas expressing the nature of a channel as

affecting the friction slope of water flowing therein (45).

*Entrance Head.* The head required to cause flow into a conduit or other structure; it includes both entrance loss and velocity head (45).

*Flow Line.*

- a. The hydraulic grade line (45).
- b. A conduit, as a laid pipe, laid on the hydraulic gradient (45).
- c. Flowage line (45).

*Friction Head (or Loss).* The head or energy lost as the result of the disturbances set up by the contact between a moving stream of water and its containing conduit. In laminar flow the friction head is approximately proportional to the first power of the velocity; in turbulent flow to a higher power, practically the square. For convenience, friction losses are best distinguished from losses due to bends, expansions, obstructions, impacts, etc., but there is no recognized line of demarcation between them, and all such losses are often included in the term "friction losses" (45).

*Friction Slope.* The friction head or loss per unit length of conduit (45).

*Gradient.* Change of elevation, velocity, pressure, or other characteristic per unit length; slope (45).

*Head.* The height of water above any point or plane of reference. Used also in various compounds, such as energy head, entrance head, friction head, static head, pressure head, lost head, etc. (45).

*Hydraulic Elements.* The depth, area, perimeter, mean depth, hydraulic radius, velocity, energy, and other quantities pertaining to a particular stage of flowing water (45).

*Hydraulic Grade.* The elevation of the surface of the liquid in a sewer above an assumed datum (41).

*Hydraulic Gradient.* The slope of the hydraulic grade line. The slope of the surface of water flowing in an open conduit (45).

*Hydraulic Radius.* The right cross-sectional area of a stream of water divided by the length of that part of its periphery in contact with its containing conduit; the ratio of area to wetted perimeter (45).

*Kutter's Formula.* An empirical formula expressing the value of the coefficient, *C*, in the Chezy formula, in terms of the friction slope, hydraulic radius, and a coefficient of roughness (45).

*Laminar Flow.* That type of flow in which each particle moves in a direction parallel to every other particle, and in which the head loss is approximately proportional to the first power of the velocity. It is sometimes designated "stream-line flow" or "viscous flow" (45).

*Manometer.* A tube containing a liquid, the surface of which moves proportionally to changes of pressure; a U-tube; a tube type of differential pressure indicator; a pressure gage (45).

*Mean Velocity.* The velocity at a given section of a stream obtained by dividing the discharge of the stream by the cross-sectional area at that section.

*Permissible Velocity.* The highest velocity at which water may be carried safely in a canal or other conduit. The highest velocity throughout a substantial length of a conduit that will not scour (45).

*Piezometer.* An instrument for measuring pressure head, usually consisting of a small pipe tapped into the side of a closed or open conduit and flush with the inside, connected with a pressure gage, mercury, water column, or other device for indicating pressure head (45).

*Pitot Tube.* A device for observing the velocity head of flowing water, consisting essentially of an orifice held to point up stream in flowing water and connected with a tube by which the rise of water in the tube above the water surface may be observed. It may be constructed with an upstream and a downstream orifice and two water columns, the difference of water levels being an index of the velocity head (45).

*Pressure Head.* The head on any point in a conduit represented by the height of the hydraulic grade line above that point (45).

*Siphon.* A closed conduit, a part of which rises above the hydraulic grade line. It utilizes atmospheric pressure to effect or increase the flow of water through it. (An inverted siphon has none of the properties of a siphon; the term is a misnomer.) (45)

*Slope.* The inclination of the invert of a sewer expressed in percentage of length, as a decimal, or as a one-foot fall in a given length of feet (41).

**Static Head.** The total head without deduction for velocity head or losses (45).

**Turbulence.** A state of flow wherein the water is agitated by cross-currents and eddies; opposed to a condition of flow that is quiet or quiescent (45).

**Turbulent flow,** that type of flow in which any particle may move in any direction with respect to any other particle, and in which the head loss is approximately proportional to the second power of the velocity (sometimes designated as "sinuous flow" or "tortuous flow") (45).

**Turbulent velocity,** that velocity above which, in a particular conduit, turbulent flow will always exist, and below which the flow may be either turbulent or laminar, depending on circumstances (45).

**Uniform flow,** a constant flow or discharge, the mean velocity of which is also constant. Uniform flow is also referred to as "steady uniform flow." It is an ideal condition that can be approximated only in fact. If the velocity of the constant discharge varies, the flow is defined as "steady-non-uniform" (45).

**Velocity Head.** The distance a body must fall freely under the force of gravity to acquire the velocity it possesses (45).

**Venturi Tube.** A closed conduit which is gradually contracted to a throat causing a reduction of pressure head by which the velocity through the throat may be determined. The contraction is generally followed, but not necessarily so, by gradual enlargement to original size. Piezometers

connected to the pipe above the contracting section and at the throat indicate the drop in the pressure head which is an index of flow (45).

**Viscosity** is the internal friction of a liquid tending to reduce flow. As a measure of the coefficient of viscosity, units are used in terms of force required to move a certain area a certain distance. Absolute viscosity is in terms of cgs units, the force of one dyne required to move one square centimeter of liquid a distance of one centimeter. This unit is called a poise. Centipoises are 1/100th of a poise (Hydraulic Data) (9).

The viscosity of a fluid is measured by a viscosimeter. There are many different types. The findings are usually stated in terms of seconds required to move a liquid through a pipe of a standard cross-sectional area. The most common determination is that of the Saybolt Universal Viscosimeter, expressed in Saybolt Seconds Universal, S.S.U., for lighter liquids or Saybolt Furol for heavier liquids. These measurements establish the coefficient of viscosity. The viscosity of a fluid varies with the temperature.

The viscosity of water is 31.5 S.S.U. (or 1.1 centipoises) at 60 F.

**Water Hammer.** The phenomenon of oscillations in the pressure of water in a closed conduit, resulting from checking the flow. Momentary pressure greatly in excess of the normal static pressure may be produced in this manner (45).

## General Principles

Figure 17 shows two tanks, *A* and *B*, connected by a valved pipe. Tank *A* is full and tank *B* is empty. While the valve is closed there exists a regular hydrostatic condition (of still water) with a static head at the level of the valve equal to *h*.

When the valve is opened the water will flow into the pipe. The result will be the lowering of the water level in tank *A* until both tanks have an even water level. If no resistance of any kind existed this action would take place instantaneously or without the element of time. As long as the valve was closed there was complete resistance to any motion and also complete static pressure at the valve.

With the valve opened there is a partial resistance due to (*a*) the

limitation of the opening, (b) friction in the pipe and valve, (c) the work involved in moving the mass of water, and (d) the viscosity of the water.

*Slope.* The moment flow takes place in a pipe system it will be found that there is no longer such a thing as a fixed static head or pressure but that this head will vary from a maximum at the source of flow to a minimum at the point of discharge.

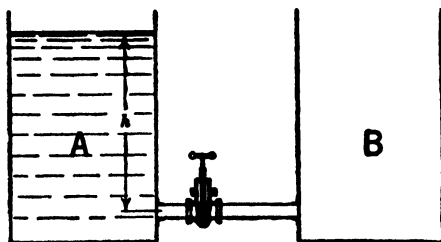

FIG. 17. Problem in Hydraulics.

The maximum or original head will be referred to as the *total pressure head*, i.e., the head which causes the water to flow. The heads along the various points of the pipe line will be referred to as the *pressure heads*.

### Pressure Losses

The causes for losses in the original head are due to forces which have to be overcome by the flow of water and are usually listed as follows:

- |   |               |
|---|---------------|
| (1) Force needed to produce flow velocity | velocity head |
| (2) Resistance to entry                   | entry head    |
| (3) Friction in the pipe                  | friction head |

The remainder of head left will produce pressure head in the receiving container (tank, pipe, etc.) or discharge head or stream if discharged into the air.

The loss of pressure per unit length of pipe is referred to as "slope" or pressure loss in pounds per square foot per feet, or feet per feet (i.e., feet of water per linear feet of conduit).

$G$  = discharge in gpm.

$d$  = diameter of pipe or orifice in inches.

$g$  = acceleration of gravity; 32.16 fps.

$v$  = velocity in fps; equals the discharge divided by the cross-sectional area of the opening  $v = \frac{Q}{A}$ . For a circular opening with

the discharge expressed in gallons:  $v$  (fps) =  $\frac{G \times 0.408}{d^2}$

$Q$  = quantity of water discharge per unit time.

$A$  = cross-sectional area of orifice.

$K_1$  = coefficient of resistance to entry.

### Velocity Head

Velocity head is expressed by the formula  $h_1 = \frac{V^2}{2g}$  and is equal to the distance a body would have to fall in a vacuum to acquire the same velocity as the flow of water in the pipe. The velocity accordingly is  $V = \sqrt{h_1 \times 2g}$ . This is the theoretical velocity of the discharge through an orifice, *the velocity of efflux*.

### Loss of Head Due to Entry

Loss of head due to entry depends on the shape of the entrance or orifice. The loss will equal  $h_2 = K_1 \frac{V^2}{2g}$ , where  $K$  is an experimental coefficient.

For inward projecting entrance	$K_1 = 0.78$
For sharp-edged entrance	$K_1 = 0.50$
For slightly rounded entrance	$K_1 = 0.23$
For bell-mouth entrance	$K_1 = 0.04$

Expressed in gallons per minute and on the basis of diameter,  $d_1$ , of a round orifice  $G = \frac{d^2}{0.408} \times \sqrt{\frac{2gh}{K_1}}$ .

*Minimum Entry Head.* Entry to any pipe, channel, or receptacle must be far enough below the surface of water in open vessels to have the water produce the sufficient entry head and velocity head. This is important in the design and installation of many fixtures and receptacles. The combined head needed is

$$h_1 + h_2 = \sqrt{\frac{V^2(1 + K_1)}{2g}}$$

Velocity head and entry head are relatively unimportant in pipe work and are usually neglected.

### Loss of Head Due to Friction

Present formulas for friction loss include factors for roughness of the interior surface and are proportioned in relation to the internal diameter of the pipe or radius of conduit. In addition, the formula for each type of liquid includes factors which are governed by the viscosity of the liquids. Figures expressing friction losses include factors which take into account the roughness of the conduit as well as the viscosity of the liquid. The roughness of the conduit, besides causing a friction, sets up turbulence of the liquid which again sets up additional resistance, depending on the viscosity of the fluids. The turbulence at any section of the conduit will vary, and the wider the conduit the greater the variation. This has the consequent result that flow in the center

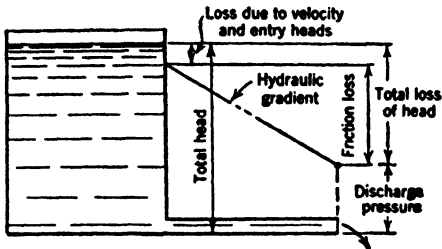

FIG. 18. Hydraulic Elements.

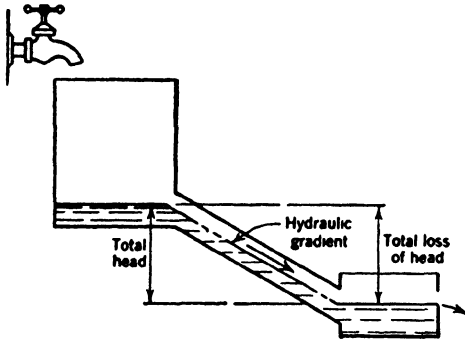

FIG. 19. Non-pressure Flow (Sewers and Drains).

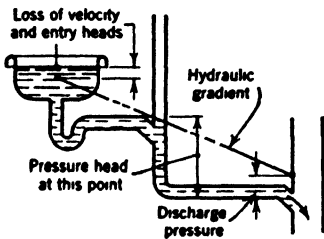

FIG. 20. Pressure Flow (Branch Wastes).

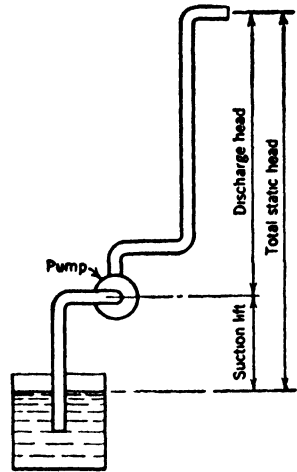

FIG. 21. Pumping Conditions.

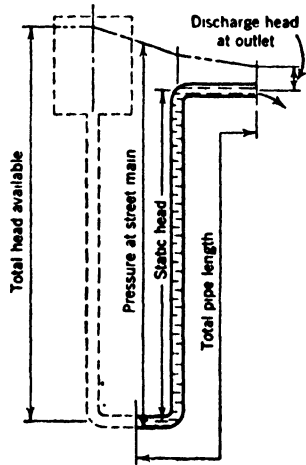

FIG. 22. Building Conditions.

of the pipe actually is dependent on entirely different conditions from the flow near the border.

For this reason pipe formulas contain a discrepancy so that no formula for any one liquid is adaptable to both small pipes and large pipes.

*Loss of Head Due to Fittings.* Any change in direction or restriction in the channel or conduit adds to the friction losses. On long runs with few fittings this pressure loss is not important in comparison with the total pressure loss. In most building work, however, the lines are comparatively short and usually have a sufficient number of valves and fittings to make them a factor. For the sake of ease in figuring, the friction losses for valves and fittings are expressed in an equivalent length of feet of pipe.

### Flow Formulas

The friction head is expressed as loss of pounds of pressure per square inch per unit length of pipe. The additional loss of head due to friction in fittings and valves is expressed in equivalent feet of pipe. There are many formulas for friction losses. For open channels and pipes partly full (as in sewers) the most commonly used formula is Kutter's formula. For pressure pipes the most commonly used formula is the Hazen-Williams formula.

$$V = 1.318C_w R^{0.63} S^{0.54}$$

$V$  = mean velocity in feet per second.

$R$  = hydraulic radius in feet.

$S$  = hydraulic slope in feet per linear foot of conduit.

$C_w$  = Hazen-Williams coefficient of roughness.

A modification of the Hazen-Williams formula, based on tests conducted at Harvard University on pipes of small diameter for both hot and cold water, is formulated by Fair, Whipple, and Hsiao.

### Water Hammer

Most of the research on water hammer has been done in connection with large water mains, and the facts obtained are not directly applicable to smaller systems.

When the flow of water in a pipe is stopped it can be compared with a solid body of a certain weight and velocity being halted. Water is compressible in a very small degree and will thus cause a recoiling action. This action is, of course, far more effective in long mains. In domestic piping the recoiling effect takes place in any severe degree only where there is air in the water. Such air may occur in pneumatic water systems and, in particular, in hot-water systems. What appears as a recoil effect in domestic water systems is usually vibration in the pipes.



The quickness with which the water is halted is the determining factor in the intensity of the water hammer. To overcome water hammer some slow-acting brake effect must be used, and it should be kept in mind that the proper and most effective way is to apply this at the head of the water column and not wait for the water column to rebound. The remedies are slow-closing valves or faucets, air chambers, shock absorbers, and relief valves.

TABLE 6  
RATE OF FLOW EQUIVALENTS (27)

Units	Cubic Feet per Second	Cubic Feet per Minute	U. S. Gallons per Minute	U. S. Gallons per 24 Hours
1 cubic foot per second	= 1.	60.	448.831	646317.
1 cubic foot per minute	= 0.016667	1.	7.48052	10771.9
1 U. S. gallon per minute	= 0.0022280	0.13368	1.	1440.
1 U. S. gallon per 24 hours	= $1.547 \times 10^{-6}$	$9.283 \times 10^{-6}$	0.0006944	1.
1 British Imperial gallon per minute	= 0.0026757	0.16054	1.20095	1729.37
1 liter per minute	= 0.0005886	0.035315	0.26418	380.416
1 acre-foot per hour	= 12.1	726.	5430.86	7820434.
1 acre-foot per 24 hours	= 0.50417	30.25	226.286	325.851

Units	British Imperial Gallons per Minute	Liters per Minute	Acre-feet per Hour	Acre-feet per 24 Hours
1 cubic foot per second	= 373.729	1698.98	0.082645	1.98347
1 cubic foot per minute	= 6.22882	28.3163	0.0013774	0.033058
1 U. S. gallon per minute	= 0.83267	3.78533	0.0001841	0.0044192
1 U. S. gallon per 24 hours	= 0.0005782	0.0026287	$1.279 \times 10^{-7}$	$3.069 \times 10^{-6}$
1 British Imperial gallon per minute	= 1.	4.54601	0.0002211	0.0053072
1 liter per minute	= 0.21997	1.	$4.864 \times 10^{-6}$	0.001167
1 acre-foot per hour	= 4522.13	20557.6	1.	24.
1 acre-foot per 24 hours	= 188.422	856.567	0.041667	1.

TABLE 7  
VOLUME AND CAPACITY EQUIVALENTS (27)

Units	United States Gallons	British Imperial Gallons	Liters
1 United States gallon	= 1.	0.832672	3.78533
1 British Imperial gallon	= 1.20095	1.	4.54601
1 liter	= 0.264177	0.219973	1.
1 cubic foot	= 7.48052	6.22882	28.3163
1 cubic inch	= $4.329 \times 10^{-3}$	$3.605 \times 10^{-2}$	0.016387
1 acre-foot	= 325851.	271328.	1233456.
1 inch deep on 1 acre	= 27154.3	22610.6	102788.
1 inch deep on 1 square mile	= 17378743.	14470801.	65784344.
1 meter deep on 1 hectare	= 2641705.	2199675.	9999734.
1 centimeter deep on 1 square meter	= 2.64171	2.19967	9.99973
1 pound of water at 39.2 F	= 0.11983	0.099778	0.45359
1 pound of water at 50 F	= 0.11986	0.099806	0.45372
1 pound of water at 62 F	= 0.11997	0.099892	0.45411
1 U. S. gallon per minute for 24 hours	= 1440.	1199.05	5450.88
1 cubic foot per minute for 24 hours	= 10771.9	8969.50	40775.4

Units	Cubic Feet	Cubic Inches	Acre-feet
1 United States gallon	= 0.133681	231.	$3.069 \times 10^{-6}$
1 British Imperial gallon	= 0.160544	277.420	$3.686 \times 10^{-6}$
1 liter	= 0.035315	61.0250	$8.107 \times 10^{-7}$
1 cubic foot	= 1.	1728.	$2.296 \times 10^{-5}$
1 cubic inch	= $5.787 \times 10^{-4}$	1.	$1.329 \times 10^{-8}$
1 acre-foot	= 43560.	75271680.	1.
1 inch deep on 1 acre	= 3630.	6272640.	0.083333
1 inch deep on 1 square mile	= 2323200.	4014489600.	53.3333
1 meter deep on 1 hectare	= 353145.	610233780.	8.10708
1 centimeter deep on 1 square meter	= 0.353145	610.234	$8.107 \times 10^{-6}$
1 pound of water at 39.2 F	= 0.016019	27.6805	$3.677 \times 10^{-7}$
1 pound of water at 50 F	= 0.016023	27.6880	$3.678 \times 10^{-7}$
1 pound of water at 62 F	= 0.016037	27.7121	$3.682 \times 10^{-7}$
1 U. S. gallon per minute for 24 hours	= 192.5	332640.	0.0044192
1 cubic foot per minute for 24 hours	= 1440.	2488320.	0.033058

## ART. 1-G. CHEMICAL TERMS

## Definitions

*Acids* are substances whose molecules ionize in water solution to give the hydrogen ion from their constituent elements. The strength of an acid is proportional to the concentration of hydrogen ions present (11).

*Bases* are substances which ionize in water to give the hydroxyl ion from their constituent elements. The strength of a

base is proportional to the concentration of hydroxyl ions (11).

*Electrolytic Dissociation or Ionization Theory.* When an acid, base, or salt is dissolved in water or any other dissociating solvent, a part or all of the molecules of the dissolved substance are broken up into parts called ions, some of which are charged with positive electricity and are called

TABLE 8  
ELECTROMOTIVE FORCE SERIES

Positive End		
Element	Ion	Potential
Alkali: Cs·Rb·K·Na·Li		
Alkaline earth: Ba·Sr·Ca		
Sodium	Na <sup>+</sup>	+2.715
Calcium	Ca <sup>++</sup>	... ..
Magnesium	Mg <sup>++</sup>	+1.550
Aluminum	Al <sup>+++</sup>	+1.276
Manganese	Mn <sup>++</sup>	+1.075
Zinc	Zn <sup>++</sup>	+0.770
Chromium	Cr	... ..
Cadmium	Cd	+0.420
Iron	Fe <sup>++</sup>	+0.340
Cobalt	Co	+0.232
Nickel	Ni <sup>++</sup>	+0.228
Tin	Sn <sup>++</sup>	+0.192
Lead	Pb <sup>++</sup>	+0.148
Hydrogen	H <sup>+</sup>	+0.000
Copper	Cu <sup>++</sup>	+0.329
Arsenic	As	... ..
Bismuth	Bi	... ..
Antimony	Sb	... ..
Mercury	Hg <sup>++</sup>	0.748
Silver	Ag <sup>+</sup>	0.771
Palladium	Pd	... ..
Platinum	Pt	0.863
Gold	Au	1.079
Oxygen	O	... ..
Negative End		

NOTE: In the second column each cross after the chemical symbol stands for one "charge" of electricity on the ion. In the third column the cross sign indicates that the solution is charged positively with respect to the metal. The potential of hydrogen is taken as zero, and the potentials of the other metals are referred to it (1).

Any metal will replace any other metal below it in the series (11).

The higher the potential the higher the solution pressure of the metal and, in general, the greater the chemical activity (1).

*Ease of Reduction of Oxides.* The metallic oxides down to and including Mn cannot be completely reduced to the metallic state, even in a current of hydrogen. The oxides of Cd and succeeding metals are easily reduced and, far down the list, the oxides of

cations, and an equivalent number of which are charged with negative electricity and are called anions (11).

*Electrolytic Solution Tension Theory (or the Helmholtz Double Layer Theory.* When a metal, or any other substance capable of existing in solution as ions, is placed in water or any other dissociating solvent, a part of the metal or other substances passes into solution in the form of ions, thus leaving the remainder of the metal or substances charged with an equivalent amount of electricity of opposite sign from that carried by the ions. This establishes a difference in potential between the metal and the solvent in which it is immersed (11).

*Electron Theory of Matter.* An atom is believed to consist of a nucleus bearing a positive charge, different for each sort of atom, surrounded by electrons or negative charges equal in total charge to the positive

charge of the nucleus. The nucleus may consist of a certain number of protons or elementary positive charges and a part of the electrons. The remaining electrons revolve as satellites around the nucleus. The electron and the proton have equal negative and positive charges; hence a neutral atom will contain as many electrons as protons.

The protons contain practically all the mass of the atom, the number of protons determining the atomic weight. The number of satellite electrons determines the chemical properties of the atom.

According to recent views, the nucleus consists only of heavy particles, neutrons, and protons (11).

*The hydrogen equivalent* of a substance is the number of replaceable hydrogen atoms in one molecule or the number of atoms of hydrogen with which one molecule could react (11).

---

silver, platinum, mercury, and gold are reduced (decomposed into metal and oxygen) even by heat alone (11).

*Ease of Rusting (Oxidation in the Air).* The alkali and alkaline-earth metals rust very rapidly and with considerable evolution of heat. All the metals down to copper rust with comparative ease. The metals below copper do not rust (11).

*The Occurrence of the Metals in the Free State in Nature.* Natural waters are frequently dilute solutions of carbonic, nitric, humic, etc., acids. As such they contain displaceable hydrogen. Metals *above* hydrogen in the electromotive force series scarcely, if ever, occur in the free state in nature, but are practically without exception found in the combined state as sulfides, carbonates, etc. Metals *below* hydrogen are frequently found in the free state in nature but also in the combined state (11).

*Action of the Metals on Water.* The alkali and alkaline-earth metals displace hydrogen from water, even in the cold, and with evolution of much heat. Mg and succeeding metals will displace hydrogen from steam. Metals at the bottom of the list will not displace hydrogen from steam (11).

*The Solubility and Stability of Hydroxides.* The alkali metal oxides have great avidity for water, forming hydroxides. The alkaline-earth metal oxides react with less readiness, forming hydroxides.

MgO reacts slowly and incompletely with water, forming the hydroxide. All other metallic oxides and hydroxides are insoluble in water and have no perceptible reaction therewith (11).

*Carbonates.* The alkali metals form normal stable, soluble carbonates not easily decomposed on heating. The alkaline-earth metals form normal carbonates, which are insoluble in water and decompose upon heating, leaving the oxide; carbon dioxide is evolved. When sodium carbonate solution acts on solutions of all the other metals, as a rule, a basic carbonate is precipitated, being insoluble in water, and decomposed by heat into oxide and carbon dioxide. If the solution is cold, Ag, Hg, Cd, Fe, and Mn give normal carbonates. If the solution is warm, Sb, Hg, Ag, Pd, Pt, and Au give a precipitate of the *oxide*, instead of the carbonate, thus showing the instability of the carbonates of the lowest metals in the series (11).

*Hydrogen-ion concentration* or *pH* value is the logarithm of the reciprocal of the gram ionic hydrogen equivalents per liter, i.e.,  $pH = \log \frac{1}{(H^+)}$  per liter. Water has a concentration of  $H^+$  ion of  $10^{-7}$  and  $OH^-$  ion of  $10^{-7}$  mole per liter, or a *pH* value of 7. Owing to hydrolysis, the composition of a weak acid solution titrated against a strong base is basic and of a weak base against a strong acid is acid. A truly neutral titrated solution of a strong acid or base has the same concentration of  $H^+$  and  $OH^-$  ions as water (11).

*Hydrolysis.* A change in the molecular composition of matter by the addition of water (41). Reactions involving water.

*Ion.* Acids, bases, and salts (electrolytes) when dissolved in certain solvents are more or less dissociated into electrically charged units, or parts of the molecules, called ions.

Some electrolytes dissociate into ions when fused.

Ions carry charges of electricity, and in consequence have different properties from the uncharged radicals.

Positive ions are atoms or group of atoms which have lost valence electrons; negative ions are those to which additional electrons have been added (11).

*Oxidation* is any process which increases the proportion of oxygen or acid-forming element or radical in a compound (11).

*Reduction* is any process which increases the proportion of hydrogen or base-forming elements or radical in a compound (11).

*Salt.* Any substance which yields ions, other than hydrogen or hydroxyl ions (11).

*Solubility product* or *precipitation value* is the product of the concentrations of the ions of a substance in a saturated solution of the substance (11).

## ART. 1-H. COMPRESSED AIR

### Definitions

*Absolute pressure* is the total pressure measured from absolute zero. It equals the sum of the gage pressure plus the atmospheric pressure corresponding with the barometer (gage pressure reading in pounds per square inch plus the barometric pressure expressed in pounds per square inch) (25).

*Absolute temperature* equals the degrees Fahrenheit plus 459.6. Absolute temperature on the centigrade scale equals the degrees centigrade plus 273 (25).

*Adiabatic compression* of air or gas is effected when no heat is transferred between the air or gas and surrounding bodies (that is, cylinders and pistons). It is characterized by increase in temperature during compression and decrease in temperature during expansion (25).

The characteristic equation for adiabatic compression is

$$PV^k = C$$

where *k* is an exponent corresponding to the ratio of the specific heat at constant pres-

sure to the specific heat at constant volume (25).

*Free air* is defined as air at atmospheric conditions at any specific location. Because the altitude, barometer, and temperature vary at different localities and at different times, it follows that this term does not mean air under identical or standard conditions (25).

*Isothermal compression* of air or gas is effected when interchange of heat between the air or gas and surrounding bodies (that is, cylinders and pistons) takes place at a rate exactly sufficient to maintain the air or gas at constant temperature with increased pressure (25).

The characteristic equation for isothermal compression is

$$PV = P_1V_1 = C$$

where

*P* = absolute pressure.

*V* = volume.

*C* = constant (25). (Boyle's law)

*Ratio of compression* is the ratio of the absolute discharge pressure to the absolute intake pressure (25).

*Standard air* is defined as air at a temperature of 68 F, a pressure of 14.7 psi

absolute, and a relative humidity of 36%. This agrees with the definition adopted by the ASME, but in the gas industries the temperature of "standard air" is usually given as 60 F (25).

## ART. 1-I. HEAT

### Definitions

*Absolute temperature*, 273.1 C.

*Change of state. Latent heat* is the additional heat required to transform a substance from one form to another. The temperature of the substance is not increased during this transformation. The heat required to change a substance from solid to liquid is called the *latent heat of fusion*. The heat required to change a substance from a liquid to a vapor is called the *latent heat of vaporization*. For water this amount is 970.4 Btu.

*Combustion* is a chemical change known as rapid oxidation, or the rapid combining of oxygen with the combustible elements of the fuel employed.

*Conduction of Heat.* A process by which heat is transferred from a hotter to a cooler portion of a medium without visible motion of the medium (18).

*Convection of Heat.* The transfer of heat from one part of a fluid to another by motion of the fluid from the hotter part to the colder. The motion is usually due to the hot, less dense, fluid rising through the colder, denser regions,

and thus causing convection currents (18).

*Heat Quantity.* Heat quantity is measured by the change of temperature produced. (11). The British Thermal Unit (Btu) is the heat required to raise the temperature of one pound of water at its maximum density one degree Fahrenheit (11).

*Radiation.* Radiant heat is of the same nature as light. It can pass through a vacuum (18).

*Specific heat* is the ratio heat to be applied to any substance to raise it one degree Fahrenheit as compared with water. Specific heat is not a constant factor but increases with rise in temperature.

*Temperature.* Temperature may be defined as the condition of a body which determines the transfer of heat to or from other bodies (11). There are several units in use. The Fahrenheit unit divides the difference between the melting point of ice and the boiling point of water under ordinary atmospheric pressure in 180 degrees; the first point being 32 and the latter 212 F.

*Transfer of heat*, convection, conduction, radiation.

### Equivalents.

1 Btu—Quantity of heat required to raise 1 lb of water 1 F.

970 Btu required to evaporate 1 lb of water at 212 F at atmospheric pressure.

1 Boiler hp—Evaporation of 34.5 lb per hour at 212 F steam at atmospheric pressure.

1 Boiler hp—33,479 Btu.

1 Boiler hp—139 sq ft of steam radiation.

1 Boiler hp—222 sq ft of hot-water radiation.

### Fuels

*Fuel oils* may be any oil used as a fuel. The U.S. Commercial Standard Specifications for fuel oils classify them for oil burners according to Table 9.

*Gas Fuels.* Manufactured gases are produced in many ways, the ordinary city gas being carbureted-water gas or retort gas. In some localities it is mixed with natural gas.

*Other gases* are blast-furnace gas, a product of blast-furnace operation and low in heat value; blue-water gas, made by forcing steam through a bed of glowing coke or anthracite; carbureted-water gas, a blue-water gas with additional hydrocarbon from vaporized oil; coke-oven gas, a product of distillation of coals at high temperature; oil gas, vaporized oils; producer gas, same process as blue-water gas; and retort gas, sometimes called coal gas, manufactured by distillation of bituminous coal.

*Mixed gas* is any mixture of natural and manufactured gas.

*Natural gas* is a mixture of hydrocarbon gases, chiefly methane and ethane. Generally it is colorless and odorless. It has a higher ignition temperature than manufactured gas and requires approximately one cubic foot of air for each 100 Btu of gas burned. Being so much lighter than air it does not mix readily and, if sufficient turbulence is not provided to insure intimate mixture of gas and air, there is a considerable loss through unburned fuel escaping up the flue.

*Fuel Units.* The unit for heat measurement with solid or liquid fuels is the pound (avoirdupois), and for gases the cubic foot.

The merchandising units for these fuels are usually the ton for solid fuels, the barrel (42 gallons) for oil, and 1000 cubic feet (mcf) for gas or a therm (100,000 Btu).

### Heat Content of Fuels

*Gross heat content* of coal may vary from 10,000 Btu per lb to 14,500 Btu per lb.

*Heating Value of Gas.* (Standards for Gas Service, Circular 405 of the National Bureau of Standards) (22). Probably without exception at the present time, all city gas supplies consist of mixtures of a number of individual chemical substances. Natural gas is usually mainly methane with some ethane, propane, butane, etc., all of which are fuels, and some nitrogen, and at times other constituents which are not fuels. Manufactured gas usually contains as important combustible constituents hydrogen and carbon monoxide, methane, ethylene, and minor amounts of other hydrocarbons (compounds of the elements of hydrogen and carbon). Inert nitrogen and carbon dioxide are also present. Given quantities of each of the combustible constituents produce perfectly definite, but very different, amounts of heat when burned, and any mixture of them produces an amount of heat equal to the sum of the heat available from the individual constituents of the mixture. Consequently, a measured quantity of gas may have any heating value within a wide range, depending upon the proportions in which the various constituents of the mixture are present.

TABLE 9

## APPROXIMATE HEAT CONTENT OF FUEL OILS

Commercial Standard Grade	Classification	Approximate Btu per Gallon
No. 1	Light domestic	136,000
No. 2	Medium "	139,000
No. 3	Heavy "	141,000
No. 4	Light industrial	145,000
No. 5	Medium "	149,000
No. 6	Heavy "	152,000

TABLE 10

## APPROXIMATE HEAT VALUE OF FUEL GASES

Kind of Gas	Btu per Cubic Foot
Anthracite producer gas	135
Bituminous producer gas	150
Blast-furnace gas	100
Blue-water gas	300
Carbureted-water gas	530
Coke-oven gas	550
Mixed gas	800
Retort gas	600

The heating value of a gas is the amount of heat which is given off when a unit quantity of the gas is burned. The heat quantity is expressed in Btu. The unit quantity of gas used is the cubic foot. The heating value is expressed in Btu per cubic foot (22).

*The total heating value* of a gas is the number of Btu produced by the combustion, at constant pressure, of 1 cu ft of gas at 60 F, if saturated with water vapor when the products of combustion are cooled to the initial temperature of gas and air, and when the water formed by combustion is condensed to the liquid state.

*The net heating value* of a gas differs from the total heating value in that the water formed during combustion remains in the state of vapor. Roughly, the net heating value is usually about 90 per cent of the total.



For the sake of comparison with solid fuels, which are classified by their total heating value, commercial standards for gas are expressed in the same manner (22).

*Observed heating value* is an experimental term used to express the actual measured heat. Somewhat less than the actual total heating value.

Most of the gas companies distributing butane and air are sending out a mixture having a heating value of from 500 to 550 Btu per cu ft (22).

*Gas Heat Transfer.* (Relation between heating value of gas and its usefulness to the consumer, by E. R. Weaver, Technological Papers of the Bureau of Standards, No. 290) (7). The key to the problem lies in the fact that when any of the commercial combustible gases is burned with air under favorable conditions the hottest part of the flame has about the same temperature for each gas. In a few applications all the heat of the gas is directly utilized. In all others, there is an incomplete transfer of the heat of combustion from the flame to some object to be heated, and the efficiency of the transfer depends upon bringing the zone of maximum flame temperature into the most favorable position with respect to the object. When this is done, that is, when the appliance is correctly adjusted, the rate of heat transfer from the flame to the object will remain the same provided the total amount of heat supplied to the region of transfer is the same.

There are in the literature several discussions of this subject based upon more or less theoretical grounds involving the relations between flame velocities, specific heats, the potential heat per unit volume of the gas-air mixtures in correct proportion for complete reaction, dissociation at high temperature, etc. Few, if any, of these discussions are complete, and in view of the uncertain accuracy of some of the important data, such as the specific heats of gases at high temperature, we are justified in avoiding the complication and the uncertainty of a theoretical discussion by considering only directly observed facts (7).

## ART. 1-J. ELECTRIC TERMS

### Definitions

*Ampere.* The unit expressing the volume or rate of current (similar to the rate of flow in hydraulics).

$$\text{Ampere} = \text{Volts} \div \text{Ohms}$$

*Ohm.* The unit expressing resistance (similar to friction loss in hydraulics).

$$\text{Ohm} = \text{Volts} \div \text{Amperes}$$

*Volt.* The unit expressing electric tension (similar to the expression "pressure head" in hydraulics).

$$\text{Volt} = \text{Ampere} \times \text{Ohms}$$

*Watts.* The unit expressing power. It is the rate of energy used when one ampere flows through a resistance of one ohm. The watt-hour equals product of the watts used and the number of hours during which it was used.

$$\text{Kilowatt-hour} = 1000 \text{ Watt-hours}$$

$$\text{One horsepower} = 746 \text{ Watts}$$

**Equivalents**

1 kwhr = 1000 watt-hours = 3412 Btu

1 kwhr = 4.12 gallons raised 100 F at a 100% efficiency

$$\text{Rate of heating in minutes} = \frac{146 \times \text{Number of gallons} \times \text{Deg F Rise}}{\text{Wattage} \times \text{Efficiency}}$$

$$\text{Efficiency} = \frac{\text{Gallons} \times \text{Average Temp. rise} \times 0.00243}{\text{Kwhr Input}}$$

From many comparative tests the following equivalents have been developed, from which by applying local rates the relative cost of gas and electric cooking can be determined:

1000 cu ft of manufactured gas (530 Btu) = 71.5 kwhr

1000 cu ft of mixed gas (850 Btu) = 114 kwhr

1000 cu ft of natural gas (1100 Btu) = 148 kwhr

The above figures include gas for pilots (17).

**Horsepower Required***Horsepower to Pump Water*

A theoretical hp = gpm  $\times$  total head in feet/3960

*Example:*

100 gal per min

Total head = 200 ft

Theoretical hp =  $100 \times 200/3960 = 5.05$

Actual brake hp = Theoretical hp/ $E$

$E$  = efficiency of pump in %

At 70%, e.g.,

$5.05/0.70 = 7.21$  hp

## CHAPTER 2

### CODES AND REGULATIONS

#### ART. 2-A. CODE REQUIREMENTS

##### **Types of Codes**

*Classes.* Not one code, but several, govern the work of plumbing. They may be termed:

- Plumbing codes.
- Sanitary codes.
- Safety codes.
- Service codes.

##### **Plumbing Codes**

*General Provisions.* The plumbing codes govern mainly the methods of carrying off the wastes from buildings and stipulate a sufficient water supply for the various fixtures.

To insure proper workmanship, the codes set up regulations for the trade, including the licensing of plumbers, boards of examiners, and plumbing inspectors.

The plumbing code thus generally covers the execution of the work, and it is only within recent time that additional provisions of more specific nature have been included.

##### *Code Principles.*

1. Principles governing safe water supply:
  - a. Water supply needed.
  - b. Water supply shall be pure.
  - c. Water supply shall be protected against contamination.
  - d. Water supply shall be adequate.
2. Principles governing disposal of wastes:
  - a. Connection required to public sewer, or
  - b. Sanitary disposal of wastes shall be established where no public sewer exists.
  - c. Preliminary treatment is required.
3. Principles governing drainage systems:
  - a. Systems shall be of adequate design for drainage purposes.
  - b. Systems shall be of proper design to prevent entrance from the sewer into buildings of any air, liquid, vermin, rodents, etc.
  - c. Systems shall be maintained in sanitary condition and proper working order.

**4. Principles governing sanitary fixtures:**

- a. Fixtures shall be installed in adequate number.
- b. Fixtures shall be of sanitary design.
- c. Fixtures shall be foolproof in operation and safe to handle.
- d. Fixtures shall be installed and kept in sanitary condition and surroundings.
- e. Certain fixtures, appliances, etc., should have no direct connection with the drainage system.

**5. Principles governing materials:**

- a. Materials shall withstand effectively the use to which they are subjected.

**6. Principles governing workmanship:**

- a. Connections shall be airtight, leakproof, and tamperproof.

**7. Principles governing tests and inspections:**

- a. All installations shall be supervised and approved by the authorities.

**Sanitary Codes**

*General Provisions.* Several other sanitary regulations in regard to the use of fixtures determine their design, connections, supply, discharge, etc. Such regulations are generally included in a sanitary code.

The sanitary code supplements the provisions of the plumbing code in respect to the use of establishments and conditions affecting life and health. The code has regulations concerning communicable diseases, specifying the procedure in case of disease and making provision to prevent the spread of diseases by supervising the manufacturing and treatment of foods and essentials, such as milk and cream, personnel handling of foods and essentials (food workers, hospital workers, barbers, beauty operators), washing and cleaning of supplies and implements used in common by the public (sterilization of dishes), protection of water supplies through their proper use and discharge of wastes into potable waters (including the regulations of swimming pools, bathhouses, etc.), protection against nuisances which may affect life and health, and other health hazards (e.g., leaded gas, nitrocellulose X-ray films, poisonous substances found in commercial products, spitting in public places, washing and drinking fixtures in public places, public towels, etc.), transportation and care of dead bodies, etc.

*Sanitary Provisions.*

- Number of fixtures per occupant.
- Sterilization of water (pools).
- Equipment (sterilizers) connections.
- Sewage disposal.

## Safety Codes

*General Provisions.* In addition to the safeguarding of health there are other precautions which must be taken in the behalf of general safety.

Among these may be listed all safety regulations which tend to prevent accidents or unwarranted emergencies. The ASME has formulated codes for pressure vessels and piping, regulating materials, joints and use of valves, controls and relief valves. Regulations to prevent flooding may also be included in this group.

The National Board of Fire Underwriters has covered practically every phase in relation to fire emergencies.

### *Safety Provisions.*

Leakage.

Non-obstructing installations.

Treatment (odors in gas).

Safety shut-offs.

Non-injurious (non-scalding) water.

Fire protection.

## Service Rules

*General Provisions.* Service rules are generally formulated by the utility companies or government- (city or state) owned agencies.

They are primarily for the purpose of facilitating service and repairs. In addition they serve to protect the rights of the owners, be it the utility company or the larger interests of the citizens, through the proper administration of the company, the government agency, or public property.

### *Service Provisions.*

Access for metering and repairs.

Right of way.

Shut-off for discontinued service.

Shut-off for protection.

Materials and equipment to safeguard supply.

Protection of supplies.

## Legality of Codes

*Protection of Health.* The adoption and enforcement of codes for plumbing systems are thus justified by the Subcommittee on Plumbing of the Building Code Committee (1):

The control of plumbing by government is distinctly an act done under the police power, because it has to do with protection of the health of the people against injury, using this term in its broad and popular sense (1).

Justification of the above is based on evidence that certain conditions are health hazards.

Passage of rodents, vermin, etc., through pipes.

Escape of solids, liquids, or gases.

Pollution of water supplies.

Defective materials and workmanship.

The enforcement of the codes is carried out by a system of permits, inspections, and tests, and the setting up of licensing and examining boards.

*Minimum Requirements.* It must be borne in mind that, because the code is a legal document, it cannot prescribe methods of design or practice, but must simply state minimum requirements. Consequently, there are many details and conditions not covered by the code, and adherence to a code does not necessarily mean that a plumbing system is practical or serviceable.

## CHAPTER 3

### ARCHITECTURAL PRACTICE

#### ART. 3-A. GENERAL DESIGN

##### **Layout**

*General Problems.* As an outline classification of the various plumbing problems we can list:

Fixtures, including supply fixtures and traps, pumps, tanks, and other accessories.

Water supply for domestic use and fire protection, its storage and distribution, its treatment in case of water softeners, heaters, and coolers.

Drainage for storm water, including roofs, areas, courts, lawns, and roads, and inside and outside subsoil drainage.

Drainage for sanitary sewers for all sanitary fixtures, kitchens and laundries, industrial wastes containing greases, acids, condenser water, grit, ashes, inflammables, etc.

Gas and air piping and systems with their accessories, and vacuum cleaning.

Although in residential work a great deal depends on the individual desires or habits of the owner, any institution like a school, college, hospital, or church should be considered as a living organism placed under a central control. No part can be extravagant at the expense of the whole and no part should suffer because of the centralized control of the institution.

To design a plumbing system that will provide properly for each individual department and at the same time unify all efforts so that the complete system is efficient and practical is the first important consideration. This is by no means a task to be treated in an off-hand manner, and upon its correct solution depend the future success and economy in maintenance.

*Preliminary Work.* The building plans are laid out by the architect. It is well to be on hand at the time and observe the layout and assist in locating fixtures and determine locations of main risers and stacks. Check with the structural engineers to see that no unnecessary obstructions are in the way and that some system of framing can be adopted which will facilitate the installation of pipes. Watch for location of fixtures which have traps in or below the floor construction (stall

urinals, bathtubs, showers, etc.). See that space is provided for connections for wall-hanging fixtures and that pipe chases and pipe shafts are of adequate dimensions.

In this work it is well that the designer should have some idea of what constitutes a good layout.

### **Minimum Requirements**

*Apartment houses* shall have one toilet room with one water closet for each apartment. Apartment houses with one- or two-room apartments may have a toilet room with one water closet for every 15 rooms, not counting rooms which have private toilets. There shall be one sink or lavatory for each apartment.

The above are minimum requirements. Any first-class apartment house should have one bath for each apartment.

*Auditoriums.* The number of water closets required is one for every 100 to 200 females and every 150 to 250 males, plus one urinal for every 150 to 400 men (usually two urinals plus one water closet for each 300 males). Lavatories required are usually one for each two water closets, counting two urinals as one water closet. Larger auditoriums (over 500 capacity) should have separate toilet provisions for the stage. Motion picture booths used continuously over a period of several hours should have one water closet and one wash basin. Drinking fountains should be provided for the stage and the public, but not placed in the toilet rooms.

Where stimulating drinks are served, additional provisions should be made with one water closet for every 40 females, one water closet for every 75 males, and one urinal for every 50 males. Where the capacity of the place exceeds 300, the ratio for population above 300 may be half of that above (46). The equivalent population figure is 15 sq ft of clear floor space per person for assembly halls.

*Banks.* The number of water closets required is one for every 10 to 15 females and every 15 to 20 males, plus one urinal for every 25 to 35 males. Requirements for lavatories are one for every 15 to 25 persons of either sex.

*Bar Fountains.* See *Fountains.*

*Churches.* The number of water closets required is one for every 100 to 150 females and every 150 to 200 males, plus one urinal for every 300 to 400 males. Requirements for lavatories are one for every 150 to 300 persons of either sex.

*Clubs for Men.* The number of water closets required is one for every 50 to 100 males, plus one urinal for every 200 to 300 males. Lavatories required equal half the number of urinals.

If stimulating drinks are served, the same rules apply as listed under auditoriums.

*Dance Halls.* The number of water closets required is one for every 100 to 150 females and every 300 to 400 males, plus one urinal for



every 150 to 200 males. If stimulating drinks are served, the same rules apply as listed for auditoriums.

*Department Stores.* The number of water closets required is one for every 75 to 125 females and every 100 to 200 males, plus one urinal for every 250 to 300 males. Lavatories required are one for every 100 to 200 persons of either sex.

*Dormitories.*

1. *Women's Dormitories.*

1 WC per 4 people.

1 Lav. " 3 " .

1 Tub " 10 " .

1 Shower per 4 to 10 people.

1 Laundry tub per 24 people.

Add for heads, chaperons, visitors (male and female), etc.

2. *Nurses' Dormitories.*

1 WC per 5 people.

1 Lav. " 1 person.

1 Tub " 5 people.

1 Shower per 5 people.

1 Laundry tub per 20 people.

Add for heads, visitors (male and female), etc.

3. *Men's Dormitories.*

1 WC per 5 people.

No Urinals.

1 Lav. per person.

1 Shower per 2½ people.

1 Tub per 25 people.

*Educational Buildings.* Elementary and secondary schools have in the past generally used a declining scale for the ratio of fixtures to persons.

In *The Utilization of School Sanitary Facilities*, prepared by the American Council on Education, Washington, D.C., Mr. Francis R. Scherer \* makes the following recommendations with respect to adequate ratios:

*Girls*

Elementary schools 1 WC per 35 people

Secondary schools 1 WC per 45 people.

*Boys*

1 WC per 100 people

1 Urinal per 30 people

*Lavatories*

Elementary schools 1 Lav. per 60 people

Secondary schools 1 Lav. per 100 people

\* Superintendent of School Buildings, Rochester, N. Y.

Mr. Scherer adds the following recommendations: "When elementary and secondary school grades are housed in combination within a single building, the standards for sanitary facilities should be the same as those here proposed for elementary schools. The above ratios are recommended *only under condition that not less than two fixtures of each type be installed in each toilet room.* This is suggested so as to meet the pupils' needs when a single fixture may be out of order and to provide facilities in the smaller schools which follow the practice of groups visitation."

*Factories.* The number of water closets required is one for every 15 to 20 females and one for every 25 to 30 males, plus one urinal for every 50 to 60 males. The lavatories required are one for every 20 to 30 persons of either sex, usually one lavatory for every two water closets and urinals.

*Fountains.* There is a rising demand for public toilets in connection with bar fountains and similar installations accommodating over 50 people. The standard may even be lowered to 25 people.

*Hotels.* Hotels usually have an individual bathroom for each bedroom. In any case a hotel installation would not likely be guided by any minimum requirements.

*Hospitals.* Minimum requirement would apply only to employees' locker rooms and similar quarters.

*Libraries.* The number of water closets required is one for every 100 to 150 females and every 150 to 200 males, plus one urinal for every 300 to 400 males. The lavatories required are one for every 150 to 300 persons of either sex.

*Theaters.* Theaters are governed by the same rules as auditoriums.

## ART. 3-B. DRAWINGS

### Standards

Standards for Drawings and Drafting Room Practice, ASA Z-14.  
Scientific and Engineering Symbols and Abbreviations, ASA Z-10.  
Symbols for Hydraulics (ASA).

### Symbols

There are in use so many different symbols for plumbing and it must be assumed that they all are expressions of someone's preference. Of these only the symbols adopted by American Standards Association and the ones used by the author are reproduced.

The use of these symbols depends much on the type of drawings to be made.

*Working drawings* for architectural work are made for the purpose of showing the extent and quality of the project so that the contractor can make a bid estimate and later use the drawings for general erection purposes.

In the first-mentioned task he is assisted by no one. As sources of information for his bid the drawings must be plain and easy to understand.

In the second-mentioned task—that of erection—the contractor has far more time and assistance plus the facilities of more detailed drawings.

Shop drawings are fabrication drawings. They are more detailed than working drawings. They practically always comprise only one trade. The draftsman can allow himself a greater range of symbols and indications as there is no danger of misinterpretation.

The following suggestions are in regard to “working drawings” for use in making bid estimates.

As mentioned, the main consideration for the draftsman in making the drawing is that it should serve as a perfect information sheet for the contractor in making his estimate.

The contractor must know the sizes and lengths of pipes and the joints to be used, the location and number of valves, and other appurtenances. He must know the job conditions, which—to mention a few—are the type and construction of building, accessibility, working space, storage facilities, etc. Materials may be specified or indicated on the drawings. To facilitate his work, schedules of various sorts may be added. Valve schedules may be very useful both for estimating purposes and later for maintenance purposes.

In the architectural business many methods are used which do not always agree with general engineering methods. It has long been a habit on smaller jobs to indicate the structural steel on the architectural plans by showing on each floor plan the structural steel located in the *ceiling* of that floor. This is probably due to the fact that the steel affects the ceiling design.

On the other hand, when plumbing lines are drawn in on the architectural plans such pipe lines will be the ones serving the fixtures on the floor in question. Thus we have the confusing spectacle of plumbing lines dodging around some steel beams they do not even come near. The arguments are many but there is only one answer: Do not place plumbing lines on the architectural layouts. Where the size of the job warrants it, separate plans should be made. For smaller jobs the architect should be encouraged to show only *stacks and risers*. The basement plan may in addition show outside services coming in, meters, main valves, by-passes, and other service installations, and the house drains. The horizontal lines and branch risers, vents, etc., should be shown in separate diagrams or isometric views.

### Drawing Symbols

Here we may differentiate between purely architectural symbols and symbols for pipes and accessories.

Symbols indicating fixtures and equipment are used on architectural drawings as part of the general scheme to show space requirements and

functions of such space. They are of no use unless drawn to a scale which clearly indicates the space occupied.

This can be done easily enough on fixtures like lavatories, sinks, tubs, and the like. On water closets, where the indication shows a very simplified design, the actual scale is only approximated.

All these indications are of use to the architectural trades but help the mechanical trades very little. On a pipe layout they are decidedly detrimental and should be omitted entirely. Fixtures should be indicated as outlets on the pipes and a letter symbol (like WC) used. For different types of the same kind of fixture, numbers may be used (as WC.1, WC.2, etc.).

In general it may be said that only symbols which are self-explanatory should be used. Even at that, it may be necessary to title them. For all special features, the one and only good way is to mark the drawings plainly.

### Pipe Indications

Pipe layouts are usually shown either in such small scale that it is impossible to indicate every little thing or in such large scale that no special indications are needed.

The argument is that there generally is no call for indications showing methods of jointing, such as screwed, soldered, or welded. Like choice of material, it usually is a matter left to the specifications. An attempt to differentiate between the various pipes by showing them in combinations of dots and dashes is to be discouraged. Dots and dashes take too much time to draw and are difficult to read. The question in plumbing is not alone one of indicating various services but also various levels. In heating work it has been the practice for a long time to indicate steam supplies with a full line and returns with a dash line. Such a method does not work in plumbing as there is no point of demarcation between a supply and a return line. Furthermore it is of no consequence. Both pipes will be of the same material.

*All* lines shown on architectural drawings (a method which is not to be recommended) should be shown in dot and dash so as not to confuse the general layout.

*All* lines on separate diagrams and isometric views should be drawn in full lines, although there is no harm in showing vents in dash lines.

Pipe lines shown on separate plumbing plans should be drawn in *full* but with overhead lines serving these pipes shown in dash, i.e., every pipe below the plane of the drawing to be in full line; every pipe above the plane of the drawing to be in dash line. Sometimes, particularly on low buildings, it may be convenient to show lines in a plane even higher (e.g., an attic space). Such lines usually are circulating lines and may not warrant the making of a separate drawing. They may be shown in dotted lines.

Indications for joints are seldom needed except in two cases: (a) equipment hook-ups, to be sure flanged fittings are used and (b) to indicate union joints where they may be wanted for future repair work.

Full lines are easier to draw than dash lines, and they again are easier to draw than dotted lines. Circles are far easier to draw than squares. Free-hand indications should be of a small scale.

TABLE 11  
PLUMBING SYMBOLS

Fixture Indications for Architectural Drawings

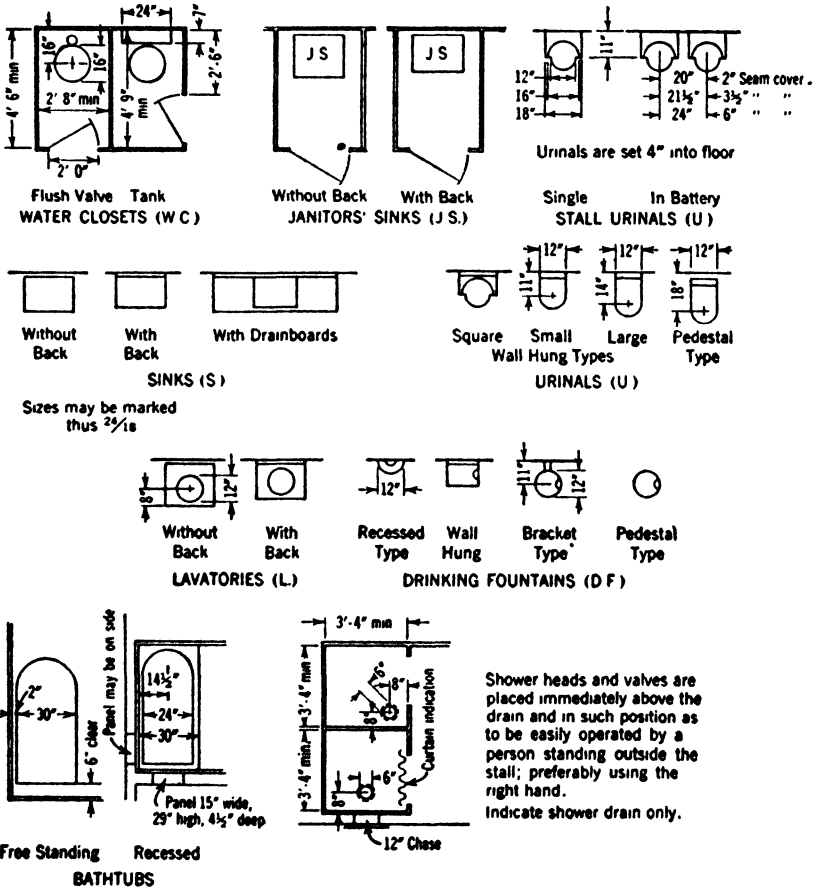

Plot Plans

When indicating main and service lines for plumbing on a general plot plan, it may be necessary to use different symbols. Full-line indications spoil a plot plan for they make the plan confusing. Dot and dash

TABLE 12

PLUMBING INDICATIONS

Lines		Risers	
	Under Floor	Above Floor	
Sanitary Waste Lines or Combined Lines			o S S Sanitary Soil or Waste Stack
Rain Water Lines, if Separate			o V Vent Stack or Riser
Cold Water Lines			o Cond. Rain Water Conductor
Hot Water Lines			o A S Acid Waste Stack
Chilled Water Lines			o C W Cold Water
Distilled Water Lines			o H W Hot Water
Gas			o H W R Hot Water Return
Compressed Air			o G Gas
Suction			o A Air
Vacuum Cleaning			o S Suction
			o D W Distilled Water
			o V C Vacuum Cleaning

Fixtures and Outlets

Water Closet		W C	Floor Drain		F D.
Urinal		U	Roof Drain		R D
Janitors' Sink		J S	Area Drain		A.D.
Laboratory Sink		L S	Yard Drain		Y.D.
Table Sink		T S	Mud Crock		M C.
Kitchen Sink		K S	Cleanout		C O.
Wash Sink		W S	Drain Outlet (Roughing in for future work etc)		D.
Sink		S	Gas		G
Lavatory		L	Gas Duplex		2G
Bathtub		T B	Air		A.
Shower Bath		S B	Cold Water		C.W.
Foot Bath		F B	Hot Water		H.W.
Laundry Tray		L T	Distilled Water		D.W.
Drinking Fountain		D F.	Vacuum Cleaner		

Valves and Fittings

Gate Valve		Joint	
Globe Valve		Flanges	
Cock		Union	
Check		Tee	
Arrow indicates direction of flow		Tee Outlet Up	
Relief		Tee Outlet Down	
Regulator		Elbow	
Strainer		Elbow - Turned Up	
		Elbow - Turned Down	
		Laterals	
		Reducer	

TABLE 13  
 GRAPHICAL SYMBOLS FOR USE ON DRAWINGS  
 (Proposed American Standard, ASA, December, 1940)

Piping		Pipe Fittings and Valves (cont'd)	
Plumbing			Screwed
100 Soil, Waste, or Leader (above Grade)		139 Double Branch Elbow	
101 Soil, Waste, or Leader (below Grade)		140 Single Sweep Tee	
102 Vent		141 Double Sweep Tee	
103 Cold Water		142 Reducing Elbow	
104 Hot Water		143 Tee	
105 Hot Water Return		144 Tee - Outlet Up	
106 Fire Line		145 Tee - Outlet Down	
107 Gas		146 Side Outlet Tee Outlet Up	
108 Acid Waste		147 Side Outlet Tee Outlet Down	
109 Drinking Water Flow		148 Cross	
110 Drinking Water Return		149 Reducer	
111 Vacuum Cleaning		150 Eccentric Reducer	
112 Compressed Air		151 Lateral	
Sprinklers		152 Gate Valve	
120 Main Supplies		153 Globe Valve	
121 Branch and Head		154 Angle Globe Valve	
122 Drain		155 Angle Gate Valve	
Pneumatic Tubes		156 Check Valve	
123 Tube Runs		157 Angle Check Valve	
Pipe Fittings and Valves	Screwed	158 Stop Cock	
130 Joint		159 Safety Valve	
131 Elbow - 90 deg		160 Quick Opening Valve	
132 Elbow - 45 deg		161 Float Operating Valve	
133 Elbow - Turned Up		162 Motor Operated Gate Valve	
134 Elbow - Turned Down		163 Expansion Joint Flange	
135 Elbow - Long Radius		164 Reducing Flange	
136 Side Outlet Elbow - Outlet Down		165 Union	
137 Side Outlet Elbow - Outlet Up		166 Bushing	
138 Base Elbow			

indications are all right, when limited to use in plans which show only a few varieties of utility lines.

For plot plans showing complete layouts of all utilities, as, e.g., sewers, water, gas, electricity, steam, phones, and each of these divided into groups, sanitary and storm sewers, high and low pressure, etc., it will be seen that the dot and dash system will not be adequate.

The simplest method is to use a similar type of dot and dash for all underground wiring, a still heavier type for underground piping, and a very heavy type for sewers, and a fine double dash for overhead wiring. Sometimes pipes, or even sewers, are carried overhead from one building to another or across bridges, and a medium and heavy double dash line respectively will be suitable for that. To differentiate between the lines they are simply marked every so often with an easily recognizable letter symbol.

### **Sewer Plans**

*Institutional and Private Sewer Systems.* Application must usually be made to city, county, and state authorities, depending on the location of the installation.

Unless the sewage system connects up with an existing system, it must discharge into some body of water over which usually the state has jurisdiction, or into soil which usually affects neighboring owners.

Approval is not required for storm water drainage unless emptied into state-controlled waters, as navigable streams and canals.

*Plans (42).* For practical purposes a scale of 20 to 30 ft to 1 in. should be used showing (a) topography by contour lines or sufficient elevations to indicate the slope of the ground, (b) all property lines including streets, roads, etc., (c) buildings and prominent landmarks, (d) existing and proposed sewers, giving sizes, materials, slopes of elevation of inverts at all points of change of grade or alignment, (e) existing and proposed sewer disposal works, pumping stations, manholes, outlets, and other appurtenances, (f) location and direction of flow of all streams, etc.

The plans must show the location and extent of the area or areas on which sewage-disposal works are proposed to be constructed for both present and future requirements. The general character and arrangements of works to meet future requirements should be indicated on the plans.

### **Profiles**

Profiles should be drawn up in practically all cases, as it is the only proper way to determine the correct slopes and to avoid interferences with other pipe lines and structures.

Profiles should be drawn to a horizontal scale the same as the plan drawing and a vertical scale which will allow for accurate indication of all vertical distances.  $1'' = 4' - 0''$  is a good scale to use as it can be read with both an engineer's and an architect's scale.



Branches connecting into mains should have their flow line \* equal to or above the main sewer. In the same manner, the size of a sewer should be increased by dropping the invert of the larger pipe. For storm-water sewers this means that the top of the connecting sewer should be equal to or above the top of the main sewer. For sanitary sewers—assuming them to flow half full—the center of the connecting sewer shall be equal to or above the center of the main sewer. On all smaller sanitary sewers they should follow the same rule as for storm sewers. Where the velocity of the connecting sewer is lower than the velocity of the main sewer the flow from the connecting sewer should *drop* into the main sewer.

In general, the minimum size for storm sewers should be 12 in. and for sanitary sewers 8 in.

### ART. 3-C. COSTS

#### Estimates

The designer should at this point also be able to make some preliminary cost calculations as the planners often fool themselves as to the real cost of plumbing. This does not mean that anyone at this stage should be able to estimate the cost accurately, but simply that an approximation of cost should be obtained.

Very often an estimate is made on the basis of the number of fixtures. This is not regularly a good indicator of the cost, unless the building is very similar to the one from which the data are obtained. The individual building, rather, used in comparison with other buildings of a similar nature and with the same equipment, will give a better idea of the cost of plumbing for future estimating, expressing the plumbing cost as a percentage of the total cost of the building.

The layout man should work out some cost figures for general use. In small piping usually the lineal feet of piping is sufficient for an estimate. On larger piping the fittings become very costly.

He should have some general idea of the comparative cost of pipe layouts. As a general rule it can be said that collecting pipe by advancing along to the next nearest pipe is the most economical method.

In Fig. 23 method *A* generally is better than method *B*.

Taking off branches from a main may sometimes warrant the method *D*. If the distance *L* is of any account at all (and it usually is), method *D* is more economical than *C*.

Distribution throughout the building should be done in the basement area or pipe stories. All other piping should be vertical. Vertical distribution is far more economical than horizontal work. Even if a riser serves comparatively few fixtures it is better to use a separate riser than to let it branch out horizontally.

\* See definition, page 16.

**Selection of Materials**

*Probable Life.* The selection of materials for water piping should bear some relation to the probable life of the building. This may not mean the life of the structure itself but rather the time it takes to become

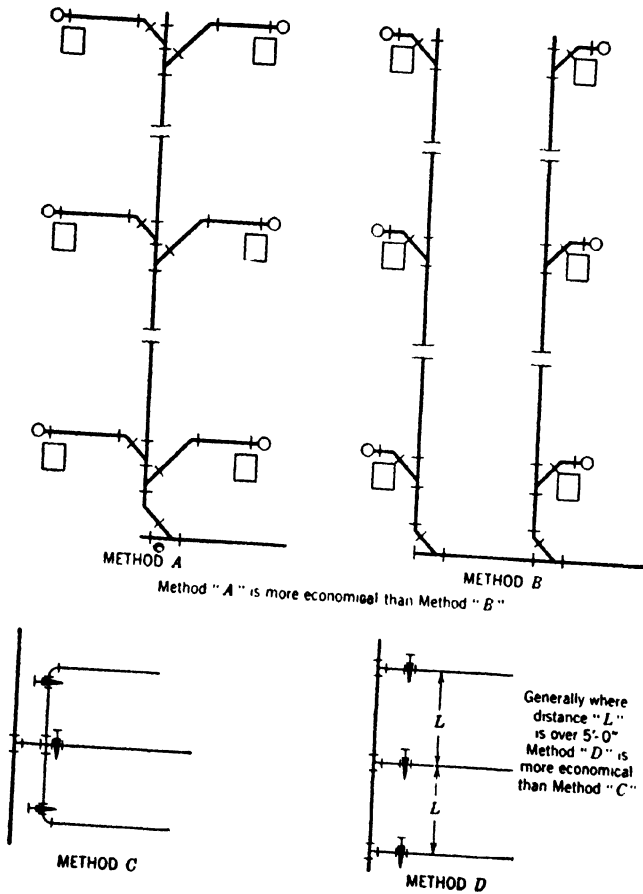

FIG. 23. Piping Economies.

obsolete in its present form or for its present purpose. Most structures are due for a modernization after 25 years, and the very parts which lag behind in progress are always the working parts like the plumbing system.

In general, a maximum life of a plumbing system can be placed at 30 years, this limit to be modified in certain cases.

Materials with shorter life can be used where pipes are within easy access and can readily be replaced. The relative economy of more

expensive materials with no replacements versus less expensive materials with one or several replacements inside of 30 years must be considered. A distinction must be made between (a) concealed piping, (b) accessible shafts, (c) accessible piping in unfinished spaces (like basements, attics, storerooms, etc.), (d) underground piping in paved and public areas, and (e) underground piping in unpaved and private areas.

In public buildings, particularly monumental buildings and structures of unusual permanent construction (museums) and buildings where owing to the nature of occupancy pipes must be practically buried or embedded in the construction (penal institutions), it becomes necessary to place the life of the pipe lines at a much longer period, based for some on the usual life of such buildings (as much as 50 to 75 years, and sometimes more), or for some buildings for practically an indefinite period.

Of course, if the expected life becomes too long, it is sensible to install plumbing in such a manner that it can be renewed or modernized at some future date without wrecking the building.

### Service Characteristics

Pipes deteriorate through scale formation and deposits, and their efficiency decreases with use.

Corrosion takes place in pipes in use by being exposed to free oxygen which is furnished through ever new supplies of water, and also in pipes not in use and left empty by being exposed to air.

Pipe lines which are alternately full and empty—as happens in buildings of seasonal occupancy (as bathhouses)—are even more subject to corrosion.

With the above factors in mind, materials should be selected for the various parts of the system.

These materials and the expected life will then determine the coefficient ( $C_w$ ) to be used in calculating pipe sizes. (See Chapter 6.)

## CHAPTER 4

### PIPE WORK

#### ART. 4-A. PIPING

##### Definitions

*Blow-off.* A controlled outlet on a pipe line used to discharge water or detritus (45).

*Branch.* The outlet or inlet of a fitting not in line with the run, but which may make any angle (12).

The branch of any system of piping is that part of the system which extends horizontally at a slight grade, with or without lateral or vertical extensions or vertical arms, from the main to receive fixture outlets not directly connected to the main (1).

*Branches.* Special forms of vitrified tile and cast-iron pipe for making connections to a sewer. They are called Tee, Y, Tee-Y, Double-Y, and V, because of their shapes (41).

*By-pass.* Any method by which water may pass around a fixture, appliance, connection, or length of pipe. Sometimes applied by an erroneous connection between a drain pipe and a vent pipe which will allow sewer air to enter the building (4).

A small passage to permit equalizing the pressure on the two sides of a large valve so that it may readily be opened (or closed) (12).

*Calking.* In iron working, the calking consists of striking a chisel or calking tool with a hammer, making a slight indentation along the seam. The effect of this is to force the edge of one plate hard against the other, and thus fill up any slight crevice between the plates which the rivets fail to close (12).

The term is used in connection with lead joints or bell and spigot joints in which the lead is calked (12).

*Calking Recess.* A counterbore or recess in the back of the flange into which lead

may be calked for water, or copper for steam (12).

*Calking Tool.* Calking iron, a blunt-end chisel used in calking (12).

*Chain Tongs.* A pipe-fitter's tool; a lever with a serrated end provided with a chain to enlace the pipe. The chain is wrapped around the pipe to hold the lever in place, and the teeth on the end of the latter grip into the pipe, thus affording a powerful leverage to screw or unscrew the joints (12).

*Clamp.* See *Service Clamp*.

*Coil.* A number of turns of piping or series of connected pipes in rows or layers for the purpose of radiating or absorbing heat (12).

*Cradle.* A footing structure shaped to fit the conduit it supports (45).

*Die.* The name of a tool used for cutting threads usually at one passage. The essential distinctive feature of a die is its multiple-cutting edges, whereas a chasing or threading tool usually has one or, at most, only a few cutting edges. Some dies are highly complex and ingenious pieces of mechanism, equipped to trip after cutting a certain predetermined number of threads (12).

*Distributaries.* Any system of secondary conduits (45).

*Distribution System.* The system of laterals, distributaries, and their appurtenances, conveying irrigation water from the main to the farm units (45).

Any system by which a primary water supply is distributed to consumers (45).

*Drain.* A conduit for carrying off surplus ground or surface water. Closed drains are usually buried (45).

A conduit or pipe, usually underground, for carrying off, by gravity, liquids other than sewage and industrial wastes, and including ground or subsoil water, surface water, and storm water (41).

*Expansion Joint.* A device used in connecting up long lines of pipe, etc., to permit linear expansion or contraction as the temperature rises or falls. Usually patterns consist of a sleeve secured to one length of pipe, which works within a stuffing box attached to the next length (12).

There are several, such as slip, swing, balanced, diaphragm, loop, and swivel (12).

*Expansion Loop.* Either a bend shaped like the letter U or a coil like a "pigtail" (12).

*Finishing.* See *Roughing-in*.

*Flexible Joint.* Any joint between two pipes that permits one of them to be deflected without disturbing the other pipes (12).

*Follower.* Part of a threading tool which keeps the thread straight (4).

*Fusion Welding.* A term which refers to the union of metals by fusion, using acetylene blowpipe, electric current, or the thermit reaction (12).

*Header.* Headers are essentially branch pipes with many outlets, which are usually parallel (12).

*Interconnection.* An interconnection is a water supply connection to a fixture or a drainage soil, or waste pipe so installed that the contents of the fixture or the drain may enter the water supply line (43).

*Inverted Joint.* In plumbing, a fitting reversed in order of position—upside down—turned in contrary direction (12).

*Joint.* In the pipe trade, joint applies to the means used to connect pipes to one another or to fittings (12).

*Joint Runner.* An incombustible type of packing usually used for holding lead in the bell in the pouring of lead joints (4).

*Lateral.* A secondary pipe line or ditch (45).

*Lead Joint.* Generally used to signify the connection between pipes which is made by pouring molten lead into the annular

space between a bell and a spigot—and then making the lead tight by calking.

Rarely used to mean the joint made by pressing the lead between adjacent pieces as when lead gasket is used between flanges (12).

*Lock Nut.* A nut placed on a parallel threaded portion of pipe at a joint in order to stop leaks by means of a gasket or packing.

Also used to make a joint where the long screw or lock nut nipple has been run through the tank, the lock nuts being used to wedge up against the tank on either side (12).

*Long Screw.* A short length of pipe having ordinary thread on one end, and the other end threaded for such distance as will allow a lock nut and a coupling to be screwed by hand without overhanging the end of the pipe. It is used in making up connections or joining lines in place (12).

*Long Screw Follower.* A half coupling or lock nut used on a long screw (12).

*Manifold.* A fitting with numerous branches used to convey fluids between a large pipe and several smaller pipes.

A header for a coil (12).

*Nozzle.* A short piece of pipe with a flange on one end and a saddle flange on the other end. May be made of cast iron, cast steel, or wrought steel.

A side outlet attached to a pipe by such means as riveting, brazing, or welding (12).

*Oakum.* Hemp or old hemp rope soaked in oil to make it waterproof (4).

Used as packing in calked lead joints.

*Pipe Stock.* A holder for dies by means of which threads are cut on pipes by hand (12).

*Pipe Tongs.* A hand tool for gripping or rotating pipe. It is frequently made like a large pair of pliers one of whose noses is hook-shaped and the other is made shorter and sharpened so as to dig into the pipe. Chain tongs and pipe wrenches are used for about the same purpose (12).

*Pipe Wrench.* A wrench whose jaws are usually serrated and arranged to grip with increasing pressure as the handle is pulled.

There are many forms such as the Alligator, Stillson, Trimo, etc. (12).

*Piping.* In plumbing, steam and gas fitting, the whole system of pipes in a factory, mill, or house.

The act of laying a pipe system (12).

*Plain End.* Usually contracted to P.E. Used to signify pipe cut off and not threaded; i.e., ends left as cut (12).

*Plug.* When used without qualification, it always means, in the pipe trade, the ordinary plug or pipe plug that has an exterior pipe thread and a projection head (usually square), by which it is screwed into the opening of a fitting, etc. (12).

*Plug Pipe.* A short piece of pipe, screwed with a male thread at one end and closed or welded at the other, used as a plug to close another pipe or an opening in a fitting, when a proper plug is not obtainable (12).

*Rake.* The angle of the cutting edge of the teeth of a tap or die (12).

*Reamed.* In pipe trade means having the burr from cutting-off tool removed from inside, at ends, by a slight countersinking (12).

*Riser Pipe.* A pipe extending vertically and having side branches (12).

*Roughing-in.* The installation of all pipes in the drainage system and such water pipes as are in partitions and under floors. It includes all the plumbing work except the setting of the fixtures. This latter work is known as the finishing (4).

*Run.* A length of pipe that is made of more than one piece of pipe.

The portion of any fitting having its ends "in line" or nearly so, in contradistinction to the branch or side opening as of a tee. The two main openings of an ell also indicate its run, and, when there is a third opening on an ell, the fitting is a "side outlet" or "back outlet" elbow except that, when all three openings are in one plane and the back outlet is in line with one of the run openings, the fitting is a "heel outlet elbow" or a "single sweep tee" or sometimes (less correctly) a "branch tee" (12).

*Service Clamp.* A clamp applied to a main at a point of connection for such use

as a house service. It is also, but less correctly, called "pipe saddle (12)."

*Shrunk Joint.* A joint secured in place by shrinking a larger pipe on a smaller one (12).

*Slip Joint.* An inserted joint in which the end of one pipe is slipped into the flared or swaged end of an adjacent pipe. The two pipes are often soldered together (12).

*Soldered Fittings and Soldered-Joint Fittings.* See *Sweated*.

*Standpipe.* A vertical pipe arrangement (12).

*Stock.* The tool which holds the dies in threading pipes, screws, bolts, etc. (4).

*Swaged.* Reduced in diameter by use of blacksmith's swages or swedges, hence the name. This is a hammering process, but the same result may be attained by press forging or spinning (12).

*Sweat Joint.* See *Sweated*.

*Sweated.* A term used synonymously with tinned; that is, coated with soft solder or tin. It is usual in making sweated joints on pipe to sweat both the pipe and the fitting or socket separately before sweating them assembled (12).

*Sweating.* The appearance of condensed moisture from the air on the surface of a cool pipe or fixture (4).

*Swedge.* See *Swaged*.

*Swing Joint.* A joint consisting of two or more fittings assembled in such a manner that they allow for expansion or contraction in the pipe line (12).

*Swivel Joint.* One that rotates about an axis without decreasing its efficiency as a joint (12).

*Tap.* A tool used for cutting internal threads. Small sizes are usually made solid, but larger sizes are often made with inserted cutters, so that they can be withdrawn from the work, without stopping, when the desired threads are cut (12).

*Tapped.* The operation of making an internal thread by means of taps.

In the pipe trade it means threaded, regardless of the method of production (12).

*Tongs.* See *Chain Tongs*, *Pipe Tongs*.

*Trimo Wrench.* See *Pipe Wrench*.

*Washer.* An annular ring threaded on the inside to be used as a lock nut.

A smooth, flat annular ring placed under a nut or bolt head to fill space or to protect the material under the nut or bolt.

A flat annular ring of soft material used in valves to prevent leakage (4).

*Wiped Joint.* A lead joint in which the molten solder is poured upon the desired place after scraping and fitting the parts together, and the joint is wiped up by hand with a moleskin or cloth pad while the metal

is in a plastic condition. It makes a neat and reliable connection in the pipe (12).

*Yoke.* A pipe with two branches, as for hot and cold water, uniting them to form one stream (12).

In drainage systems, a vertical connection between a branch waste line or wet vent and a continuous vent stack. The connection to the vent is made at a point at least a foot above the water level of the fixtures on the branch.

## Pipes and Connections

*Weight.* There is no purpose in using extra weight pipe on water lines, except for extraordinary high pressures and *exterior* causes of corrosion, certainly not for any interior causes (as extra weight cuts down the inside diameter, and, if corrosion takes place on the inside, the smaller diameter will only help to clog up the pipe so much more quickly).

In figuring pipes, therefore, be sure that the internal diameter is sufficient and specify extra weight only if needed for pressure and external conditions.

Steel and wrought iron lighter than "Schedule 40" shall not be threaded.

Pipe thickness (according to ASME Code for Pressure Piping) is determined by the formula:

$$t_m = \frac{PD}{2S} + C$$

where

$t_m$  = minimum pipe wall thickness.

$P$  = maximum internal service pressure in psi (plus water hammer allowance in case of cast-iron pipe conveying liquids).

$D$  = actual outside diam., inches.

$S$  = allowable stress in material, psi.

$C$  = allowances for threading, mechanical strength, and/or corrosion, in inches. For pipe over 1 in.,  $C = 0.065$ .

### *Joints Used.*

*Screw threaded joint.* Mostly on sizes 3 in. and smaller.

*Lapped joints.* Mostly on sizes above 2 in.

*Gas and electric welded joints.* On sizes above 3 in.

*Soldered joints.* On sizes 2 in. and smaller.

*Flared tubing joint.* On sizes 1 in. and smaller.

*Slip joint with gasket.* On small plumbing lines and long medium pressure gas lines.

*Calked joints.* For buried city water and gas lines and on soil pipes

*Ring joint.* For extreme pressures and temperatures.

*Flanged connections* on sizes over 6 in. and at equipment connections.

All joints and connections shall be made permanently gas and water-tight.

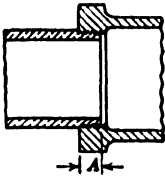

TABLE 14

LENGTH OF  
THREAD OF PIPE,  
IN INCHES

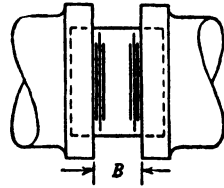

TABLE 15

NIPPLES  
LENGTH OF SHOULDER, B

Size Pipe	A	Size Pipe	Close	Special Short	Short	Length of Nipple, Inches								
						2	2½	3	3½	4	4½	5	5½	6
¾	¾	¾	¼	...	¾	1¼	1¾	2¼	2¾	3¼	3¾	4¼	4¾	5¼
½	½	½	⅛	...	½	1	1½	2	2½	3	3½	4	4½	5
¾	½	¾	⅜	½	1	...	1½	2	2½	3	3½	4	4½	5
1	9/16	1	⅜	...	7/8	...	1¾	1¾	2¾	2¾	3¾	3¾	4¾	4¾
1¼	5/8	1¼	⅜	¾	1¼	...	...	1¾	2¼	2¾	3¼	3¾	4¼	4¾
1½	5/8	1½	½	¾	1¼	...	...	1¾	2¼	2¾	3¼	3¾	4¼	4¾
2	11/16	2	5/8	...	1½	...	...	1¾	2½	2¾	3½	3¾	4½	4¾
2½	15/16	2½	5/8	...	1½	...	...	1¾	2½	2¾	3½	3¾	4½	4¾
3	1	3	5/8	...	1	...	...	1½	2	2½	3	3½	4	4
4	1 1/16	4	¾	...	1½	...	...	...	...	2¾	2¾	3¾	3¾	3¾
5	1 3/16	5	5/8	15/8	2 1/8	...	...	...	...	...	2¾	3½	3½	3½
6	1¼	6	5/8	1½	2	...	...	...	...	...	2½	3	3	3½
8	1 5/16	8	⅞	...	2 3/8	...	...	...	...	...	...	2¾	3	3 3/8

*Vitrified-Clay and Concrete-Pipe Joints.* Joints in vitrified clay and concrete pipe, or between such pipe and metals, shall be hot-poured or precast bituminous joints or cemented (gasket and mortar) joints.

Hot-poured bituminous compound joints shall be made in accordance with manufacturers' directions. Enough packing shall be used to hold the pipes in alignment. On horizontal piping a joint runner should be used. One or more joints may be poured in a vertical position before being lowered into the trench.

Gasket and mortar joints are made with a gasket of oakum rope soaked in cement paste and pointed with a mixture of one part Portland cement and two parts sand.



*Calked Joints.* Joints for cast-iron water pipe shall be approved calked lead joints made up with a gasket of hemp or jute. The space between the pipe and the bell shall be packed with clean hemp packing yarn, free from tar, deep enough to leave room for  $2\frac{1}{4}$ -in. depth of lead. The remaining space shall then be filled by running it full of lead, leaving an excess thereof protruding beyond the face of the bell, enough to allow for calking, so that, when the joint is properly calked, the lead will be practically flush with the face of the bell. After the joint has been run with lead, it shall be calked by means of proper tools so as to make a watertight joint.

Joints on cast-iron soil pipe shall be made with gasket of tarred rope oakum and shall be secured with 12 oz of lead for every inch diameter of pipe. After the lead has cooled, the joints shall be thoroughly calked, made tight, smoothly faced, and left without putty, paint, or cement until after the joint is tested.

Calked joints in acidproof pipe shall be made with pure asbestos rope and molten lead, thoroughly calked.

All lead for joints in cast-iron soil and cast-iron water piping shall be sufficiently hot to run joint full at one pouring without hardening. Dross shall not be allowed to accumulate in the melting pot.

*Screwed and Flanged Joints.* Joints for wrought iron, steel pipe, and threaded cast-iron pipe shall be screwed joints (excepting flanges required for connection to flanged valves and to make up piping, etc.) and shall be made with regular standard or extra heavy couplings corresponding to the pipe.

Proper cast-iron screwed companion flanges, properly planed, shall be provided to correspond with the valve or equipment flanges, etc.

Screwed joints shall be made up to be perfectly tight without the use of lead or filler of any kind except oil or graphite. Dope, if used, shall be applied to the male thread only.

Joints for white metal pipe or tubing shall, in general, be screwed joints.

Unions in screwed pipe, 2 in. and smaller, shall be ground joint with brass seats. Unions in pipes larger than 2 in. shall be flanged unions except waste lines, which shall have Tucker or similar type, calked joints.

*Wiped joints* in lead pipe, or between lead pipe and brass or copper pipes, ferrules, soldering nipples, bushings or traps, in all cases on the sewer side of the trap and in concealed joints on the inlet side of the trap, shall be full-wiped joints, with an exposed surface of the solder on each side of the joint not less than  $\frac{3}{4}$  in., and a minimum thickness at the thickest part of the joint of not less than  $\frac{3}{8}$  in. Where a round joint is made, a thickness of not less than  $\frac{3}{8}$  in. for bushings and flange joints shall be provided (23).

*Joints between Lead and Other Piping.* Joints between lead and cast-iron, steel, or wrought-iron piping shall be made by means of a calking ferrule, soldering nipple, or bushing (23).

*Gasket for Flanged Joints.* In general, for flanged fittings with plain faces and ordinary cold-water service a  $\frac{1}{16}$ -in. rubber gasket is used, and a  $\frac{1}{16}$ -in. asbestos composition gasket for hot-water services.

Further requirements stated below are abstracts from ASME Code for Pressure Piping.

Pressure lines above 250 F: metallic, asbestos, or other non-burning material (38). Plain-face flanges and temperatures not over 250 F: rubber or rubber-inserted gaskets (38). Paper or vegetable fiber gaskets may be used where this type of gasket material is required to resist the action of the fluid but shall not be used for temperatures in excess of 250 F (38).

Asbestos-composition gaskets may be used with any of the various types of flange facings except small male and female or narrow tongue and groove. This type of gasket shall not be used on hot-oil lines where the blowing out of a gasket would be the cause of a fire (38).

Jacketed asbestos and metallic gaskets of either the plain or corrugated type are not limited as to pressure or temperature (38).

Flanges with small male and female or narrow tongue and groove facing, owing to the narrow gasket surface, should have metallic gaskets (38).

Gaskets removed often should be covered with graphite.

*Other Joints.* Sweat joints shall be made in each case according to the manufacturer's specifications. Use a non-corrosive flux and wire solder (60% lead, 39% tin, 1% antimony, melting point 358 F, or 95% lead, 5% tin, melting point 522 F).

Fittings should preferably be pure wrought copper or a cast red brass or wrought metal containing not less than 85% copper.

For joints between cast-iron and screwed pipe, screw a half coupling on a screwed pipe to form spigot head, then make a calked joint as specified for cast-iron pipe. Joints on pipes leading from screwed pipes to calked pipe shall be made by using special hub connector with one screwed outlet.

Slip joints should be permitted only at tailpiece inlet to traps. Unions on sewer side of traps shall be ground faced and shall not be concealed or enclosed.

Welded joints shall be made in accordance with the ASME Code for Pressure Piping.

To prevent galvanic action on the zinc coating of water pipes, water meters shall be insulated from the galvanized pipe by semi-hard rubber parts.

*Roof Flashings.* Joints at the roof shall be made watertight by use of copper, lead, or zinc-coated (galvanized) iron flashings, cast-iron plates, or other approved materials (23).

*Floor or wall connections* for china fixtures mounted directly to the waste or soil pipe shall be made by means of approved brass or cast-iron floor flanges or special castings. Such castings shall be constructed to accommodate an approved gasket ring or compound.

## Valves

*Materials.* Valves for WP of less than 120 lb shall be tested for 250 lb and designed for a working pressure of 125 lb.

Valves on fire lines shall be good for a WP of 250 lb or higher.

Valves (stops, cocks, checks, etc.) on wrought-iron steel and standard brass pipe 2 in. or less shall be red rough brass bodies with machine trimmings and screwed ends, on 2½-in., and over, iron bodies, bronze mountings, non-corrosive stem contacts, including bronze stems and faces, 2½ to 4 in. shall have screwed ends, 5 in. and over shall be flanged.

Key handles on underground pipes. Lever handles on stops. Iron wheels on general control valves and cocks. Brass-milled wheel handles on fixture controls finished same as the piping.

## Installation

*General Notes.* Pipes shall be installed so as to provide proper head room. Offsets should be permitted only where required to follow walls, in which case standard fittings shall be used.

All risers shall be erected plumb and true.

All horizontal runs of piping hung from ceilings shall be erected as close as possible to bottom of floor slab, ceiling, or beams.

Where pipes are shown or specified to be installed concealed in floor fills, they shall be provided with a protecting cover of at least No. 20 galvanized approved duct or space around the pipes so as to care properly for expansion, allow room for insulating material, etc.

Connections to fixtures, shown to be installed concealed in building construction, shall, in general, be carried concealed to points above the floor (near fixtures) where they shall break out and rise exposed to fixtures.

All piping passing through outside of building walls, unless otherwise especially approved, shall be installed so as to be built in with the construction.

Reducing fittings, except in some cases, shall be used in making reductions in size of pipes. Bushings should, as a general rule, not be allowed.

All open ends of pipes, etc., shall be left properly capped or plugged during the installation of the apparatus, in order to keep out dirt, etc.

*Cutting and Chases.* The specifications for general contract work usually provide for such openings as are shown on the construction drawings and where directed as the work progresses.

The responsibility for laying out and indicating all holes, chases, providing sleeves, inserts, etc., to the general contractor at an early date rests with the plumbing contractor, and any cutting and patching in new work or alterations to original holes, openings, and chases made by general contractor shall be done at the expense of the plumbing contractor.

Chases are usually provided in the walls by the masonry contractor.

It is advisable to know the size of chases so that adequate space can be provided. In buildings with structural frames the roughing-in is usually done before the partitions and masonry are erected.

Allowance should be made for the pipes, and consequently it is necessary to know how to space them.

TABLE 16  
THE MOST COMMON TYPES OF CHASES

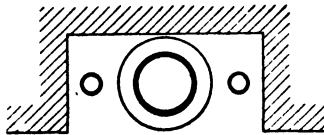

LAVATORY RISER  
For Sizes Up To and  
Including 2" Waste  
3½" x 8"

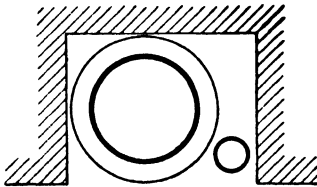

WATER CLOSET STACK  
4" Soil Pipe  
6" x 8"

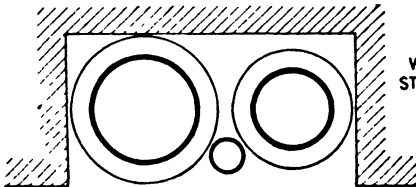

WATER CLOSET  
STACK AND VENT  
4" Soil Pipe  
6" x 12"

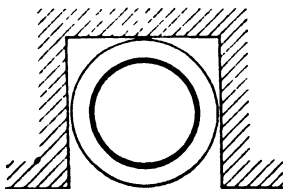

RAIN WATER CONDUCTOR  
3 Inch 4½" x 4½"  
4 Inch 6" x 6"  
5 Inch 7" x 7"  
6 Inch 8" x 8"  
8 Inch 10" x 10"

Where masonry work goes up in advance of pipe work chases should be large enough so that the workman can install the pipe properly. For calked joints he must have room to work the joint. For screwed piping he must have space enough to turn the fittings.

The minimum space between two pipes is thus usually determined by the swing of the fitting in the largest pipe. The next consideration is the take-offs for branches. In many cases this take-off must be provided with a swing joint.

*Pipe Sleeves.* All pipes, except pipes from fixtures or pipes passing through construction with inaccessible space on one side, shall be provided with metal thimbles where passing through construction.

Permanent sleeves shall be wrought-iron or steel pipe in lengths equal to the finished thickness of the floor and ceiling construction. Where floor may become wet the sleeve should project about  $\frac{1}{4}$  in. above floor.

Temporary pipe sleeves may be made of galvanized sheet metal and shall be 4 in. longer than the thickness of the rough floor construction.

*Slope of Pipes.* Pipes should be sloped for drainage purposes only.

Slope of pipe has no effect on flow of water, and do not let anyone tell you that a hot water circulating pipe must slope in order to circulate.

TABLE 17

## SLEEVES—MINIMUM SIZES

$\frac{3}{8}$ -in Pipe	$\frac{3}{4}$ -in. Sleeve
$\frac{1}{2}$	1
$\frac{3}{4}$	1 $\frac{1}{2}$
1	2
1 $\frac{1}{4}$	2
1 $\frac{1}{2}$	3
2	3
2 $\frac{1}{2}$	4
3	4
4	5

*Expansion in Pipes.* Proper provision shall be made for expansion of pipes.

Changes in length of 100 ft of pipe for 100 F change in temperature—in feet:

W.I.	$\frac{1}{16}$
Steel	$\frac{1}{16}$
C.I.	$\frac{1}{16}$
Copper	$\frac{3}{32}$
Brass	$\frac{7}{64}$
Lead	$\frac{5}{32}$

*Templets.* Where plumbing pipes or fixtures require drilling through materials or construction erected by other contractors, the plumbing contractor shall furnish all necessary templets and other information for the proper location and execution of such work.

*Pipe Hangers and Inserts.* All pipes shall be adequately supported on hangers or carriers.

Hangers and supports shall be of malleable iron, adjustable design. Hangers shall be threaded rods, fastened to inserts in new buildings or beam clamps or expansion bolts in old buildings.

Size of rods for hangers shall not be smaller than:

$\frac{1}{2}$ in. to 2 in. pipe	$\frac{3}{8}$ in. diam. rods
2 in. to 4 in. pipe	$\frac{1}{2}$ in. diam. rods
5 in. and larger	$\frac{3}{4}$ in. diam. rods

Where three or more pipes are running parallel to each other on basement ceiling, these shall be grouped together on single hangers consisting of  $1\frac{1}{4}$ -in. pipe of lengths as required, held up at each end by  $\frac{1}{2}$ -in. rods hung from ceiling. These lines shall all be clamped on pipe racks and provided with spacers between lines. Where necessary, owing to the weight of lines, pipe hangers larger than  $1\frac{1}{4}$  in. shall be installed.

All hangers shall be placed 6 ft apart on  $\frac{1}{2}$ -in. and  $\frac{3}{4}$ -in. pipes, 8 ft apart on pipes 1 in. to 4 in., and 10 ft apart on pipes larger than 4 in. Cast-iron soil pipe shall be supported at least at each length.

All vertical piping shall be supported by standard type galvanized-iron hangers calked into wall with expansion bolts.

Supports on vertical piping up to 1 in. diameter are to be not more than 6 ft apart; on pipe above 1 in. diameter, not more than 10 ft apart.

Vertical risers and stacks 2 in. and over shall be supported at each floor level with riser clamps.

The following are abstracts from the ASME Code for Pressure Piping (38):

1. *Special material requirements:*

(a) Hanger, supports, anchors, etc., shall be fabricated from durable materials suitable for the service. Where exposed to corrosive effects they shall be painted or preserved.

(b) In tunnels of fireproof buildings all permanent supports shall be of non-combustible materials.

In non-fireproof buildings and outside areas piping may be hung from combustible structures, provided that pipes conveying fluids at a temperature above 230 F shall be spaced or insulated from combustible members to prevent dangerous heating.

(c) Steel and wrought iron shall be used for hanger rods, turnbuckles, beam clamps, pipe clamps and straps, chains, supports, rollers, guides, bases, and all other parts used for the support of piping.

(d) Cast iron shall be used for roller bearing bases, rollers, guides, anchor bases, brackets, and parts of piping supports upon which the loading will be mainly that of compression. (Not used for tension.)

(e) Malleable iron pipe clamps, beam clamps, hanger flanges, clips and bases, swivel rings, and similar parts of pipe supports shall be limited to use for operating temperatures up to 450 F.

(f) Non-ferrous metals shall be used for corrosive conditions. Cast iron and malleable iron may be suitable.

2. *Protective coatings.* In lieu of corrosive-resistant materials, galvanizing, paint, etc., may be used.

3. *Design limitations.* Pipe straps, or bars of strength equal to the equivalent hanger rod, may be fabricated for use instead of hanger rods for the support of piping of nominal pipe sizes  $3\frac{1}{2}$  in. and smaller.

Hangers for 2-in. pipe and larger shall be adjustable. Exception to this may be made in cases where hangers are to be used for the support of piping requiring exact grades, for which they may be fabricated as rigid hangers.

4. *Dimensional limitations.*

(a) Straps:  $\frac{1}{8}$  in. by 1 in. min. If exposed to the weather,  $\frac{1}{4}$  in. by 1 in. min. Exception: For 1-in. pipe and smaller  $\frac{1}{16}$  in. by  $\frac{3}{4}$  in. and, if exposed to the weather,  $\frac{1}{8}$  in. by  $\frac{3}{4}$  in.

(b) Hanger rods:  $\frac{3}{8}$  in. round for 2-in. pipe and smaller,  $\frac{1}{2}$  in. round for  $2\frac{1}{2}$ -in. pipe and larger.

(c) Chains for hangers:  $\frac{3}{16}$  in. round stock for 2-in. pipes and smaller,  $\frac{3}{8}$  in. round stock for  $2\frac{1}{2}$ -in. pipes and larger. Bolted plate clamps, used in connection with rod and chain hangers, shall have  $\frac{3}{16}$  in. min. thickness (if weather-protected),  $\frac{1}{4}$  in. (where exposed). Bolts shall be same diameter as hanger rods or  $\frac{3}{8}$  in. diameter when clamps are used with chain.

5. *Inserts* shall be of one piece, malleable iron or wrought steel of an approved type and size with long neck and keyhole slot, designed to attach to the forms.

*Accessories.*

1. *Pipe cleanouts.* The bodies of cleanout ferrules shall be made of standard pipe sizes, conform in thickness to that required for pipe and fittings of the same metal, and extend not less than  $\frac{1}{4}$  in. above the hub. The cleanout cap or plug shall be of heavy red brass not less than  $\frac{1}{8}$  in. thick and be provided with raised nut or recessed socket for removal and shall be threaded with not less than six standard pipe threads.

Cleanouts shall be full size, on pipe up to 4 in. in diameter and not less than 4 in. for larger pipes.

2. *Cleanout extension and floor boxes.* All cleanouts shall be extended to an accessible space. Cleanouts for underground pipes shall have cast-iron boxes with flush cast-iron removable cover plates.

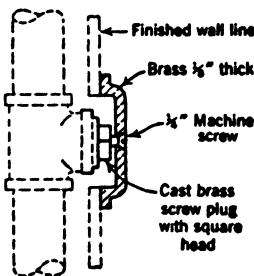

FIG. 24. Wall Clean-out Plug and Cover. (From Federal Specifications WW-P-541a.)

Cleanout extensions terminating at floors shall be covered with cast-iron boxes set flush with floor and polished brass flush cover plate or be of a design to fit flush with the floor.

Extensions to floors and ground surface shall be made by using one-eighth bends.

3. *Cleanout covers.*

9 × 9 in. brass for 4 in. and less cleanouts

12 × 12 in. cast iron for 6 in.

16 × 16 in. cast iron for 8 in. and 10 in.

Covers set in walls: polished cast brass (Fig. 24).

4. *Floor, ceiling and wall flanges* shall be furnished and installed on all exposed pipes where they pass through finished floors and walls. Covered pipes shall, in addition, be furnished with aluminum protectors.

Finished rooms, on exposed uncovered pipe: heavy chromium plate, cast metal, split type with set screw.

Exposed covered pipe shall be aluminum pipe covering protectors with heavy chromium-plated cast metal split type flange of same size as covering.

Unfinished rooms to have plain cast-iron flanges.

*Temporary Fixtures.* Contracts for larger jobs should include provisions for the installation and maintenance of temporary fixtures.

All fixtures may be second-hand but shall be in good working order. The contractor shall install complete and adequate piping for cold water and waste. Waste may be run to a cesspool, excavated by the contractor. If and when a sanitary sewer is available, connection shall be made to same.

Contractor shall at all times keep this toilet room in sanitary condition and make all necessary repairs to plumbing installation, and furnish liquid soap, paper towels, and toilet paper during the entire process of the building.

At termination of contract, the contractor shall remove all fixtures and piping and cap or plug connections to water line and sewer.

*Valve Tags.* All valves on inside work shall be tagged by numbers stamped thereon. Tags shall be securely wired to valves with copper wire and a complete directory of all valves shall be furnished to the architect. Similar tags and directory shall be furnished for gas piping.

## ART. 4-B. UNDERGROUND WORK

### Definitions

*Backfilling.* Replacing the earth taken from a trench.

*Curb Box.* See *Service Box*.

*Datum.* Plane of reference for elevations (45).

*Dual-Main System.* The use of two underground conduits, pipes, or lines, each one to supply only one side of the street. (President's Conference on Home Building.)

*Extension Valve Box.* See *Valve Box*.

*Grade.* The slope of a road, channel, or natural ground (45).

The finished surface of a canal bed, road bed, top of embankment, or bottom of excavation (45).

Any surface prepared for the support of a conduit, paving, ties, rails, etc. (45).

*Invert.* The floor, bottom, or lowest part of the internal cross-section of a conduit (45).

*Planting Strip.* The ground between the street pavement and the sidewalk. (President's Conference on Home Building.)

*Rear Lot Easement.* A right of way granted to a utility agency or agencies by the lot owner, for the installation of pipe or pole lines along the rear lot line. (President's Conference on Home Building.)

*Service Box.* Small valve box. Service box is the name usually employed for those boxes used with corporation or curb cocks (12).

*Service Line.* A pipe or cable, usually located in part or wholly on the lot, that



connects the supply main or line in the street, alley, or easement with the house. (President's Conference on Home Building.)

*Service Pipe.* A pipe connecting main with a dwelling; as in gas pipes and the like (12).

*Single-Main System.* The use of one underground conduit, pipe, or line to supply both sides of the street. It is frequently laid in the center or toward either side of the street. (President's Conference on Home Building.)

*Soil.* Finely divided material composed of disintegrated rock mixed with organic matter; the loose surface material in which plants grow (45).

*Street Box.* See *Valve Box.*

*Street Opening.* A cut through the street surfacing, if any, for digging a trench to install or repair utility pipes or lines. (President's Conference on Home Building.)

*Subgrade.* The elevation of the bottom of a trench in which a sewer or drain is laid (41).

*Subsoil.* The material lying below the surface soil, generally devoid of humus or organic matter (45).

*Supply Line.* A main or line that runs along the street and connects with the service lines. (President's Conference on Home Building.)

*Test Pit.* An excavation to determine the nature of the material encountered or to disclose subsurface conditions (45).

*Utility Agencies.* Include all public and private organizations supplying utility services to the house holder. (President's Conference on Home Building.)

*Valve Box.* A pipe placed over a buried valve to allow access to the valve stem or wheel for opening or closing. The top of the pipe is usually closed by a plate or cap to exclude dirt that would interfere with operation. There are many designs, the most usual being adjustable within limited range to suit the depth planted; they are called *Extension Valve Boxes*, *Street Boxes*, or *Service Boxes* (12).

## Trenches

*General Requirements.* Unless otherwise directed or permitted, not more than 200 ft of any sewer trench, in advance of the end of the built sewer, shall be open at any time; and, unless written permission to the contrary is given, the trench shall be excavated and cleaned out to its full depth and grade for a distance of at least 50 ft in advance of the pipe laying.

*Depths and Widths of Trenches.* Trenches for water pipes shall be excavated to such a depth as to allow a finished covering sufficient to protect it from frost and other damage. New line sewer trenches shall be excavated to the depths required for the foundations of the sewers and appurtenances shown on the plan.

Trenches for water pipe shall be 18 in. more than the internal diameter of the pipe, but not less than 24 in.

Trenches for sewer lines shall be at least 20 in. wider than the internal diameter of the pipe, but not less than 30 in.

Additional depth and width will be required in water pipe trenches at joints. All such joint holes must be of ample size and must be kept dry while the joints are made.

All irregularities in the bottoms of the trenches shall be filled up to the required grade with suitable material.

The grade lines shown on the profile plans indicate the bottom of the inside (invert) of sewers and top of exterior pipe for water lines.

TABLE 18  
CROSS-SECTION OF SEWER TRENCH (SEPARATE SYSTEM)

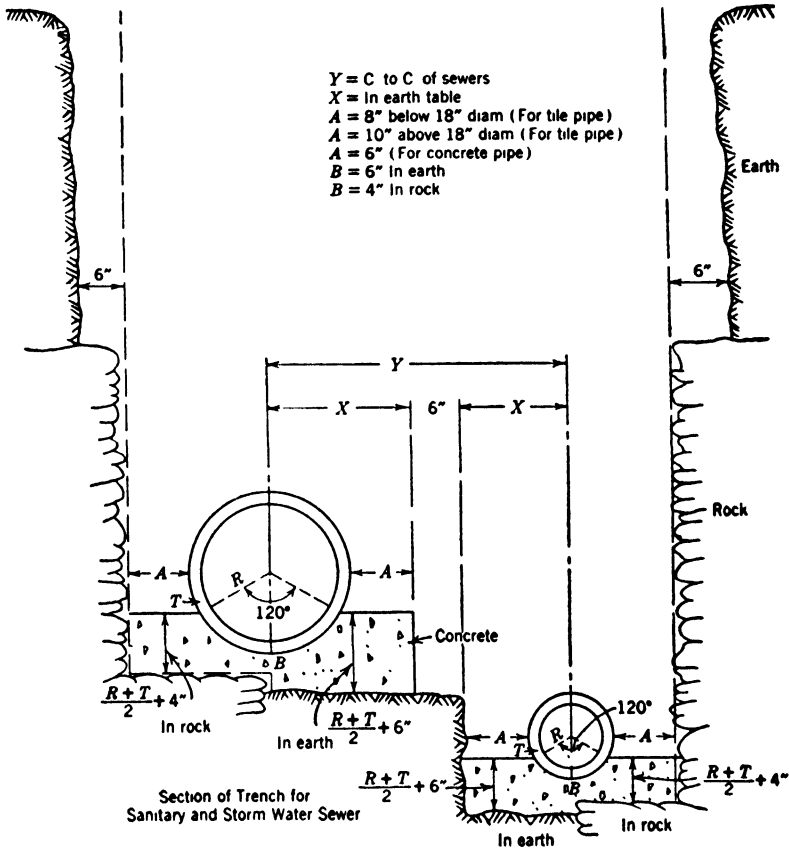

Table Showing Distances  $X$  and  $Y$  for Sewers Laid in the Same Trench.

The Distance  $Y$  Between Center Lines of Pipes =  $2X + 6''$

Kind	Size	$X$	Kind	Size	$X$
Tile pipe	8"	1' $\frac{3}{4}$ "	Concrete pipe	27"	1'11"
" "	10"	1' $1\frac{1}{8}$ "	" "	30"	2' $\frac{1}{2}$ "
" "	12"	1' 3"	" "	33"	2' $2\frac{1}{2}$ "
" "	15"	1' $4\frac{3}{4}$ "	" "	36"	2' 4"
" "	18"	1' $6\frac{1}{2}$ "	" "	42"	2' $7\frac{1}{2}$ "
" "	21"	1' $10\frac{1}{4}$ "	" "	45"	2' 9"
" "	24"	2'00"	" "	48"	2'11"

TABLE 19

CROSS-SECTIONS OF SEWER TRENCHES

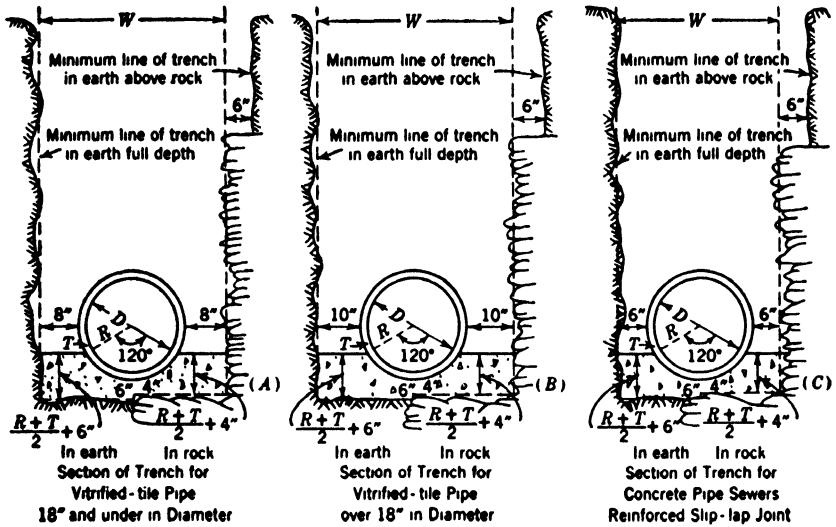

Pipe Sewers  
18" and Under

Pipe Sewers  
Over 18"

Concrete Sewers  
27" and Over

In Earth—A

In Earth—B

In Earth—C

D	W
8"	2'1½"
10"	2'3¾"
12"	2'6"
15"	2'9½"
18"	3'1"

D	W
21"	3' 8½"
24"	4'00"
27"	4' 3½"
30"	4' 7"
33"	4'10¼"
36"	5' 1½"

D	W
27"	3'10"
30"	4' 1"
33"	4' 5"
36"	4' 8"
42"	5' 3"
45"	5' 6"
48"	5'10"

*Manholes, Basins, etc.* The minimum excavation in earth for manholes, receiving basins, etc., shall be such as to give a clearance inside the sheeting of 1 ft on all sides above the foundation, but in all cases the excavation shall be large enough to include the foundation for the structure.

*Bracing Trenches.* Where material to be excavated is of such a nature, or other conditions are such as to render it necessary, the sides of the trenches and excavation shall be firmly supported by adequate sheeting and bracing.

*Tunneling.* All work shall in general be done in open trenches or excavations. No tunneling shall be done except with the written consent of the architect.

*Pumping.* Sewers, water lines, and other appurtenances should be constructed in a trench, free from water, with a stable bottom, and should, upon completion, form practically watertight sewer construction and watertight water lines. The contractor should keep the trench at the points under construction free from water until the pipe work and foundations have been completed and sufficient backfill has been placed to insure that the construction will not be harmed by water in the trenches.

No work should be allowed to be constructed in water or upon an unstable foundation.

Whenever water appears in the trench, the contractor should provide sumps and pumping equipment of necessary capacity, and the operation thereof, and, if found necessary, install pipe subdrains or rock-filled trenches for the purpose of collecting water in the sumps.

If the trench cannot be kept free from water by the above methods, the contractor should be required to use the well-point or other approved methods for keeping water from the trench.

Water from trenches and excavations shall be disposed of in such manner as to cause no inconvenience to other work.

At least one pump in good order shall be on the site of the work at all times.

*Preliminary Backfilling of Water Pipe Trenches.* As soon as possible after the pipes have been laid and calked in the trenches for such a distance as directed, the work of refilling the trenches can be commenced.

In this operation no large stones shall be thrown in, and only the finest selected earth material shall be deposited under and around the pipes and appurtenances and also covering them for a depth of about 3 in. This earth shall be thoroughly pounded or rammed as it is being thrown in, particularly under and around the haunches of the pipe, so as to fill the lower portions of the trench compactly throughout and give the pipe a solid bearing for its entire length.

The material must not be thrown down from above faster than the workmen below can properly distribute and compact it, and care must

be taken to leave all joints free for inspection until after the water pressure test has been applied.

Thereupon, thick earth dams, not less than 2 ft high above the top of the pipe shall be constructed across the trench between the joints to prevent any flooding of the whole trench in case of a break.

After water-pressure test has been applied and the joints made tight, all spaces left unfilled at the joints shall be properly filled with fine earth material, thoroughly rammed into place as specified above.

Where abrupt curves occur in the pipe alignment the contractor shall backfill around the sides of the pipe with 1 : 3 : 5 mix concrete.

*Backfilling.* Sewer trenches shall be backfilled for a depth of at least 2 ft over the top of pipe with clean earth or sand. It shall be carefully deposited in uniform layers not exceeding 6 in. in depth. Each layer shall be carefully and solidly tamped with appropriate tools in such a manner as to avoid injuring or disturbing the complete work.

Backfilling for remainder of trenches (both sewer and water lines) shall be approved material free from organic matter and containing no stones over 10 in. in their largest dimensions. Stones which are used in backfilling shall be distributed through the earth backfill so that all interstices are filled with fine material. All backfilling shall be deposited as directed and shall be spread in layers and solidly tamped or flooded according to the type of backfill.

*Repairing and Cleaning Up.* In all paved or improved streets and sidewalks, the surface of the excavations, after being filled, dried, and settled, shall be finished with the same kind of pavement or improvement that was removed in excavating the trench, and so that the underlying courses, as well as the finished surface, shall conform to the remainder of the roadway or sidewalk.

#### ART. 4-C. PIPE TESTS

##### General Methods (Listed in order of choice)

*House Drains.* 1. Hydraulic test. Fill system with water to a head of 3 ft. Test to last one hour without drop in head.

2. Smoke or air test under pressure of 1 to 2 in. of water column.

*Soil and Waste Pipes and Vents.* 1. Hydraulic test. Fill entire system to the top with water. Test to last long enough to inspect all joints.

2. Compressed air test (second choice). 10 psi for one hour or longer. Actual leak detected by soap solution on joints forming bubbles or by passing essential oil of peppermint into system and detecting by odor. A pressure gage should be used, but a drop in pressure does not necessarily indicate leakage, but may be due rather to the cooling of the air. The gage is used more for the purpose of maintaining the proper pressure.

3. Smoke test.

*Hot- and Cold-Water Supply Piping.* Fill system and apply a pressure of twice the actual working pressure for a period of 1 hr or more. On important work the test period should be extended to as much as 24 hr.

*Gas Piping.* Air pressure, using a very accurate gage (mercury column) and a pressure of 15 to 20 in. mercury. Test to last 24 hr. Leaks detected by ether fumes under pressure. (See also Art. 10-B.)

#### ART. 4-D. INSULATIONS

##### General Practice

*Insulation Efficiency.*

$$E = \frac{BLB - BLC}{BLB} \times 100$$

where

$E$  = efficiency expressed in per cent.

$BLB$  = Btu loss per sq ft per hr for uninsulated pipe.

$BLC$  = Btu loss per sq ft per hr for insulated pipe.

*Suggested Insulations.*

1. *Domestic hot-water tanks; receivers, tanks, heaters, etc.* Cover tanks with 1- or 1½-in. blocks of 85% magnesia wired firmly in position and covered with 2-in. hexagonal mesh wire stretched tight. Cover outer surface with a ¼-in. layer of plastic 85% magnesia cement smoothly troweled on. For outer protection paste on a heavy canvas jacket or trowel on a ¼-in. layer of hard finish cement consisting of two parts by weight of hard finish asbestos cement and one part of Portland cement.

2. *Low-pressure piping.* 4-ply (6-ply, 8-ply) 1-in. asbestos sectional covering, lacquered brass bands 18 in. on centers. Concealed piping within 18 in. of outside walls ½ in. asbestos.

Standard thickness 85% magnesia sectional pipe covering with lacquered brass bands 18 in. on centers.

3. For exposed piping add rosin-sized paper or asbestos paper and 8-oz canvas sewed on with about three stitches to the inch.

4. *Valves and fittings.* Plastic cement equal to insulation for pipes.

5. *Underground pipes.* Run in tile; additional wrapping of tar paper and coated with asphaltum.

6. *Cold-water tanks.* All cold-water tanks placed inside a building should be covered to prevent condensation (sweating). Tanks receiving a continuous fresh supply of water, as pneumatic tanks, storage, and surge tanks, should be placed over a watertight area with drain outlet.

Tanks provided with mud blows should have an ample spillbasin below them.

Owing to excessive sweating on bare tanks, it is advisable to place them above a curbed-in area.

7. *Hot water and circulation.*  $\frac{3}{4}$ -in. solid wool felt sectional covering, asbestos-lined. Neatly paste down all joints and secure in position with lacquered brass bands 18 in. on centers.

8. *Cold water.* Two  $\frac{1}{2}$ -in. layers of solid wool felt, sectional covering, tar-lined, applied with joints broken. Neatly paste down all joints and secure in position with lacquered brass bands 18 in. on centers. Fittings and valves to be insulated with  $\frac{3}{4}$ -in. thick standard hair-felt finished with  $\frac{1}{4}$ -in. hard finish asbestos cement.

9. *Waste lines* (against sound). Insulate all vertical waste lines concealed in partitions adjacent to principal rooms and all horizontal offsets in upper floor construction with 1 in. hair-felt cut to fit between hubs and wound spirally with steel wire. Cover hubs also with same material.

10. *Range Boiler.* 1-in. asbestos applied on wire netting while tank is hot. Trowel smooth and hard, and finish with  $\frac{1}{2}$ -in. coat.

11. *Ammonia or brine lines.* Built-up layers of hair-felt. Apply heavy asphalt waterproof compound on pipe and between each successive layer of felt. Felt to be fastened with spirally wound steel wire. Additional layer shall be applied with joints broken.

12. For brine piping use three layers of 1 in. each.

13. *Canvas jackets.* Where pipes are exposed so that covering may be damaged or for finished rooms where a neater appearance is required, apply over the standard canvas jacket a heavy sheathing paper, followed by an 8-oz canvas jacket sewed on, with approximately three stitches to the inch.

14. *Exposed piping.* Pipes exposed to extremely low temperatures or placed outdoors shall be covered with 1 in. greater thickness than required for interior work, and shall be finished with 3-ply waterproof roofing (in place of canvas) applied with lapped joints and secured with No. 16 copper wire spaced not over 8 in. on centers.

15. *Painting.* All canvas jackets to be painted shall first be covered with at least one coat of glue sizing.

#### ART. 4-E. PAINTING

##### General Practice

*Standards.* Scheme for the Identification of Pipe Systems, American Recommended Practice, ASA A-13, ASME, NSC.

*Corrosion.* Provisions shall be made for parts subject to corrosive agents. If the parts are not made of corrosive-resistance metal or extra weight, they should be protected by a covering or paint.

## CHAPTER 5

### WATER SUPPLY

#### ART. 5-A. STANDARDS

##### Pure Water

*Definition.* Water in its pure form is a chemical combination of two gases, two parts hydrogen and one part oxygen (H<sub>2</sub>O), but as such it is never found in nature.

Without deliberating upon the marvels of creation, it can be stated just as a matter of fact that water, in order to fulfill its wonderful task as the universal carrier of the necessary life-sustaining elements, fortunately does, and of necessity must, possess the particular quality of drawing to itself a number of foreign substances so that it is never found as strictly pure water.

The qualification for being classified as pure water depends, of course, upon the purpose for which it is meant, and, in most cases, when water associates itself to any degree with foreign matters, it usually is recognized as a liquid by some other name.

Rather than referring to water as "pure" it has become common practice to use the term "drinking water" for all water suitable for domestic use and reasonably free from organic matters.

(a) *Contaminated water.* Water unfit for any given use because of contact with or the presence of injurious substances (41).

(b) *Contamination.* The introduction into water, otherwise satisfactory, of bacteria, sewage, or other substance, which makes it unfit for any given use.

(c) *Infected water.* Water which contains pathogenic bacteria (41).

(d) *Pathogenic.* Causing disease (14).\*

(e) *Pollution.* The act of making unclean or impure, or the state of being unclean or impure—as a result of admixtures of sewage, industrial wastes, or other substances (41).

(f) *Potable.* Drinkable; used for drinking purposes.

##### Standards for Drinking Water

The United States standards are the Public Health Service Drinking Water Standards (*Public Health Reports*, Vol. 61, No. 11, March 15, 1946).

*Bacteriological Quality* The standards include determination of the coliform group of bacteria. Generally "of all the standard ten milliliter portions examined per month in accordance with the specified procedure, not more than ten per cent shall show the presence of organisms of the coliform group.

\* From Gould's *Pocket Medical Dictionary*; copyright, the Blakiston Company, Philadelphia, Pa.



"The coliform group of bacteria is defined, for the purpose of the Standards, as including all organisms considered in the coli-aerogenes group as set forth in the *Standard Methods for the Examination of Water and Sewage*, current edition, prepared, approved, and published jointly by the American Public Health Association and the American Water Works Association."

*Physical and Chemical Characteristics.* The water shall not contain an excessive amount of soluble mineral substance, nor excessive amounts of any chemical employed in treatment. Under ordinary circumstances, the analytical evidence that water satisfies the physical and chemical standards given in sections 4.1 and 4.21 and simple evidence that it is acceptable for taste and odor will be sufficient for certification with respect to physical and chemical characteristics.

*Physical Characteristics* (Section 4 1). The turbidity of the water shall not exceed 10 ppm (silicon scale), nor shall the color exceed 20 (standard cobalt scale).

The water shall have no objectionable taste or odor.

*Chemical Characteristics* (Section 4 21). The presence of lead (Pb) in excess of 0.1 ppm, of fluoride in excess of 1.5 ppm, of arsenic in excess of 0.05 ppm, of selenium in excess of 0 05 ppm, of hexavalent chromium in excess of 0.05 ppm shall constitute ground for rejection of the supply. These limits are given in parts per million by weight. . . .

Salts of barium, hexavalent chromium, heavy metal glucosides, or other substances with deleterious physiological effects shall not be allowed in the water-supply system.

(Section 4.22). The following chemical substances which may be present in natural or treated waters should preferably not occur in excess of the following concentrations where other, more suitable, supplies are available in the judgment of the certifying authority: Copper (Cu) should not exceed 3 0 ppm. Iron (Fe) and manganese (Mn) together should not exceed 0 3 ppm. Magnesium (Mg) should not exceed 125 ppm. Zinc (Zn) should not exceed 15 ppm. Chloride (Cl) should not exceed 250 ppm. Sulfate (SO<sub>4</sub>) should not exceed 250 ppm. Phenolic compounds should not exceed 0.001 ppm in terms of phenol. Total solids should not exceed 500 ppm for a water of good chemical quality. However, if such water is not available, a total solids content of 1,000 ppm may be permitted.

For chemically treated waters, i.e., lime softened, zeolite or other ion exchange treated waters, or waters given any other chemical treatments, the following three requirements should be met: (1) The phenolphthalein alkalinity (calculated as CaCO<sub>3</sub>) should not be greater than 15 ppm plus 0.4 times the total alkalinity. This requirement limits the permissible pH to about 10.6 at 25 C. (2) The normal carbonate alkalinity should not exceed 120 ppm. Since the normal alkalinity is a function of the pH and the total alkalinity, this requirement may be met by keeping the total alkalinity within the limits suggested in the table when the pH of the water is within the range given. These values apply to water at 25 C. (3) If excess alkalinity is produced by chemical treatment, the total alkalinity should not exceed the hardness by more than 35 ppm (calculated as CaCO<sub>3</sub>).

pH range	Limit for	pH range	Limit for
	total alkalinity (ppm as CaCO <sub>3</sub> )		total alkalinity (ppm as CaCO <sub>3</sub> )
8.0 to 9.6	400	10 1	210
9.7	340	10 2	190
9.8	300	10 3	180
9.9	260	10 4	170
10.0	230	10.5 to 10.6	160

ART. 5-B. WATER SUPPLY

Sources

*Water Sources.* The water used in the plumbing system is obtained from public sources through public water mains or from private sources.

*Definitions.*

*Gravity water.* Water that moves through soil under the influence of gravity (45).

A gravity supply of water as distinguished from a pumped supply (45).

*Gravity ground water.* The water that would drain from a given soil zone if the zone were subject to the unimpeded action of gravity. The term is indefinite as the quantity is dependent upon period for draining, temperature, and other factors (45).

*Surface water.* Water which flows upon or over the surface of the ground (41).

*Water table.* The upper surface of a zone of saturation in soil or in permeable strata or beds (45).

*Private Water Supplies.*

Private water supplies may be:

- (a) Wells or underground galleries.
  - (b) Cisterns collecting rain water.
  - (c) Springs.
  - (d) Surface streams.
- (Listed in order of their usefulness)

“Dug wells are relatively shallow, masonry-walled wells” (6).\*

“An ordinary driven well consists of steel pipe, usually 1½ to 4 in. in diameter, to the lower end of which a suitable point and a strainer are attached. It is driven by a hammer or by jetting and is seldom used for depths over 150 ft” (6).

“Drilled wells are wells sunk in consolidated rock by means of special cutting tools. In the soft formation above the rock the wells are cased with steel pipe or casing” (6).

“Bored wells are those sunk in unconsolidated formations by suitable boring tools. They are provided with casings set as, or after, the well is bored, and are equipped with screens or strainers set in the water-bearing medium” (6).

“Infiltration galleries are horizontal galleries or pipes constructed below the water table and provided with numerous small openings to admit water” (6).

*Code of Principles on Sanitary Control in the Development of Ground-Water Supplies (Report of the Committee on Sanitary Control in the Development of Ground-Water Supplies)* (30).†

1. Sources of ground-water supplies should be located so as to prevent their contamination by surface drainage, flooding at times of high water, and by pollution resulting from proximity to sewers, privy vaults, cesspools, sewage wells, other leaching devices for sewage, streams, abandoned uncapped wells, sink holes, etc. (30).

2. Suction and gravity piping should be constructed with watertight material and joint; preferably cast-iron and never sewer pipe. These lines should be

\* This and immediately succeeding quotations are from *Water Works Practice*, Abel Wolman, Editor, The Williams and Wilkins Co., Baltimore, Md.

† The following outlines, set in reduced type, are adapted from this report.

located at a safe distance from sources of pollution and tested frequently to determine their tightness (30).

3. Collecting or storage reservoirs and suction wells should be carefully located, of waterproof construction, and covered. All manholes, vents, and overflow openings should be properly protected from dust, small animals, and willful pollution (30).

4. All connections between a safe source of supply and a polluted water supply should be effectively eliminated (30).

5. Well supplies should be protected from contamination at the surface by the following safeguards:

(a) A well pit or subground level pump room should be avoided wherever practicable, and the pumps installed on a pump-room floor located above the surrounding ground level (30).

(b) If conditions necessitate the installation of a well pit or subground level pump room, the floor and walls should be made watertight and a drain to an open outlet (under no condition connected to a sewer), or a sump and automatic ejector, should be provided to remove the waste water (30).

(c) The outside casing or curbing of wells should be extended above the level of the ground or floor of the pump room or pit and a watertight connection installed to close the annular opening between the well casing and pump column or drop pipe. Dug wells should be provided with a watertight cover, and the pump pipe, manhole, and other openings should be properly protected so as to prevent waste water or other contaminating material from entering the well. Pumping equipment should not be installed in the well in a manner requiring entrance of an attendant (30).

(d) On air-lift pumping systems, the air inlet should be properly located and protected to minimize the entrance of dust and other contaminating material (30).

6. Well supplies should be protected from underground contamination by the following safeguards:

(a) A watertight outside casing or curbing should be installed extending deep enough to prevent contaminated surface or shallow ground water or other pollution from entering the well through strata such as coarse gravel and limestone containing fissures, openings, and solution channels. The bottom of the casing or curbing should be effectively sealed into a solid formation and thoroughly tested to make certain that contaminated water on the outside of the casing cannot enter the well (30).

(b) Wells installed with a gravel wall should be protected by forcing into the space between the outside casing and well hole sufficient puddled clay to give a protective clay depth of at least 12 ft below the ground surface or any strata carrying contaminated water (30).

(c) Where the water is known to be or suspected of being corrosive, a metal well casing should be protected by providing a shell of cement grout, at least 2 in. thick, around same. An alternate method, suitable in some instances, is the use of a casing consisting of a cast-iron or best-grade, strictly wrought-iron pipe with a double coating of bituminous material (30).

(d) A separate suction or discharge pipe should be installed inside a well casing in all instances, whether the well is to be pumped by suction, air-lift, or deep-well pump (30).

(e) Continuous purification or treatment should be provided to suit the circumstances where wells are not provided with the required sanitary safeguards as outlined above or where bacteriological or chemical tests or other conditions indicate that contamination is reaching the water-bearing strata (30).

7. Springs should be protected from surface contamination by a waterproof concrete curbing and top. Springs which show analytical or field evidence of underground contamination with surface water or sewage should be effectively purified or treated (30).

8. Mine Water. Water from mines subject to contamination or pollution require adequate purification or treatment to make a safe supply. Special water-supply drifts located in mines should be protected from flooding and drainage from working shafts and drifts (30).

9. Infiltration Galleries. Water from infiltration galleries should receive suitable purification or treatment unless located and operated so that satisfactory bacterial removal is secured (30).

#### *Pumping Machinery (35).*

Hydraulic rams.

Suction pumps.

Force pumps.

Combination suction and force pumps.

Compressed air.

Air displacement pumps.

Windmills.

*Cisterns.* Water supplies obtained directly from rains are collected mostly from roofs and piped to a cistern.

The usual treatment is filtering through sand or charcoal.

*Surface Water.* Streams, ponds, irrigation ditches, and small open reservoirs are unsafe sources of water supply. The temperature of such water seldom is satisfactory, and the presence of more or less polluting matter is certain. The only safe course is to avoid drinking water from any surface source unless such water has been disinfected (35).

#### *Temperature of Water.*

1. *Ground water.* The temperature of ground water is generally 2 F to 3 F above the mean annual air temperature if the water is between 30 and 60 ft below the surface of the ground. At a depth of 10 ft the temperature may range from 10 F above to 10 F below the mean annual temperature. An approximate average for the increase in temperature with depth is about 1 F for each 64 ft (50).

The map that shows the probable temperature of ground water in the United States at depths of 30 to 60 ft (Fig. 25) is based on the map of

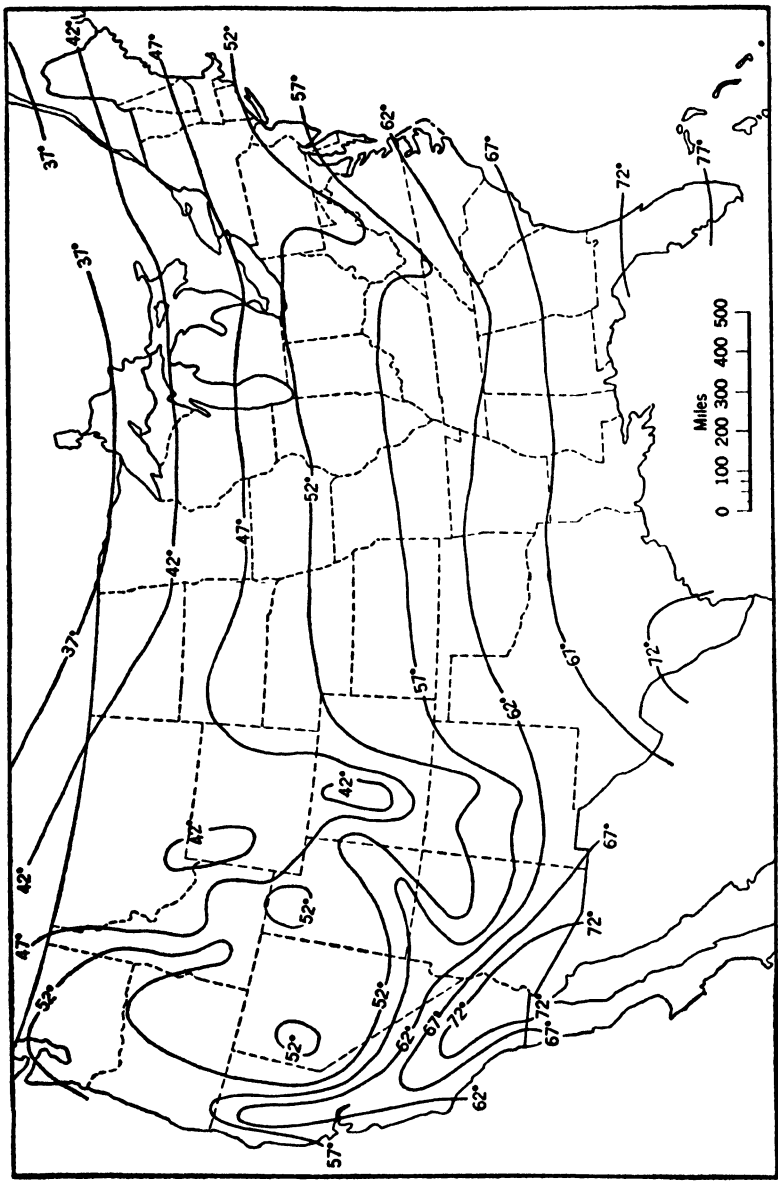

FIG. 25. Approximate Temperature of Water from Non-thermal Wells at Depths of 30 to 60 Feet. (From U. S. Geological Survey, *Water Supply Paper 520*.)

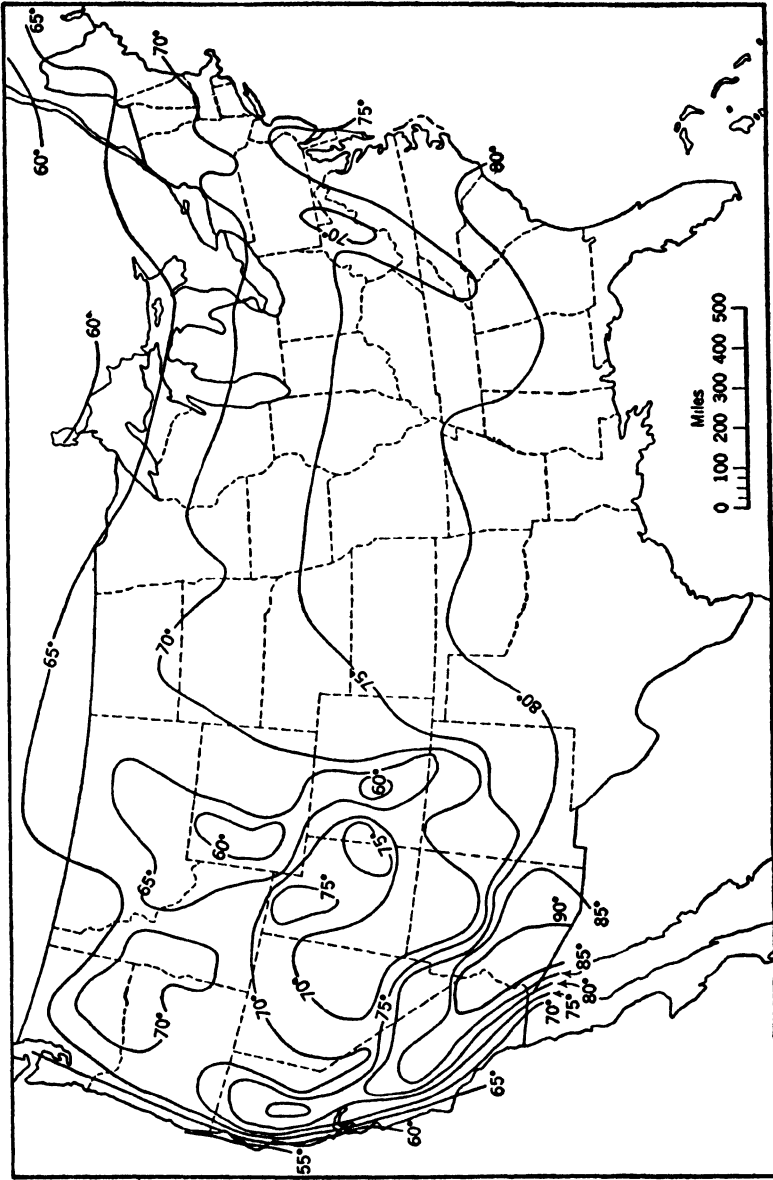

FIG. 26. Approximate Mean Monthly Temperature of Water from Surface Sources for July and August. (From U. S. Geological Survey, *Water Supply Paper 520*.)

the United States Weather Bureau showing normal annual air temperature. It is necessarily generalized. Closer approximation to the ground-water temperature at any place can be obtained from the detailed data in reports of the Weather Bureau, which give the normal temperatures at individual stations (50).

2. *Surface water.* The mean monthly temperature of a surface water at any place is generally within a few degrees of the mean monthly air temperature when the air temperature is above the freezing point. The maximum water temperature in any of the warmer months is usually 2 F to 6 F higher than the mean monthly water temperature.

It is not possible to give a map showing the probable surface temperature as closely as the probable ground-water temperature as indicated on Fig. 25, but Fig. 26 gives a basis for estimating probable maximum monthly surface-water temperature.

The minimum recorded water temperature will be 32 F to 34 F during the coldest months (50).

## Mains

*Public Supplies.* Where a public water supply is available, the architect or engineer merely has to ascertain the type of service which can be obtained.

Information should be obtained from the water works about the present pressure, the possible future minimum pressure, and possible future maximum pressure.

Pressure may be lower because of inadequate supply for future use. Pressure may be higher because of new or additional mains.

*Fire Emergency.* Where pressure may be boosted to several hundred pounds, the whole system must be designed to withstand this pressure and all low-pressure pipes and fittings must be placed back of a reliable pressure reducer.

*Private Systems.* Private systems may be smaller layouts with water obtained from privately owned sources or works, or they may be extensions to the public system comprising all water lines on private ground.

General requirements for private systems are outlined in Chapter 7, Volume I.

## Services

### *Definitions.*

*Water-distributing pipes.* The water-distributing pipes are those which convey water from the service pipe to the plumbing fixtures (1).

*Water-service pipe.* The water-service pipe is the pipe from the water main to the building served (1).

*Goose neck.* Flexible tubing used as a connection between water mains and service pipes.

*Materials.* Service lines are:

- (a) Galvanized wrought iron or steel, unlined, or lined with lead, tin, or cement.
- (b) Cast iron.
- (c) Copper, or
- (d) Brass.

The most economical material is unlined wrought iron or steel. Both corrode in certain soils or by certain waters. The minimum size used should be  $\frac{3}{4}$  in.

Lead pipe does not rust but is dissolved by certain waters. It is easily punctured and high in first cost.

Cast iron can be obtained in small sizes and is ideal for service lines. The cost is moderate, and the life of the pipe is very long.

Copper tubing is free from corrosion and incrustation. It is fairly durable but can be injured and is not too expensive.

*Joints.* Lead pipe joining lead, brass or copper pipe; use wiped or flanged joint. Lead pipe joining iron pipe; use wiped joints with extra heavy cast-brass soldering nipples, or flanges.

Brass pipe joining brass or copper or iron pipe; use brass fittings.

Copper pipe joining copper, brass or iron pipe; use brass fittings.

Iron pipe joining iron pipe; use malleable iron fittings.

Cast-iron pipe joining cast-iron pipe; use lead calked joints.

Care should be taken to avoid establishing galvanic action by use of dissimilar metals.

*Sizes.* Too large service lines are not to be recommended. Leakage is increased, and the demand on the mains is increased. In any case the water works will decide on the maximum take-off from any main. If it is insufficient for the maximum peak demand in the building, additional services may be required to other streets or storage tanks may be installed.

*Installation.*

1. *Domestic: for dwellings.* A corporation cock at the street main, a goose neck, the service pipe, curb cock and box, and stop cock and valve inside the building.

The goose neck, 36 in. long, of lead, copper, or brass. Small service pipes, less than 2 in., from main to curb cock, of lead, copper, or brass. From curb cock to stop cock inside building, lead, brass, copper, or cast iron. For 2 in. and larger, brass, copper, galvanized iron, or cast iron.

2. *Larger buildings* usually require a special connection in the form of fitting installed by the utility company. The service line usually is cast iron.

3. *Fire:* gate valve at curb. Detector check with 2-in. by-pass and control valves inside building or in pit with meter on by-pass.



4. *Miscellaneous provisions.* Lines shall, where possible, be laid in a straight line from street to building and at right angles to street main. Depth determined by local conditions to be free from frost and clear the right-of-way of other service lines.

5. *Boilers.* Steam boilers supplied with water through water services from the street mains must be equipped with a safety valve, a vacuum valve, or other approved safety device to prevent damage in case the water is shut off.

Hot-water boilers shall be equipped with suitable safety or vacuum valves.

6. *Stop and waste valves.* Entire water system inside the building shall be sloped to drain to stop-and-waste valves provided at low points.

*Valves on Water Service.* Minimum requirements: one valve at curb and one inside the building.

Curb cock: Service 1 in. or less, inverted key curb cock. Larger service: double-disk gate valve.

House shut-off: On services 1 in. or less.

On services over 1 in.: Double-disk gate valve.

Curb cocks must be brass and usually a type approved by and/or furnished by utility company. Water

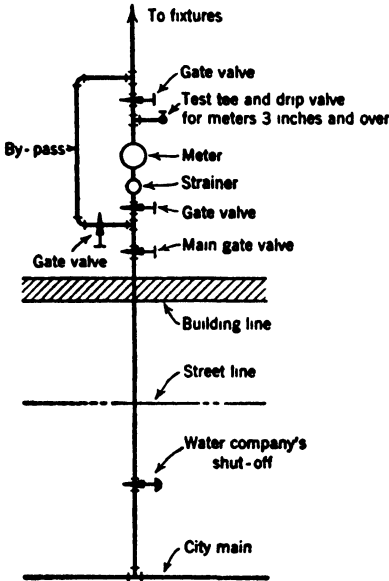

FIG. 27. Service Piping.

way in cocks must be round. They must be provided with service box and cap.

Gate valves shall have iron or brass bodies, double-disk gate type with non-rising stems, and, when used outside of buildings, provided with valve boxes and covers.

Test pressure for all cocks and valves shall be 300 psi.

Location of curb cock between 1 and 2 ft from curb.

Location of house shut-off between main and meter and not more than 2 ft from point of service pipes entrance into building.

ART. 5-C. WATER ANALYSIS

Definitions

*Turbidity.* "The turbidity of water is due to suspended matter, such as clay, silt, finely divided organic matter, microscopic organisms, and similar material" (37).

Turbidity is expressed in parts per million by comparing the cloudi-

ness of the water with similar concentrations of known standards based originally on 100 ppm of silica.

"*Total residue on evaporation* or total solids include both suspended and dissolved solids" (37).

"*Total fixed residue* and fixed residue from dissolved solids are the residues remaining after ignition of total residue and of dissolved solids respectively" (37).

"*Loss of ignition* represents not only organic matter, but volatile decomposition products from carbonates, nitrates, and other components of the residue" (37).

*Suspended matter* includes all organic and inorganic matter that can be removed by filtering.

*The alkalinity* of a natural water represents its contents of carbonates, bicarbonates, hydroxides, and occasional borates, silicates, and phosphates (37).

Results are expressed as parts per million of calcium carbonate or as hydrogen-ion concentration.

*The acidity* of a natural water represents the content of free carbon dioxide, mineral acids, and salts (especially sulfates of iron and aluminum) which hydrolyze to give hydrogen ions (37).

Results are expressed as parts per million of calcium carbonate or as hydrogen-ion concentration.

$$\begin{aligned} \text{Carbonate (CO}_3\text{)} &= \text{Calcium carbonate} \times 0.6 \\ \text{Carbon dioxide as carbonate (CO}_2\text{)} &= \text{Calcium carbonate} \times 0.44 \\ \text{Bound carbon dioxide (CO}_2\text{)} &= \text{Carbon dioxide as carbonate} \\ &\quad \text{plus } \frac{1}{2} \text{ that as bicarbonate} \\ \text{Sulfate (SO}_4\text{)} &= \text{Calcium carbonate} \times 0.96 \end{aligned}$$

### General Practice \*

Water is analyzed for drinking water standards, corrosion, and hardness.

Analyses are reported in parts per million of the radicals determined. For practical use, quantities of less than one part per million of the ordinary mineral constituents of water have little or no significance, with the exception of iron (49).

*Drinking Water.* The determinations for drinking water are stated in Art. 5-A.

*Corrosive Action of Water.* The corrosiveness of water involves chiefly the determinations of alkalinity, free CO, the pH value, dissolved oxygen, and the mineral constituents.

Herman Stabler in U.S.G.S. *Water Supply Paper 274* offers methods for the determination of corrosive tendencies in water.

\* See also "Tentative Method of Reporting Results of Analysis of Industrial Waters," ASTM Designation D596-40T.

*Coefficient of corrosion:*

$$C = H + 0.1116Al + 0.0361Fe + 0.0828Mg - 0.0336CO_3 - 0.0165HCO_3$$

Acidity is expressed here as hydrogen (H) and may be converted to this form from others by using the following factors: Hydrogen (H) = Hydrochloric acid (HCl)  $\times$  0.0276 = Sulfuric acid (H<sub>2</sub>SO<sub>4</sub>)  $\times$  0.0206 = Calcium carbonate (CaCO<sub>3</sub>)  $\times$  0.0202.

*Corrosive water.* If  $C$  is positive, the water is certain to be corrosive.

*Non-corrosive water.* If  $C + 0.0503Ca$  is negative, no corrosion will occur on account of the mineral constituents in the water.

*Semi-corrosive water.* If  $C$  is negative, but  $C + 0.0503Ca$  is positive, corrosion may or may not occur, the probability of corrosive action varying directly with the value of the expression  $C + 0.0503Ca$ .

*Example**Analysis*

+H	= 0.08 $\times$ 1.0	= +0.08	
+Al	= 0.00		
+Fe	= 0.00		
+Mg	= 4.20 $\times$ 0.0828	= +0.34776	
-CO <sub>3</sub>	= 0.00		
-HCO <sub>3</sub>	= 0.00		
			+0.42776

The water is corrosive.

*Hardness of Water.* "The hardness of almost all water supplies is due to four mineral compounds which they hold in solution" (6).

(a) Carbonate hardness (temporary hardness).

Calcium bicarbonate (limestone).

Magnesium bicarbonate (magnesite).

(b) Non-carbonate hardness (permanent hardness or "incrustants").

Calcium sulfate (gypsum).

Magnesium sulfate (Epsom salts).

Chlorides and nitrates of calcium and magnesium are also sometimes present (6).

"Hardness is expressed in terms of calcium carbonate. The calcium carbonate (CaCO<sub>3</sub>) equivalent of the calcium and magnesium content, sometimes with that of iron and aluminum, is a measure of the total hardness of a water" (37).

*Relative Hardness of Water.*

Parts per million	15	Extra soft
	30	Very soft
	45	Soft
	90	Moderately soft
	110	Moderately hard
	130	Hard
	170	Very hard
	230	Excessively hard
	250	Too hard for use

TABLE 20  
CONVERSION TABLE FOR HARDNESS EQUIVALENT

Unit	Parts per Million	Grains per U. S. Gallon	Clark Degrees	French Degrees	German Degrees
One part per million	1.0	0.058	0.07	0.10	0.056
One grain per U. S. gallon	17.1	1.0	1.2	1.71	0.958
One Clark degree	14.3	0.829	1.0	1.43	0.80
One French degree	10.0	0.583	0.70	1.00	0.56
One German degree	17.9	1.044	1.24	1.78	1.00

The above factors are based on the molecular weight of 100 for calcium carbonate universally used in reporting hardness

#### ART. 5-D. TREATMENTS

##### Definitions

###### *Aeration.*

1. The process or method of bringing about intimate contact between air and a liquid by allowing finely divided air to pass through the liquid or the finely divided liquid to pass through the air (41).

2. The process of relieving the effects of cavitation by admitting air to the section affected (45).

*Bleach.* Calcium hypochlorite (bleaching powder) (41).

*Chlorination.* Treatment with chlorine or bleaching powder for the purpose of disinfection, the retardation of decomposition, or the oxidation of organic matter (41).

*Clarification.* The process of removing suspended and colloidal matter from a turbid liquid (41).

*Coagulation.* The flocculation of colloidal or suspended matter brought about by the addition of some chemical to the liquid, by contact or by other means (41).

###### *Colloid.*

1. Glue-like (14).\*
2. A non-crystallizable organic substance (14).

*Colloidal Matter.* Colloids or matter colloidal in nature and action (41).

###### *Colloids.*

1. The finely divided suspended matter which will not settle and the apparently dissolved matter which may be transformed into suspended matter by contact with solid surfaces or precipitated by chemical treatment (41).

2. Substances which are soluble as judged by ordinary physical tests, but will not pass through a parchment membrane (41).

*Disinfection.* The partial destruction, ordinarily by the use of some chemical, of the micro-organisms likely to cause infection and disease (41).

*Flocculent Matter.* Particles that in settling collect together into larger and larger masses and consequently increase their subsiding velocities continually (2).

The above process is called "flocculation."

*Sterilization.* The destruction of all micro-organisms ordinarily through the agency of heat or of some chemical (41).

\* From Gould's *Pocket Medical Dictionary*; copyright, The Blakiston Company, Philadelphia, Pa.

## General Outline

The different methods of water treatments and their various steps, as outlined in *Water Works Practice* (6), are shown below. Most of these methods are beyond the scope of plumbing and are mentioned here only to give a better understanding of the problem.

Some of them, as rapid sand filtration, chlorination, coagulation, and water softening, will be discussed a little more in detail insofar as they are applicable to smaller installations.

### *Self-purification.*

Devitalization of pathogenic bacteria.

Dilution.

Sedimentation.

Aggregation and coagulation.

Light.

Aeration.

Digestion of organic matter.

### *Clarification.*

(a) *Aeration*, for removal of certain gases and volatile organic substances which give the water unpleasant taste or odor or increase corrosion. Also to increase free oxygen.

(b) *Natural subsidence*—to remove turbidity. Reservoirs with retention periods stated in weeks and months. Artificial basins with retention periods stated in hours or days.

(c) *Coagulation*. Chemical process to hasten clarification or to condition the water for efficient filtration.

*Coagulants*. Aluminum sulfate ("filter alum"), ferrous sulfate ("sugar sulfate," "sugar of iron," "copperas"). Addition of soda ash ("dry sodium carbonate") or lime ("quick lime," or "hydrated lime") for water low in alkalinity.

(d) *Filtration*. Rapid sand filtration, by pressure (2 gal per sq ft per min). Slow sand filtration, by gravity (3 gal per sq ft per hr).

*Removal of Iron and Manganese*. Aeration; sedimentation; coarse contact beds; sand filters; chemical treatment: lime and alum.

*Water Softening*. Chemicals: lime and soda; zeolite.

*Water Treatment to Reduce Corrosion*. See *Threshold Treatment* below.

*Disinfection, for Destruction of Microscopic Organisms*. Chlorination: chlorinated lime or chloride of lime ("bleach"); chloramine ( $\text{NH}_2\text{Cl}$ ); liquid chlorine; sodium hypochloride; ultraviolet ray; ozonization.

*Threshold Treatment*. The use of sodium hexametaphosphate for scale prevention and corrosion control.

## Rapid Sand Filters

Essential features (6):

(a) Suitable underdrain system in bottom for collecting the filtrate

without loss of sand and for distributing the wash water during the cleaning operation.

(b) A thick layer of selected uniform sand, constituting, in conjunction with the artificial mat formed by coagulation, the filtering medium.

(c) Suitable gutters or troughs above the sand for removing the dirty wash water.

(d) Suitable pipe connections and valves for controlling the water during the filtering and washing operations.

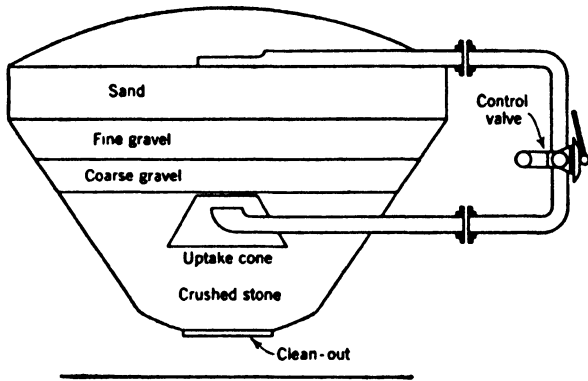

FIG. 28. Pressure Filter.

(e) Suitable facilities for furnishing a reversed flow of filtered water to the underdrain system during washing.

(f) Suitable appurtenances as controllers and gages. (Standard Specifications for Pressure Water Filters, AWWA.)

The filtering process is preceded by coagulation. *Precipitants:* Aluminum hydrate or iron hydrate, by feeding into the water, commercial ammonium alum or potassium alum, aluminum sulfate or iron sulfate with lime.

*Materials of Construction.* Steel shell, wash troughs and gutters of steel plate or cast iron.

*Freeboard.* "This term is frequently used to designate the height of top of wash trough above the sand surface" (6). This dimension depends upon the depth of the sand, the size of the sand, and the rate of washing. An empirical rule is that the freeboard in inches closely approximates the wash rate in vertical inches per minute.

*Ratings and Capacity.* Nominal capacity is 2 gal per sq ft per min, with allowance of 25 to 50% excess or even more, if the type of water permits. Filters are furnished for 30, 65, 100, and 125 psi working pressure.

*Filter Valves.* Operated manually, hydraulically, or electrically. Manual operation is satisfactory on units up to 0.5 mgd.

*Back Washing.* When the accumulation of solids on the surface of the bed makes the frictional resistance excessive (say 5 psi) the filters are cleared by forcing the water backwards through the filter at a rapid rate, thus removing the excess solids. A conical-shaped filter has the advantage in this case of creating a higher velocity in the heavy stone section of the filter and a lower velocity in the fine sand section.

*Rate of Washing.* Average velocity = 10 in. vertical rise per min or 6.2 gal per sq ft per min. Effective velocity 12 to 15 in. vertical rise per min or 7.5 to 10 gal per sq ft per min.

*Duration of Washing.* 3 to 8 min or more under severe conditions.

*Amount of Wash Water.* 1 to 5% of total amount of water filtered; 2% is considered a good figure.

*Rate controller* placed on effluent pipe for automatically maintaining a uniform delivery from the filter to allow for the gradual clogging of the filters by the coagulants. It is also practice to place automatic rate controllers on the wash-water waste line.

*Filter Gages.* Showing loss of head and rate of flow. Loss of head shown by difference in readings on gages on influent and effluent pipes, or by mercury manometer.

*Rate of Flow Gages.* Water float or mercury pot styles. The water differentials are obtained from a venturi tube on the effluent pipe.

TABLE 21  
CAPACITY TABLE—VERTICAL AND HORIZONTAL FILTERS

Size	Type	Area Sq Ft Surface of Bed	Gph Capacities of Filters for Rates of 2, 2½, 3, 3½, and 4 Gal per Sq Ft per Min					
			2	2½	3	3½	4	
2'6"	Vertical	4.90	600	750	900	1,050	1,200	
3'0"		7.07	850	1,050	1,300	1,500	1,700	
3'6"		9.62	1,200	1,500	1,800	2,000	2,300	
4'0"		12.56	1,500	1,900	2,300	2,700	3,000	
4'6"		15.90	1,900	2,400	2,900	3,400	3,800	
5'0"		19.63	2,400	3,000	3,600	4,100	4,700	
5'6"		23.75	2,900	3,600	4,300	5,000	5,700	
6'0"		28.27	3,400	4,300	5,100	6,000	6,800	
6'6"		33.18	4,000	5,000	6,000	7,000	8,000	
7'0"		38.48	4,600	5,800	6,900	8,100	9,300	
7'6"		44.17	5,300	6,700	8,000	9,300	10,600	
8'0"		50.27	6,100	7,600	9,100	10,600	12,100	
8'6"		56.74	6,800	8,500	10,200	11,900	13,600	
9'0"		63.61	7,700	9,600	11,500	13,400	15,300	
9'6"		70.88	8,500	10,700	12,800	14,900	17,000	
10'0"		78.54	9,500	11,000	14,200	16,500	18,950	
10'0"		Horizontal	72.42	8,700	10,900	13,100	15,200	17,400
12'0"			88.02	10,600	13,200	15,900	18,500	21,200
14'0"			103.72	12,500	15,600	18,700	21,800	24,900
16'0"			119.32	14,300	17,900	21,500	25,100	28,700
20'0"	150.72		18,100	22,600	27,200	31,700	36,200	
25'0"	189.82		22,800	28,500	34,200	39,900	45,600	

Courtesy Cochrane Corp., Philadelphia, Pa.



TABLE 22  
COCHRANE VERTICAL PRESSURE FILTER WITH VALVE NEST

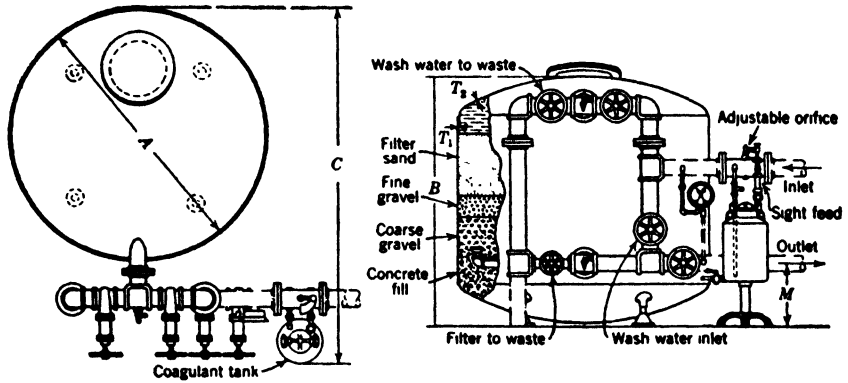

Diagrammatic Illustration of the Cochrane Vertical Filter.

Table Below Gives the Most Important Dimensions and Pipe Sizes.

DIMENSIONS

(The dimensions given are subject to reasonable variations and to change without notice. For installation purposes, certified blueprints are furnished.)

Dimensions			Openings		Wash Water (Rate: 12 Gal per Sq Ft per Min)	Wash Water (Rate: 15 Gal per Sq Ft per Min)	Shipping Weight				Concrete Fill Required Cu Ft	Weight on Foundation † Lb
A Diameter	B	C	Inlet, Outlet, and Waste	Filter to Waste			* 65 Lb Working Pressure Lb	* 100 Lb Working Pressure Lb	Sand and Gravel Lb	An-thra-cite Lb		
2'6"	5' 2 1/2"	4'2"	1 1/2"	1"	59	59	2,800	2,800	1,700	900	4	4,200
3'0"	5' 3 3/4"	4'9"	2"	1 1/4"	85	106	3,700	3,760	2,500	1,280	5	5,530
3'6"	5' 4 1/2"	5'3"	2"	1 1/2"	115	144	4,750	4,780	3,400	1,745	7	7,270
4'0"	5' 4 1/4"	6'1"	2 1/2"	1 1/2"	151	189	5,961	6,170	4,400	2,270	10	9,325
4'6"	5' 6"	6'7"	2 1/2"	2"	191	239	7,613	7,841	5,500	2,880	13	12,185
5'0"	5' 7"	7'2"	3"	2"	235	294	9,355	9,840	6,800	3,540	17	15,300
5'6"	5' 9"	7'8"	3"	2"	286	357	10,815	11,300	8,300	4,280	23	18,270
6'0"	5'11"	8'7"	4"	2"	340	425	13,000	13,560	9,800	5,100	29	22,085
6'6"	6' 0 1/2"	9'1"	4"	2 1/2"	398	498	15,230	15,830	11,500	5,980	35	23,730
7'0"	6' 2"	9'7"	4"	2 1/2"	462	578	17,665	18,340	13,400	6,930	42	30,400
7'6"	6' 4"	10'1"	4"	2 1/2"	532	665	20,260	20,980	15,300	7,950	50	34,030
8'0"	6' 6"	11'0"	5"	2 1/2"	604	755	23,225	24,100	17,400	9,050	58	40,560
8'6"	6' 7 1/2"	11'6"	5"	3"	680	851	27,005	27,480	19,700	10,230	68	46,455
9'0"	6' 9"	12'0"	5"	3"	763	954	29,305	30,950	22,000	11,450	79	52,345
9'6"	6'10 1/2"	12'6"	5"	3"	850	1,062	32,505	34,625	24,400	13,000	89	58,935
10'0"	7' 0"	13'0"	6"	3"	942	1,178	36,245	38,380	26,900	14,200	100	65,540

\* Standard Filters are also furnished for 30 lb and 125 lb working pressure if specified. † Sand and gravel.

TABLE 23

COCHRANE HORIZONTAL PRESSURE FILTER WITH VALVE NEST

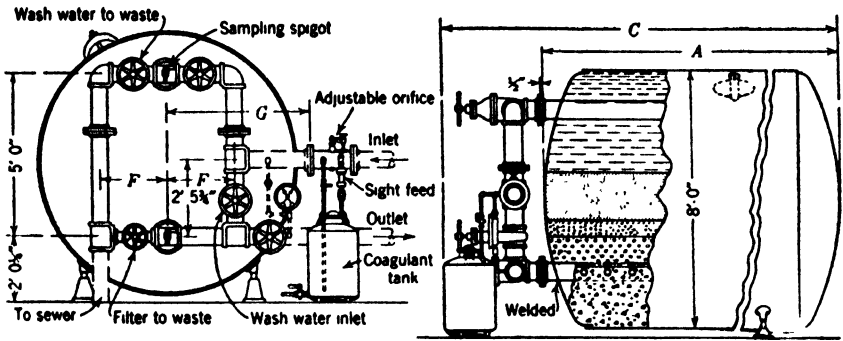

Diagrammatic Illustration of the Cochrane Horizontal Filter.

Table Below Gives the Most Important Dimensions and Pipe Sizes.

DIMENSIONS

(The dimensions given are subject to reasonable variations and to change without notice. For installation purposes, certified blueprints are furnished.)

Dimensions		Openings		Distributing Pipe and Strainer or Manifold	Wash Water (Rate- 12 Gal per Sq Ft per Min)	Wash Water (Rate 15 Gal per Sq Ft per Min)	Shipping Weight				Concrete Fill Required Cu Ft	Weight on Foundation Lb
A Length Over Heads	C Over-all	Inlet, Out-let, Over-flow	Filter to Waste				* 65 Lb Working Pressure Lb	* 100 Lb Working Pressure Lb	Sand and Gravel Lb	Anthracite Lb		
10'0"	13'1"	6"	3"	6"	869	1,086	8,650	9,875	24,700	13,000	76	59,150
12'0"	15'1"	6"	3"	6"	1,056	1,320	9,715	11,040	29,800	15,800	94	74,775
14'0"	17'1"	6"	4"	6"	1,245	1,556	11,070	12,645	34,800	18,600	111	84,630
16'0"	19'1"	6"	4"	6"	1,432	1,790	12,480	14,030	40,000	21,300	128	97,215
20'0"	23'5"	8"	4"	8"	1,809	2,261	17,250	19,060	50,200	26,900	163	123,985
25'0"	28'7"	8"	4"	10"	2,278	2,847	19,640	21,780	63,000	33,800	206	153,880

\* Standard Filters are also furnished for 30 lb and 125 lb working pressure, if specified.

Courtesy Cochrane Corp., Philadelphia, Pa.

TABLE 24

COCHRANE VERTICAL PRESSURE FILTER WITH SINGLE CONTROL VALVE

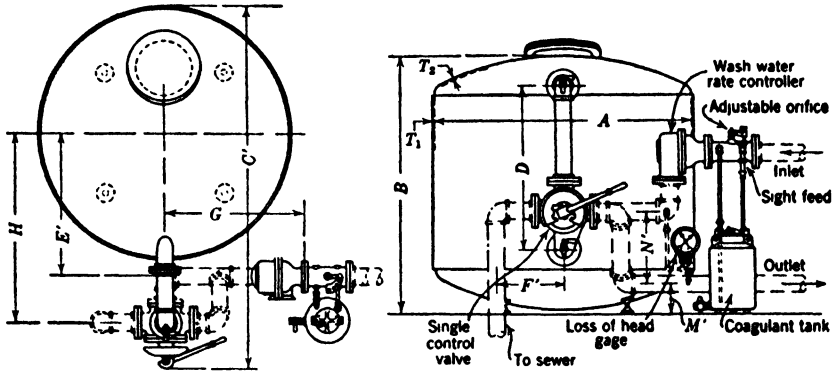

Diagrammatic Illustration of the Cochrane Vertical Filter.

Table Below Gives the Most Important Dimensions and Pipe Sizes.

DIMENSIONS

(The dimensions given are subject to reasonable variations and to change without notice. For installation purposes, certified blueprints are furnished.)

Dimensions			Openings Inlet, Outlet and Waste	Wash Water Rate (Rate 12 Gal per Sq Ft per Min)	Wash Water Rate (Rate 15 Gal per Sq Ft per Min)	Shipping Weight				Concrete Fill Re- quired Cu Ft	Weight on Foun- dation Lb
A Diam- eter	B	C				* 65 Lb Working Pressure Lb	* 100 Lb Working Pressure Lb	Sand and Gravel Lb	An- thra- cite Lb		
2'6"	5' 2 1/2"	3' 0"	1 1/2"	59	74	2,925	2,925	1,700	900	4	4,350
3'0"	5' 3 3/4"	3' 4"	2"	85	106	3,810	3,870	2,500	1,280	5	5,635
3'6"	5' 4 1/2"	3' 7"	2"	115	144	4,855	4,875	3,400	1,745	7	7,420
4'0"	5' 5 1/4"	3' 11"	2 1/2"	151	189	6,025	6,235	4,400	2,270	10	9,595
4'6"	5' 6"	4' 4"	2 1/2"	191	239	7,858	8,050	5,500	2,880	13	14,313
5'0"	5' 7"	4' 9"	3"	235	294	9,490	9,975	6,800	3,540	17	15,425
5'6"	5' 9"	5' 0"	3"	286	357	10,995	11,485	8,300	4,280	23	18,455
6'0"	5' 11"	5' 4"	4"	340	425	13,203	13,290	9,800	5,100	29	21,315
6'6"	6' 0 1/2"	5' 10"	4"	398	498	15,535	16,140	11,500	5,980	35	26,310
7'0"	6' 2"	6' 1"	4"	462	578	17,970	18,646	13,400	6,930	42	30,695
7'6"	6' 4"	6' 3"	4"	532	665	20,565	21,285	15,300	7,950	50	35,560
8'0"	6' 6"	6' 0"	5"	604	755	23,370	24,355	17,400	9,050	58	40,705
8'6"	6' 7 1/2"	6' 1"	5"	680	851	27,033	28,075	19,700	10,230	68	47,050
9'0"	6' 9"	6' 4"	5"	763	954	29,900	31,545	22,000	11,450	79	52,940
9'6"	6' 10 1/2"	6' 7"	5"	850	1,062	33,100	35,220	24,400	13,000	89	59,530
10'0"	7' 0"	6' 11"	6"	942	1,178	36,565	38,710	26,900	14,200	100	65,860

\* Standard Filters are also furnished for 30 lb and 125 lb working pressure, if specified.

Courtesy Cochrane Corp., Philadelphia, Pa.

TABLE 25  
VERTICAL PRESSURE FILTER (CONICAL TYPE) WITH CONTROL VALVE

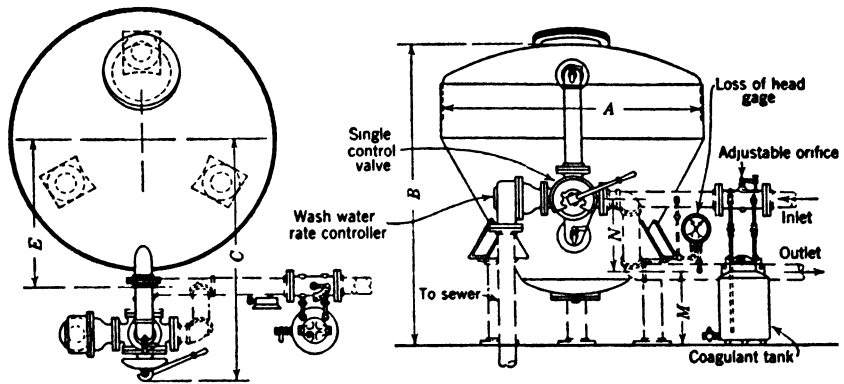

Dimensions						Openings	Wash Water (Rate 12 Gal per Sq Ft per Min)	Wash Water (Rate 15 Gal per Sq Ft per Min)
A Diameter	B	C	E	M	N	Inlet, Outlet and Waste		
2'6"	4' 9½"	2'10"	16½"	2' 0"	11"	1½"	59	74
3'0"	4'10½"	2'11"	17½"	21¼"	13¼"	2"	85	106
3'6"	5' 8"	3' 2"	20½"	21½"	13¼"	2"	115	144
4'0"	6' 0"	3'11"	23"	21"	13¼"	2½"	151	189
4'6"	6' 6½"	4' 1"	2' 4"	2' 6¼"	16½"	2½"	191	239
5'0"	6' 7½"	4' 6"	2' 8"	2' 6½"	16½"	3"	236	294
5'6"	6' 9"	4' 9"	2'11"	2' 6½"	16½"	3"	286	357
6'0"	6'10½"	4'11"	3' 0"	2' 5¾"	16½"	4"	340	425
6'6"	6'11½"	5' 5"	3' 4"	2' 4"	19¼"	4"	398	498
7'0"	7' 1½"	5' 8"	3' 7"	2' 4½"	19¼"	4"	462	578
7'6"	7' 2½"	5'11"	3'10"	2' 5"	19¼"	4"	532	665
8'0"	7' 4"	6'10"	4' 1½"	2' 5½"	19¼"	5"	604	755
8'6"	7' 5"	7' 0"	4' 9"	2' 6¾"	23"	5"	680	851
9'0"	7' 6½"	8' 1"	4'10½"	2' 6¾"	23"	5"	763	954
9'6"	7' 7½"	8' 6"	5' 3½"	2' 6¾"	23"	5"	850	1062
10'0"	7' 8"	8' 8"	5' 5½"	2' 7"	23"	6"	942	1178
11'0"	7'11"	9' 3"	6' 0½"	2' 8"	23"	6"	1140	1425
12'0"	8' 1"	9' 9"	6' 6"	23"	2' 5¾"	8"	1350	1700

Courtesy Cochrane Corp., Philadelphia, Pa.

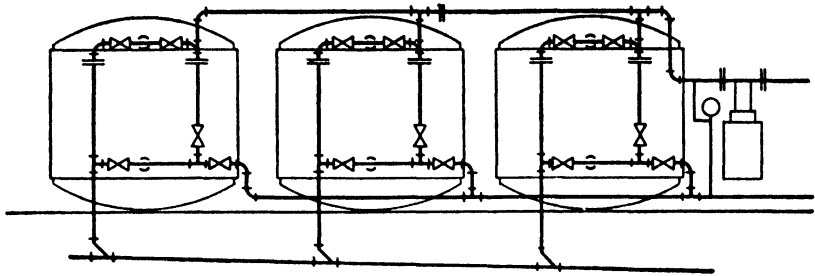

Piping arrangement for multiple vertical filters with multiple control valves and coagulant feeder

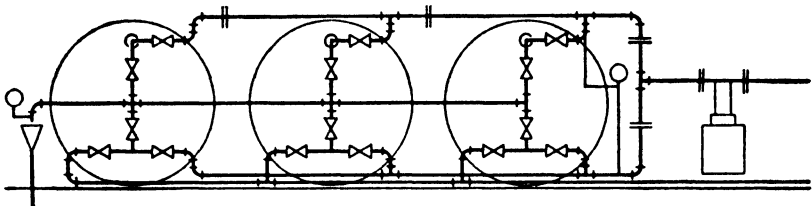

Piping arrangement for multiple horizontal cylindrical filters with multiple control valves and coagulant feeder

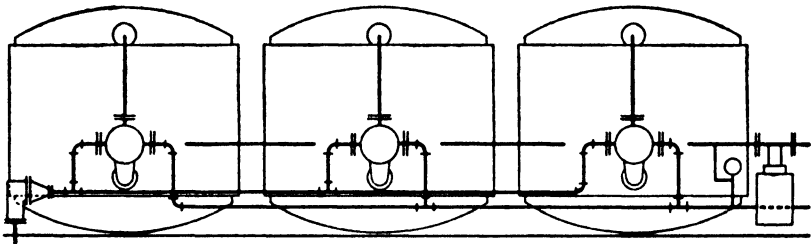

Piping arrangement for multiple strainer type vertical filters with single control valves and coagulant feeder.

FIG. 29. Multiple Filters. (Courtesy Cochrane Corporation, Philadelphia, Pa.)

### Removal of Iron and Manganese

"Many waters, clear when drawn, contain dissolved iron, which, upon release of pressure and exposure to air, settles out as a rusty-looking sediment. Such water is likely to cause rust spots on laundry work and is undesirable for other household purposes.

"Water of this kind can usually be improved by thorough aeration, followed by a period of rest to settle the precipitate, and filtering the uppermost water through muslin, linen, cotton duck, or sand. The precipitation of the iron is hastened by adding a little (determine the quantity by trial) limewater or washing soda" (35).

Iron in excess of 0.5 ppm is objectionable.

The sum of iron and manganese should not exceed 0.3 ppm.

*Methods of Removal.* "No single method has been found applicable to all problems of iron and manganese removal because other impurities have a marked effect on behavior. These impurities, in order of importance, are: organic matter, manganese, carbon dioxide, and carbonates.

The processes found applicable are as follows: aeration, sedimentation, coarse contact beds, sand filters, and chemical treatment (lime and alum)" (6).\*

### Water Softening

Water softening is applied in communities where the water is excessively hard and in most commercial and institutional laundries as an economy measure.

The principal hardening constituents are the carbonates, sulfates, and chlorides of lime and magnesia.

The principal scale-forming constituents are the carbonates and sulfates of lime and magnesia.

*Removing Hardness.* Hardness caused by lime and magnesia carbonates held in solution by carbonic acid may be partly removed by boiling the water, which drives off the acid, or by adding lime water or caustic lime, which neutralizes the acid.

Hardness caused by the sulfates of lime and magnesia is not removed by boiling but may be partly removed by adding soda ash.

Such water may be treated chemically to form a more or less insoluble precipitate, which may be removed by sedimentation followed by filtration.

A group of impurities found in alkaline waters are sodium chloride (common salt), sodium sulfate (Glauber's salt), and sodium carbonate (soda ash). The first two constitute what is known as white alkali and the third constitutes black alkali. These compounds are non-scale-forming, but their presence in more than normal amounts makes water unfit for domestic consumption. The sodium salts are very soluble in water. They are not precipitated by heat or chemicals nor are they removed by filtration, but they may be removed by distillation (35).

*Zeolite Treatment.* "Base exchange materials, commonly known as zeolites, are silicates containing sodium (hydrous aluminum sodium silicates), which may be replaced with other bases, such as calcium and magnesium. Compounds of calcium and magnesium cause the hardness of water. When a hard water is passed through a bed of zeolite, the calcium and magnesium are removed from their compounds in the water and are replaced with sodium. The sodium compounds do not cause hardness, so that as a result the water is softened.

"The capacity of a zeolite for softening water is, therefore, limited by the amount of replaceable sodium it contains. When all of the replace-

\* From *Water Works Practice*, Abel Wolman, Editor, The Williams and Wilkins Co., Baltimore, Md.

able sodium has been exchanged for calcium and magnesium from the hard water, the zeolite must be regenerated. This is accomplished in practice by treating the material with a solution of common salt, sodium chloride. The sodium of the salt drives out the calcium and magnesium from the zeolite, and replaces them with a fresh supply of replaceable sodium. After regenerating, the salt solution is washed out and the zeolite is again in condition to soften water" (6).\*

*Softening for laundry and cleaning purposes* (only) by dosing with ammonia, borax, or washing soda.

The advantages of softening water may be summarized as follows:

(a) Increased sanitary quality of the water, as softening renders the water practically sterile and bacterially safe.

(b) Lime treatment, in addition to softening the water, precipitates the iron and absorbs any color present due to iron or organic matter.

The losses due to hard water are:

(a) Extra cost of soap and other preparations for softening water.

(b) Extra expense of cisterns and double plumbing systems.

(c) Heat losses in hot-water heaters and boilers.

(d) Extra expense for operating steam-boiler plants (6).

### Water Treatment to Reduce Corrosion

#### *Methods Used.*

Usually: Reduce acidity or hydrogen-ion concentration.

Less often: Formation of protective chemical coating on pipe walls.

Infrequent: The removal of oxygen.

Much of the acidity of natural waters is due to free carbon dioxide or organic matter. Treatment: Aeration removes carbon dioxide (decarbonation) but adds oxygen to water low in oxygen.

Lime (calcium oxide) can be applied to neutralize acidity. Lime increases the alkalinity and total hardness of water. Soda ash (sodium carbonate) and caustic soda (sodium hydroxide) reduce the permanent or non-carbonate hardness (incrustants) of the water as well as the carbon dioxide.

"Water containing much calcium often forms a protective coating on the pipe wall. This natural 'deposit' coating may be obtained also as a result of the treatment of water with lime for decarbonation or following the coagulation of water with iron and lime. Silicate of soda has been used successfully to form similar deposit coatings, mainly to hot water systems" (6).†

"De-oxygenation can be accomplished by either physical or chemical means. The chemical removal of oxygen is called 'deactivation' and

\* From *Water Works Practice*, Abel Wolman, Editor, The Williams and Wilkins Co., Baltimore, Md.

† This and two succeeding paragraphs from *Water Works Practice*, Abel Wolman, Editor, The Williams and Wilkins Co., Baltimore, Md.

consists in passing water through a chamber containing readily corrodible metal on which the water exhausts its corrosive constituents, principally oxygen, before entering the hot water system.

"Physical 'degassing' is accomplished by heat, which throws all the gases present in the water out of solution, when the temperature is raised, or by vacuum which accelerates the removal of the gases at low temperatures. A combination of both heat and vacuum is commonly employed" (6).

### Threshold Treatment

The use of sodium hexametaphosphate is described by Owen Rice and G. B. Hatch in the *Journal of the American Water Works Association*, Vol. 31, No. 7, July, 1939, as an almost ideal universal agent to prevent precipitation of the calcium carbonate and at the same time prevent corrosion.

The term *threshold treatment* has been used because the quantities of sodium hexametaphosphate \* required are so very small as to be only on the "threshold" of water treatment as ordinarily practiced. Only 1 ppm to 5 ppm (1 lb to 120,000 to 24,000 gal) is usually required to obtain the desired results. The sodium hexametaphosphate forms a protective film on the surface of all metals which almost entirely prevents corrosion and which also, in the case of hard water, holds the minerals in solution and prevents the formation of scale.

A very slowly soluble metaphosphate has also been developed. It is especially well adapted to the treatment of very small supplies, i.e., individual homes, small apartments, and buildings. This material, distributed under the trade name Micromet, can be placed in a simple bypass feeder where a portion of the water to be treated will run through it. Sufficient metaphosphate will dissolve to give the proper concentration in the water while, at the same time, it is so slowly soluble that the feeder need not be replenished more often than once each month.

### Code Regulations

All types of chemical treatment of water supplies in buildings may be subjected to municipal or state regulations.

New York City in 1939 enacted regulations governing the addition of chemicals to water supply in buildings for anti-corrosion or anti-scaling purposes. Permits are issued only to experienced sanitary engineers or chemists.

\* Sodium hexametaphosphate is obtainable under the trade name Calgon from Calgon, Inc., 300 Ross Street, Pittsburgh, Pa.



## CHAPTER 6

### WATER PIPING

#### ART. 6-A. PIPING SYSTEMS

##### Types

The water-distribution system may be supplied with pressure from outside sources, usually the city mains, or be fed by gravity from overhead tanks.

In the first case the static head acts against the flow; in the second

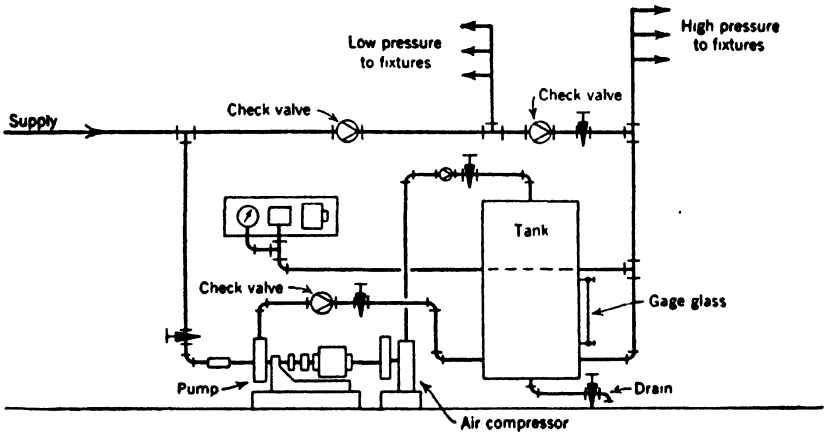

FIG. 30. Pneumatic System.

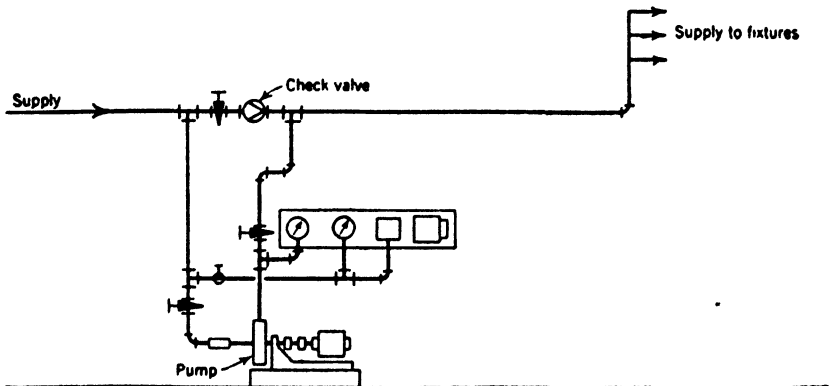

FIG. 31. Booster System.

case the static head produces the flow. This will cause a difference in determining the pipe sizes.

*Pressure systems* are fed from the city main or a private pumping system. The latter may be either a booster type or a pneumatic-tank type.

*Gravity systems* require a storage tank well above the highest fixture on the system. The tanks are supplied from pumps and regulated by flow controls.

### **Height Limitations**

*Pressure Limits.* There are certain limits in pressure, above and below which it is not advisable to go. A minimum of 20 lb and a maximum of 60 lb are very desirable, although both limits can be stretched. There are exceptions to this in cases of special application, but the rule holds for the general type of building.

*Tall Buildings.* To avoid excessive water pressures tall buildings are divided into zones of 10 to 15 stories. Each zone has its separate tank. There are many methods to accomplish this in the most economical manner.

If house tanks are used, they should be placed at least two stories above the top floor in each zone. The hot-water tank for each zone must be placed at the bottom of each zone but can be placed in the room used for the tank serving the zone below. It can still operate on a circulating system or feed the floor below without circulation.

*Zone Distribution.* The five different systems shown in Figs. 32 to 36, incl., give suggestions on how distribution may be accomplished.

Figure 32 shows a water system suitable for two or more zones in buildings having a heavy water consumption. The advantages of the system are: provision of spare or alternate pump for each level or section of the building; elimination of extra-heavy piping and possible overpressure on plumbing fixtures; simplified piping connections and control wiring; and greater overall efficiency. Greater efficiency can be obtained because the discharge heads for each stage or section of the building can be held within the limits of good centrifugal pump efficiency.

Figure 33 shows a system which should be used only in buildings having a low water consumption, as only one pump is available for emergency service. The spare pump must be capable of pumping into any of the gravity tanks located on the different levels and must also be so designed that it will not overload its motor under any of the varied operating conditions. The piping required for this system is quite simple, and in most cases only the spare pump discharge line carries sufficient pressure to necessitate the use of extra-heavy piping.

Figure 34 shows a system for buildings with low water consumption. All pumps are located in the basement. The lower levels take suction from the city main while the higher level takes suction from the first-level house tank. This arrangement cuts down the high discharge head for the upper-level pumps.

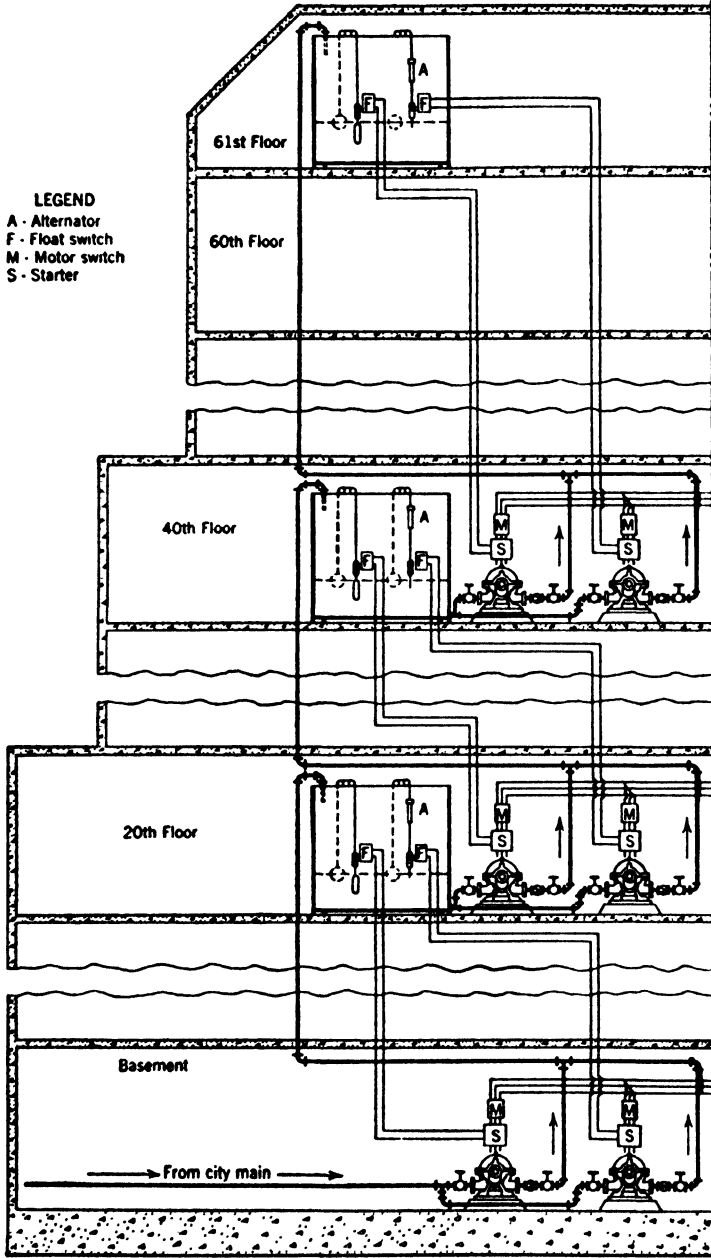

FIG. 32. (See text page 95.) (Courtesy Chicago Pump Company, Chicago, Ill.)

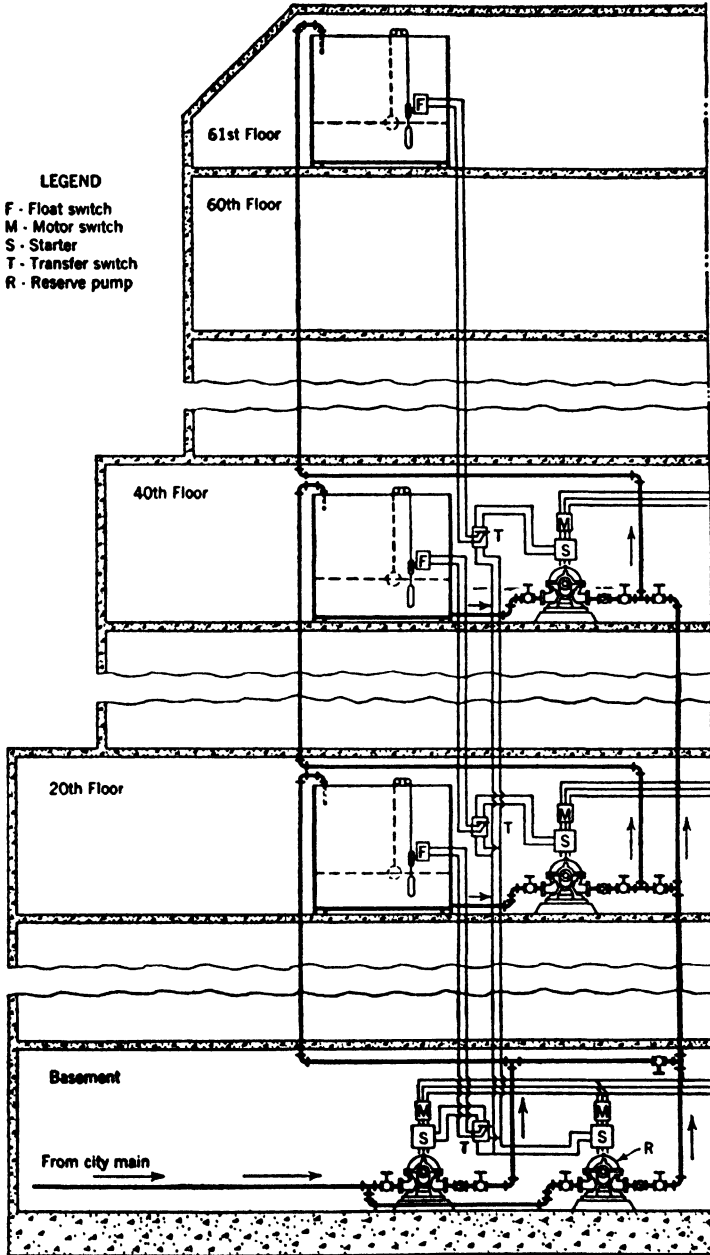

FIG. 33. (See text page 95.) (Courtesy Chicago Pumps Company, Chicago, Ill.)

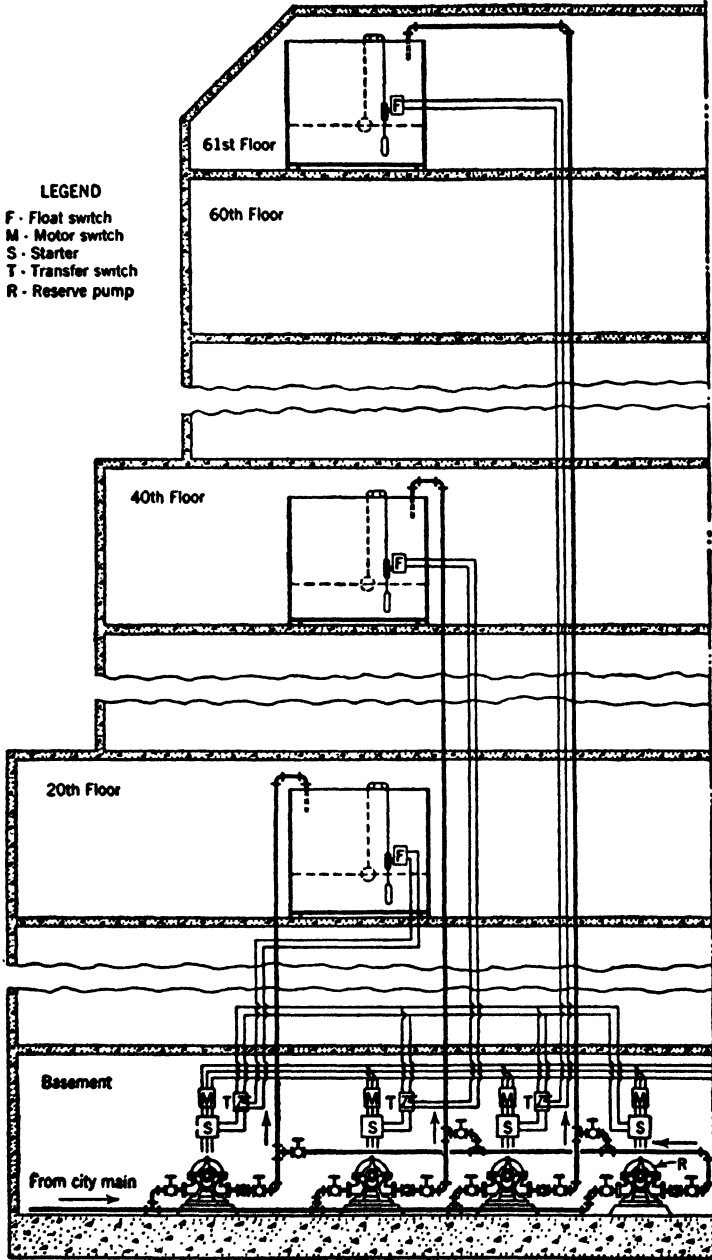

FIG. 34. (See text page 95.) (Courtesy Chicago Pump Company, Chicago, Ill.)

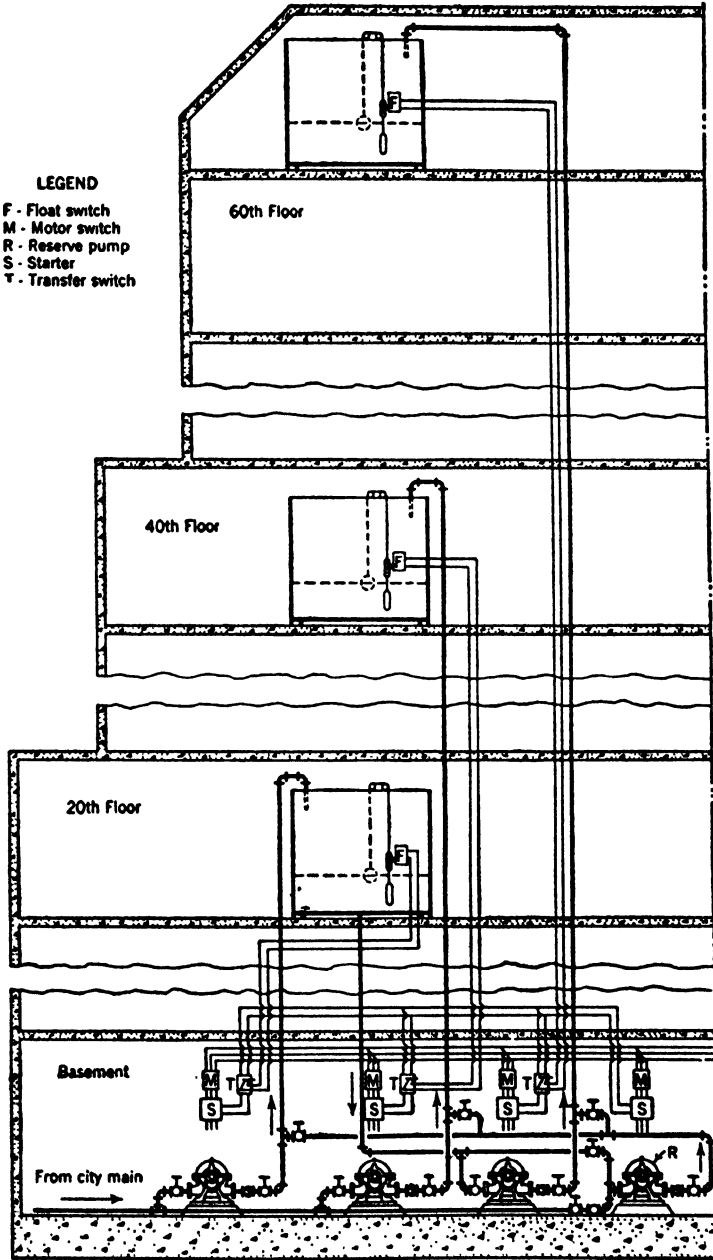

FIG. 35. (See text page 101.) (Courtesy Chicago Pump Company, Chicago, Ill.)

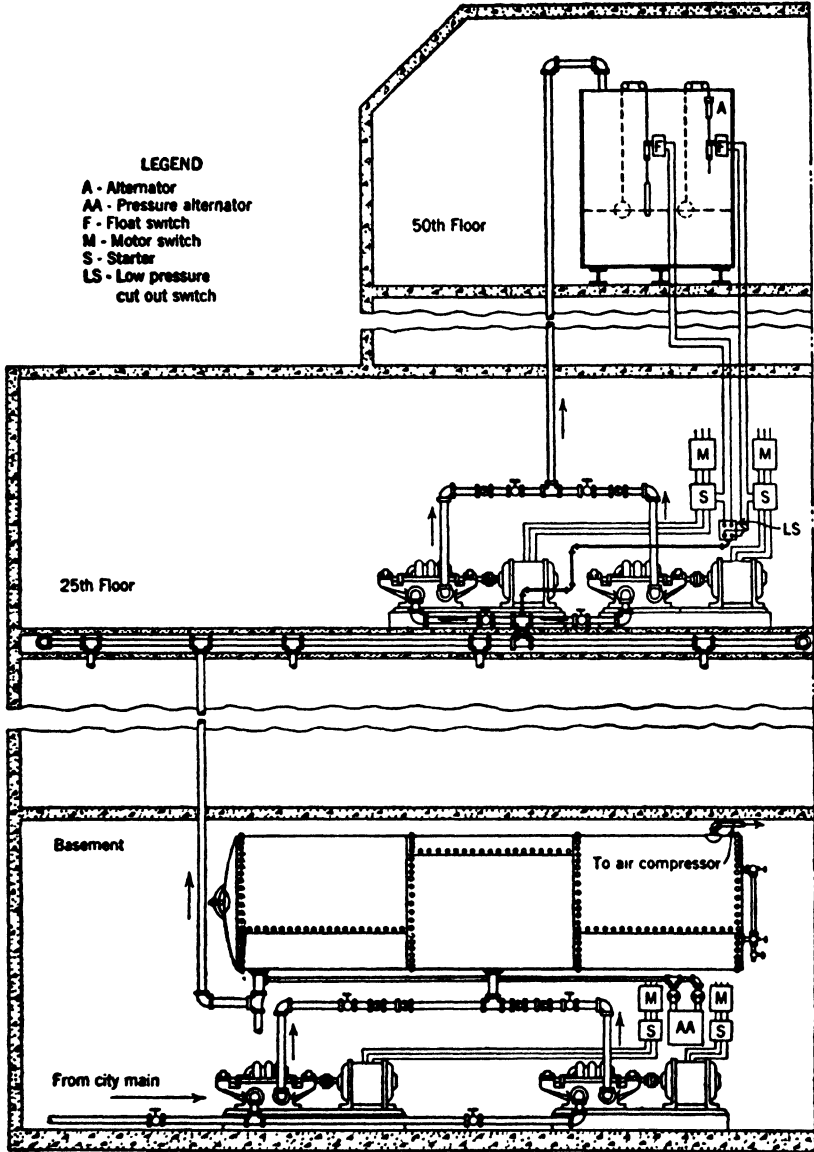

FIG. 36. (See text page 101.) (Courtesy Chicago Pump Company, Chicago, Ill.)

Figure 35 shows a similar system but with all pumps taking suction from the city main or surge tank. The advantage is that each level is supplied by its own pumps. The disadvantages are extra-heavy piping and low efficiency for the high-level pumps.

Figure 36 shows a combination compression and gravity tank system. The first level of the building is supplied by a duplex pneumatic water system located in the basement. The second level of the building is supplied by a gravity system with duplex pumps located on the highest floor supplied by first-level pumps. The second-level pumps take suction from the first-level distributing loop and discharge into gravity tanks located in the penthouse. Good overall efficiency can be obtained with this system and very little building area is required, as the tanks are located in basement and penthouse. In buildings of 30 to 50 floors, the pumps' discharge heads may be held well within the limit of good efficiency, and little or no extra-heavy piping is required. The existing pressure in the first-level distributing loop is utilized as suction head by the second-level pumps. This system is recommended for all classes of buildings where extreme economy of rentable area is necessary. It is practical for buildings having either heavy or light water requirements as it provides a spare pump for each level.

*Pump Capacities.* All pumps or sets of pumps shall be figured to have a capacity equal to the zone they serve plus the added capacities of the pumps which receive their supply from the tank belonging to that zone. In this way the capacities of the pumps will diminish with each succeeding zone.

## ART. 6-B. MATERIALS AND CONSTRUCTION

### Materials Used

*Piping* for water systems may be mild steel pipe or wrought iron, galvanized; copper-bearing steel pipe, galvanized; or any corrosive-resistant iron alloy. Where cost is a secondary factor or the pipes are installed in spaces inaccessible for repair, and for hot-water systems, brass and copper piping may be used.

*Underground piping* should be done in the same manner as water mains and service lines. Accessible drain pockets or pits should be provided where lines may have to be emptied.

*Fittings* shall be cast-iron screwed or flanged or malleable-iron screwed fittings; brass or bronze screwed fittings; welding fittings, wrought or forged or cast-steel fittings with welding ends.

*Unions* shall be without gaskets, navy type, brass to iron or brass to brass seats.

*Joints* shall be screwed or flanged with bolts. Plain-face flanges shall be faced smooth (regular for 125 lb cast iron and 150 and 250 lb bronze) with either full gasket or a ring to the inside of the bolt holes.



*Valves* shall be cast iron, malleable iron, steel or brass bodies, bonnets, disks, and yokes.

### Valve Installation

One gate valve, placed near the junction of branch and main in each hot water, circulation and cold-water supply riser or branch (or the horizontal run serving such riser or branch) and sill cock connection, so that all risers and branches (except fire risers) will be valved near the main lines. Each such riser or branch shall have a  $\frac{3}{8}$ -in. drip connection with globe valve on the house side of and near the gate valve controlling it.

Branch connections to fire risers shall not be valved.

Angle fire-hose valves shall be installed for each fire-hose outlet. Only valves used for constant operating shall be globe-type valves. Main shut-offs on water main and by-pass valves shall be gate valves. Emergency shut-offs to be gate valves, except smaller branches up to  $\frac{3}{4}$  in., may use globe valves.

An approved relief valve shall be installed on the supply to each hot-water system. The relief valve shall be installed adjacent to the hot-water tank with no shut-off or check valve between it and the tank.

### Pipe Installation

Pipes shall be sloped for drainage not less than 1 in. per 40 ft toward the source of supply. If this is impractical—as it may be on long runs—the slope shall be maintained until it reaches the highest permissible point from where a new level shall be established. Each such drop shall have a  $\frac{1}{2}$ -in. drip leg with  $\frac{1}{2}$ -in. brass globe valve.

*Hot-Water Lines.* All lines shall be installed with proper allowance for expansion and contraction by the use of effective expansion loops or bends—swing joints on screwed piping and bends on tubing. On concealed risers a self-contained accordion (bellows) type expansion joint may be used.

Horizontal runs of pipe over 50 ft in length shall be anchored about midway of the run, so as to force the expansion equally to both ends.

All risers shall be anchored so as to force the expansion in the proper direction.

Where the responsibility is placed on the contractor to install sufficient swing joints, offsets, loops, etc., to provide for expansion, the specification should state the number of inches per 100 ft to be allowed for (say  $2\frac{1}{2}$  in.).

### Accessories

*Gages* shall be installed on house side of regulating valves, on discharge side of all pumps, and on discharge side of pneumatic tanks.

It is desirable that gages should be installed on both inlet and outlet side of any apparatus which causes a change in pressure. Gages may be iron bodies, nickel-plated. A shut-off shall be installed on all gage lines.

*Thermometers* shall be installed at all heaters, water mixers, and circulating lines.

*Strainers.* Baskets on water suction lines should have a diameter equal to  $1\frac{1}{2}$  times the pipe diameter and a length equal to twice the pipe diameter. The holes in the basket are  $\frac{3}{8}$  in., spaced  $\frac{5}{8}$  in. on centers. (Navy Specifications.)

*Shock Absorbers.* The use of absorbers depends so much on the type of installation, the speed with which valves are closed, etc., that no definite recommendations can be set up. It is advisable to consult the manufacturers in each case.

With rigid pipes and instant-closing valves the pipes burst unless adequate provisions are taken. The instant-closing valve, however, is not a common feature. The sudden shock most often is produced by loose valve seats. The rigid pipes usually are the buried pipes.

In addition, the hot-water systems and pneumatic systems should receive special consideration.

ART. 6-C. METERS

Disk Meters

Standard Specifications for Cold Water Meters—Disk Type, adopted by the American Water Works Association and the New England Water Works Association.

Sizes:  $\frac{5}{8}$ ,  $\frac{3}{4}$ , 1 in. Spud connections:  $\frac{3}{4}$ , 1, and  $1\frac{1}{4}$  in., respectively. Overall lengths of meters, face to face of spuds:

$\frac{5}{8}$	7½ in.
$\frac{3}{4}$	9 in.
1	10¾ in.

Tailpieces threaded  $\frac{1}{2}$ ,  $\frac{3}{4}$ , and 1 in. respectively. Overall lengths of tailpieces:

$\frac{3}{4}$	2½ in.
1	2⅝ in.

CONNECTIONS FOR 1½-IN. AND 2-IN. DISK METERS

Size	Spuds; threaded (female)	Face to face of spuds; overall length of meter	Size; nuts	Tailpieces (male)	Bushings	Overall length of tailpieces
1½"	1½"	12⅝"	2"	1½"	2" x 1½"	2⅝"
2"	2"	15¼"	2½"	2"	2½" x 2"	3"

## CONNECTIONS FOR 3-, 4-, AND 6-IN. DISK METERS

Size	Spuds; flanged	Face to face of flanges; overall length of meter
3"	3"	24"
4"	4"	29"
6"	6"	36½"

## RATED CAPACITIES OF DISK METERS AT 25 PSI LOSS IN PRESSURE

(For capacities at different pressures, see Art. 6-G.)

5/8 in.	20 gpm	2 in.	160 gpm
3/4 "	34 "	3 "	315 "
1 "	53 "	4 "	500 "
1½ "	100 "	6 "	1000 "

*Disk meters* are the most accurate, with considerable range of flow. 1½, 2 in. sizes, adjustable delivery, oil-inclosed gear train. 3, 4, and 6 in. sizes, oil-inclosed gear train.

*Frostproof meters*, 5/8 to 1¼ in., can be furnished. They are not designed to prevent frost, but to have easily replaced parts snap at pressures above 500 psi, thus relieving pressure on the more costly parts.

*Split-case meters* (5/8 to 1¼ in.) for warm climatic conditions. Bronze casing. The split casing allows inspection of the entire mechanism without removing the meter from the line.

Adjustable delivery to avoid overrunning of the meter. (Set at 70 psi unless otherwise specified.)

*Specifications.* Main case, bronze; disk (piston) and ball, hard rubber; disk spindle roller, hard rubber; disk chamber, bronze; oil-inclosed gear train; register, round or straight reading, reading in cubic feet, gallons, or metric system; frostproof construction.

**Displacement, Current, Compound, and Fire Meters**

*Standard Specifications* for Displacement, Current, Compound, and Fire Service Meters, adopted by the American Water Works Association and the New England Water Works Association.

Displacement meters	Sizes 5/8 to 6 in.
Current meters	1½ to 20 in.
Compound meters	1½ to 12 in.
Fire service meters	3 to 12 in.

TABLE 26

DIMENSIONS OF WATER METERS

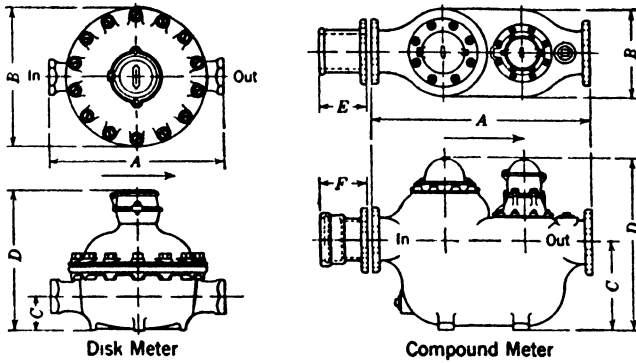

	Meter Size Inches	A Inches	B Inches	C Inches	D Inches	E Inches	F Inches	Weight Lbs	* Delivery GPM
Disk Meters	1½ Screw end	12¾	10	2¾	10¾	.	.	36	100
	1½ Flange	13	10	2¾	10¾	.	.	40	100
	2 Screw end	15¼	12¾	3¼	11¾	.	.	58	160
	2 Flange	17	12¾	3¼	11¾	.	.	61	160
	3	24	16¾	3¾	17¾	.	.	105	315
	4	29¼	22¾	4¾	20¾	.	.	257	500
	6	36¾	29	5¾	25¾	.	.	589	1000
Compound Meters	1½ Screw end	18¾	9¾	5¾	16¾	.	.	140	100
	1½ Flange	20¾	9¾	5¾	16¾	.	.	142	100
	2 Screw end	19	9¾	6¾	17¾	.	.	150	160
	2 Flange	20¾	9¾	6¾	17¾	.	.	156	160
	3	33	13¾	13¼	27¼	15	10	500	315
	4	33	13¾	13¼	27¼	18	11	530	500
	6	36½	14¾	14¾	28¾	18	14	685	1000
	8	42	17½	15¾	29¾	18	14	970	1600
	10	457/8	20¾	137/8	29¾	18	16	1390	2300

\* American Water Works Association & New Eng Water Works Association Standard Specifications

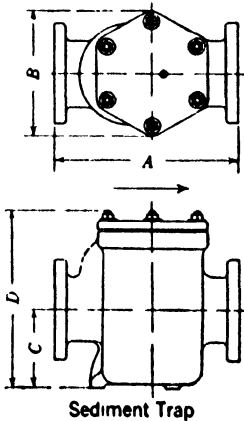

TABLE 27  
DIMENSIONS AND WEIGHTS OF TRIDENT BASKET TYPE SEDIMENT TRAPS

Sediment Trap Size Inches	A Inches	B Inches	C Inches	D Inches	Weight, Lb
5/8	5¼	3¾	2¾	5½	7
¾	5½	3¾	3½	6¼	8
1	65/16	4½	3	7	13
1½ Screw end	7½	5	4	9½	24
1½ Flange	7½	5¾	4	9½	24
2 Screw end	10	6½	4¾	11½	45
2 Flange	10	6½	4¾	11½	46
3	12	7½	5½	14½	78
4	14¾	9	6	16¾	128
6	20½	13¾	8	18½	207
8	24¾	18	9¾	23	340
10	31	22¾	11¾	26¾	450

Courtesy Neptune Meter Co., Chicago, Ill

*Current Meters or Turbine or Crest Meters.* Size  $1\frac{1}{2}$  in. to 20 in. are of the velocity or inferential type designed to measure continuous high rates of flow. Measuring is done by propellers of hard rubber.

*Specifications.* Oil-inclosed gear train. Register: Eight-spindle, rubber-bushed, heatproof, round-reading or eight-spindle straight-reading type; main casing; cover, heavy bronze with hinged hood which can be locked to seal; propeller, molded hard rubber; propeller shaft, phosphor-bronze; hard rubber bushing.

MAXIMUM AND MINIMUM LENGTHS OF METERS

Size	Displacement	Current		Compound	
		Min.	Max.	Min.	Max.
$\frac{3}{8}$	$7\frac{1}{2}$				
$\frac{3}{4}$	9				
1	$10\frac{3}{4}$				
$1\frac{1}{2}$	$12\frac{5}{8}$	13	$15\frac{1}{4}$	$18\frac{5}{16}$	$18\frac{5}{16}$
2	$15\frac{1}{4}$	$15\frac{1}{4}$	19	$15\frac{1}{4}$	$28\frac{7}{8}$
3	24	20	24	24	$37\frac{1}{2}$
4	29	22	$29\frac{1}{4}$	29	$39\frac{1}{4}$
6	$36\frac{1}{2}$	24	$36\frac{1}{2}$	36	$50\frac{3}{4}$
8		$26\frac{3}{4}$	$48\frac{3}{4}$	42	$61\frac{1}{4}$
10		30	60	$63\frac{1}{2}$	$72\frac{3}{4}$
12		36	70	$64\frac{1}{4}$	77

*Compound meters* ( $1\frac{1}{2}$  in. to 10 in.) for accurate measurements of both large and extremely low flow.

Combination of the disk- and current-type meters. When flow increases beyond the capacity of the disk meter, a special automatic valve opens and permits the large volume of water to flow through the current meter.

*Compounding valve* (2 in. to 8 in.), a unit to be bolted to existing current meters to give the same results as a compound meter. The compound valve contains a disk meter.

*Fire service meters* (3 in. to 10 in.), accuracy on all flows, un failing reliability, and minimum loss of head, cast-iron housing. Low flows are measured through a standard disk meter; large flows through a current meter.

Detector check (automatic valve) and by-pass with disk meter. Low flows are measured by disk meter. No metering of large flows.

TABLE 28  
DETECTOR CHECK VALVE

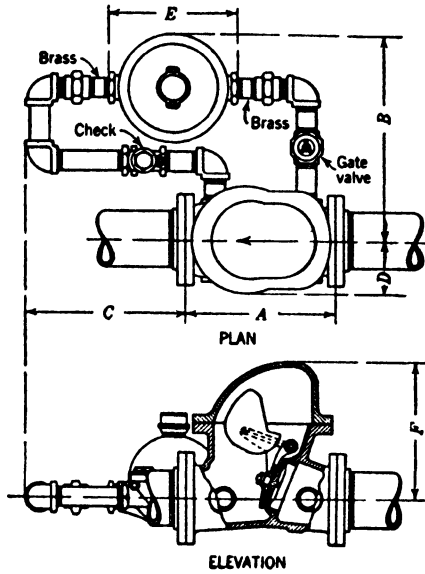

DIMENSIONS, IN INCHES

Size	By-Pass	A	B	C	D	E	F
4	1½	14 <sup>9</sup> / <sub>16</sub>	22	18½	5 <sup>7</sup> / <sub>8</sub>	12 <sup>5</sup> / <sub>8</sub>	13¼
	2	14 <sup>9</sup> / <sub>16</sub>	24	22¼	5 <sup>7</sup> / <sub>8</sub>	15¼	13¼
6	1½	18	23	15½	6 <sup>5</sup> / <sub>8</sub>	12 <sup>5</sup> / <sub>8</sub>	16¾
	2	18	25	19	6 <sup>5</sup> / <sub>8</sub>	15¼	16¾
8	1½	21½	24	12	8¼	12 <sup>5</sup> / <sub>8</sub>	21¼
	2	21½	26	15¾	8¼	15¼	21¼

Courtesy Grinnell Co., Providence, R. I.

### Installation of Water Meters

Pressure should be practically equal on both sides. If not, the meter may overrun itself or "race." Racing can be prevented by throttling the outlet to a point where no ordinary pressure can produce delivery sufficient to overrun the meter.

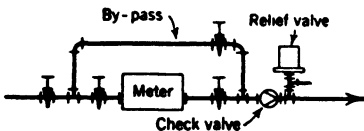
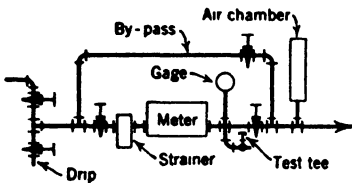
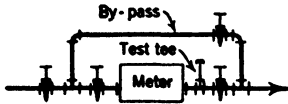

FIG. 37. Water-Meter Connections.

On services  $1\frac{1}{2}$  in. or larger, a by-pass shall be provided. Size of by-pass shall not be less than half the nominal size of the service line. By-pass shall be valved and sealed.

Sediment traps ( $\frac{5}{8}$  in. to 20 in.). All dirt in the basket type. Main casing of iron. Basket, heavy, perforated sheet copper, nickerled.

Test tee inserted in the line beyond the outlet of the meter with a valve on each side of the meter for testing.

Cold water to boilers: Provide check valve and relief valve.

*Setting of Meters.* Meters shall be located within two feet of the building wall or vault near point where service line enters. If in basements, it shall not be set higher than  $\frac{1}{4}$  ft above floor.

Meters, if set by utility company, are provided for by the insertion of a filling-in piece with couplings, unions, or flange unions.

A stop cock, in addition to the house shut-off, shall be located on the house piping within a foot of the meter.

### ART. 6-D. WATER CONSUMPTION

A water system cannot be designed unless the water consumption is known. No concerted effort has been made to collect these data in a way in which they will be of a definite design value. The consequences, therefore, have been that most water systems have been designed on the basis of the wildest guesses. The following data have been selected from so many and so varied sources that it is impossible to guarantee their accuracy. By comparing the data it is, however, possible to gain some knowledge of the true facts.

Estimates on water consumption may be needed for many purposes, to estimate pipe sizes, tanks and reservoirs, meter capacities, and operating cost. For this reason the data are available in many different forms based on units practical for the various purposes, e.g., per capita, per fixture, per cubic foot of building, etc.

TABLE 29A

MAXIMUM WATER CONSUMPTION (COMBINED HOT AND COLD WATER) IN U. S. GALLONS PER CAPITA

	Max. Gal per Hour	Max. Gal per 24 Hours	Average Gal per Year	Reference
Institutions				
Schools, Public			4000	Rochester, N. Y.
"    "	5			
Hospitals, per bed		80		(20)

TABLE 29B

AVERAGE WATER CONSUMPTION (COMBINED HOT AND COLD WATER) IN U. S. GALLONS PER CAPITA

	Averages		Reference
	Gal per 24 Hours	Gal per Month	
Rural: Per person	25-50		
Per horse, mule, or cow	12		(35)
Per horse or mule (heavily worked) and milch cows, in dry weather	20-25		(35)
Per sheep or hog	1		(35)
Domestic purposes, 1 pump at kitchen sink	4-8		(35)
1 faucet at kitchen sink	7-15		(35)
Running hot and cold water in kitchen, bath- room and laundry	20-25		(35)
Sprinkling and cooling purposes, outdoor washing, leakage, etc.	15		(35)
Schools, 3-15 gal per person	7		
Factories	100		
Residential, urban, general	25-50		
Women's dormitory		2000	U. of R.*

\* University of Rochester, N. Y.



**Domestic Water Consumption** (*Journal of AWWA*, December, 1939, by M. A. Pond) (52).

Absolute minimum is 20 gal per capita per day for washing, cooking, and laundry, to which must be added allowances for lawn sprinkling, car washing, etc. After adding the above, the minimum for estimating should not be less than 30 gal per capita per day.

TABLE 29C

WATER CONSUMPTION (COMBINED HOT AND COLD WATER) IN U. S. GALLONS PER FIXTURE

	Type	Size of Inlet	Pressure at Outlet in Psi				
			10	20	30	40	50
Water closets Tank types	All types		18				
Flush valve types	Wash down Siphon jet Blow-out		30	30 40			
Urinals Tank types	All types		5				
Flush valve types	Stall Wash-down Siphon jet Blow-out	$\frac{3}{4}$	5 7	25 30			
Showers	$2\frac{1}{4}$ " head 4 " " 5 " " 6 " " 8 " " 8", tubular	$\frac{1}{2}$ " " " $\frac{3}{4}$ "		4 5 $\frac{1}{2}$ 6 $\frac{1}{2}$ 7 $\frac{1}{4}$ 9 16			
Lavatory	18 x 20 21 x 24		5 9				
Kitchen sink			7				
Bathtub			15				
Laundry tray			9				
Hoses, lawn	Solid stream with spray	$\frac{3}{4}$ $\frac{3}{4}$	6 4				

TABLE 29C (Continued)

	Type	Size of Inlet	Pressure at Outlet in Psi				
			10	20	30	40	50
Open pipes		½		11			
Mixing valves	Pressure equalizing type	½	4	7	8		11
		¾	9	14	19		24
	Steam and water mixer	½	2	3½	4½		6
		¾	6	8½	11		16
		1	9	13	18		30
	Thermostatic type	½	4	6	8	9	10
		¾				12	
		1				22	
		1¼				40	
1½					100		
	2				125		

TABLE 29D

WATER CONSUMPTION (COMBINED HOT AND COLD) IN U. S. GALLONS PER UNIT TIME PER BUILDING

	Gallon	Per Unit Time	Source of Information
Medical school and hospital	2	per cu ft of bldg. per month	N. Y. Hospital and Cornell Medical College Assoc. Estimate
Rural, modern home, average	40	per bldg., per month	(35)
“ “ “ , maximum	100	“ “ “ “	(35)

TABLE 29E  
WATER CONSUMPTION IN U. S. GALLONS PER UNIT OF OPERATION

		Gallons per Unit	Unit of Operation
Lawns		25-40	per 100 sq ft of lawn
Garages	Car Washing (hot and cold water combined)	100	per car
Restaurants	100 meals per day (hot and cold water combined)	1	per meal per person

**Air-Conditioning Apparatus.** (Information furnished by Carrier Corporation, Syracuse, New York.)

*Water Consumption for Water-Cooled Condensers.*

TABLE 29F  
WATER FLOW FACTORS  
(For Water-Cooled Self-Contained Units Using Freon)

Suction Temperature °F	Condensing Temperatures				
	82°	90°	98°	105°	112°
Water Flow Factors					
-20	2.814	2.920	3.040	3.150	3.270
-10	2.680	2.766	2.870	2.966	3.070
0	2.560	2.646	2.740	2.814	2.870
10	2.450	2.540	2.620	2.690	2.760
* 20	2.364	2.440	2.501	2.574	2.636
* 30	2.290	2.360	2.420	2.478	2.534
* 40	2.204	2.266	2.330	2.380	2.440
* 55	2.075	2.125	2.195	2.233	2.097

Note The water flow factor is in gpm/1000 Btu/°F range.

Range °F = (Cond. Temp. - Water Temp.) - 6° (for 7K3 and smaller machines)

\* Range °F = (Cond. Temp. - Water Temp.) - 8° (for 7K4 and larger machines with suction temp. between 20 F and 55 F)

The evaporative condenser is a device designed to replace the air- or water-cooled condenser normally supplied with a refrigerating unit. As its name implies, the evaporative condenser utilizes the principle of evaporative cooling to condense the refrigerant.

The evaporative condenser is essentially an air-cooled condenser consisting of a finned tube coil in which the refrigerant gas is condensed by the evaporative cooling effect of water sprayed over the outside of the coil. Fans draw the air over the coils and through the sprays. Since the rate of evaporation is related to the wet bulb temperature of the air, the capacity of the condenser also depends upon the wet bulb temperature.

The evaporative condenser is not simply a cooling tower; it is a complete condenser unit which replaces the cooling tower, the water-cooled condenser, and the water-circulating system.

TABLE 29G

WATER CONSUMPTION EVAPORATIVE CONDENSERS

Unit	Gpm	Nominal Cap.—Tons	Gpm/Ton*
9P2	0.2	2	1 <sub>10</sub>
9P3	0.3	3	1 <sub>10</sub>
9Q2	0.6	10	1 <sub>16</sub>
9Q6	1.1	20	1 <sub>20</sub>
9Q7	1.7	30	1 <sub>18</sub>
9Q9	2.1	40	1 <sub>19</sub>

\* Average value for water-cooled machine ranges from 1 to 2<sup>1</sup>/<sub>2</sub> gpm/ton

**Cooling Water** for Intercoolers, Cylinder Jackets and Aftercoolers on Air Compressors; see Table 124, page 278, Vol. I.

**Laundry Machinery**

Use sleeve layout furnished by manufacturer. Allow this flow for each pipe.

1 in.	30 gpm H. W.	plus 20 gpm C. W.	= 50 gpm total
1 <sup>1</sup> / <sub>4</sub> "	60 " " " "	40 " " " "	= 100 " "
1 <sup>1</sup> / <sub>2</sub> "	90 " " " "	60 " " " "	= 150 " "
2 "	180 " " " "	120 " " " "	= 300 " "
2 <sup>1</sup> / <sub>2</sub> "	300 " " " "	200 " " " "	= 500 " "

Consumption: 3<sup>1</sup>/<sub>2</sub> to 5 gal per lb. of washing, of which 60% is hot water.

### Method of Estimating Maximum Demand

The sizes of all pipes are determined by the maximum flow which may at any one moment be required to pass through them.

What this maximum demand may be becomes in several instances a highly problematic factor. Quite a few methods have been devised but so far none of them can be said to approach accuracy.

Beginning at the various fixtures themselves, there is, of course, no question what the maximum demand is. The branch to each fixture is determined by the flow demand to that fixture. Proposed adequate flows for individual fixtures are given in Table 29C, page 110.

Progressing from the individual fixtures, we may note the following definite groups or branches: the fixture group or branch, the risers, distributing branches, and the main. For each additional step the factor of uncertainty becomes greater.

*Types of Flow.* The flow from the different fixtures may vary from short, intermittent flow to continuous flow, and from flow of small volume to flow of large volume. Of these the small intermittent flows may be inconsequential and the continuous flows, whether small or large in volume, need not be included in any formulas, as they are simply added to the total flow estimate.

*General Theories.* Apart from some empirical rules it is a well-established fact and generally agreed that the accumulated flow takes the form of a curve. With the abscissa representing the connected load and the ordinate the equivalent flow, the curve starts at a 45-degree angle and then tapers off gradually.

For the first few fixtures this would give an equivalent flow equal to the connected load. After the second or third fixture the probability of overlapping of the flow diminishes. From this point on to within a reasonably small amount of fixtures, a conservative estimate based on the theory of probabilities will give a curve which can be used for practically all cases. A conservative estimate is satisfactory as long as it does not involve too large piping.

For the sake of an argument it may be said that this point is reached the moment a 2-in. pipe becomes necessary or when the flow becomes about 200 gpm. From then on the curve may vary greatly, depending on the type of building and the use of the fixtures. The proof of the accuracy of any curve is in the final figure for the total flow which determines the main into the building.

No estimate can claim to be exact. The best that can be done is to furnish an estimate on the safe side. Where large piping is used it does, however, become urgent to make certain that the curve is not over-conservative.

As variations in flow affect the pressure much more in the smaller pipes it is necessary to be more exact in the estimate of smaller pipes than larger pipes. That means inclusion of all fixtures and a conservative allowance for flow. In the larger pipes the flows to minor fixtures

may be disregarded, and the allowance for variations in flow need not be so generous.

*The Fixture Group.* Rather than estimate the branches to smaller installations or fixture groups it is much better to follow generally accepted standards and to consider installations like bathrooms equal to one fixture.

*The Riser* (including the distributing branches in the basement). If the riser serves only small fixture units it should be determined in the same manner as fixture branches, i.e., by fixtures.

If the riser serves large fixture units (1½-in. piping and up) it can be determined on the basis of the major fixtures or equivalent flow. The risers may safely be determined by using the equivalent-flow figure from each branch and then, for each succeeding story (moving from the most remote branch toward the main), decrease the figure in accordance with the same principles as the curve.

Flows from continuous running fixtures should be kept separate and added to the total allowance for fixture zones. Omit fixtures which are not in use during rush periods.

*The Main.* The size of the main may be entirely independent of the number of fixtures and be determined almost solely by a few fixtures or fixture groups, the flows of which cause a momentary heavy demand. The main may, with the same set of figures, vary greatly, all depending on how these fixtures are used—whether in close succession or spread over a long period.

*Special Conditions.* In small buildings all pipes are determined by the same rules as the branches. In long buildings of few stories, the main in the basement may have to be determined for quite a distance in the same manner as described for risers.

*Demand Zones.* Usually the various functions performed within a building are separated. The pipe branches serving each special installation are designed for only one type of demand.

Thus while the problem in regard to each branch or fixture group may be only to estimate the peak demand and possible overlapping of fixture discharges, the problem for larger branches, risers, and mains serving several and various fixture groups may be to determine conditions and periods during which there will be an overlapping of demand on the fixture groups.

The larger pipes may be determined solely on the basis of one or more dominant fixture groups which cause such heavy demand during certain periods that all other demands during the day become insignificant.

Demand zones should be established for each type of fixture or fixture group, such as water closets and showers.

For each such group a rush period should be determined and the possibility of two or more of these periods overlapping.

Usually it will be found that several fixture groups can be eliminated from consideration. In office buildings the water-closet batteries will

generally determine the flow. Schools have a decided demand-zone layout. All showers may be in use at one time in addition to class or laboratory demand. During recess there may be a heavy demand on the toilet groups. During the evening the service sinks may be in continuous use. Thus in all buildings advantage should be taken of the distribution of demand zones. The designer should not overlook the possibility of steady demands like lawn sprinklers and air-conditioning apparatus.

**The Hunter Method**

The method developed by Dr. Roy B. Hunter (8) applies fixture units or "weights" to the various fixtures as follows:

TABLE 30  
DEMAND WEIGHTS OF PLUMBING FIXTURES

Fixture or Group	Occu-pancy	Type of Supply	Weight per Fixture or Group in Fixture Units
Water closet	Public	Flush valve	10
" "	"	Flush tank	5
Pedestal urinal	"	Flush valve	10
Stall or wall urinal	"	" "	5
" " " "	"	Flush tank	3
Lavatory	"	Total	2
"	"	Hot or cold	1.5
Bathtubs	"	Total	4
"	"	Hot or cold	3
Shower head	"	Total	4
" "	"	Hot or cold	3
Bathroom group	Private	Flush valve (total)	8
" "	"	Flush valve (cold only)	6
" "	"	Flush tank (total)	6
" "	"	Flush tank (cold only)	4
" "	"	Hot water only	3
Bathroom group with separate shower	"	Add to corresponding group above	
		For Total	2
		For cold or hot	1.5

*Application of Load Chart and Weight Table.* "In estimating the demand load for a supply pipe in any building, the total number of each kind of weighted fixtures or weighted groups of fixtures will be multiplied by the weight of that fixture or group (Table 30) and the products

added to obtain the total number of fixture units. The demand load is given by the corresponding ordinate of the appropriate curve in Fig. 38. For example, assume that an apartment house or a hotel has 100 bathrooms with flush-tank supply for all water closets and that any other fixtures in the building are negligible in relation to peak demand. The

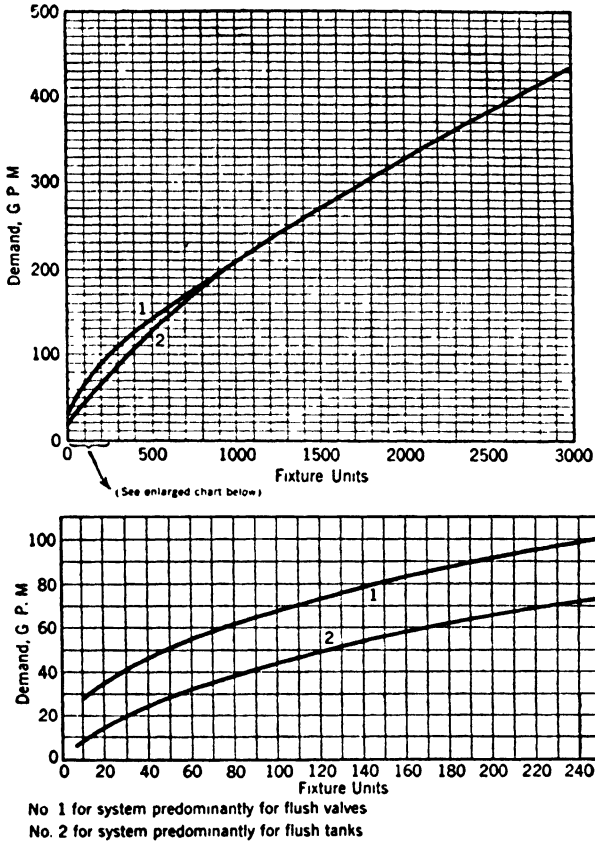

FIG. 38. Estimate Curve for Design Purposes. (From U. S. Department of Commerce Report BMS 65 (8).)

total number of fixture units will be  $100 \times 6$ , or 600. The ordinate on curve 2 of Fig. 38 corresponding to this abscissa is 147 gpm. This estimate, of course, applies only to the main supply or service pipe for the building and does not include any continuous demand, such as that for lawn sprinklers or air conditioning, etc. Again, assume that an office building has 100 water closets with flush-valve supply, 25 stall urinals with flush-valve supply, and 100 lavatories, and that the demand of other plumbing fixtures is negligible in relation to these, but that the building has an air-cooling system which demands a maximum rate of



TABLE 31  
DEMAND ESTIMATES IN GALLONS PER MINUTE (8)

Kind of Fixture	Number of Fixtures												
	2	4	8	12	16	24	40	50	80	100	150	200	300
Water-closet flush tanks	8	12	18	24	30	39	56	66	96	117	167	216	310
Water-closet flush valves	36	47	64	70	82	98	125	140	182	205	269	327	435
Urinal flush valves	27	36	47	54	61	71	89	98	125	140	175	205	269
Lavatories	8	12	16	20	23	29	39	43	58	65	84	102	137

TABLE 32  
WATER DEMAND ESTIMATES FOR RESIDENTIAL TYPE OF BUILDINGS (FLUSH-TANK SUPPLY) (23)

Building types as to number and kind of fixtures	Kind of Demand			Total Fixture Units		Total Demand	
	Bath-rooms	Kitchen sinks	Groups of 1 to 3 laundry trays	Main and cold-water branch	Hot-water branch	Main and cold-water branch*	Hot-water branch
	Number	Number	Number	Number	Number	gpm	gpm
Separate dwellings	1	1	1	11	6	12	8
	2	1	1	17	9	16	10
	3	2	1	25	12	20	12
Small apartment houses	4	4	2	38	20	25	16
	8	8	3	73	37	35	24
	16	16	4	140	69	52	34

\* Add any continuous demand to fixture demand to obtain total demand on building main. Reasonably satisfactory estimates for total demands for garden hose connections or sill cocks are as follows:

Number of outlets:	Estimated demand, gpm:
1	5
2	9
3	12
4	14
5 or more	3 gpm per outlet (23)

No supply to any residence should be figured for less than 30 gpm.

225 gpm. By referring to Table 30 it is found that the total number of fixture units is  $100 \times 10 + 25 \times 5 + 100 \times 2$ , or 1325. The corresponding estimated demand load is 247 gpm, to which 225 gpm must be added, giving 472 gpm for the total estimated demand on the service pipe of the building. The method of estimating for branch risers and other distributing pipes is similar, the estimate being based on the number of fixtures or groups supplied through the branch, and the weights being selected according to whether the branch supply pipe carried the total supply, the cold water only, or the hot water only" (8).

**ART. 6-E. STORAGE AND PUMPS**

**House Tanks and Pumps**

Storage tanks for irregular water supply:

- (a) Gravity storage.
- (b) Pneumatic storage.

Gravity tanks are fed by:

- (a) Intermittent excess pressure.
- (b) Pumps.

House tanks placed inside the building are practically always steel.

**Storage**

The problem of figuring storage capacity resolves itself into determining the length of time during which the average demand equals the average supply.

Storage facilities become necessary where intermittent demands exceed the rate of supply.

If the supply  $S$  equals or exceeds the demand  $D$ , no storage is necessary. If, however, for one minute the demand rate is 10 gal above the supply rate, it will be necessary to have 10 gal extra storage or the equivalent to one minute's supply deficiency. This deficiency equals the demand rate less the supply rate per unit time, multiplied by the length of time, or  $(R_D - R_S)t$ . (See Fig. 39.)

Assume that a hotel building has a daily consumption of 100,000 gal, a maximum hour consumption of 6667 gal during the hours of 8 A.M. to 2 P.M. and 6 P.M. to 12 midnight.

The average supply from the street main is 100 gal per min, or 6000 gal per hr.

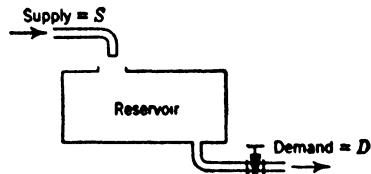

Deficiency in reservoir equals  $(R_D - R_S) t$   
 $R_S$  = Rate of supply, in unit volume per unit time.  
 $R_D$  = Rate of demand, in unit volume per unit time  
 $t$  = Length of time, in same units of time as above

FIG. 39. Water-Storage Requirements.

The chart (Fig. 40) shows the accumulated water demands during the 24 hours. The line *O-A* represents the rate of supply to the tank if it was running continuously. During the hours from 12 midnight to

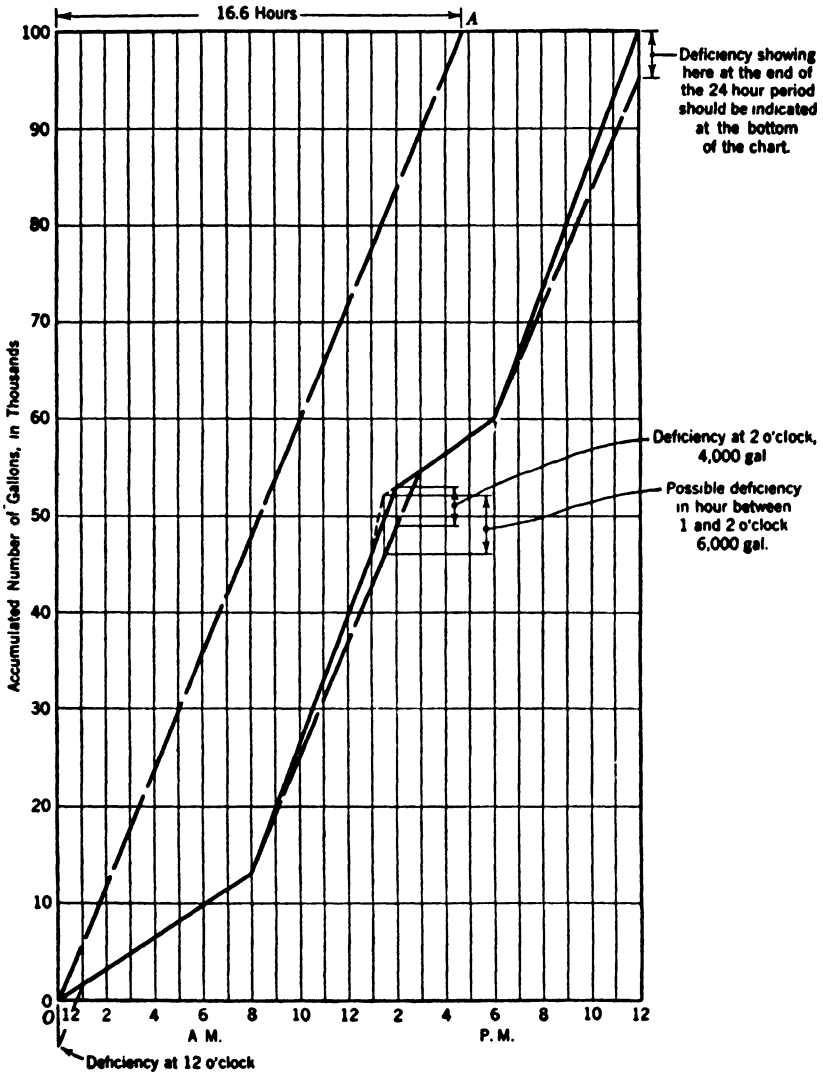

FIG. 40. Cold-Water Storage Requirements Based on a 100,000-gallon Daily Demand. (Typical case for a hotel: 6,000 gpm supply.)

8 A.M. the rate of demand is less than the supply, so the supply works only in periods, and the result will be a supply equal to the demand. At 8 o'clock A.M., however, the rate of demand rises above the rate of supply until somewhere at 3 o'clock P.M. the supply catches up with it.

The maximum deficiency can be measured on the chart and equals about 4000 gal. This figure, however, does not indicate the possible needed maximum storage capacity. For while it may be determined that the deficiency at the end of the hour equals 4000 gal it does not mean that this deficiency came about gradually during the hour. The demands during that hour have been intermittent and may during part of the hour have been at a much greater rate. It is possible that the actual demand took a form like the curve indicated with a dotted line, and in such case the maximum deficiency would have been much greater. Unless an additional chart can be made up showing the demands by smaller intervals, an allowance equal to  $\frac{1}{3}$  hour's supply should be added, i.e.,  $100 \text{ gpm} \times 20 \text{ min}$  equals 2000 gal. In this case the tank should be at least 6000 gal.

### **Pneumatic Water Tanks**

A pneumatic water tank is simply a water tank partly filled with air.

Used in connection with a water pump it acts as an equalizer of the water demand. The pump motor is regulated to stop at a certain maximum pressure at which there will be in the tank a reserve supply of water under high pressure ready to furnish smaller intermittent demands.

Do not overlook the important fact that every pound of water used in the system is pumped into it by the water pump. No other agency furnishes a single ounce of work toward performing this duty. The air acts only as a cushion forced into compression by the water pump and it releases the water, when needed, at the same pressure. As the water volume diminishes in the tank, the air volume expands and the pressure is reduced. This goes on until a minimum allowable pressure is reached, which automatically cuts in the motor and starts the water pump.

If the water demand was constant at all times, it can be seen that a pump of a capacity equal to that demand would do the work without the use of any tank. It is only because and when the water demand is not constant, but intermittent, that the tank is introduced to offset undue strain on the pump and the pipe system. Systems with fairly good average water demand can be and are operated without a tank and only a centrifugal pump running.

The tank can be placed in any location, either at the low point or high point of the system. The low point location has the advantage of eliminating extra cost due to additional structural strength and also cuts down the length of pipe lines required. Tanks can be made into a combination equalizer and storage tank by leaving sufficient permanent water storage in them for emergency use by gravity. In such cases, the tanks, of course, will have to be placed at the top of the system.

Tanks used on systems without pumps act as pressure reservoirs by accumulating water at high pressure and releasing it when, owing to sudden demand, the pressure in the main diminishes.

Air volume in the tank is maintained by an air compressor or by temporarily emptying the tank and letting it be filled with air at atmospheric pressure.

In all the above cases the size of the tank, the tapplings, and the location of the gage glass are different. Consequently, each tank installation should be designed for its particular purpose.

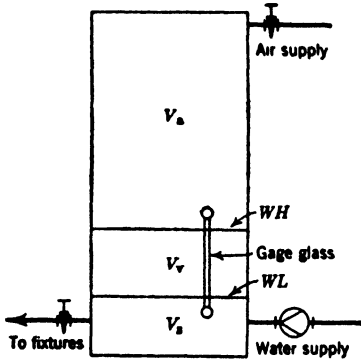

FIG. 41. Elements of Pneumatic Water Tank.

The space  $V_s$  indicates the permanent water volume, and the line  $WL$  the low water line (see Fig. 41).

The space  $V_v$  indicates the variable volume, which may be either water or air. At high pressure it is filled with water, and at low pressure it is filled with air. The gage glass should, of course, be placed to show this variation and should be placed in its proper location and be of a length slightly longer than the height of the space  $V_v$ . The line  $WH$  indicates the high water level.

The space  $V_a$  is the air volume under high pressure.

To design a tank properly, it is necessary to compute the exact size of each of the volumes,  $V_s$ ,  $V_v$ , and  $V_a$ .

*Formulas.* The variations in water and air volumes are determined by Boyle's or Mariotte's law: The volume of a gas diminishes in the same ratio as the pressure upon it is increased, if the temperature is unchanged. If  $P_1$  equals the pressure at volume  $V_1$ , and  $P_2$  equals the pressure at volume  $V_2$ , then  $P_1V_1 = P_2V_2$ . From this it follows that the difference in volume,

$$V_2 - V_1 = \frac{V_1(P_1 - P_2)}{P_2}$$

*Pump Systems.* The space  $V_s$  is arbitrary. In the ordinary tank operated with air compressor it should merely be sufficient to extend over the inlet and the outlet so that there is no danger of air ever reaching that point.

The variation in volume, represented by the space  $V_v$ , is determined in the following way. The amount of water contained in this space determines the frequency of the starting of the motor. If the maximum consumption of water is  $C$  cfm and it is desired that a rest period between pump operation should be  $K$  min, then the space  $V_v$  must contain  $KC$  cu ft of water. The factor  $K$  is arbitrary and has usually in the past been placed at too high a value. It can be seen that for every cubic foot provided in the space  $V_v$ , many times its volume will have to be provided in space  $V_a$ .

The first requisite then is to install a booster pump which will deliver the maximum quantity of water needed at any maximum demand period and give that pump an opportunity to furnish this service with the least amount of work. That means that the system should be designed in such a way that the pump does not have to work against a greater pressure head than necessary. Since the pump is going to deliver all the water anyway, there is no purpose in trying to establish a long rest period between pumpings. All that is required is simply to make that period long enough so that under maximum demand the pump will at least have a short interval between stopping and starting. This interval can theoretically be set as low as a quarter of a minute or even less, inasmuch as a condition like that only seldom occurs. By making the factor  $K$  low a great saving in cost and space is accomplished by the corresponding decrease in size of the tank.

Having determined  $K$ , and making  $C$  equal to the maximum demand, which again equals the capacity of the pump in cubic feet per minute, we need only to determine the pressure variation to find the volume of the space  $V_a$ .

It is never advantageous to have any great pressure variation in any system. This variation can be greatly diminished by placing a pressure-regulating valve at the outlet of the tank, and any variation in pressure in the tank can be disregarded so far as the fixtures on the water system are concerned. There is still to be considered the amount of work placed upon the pump. The less variation in pressure the more water is furnished with the least amount of work. On the other hand, as can be seen by studying the formula, the smaller the variation in pressure, the greater becomes the tank. Most systems should be able to stand a variation in pressure from 5 to 10 lb. Where lack of space for the tank makes it necessary to use higher pressure variations, a pressure-regulating valve can be installed in the line to the fixtures.

$P_1$  = Maximum air pressure (absolute).

Occurs when air volume is at minimum or occupying space  $V_a$ .

$P_2$  = Minimum air pressure (absolute).

Occurs when air volume is at maximum or occupying spaces  $V_a + V_v$ . It should equal the required minimum pressure in the system.

$V_v$  = Variation in air and water volumes =  $K \cdot C$ .

$C$  = Maximum water demand or pump capacity in cubic feet per minute.

$K$  = Time factor, in minutes.

$V_a$  = Minimum air space.

$$\text{Space } V_v = KC$$

$$\text{Space } V_a = \frac{V_v \times P_2}{P_1 - P_2}$$

**Example:**

Pump capacity,  $C$ , 10 cfm.

Minimum pressure, 80 lb gage pressure, or 94.7 abs pressure.

Maximum gage pressure, 90 lb.

Difference in pressure, 10 lb.

The factor  $K$  is set at  $\frac{1}{2}$  min.

Space  $V_v$  equals  $0.5 \times 10 = 5.0$  cu ft.

Space  $V_a$  equals  $5 \times \frac{94.7}{10} = 47.35$  cu ft.

$V_a + V_v = 52.35$  cu ft.

If we assume that there is room for an eight-foot high tank and that one foot is used for space  $V_s$ , the seven remaining feet shall contain 52.35 cu ft, or 7.47 cu ft per ft, which gives a tank a little more than 3 ft in diameter.

*Pump Systems with Reservoir.* The computations for such systems are similar to the regular pump systems, except that the space  $V_s$  must be enlarged to take care of the needed emergency reservoir. If the reservoir is for fire protection, the domestic water-supply line will be placed in the same relation to the usual low water level, say 6 to 8 in. below it, and the emergency supply taken off from the bottom. If the emergency reservoir is for the domestic supply only, the outlet will be placed near the bottom of the tank.

*Systems without Pumps.* In systems without a pump the pressure variation is determined by the conditions in each case. The maximum pressure will equal the pressure in the water main when the water demand is small, and the minimum pressure will equal the pressure in the water main when the maximum amount of water is used. During periods of small demand the excess water pressure will refill the tank for use during periods of greater demand.

Where an independent source of compressed air is available (as seldom is the case) volume  $V_s$  is determined arbitrarily in the same manner as for pump systems. If compressed air is not available  $V_s$  is determined by deducting volumes  $V_v$  and  $V_a$  from the total required tank volume plus an allowance for space occupied by fittings.

The total tank volume should equal the required air volume under atmospheric pressure or

$$V_t = \frac{V_a P_2}{14.7}$$

Volume  $V_v$  is determined on the basis of any maximum load that may be expected, e.g., the flushing of a water closet.

A great deal of good judgment should be used in these cases. Tanks of this type become unduly large if used for large demands.

$$\text{Air volume, } V_a = \frac{V_v P_2}{P_1 - P_2}$$

*Example:*

Maximum discharge = 1 cu ft.  
 Maximum gage pressure in main = 40 lb, or 54.7 lb abs.  
 Minimum gage pressure = 30 lb.  
 Pressure variation = 10 lb.  
 Space  $V_v$  = 1.0 cu ft.

$$\text{Space } V_a = 1 \times \frac{54.7}{10} = 5.47 \text{ cu ft.}$$

$$\text{Total theoretical tank volume, } V_t = 5.47 \times \frac{54.7}{14.7} = 20 \text{ cu ft.}$$

If we use a 2-ft diameter tank with 3.14 cu ft per lin ft, it is then necessary to make it  $6\frac{1}{2}$  ft tall (say 7 ft, no inches). This is a much larger tank than is generally used for domestic operation of water closets. In actual practice, a wash-down bowl will require only 4 to  $4\frac{1}{2}$  gal and the tank can be safely designed on the basis of  $\frac{1}{2}$  cu ft demand, depending on the regular water supply to furnish the afterfill. In that case, the space  $V_t$  will be only 10 cu ft.

*Limitations to Pneumatic Tanks.* While pneumatic water tanks give an advantage in saving of structural supports and pipe, and become necessary where conditions (as at airports) prohibit tall water structures, they have their disadvantage in the fact that the water, particularly under pressure, will absorb a great deal of the air in the tank. The air volume will have to be regulated daily. Where also used to feed the hot water tank they have the added disadvantage that during the process of heating the air is again liberated. This is a handicap in all water heating, even when using the regular water supply, and is greatly magnified by using water from a pneumatic tank. It is quite necessary in such cases to make extra provisions for the escape of air from the hot-water lines.

*Air Compressor.* The air compressor can be driven by the water pump, connected to it by a belt, and thus charge whenever the pump is running. A relief valve set at the maximum pressure should be inserted in the air line.

If air compressor is operated by a separate motor its action is usually non-automatic. It is turned on once a day to replenish the air supply. An air relief valve is not necessary, but advisable. Where reciprocating pumps are used an air valve can be used for smaller installations.

The size of the air compressor depends very much on how much air is already absorbed by the water before it enters the pneumatic tank. Under ordinary conditions the following formula may be used:

$$\left. \begin{array}{l} \text{Capacity of com-} \\ \text{pressor in cu ft} \\ \text{per min} \end{array} \right\} = \frac{\text{Tank size in cu ft} \times (\text{Maximum absolute pressure})^2}{12,000 \times \left( \begin{array}{l} \text{Time in minutes allowed for operating} \\ \text{the compressor} \end{array} \right)}$$



TABLE 33  
AIR COMPRESSORS FOR PNEUMATIC WATER TANKS

Displacement, cu ft per min	Maximum Pressure, lb	Motor Required, hp
1.2-1.4	150	$\frac{1}{4}$
2.5-2.9	"	$\frac{1}{2}$
4.0-4.7	"	$\frac{3}{4}$
5.0-5.8	"	1
7.2-8.3	"	$1\frac{1}{2}$

TABLE 34  
CAPACITIES OF ROUND TANKS ONE FOOT HIGH

Diam ft-in.	Cubic Feet	U. S. Gallons
1-8	2.18	16.32
2-0	3.14	23.50
2-6	4.91	36.72
3-0	7.07	52.88
3-6	9.62	71.97
4-0	12.57	94.00
4-6	15.90	118.97
5-0	19.63	146.88
6-0	28.27	211.51
7-0	38.48	287.88
8-0	50.27	376.01

#### ART. 6-F. HOT-WATER SYSTEMS

##### Types of Systems

*Piping Systems.* There are in general two classes of piping systems: non-circulating (or direct) systems and circulating systems. In the first, pipes run directly from the heater, manifold, or main to hot-water outlets, with no return piping. In the second, mains run to the general location of fixtures and then return to the heater, direct branches being taken off to supply all outlets. The object here is to maintain a constant flow of hot water which may be drawn upon at any point. Opera-

tion of circulating systems is ordinarily more expensive than operation of direct systems. There are many types of circulating systems, the method or degree of completeness of circulation usually determining the type (19).

Recent research on direct systems at Purdue University \* tends to show that, for small homes, use of the smallest pipe sizes which will satisfactorily meet demands results in economical hot-water service comparable to that provided by circulating systems. Use of copper tubing rather than rigid piping has the following advantages: (1) practical freedom from corrosion; (2) interior surface smoothness; (3) small diameters

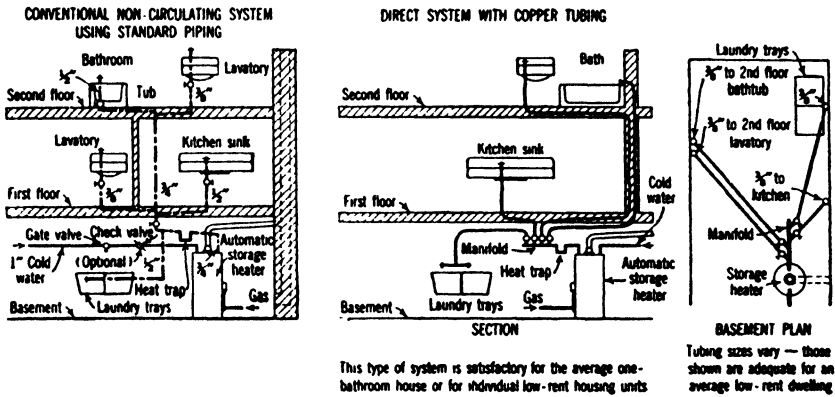

FIG. 42. Hot-Water Systems. (From *Domestic Hot Water Systems*, by T. S. Rogers (19).)

cause high water velocities and thus cause flushing action; (4) tubing's flexibility eliminates sharp bends; (5) permits direct runs; (6) decreases installation costs; (7) increases salvage value; (8) reduces the amount of water held in the piping system (19).

In this type of direct system, hot water is discharged from the heater into a short manifold or section of conventional pipe, from which a separate copper tube runs to each faucet or outlet. Use of the system is limited only by the necessity of keeping piping runs as short as possible. Savings in heat losses due to use of small sizes may average 20 to 25%, depending on water consumption (19).

The single-pipe system offers no problems outside those of the ordinary water system. It is, of course, not satisfactory on installations which call for long runs of piping.

Circulation systems are of two kinds: gravity systems and forced (pumped) systems. Whether the one or the other is used, the designer is urged to adopt the following recommendations for a balanced system.

\* *Research Series 64*, Engineering Experiment Station, Purdue University, "Improved Hot Water Supply Piping," by J. M. Krappe.

If, after having made the proper piping layout, it is found that the system will not circulate without a pump, then the pump feature may be added. In other words, try to design all systems on the gravity principle and only add pumps to do the necessary extra work; it makes a

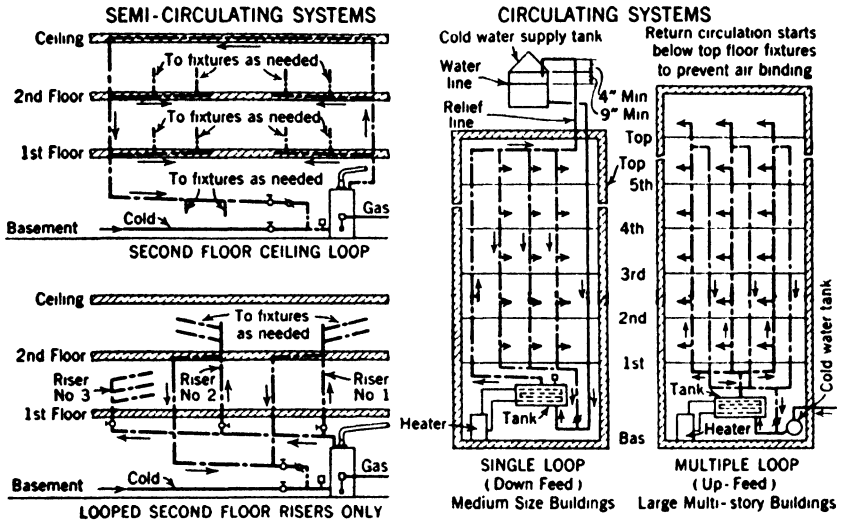

FIG. 43. Hot-Water Circulating Systems. (From *Domestic Hot Water Systems* by T. S. Rogers (19).)

far more satisfactory working system and saves unnecessary work for the pump.

### Circulation Systems

Circulation in a hot-water gravity system is accomplished in one way only, by the difference in weight of the water in the feed risers and the return risers. This weight is so small that it takes very little to prevent circulation. It is usually expressed in millinches.

In Fig. 44 is shown the simplest type of circulating unit. The weight of the water in the return riser less the weight of the water in the feed riser furnishes the only working force. Naturally the greater the difference in temperature between the two columns of water the greater the force; and the higher the columns the greater the force.

This simple system may be extended to various types of systems which are based upon the idea of establishing the greatest temperature differences and columns heights.

Figure 45a shows in principle the best system. The feed riser is taken off immediately after leaving the heater and the return riser is the last unit of the piping, thus giving the greater temperature difference

As will be seen, this system would call for all outlets to be placed at the top of the system, a condition which would be very unlikely to happen.

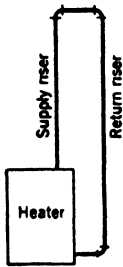

FIG. 44.

$L$  = Total length of pipes (incl risers)  
 $H$  = Height of risers  
 $t_o$  = Temperature difference between supply riser and return riser.

Relative ratings of systems expressed by formula  $100 \times \frac{t_o \times H}{L}$

Each run of pipe figured as 10 ft.

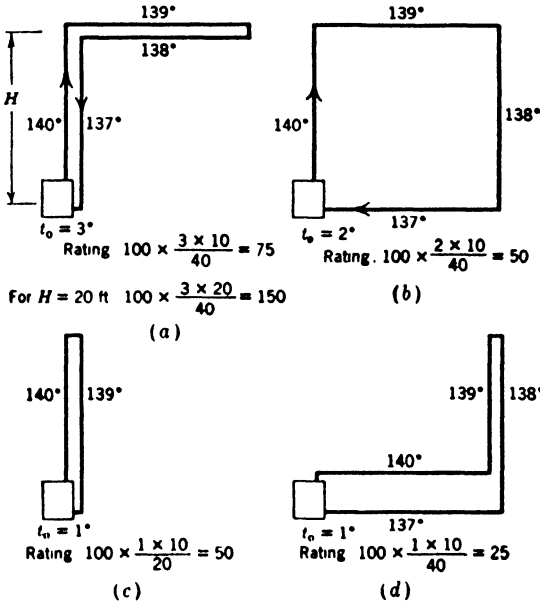

FIG. 45.

Comparison of Circulating Systems.

Figure 45b shows a further modification. In this case the return riser is placed at the far end of the pipe system and the temperature difference consequently would be less.

Assuming an equal temperature loss per linear foot of the different systems shown, equal columns heights and equal horizontal runs, we can

compare the relative efficiency of the systems by counting the column height and the temperature differences in their favor and the pipe runs against them.

For the sake of demonstration, let us show how variations of the above affect the system for better or worse. Call the risers or columns heights 10 ft and the horizontal runs 10 ft. The height expresses directly the weight of the water. The temperature difference,  $t_o$ , expresses directly the difference in weights of the columns, so the height multiplied by  $t_o$  gives a direct expression of the efficiency of the system. We also

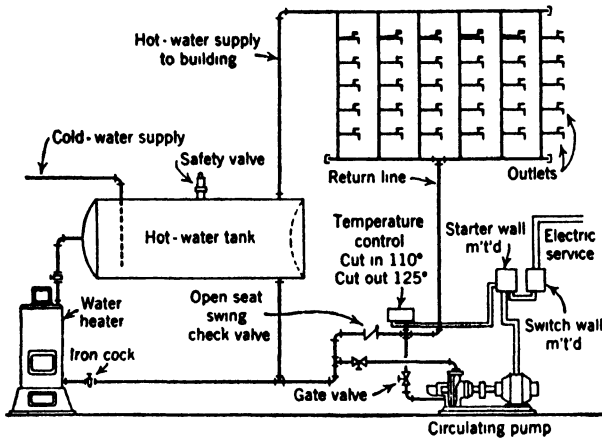

FIG. 46. Pumped Circulating System. (Courtesy Chicago Pump Company, Chicago, Ill.)

arbitrarily assign a temperature loss of 1 degree per 10 ft of pipe. As the length of pipe is a direct expression of the efficiency we divide this term by the length in feet and multiply by 100 to obtain the coefficient of efficiency.

### Insulation

On direct piping systems, insulation is valuable on all long runs of large-sized piping, particularly on runs to kitchen faucets. Although the practice of insulating domestic hot-water piping is not well established, insulation of at least exposed cellar runs may result in heat losses lowered by as much as 12 to 15%, depending on water consumption, for small houses. Insulation of all circulating supplies and returns is necessary for even reasonably economical operation (19).

Tanks furnished with automatic storage heaters are insulated by their manufacturers. Insulation at least 1½ in. thick (preferably 2 to 4 in.) is desirable on tanks for special installations and circulating tanks whose heaters have been converted to automatic operation (19).

### Hot-Water Consumption

The *proportion of hot water* needed for any mixed flow is determined by the following formulas:

Hot and Cold Mix:

$$T_m = \frac{Q_c \times T_c + Q_h \times T_h}{Q_c + Q_h}$$

$Q_c$  = Rate of flow of cold water.

$Q_h$  = Rate of flow of hot water.

$T_m$  = Temperature of mixed water.

$T_h$  = Temperature of hot water.

$T_c$  = Temperature of cold water.

The proportion of hot water for each gallon of mixed water:

$$Q_h = \frac{T_m - T_c}{T_h - T_c}$$

For the purpose of determining maximum flows the lowest cold-water temperature should be used (see Fig. 25, p. 74).

For estimating relative costs of heating hot water a check-up should be made of both summer and winter consumption.

### ART. 6-G. SIZING OF PIPES

The procedure usually is to find or establish the extreme pressures, i.e., the needed operating pressure at the highest and most remote point and the pressure at the service. From this available pressure range must be deducted the loss in pressure due to height, i.e., the static head expressed in pounds per square inch equal to the rise in feet. The remaining pressure may be used for friction losses through the meter, pipes, and fittings.

#### Pressures and Pressure Losses

After the maximum flow has been estimated for the various pipe mains and branches on the water system, it is necessary to determine (a) the required pressures at the outlets and (b) the allowable pressure losses between the service pipe and the outlet.

*Outlet pressures* must be adequate to serve the fixture as explained in Chapter 5, Volume I. In addition, an allowance should be made as a factor of safety.

TABLE 35  
OUTLET PRESSURES

	<i>Minimum</i>
Water closets	
Blow-out	20 psi
Siphon jet	15 "
Wash-down	10 "
Tanks	10 "
Bed pan hoppers	10 "
Urinals	
Stall	10 "
Siphon jet	15 "
Blow-out	15 "
Tank	10 "
Wall-hung	10 "
Service sinks	5 "
Showers	20 "
Bathtubs	5 " *
Dishwashing machines	10 " *
Sinks	5 " *
Laundry trays	5 " *
Lavatories	5-8 " *
Garden hose	15 (Allow for additional piping equal to length of hose.)

\* Where instantaneous water heaters are used, pressure should be 15 psi minimum

### Sizing.

*Size of Fixture Branches.* The minimum size of fixture branches and other supply outlets shall be as follows:

Sill cocks	$\frac{1}{2}$ in.
Domestic water heaters	$\frac{1}{2}$ "
Laundry trays	$\frac{1}{2}$ "
Sinks	$\frac{1}{2}$ "
Lavatories	$\frac{3}{8}$ "
Bathtubs	$\frac{1}{2}$ "
Water-closet tanks	$\frac{3}{8}$ "
Water-closet flush valves	1 "
Flush valves for pedestal urinals	1 "
Flush valves for wall or stall urinals	$\frac{1}{2}$ " (23)

In addition there are many special fixtures and appurtenances which require high pressures, e.g., hydrotherapeutic apparatus. Information about proper working pressures should be obtained in each case from the manufacturers.

*The static pressures* in the water line vary according to height. The allowable pressure drop from the riser to the fixture may therefore vary

considerably. On upper floors it may be small; on the lower floors it may be large. Since pipes come only in certain standard sizes, it is impossible to calibrate a system so finely that all outlets have the same pressure. On tall buildings some result may be gained by using larger branch piping at the top and smaller at the bottom, but otherwise the only efficient method is to throttle down the flow in each branch by a valve or inserted orifice.

The general practice is to allow fairly large pressure drops in branches and lesser pressure drops in the larger pipes. For the sake of economy and because of the comparatively short runs occurring in residential work, such work is based on large pressure drops. On larger buildings there may, however, not be sufficient pressure to allow for large pressure drops in the branches. Consequently, branch piping for small jobs may be based on large pressure drops, and branch piping on upper stories in tall buildings or at the end of long runs may have to be figured on the basis of low pressure drops. The whole idea becomes very clear the minute a diagram is drawn up of the water system and the pressures are assigned for the various points.

For the sake of illustration three cases are shown below (Fig. 47):

*Case I.* Assign 20 lb to most remote fixture and 40 lb per 100 ft pressure drop to branch. This will require 22 lb at point *A*. Assume height of riser (10 ft) plus run to service (10 ft) plus allowance for fittings equal to 25 ft total. The loss in head (10 ft riser) equals 4.33 lb. Allowable pressure drop between point *A* and service =  $60 - 22 - 4.33 = 33.67$  lb. Loss through meter should not exceed half this amount. For maximum service of 30 gpm, a  $\frac{3}{4}$ -in. disk meter will lose 15 lb. This leaves  $33.67 - 15 = 18.67$  lb for 25 ft, or the equivalent of about 75 lb per 100 ft.

*Case II.* Use the same figures as for Case I. Loss of head through 40 ft rise equals 17.3 lb. Naturally, a much smaller pressure drop will have to be used. If 10 lb is allowed for the meter, there will be  $60 - 22 - 17.3 - 10$  lb equals 10.7 lb pressure drop available for a total of  $70 + 5$  ft plus allowance for fittings, equal, say 90 ft. Allowable

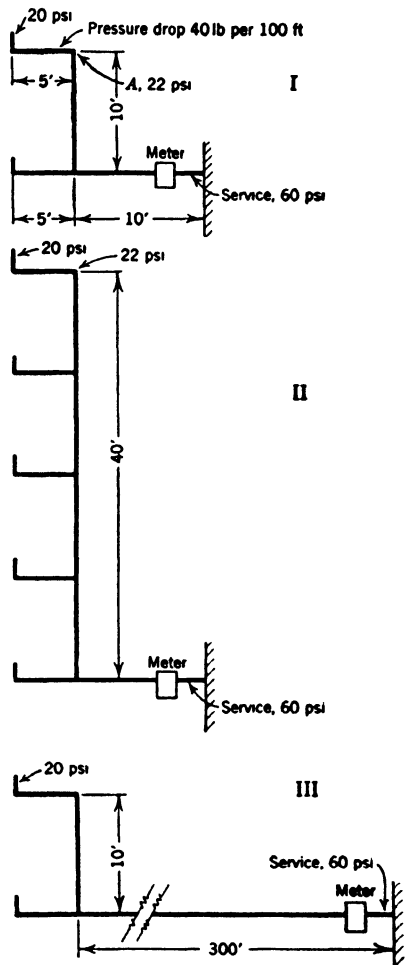

FIG. 47. Comparison of Cold-Water Systems.



pressure drop will be about 12 lb per 100 ft. This would give a pressure at the bottom of the riser equal to 60 lb - 2 lb (for the pipes and fittings) - 10 lb (for the meter) equal to 48 lb. If pressure at the outlet of the lowest branch need be only 20 lb, then the branch could theoretically be designed for a pressure drop of 48 - 20 equal to 28 lb per 5 ft, or 560 lb per 100. This would call for too high velocities and the branch should be proportioned for not more than 40 lb per 100 ft pressure drop and then throttled near the riser with a valve or orifice inserted in the valve.

*Case III.* Total static head loss through 10 ft riser is 4.33 lb. Total available head is 60 - 22 - 4.33 = 33.67 lb. If half of this is allowed for the meter, there is available for the pipes about 17 lb for 315 ft of pipe plus fittings, say 330 ft, or the equivalent of 5 lb per 100 ft. Consequently, the upper branch would have to be figured for a comparatively low pressure drop.

As can be seen, there may be occasion to use many different degrees of pressure drops. There are, however, practical limits.

Pressure drops should not be too high. They will cause too great a change in pressure between the static condition and the flow condition. They will cause unfavorable variations in the flow whenever a valve or faucet is opened.

Low pressure losses generally create a pleasant flow. They do, however, require larger piping.

It is better first to make a general estimate of the average pressure loss per 100 ft and then, after some of the pipe sizes are determined, to adjust the figure for the different sections.

The service line from the street main to the building should, if possible, be figured for a small pressure drop. Where the distance is great this becomes very important. It should be remembered that a fair-sized service line need be no more expensive than a small one. A 1½-in. or 2-in. cast-iron pipe in a trench usually is cheaper than a smaller-sized pipe of more expensive material.

Consider also fixtures which cannot afford to be affected by large pressure drops, e.g., showers. They should be taken off from sufficiently large lines where large pressure drops do not occur.

Outlets which cause severe drops should be provided with adequate supply (e.g., flushing valves) or regulating devices should be used to control the flow (e.g., large outlets at the lower points of the system, hose outlets, laundry trays, etc.).

Pressure variations are not so bothersome in fixtures with flows of short duration. The longer the flow takes place the more it becomes desirable to have a steady and uniform rate of flow. This becomes even more important where hot and cold water are mixed at the fixture to a desired fixed temperature.

*Flow Regulators.* All the theory about maximum flow per fixture is of little use unless in the design and construction of the system provisions are made to keep the flow within the limits adopted. (In particular, flows of long duration and large volume, e.g., showers and flush valves.)

When the pressure is not equal at the various points, as in multi-story buildings, it becomes an easy matter for fixtures at lower levels and greater pressure to "hog" the supply.

Provisions must be made for proper adjustments of stream by insertion of orifices, regulators, and other adjustments to insure even distribution.

*Selection of Water Meter.* The size of the water meter should not be determined by any guess or arbitrary rule. A water meter costs money, and there seems to be some reluctance toward installing a generous-sized meter. The size of the main does not determine the meter size, and the idea that the meter can safely be of a size smaller than the main is even more dangerous.

Where the water pressure is high and a great pressure loss can be allowed through the meter, it is possible that a smaller-sized meter can be used. In such cases, however, it should be followed by a pressure regulator, or the effect will be abnormal high pressure variations in the pipe system. In most cases the water meter may be the same size as the main, particularly where compound meters are used; and in many cases it may have to be a larger size.

The water meter size should be determined on the basis of allowable maximum pressure loss under the estimated maximum delivery.

The estimated maximum delivery easily becomes the great question mark in this discussion. It all depends on how this maximum delivery is estimated. As stated in Art. 6-D, many arbitrary methods have been used in the past. As a general rule, the larger the installation the greater the error, and usually the error favored making the estimate too high.

As an example, let us assume a system with an estimated maximum demand of 600 gpm but an actual maximum demand of only 300 gpm. (This wide difference in estimated and actual demand is not at all improbable.) With a 4-in. disk meter the pressure loss under the estimated 600 gpm would be 22 psi, but under the actual conditions of 300 gpm it is never over 6 psi. Thus the meter proves adequate, but only because it was based on a faulty estimate. If the correct estimate had been made the temptation might have been to install a 3-in. disk meter, and in such case there would have been a certain pressure drop of 14 psi.

It will be seen that a great variation in selection may take place, depending on the correct estimate of water demand, and that the incorrect choice of meter may render a perfectly good piping system inadequate. The designer should keep this in mind and not permit a great pressure loss in the meter unless there is pressure to spare.

It is a good rule not to allow more than half the pressure loss between the service line and the most remote fixture to take place in the meter, i.e., half the pressure loss is in the meter and half in the piping. Unless there is an excessive pressure where a great loss can be afforded, and then only if the meter is followed by a pressure regulator, pressure losses in excess of 10 psi should not be permitted.

With more careful methods of calculating the water demand, water meters in turn should be figured for extra capacities, as any possible demand in excess of the estimated amount will greatly increase the pressure loss. As the excess pressure (that is, the pressure allowed at the fixture) in many cases may be only 5 psi, it can be seen from Fig. 49 that it does not take much additional demand to increase the loss in the meter to such an extent that there is no excess pressure available.

*Pipe Losses.* The coefficient,  $C_w$ , is a direct expression of the flow characteristics of a pipe when used with a certain fluid. In selecting a

TABLE 36

VALUES OF  $C_w$

33°-77° Water

	Years (Based on 5000 Cu Ft per Year per 3/4-In. Pipe)										
	0	5	10	15	20	25	30	35	40	45	50
1000 Cu Ft	0	25	50	75	100	125	150	175	200	225	250
Copper	140	130									
Red brass	140	130									
Admiralty	140	130									
Galv. steel	130	125	125	125	125	125	125	124	124	120	102
Galv. W. I.	120	114	114	114	114	112	111	111	111	105	
Steel	118	76	63	55	40	24					
Wrought iron	120	82	65	55	40	28					
Cast iron		120	110	100		90		80			

140° Water

Copper	145	130	130	130	130						
Red brass	145	130	130	130	130						
Admiralty	145	130	130	130	130						
Galv. steel	95										
Galv. W. I.	90	80	55	30	—						
Steel	45	5	—								
Wrought iron	60	5	—								

figure for  $C_w$ , we must keep in mind that this coefficient decreases as the pipe is being used. If an installation is expected to function properly for a certain number of years, the  $C_w$  should be chosen to correspond

with this period of time. Unfortunately, there are not sufficient data available to predetermine the figure for  $C_w$  with any accuracy.

Tables are submitted showing generally approved figures.

In addition, attention is called to the data in "Hydraulic Service Characteristics," *Journal of the New England Water Works Association*, Vol. XLIV, No. 4, by Fair, Whipple, and Hsiao, where definite decreases are shown in the  $C_w$  coefficient under various uses and for different materials. The decreases are measured in relation to actual volume of water passed through the pipes. Both because such tests are limited by time and economical factors and also because the actual amount of water used in any installation may be difficult to estimate, the tables can serve only as a guide. If, however, we assume that under ordinary residential conditions a  $\frac{3}{4}$ -in. pipe will handle 5000 cu ft per yr, we may indicate the expected life of the various pipe materials and thus aid in the selection of the proper material for the building.

In Table 36, a time in years has been added. It should not be followed blindly, however, but preferably checked against the type of installation in question. For some buildings the quantity of water per year may be much greater and the life of the pipe therefore proportionally shorter.

*Flow Tables.* All flow tables are based on hypothetical conditions. There is no need of being too particular in applying such tables, as actual conditions of workmanship may cause variations which may safely be assumed as high as 10%.

Published tables usually are based on an assumed greater demand and higher pressure drop while recommendations in this book are based on assumed lower demand and lower pressure drops.

Since high pressure drops allow for smaller pipes and lower pressure drops for larger pipes, the result of either procedure may be the same. We do, however, recommend the latter method as it often affects sizes of pipes where the use of high pressure drops will cause undesirable variations in pressure, and, in case demands are assumed too great, a saving can be accomplished even with lower pressure drop. The latter consideration is true mostly on larger mains and feeders.

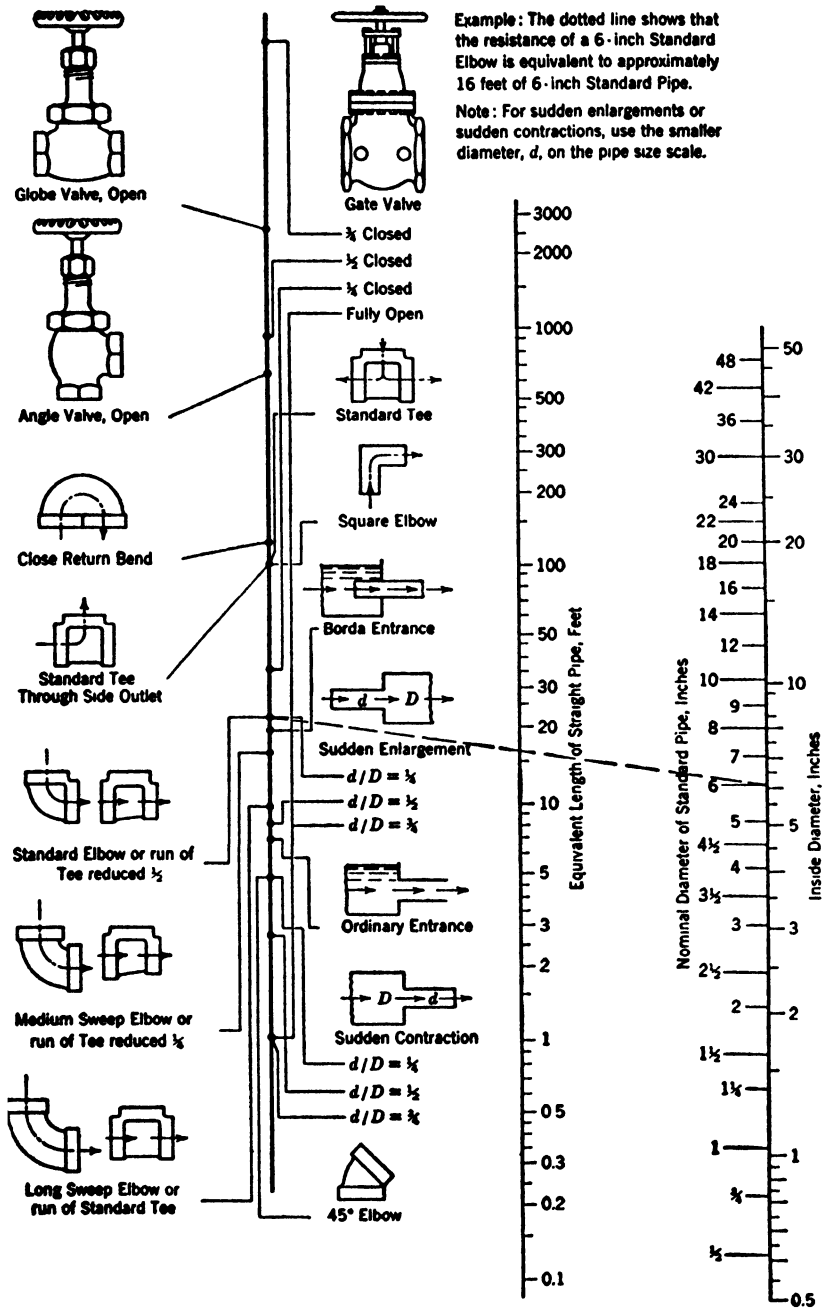

Copyright by Crane Company.

FIG. 48. Resistance of Valves and Fittings to Flow of Fluids. (Courtesy Crane Company, Chicago, Ill.)

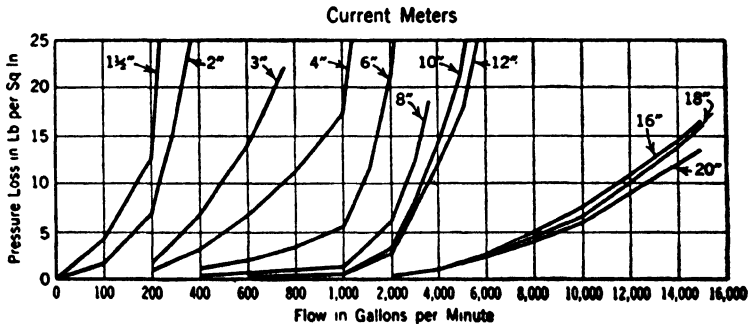
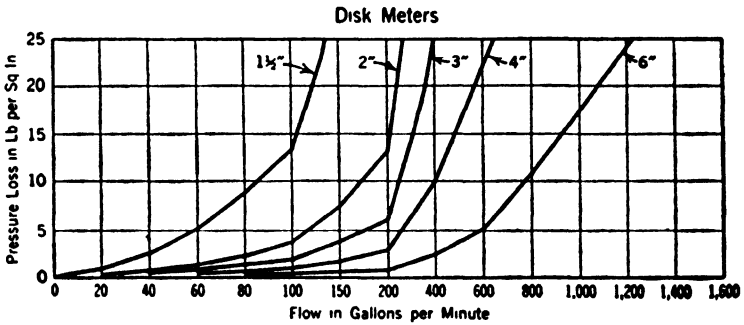
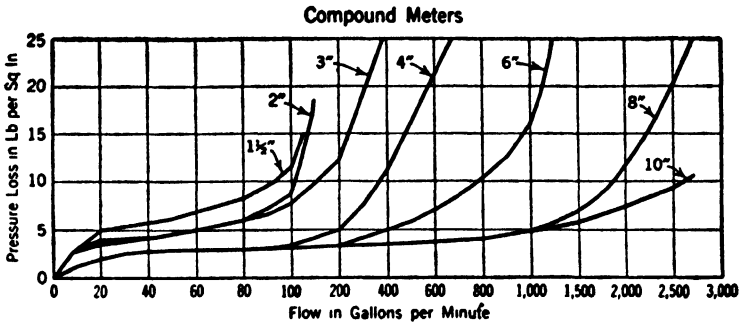

FIG. 49. Flow of Water through Meters in U. S. Gallons per Minute for Various Pressure Drops in Pounds per Square Inch. (Based on data obtained from the Neptune Meter Co., New York, N. Y.)

TABLE 37  
PRESSURE OF WATER AT DIFFERENT HEADS  
TABLE OF EQUIVALENTS

Feet of Water	Lb per Sq In.	Lb per Sq In.	Feet of Water
1	0.43	1	2.31
2	0.87	2	4.62
3	1.30	3	6.93
4	1.73	4	9.24
5	2.17	5	11.54
6	2.60	6	13.85
7	3.03	7	16.16
8	3.40	8	18.47
9	3.90	9	20.78
10	4.33	10	23.09

*Example.* To find pressure of 136 ft of water.

$$100 \text{ ft} = 43.3 \text{ lb}$$

$$30 \text{ ft} = 13.0 \text{ lb}$$

$$6 \text{ ft} = 2.6 \text{ lb}$$

$$136 \text{ ft} = 58.9 \text{ psi}$$

TABLE 38  
DISK METERS (LAMBERT)

(Flow in U. S. Gallons per Minute for Various Pressure Drops in I b per Sq In.)

Pressure Loss in Pounds per Square Inch	Size of Meter (in Inches)								
	$\frac{5}{8}$	$\frac{3}{4}$	1	$1\frac{1}{4}$	$1\frac{1}{2}$	2	3	4	6
$2\frac{1}{2}$	7.5	11.7	16.5	30	37	51	108	195	360
5	10.6	17.3	25	42	50.5	72.5	152	285	530
$7\frac{1}{2}$	13	21.4	31.5	51	62.5	89	187	360	650
10	14.6	24.5	36.5	58.5	73	102	220	420	750
$12\frac{1}{2}$	16.2	27.2	42	65	82	114	247	470	840
15	17.6	29.6	46	71	90	125	273	515	930
$17\frac{1}{2}$	18.8	32	49.5	76	97	136	295	560	1005
20	20.2	34.5	53	80	105	146	316	600	1080
$22\frac{1}{2}$	21.4	36.6	56	84	112	155	337	640	1150
25	22.6	38.7	59	88	118	165	360	673	1220

*Courtesy Neptune Meter Co., Chicago, Ill*

TABLE 39A  
FLOW OF WATER IN GALLONS PER MINUTE

Friction Loss in Psi per 100 ft		Through I.P.S. Pipe											
		Fair-Whipple-Hsiao Formula					Hazen-Williams Formula						
		$C_w = 145$											
		$\frac{3}{8}$ "	$\frac{1}{2}$ "	$\frac{3}{4}$ "	1"	$1\frac{1}{4}$ "	$1\frac{1}{2}$ "	2"	$2\frac{1}{2}$ "	3"	4"	5"	6"
		0.493	0.622	0.824	1.049	1.380	1.610	2.067	2.469	3.068	4.026	5.047	6.065
0.12	0.25	0.46	0.99	1.9	4	6	11	18	32	66	120	194	
0.25	0.37	0.70	1.5	2.9	6	9	17	27	48	98	178	289	
0.50	0.55	1.0	2.2	4.2	9	14	25	40	70	143	259	421	
0.75	0.70	1.3	2.8	5.4	11	17	31	49	87	178	323	524	
1.0	0.82	1.5	3.3	6.3	13	20	36	57	101	208	377	611	
1.5	1.0	1.9	4.2	8.0	17	26	45	71	126	259	469	760	
2.0	1.2	2.3	4.9	9.0	20	30	52	84	147	303	548	889	
2.5	1.4	2.6	5.6	11.0	22	34	59	94	166	341	618	1002	
3.0	1.5	2.9	6.2	12.0	25	38	65	104	183	377	682	1107	
4.0	1.8	3.4	7.3	14.0	29	45	76	121	214	440	796	1291	
5.0	2.1	3.8	8.3	16.0	33	51	86	137	242	497	900	1459	
6.0	2.3	4.3	9.2	18.0	37	56	95	151	267	548	993	1611	
8.0	2.7	5.0	10.8	21.0	44	66	111	177	311	640	1159	1879	
10.0	3.0	5.7	12.3	24.0	50	75	124	197	348	714	1294	2099	
12.5	3.4	6.5	13.9	27.0	56	85	141	225	396	815	1476	2393	
15.0	3.8	7.2	15.4	30.0	62	95	155	248	436	897	1626	2636	
20.0	4.5	8.5	18.2	35.0	74	112	182	290	510	1050	1901	3083	
25.0	5.1	9.6	20.6	40.0	83	127	206	327	575	1183	2143	3475	
30.0	5.7	10.7	23.0	44.0	93	141	226	361	635	1306	2366	3837	
40.0	6.7	12.5	27.0	52.0	109	166	264	421	741	1524	2761	4477	



TABLE 39B  
FLOW OF WATER IN GALLONS PER MINUTE

Friction Loss in Psi per 100 ft		Through Tubing Type L Copper											
		Fair-Whipple-Hsiao Formula					Hazen-Williams Formula						
		$C_w = 145$											
		$\frac{3}{8}$ " 0.430	$\frac{1}{2}$ " 0.545	$\frac{3}{4}$ " 0.785	1" 1.025	$1\frac{1}{4}$ " 1.265	$1\frac{1}{2}$ " 1.505	2" 1.985	$2\frac{1}{2}$ " 2.465	3" 2.945	4" 3.905	5" 4.875	6" 5.845
0.12	0.17	0.32	0.49	0.87	1.8	3.2	5	10	18	30	61	109	177
0.25	0.26	0.49	0.73	1.3	2.7	4.8	8	15	27	45	91	163	262
0.50	0.38	0.73	1.0	2.0	4.0	7.1	11	22	39	66	132	237	382
0.75	0.48	0.91	1.3	2.5	5.1	9.0	14	28	49	82	164	294	475
1.00	0.57	1.1	1.6	2.9	6.0	11.0	17	32	57	96	192	344	555
1.5	0.71	1.4	2.1	3.7	7.5	13.0	21	40	71	119	239	428	690
2.0	0.84	1.6	2.5	4.3	8.8	16.0	25	47	83	139	279	500	807
2.5	0.96	1.8	2.8	4.9	10.0	18.0	28	53	94	157	315	564	910
3.0	1.1	2.0	3.1	5.4	11.0	20.0	32	59	104	173	348	622	1005
4.0	1.2	2.4	3.4	6.4	13.0	23.0	37	68	121	202	406	726	1172
5.0	1.4	2.7	3.7	7.3	15.0	26.0	42	77	137	229	458	820	1324
6.0	1.6	3.0	4.0	8.1	17.0	29.0	47	85	151	252	506	906	1462
8.0	1.9	3.5	4.7	9.5	20.0	35.0	55	99	176	294	590	1057	1706
10.0	2.1	4.0	5.2	10.8	22.0	39.0	63	111	196	329	659	1180	1905
12.5	2.4	4.5	5.9	12.3	25.0	44.0	71	127	224	375	752	1346	2173
15.0	2.7	5.0	6.6	13.6	28.0	49.0	79	140	247	413	828	1483	2393
20.0	3.1	5.9	7.8	16.1	33.0	58.0	93	163	288	483	968	1734	2799
25.0	3.5	6.7	8.9	18.2	37.0	66.0	106	184	325	545	1091	1954	3155
30.0	3.9	7.5	10.0	20.2	41.0	73.0	117	203	359	601	1205	2158	3483
40.0	4.6	8.8	12.0	23.8	49.0	86.0	138	237	419	702	1406	2518	4064

TABLE 39C  
FLOW OF WATER IN GALLONS PER MINUTE

Friction Loss in Psi per 100 ft	Through I.P.S. Pipe											
	Fair-Whipple-Hsiao Formula						Hazen-Williams Formula					
	3/8"	1/2"	3/4"	1"	1 1/4"	1 1/2"	2"	2 1/2"	3"	4"	5"	6"
	0.493	0.622	0.824	1.049	1.380	1.610	2.067	2.469	3.068	4.026	5.047	6.065
0.12	0.22	0.41	0.87	1.7	3.5	5	10	16	29	59	107	174
0.25	0.33	0.62	1.3	2.5	5.0	8	15	24	43	88	160	259
0.50	0.49	0.91	2.0	3.8	8.0	12	22	35	62	128	232	377
0.75	0.62	1.2	2.5	4.7	10.0	15	28	44	78	160	289	469
1.0	0.73	1.4	2.9	5.6	12.0	18	32	51	91	186	337	547
1.5	0.91	1.7	3.7	7.0	15.0	23	40	64	113	232	420	681
2.0	1.1	2.0	4.3	8.0	18.0	27	47	75	132	271	491	796
2.5	1.2	2.3	4.9	9.0	20.0	30	53	84	149	306	553	897
3.0	1.4	2.5	5.5	10.0	22.0	34	58	93	164	337	611	991
4.0	1.6	3.0	6.4	12.0	26.0	39	68	109	191	394	713	1156
5.0	1.8	3.4	7.3	14.0	30.0	45	77	123	216	445	805	1306
6.0	2.0	3.8	8.1	15.0	33.0	50	85	136	239	491	889	1442
8.0	2.4	4.4	9.6	18.0	39.0	59	99	158	279	573	1038	1683
10.0	2.7	5.0	10.8	21.0	44.0	67	111	177	311	640	1159	1879
12.5	3.0	5.7	12.3	24.0	50.0	76	126	201	355	728	1321	2143
15.0	3.4	6.4	13.7	26.0	55.0	84	139	222	391	804	1455	2360
20.0	4.0	7.5	16.1	31.0	65.0	99	163	259	457	940	1702	2761
25.0	4.5	8.5	18.3	35.0	74.0	112	183	292	515	1059	1919	3112
30.0	5.0	9.4	20.3	39.0	82.0	125	202	323	569	1170	2118	3436
40.0	5.9	11.1	23.9	46.0	96.0	147	236	377	664	1365	2472	4009

**C<sub>w</sub> = 130**

TABLE 39D  
FLOW OF WATER IN GALLONS PER MINUTE

Through Tubing Type L Copper		Fair-Whipple-Hsiao Formula										Hazen-Williams Formula													
		3/8"	1/2"	3/4"	1"	1 1/4"	1 1/2"	2"	2 1/2"	3"	4"	5"	6"	3/8"	1/2"	3/4"	1"	1 1/4"	1 1/2"	2"	2 1/2"	3"	4"	5"	6"
Friction Loss in Psi per 100 ft		0.430	0.545	0.785	1.025	1.265	1.505	1.985	2.465	2.945	3.905	4.875	5.845	0.430	0.545	0.785	1.025	1.265	1.505	1.985	2.465	2.945	3.905	4.875	5.845
0.12	0.18	0.28	0.43	0.77	1.6	3	4	9	16	27	55	98	158	0.12	0.18	0.28	1.6	3	4	9	16	27	55	98	158
0.25	0.23	0.43	0.64	1.2	2.4	4	7	14	24	40	81	145	234	0.25	0.23	0.43	2.4	4	7	14	24	40	81	145	234
0.50	0.34	0.64	1.7	3.6	3.6	6	10	19	33	55	111	199	321	0.50	0.34	0.64	3.6	6	10	19	33	55	111	199	321
0.75	0.43	0.81	2.2	4.5	4.5	8	13	25	44	73	147	264	426	0.75	0.43	0.81	4.5	8	13	25	44	73	147	264	426
1.0	0.50	0.95	2.6	5.3	5.3	9	15	29	51	86	172	308	497	1.0	0.50	0.95	5.3	9	15	29	51	86	172	308	497
1.5	0.63	1.2	3.2	6.6	6.6	12	19	36	64	107	214	383	618	1.5	0.63	1.2	6.6	12	19	36	64	107	214	383	618
2.0	0.74	1.4	3.8	7.8	7.8	14	22	42	74	125	250	448	723	2.0	0.74	1.4	7.8	14	22	42	74	125	250	448	723
2.5	0.84	1.6	4.3	8.9	8.9	16	25	48	84	141	282	505	815	2.5	0.84	1.6	8.9	16	25	48	84	141	282	505	815
3.0	0.94	1.8	4.8	9.8	9.8	17	28	53	93	155	311	557	900	3.0	0.94	1.8	9.8	17	28	53	93	155	311	557	900
4.0	1.1	2.1	5.7	12.0	12.0	21	33	61	108	182	363	650	1050	4.0	1.1	2.1	12.0	21	33	61	108	182	363	650	1050
5.0	1.3	2.4	6.4	13.0	13.0	23	37	69	122	205	410	735	1186	5.0	1.3	2.4	13.0	23	37	69	122	205	410	735	1186
6.0	1.4	2.6	7.1	15.0	15.0	26	41	76	135	226	453	811	1309	6.0	1.4	2.6	15.0	26	41	76	135	226	453	811	1309
8.0	1.6	3.1	8.4	17.0	17.0	30	49	89	157	264	528	946	1528	8.0	1.6	3.1	17.0	30	49	89	157	264	528	946	1528
10.0	1.9	3.5	9.6	20.0	20.0	35	55	100	176	294	590	1057	1706	10.0	1.9	3.5	20.0	35	55	100	176	294	590	1057	1706
12.5	2.1	4.0	10.8	22.0	22.0	39	63	114	200	336	673	1205	1945	12.5	2.1	4.0	22.0	39	63	114	200	336	673	1205	1945
15.0	2.3	4.5	12.1	25.0	25.0	44	70	125	221	370	741	1327	2143	15.0	2.3	4.5	25.0	44	70	125	221	370	741	1327	2143
20.0	2.8	5.3	14.2	29.0	29.0	51	82	146	258	433	867	1552	2506	20.0	2.8	5.3	29.0	51	82	146	258	433	867	1552	2506
25.0	3.1	6.0	16.1	33.0	33.0	58	93	165	291	488	977	1750	3119	25.0	3.1	6.0	33.0	58	93	165	291	488	977	1750	3119
30.0	3.5	6.6	17.9	37.0	37.0	65	103	182	321	538	1079	1932	3639	30.0	3.5	6.6	37.0	65	103	182	321	538	1079	1932	3639
40.0	4.1	7.8	21.0	43.0	43.0	76	121	212	375	628	1259	2254		40.0	4.1	7.8	43.0	76	121	212	375	628	1259	2254	

C<sub>w</sub> = 130

TABLE 39E  
FLOW OF WATER IN GALLONS PER MINUTE

Friction Loss in Psi per 100 ft		Through I.P.S. Pipe											
		Fair-Whipple-Hsiao Formula					Hazen-Williams Formula						
		3/8"	1/2"	3/4"	1"	1 1/4"	1 1/2"	2"	2 1/2"	3"	4"	5"	6"
		0.493	0.622	0.824	1.049	1.380	1.610	2.067	2.469	3.068	4.026	5.047	6.065
0.12	0.21	0.39	0.58	0.81	1.5	3.1	4.6	9	14	26	52	95	154
0.25	0.31	0.58	0.83	1.2	2.2	4.6	6.8	13	22	38	78	141	229
0.50	0.45	1.0	1.7	2.5	3.2	6.6	10.0	20	31	55	114	206	333
0.75	0.55	1.0	2.1	3.9	3.9	8.0	12.0	24	39	69	141	256	415
1.0	0.65	1.2	2.5	4.7	4.7	9.5	14.0	29	46	80	165	299	484
1.5	0.81	1.5	3.1	5.8	5.8	12.0	18.0	35	57	100	205	372	603
2.0	0.94	1.7	3.6	6.7	6.7	14.0	21.0	42	66	117	240	435	705
2.5	1.1	2.0	4.0	7.6	7.6	15.0	23.0	47	75	132	270	490	794
3.0	1.2	2.1	4.5	8.4	8.4	17.0	25.0	52	82	145	299	541	877
4.0	1.4	2.5	5.2	10.0	10.0	20.0	30.0	60	96	169	348	631	1023
5.0	1.5	2.8	5.8	11.0	11.0	22.0	33.0	68	109	191	394	713	1156
6.0	1.7	3.1	6.4	12.0	12.0	25.0	37.0	75	120	211	435	787	1276
8.0	2.0	3.6	7.5	14.0	14.0	29.0	43.0	88	140	247	507	918	1489
10.0	2.2	4.1	8.4	16.0	16.0	32.0	48.0	98	156	275	566	1026	1663
12.5	2.5	4.6	9.5	18.0	18.0	36.0	54.0	112	178	314	646	1169	1897
15.0	2.7	5.0	10.0	20.0	20.0	40.0	60.0	123	196	346	711	1288	2089
20.0	3.2	5.9	12.0	23.0	23.0	47.0	70.0	144	230	405	832	1507	2443
25.0	3.6	6.6	14.0	26.0	26.0	52.0	78.0	162	259	456	938	1698	2754
30.0	4.0	7.3	15.0	28.0	28.0	58.0	86.0	179	286	504	1035	1875	3041
40.0	4.6	8.5	18.0	33.0	33.0	67.0	101.0	209	333	588	1208	2188	3548

C<sub>w</sub> = 115

TABLE 39F  
FLOW OF WATER IN GALLONS PER MINUTE

Friction Loss in Psi per 100 ft		Through I.P.S. Pipe $C_w = 100$											
		Fair-Whipple-Hsiao Formula					Hazen-Williams Formula						
		3/8"	1/2"	3/4"	1"	1 1/4"	1 1/2"	2"	2 1/2"	3"	4"	5"	6"
		0.493	0.622	0.824	1.049	1.380	1.610	2.067	2.469	3.068	4.026	5.047	6.065
0.12	0.19	0.36	0.49	0.64	0.81	1.00	1.21	1.44	1.69	2.06	2.56	3.19	3.94
0.25	0.27	0.50	0.67	0.88	1.12	1.39	1.69	2.02	2.39	2.88	3.50	4.26	5.15
0.50	0.39	0.72	0.98	1.28	1.63	2.03	2.48	2.97	3.51	4.10	4.83	5.69	6.68
0.75	0.48	0.88	1.18	1.53	1.93	2.38	2.88	3.42	4.00	4.62	5.28	6.00	6.85
1.00	0.57	1.0	1.3	1.7	2.1	2.5	3.0	3.5	4.1	4.7	5.4	6.2	7.1
1.5	0.71	1.3	1.7	2.2	2.7	3.3	3.9	4.6	5.3	6.1	7.0	8.0	9.1
2.0	0.82	1.5	2.0	2.6	3.2	3.9	4.7	5.5	6.4	7.4	8.5	9.7	11.0
2.5	0.93	1.7	2.2	2.9	3.6	4.4	5.3	6.3	7.4	8.6	9.9	11.3	12.9
3.0	1.0	1.9	2.4	3.1	3.9	4.8	5.8	6.9	8.1	9.4	10.9	12.5	14.3
4.0	1.2	2.2	2.8	3.6	4.5	5.5	6.6	7.8	9.2	10.7	12.4	14.2	16.3
5.0	1.3	2.4	3.1	4.0	5.0	6.1	7.3	8.6	10.1	11.7	13.5	15.5	17.8
6.0	1.5	2.7	3.5	4.5	5.6	6.8	8.1	9.5	11.1	12.8	14.7	16.8	19.3
8.0	1.7	3.1	4.0	5.1	6.3	7.6	9.1	10.7	12.4	14.3	16.4	18.7	21.4
10.0	1.9	3.5	4.5	5.7	7.0	8.4	10.0	11.7	13.6	15.6	17.8	20.2	23.0
12.5	2.2	4.0	5.1	6.4	7.8	9.3	11.0	12.8	14.8	17.0	19.4	22.0	25.0
15.0	2.4	4.4	5.6	7.0	8.5	10.1	11.9	13.8	16.0	18.3	20.9	23.6	26.8
20.0	2.8	5.1	6.4	8.0	9.7	11.5	13.5	15.6	18.0	20.6	23.4	26.4	30.0
25.0	3.1	5.8	7.2	8.9	10.8	12.8	14.9	17.1	19.6	22.3	25.2	28.4	32.0
30.0	3.5	6.3	7.8	9.6	11.6	13.7	15.9	18.2	20.9	23.8	26.8	30.1	34.0
40.0	4.0	7.4	9.1	11.1	13.3	15.6	18.1	20.8	23.8	27.0	30.4	34.1	38.8

### Hot-Water Lines

*Service Characteristics.* The sizing of hot-water supply lines presents no problem not already discussed under cold-water lines. The only difference is the lower coefficient of viscosity for water of higher temperatures which changes the value of the coefficient  $C_w$ . (See Table 36, p. 136.)

*Return Lines.* The same rules applying for cold-water systems should be used for hot-water supply lines. After the supply lines are sized, the only problem left is to determine the return lines in cases where a circulating system is used.

As already pointed out, whether the circulating system operates by gravity or by pump, the return lines should be figured to give the least possible friction losses. Any system should preferably be designed with the idea of using gravitation as the motive force, and only where this is found impossible should a pump be installed. Even where a pump is used it is advantageous to design the system so that the pump will operate with the least amount of work.

The temperature difference,  $t_o$ , is the driving force. The greater it is, the easier the circulation; but, on the other hand, the greater is the expense in heat loss. The ideal thing is to design a system with as great a  $t_o$  as possible, obtained not by actual great heat loss but by employing an efficient layout which makes the temperature differences in the supply and return risers a maximum and otherwise to obtain as much column height as practical.

In the following discussion, in order to eliminate as many unknown factors as possible, we are assuming a  $t_o$  of 5 F. This figure will be changed only if the computations show it to be necessary.

The permissible temperature difference,  $t_o$ , should be treated purely as an economical factor. Every degree of temperature loss is an added expense.

It is considered the best policy to assume or establish a figure for  $t_o$  and to change it only if the computations prove it to be advisable.

The problem resolves itself into: (1) assume a value for  $t_o$ ; (2) find the flow of circulating water in gallons per minute; (3) compute the available head in millinches, deduct the loss in head, and then on the basis of any surplus head, if any; (4) select from the table the proper pipe size. If the flow of circulating water becomes a large factor the supply pipes shall be refigured to accommodate this amount. On large systems the smaller branches usually will be affected.

The following symbols are used:

- $d$  = Nominal diameter of pipe.
- $p$  = Pounds of water per foot of pipe.
- $L$  = Linear feet of pipe.
- $B_p$  = Permissible heat loss in Btu per hour.
- $B_a$  = Actual heat loss in Btu per hour.

- $t_o$  = Permissible temperature difference in deg F between supply and return.  
 $k$  = Heat transmission in Btu per deg F temperature difference per linear foot of pipe.  
 $m$  = Circulation time in minutes.  
 $H_i$  = Available head in feet.  
 $G$  = Rate of flow in gallons per minute.  
 $t_e$  = Temperature difference between water in pipe and the air in the building.

To analyze the problem, let us assume a simple system as shown (Fig. 50).

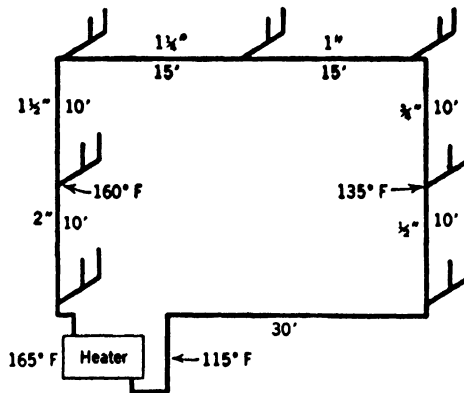

FIG. 50. Sample Circulation System.

The supply lines have already been determined.

Assume a heater temperature of 165 F and a minimum temperature of 130 F at the last fixture. This gives a temperature drop of 35 F per 70 ft of pipe or 5 F per 10 ft. From this we can mark the average temperature in the risers, namely, 160 F in the supply riser and 135 F in the return riser. The difference between the two,  $t_o$ , is 25 F.

To find the size of the return pipe, we must in addition know how much flow takes place by the circulating water. It is necessary then to compute the total amount of water in the system expressed in pounds and to multiply it with the allowable temperature drop to find the total Btu loss permissible.

The entire system should for computation purposes be considered at rest. As such it will emit a certain amount of heat.

The following tables give the heat losses for pipes under varying conditions. The degree of insulation must be determined and some fair assumption made of the temperature in the building spaces.

TABLE 40

HEAT RADIATION FROM PIPES

(In Btu per Hr per Lin Ft per Deg Temp. Difference—Based on 70 F Temp. Difference)

Size Pipe, Inches	Bare Pipes		Air-Cell 4-Corr. per Inch		85% Magnesia Std. Thickness
	Black Iron*	Copper, oxidized	3-ply	4-ply	
1/2	0.57	0.34	0.218	0.194	0.120
3/4	0.68	0.41	0.25	0.22	0.132
1	0.82	0.49	0.29	0.254	0.152
1 1/4	1.02	0.61	0.335	0.29	0.172
1 1/2	1.15	0.69	0.36	0.32	0.184
2	1.40	0.84	0.42	0.37	0.196
2 1/2	1.65	0.99	0.475	0.42	0.230
3	1.96	1.08	0.55	0.49	0.255
4	2.46	1.48	0.655	0.58	0.296
5	3.00	1.80	0.78	0.69	0.340
6	3.54	2.12	0.89	0.81	0.384

\* Also any pipe covered with pigment paint

Figures above are for horizontal pipes. There is, however, little difference between losses for horizontal and vertical piping.

TABLE 41

TRIAL TEMPERATURES FOR HOT-WATER STORAGE SYSTEMS\*

Private houses under 4 stories	130 F
For each additional floor	5 F
Apartment houses under 6 stories	135 F
For each additional floor (180° max)	5 F
Offices and lofts under 6 stories	125 F
For each additional 2 floors	5 F
Hotels	160-180 F
Public baths, gymnasiums, etc.	125 F
For dishwashing machines†	160 F

\* From *Water Heating*, courtesy of American Gas Assoc., New York, N. Y.

† Code requirement may demand higher temperatures.

Actual heat loss,  $B_a$ , in Btu per hour, is the total heat emission per hour in the system:

$$B_a = \Sigma kt_e L \tag{1}$$

The permissible heat loss,  $B_p$ , in Btu, is the total heat emission allowable in the system in order not to exceed the permissible temperature



difference,  $t_o$ . If  $L$  is equal to the linear feet of pipe and  $p$  is the pounds of water per foot of pipe, then

$$B_p = \Sigma(pL)t_o \quad (2)$$

Circulation time,  $m$ , in minutes, must then be the time required to move the complete quantity of water in the system so that the heat loss stays within the limit of the allowable heat loss,  $B_a$ .

$$m = \frac{B_p(\text{Btu}) \times 60 (\text{min per hr})}{B_a(\text{Btu per hr})} \quad (3)$$

Rate of flow in gallons,  $G$ , then becomes

$$G = \frac{\Sigma(p \times L)}{8.4 \times m} \text{ gpm}$$

From equation 3 we then have

$$G = \frac{B_a}{t_o \times 504} \quad (4)$$

Thus in the case above (Fig. 50) we can tabulate the figures as follows, assuming a standard thickness 85% magnesia covering and an average building space temperature of 70 F; mean temperature in hot-water lines is  $(165 + 130)\frac{1}{2} = 147.5$ , say 150 F. The heat difference,  $t_e = 80$  F.

SAMPLE TABULATION OF HEAT LOSSES IN PIPES

$$t_e = 80 \text{ F}$$

Diam pipe $d$	Length pipe $L$	$k$	$k \times t_e \times L$
$\frac{1}{2}$	10	0.120	96
$\frac{3}{4}$	10	0.132	106
1	15	0.152	182
$1\frac{1}{4}$	15	0.172	206
$1\frac{1}{2}$	10	0.184	147
2	10	0.196	157

Sum: 894 Btu per hr =  $B_a$

$$G = \frac{894}{35 \times 504} = 0.06 \text{ gal per min (equation 4)}$$

The available head in millinches is found from Table 42.

The average temperature in the return riser is 135 F, which gives a head per foot of 11,824 millinches; the temperature in the supply riser is 160 F, which gives a head per foot of 11,734 millinches. The difference is 90 millinches per foot. The column being 20 ft high, the total available head is  $90 \times 20 = 1800$  millinches.

TABLE 42

TABLE OF DIFFERENCES IN WEIGHT OF WATER

Temp, °F	Lb per cu ft	Millinches per ft
80	62.186	11,970
85	62.137	11,959
90	62.084	11,948
95	62.027	11,937
100	61.965	11,926
105	61.899	11,913
110	61.830	11,899
115	61.758	11,885
120	61.682	11,871
125	61.603	11,856
130	61.521	11,840
135	61.435	11,824
140	61.347	11,807
145	61.257	11,789
150	61.163	11,771
155	61.068	11,752
160	60.970	11,734
165	60.870	11,715
170	60.767	11,695
175	60.662	11,675
180	60.557	11,655
185	60.449	11,634
190	60.339	11,613
195	60.227	11,592
200	60.115	11,570

Loss of head is found from Table 43 for 0.06 gpm.

Go down each column corresponding to pipe diameter until a flow closest to the one desired is found. Read then in the extreme left column the drop in millinches, e.g., in the  $\frac{1}{2}$ -in. column the figure 0.059 comes closest to 0.06 gpm. Following this line to the left 0.9 is found in the column showing drop in millinches per foot.

TABLE 43

FLOW OF WATER IN GALLONS PER MINUTE

THROUGH I.P.S. Pipe

$C_w = 145$

Drop in Mill- inches per foot	Drop in feet per 1000 ft	Fair-Whipple-Hsiao Formula						Williams-Hazen		
		$\frac{3}{8}$	$\frac{1}{2}$	$\frac{3}{4}$	1	$1\frac{1}{4}$	$1\frac{1}{2}$	2	$2\frac{1}{2}$	3
0.1	0.008	0.009	0.017	0.036	0.069	0.146	0.222	0.413	0.658	1.16
0.2	0.017	0.013	0.025	0.054	0.104	0.219	0.333	0.618	0.984	1.73
0.3	0.025	0.017	0.031	0.068	0.129	0.272	0.414	0.775	1.225	2.16
0.4	0.033	0.020	0.037	0.079	0.151	0.319	0.485	0.902	1.436	2.53
0.5	0.042	0.022	0.042	0.091	0.173	0.366	0.556	1.033	1.644	2.89
0.6	0.050	0.025	0.047	0.100	0.192	0.404	0.614	1.140	1.815	3.20
0.7	0.058	0.027	0.051	0.109	0.208	0.440	0.669	1.24	1.98	3.48
0.8	0.067	0.029	0.055	0.118	0.226	0.476	0.724	1.35	2.17	3.82
0.9	0.075	0.031	0.059	0.126	0.242	0.509	0.774	1.44	2.32	4.08
1	0.084	0.033	0.063	0.135	0.258	0.543	0.83	1.54	2.44	4.31
2	0.167	0.049	0.093	0.199	0.381	0.804	1.22	2.27	3.61	6.37
3	0.251	0.062	0.117	0.251	0.481	1.014	1.54	2.86	4.56	8.04
4	0.333	0.073	0.137	0.295	0.565	1.19	1.81	3.37	5.36	9.44
5	0.420	0.083	0.156	0.337	0.644	1.36	2.07	3.84	6.11	10.76
6	0.500	0.092	0.173	0.373	0.713	1.50	2.29	4.25	6.76	
7	0.583	0.101	0.189	0.407	0.778	1.64	2.50	4.64	7.38	
8	0.667	0.108	0.204	0.439	0.840	1.77	2.69	5.00	7.96	
9	0.750	0.116	0.218	0.478	0.898	1.89	2.88	5.35	8.51	
10	0.840	0.124	0.232	0.500	0.957	2.02	3.07	5.70	9.08	
15	1.26	0.156	0.293	0.63	1.21	2.54	3.86	7.18	11.43	
20	1.67	0.175	0.328	0.71	1.35	2.85	4.34	8.05		
25	2.09	0.208	0.391	0.84	1.61	3.40	5.16	9.59		
30	2.51	0.231	0.434	0.93	1.79	3.77	5.73	10.64		
35	2.93	0.252	0.473	1.02	1.95	4.11	6.25			
40	3.33	0.272	0.509	1.10	2.10	4.43	6.73			
45	3.75	0.290	0.545	1.17	2.24	4.73	7.20			
50	4.16	0.308	0.578	1.25	2.38	5.02	7.64			
60	5.00	0.342	0.643	1.38	2.65	5.59	8.49			
70	5.83	0.374	0.701	1.51	2.89	6.10	9.27			
80	6.67	0.403	0.757	1.63	3.12	6.58	10.00			
90	7.50	0.431	0.809	1.74	3.33	7.03	10.70			
100	8.40	0.460	0.863	1.86	3.56	7.49				
120	10.00	0.508	0.953	2.05	3.93	8.28				

Allowance should be made in the column showing length of pipe,  $L$ , for loss of head through fittings.

$d$	$L$	Drop in millinches per ft	Total drop
$\frac{1}{2}$ "	12	0.9	10.8
$\frac{3}{4}$ "	12	0.2	2.4
1"	17	0.1	1.5
$1\frac{1}{4}$ "	17	—	—
$1\frac{1}{2}$ "	12	—	—
2"	12	—	—

} Too small to be considered

Sum = 14.7

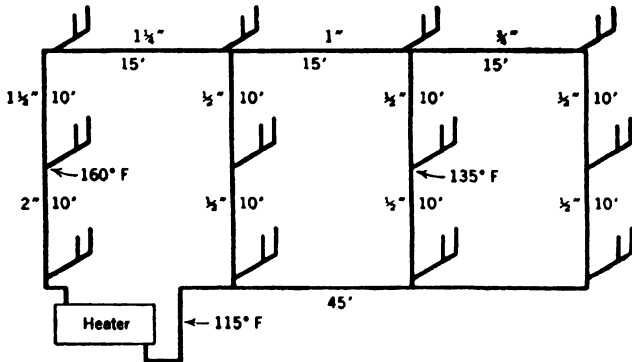

FIG. 51A.

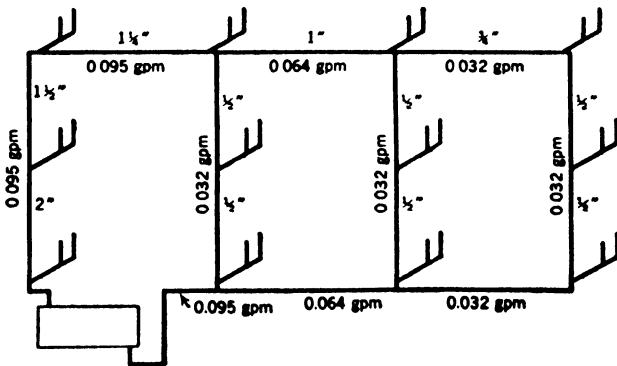

FIG. 51B.

Sample Circulation System.

Available head less loss of head =  $1800 - 14.7 =$  say, 1785. Permissible loss of head through return pipe per foot, allowing for fittings =  $1785 : 34 = 53$  millinches per foot. With a flow of 0.060 gpm it can be seen from Table 43 that a  $\frac{3}{8}$ -in. pipe will be quite large enough.

For multiple risers the following method may be used (see Fig. 51(A)):

(a) For temperature differences, use the difference between average temperature of supply riser and the average temperature of the return riser nearest the center of the group.

(b) Calculate the combined heat drop of all risers.

(c) And, in figuring the drop in millinches per foot, the calculated flow in gallons per minute must be divided proportionally between the risers. The pressure drop equals the pressure drop for one riser only. For this calculation, use the most distant riser and omit the other risers from the calculations.

*Example* (See Fig. 51A.)

HEAT LOSSES ( $t_e = 80$  F)

Diam Pipe $d$	Length of Pipe $L$	$k$	$k \times t_e \times L$
$\frac{1}{2}$	60	0.120	580
$\frac{3}{4}$	15	0.132	160
1	15	0.152	182
$1\frac{1}{4}$	15	0.172	206
$1\frac{1}{2}$	10	0.184	147
2	10	0.196	157
			1432

$$G = \frac{1432}{35 \times 504} = 0.095 \text{ gpm}$$

Available head in millinches is found from Table 42. The average temperature in the middle return riser is 135 F, which gives a head per foot of 11,824 millinches; the temperature in the supply riser is 160 F, which gives a head per foot of 11,734 millinches. The difference is 90 millinches per foot or  $20 \times 90 = 1800$  millinches for the total column height. (The head remains the same no matter how many risers there are.)

Loss of head is found by first dividing the flow of 0.095 gpm between the three risers, i.e., about 0.032 gpm for each riser. (See Fig. 51B.)

PRESSURE DROPS

<i>d</i>	<i>L</i> , plus allowance for fittings	Drop in millinches per foot	Total drop
½" for 0.032 gpm	24	0.3	7.2
¾" for 0.032 gpm	17	0.1	1.7
1" for 0.064 gpm	17	0.1	1.7
1¼" for 0.095 gpm	Too small to be considered		
1½" for 0.095 gpm			
2" for 0.095 gpm			

Sum = 10.6

Available head less loss of head = 1800 - 10.6 = say, 1789 millinches.

Permissible loss of head through return riser (allowing for fittings) = 1789 : 51 = 35 millinches per foot.

From Table 43, we have:

For a flow of 0.095 gpm

For a flow of 0.064 gpm ½" sufficient in each case.

For a flow of 0.032 gpm

TABLE 44

SIZES OF HOT-WATER RISERS (19)

(Use for rough checking only)

Gallons per Maximum Hour	Size of Riser (inches)
500	2
750	2½
1000	2½
1250	3
1500	3
1750	3½
2000	3½
2500	4
3000	4

*Air in Pipes.* Hot-water pipes should be installed so that no air pockets are formed.

The hotter the water the more air is liberated. Most of this air is liberated in the heater, and comparatively small amounts reach the top of the system.

Provisions should be made at top of system for escape of air by installing a fixture at the highest point or an air valve.

In addition, there should be an air valve near the heater.

**Heat Traps.** While little is understood about the phenomenon known as one-pipe hot-water circulation, it is recognized, particularly in the larger pipe sizes and in vertical risers which start close to storage tanks, that convection currents arise within hot-water pipes and tend to cool off tank water while drawing hot water into the system, even though

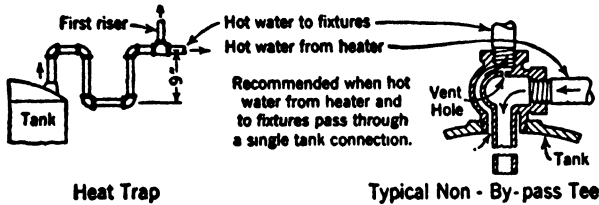

FIG. 52. (From *Domestic Hot Water Systems*, by T. S. Rogers (19).)

there may be no demand. Such partial one-pipe circulation may be easily detected by touching such a pipe; temperatures increase towards the heater.

To eliminate any possibility of such heat losses and consequent fuel wastage, heat traps are recommended. Heat traps consist of double bends of piping and may be made up of standard pipe and fittings, or bent from tubing, or patented types may be purchased. Their use with circulating systems is not recommended, as they may slow up circulation when so used (19).

**Leaking Faucets.** Aside from the use of too large piping, the most common cause of hot-water waste, resulting in excessive fuel costs, is leaking faucets. A single faucet which leaks one drop per second may waste as much as 192 gal of water per month. The ratio increases until, if the faucet leaks in a smooth stream approximately 6 in. long, the total waste may amount to 1290 gal per month. In terms of extra gas consumed, this may mean 380 to over 4000 cu ft—sizable portions of the monthly bills. For this reason, hot-water faucets, particularly, should be kept in good repair (19).

### Hot-Water Systems for Small-to-Average-Sized Installations \*

When the demand for hot water is relatively constant, when economy in both installation and operation is a necessary factor, and when systems are reasonably small, direct systems are desirable. Installations which are characterized by these factors include: small to average-sized houses of moderate cost; small restaurants, usually of the two and three meal a day class; small clubs; the usual two-story "taxpayer" with stores and offices; and group housing developments.

\* Adapted from *Domestic Hot Water Systems*, by T. S. Rogers, Assoc. of Gas Appliance and Equipment Manufacturers, New York, N. Y.

Fundamentals of system design, previously discussed, should be scrupulously observed if the most satisfactory performance and the greatest economy are to be obtained. No matter what the type of system, piping or tubing sizes should be the smallest which are consistent with the given conditions of pressure, type of outlet (or demand), and length of run. The principal advantages of small-sized pipes are due to the fact that comparatively little hot water stands in them between demands; while in larger pipes, greater quantities of hot water stand, cool, and must be drawn off and wasted before fresh hot water is obtained. Heaters should be as centrally located as possible; insulation of tanks, and preferably of at least exposed cellar runs of piping, is desirable. Automatic storage heater tanks are, of course, supplied with insulation by manufacturers (19).

### *Types of Direct Systems*

There are two principal types: (1) the type in which individual hot-water lines, usually copper tubing, run directly from a short manifold or pipe header at the heater to each outlet; and (2) the type with a relatively long main, usually at basement ceiling level, from which risers run to each fixture or group of fixtures.

Type I has been fully discussed before; it is particularly suitable to low cost houses which contain one bath or a bath and lavatory. It is also possible to use this system in houses having more bathrooms, provided all hot-water outlets are reasonably close together.

Type II is suitable for small and average-sized jobs in which a compact layout is impossible. It may be used with some degree of success for all small installations, but maximum economies will not be achieved. Some designers recommend that, in any event, a separate line of copper tubing be run directly to the kitchen sink. Using small-sized copper tubing to this outlet should result in substantial economies (19).

### *Systems for Group Housing Developments*

Group housing developments may be supplied with hot water through centralized heaters serving a number of dwelling units, or by individual heaters and systems for each dwelling unit. Although local conditions will always have some bearing on the choice of method, the individual systems are usually preferable.

The prime purpose of most such developments is low-rent housing. Types of buildings which place upon tenants' shoulders the bulk of the responsibility for maintenance are preferred; most of these are spread out horizontally. Use of centralized water heating systems for such structures involves costly installations and allocates maintenance and operating charges to the project management. Use of individual systems reduces installation cost, particularly with direct copper tubing systems; maintenance charges are reduced since each tenant has his own system to look after; and operating costs are borne directly by the tenant. Since a householder who pays for his own water and water heating is likely to be careful in using it, waste is reduced. The monthly cost to each tenant will ordinarily tend to be smaller if individual hot-water heating systems are used and the savings to the project are applied to the rent.



TABLE 45

## SELECTION OF SIZE OF COPPER TUBE (19)

Length of Tube Permissible at Various Street-Main Pressures \*

Size of tube	To Kitchen Sink, Bathtub, Laundry Tub, or 4-inch Shower Head, Flow 4 Gallons Per Minute Street-Main Pressure, Pounds Per Square Inch					90 lb
	40 lb	50 lb	60 lb	70 lb	80 lb	
¼ inch	13'	18'	23'	29'	34'	40'
⅜ inch	62'	87'	110'	137'	160'	187'
½ inch	178'	250'	320'	390'	460'	530'
Size of tube	To Wash Basin, Flow 2 Gallons Per Minute Street-Main Pressure, Pounds Per Square Inch					90 lb
	40 lb	50 lb	60 lb	70 lb	80 lb	
¼ inch	50'	70'	90'	110'	130'	150'
⅜ inch	190'	260'	340'	420'	540'	620'
Size of tube	To 6-inch Shower Head, Flow 5.7 Gallons Per Minute Street-Main Pressure, Pounds Per Square Inch					90 lb
	40 lb	50 lb	60 lb	70 lb	80 lb	
⅜ inch	34'	47'	60'	74'	88'	100'
½ inch	100'	140'	180'	220'	260'	300'
⅝ inch	280'	390'				
Size of tube	To 8-inch Shower Head, Flow 8.6 Gallons Per Minute Street-Main Pressure, Pounds Per Square Inch					90 lb
	40 lb	50 lb	60 lb	70 lb	80 lb	
⅜ inch	16'	23'	30'	36'	43'	50'
½ inch	47'	68'	88'	108'	127'	147'
⅝ inch	139'	194'	250'	300'		

\* For fixtures on the second floor, deduct 5 lb from the available street-main pressures; and for fixtures on the third floor deduct 9 lb.

TABLE 46

SELECTION OF RIGID PIPE (STANDARD PIPE SIZES) (19)

Length of Pipe Permissible at Various Street-Main Pressures \*

Size of pipe	To Kitchen Sink, Bathtub, Laundry Tub, or 4-inch Shower Head, Flow 4 Gallons Per Minute					90 lb
	Street-Main Pressure, Pounds Per Square Inch					
	40 lb	50 lb	60 lb	70 lb	80 lb	
¼ inch	16'	23'	29'	35'	42'	48'
⅜ inch	76'	106'	136'	166'	197'	227'
½ inch	278'	389'	500'	612'	720'	830'
Size of pipe	To Wash Basin, Flow 2 Gallons Per Minute					90 lb
	Street-Main Pressure, Pound Per Square Inch					
	40 lb	50 lb	60 lb	70 lb	80 lb	
¼ inch	52'	73'	93'	114'	135'	156'
⅜ inch	250'	350'	450'	550'	650'	750'
Size of pipe	To 6-inch Shower Head, Flow 5.7 Gallons Per Minute					90 lb
	Street-Main Pressure, Pounds Per Square Inch					
	40 lb	50 lb	60 lb	70 lb	80 lb	
⅜ inch	40'	56'	72'	88'	104'	120'
½ inch	143'	200'	256'	314'	371'	428'
¾ inch	556'	778'	1000'	1220'	1500'	1670'
Size of Pipe	To 8-inch Shower Head, Flow 8.6 Gallons Per Minute					90 lb
	Street-Main Pressure, Pounds Per Square Inch					
	40 lb	50 lb	60 lb	70 lb	80 lb	
⅜ inch	19'	26'	34'	41'	49'	47'
½ inch	67'	93'	120'	147'	173'	200'
¾ inch	278'	389'	599'	610'	722'	833'

\* For fixtures on the second floor, deduct 5 lb from the available street-main pressures; and for fixtures on the third floor deduct 9 lb.

## Hot-Water Systems for Large Installations (19)

For the various types of building which come under this classification, various adaptations of the circulating type of hot-water system are suitable. In general, circulating systems consist of branches fed from one or more supply mains, the mains being returned to the gas hot-water heater. They are almost instantly responsive to demands for hot water; more expensive than direct systems in operation; and, due to the continuous flow of hot water, ordinarily not suitable for use with instantaneous heaters. Descriptions of the many kinds of circulating systems are given below, with general recommendations for the use of each kind. In some border-line cases, such as good-sized residences which are extremely compact, direct hot-water systems can satisfy "luxury" demands almost as well as circulating systems; and the economies of direct piping merit serious consideration.

### (a) Basic Design Data

Certain requirements apply to all types of circulating systems, as follows:

1. *Insulation* of at least the circulation piping is essential for economy.
2. *Pitch* of all horizontal piping should be at least  $\frac{1}{16}$  in. per foot, preferably  $\frac{1}{8}$  in. per foot.
3. *Drips* should be sufficient in number and properly located to drain all hot-water piping and storage tanks.
4. *Shut-off valves* are necessary to close hot-water return circulation, to close individual risers in case of repairs or other emergencies. These valves may be tagged or otherwise permanently identified so that the non-technical user can operate them intelligently. The riser to each fixture may also be valved.
5. *Check valves* are desirable on the heater return from tank, cold-water supply to heater, and on the hot-water return circulation line.
6. A *pressure relief valve* should be installed on the cold-water line to the storage tank or a combination temperature and pressure relief valve on the hot-water main. An automatic gas shut-off plus a pressure relief valve is an alternate for safety protection.
7. *Risers* to individual fixtures should not be less than  $\frac{1}{2}$  inch (iron pipe size) for laundry tubs, sinks or bathtubs and showers;  $\frac{3}{8}$  inch for lavatories.

### (b) Types of Circulating Systems (See Fig. 43.)

*Semi-circulating* systems consist of a circulating line, supply and return, which usually runs around basement ceiling; from this, direct, non-circulating risers feed groups of fixtures. This type of system is suitable for larger private homes, small apartments and two-family houses with unified hot-water systems, and other buildings which spread out over considerable area yet are not more than two or three stories, plus basement, in height.

A variation on this type consists of a supply main which serves part of the fixtures, the remainder being tapped from a return main. Circulation between the supply and return is provided by a piping loop or loops concealed in second floor ceiling or attic construction. This type is probably limited economically

to buildings of moderate extent. A third type, more elaborate yet perhaps more economical for buildings of greater extent, employs a supply main at basement ceiling level from which basement and first floor fixtures are served. Second floor fixtures are served (preferably in groups) by risers which return to basement level, are interconnected, and extended as a single circulation return to the storage tank.

*Circulating systems* are of two main types: *single loop* and *multiple loop*, both of which may be further described as *up-feed*, *down-feed*, or *combined up-and-down feed*, depending on the location of branch and riser tapplings. While all are suitable for most multi-story buildings, the multiple loop system is particularly suited to buildings such as hospitals or other institutions requiring constantly instantaneous hot-water supply at all fixtures. When used for this type of demand, up-feed is usually recommended. Single loop systems are suited to buildings of medium size; multiple loop systems in general to larger ones.

#### (c) *Designing Complicated Systems*

Sizes of piping are difficult to determine exactly for larger buildings. In most cases, engineering knowledge is essential. Requirements of building and sanitary codes and of fire underwriters should always be consulted in determining piping sizes and locations. In addition to the data noted under "Basic Design," check valves may be required at other points in the systems; and for multi-story buildings particularly, an expansion pipe may be required. This runs from the topmost point of the supply system and discharges into the house water tank on the roof, if possible.

**TABLE 47**  
**APARTMENT HOUSE PIPING**  
**SIZE OF HOT-WATER SUPPLY RISERS IN INCHES (19)**

	Number of Apartments per Floor Supplied by One Riser														
	One			Two			Four			Six			Eight		
No. Baths per Apartment	1	2	3	1	2	3	1	2	3	1	2	3	1	2	3
Furthest floor supplied	¾	1	1¼	1	1½	1½	1½	2	2	1½	2	2½	2	2½	2½
Next	1	1¼	1½	1¼	2	2	2	2½	2½	2	2½	3	2½	3	3
Next	1¼	1½	1½	1½	2	2	2	2½	3	2½	3	3	2½	3½	3½
Next	1¼	1½	2	1½	2	2½	2	2½	3	2½	3	3½	2½	3½	4
Next	1¼	1½	2	1½	2	2½	2	3	3	2½	3	3½	3	3½	4
Next	1¼	1½	2	1½	2	2½	2	3	3	2½	3	3½	3	3½	4
Next	1¼	1½	2	1½	2	2½	2	3	3	2½	3	3½	3	3½	4
Next	1¼	2	2	2	2½	2½	2½	3	3	2½	3½	4	3	4	4
Next	1½	2	2	2	2½	2½	2½	3	3½	3	3½	4	3	4	4
Next	1½	2	2	2	2½	3	2½	3½	3½	3	4	4	3½	4	4

**SIZE OF MAINS AND METERS (pressure drop = 10 lb per 100 ft)**

No. of Baths	Apartments per Floor							
	Four		Six		Eight		Ten	
	Gal	Main	Gal	Main	Gal	Main	Gal	Main
<b>4 and 5 Story Buildings</b>								
1	120	2½	160	3	200	3	240	3
2	160	3	200	3	240	3	280	3
3	200	3	240	3	280	3	320	3½
<b>6, 7, 8 Stories</b>								
1	150	2½	190	3	230	3	270	3
2	190	3	230	3	270	3	310	3½
3	230	3	270	3	310	3½	350	3½
<b>9, 10, 11, 12 Stories</b>								
1	200	3	250	3	300	3½	350	3½
2	250	3	300	3½	350	3½	400	3½
3	300	3½	350	3½	400	3½	450	4

## CHAPTER 7

### DRAINAGE

#### ART. 7-A. GENERAL TERMS

##### Definitions

*Backflow.* A term which denotes the reversal of flow in a drainage system (46).

*Backflow Connection.* A backflow connection is any arrangement whereby backflow can occur (23).

*Back Pressure.* Air pressure in pipes greater than atmospheric pressure (4).

*Back Siphonage.* The formation of a partial vacuum in water-supply lines created by atmospheric pressure which causes a sucking back of polluted water or other liquids into the water-supply piping (46).

*Back Vent.* A back vent is a branch vent installed primarily for the purpose of protecting fixture traps from self-siphonage (23).

*Back-Vent Pipe.* That part of a vent pipe line which connects directly with an individual trap underneath or back of the fixture and extends to the branch, main, soil, waste, or vent pipe at any point higher than the fixture or fixtures trap it serves (46).

*Branch.* A branch is any part of a piping system other than a main (23).

*Branch Interval.* A branch interval is a length of soil or waste stack corresponding in general to a story height but in no case less than 8 ft, within which the horizontal branches from one floor or story of the building are connected to the stack (23).

*Branch Vent.* A branch vent is any vent pipe connecting from a branch of the drainage system to the vent stack (23).

*Building Drain.* Same as *House Drain*.

*Building-Drainage System.* The building-drainage system consists of all piping provided for carrying waste water, sewage, or other drainage from the building to the street sewer or place of disposal (23).

*Building Sewer.* Same as *House Sewer*.

*Building Subdrain.* A building (house) subdrain is that portion of a drainage system which cannot drain by gravity into the building sewer (23).

*By-pass Vent.* A vent parallel to a stack with frequent connections to the stack (4). (Term coined in connection with tests at the University of Illinois.)

*Catch Basin.* A watertight receptacle built to arrest the sediment of surface subsoil or other waste drainage and to retain oily or greasy wastes, to prevent their entrance into the house sewer or drain (46).

*Circuit Vent.* A circuit vent is a group vent extending from in front of the last fixture connection of a horizontal branch to the vent stack (23). See also *Loop Vent*.

*Combination Fixture.* Combination fixture is a trade term designating an integral combination of one sink and one or two laundry trays in one fixture (23).

*Conductor.* A pipe to convey rainwater. The term is usually applied for pipes placed inside of buildings. See also *Leader*.

*Continuous Waste.* A waste from two or more fixtures connected to a single trap (23).

The term applies only when the fixtures are placed together or in combination.

*Continuous-Waste-and-Vent.* A continuous-waste-and-vent is a vent that is a continuation of and in a straight line with the drain to which it connects. A continuous-waste-and-vent is further defined by the angle the drain and vent at the point of connection make with the horizontal; for example, vertical continuous-waste-and-vent, 45-degree continuous-waste-and-vent,

and flat (small-angle) continuous-waste-and-vent (23).

*Cross-connection.* See *Interconnection.*

*Crown.* The crown of a trap. This is the part of a trap in which the direction of flow is changed from an upward to a downward direction (4). (Fig. 57.)

*Crown Vent.* A vent pipe connected at the crown of a trap (4).

*Crown Weir.* The highest portion of the inside bottom surface at the crown of a trap (4). (Fig. 57.)

*Dead End.* A dead end is a branch leading from a soil, waste, vent, house drain, or house sewer which is terminated at a developed distance of 2 ft or more by means of a cap, plug, or other fitting not used for admitting water to the pipe (1).

*Deep-Seal Resealing Traps.* A deep seal resealing trap of the centrifugal self-scouring type is a trap in which the water motion is both centrifugal and upward at each discharge of the fixture and retains an adequate amount of water to form an efficient trap seal (46).

*Deep-Seal Trap.* A trap with a seal of 4 in. or more (4).

*Developed Length.* The developed length of a pipe is its length along the center line of the pipe and fittings (23).

*Dip.* Dip of a trap. The lowest portion of the inside top surface of the channel through the trap (4). (Fig. 57.)

*Distance.* The distance or difference in elevation between two sloping pipes is the distance between the intersection of their center lines with the center line of the pipe to which both are connected (23).

*Double Offset.* A double offset is two offsets installed in succession or series in the same line (23).

*Down Spout.* See *Leader.*

*Drain.* A drain or drain pipe is any pipe which carries water or water-borne wastes in a building-drainage system (23).

*Drainage Piping.* Drainage piping is all or any part of the drain pipes of a plumbing system (23).

*Drainage System.* A system of drains (41).

*Drain Tile.* Pipe of burned clay, concrete, etc., in short lengths, usually laid with open joints to collect and remove drainage water (45).

*Drum Trap.* A trap consisting of a cylinder with its axis vertical. The cylinder is larger in diameter than the inlet or outlet pipe. It is usually 4 in. in diameter with 1½- or 2-in. inlets and outlets. A trap screw of the same size as the cylinder, accessible for cleaning purposes, is provided (46).

*Dry Vent.* A dry vent is any vent that does not carry water or water-borne wastes (23).

*Dual Vent.* A dual vent (sometimes called a unit vent) is a group vent connecting at the junction of two fixture branches and serving as a back vent for both branches (23). (Fig. 64.)

*Fixture Drain.* A fixture drain is the drain from the trap of a fixture to the junction of the drain with any other drain pipe (23).

*Fixture Unit.* A fixture unit is a factor so chosen that the load-producing values of the different plumbing fixtures can be expressed approximately as multiples of that factor (23).

*Fresh-Air Inlet.* A connection made to a house drain above the house or main trap, leading to the outside atmosphere (4).

*Grade.* The grade of a line of pipe is its slope in reference to a horizontal plane. In plumbing it is usually expressed as the fall in inches per foot length of pipe (23).

*Gravity Flow.* See *Non-pressure Drainage.*

*Grease Trap.* A device by means of which the grease content of sewage is cooled and congealed so that it may be skimmed from the surface (41). (Fig. 74.)

*Group Vent.* A group vent is a branch vent that performs its function for two or more traps (23). (Fig. 65.)

*House Drain.* The house drain is that part of the lowest horizontal piping of a house-drainage system which receives the discharge from soil, waste, and other drainage pipes inside the walls of any building and conveys it to the house sewer, begin-

ning 5 ft outside the inner face of the building wall (1).

*House Sewer.* The house sewer is that part of the horizontal piping of a house-drainage system extending from the house drain 5 ft outside the inner face of the building wall to its connection with the main sewer or cesspool and conveying the drainage of but one building site (1).

*Horizontal Branch.* A horizontal branch is a branch drain extending laterally from a soil or waste stack or building drain, with or without vertical sections or branches, which receives the discharge from one or more fixture drains and conducts it to the soil or waste stack or to the building (house) drain (23).

*Indirect Waste Pipe.* An indirect waste pipe is a waste pipe which does not connect directly with the building-drainage system but discharges into it through a properly trapped fixture or receptacle (23).

More extensive layouts may be termed indirect systems or secondary systems.

*Interconnection.* An interconnection, as the term is used in this manual, is any physical connection or arrangement of pipes between two otherwise separate building water-supply systems whereby water may flow from one system to the other, the direction of flow depending upon the pressure differential between the two systems (23).

Where such connection occurs between the sources of two such systems and the first branch from either, whether inside or outside the building, the term cross-connection (American water works terminology) applies and is generally used (23).

*Jumpover.* See *Return Offset*.

*Kitchen Waste.* Liquid culinary wastes (41).

*Leader.* A leader or downspout is the water conductor from the roof to the storm drain or other means of disposal (23).

*Local Ventilating Pipe.* A local ventilating pipe is a pipe through which foul air is removed from a room or fixture (1).

*Loop Vent.* A loop vent is the same as a circuit vent except that it loops back and

connects with a soil or waste stack instead of the vent stack (23). (Figs. 68 and 69.)

*Main.* The main of any system of continuous piping is the principal artery of the system to which branches may be connected (23).

*Main Vent.* See *Vent Stack*.

*Non-pressure Drainage.* Non-pressure drainage refers to a condition in which a static pressure cannot be imposed safely on the building drain. This condition is sometimes referred to as gravity flow and implies that the sloping pipes are not completely filled (23).

*Non-siphon Traps.* Any trap in which the diameter is not greater than 4 in. and the depth of seal is between 3 and 4 in., and in which the volume of water held back in the trap and waste pipe is not less than 1 qt, may be classed as a non-siphon trap. A satisfactory non-siphon trap is one which offers greater resistance than is offered by a simple trap to the breaking of its seal by siphonage but at the same time is not subjected to clogging and is easily cleaned (4).

*Offset.* An offset in a line of piping is a combination of elbows or bends which brings one section of the pipe out of line with, but into a line parallel with, another section (23).

*Pressure Drainage.* Pressure drainage, as used in this manual, refers to a condition in which a static pressure may be imposed safely on the entrances of sloping building drains through soil and waste stacks connected thereto (23).

*Primary Branch.* A primary branch of the building (house) drain is the single sloping drain from the base of a soil or waste stack to its junction with the main building drain or with another branch thereof (23).

*Protected Waste.* See *Safe Waste*.

*Protected Waste Pipe.* A protected waste pipe is one from a fixture which is not directly connected to a drain, soil, vent, or waste pipe (43).

*Relief Vent.* A relief vent is a branch from the vent stack, connected to a horizontal branch between the first fixture



branch and the soil or waste stack, whose primary function is to provide for circulation of air between the vent stack and the soil or waste stack (23).

*Return Offset.* A return offset or jump-over is a double offset installed so as to return the pipe to its original line (23).

*Revent.* See *Back Vent*.

*Roof Leader.* A pipe to convey rainwater. The term is usually applied for pipes placed on the exterior of buildings. Same as *Down Spout*. See also *Conductor*.

*Safe.* A pan or other collector placed beneath a pipe or fixture to prevent leakage from escaping onto the floor, ceiling, or walls (4).

The collecting basin for any fixture or apparatus which is not directly connected to the drainage system.

*Safe Waste.* The waste line from a safe (4). See *Safe*. A term now generally used to imply that there is a distinct break or separation between the fixture or apparatus and the drainage system proper.

A protected waste.

*Safing.* See *Safe*.

*Sand Interceptor* (sand trap). A sand interceptor (sand trap) is a watertight receptacle designed and constructed to intercept and prevent the passage of sand or other solids into the drainage system to which it is directly or indirectly connected (23).

*Secondary Branch.* A secondary branch of the building drain is any branch of the building drain other than a primary branch (23).

*Secondary Systems.* An independent line or system emptying into the regular plumbing system. See Art. 7-B.

*Self-siphonage.* The breaking of the seal of a trap as a result of removing the water therefrom by the discharge of a fixture through the trap (4).

*Side Vent.* A side vent is a vent connecting to the drain pipe through a 45-degree wye (23).

*Soil Pipe.* A soil pipe is any pipe which conveys the discharge of water closets, with or without the discharges from other fixtures, to the house drain (1).

*Soil Stack.* A vertical soil pipe (4).

*Special Waste.* See *Indirect Waste Pipe*.

*Stack.* Stack is a general term for any vertical line of soil, waste, or vent piping (1).

*Stack Vent.* A stack vent is the extension of a soil or waste stack above the highest horizontal or fixture branch connected to the stack (23).

*Stench Trap.* A flap in a frame which opens to admit cellar drainage to a sewer and then closes to prevent sewer air from entering the house (41).

*Storm Drain.* A storm drain is a drain used for conveying rainwater, subsurface water, condensate, cooling water, or other similar discharges (23).

*Subdrain.* A drain built beneath a sewer to intercept ground water and prevent it from entering the sewer, especially during construction (41). See also *Building Subdrain*.

*Subsoil Drain.* A subsoil drain is a drain installed for collecting subsurface or seepage water and conveying it to a place of disposal (23).

*Sump.* A pit or receptacle at a low point to which liquid wastes are drained (4).

*Surface-Water Drain.* A drain which carries surface water (41).

*Trap.* A trap is a fitting or device so designed and constructed as to provide a liquid trap seal which will prevent the passage of air through it (23).

*Trap Seal.* The trap seal is the vertical distance between the crown weir and the dip of the trap (1). (Fig. 57.)

*Union Vent.* See *Dual Vent*.

*Vent Pipe.* A vent pipe is any pipe provided to ventilate a house-drainage system and to prevent trap siphonage and back pressure (1).

*Vent Stack.* A vent stack, sometimes called a main vent, is a vertical vent pipe installed primarily for the purpose of providing circulation of air to or from any part of the building-drainage system.

*Waste Pipe.* A waste pipe is a drain pipe which receives the discharge of any fixture other than water closets or other fixtures receiving human excreta (23).

*Wet Vent.* That portion of a vent line which is below the flow line of the waste or soil line to which it connects. A wet vent is a soil or waste pipe that serves also as a vent (23).

*Yoke Vent.* A yoke vent is a vertical or 45-degree relief vent of the continuous-

waste-and-vent type formed by the extension of an upright wye branch or 45-degree wye branch inlet of the horizontal branch to the stack. It becomes a dual yoke vent when two horizontal branches are thus vented by the same relief vent (23).

### ART. 7-B. ELEMENTS OF WASTE

A waste system consists of a series of stages, beginning at the origin or source and terminating in the final disposal. The stages are in general:

- (a) The source.
- (b) The break.
- (c) Preliminary treatment.
- (d) The receptacle.
- (e) The drainage system.
- (f) Sewers.
- (g) Final treatment.
- (h) Disposal.

#### Source

The source of any waste matter may be:

- (a) The use of any plumbing fixture (disposal of organic wastes, excreta, food).
- (b) Equipment or apparatus performing certain work (pumps, generators, cooling apparatus, etc.).
- (c) Any secondary system of plumbing.

#### The Break

Between the initial stage and the actual drainage lines there must be a definite break. It is called "the break" to emphasize the most important element of its construction. In the trade it is often referred to as a "safe waste," but, depending somewhat on the type of installation, may be classified as a "protected waste," "spill basin," "air break," or similar names.

In the ordinary plumbing fixture connected directly to the drainage lines there is no apparent break in the line, yet the same requirements hold, depending again on the use and nature of the fixture. The break is accomplished in such cases by an efficient trap connected with an air vent where necessary.

All breaks, no matter the name attached to them, are *safe* methods of wasting in order to *protect* the *supply* or source.

It is impossible to specify a definite location for the break as it depends entirely on the nature of the installation and, in the case of more

elaborate hookups, more than one break may be required. In general, it may be said that the break (moving in the direction of the flow) must follow immediately the point where a protected supply discharges into a receptacle (vessel, pipe, or conduit) having an unprotected waste or a protected supply of a different composition.

*Cross-connections.* The discharge of waste from any source, as mentioned above, is always made in such a manner that there is a positive assurance that the waste, in whatever form it is, can enter the drainage system while no part of the contents of the drainage system can revert to the origin.

This object is obtained by means of:

- (a) Plumbing fixtures designed to prevent backflow or pollution through cross-connections, or
- (b) Equipment installed with safe-waste connections, or
- (c) An independent system or "secondary" group of pipes which discharge into the drainage system through a specially designed basin, safe waste, trap, spill basin, or whatever it may be.

In the design of plumbing lines it is important to keep this last stage in mind as a separate unit, as the general code rules do not apply. As a matter of fact, most secondary systems have come into being because they were of such a nature that it was impossible to comply with the plumbing code.

Methods to prevent backflow are discussed at length in Art. 1-D.

*Secondary Systems.* Secondary systems are permitted only in cases where liquids of special nature discharge into the regular system or for the purpose of unusual precautions or sanitation. All such secondary systems shall discharge into at least one stack of primary design or be vented at the outlet to the sewer where leaving the building.

The interceptor shall be designed to form a water seal and no sanitary fixtures shall be placed on a secondary system.

When laying out secondary systems there is no need to violate all principles of plumbing. Too often it seems to be taken for granted that the introduction of a safe waste permits any sort of installation beyond that point.

Of course conditions vary. Liberties may be allowed on condition that certain limitations in use be set up, e.g., acid sinks with no traps are all right, if used for that purpose only and also installed in a manner proper for that type of sink. Refrigerator drains with no traps are also satisfactory but should be used for short runs only. Special sinks, usually installed at points where it is impossible to adhere to the code demands for proper venting, should be treated so much more carefully. Runs in such cases should be limited and traps installed so that no siphoning will take place and flow is not retarded.

In other words, on secondary systems, the rule should be that, inasmuch as more freedom is allowed in certain respects, greater restrictions and care should be exercised in other matters.

### Preliminary Treatment

*Scope.* Preliminary treatment is made by:

- (a) Dilution.
- (b) Screening.
- (c) Sedimentation.
- (d) Separation, or  
Combinations of such treatments.

*Dilution.* In the ordinary use of plumbing fixtures dilution consists merely of applying enough water to float the waste particles and render organic waste stable for a limited time.

*Screening.* Where necessary, fixture outlets are provided with strainers to prevent passage of substances which will clog the pipes.

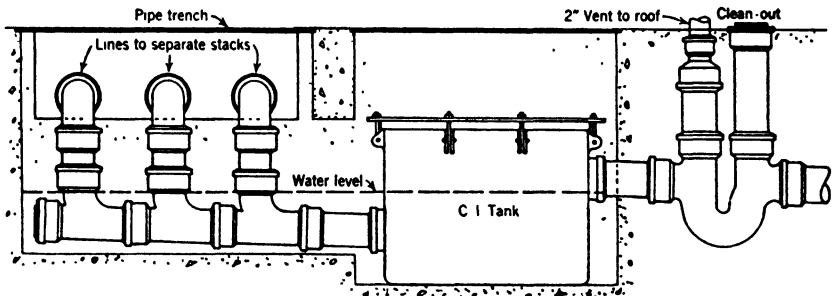

FIG. 53. Diluting Tank for Acid Wastes.

Additional screening is sometimes necessary on specially designed waste receptacles as strainer baskets on floor drains, potato peelers, and combined diluting and screening for the chemical lines. (See Fig. 53.)

*Sedimentation* is applied in many cases in order to separate grit which would otherwise fill up the drains and sewers (mudcrocks, catch basins, etc.).

*Separation* becomes necessary where flocculent (particularly greasy and oily) matter will either clog the sewers or render the sewage unfit for treatment. This kind of treatment is usually required by law. (Grease traps, oil separators, etc.)

Where the entire fluid contents of a sink are emptied into a separator the unit should be of a size large enough to cool the grease and separate it. For more continuous types of flow sometimes flow retarders are used to allow for the installation of smaller units. The practice is not to be recommended and in some localities it is forbidden.



## The Receptacle

*Definition.* Receptacles are all vessels which act as receptacles (receivers) for the discharge of waste.

*The Trap and the Vent.* No two factors have been the objects of more discussion and controversy in plumbing than the apparently necessary trap and its companion, the vent. There is an evident need of the trap in plumbing systems, but there is also a lack of understanding of its functions, so that much effort has been spent to fill the ordinances of numerous communities with nonsensical provisions regarding the "trap" and the "vent," thus giving the authorities an arbitrary weapon to use for accepting or rejecting plumbing installations. All this for one reason only. No one has ever tried to formulate a set of understandable or applicable rules for use in plumbing codes—rules based on scientific laws and not on guesswork.

*Siphon Action.* Figure 55 will be termed the experimental siphon. It can be used only when the siphon is first filled with water and then

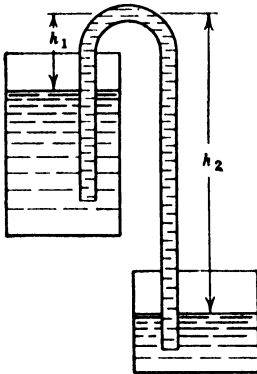

FIG. 55. Experimental Siphon.

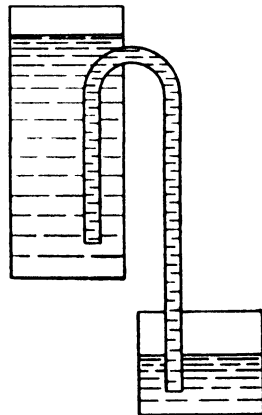

FIG. 56. Automatic Siphon.

placed in the position shown. It does not operate automatically or by itself. In order to work, both vessels must be open for atmospheric pressure. Column  $h_2$  must be greater than  $h_1$ , and there must be no air in the columns.

An automatic siphon, Fig. 56, will operate and overflow only if passage of water through the column can be temporarily restricted so that it will completely fill with water or if the water supply into the vessel is more rapid than the discharge through the column. In such case the column will ultimately fill up completely with water and siphoning will take place. This condition occurs in several plumbing fixtures with large water content and small outlets, as in bathtubs and laundry trays or where the flow is quick and the outlet designed for slow flow as in siphon-action toilets.

*Trap requirements* are to form a seal which will not siphon. (Loss of seal by evaporation may take place in any trap, all depending upon the time and circumstances, and cannot be prevented by any inherent feature in the trap, but only delayed by having a fair amount of water in the trap.)

Loss of seal by siphoning can be prevented only in two ways:

- (a) Siphon action is followed by non-siphon action.
- (b) No siphon action ever takes place.

“Siphon action followed by non-siphon action” simply means that in vessels like water closets and tubs, where siphon action is a necessity or an unavoidable circumstance, the fixture shall be designed to have an afterflow or filling period.

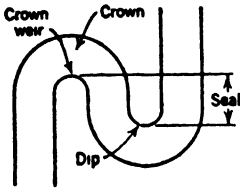

FIG. 57. Parts of Trap.

“No siphon action” means that the installation shall be designed so that no siphoning can take place. Knowing the principles which produce a siphon, namely, the complete filling of the siphon column with no air accessible and the proper height of the column legs, it is apparent

that no siphoning will take place if the column is broken or not of sufficient proportions.

The velocity of the discharge through the trap also must be decreased so that the trap will not empty by wash action, which means that the velocity (or surge) is so great that it overcomes the seal.

*Minimum trap sizes*, as established by *Recommended Minimum Requirements* (1) and *Plumbing Manual* (23), are as follows:

<i>Fixture</i>	<i>Minimum size of trap and fixture drain, inches</i>
Bathtubs . . . . .	1½
Combination fixtures . . . . .	1½
Drinking fountains . . . . .	1¼
Floor drains . . . . .	2
Laundry trays . . . . .	1½
Lavatories . . . . .	1¼
Shower stalls . . . . .	2
Sinks, kitchen, residence . . . . .	1½
Sinks, hotel or public . . . . .	2
Sinks, small, pantry, or bar . . . . .	1¼
Sinks, dishwasher . . . . .	1½
Sinks, service . . . . .	2
Urinals, trough . . . . .	2
Urinals, stall . . . . .	2

## The Drainage System

Beginning at the sewer lateral the drainage system develops into the building sewer (or horizontal drains) with its primary and secondary branches. From the primary branches it extends to the stacks and risers. From this point on, all long horizontal branches and offsets should be avoided and the system designed with the stack as the focal point.

In order properly to design and size the various parts of the system it is essential that it be assembled in the order mentioned. As a help in classifying the parts, each fixture should be considered as connected to a building drain, primary branch, or stack by means of a fixture branch.

### ART. 7-C. SOIL AND WASTE PIPES

#### Design

*General Principles.* General regulations have been formulated by the Subcommittee on Plumbing of the Department of Commerce Building Code Committee in *Recommended Minimum Requirements for Plumbing*.

These recommendations have already been adopted by many communities. In 1940 the Subcommittee on Plumbing of the Central Housing Committee on Research, Design, and Construction, representing a number of U.S. Government Agencies issued a *Plumbing Manual* based on the original *Recommended Minimum Requirements* and modified to include the results of more advanced research. The *Manual* is intended to be used in the Federal Government Service but is also recommended for other use.

A great deal of commonsense should be applied both in the use of all codes and also in the general design. A code cannot cover every conceivable condition and there is always at least one cranky member on each plumbing board who is going to raise an argument. So the designer must be prepared to meet them, not with fancy theories but with practical and logical answers.

Drainage systems are designed according to hydraulic and pneumatic principles and on the basis of practical tests and experience.

The demand on a drainage system fluctuates greatly and varies from being practically empty, or full of air, to being filled to its designed capacity with liquid (usually half full).

Drainage systems are designed as *partly* filled channels flowing at gravity. However, there are exceptions:

- (a) During heavy storms the storm sewers may be flowing full.
- (b) Branch connections from certain fixtures (tub-shaped fixtures) are full most of the time when in use.

Finally, the pipes will fill when stoppage occurs but then again there is, of course, no flow.

According to Dr. Roy B. Hunter (8), the flow in soil and waste pipes has the following characteristics:



“... The flow from a water closet through the fixture drain into a horizontal branch will be at about the average rate of 27 gpm for a period of from 8 to 10 seconds. However, the flow will be less nearly uniform than the flow into the bowl, rising to a rate of from 30 to 40 gpm temporarily, as siphon or jet action comes into play in the bowl, and dropping immediately following the peak siphon action to a rate approximately equal to that of the supply at the time.

“In the horizontal branch the temporary peak flow will flatten out, and the stream will tend to assume the terminal velocity \* for the diameter and slope of the drain and the existing volume rate of flow.

As the stream enters the vertical stack, the sudden change in direction piles the water up, tending to form a slug of water at the entrance. In fact, the surge from a single water closet entering a 3- or 4-in. vertical stack through a short horizontal branch of the same diameter will almost fill the stack at this point. Immediate acceleration takes place in the vertical stack and continues throughout the length of the stack or until the terminal velocity of the stack is reached for the volume rate of flow.

“From the stack the stream will enter the sloping primary branch at a velocity much greater than the terminal velocity for that branch (shooting flow)† and will be decelerated until the terminal velocity for that volume rate of flow is approximately reached. If the volume rate of flow, the entrance velocity, and the slope, diameter, and roughness of the primary branch are in the proper relation, the transition from shooting flow at the entrance to gravity flow will occur in a hydraulic jump, a phenomenon which frequently occurs in the primary branches of building drains.”

We have the problem of designing the pipe lines as they pass from the stage of being empty of fluids and full of air to becoming partly full so that not alone is enough head produced to overcome friction and create sufficient velocity but also to force a corresponding volume of air out of the way. As the flow ceases, provisions must also be made to allow the restoring of this air or the prevention of creating a vacuum or suction effect.

This process of permitting air to escape and re-enter is called “venting.”

The vents, in addition, serve the purpose of eliminating gases produced in the pipes.

The Government Committee (Subcommittee on Plumbing) in its research tests adopted a limit of one-inch water pressure as the maximum pressure or vacuum permissible.

\* Terminal velocity is the constant velocity of flow that exists under fixed conditions when equilibrium between the forces (gravitational) producing and the forces (frictional) opposing flow has been established.

† Shooting flow here refers to the high-velocity constantly decelerating flow that occurs in the primary branch of a building drain between its juncture with the soil stack and the hydraulic jump in the primary branch.

**Slope of Drainage Piping (23)**

*Rules (from Plumbing Manual) (23)*

Horizontal piping shall generally have a slope of  $\frac{1}{4}$  in. per ft. Sizes  $2\frac{1}{2}$  in. and over may have lesser slopes, as  $\frac{1}{8}$  in. per ft for  $2\frac{1}{2}$ - to 4-in. diameters and  $\frac{1}{16}$  in. per ft for 5- to 8-in. diameters. Larger pipes shall have slopes which will produce a minimum velocity of 2 fps according to formula

$$\frac{h}{12L} = \frac{0.0008385 V^2}{d}$$

where

- $h$  = fall in inches per foot.
- $L$  = length of pipe in feet.
- $V$  = velocity in feet per second.
- $d$  = diameter in feet.

The required fall in inches per foot is given by the formula

$$S = S_1 \left( \frac{V}{V_1} \right)^2$$

in which

- $S$  = fall in inches per foot necessary to give a selected velocity.
- $S_1$  = fall in inches per foot for a known velocity  $V_1$  for a pipe of the same diameter.

TABLE 48

APPROXIMATE VELOCITIES FOR GIVEN SLOPES AND DIAMETERS (23)

Diameter of Pipe	Velocities				
	$\frac{1}{8}$ 2-Inch Fall per Foot	$\frac{1}{16}$ -Inch Fall per Foot	$\frac{1}{8}$ -Inch Fall per Foot	$\frac{1}{4}$ -Inch Fall per Foot	$\frac{1}{2}$ -Inch Fall per Foot
Inches	fps	fps	fps	fps	fps
$1\frac{1}{4}$	0.57	0.80	1.14	1.61	2.28
$1\frac{1}{2}$	0.62	0.88	1.24	1.76	2.45
2	0.72	1.02	1.44	2.03	2.88
$2\frac{1}{2}$	0.81	1.14	1.61	2.28	3.23
3	0.88	1.24	1.76	2.49	3.53
4	1.02	1.44	2.03	2.88	4.07
5	1.14	1.61	2.28	3.23	4.56
6	1.24	1.76	2.49	3.53	5.00
8	1.44	2.03	2.88	4.07	5.75
10	1.61	2.28	3.23	4.56	6.44
12	1.76	2.49	3.53	5.00	7.06

From "Plumbing Manual" (23).

TABLE 49  
 FIXTURE UNITS PER FIXTURE OR GROUP \* (23)

Fixture and Type of Installation	Number of Fixture Units
Lavatory or washbasin:	
Public	2
Private	1
Water closet:	
Public	10
Private	6
Bath tub, public	4
Shower head:	
Public	4
Private	2
Pedestal urinal, public	10
Wall or stall urinal, public	5
Service sink †	3
Kitchen sink, private †	2
Bath tub, private	2
Bathroom group, private	8
Bathroom group, with separate shower stall, private	10
Two or three laundry trays with single trap, private †	3
Combination sink and laundry tray, private †	3
Sewage ejector or sump pump, for each 25 gpm	5)

\* Fixtures not given a rating in the above table, when installed in sufficient numbers to justify their consideration relative to the total load to be provided for, may be given the rating of some comparable fixture given in the table. For example, a bedpan washer may be assigned the same rating as a water closet in public use. Similarly, other fixtures may be assigned the same rating as some fixture given in the table, which has the same size of trap and fixture drain and uses water in comparable volumes and frequencies; or fixtures may be assigned ratings proportional to the cross-sections of fixture drains. It should be noted that ratings are given in integers in the scale of 1 to 10, and that no greater accuracy is required in assigning ratings for unusual or unlisted fixtures.

The fixture unit does not necessarily bear a direct relation to the rate of discharge but is adjusted to allow for the length of time of discharge. Thus, e.g., shower heads have a proportionally higher number of fixture units due to the continuity of flow. Wash fountains should be placed in the same class as showers.

The rates given for "public" fixtures should be used on all work where rush periods occur, like office buildings, schools, and factories.

† These fixtures and groups may be omitted in determining the total fixture units to be applied for soil pipes but the fixture-unit weights assigned must be applied for separate waste lines for groups of these fixtures.

*Pressure Drainage.* The slope of the liquid within the pipes (not the slope of the pipe) determines the rate of flow through the pipe. In practically all cases the capacity of the pipe is determined on the basis of the slope of the pipe, with the consequent result that the hydraulic slope (or gradient) corresponds to the slope of the pipe. This is called non-pressure drainage (Fig. 19, page 20).

Conditions do occur, however, where it is not practical to install the pipes at steeper slopes and a head is permitted to develop in the stacks (or vertical risers). This would be similar to conditions shown in Fig. 11 and Fig. 20. As the capacity of the pipe is determined by the hydraulic slope (or gradient), pressure piping should be figured to carry a larger volume of water, depending on the known or assumed head developed in the vertical pipe.

### **Fixture Units**

*Rules (from Plumbing Manual) (23)*

In general, fixtures are rated in fixture units on the basis of the average volume discharged, the average rate of discharge, and the average frequency of use.

The above table of fixture-unit values designating the relative load weights of different kinds of fixtures may be employed in estimating the total load carried by a soil or waste pipe.

### **Size of Soil and Waste Stacks**

*Rules (from Plumbing Manual) (23)*

Every building in which plumbing fixtures are installed shall have a soil or waste stack, or stacks, extending full size through the roof. Soil and waste stacks shall be as direct as possible and free from sharp bends and turns. The required size of a soil or waste stack shall be determined from the distribution and total of all fixture units connected to the stack in accordance with Table 50, except that no water closets shall discharge into a stack less than 3 in. in diameter:

Table 50 is particularly applicable for buildings of one or two stories (one or two branch intervals) in which nothing is to be gained by considering the distribution of fixtures further than as controlled by the limits set on the number of fixture units on one horizontal branch. The table may be applied safely, but not economically, to buildings of any height (23).

If the total fixture units are distributed on horizontal branches in three or more branch intervals of the stack, the total number of fixture units on a straight soil or waste stack of a given diameter may be increased from the values given in Table 50 within the limits of Table 51, provided the maximum fixture units for one branch interval as computed in accordance with Table 51 are not exceeded in any branch interval of the system.

The provisions in Table 51 are intended to permit an economical use of pipe in regard to sizes when the building is of sufficient height to render it safe to install a greater number of fixtures on a stack of a given diameter than is permitted under Table 50; and they are especially applicable to buildings of three stories (three branch intervals) or more in height and to systems with relatively small horizontal branches. It is essential in applying the above provisions that the number of fixture

TABLE 50

PERMISSIBLE NUMBER OF FIXTURE UNITS ON HORIZONTAL BRANCHES AND STACKS

Diameter of Pipe (Inches)	Fixture Units on One Horizontal Branch	Fixture Units on One Stack
1¼	1	2
1½	3	4
2	6	10
3 waste only	32	48
3 soil	20	30
4	160	240
5	360	540
6	640	960
8	1200	2240
10	1800	3780
12	2800	6000

units in any one branch interval shall be in accordance with the quantity  $(N/2n + N/4)$ —where  $n$  is the number of branch intervals and  $N$  is the permissible number of fixture units for a stack having one branch interval only) and that the total number of fixture units on the entire stack shall be within the limits of Table 51.

#### *Offsets.*

(a) A single offset, a double offset, or a return offset, with no change in direction greater than 45 degrees, may be installed in a soil or waste stack with the stack and branches vented as required for a straight stack, provided that the total number of fixture units on such stack does not exceed one-half the limit permitted in Table 50, and no horizontal branch connects to the stack in or within 4 diameters (stack) above or below a sloping section of the offset (23).

(b) If an offset is made at an angle greater than 45 degrees, the required diameter of that portion of the stack above the offset shall be determined as for a separate stack. The diameter of the offset shall be determined as for a primary branch, and the portion above the offset shall be considered as a horizontal

branch in determining the diameter of that portion of the stack below the offset. A relief vent shall be installed at the offset or between it and the next lower horizontal branch.

TABLE 51

LIMITS IN FIXTURE UNITS ON SOIL AND WASTE STACKS IN MULTI-STORY BUILDINGS

Diam. Inches	Number of Branch Intervals										Maximum Fixture Units on One Stack
	1	2	3	4	5	6	7	8	9	10	
1¼	1	1	1	1	1	1	1	1	1	1	2
1½	3	2	2	2	2	2	2	2	2	2	8
2	6	6	6	6	6	6	6	6	6	6	24
3	32	16	13	12	11	10	10	10	9	9	80
4	240	120	100	90	84	80	77	75	73	72	600
5	540	270	225	202	189	180	173	168	165	162	1,500
6	960	480	400	360	336	320	308	300	293	288	2,800
8	1,800	900	750	675	630	600	578	562	550	540	5,400
10	2,700	1,350	1,125	1,012	945	900	868	844	825	810	8,000
12	4,200	2,100	1,750	1,575	1,475	1,400	1,350	1,312	1,283	1,260	14,000

Diam. Inches	Number of Branch Intervals										Maximum Fixture Units on One Stack
	11	12	13	14	15	16	17	18	19	20	
1¼	1	1	1	1	1	1	1	1	1	1	2
1½	2	2	2	2	2	2	2	2	2	2	8
2	6	6	6	6	6	6	6	6	6	6	24
3	9	9	9	9	9	9	9	9	9	9	80
4	71	70	69	68	68	67	67	66	66	66	600
5	159	157	155	154	153	152	151	150	149	148	1,500
6	283	280	277	274	272	270	268	267	265	264	2,800
8	532	525	519	514	510	506	503	500	497	495	5,400
10	798	787	778	771	765	759	754	750	746	743	8,000
12	1,225	1,225	1,211	1,200	1,190	1,181	1,174	1,167	1,160	1,155	14,000

(c) An offset above the highest horizontal branch in a soil or waste stack system is an offset in the stack vent and shall not be considered in this connection other than as to its effect on the developed length of the vent.

(d) In case of an offset in a soil or a waste stack below the lowest horizontal branch, no change in diameter of the stack because of the offset shall be required if it is made at an angle not greater than 45 degrees. If such an offset is made

at an angle greater than 45 degrees, the required diameter of the offset and the stack below it shall be determined as for a primary branch.

### Horizontal and Primary Branches

#### Rules (from *Plumbing Manual*) (23)

(a) The required sizes of horizontal branches and primary branches of the building drain shall be in accordance with Table 52, except that the permissible number of fixture units on primary branches as given in Table 52 may be increased as provided for in section *d* below.

TABLE 52

CAPACITIES OF HORIZONTAL BRANCHES AND PRIMARY BRANCHES OF THE BUILDING DRAIN

Diameter of Pipe, inches	Permissible Number of Fixture Units				
	Horizontal Branch at Minimum Permissible Slope or Greater	Primary Branch			
		$\frac{1}{16}$ -in. fall per ft	$\frac{1}{8}$ -in. fall per ft	$\frac{1}{4}$ -in. fall per ft	$\frac{1}{2}$ -in. fall per ft
	Number	Number	Number	Number	Number
$1\frac{1}{4}$	1			2	2
$1\frac{1}{2}$	3			5	7
2	6			21	26
3 waste only	32		36	42	50
3 soil	20		24	27	36
4	160		180	216	250
5	360	360	400	480	560
6	600	600	660	790	940
8	1200	1400	1600	1920	2240
10	1800	2400	2700	3240	3780
12	2800	3600	4200	5000	6000

Table 52 is particularly applicable to comparatively simple systems with few stacks and branches, but the limits may be applied to systems of any size without the restrictions governing the application of sections *c* and *d* below.

(b) In case the sanitary system consists of one soil stack and one or more waste stacks of less than 3-in. diameter, the building drain and building sewer shall be of the same nominal size as the primary branch from the soil stack as given by Table 52 except that section *d* and the rules below relating to pressure drainage may apply when the prescribed conditions are complied with.

(c) In case the plumbing system has two or more soil stacks, each having its separate primary branch, or has one or more soil stacks and one or more waste stacks of 3-in. diameter or larger, each soil and waste stack having its separate primary branch, the main building drain or the building sewer of a given diameter and slope may be increased from the value given in Table 52 for a primary branch of the same diameter and slope to the value given in Table 53, provided that the increase is made strictly within the principles and rules following.

TABLE 53

LIMITS IN CAPACITIES OF BUILDING DRAINS UNDER THE PROVISIONS OF SECTION c  
(NON-PRESSURE DRAINAGE)

Limits in Fixture Units

Diameter (inches)	Primary Branch				Secondary Branch			
	1/16-in. fall per ft	1/8-in. fall per ft	1/4-in. fall per ft	1/2-in. fall per ft	1/16-in. fall per ft	1/8-in. fall per ft	1/4-in. fall per ft	1/2-in. fall per ft
	Num- ber	Num- ber	Num- ber	Num- ber	Num- ber	Num- ber	Num- ber	Num- ber
2		18	21	26				
3		24	27	36		90	125	180
4		180	216	250		450	630	900
5	360	400	480	560	600	850	1,200	1,700
6	600	660	790	940	950	1,350	1,900	2,700
8	1,400	1,600	1,920	2,240	1,950	2,800	3,900	5,600
10	2,400	2,700	3,240	3,780	3,400	4,900	6,800	9,800
12	3,600	4,200	5,240	6,080	5,600	8,000	11,200	16,000

Table 53 is particularly applicable to the plumbing systems of buildings covering a relatively large area with several widely separated soil stacks. The limits for primary branches will determine the size of pipe required unless the total length of all branches (primary and secondary) of the building drain is more than 40 ft.

(d) In case there is no fixture drain or horizontal branch connecting directly with the building drain or a branch thereof and the lowest fixture branch or horizontal branch connected to any soil or waste stack of the system is 3 ft or more above the grade line of the building drain, the permissible number of fixture units on primary branches, secondary branches, main building drain, and building sewer may be increased within the limits given by Table 54.



TABLE 54

LIMITS IN CAPACITIES OF BUILDING DRAINS UNDER THE PROVISIONS OF SECTION *d*  
(PRESSURE DRAINAGE)  
Limits in Fixture Units

Diameter (inches)	Primary Branch				Secondary Branch			
	$\frac{1}{16}$ -in. fall per ft	$\frac{1}{8}$ -in. fall per ft	$\frac{1}{4}$ -in. fall per ft	$\frac{1}{2}$ -in. fall per ft	$\frac{1}{16}$ -in. fall per ft	$\frac{1}{8}$ -in. fall per ft	$\frac{1}{4}$ -in. fall per ft	$\frac{1}{2}$ -in. fall per ft
	Num- ber	Num- ber	Num- ber	Num- ber	Num- ber	Num- ber	Num- ber	Num- ber
2			42	52				
3		48	54	72		180	250	360
4		360	432	500		900	1,250	1,800
5	720	800	960	1,120	1,200	1,700	2,400	3,400
6	1,200	1,320	1,580	1,880	1,900	2,700	3,800	5,400
8	2,800	3,200	3,840	4,480	3,900	5,600	7,800	11,200
10	4,800	5,400	6,480	7,560	6,800	9,800	13,700	19,800
12	7,200	8,400	10,400	12,000	11,200	16,000	22,400	32,000

Table 54 is particularly applicable to large buildings in which basement fixtures and possibly first-floor fixtures are to be drained into a sump in such a manner that all direct connections of fixture branches and horizontal branches will be materially greater than 3 ft above the grade line of the building drain.

In computing the permissible limits for particular systems under the rules applying to pressure drainage, both sections *c* and *d* apply.

(*e*) The provisions of sections *c* and *d* shall not apply unless plans drawn to scale showing the proposed installation in detail in regard to the diameter, direction, length, and slope of the building drain and its branches and of the building sewer have been submitted to and approved by the authority having jurisdiction over plumbing.

The rules given above are from *Plumbing Manual* issued as Report BMS 66 by the U.S. Department of Commerce, National Bureau of Standards (23).

### Sumps and Receiving Tanks

All building subdrains shall discharge into an airtight sump or receiving tank so located as to receive the sewage by gravity, from which sump or receiving tank the sewage shall be lifted and discharged into the building sewer by pumps, ejectors, or any equally efficient method.

Such sumps shall either be automatically discharged or be of sufficient capacity to receive the building sewage and wastes for not less than 24 hours.

**ART. 7-D. STORM DRAINS**

**General**

Roofs and paved areas, yards, courts, and courtyards shall be drained into the storm-water system or the combined sewerage system but not into sewers intended for sanitary sewerage only. When connected with a combined sewerage system, storm drains, the intakes of which are within 12 ft of any door, window, or ventilating opening, if not at least 3 ft higher than the top of such opening, shall be effectively trapped. One trap on the main storm drain may serve for all such connections. Traps shall be set below the frost line or on the inside of the building. Where there is no sewer accessible, storm drainage shall discharge into the public gutter, unless otherwise permitted by the proper authorities, and in such case need not be trapped (23).

Where connecting into a combined sewer the local authorities should be consulted in regard to plans for future separation of sanitary and storm sewers. It may be advisable in such cases to run separate lines for sanitary and storm sewers to some convenient point.

For private storm-water systems, see Arts. 8-C and 9-B.

**Sizes of Gutters**

Although gutters as a rule are not included in the plumbing work, the designer should check them for correct design. The following table is from *Plumbing Manual* (23).

TABLE 55

MAXIMUM ROOF AREA FOR SEMI-CIRCULAR ROOF GUTTERS WITH A FALL OF  $\frac{1}{16}$  INCH PER FOOT OR LESS

Diameter of Gutter	Maximum Roof Area
Inches	Square feet
3	170
4	360
5	625
6	960
7	1380
8	1990
10	3600
12	6800

The capacities in Table 55 are based on flow capacities of gutters of semi-circular sections, no slope, one outlet, and a rate of rainfall of 4 in. per hr. If the fall is greater than  $\frac{1}{16}$  in. per ft the permissible roof area may be increased by multiplying it by

$$\sqrt{\frac{S}{\frac{1}{16}}}$$

where  $S$  is the actual fall in inches per foot.

For example, assume that a 3-in. semi-circular roof gutter is pitched with a fall of  $\frac{1}{8}$  in. per ft. The permissible roof area per leader becomes

$$170 \sqrt{\frac{\frac{1}{8}}{\frac{1}{16}}} = 170 \sqrt{2} = 240 \text{ sq ft}$$

For roof gutters with rectangular or polygon-shaped cross-sections the depth should be equal to the radius and the average width equal to the semi-circular section.

### Size of Storm Drains and Leaders

TABLE 56

MAXIMUM ROOF AREA FOR LEADERS

Diameter of Leader or Pipe	Maximum Roof Area
Inches	Square feet
2	500
2½	960
3	1,500
4	3,100
5	5,400
6	8,400
8	17,400

Tables 56 and 57 are from *Plumbing Manual* (23) and are said to be based on a rate of rainfall of 4 in. per hour. This is not exactly correct.

On buildings covering a small area the collection time may be as short as one minute. For buildings stretching over larger areas the collection time is proportionally longer and the rate of precipitation will be less.

Inasmuch as the larger sizes of drains correspond to larger areas of roof a reduction in rainfall rate is permissible. Tables 56 and 57 actu-

ally do not use a fixed figure of 4 in. rainfall but make allowance for the collection period mentioned and in addition include a safety factor.

Depending on the locality, the rate may vary from 4 in. to 6 in. per hour. Corrections to Tables 57 and 58 can be made by multiplying by

TABLE 57

MAXIMUM ROOF AREA FOR HORIZONTAL BUILDING STORM SEWERS OR DRAINS

Diameter of Pipe (Inches)	Maximum Roof Area for Drains of Various Slopes			
	$\frac{1}{8}$ -in. fall per ft	$\frac{1}{8}$ -in. fall per ft	$\frac{1}{4}$ -in. fall per ft	$\frac{1}{2}$ -in. fall per ft
	Square feet	Square feet	Square feet	Square feet
2	.....	.....	350	500
3	.....	750	1,050	1,500
4	.....	1,550	2,150	3,100
5	1,800	2,700	3,600	5,400
6	3,000	4,200	6,000	8,400
8	5,900	8,700	11,900	17,400
10	9,800	15,200	19,600	30,400
12	15,900	24,700	31,800	49,400

4 and dividing by the local rate in inches per hour based on a 5-minute period.

Roof area or drained area as applying in Tables 56 and 57 shall be the horizontal projection of the area except that, where a building wall extends above the roof or court in such a manner as to drain onto the roof or court, due allowance for the additional run-off shall be made (23).

It is assumed that a driving rain will apply at an angle of 30 degrees with the vertical. Consideration should be given to prevailing winds and exposed sides and the relative areas of the walls to the roofs in question. An allowance of 50% of the wall area for one wall and 35% of the wall area for adjoining walls will generally be adequate.

**Sizes of Combined Drains**

A combined drain shall never be less than 4 in. nor less than either the soil or rain drain entering into it, provided none of them carries more than one-half its allowable load according to Table 57 (23).

If either or both of the storm or sanitary branch drains carry more than one-half the allowable load, the combined drain or combined building sewer shall be in accordance with Table 58.



### Subsoil Drainage

The task of providing adequate foundation drainage usually falls to the architect, but it is left to the plumbing contractor to dispose of the effluent. The designer should have some knowledge of the working principles of such a system.

Foundation drains consist in general of agricultural tile (farm tile) of 4 or 6 in. diameter laid end to end with open joints. The joints are wrapped with burlap and sometimes covered with tar paper or special metal collars are used. U.S. Government specifications call for strips of copper screen in place of burlap. The fill immediately around the tiles should be of crushed stone. Sometimes, to maintain a proper grade, the tiles are laid on top of a plank or even in a simple trough formed of wood planks. Tiles laid below the basement floor should have a minimum depth of 2 ft, and 3 ft minimum under living quarters.

No definite slope seems to be accepted. The maximum fall should be not more than the distance determined by the underside of the basement floor and the bottom of the footing. Where a definite slope is specified, this maximum fall will determine the maximum length (or run) of tile. The absolute minimum should be 0.3% (or about 1 in. per 30 ft). All bends should be made with regular vitrified sewer tile fittings, and connections through building walls should be made of cast-iron pipe. U.S. Government specifications call for all dead ends to be carried at a 45-degree slope up to grade (or some accessible space) and be provided with a cleanout cover.

The purpose of the drain is to accumulate seepage from the ground. The drain will lower the ground-water level to some extent, but is not a means for overcoming hydrostatic pressure. Where foundation walls are properly waterproofed the drain will help to decrease the pressure head. Where tiles are laid under the basement or cellar floor, such lines should not have any direct connections with the tiles along the outside foundation walls. All connections with any line which has a greater pressure or which may develop a greater pressure must be avoided.

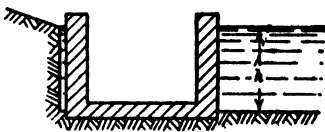

FIG. 58A.

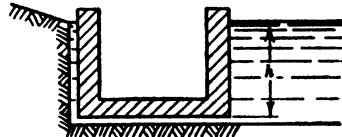

FIG. 58B.

Water Pressures on Containers.

Water pressure against the sides of the container on Fig. 58A is equal to the weight of water at that point, regardless of the volume of water.

Water pressure against the bottom of the container on Fig. 58B is equal to the weight of the water column  $h$  regardless of the thickness of the water layer under the bottom.

These facts become very important in many cases.

If Fig. 58B represents a structure set below the ground-water level, the weight of the building must exceed the weight of the water displaced (i.e., a volume equal to the submerged part of the structure) or the buoyancy of the water will lift the structure.

Usually the soil forms a resistance to a complete saturation by water, but investigation should be made in all cases to be certain of the existing conditions. The same phenomenon often takes place in buried tanks, cisterns, and pipes. Where such containers and conduits may be empty at times, provisions must be made for anchoring or adding sufficient dead weight.

On the other hand, all excavation work greatly upsets the *status quo* of the ground water and, even after backfilling has taken place, forms new and easier channels for underground water movements.

Any methods which will create a drain upon this water condition will cause the hydrostatic pressure to diminish in a degree, more or less. Natural drainage is by far the best and least expensive method. If drainage cannot be accomplished at the base of the structure, a higher point of drainage should be used, as any decrease in the height of the water column will be of advantage.

Positive drainage should be established for water conditions below the structure and an attempt made to cut down the pressure head. Care should be exercised that these drainage channels or conduits do not become self-reversing, i.e., that possible higher pressures on the intended discharge end, as caused by floods or pressures in sewers, will enter into the area that is to be relieved.

Connections to the sewer must be made through a "sump" or "mud-crock" with the inlet bent down to form a trap. The outlet line to the sewer should be provided with a back-water valve. The mudcrocks should be made of lengths of vitrified sewer pipe fittings, preferably 18 in. in diameter or larger, with solid bottom and leaving a small space for settling of mud. The cover should be of cast iron and should be tight. The mudcrock should not be used as a floor drain. It should be placed in an accessible space and cleaned out often.

It will be found that any water in the ground will soon follow the drain as a natural outlet. This tendency is likely to increase with time unless other factors (as new buildings on adjoining lots) will change the water level. Consequently, foundation drains should not be installed unless ample and reliable provisions are made for the discharge of the water. The designer will sometimes face some very problematic conditions and the actual nature of the ground, the soil and forms of substrata may not be ascertained in time to provide for intelligent planning. Conditions may in some cases rectify themselves or, on the contrary, become aggravated due to construction work. Under no circumstances should any automatic pumping machinery be placed in connection with it except in such a manner that the automatic pump operates only in an emergency.

## ART. 7-E. VENTS AND VENTING

**General Requirements**

Every soil or waste stack shall be extended vertically as a stack vent to at least 6 in. above the highest horizontal branch and then to the open air above the roof or otherwise terminated in the open air outside the building; or the stack vent and vent stack may be connected together within the building at least 6 in. above the flood level of the highest fixture, with a single extension from the connection to the open air (23).

*Distance of Trap from Vent.* The most effective point for venting a fixture drain depends on the form of the drain. If the fixture drain turns to the vertical within 48 pipe diameters from the trap weir, a vertical continuous-waste-and-vent at that point is the most effective vent that can be installed. If the fixture drain slopes continuously from the trap weir, the requirement, assuming a fall of  $\frac{1}{4}$  in. per ft, limits the permissible length of drain between trap and vent to:

- 5 ft for a  $1\frac{1}{4}$ -in. drain
- 6 ft for a  $1\frac{1}{2}$ -in. drain
- 8 ft for a 2-in. drain
- 12 ft for a 3-in. drain

If a fixture drain connects with an adequate relief vent or with a stack vent within these limits, the relief vent or stack vent will perform the functions of a back vent. See Fig. 59 (23).

*Dual vents (or unit vents)* for two fixture traps installed as a vertical continuous-waste-and-vent or a stack vent in a dual capacity may be employed under certain conditions, as indicated on Fig. 60 (23).

*Group vents* for a lavatory and a bathtub or shower stall may be installed according to Fig. 61. Other group vents are shown in Figs. 62 and 63.

*Vents for Flat-Bottomed Fixtures.* Special dispensations are allowed on drains not over 2-in. diameter and relatively flat-bottomed fixtures with bottoms of an area of at least 200 sq in. The rules apply particularly to kitchen sinks to provide more effective drainage and scouring of the fixture drain than can be obtained in some cases by an installation back-vented near the trap. Limitations are shown in Fig. 67.

*Vents for Resealing Traps.* The same rules as above may be used for fixtures located so that no space is available for a properly installed vent for a P-trap, if a resealing trap of approved design is installed for a fixture or a group of not more than three fixtures (23).

*Fixtures at Base of Main Vent.* A group of not more than three fixtures, none of which discharges greasy wastes, may be installed on a main vent or vent stack below the lowest branch vent provided the load does not exceed one-half the allowable load, according to Table 52, on a horizontal branch of the same diameter as the main vent. The purpose of this provision is to wash out rust or other products of corrosion (23).



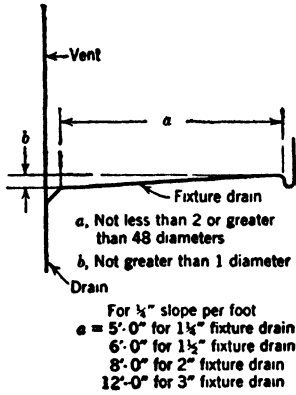

FIG. 59. Distance of Trap from Vent.

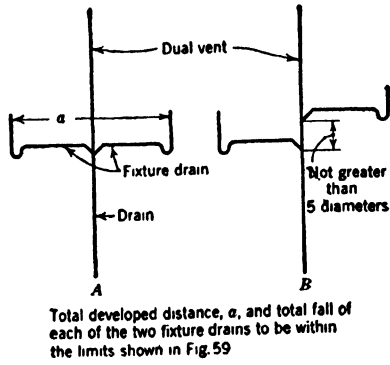
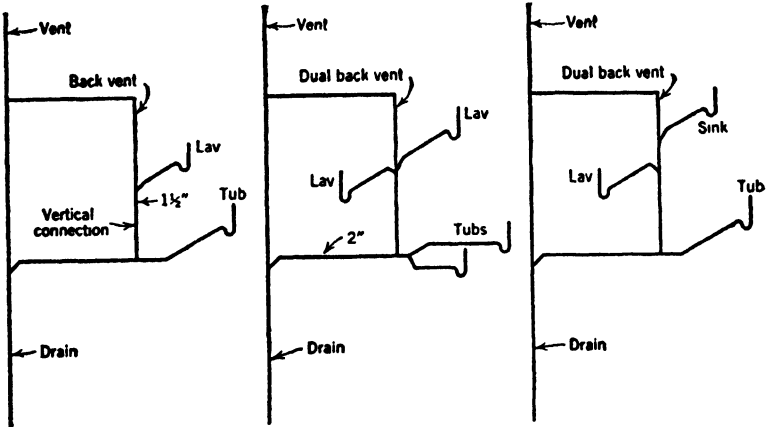

FIG. 60. Dual Vents.



Developed lengths of fixture drains to be within limits shown in Fig. 59.

FIG. 61. Group Vents for Lavatories and Bathtubs.

*From Plumbing Manual (23)*

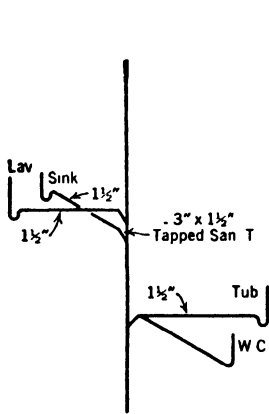

This group venting may be used on a yoke vented section of a horizontal branch not less than 3" in diameter, in any branch interval of a soil stack

FIG. 62. Stack-Vented Piping Layout for One-Story House.

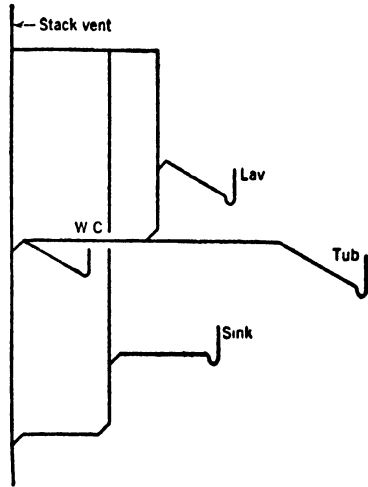
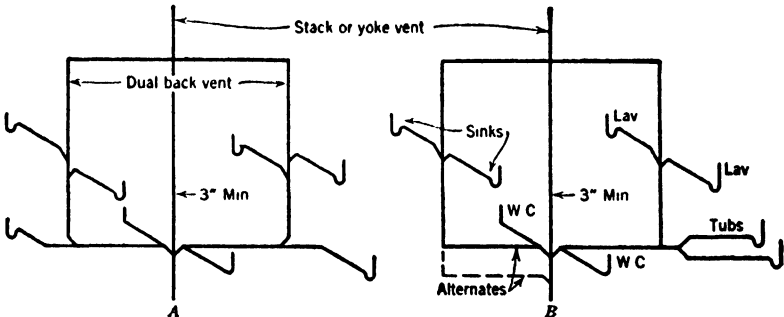

FIG. 63. Piping Layout for Two-Story House with One Bathroom.



Developed lengths of fixture drains shall be within limits shown in Fig 59

FIG. 64. Piping Layout for One-Story Duplex House.

*From Plumbing Manual (23)*

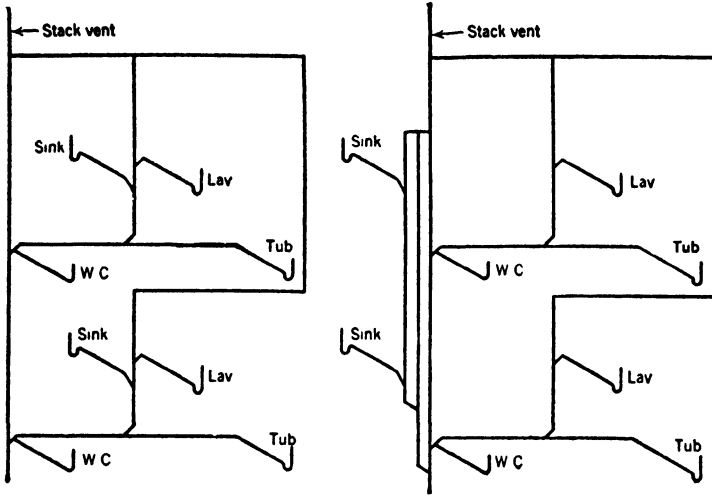

FIG. 65. Piping Layout for Bathroom in Each of Two Stories.

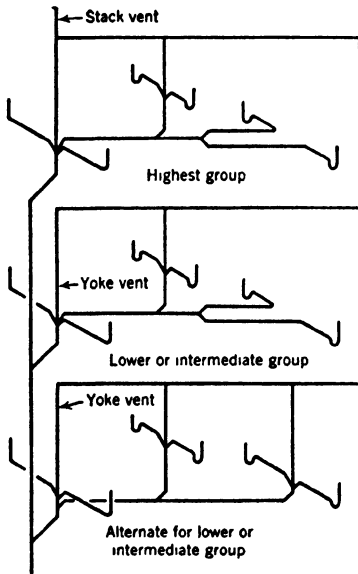
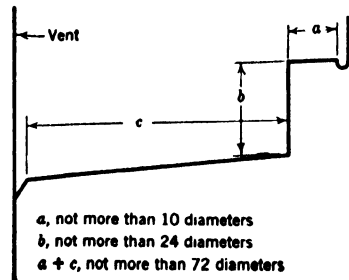

FIG. 66. Piping Layout for Duplex Apartments.



*a*, not more than 10 diameters  
*b*, not more than 24 diameters  
*a + c*, not more than 72 diameters

FIG. 67. Limitations to Vents for Flat-Bottomed Fixtures.

*From Plumbing Manual (23)*

**Circuit Vents and Loop Vents (23)**

(a) A group of fixtures in line (battery) on the same floor or level may be installed on one horizontal branch with a circuit or loop vent connected to the horizontal branch in front of the last fixture drain, within the limits given in Table 59 and with the following additional provisions.

Relief vents shall be installed in front of the first fixture drain if the total fixture units on the branch exceed one-half the number allowed in Table 59.

No relief vent, however, shall be required in

(1) The highest branch interval.

(2) If the total number of fixture units on the stack above the horizontal branch does not exceed the limits for one stack, as given in Table 51, and the number of fixtures on the circuit- or loop-vented horizontal branch does not exceed one-half the permissible number as given in column 2 of Table 59 for 4-in. and larger horizontal branches. A dual relief vent for two circuit- or loop-vented horizontal branches in the same branch interval may be installed (23).

TABLE 59  
LIMITS FOR CIRCUIT AND LOOP VENTING

(1) Diameter of horizontal branch	(2) Water closets, pedestal urinals, or trap-standard fixtures	(3) Fixture units for fixtures other than designated in column 2
Inches	Number	Number
2	None	6
3	2	20
4	8	60
5	16	120
6	24	180

(b) The limits for circuit- or loop-vented horizontal branches may be increased to one and one-half times the values given in Table 59 for 3-in. and larger branches when relief vents are installed so that there is a relief vent inside the first fixture drain, the number of fixtures or fixture units outside the last relief vent does not exceed the limits given in columns 2 and 3 of Table 59, and the number of fixture drains between any two successive relief vents does not exceed two for a 3-in., three for a 4-in., five for a 5-in., or eight for a 6-in. or larger horizontal branch.

(c) Two lines of fixtures back-to-back (double battery) shall not be circuit- or loop-vented on one branch, but each line may be installed on a separate branch and circuit- or loop-vented. (See Fig. 68.)

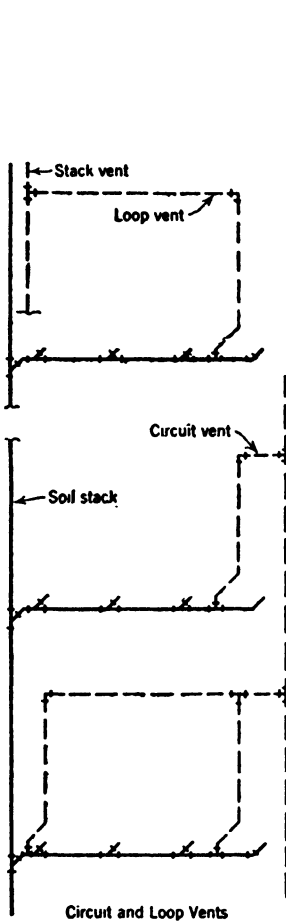
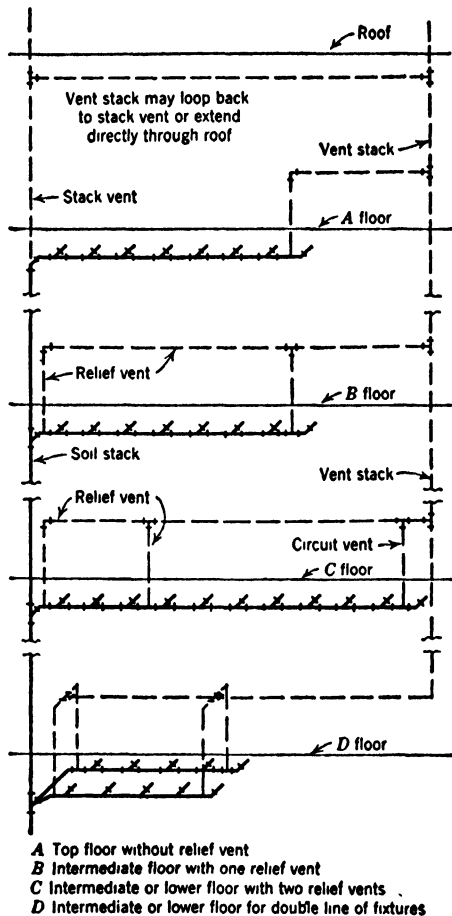

FIG. 68. Circuit and Loop Vents.



A Top floor without relief vent  
 B Intermediate floor with one relief vent  
 C Intermediate or lower floor with two relief vents  
 D Intermediate or lower floor for double line of fixtures

FIG. 69. Limits for Circuit and Loop Vents.

From Plumbing Manual (23)

### Size and Length of Vents (23)

*Size and Length of Main Vents.* Vent stacks or main vents shall have a diameter of at least one-half that of the soil or waste stack and shall be of larger diameter in accordance with the limits of length and number of fixture units as given in Table 60. The length of the main vent for application in connection with Table 60 shall be the total developed length as follows:

(a) From the lowest connection of the vent system with the soil stack, waste stack, or primary branch to the terminal of the vent, if it terminates separately to the open air.

(b) From the lowest connection of the vent system with the soil stack, waste stack, or primary branch to the stack vent plus the developed length of the stack vent to its terminal in the open air, if the stack vent and vent stack are joined with a single extension to the open air.

TABLE 60  
SIZE AND LENGTH OF MAIN VENTS

Diameter of Soil or Waste Stack (Inches)	Number of Fixture Units on Soil or Waste Stack	Maximum Permissible Developed Length of Vent								
		1¼-in. vent	1½-in. vent	2-in. vent	2½-in. vent	3-in. vent	4-in. vent	5-in. vent	6-in. vent	8-in. vent
		Feet	Feet	Feet	Feet	Feet	Feet	Feet	Feet	Feet
1¼	2	75								
1½	8	70	150							
2	24	28	70	300						
3	40		20	80	260	650				
3	80		18	75	240	600				
4	310			30	95	240	1000			
4	620			22	70	180	750			
5	750				28	70	320	1000		
5	1500				20	50	240	750		
6	1440					20	95	240	1000	
6	2880					18	70	180	750	
8	3100						30	80	350	1100
8	6200						25	60	250	800

*Size and Length of Stack Vents.* Stack vents shall be of the same diameter as the soil or waste stack, if the soil or waste stack carries one-half or more of its permissible load, according to Table 50, or has horizontal branches in more than two branch intervals. If the soil or waste stack carries less than one-half its permissible load and has horizontal branches in not more than two branch intervals, the stack vent may be of a diameter not less and a length not greater than required by Table 60.

*Size of Back Vents and Relief Vents.* The nominal diameter of a back vent, when required, shall be not less than 1¼ in. nor less than one-half the diameter of the drain to which it is connected; and, under conditions that require a relief vent for approved forms of group venting, the sum of the cross-sections of all vents installed on the horizontal branches in one branch interval shall be at least equal to that of either the main vent or the largest horizontal branch in the branch interval.

*Size of Circuit and Loop Vents.* (a) The nominal diameter of a circuit or loop vent and the first relief vent shall be not less than one-half the diameter of the horizontal branch thus vented. Under conditions

**Procedure :**

- Determine stack size. The size of the stack will determine the maximum size of branch.
- Determine size of main vent ( not to exceed size of stack )
- Determine loop and relief vents

**Note :**

Relief vents next to main stack may be omitted on top floors.

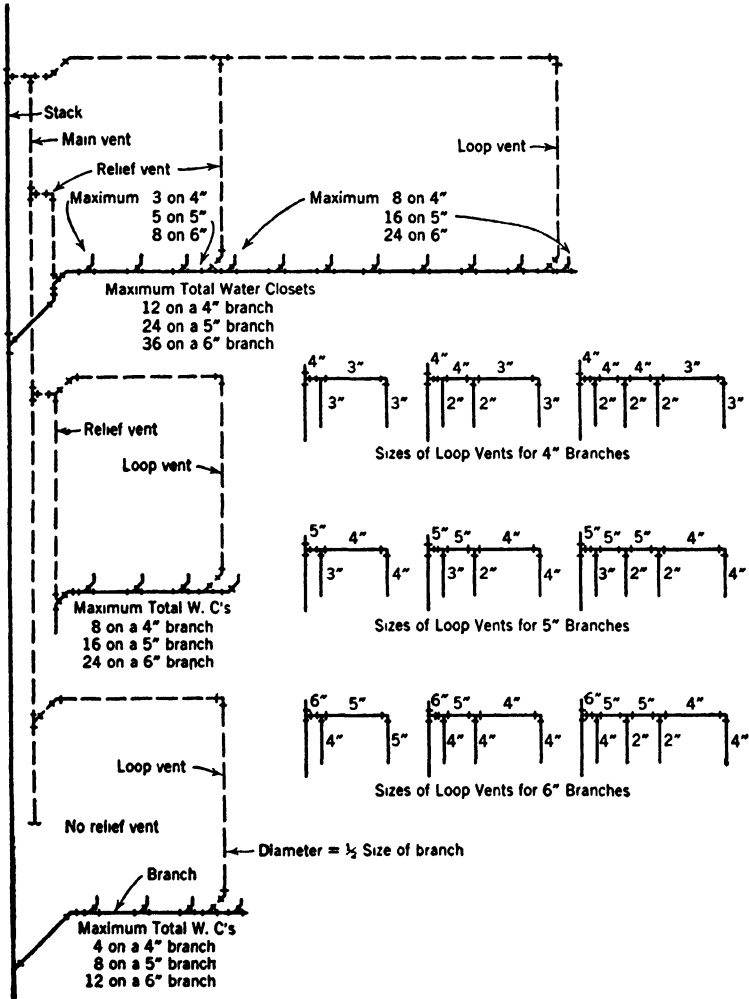

FIG. 70. Loop Vents for Water Closets.

that require a relief vent the sum of the cross-sections of the circuit or loop and relief vents shall be at least equal to that of either the main vent required or the horizontal branch. In determining the sum of cross-sections for this requirement all relief vents connected to the horizontal branch may be included.

(b) Additional relief vents, installed in compliance with the section on "Circuit Vents and Loop Vents," subsection *b*, shall be not less in diameter than one-half that of the largest fixture branch connected to the horizontal branch.

#### ART. 7-F. MATERIALS AND CONSTRUCTION

##### Materials Used

*Drainage and waste pipe* underground or in basements or unfinished spaces usually is cast-iron soil pipe and fittings.

To avoid too many joints, sometimes cast-iron water pipe Class 100 is permitted in lieu of soil pipe.

Exposed or accessible drainage piping above the basement may be standard galvanized steel or wrought iron with galvanized cast-iron drainage fittings.

Concealed drainage piping above basement may be iron-alloy pipe (as copper-molybdenum alloy iron) with galvanized cast-iron drainage fittings or copper tubing with wrought-copper drainage fittings.

Vent lines usually corrode more easily than the wet waste lines and should be cast-iron or iron-alloy pipe.

*Stacks and Risers.* All connections to risers 4 in. and over shall be made with Y branches and  $\frac{1}{8}$  bends, and on risers 3 in. and less with T-Y's, except that all connections on 3-in. rainwater conductors shall also be made with Y branches and  $\frac{1}{8}$  bends.

Stacks shall be supported on the floor construction by a flat bar iron clamp support.

Stacks shall be provided with an increaser at the roof line in accordance with code requirements and be flashed with a 24 × 24-in. copper sheet and thimble. The thimble shall be jointed at the top with an inverted hub connection for screwed pipe or turned over into the pipe for calked pipe.

*Horizontal Pipes.* All junctions shall be made by means of Y branches. Cleanouts shall be provided at any change of direction and at ends of all runs.

Hung soil pipe shall be supported by wrought-iron hangers at least at each joint.

*Joints* shall be calked or screwed.

Union type connections are usually prohibited on waste lines. On vent lines they may be ground joint unions.

The generally accepted joint between screwed and calked pipe on waste lines is the so-called Tucker fitting.



*Cleanouts* shall be of a construction as specified by the code and shall be installed on all drainage and vent lines. They shall be the size of the pipe up to 4 in., and not less than 4 in. for larger pipes.

*Waterproof pans* of lead, copper, steel, or roofing are often installed for individual showers, shower rooms, stall urinals, recessed foot baths, and similar installations.

Pans are placed on the rough floor and have the edges turned up to within  $\frac{1}{2}$  in. of the finished floor. There are, however, installations where higher edges may be needed. The pans shall, where possible, be pitched to a drain. Usually the connection to the drain is a so-called double-drainage feature.

Lead pans shall be made of 4-lb sheet lead. All joints shall be locked and hammered together.

### **Tall Buildings**

*Soil Stacks.* It has been found advisable to let the soil and waste stacks serve only a number of floors similar to the regular zones served by the water system, usually 10 to 15 floors. By doing this unusually large sizes of pipes are avoided. To avoid complete breakdown of the drainage facilities branch due to stoppage, each zone may be served by at least two stacks, each stack connected to alternate floors and discharging, if possible, into separate laterals at grade.

Tests conducted in connection with the formulating of the Hoover Code tend to show that there should be no danger of excessive velocities in tall stacks; yet it must be remembered that soil stacks are tested to withstand the pressure where filled with water, because any stoppage at the base of the stack would cause such a condition. For this reason it is also advisable to have the stacks for each zone run down to the basement without receiving any additional branches.

Again it is advisable to offset the stacks at each zone division, first to be certain that undue velocities do not occur and second to help in more substantial support of the stacks and allow for elements of expansion and contraction.

*Rainwater leaders and roof drains* should be computed to take into account, in addition to the horizontal surfaces of roof, the vertical surfaces adjoining these roof areas.

*The material used* is generally galvanized steel or wrought iron with galvanized drainage fittings.

Expansion joints may be used if they are of a type approved by the plumbing board.

## CHAPTER 8

### SEWERS

#### ART. 8-A. GENERAL TERMS

##### Definitions

*Branch Sewer.* An arbitrary term for a sewer which receives sewage from a relatively small area (41).

*Depressed Sewer.* A sewer, often crossing beneath a valley or a water course, which runs full or under greater than atmospheric pressure because its profile is depressed below the hydraulic grade line (41).

*Discharge.* The quantity of water, silt, or other mobile substances passing along a conduit per unit of time; rate of flow; cubic feet per second; etc. (45).

*Domestic Sewage.* Sewage derived principally from dwellings, business buildings, institutions, and the like. (It may or may not contain ground water, surface water, or storm water. It may also contain a small proportion of industrial waste liquid.) (41)

*Drainage.* A general term for gravity flow of liquids in conduits. Commonly applied to surface and ground water (41).

The process of removing surplus ground or surface water by artificial means (45).

The manner in which the waters of an area are removed (45).

The area from which waters are drained; a drainage basin (45).

*Dry-Weather Flow.* Flow of sewage in a sewer during dry weather (41). Used mostly in connection with combined sewers where the flow during dry weather is practically all sanitary sewage.

*Gravity System.* A system in which all sewage runs on descending gradients from source to outlet, or where no pumping is required (41).

*House Sewage.* Sewage from dwellings. Loosely used for domestic sewage (41).

*House Sewer.* A pipe conveying the sewage from a single building to a common sewer or point of immediate disposal (41).

*Industrial Sewage.* Sewage in which industrial wastes predominate (41).

See also *Domestic Sewage*; *Industrial Wastes*.

*Industrial Wastes.* Liquid wastes from industrial processes (41).

*Inlet.* 1. A surface connection to a closed drain (45).

2. A structure at the diversion end of a conduit (45).

3. The upstream end of any structure through which water may flow (45).

*Intercepting Sewer.* A sewer which receives the dry-weather flow from a number of transverse sewers or outlets, with or without a determined quantity of storm water if from a combined system (41).

*Inverted Siphon.* A pipe line crossing over from a depression or under a highway, railroad, canal, etc. The term is common but inappropriate, as no siphonic action is involved. The suggested term "sag pipe" is very expressive and appropriate (45).

See also *Depressed Sewer*.

*Junction Chamber.* A converging section of a sewer used to facilitate the flow from one or more sewers into a main sewer (41).

*Lateral Sewer.* A sewer which discharges into a branch or other sewer and has no other common sewer tributary to it (41).

*Main Sewer.* A sewer which receives one or more branch sewers as tributaries (41).

*Outfall.* The point where water flows from a conduit; the mouth of drains and sewers (45).

*Pneumatic Ejector.* A means of raising sewage, or other liquid, by alternately admitting it through a check valve into the bottom of a pot and then ejecting it through another check valve into the discharge pipe, by admitting compressed air to the pot above the liquid (41).

*Relief Sewer.* A sewer built to relieve an existing sewer of inadequate capacity (41).

*Sag Pipe.* A very appropriate term proposed as a substitute for "inverted siphon" (45).

See also *Depressed Sewer.*

*Sewage.* 1. Wash water and water-carried animal, culinary, and, in some cases, industrial wastes (41).

2. Liquid waste containing human excreta and other matter flowing in or from a house drainage system or sewer. Excreta include feces, urine, secretions from the skin, expectoration, etc. (41).

3. Liquid wastes from dwellings and institutions, stables, and business buildings. It may also contain liquid wastes from industries (41).

4. A combination of (a) the liquid wastes conducted away from residences, business

buildings, and institutions, and (b) from industrial establishments with (c) such ground, surface, and storm water as may be admitted to or find its way into the sewers (41).

5. The ordinary liquid contents of a sewer containing organic wastes, which may or may not include street wash (41).

*Sewer.* A pipe or conduit, generally closed, but normally not flowing full, for carrying sewage or other waste liquids (41).

*Sewerage System.* A collecting system of sewers and appurtenances (41).

*Sewerage Works.* A comprehensive term, including all construction for collection, transportation, pumping, treatment, and final disposition of sewage (41).

*Street Sewer.* Common sewer or public sewer in a street (41).

*Subdrain.* A drain built beneath a sewer to intercept ground water and prevent it from entering the sewer, especially during construction (41).

*Trunk Sewer.* A sewer which receives many tributary branches and serves as an outlet for a large territory (41). See also *Main Sewer.*

## ART. 8-B. SANITARY SEWERS

### Scope

Sanitary sewers are for the purpose of collecting and disposing of all wastes containing organic matters.

*Sanitary Sewer.* A sewer which carries sewage and excludes storm, surface, and ground water (41).

*Sanitary Sewage.*

(a) Domestic sewage with storm water excluded by design (41).

(b) Sewage originating in the sanitary conveniences of a dwelling, business building, factory, or institution (41).

(c) The water supply of a community after it has been used and discharged into a sewer (41).

### Design

*Slope and Velocity.* Sewers carrying raw or untreated sewage should be at least 6 in. in diameter and have slopes of at least  $\frac{1}{8}$  in. to the foot (1.0%). In smaller installations 4-in. sewers with slopes of  $\frac{1}{4}$  in. to the foot (2.0%) are acceptable for carrying settled sewage.

In general, all sewers should be designed with hydraulic slopes which will give mean velocities when flowing full, or half full, of not less than 2.0 ft per sec, based on Kutter's formula with  $n = 0.013$ . Under exceptional conditions, if full and justifiable reasons are given for it and if special arrangements are available or will be provided for flushing, velocities under 2.0 ft per sec (as low as 1.5 ft per sec) may be permitted (42).

In general, the following minimum grades should be provided:

TABLE 61  
MINIMUM SLOPES OF SEWERS

Diameter Inches	Cu Ft per Min Running Full	Minimum Slope		N. Y. State Minimum Slope	Minimum Velocity: 2 ft per sec
			Per Cent	Per Cent	
4*	—	—	—	2.0 †	
6	33.7	1/150	0.67	1.0	
8	60.03	1/200	0.50	0.40	
10	93.74	1/250	0.40	0.28	
12	135.00	1/300	0.33	0.22	
15	211.00	1/375	0.27	0.15	
18	304.00	1/450	0.22	0.12	
21	395.00	1/525	0.19	0.10	
24	540.00	1/600	0.16	0.08	

\* For small installations only  
† Not permitted for street use.

The use of a large sewer on a flat slope to comply with the above minimum slopes is not advisable. Sewer lines must be laid on perfect alignment and uniform slope between manholes.

See also notes on "Sewer Profiles," page 45.

*Sewage Flows.* Discharge of the individual sewer should be based on this water consumption:

$$0.000162PG = Q(\text{cu ft per min})$$

where

$P$  = Population.

$G$  = Per capita water consumption per day.

Using  $G = 50$ ;  $Q = 0.0081P$  cfm.

Computation should include future population for one to two decades.

For group buildings, institutions, etc., the sewer should be based on the maximum flow estimated on the basis of maximum water consumption for the fixtures emptying into the sewer.

"Lateral or main sewers should be designed with capacities, when running full, of not less than ten times the average estimated daily flow of sewage.

"Outfall sewers should be designed for capacities, when running full, of not less than five times the average estimated daily flow of sewage.

"The above is a statement of minimum capacities allowed and not a rule for computing the flow" (42).

TABLE 62  
SEWAGE FLOWS (42)

	Gallons per Day per Person
Camps .....	25
Small dwellings	40
Farmhouses	
Summer cottages, etc. }	
Large dwellings, boarding schools, etc., with numerous fixtures . .	75
Institutions (except hospitals) . . . . .	100
Hospitals .....	150-250
Day schools .....	15
Day schools, with showers .....	20
Factories (per 8-hr shift) . . . . .	25 to 40
Army camps .....	60 *
Army hospitals .....	150 per patient *
" " .....	60 per attendant *

\* Major Leonard S. Doten, in *Transactions of the American Society of Civil Engineers*, Paper 1432

### *Ventilation.*

(Extract from paper by D. Donaldson, *Sewage Works Journal*, Vol. IV, No. 1.)

Ventilation of sewers is necessary for three good reasons:

(a) For the benefit of their contents, to maintain sufficient oxygen to keep the sewage stable.

(b) For the security of their construction, to avoid acid decomposition with consequent deterioration of materials.

(c) For the safety of the public and sewer maintenance crews by elimination of gases from sewage and leakage from faulty gas mains.

One part of illuminating gas to seven of air or 1.5% mixture of gasoline with air will create explosive mixtures.

Ventilation in built-up sections is obtained by inlets for air with outlets provided through the house stacks. This, of course, necessitates the elimination of house traps.

If air is supplied in sufficient volume, the air in the sewers should not be objectionable. If odors still are objectionable, they must be traced to other causes.

*Industrial Wastes.*

(From paper by H. M. Freeburn, *Sewage Works Journal*, Vol. IV, No. 1.)

1. Industrial wastes may be admitted to the sewerage system:

- (a) When it does not throw an undue burden on the other taxpayers by materially increasing sewer maintenance and sewage treatment works operating costs.
- (b) When it has no injurious effect on the sewers or the receiving body of water.
- (c) When it does not materially affect the existing or proposed sewage treatment processes.

In other words, industrial waste that is discharged at a fairly uniform rate and does not differ greatly from ordinary domestic sewage, nor constitute a large percentage of the total flow, could be admitted to sewers and sewage works without doing any harm. When industrial waste flows are high compared to sewage flows, trouble may be expected at the sewage works.

2. Industrial wastes which are released in large volumes over short periods of time can be admitted to the sewerage system after flow has been equalized and discharge can be made at a reasonable uniform rate. Sudden large discharges should not be allowed.

3. Industrial wastes, such as the following, that cause objectionable conditions should not be admitted to sewer systems unless the producer provides satisfactory treatment:

- (a) Wastes which contain substances that will form deposits in the sewers or stick to the inverts.
- (b) Those containing excessive amounts of fats or oils.
- (c) Acid wastes that injure joints, concrete, or seriously interfere with treatment processes.
- (d) Wastes very much stronger than ordinary sewage.
- (e) Wastes having high solid contents that will overload treatment works.
- (f) Wastes that create offensive odors at treatment works.
- (g) Wastes having an inhibitive effect on bacterial and biological activity at the treatment works, thus decreasing efficiency.

4. Wastes that should be excluded from the sewerage system:

- (a) Live steam.
- (b) Scalding liquids.
- (c) Illuminating gas.
- (d) Exhaust gases.
- (e) Gasoline.
- (f) Oil.
- (g) Wastes having a low oxygen demand, with a large solid content that can be removed at the industrial establishment, should be treated there and the effluent discharged to a near-by storm sewer or water course, if available.
- (h) Strong acid wastes should be reclaimed.
- (i) Weak acid wastes should be neutralized and discharged to the nearest water course or storm water sewer.
- (j) Wastes discharged in such large volumes that they predominate over the sewage received at the sewage treatment works, especially if the discharge materially increases operation costs or seriously interferes with treatment processes.

## ART. 8-C. STORM SEWERS AND COMBINED SEWERS

### Definitions

Storm sewers are sewers designed for the collection of rain water. Usually accepted in storm sewers are all discharges containing no organic matters.

*Acre-Foot.* Quantity of water that would cover 1 acre, 1 ft deep. An acre-foot contains 43,560 cu ft (45). Abr.: acre-ft.

*Coefficient of Imperviousness.* The ratio, expressed decimally, of effectively impervious surface to the total catchment area (45).

*Combined Sewer.* A sewer designed to receive both storm water and sewage (41).

*Debris.* Any material, including floating trash, suspended sediment, or bed load, moved by a floating stream; detritus (45).

*Drainage Area.* 1. The area (sq ft, acres, etc.) of the drainage basin (45).

2. Catchment area; drainage basin (45).

*Drainage Basin.* The area from which water is carried off by a drainage system, a water-shed or catchment area (45).

*Imperviousness.* That quality or condition of a material that minimizes percolation (45).

*Precipitation.* The total measureable supply of water received directly from clouds, as rain, snow, and hail; usually expressed as depth in a day, month, or year,

and designated as daily, monthly, or annual precipitation (45).

*Rainfall.* Precipitation in the form of water. Usage includes snow and hail in the term (45).

*Rainfall Rate.* Precipitation, generally expressed in inches per hour (41).

*Run-off.* That part of the rainfall which reaches a stream, drain or sewer (41).

*Run-off Coefficient.* The rate of run-off to precipitation (45).

*Run-off Rate.* An expression of the rate at which rainfall runs off from a surface, expressed in inches in depth of rainfall per hour, cubic feet per second, or other units (41).

*Storm Overflow.* A weir, orifice, or other device for permitting the discharge from a combined sewer of that part of the flow in excess of that which the sewer is designed to carry (41).

*Storm Sewer.* A sewer which carries storm and surface water, street wash, and other wash waters, or drainage, but excludes sewage (41).

*Storm Water or Sewage.* Excess water during rainfall or continuously following and resulting therefrom (41).

### Design

Storm sewers are designed on the basis of average rainfall intensities.

$r$  = Rate of rainfall in inches per hour.

$t$  = Time in minutes for which rain intensity,  $r$ , is the average.

$L$  = Length of pipe in feet.

$C$  = Coefficient.

$a$  = Drainage area in acres.

$Q$  = Rate of flow of water in cubic feet per second.

$I$  = Factor of imperviousness (or runoff coefficient) or percentage of imperviousness.

Rainfall rates or intensities vary according to the time involved. The time is determined by the extent of the system. The longer the pipe run, the longer the time to collect, and the less the chance of an intense rain affecting the entire system at once.

Thus we have to assume a time element based on the velocity of the water in the sewer. This, of course, depends a great deal on the general contour and slope of the area in question, but for smaller systems we can safely allow 6 fps as a proper velocity.

After plotting the sewers on the plan, measure the greatest length in feet ( $L$ ) from the beginning of the sewer to the point of computation. The collection time ( $t$ ) in minutes is then:

$$t = \frac{L}{6 \times 60} \text{ min}$$

Sometimes an allowance is made for collection time before the water reaches the sewer, say 7 min; in which case the total time will equal

$$t = \frac{L}{360} + 7 \text{ min}$$

The rain rate is generally expressed by a formula similar to

$$r = \frac{C}{\sqrt{t}}$$

or

$$r = \frac{C}{t + y} \text{ (Meyer's formula)}$$

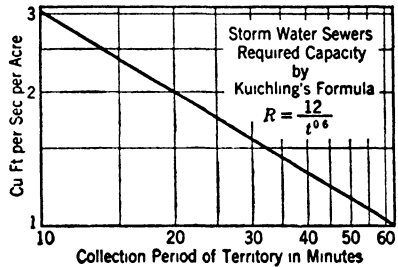

Fig. 71.

where  $C$  and  $y$  are coefficients which vary according to the different localities and  $r$  is the intensity of rainfall in inches per hour. With any small information regarding rainfalls in the community, the value  $C$  can be figured and a graph (see Fig. 71) drawn up. In many communities a value for  $C$  is already adopted by the city engineering department.

The total run-off in any given period, then

$$= a \times I \times r \text{ acres} \times \text{inches per hour}$$

$a$  = Drainage area in acres.

$I$  = Factor or percentage of imperviousness. This factor is estimated by various engineers as follows:

Roofs	100%
Asphalt pavements	80%
Sidewalks, surrounded by grass	60%
Waterbound macadam	50%
Gravel walks and roads	40%
Hard-earth yards	20%
Grass and rough ground	0%

The above table is as good a guide as any for simple work. It was used by Emil Kuichling in his report for the East Side Trunk Sewer in Rochester, N. Y.



1 in. rain per hour on 1 acre =  $\frac{1(\text{in.}) \times 43,560}{12 \times 60 \times 60} = 1 \text{ cu ft per sec}$   
 (or nearly so); consequently,

$$Q = a \times I \times r \text{ cu ft per sec}$$

For small roof areas we have

$$\frac{100 (\text{sq ft}) \times 7.48 (\text{gal}) \times 60 (\text{min})}{43,560 (\text{sq ft per acre})} = 1$$

or nearly so, which gives for each inch of rain per hour 1 gal per 100 sq ft, or, for a maximum intensity of 4 in. an hour, a discharge of 4 gal per min for each 100 sq ft of roof.

See also notes on "Sewer Profiles," page 45.

## ART. 8-D. CONSTRUCTION

### Definitions

**Catch Basin.** A receptacle, generally of masonry, located in the ground with entrance at the curb and connection to the sewer from the lower compartment, so placed as to receive the storm water run-off from the street and deliver to the drain after leaving the detritus, grit, and sediment in the lower chamber of the catch basin. (President's Conference on Home Building.)

A chamber or well, designed to prevent the admission of grit and detritus into a sewer (41).

**Crown.** The inside top of a sewer (41).

**Drop Manhole.** A shaft in which sewage falls from a sewer to a lower level (41).

**Flush Tank.** A chamber in which water or sewage is accumulated and discharged at intervals for flushing a sewer (41).

**Flushing Manhole.** A manhole provided with a gate so that sewage or water may be accumulated and then discharged rapidly for flushing a sewer (41).

**Inlet.** A connection between the surface of the ground and a sewer for the admission of surface or storm water (41).

**Inlet Well.** A well or opening at the surface of the ground to receive surface water,

which is thence conducted to a sewer (41). (Fig. 73.)

**Junction Manhole.** A manhole at the junction of two or more sewers (41).

**Lamphole.** A small vertical pipe or shaft leading from the surface of the ground to a sewer, for admitting light for purposes of inspection (41).

**Manhole.** A shaft or chamber from the surface of the ground to a sewer large enough to enable a man to have access for the purpose of inspection and cleaning (41). (Fig. 72.)

**Manhole Head.** The cast-iron fixture surmounting a manhole. It is made up of two parts: a "frame" which rests on the masonry of the shaft and a removable "cover." Frames are either "fixed" or "adjustable" in height. Covers are "tight," "ventilated," or "anti-rattling" (41).

**Sewer Appurtenances.** Constructions, devices, and appliances other than the pipe or conduit, which are appurtenant to a sewer, such as manholes, flush tanks, and surface inlets (41).

**Tight Manhole Cover.** A manhole cover without openings (41).

**Ventilated Manhole Cover.** A manhole cover with openings (41).

**Materials**

*Vitrified tile* for all kinds of sewers, with mortar and gasket joints for storm sewers over 15 in. and bituminous joints for smaller storm sewers and all sanitary sewers.

*Reinforced concrete pipe* usually economical only for larger sizes, for storm sewers with gasket and mortar joints.

*Asbestos-cement pipe* with sleeve joints and cement or asphalt compound.

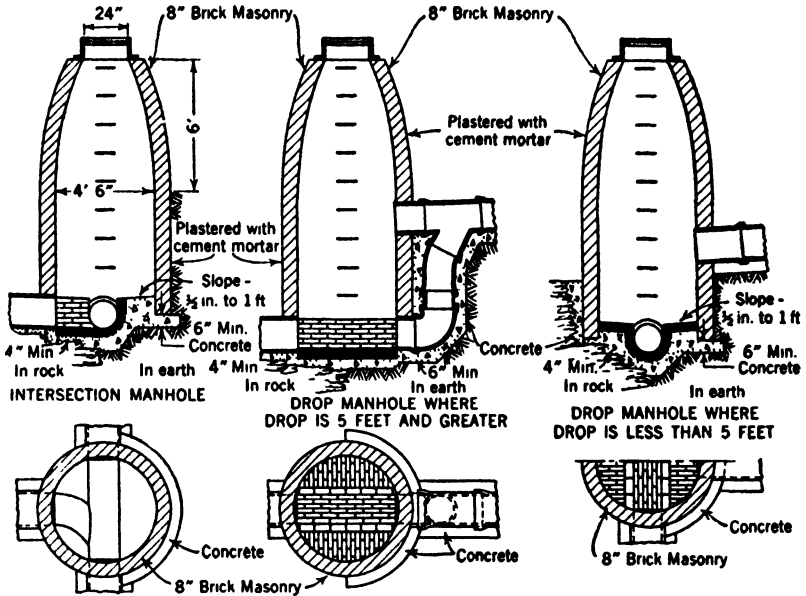

FIG. 72. Typical Manholes for Tile Pipe Sewers.  
(City Engineering Standards, Rochester, N. Y.)

**Benchwalls**

*Height of Benchwalls:*

- For sewers 15 in. diameter and smaller —top of sewer
- For sewers 15 in. diameter to 30 in. diameter—15 in. high
- For larger sewers —centerline of sewer

No benchwalls required in dead end manholes but bottoms to be properly dished. Benchwalls in drop manholes to be paved on top with vitrified brick.

**Inverts**

Inverts in manholes may be built of either tile or brick.

**Manhole Walls**

Walls to be increased to 12 in. below depth of 12 ft. Walls to be backed with concrete if soil conditions require it.

*Cast-iron pipe* with calked lead joints underneath structures and roads and within 100 ft of wells, etc.

**Construction**

*Manholes* should be placed at all points of change in slope or alignment, at the upper end of all sewers, and otherwise at intervals not over 300 ft apart (42).

If conditions call for an unusual number of manholes, a limited number of lampholes may be substituted, but not more than one lamphole between two successive manholes.

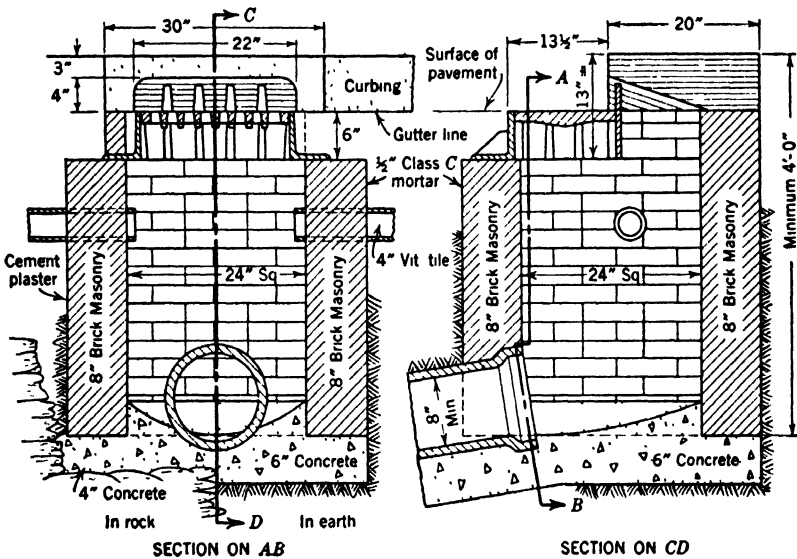

FIG. 73. Surface Sewer Well for Improved Streets.

(City Engineering Standards, Rochester, N. Y.)

**Cradles.** Sewers shall be laid in cradles forming a solid and continuous support under at least the lower one-third part of the pipe circumference. The cradle shall be substantial enough to transmit the load superimposed on the sewer to the ground below.

Earth cradles should be used only where there is an absolutely firm earth foundation and no permanent ground water. For doubtful conditions, under heavy loads, and in deep cuts concrete cradles are recommended.

In rock, wet clay, quicksand, or where the water table rises above the pipe level, sewer shall be laid in cradles of concrete, gravel, or broken stone, as the conditions demand.



TABLE 64  
 VELOCITIES OF CIRCULAR SEWERS RUNNING  
 FULL OR HALF FULL; IN FEET PER MINUTE

Slope		Size										
Rate of Inclination	Per Cent Grade per 100 Ft	4	6	8	10	12	15	18	21	24	30	36
1 in	50	246	307	354	394	432	481	525				
	60	226	279	323	361	395	440	481				
	70	209	251	298	334	366	408	446				
	80	194	239	278	312	342	382	418				
	90	182	225	262	294	322	360	394				
	100	172	213	248	279	306	342	374	404	432		
	110	163	202	236	265	291	326	357	385	413		
	120	155	193	225	253	278	312	342	369	395		
	130	149	186	216	243	267	299	328	360	379		
	140	143	178	208	233	257	288	316	342	365		
	150	138	172	201	225	248	278	306	330	353		
	160	133	166	194	218	240	269	296	320	342		
	170	129	160	188	211	232	261	287	310	332		
	180	125	155	182	205	225	253	278	301	322		
	190	121	151	177	199	219	246	270	293	313		
	200	118	147	172	194	213	239	263	285	305	342	375
	250		131	153	172	189	213	234	254	272	305	335
	300		118	138	156	172	193	213	231	248	278	305
	350			127	143	158	178	196	213	228	256	282
	400			118	133	147	166	183	198	213	239	263
	450				125	138	156	172	187	200	225	247
	500				118	130	147	162	177	189	213	234
	550	..	...	...	...	124	140	154	168	180	203	223
	600					118	134	147	160	172	194	213
	650						128	141	153	165	186	204
	700						123	135	147	158	179	196
	750	0 133					118	130	142	152	172	189
	800	0 125						126	137	147	166	183
	850	0 117						122	133	142	161	177
	900	0 111						118	129	138	156	172
	950	0 105							125	134	151	167
	1000	0 100				...			121	130	147	162
	1100	0 091							118	124	140	154
	1200	0 083								118	133	147
	1300	0 077									127	141
	1400	0 071		..						..	122	135
	1500	0 067								...	118	130
	1600	0 063					..					126
	1700	0 059			..		..					122
	1800	0 056	..		..		..			..		118



# CHAPTER 9

## SEWAGE DISPOSAL AND TREATMENT

### ART. 9-A. SEWAGE

#### Definitions

*Anaerobic.* Living without air (14).\*

*Barn Sewage.* Wash water from stables, containing considerable quantities of animal wastes (41).

*Biochemical Action.* Chemical action resulting from the growth or metabolism of living organisms.

*Biochemical Oxygen Demand.* The quantity of oxygen required for biochemical oxidation in a given time at a given temperature, the determinations usually being for 5 days at 20 C (41). Abr: B.O.D.

*Clarified Sewage.* Term loosely used for sewage from which suspended matter has been partly or completely removed (41).

*Crude Sewage.* Sewage which has received no treatment (41).

*Degree of Purification.* A measure of the removal and oxidation of the objectionable or putrescible contents of sewage (41).

*Digestion.* The biochemical decomposition of organic matter, resulting in the formation of mineral and simple organic compounds (41).

*Dilute Sewage.* A relative term. Sewage containing a relatively small quantity of organic matter (41).

*Effluent.* Sewage, partly or completely treated, flowing out of any sewage treatment device (41).

*Fresh Sewage.* Sewage of recent origin still containing free dissolved oxygen (41).

*Influent.* Sewage, raw, or partly treated, flowing into any sewage treatment device (41).

*Oxidized Sewage.* Sewage in which the organic matter has been combined with oxygen and has become stable (41).

*Putrefaction.* Biological decomposition of organic matter with the production of ill-smelling products. It occurs under conditions of oxygen deficiency (41).

*Putrescibility.* 1. The susceptibility of waste waters, sewage, effluent, or sludge to putrefaction (41).

2. The relative tendency of organic matter to undergo decomposition in the absence of oxygen (41).

*Relative Stability.* The ratio, expressed in percentage, of available oxygen in waste waters, sewage, effluent, or diluted sewage to that required to provide complete biochemical oxidation of the organic matters contained therein (41).

*Septic Sewage.* Sewage undergoing putrefaction in the absence of oxygen (41).

*Sewage Disposal.* A general term. The act of disposing of sewage by any method (41).

*Sewage Purification.* The removal or mineralization of all putrescible organic matter and the removal of all infectious and offensive matter (41).

*Sewage Treatment.* Any artificial process to which sewage is subjected in order to remove or so alter its objectionable constituents as to render it less offensive and dangerous (41).

*Sewage Treatment Works.* Treatment plant and means of disposal (41):

\* From Gould's *Pocket Medical Dictionary*; copyright, The Blakiston Company, Publishers, Philadelphia, Pa.

*Sleek.* The thin oily film usually present which gives characteristic appearance to the surface of water into which sewage or oily waste is discharged (41).

*Sludge.* The accumulated suspended solids of sewage deposited in tanks or basins, mixed with more or less water to form a semi-liquid mass (41).

*Stability.* The ability of any substance, such as sewage, effluent, or digested sludge,

to resist putrefaction (41). (Antonym: Putrescibility.)

*Stable Effluent.* A treated sewage which contains enough oxygen to satisfy its oxygen demand (41).

*Stale Sewage.* Sewage containing little or no oxygen, but as yet free from putrefaction (41).

*Strong Sewage.* Sewage containing above the normal quantity of organic matter (41).

## Treatments

*Composition.* Sewage is a mixture of water and organic and mineral matters. For larger communities in the United States the average composition, based roughly on 100 gal of water per capita, is about 800 parts per million. For smaller flows from other sources (such as industrial plants), the sewage is correspondingly stronger.

*Decomposition.* Sewage treatment is a natural decomposition process carried on by bacteria and micro-organisms. The design of a treatment plant provides for stages to facilitate this process.

The biological action may be due to the work of aerobic micro-organisms which need oxygen for their existence. Sufficient oxygen must be found dissolved in the sewage to carry on this work (oxidation).

Decomposition by anaerobic micro-organisms (putrefaction or septic action) takes place in the absence of oxygen.

The necessary amount of oxygen needed for aerobic decomposition (biochemical oxidation) is called the "biochemical oxygen demand," usually abbreviated B.O.D. It is expressed in parts per million.

*Available oxygen* is the amount of atmospheric oxygen dissolved in the sewage (3).

*Hydrogen-Ion Concentration.* It has been found that the condition of sewage or sludge as to acidity or alkalinity has an important effect upon the amount, nature, and rapidity of decomposition, and this determination is made in some cases. It is usually expressed as hydrogen-iron concentration, the symbol for which is *pH*. Figures for *pH* below 7.0 indicate acidity; those above 7.0, alkalinity (3).

*Methods of Treatment.* Sewage treatment consists of:

- (a) Screening and separation of flocculent matter and grit.
- (b) Sedimentation—The separation of settleable solids (sludge) from the sewage.
- (c) Sludge digestion.
- (d) Oxidation of the soluble organic matters in the clarified sewage.
- (e) Disposal of effluent.
- (f) Disposal of digested sludge.



### Choice of System

While the various separate stages are mentioned here, only the simpler units for small installations will be discussed in detail.

The choice of system depends upon the facilities available for final disposal of the effluent.

- (a) Discharge into large or non-potable streams.
- (b) Discharge into potable streams.
- (c) Discharge into soil (13).

#### *Oxidation Processes.*

1. Oxidation processes should always be preceded by settling tanks.
2. Processes active in the atmosphere:
  - (a) Broad irrigation or sewage farming.
  - (b) Intermittent sand filtration and trickling filters.
3. Processes active under water:
  - (a) Disposal into streams, lakes, and ponds.
  - (b) Activated sludge tanks.
  - (c) Submerged contact aerators.

*Discharge into Large or Non-potable Stream.* Separate the grease. Remove floating and coarse solids by septic tank or by biolytic tank, followed by settling tank. Discharge through submerged outlet (13).

For a hotel, an institution, or a community of several hundred people, where power and daily attendance are available, and where a non-potable stream receives the discharge:

- (a) Separate the grease. Remove coarse solids by self-cleaning fine screen and scum board.
- (b) Discharge, as fresh as possible, through submerged outlet (13).

*Discharge into potable stream* or into stream whose waters are drunk by cattle, or upon a bathing beach.

Separate the grease. Remove solids by Imhoff tank. Oxidize on sand filter or on trickling filter. Discharge through submerged outlet (13).

*Discharge upon or into Soil.* Separate the grease. Remove solids by septic, biolytic, or Imhoff tank.

If remote (at least 500 ft from dwellings) and land is available, discharge intermittently into furrows of irrigation field growing crops on the ridges. (Vegetables which are eaten raw should be excluded.)

Discharge intermittently into subsoil distributing tile.

If the ground is sufficiently dry and porous this will be sufficient.

If the ground is not sufficiently dry and porous, lay another system of drains midway between the distributing tile, one foot lower and leading to a free discharge.

If soil is heavy, in addition to the last method, lighten the soil by deep plowing and by mixing in sand or cinders (13).

## ART. 9-B. SCREENING AND SEPARATION

### Interceptors

*Screening and separation* are necessary always for combined sewage. For strictly sanitary sewage, screens are seldom needed.

Certain other wastes, however, should be treated, either before entering the sewer or before entering the disposal plant.

*Kitchen wastes* from large kitchens, supplying institutions, public restaurants, etc., should be discharged through a grease trap.

*Dairy wastes*, if large in amount, should be treated separately, the sludge precipitated with alum or iron, and only the effluent admitted to the sewer.

*Barn wastes* should be screened to exclude straw, feed, and other solids, after which the liquid wastes and a limited amount of wash water may be admitted to the sewer.

*Gasoline and wash water* carrying, mainly, inorganic solids must not be discharged into the sewers.

### Screening

#### Definitions.

*Bar Screen.* A screen composed of parallel bars or rods (41). See also *Rack*.

*Coarse Rack.* A relative term, but generally used when the clear space between bars is 2 in. or more (41).

*Fine Rack.* A relative term, but generally used when the clear space between the bars is 1 in. or less (41).

*Grating.* A screen consisting of parallel bars, two sets being transverse to each other in the same plane (41).

*Medium Screens.* A screen having openings intermediate between those of a coarse and fine screen (41).

*Mesh Screen.* A screen composed of woven fabric, usually wire (41).

*Plate Screen.* A screen composed of one or more perforated plates (41).

*Rack.* A screen composed of parallel

bars, either vertical or inclined, from which the screenings may be raked (41).

*Screen.* A device with openings, generally of uniform size, used to retain coarse sewage solids. The screening element may consist of parallel bars, rods, or wires, grating, wire mesh, or perforated plate, and the openings may be of any shape, generally circular or rectangular slots (41).

*Screening.* The removal of relatively coarse floating and suspended solids by straining through racks or screens made of bars, grating, wires, or perforated plates (41).

*Screenings.* Material removed from sewage by screens and racks (41).

*Trash.* The material removed from combined and storm-water sewers by coarse racks (41).

*Types.* Screens are classified as coarse screens and fine screens.

*Fine Screens.* They retain sewage solids down to  $\frac{1}{8}$  in. in size and are usually required only on large installations. They are of mechanical self-cleaning types.

*Coarse Screens.* They are located at the very inlet to the disposal plant. They have openings over 1 in. in the least dimension and are for the general purpose of retaining large floating particles and branches from trees, etc. They are not self-cleaning. They should be set at an

angle of 30 to 60 degrees with the vertical (Folwell). The sewage channel should be increased to produce a mean velocity of about 2 fps.

If coarse screens are used for the protection of pumps, the clear openings should be only  $\frac{3}{4}$  in.

### Skimming Tanks

#### Definitions.

**Degreasing.** The process of removing fats and greases from sewage, waste, or sludge (41).

**Skimming.** Diverting surface water by shallow overflow to avoid diverting sand, silt, or other debris carried as bottom load (45).

**Skimming Tank.** A chamber so arranged that floating matter rises and remains on the surface of the sewage until removed, while the liquid flows out continuously under partitions, curtain walls, or scum boards (41).

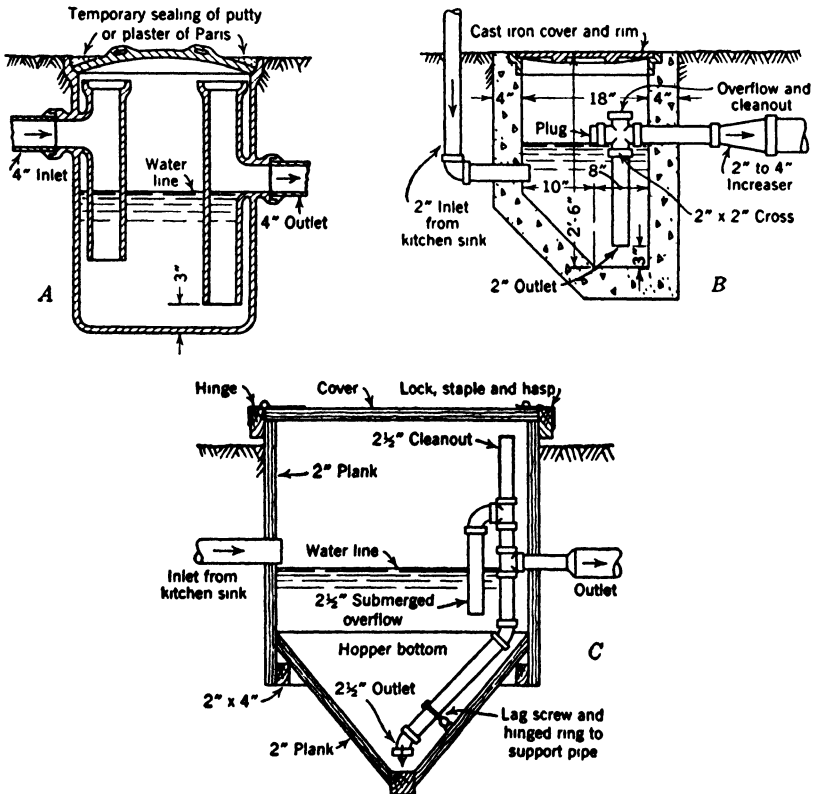

FIG. 74. Three Types of Grease Traps. (From U. S. Department of Agriculture, *Farmers Bull.* 1227.)

*A.* Ready-made grease trap; vitrified, salt-glazed earthenware; stock sizes; 10 in. diameter by 24 in., 12 in. diameter by 24 in., 15 in. diameter by 24 in. *B.* Homemade grease trap; concrete or well-plastered brickwork; elbow, cross, and increaser to be recessed drainage fittings. *C.* Type of grease trap used at United States Army camps.

*Types: Skimming Tanks.* On small plants they consist usually of grease traps, oil separators, and the like. These units usually are placed near the fixtures or building which they serve and thus, strictly speaking, are not part of the disposal plant.

**Grit Chambers**

*Definitions.*

*Grit.* The heavy mineral matter contained in sewage, such as sand, gravel, and cinders (41).

*Grit Catcher.* A chamber usually placed at the upper end of a depressed sewer, or at other points of protection on combined or storm-water sewers, of such shape and dimensions as to reduce the velocity of flow

and thus permit the settling out of grit (41).

*Grit Chamber.* A small detention chamber or an enlargement of a sewer designed to check the velocity of the sewage enough to permit the heaviest solid matter, such as grit, to be deposited with a view to its frequent and easy removal (41).

*Design.* Grit chambers, while mostly required on large plants, may be required where storm water is disposed into waters like canals or park lakes. They should be used in connection with a coarse screen.

The design should be based on maintaining a velocity of 1 fps, which will allow grit to settle but organic matters to be carried along. The length of the chamber (or time of flow) is determined by the time it takes the particles to settle.

$$\text{Cross-section (sq ft)} = \frac{\text{Rate of flow (cfs)}}{\text{Velocity (fps)}}$$

or

$$\text{Cross-section (sq ft)} = 0.00223 \times \text{gal per min (2)}$$

The approach channel to grit chambers should be designed for a velocity of 2 fps and the effluent channel for 1.5 fps.

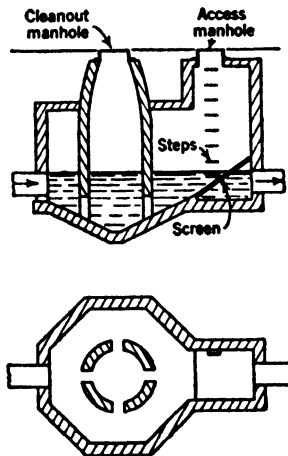

FIG. 75. Grit Chamber for Private Systems.

## ART. 9-C. TANK TREATMENTS

**Definitions**

*Activated Sludge.* Sludge settled out of sewage previously agitated in the presence of abundant atmospheric oxygen (41).

*Activated-Sludge Process.* Sewage treatment in which sewage standing in or flowing through a tank is brought into intimate contact with air and with biologically active sludge, previously produced by the same process. The effluent is subsequently clarified by sedimentation (41).

*Baffles.* Deflectors of wood, metal, or masonry placed in flowing liquid to divert, guide, or agitate the flow of such liquid (41).

*Biolytic Tank.* A continuous-flow tank with hopper bottom, with inlet arranged so as to agitate the sludge by the entry of sewage at the apex of the hopper-shaped bottom. This agitation tank is sometimes followed by a settling tank in which the sludge is detained until removed (41).

*Chamber.* A general term for a space inclosed by walls or a compartment, often prefixed by such a descriptive word as "grit chamber" or "screen chamber," indicating its contents, or "discharge chamber" or "flushing chamber," indicating its office (41).

*Chemical Precipitation.* Sedimentation accelerated by the coagulation of suspended or colloidal matter through the addition of chemicals (41).

*Detritus Tank or Chamber.* A detention chamber larger than a grit chamber, usually with provision for removing the sediment without interrupting the flow of sewage. A settling tank of short detention period designed, primarily, to remove heavy settleable solids (41).

*Filtration.* 1. The process of removing suspended and colloidal matter from a liquid and the oxidation of its dissolved organic matter, by causing it to flow through a relatively fine porous medium (41).

2. Sometimes loosely applied to the removal of solids and liquid organic matter in treatment beds (41).

*Final Settling Basin.* A tank through which the effluent of a trickling filter, or other oxidizing device, passes for the purpose of removing the settleable solids before its discharge (41).

*Final Settling Tank.* Same as final settling basin, but deeper and of less area (41).

*Flotation.* A method of collecting suspended matter in a tank as a scum at the surface by the evolution of gas by chemicals, electrolysis, heat, or bacterial decomposition (41).

*Gas Vent.* (a) A passage to permit the escape of gases of decomposition.

(b) An opening which allows gas, liberated in an Imhoff tank sludge digestion chamber, to reach the atmosphere without passing up through the sewage in the settling chamber (41).

*Horizontal-Flow Tank.* A tank or basin, with or without baffles, in which the direction of flow is generally horizontal (41).

*Humus Sludge.* (a) Digested sludge deposited in final or secondary settling tanks, following trickling filters or other oxidizing device (41).

(b) Sludge resembling humus in appearance (41).

*Humus Tank.* A tank for collecting humus sludge (41).

See also *Final Settling Tank*; *Final Settling Basin*.

*Hydrolytic Tank.* In general, any sewage tank in which hydrolysis occurs, specifically applied to a special form of vertical flow tank.

General term for any sedimentation tank in which, by biochemical processes, a part of the suspended organic matter is liquefied and gasified (41).

*Imhoff Tank.* A deep two-storied tank invented by Karl Imhoff, consisting of an upper or continuous sedimentation chamber and a lower or sludge digestion chamber. The floor of the upper chamber slopes steeply to trapped slots, through which solids may settle into the lower chamber.

The lower chamber receives no fresh sewage directly, but is provided with gas vents and with means for drawing sludge from near the bottom (41).

*Liquid Sludge.* Sludge containing sufficient water to permit it to flow by gravity (ordinarily above 80%) (41).

*Scum.* A mass of sewage solids, buoyed up by entrained gas, grease, or other substance, which floats at the surface of the sewage (41).

*Scum Board.* A vertical baffle dipping below the surface of sewage in a tank to prevent the passage of floating matter (41).

*Sedimentation.* The subsidence and deposition of suspended matter in a liquid by gravity (41).

*Sedimentation tank* is a tank or basin in which sewage, partly treated sewage, or other liquid containing settleable solids, is retained long enough, and in which the velocity is low enough, to bring about sedimentation of a part of the suspended matter, but without a sufficient detention period to produce anaerobic decomposition (41).

*Septic Tank.* A settling tank intended to retain the sludge in immediate contact with the sewage flowing through the tank for a sufficient period to secure a satisfactory decomposition of organic solids by anaerobic bacterial action (41).

*Settleable Solids.* Suspended solids which will subside in quiescent sewage in a reasonable period (41).

*Settled Sewage.* Sewage from which some of the solids have settled out in a tank during quiescence or slow flow (41).

*Settling Chamber.*

1. The second or final element of the so-called biolytic tank (41).

2. Sometimes used to designate the sedi-

mentation compartment of a two-story tank, as in the case of the Imhoff tank (41).

See also *Sedimentation Tank.*

*Sludge.* The accumulated suspended solids of sewage deposited in tanks or basins, mixed with more or less water to form a semi-liquid mass (41).

*Sludge Bed.* Natural or artificial layers of porous material upon which sludge is dried by drainage and evaporation (41).

*Sludge Digestion.* The biochemical process by which organic matter in sludge is gasified, liquefied, mineralized, or converted into more stable organic matter (41).

*Sludge-Digestion Chamber.* Any chamber used for the digestion of sludge (41).

The lower story of an Imhoff or Travis tank (41).

*Sludge-Digestion Tanks.* May be separate tanks but on small plants constitute the lower chamber of a two-story tank, the sludge-digestion chamber.

*Sludge Drying.* The process of drying sludge by drainage or evaporation, by exposure to the air, or by application of heat (41).

*Suspended Matter.* Solids physically suspended in sewage or effluent (41).

*Two-Story Tanks.* Tanks with an upper and lower chamber, divided by a hopper-shaped partition constructed so that the gas generated by the sludge in the bottom chamber will not rise into the upper chamber. The gas is made to escape through gas vents along the side.

*Vertical Flow Tank.* A sedimentation tank in which the sewage enters near the bottom, rises vertically, and flows out at the top (41).

*Weir.* A dam across a stream for diverting or for measuring the flow (45).

## Sedimentation Tanks

*Operation.* Settling of suspended particles may be done in plain settling tanks which are proportioned so that the sewage is detained long enough for the particles to settle. This process separates the settleable particles (sludge) from the liquid (effluent).

The settled sludge accumulates at the bottom, from which it can be removed either to a separate sludge-digestion tank or left long enough

for digestion in the tank itself (septic tanks). In two-story tanks (Imhoff tanks), the lower (sludge) chamber is separated from the upper by a baffled hopper to prevent gases from the decomposing sludge stirring up the settling action.

*Capacity.* Capacity (below flow line) in cubic feet equals detention period in hours times 8.02 times the flow in gpm (Imhoff).

Capacities recommended by New York State:

Single family dwellings.	} 1 day's flow, but not less than 300 gal
Small institutions with less than 25 population.	
Day schools with less than 100 pupils.	

For above types of buildings with larger flows the ratio may be reduced, in general, with capacities of 1500 gal per day or less, the tank capacity should be equal to one day's flow and with flows of 4000 gal per day or more, the tank capacity should be equal to one-half day's flow.

Detention period is based on the time needed for suspended matters to settle. The settling properties of sewage solids vary and on intricate work must be found first by tests. The degree to which settlement should take place usually is established by health authorities.

The deeper the tank, the longer the detention period required. A detention period of  $1\frac{1}{2}$  hours applies to a mean depth of 5 ft, which is the most common in small plants. With this depth, a detention period of  $\frac{1}{2}$  hour provides a surface area of 1 sq ft for each 600 gal per day. APHA recommends  $\frac{1}{2}$  day's flow plus 1 cu ft per capita (13).

All sedimentation tanks should be provided with scum boards at inlet and outlet and a long overflow weir at the outlet end. Variations of the above in the form of inverted T fittings are often used in septic tanks.

### Septic Tanks

*Function.* "This primitive form of digestion tank is no longer used in municipal treatment works, because septic action cannot be confined to the sludge proper, but reaches up into the flowing sewage. As a consequence, the effluent from septic tanks generally possesses a high immediate B.O.D., smells of hydrogen sulfide, and contains gas-lifted solids in suspension. Subsequent biological treatment becomes more difficult. In properly proportioned small treatment works and in residential and industrial sewage disposal, however, septic tanks still serve a useful purpose. Here their bad features are offset in part by the advantage that they are easy to build and need but little attention" (2).

*Capacity.* Recommendations for septic tank capacities vary greatly: Imhoff recommends a capacity of 80 gal per capita, based on sludge removal twice a year. The capacity may have to be increased to over 250 gal per capita if sludge removal is reduced in frequency.

APHA recommends  $\frac{1}{2}$  day's flow plus 1 cu ft per capita with a minimum size based on 10 persons (13).

In general, health authorities are trying to standardize on a basis of capacities of 50 gal or 6 cu ft per capita for residences; 2 cu ft per capita for schools; with a minimum capacity of 250 gal. This should be considered an absolute minimum.

The New York State Board of Health requires that settling basins shall be designed on the basis of the following minimum flows:

Private residences or private or public institutions where the resident population dwells in them .....	100 gal per capita per day
Day schools having toilets, wash basins, and shower baths ..	20 " " " " "
Day schools having only toilets and wash basins .....	15 " " " " "

The settling tank capacity below the flow line should be for:

Single family dwellings or for small institutions with population less than 25 persons or for	
Day schools with populations less than 100 .....	1 day's flow
Dwellings, institutions, and day schools with larger populations .....	1/2 " "

These figures allow for storage space of sludge and scum.

To give sufficient area for the formation of scum, the tank should have a minimum surface area of 0.33 sq ft per capita.

*Example.* A day school of 400 people with 20 gal per pupil per day requires  $400 \times 20 \times \frac{1}{2}$  or 4000 gal tank capacity or 535 cu ft, and an area of  $0.33 \times 400$  or 132 sq ft. This in most cases will determine the depth, which equals 535 divided by 132 or 4 ft. It is generally impractical to make the tank less than 5 ft deep, and this dimension should in this case determine the tank size: 5 ft  $\times$  107 sq ft.

*Design.* The width should be  $\frac{1}{3}$  to  $\frac{1}{5}$  the length, or width equals the square root of the area divided by  $c$  ( $c$  being anything from 3 to 5). In the above case  $b$  is approximately 5 ft, the length being 21 ft. This can be obtained by dividing a tank about 12 ft  $\times$  12 ft sq with a baffle wall in center, the channel width being 5 ft and the total run about 21 ft.

The above rule applies to all smaller installations. For plants with a flow of 2000 cu ft per hr or more, a detention period should be determined from tests of the sewage.

Length of tank in relation to width  $b$  and height  $h$ ,

$$L = \pm b + h$$

or

$$L = \pm 2 \sqrt{bh}$$

For minor installations,  $h$  is practically always 5 ft.

*Plant.* A sewage-disposal plant with a septic tank generally consists of a tank, divided into several compartments, a dosing apparatus, an outlet sewer, and a drainage field.



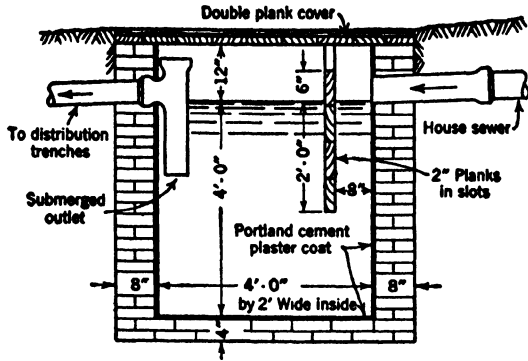

FIG. 76. One-Chamber Septic Tank. (From U. S. Department of Agriculture, Farmers' Bull. 1227.)

It does nothing more than a tight cesspool. Brick construction, heavily plastered inside; size suitable for 180 to 280 gallons of sewage daily (nominally 4 to 7 persons).

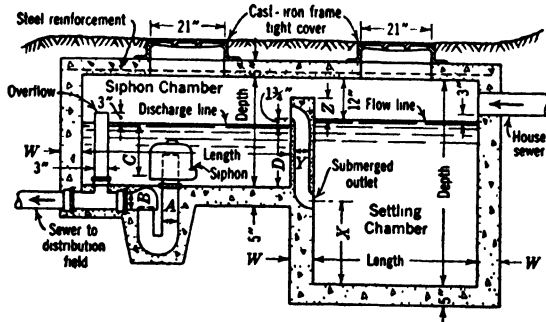

FIG. 77. Typical Two-Chamber Concrete Septic Tank. (From U. S. Department of Agriculture, Farmers' Bull. 1227.)

(See Table 66 for dimensions and quantities for different sizes.)

TABLE 66  
DIMENSIONS AND QUANTITIES FOR SEPTIC TANKS

Number of Persons	Quantity of Sewage in 24 Hours	Settling Chamber											
		Capacity below Flow Line	Length		Depth		Width		W	X	Y	Z	
	Gal	Gal	Ft	In.	Ft	In.	Ft	In.	In.	Ft	In.	In.	In.
5	180-280	240	4	0	5	0	2	0	6	2	0	4	6
10	320-480	420	5	0	5	6	2	6	6	2	3	4	6
15	520-680	620	5	6	6	0	3	0	8	2	6	5	8
20	720-960	860	6	0	6	6	3	6	8	2	9	5	8

Number of Persons	Quantity of Sewage in 24 Hours	Siphon Chamber								Concrete	Cement	Sand	Stone	Reinforcement in Top Slab (Strip of Heavy Stock Fencing)			
		Length		Depth		Width		A	B					C	D	Length	Width
	Gal	Ft	In.	Ft	In.	Ft	In.	In.	In.	In.	Cu yd	Bbl	Cu yd	Cu yd	Ft	In.	
5	180-280	5	0	2	8	2	0	3	4	15	18 1/4	3	4 1/2	1 1/8	2 3/8	10	32
10	320-480	8	0	2	8	2	6	3	4	15	18 1/4	4 1/4	6 1/4	2	3 3/4	14	39
15	520-680	8	8	2	10	3	0	4	4	17	20 1/4	6 3/8	9 3/4	3	6	15 3/4	47
20	720-960	10	0	2	10	3	6	4	4	17	20 1/4	8	12	3 1/2	7	17 1/2	56

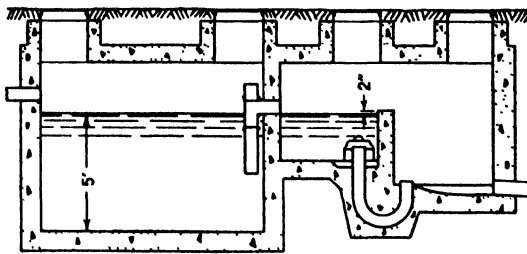
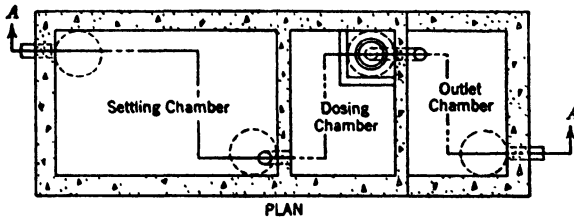

FIG. 78. Three-Chamber Concrete Septic Tank.

Septic tanks are for sanitary sewage only, and all foreign or trade wastes and rainwater should be disposed of in some other manner.

1. *Tank*. The tank has one or more compartments for the following purposes:

- (a) Sedimentation tank.
- (b) Dosing chamber.
- (c) Outlet chamber.

2. *Sewer*. The sewer should be designed to discharge a certain amount of liquid under certain conditions given (mostly the available or natural slope of the ground).

3. *Irrigation Field (Drainage Field)*. The field is for the double purpose of oxidizing the effluent and dispersing it into the ground. The determining factors are the amount of liquid, the time necessary for infiltration, and soil conditions. To determine this, the following data must be on hand:

*For residences*: The number of people to be served.

*For institutions*: Sufficient statistics to determine the ultimate population to be served within the proposed life of the plant (10 years a minimum).

The general topography of the area to be used for the plant. The nature of the soil (see percolation test).

4. The sewage consists of human wastes mixed with a proportionally large amount of water. A certain percentage of the solids will settle in the settling tank and be digested by bacteria, who depend on the exclusion of air for their existence (septic action). This work is done in the bottom of the settling tank. The excess liquid can be further purified by digestion by bacteria, who depend on the presence of air for their existence. For this reason it is essential that air is permitted (oxidation). Septic tanks which drain into the ground at such depths that no oxygen can enter the effluent may apparently work satisfactorily if the soil is able to dissipate it and the pipes do not clog, but the result is a general pollution of the ground and, where veins of any sort occur, this effluent can be carried long distances in its impure state and putrefy water wells and water supplies, etc. The effluent should be carried into a drainage field or some other filtration device where the oxygen can reach it through infiltration from the surface and the proper bacteriological action with its consequent clarification of the liquid can take place before it seeps into the ground.

The total amount of liquid to be handled daily is in direct proportion to the amount of water consumed and emptied into the tank.

### **Imhoff Tanks**

*Capacity and Sizes* (13).

1. *Settling chamber*. Capacity— $\frac{1}{4}$  day's flow; twin channels; rectangular in plan; bottom slopes—4 vertical on 3 horizontal; slot—4 in.; gas trap, 5 in. horizontal.

2. *Sludge chamber.* Capacity—2 cu ft per capita from bottom to a level 8 in. above slot.
3. *Gas vent.* Length of tank and not less than 12 in. wide.
4. *Sludge pipe.* 4-in. cast-iron soil pipe or cast-iron water pipe.

**Biolytic Tanks**

*Capacities and Sizes* (APHA Recommendation) (13).

1. *Agitation chamber capacity.*  $\frac{1}{3}$  day's flow. Square in plan with hopper bottom; hopper one-half total depth. Bottom slopes 4 vertical on 3 horizontal.
2. *Settling chamber capacity.*  $\frac{1}{6}$  day's flow plus 1 cu ft per capita. Area same as for agitation chamber.

**Capacities of Sludge Digestion Tanks** (Minimum recommendations for small plants)

Two-story digestion tanks .....	3-4 cu ft per capita
Deep, separate digestion tanks, unheated .....	5-6 " " "
Separate digestion tanks, heated .....	3-4 " " " "

Unheated separate digestion tanks are not generally recommended and are prohibited in some localities.

**Final Settling Tanks**

*Capacity.* Final settling tanks following trickling filters shall have capacities sufficient to provide a detention of one hour. The tanks should, in general, be otherwise designed similar to the primary sedimentation tanks. Provision should be made for the frequent and regular removal of the sludge, which should be carried either to the inlet of the primary sedimentation tank or to the separate sludge-digestion tank (42).

**ART. 9-D. CLARIFICATION OF EFFLUENT**

**Definitions**

*Broad Irrigation.* The disposal of sewage by application to farm land, involving the incidental benefit to crops growing out of the irrigation and fertilization resulting from the application of the sewage. (Differs from sewage farming in that the primary purpose is the disposal of sewage while the raising of crops is incidental only) (41).

*Cesspool.* An excavation in the ground made for the reception of crude sewage, and so constructed that the organic matter is retained while the liquid portion is permitted to seep through its walls (46).

*Coarse-Grained Filter.* General term for contact bed or trickling filter (41).

*Contact Bed.* An artificial bed of coarse material, such as broken stone or clinkers, in a watertight basin provided with controlled inlet and outlet. It is operated in cycles of filling with sewage, standing full in contact, emptying, and resting empty, in order to remove some of the suspended matter and oxidize organic matter by biochemical agencies (41).

*Dilution.* 1. A method of disposing of sewage or effluent by discharging into a stream or other body of water (41).

2. The ratio of the volume of flow of a stream to the volume of sewage or effluent discharged into it (41).

*Dispersion.* A method of disposal of the suspended solids in sewage or effluent by scattering them widely in a stream or other body of water (41).

*Distributor.* A device used to apply sewage to the surface of a filter. There are two general types: fixed and movable. The fixed type may consist of perforated pipes or notched troughs, sloping boards, or sprinkler nozzles. The movable type may consist of rotating or reciprocating perforated pipes or troughs applying spray or a thin sheet of sewage (41).

*Division Box.* A structure for dividing and diverting water into other channels. It may divide all flow pro rata, or it may divert a definite quantity, within a reasonable tolerance, regardless of the total flow (45).

*Dosing Siphon.* An automatic siphon for discharging the contents of a dosing tank (41).

*Dosing Tank.* A tank into which raw or partly treated sewage is introduced and held until the desired quantity has been accumulated, after which it is discharged at such a rate as may be necessary for distribution essential to the subsequent treatment (41).

*Dry Well.* An underground receptacle equipped with a manhole and cover brought to the surface of the ground for observation and cleaning purposes, so constructed as to insure the disposal of treated wastes, by soil absorption through its walls and bottom (46).

*Intermittent Filter.* A natural or artificial bed of sand or other fine-grained material to which sewage is intermittently applied in doses and through which it flows, opportunity being given for filtration and also oxidation of the organic matter by biochemical agencies (41).

*Irrigation.* The artificial application of water to lands for agricultural purposes (45).

*Leaching Cesspool.* A cesspool out of

which the liquid leaches into the surrounding soil (41).

*Percolation.* Movement of water through the interstices of a substance, as through soils (45).

*Sand Filter.* A filter in which sand is the filtering medium (41).

See also *Intermittent Filter.*

*Sewage Farming.* A term applied to the raising of crops where sewage is applied to the land for irrigation and fertilization purposes (41).

See also *Broad Irrigation.*

*Sewage Oxidation.* The process whereby, through the agency of living organisms in the presence of oxygen, the organic matter is converted into a more stable mineral form (41).

*Sprinkler Nozzle.* A nozzle used for applying sewage in the form of a spray to a trickling filter (41).

*Sprinkling Filter.* A trickling filter in which the sewage is applied by spray (41).

*Subsoil Drain.* A land drain deep enough to take water from the subsoil (41).

*Subsurface Irrigation.* The process of sewage treatment in which sewage or effluent is applied to land by distributing it beneath the surface through open-jointed pipes or drains (41).

*Surface Irrigation.* The process of sewage irrigation in which sewage is applied to and distributed over the surface of the ground (41).

*Trickling Filter.* An artificial bed of coarse material, such as broken stone, clinkers, slate, slats, or brush, over which sewage is distributed and applied in drops, films, or spray, from troughs or drippers, moving distributors, or fixed nozzles, and through which it trickles to the underdrains, giving opportunity for organic matter to be oxidized by biochemical agencies (41).

*Underdrain.* A land drain laid below the surface of the ground or of a sand filter or sludge bed (41). Subdrain.

*Watertight Cesspool.* A cesspool with tight walls to prevent leaching and from which the contents are removed at intervals (41).

TABLE 67  
 THE MILLER SEWAGE SIPHON  
 3", 4", 5", 6" and 8" Standard Design Single Sewage Siphons

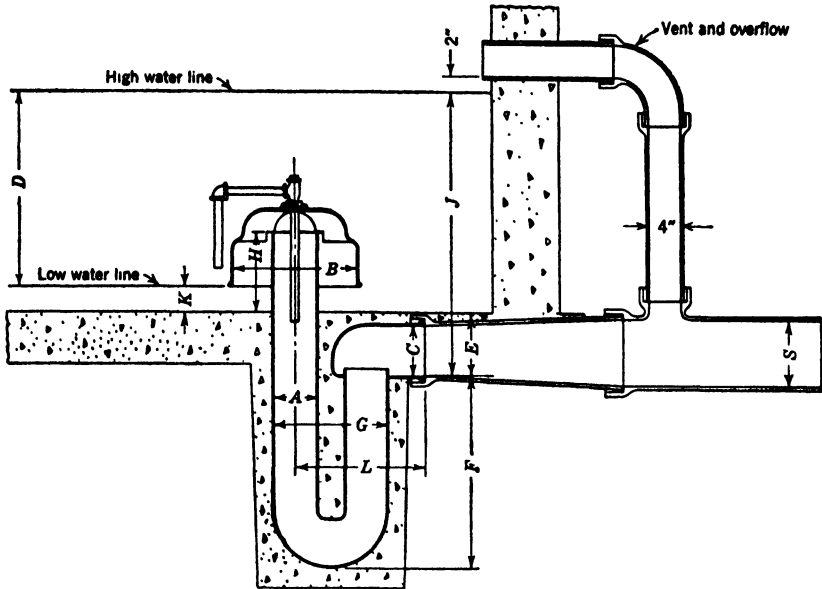

APPROXIMATE DIMENSIONS IN INCHES AND AVERAGE WEIGHTS IN POUNDS

Diameter of siphon	A	3	3	4	4	5	6	8
Drawing depth	D	13	15	14	17	23	30	35
Diameter of discharge head	C	4	4	4	4	6	8	10
Diameter of bell	B	10	10	12	12	15	19	24
Invert below floor	E	4 1/4	4 1/4	5 1/2	5 1/2	7 1/2	10	12
Depth of trap	F	13	13	14 1/4	14 1/4	23	30 1/4	36 1/2
Width of trap	G	10	10	12	12	14	16	22 1/2
Height above floor	H	7 1/4	9 1/4	8 3/4	11 3/4	9 1/2	11	13 1/2
Invert to discharge = D + E + K	I	20 1/4	22 1/4	22 1/2	25 1/2	33 1/2	44	52
Bottom of bell to floor	K	3	3	3	3	3	4	5
Center of trap to end of discharge ell	L	8 5/8	8 5/8	11 3/4	11 3/4	15 1/2	17 1/8	23 1/2
Diameter of carrier	S	4	4	4-6	4-6	6-8	8-10	12-15
Average discharge rate, gpm		72	76	157	165	328	474	950
Maximum discharge rate, gpm		96	104	213	227	422	604	1210
Minimum discharge rate, gpm		48	48	102	102	234	340	690
Shipping weight in pounds		00	70	110	120	190	300	500

Note: Two single siphons of this type set side by side in the same tank will alternate. The draft D will be 1 to 2 less in this case

The size and drawing depth of the siphon selected will depend upon the fall available and the amount of sewage to be treated. Recommended sizes:

- 5 to 15 persons, use 3-in. siphon.
- 16 to 40 persons, use 4-in. siphon.
- 41 to 100 persons, use 5-in. siphon.
- 101 to 200 persons, use 6-in. siphon.
- 201 to 1000 persons, use 8-in. siphon.

Attention is called to the vent leading from the discharge pipe back into the dosing tank at a point above the siphon discharge line. This vent should not be omitted as it is quite necessary to the proper operation of the siphon. The same results can be obtained by setting the siphon farther back in the dosing tank, placing a tee at the discharge head, and then raising a straight piece of pipe up from the tee outlet inside the dosing tank to a point 3 or 4 in. above the discharge line.

Courtesy Pacific Flush-Tank Co., Chicago, Ill.

## Dosing Tanks

Dosing tanks are equipped with automatic siphons. The capacity of the tank or chamber below the flow line should be approximately equal to, but not greater than, three-fourths of the interior capacity of the pipe in the portion of the subsurface irrigation which is dosed at one time. In general, where the total length of tile laterals exceeds 1000 ft, the dosing tank should be provided with two siphons, each serving one-half the tile field and dosing in alternation (42).

Dosing tanks used in connection with sand filters should have a capacity to flood the beds to a depth of between 1 and 4 in.

Dosing apparatus used in connection with sand filters should have a capacity to give a rate of discharge at minimum head of at least two times the maximum rate of inflow.

## Sand Filters

### *Design.*

1. *Sand filters.* Intermittent sand filters should be divided into not fewer than two units; depths of beds not less than 3 ft above under-drains; effective size of sand between 0.2 and 0.5 mm; uniformity coefficient preferably not over 3.0; area of beds to give a rate of filtration of not over 50,000 to 75,000 gal per acre per day (depending on the latitude) if preceded by settling tanks, and the rate may be increased to not over 200,000 gal per acre per day if the filters are preceded by adequate settling tanks and trickling filters with secondary settling tanks. These figures are to be reduced 50% if the location of filters is on a limited watershed used for water-supply purposes (42).

2. *Dosing tanks.* Should have a capacity to flood the beds to a depth of between 1 and 4 in. and dosing apparatus a capacity to give a rate of discharge at minimum head of at least two times the maximum rate of inflow (42).

3. *The sewage* should be applied to beds by means of distribution troughs laid on the surface or other suitable means to distribute the sewage effectively (42).

4. *Capacity.* Not more than 1 gal per sq ft daily. Not less than 87 sq ft per capita (APHA) (13).

## Trickling Filters

### *Design.*

1. *Trickling filters.* Should, in general, have depths between 6 and 10 ft, filter medium of carefully selected material of fairly uniform size between the limits of 1 and  $2\frac{1}{2}$  in.; filter area sufficient to give a rate of filtration of not over 150,000 gal per acre per day per ft of effective depth of filter material. The method of distribution of the sewage on the filter may be by spray nozzles, traveling or revolving distributors, or other suitable means. Provision should be made for flushing the dis-

tribution and underdrainage systems and for draining the distribution system. The underdrainage system should provide adequate drainage.

Trickling filters should be followed by final settling tanks (42).

2. *Capacity.* Not over 36 gal per sq ft daily nor less than 8 cu ft per capita (APHA) (13).

*Material.* Broken stone, brush, or lath (APHA). 1 cu ft per 10 gal sewage per day (2).

*Plan.* Rectangular, hexagonal or circular.

*Depth.* 4.5 to 6 ft (APHA) (13).

**Subsurface Irrigation**

*Design* (13).

1. Area of tile field: Not less than 100 sq ft per capita nor less than 2 sq ft per gal daily.

2. Tile distributors:

Length: 20 ft (average) per capita, depending on the soil.

Spacing: Gallons per capita ÷ 10, but not less than 5 ft (4 ft minimum).

Diameter: 2 in. up to 50 gal per capita and 16 discharges daily.

3 in. above 50 gal per capita daily.

Number of discharges daily = daily flow ÷ contents of tiles, but not over 16.

3. Contents of tiles:

<i>Diameter of tile in inches</i>	<i>Volume in gal per linear ft</i>
3	0.367
4	0.652
5	1.02
6	1.46

4. Subsurface irrigation systems should be preceded in all cases by settling tanks and, for the larger systems, be divided into not less than two sections so arranged that one section may be put out of service for periods of rest.

5. Length of tile should in general be based upon tests of the soil on the site. (See soil tests.)

Diameter of tiles: Main distributors not less than 4 in. on uniform slope not greater than 1%, or approximately 1/8 in. per ft.

Laterals should be 4 in. in diameter on a uniform slope not greater than 0.5%.

*Construction.* Laterals laid in trenches 1 to 3 ft wide and 18 in. deep, and 4 to 9 ft apart. Tiles laid with open joints 1/8 to 1/4 in., protected with strips of tar paper 4 in. wide laid over the top and two-thirds around the circumference of the pipe. Entire pipe to be surrounded by gravel or broken stone of graded sizes, from a level 2 in. below the bottom of the tile to a level 4 in. above the top of the tile. Tops of tile to be 12 to 18 in. below surface of ground (42).



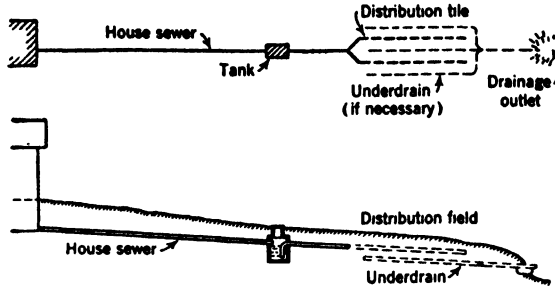

FIG. 79. Parts of Septic Tank Installation. (From U. S. Department of Agriculture, Farmers' Bull. 1227.)

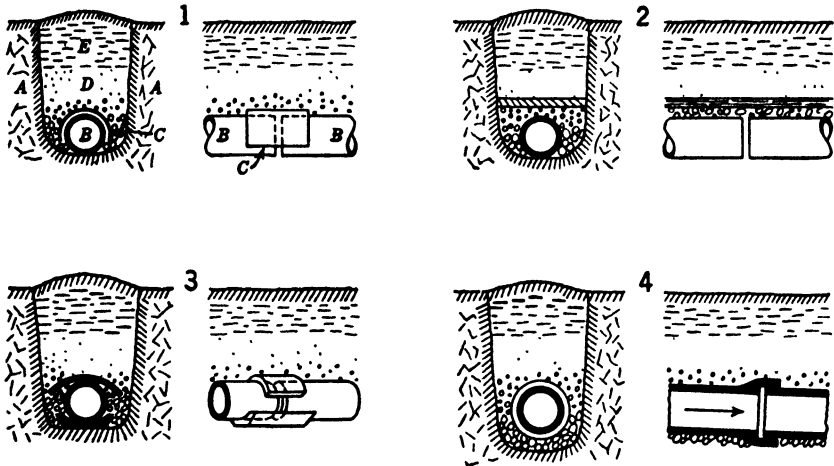

FIG. 80. Four Methods of Protecting Open Joints in Distribution Lines—an All-important Work. (From U. S. Department of Agriculture, Farmers' Bull. 1227.)

Sketches show cross-section and longitudinal views; the depth from the surface of the ground to the top of the tile is about 10 in.

1. *A*, Subsoiled ground; *B*, 3- or 4-in. drain tile; *C*, strip of tarred paper about 6 in. wide and extending three-fourths the distance around the tile, allowing sewage to escape at the bottom; *D*, coarse sand, gravel, broken stone or brick, slag, cinders, or coke, the coarsest material placed around the tile (where the ground is naturally very porous and well drained, special filling in the trench may be omitted); *E*, natural soil.

2. Drain tile covered with a board laid flat, leaving the entire joint open.

3. Drain tile laid in stoneware gutter pieces and the joint covered with stoneware caps; gutter and cap pieces are inexpensive commercial products; their radius is longer than that of the outside of the tile, thus leaving open most of the joint space; the gutter aids in keeping the tile in line.

4. Vitrified sewer pipe with hubs facing downhill; the spigot end should be centered in the hub with a few small chinks or wedges.

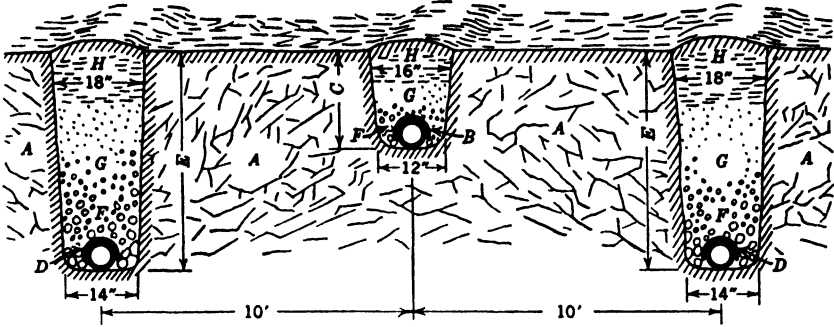

FIG. 81. Close Soils Should be Deeply Subsoiled and Underdrained. (From U. S. Department of Agriculture, Farmers' Bull. 1227.)

Porous, well-drained, air-filled soil is absolutely necessary. *A*, Subsoiled ground; *B*, 3- or 4-in. distribution tile; *C*, depth variable with the climate,  $1\frac{1}{4}$  to  $3\frac{1}{2}$  ft; *D*, 4-in. underdrain; *E*, depth such as would prepare land for good crop production, generally  $3\frac{1}{2}$  to 4 ft; *F*, stone or other coarse material; *G*, gravel grading upward to coarse sand; *H*, loose soil.

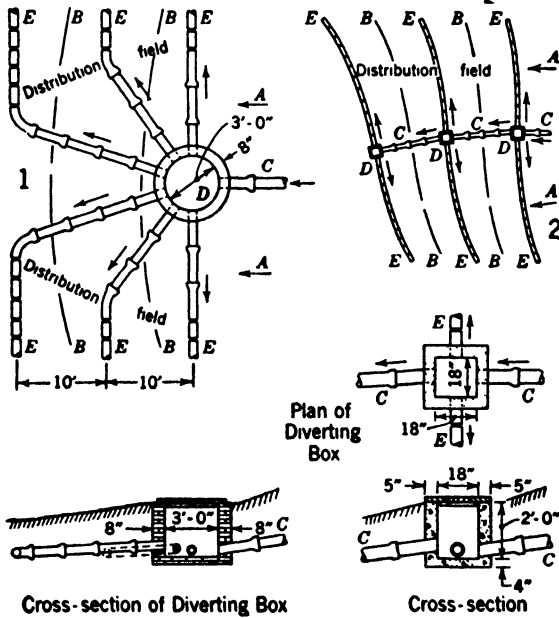

FIG. 82. Two Systems of Distribution on Steep Slopes and Use of Diverting Box. (From U. S. Department of Agriculture, Farmers' Bull. 1227.)

*A*, Direction of slope; *B*, contour of field; *C*, 4-, 5-, or 6-in. sewer from tank; *D*, diverting box; *E*, 3-in. or 4-in. distribution tile.

Main distributors should be bell and spigot type tiles with watertight joints.

*Leaching Cesspools* (N. Y. State Recommendation). Leaching cesspools may be used for private residences and institutions of small populations and are usually preferable where the soil below a depth of 2 or 3 ft is more porous than that above this depth and where the subsoil is fairly well drained. They should be preceded by a settling tank.

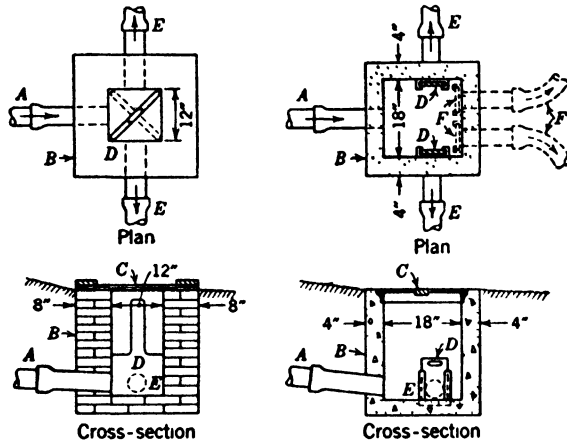

FIG. 83. Two Simple Types of Sewage Switch. (From U. S. Department of Agriculture, *Farmers' Bull.* 1227.)

A, Sewer from tank; B, switch box; C, cover; D, blade or stop board (in the left-hand box the direction of flow is controlled by placing the blade in alternate diagonal position; in the right-hand box the stop works in iron guides cast integral with a short piece of light-weight pipe set in the masonry; if desired the guides may be wood, fastened to the masonry with expansion bolts); E, sewer to distribution area; F (right-hand box), alternate position of outlets or additional outlets if required.

Leaching cesspools should be constructed of hollow tile, hollow brick, or dry rubble masonry, etc., of durable material, should be placed not closer than 20 ft apart out to out of walls, and be arranged in groups running generally parallel to contour lines.

The total number and size of cesspools for private houses and institutions occupied during the 24 hours and for day schools or institutions occupied only through the daytime should be such as to provide a total superficial percolating area above the ground water table in square feet, including bottoms and exterior side walls below flow lines, based on percolation tests.

*Percolation Tests* (N. Y. State Recommendation). Percolation tests for subsurface irrigation systems. Soil tests are made by digging a hole 1 ft sq and 18 in. deep (the depth of the tile trenches) and then filling the hole with water to a depth of 6 in. The downward rate of percola-



tion or drop of water surface should then be observed, taking the average time in minutes for the water to lower 1 in. in the hole.

In the case of leaching cesspools the test hole should be dug in the bottom of a pit excavated to a depth of about one-half the proposed depth of the cesspool.

In dry soil the test should be repeated and the slower rate of percolation used.

A test showing a rate of percolation slower than one hour would indicate that this method of disposal is not suitable.

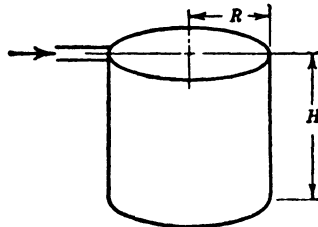

$H$  = Distance from flowline to bottom

$A$  = Percolating area, as determined by soil tests (sides and bottom of cesspool).

$R$  = Radius of cesspool.

$$R = \sqrt{\frac{A}{3.14} + H^2} - H$$

FIG. 85. Dimensions of Leaching Cesspools.

*Rate of Sewage Application* (N. Y. State Recommendation). The allowable rate of sewage application per square foot per day based on the total superficial bottom area of the trenches in which the tile is laid or the superficial percolating area of the cesspools may be taken from Table 68.

TABLE 68

ALLOWABLE RATE OF SEWAGE APPLICATION PER SQUARE FOOT PER DAY

Time for Water to Fall 1 In.	Bottom Area of Trenches	Percolating Area of Cesspools
1 min	4.0 gal	5.3 gal
2 "	3.2 "	4.3 "
5 "	2.4 "	3.2 "
10 "	1.7 "	2.3 "
30 "	0.8 "	1.1 "
60 "	0.6 "	0.8 "

The allowable rate of sewage application indicated for the one-minute rate of fall should be the maximum used for any installation.

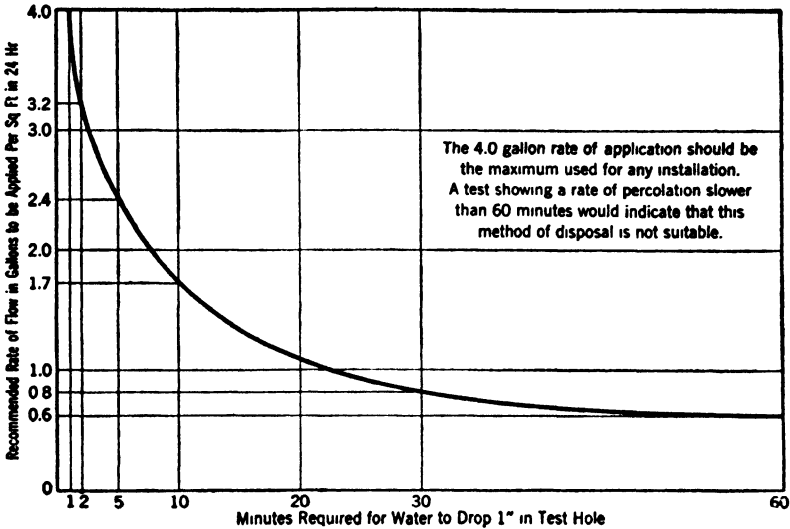

FIG. 86. Subsurface Irrigation. Irrigation Capacity of Trenches with Unglazed Tiles. (For leaching pools allow 133% of figure shown.)

Test hole should be one foot square and 18 in. deep (or the depth of the trenches). After filling the hole with 6 in. of water register the average time it takes for the water to drop 1 in. In dry soil the test should be repeated and the slower rate used.

Example: For 800 gal per day, assuming that the percolation test shows a 1 in. drop in 10 min, the chart allows a rate of flow of 1.7 gal per sq ft per day. The total length of tiles required will be  $800/1.7$ , or 470 ft.

If leaching pools are used, the total surface area, including the bottom, shall be  $800/(1.7 \times 1.33)$ , or 352 sq ft, or 75 per cent of 470.

### Other Methods

*Artificial Subsurface Filtration* (N. Y. State Recommendation). Artificial sand filter trenches or subsurface sand filter beds should be designed for a rate of filtration not greater than 50,000 gal per acre per day. The filtering material should be a coarse, clean sand, having approximately an effective size between 0.2 and 0.5 millimeter and a uniformity coefficient preferably not over 3.0 and should be 3 ft deep measured between center lines of the distributors and underdrains.

The distributing tile and underdrains should be laid entirely in graded or crushed stone 1 to 1¼ in. in size. The trenches should be spaced approximately 5 ft on centers, and in the case of filter beds the underdrains should be spaced midway between the distributors.

*Broad Irrigation.* Area not less than 436 sq ft per capita. Area not less than 10 sq ft per gal daily (APHA) (64). This rate can be increased if the sewage is clarified in advance.

**ART. 9-E. DISINFECTION****Definitions**

*Disinfected Sewage.* Crude sewage, or a sewage plant effluent, which has been treated with a disinfecting agent, commonly chlorine or "bleach," resulting in the destruction of bacteria sufficient to reduce materially the danger of infection (41).

*Chlorine and Chlorine Compounds.* Chlorine is generally purchased as liquid chlorine or chlorine gas that has been liquefied by compression. Liquid chlorine is shipped and stored in steel cylinders, drums, or tank cars and is applied to sewage either directly as a gas through a submerged diffuser or as a solution of chlorine gas in water. The amount of chlorine that can be dissolved satisfactorily in sewage by diffusion is limited to something less than 3.5 ppm. Application is controlled in both methods of feeding by passing the chlorine gas released from the storage vessel through a chlorinator or gas-measuring and gas-regulating device. Great care must be exercised in handling chlorine; it is a highly toxic and corrosive substance (2).

## CHAPTER 10

### GAS PIPING AND APPLIANCES

#### ART. 10-A. GAS SERVICES

##### **Definitions**

*Mains and Service Pipes.* Any pipes laid in public highways, private ways, or on rights-of-way owned or leased by the utility, for the purpose of conveying gas in the direction of such highways or rights-of-way, shall be considered as mains.

Any pipes used to convey gas from the mains to the premises of, or to, the piping owned by any customer shall be considered as service pipes (22).

##### **Minimum Pressure in Mains**

Two inches of water column is the traditional minimum limit of pressure for the distribution of manufactured gas in this country. It is the pressure specified in almost all the regulatory ordinances and requirements in effect. No such general agreement appears in relation to natural gas, the pressure of which is usually expressed in ounces per square inch rather than in inches of water column. Two ounces is probably the figure most frequently employed.

One ounce per square inch is equivalent to 1.73 in. of water column. There is a tendency to abandon the expression of gas pressure in ounces.

The great majority of present-day appliances are built to meet the approval requirements of the American Gas Association (also adopted generally as "American Standards" by the American Standards Association). These requirements specify that the appliances be adjusted for test to give their normal ratings at a pressure at the appliance of 3.5 in. of water column with manufactured gas and 7 in. with natural gas. The difference results from the fact that much smaller orifices must be used with natural gas to permit the injection of the greater percentage of air needed.

The requirements of the AGA for house piping and appliances installation recommend the design of house piping for a pressure drop of 0.5 in. This must, of course, be added to the pressure at the orifice, making the minimum pressure 4.0 in. for manufactured and 7.5 in. for natural gas.

The problem of selecting suitable minimum pressures for mixed gases of compositions intermediate between those of the usual manufactured and natural gases is most simply solved by making the minimum pres-



sure at the appliance proportional to the heating value. Of course the minimum pressure is related to the "air requirement" of the gas and not directly to the heating value, but the substantial proportionality between these two properties permits the one to be substituted for the other, as a matter of convenience, in an approximate computation of this kind.

The formula, reduced to its simplest terms, is

$$0.4H + 0.3$$

where  $H$  represents the heating value of the gas in hundreds of Btu per cu ft.

Permissible variations in pressure are:

<i>Minimum pressure in inches</i>	<i>Greatest variation permissible, in inches</i>
2 to 3	2
3 to 4	2½
Over 4	3

This schedule has been adopted in several states (22).

### **Installation, Maintenance, and Ownership of Service Pipes**

Rules relating to the installation and ownership of service pipes are in as confused a state as those relating to mains. In some cases the customer pays for the entire cost of the service connection but this is relatively rare. In other cases the utility pays for and owns the entire service connection. Various rules exist as to the length of service pipe installed without charge to the customers; the most common provisions specify 50 or 100 ft. A large number of companies, possibly a majority, install the entire service pipe, but pay for and own only the portion from the main to the curb or to the property line. A few companies will install the service pipe only to the property line and require the remainder of the connection to be made by the customer. There is a similar discrepancy in the rules relating to maintenance. In many cases the utilities specifically provide that they will maintain and repair only the portion of the service pipe which they own, but the majority will maintain the entire service pipe by whomever it is installed or owned.

The recommended practice is to have the utilities install, own, and maintain all services except those of unusual length (22).

### **Meters**

*B type meters* up to 100 lights are used for all domestic, institution, and small industrial purposes.

*C type meters* are used on large installations and whenever the customer receives gas service at an hourly demand rate, so in each case it is essential to meter all consumption through one meter in order to register on a special indicator the maximum demand during any one hour.

TABLE 69  
APPROXIMATE SIZES AND CAPACITIES OF GAS METERS

B TYPE METERS

Size	Size Conn. Iron Pipe	Cap. ½ In.	Width	Depth	Height
3/100	¾ in.	100	11¾ <sub>16</sub> in.	8¼ in.	14½ in.
5/150	½ in.	150	12¾ <sub>16</sub> in.	9¾ <sub>16</sub> in.	16¼ in.
10/300	¾ in.	300	14¾ in.	11¼ in.	18½ in.
20/450	1 in.	450	17¼ in.	12½ <sub>16</sub> in.	21½ in.
30/600	1¼ in.	600	20¼ in.	14½ <sub>16</sub> in.	26½ in.
60/1250	1½ in.	1250	26¾ <sub>16</sub> in.	20¾ in.	31¾ in.
100/1850	2 in.	1850	30 in.	23¼ in.	36¾ in.
200/3200	2½ in.	3200	37¾ <sub>16</sub> in.	30¾ in.	42¾ in.
500	6 in.	9000	60¼ in.	47 in.	66¾ in.

TABLE 70

C TYPE METERS

Size	Size Conn. Iron Pipe	Cap. ½ In.	Width	Depth	Height
6	1¼ in.	600	16 in.	13 in.	19¾ in.
11	2 in.	1,100	22¼ in.	16¾ in.	27¼ in.
25	2½ in.	2,500	28 in.	24½ in.	34 in.
40	3 in.	4,000	32¾ in.	29½ in.	38½ in.
60	4 in.	6,000	41 in.	35¾ in.	45 in.
170	8 in.	17,000	67 in.	60 in.	69½ in.

Above capacities are figured on a pressure of 3 in. at meter inlet and ½ in. loss through meter.

*Rotary positive displacement gas meters* are used mainly for industrial gas measurements. Because of their unusually wide range of accurate operation they are especially applicable to industrial loads, where such a condition is usually encountered. They are also widely used as station meters and might be considered the standard method of measuring the output of gas plants.

Capacities vary from 4000 cu ft per hr to over 1,000,000 cu ft per hr meter displacement. They are available in cases of different strengths to withstand 25 or 50 and 125 lb static pressure. Special meters can be furnished for much higher pressures.

This type of meter has an extremely high capacity with low pressure drop as compared to other types of meters. Thus a single rotary displacement meter occupying less space and having less piping may do the work of a whole bank of the diaphragm type of meters. The rotary displacement meter requires no internal seals of any kind or electric current for its operation. The register furnished with the meter reads directly in cubic feet units at line conditions. If so required, indicating or recording, or integrating, instruments can be attached to the meter which will give a reading correcting to the desired pressure and temperature base.\*

*Installation.* Gas meters are usually set at the front basement wall where the service pipe enters the building. It should be placed in an easily accessible location. In apartment buildings where there are separate meters to the individual apartments, a separate room should be provided. Such a meter room should be ventilated to the outside, located conveniently to the gas service, and be accessible without passing through any leased portions of the building.

Gas meters must be protected from extreme temperatures. They should not be installed in unprotected or unheated buildings or be placed near furnaces, boilers, or heating pipes that are not properly covered or insulated.

## ART. 10-B. GAS PIPING

### Designing Gas-Piping Systems

Without proper adequate house piping the use of gas is restricted and the selection of the best appliances for a particular installation interfered with. Architects and builders should insist on complete piping for gas in all new buildings. Some may not be aware of the desirability of using gas for all fuel purposes. Future occupants of the same building, however, may wish to install gas appliances, and the expense of subsequent piping of the house will be excessive; thus the lack of adequate house piping in a building may prevent its future lease or sale (17).

*Municipal Regulations Regarding Gas Piping.* The installation of gas piping is usually governed by local ordinances and all requirements of the community should be complied with (17).

*General Specifications for Gas Piping.* All house piping must be installed so as to grade back toward the inlet, provided, however, that in cases where such grading is impracticable, and it is necessary to grade the house piping away from the inlet, drip pipes of adequate capacity be installed at all points where the house piping is trapped by such changes in grade. Drip pipes must be so located as to be readily accessible at all times. Drip pipes shall not be used as outlets for the attach-

\* Information furnished by Roots-Connersville Blower Corporation, Connersville, Indiana.

ment of any fixture or gas appliance. Drip pipes at least 6 in. in length must also be placed at the bottom of all vertical pipes which rise from and are connected at the end of a horizontal pipe (17).

All house piping must be securely fastened in place in such a manner as to maintain the grading and shall not be used for supporting any weight other than lighting fixtures which may be attached thereto (17).

Pipe ends must be thoroughly reamed after threading before making up (17).

Piping installed underground, or in places exposed to sudden changes or wide ranges of temperature, must be protected from corrosion with an asphaltic coating or with suitable insulation, as the conditions may require (17).

All branch outlet pipes shall be taken from the top or sides of running horizontal lines and not from the bottom. No crosses shall be installed on horizontal lines (17).

Above the basement, pipe shall not be run under beams or floor joists where it will be covered with lath and plastering but shall be run along the top of the beams or joists, so that it will be accessible by removing one or two boards from the floor. Where it is necessary to notch beams or joists, piping shall not be more than 24 in. from the wall or supports below the beam (17).

No unions, gas cocks, or valves shall be used in concealed work. Every gas cock or valve should be readily accessible for inspection and repair (17).

Outlets shall extend one inch through finished ceiling, floors, or walls, and either the outlet fitting or the pipe should be securely fastened to the wall or partition. In the case of masonry walls, the walls shall be plugged, either with a wooden plug or with a metal expansion plug. Ceiling drops shall be supported between joists or beams to prevent fixtures from swinging (17).

After all house piping has been installed and concealed, and before any fixtures or appliances have been attached, a test shall be made, at which time the house piping shall stand an air pressure equal to not less than 6 in. of mercury and the house piping shall hold this air pressure for not less than 10 min. without a perceptible drop in pressure. When tests are made by official inspector, plumbing contractor shall present certificate certifying that piping complies with all municipal requirements (17).

*Useful Suggestions.* The inlet for every house gas-piping system should be located within 30 in. of and above the proposed location for the gas company's gas meter or service gas-piping outlet (17).

Where two or more systems of house gas piping are installed in the same building, the inlets should be not less than 18 in. apart in a horizontal plane nor more than 24 in. apart in a vertical plane. Each should be plainly and permanently marked with metal tags die-marked to designate the systems (17).

No house piping should be less than  $\frac{3}{4}$  in., except ceiling, wall, or floor outlets. If imbedded in concrete no house line should be less than 1 in. (17).

Outlets for cooking appliances should be not less than  $\frac{3}{4}$  in. and for gas water heaters not less than 1 in. In no instance should the house supply line to the appliance be less in diameter than the inlet on the appliance (17).

Water heaters and furnaces, or boilers, should have a separate house supply line to each from the meter location, except that water heaters of less than 50,000 Btu input (i.e., using less than 50,000 Btu's per hour) do not require a separate house line (17).

*Sizing of Pipes.\** The correct size of gas piping is determined by three factors: the length of the pipe, the allowable pressure drop, and the flow through the pipe.

*Step A: Length of Pipe.* The length of the pipe may be measured directly, or may be obtained from plans of the building.

*Step B: Allowable Pressure Drop.* In designing a system of piping, a pressure drop of 0.5 in. water column may be allowed from the meter to the appliance. If the piping includes vertical risers, the tendency of the gas to rise will help it to flow through the pipe. An allowance for this may be added to the 0.5 in. allowable pressure drop. Table 71 shows the increased pressure available due to a vertical rise. (If the gas flows *down* through a vertical pipe, this pressure should be deducted from the allowable pressure drop.)

TABLE 71  
INCREASE OF PRESSURE WITH ALTITUDE (AT SEA LEVEL)

Specific Gravity of Gas	Gain in Pressure per Hundred Feet of Vertical Pipe, Inches of Water
0.35	0.96
0.40	0.89
0.45	0.81
0.50	0.74
0.55	0.66
0.60	0.59
0.65	0.52
0.70	0.44

*Step C: Flow through Pipe.* The input to a domestic gas range with a four-burner top may be taken as 62,500 Btu per hr, and to one with a

\* This method does not mention friction losses for valves and fittings. The sizing procedure is, however, liberal enough to cover the ordinary number of fittings.

six-burner top and dual ovens as 107,500 Btu per hr. The input ratings of other appliances will be found on the nameplates. The input rating of each appliance in Btu per hr is divided by the heating value of the gas in Btu per cu ft to get the input to each appliance in cubic feet per hour. This figure should then be multiplied by the proper factor from Table 72 to allow for the specific gravity of the gas. The pipe sizing

TABLE 72  
SPECIFIC-GRAVITY FACTOR

Specific Gravity of the Gas	Factor
0.35	0.77
0.40	0.82
0.45	0.87
0.50	0.91
0.55	0.96
0.60	1.0
0.65	1.04
0.70	1.08

Multiply number of cubic feet of gas by factor from Table 72 to get number of cubic feet to use in Table 73.

table is based on a gas of 0.60 specific gravity. A lighter gas will flow more easily; hence it is equivalent to a smaller amount of 0.60 gravity gas when it comes to sizing the gas piping. This gives the corrected flow in cubic feet per hour of 0.60 gravity gas.

*Step D: Determining Pipe Size.* Determine the length of the longest run from the meter to the appliance. Enter Table 73 at the left in the column headed "Length of Pipe Feet" with the next largest figure. Follow to the right along this horizontal line until you come to a pressure drop just less than that obtained in paragraph B. Go down this vertical column to the first flow figure larger than the corrected flow required for each section of this longest run. Go to the left along each horizontal line to get the size of pipe.

*Step E: Branches.* After determining the sizes of pipe to be used in the longest run, the size of each branch may be determined by entering the table with the length of the branch from the meter to the appliance. Go to the right to the pressure drop next lower than that determined for the branch in paragraph B. Go down to the flow figure next larger than the corrected flow for the branch. Go to the left for the size of pipe for this branch. This process is repeated until the pipe size has been selected for all the branches.

**Example 1.** A four-burner, single-oven gas range is to be supplied through 90 ft of horizontal run. The gas has 600 Btu per cu ft and a specific gravity of 0.6.

*Solution.*

*Step A:* Length of pipe 90 ft.

*Step B:* Since there is no vertical run, no correction for altitude need be made. The allowable pressure drop is therefore 0.5.

*Step C:* The input to the range may be taken as 62,500 Btu per hr.  $\frac{62,500}{600} = 104$  cu ft per hr flow. Since the gas has a specific gravity of 0.6, no correction is needed.

*Step D:* Enter Table 73 at upper left with next longer length of run (100 ft). Go to right along this line to next lower pressure drop (0.40 in.). Go down this column to next larger flow (158 cu ft per hr). Go to the left and get size of pipe (1 in.).

*Example 2.* A piping system is to be designed for a small apartment house having a four-burner gas range with a single oven in each of three apartments on three separate floors. (See Fig. 87 for layout.)

The gas has a heating value of 570 Btu per cu ft and 0.45 specific gravity.

*Solution.*

*Step A:* Length of pipe on longest run is  $20 + 5 + 10 + 10 + 15 = 60$  ft.

*Step B:* The vertical rise to the top floor is 25 ft. Table 71 shows that the gain in pressure for a 100-ft rise with a gas of 0.45 specific gravity is 0.81 in.

For a rise of 25 ft the gain in pressure is  $\frac{25 \times 0.81}{100} = 0.20$  in.

This is added to the figure of 0.5 in. given in paragraph B, making an allowable pressure drop of 0.70 in.

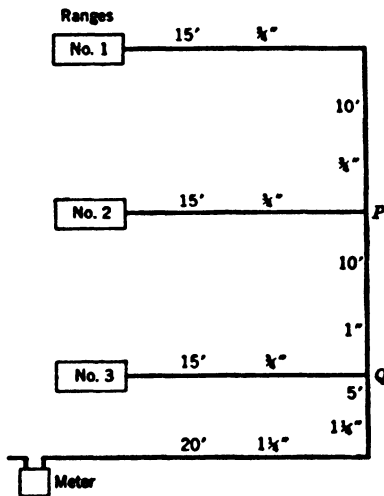

FIG. 87. Layout of Piping for Small Apartment House.

*Step C:* The input to each range may be taken as 62,500 Btu per hr.  $\frac{62,500}{570} = 110$  cu ft per hr of 0.45 specific-gravity gas.

Table 72 shows a specific-gravity factor of 0.87 for a gas of 0.45 specific gravity. To obtain the equivalent volume of 0.6 specific-gravity gas, multiply by this factor.  $110 \times 0.87 = 96$  cu ft of 0.6 specific-gravity gas.

*Step D:* Enter Table 73 with the length of run (60 ft). Go to the right along this line to the next lower pressure drop (0.6 in.). Go down this column to the next larger flow (135 cu ft). Go to the left and get the size of pipe ( $\frac{3}{4}$  in.) for the run from P to range 1. From Q to P the volume flowing is  $96 + 96 = 192$  cu ft. In the same vertical column just used, go down to the next larger flow (249 cu ft). This corresponds to a pipe size of 1 in. From the meter to Q the flow is  $192 + 96 = 288$  cu ft. In the same vertical column, go down to the next larger flow (510 cu ft). This corresponds to a pipe size of  $1\frac{1}{4}$  in.

*Step E:* For branch from P to range 2, proceed as follows:

a. Length of pipe is  $20 + 5 + 10 + 15 = 50$  ft.

TABLE 73  
SIZE OF PIPE

Length of Pipe, Feet	Total Pressure Drop, Inches of Water													Flow, Cubic Feet per Hour				
	10	15	20	30	40	60	80	100	150	200	0.10	0.15	0.20		0.30	0.40	0.60	0.80
10	. . . . .	. . . . .	. . . . .	. . . . .	. . . . .	. . . . .	. . . . .	. . . . .	. . . . .	. . . . .	. . . . .	. . . . .	. . . . .	. . . . .	. . . . .	. . . . .	. . . . .	. . . . .
15	. . . . .	. . . . .	. . . . .	. . . . .	. . . . .	. . . . .	. . . . .	. . . . .	. . . . .	. . . . .	. . . . .	. . . . .	. . . . .	. . . . .	. . . . .	. . . . .	. . . . .	. . . . .
20	. . . . .	. . . . .	. . . . .	. . . . .	. . . . .	. . . . .	. . . . .	. . . . .	. . . . .	. . . . .	. . . . .	. . . . .	. . . . .	. . . . .	. . . . .	. . . . .	. . . . .	. . . . .
30	. . . . .	. . . . .	. . . . .	. . . . .	. . . . .	. . . . .	. . . . .	. . . . .	. . . . .	. . . . .	. . . . .	. . . . .	. . . . .	. . . . .	. . . . .	. . . . .	. . . . .	. . . . .
40	. . . . .	. . . . .	. . . . .	. . . . .	. . . . .	. . . . .	. . . . .	. . . . .	. . . . .	. . . . .	. . . . .	. . . . .	. . . . .	. . . . .	. . . . .	. . . . .	. . . . .	. . . . .
60	. . . . .	. . . . .	. . . . .	. . . . .	. . . . .	. . . . .	. . . . .	. . . . .	. . . . .	. . . . .	. . . . .	. . . . .	. . . . .	. . . . .	. . . . .	. . . . .	. . . . .	. . . . .
80	. . . . .	. . . . .	. . . . .	. . . . .	. . . . .	. . . . .	. . . . .	. . . . .	. . . . .	. . . . .	. . . . .	. . . . .	. . . . .	. . . . .	. . . . .	. . . . .	. . . . .	. . . . .
100	. . . . .	. . . . .	. . . . .	. . . . .	. . . . .	. . . . .	. . . . .	. . . . .	. . . . .	. . . . .	. . . . .	. . . . .	. . . . .	. . . . .	. . . . .	. . . . .	. . . . .	. . . . .
150	. . . . .	. . . . .	. . . . .	. . . . .	. . . . .	. . . . .	. . . . .	. . . . .	. . . . .	. . . . .	. . . . .	. . . . .	. . . . .	. . . . .	. . . . .	. . . . .	. . . . .	. . . . .
200	. . . . .	. . . . .	. . . . .	. . . . .	. . . . .	. . . . .	. . . . .	. . . . .	. . . . .	. . . . .	. . . . .	. . . . .	. . . . .	. . . . .	. . . . .	. . . . .	. . . . .	. . . . .

Size of Pipe, Inches	Flow, Cubic Feet per Hour																
	6.2	7.1	8.7	10.5	12.5	14.8	17.0	20.5	24.0	27.5	33	38	48	55	68	78	88
3/8	6.2	7.1	8.7	10.5	12.5	14.8	17.0	20.5	24.0	27.5	33	38	48	55	68	78	88
1/2	10.9	12.6	15.4	19.0	21.9	26.7	30.9	38.0	43.2	48.0	60	68	84	96	118	137	152
3/4	30.2	35.0	42.5	52.5	60.5	74	85	105	121	135	168	191	235	270	335	385	430
1	55.5	64	78	97	111	137	158	191	221	249	304	348	430	490	600	690	780
1 1/4	115	132	161	200	230	282	325	391	460	510	630	720	890	1,010	1,250	1,440	1,600
1 1/2	178	206	251	310	355	440	500	615	710	795	980	1,110	1,370	1,580	1,910	2,220	2,500
2	365	420	510	630	720	890	1,000	1,250	1,430	1,600	2,000	2,280	2,800	3,200	3,950	4,550	5,100
2 1/2	580	670	820	1,000	1,160	1,420	1,770	2,000	2,300	2,600	3,200	3,650	4,500	5,150	6,300	7,300	8,200
3	1,030	1,200	1,460	1,800	2,080	2,550	2,900	3,600	4,200	4,650	5,700	6,500	8,000	9,300	11,300	13,100	14,800
3 1/2	1,550	1,800	2,200	2,700	3,100	3,800	4,400	5,400	6,200	7,000	8,600	9,800	12,000	13,900	17,000	19,600	22,000
4	2,170	2,460	2,990	3,700	4,300	5,250	6,000	7,400	8,500	9,500	11,700	13,300	16,600	19,000	23,300	26,900	30,000
5	3,750	4,380	5,300	6,600	7,600	9,200	10,600	13,000	15,000	17,000	21,000	24,000	29,000	33,500	41,500	47,500	53,500



b. Vertical rise is 15 ft.  $\frac{15 \times 0.81}{100} = 0.12$  in.

$0.12 + 0.5 = 0.62$  in. allowable drop.

c. The flow is 96 cu ft per hr of 0.6 specific-gravity gas.

d. Enter Table 73 with the next longer length of run (60 ft). Go to the right along this line to the next lower pressure drop (0.6 in.). Go down this column to the next larger flow (135 cu ft). Go to the left and get the size of pipe from *P* to range 2 ( $\frac{3}{4}$  in.).

*Step F:* For branch from *Q* to range 3, proceed the same way.

a. Length of pipe is  $20 + 5 + 15 = 40$  ft.

b. Vertical rise is 5 ft.  $\frac{5 \times 0.81}{100} = 0.04$  in.

$0.04 + 0.5 = 0.54$  in. allowable drop.

c. Flow is 96 cu ft per hr of 0.6 specific-gravity gas.

d. Enter Table 73 with the length of run (40 ft). Go to the right to next lower pressure drop (0.4 in.). Go down this column to the next larger flow (135 cu ft). Go to the left and get the size of pipe from *Q* to range 3 ( $\frac{3}{4}$  in.).

#### ART. 10-C. GAS APPLIANCES

##### Gas Vents, Flues, and Vent Connections (Minimum Standards) (17)

*When Vents Are Necessary.* Every new building must be equipped with adequate chimneys and flues for gas appliances. The purpose of vents on gas appliances is to carry products of combustion to the outside air. These products are normally carbon dioxide and water vapor but may, in some districts, contain traces of sulfur or other compounds having an objectionable odor. In all except extremely dry climates the water vapor alone will prove objectionable in the atmosphere of a room as it will condense on cold surfaces.

*New Chimney Flue or Gas Vent Construction.* Flues used as gas vents should be vertical without offsets and without restricted area at the cap. They should extend at least 2 ft above the highest point of the roof, as shown in Fig. 88. Draft is due to a difference of pressure between the hot gases in the flue and the cold outside air. If for any reason, such as wind pressure, the external pressure becomes greater than the internal, it will be impossible for the products of combustion to rise, and there will be a back draft to be taken care of by the draft hood on the appliance. The only remedy is to carry the chimney clear of the obstruction which creates the wind pressure.

*Location of Flue.* Flues should be located at an inside wall where possible, because the exposure of an outside wall will chill the products of combustion, diminishing the pressure differential and causing condensation which may damage the flue. It is obvious that a wall in which it is planned to place a flue should have sufficient width to accommodate a flue of adequate size.

*Flue Material for New Buildings.* All flues and vents should conform to local ordinances. In the absence of these the following specifications will serve as a guide for minimum standards.

Brick chimneys may have 4-in. walls but should be acid and moisture resistant, preferably being lined with a terra-cotta or fire-clay tile flue lining. A rich cement mortar should be used as it is very important that condensation does not seep through the joints.

Material successfully used for gas vents includes metallic pipe, terra-cotta pipe, cement pipe, glazed sewer pipe, and asbestos pipe. Unlined metallic vents should never be concealed in walls. Of the metallic vents, copper (16 oz), Monel metal (26 gage), and Alleghany metal (24 gage)

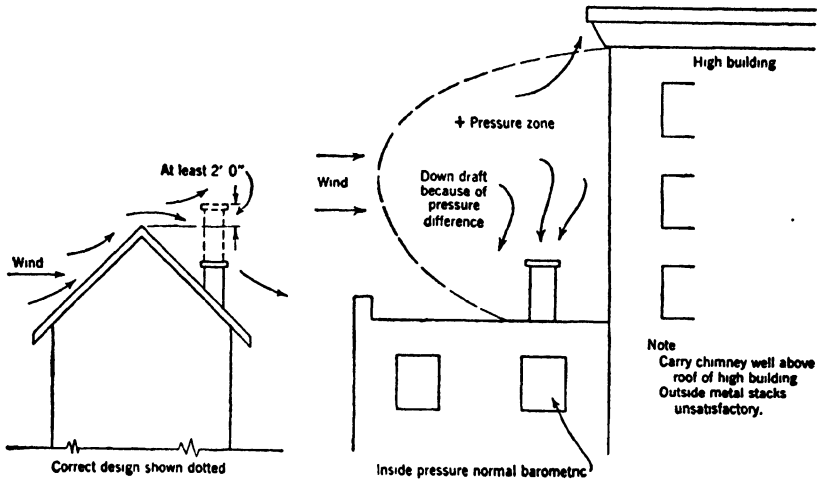

FIG. 88. Safe Practice in Chimney Heights under Various Conditions. (From *Data Book on Gas Utilization* (17).)

are all durable. Galvanized iron is cheaper but will have a short life, particularly when used on manufactured gas installations. Sheet-metal vents should be insulated with three thicknesses of asbestos paper (12 lb per 100 sq ft) or asbestos air-cell insulation. There are various types of patent built-up flue pipe on the market made of combinations of the above materials and produced in shapes to fit between 4-in. and 6-in. studding.

*Flue Openings, Cleanout, and Condensation Drain.* Openings into a flue should not enter on the same level since the connected appliances may not function properly. No opening should enter a flue closer than 1 ft from the bottom and the connection should not protrude within the flue so as to offer an obstruction to chimney flow. A tight-fitting cleanout door should be placed near the bottom.

A gas appliance should be located as closely as possible to its flue as it is important that the vent connection should be short and free from bends. The vent connection should grade upward at least one-half inch per foot of length; for domestic installations its length should not exceed

20 ft nor should it contain more than two elbows nor be less in area than the vent collar of the appliance to which it is connected.

When several vent connections tie into a common horizontal run, these branch connections are better Y-connected than if they enter at a

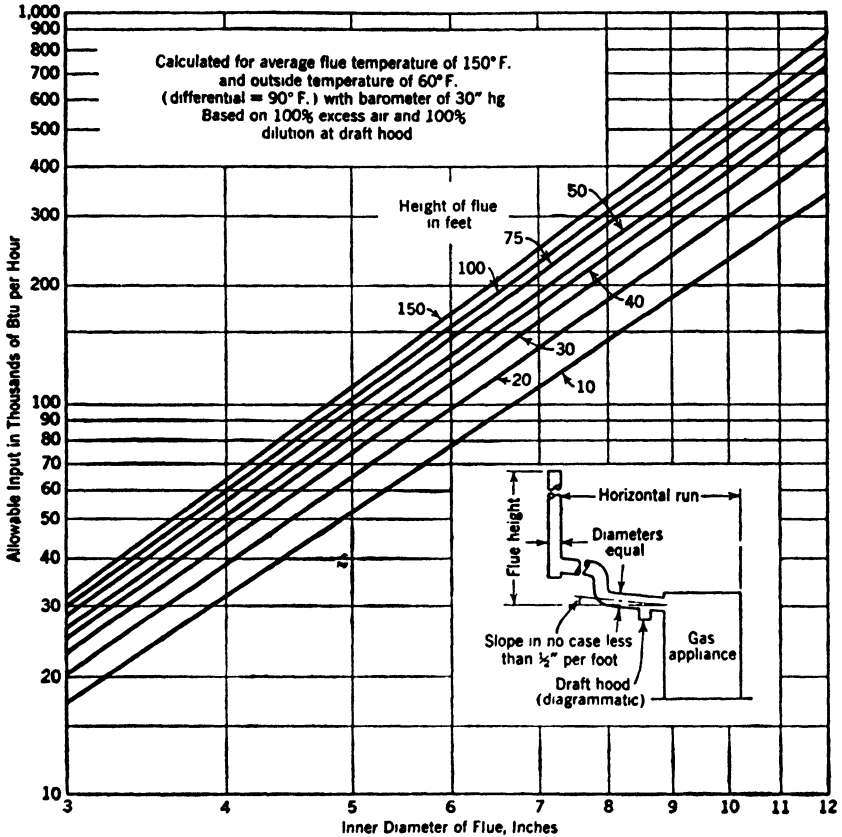

FIG. 89. Allowance in Btu Input to Circular Flues for Domestic Gas Appliances with Draft Hoods. (From Data Book on Gas Utilization (17).)

right angle. When Y-connected, the flue products should be directed toward the chimney.

**Installation of Vent Connections.** Vent connections should not be installed within 3 in. of any unprotected combustible material. They may be installed within 1 in. of protected combustible material. When passing through walls, partitions, or floors of combustible material, approved ventilated or insulated sleeves must be installed.

A vent connection must be securely supported at intervals of not less than 6 ft so that no ordinary blow will knock it down. The individual

sections must be securely fastened together and, if of metal, not less than three metal screws shall be used at each joint. Dependence must not be placed on the friction of pipe ends or on solder.

*Vent Material.* Vent connections are usually of metal or asbestos pipe. Black-iron pipe is recommended only for gas ranges and even here other metals, such as copper, Monel, or Alleghany metal are much superior. Vent connections on gas ranges are sometimes conspicuously located and can add to the appearance of a kitchen if coated with Duco to match the color scheme of the room, or if made of copper or chromium-plated metal.

*Draft Hoods.* Every flue-connected appliance (except an incinerator), unless its construction serves the same purpose, should be equipped with a draft hood. Draft hoods are ordinarily supplied by the manufacturer as a part of the appliance and are designed to provide escape of flue gases in the event of no draft or flue stoppage, prevent back drafts from entering the appliance, and neutralize stack action with respect to appliance operation.

*The Capacities for Domestic Appliances.* In Fig. 89, capacities in Btu per hour are given for circular flues of different diameters and heights. For other than circular flues, see Figs. 92 and 93. When flues are connected to several appliances, determine the run sizes from Table 74.

TABLE 74

THE NUMBER OF PARALLEL HORIZONTAL RUNS OF VARIOUS SIZES THAT MAY BE SUBSTITUTED FOR THE SINGLE RUN WHOSE DIAMETER IS EQUAL TO THAT OF THE FLUE

(For Domestic Installations [Fig. 89])

Diameter of Horizontal Runs	Size of Flue						
	3	4	5	6	8	10	12
	Number of Parallel Runs That May Be Substituted						
3	1	2	3	5	9	12	22
4	.	1	2	3	5	7	11
5	.	.	1	2	3	4	7
6	.	.	.	1	2	3	5
8	.	.	.	.	1	2	3

Capacities in the chart should be decreased 3.5% for each 1000 ft above sea level.

When the combined input of two or more appliances is used to pick a common flue from Fig. 89, the two or more horizontal runs must offer no more resistance than the single run of the flue size, which was assumed in preparing Fig. 89. It will not always follow that runs of the same

size as the flue collars on the appliances will satisfy this requirement, and Table 74 should be used to check sizes.

*Example.* Instead of a 10-in. run, there must be substituted 2 eights, or 1 eight and 2 sixes, or another group that may be substituted for 1 eight.

*Apartment House Flues.* In Fig. 90 is given the circular flue size required at any point for the aggregate of appliance inputs from the floors below.

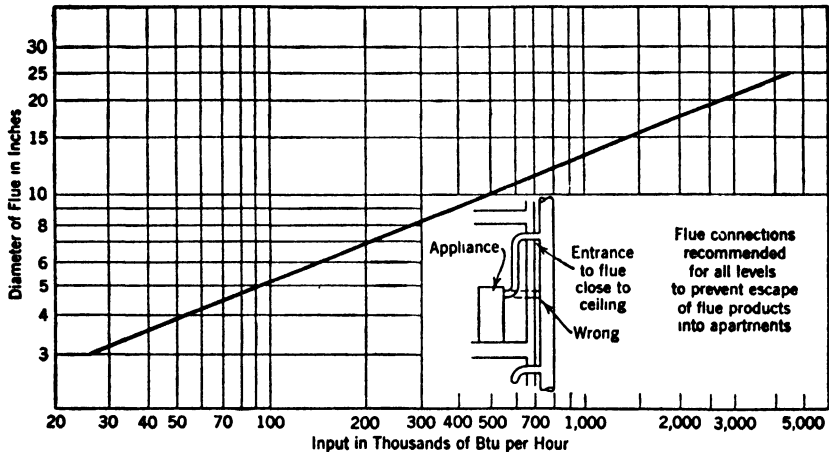

FIG. 90. Diameter of Apartment House Flues vs. Btu Input to Gas Appliances.  
(From *Data Book on Gas Utilization* (17).)

Based on the conditions that the horizontal runs on all floors are short enough to be neglected, that the outside atmospheric temperature is 60 F, and that the average flue temperature is 100 F due to a possible excess dilution where connected appliances are unused, and to the chilling effect of the walls.

1. The flue diameter at any floor shall not be less than that indicated on the graph for a Btu input comprising a summation of the inputs at all floors below.
2. The flue diameter above the top floor is then dependent upon the entire input to the flue. The size, to simplify construction, may be maintained for the full height of the flue, or the flue size may be reduced in steps from the top.

*Flue Capacities for Commercial Installations.* With commercial installations a variety of conditions may exist with respect to length and size of runs, number of bends, and offsets. The capacities in Fig. 91 will only apply to such installations as are confined to the limitations given. When slightly longer runs, additional bends, or runs of slightly less diameter are required, the next larger flue size may be used. For unusual cases of long runs, numerous bends, etc., and connections to two or more pieces of equipment, refer to the section on Flues and Chimneys in *Gas Engineers Handbook*, McGraw-Hill Book Company. Capacities in chart should be reduced 3.5% for each 1000 ft above sea level.

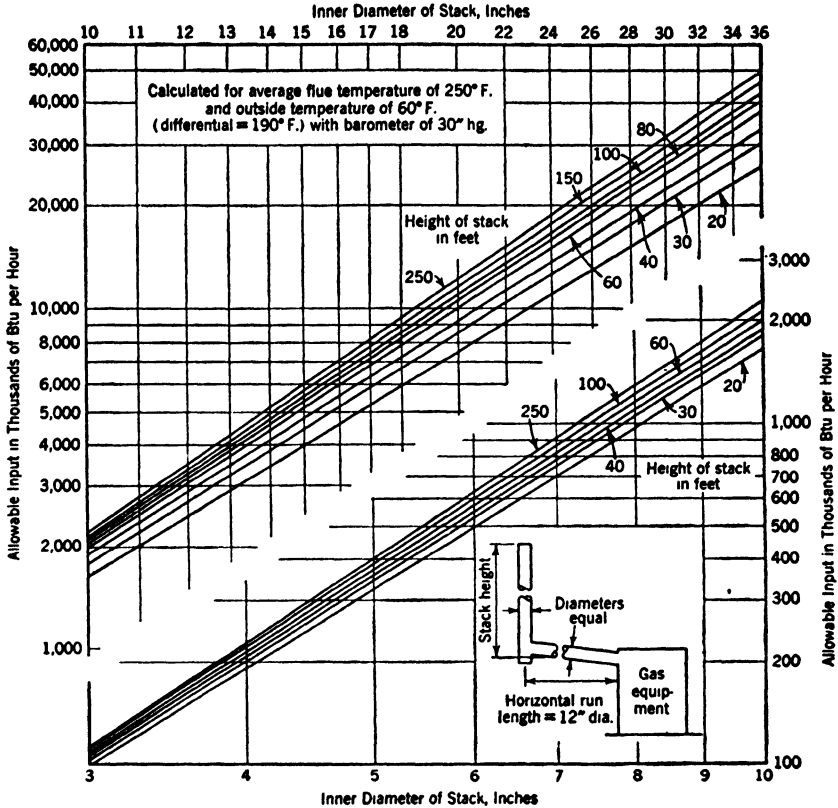

FIG. 91. Allowable Btu Input to Circular Stacks for Commercial Gas Installations (Manufactured and Natural Gas). (From Data Book on Gas Utilization (17).)

For metal and terra-cotta lined flues. With rough brick flues capacities are to be reduced 15 per cent.

Based upon the condition that the length of horizontal run is not greater in feet than its diameter in inches and contains no elbows, and diameters of stack and run are equal.

These values provide for 25 per cent excess air and 25 per cent dilution at the check draft.

### Equivalent Rectangular and Elliptical Flues

*Example.* Given a domestic appliance input of 100,000 Btu per hour and a flue height of 20 ft. The horizontal run may be circular but the flue is limited to a 4-in. width so as to fit within a wall. What will be the dimensions of the run and the flue?

From Fig. 89 a 6-in. circular flue and run will do, thus fixing the dimension of the run alone.

From Fig. 89 a 4-in. circular flue and run has a capacity of 38,000 Btu per hour. Thus, an elongation of flue cross-section must add 62,000 Btu per hour capacity. This increase is  $(62,000)/(38,000) = 1.63$  or 163% over the capacity of the 4-in. circular flue. From Fig. 93 a semi-elliptical flue with a ratio of long to short dimension of 2.0 will suffice and the dimensions of the flue will be 4 in. by 8 in. From Fig. 92 a rectangular flue would have been 4 in. by 7.3 in.

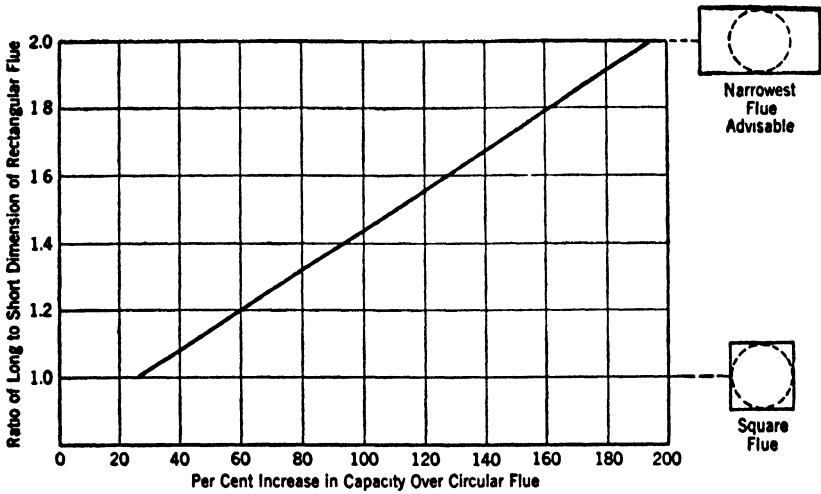

FIG. 92. Capacity of a Rectangular Flue, Having Its Minimum Width Equal to the Diameter of a Circular Flue, Compared with the Capacity of the Circular Flue. (For Use with Domestic and Commercial Installations.) (From *Data Book on Gas Utilization* (17).)

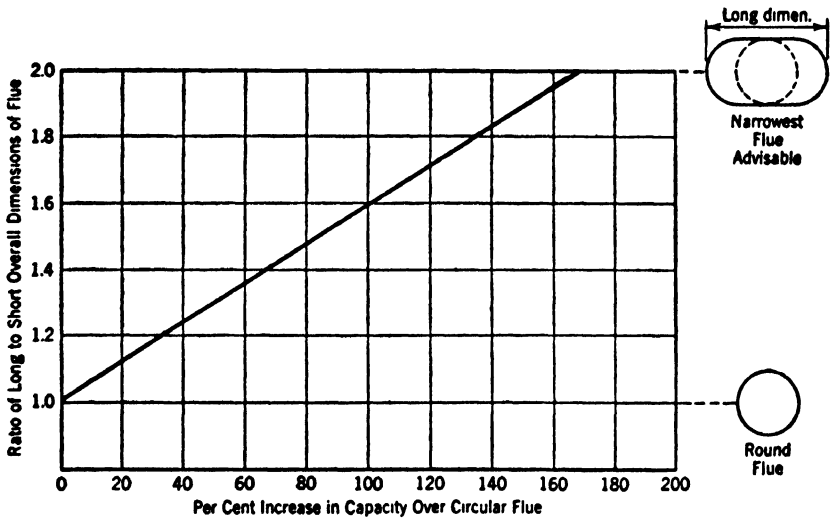

FIG. 93. Capacity of a Semi-elliptical Flue, with Semicircular Ends, Having Its Minimum Width Equal to the Diameter of a Circular Flue, Compared with the Capacity of the Circular Flue. (For Use with Domestic and Commercial Installations.) (From *Data Book on Gas Utilization* (17).)

### Gas Ranges and Cooking Devices (17)

*Gas Ranges.* Most modern ranges come in standard cooking surface height (36 in.) and, while dimensions vary, an average domestic range requires a space 48 in. long and 30 in. deep. Ranges with double ovens, built-in gas heaters, or trash burners or other special features will of course be longer. It is advisable to have the actual dimensions of the range desired before passing the kitchen plans. Important points on range installations are:

The cooking surface should be easily accessible and well lighted by natural light during the day and artificial light at night. (Many gas ranges are equipped with electric light.)

The range should be close to both food preparation center and dining room.

All parts of the range, with oven and broiler doors open, should be well clear of swinging doors. Controls should be accessible for operation and not blocked by cabinet work or walls.

The range and space around it should be accessible for cleaning, and range parts for adjustment. Many ranges are inclosed to the floor and built to fit flush to the wall back of them. These flush wall type ranges usually are arranged so that all adjustments can be made from the front. This, however, is a point to check.

Ranges should be set so that cooking tops and oven racks are level. This insures good cooking results.

*Piping.* The gas supply pipe should be of the same size as the range manifold, but never less than  $\frac{3}{4}$  in. The rate of gas use on range burners is shown in Table 75.

TABLE 75

#### MINIMUM GAS-BURNING CAPACITY OF RANGE BURNERS \*

<i>Burner</i>	<i>Capacity in Btu per Hour</i>
Simmer	1,800
Top (Regular)	9,000
Top (Giant)	12,000
Oven (Vol. 1.5 cu ft)	11,990
Oven (Vol. 2.0 cu ft)	15,950
Oven (Vol. 2.4 cu ft) †	19,250

\* From A. G. A. *Gas Range Manual*.

† Average size oven.

*Venting.* Approved gas ranges will operate satisfactorily without a vent, and many of the newer ranges have no provision for vents. The modern insulated oven heats up so rapidly and maintains its temperature with such a small flame that venting serves no useful purpose. No kitchen should be without some form of positive ventilation to carry off steam from top burner operations and cooking odors.

When oven vent is installed provide a 4-in. flue for an average range



with one oven, a 5-in. flue for a range with two ovens. Ranges with gas kitchen heaters or trash burners should be provided with a 6-in. flue.

### Gas Refrigeration (17)

There are a few points which must be kept in mind whenever recommending any type of refrigerating systems. First—it has been definitely determined that a uniform box temperature automatically maintained below 50 F is the most desirable for proper food preservation.

Cleanliness is another important feature. The interior of the refrigerator should be vitreous porcelain fused on rust-resisting metal. It should be so constructed that there are no cracks or corners or devices in which germs can lodge. This is essential to the maintenance of health.

To provide proper refrigeration the cabinet must be of good construction, well insulated, and have the interior so designed as to secure adequate air circulation.

*Automatic Refrigeration.* Refrigeration by automatic means is based upon the physical law that when a liquid changes to a vapor, heat is absorbed, thus making the refrigerator and its contents cold. Refrigeration mediums usually employed are ammonia, methyl chloride, ethyl chloride, sulphur dioxide, butane, etc.

In household use today are found two types of automatic refrigeration, viz.: compression and absorption. The compression types are referred to as mechanical refrigerators and employ an electric motor and compressor and have many moving parts. The other type employs the absorption principle and has no moving parts.

*Gas Refrigeration.* The expression, gas refrigeration, is today generally accepted as meaning not only a system that employs the absorption principle, but also one that operates by household gas. Gas refrigerators differ radically from other types in that they operate without machinery of any kind. With no moving parts there is no possibility of mechanical breakdown—nothing to wear out. It is perfectly silent in operation and remains so indefinitely. Once lighted, the freezing process goes on continuously, creating even, dry cold at all times below 50 F, the danger point. If the flame goes out, the gas is automatically shut off.

The cost of operation of gas refrigeration is very reasonable and usually is less than that of any other method of refrigeration. Repairs and renewals have been reduced to a minimum.

*Gas Outlet.* Installation of gas refrigerators is easier when the gas outlet is properly spotted in the plans. The outlet may be specified from wall or floor. If from the floor, connections are simpler if the outlet is not farther forward than one-third of the distance from the back edge of the box. Also the outlet should properly emerge near the right side.

*Light Outlet.* If the refrigerator is recessed, a double electric outlet about doorhandle height serves for the interior light and for a portable mixer as well. The lower baseboard below the working surface of the cabinets can also be used for double convenience.

# CHAPTER 11

## WATER HEATING

### ART. 11-A. TYPES

#### Definitions

*Air Shutter.* An adjustable device for varying the size of the primary air inlet or inlets (26).

*Appliance Flue.* See *Flue*.

*Baffle.* An object placed in an appliance to change the direction of, or retard the flow of, air, gas, air-gas mixtures, or flue gases (26).

*Btu.* Abbreviation for British Thermal Unit. The quantity of heat required to raise the temperature of one pound of water 1 F (26).

*Burner.* A device for the final conveyance of the gas, or a mixture of gas and air, to the combustion zone (26).

*A. Injection burner.* A burner employing the energy of a jet of gas to inject air for combustion into the burner and mix it with the gas at line pressure.

1. *Atmospheric injection burner.*  
A burner in which the air at atmospheric pressure is injected into the burner by a jet of gas (26).

*B. Yellow flame burner.* A burner in which secondary air only is depended on for the combustion of the gas (26).

*C. Power burner.* A burner in which either gas or air or both are supplied at pressures exceeding, for gas, the line pressure and, for air, atmospheric pressure. This added pressure is applied at the burner.

1. *Pre-mixing burner.* A power burner in which all or nearly all the air for combustion is

mixed with the gas as primary air (26).

*D. Pressure burner.* A burner which is supplied with an air-gas mixture under pressure (usually 0.5 to 14 in. of water and occasionally higher (26).

*Burner Head.* The portion of the burner which is beyond the outlet end of the mixer tube and contains the ports (26).

*Burner Valve, Gas.* A manually or mechanically operated valve which permits control of the flow of gas (26).

*Chimney Flue.* See *Flue*.

*Cock, Gas.* A gas-burner valve of the plug and barrel type (26).

*Combustion.* Combustion, as used herein, refers to the rapid oxidation of fuel gases accompanied by the production of heat or heat and light (26).

*Combustion Chamber.* The portion of an appliance within which combustion occurs (26).

*Combustion Products.* Constituents resulting from the combustion of a fuel gas with the oxygen of the air, including the inerts but excluding excess air (26).

*Condensate.* The liquid which separates from a gas (including flue gases) due to a reduction in temperature (26).

*Condensation Sheds.* Devices placed in a heater to direct the flow of condensate (26).

*Controls.* Devices designed to regulate the gas, air, water, and/or electrical supplies to a gas appliance. These may be manual, semi-automatic, or automatic (26).

**Cubic Foot of Gas.** The amount of gas which would occupy 1 cu ft at a temperature of 60 F if saturated with water vapor and under an absolute pressure equivalent to that of 30 in. of mercury (26).

**Draft Hood.** A device placed in, and made a part of, the flue pipe from an appliance or in the appliance itself, which is designed to (1) insure the ready escape of the products of combustion in the event of no draft, back draft, or stoppage beyond the draft hood; (2) prevent a back draft from entering the appliance; and (3) neutralize the effect of stack action of the chimney flue upon the operation of the appliance (26).

**Drip Pan.** A receptacle located below the burners for the purpose of collecting water condensed from the flue gases (26).

**Excess Air.** Air which passes through the combustion chamber and the appliance flues in excess of that which is required for complete combustion (26).

**Flame Check.** A gauze, grid, or any other portion of the burner assembly used to avert flash back (26).

**Flue.** The general term for the passages and conduits through which flue gases pass from the combustion chamber to the outer air.

**A. Appliance flue.** The flue passages within an appliance.

**B. Chimney flue.** A conduit for conveying to the outer air the flue gases delivered into it by a flue pipe.

**C. Dilution flue.** A passage designed to effect the dilution of flue gases with air before discharge from an appliance.

**D. Flue pipe (vent pipe).** The conduit connecting an appliance with the chimney flue (26).

**Flue Collar.** A projection or recess provided to accommodate the flue pipe (26).

**Flue Gases.** Products of combustion and excess air (26).

**Flue Losses.** The sensible heat and latent heat above room temperature of the flue gases leaving the appliance (26).

**Flue Outlet (Vent).** The opening provided

in an appliance for the escape of the flue gases (26).

**Flue Pipe (Vent Pipe).** See *Flue*.

**Free Air.** Air which passes through the combustion chamber and appliance flues but takes no part in combustion (26).

**Heat-Input Rating.** The gas-burning capacity of an appliance in Btu per hr as specified by the manufacturer (26).

**Heating Surface.** All surfaces which transmit heat from flames or flue gases to the medium to be heated (26).

**Heating Value (Total).** The number of Btu produced by the combustion, at constant pressure, of 1 cu ft of gas (see definition of *Cubic Foot of Gas*) when the products of combustion are cooled to the initial temperature of the gas and air, when the water vapor formed during combustion is condensed, and when all the necessary corrections have been applied (26).

**Instantaneous Heater.** A heater which supplies hot water for immediate use and requires no storage vessel. Any heater with a gas-burning capacity of 4000 Btu per hr, or more, per gal of stored water shall also be included under this classification (26).

**A. Non-automatic:**

1. Contact type.

2. Heating-surface type.

**B. Automatic.** A heater in which the gas supplied to the burners is mechanically controlled.

1. Water motor control only.

2. Thermostat control only.

3. Combination water motor and thermostat control (26).

**Jacket.** The outer casing or shell of the heater or storage vessel (26).

**Liquefied Petroleum Gases, Approved.** Approved liquefied petroleum gases shall be considered as those gases meeting the following requirements: (a) a hydrocarbon product composed predominantly of propane and/or propylene; (b) a hydrocarbon product composed predominantly of butane and/or butylenes; (c) a uniform mixture of the two hydrocarbon products indicated in a and b.

Commercial propane and butane conforming to the specifications of the Natural

Gasoline Association of America as reproduced in the Handbook, *Butane-Propane Gases*, Second Edition, Chapter 5, page 47, meet this requirement (26).

**Main Control Valve.** A valve in the gas line before all regulating devices and the branch to the pilot or pilots, except where such pilot or pilots are equipped with independent shut-off valves, for the purpose of completely turning on or shutting off the gas supply to the appliance (26).

**Manifold.** The conduit of an appliance which supplies gas to the individual burners (26).

**Mixer.** The combination of mixer head, mixer throat, and mixer tube.

**A. Mixer head.** That portion of an injection-type burner, usually enlarged, into which primary air flows to mix with the gas stream.

**B. Mixer throat.** The portion of the mixer which has the smallest cross-sectional area and lies between the mixer head and the mixer tube.

**C. Mixer tube.** The portion of the mixer which lies between the throat and the burner head (26).

**Mixer Face.** The air inlet end of the mixer head (26).

**Needle, Adjustable.** A tapered projection, coaxial with and movable with respect to an orifice the position of which is fixed, to regulate the flow of gas (26).

**Needle, Fixed.** A tapered projection, the position of which is fixed, coaxial with an orifice which can be moved with respect to it, to regulate the flow of gas (26).

**Normal Gas Pressures.** Normal gas pressures are those pressures specified for testing purposes at which adjustment of burner ratings and primary air adjustments are made (26).

**Orifice.** The opening in an orifice cap, orifice spud, or other device whereby the flow of gas is limited and through which the gas is discharged (26).

**Orifice Cap (Hood).** A movable fitting having an orifice which permits adjustment of the flow of gas by the changing of its position with respect to a fixed needle or other device (26).

**Orifice Spud.** A removable plug or cap containing an orifice which permits adjustment of the flow of gas either by substitution of a spud with a different-sized orifice or by the motion of a needle with respect to it (26).

**Pilot.** A small flame which is utilized to ignite the gas at the main burner or burners (26).

**Port.** Any opening in a burner head through which gas or an air-gas mixture is discharged for ignition (26).

**Primary Air.** The air introduced into a burner which mixes with the gas before it reaches the port or ports (26).

**Primary Air Inlet.** The opening or openings through which primary air is admitted into a burner (26).

**Recovery Capacity.** Amount of water in U.S. or Imperial gallons raised 60F per hr or per min when calculated on a thermal efficiency of 70% representing the water heated by a gas input of 715 Btu per U.S. gallon or 858.3 per Imperial gallon (26).

**Regulator.** A device for controlling and maintaining a uniform gas-supply pressure.

**A. Spring type.** A regulator in which the regulating force acting upon the atmospheric side of the diaphragm is derived from a compressed spring.

**B. Dead-weight type.** A regulator in which the regulating force acting upon the atmospheric side of the diaphragm is derived from a weight or combination of weights (26).

**Relief Devices.** A safety device designed to forestall the development of a dangerous condition in the medium being heated, by relieving either pressure, temperature, or vacuum built up in the appliance; or by permanently shutting off the main gas supply.

**A. Pressure-relief valve.** An automatic device which opens or closes a relief vent, depending upon whether the pressure is above or below a predetermined value.

**B. Temperature-relief valve.**

**1. Fusible plug type.** A device which opens and keeps open a

relief vent by the melting or softening of a fusible plug or cartridge at a predetermined temperature.

2. *Reseating or self-closing type.*

An automatic device which opens and closes a relief vent, depending upon whether the temperature is above or below a predetermined value.

C. *Vacuum-relief valve.* An automatic device which opens or closes a relief vent, depending upon whether the vacuum is above or below a predetermined value (26).

*Secondary Air.* The air externally supplied to the flame at the point of combustion (26).

*Specific Gravity.* As applied to gas, specific gravity is the ratio of the weight of a given volume to that of the same volume of air, both measured at the same temperature and pressure (26).

*Storage Heater.* A heater which furnishes hot water to be stored (26).

A. *Non-automatic* (insulated and non-insulated, direct and indirect).

1. Circulating tank water heater.
2. Combination heater and water-storage vessel.

a. Internal heater with flue inside storage vessel.

b. Internal heater with flue outside storage vessel.

c. External heater where flue has no contact with storage vessel.

d. External heater where flue has contact with storage vessel (26).

B. *Automatic.* A heater which furnishes hot water to be stored at a mechanically controlled temperature (insulated and non-insulated, direct and indirect).

1. Circulating heater only.
2. Combination heater and water storage vessel.

a. Internal heater with flue inside storage vessel.

b. Internal heater with flue outside storage vessel.

c. External heater where flue has no contact with storage vessel.

d. External heater where flue has contact with storage vessel (26).

*Storage Vessel.* Container provided for storage of hot water under pressure (26).

*Thermal Efficiency.*

A. *Uncorrected thermal efficiency.* The overall efficiency of the heater, computed by multiplying the weight of water heated by the temperature rise and dividing the product by the corrected hourly Btu input when the heater is operated within 5% of the manufacturer's rated input.

B. *Corrected thermal efficiency.* Percentage of heat input converted into useful heat, computed by multiplying the weight of water heated by the temperature rise, plus the heat loss from the stored water through the jacket during the period of test, and dividing the sum by the corrected hourly Btu input when the heater is operated within 5% of the manufacturer's rated input (26).

*Thermostat.* An automatic device actuated by temperature changes designed to control the gas supply to a burner, or burners, in order to maintain temperatures between predetermined limits.

A. *Graduating thermostat.* A thermostat in which the motion of the thermostatic valve is in direct proportion to the effective motion of the thermal element induced by temperature change.

B. *Quick-acting thermostat.* A thermostat which changes from the completely open to the completely closed position, or vice versa, quickly, but not with a snap.

C. *Snap-acting thermostat.* A thermostat in which the thermostatic valve travels instantly from the closed to the open position or vice versa (26).

*Water Heater, Direct Type.* An apparatus or appliance in which heat is transferred through a heating surface from the flue gases directly to the water (26).

*Water Heater, Indirect Type.* An apparatus or appliance in which heat is transferred to an intermediate medium and from this medium to the water (26).

**Classifications**

Heating units may operate with gas, coal, oil, electricity, or steam and transfer the heat from these media or fuels to the water by direct contact against a tank or coil.

The heating units may be complete in themselves and act as instantaneous heaters or be connected with or built into a storage tank. The latter are called self-contained storage heaters. Depending on the degree rise in temperature and the speed required, the heaters are classified as slow or fast recovery.

The principal difference in all heaters is whether they are instantaneous or storage-type.

Instantaneous heaters must be selected in capacity to correspond with the maximum hot-water demand on the line and the required temperature rise.

Storage-type heaters vary to a great extent. The slower the heat input the greater the storage. Where the incoming water already is heated to some degree, the heater is classified as a booster.

*Direct and Indirect Heat.* The proper classification of any heater as to whether it is a direct or indirect heater depends on what is considered the heating medium. The distinction is of no real importance.

*Kettle Action and Circulating Action.* These terms express the process of heat distribution from the heating medium to the water and are important in the proper installation of equipment and auxiliaries.

*Process 1* (Fig. 94). Water heated at the bottom. The hot water rises to the top. The cold water sinks to the bottom. This is nothing but an elaborate kettle.

Hot-water outlet at the top. Cold-water inlet at the bottom.

*Process 2.* Water heated by a separate unit and carried by pipes to the top of the tank. This eliminates the kettle action in the tank and assures a one-way flow.

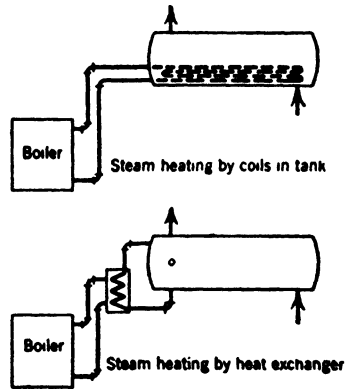
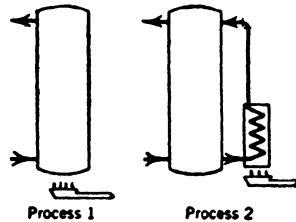

FIG. 94.

Steam heating by coils applies the heat in the tank, and the same (kettle action) principle is used as in Process 1. If heat is applied through a separate heat exchanger, the principle will be like Process 2.

Thus whether the means of heating are direct or indirect we have in Process 1 a non-circulating heater and in Process 2 a circulating heater; i.e., in the one only kettle action takes place but in the other the water is forced to pass a natural road of circulation.

*Relief Valves.* Free oxygen occurs in all water and is liberated from it when heated (not completely unless boiled). This oxygen (or air)

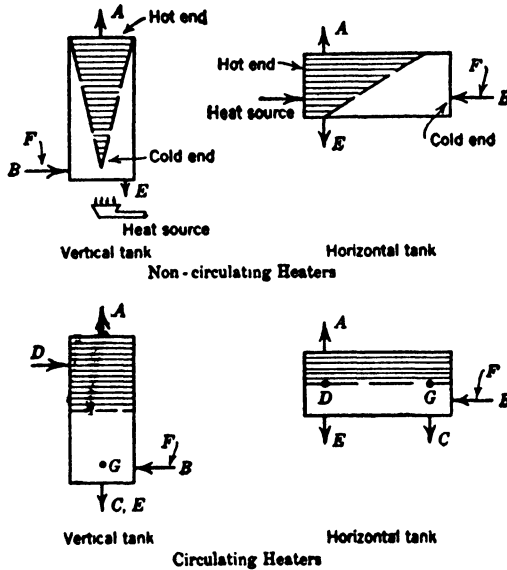

FIG. 95. Connections to Heaters.

*A*, correct outlet for hot-water supply to fixtures and air relief. *B*, correct inlet for cold-water supply and water pressure relief. *C*, correct outlet for circulator (to heating unit from tank). *D*, correct inlet for circulator (from heating unit to tank). *E*, correct outlet for blow-off. *F*, correct inlet for hot-water return (by gravity). *G*, correct inlet for hot-water return (by pump). Near *C* or, if necessary, the same as *F*.

expands under the heat and unless a relief is provided will exert an excess pressure. The pressure will work toward the first and best exit, which more than likely will be along the cold-water supply. If the pressure exceeds the static and friction head in the cold-water line, the slightest decrease in pressure, as when a faucet is opened, will cause the hot water to be pushed into the cold-water line. It is a practice, at least on larger installations, to install a check valve on the cold-water line to prevent such reverse flow. If this is done, additional provisions should be made to insure proper relief of excess pressure. A relief valve should be placed between the check valve and the tank.

To allow for the escape of air an air-relief valve should be located at the high point.

To allow for cleaning of settlement in the tank a (mud) blow-off should be located at the bottom. In horizontal tanks of medium size it is located near the center, on larger sizes near the hot end, and in very large tanks two or more may be needed.

Where no air-relief valve is used the upper part of the tank may be partly filled with air. For this reason the pressure-relief valve, which is a water-operating device, should be placed at a lower point; on smaller tanks it should be placed on the cold-water line, which has no air in it.

Even where air reliefs are used they, of necessity, must be set at a relieving pressure somewhat higher than the static water pressure (usually 10 lb higher), which allows for a certain accumulation of air in the top. Water-pressure relief valves are therefore always more certain of action and insured against corrosive effects if kept away from the top of the tank.

#### ART. 11-B. GAS HEATERS

##### Types

###### *Storage Heater.*

Manual-operated.

Tank heaters (side-arm heater).

Automatic (for 100 gal per hr or less).

Quick recovery (underfired, or kettle, heater).

Heat input 15,000 Btu per hr or more.

Slow recovery (low demand or low input heater).

Heat input less than 15,000 Btu per hr.

For recovery of over 100 gal per hr.

Large-volume heater.

###### *Instantaneous (or Continuous-Flow) Heaters.*

###### *Conversion Heaters.*

##### Rating of Heaters

Heaters are rated according to their capacity to heat water, in gallons, through a temperature rise of 60 F (the "recovery capacity"). The actual rise in temperature varies with the seasons, and, in selecting a heater, allowance should be made for the coldest water temperature. The capacity is inversely proportional to the temperature degree rise.

When in actual service the true recovery capacity of a heater depends upon the temperature of the incoming cold water and the desired temperature of the hot water as established by the setting of the thermostatic control. For ordinary household service a hot-water temperature of 130 to 140 F is satisfactory. If cold water enters at 70 F (which may occur in the summer in some sections) and the heater is set at 130 F, the actual rise in temperature (60 F) is equal to the rise upon which



heaters are rated. But if the entering water is at 50 F and the thermostat is set at 140 F, the heater is required to raise the temperature 90 F. All storage heaters are rated in hourly capacity while instantaneous heaters are rated in gallons per minute (19).

When the demand is for more than 60 F temperature rise, the recovery capacity of a heater diminishes in proportion; hence conversion is easy. A heater rated at 20 gal per hr (at 60 F rise) will provide 10 gal at 120 F rise, or proportionately 12 gal at 100 F rise and 15 gals at 80 F rise. Manufacturers of heaters put the standard 60 F rise rating on the equipment rating label (19).

*Input Rate.* Automatic storage heaters are further classified by their input rate. Most of these heaters in residential use have tanks holding 50 gal of water or less. The industry generally regards a heater with 5 to 9 gal per hr recovery capacity as a low-input heater; 9 to 15 gal per hr as a medium-input heater; and 20 to 50 gal per hr as a high-input heater (19).

However, these terms become relative when large storage tanks are used. It may be said that any heater having a recovery capacity less than one-third the storage tank capacity is a low-input heater. If rated capacity approaches storage tank capacity, the unit is a high-input heater (19).

An adjustable-input unit is one in which the rate of gas consumption can be manually adjusted through a range from low to high input. If unusual loads occur, the capacity can be increased to meet them (19).

### **Hard and Soft Waters**

Waters of certain types, though otherwise suitable for all domestic uses, may contain minerals in solution which become deposited on the inside of pipes and tanks to form an incrustation, which not only reduces the flow of water but also retards heat transmission. This is often called liming, since a high calcium carbonate content is usually characteristic of the deposits from these "hard" waters. Liming is greatly accelerated by heat; water at boiling temperatures deposits these minerals much more rapidly than water at 130 to 140 F. In hard-water districts, where liming is serious, a type of heater should be chosen which has very large area heat-transmitting surfaces so that heating surface temperature will be as low as possible. It is also advisable to operate such heaters at as low a temperature as will give satisfactory service. Most manufacturers will furnish tanks with cleanout openings near the bottom so that periodically any accumulation of scale may be easily removed. Heat-transfer surfaces consisting of small copper coils are unsuited for use in hard-water territory. For large systems, the indirect method is sometimes used: that is, the water which circulates through the heater itself—called the element water—is never changed but heats the hot-water supply indirectly (19).

TABLE 76  
TANK HEATERS  
GENERAL TABLE

Water Heater No.	15	20	25
Heat speed in gallons per hour (60° rise) (natural gas)	30.8	33.6	37.8
Heat speed in gallons per hour (60° rise) (manf. gas)	37.8	39.2	42.
Heat speed in gallons per hour (60° rise) (liquefied petr. gas)	28	28	28
Hourly Btu input (natural gas)	22,000	24,000	27,000
Hourly Btu input (manf. gas)	27,000	28,000	30,000
Hourly Btu input (liquefied petroleum gas)	20,000	20,000	20,000
Coil length (feet)	13	17	21

OPTIONAL EQUIPMENT

Optional equipment includes a choice of vertical or angle mixer and vertical or angle gas cock; also ground joint unions or washer type; also a regular union connection tapped 3/4-in. female or a cold-water spud, 1-in. male and tapped 3/4-in. female.

CAPACITIES

No. 15 is usually connected to a tank of 30 gal storage capacity.

No. 20 is usually connected to a tank of 30 or 40 gal storage capacity.

No. 25 is usually connected to a tank of 30 or 40 gal storage capacity.

ROUGHING-IN DIMENSIONS (INCHES)

Number	A	B	C	D
15	18"	24 1/4"	9 3/4"	8 1/2"
20	21 1/8"	28 1/4"	9 3/4"	8 1/2"
25	23"	30 1/8"	9 3/4"	8 1/2"

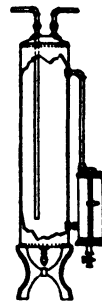
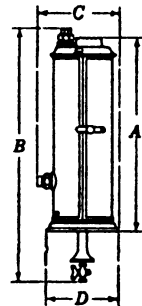

Fig. 96

Courtesy Ruud Manufacturing Co., Pittsburgh, Pa.

### Tank Heaters (Fig. 96)

Tank heater is manually controlled. The amount of water to be heated and the temperature depend entirely on the time the heater is allowed to operate. The tank is usually bare (not insulated) and the heater is not adapted for storage. Owing to the lack of exact control of the heater it is not economical in use.

The thermal efficiency depends mainly on the surface of the copper coil. The coil varies from 14 to 20 ft in length and  $\frac{5}{8}$  to 1 in. in diameter.

A good tank heater of ordinary size will burn about 20,000 Btu per hr.

At 65% thermal efficiency the heater will deliver 19.5 gal per hr at 80 F temperature rise.

$$\frac{20,000 \times 0.65}{8.33 \times 80} = 19.5 \quad (8.33 \text{ is the Btu absorbed in raising } 1 \text{ gal of water } 1 \text{ F})$$

In addition, the standby losses for this type of heater require about 40 min burner time per day (21).

### Modernization with Automatic Circulating Tank Heaters

When existing buildings are equipped with storage tanks of suitable size and in good condition, the advantages of modern automatic gas hot-water service may be gained by modernization of the system with conversion-type automatic circulating tank heaters.

These heaters are external to the tank and may either be directly connected to the domestic hot-water piping system through the tank or may serve as indirect heaters, as described for large volume heaters.

Tanks should always be examined for condition and adequacy and should be thoroughly insulated, preferably with 2 to 4 in. of approved hot-water tank insulation material. Sizing of heater in relation to tank size and demand may follow the methods described for automatic storage heaters (19).

TABLE 77  
SELECTION OF CONVERSION GAS WATER HEATERS

Tank Capacity (Gallons)	Input Rating (Btu per hour)	Recovery Capacity (Gal raised 60F per hr)
15	2,500 to 10,000	3.5 to 14
20	2,500 to 20,000	3.5 to 28
30	2,500 to 20,000	3.5 to 28
40	2,500 to 20,000	3.5 to 28
44	2,500 to 25,000	3.5 to 35
65	2,500 to 27,000	3.5 to 37.8
75	3,000 to 38,000	4.2 to 53.2

### Automatic Storage Heaters

An automatic storage heater is a gas water heater unit made up of (a) the burner; (b) an insulated storage tank; (c) automatic thermostatic and safety controls; and (d) a casing enclosing all these elements (19).

This is a modern type of heater for all normal domestic hot-water services in dwellings, small stores, and shops, and whenever fairly constant loads do not exceed 100 gal of hot water per hr (19).

$$\text{The recovery capacity} = \frac{\text{Btu input per hr} \times \text{Efficiency}}{8.33 \times \text{Degrees rise in temperature}}$$

*Example:*

$$\frac{20,000 \times 0.75}{8.33 \times 80} = 22.2 \text{ gal recovery per hr (21)}$$

TABLE 78

AUTOMATIC-STORAGE (GALV. STEEL TANK),\* EXTERNAL-FLUE, QUICK-RECOVERY HEATER

† CAPACITIES

GENERAL TABLE

Water Heater No.	1015	1020	1030	1045	1060	1075
Tank capacity (gallons)	15	20	30	45	60	75
Heat speed in gallons per hour (60° rise) (nat or manf. gas)	22.4	28	35	56	70	77
Heat speed in gallons per hour (60° rise) (liquefied petr. gas)	22.4	28	28	44.8	70	77
Hourly Btu input (nat. or manf. gas) (thousands)	16	20	25	40	50	55
Hourly Btu input (liquefied petr gas) (thousands)	16	20	20	32	50	55
Gas line (inches)	3/8	3/8	3/8	1/2	1/2	1/2
Water line (inches)	3/4	3/4	3/4	1	3/4	1
Flue (inches)	3	3	3	4	4	5

No. 1015. Capacity: 15 gal storage.

For: Small families normally using between 30 and 60 gal of hot water a day. In general, for very small houses.

No. 1020. Capacity: 20 gal storage.

For: Average families normally using between 60 and 100 gal a day. In general, for one-bathroom houses.

No. 1030. Capacity: 30 gal storage.

For: Average families normally using between 100 and 200 gal a day. In general, for one- and two-bathroom houses.

No. 1045. Capacity: 45 gal storage.

For: Larger families normally using between 200 and 300 gal a day. In general, for larger homes and for small and average commercial institutions.

No. 1060. Capacity: 60 gal storage.

For: Large homes, small apartments, and many commercial and industrial requirements.

No. 1075. Capacity: 75 gal storage.

For: Large homes, small apartments of not more than four families—office building, institution, and many other commercial and industrial requirements.

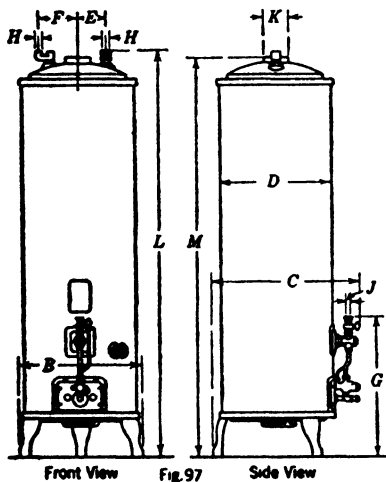

ROUGHING-IN DIMENSIONS (INCHES)

No.	1015	1020	1030	1045	1060	1075
B	17 1/8	17 1/8	18 5/8	23	25 1/2	27 1/8
C	21 5/8	21 5/8	23 3/8	28 5/8	29	31 1/4
D	16 1/4	16 1/4	18	22 1/2	24 1/2	26 5/8
E	4	4	4 1/2	6	6	6
F	5 3/4	5 3/4	6 1/4	8	8	8
G	22 3/4	22 3/4	22 3/8	26 1/2	26	28
H	3/4	3/4	3/4	1	3/4	1
J	3/8	3/8	3/8	1/2	1/2	1/2
K	3	3	3	4	4	5
L	50 3/4	62 1/2	65 3/4	64 1/4	69 1/2	69 3/4
†M	49 3/4	61 1/4	64 3/8	62 7/8	69 3/8	68 1/2

\* Sizes 20, 30, 45, and 60 can also be furnished with Monel tanks.

† These are for natural and manufactured gas only. For heat speeds and Btu inputs for liquefied petroleum gas, see the general table.

‡ For draft hood, add 6 3/4" to dimension "M" for Nos. 1015, 1020 and 1030,—7" for Nos. 1045, and 1060,—9 1/2" for No. 1075.

Courtesy Ruid Manufacturing Co., Pittsburgh, Pa

TABLE 79

AUTOMATIC-STORAGE (GALV. STEEL TANK), INTERNAL-FLUE, QUICK-RECOVERY HEATER

GENERAL TABLE

Water Heater No.	815	820	830
Tank capacity (gallons)	15	20	30
Heat speed in gallons per hour (60° rise) (nat and manf gas)	22.4	28	35
Heat speed in gallons per hour (liquefied petr. gas) (60° rise)	22.4	28	28
Hourly Btu input (nat. or manf. gas) (thousands)	16	20	25
Hourly Btu input (liquefied petr. gas) (thousands)	16	20	20
Gas line (inches)	3/8	3/8	3/8
Water line (inches)	3/4	3/4	3/4
Flue (inches)	3	3	3

\* CAPACITIES

No. 815. Capacity: 15 gal storage.

For: Small families normally using between 30 and 60 gal of hot water a day. In general, for very small houses.

No. 820. Capacity: 20 gal storage.

For: Average families normally using between 60 and 100 gal a day. In general, for one-bathroom houses.

No. 830. Capacity: 30 gal storage.

For: Average families normally using between 100 and 200 gal a day. In general, for one- and two-bathroom houses.

ROUGHING-IN DIMENSIONS (INCHES)

Number	815	820	830
B	16 1/2"	16 1/2"	18 1/8"
C	20 3/4"	20 3/4"	22 3/8"
D	15 1/4"	15 1/4"	17 1/4"
E	4"	4"	4 1/2"
F	5 3/4"	5 3/4"	6 1/4"
G	22 3/8"	22 3/8"	23 3/8"
H	3/4"	3/4"	3/4"
J	3/8"	3/8"	3/8"
K	3"	3"	3"
L	50 3/4"	61 5/8"	66 1/8"
M	49 3/4"	60 1/2"	65 1/8"

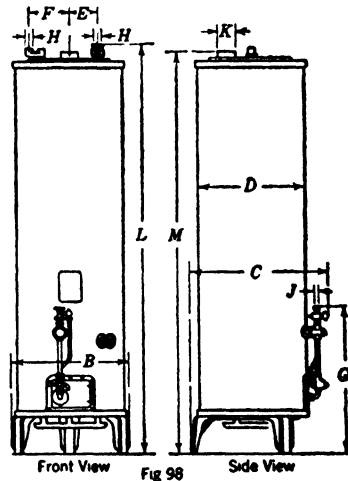

Add 6 1/4" to "M" for draft hood.

\* These are for natural and manufactured gas only For heat speeds and Btu inputs for liquefied petroleum gas, see the general table.

Courtesy Roud Manufacturing Co., Pittsburgh, Pa.

TABLE 80

AUTOMATIC-STORAGE (MONEL TANK), EXTERNAL-FLUE, SLOW-RECOVERY HEATER

\* CAPACITIES

No. 425 \* (25 gal a day). This unit is the smallest of the Four Hundred Series and is not generally recommended for home use, except in very small houses. Greatest application is for small commercial demands—stores, offices, gasoline stations, etc., and in many of them can meet greater demands than its home rating of 25 gal per day.

No. 440 \* (40 gal a day). A very substantial number of modern and semi-modern homes in the three, four, and five thousand dollar class will find their ideal hot-water service in the No. 440. Small-family apartments, also. Installation should not be made where pipe runs are long or where the family is an extremely liberal user of hot water.

No. 460 \* (60 gal a day). In general, this is built for the five, six, and seven thousand dollar home bracket—compactly arranged fixtures, short pipe runs—small family—single bathroom. A major part of small home construction today is in this class and since many are built on long term mortgages, the 20 year Monel tank guarantee is especially liked by money-lending agencies.

GENERAL TABLE

Water Heater No	425	440	460
Tank capacity (gallons)	5	9	14
Heat speed in gallons per per hour (60° rise) (nat, manf, or liquefied petr gas)	7	14	22 4
Hourly Btu input (nat, manf, or liquefied petroleum gas (thousands)	5,000	10,000	16,000
Gas line (inches)	¼ IPS	¼ IPS	¾ IPS
Water line (inches)	½ IPS	½ IPS	½ IPS
Flue (inches)	. . .	3 Dia.	3 Dia

ROUGHING-IN DIMENSIONS (INCHES)

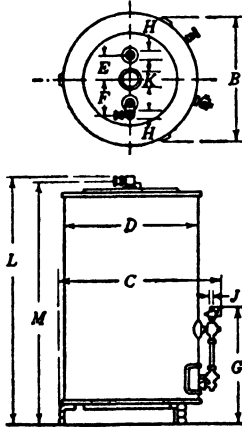

Fig. 99

Number	425	440	460
B	13 9/16	15 1/2	15 1/2
C	17 3/8	19 3/4	20 3/8
D	14	16 3/4	16 3/4
E	3	4	4
F	4 1/2	5 1/2	5 1/2
G	12 3/8	15 3/4	18 3/4
H	1/2	1/2	1/2
J	1/4	1/4	3/8
K	.	3	3
L	29 5/8	34 1/16	48 1/16
M	29 3/4	32 3/4	46 3/8

\* Figures shown (25, 40, and 60 gal a day) meet the normal, daily hot-water-use schedules in these classes of homes, both in time of use and quantity used. In many commercial institutions, where hot-water demands are more evenly distributed, hot-water delivery may be greatly in excess of the home use figures given.

Courtesy Ransd Manufacturing Co., Pittsburgh, Pa.

TABLE 81

AUTOMATIC-STORAGE (GALV. STEEL TANK), INTERNAL-FLUE, QUICK-RECOVERY HEATER,  
COUNTER HEIGHT TYPE

GENERAL TABLE

Water Heater No.	16-20
Tank capacity (gallons)	20
Heat speed in gallons per hour (60° rise) (nat. and manf. gas)	28
Heat speed in gallons per hour (60° rise) (liquefied petr. gas)	28
Hourly Btu input (nat. or manf. gas) (thousands)	20
Hourly Btu input (liquefied petr. gas) (thousands)	20
Gas line (inches)	$\frac{3}{8}$
Water line (inches)	$\frac{3}{4}$
Flue (inches)	3

ROUGHING-IN DIMENSIONS  
(INCHES)

No.	16-20
A	$20\frac{1}{4}$
B	$20\frac{1}{4}$
C	$27\frac{1}{8}$
D	23
E	$4\frac{1}{2}$
F	$2\frac{1}{4}$
G	33
H	$\frac{3}{4}$
I	$2\frac{1}{2}$
J	$\frac{3}{8}$
K	3
L	$34\frac{1}{2}$
M	41
N	$4\frac{1}{2}$
O	36
P	$6\frac{1}{2}$

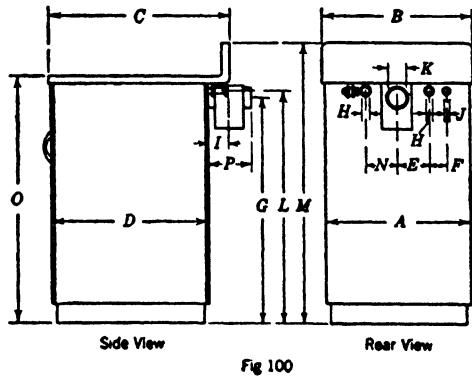

Courtesy Ruid Manufacturing Co., Pittsburgh, Pa.



### Instantaneous Heaters

These heaters have large burners and heat-absorbing surfaces to permit delivery of water instantaneously to meet the maximum demand load. They are always automatic in operation and require no tanks. They are used under two widely varying sets of conditions: (a) when there is a uniform maximum demand over long periods and (b) where the load is highly intermittent and there are long periods between demands. They may also be used as "boosters" where there are long runs of piping or exceptionally high peak loads such as occur in one-meal-a-day restaurants. When used for periodic demands they save storage losses from tanks and piping during the idle period. Since they have a fixed capacity, always operating at maximum load, they are best suited to fairly constant loads.

Controls may operate thermostatically or upon the flow of water, as when any faucet is turned on. Special controls prevent operation due to leaky faucets.

The first of the numbers which designate size usually indicates the nominal delivery capacity in gallons per minute for the standard temperature rise of 60 F.

Usually four times as many fixtures can be supplied as the capacity of the heater indicates (19)

TABLE 82

INSTANTANEOUS HEATER CAPACITIES (19)

Capacity (60° rise)	Number Showers Which Can Be Supplied			
	3	4	6	8
Capacity (100° rise)	1.8	2.4	3.6	4.8
No. Shower Heads for Size (inches)				
3 in.	1.3	1.7	2.6	3.4
4 in.	1.0	1.2	1.8	2.4
5 in.		1.0	1.5	1.8
6½ in.			1.1	1.5
8 in.				1.0

#### Number of Faucets Which Can Be Supplied

Heater Capacity 60 F Rise	No. Faucets in Use at One Time	No. Faucets Which Can Safely Be Connected to One Heater	Approximate Gas Demand (cu ft per hr)	
			Manufactured Gas	Natural Gas
3	1.5	6	120	97
4	2	8	240	130
6	3	12	360	195
8	4	16	480	250

**TABLE 83**  
**INSTANTANEOUS (CONTINUOUS-FLOW HEATERS)**

**GENERAL TABLE**

Water Heater No.	95	3	4	6	8
Capacity in gallons per minute (60° rise)					
Nat. gas	1 92	2 56	3 21	5 13	6 41
Manf. gas	2.03	2 70	3 38	5 41	6 76
Hourly Btu input					
Nat. gas	82,500	110,000	137,500	220,000	275,000
Manf. gas	87,000	116,000	145,000	232,000	290,000
Gas line (inches)	3/4	1	1 1/4	1 1/2	2
Cold-water line (inches)	1/2	1/2	1/2	3/4	3/4
Hot-water line (inches)	1/2	1/2	1/2	3/4	3/4
Flue (inches)	5	6	6	7	8

*Note:* 25 lb minimum water pressure required for standard water heaters. From 5 to 25 lb, use the low pressure type supplied in the No. 4, 6, and 8 sizes. Where pressure is below 5 lb, use the storage type.

**CAPACITIES**

No. 95. For: Very small homes with compactly arranged fixtures.

No. 3. For: Small homes having ordinary bathroom, kitchen, and laundry fixtures.

No. 4. For: Average, modern homes having kitchen, one or two bathrooms, and laundry.

No. 6. For: Homes with two or three bathrooms and other fixtures in proportion. For small duplex apartments.

No. 8. For: Large homes with three to five bathrooms and other fixtures in proportion. Also for small hotels, apartment houses, and restaurants. *Note:* This is only a general guide to be supplemented by study of individual requirements. In addition to residences, this type has wide application in commercial buildings.

**ROUGHING-IN DIMENSIONS (INCHES)**

Number	95	3	4	6	8
B	21 7/8	25 1/2	27 1/4	30 1/4	32 3/8
C	16 1/2	17 1/2	19	22 1/2	23 1/2
D	13 7/8	14 1/2	16 3/8	19	21 1/2
E	9 3/8	10 3/8	11 3/8	12 3/4	13 3/8
F	9 1/4	10	10 3/4	12 3/4	13 3/8
G	16 3/4	29 1/2	31	33 3/4	33 3/4
H	3 3/4	1 1/2	1 3/4	1 3/4	2
J	5	6	6	7	8
K	19 3/4	26 3/4	27 3/4	28 3/4	29 1/2
L	42 3/8	45 3/4	47 1/4	55 3/4	58 1/2
M	2 1/4	2 1/4	2 3/4	2 3/4	2 3/4
N	3 1/2	3 1/2	3 3/4	3 3/4	3 3/4
P	1 1/2	1 1/2	1 1/2	1 1/2	1 1/2
R	23 3/4	20 1/4	20 3/8	22 1/4	22 1/2

Add 6 3/4" to "M" for draft hood for No. 95.  
Add 7 3/4" to "M" for draft hood for Nos. 3, 4, and 6.  
Add 8 3/4" to "M" for draft hood for No. 8.

*Courtesy Ruud Manufacturing Co., Pittsburg, Pa.*

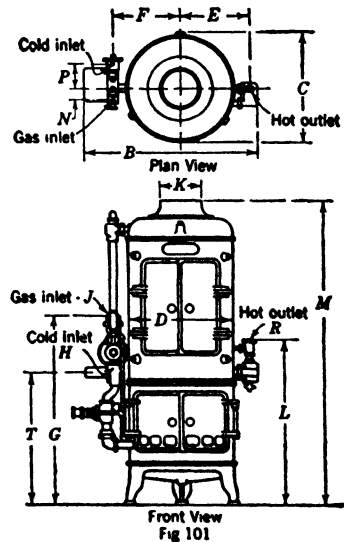

Front View  
Fig 101

### Large-Volume Heaters

Where heaters must supply more than 100 gal per hr they are classed as large-volume heaters. This classification, being based on size, includes large circulating tank and instantaneous heaters, multi-coil heaters, "boosters," and steam or hot-water boilers of various types. Where liming may occur, large-volume heaters are usually connected as indirect heaters. The steam or hot water generated in the boiler or heater is

TABLE 84  
SELECTION OF LARGE-VOLUME HEATERS\* (19)

Multi-coil Heaters †

Max Day Gallons		500	1000	2000	3000	4000	5000	6000	7000
System Overall Efficiency*	Temperature Rise °F	Capacity Rating Gal Hot Water per Hour							
60%	60	60	107	214	320	427	535	641	748
	100	100	178	352	533	712	892	1068	1247
55%	60	62	110	220	331	441	551	661	771
	100	103	183	367	550	735	919	1102	1285
50%	60	64	114	229	343	457	571	686	800
	100	107	190	382	572	762	952	1143	1334
45%	60	66	120	239	359	478	598	717	837
	100	110	200	398	598	797	997	1195	1395
Typical Installations		Tank Sizes							
Hotels, all-day restaurants		70	70	125	175	200	250	300	350
Apartments, 2-meal restaurants, residences		70	125	200	300	400	500	600	700
Offices, lofts		70	125	200	300	400	500	600	700
One-meal restaurants		175	300	600	900	1200	1500	1800	2100

\* Efficiency must be picked, taking into account size of installation, whether piping and tank are insulated, etc. In restaurants or where there but is little piping, overall efficiency is high.

† Sizing is on the basis of 1-10 maximum day. Extra capacity to take care of radiation losses has been added.

passed through heat-transfer coils within the storage tank without direct connection between the "element water" in the heater and the domestic hot water in the tank. Selection tables (Tables 84 and 85) include multi-coil heaters, cast-iron boilers, and tanks required for both, but installations of this magnitude should always be designed or checked by competent engineers or specialists (19).

TABLE 85  
SELECTION OF LARGE-VOLUME HEATERS \* (19)

Cast-Iron Boilers †

Max Day Gallons		1000	2000	3000	4000	5000	6000	7000
System Overall Efficiency *	Temperature and F. D. R. Steam	Capacity Rating Gal Hot Water per Hour						
60%	100° rise sq ft steam	60	121	181	242	302	363	423
		210	420	630	840	1050	1270	1480
55%	100° rise sq ft steam	64	128	193	257	321	385	449
		230	450	680	890	1120	1340	1570
50%	100° rise sq ft steam	69	138	206	275	344	413	482
		240	480	720	960	1200	1440	1680
45%	100° rise sq ft steam	74	149	223	297	372	446	521
		260	520	780	1040	1300	1550	1800
Typical Installations		Tank Sizes						
Hotels, all-day restaurants		100	200	300	400	500	600	700
Apartments, 2-meal restaurants, residences		200	400	400	800	1000	1200	1400
Offices, lofts		110	330	500	660	830	1000	1170
One-meal restaurants		450	900	1350	1800	2250	2700	3150

\* Efficiency must be picked, taking into account size of installation, whether piping and tank are insulated, etc. In restaurants or where there is but little piping, overall efficiency is high.

† Sizing is on the basis of 1-20 maximum day. Extra capacity to take care of radiation losses has been added.

TABLE 86  
AUTOMATIC-STORAGE, LARGE-VOLUME (MULTICOIL) HEATERS

GENERAL TABLE

No.	Size Moment Valve	Thermostat Tank Tapping Required	Heat Speed Gallons per Hour 60° Rise Nat. or Manf Gas	Heat Speed Gallons per Hour 60° Rise Liquefied Petr. Gas	Hourly Btu Input Nat or Manf. Gas	Hourly Btu Input Liquefied Petr Gas	Gas Line	Water Circulating Lines	Flue
50	3/4"	1 1/4"	49	43.4	35,000	31,000	1/2"	1 1/4"	4"
75	3/4"	1 1/4"	77	63	55,000	45,000	1/2"	1 1/2"	4"

\* 1/8" between water heater and thermostat; 3/4" to thermostat

CAPACITIES

No. 50. Furnished regularly with tanks of 50, 60, and 80 gal but can be connected to tanks of other sizes, singly and in duplex.

For: Larger-than-average homes and a variety of commercial requirements.

No. 75. Furnished regularly with tanks of 60, 80, and 100 gal, but can be connected to tanks of other sizes, singly and in duplex.

For: Large homes having from three to five bathrooms. Apartment buildings with four apartments of four and five rooms each. For many commercial and volume water-heating requirements.

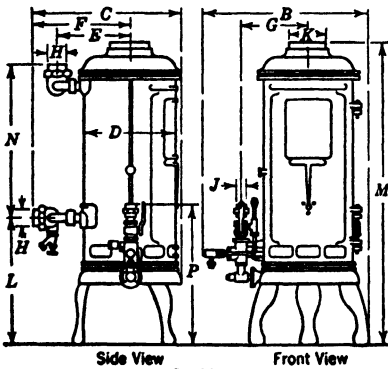

Fig 102

No. 75 ROUGHING-IN DIMENSIONS (INCHES)

Number	75
B	20
C	18 1/4
D	11 1/2
E	8 1/2
F	11 3/4
G	8 3/4
H	11 1/2
J	1 1/2
K	4
L	16 3/8
M	39 1/2
N	21 1/4
P	18 3/8

Add 7" to "M" for draft hood Legs are 7 1/2" high.

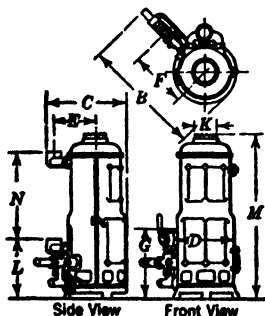

Fig 103

No. 50 ROUGHING-IN DIMENSIONS (INCHES)

Number	50
B	17 3/4
C	14
D	9 3/4
E	7
F	8 3/8
G	12
K	4
L	10 1/8
M	27
N	14 3/4

Add 7" to "M" for draft hood.

TABLE 87  
AUTOMATIC-STORAGE, LARGE-VOLUME (MULTICOIL) HEATERS

ROUGHING-IN DIMENSIONS  
(INCHES)

No.	100	200	350	500
A	45	53 $\frac{3}{8}$	61	64 $\frac{1}{8}$
B	41 $\frac{1}{4}$	49 $\frac{1}{2}$	56 $\frac{1}{4}$	58 $\frac{1}{2}$
C	37 $\frac{1}{4}$	45 $\frac{1}{2}$	52	53 $\frac{1}{2}$
D	12 $\frac{3}{4}$	16	18 $\frac{1}{2}$	20 $\frac{1}{2}$
E	10 $\frac{1}{2}$	13	14 $\frac{3}{4}$	15 $\frac{3}{4}$
F	5	6	7	8
G	17 $\frac{1}{4}$	18	19	18 $\frac{1}{2}$
H	41	49	56	58
I	1 $\frac{1}{2}$	2	2 $\frac{1}{2}$	2 $\frac{1}{2}$
J	27	32	36 $\frac{1}{2}$	38 $\frac{1}{2}$
K	21 $\frac{1}{2}$	26	29 $\frac{1}{2}$	31 $\frac{1}{2}$
L	3	3 $\frac{1}{2}$	4	4

Note. H equals minimum dimension.

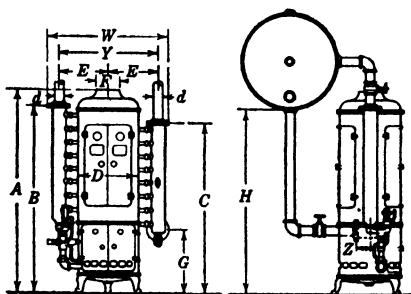

Fig 104

GENERAL TABLE

Water Heater No	100	200	350	500
Heat speed in gallons per hour (60° rise)				
Natural gas	107.7	215.4	377.6	538.5
Manufactured gas	111.9	223.8	391.6	559.4
Number of coil sections	6	7	7	8
Size manifold connection	1 $\frac{1}{2}$ "	2"	2 $\frac{1}{2}$ "	2 $\frac{1}{2}$ "
Size of gas inlet	3 $\frac{3}{4}$ "	4"	4 $\frac{1}{2}$ "	5"
Size flue connection	5"	6"	7"	8"
Number of burners	6	12	21	30
Orifice natural gas	52	52	52	52
Orifice* manufactured gas	40	40	40	40
Size thermostat required	3 $\frac{1}{4}$ " A	1"	1 $\frac{1}{4}$ "	1 $\frac{1}{2}$ "
Tank tapping required for thermostat	1 $\frac{1}{4}$ "	1 $\frac{1}{4}$ "	1 $\frac{1}{4}$ "	1 $\frac{1}{2}$ "
Size of gas meter	20	45	60	80
Hourly Btu input				
Natural gas	77,000	154,000	270,000	385,000
Manufactured gas	80,000	160,000	280,000	400,000

\* Manufactured gas orifice varies with specific gravity, Btu and pressure of the gas.

CAPACITIES

No. 100. Furnished regularly with tanks of 80, 100, and 150 gal storage capacity.

For: In general, homes having three to five bathrooms, bedroom lavatories, large kitchen sink, and laundry. Apartment buildings with six apartments of four and five rooms each.

No. 200. Furnished regularly with tanks of 100, 150, 200, 250, and 300 gal capacity; singly 100 and 150, duplex 200, 250, and 300 gal.

For: In general, homes having five to eight bathrooms, large kitchen sink, dishwashing machine, large laundry. Apartment buildings with six to twelve apartments of five or six rooms each.

No. 350. Furnished regularly with tanks of 300, 365, 425, 500, and 600 gal capacity, singly and in duplex.

For: In general, homes having seven to ten bathrooms, large kitchen sink, pantry sink, dishwashing machine, large laundry. Apartment buildings with ten to twenty apartments of five and six rooms each.

No. 500. Furnished regularly with tanks of 425, 500, 600, 700, 800, 1000, 1200, 1500, 1800, 2000, and 2500 gal capacity in black iron and galvanized. Alloy (strengthened copper) tanks furnished up to 1200 gal capacity.

For: Single, duplex, and triplex installations.

Courtesy Ruid Manufacturing Co, Pittsburgh, Pa.

**TABLE 88**  
**AUTOMATIC-STORAGE, LARGE-VOLUME (MULTICOIL) SYSTEMS**

STANDARD COMBINATIONS (BLACK AND GALVANIZED IRON STANDARD TANK COMBINATIONS)

Heater No.	Capacity of Tank in Gallons	Diameter of Tank	Length of Tank	Number of Heaters Tapped for	Cold Inlet to Tank	Hot Outlet from Tank	Size of Circulators
100	80	20"	5'0"	1	1 1/2"	1 1/4"	1 1/2"
100	100	22"	5'0"	1	1 1/2"	1 1/4"	1 1/2"
100	150	24"	6'4"	1	1 1/2"	1 1/4"	1 1/2"
200	100	22"	5'0"	1	1 1/2"	1 1/4"	2"
200	150	24"	6'4"	1	1 1/2"	1 1/4"	2"
200	200	24"	8'6"	2	2"	1 1/2"	2"
200	250	30"	7'0"	2	2"	1 1/2"	2"
200	300	30"	8'0"	2	2"	1 1/2"	2"
350	300	30"	8'0"	2	2 1/2"	2 1/2"	2 1/2"
350	365	30"	10'0"	2	2 1/2"	2 1/2"	2 1/2"
350	425	36"	8'0"	2	2 1/2"	2 1/2"	2 1/2"
350	500	36"	9'6"	2	2 1/2"	2 1/2"	2 1/2"
350	600	42"	8'6"	2	2 1/2"	2 1/2"	2 1/2"
500	425	36"	8'0"	2	2 1/2"	2 1/2"	2 1/2"
500	500	36"	9'6"	2	2 1/2"	2 1/2"	2 1/2"
500	600	42"	8'6"	2	2 1/2"	2 1/2"	2 1/2"
500	700	42"	10'0"	2	2 1/2"	2 1/2"	2 1/2"
500	800	48"	8'6"	2	2 1/2"	2 1/2"	2 1/2"
500	1000	48"	10'0"	2	2 1/2"	2 1/2"	2 1/2"
500	1200	48"	13'0"	3	3"	3"	2 1/2"
500	1500	54"	12'9"	3	3"	3"	2 1/2"
500	1800	54"	15'3"	3	3"	3"	2 1/2"
500	1800	60"	12'6"	3	3"	3"	2 1/2"
500	2000	54"	17'0"	4	3"	3"	2 1/2"
500	2500	60"	17'0"	4	3"	3"	2 1/2"

Above Tanks may be equipped with Steam Coils, Manholes and Handholes.

**TABLE 89**

GALLONS PER HOUR DELIVERED BY RUUD MULTICOIL STORAGE HEATERS (NATURAL GAS) \*

Size of Heater	Temperature Rise in Degrees F														
	10°	20°	30°	40°	50°	60°	70°	80°	90°	100°	110°	120°	130°	140°	150°
100	649	325	216	162	130	108	93	81	72	65	59	54	50	46	43
200	1300	650	430	325	260	216	185	162	144	130	118	108	100	92	86
350	2280	1140	760	570	455	378	325	285	253	228	207	189	175	163	152
500	3240	1620	1008	810	650	540	464	406	361	325	295	270	250	232	216

\* For "gallons per hour" figures for manufactured gas, multiply the figures in the table by 1.038.

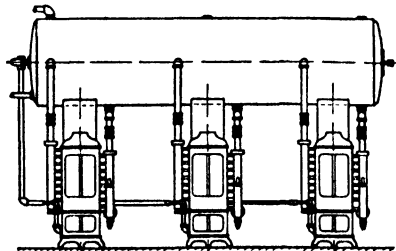

"Triplex" Automatic Multi-Copper-Coil Storage System  
 Fig. 105

Courtesy Ruud Manufacturing Co., Pittsburgh, Pa.

**Immersion-Type Water Heaters**

Immersion water heaters are equipped with special burners, and the heat travels through long horizontal tubes immersed in the tank.

The overall efficiency is very high on this type of heater.

Each unit is entirely automatic in operation.

The tanks have cleanouts and connections for mud blow and water piping.

Steam coils can be furnished for convertible units.

There are two types available, atmospheric type and blast type.

*Atmospheric type* is equipped with atmospheric burners.

TABLE 90  
IMMERSION WATER HEATER, ATMOSPHERIC-TYPE

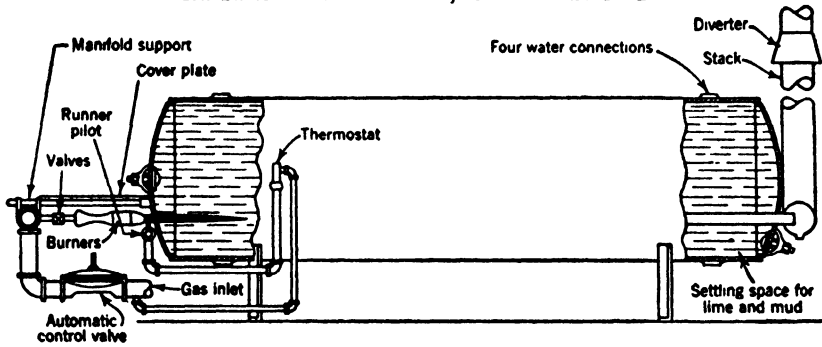

Capacities of the Immersion Water Heater

Number of Storage Water Heater	Tank Size Dimensions	Tank Capacity in Gallons	Btu Input per Hr	Size Gas Connection	Size of Flue	Capacity in Gallons Hot Water per Hour at Various Temperature Rises					
						40°	60°	80°	100°	120°	140°
A-51	20" x 6'	99	64,000	3/4"	6"	154	102	76	61	51	44
A-52	30" x 6'	224	64,000	3/4"	6"	154	102	76	61	51	44
A-53	42" x 6'	447	64,000	3/4"	6"	154	102	76	61	51	44
A-54	48" x 6'	592	64,000	3/4"	6"	154	102	76	61	51	44
A-101	20" x 6'	94	125,500	1"	6"	300	200	150	120	100	85
A-102	30" x 6'	219	125,500	1"	6"	300	200	150	120	100	85
A-103	42" x 6'	442	125,500	1"	6"	300	200	150	120	100	85
A-104	48" x 6'	587	125,500	1"	6"	300	200	150	120	100	85
A-151	20" x 6'	90	192,000	1 1/4"	6"	461	307	250	184	153	132
A-152	30" x 6'	215	192,000	1 1/4"	6"	461	307	250	184	153	132
A-153	42" x 6'	438	192,000	1 1/4"	6"	461	307	250	184	153	132
A-154	48" x 6'	582	192,000	1 1/4"	6"	461	307	250	184	153	132
A-241	20" x 6'	82	320,000	1 1/2"	8"	768	512	384	307	256	220
A-242	30" x 6'	207	320,000	1 1/2"	8"	768	512	384	307	256	220
A-243	42" x 6'	430	320,000	1 1/2"	8"	768	512	384	307	256	220
A-244	48" x 6'	575	320,000	1 1/2"	8"	768	512	384	307	256	220

Courtesy Sellers Engineering Co., Chicago, Ill.



TABLE 91  
IMMERSION WATER HEATER, ATMOSPHERIC-TYPE

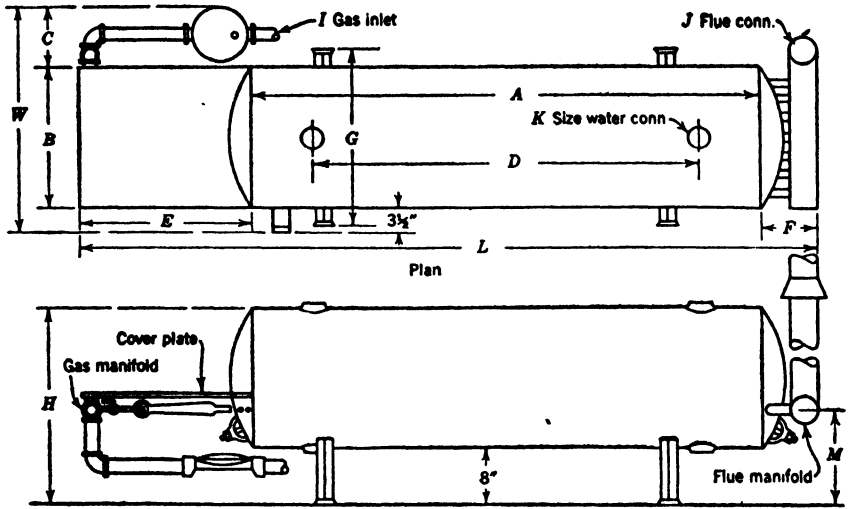

Dimensions of Immersion Water Heaters  
(All dimensions in inches)

No. of heater	L	W(1)	H(2)	A	B	C(1)	D	E	F	G(3)	I Gas Con.	J Flue Con.	K(4)	M
A-51	106	32½	28	72	20	9	54½	24	10	24	¾	6	2	16½
A-52	107	42½	38	72	30	9	54½	24	11	33	¾	6	2	16½
A-53	108	54½	50	72	42	9	54½	24	12	45	¾	6	2	16½
A-54	109	60½	56	72	48	9	54½	24	13	51	¾	6	2	16½
A-101	106	32½	28	72	20	9	54½	24	10	24	1	6	2	16½
A-102	107	42½	38	72	30	9	54½	24	11	33	1	6	2	16½
A-103	108	54½	50	72	42	9	54½	24	12	45	1	6	2	16½
A-104	109	60½	56	72	48	9	54½	24	13	51	1	6	2	16½
A-151	106	34	28	72	20	10½	54½	24	10	24	1¼	6	2	16½
A-152	107	44	38	72	30	10½	54½	24	11	33	1¼	6	2	16½
A-153	108	56	50	72	42	10½	54½	24	12	45	1¼	6	2	16½
A-154	109	62	56	72	48	10½	54½	24	13	51	1¼	6	2	16½
A-241	108	34½	28	72	20	11	54½	24	12	24	1½	8	2	16½
A-242	109	44½	38	72	30	11	54½	24	13	33	1½	8	2	16½
A-243	110	56½	50	72	42	11	54½	24	14	45	1½	8	2	16½
A-244	111	62½	56	72	48	11	54½	24	15	51	1½	8	2	16½

- Note: (1) Width may be decreased when necessary.  
 (2) 8" Legs or suspension bands or 24" pipe stand furnished as standard. High stand furnished for small additional charge.  
 (3) Legs may be placed at any desired position along the tank.  
 (4) Four water connections all 2" unless otherwise specified.

Courtesy Sellers Engineering Company, Chicago, Ill.

TABLE 92  
IMMERSION WATER HEATER, BLAST-TYPE

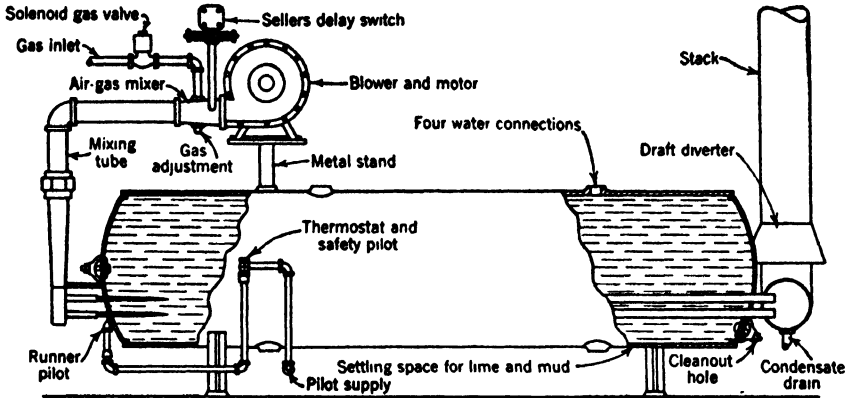

Dimensions of Blast-Type Immersion Water Heaters

Number of Storage Water Heater	Tank Size Dimensions	Tank Capacity in Gallons	Btu Input per Hr	Size Gas Connection	Size of Flue	Capacity in Gallons Hot Water per Hour at Various Temperature Rises					
						40°	60°	80°	100°	120°	140°
B-41	20" x 8'	132	96,000	3/4"	6"	230	154	115	92	77	65
B-42	30" x 8'	298	96,000	3/4"	6"	230	154	115	92	77	65
B-43	42" x 8'	591	96,000	3/4"	6"	230	154	115	92	77	65
B-44	48" x 8'	780	96,000	3/4"	6"	230	154	115	92	77	65
B-81	20" x 8'	128	192,000	1"	6"	461	307	250	184	153	132
B-82	30" x 8'	294	192,000	1"	6"	461	307	250	184	153	132
B-83	42" x 8'	588	192,000	1"	6"	461	307	250	184	153	132
B-84	48" x 8'	777	192,000	1"	6"	461	307	250	184	153	132
B-121	20" x 8'	125	288,000	1"	8"	692	461	375	276	230	198
B-122	30" x 8'	291	288,000	1"	8"	692	461	375	276	230	198
B-123	42" x 8'	585	288,000	1"	8"	692	461	375	276	230	198
B-124	48" x 8'	773	288,000	1"	8"	692	461	375	276	230	198
B-201	20" x 8'	117	480,000	1 1/4"	8"	1250	770	575	460	385	325
B-202	30" x 8'	283	480,000	1 1/4"	8"	1250	770	575	460	385	325
B-203	42" x 8'	578	480,000	1 1/4"	8"	1250	770	575	460	385	325
B-204	48" x 8'	765	480,000	1 1/4"	8"	1250	770	575	460	385	325
B-303	42" x 8'	569	720,000	1 1/2"	10"	1725	1155	862	690	577	487
B-304	48" x 8'	757	720,000	1 1/2"	10"	1725	1155	862	690	577	487
B-403	42" x 8'	559	960,000	2"	12"	2300	1540	1150	920	770	650
B-404	48" x 8'	748	960,000	2"	12"	2300	1540	1150	920	770	650
B-503	42" x 8'	550	1,200,000	2"	12"	2875	1925	1435	1150	962	812
B-504	48" x 8'	739	1,200,000	2"	12"	2875	1925	1435	1150	962	812
B-603	42" x 8'	541	1,440,000	2"	12"	3450	2310	1725	1380	1155	975
B-604	48" x 8'	729	1,440,000	2"	12"	3450	2310	1725	1380	1155	975
B-703	42" x 8'	533	1,680,000	2"	12"	4025	2695	2012	1610	1347	1137
B-704	48" x 8'	721	1,680,000	2"	12"	4025	2695	2012	1610	1347	1137

Courtesy Sellers Engineering Company, Chicago, Ill.

Units consist of storage tank with alloy tubes welded into place; atmospheric burners; burner cover plate; gas manifold; thermostat; two safety pilots; diaphragm gas valve; exhaust manifold; pressure-relief valve and legs or suspension bands.

*Blast type* is equipped with special blast-type burners. With blast firing there is greater assurance of complete combustion. The air and gas are under positive control at all times. The velocity of the gas from the burner is sufficient to carry the products of combustion all the way through the heater.

Units consist of storage tank with alloy tubes welded into place; burners; burner cover plate; burner manifold and mixing tube; blower and motor; air-gas mixer; diaphragm control switch; safety pilot valve; solenoid gas valve; delay switch; combination thermostat; pilot and safety pilot; runner pilot; exhaust manifold; temperature and pressure-relief valve and legs or suspension bands.

### Fittings and Attachments

*Gas piping* should not be less than the size called for on each individual heater;  $\frac{1}{2}$  in. is the usual minimum. Automatic gas water heaters equipped with "snap" or quick-acting gas valves, and which have ratings greater than 50,000 Btu per hr, should be supplied by gas pipe, independent of piping for other appliances, direct to meter.

*Valves* should be of gate-valve rather than globe-valve type in order to minimize obstructions to the flow of water.

*Gas-saving devices* of various sorts are offered for sale at times. Such a great proportion of these are found to be hazardous when tested by the U. S. Bureau of Standards and the American Gas Association Testing Laboratory that use of any attachment of this kind is discouraged. Furthermore, these devices usually result in higher gas consumption instead of a saving (19).

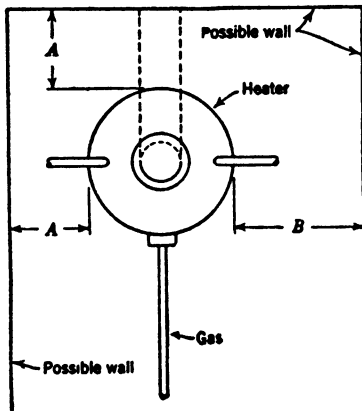

FIG. 106. Heater Location. (From *Domestic Hot Water Systems* (19).)

If heater is located in a recess the minimum dimension for *A* equals 3 in. if walls are fireproof, 6 in. if walls or trim are non-fireproof.

Dimension *B* may equal *A* but is preferably 1 ft-6 in. for access. One side of such a recess is preferably left open.

back-draft diverter. Diverter protect gas appliances from downdrafts and excessive and insufficient updrafts and are made in two types,

### Heater Flues and Chimneys

The flue connection between the heater and the chimney should be of the same size as the vent collar on the heater, and should always have a

back-draft diverter. Diverter protect gas appliances from downdrafts and excessive and insufficient updrafts and are made in two types,

vertical and horizontal. Vertical diverters should not be used in horizontal positions, and vice versa. The flue connection should preferably be not longer than 20 ft, should be straight, and pitched to rise at least  $\frac{1}{4}$  in. per ft towards the chimney. Local ordinances may require even shorter flues and may necessitate treating ceilings over flues with fire-resistant materials (19).

Chimney flues for gas appliances should always be lined. Vitrified clay liners, preferably with acid-resisting mortar joints, are satisfactory; in some localities, for both new and remodeling jobs, vitreous enameled iron, or stainless steel, liners are used. All chimneys should be built at least 2 ft higher than any adjacent ridge, to avoid downdrafts (19). See also Art. 10-C.

ART. 11-C. OTHER HEATERS

Coal Heaters (Fed. Specs.)

Coal heaters shall be designed so that all surfaces can be cleaned easily of soot and dust. Grates shall be cast iron, heavy pattern, sectional, rocking and dumping, and removable without disturbing the heater.

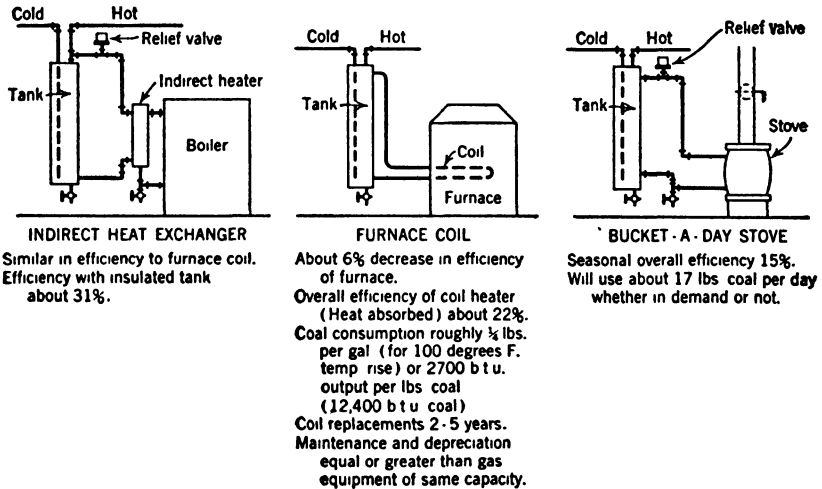

FIG. 107. Coal Heaters.

All doors and bases shall be cast iron and of heavy pattern. Shaker levers and cleaning appliances shall be provided.

The minimum thickness of the steel for the head shall be  $\frac{3}{16}$  in. Steel heaters shall be designed for a working pressure of 120 psi gage and shall be tested at the factory with a hydrostatic pressure of 300 psi gage.

Cast-iron heaters shall be designed for a working pressure of 100 psi gage and shall be tested at the factory with a hydrostatic pressure of 300 psi gage.

Dimensions shall conform to the following table:

Dimensions (minimum) inches	Grate diameter (inches)		
	12	14	16
Height of heater above grate	24	30	35
Flow and return openings	1 ½	1 ½	2

### Oil Heaters

Types, according to Merriam (21).

1. Direct-fired, separate water heater.
  - a. Wick fire type (24.3% thermal efficiency).
  - b. Volatilizing type (37.7% thermal efficiency).
2. Central house heating (either oil-designed or conversion burner) connected to a water-storage tank by means of:
  - a. Copper coils built into the inside of the boiler sections and partially submerged below water line.
  - b. Indirect external heat exchanger.
  - c. Coil in furnace chamber or flue.

While the cost of oil on a Btu basis is less than gas, the efficiency of the heaters is much less, varying from 10.6% in summertime to 54.0% in the winter.

### Electric Heaters

They have a greater thermal efficiency which, however, is offset by the greater cost of electricity. Average thermal efficiency is 83.3% for a 50-gal per day withdrawal (compared with an average of 51.0% for a gas heater) (21).

Comparison between gas and electric heating cost:

$$\frac{3415 \times \text{elec eff}}{\text{Price per kwhr}} = \frac{\text{Thermal value per mcf} \times \text{gas eff}}{\text{Price per mcf}}$$

For a 540 Btu gas the cost of the gas, to break even with the electricity, must be:

TABLE 93 (21)

Price of Electricity per Kwhr	Break-Even Price of Gas per 1000 Cu Ft
3.5 cents	3.38
3.0	2.90
2.5	2.42
2.0	1.93
1.5	1.45
1.0	0.97
0.8	0.77
0.6	0.58
0.4	0.39

**Steam Heaters**

*Steam Required to Heat Water.* To determine the amount of steam per hour required to heat a given quantity of water through any temperature range and with any steam pressure, apply the following formula:

$$\frac{\text{Gallons per hour} \times 8\frac{1}{3} \times \text{Degrees rise}}{\text{Latent heat of steam}} = \text{Pounds of steam per hour}$$

*Example:* Required the amount of steam at 5 lb pressure to heat 9000 gph from 50 F to 160 F.

$$\frac{9000 \times 8\frac{1}{3} \times 110}{976} = 8453 \text{ lb steam per hour}$$

TABLE 94

LATENT HEAT OF STEAM

Steam pressure, lb	0	5	10	25	50	75	100
Heat (Btu)	970	976	980	989	998	1005	1009

*Steam Radiation per Gallon.* Allowing for radiation loss from storage tank and piping, figure 0.04 sq ft of steam radiation for each gallon heated per degree temperature (F) rise.

*Auxiliary Heaters.* When hot water is obtained in winter from furnace coils or furnace-connected heat exchangers, several factors must be considered. In no case can hot water so obtained be said to cost nothing; the amount of excess steam or water radiation necessary, and the

fuel required to heat it, can be calculated easily. Boilers must be sized sufficiently large to accommodate this excess on the coldest days.

Water temperatures are likely to be uneven and recovery slow. Water may become so hot as to cause danger of scalding and of undue corrosion; if cross-connections with the gas heater are not properly made, serious damage may be done to the thermostat.

If conditions make it imperative to use the gas water heater as a summer service only, the best procedure is to install an automatic gas heater complete with its own storage tank. Cold water is fed through the existing furnace-heated storage tank into the gas heater. This winter storage tank should be left uninsulated so that in summer it serves as a "tempering tank" in which excessively cold water from the street main is warmed to cellar temperature and the load on the gas heater is reduced. Piping connections may be so valved that it is possible to cut the gas heater out of the system in winter.

#### ART. 11-D. TANKS AND HEATING COILS

##### Types of Storage Tanks

Galvanized welded steel tanks are most generally used in automatic-storage systems, and they are satisfactory for most localities in the United States. In some districts they are not satisfactory and non-ferrous metal tanks should be used. As a guide to selecting tank materials, the experience, in the district under consideration, with respect to galvanized range boilers should be taken into account. Monel metal, a copper nickel alloy, and silicon bronzes, going under several trade names, as Everdur, Herculoy, and Arcoloy, are most generally used in the manufacture of non-ferrous tanks. Pure copper, as a heater tank material, has been almost entirely displaced by the strong silicon bronze alloys (19).

##### Range Boilers (Fed. Specs.)

Tanks shall be vertical and shall be provided with interior water-supply pipes and stand. They shall be designed for a working pressure of 150 psi gage and shall be tested at the factory with a hydrostatic pressure of 300 psi gage.

*Steel tanks*, zinc-coated, shall have all seams riveted or riveted and welded. The tapping for the cold-water supply shall be provided with a coupling tapped for and provided with a  $\frac{3}{4}$ -in. brass pipe, iron-pipe size.

*Copper tanks* shall be constructed of copper conforming to Federal Specification QQ-C-501. They shall be in the form of two bells without seams and put together with heavy connecting bands sweated on, or shall have brazed longitudinal seams and brazed or riveted heads, or all brazed and riveted seams. The inside of the tanks shall be heavily tinned. The tapping for the cold-water supply shall be supplied with

a coupling suitable for and provided with a 3/4-in. copper tube having a wall thickness of not less than 0.050 in.

*Dimensions.* Tanks shall be of the dimensions, capacities, and thicknesses indicated in Table 95.

TABLE 95  
RANGE BOILER DIMENSIONS

Capacity, Gallons	Diameter	Length	Shell Thickness		Ends, Thickness	
			Steel	Copper	Steel	Copper
30	12	60	0.125	0.060	0.140	0.145
40	14	60	0.125	0.070	0.140	0.145
50	16	60	0.125	0.080	0.140	0.185
66	18	60	0.140	0.090	0.172	0.218
80	20	60	0.140	0.100	0.187	0.250

Stands are 15 in. high.

TABLE 96  
OTHER RANGE BOILER DIMENSIONS

Capacity, Gallons	Diameter, Inches	Length, Inches
18	12	36
24	12	48
30	12	60
32	14	48
40	12	60
42	16	48
52	16	60
66	18	60
82	20	60
100	22	60
120	24	60
144	24	72
192	24	96

*Stands.* Each range boiler shall be supplied with an extra-heavy painted cast-iron stand, of the proper diameter for the tank.



**MONEL RANGE BOILERS**

Available in the following pressures:

200-lb. Test  
(85-lb W.P.)

250-lb Test  
(106-lb W.P.)

350-lb Test  
(148-lb W.P.)

**TABLE 97**  
**TABLE OF DIMENSIONS**

**HORIZONTAL**

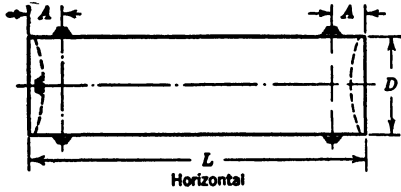

Capacity	Diam <i>D</i>	Length <i>L</i>	<i>A</i>	Connection
25 Gal	12"	51"	6"	1" Female
30 "	12"	61"	6"	1" "
40 "	14"	61"	6"	1" "
50 "	16"	61"	6"	1" "
60 "	18"	61"	6"	1" "
80 "	20"	61"	6"	1 1/4" "
100 "	22"	64"	6"	1 1/4" "

**VERTICAL**

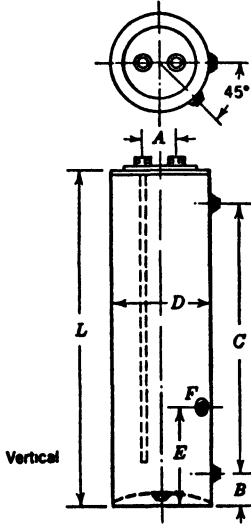

Capacity	Diam <i>D</i>	Length <i>L</i>	<i>A</i>	<i>B</i>	<i>C</i>	<i>E</i>	Conne- ction <i>F</i>
25 Gal	12	51	4	6	38	15	1" Female
30 "	12	61	4	6	48	18	1" "
40 "	14	61	5	6	48	18	1" "
50 "	16	61	5	6	48	18	1" "
60 "	18	61	5	6	48	18	1" "
80 "	20	61	5	6	48	18	1 1/4" "
100 "	22	64	5	6	48	18	1 1/4" "

*F*—Universal tapping optional, left hand unless otherwise specified.

Courtesy Whitehead Metal Products Co., Inc., New York, N. Y.

**Large Tanks**

*All Types.* All openings and tapings shall be reinforced properly. Horizontal tanks 36 in. in diameter shall have manholes; all other tanks shall have handholes. Handholes and manholes shall be provided with plates, yokes, and gaskets, and in horizontal tanks may be either in the center of the heads or in the heads near the bottom. Horizontal tanks with steam coils shall be designed for the installation of the heater flange

for the coils. The name of the manufacturer and the working pressure shall be marked on a brass plate secured to the tank. Tank outfits shall include tank supports, relief valves, thermometers, supply pipes within the tanks, and regulators and their accessories.

TABLE 98  
LARGE MONEL STORAGE TANKS

Capacity, Gallons	Shell Dimensions, Inches	Overall Dimensions, Inches
125	24 × 60	Add approx. 6
150	24 × 72	" " 6
180	30 × 60	" " 8
200	30 × 70	" " 8
250	30 × 84	" " 8
300	30 × 96	" " 8
300 Alt.	36 × 72	" " 8
350	36 × 84	" " 10
400	36 × 96	" " 10
450	36 × 108	" " 10
500	36 × 120	" " 10
500 Alt.	42 × 84	" " 10
600	42 × 96	" " 11
700	42 × 108	" " 11
800	42 × 120	" " 11

*Note* Handholes and manholes furnished to specifications

*Courtesy Whitehead Metal Products Company, Inc., New York, N. Y.*

Tanks shall be tested at the factory under a hydrostatic pressure of 300 psi gage.

**Steel Tanks.** Heads and shells shall be constructed of steel as specified in Chapter 2, Volume I. Tanks shall be zinc-coated inside and outside after fabrication. Seams shall be riveted and welded for a working pressure of not less than 120 psi gage.

**Copper Tanks.** Heads and shells shall be constructed of copper conforming to Federal Specification QQ-C-501. Plates and yokes shall be of heavy pattern and shall be constructed of cast brass conforming to Federal Specification QQ-C-621. Seams shall be single-riveted and brazed or double-riveted and soldered for a working pressure of 120 psi gage.

**Copper-Silicon Alloy Tanks.** Heads and shells shall be constructed of copper-silicon alloy conforming to the requirements specified in Chap-

ter 2, Volume I. Seams shall be welded or riveted for a working pressure of not less than 120 psi gage.

Dimensions shall conform to Table 99.

TABLE 99

Dimensions (Minimum)	Diameter (Inches)					
	Horizontal Tanks			Vertical Tanks		
	20	24	36	36	42	48
Length (or height)	60	72	96	60	60	60
Shell thickness						
Steel	$\frac{3}{4}$	$\frac{3}{4}$	$\frac{5}{16}$	$\frac{5}{16}$	$\frac{3}{8}$	$1\frac{3}{8}$
Copper	0.200	0.240	0.360			
Alloy	0.109	0.131	0.196	0.196	0.229	0.262
Head thickness						
Steel: Convex	$\frac{3}{8}$	$\frac{3}{8}$	$\frac{7}{16}$	$\frac{7}{16}$	$\frac{1}{2}$	$\frac{9}{16}$
Steel: Concave	$\frac{3}{8}$	$\frac{3}{8}$	$\frac{1}{2}$	$\frac{1}{2}$	$\frac{9}{16}$	$\frac{5}{8}$
Copper: Convex	0.330	0.400	0.600			
Alloy: Convex	0.303	0.363	0.545	0.545	0.637	0.727
Alloy: Concave	0.182	0.218	0.327	0.327	0.382	0.436
Taps	$1\frac{1}{2}$	$1\frac{1}{2}$	2	$1\frac{1}{2}$	$1\frac{1}{2}$	2
Relief valve	$\frac{3}{4}$	$\frac{3}{4}$	$\frac{3}{4}$	1	1	1
Steam coil						
Heating surface (sq ft)	4.90	9.75	18.25			
Steam inlet	$1\frac{1}{4}$	$1\frac{1}{2}$	2			
Steam regulator	$\frac{3}{4}$	$1\frac{1}{4}$	2			
Steam return	1	$1\frac{1}{4}$	$1\frac{1}{2}$			
Support (pipe)	2	$2\frac{1}{2}$	3	2	2	2

*Nickel-Clad Steel Tanks.* Heads and shell shall be constructed of 10% nickel-clad steel. The practical and economical way of joining is by welding. Riveted joints can be made where code requirements prohibit welded joints. Thickness of steel can safely be the same as for plain steel tanks as the nickel increases the strength of the composite plate.

**Hot-Water Storage Tanks**

(U.S. Department of Commerce, *Simplified Practice Recommendation 25*.)

1. *Sizes.*

TABLE 100

Diameter *	Length *	Actual capacity	Diameter *	Length *	Actual capacity
Inches	Feet	U.S. gallons	Inches	Feet	U.S. gallons
20	5	82	42	7	504
24	5	118	42	8	576
24	6	141	42	10	720
30	6	220	42	14	1008
30	8	294	48	10	940
36	6	318	48	16	1504
36	8	423	48	20	1880

\* By diameter is meant inside diameter; length means length of sheet, not overall length of tank

2. *Working pressures, classification, and marking.* (a) These sizes to be made in two working pressures, viz., 65 psi and 100 psi. (b) Those made for 65 lb working pressure are to be classified as "standard," and those for 100 lb working pressure as "extra heavy."

3. *Interchangeability.* The tanks listed above are to be made interchangeable for either horizontal or vertical installation.

4. *Tappings.* Tappings shall be as shown in Table 101. Sizes of all tappings on tanks up to and including 24 in. in diameter to be  $1\frac{1}{2}$  in., on tanks 30 to 42 in. in diameter to be 2 in., and on larger tanks to be 3 in.

5. *Handholes.* Handholes to be  $4 \times 6$  in., located as desired.

6. *Heating coils.* Coils for either horizontal or vertical installation of these tanks must not be less in size or total length than appears in Table 100.

*Heating Units.* Heads on shells are made for the installation of single or double units of heater coils or two heads with single units each.

Heaters generally are seamless drawn copper tubing bent into U shape with the ends expanded into a steel tube sheet. They can also be furnished in stainless steel.

*Supports.* Horizontal tanks 20 in. in diameter shall be provided with hangers of  $1\frac{1}{2}$  by  $\frac{5}{16}$ -in. iron straps or  $\frac{3}{4}$ -in. iron round bars placed around the tanks and adapted for being secured at both ends to the ceiling in an approved manner. All other horizontal tanks shall be provided with cast- or wrought-iron cradles and frames constructed of steel

TABLE 101  
HOT-WATER STORAGE TANKS  
And Standard Location of Openings

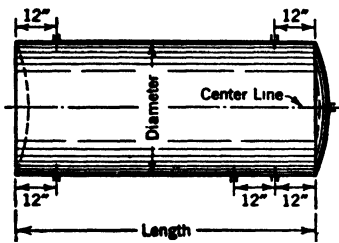

Tank Dimensions		Size of Pipe	Minimum Length of Heating Coil
Diameter	Length		
<i>Inches</i>	<i>Feet</i>	<i>Inches</i>	<i>Feet</i>
20	5	1	14
24	5	1 1/4	14
24	6	1 1/4	18
30	6	1 1/4	18
30	8	1 1/4	26
36	6	1 1/2	18
36	8	1 1/2	26
42	7	1 1/2	22
42	8	1 1/2	26
42	10	1 1/2	34
42	14	1 1/2	50
48	10	2	34
48	16	2	58
48	20	2	74

TABLE 102

RECOMMENDED THICKNESSES OF SHELLS AND HEADS FOR STEEL SHELL HOT-WATER STORAGE HEATERS UNDER VARIOUS PRESSURES

(These thicknesses are properly conservative and provide for the element of corrosion.)

Working Pressure, Pounds per Sq In.

Shell Diameter, Inches	Thickness in Inches													
	80		90		100		125		150		175		200	
	Shell	Heads	Shell	Heads	Shell	Heads	Shell	Heads	Shell	Heads	Shell	Heads	Shell	Heads
24	1/4	3/8	1/4	3/8	1/4	3/8	1/4	3/8	1/4	3/8	5/16	1/2	5/16	1/2
30	1/4	3/8	1/4	3/8	1/4	3/8	1/4	3/8	5/16	1/2	3/8	1/2	3/8	1/2
36	1/4	3/8	1/4	3/8	1/4	3/8	5/16	1/2	5/16	1/2	7/16	5/16	7/16	5/16
42	1/4	3/8	1/4	3/8	5/16	1/2	5/16	1/2	3/8	1/2	7/16	5/16	1/2	3/8
48	5/16	1/2	5/16	1/2	5/16	1/2	3/8	1/2	7/16	5/16	7/16	5/16	1/2	3/8
54	5/16	1/2	5/16	1/2	3/8	1/2	7/16	5/16	1/2	3/8	1/2	3/8	5/16	1 1/16
60	5/16	1/2	3/8	1/2	3/8	1/2	7/16	5/16	1/2	3/8	5/16	1 1/16	3/8	3/8
72	7/16	5/16	7/16	5/16	7/16	5/16	1/2	3/8	5/16	1 1/16	3/8	3/8	3/8	3/8

Courtesy The Patterson-Kelley Co., Inc., East Stroudsburg, Pa.

TABLE 103  
STEAM-HEATER CLEARANCE DIMENSIONS

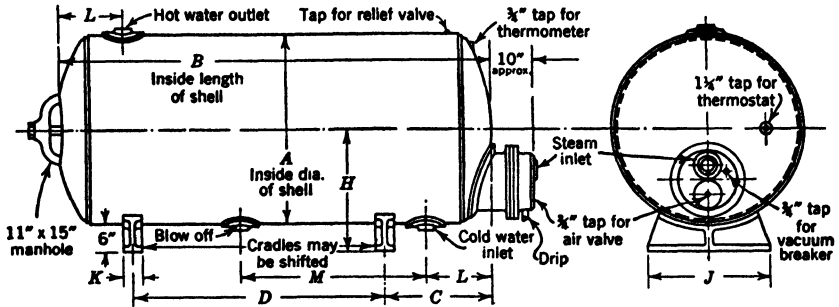

Capacity in Gallons	Clearance Dimensions in Inches									Standard Openings, Inches		
	A	B	C	D	H	J	K	L	M	Water	Blow Off	Relief Valve
94	24	48	24	10	18	16	4	14	17	2 1/2	1 1/2	1
118	24	60	24	21	18	16	4	14	23	2 1/2	1 1/2	1
141	24	72	24	34	18	16	4	14	29	2 1/2	1 1/2	1
164	24	84	24	46	18	16	4	14	35	2 1/2	1 1/2	1
180	30	60	26	18	21	18	4	16	22	2 1/2	1 1/2	1
215	30	72	26	30	21	18	4	16	28	2 1/2	1 1/2	1
255	30	84	26	42	21	18	4	16	34	2 1/2	1 1/2	1
285	30	96	26	54	21	18	4	16	40	2 1/2	1 1/2	1
360	30	120	30	74	21	18	4	16	52	2 1/2	1 1/2	1
310	36	72	27	29	24	20	4	16	28	3	1 1/2	1
365	36	84	27	39	24	20	4	16	34	3	1 1/2	1
415	36	96	27	53	24	20	4	16	40	3	1 1/2	1
475	36	108	27	65	24	20	4	16	46	3	1 1/2	1
500	36	120	36	68	24	20	4	16	52	3	1 1/2	1
640	36	144	36	92	24	20	4	16	64	3	1 1/2	1
430	42	72	27	29	27	24	4	16	28	3	2	1
500	42	84	27	39	27	24	4	16	34	3	2	1
575	42	96	27	53	27	24	4	16	40	3	2	1
650	42	108	27	65	27	24	4	16	46	3	2	1
720	42	120	30	70	27	24	4	16	52	3	2	1
860	42	144	30	98	27	24	4	16	64	3	2	1 1/2
1000	42	168	42	110	27	24	4	16	76	3	2	1 1/2
1155	42	192	42	130	27	24	4	16	88	3	2	1 1/2
750	48	96	36	42	30	30	5	18	39	4	2 1/2	1 1/2
940	48	120	36	60	30	30	5	18	51	4	2 1/2	1 1/2
1125	48	144	36	90	30	30	5	18	63	4	2 1/2	1 1/2
1300	48	168	42	108	30	30	5	18	75	4	2 1/2	1 1/2
1500	48	192	42	132	30	30	5	18	87	4	2 1/2	1 1/2
1190	54	120	36	66	33	30	5	18	51	4	2 1/2	1 1/2
1425	54	144	36	90	33	30	5	18	63	4	2 1/2	1 1/2
1665	54	168	42	108	33	30	5	18	75	4	2 1/2	1 1/2
1900	54	192	42	132	33	30	5	18	87	4	2 1/2	1 1/2
1400	60	120	36	64	36	36	6	20	50	4	2 1/2	1 1/2
1700	60	144	36	88	36	36	6	20	62	4	2 1/2	1 1/2
2000	60	168	42	112	36	36	6	20	74	4	2 1/2	1 1/2
2240	60	192	48	130	36	36	6	20	86	4	2 1/2	1 1/2
3000	72	174	42	108	42	36	6	24	75	5	2 1/2	1 1/2
4000	84	168	42	102	48	42	6	24	72	6	2 1/2	1 1/2
5200	96	168	48	94	56	48	8	26	71	6	2 1/2	1 1/2
6000	96	192	48	118	56	48	8	26	83	6	2 1/2	1 1/2

Courtesy The Patterson-Kelley Co., Inc., East Stroudsburg, Pa.

pipe with standard-weight black cast or malleable iron fittings and floor flanges with two bolts for each flange. Vertical tanks shall be adapted for being supported on the floors by frames constructed of steel pipe, malleable railing fittings, and floor flanges with two bolts for each flange.

*Steam coils* shall be removable and shall be constructed of seamless copper tubing having a wall thickness of not less than 0.045 in. in the form of U bends.

#### ART. 11-E. OPERATING AND EMERGENCY CONTROLS FOR AUTOMATIC STORAGE SYSTEMS

##### Types (for Gas Heaters)

*Thermostats* are used to control the supply of gas to the heaters to maintain the water at the desired temperature. They are of two types, snap-acting and graduating.

Snap-action thermostats are either full on or full off. The gas valve is opened when the temperature of the actuating element, usually submerged in the water, reaches a predetermined low temperature and closed when this temperature reaches a higher degree. The difference between the opening and closing temperatures is the differential of the thermostat (19).

Graduating thermostats, as their name implies, gradually reduce the supply of gas to the burner as the temperature increases, at the set temperature passing just enough gas to maintain the water at this temperature (19).

Safety shutoffs are provided to shut off the gas supply to main burners and sometimes to pilots as well, if for any reason the flames should become extinguished, in this manner preventing the escape of unburned gas (19).

*Pressure-relief valves* serve to prevent excessive pressures in the system. They must be used on all closed systems. If damage can be caused by their discharge, their outlets should be piped to a location where this cannot occur, as for instance an open sink (19).

*Pressure and temperature-relief valves* are designed to safeguard against both excessive pressure and temperature. The temperature-relieving element is usually of the fusible plug type of a composition to melt at a temperature of about 212 F. They should be installed on all systems having an external source of heat such as a furnace coil or its equivalent. The discharge should be piped to a place where it can cause no damage (19).

*Automatic gas shutoff valves* serve to prevent excessive water temperatures by shutting off the gas supply to the heater should the normal thermostatic control fail, owing to such derangement as might be caused by pipe scale under the seat. No drain connection is necessary as there is no discharge of waste water. They are designed to shut off the gas before a temperature of 212 F is reached (19).

**Regulators (for Coal Heaters) (Fed. Specs.)**

Regulators on coal heaters shall be adjustable and shall be set to maintain the temperature of the water in the tank at approximately 140 F. The draft and check doors shall be operated through chains and pulleys. Steam coils shall be controlled through regulation of the steam supply. In outfits including both heaters and steam coils regulation may be effected:

- (a) By means of a single regulator that controls both the steam supply and the heater or
- (b) By means of individual regulators for each of these functions.

Regulators may be any of these types:

- (a) A tube containing a volatile liquid.
- (b) An expanding tube containing a non-expanding member.
- (c) A combination of *a* and *b* or
- (d) An all-metal bulb containing an expanding metallic bellows surrounded by a volatile liquid.

Regulators shall bear the name and trade mark of the manufacturers.

**Relief Valve**

Each tank shall be provided with a spring-loaded brass pressure-relief valve set 25 lb above the maximum water pressure (except fire pressure).

The valve shall be placed on a vertical dead-end pipe attached to the cold-water supply pipe connection close to the tank or directly to the tank without an intervening valve.

TABLE 104

MINIMUM ALLOWABLE SIZES OF WATER-RELIEF VALVES FOR WATER-SUPPLY TANKS

Diam of Valve, Inches	Rated Capacity in Gallons per Hour			
	25 F Rise	50 F Rise	100 F Rise	140 F Rise
½	540	270	135	97
¾	1,440	720	360	257
1	2,520	1,260	630	450
1¼	5,400	2,700	1,350	965
1½	10,800	5,400	2,700	1,930
2	21,600	10,800	5,400	3,860

No valve smaller than ½ in. or larger than 2 in. should be used.  
From ASME Code for Low-Pressure Heating Boilers



**Thermometer** shall be  $\frac{3}{4}$  in. hot-water mercury thermometer graduated from 40 to 240 F.

The thermometer shall be so located that it shall at all times indicate the temperature in degrees Fahrenheit of the water in the tank at or near the outlet (ASME Code for Low-Pressure Heating Boilers).

#### ART. 11-F. SELECTION OF HEATERS

##### Hot-Water Storage

The figuring of storage capacity for hot water is similar to figuring storage capacity for cold water.

First it is necessary to know the demands during the different hours of the day. Hourly demands can be estimated on the basis of tables showing hot-water consumption per capita, per fixture, or per utensil. In addition allowance should be made for some leakage and radiation losses. From such estimated figures a graph can be drawn similar to the typical ones shown.

In some typical installations the hourly demands are fairly well known. The following charts are based on observations and data accumulated by the American Gas Association. To be applicable to all sizes of buildings the charts are reduced to a basis of 1000 gal per day total consumption (Fig. 108).

To find the needed theoretical storage capacity another chart should be drawn (Fig. 109).

Let the base line represent the 24-hour day, beginning and ending at 12 o'clock midnight. The vertical ordinates represent the accumulated amount of hot water used during the period from 12 o'clock midnight to the hour indicated.

Another line drawn from the same starting point to the intersection of the top line and the 8 o'clock P.M. line would indicate the accumulated heat input during 20 hours, and the slope of this line (1000 gal per 20 hr) will give the rate of heating or 50 gph.

As long as the rate of demand, represented by the crooked line, is less than the rate of heating, the heater will operate only at intermittent periods, and the heat input will cease as soon as the line representing it reaches the line representing the demand.

It is necessary therefore to draw a line parallel to the line *AB* and touching the demand curve at the lowest point (at *C*) and carry it on until it reaches the demand curve (at *D*). At each point where the straight-line curve hits the crooked curve it means that the heater has caught up with the withdrawal. The heater will shut off and not operate at full rate until the withdrawal is equal to or greater than the heating rate. The graph gives a very good picture of this whole operation.

At the point then where the withdrawal is farthest from the heating capacity we have the maximum deficiency. In the case shown it measures 100 gal. This amount does not represent the possible maximum

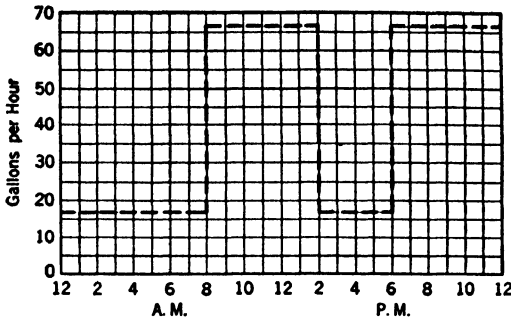

**I**  
 For Hotels,  
 All Day Restaurants  
 and Apartment Hotels  
 Maximum Hour Equals  
 $\frac{1}{16}$  of 24 Hour Load  
 Duration of Each Peak  
 Equals 6 Hours

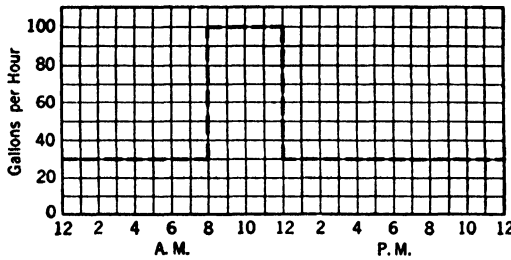

**II**  
 For Apartment Houses,  
 Large Private Houses  
 and Two-Meal Restaurants  
 Maximum Hour Equals  
 $\frac{1}{10}$  of 24 Hour Load  
 Duration of Peak  
 Equals 4 Hours

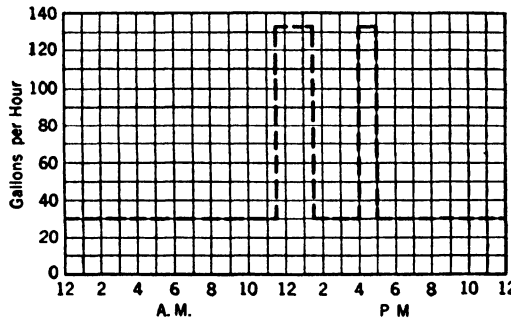

**III**  
 For Office Buildings  
 and Loft Buildings  
 Maximum Hour Equals  
 $\frac{3}{15}$  of 24 Hour Load  
 Duration of Peaks  
 Equals 2 Hours  
 and 1 Hour

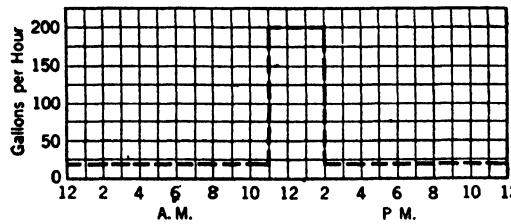

**IV**  
 For One-Meal Restaurants  
 Maximum Hour Equals  
 $\frac{1}{4}$  of 24 Hour Load  
 Duration of Peak  
 Equals 3 Hours

FIG. 108. Hourly Hot Water Demands for Each 1,000 Gallons Daily Hot Water Load.  
 (From *Water Heating* (20).)

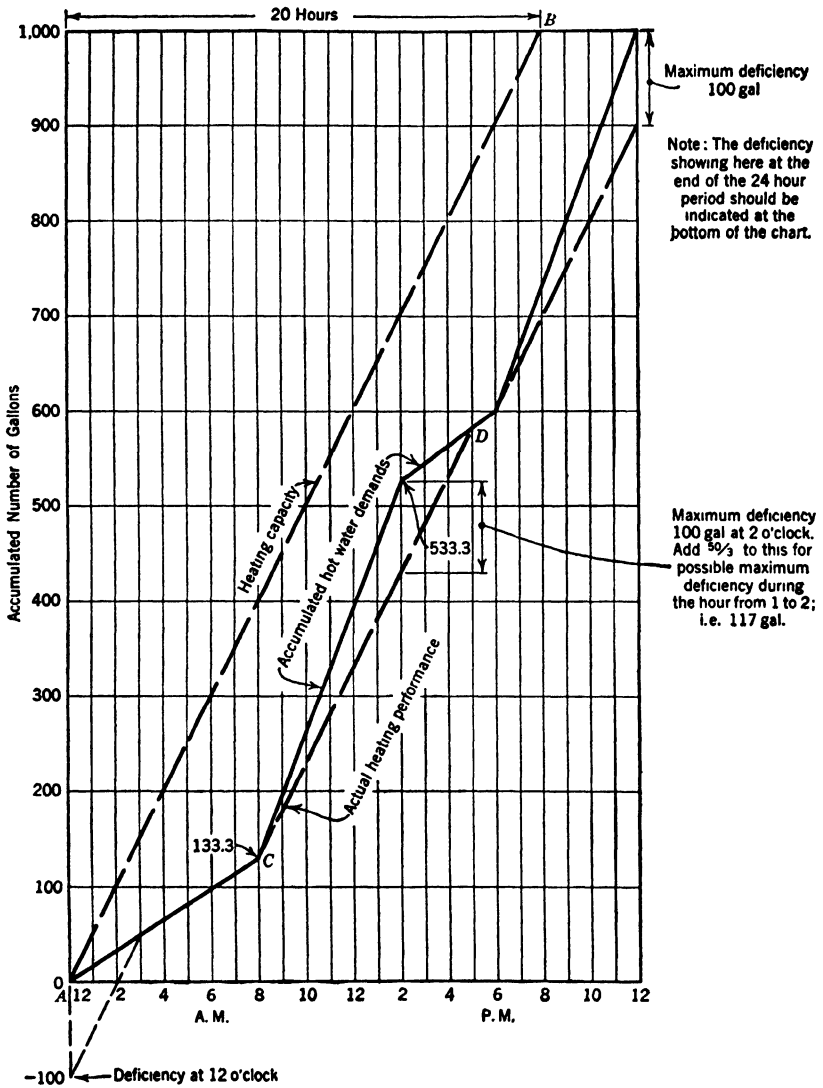

FIG. 109. Hot-Water Storage and Heating Requirements for Each 1,000 Gallons Daily Hot-Water Load.

Typical for hotels, all day restaurants and apartment hotels.

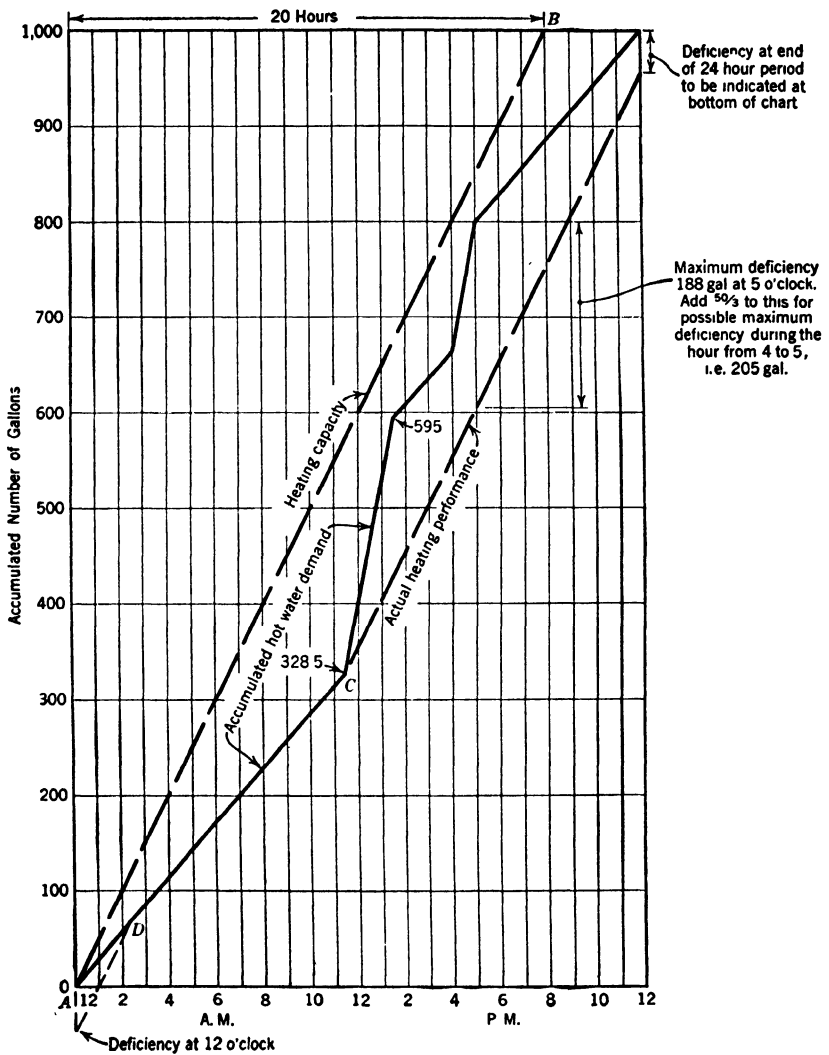

FIG. 110. Hot-Water Storage and Heating Requirements for Each 1,000 Gallons Daily Hot Water Load.

Typical for office buildings and loft buildings.

storage needed. As described under cold-water storage tanks, the demand during the hour is not at a uniform rate, and it is possible that a greater deficiency was reached during the hour. To cover this deficiency an amount equal to one-third the hourly heating rate should be added. In this case it will be  $50 \times \frac{1}{3}$ , or 17 gal, making the total theoretical storage 117 gal.

The actual size of the heater should, in addition, allow for possible leakage and radiation, unless this item has already been included in the demand figures, and for errors in estimating and for the time laps between withdrawal and operation of the thermostat. It usually is considered necessary to add about 20% to the theoretical storage to obtain the actual storage size needed.

Chart (Fig. 111) for type III buildings, office, and loft buildings, shows a condition where the heater capacity, based on a 20-hr schedule, is not sufficient to restore the tank fully after the first maximum demand period, and the tank will start the second maximum demand period with a deficiency. As a result, the maximum deficiency will occur at the end of the second period, at 5 P.M.

Formulas have been proposed for the figuring of storage capacities, but the safe and convincing way is to make a chart.

*Recommended Minimum Storage Capacities.* Based on actual tests, the following minimum sizes are recommended.

"Maximum deficiency" or "point of greatest cumulative demand" is the maximum deficiency referred to in the previous section.

TABLE 105

Input of Heaters, Btu per Hr	Total Storage
9,000 or less	200% of the maximum deficiency
9,000-15,000	160 " " " " "
15,000 and over	135 " " " " "

No heater with 4500 Btu input or under to have less than 30 gal storage.

No heater with 17,500 Btu input or more to have less than 12 gal storage (21).

TABLE 106  
HOT-WATER DEMAND

Classification	Ratio of Max. Hour Hot-Water Demand to 24-Hr Load	Storage Capacity for 1000 Gal Load per Day
Hotels	$\frac{1}{15}$	100 gal
All-day restaurants	$\frac{1}{15}$	100 "
Two-meal "	$\frac{1}{10}$	200 "
One-meal "	$\frac{1}{5}$	450 "
Residences	$\frac{1}{6}$	500 "

*Example.* 1000 gal total load.

Add 20% safety factor = 1200 gal per 24 hr = 50 gph average.

Heater capacity = 50 gph.

For one-meal restaurants max hour =  $\frac{1}{5}$  total load and lasts 3 hr. Then

$$3 \times (\frac{1}{5} \times 1000 - 50) = 450 \text{ gal storage}$$

See also Figs. 111 and 112.

### Domestic Water Heating with Gas (17)

*Sizing.* A proper understanding of hot-water requirements is essential to correctly size domestic water heaters. Some of the important factors in determining hot-water usage are mentioned under Commercial Water Heating.

A number of methods for sizing domestic water heaters have been proposed. Table 107 summarizes the results of a great many tests and has proved itself satisfactory through long experience. This table assumes the selection of a storage heater of reasonable high Btu input leading to rapid recovery. Self-contained storage heaters should have a Btu input of not less than 250 to 800 Btu per hour per gallon capacity.

*Selection of Type of Heater.* Factors governing the selection of the type of heater are:

1. Initial cost and operating costs.
2. Demand characteristics.
3. Character of water supply with reference to liming.

*Initial Cost and Operating Costs.* The tank water heater is used in some isolated cases because of its low initial cost. However, it should be noted that the storage tanks attached to these heaters are seldom insulated and generally more water is heated than used or needed so

that a cost per useful gallon of water heated is usually higher for this type of heater than for the automatic. Because of this and the inconvenience of a limited hot-water service, the lower initial cost may

TABLE 107

## SIZING THERMO-STORAGE AND INSTANTANEOUS WATER HEATERS

No. of Bathrooms	No. of Bedrooms	Thermo-Storage Capacity in Gallons—140 F	Instantaneous 80° Rise Continuous Flow in Gallons per Minute
1	1	20	2.3
1	2	25	2.3
1	3	30	2.3
1	4	35	3.0
2	2	35	3.0
2	3	35-40	3.0
2	4	40	3.0
2	5	50	3.0
3	3	50	4.5
3	4	60	4.5

*Note:* In houses having 4 or more bathrooms, improved service and increased efficiency may frequently be rendered by the installation of more than one unit.

produce a higher overall expense. The automatic storage or the instantaneous water heater is recommended.

*Demand Characteristics.* Except for the slow recovery water heater which can be operated as a budgeted unit, the operating cost of domestic water heaters depends on hot-water demand. The selection of the type

TABLE 108

## TYPES OF DOMESTIC WATER HEATERS

Type	Btu Input	Recovery Capacity Gph 60 F Rise
Tank	20,000- 40,000	28- 56
Automatic instantaneous	48,000-275,000	67-385
Automatic storage	20,000-115,500	78-162

of automatic water heater with respect to hot-water demand characteristics may be based upon:

1. The use of instantaneous heaters where the hot-water demand is intermittent but subject to high peaks. The instantaneous water heater should not be installed unless a water pressure of 15 psi is available at the highest and most distant faucet to be served by the heater.
2. The use of the automatic storage water heater when supplying a more or less uniform hot-water demand.

*Character of Water Supply with Reference to Liming.* The selection of the type of heater may be further influenced by the locality with reference to liming trouble. In hard-water districts the indirect type automatic storage water heater is recommended.

*Heater Location* (Fig. 106). The water heater should be located to:

1. Insure direct run, independent flue if possible.
2. Be near faucet used most.
3. Not to be placed in closets or other closed recesses lacking adequate ventilation and accessibility for servicing. Local ordinances usually control this phase of installation.
4. Be placed at least 6 in. from unprotected wood and 3 in. from brick, protected wood, or fireproof walls.
5. Not be installed in bathrooms, bedrooms, or any occupied room normally kept closed.

### Commercial Water Heating with Gas (17)

*Hot-Water Demand.* An estimate of the hot-water demand is essential to selection of adequately sized equipment. Hot-water demand is affected by a large number of variables, such as:

1. Type and size of building.
2. Number and characteristics of the occupants.
3. Number and type of hot-water faucets.
4. Cold-water temperature.
5. Average hot-water faucet temperature.
6. Hydrostatic pressure of water at the faucet.

A method for estimating demand that has been developed in one locality or climate should be used with discretion in another.

Table 109 is based on data obtained from tests made in Southern California and should be used for that locality. Table 110 is taken from the American Gas Association's publication *Water Heating*, and is based on data from Chicago, New York, Pittsburgh, St. Louis, and Portland (Oregon).

*Boarding Houses.* Boarding houses and small hotels require hot-water service similar to apartment houses. Heaters may be sized from Table 111. Note that when large, obsolete private residences are converted to



boarding or rooming houses, the old water heater should be replaced with a modern, adequate automatic gas heater (19).

*Commercial Applications.* When load characteristics are similar to those in dwellings and do not exceed 100 gal of hot water per hour, automatic storage heaters may be used, and Table 111 employed as a guide to their selection (19).

TABLE 109

MAXIMUM DAILY HOT-WATER DEMAND IN GALLONS RAISED 70 F\*

(Based on Data Obtained in Southern California)

Apartment Houses

Type Apartment †	Number of Bathrooms		
	1	2	3
Bachelor	45	..	..
Single	50	..	..
Double	55	..	..
4-Room †	60	85	..
5-Room ††	70	100	..
6-Room ††	85	115	150

\* From cold-water temperature to average faucet temperature

† Bachelor—one room excluding bath

Single—two rooms (combination living room-bedroom and kitchen).

Double—three rooms (living room, separate bedroom, and kitchen).

†† Includes kitchen.

*Special uses* of hot water, e.g., for washing floors. Usually the demand is stated as a certain amount of gallons per square foot, but it is also necessary to check on the rate of use by obtaining information on the sizes of pails or movable tanks to be used, the number of workers, etc. It is perfectly possible for a gang of cleaning workers to empty the hot-water tank in very short time.

In such cases it becomes necessary to investigate the possible need of a large hot-water tank to take care of all rushes or an ordinary-sized tank for daily use with the addition of an instantaneous heater to boost the supply during extraordinary demand. In doing this compare the demand and length of time of rush periods and the interval between them.

*Hot-water demand* compared with cold-water demand: Apartment houses—0.31 gal hot water for each gallon cold water entering building.

*Sizing Heater and Storage Tank.* Undersized equipment gives poor service, oversized units cause high standby losses and consequently high gas bills. The use of Figs. 111 and 112 should result in the selection of correct size heater and storage tank.

*Selection of Type of Heater.* The required size of the equipment will partly influence the choice of the type of heater.

TABLE 110

MAXIMUM DAY REQUIREMENTS FOR HOT WATER IN GALLONS (RAISED 100 F\*) PER 24 HOURS

(Based on Data Obtained in Northern and Eastern Sections of the United States)

Apartments and Private Houses (Including Laundry Requirements)

Per Apartment, 160° Water

Rooms to Suite †	Number of Bathrooms				
	1	2	3	4	5
1	60	...	...	...	...
2	70	...	...	...	...
3	80	...	...	...	...
4	90	120	...	...	...
5	100	140	...	...	...
6	120	160	200	...	...
7	140	180	220	...	...
8	160	200	240	250	...
9	180	220	260	275	...
10	200	240	280	300	...
11	...	260	300	340	...
12	...	280	325	380	450
13	...	300	350	420	500
14	...	...	375	460	550
15	...	...	400	500	600
16	...	...	...	540	650
17	...	...	...	580	700
18	...	...	...	620	750
19	...	...	...	...	800
20	...	...	...	...	850

Hotels

Per Room or Suite	Gallons per 24 Hours
Room with basin	10
Room with bath and/or shower:	
Transient	40
Resident (Bachelor)	40
Resident (Women)	70
Resident (Mixed)	60
Two rooms, bath and/or shower	80
Three rooms, bath and/or shower	100
Public bath, per fixture	150
Public shower, per fixture	200
Public basins, per fixture	150
Public basins with attendant, per fixture	200
Slop sinks for cleaning purposes	30

Restaurants

	Hand Dishwashing	Machine Dishwashing
Per Meal \$0.50	1.0	1.5
Per Meal 1.00	1.5	2.5
Per Meal 1.50	2.0	4.5

Lofts and Offices

	Gallons
Office Help per Person	2
Factory Help per Person	5
Cleaning per 10,000 Sq Ft	30

\* From cold-water temperature to storage tank outlet temperature.

† Not including bathrooms or kitchen.

These figures apply to apartment houses of the better class and to exceptional private houses of small size but high class. Use Water Heater Sizer as described on page 304.

Note: Average day requirements are 80% of the Maximum Day Requirements given in this table.

TABLE 111  
SELECTION OF AUTOMATIC STORAGE HEATERS (19)

Approx. Tank Size (Gallons)	Fixed Recovery Types		Adjustable Recovery Types			
	Range of Recovery Capacities (Gal per Hour)	Range of Input Ratings	Range of Recovery Capacities (Gal per Hour)		Range of Input Ratings	
			Min	Max	Min	Max
15	15.4 to 35	11,000 to 25,000	3.5 to 7	21 to 35	2,500 to 5,000	15,000 to 25,000
20	21 to 58.7	15,000 to 42,000	4.2 to 11.2	7.6 to 34	3,000 to 8,000	5,400 to 24,300
25	28 to 62.9	20,000 to 45,000	.....	.....	.....	.....
30	14 to 62.9	10,000 to 45,000	3.5 to 7.0	7.6 to 45.3	2,500 to 5,000	5,400 to 32,400
40	28 to 69.9	20,000 to 50,000	3.5 to 7.7	6.3 to 35	2,500 to 5,500	4,500 to 25,000
50	46.2 to 78.3	33,000 to 56,000	4.2 to 16.8	21 to 28	3,000 to 12,000	15,000 to 20,000
60	49 to 78.3	35,000 to 56,000	2.8 to 7.7	6.3 to 39.2	2,000 to 5,500	4,500 to 28,000
75	55.9 to 90.9	40,000 to 65,000	<p><i>Note:</i> Tank sizes for both fixed and adjustable recovery heaters may vary from those given; but the tank sizes given on the particular heater are correct within two or three gallons.</p>			
80	49 to 118.5	35,000 to 84,700				
90	50.3 to 104.9	36,000 to 75,000				
100	49 to 139.9	35,000 to 100,000				

From the standpoint of initial costs:

1. Boosters and multi-coils can compete for jobs up to 16 single apartments or their equal. Automatic storage and copper coil tank heaters are indicated where available boosters would be too large, and instantaneous heaters for gymnasiums, washrooms, restaurants, and similar jobs with intermittent demands and especially high peaks where multi-coils would be oversize.
2. Boosters, multi-coils and gas-fired boilers (direct) can compete for jobs between 16 and 35 single apartments or their equal.
3. Jobs above 55 single apartments or their equal can be handled most economically by gas-fired boilers (indirect).

TABLE 112

TYPES OF VOLUME WATER HEATERS

Type	Btu Input	Recovery Capacity, Gph—60 F Rise
Boosters	50,000 to 215,000	70 to 300
Multi-coils	77,000 to 385,000	110 to 540
Gas-fired boilers—Direct	47,000 to 217,000	75 to 330
Gas-fired boilers—Indirect	67,500 up	108 up
Gas immersion heaters	64,000 up	102 up

The location, fixed by such factors as local ordinances and nearness to the vent or chimney and to the hot- and cold-water pipes with which the tank must be connected, should provide ample headroom for circulation (see Fig. 113).

The hardness of the water supply in the locality where the installation is to be made has an important bearing on the choice of the type of heater. Direct-type boosters and multi-coils must be sized on a 10-hr burning basis recommended by manufacturers and AGA in order to insure against a short life due to high temperatures (over 140 F) resulting in liming. In extremely hard-water districts direct-type boosters should be provided with a removable tank. Multi-coils will lime in hard-water districts but the coils can be easily removed and cleaned at a reasonable cost. Direct gas-fired boilers should not be used where the water is hard.

Indirect gas-fired boilers and indirect boosters are recommended for extremely hard-water districts. If the former is used, ample space should be provided for the removal and cleaning of internal tank coils or external heat exchanger coils. If the latter is chosen, the element water

expansion line should be so connected that it will neither lime nor allow hard water to enter the element water system.

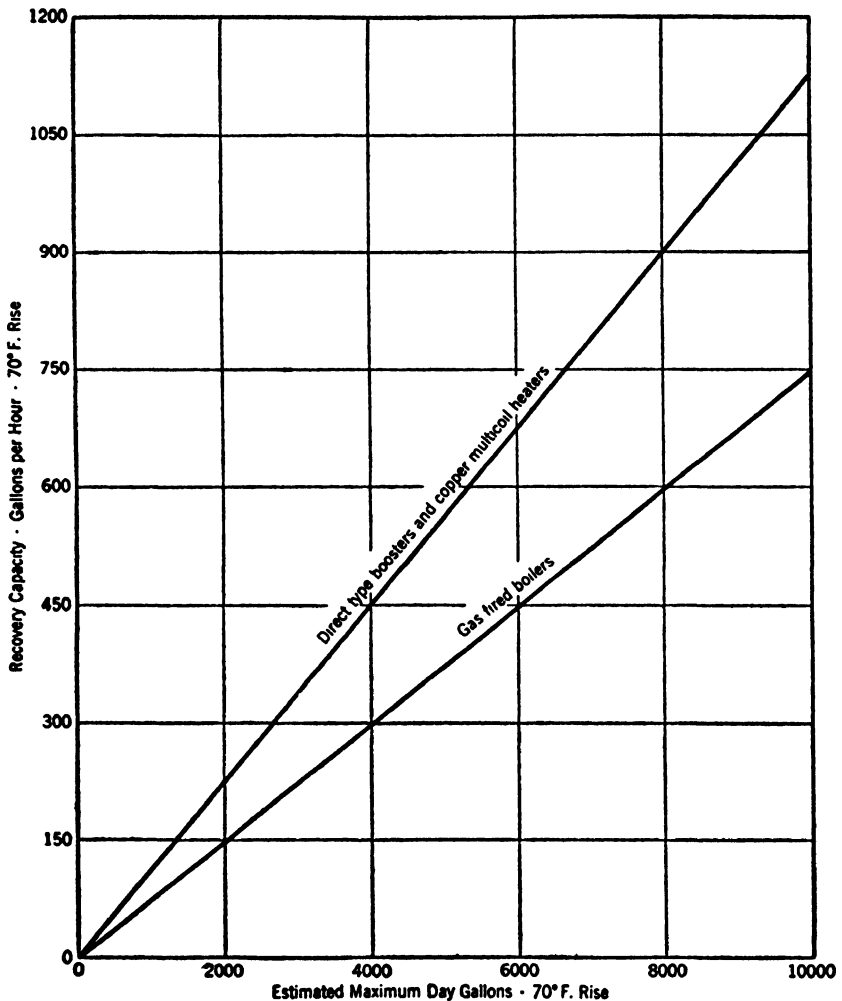

FIG. 111. Selection of Heater Size. (From Data Book on Gas Utilization (17).)

Multi-coils, if correctly sized on the 10-hr burning basis, are particularly suitable for certain demands.

1. Short demands with especially high peaks (clubs, restaurants, theaters, and churches).
2. Intermittent demands where peaks occur at irregular intervals (gymnasiums, stadiums, and the like).

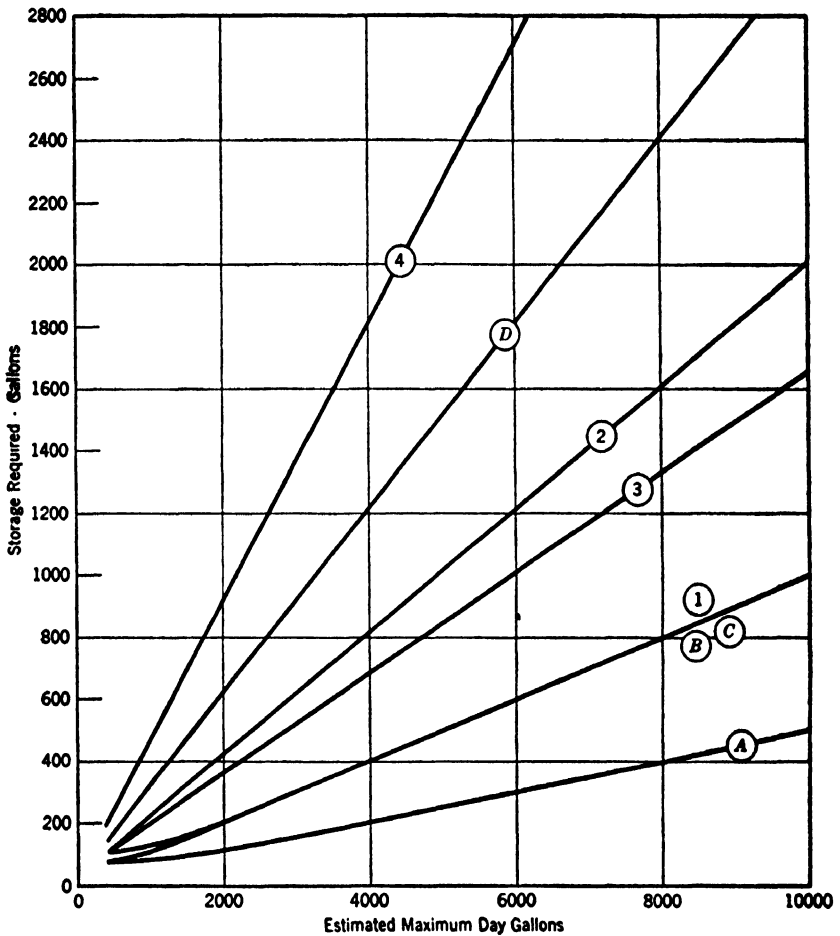

FIG. 112. Selection of Storage Capacity. (From Data Book on Gas Utilization (17).)

*Gas-Fired Boilers and Indirect Boosters*

- 1. Hotels, all-day restaurants, and apartment hotels.
- 2. Apartment houses, two-meal restaurants, and private houses.
- 3. Office buildings and loft buildings.
- 4. One-meal restaurants.

*Multi-coil Heaters and Direct Boosters*

- A. Hotels, all-day restaurants, and apartment hotels.
- B. Apartment houses, two-meal restaurants, and private houses.
- C. Office buildings and loft buildings.
- D. One-meal restaurants.

Direct-connected cast-iron boilers should not be used where the water service pressure is greater than 35 psi or than that required by local ordinances or where the building is over 8 stories high. Multi-coils are not recommended where the static head of water is more than 100 psi.

The gas immersion water heater (Fig. 113), having water-storage capacities in excess of 150 gal, is a type being developed by a number of gas companies.

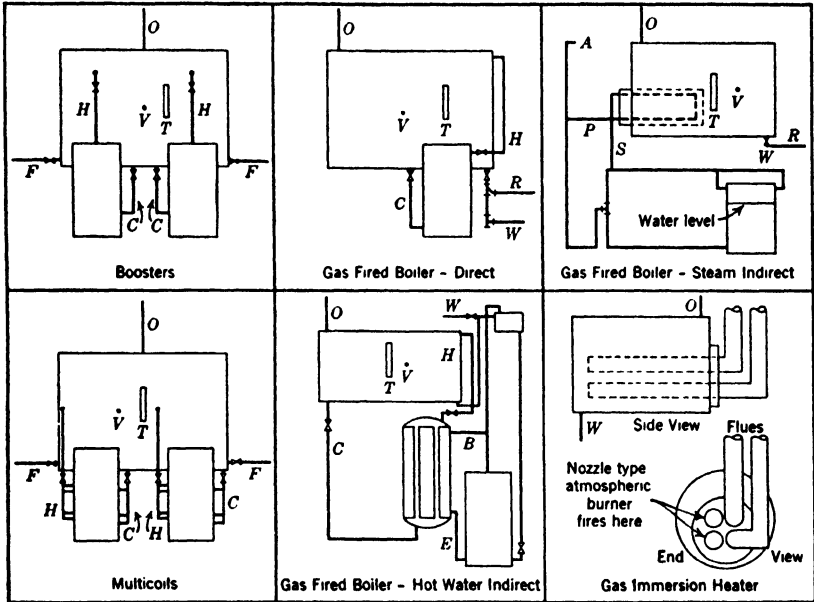

FIG. 113. Typical Heater-Tank Hook-ups. (From Data Book on Gas Utilization (17).)

Note: Valves in circulator lines prohibited in some localities by ordinances.

A, vacuum or pressure breaking vent valve. B, hot water from boiler. C, cold water circulator. E, hot water to boiler. F, cold-water inlet or return. H, hot-water circulator. O, hot-water outlet. P, condensate. R, return. S, steam. T, thermometer. V, thermostatic valve. W, cold-water inlet.

## APPENDIX

### NATIONAL INSTITUTIONS

American Council on Education

744 Jackson Place, Washington, D. C.

American Public Health Association

1790 Broadway, New York, N. Y.

American Gas Association

420 Lexington Avenue, New York, N. Y.

American Standards Association

29 West 39th Street, New York, N. Y.

American Water Works Association

22 East 40th Street, New York, N. Y.

Manufacturers' Standardization Society of the Valve and  
Fittings Industry

420 Lexington Avenue, New York, N. Y.

Lead Industries Association

420 Lexington Avenue, New York, N. Y.

National Fire Protection Association

60 Batterymarch Street, Boston, Mass.



## ABBREVIATIONS AND SYMBOLS

<i>A</i>	Area
<i>a</i>	Minor areas
abs	Absolute
acre-ft	Acre-foot
AGA	American Gas Association
APHA	American Public Health Association
ASA	American Standards Association
ASCE	American Society of Civil Engineers
ASME	American Society of Mechanical Engineers
ASTM	American Society for Testing Materials
AWWA	American Water Works Association
Ag	Silver (Chem.)
Al	Aluminum (Chem.)
As	Arsenic (Chem.)
Au	Gold (Chem.)
B.	Bacteria
<i>b</i>	Width
<i>B<sub>a</sub></i>	Actual heat loss in Btu per hour
<i>B<sub>p</sub></i>	Permissible heat loss in Btu per hour
<i>BLB</i>	Btu loss per square foot per hour for uninsulated pipe
B.O.D.	Biochemical Oxygen Demand
<i>BPL</i>	Btu loss per square foot per hour for insulated pipe
Btu	British thermal unit
Bi	Bismuth (Chem.)
<i>C</i>	Coefficient or constant
<i>C</i>	Allowance for loss of material (from threading, corrosion, etc.) in inches
<i>C</i>	Centigrade degrees
<i>C</i>	Demand
cfm	Cubic feet per minute
cfs	Cubic feet per second
cgs	Centimeter-gram-seconds
cm	Centimeter
cu	Cubic
cu ft	Cubic feet

$C_w$	Hazen-Williams' coefficient of roughness
C.I.	Cast iron
Ca	Calcium (Chem.)
Cd	Cadmium (Chem.)
Cl	Chlorine (Chem.)
Co	Cobalt (Chem.)
Cr	Chromium (Chem.)
Cs	Caesium (Chem.)
Cu	Copper (Chem.)
$D$	Demand
$D$	Diameter
$d$	Diameter
deg	Degree
diam	Diameter
$E$	Efficiency expressed as a percentage
E.D.R.	Equivalent direct radiation
eff	Efficiency
elec	Electric
F	Fahrenheit degrees
fps	Feet per second
ft	Foot
Fe	Iron (Chem.)
$G$	Discharge in gallons per minute
$g$	Acceleration of gravity; 32.16 fps
ga	Gage
gal	Gallon
galv	Galvanized
gph	Gallons per hour
gpm	Gallons per minute
$H$	Heating value of gas in hundreds of Btu
$H$	Head, total
$h$	Fall in inches per foot; pressure expressed in height of water column; height
$h_a$	Atmospheric pressure
$h_b$	Pressure expressed in height of water column
$h_e$	Limiting vacuum pressure
hp	Horsepower
hr	Hour

<b>H</b>	<b>Hydrogen (Chem.)</b>
<b>Hg</b>	<b>Mercury (Chem.)</b>
<b>I</b>	<b>Factor of imperviousness</b>
<b>in.</b>	<b>Inch</b>
<b>IPS</b>	<b>Iron pipe size</b>
<b>K</b>	<b>Coefficient or Factor</b>
<b>k</b>	<b>Heat transmission coefficient</b>
<b>kw</b>	<b>Kilowatt</b>
<b>kwhr</b>	<b>Kilowatt-hour</b>
<b>K</b>	<b>Potassium (Chem.)</b>
<b>L</b>	<b>Length</b>
<b>Lav.</b>	<b>Lavatory</b>
<b>lb</b>	<b>Pound</b>
<b>lin</b>	<b>Linear</b>
<b>log</b>	<b>Logarithm</b>
<b>Li</b>	<b>Lithium (Chem.)</b>
<b>m</b>	<b>Time in minutes</b>
<b>manf.</b>	<b>Manufactured</b>
<b>max.</b>	<b>Maximum</b>
<b>mcf</b>	<b>Thousand cubic feet</b>
<b>mgd</b>	<b>Million gallons per day</b>
<b>min</b>	<b>Minimum</b>
<b>min</b>	<b>Minute</b>
<b>mm</b>	<b>Millimeter</b>
<b>Mg</b>	<b>Magnesium (Chem.)</b>
<b>Mn</b>	<b>Manganese (Chem.)</b>
<b>N</b>	<b>Number of fixture units</b>
<b>n</b>	<b>Coefficient of friction</b>
<b>n</b>	<b>Number of branch intervals</b>
<b>nat.</b>	<b>Natural</b>
<b>NSC</b>	<b>National Safety Council</b>
<b>Na</b>	<b>Sodium (Chem.)</b>
<b>Ni</b>	<b>Nickel (Chem.)</b>
<b>oz</b>	<b>Ounce</b>

O	Oxygen (Chem.)
<i>P</i>	Pressure
<i>P</i>	Population
<i>p</i>	Pounds of water
petr.	Petroleum
<i>pH</i>	Hydrogen-ion concentration
ppm	Parts per million
psi	Pounds per square inch
P.E.	Plain ends (Piping)
Pb	Lead (Chem.)
Pd	Palladium (Chem.)
Pt	Platinum (Chem.)
<i>Q</i>	Major discharge or flow, volume per unit of time
<i>R</i>	Hydraulic radius
<i>r</i>	Rate of rainfall
<i>R<sub>D</sub></i>	Rate of demand
<i>R<sub>S</sub></i>	Rate of supply
Rb	Rubidium (Chem.)
sec	Second
std	Standard
sq ft	Square foot
sq in.	Square inch
<i>S</i>	Hydraulic slope; fall in inches per foot
<i>S</i>	Stress in pounds per square inch
<i>S</i>	Supply
S.S.U.	Saybolt Seconds Universal
Sb	Antimony (Chem.)
Sn	Tin (Chem.)
<i>T</i>	Temperature
<i>t</i>	Time
<i>t</i>	Temperature
temp.	Temperature
therm	100,000 Btu
U.S.G.S.	United States Geological Survey
<i>V</i>	Volume
<i>V</i>	Velocity head
<i>v</i>	Velocity

<i>WH</i>	High water level
<i>WL</i>	Low water level
<i>w</i>	Weight of fluid per unit
WC	Water closet
W.I.	Wrought iron
WP	Working pressure
<i>y</i>	Coefficient
yr	Year
Zn	Zinc (Chem.)
$\Sigma$	Sigma; Sum
$\rho_m$	Density of mixture of air and water
$\rho_w$	Density of water

## REFERENCES

1. *Recommended Minimum Requirements for Plumbing*, U.S. Department of Commerce, Elimination of Waste Series, Bureau of Standards, BH 13, Superintendent of Documents, Washington, D. C.
2. *Sewage Treatment*, by KARL IMHOFF and GORDON M. FAIR, John Wiley and Sons, New York, N. Y.
3. *Sewerage*, by A. PRESCOTT FOLWELL, John Wiley and Sons, New York, N. Y.
4. *Plumbing*, by HAROLD F. BABBITT, McGraw-Hill Book Co., New York, N. Y.
5. Circular of the National Bureau of Standards No. 19, 6th Edition, 1924.
6. *Water Works Practice*, A manual issued by the American Water Works Association, ABEL WOLMAN, Editor, The Williams and Wilkins Co., Baltimore, Md.
7. "Relation between Heating Value of Gas and Its Usefulness to the Consumer," by E. R. WEAVER, *Technological Papers of the Bureau of Standards*, No. 290.
8. *Methods of Estimating Loads in Plumbing Systems*, by ROY B. HUNTER, U.S. Department of Commerce, National Bureau of Standards, Report BMS 65, Superintendent of Documents, Washington, D. C.
9. *Cameron Hydraulic Data*, by Cameron Pump Division, Ingersoll-Rand Co., New York, N. Y.
10. *The Sanitary Code*, New York State Department of Health, Albany, N. Y.
11. *Handbook of Chemistry and Physics*, by CHARLES D. HODGMAN, Chemical Rubber Publishing Co., Cleveland, Ohio.
12. *National Pipe Standards*, National Tube Co., Pittsburgh, Pa.
13. *Report of Subcommittee on Rural Sanitation*, presented at the American Public Health Association's Meeting at San Francisco, Cal., September, 1920, JOHN F. SKINNER, Chairman.
14. *Gould's Pocket Medical Dictionary*, The Blakiston Co., Philadelphia, Pa.
15. *Interior Water Supply Piping for Residential Buildings*, by FRANCIS M. DAWSON and JAMES S. BOWMAN, The University of Wisconsin Engineering Experiment Station, *Bulletin* 77, Madison, Wis.
16. *Hydraulics and Pneumatics of Plumbing Systems*, by HAROLD E. BABBITT, University of Illinois Engineering Experiment Stations, Urbana, Ill., *Bulletins* 143 and 178.
17. *Gas Utilization, Data Book on*, by H. ROY KELLEY, Pacific Coast Gas Association, San Francisco, Cal., and *Gas Engineers' Handbook*, McGraw-Hill Book Co., New York, N. Y.
18. *Hutchinson's Technical and Scientific Encyclopedia*, Hutchinson & Co., Ltd., London, England.
19. *Domestic Hot Water Systems*, by T. S. ROGERS, Association of Gas Appliance and Equipment Manufacturers, New York, N. Y.
20. *Water Heating*, Industrial Gas Series, American Gas Association, New York, N. Y.
21. *Household Gas Heating*, by CHARLES W. MERRIAM, Jr., American Gas Journal, Inc., New York, N. Y.
22. *Standards for Gas Service, Circular 405*, National Bureau of Standards, Superintendent of Documents, Washington, D. C.
23. *Plumbing Manual*, Report BMS 66, National Bureau of Standards, Superintendent of Documents, Washington, D. C.

24. *American Gas Association Requirements for House Piping and Appliance Installation*, American Gas Association, New York, N. Y.
25. *Trade Standards*, by Compressed Air Institute, New York, N. Y.
26. *American Standard Approval Requirements for Gas Water Heaters*, American Gas Association, New York, N. Y., ASA Z21.10.
27. *National Steel Pipe for Underground Water Lines*, National Tube Co., Pittsburgh, Pa., Bulletin 21.
28. *Sewage and Sewerage of Farm Homes*, by GEORGE M. WARREN, U. S. Department of Agriculture, *Farmers' Bulletin* 1227, Superintendent of Documents, Washington, D. C.
29. *Treatment and Disposal of Sewage*, by HOMMON, HOSKINS, STREETER, TARBETT, and WAGENHALS, U. S. Public Health Service, Reprint 580 from Public Health Reports, Superintendent of Documents, Washington, D. C.
30. *Report of the Committee on Sanitary Control in the Development of Ground Water Supplies*, U. S. Treasury Department, Public Health Service, Reprint 1126 from the Public Health Reports, Superintendent of Documents, Washington, D. C.
31. *Ground-Water Supplies*, Progress Report of the Committee on Ground-Water Supplies, Conference of State Sanitary Engineers, 1937, U. S. Treasury Department, Public Health Service, Supplement 124 to the Public Health Reports, Superintendent of Documents, Washington, D. C.
32. *Requirements for House Piping and Appliance Installation*, American Gas Association, New York, N. Y.
33. *Recommended Good Practice Requirements for the Installation, Maintenance, and Use of Piping and Fittings for City Gas*, National Fire Protection Association, Boston, Mass.
34. *Report of the Joint Committee on Bathing Places*, Conference of State Sanitary Engineers and American Public Health Association, Supplement 139 to the Public Health Reports, U. S. Treasury Department, Superintendent of Documents, Washington, D. C.
35. *Farmstead Water Supply*, by GEORGE M. WARREN, U. S. Department of Agriculture, *Farmers' Bulletin* 1448, Superintendent of Documents, Washington, D. C.
36. *Practical Brass Plumbing*, by T. N. THOMSON, Copper and Brass Research Association, New York, N. Y.
37. *Standard Methods for the Examination of Water and Sewage*, American Public Health Association, New York, N. Y.
38. *Code for Pressure Piping*, American Tentative Standard, ASA B31.1, American Standards Association, New York, N. Y.
39. "Combating Backflow in Water Supply Systems," by R. H. ZINKIL, *Journal of the New England Water Works Association*, Vol. LIII, No. 4.
40. "Hydraulic Service Characteristics of Small Metallic Pipes," by G. M. FAIR, M. C. WHIPPLE, and C. Y. HSIAO, *Journal of the New England Water Works Association*, Vol. XLIV, No. 4.
41. *Manuals of Practice*, No. 2, American Society of Civil Engineers, New York, N. Y.
42. *Rules and Regulations for Preparation and Submission of Plans for Systems of Sewerage and Sewage and Waste Disposal*, New York State Department of Health, Albany, N. Y., *Bulletin* 1.
43. *Standard Plumbing Code*, New York State Department of Health, Albany, N. Y., *Bulletin* 23.
44. *The Operation of Swimming Pools and Bathing Beaches*, New York State Department of Health, Albany, N. Y.
45. *Manual of Practice*, No. 11, American Society of Civil Engineers, New York, N. Y.
46. *Wisconsin State Plumbing Code*, Madison, Wis.

47. *Cross Connections in Plumbing Systems*, by ROY B. HUNTER, GENE E. GOLDEN, and HERBERT N. EATON, National Bureau of Standards, Research Paper RP 1086, Superintendent of Documents, Washington, D. C.
48. *Backflow Prevention in Over-Run Water Supplies*, by GENE E. GOLDEN and ROY B. HUNTER, National Bureau of Standards, BMS Report 28, Superintendent of Documents, Washington, D. C.
49. *Notes on Practical Water Analysis*, by W. D. COLLINS, U. S. Geological Survey, Water Supply Paper 596-H, Superintendent of Documents, Washington, D. C.
50. *Temperature of Water Available for Industrial Use in the United States*, by W. D. COLLINS, U. S. Geological Survey, Water Supply Paper 520-F, Superintendent of Documents, Washington, D. C.
51. *Reprint from the Public Health Reports*, U. S. Treasury Department, Vol. 29, No. 45.
52. "Domestic Water Consumption," by M. A. POND, *Journal of the American Water Works Association*, December, 1939, New York, N. Y.





## INDEX

The numbers in *Italic* type refer to pages containing definitions; the numbers in **Bold Face** type refer to pages containing illustrations.

- Absolute pressure, *26*  
temperature, *26, 27*
- Acid wastes, diluting tank, **169, 170**
- Acidity of water, *79*
- Acids, *23*
- Activated sludge, *218*  
process, *218*
- Adiabatic compression, *26*
- Aeration of water, *81*
- Air bound pipes, *15*
- Air break, *11*  
funnel, *11*
- Air compressors for pneumatic tanks, *125, 126*
- Air conditioning, water consumption, *112, 113*
- Air gaps, *4, 6, 7*
- Air in hot-water piping, *155*
- Air inlet, *11*
- Air inlet valve, *11*
- Air shutter, *255*
- Alkali, white and black, *see* Salts in water
- Alkalinity of water, *79*
- Ampere, *30*
- Anaerobic, *212*
- Apartment house, drainage piping, *192*  
fixture requirements, *37*  
gas flues, *250*  
gas water heaters, *266, 271, 273, 274, 275*  
hot-water demand, *295, 296, 302, 303*  
hot-water temperatures, *149*  
water pipe sizes, *162*  
water requirements, *118*
- Appliance flue, *255*
- Architectural practice, *36-48*
- Army camps, sewage flows, *202*
- Aspirator-filter pumps, siphon-preventers for, *10*
- Auditoriums, fixture requirements, *37*
- Automatic storage heaters, gas, *265-269, 266-269*
- Back pressure, **163**
- Back siphonage, *5, 163*  
preventer, *5, 9*
- Back vent, **163**
- Backfilling, *61*  
final, *66*  
preliminary, *65*
- Backflow, *5, 163*
- Bacteriological standard for drinking water, *69, 70*
- Baffle, *218, 255*
- Banks, fixture requirements, *37*
- Bar fountains, *see* Fountains
- Barn sewage, *212*
- Barometer, liquid, **3**
- Bases, *23*
- Baths, public, hot-water temperatures, *149*
- Bathtubs, air breaks on, *10*
- Bed-pan washers, air breaks on, *10*
- Bidets, air breaks on, *10*
- Biochemical action, *212*  
oxygen demand, *212*
- Bolytic tanks, *218, 225*
- Black alkali, *see* Salts in water
- Blast-furnace gas, *28, 29*
- Bleach, *81*
- Blow-off, *49*
- Blue-water gas, *28, 29*
- Boarding houses, water heating, *301*
- Boilers, cast-iron, for gas, *273*
- Booster, water system, **94**
- Branch, *49, 163*
- Branch interval, *163*
- Branch sewer, *199*
- Branch vent, *163*
- Broad irrigation, *225*
- Btu, *255*
- Building drain, *163*  
drainage system, *163*  
sewer, *163*  
subdrain, *163*

- Burner, 255  
 Burner head, 255  
 Burner valve, gas, 255  
 By-pass, 49  
 By-pass vent, 163
- Calcium hypochlorite, *see* Bleach  
 Calcium oxide, *see* Lime treatment  
 Calgon, water treatment, 93  
 Calking, 49  
 Calking recess, 49  
 Calking tool, 49  
 Camps, sewage flows, 202  
 Capacities of horizontal branch drains, 178  
   gas pipes, 245  
   gas ranges, 253  
   horizontal building drains, 180  
   non-pressure building drains, 181  
   pressure building drains, 182  
   sewers, 209-211  
   soil and waste stacks, 178  
     in multi-story buildings, 179  
 Car washing, water consumption, 112  
 Carbureted-water gas, 28, 29  
 Catch basin, 163, 206  
 Caulk, *see* Calking  
 Caustic soda treatment, 92  
 Centipoises, *see* Viscosity  
 Cesspool, 225 (*see also* Leaching cesspool)  
 Chain tongs, 49  
 Chamber, 218  
 Chases, 56, 57  
 Chemical precipitation, 218  
   terms, 23  
 Chlorination of water, 81  
 Chlorine and chlorine compounds, 236  
 Churches, fixture requirements, 37  
 Circuit vents, 163, 193-197  
 Cisterns, 73  
 Clamp, *see* Service clamp, 49  
 Clarification of effluent, 225-235  
   of water, 81, 82  
 Clarified sewage, 212  
 Cleanouts, pipe, 60  
 Clubs for men, fixture requirements, 37  
 Coagulation of water, 81, 82  
 Coal heaters, 281, 282  
 Coarse-grained filter, 225  
 Cock, gas, 255  
 Code regulations, water treatment, 93  
 Codes and regulations, 32-35  
 Coefficient of roughness, 15  
   recommended, 136  
 Coil, 49  
 Coke-oven gas, 28, 29  
 Colleges, *see* Educational buildings, Dormi-  
   tories, and Libraries  
 Colloid, 81  
 Combination fixture, 163  
 Combined sewers, 204-206  
 Combustion, 27, 255  
 Combustion chamber, 255  
 Combustion products, 255  
 Commercial water heating, 301-308  
 Compound water meters, 104, 106  
 Compounding valve, 106  
 Compressed air, 26  
 Compression, adiabatic, 26  
   isothermal, 26  
   ratio of, 27  
 Condensate in gas lines, 255  
 Condensation sheds, 255  
 Conduction of heat, 27  
 Conductor, 163  
   sizes, 184  
 Consumption of hot water in relation to  
   cold water, 131  
 Contact bed, 225  
 Contaminated water, 69  
 Contamination, 69  
 Continuous-waste-and-vent, 163  
 Continuous waste, 163  
 Controls, gas, 255  
   for gas heaters, 292  
 Convection of heat, 27  
 Conversion tables, carbonates, 79  
   fixture units, gallons, 117  
   gas, kwhr, 282, 283  
   gas, watts, 31  
   heat, boiler hp, radiation, 27  
   kwhr, gas, 282, 283  
   pressure equivalents, 4  
   pressure of water, 14  
   rate of flow, 22  
   volume and capacity, 23  
   volume of water, 14  
   watts, btu, 31  
   weight of water, 14  
 Corrosive action of water, 79-80  
 Cost estimates, 46

- Cottages, sewage flows, 202  
 Cradle, 49  
 Cradles, sewer, 208  
 Crest meter, *see* Current meters  
 Critical level, 5  
 Cross-connections, 4-6, 164, 168  
 Crown of trap, 164  
   of sewer, 206  
   vent, 164  
   weir, 164  
 Crude sewage, 212  
 Cubic foot of gas, 256  
 Curb box, 61  
 Current meters, water, 104, 106
- Dance halls, fixture requirements, 37  
 Datum, 61  
 Deactivation of water, 92  
 Dead end, 164  
 Deep seal resealing traps, 164  
 Deep seal trap, 164  
 Degassing of water, 93  
 Degreasing, 216  
 Dental cuspidors, air breaks on, 10  
 De-oxygenation of water, 92  
 Department stores, fixture requirements, 38  
 Depressed sewer, 199  
 Detector check, 106, 107  
 Detritus tank or chamber, 218  
 Developed length, 164  
 Developing tanks, air breaks on, 12  
 Die, 49  
 Digestion, 212  
   tanks, capacities, 225  
 Dilute sewage, 212  
 Dilution, 225  
   of acid wastes, 169, 170  
 Dip of trap, 164  
 Discharge of sewers, 199  
 Dishwashing, hot-water demand, 303  
   machines, hot-water temperatures, 149  
 Disinfected sewage, 236  
 Disinfection of sewage, 236  
   of water, 81  
 Disk meters, water, 103, 104, 105  
 Dispersion, 226  
 Displacement meters, water, 104, 106  
 Distance, 164  
   of trap from vent, 189, 190, 192
- Distributaries, 49  
 Distributing pipes, water, 76  
   system, 49  
 Distributor, 226  
 Division box, 226, 231, 232, 233  
 Domestic hot-water temperatures, 149  
 Domestic sewage, 199  
 Domestic water consumption, 109-112  
 Dormitories, fixture requirements, 38  
   water consumption, 109  
 Dosing tanks, 226, 228  
   siphon, 226, 227  
 Double offset, 164  
 Down spout, *see* Leader  
 Draft hood, 256  
 Drain, 49, 164  
   tile, 164  
 Drainage, 199  
 Drainage piping, 164  
   slopes, 175  
 Drainage system, 164  
 Drawings, plumbing, 39  
 Drinking fountains, air breaks on, 12  
 Drinking water, 69  
   standards for, 69-70  
 Drip pan, 256  
 Drop manhole, 206, 207  
 Drum trap, 164  
 Dry vent, 164  
 Dry-weather flow, 199  
 Dry well, 226  
 Dual-main system, 61  
 Dual vents, 164, 189, 190
- Easement, rear lot, 61  
 Educational buildings, fixture requirements, 38  
   sewage flows, 202  
   water consumption, 109  
 Effective opening, 5, 6  
 Effluent, 212  
 Electric heaters, 282  
 Electric terms, 30, 31  
 Electrolytic dissociation, 23  
 Electrolytic solution tension theory, 25  
 Electromotive force series, 24  
 Electron theory, 25  
 Entrance head, *see* Entry head  
 Entry head, 15, 18, 19, 20  
   resistance to, 18

- Equivalents, gas, watts, 31
  - heat, 27
  - pressure, 4
  - rate of flow, 22
  - volume and capacity, 23
  - watts, btu, 31
- Evaporation, 12
- Excavation of trenches, 62-66
- Excess air, 256
- Expansion in pipes, 58
  - joint, 50
  - loop, 50
- Factories, fixture requirements, 39
  - hot-water demand, 303
  - sewage flows, 202
  - water consumption, 109
- Filters for water, 82-90, 83, 86-90
- Filtration, 218
- Final settling basin, 218
- Final settling tanks, 218, 225
- Finishing, 50
- Fire meters, water, 104, 106, 107
- Fish trap, *see* Strainer basket
- Fixture drain, 164
- Fixture unit, 164
  - for drainage lines, 176, 177
  - for water supply, 116
- Fixtures, minimum required, 37-39
  - outlet pressures, 132
  - sizes of water connections, 132
  - trap sizes, minimum, 172
  - water consumption per, 110
- Flame check, 256
- Flexible joint, 50
- Flocculation, 81
- Flocculent matter in water, 81
- Flood level, 6
- Floor, ceiling and wall flanges, 61
  - drains, flush rim, air breaks on, 12
  - or wall connections, 55
- Flotation, 218
- Flow formulas, 21
- Flow in sewers, 209-211
  - line, 16
  - of water in pipes, 15
    - tables, 141-146
  - regulators on water piping, 134
  - uniform, 17
- Flue, 256
- Flue collar, 256
- Flue gases, 256
- Flue losses, 256
- Flue outlet, 256
- Flues for gas heaters, 280, 281 (*see also* Gas flues)
- Flush tank, 206
- Flushing manhole, 206
- Follower, 50
- Foot baths, air breaks on, 10
- Fountains, fixture requirements, 39
- Free air, 26, 256
- Fresh-air inlet, 164
- Fresh sewage, 212
- Friction head, 16, 18, 19, 20
  - loss, 16, 19, 20
  - losses in fittings and valves, 138
  - in water pipes, 136
    - tables, 138-146
  - slope, 16, 18, 20
- Fuel gas, 28-30
- Fuel oil, 27-29
- Fuel units, 28
- Fuels, 27-30
- Funnel air-break, 11
- Fusion welding, 50
- Gage, 1
- Gages on water piping, 102
- Garages, water consumption, 112
- Gas appliances, 246-254
  - flues, 246-252
  - fuels, 28
  - heating value of, 28, 29
  - meters, 238-240
  - piping for heaters, 280
    - for ranges, 253
    - sizing, 240-246
  - pressure in mains, 237
  - ranges and cooking devices, 253
  - refrigeration, 254
  - services, 237-240
  - vent, sewage, 218
  - vents, 246-252
  - water heaters, 261-281
- Gauge, *see* Gage
- Goose neck, on service lines, 76
- Grade, 61, 164
- Gradient, 16, 20
- Gravity-flow, *see* Non-pressure drainage

- Gravity ground water, *71*  
 Gravity systems, sewers, *199*  
 Gravity water, *70*  
 Grease traps, *164, 216*  
 Grit, *217*  
 Grit catcher, *217*  
 Grit chamber, *217, 217*  
 Group housing, hot-water system for, *157*  
 Group vents, *189, 190*  
 Gutter sizes, *183*  
 Gymnasiums, hot-water temperatures, *149*
- Hangers, pipe, *58-60*  
 Hardness of water, *80, 81*  
 Head, *16*  
 Header, *50*  
 Heat, conduction of, *27*  
   content of fuels, *28*  
   convection of, *27*  
   input rating, *256*  
   latent, *27*  
   quantity, *27*  
   radiation, *27*  
   specific, *27*  
   transfer, *27*  
     gas, *30*  
   traps in hot-water piping, *156*  
 Heater-tank hook-ups, *260, 308*  
 Heating surface, *256*  
   value, of gas, *28, 30*  
   total, *256*  
 Horizontal and primary branches, *180-182*  
 Horizontal branch, *165*  
 Horizontal-flow tank, *218*  
 Horsepower required to pump, *31*  
 Hospitals, fixture requirements, *39*  
   sewage flows, *202*  
   water consumption, *109, 111*  
 Hotels, fixture requirements, *39*  
   gas water-heaters, *271, 272, 273, 277*  
   hot-water demand, *295, 296, 299, 307*  
   hot-water temperatures, *149*  
 Hot-water demand, hourly, *295*  
 Hot-water lines, sizing, *147*  
 Hot-water piping systems, *126-131*  
 Hot-water tanks, *286-292*  
   standards, *289, 290*  
 Hot-water temperatures, *149*  
 House drain, *164*  
 House sewage, *199*  
   House sewer, *165, 199*  
   Humus tank, *218*  
   Humus sludge, *218*  
   Hydraulic grade, *16*  
   Hydraulic gradient, *16, 20*  
   Hydraulic radius, *16*  
   Hydrogen equivalent, *25*  
   Hydrogen-ion concentration, *26, 213*  
   Hydrolysis, *26*  
   Hydrolytic tank, *218*  
   Hydrostatic pressure, *13*  
   Hydroxides, solubility and stability of, *25*
- Imhoff tanks, *218, 224*  
 Immersion-type water heaters, *277-280, 277-279*  
 Incrustants, *80*  
 Indications, plumbing, *39, 41, 43, 45*  
 Indirect waste pipe, *165*  
 Industrial sewage, *199*  
 Industrial wastes, *199, 203*  
 Infected water, *69*  
 Influent, *212*  
 Injection burner, *255*  
 Inlet, sewers, *199, 206, 208*  
 Inlet well, *206, 208*  
 Instantaneous heater, *256*  
 Instantaneous heaters, gas, *270-271, 271*  
 Insulation of hot-water pipes, *130*  
   of pipes and tanks, *67, 68*  
 Intercepting sewers, *199*  
 Interceptors for sewage, *215*  
 Interconnection, *50, 165*  
 Intermittent filter, *226*  
 Invert, *61*  
 Inverted joint, *50*  
 Inverted siphon, *199*  
 Ion, *26*  
 Ionization, *23*  
 Iron and manganese removal in water, *90-91*  
 Irrigation, sewage, *226*  
 Isothermal compression, *26*
- Jacket, *256*  
 Joint, *50*  
 Joint runner, *50*  
 Joints and connections, *52*  
   used, *52-55*

- Joints and connections, water piping, 101  
     water service lines, 77  
 Jumper, *see* Return offset  
 Junction chamber, 199  
 Junction manhole, 206
- Kitchen fixtures, air breaks on, 12  
     waste, 165  
 Kutter's formula, 16
- Laminar flow, 16  
 Lamphole, 206  
 Large-volume heaters, gas, 272-276, 274-276  
 Latent heat, 27  
 Lateral, 50  
     sewer, 199  
 Laundry machines, air breaks on, 12  
     water consumption, 113  
 Laundry trays, air breaks on, 12  
 Lavatories, air breaks on, 12  
     in battery, water requirements, 118  
 Lawns, water consumption, 112  
 Leaching cesspool, 226, 232, 234  
 Lead joint, 50  
     calked, 54  
     wiped, 54  
 Leader, 165  
     sizes, 184  
 Leaking faucets, loss through, 156  
 Libraries, fixture requirements, 39  
 Lime treatment, 92  
 Liquefied petroleum gases, 256  
 Liquid sludge, 219  
 Local ventilating pipe, 165  
 Lock nut, 50  
 Loft buildings, hot-water demand, 295, 297, 303, 307  
     hot-water temperatures, 149  
 Long screw, 50  
 Long screw follower, 50  
 Loop vents, 165, 193-197  
 Loss of ignition, 79
- Main, 165  
 Main sewer, 199  
 Main vent, *see* Vent stack  
 Mains, gas, 237  
     water, 76
- Manhole, 206, 207  
 Manhole head, 206  
 Manholes, basins, etc., excavation, 65  
 Manifold, 50, 257  
 Manometer, 16  
 Material selection, 47, 48  
 Materials for drainage and vent piping, 197, 198  
     for sewers, 207  
     subsurface irrigation, 229  
     trickling filters, 229  
     for water piping, 101-103  
     water-service lines, 77  
 Medical school, water consumption, 111  
 Metal in the free state in nature, 25  
 Meters, gas, 238-240  
     water, 103-108, 105, 107, 108  
     friction loss in, 139, 140  
     selection of, 135, 136  
 Micromet, water treatment, 93  
 Mixed gas, 28, 29  
 Mixer, gas, 257  
 Mixture of hot and cold water, 131  
 Monel range boilers, 286  
 Mudcrocks for subsoil-building drainage, 188  
 Multi-coil heaters, gas, 272-276, 274-276
- Natural gas, 28  
 Needle, 257  
 Nickel-clad steel tanks, 288  
 Nipples, connected lengths, 53  
 Non-pressure drainage, 165  
 Non-pressure flow, 20  
 Non-siphon traps, 165  
 Normal gas pressure, 257  
 Nozzle, 50  
 Nurses' home, fixture requirements, 38
- Oakum, 50  
 Office buildings, gas hot-water heaters, 272, 273  
     hot-water demands, 295, 297, 303, 307  
     hot-water temperatures, 149  
 Offset, 165  
 Ohm, 30  
 Oil gas, 28  
 Oil heaters, 282  
 Orifice, 257  
 Orifice cap, 257

- Orifice spud, 257  
 Outfall, 199  
 Outlet pressures of water lines, 131, 132  
 Oxidation, 26  
   in air, 25  
 Oxides, reduction of, 24  
 Oxidized sewage, 212  
 Oxygen, free, 13
- Painting of pipes, 68  
 Pathogenic, 69  
 Percolation, 226  
   tests, 232-235  
 Petroleum gases, liquefied, 256  
 Piezometer, 16  
 Pilot, 257  
 Pipe installation, 56-61  
 Pipe stock, 50  
 Pipe work, 49-68  
 Piping, 51  
 Pitot tube, 16  
 Plain end, 51  
 Planting strip, 61  
 Plot plans, requirements, 45  
 Plug, 51  
 Plumbing layouts, 36  
 Pneumatic ejector, 200  
 Pneumatic water system, 94, 121  
 Poise, *see* Viscosity  
 Pollution, 69  
 Port, gas, 257  
 Potable, 69  
 Power burner, 255  
 Precipitation, *see* Rainfall rates  
 Precipitation value, *see* Solubility product  
 Pressure, 1  
   absolute, 1, 26  
   air (atmosphere), 26  
   burner, 255  
   drainage, 165, 177  
   flow, 20  
   gage, 1  
   in gas mains, 237  
   intensity of, 1  
   head, 16  
   losses, water, 18  
   negative, 1  
   positive, 1  
   vapor, 2  
   water, 13
- Pressure-relief valves, code requirements, 293  
   for gas heaters, 292  
   gas, 257  
 Primary air, 257  
 Primary air inlet, 257  
 Primary branch, 165  
 Producer gas, 28, 29  
 Profiles, sewer, 45  
 Protected waste, *see* Safe waste  
   waste pipe, 165  
 Pump primers, air breaks on, 12  
 Pumping machinery, of trenches, 65  
   for wells, 73  
 Pure water, 69  
 Purification, degree of, 212  
 Putrefaction, 212  
 Putrescibility, 212
- Radiation, 27  
   from pipes, 149  
   from tanks, 283  
 Rainfall rates, 205  
 Rake, 51  
 Range boilers, 284-286, 286  
 Rate of flow equivalents, 22  
 Reamed, 51  
 Recovery capacity on gas heaters, 257  
 Reduction, chemical process of, 26  
 Refrigeration by gas, 254  
 Regulator, gas, 257  
 Regulators for coal heaters, 293  
 Relief devices, gas, 257  
 Relief sewer, 200  
 Relief valves, code requirements, 293  
   for gas heaters, 292  
   on water heaters, 260, 261, 293  
 Relief vent, 165  
 Residential drainage piping, 190-192  
 Residential gas water heaters, 266-269, 270,  
   271, 274, 275  
 Residential hot-water demands, 295, 299-  
   301, 303, 307  
   hot-water temperatures, 149  
 Residential sewage flows, 202  
 Residential sewage treatment plant, 233  
 Residential water consumption, 109,  
   118  
 Residential water pipe sizes, 158, 159  
 Residue on evaporation, fixed, 79



- Restaurants, dishwashing machines, hot-water temperatures, 149  
 gas hot-water heaters, 271, 272, 273, 277  
 hot-water demand, 295, 296, 299, 307  
 water consumption, 112
- Retort gas, 28, 29
- Return offset, 166
- Revent, *see* Back vent
- Riser pipe, 51
- Roof flashing, 55
- Roof leader, 166
- Roughing-in, 51
- Run, 51
- Runner, joint, 50
- Rural homes and farms, water consumption, 109, 111
- Rural sewage-disposal plant, 233
- Rural sewage flows, 202
- Rusting, 25
- Safe, 166
- Safe air gap, 6
- Safe waste, 166
- Safing, 166
- Sag Pipe, 200
- Salt, 26
- Salts in water, 91
- Sand filter, 226, 228
- Sand interceptor, 166
- Sanitary sewage, 200
- Sanitary sewers, 200  
 design, 200-203  
 slope and velocity, 200-202  
 ventilation, 202
- Saturation, 12
- Saybolt Furol, *see* Viscosity
- Saybolt Universal, *see* Viscosity
- Schools, *see* Educational buildings
- Scum, 219
- Scum board, 219
- Seat baths, air breaks on, 10
- Secondary air, 258
- Secondary branch, 166
- Secondary systems, 166, 168
- Sediment trap, *see* Strainer basket
- Sedimentation, 219
- Sedimentation tanks, 219, 219-220
- Self-siphonage, 166
- Septic sewage, 212
- Septic tank installation, 230
- Septic tanks, 219, 220-224, 222, 223
- Service box, 61
- Service clamp, 51
- Service line, 61
- Service pipe, 62  
 gas, 237  
 installation, 238  
 water, 76  
 installation, 77  
 materials, 77  
 sizes, 77
- Settleable solids, 219
- Settled sewage, 219
- Settling chamber, 219
- Sewage, 200  
 disposal, 212  
 and treatment, 212-236  
 farming, 226  
 flows, 201-202  
 oxidation, 226  
 purification, 212  
 screening, 215  
 siphon, 227  
 switch, 232  
 system, choice of, 214  
 treatment works, 212  
 treatments, 212, 213
- Sewer, 200
- Sewer appurtenances, 206
- Sewer construction, 206
- Sewer cradles, 208
- Sewer plans, 45
- Sewer profiles, 45
- Sewerage system, 200  
 works, 200
- Sewers, 199-211
- Shock absorbers on water piping, 103
- Shrunk joint, 51
- Side vent, 166
- Single main system, 62
- Sinks, air breaks on, 12
- Siphon, 1, 2, 16 (*see also* Sewage siphon)  
 simple, 2, 3
- Siphon action in fixtures, 172
- Siphon breakers, 8, 9
- Siphon-preventer check valve, 11
- Siphonage, 1  
 back, 5
- Sizing of gas piping, 242-246  
 tables, 245

- Sizing, of sanitary sewers, 200-202  
of storm sewers, 204-206  
of water piping, 131-162  
tables, 141-146  
sewers, tables, 209-211
- Skimming tank, 216
- Sleek, 212
- Sleeves, 58
- Slip joint, 51
- Slope, 16, 18  
of pipes, 58  
of sewers, minimum, 201
- Sludge, 212, 219
- Sludge bed, 219
- Sludge digestion, 219  
chamber, 219  
tanks, 219  
capacities, 225
- Sludge drying, 219
- Soda ash treatment, 92
- Sodium carbonate, *see* Soda ash treatment
- Sodium chloride, *see* Salts in water
- Sodium hexametaphosphate, 93
- Sodium hydroxide, *see* Caustic soda treatment
- Sodium sulfate, *see* Salts in water
- Softening of water, 91, 92
- Soil, 62
- Soil pipe, 166
- Soil stack, 166
- Soil stack sizes, 177-179
- Soldered joint fittings, 51
- Solubility product, 26
- Special waste, *see* Industrial wastes
- Specific gravity, 258
- Specific heat, 27
- Spray heads, movable, air breaks on, 12
- Sprinkler nozzle, sewage, 226
- Sprinkling filter, 226
- Spud, orifice, 257
- Stability, 212  
relative, 212
- Stable effluent, 212
- Stack, 166
- Stack vent, 166
- Stale sewage, 212
- Standard air, 27
- Standpipe, 51
- Static head, 17
- Steam heaters, 283, 284  
radiation per gallon, 283  
required to heat water, 283
- Stench trap, 166
- Sterilization of water, 81
- Sterilizer plumbing, 11, 12
- Stock, 51  
pipe, 50
- Storage and pumps for water systems, 119-126  
heater, 258  
requirements for water systems, 119-126  
vessel, 258
- Stores, *see* Department stores
- Storm building drains, 183-188
- Storm drain, 166
- Storm sewers and combined sewers, 204-206
- Strainer basket, 105
- Strainers on water piping, 103
- Stream-line flow, *see* Laminar flow
- Street box, 62
- Street sewer, 200
- Strong sewage, 212
- Subdrain, 166  
on sewers, 200
- Subgrade, 62
- Subsoil, 62  
building drainage, 187, 188  
drain, 166  
sewage, 226
- Subsurface filtration, artificial, 235  
irrigation, 226, 229-235, 230-233
- Sump, 166
- Sumps and receiving tanks, 182  
for subsoil building-drainage, 188
- Supply line, 62
- Surface irrigation, 226
- Surface water, 71, 73
- Surface water drain, 166
- Surface water temperatures, 75
- Suspended matter, 219  
in water analysis, 79
- Swaged, 51
- Sweat joint, 51
- Sweated, 51
- Swedge, 51
- Swing joint, 51
- Swivel joint, 51
- Symbols, plumbing, 39, 40, 43, 44

- Tags for valves, 61  
 Tall buildings, drainage piping, 198  
   water pipes in, 95-101  
 Tank heaters, gas, 263, 264  
 Tank treatment, sewage, 218-225  
 Tanks and heating coils, 284  
   copper, 284, 287  
   copper-silicon alloy, 287, 288  
   nickel-clad steel, 288  
   steel, 284, 287  
 Tap, 51  
 Temperature, 27  
   absolute, 26, 27  
   of ground water, 73-76, 74  
   relief valve, gas, 257  
   of surface water, 75, 76  
 Templets required, 58  
 Temporary fixtures, 61  
 Test pit, 62  
 Tests of pipes, 66-68  
   gas, 241  
 Theaters, fixture requirements, *see* Auditoriums  
 Thermal efficiency, 258  
 Thermometer for water heaters, 294  
   on water piping, 103  
 Thermostat, 258  
   for gas heaters, 292  
 Thread, length of, 53  
 Threshold treatment, 93  
 Tight manhole cover, 206  
 Tongs, chain, 49  
   pipe, 50  
 Transfer of heat, 27  
 Trap, 166  
 Trap requirements, 172  
 Trap seal, 166  
 Trap sizes for fixtures, 172  
 Trap and vent principles, 171  
 Treatments of water, 81-93  
 Trenches, 62, 63, 64  
 Trickling filter, 226, 228  
 Trim wrench, 51  
 Trunk sewers, 200  
 Tunneling, 65  
 Turbidity, 78  
 Turbine meter, *see* Current meters  
 Turbulence, 17  
 Turbulent flow, 17  
 Turbulent velocity, 17  
 Underdrain, sewage, 226  
 Underground work, 61  
 Unit vents, 189, 190 (*see also* Dual vent)  
 Urinals, air breaks on, 12  
   in battery, water requirements, 118  
 Utility agencies, 62  
 Vacuum, 2  
 Vacuum breaker, 5, 9  
 Vacuum-relief valve, gas, 258  
 Valve box, 62  
   installation, water piping, 102  
   tags, 61  
   uses, 56  
 Vapor pressure, 2  
 Velocity head, 17, 18-19  
   mean, 16  
   permissible, 16  
 Vent pipe, 166  
 Vent sizes, 194, 195, 196  
 Vent stack, 166  
 Ventilated manhole cover, 206  
 Ventilation of sanitary sewers, 202  
 Vents and venting, 189-197  
   for flat-bottomed fixtures, 189, 192  
 Venturi air break, 11  
 Venturi tube, 17  
 Vertical flow tanks, 219  
 Viscosity, 17  
 Viscous flow, *see* Laminar flow  
 Volt, 30  
 Washer, 51  
 Waste pipe, 166  
 Waste pipes, flow characteristics, 173, 174  
 Waste stack sizes, 177-179  
 Water, absorption by, 13  
   analysis, 78-81  
   closets, air breaks on, 12  
   closets in batteries, water requirements, 118  
   consumption, 108-119  
     estimating, 114-119  
   corrosive action of, 79, 80  
   distributing systems, auxiliary, 10, 11, 12  
   flow of, 15  
   hammer, 17, 21  
   hardness of, 80, 81

- Water, heaters, classification, 259, 259-261  
  gas, 261-281  
  selection, 294  
  heating, 255-308  
  mains, 76  
  meters, 103-108, 105, 107  
    installation, 108  
  piping, 94-162  
    estimating maximum demand, 114  
    installation, 102  
    materials, 101-103  
    systems, 94-101  
  pressure, 13  
  properties of, 12, 13  
  service lines, *see* Service pipe  
  services, 76  
  softening, 91, 92  
  supply, 69-93  
  supply sources, 70-76  
  table, 71  
  temperature of ground, 73-76, 74  
  temperature of surface, 75, 76
- Water, temperatures (*see also* Hot-water temperatures)  
  treatment to reduce corrosion, 92, 93  
  treatments, 81-93  
  volume of, 14  
  weight of, 13, 14
- Watertight cesspool, 226
- Watts, 30
- Weir, 219
- Welding, fusion, 50
- Well standards, 71-73
- Wells, 71
- Wet vent, 167
- White alkali, *see* Salts in water
- Wiped joint, 52
- Wrench, pipe, 50
- Yellow flame burner, 255
- Yoke, 52
- Yoke vent, 167
- Zeolite treatment, 91, 92



