

Birla Central Library

PILANI (Rajasthan)

Class No... 697

Book No M.73P

Accession No 55465

Acc. No.....

ISSUE LABEL

Not later than the latest date stamped below.

--	--	--

**PRINCIPLES AND PRACTICE OF
HEATING AND VENTILATING**

*Newnes' Books on Building and
Allied Subjects.*

ROOF CONSTRUCTION AND REPAIR

BRICKWORK AND MASONRY

BUILDERS' MACHINERY

CONCRETE WORK

WINDOWS AND WINDOW GLAZING

COPPER PIPE WORK

SHEET LEAD WORK

LEAD PIPE WORK

BUILDING TIMBERS

MODERN SANITARY ENGINEERING

HOT WATER ENGINEERING

PRINCIPLES AND PRACTICE OF HEATING AND VENTILATING

*Prepared by a Staff of Technical
Experts under the direction of*

E. MOLLOY

With Foreword by

A. C. PALLOT

M.B.E., B.Sc.(Eng.), M.Inst.C.E., M.I.H.V.E.

LONDON
GEORGE NEWNES LIMITED
TOWER HOUSE, SOUTHAMPTON STREET
STRAND, W.C.2

Copyright
All Rights Reserved

C/85
M

C/81

55465

First published in . 1945

C/80

SPECIAL GOVERNMENT
BIRLA ENGINEERING
LIBRARY BOOKS.

SECTION
LLEGE-

FOREWORD

BY A. C. PALLOT, M.B.E., B.SC.(ENG.), M.I.C.E., M.I.H.V.E.

THE subject of heating has been steadily growing in importance for some years, and much thought has been and is being given to the means by which essential warmth can be provided efficiently and economically. It is, perhaps, surprising that this basic need has only within comparatively recent times been placed on a rational basis, but with a wider realisation of the technicalities involved the profession of the Heating and Ventilating Engineer has reached a new dignity. Indeed, his work is of primary importance to the community, not only in providing the conditions necessary for health and comfort; but in the wider aspect of the economic use of our diminishing fuel resources, and in the mitigation of that atmospheric pollution which has marred so many of our centres of population.

Of the 240 million tons of coal raised annually in this country, it has been estimated that not less than 90 million tons are utilised for heating, whether in the form of solid fuel or of gas or electricity. These figures indicate the importance of ensuring that heat energy is correctly applied, particularly in view of its greatly increased cost. It cannot be said that finality has been reached in heating methods and further study will undoubtedly lead to fresh developments.

In the next few years, a very large amount of heating and ventilation work will be carried out, and the necessity of a thorough understanding of the subject cannot be too strongly stressed amongst those upon whom will devolve this important part of the re-building of Britain.

I have had the privilege of reading this book in the proof stage. It combines in an excellent way both the theoretical principles of heating and the practical factors involved in installation, and will be of very great value to all engaged in this most interesting of industries.

P R E F A C E

THE material in this book represents the work of a number of engineers, each of whom has specialised in a particular aspect of the subject. The treatment has been planned to be useful to those who are concerned with the design and installation of heating and ventilating systems for use in factories, workshops, public buildings and communal buildings, such as hotels, flats and offices.

As with all other branches of engineering, it is essential for the heating and ventilating engineer to have in the first place a thorough grasp of the basic principles of the subject. The first three chapters have, therefore, been devoted respectively to discussing the fundamentals of heat transmission, the various methods of heating which are available to-day, and the heat requirements of different types of buildings.

Succeeding chapters deal with all the important components of modern heating and ventilating systems, including hot-water heating systems, steam-heating systems and various electrical heating and warming appliances. Closely connected with heating and ventilating is the subject of automatic temperature control. This has been dealt with at some length in Chapter XI.

Another important aspect of a scientifically designed system is the question of thermal insulation, which ensures that heat is properly conserved during its passage from the boiler to the point at which it is required in the system. This subject also, has therefore been dealt with in a special chapter. Air conditioning (which includes humidifying, cleaning, dust and fume extraction, and drying) forms the subject of Chapter XIV.

The work concludes with some practical notes on estimates, specifications and running costs. These are intended, not only for the builder and contractor, but also for the engineer who must in the end be judged, not only by the mechanical or engineering excellence of his work, but also by the heat efficiency of the installation for which he is responsible.

E. M.

CONTENTS

	PAGE
Chapter I.—THE TRANSMISSION OF HEAT	1
II.—METHODS OF HEATING	10
III.—THE HEAT REQUIREMENTS OF BUILDINGS	17
IV.—BOILERS, BOILER HOUSES AND BOILER INSTALLATION	26
V.—GENERAL NOTES ON PIPEWORK	53
VI.—RADIATORS	66
VII.—HOT WATER HEATING SYSTEMS	75
VIII.—STEAM HEATING SYSTEMS	135
IX.—ELECTRICAL WARMING APPLIANCES AND INDIRECT ELECTRICAL HEATING SYSTEMS	172
X.—UNIT HEATERS	194
XI.—AUTOMATIC TEMPERATURE CONTROL IN HEATING AND VENTILATION	211
XII.—THERMAL INSULATION	228
XIII.—WARM AIR HEATING	242
XIV.—VENTILATION AND AIR CONDITIONING, DUST AND FUME EXTRACTION—DRYING PLANTS	250
XV.—BUILDER'S WORK, ESTIMATES AND SPECIFICATIONS, RUNNING COSTS	292
GENERAL INDEX	309

LIST OF TABLES

	<i>Page</i>		<i>Page</i>
CHAPTER I			
Table 1.—Specific Heats	2	3.—Low-Pressure Steam Pipe Sizes	142
2.—Values of Conductivities	4	4.—Minimum Pitch for Running Steam Piping	143
3.—Heat Transfer in Still and Moving Air	6	5.—Size of Steam Main	146
4.—Heat Transmission from Iron Pipes, with Hot Water	8	6.—Properties of Saturated Steam	148
5.—Heat Transmission from Iron Pipes, with Steam	9	7.—Capacity of Traps	157
CHAPTER III			
Table 1.—Temperature Required in Buildings	18	CHAPTER IX	
2.—Values of U	18	Table 1.—Electrical Loadings for Hot Water Radiators	181
3.—Values of U and R	20	CHAPTER X	
4.—Air Changes in Buildings	22	Table 1.—Rates of Air Change	198
5.—Allowances for Exposure	22	2.—Factors for Steam Mains	204
6.—Allowances for Intermittent Heating	23	3.—Equivalent Lengths of Pipe for Elbow Resistance	204
CHAPTER IV			
Table 1.—Chimney Capacities	41	4.—Heat Emitted from Pipes	206
2.—Composition of Fuels	44	CHAPTER XII	
CHAPTER V			
Table 1.—Particulars of Pipes	53	Table 1.—Variation of Conductivity with Temperature	230
2.—Expansion of Pipes	55	2.—Insulating Materials	231
3.—Accommodation for Expansion	56	3.—Thicknesses of Insulation for Hot Water	232
4.—Dimensions of Expansion Loops	57	4.—Thicknesses of Insulation for Steam	233
CHAPTER VI			
Table 1.—Heat Transmission from Radiators	69	5.—Resistivity of Materials	236
CHAPTER VII			
Table 1.—Density of Water	76	CHAPTER XIII	
2.—Circulating Head	76	Table 1.—Air Speeds in Plenum Systems	245
3.—Friction Equivalent of Fittings	80	2.—Performance of Vento Heaters	248
CHAPTER VIII			
Table 1.—Flow of Steam through Pipes	135	CHAPTER XIV	
2.—Properties of Vapour	140	Table 1.—Hygrometric Data	252
		2.—Rates of Air Change	255
		3.—Air Discharge by Gravity	256
		4.—Thickness of Metal Ducts	266
		5.—Velocity Heads	267
		6.—Allowances for Bends in Ductwork	267
		CHAPTER XV	
		Table 1.—Time Required for Installation	303

PRINCIPLES AND PRACTICE OF HEATING AND VENTILATING

Chapter I

THE TRANSMISSION OF HEAT

THE heating of buildings is of great and increasing importance, but before dealing with the more technical aspects of this very wide and interesting subject it is necessary to be acquainted with the methods by which heat itself is transferred. Heating is tending more and more to become an exact science, and before proceeding to the design of installations which are to be both satisfactory and economical in operation, some study must be made of the physical laws involved.

The object of this book is to present, in a simple and practical way, all the essential physical and technical factors involved in heating.

Measurement of Heat

Heat is a form of energy which can be measured.

If 1 lb. of water is heated so that its temperature is raised by 1° F., its heat content is increased by an amount which is taken as the standard of measurement, and called a "British Thermal Unit," usually written as "B.T.U." (or B.Th.U.). Thus the amount of heat in B.T.U. added to any quantity of water is the product of its weight in pounds and the rise in its temperature. Conversely, the amount of heat in B.T.U. given up by water when its temperature falls is the product of its weight and the number of degrees by which its temperature is reduced.

It is important to distinguish between temperature and heat. For example, a piece of wire held in a flame will rapidly come to a red heat: its temperature is high, but the amount of heat it contains is quite small. On the other hand, a pail of water placed for a few minutes over a flame will not attain a high temperature, but the amount of heat it contains is considerably more than that in the wire.

Specific Heat

The specific heat of a substance may be defined as the quantity of heat required to raise the temperature of unit mass of the substance through one degree. From experiments, it has been found that one substance will require a different quantity of heat than another to raise its temperature through the same range. This difference in thermal property is expressed by saying that the substances have different specific heats.

The specific heat of dry air, for example, at 60° F. is 0.239 B.T.U. per lb. and the weight of a cubic foot of dry air at the same temperature is 0.076 lb. Therefore, 1 B.T.U. (British Thermal Unit) will heat

$$\frac{1}{0.239 \times 0.076} = 55 \text{ cu. ft. of air through } 1^\circ \text{ F.}$$

The following Table gives the specific heats of various substances :—

TABLE I. - SPECIFIC HEATS

<i>Material</i>	<i>Specific Heat</i>	<i>Material</i>	<i>Specific Heat</i>
Water	1.0	Mercury (70°-210°)033
Air (at constant pressure)239	Brickwork and Masonry about20
Steam (at 212° F.)43	Building Stone20
Iron (70°-210°)12	Glass195
Steel (70°-210°)123	Marble21
Cast iron (70°-210°)13	Granite19
Copper (70°-210°)094	Asbestos20
Brass (70°-210°)094		

Sensible Heat

Sensible heat is that which is measured by an ordinary thermometer. Thus if 1 lb. of water is heated from freezing point to boiling point (at atmospheric pressure) the thermometer reading will rise from 32° to 212° F., and the sensible heat imparted to the water is (212-32), or 180 B.T.U.

Latent Heat

When heat is applied to ice, it melts to form water at the same temperature. Similarly, if water is raised to boiling point, and heat continues to be applied, the temperature of the water is not increased, but the energy imparted is absorbed in changing the state of the water from liquid to vapour. In either case, the heat is not measurable by a thermometer, and is therefore known as the "latent," or hidden, heat.

By experiment, the quantity of heat required to melt 1 lb. of ice is 144 B.T.U., and to evaporate 1 lb. of water at atmospheric pressure is 965.2 B.T.U. Steam at pressures above atmospheric has temperatures higher than 212° F.; these can be found from Steam Tables, published in most engineering reference books. The following are a few examples relating to dry steam, i.e. steam containing no particles of liquid water :

<i>Pressure</i>	<i>Temperature</i>
Atmospheric	212° F.
5 p.s.i.*	227° F.
50	297° F.
100	340° F.

* "p.s.i." indicates lb. per square inch.

If the boiling point (*t*) is known, the latent heat (*L*) per lb. can be found approximately from the formula :

$$L = 1,114 - .7t.$$

Steam heated after its formation is "superheated," the degree of superheat being sensible, and thus measurable by a thermometer. (Superheated steam is rarely used in heating practice, unless for the purpose of avoiding condensation in a long run of pipe : in this case the amount of superheat is arranged to equal the loss of heat from the main, so that the steam arrives at the point of utilisation in a dry condition.)

It will be observed that the amount of latent heat available decreases as the temperature increases, and this indicates that low-pressure steam is more suitable as well as more convenient for heating service than high-pressure steam.

Total Heat

When steam condenses, and the liquid subsequently cools, it is obvious that the latent heat and part of the sensible heat are available, and it is sometimes useful to know the "total heat" content of steam. This is the amount of heat required to raise the temperature of 1 lb. of water from 32° F. to boiling point (t) and to evaporate it there. Total heat (H) can be found approximately from the formula :

$$H = 1,082 + \cdot 305t.$$

Transmission of Heat

Heat always tends to pass from a body at a higher temperature to one at a lower temperature. This transfer may be effected in three ways, viz. by conduction through the material of a substance ; by convection, due to the actual motion of water or air in contact with a heated surface ; and by radiation, by which is meant the emission of energy from a hot surface to cooler surroundings. These methods of heat transfer are of fundamental importance, and must be considered in detail.

Conduction

The transference of heat from one part of a substance by conduction is very easily illustrated by the simple experiment of putting a poker into the fire and observing how quickly the handle becomes hot, even though it is screened from the direct rays of the fire. It is therefore evident that if the temperature of one part of a body is raised above that of the other parts, heat will be passed on to them. Different substances vary in their conductivities. Iron, for example, may be considered a good conductor of heat, but asbestos a bad one. Materials that are considered bad conductors are accordingly selected for use as heat insulators.

Liquids (except mercury) and gases are in general bad conductors.

The conductivity of various materials is of great importance in heating calculations.

Conductivity is usually denoted by k , and is defined as the amount

of heat in B.T.U. flowing per hour through 1 sq. ft. of material 1 in. in thickness, when the temperatures of the opposite *faces* differ by 1° F.

Conductivity must not be confused with "thermal transmittance," which is the quantity of heat flowing through 1 sq. ft. of any type of construction when the temperatures of the *air* adjoining the two faces differ by 1° F. This is considered in Chapter III.

The reciprocal of the conductivity, i.e. $\frac{1}{k}$, is termed the "resistivity," and use can be made of this quantity when calculating thermal transmittances. (The physical meaning of resistivity is the number of hours required to transmit 1 B.T.U. through a slab of material as defined for conductivity.)

The following Table gives some average values of k for various materials in common use :

TABLE 2. VALUES OF CONDUCTIVITIES

Steel	320	Plaster	4
Iron	233	Glass	7.3
Brickwork	8	Wood	1
Concrete	7	Insulating materials	0.28-0.7
Lightweight concrete	1.9	Still air	0.156

The high values of k for iron and steel indicate that a very small temperature difference between the two faces is sufficient to transfer a large amount of heat, and in practice the temperature of the outer surface of a pipe carrying a hot fluid may be assumed as that of the fluid itself.

From the definition, it follows that, for a plane slab,

$$Q = \frac{k}{L} (t_1 - t_2)$$

where Q is the amount of heat (in B.T.U.) flowing per hour per sq. ft.,

k is the conductivity of the material,

L is the thickness of the slab in inches,

t_1, t_2 are the temperatures of the opposite faces.

In dealing with heat losses through the structure of buildings a modification of the methods outlined above is usually employed, it being customary to calculate the "thermal resistance" of the particular type of construction considered. From this the overall "thermal transmittance" can be found, enabling the rate of heat flow to be computed from the known internal and external air temperatures.

Convection

Heat that is conveyed from place to place by the actual motion of the heated body causes its transference by convection.

Water and air transfer heat almost entirely by convection rather than by conduction.

In a hot-water heating installation, where pipes and radiators are used, the distribution of heat is to a large extent by convection. The water in the boiler on being heated expands and its density becomes less. Under the action of gravity the heated water moves upwards, and is replaced by colder water, which in turn is heated, and so a movement is set up through the pipes of the installation. The pipes and radiators become heated by the water and transfer heat to the surrounding air, which is also set in motion in the same way and conveys heat to the occupants and objects in the room.

The amount of heat in B.T.U. per sq. ft. per hour transferred from a hot surface at temperature t_s to surrounding air at temperature t_a by convection can be found from the formula :

$$\text{B.T.U.} = C(t_s - t_a)^{\frac{5}{4}}$$

where C is a constant depending on the shape and position of the surface.

In still air conditions the following values of C may be taken :

Vertical surfaces and cylinders	0.32
Horizontal surfaces facing upwards	0.38
Horizontal surfaces facing downwards	0.20
Horizontal cylinders (above 8 in. diameter)	0.35
Horizontal cylinders (below 8 in. diameter)	0.40

If air currents impinge upon the heated surface the transfer of heat is increased by forced convection; an approximate expression for this condition is

$$\text{B.T.U.} = (1.2 + 0.19V) (t_s - t_a)$$

where V is the air velocity in feet per second.

Radiation

The radiation of heat is a continuous emission of that form of energy, in waves of varying length from all bodies at all temperatures, and follows the laws of light. Different surfaces maintained at the same temperature have varying powers of radiation. A surface that has a high radiating power has a correspondingly high capacity for the absorption of heat. A lamp-black surface has a high radiating power, as opposed to the poor radiating property of a polished surface. For instance, if the radiating power of a lamp-black surface is taken at 100, the relative figure for a polished copper surface is 11. Use is made of this fact in the construction of a vacuum flask, which comprises a double-walled glass vessel, with the space between the walls exhausted of air, and the surfaces of the walls silvered. The vacuum minimises conduction, and the mirrored surfaces reduce radiation to a minimum.

The heating effect of the column type of radiator is largely by convection rather than radiation, whereas with low-temperature flat

surfaces employed in panel heating the percentage of radiation is greater than the convected heat.

Radiation does not appreciably heat the air through which it passes, but is absorbed in varying degrees by the surfaces of solid bodies on which it impinges, and these in turn warm the air by convection. One practical result of this property is that when the warming of a room is effected by sources which are principally radiant in effect (such as ceiling panels or electric fires) it is unnecessary to allow for the air being heated to the full temperature required for comfort.

The amount of heat in B.T.U. per sq. ft. per hour transferred by radiation from a hot surface at temperature t_s to air and surroundings at temperature t_a can be found from the formula :

$$\text{B.T.U.} = e \times 17.3 \times 10^{-10} \times \left\{ (t_s + 461)^4 - (t_a + 461)^4 \right\}$$

where e is a factor depending upon the nature of the surface.

For highly polished metals (e.g. plated towel rails) e may be as low as 0.05, but for the majority of other surfaces the value is approximately 0.9. Colour makes no difference. An exception is paints with an aluminium or bronze base : with these, the value of e may vary between 0.4 and 0.8. Such paints, therefore, retard heat transmission, and should not be used for radiators, and similar equipment.

Radiation is not affected by air movement, except in so far as the temperature of the surface may be reduced by forced convection.

Heat Transfer from Surfaces and Pipes

The amount of heat emitted from a hot surface is the sum of that due to radiation and to convection.

The following Table shows the amount of heat transfer in still and moving air respectively from a vertical surface maintained at various temperatures : air at 70° F. and $e = 0.9$ are assumed.

TABLE 3.—HEAT TRANSFER IN STILL AND MOVING AIR

Temperature of Surface (deg. Fahrenheit)	B.T.U. per Square Foot per Hour					
	Still Air Conditions			Air Moving at 15 m.p.h.		
	Radia- tion	Con- vection	Total	Radia- tion	Con- vection	Total
100	30	23	53	30	162	192
200	169	140	309	169	700	869
300	390	287	677	390	1,240	1,630
400	715	450	1,165	715	1,780	2,495

The striking features of the Table are the increase in convection loss due to air movement and the increase in radiation losses at high temperatures.

Another deduction which may be drawn is that highly polished metallic surfaces are quite good insulators. The difficulty in practice is that, except when plated or otherwise specially finished, they rapidly become dull and their efficiency falls.

For horizontal surfaces, the heat transfer may be found by multiplying the values for convection given in the Table by the following factors :

Surface facing upwards	..	1.190
" " downwards		0.825

For the same air temperature the value of the transfer by radiation is unaltered whatever the position and shape of the surface, and this, added to the value for convection, gives the total transmission in B.T.U. per sq. ft. per hour.

Heat Transmission

The amount of heat given off by the heating surface varies according to the temperature difference of the pipes and radiators and the surrounding air ; the exposed or enclosed condition of the heating surface ; the type of radiator and other factors which may tend to assist or obstruct the distribution of heat. The difference in heating effect is very noticeable if the results from pipes fixed horizontally and vertically are compared, as shown in Fig. 1.

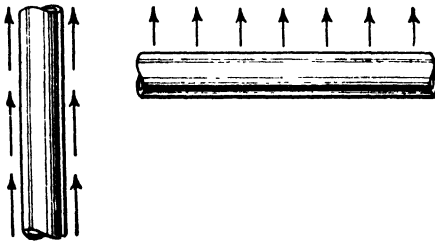

Fig. 1.— SHOWING THE DIFFERENCE IN HEATING EFFECT FROM PIPES FIXED HORIZONTALLY AND VERTICALLY

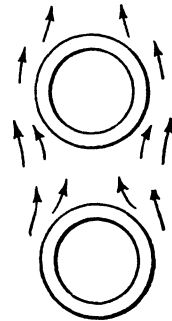

Fig. 2.— SHOWING HEAT TRANSMISSION FROM TWO HORIZONTAL PIPES PLACED ONE ABOVE THE OTHER

The heated air in the immediate vicinity of the vertical pipe rises and keeps close to the pipe, thereby reducing the temperature difference and lowering the rate of transmission. On the other hand, the air is moving with some velocity as it rises, and this increases the convection loss from the pipe. With a horizontal pipe, the air warmed by contact with the pipe rises and is immediately replaced by cooler air. The two

effects are about equal, so that in practice there is but little difference between the heat losses from vertical and horizontal pipes. There is, however, one exception. The transmission from a group of pipes is less per square foot than from a single pipe. Consider a case where two horizontal pipes are placed one above the other (Fig. 2); the heated air from the lower pipe rises and envelops the pipe immediately above. The temperature difference between the upper pipe and the surrounding air is, therefore, lower and the heat transferred correspondingly less.

As hot air leaving pipes rises, some of the heat may not be usefully employed. For example, with horizontal pipes fixed overhead, only about 80 per cent. of the figures quoted should be taken, and for vertical pipes about 50 per cent. In estimating the load on the boiler, the total heat emission must of course be taken. For horizontal pipes slung in mid-air, as in large factories, the figures in the Tables should be increased by 20 per cent.

The heat emitted from uninsulated piping in a room is always taken into account when calculations are made, and the following Table shows the heat transmission from horizontal pipes in still air: the temperature difference is that between the mean temperature of the water in the pipe and that of the surrounding air.

TABLE 4.—HEAT TRANSMISSION IN B.T.U. PER HOUR PER LINEAL FOOT FROM IRON PIPES

<i>Diameter of Pipe</i>	<i>Temperature Difference ° F.</i>											
	60°	70°	80°	90°	95°	100°	105°	110°	115°	120°	125°	130°
$\frac{1}{2}$ in. . . .	29	35	42	49	52	56	60	63	67	71	75	79
$\frac{3}{4}$ in. . . .	36	44	52	61	65	70	75	79	84	89	94	98
1 in. . . .	41	50	60	70	75	80	85	90	96	101	107	112
$1\frac{1}{4}$ in. . . .	50	61	73	85	91	98	105	111	118	124	131	138
$1\frac{1}{2}$ in. . . .	57	69	82	96	106	110	117	124	132	140	147	155
2 in. . . .	67	82	97	113	121	130	139	147	157	165	174	183
$2\frac{1}{2}$ in. . . .	79	97	115	134	144	154	164	174	185	195	206	217
3 in. . . .	97	118	141	164	176	188	200	213	226	238	252	265
4 in. . . .	120	146	174	202	217	232	247	262	280	294	310	326
5 in. . . .	145	177	210	246	264	282	300	319	340	358	378	397
6 in. . . .	170	207	247	288	308	330	352	373	398	418	442	465

It will be noticed that the heat loss is not directly proportional to the temperature difference, but rises sharply as the temperature of the water increases. A further example of this is given in the following Table relating to steam pipes.

TABLE 5.—HEAT LOSS IN B.T.U. PER HOUR PER LINEAL FOOT IN STILL AIR AT 70° F.

<i>Bore of Pipe</i>	<i>Steam Pressure, Lb. per Sq. In. ((gauge))</i>			
	5	50	100	200
1	153	254	318	417
2	275	456	574	745
3	406	674	844	1,102
4	519	861	1,082	1,411
6	766	1,275	1,600	2,084
8	974	1,622	2,020	2,638
10	1,210	2,015	2,505	3,275
12	1,448	2,410	2,996	3,920

It is very important that all pipes and surfaces from which heat emission is not required should be insulated, and this is dealt with in Chapter XII.

Insulation is of particular importance in pipes, etc., exposed to open air conditions, as in these cases the normal losses may easily be doubled by wind.

Chapter II

METHODS OF HEATING

Space and Comfort Heating

BY space heating is meant heating so that the whole of a room or a building is at the temperature required : this condition is fulfilled by central heating systems in general. By comfort heating is meant that heat is supplied (usually from high-temperature radiant sources, such as a gas fire or electric radiator) at the point where it is actually required for comfort. There are some important differences between the two methods, and although this book is concerned mainly with central heating, it is of value to understand something of the physiological principles governing comfort.

The following figures show the approximate amounts of bodily heat produced by an average adult :

At rest	300 B.T.U. per hour
Doing sedentary work	400
.. light manual work	600
.. heavy	1,000-2,000

Under ordinary conditions, the heat is lost in the following proportions :

Radiation	45 per cent.
Convection	30
Evaporation	25

Comfort is obtained when the surrounding conditions allow heat to be lost from the body approximately in these proportions. In any case the total bodily heat produced must be dissipated, so that if the loss by one means is reduced, that by others must be increased. For example, in a hot room a fan gives relief by increasing the rate of convection loss.

Equivalent Temperature

Mention should be made of "equivalent temperature," which is often used for defining the conditions in a room. The ordinary thermometer is not very sensitive to radiation from low-temperature sources such as hot-water panels. A familiar analogy is a greenhouse : the glass passes the high-temperature radiation from the sun, but when this warms the interior of the greenhouse the glass will not transmit the low-temperature radiation outwards. In consequence heat accumulates in the greenhouse which becomes very hot. Similarly the glass bulb of an ordinary thermometer does not transmit low-temperature radiation to the mercury. Also the thermometer does not respond to air movement, if the tempera-

ture of the air is unaltered, but human beings are very sensitive to draughts.

Equivalent temperature is a method of expressing the combined effect of air temperature, air movement, and radiation on comfort. It can, however, only be measured by rather elaborate instruments, and for buildings which are centrally heated the ordinary thermometer is quite reliable in indicating conditions.

It is, however, interesting to note that horizontal radiation falling on the body at the rate of 40 B.T.U. per sq. ft. per hour is equivalent to a rise in air temperature of 6° F., but that comfort cannot be attained, with radiation in one direction only, if the air temperature is less than 45° F. If radiant heating is used, the air temperature in general should not be below 55° F. for sedentary conditions.

Also, if the air velocity in a room reaches 2 ft. per second, the air temperature must be increased by 4° F. to give the same conditions of comfort as in still air.

In general, the most comfortable conditions are obtained when walls, etc., are slightly warmer than the air. If they are colder, some discomfort results, and it is particularly important that floors should not be cold.

Local Heating

By local heating is meant the actual generation of heat in the room. This may be done in a number of ways, some of which will now be considered.

Open Fireplaces

Open fireplaces are likely to remain popular: they are pleasing in appearance, but only about one-quarter of the heat in the fuel is usefully employed, the remainder escaping up the chimney. The principal heating effect is by radiation. Coal or coke burning brightly in an open fireplace radiates about 200 B.T.U. per sq. ft. per hour, measured about 3 ft. in front of the fire.

Heating Stoves

The slow-combustion stove is often used for the heating of small entertainment halls and similar buildings where there is but a limited amount of space available for the installation of the heating system. It has the advantages of being easy to install and requiring no skilled attention. On the other hand, however, its use involves the carrying of fuel into the room and the removal of ashes. The scattering of dust in carrying out these operations is a decided drawback.

Stoves are more efficient than open fires. They are mainly convective in effect. Closed stoves have an efficiency of about 70 per cent. and semi-

closed stoves an efficiency of about 45 per cent. with coal and 40 per cent. with coke.

It is impossible to regulate the output of open fires or stoves exactly in accordance with requirements, so that some overheating, with excess consumption of fuel, cannot be avoided in mild weather.

Gas Fires

Gas fires are a very convenient means of heating as a very wide range of control is possible, and there is probably less excess consumption than with any other means of heating. The radiant efficiency is about 50 per cent., but with convector patterns outputs of 60 to 70 per cent. are obtainable: with such high efficiencies the temperature of the gases escaping up the chimney is relatively low and there is some risk of condensation (1 lb. of gas in burning produces about $1\frac{1}{2}$ lb. of water). Chimneys for gas fires require special construction and normally should not be more than 30 ft. high.

The radiation emitted by a five-radiant gas fire, burning 25 cu. ft. per hour, is about 160 B.T.U. per sq. ft., measured at about 3 ft. from the fire. The temperature of the radiants is about $1,500^{\circ}$ F.

Electric Heaters

Electric heating is probably the cheapest in installation cost of all local heating systems. The ordinary electric fire is practically 100 per cent. efficient, most of the heat being emitted in the form of radiant energy; the radiation per square foot at a distance of 3 ft. from the fire is about 80 B.T.U. per kilowatt. The temperature of the elements is about $1,000^{\circ}$ F.

Low-temperature tubular heaters are also 100 per cent. efficient, about half of the emission being by convection. The elements run at low temperatures, and are practically indestructible. The heaters are produced commercially with a loading of 60 watts per foot run, the surface temperature of the tube (2 in. diameter) being about 190° F. They can be used in almost any position, and are suitable for thermostatic control. (Thermostatic control of heating installations of any type may save 25 per cent. or more of the consumption.)

A further type of electric heater is the convector, which incorporates a small fan blowing air over a heated element. This enables the air temperature within a room to be raised quickly, but a disadvantage in all such types of heating is that the air temperature tends to be considerably higher than the temperature of the walls.

Central Heating

By central heating is meant the generation of heat at a central point, and its distribution from thence to different parts of the building. Various

systems are considered in detail in subsequent Chapters, but the following notes provide a general survey of methods.

Low-Pressure Hot Water

Central heating by means of low-pressure hot water in radiators is very general in this country. There are some limitations to the system: the horizontal limit, without pumping, is about 200 ft. and the vertical limit is about 100 ft., due to the head on the radiators. The temperature of the water can be regulated to suit conditions, but the exposed surfaces are never unduly hot. With ordinary radiators, and with the average water temperature of 160° F., the emission is about 160 B.T.U. per sq. ft. of radiator surface per hour; of this about 15 per cent. is due to radiation, and the rest to convection.

The ordinary central heating boiler is moderately efficient; best efficiencies vary from about 55 per cent. in the smallest types to about 80 per cent. in the largest, but the average efficiency in service of boilers which are not continuously attended is considerably lower than these values. Also a great deal of heat is lost from the distributing mains, although part of this is, of course, utilised in raising the general temperature of the building. There is a considerable time lag in reaching the required conditions from cold, and some danger of freezing, with consequent fracturing of radiators, if systems are not in use during cold weather. The system, however, is comparatively cheap in running costs, and will remain in constant operation with comparatively little attention to the boilers, although some overheating is inevitable in mild weather.

Magazine types of boilers and various patterns of automatic stokers reduce attendance costs and can be equipped with automatic controls, which arrangement results in greatly improved efficiencies.

Gas boilers are about 80 per cent. efficient, and have the advantage that fuel delivery and ash removal are eliminated, and there is a complete absence of smoke. Their use depends upon the cost of gas.

Thermal Storage System

Electric boilers have been successfully adopted for central-heating installations when used in conjunction with what is called a "Thermal Storage System." In this arrangement the current is switched on only during the "off peak" hours of the electric supply undertaking and the heat generated is stored for use at other times. The supply authorities are usually willing to sell current for these systems at especially low rates, in some cases a fraction of a penny per unit. The fuel costs of an electrically heated thermal storage plant are thereby considerably lower than in a system using electricity at the ordinary charges. Moreover, savings can be made in the cost of building construction, as no chimney or fuel store is necessary. Labour charges are considerably reduced, as

the plant is practically automatic, and the value of the cleanliness resulting from the absence of smoke, dust and ashes cannot be disregarded.

Panel System

The panel system of heating consisting of flat grids of pipes embedded in walls or ceilings has been extensively used. The panels are generally laid on shuttering and cast solid in concrete, special finishing plaster being afterwards applied direct to the surface. The maximum temperature of the circulating water is about 120° F., but in the majority of installations it is found that temperature of the order of 95° F. is satisfactory during the greater part of the winter. Approximate emissions from panels, with a water temperature of 120° F., are as follows :—

Ceiling panels	100	B.T.U.	per	sq.	ft.	per	hour
Wall panels	115

Floor panels have advantages, but their efficiency is liable to be reduced by any form of floor covering, and their use is generally confined to entrance halls.

With water at 120° F. the emission from floor panels is 130° F. B.T.U. per sq. ft. per hour, but complaints of discomfort are received if floor temperatures are higher than about 75° F.

The advantages of the panel system are that the structure of the building becomes warm and the chilling effect of cold walls is avoided. Rooms are entirely clear of heating apparatus and the whole space is uniformly warm. There is no stuffiness due to the accumulation of dust on hot metallic surfaces and little discoloration of decoration. Maintenance and repairs are reduced to a minimum. The system can be thermostatically controlled and panel installations are found to be economical in fuel consumption. The disadvantage of panel heating is that ceiling panels (which is the form most widely used) are unsuitable in rooms less than 12 ft. high. Also the heating cannot be readily regulated in accordance with outside conditions.

Low-Pressure Steam

Steam systems are becoming more widely used in this country. They have several advantages, being cheaper in first cost than a hot water installation. Also there is no time lag or risk of freezing, and the system is applicable to buildings of any height. Disadvantages are that the surfaces are at high temperature so that there is intense heat in the vicinity of the radiator and the high temperature of the system increases the distribution loss. Steam boilers require continuous attention and it is not possible to regulate temperature in the radiators as can be done with hot water systems. There are many types of installation, but practically all of them are noisy at times. The emission from steam

radiators is about 300 B.T.U. per sq. ft. per hour. Steam systems under vacuum are also used, the temperature in these being lower. These are higher in first cost, but permit of a wide range of control.

The following figures show the approximate temperatures of vapour under various degrees of vacuum :

<i>Degree of Vacuum (Inches of Mercury)</i>	<i>Temperature of Vapour</i>
—	212° F.
5	200° F.
10	195° F.
20	160° F.
25	130° F.

High-Temperature Hot Water

At one time the Perkins system of hot water heating, at about 700° F., was widely used, a strong pipe coil being placed directly in the furnace. It is obsolete, but has been to some extent replaced by high-temperature hot water which is taken from a steam boiler at a temperature between 300° to 400° F. Surfaces at this temperature must not be within reach and the system is therefore mainly used in factories, etc., in conjunction with unit heaters. Small pipes only are required and the system is extremely rapid in action.

Hot Air Furnaces

Hot air furnaces or "pipeless heaters" are very suitable for the warming of some large spaces. Usually they consist of a cast-iron combustion chamber, surrounded by a steel jacket, air being drawn through the intervening space and discharged through a grating or ductwork. As a rule re-circulation of the hot air is arranged. This system of heating is cheap, both in first cost and operation. It is also rapid in action, but has the disadvantage that walls remain comparatively cold, and some dust is distributed.

Pipe Coils

Pipe coils at high level are sometimes used in factories. They are very unsatisfactory as a great deal of the heat emitted rises vertically and is largely lost, and floors remain comparatively cold. A pipe coil, however, should always be underneath a roof-light or roof lantern to temper the cold draughts which would otherwise occur.

Unit Heaters

Unit heaters of various types are made. These consist of coils through which hot water or steam is circulated and a fan which draws

air over the heating elements, both floor types (with centrifugal fans) and suspended types (with propeller fans) being manufactured. Unit heaters at high level require careful positioning in order to achieve the most satisfactory results, and both types may be very wasteful in fuel unless carefully controlled. Unit heaters are purely convective in effect : they are rapid in action, but have the same disadvantages as all air heaters.

Gas and electric unit heaters are also made.

Plenum Heating

With plenum heating the requisite degree of warmth is obtained by means of heated air. This may be introduced at various temperatures and velocities, depending upon the conditions, but it is inadvisable to pass air over surfaces at too high a temperature. (For the ventilation of cinemas, etc., the L.C.C. regulations prescribe that the temperature of any surface used for warming air shall not be more than 250° F.)

Plenum heating installations are bulky, as a large volume of air is necessary to transmit the required amount of heat. The system has the disadvantage that the air temperature is liable to be higher than the boundary temperature and the hot air tends to rise to the upper part of the room. It is also more expensive than ordinary central heating.

Chapter III

THE HEAT REQUIREMENTS OF BUILDINGS

Heat Loss from Buildings

THE first step in designing a heating system is to estimate the amount of heat required. This will include the heat lost by transmission through the walls, windows and roof, and, in some cases, through the floor, and the heat required to warm the air admitted for ventilation. A large amount of useful information on the subject is contained in a booklet published by the Institution of Heating and Ventilating Engineers, entitled "The Computation of the Heat Requirements in Buildings." Some of the values given in this Chapter are taken, by kind permission of the Institution, from that publication, to which the reader is referred for any further details which he may require.

As a rough rule for preliminary estimates applying to normal buildings, from 2 to 4 B.T.U. may be allowed for each cubic foot of heated space, depending on the locality and degree of exposure of the building. Another approximate formula for estimating heat requirements is :

$$H = (.25 A + S + .02 NC) R$$

where H is heat in B.T.U. per hour,

A is area of wall and ceiling in direct contact with outside air,

S is area of glass in windows or skylights,

N is number of air changes per hour,

C is volume of heated space in cubic feet,

R is temperature rise required, i.e. the difference between the inside and outside temperatures.

For more accurate estimates, the actual amount of heat lost in different directions must be calculated, and this involves a knowledge of the thermal transmittance of various parts of the structure.

Also in some cases it is necessary to allow for the heat produced by occupation, and the following figures are usually taken :

Per person	400 B.T.U. per hour.
Per horsepower in machinery	..	2.550
Per kilowatt of lighting	3.410

Temperature Required

Heating systems are generally designed on the basis of an outside temperature of 30° F.

The following Table shows the usual temperatures provided in various classes of building :

TABLE 1.—TEMPERATURES REQUIRED IN BUILDINGS

	° F.
Residences	60-65
Public buildings	58-62
Cinemas and theatres	55-60
Restaurants	60-65
Factories, heavy work	55
.. light	60
.. sedentary work	65
Garages	45
Schools	60
Warehouses	50-55
Offices	60-65

Thermal Transmittance

Thermal transmittance has already been defined as the amount of heat in B.T.U. per hour passing through any type of material or construction when the temperatures of the air adjoining the inner and the outer face differ by 1° F. It is denoted by U, and in practice values are generally obtained from published tables. The following values of U relate to normal exposures. (For sheltered or severe exposures the values are somewhat different.)

TABLE 2.—RATE OF HEAT LOSS (U) PER HOUR PER SQ. FT. PER 1° F. DIFFERENCE BETWEEN INSIDE AND OUTSIDE AIR TEMPERATURES

	U
<i>(a) Walls—</i>	
4½ in. brick, unplastered	0.64
9 in.	0.47
13½ in.	0.37
4½ in. brick, plastered one side	0.57
9 in.	0.43
13½ in.	0.35
11 in. brick, with 2 in. cavity	0.30
15½ in.	0.26
4 in. concrete	0.64
6 in.	0.54
8 in.	0.47
10 in.	0.41
<i>(b) Windows, etc.—</i>	
Single glass windows	1.00
Double	0.50
Skylight	1.20
<i>(c) Doors—</i>	
Wood, average, 1 in.	0.50
.. .. 1½ in.	0.40
<i>(d) Floors—</i>	
Concrete on earth	0.20
Ventilated wood floor on joists	0.30-0.40

(continued over)

TABLE 2 (contd.)

	Heat Flow	
	Downwards	Upwards
<i>(e) Intermediate Floors—</i>		
Wood floor on joists, plaster ceiling ..	0.22	0.29
6 in. concrete with 2 in. screed	0.43	0.54
6 in. with wood flooring	0.30	0.35
Hollow tiles, 6 in.	0.33	0.40
.. .. 8 in.	0.30	0.35
.. .. 10 in.	0.27	0.32
<i>(f) Roofs—</i>		
6 in. concrete, asphalted		0.57
6 in. asphalted and plastered		0.52
6 in. hollow tile, asphalted		0.48
Plaster ceiling with roof over—		
<i>(a)</i> With tiles and battens		0.56
<i>(b)</i> With tiles or slates on boards and felted		0.30

Calculation of Thermal Transmittance

It is useful to know how the values of U are calculated as the heating engineer can then make his own estimates for any type of construction which he may encounter.

As previously stated, heat losses through structures are usually calculated in terms of thermal resistance. The thermal conductivity (*k*) of materials has already been defined. The "thermal transmittance" (usually denoted by U) is the number of B.T.U. per hour transmitted through a square foot of construction when the temperature of the inner and outer air differs by 1° F. The inverse of this quantity is known as the "thermal resistance," usually denoted by R; this obviously is the number of hours required for the transmission of 1 B.T.U. through a square foot of the construction when the air temperatures differ by 1° F. as before. Thus $U = 1/R$.

From the definition of thermal conductivity it follows that the amount of heat passing through a slab of thickness *L* and conductivity *k* when the temperatures of the opposite faces differ by 1° F. is

$$\frac{k}{L} \text{ B.T.U. per sq. ft. per hour.}$$

Normally the temperature of each face will not be the same as that of the contiguous air, so that heat will be received or lost by radiation and convection in accordance with the expressions already given.

Surface Resistance

To express the heat flow in terms of the air temperature, it is necessary to take into account the "surface resistance." If the surface resistance of the inner and outer surfaces are denoted by *R*₁ and *R*₀ respectively, the thermal resistance of a composite wall is given by the formula $R = R_1 + R_0 + L_1/k_1 + L_2/k_2 + \dots$ where *L*₁, *L*₂, etc., are the thickness in inches of the individual components of the

structure, and k_1, k_2 are the conductivities of the respective materials.

It may be mentioned that, in the case of thin structures such as corrugated iron, the heat loss is governed mainly by the surface coefficients, as the thermal resistance of the iron is negligible. Conversely, in the case of a thick wall of low conductivity, for which the value of $\frac{L}{k}$ is large, surface resistance has comparatively little effect; the surface temperatures in this case approximate to those of the contiguous air.

In ordinary cases, values of surface resistance may be taken as follows:

Walls—

External surface (plane)	0.30
Internal surface (plane)	0.70

Roofs—

External surface (corrugated)	0.20
" " (plane)	0.25
Internal surface (corrugated)	0.48
" " (plane)	0.60

If an air space is incorporated in the structure it is necessary to add the thermal resistance of this: the following values may be taken:

Air space (minimum width $\frac{3}{4}$ in.) between plane surfaces	1.0
Air space (minimum width $\frac{3}{4}$ in.) between one plane and one corrugated surface	0.9
Air space between plane and corrugated surfaces in contact	0.5

Some typical values of U and R for building materials are shown in Table 3.

TABLE 3

	<i>Material</i>	<i>U</i>	<i>R</i>
Walls	4" concrete	0.64	1.56
	6" concrete	0.54	1.85
	4½" brick	0.64	1.56
	9" brick	0.47	2.13
	13½" brick	0.37	2.71
	11" cavity brick	0.30	3.33
	15½" cavity brick	0.26	3.84
Roofs	Corrugated iron (pitched)	1.50	0.67
	Corrugated asbestos cement (pitched)	1.40	0.71
	½" asbestos cement tiles (pitched)	1.02	0.98
	4" concrete (flat) asphalted	0.68	1.47
	6" concrete (flat) asphalted	0.57	1.75

Thus for a 9 in. brick wall ($k = 8$),

$$R = 0.30 + 0.70 + \frac{9}{8} = 2.125$$

$$\therefore U \left(= \frac{1}{R} \right) = \frac{1}{2.125} = 0.47$$

If the wall has plaster $\frac{3}{4}$ in. thick ($k = 4$) on one side,

$$R = 2.125 + \frac{3}{4} \times \frac{1}{4} = 2.31$$

$$\therefore U = \frac{1}{2.31} = 0.43$$

For a cavity wall consisting of $4\frac{1}{2}$ in. brickwork on either side of an air space, the resistance is that of 9 in. of brickwork (plastered on one side) found as above to be 2.31, plus the resistance of the air space, value 1. The total resistance is thus $2.31 + 1$, or 3.31, and the thermal transmission is $\frac{1}{3.31}$, or 0.30.

Structural Insulation

The heat requirements of a building may be substantially reduced by structural insulation. This is particularly true of buildings such as single-storey factories with a large expanse of roof. Often such a roof is of a light nature, and the loss of heat in consequence is enormous.

As an example of the economies effected by insulation, the case of a factory roof, 10,000 sq. ft. in area, may be taken. If this is of corrugated asbestos cement (*a*) uninsulated, and (*b*) lined with fibre board $\frac{1}{2}$ in. thick, comparative figures are as follows :—

	<i>Uninsulated</i>	<i>Insulated</i>
Amount of radiator surface to provide for heat transmission through roof (30° F. to 60° F.)	2,250 sq. ft.	470 sq. ft.
Approximate cost of ditto	£750	£155
Approximate fuel consumption per annum	80 tons	17 tons
Annual fuel cost (at £3 per ton)	£240	£50

The cost of lining the roof would probably be about £500, so that the economic value of insulation is obvious.

Structural insulation is considered in more detail in Chapter XII.

Heat Required for Air Change

An important part of the heat requirements of buildings is that required to warm the fresh air admitted for ventilation. Appropriate allowances, relating to the number of complete air changes per hour, in the heated space, are shown in the following Table :

HEATING AND VENTILATING

TABLE 4.—AIR CHANGES IN BUILDINGS

	<i>Per Hour</i>
Residences	1-2
Public buildings	1-3
Cinemas and theatres	1*
Restaurants	1-4
Factories (ordinary)	$\frac{1}{2}$ -2 $\frac{1}{2}$
Garages	5
Schools	3
Warehouses	$\frac{1}{2}$ -1
Offices	1 $\frac{1}{2}$ -2

Each cubic foot of air admitted requires about .02 B.T.U. to raise its temperature 1° F. The actual air change to be allowed in any particular case must be carefully considered, as if this is exceeded the heating installation will be inadequate to maintain the required temperature in cold weather.

In general, every additional air change increases the heat requirements by 15 to 20 per cent., and excessive ventilation must therefore be avoided.

An important point is that if doors and windows in a building do not fit tightly the rate of air interchange is greatly increased, particularly with high winds. Some figures of infiltration, per foot run of crevice, with a 15 m.p.h. wind, are 110 cu. ft. per hour with a wooden sash window and 52 cu. ft. per hour with a steel frame window.

Allowance for Abnormal Height

The calculated heat requirements should be increased by 1 per cent. for every foot of height of the heated space above 12 ft. up to 40 ft.

Allowance for Aspect and Exposure

To the heat requirements estimated from the thermal transmission an allowance should be made if the exposure of the building to wind and weather is abnormal. Such an allowance might apply to buildings on the coast or on hillsides, and to the upper storeys of high buildings in towns.

Appropriate allowances are given in Table 5.

TABLE 5.—ALLOWANCES FOR EXPOSURE

<i>Aspect of Room or Building</i>	<i>Increase per cent.</i>
N., N.W., N.E., or E.	15
W., S.W., or S.E.	10
Corner rooms (additional)	5
Flat roofs (additional)	20

* In some localities, the ventilation rate is prescribed by Regulations, e.g. in London fresh air must be supplied at the rate of 1,000 cu. ft. per hour per head of the audience.

For buildings not unduly exposed, 10 per cent. should be added to the transmission losses for N. and N.E. aspects.

Allowance for Intermittent Heating

In the majority of cases heating is intermittent, i.e. boilers are banked at nights and at other times when the building is unoccupied. The temperature in the building falls in consequence, and in order to restore it to the required level within a comparatively short period of preheating it is necessary to make an addition to the heat requirements as estimated for the particular case.

Appropriate allowances for buildings of normal construction, heated by means of low-pressure hot water, are shown in Table 6.

TABLE 6.—ALLOWANCES FOR INTERMITTENT HEATING

<i>Preheating Period Hours</i>	<i>Days Occupied per Week</i>	
	7	5½
3	15 per cent.	25 per cent.
6	10 „ „	15 „ „

Heat requirements calculated in this way are somewhat liberal, but a heating installation which is inadequate for its duty is a continual source of discomfort and complaint, and every care must be taken when designing a system to ensure that the amount of heating surface provided is sufficient. A generous provision of heating surface enables the required conditions to be met with comparatively moderate temperatures of the circulating water: this results in more efficient operation of the boiler.

Boiler Capacity

The boiler should provide the required B.T.U. output, including all the allowances as explained above. This loading is based upon an external temperature of 30° F., and to provide a margin for occasions when lower temperatures are experienced, and also to prevent the boiler being unduly “forced,” with a consequent risk of damage, an addition, usually of 25 per cent., is made to the calculated requirements. A boiler to give this output is selected from the ratings given in makers’ catalogues.

Example of Calculation

As an example of the calculation of heat requirements, consider the case of a two-storey block 100 ft. long and 30 ft. wide. The ground floor is a workshop, 15 ft. high, and the upper floor is used as offices, 10 ft. high. The main frontages face S. and N. A temperature of

60° F. is required in the workshop and 65° F. in the offices. The building is on the outskirts of a town, in an exposed position.

Constructional details are as follows :

Walls : 11 in. cavity brick.

Ground floor : 6 in. concrete direct on earth.

First floor : 6 in. concrete, with wood blocks.

Roof (flat) : 6 in. concrete, asphalted and plastered.

Windows, each 5 ft. × 4 ft., per floor : 10 in each long wall ; 3 in each end wall.

Doors (in each end wall of ground floor only) : 1½ in. wood, 2 each 8 ft. × 6 ft.

Air changes : Allow 2 in workshop and 1½ in offices.

Calculations for Ground Floor—

Area of each long wall	=	100	×	15	=	1,500	sq. ft.		
„ „ windows	=	10	×	5	×	4	=	200	„
∴ „ „ brickwork						1,300	„		
Area of each end wall	=	30	×	15	=	450	„		
„ „ windows	=	3	×	5	×	4	=	60	sq. ft.
„ „ doors	=	2	×	8	×	6	=	96	„
∴ „ „ brickwork						156	„		
						294	„		
Area of floor	=	100	×	30	=	3,000	„		
Cubic contents	=	100	×	30	×	15	=	45,000	cu. ft.

Heat Requirements for Ground Floor—

	Area	U	B.T.U. per hour per 1° F. difference	Total
South Wall—				
Brickwork	1,300	0.3	390	
Glass	200	1.0	200	
				590
				North wall, as south wall, plus 15% ..
				680
End Wall—				
Brickwork	294	0.3	88	
Glass	60	1.0	60	
Doors	96	0.4	38	
				186
				East wall, add 15%
				214
				West wall, add 10%
				204
Floor	3,000	0.2	600	
Air Change	45,000	× 2 × .02	1,800	
				4,088
				Additional allowance for height = 3%
				122
				Total
				4,210

∴ Heat required = $4,210 \times (60 - 30) = 126,300$ B.T.U. per hour.

Calculations for First Floor—

Area of each long wall	= 100 × 10	=	1,000 sq. ft.
" " windows		=	200 "
∴ " " brickwork		=	800 "
" " each end wall	= 30 × 10	=	300 sq. ft.
" " windows		=	60 "
∴ " " brickwork		=	240 "
" " floor (and roof)		=	3,000 "
Cubic contents	= 100 × 30 × 10	=	30,000 cu. ft.

Heat Requirements of First Floor—

	Area	×	U	=	B.T.U. per hour per 1° F. difference	Total
South Wall—						
Brickwork	800	..	0.3	..	240	
Glass	200	..	1.0	..	200	
					440	
						510
						North wall as south wall, plus 15% ..
End Wall—						
Brickwork	240	..	0.3	..	72	
Glass	60	..	1.0	..	60	
					132	
						152
						145
Roof	3,000	..	0.52	..	1,560	
						312
Air change	30,000 × 1½	..	0.2	..	900	
					4,019	
						Total for first floor ..

∴ Heat required = 4,019 × (65 — 30) = 140,000 B.T.U. per hour.

Total Heat Requirements—

Ground floor	126,300 B.T.U. per hour
First floor	140,000 " "
				266,300 " "
				Grand total ..

Notes : (i) In a building of this type, a 3-hour preheating period would probably be arranged, i.e. the boiler would be banked overnight and opened up 3 hours before the time of arrival of the staff. The heat requirements as found above should be increased by 25 per cent., making a total of about 335,000 B.T.U. per hour.

(ii) In this case, the upper storey is at a higher temperature than the lower storey, and, for the 5° F. difference, the heat leakage would be 3,000 × 0.30 × 5, or 4,500 B.T.U. per hour. Theoretically, the heat requirements of the upper storey should be increased, and those of the lower storey increased by this amount when estimating the actual heating surface to be installed in either portion. In practice, however, this might be neglected, particularly as the underside of the ceiling would be at a somewhat higher temperature than 60° F., owing to the tendency of hot air to rise. There would thus be very little transfer of heat downwards through the floor slab.

(iii) Allowing a margin of 25 per cent. on the boiler capacity, this should be rated at not less than 420,000 B.T.U. per hour.

Chapter IV

BOILERS, BOILER HOUSES AND BOILER INSTALLATION

THE most common type of boiler used for central heating by low-pressure hot water is the cast-iron or mild-steel sectional boiler, and there are many reasons for the engineer's choice of this type.

The variety of patterns and sizes available enables a suitable boiler of the correct rating to be selected for installations having heating loads of from 20,000 B.T.U. per hour and upwards by every few thousands to over 1,500,000 B.T.U. The boilers are cheap and efficient and their lifetime frequently exceeds 15 years. Repairs are easily effected by the replacement of the faulty section or sections; by the addition of sections the installation can be extended without having to replace the entire boiler. There is the additional advantage that where the only approach to the boiler-room is by means of a narrow passage or winding staircase, installation can be effected without cutting the building about—a very real and practical point in their favour.

The sections are tested by most manufacturers to a hydraulic pressure of 100 lb. per sq. in., so that the boilers are suitable for systems working under static heads up to 120 ft. Except for the very small patterns the boiler sections are assembled on site, and for their assembly push nipples are used, usually three for each section. In some types the sections are pulled close together so that there is a metal-to-metal contact, in others a space of about $\frac{3}{8}$ in. is left between them which is afterwards filled in by asbestos rope or boiler putty. Water-cooled firebars are a feature in the patterns of some manufacturers, while others continue to use the ordinary loose cast-iron firebar. Nearly all patterns can be fitted with insulated steel jackets, which are an improvement on unprotected plastic non-conducting composition in that there is less possibility of damage to the boiler insulation.

The heating surface of a boiler may be classified under two headings, Primary and Secondary. The primary surface is that which receives the heat direct from the fire and the secondary surface is that which receives the heat from the gases on their way from the firebox to the chimney. In the cast-iron heating boiler approximately 50 per cent. of the surface is primary, and the remaining 50 per cent. is the secondary surface in the boiler flues. The proportion of secondary surface is calculated to improve the efficiency of the boiler by reducing the temperature of the gases, which should leave the boiler at temperatures generally in the neighbourhood of 500° F. at full duty, although this figure is often lower at normal rates of operation. If much lower temperatures

were obtained the draught would be impaired and troubles might be experienced from condensation.

The efficiency of this type of boiler under laboratory test conditions is often as high as 75 per cent., but a percentage of 60 may be considered good for average hand-firing conditions.

Boiler Ratings

The B.T.U. output of any boiler is obviously dependent upon the amount of fuel burnt per hour, the calorific value of the fuel, and the capacity of the boiler to absorb the heat generated by the combustion of the fuel. As all these

factors are variable an agreed standard rating is desirable for the guidance of the engineer in his selection of a boiler. The makers' lists, therefore, give the heating capacity of cast-iron boilers based on a rated transmission of 4,400 B.T.U. per hour per sq. ft. of heating surface in the boiler. This figure is used as representative of the average rate of transmission under normal working conditions and for a fuel charge once in 6 hours.

It is good practice to add at least 25 per cent. to the net requirements of a heating system in a small installation and not less than 10 per cent. in the case of larger boilers when calculating the boiler power; this will make certain that the boiler is of ample capacity for the installation even under the most severe winter conditions. It is important to say that these percentages are added after all losses from circulating pipes have been included, as well as the head transmitted from radiators, etc.

Magazine Boilers

The initial cost of an automatic stoker plus the cost of a boiler for automatic firing equipment has resulted in the development of the magazine or gravity-feed boiler, but the stoker-fired boiler has certain definite advantages which are discussed on p. 37.

In this type of boiler, the fuel, which may be either coke or anthracite, is placed in the boiler in sufficient quantities for a continuous firing

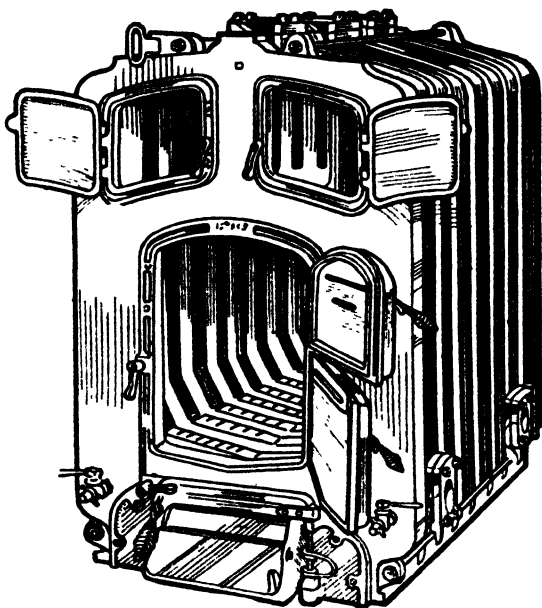

Fig. 1.—CAST-IRON BOILER BUILT UP IN SECTIONS

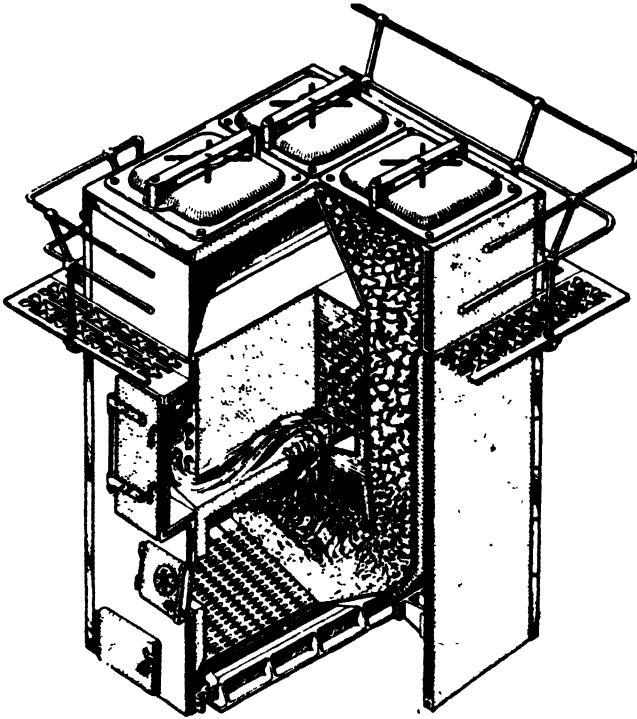

Fig. 2.—TYPICAL EXAMPLE OF MAGAZINE OR GRAVITY
FEED BOILER

period of perhaps 10 or 12 and sometimes 24 hours, and feeds automatically on to the grate according to the rate of combustion.

The draught is sometimes maintained by a motor-driven fan, which, as it can be controlled by electrically operated thermostats, regulates the volume of air. The quantity of air delivered to the grate obviously affects the combustion of the fuel, and the heat output is therefore regulated by varying the air-supply.

In boilers designed for natural draught, a thermostatically

controlled damper is actuated to control the volume of air. In the various designs now available, there are individual features which the makers claim are distinctive and improvements upon the designs of boilers of rival manufacture. The underlying principles common to all, however, are automatically controlled combustion and fuel storage by which hand firing is eliminated, and the boiler attendant's services are required only intermittently.

Test results show very high percentages of efficiency; 75 to 90 per cent. is said to be realised. The claims made that running costs are exceptionally low, in both fuel and labour, may, therefore, be considered justifiable.

Where possible, the fuel store is situated immediately above the boiler chamber, and chutes are arranged to discharge directly into the fuel space in the boiler.

Boiler Fittings

The usual mountings for any well-designed hot-water boiler installa-

tion should comprise a safety valve, thermometer, altitude gauge, damper regulator and emptying cock.

Safety Valve.—The safety valve should be of ample area at the valve seat, and loaded to approximately 10 lb. pressure excess of the actual working head, but not exceeding the boiler test pressure. It should be attached directly to the boiler without any intervening fitting such as a valve.

Thermometer.—The thermometer should be graduated from 60° F. to 240° F. and should have the bulb encased in a metal pocket to withstand the pressure. Care should be taken that, when fitted, the pocket is immersed in the water and that it is filled with mercury. It is usual to fix the thermometer at the front of the boiler where it can be easily read, but a more correct reading of the actual flow temperature is obtained by fixing it close to the flow-pipe branch or in the flow pipe itself.

Thermometers are essential to all hot-water heating systems, and not only enable the temperature of the water to be determined accurately, but also indicate whether the boiler has been overfired. When boilers are coupled, it is desirable to have a thermometer fitted in the flow header and another in the return manifold, besides one on each boiler. In this way the operator is able to keep a record of the working of all the boilers and so ensure that each is working to its maximum efficiency.

Thermometers sometimes get broken. It is quite simple to fix another whilst the boilers are working, provided that mercury wells are fitted to receive the stem of the thermometer. A mercury well consists of an iron cup, threaded and screwed into the boiler or manifold. It is screwed 1-in. iron pipe thread and makes a water-tight joint. A little mercury is emptied into the well and the stem of the thermometer, which is screwed $\frac{1}{2}$ in., is threaded into the mercury well. Thus, if at any time a thermometer gets broken, it can be replaced without emptying down. Some boiler makers only tap their boilers $\frac{1}{2}$ in. for thermometers and the tapping 1 in. for mercury-well thermometers must be specially ordered.

Altitude Gauge.—An altitude gauge is an indicator of the pressure or head of water at the boiler and is constructed in the same way as the ordinary steam-pressure gauge. The dial should be graduated in feet-head of water to approximately twice the working head, and fitted with a red pointer. As with safety valves, altitude gauges should be fixed so that direct contact is made with the water in the boilers. The red pointer is adjusted to the normal pressure and acts as an indicator of the correct working head.

If the water-level falls or excessive pressures are set up, the position of the black pointer either to the left or right of the red pointer gives

warning to the attendant that investigation is necessary to locate the cause of these vagaries.

Automatic Damper Regulator.—The automatic damper regulator is a useful fitting to include in the list of boiler mountings, as by it the air supply to the grate is controlled and the rate of combustion regulated. The regulator is screwed into a tapping at the top of the front boiler section and is fitted with a movable lever. A chain attached to the lever is hooked to a hinged draught-door fitted to the boiler ashpit door. As the temperature of the boiler increases or decreases the lever arm drops or rises and actuates the draught-door, so that the air supply is regulated accordingly.

Various Types of Sectional Boilers

Most sectional boilers have the sections joined together by means of "ground-in" taper nipples; some, however, are connected with flanged headers fixed on the outside of the boiler itself. Fig. 3 illustrates a cast-iron sectional boiler fitted with taper nipples. The sections are held together with bolts and nuts; there are four bolts to each section, viz., two at the top and one on each side at the bottom.

Fig. 4 shows a cast-iron sectional boiler also with taper nipples, but instead of having four bolts to each section only four bolts are used for the whole number of sections, being long enough to pass through the whole length of the boiler.

Fig. 5 is of a mild-steel sectional boiler and the sections are connected together on the outside by means of flanged flow and return headers.

Another type of magazine boiler is shown in Fig. 6; this being of cast-iron and sectional has the same advantages as the other sectional boilers described. The fire-bars are water cooled and the illustration is self-explanatory. The boilers are made with the fuel space either on the right-hand side or on the left.

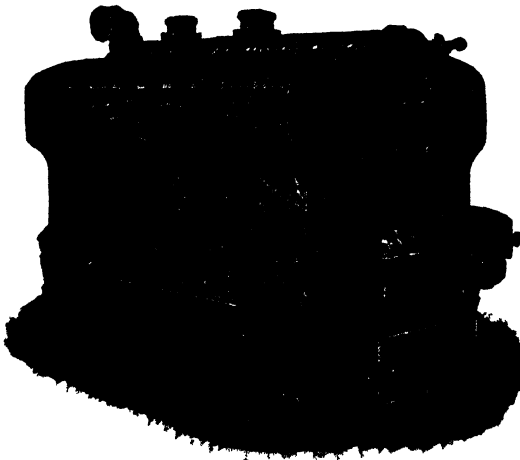

Fig. 3.—CAST-IRON SECTIONAL HEATING BOILER

Coupling Magazine Boilers Together

When it is desired to have two boilers coupled together as previously described, these are very adaptable, and the illustra-

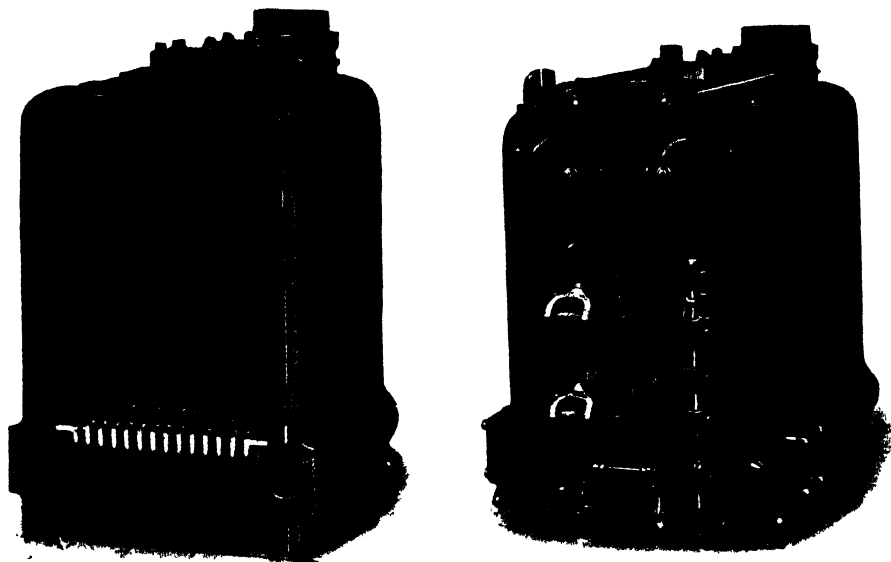

Fig. 4.—CAST-IRON SECTIONAL BOILER IN THE COURSE OF ERECTION AND COMPLETED READY FOR COUPLING-UP. THE SECTIONS ARE HELD TOGETHER BY FOUR LONG BOLTS WHICH PASS THROUGH THE WHOLE LENGTH OF THE BOILER

(Hartley & Sugden, Ltd.)

tion, Fig. 7, shows two boilers fitted close together with the magazine in the centre.

ERECTION OF SECTIONAL BOILERS

Setting Out the Foundation

The detail drawing of the boiler-room will show whether the boiler is to stand at the floor level or on a raised base of brickwork or concrete. This foundation or base must be prepared and set thoroughly before the boiler is placed upon it. It is essential that it should be level.

The building of the base is carried out by a bricklayer, but the heating engineer must set it out on a drawing, or on the floor if one exists, as it is essential that it should be in the correct position.

When only one boiler is to be installed it may not matter if the base is a little out of centre, but where several boilers are to be used in the form of a battery then the position is of great importance. It must be realised that the boiler headers, coupling pipes, etc., are probably being made to suit the detail drawing, and all dimensions must be strictly adhered to.

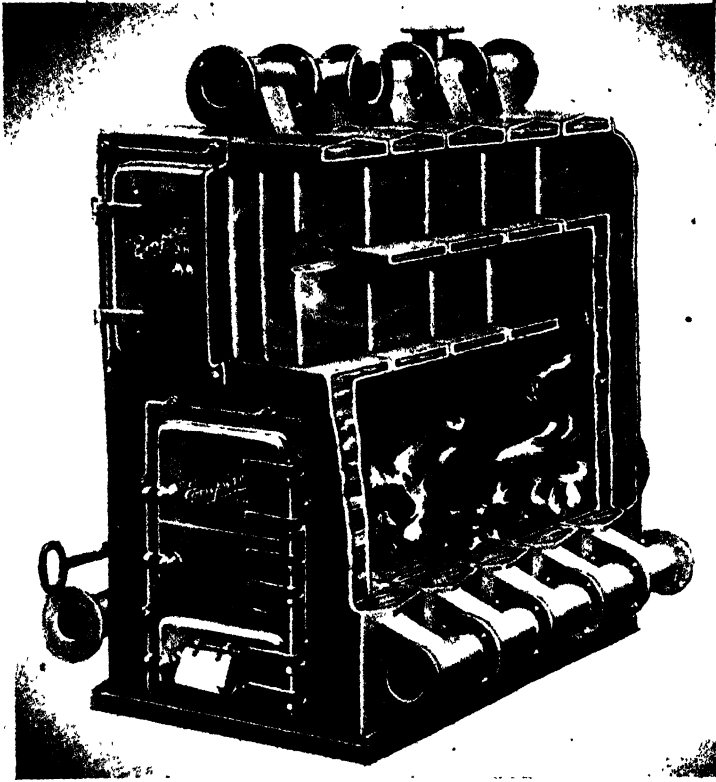

Fig. 5 —ANOTHER TYPE OF SECTIONAL STEEL BOILER IN WHICH THE SECTIONS ARE HELD TOGETHER BY MEANS OF FLANGED FLOW AND RETURN HEADERS

Marking Out Position of Boiler Stand

After having made sure that the brickwork base is set hard enough the exact position of the outside of the boiler stand should be marked on it in chalk. This will save time in having to make sundry measurements to ascertain if the stand is still in the correct position.

Placing First Section in Position

Assuming that the boiler is to be erected from the back (see instructions sent with boiler), place the back section in position and held up or strutted so that it will not fall. Clean out the port holes in the section with an oily rag or cotton waste, also clean a set of nipples likewise. Smear the nipples and the port holes with thin red-lead paint and place one nipple in each hole and tap it into position by placing a piece of wood on the nipple and striking with a hammer gently.



Fig. 6. — SECTION OF
MAGAZINE BOILER
(*Ideal Boilers and Radiators, Ltd.*)

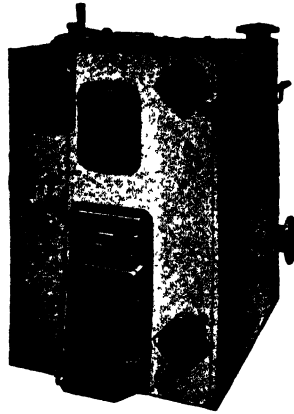

Fig. 6A. — EXTERIOR OF
MAGAZINE BOILER
(*Ideal Boilers and Radiators, Ltd.*)

Joining on other Sections

Take the next section, clean out the port holes and place it in position next to the back section and on to the nipples already in place. Gently tap the section on with a piece of wood and bolt up. The sections, when all are bolted together, will have a space between them; they are not intended to touch and should not be bolted up too tight.

A set of nipples should now be placed in position in the last section now on the stand as previously described, and another section fitted. Follow on until all the sections are in position and bolted up.

The measurements are then checked to make sure that the boiler is in its correct position. If it has shifted at all it must be levered into position carefully.

The smoke-box should next be fitted together with the damper and rod.

Fitting Doors, Fire-bars, Etc.

All other parts should now be fitted, such as the doors, fire-bars, if any (some boilers have fire-bars water cooled cast on to the sections): See that all doors work easily and



Fig. 7. — SECTIONAL VIEW OF TWO MAGAZINE
BOILERS COUPLED TOGETHER
(*Ideal Boilers and Radiators, Ltd.*)
Note the magazine in the centre.

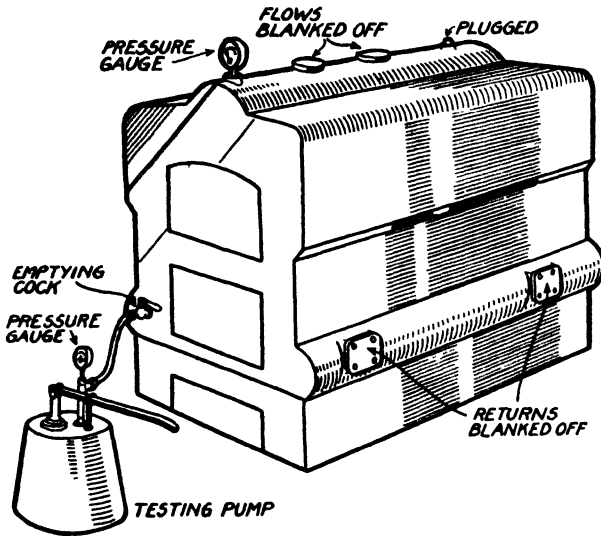

Fig. 8.—BOILER UNDER TEST

All other openings will require blanking or plugging off and sufficient blank flanges and plugs must be at hand.

After plugging off the return connections, the boiler can be filled with water by means of a hose through one of the flow connections. It is as well to leave sufficient openings on top of the boiler for the escape of air.

When the boiler is filled, the remainder of the openings must be sealed off before the pump test is applied. A pressure gauge is screwed into a tapping on top of the boiler; this gauge is in addition to the one on the pump.

When all is sealed off, pumping can be started and the emptying cock opened. Very little water pumped in will cause the gauge to start to register. When it registers about 30 lb. pressure pumping should be stopped and the boiler examined to ascertain if it is sound at that pressure. If all is in order and no sign of leakage the pumping should be proceeded with until the test pressure is reached—this may be 50 lb. or more according to the height of the building; or it may have to be tested to 100 lb. as is usually done at the boiler-makers' works; however, the boiler inspector generally determines the pressure for the test.

After a predetermined time for the test has elapsed and the gauge has not altered, the boiler has proved its soundness and should be emptied out.

The work of connecting up to the mains, headers, etc., can then be proceeded with, not forgetting the insulating jacket, etc., if one is provided with the boiler.

close properly. Place the emptying cock in position.

Cover up the flow and return connections to keep dirt from getting into the waterways of the boiler.

When boilers are supplied with "insulating jackets" these should not be fitted until the boiler has been tested.

A pressure-testing pump will be required for the purpose which can be connected on to the emptying cock on front of the boiler.

Testing Battery of Boilers—A Useful Hint

Where a battery of boilers is being installed they can all be erected and prepared ready for the test. While one is under pressure the emptying cock can be closed, the pump removed and attached to the next one and so on until all the boilers have been tested separately. By doing it this way there is a great saving of time, and although more blanks and plugs are required it enables the boiler inspector to see all the boilers tested at one visit.

COUPLED BOILERS

When one boiler is not large enough to do the work required extra power is obtained by joining two or more together. These can be either spaced apart, as Fig. 9, or if space is limited, they can be close together, as Fig. 10.

When boilers are coupled together, they should be valved so that either boiler can be worked separately or together, and in the event of a breakdown, any boiler can be isolated.

Flow and Return Connections

In coupling boilers together, the flow pipes off the tops of the boilers are generally brought into a "header" or "trunk," fixed in a convenient position towards the front of the boiler, and the flow mains serving the various parts of the building are taken off the "header."

The return connections of the boilers are invariably carried into a "return header," situated behind the boilers. The return mains from the building are sometimes connected to the return header. On occasion it is found more convenient to continue the return header at one end and form a "manifold," where all the returns are connected (Fig. 9).

Main Valves

The valves on the boilers and all mains in the boiler house should be "full-way" pattern and preferably flanged ends, which facilitate con-

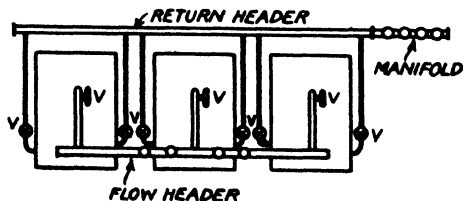

Fig. 9.—METHOD OF COUPLING BOILERS

Note where valves are placed on connections. Valves are also placed on the four flow outlets and four returns on manifold.

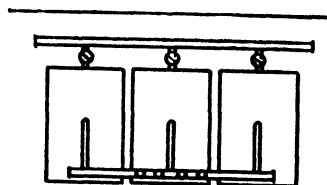

Fig. 10.—COUPLED BOILERS, FITTED CLOSE TOGETHER IF SPACE IS LIMITED

nection and disconnection at any time by merely undoing a few bolts and nuts.

Valves which have a locking device to prevent misuse are to be preferred, or some other means adopted to ensure that no unauthorised person will tamper with them. A chain and padlock is sometimes found sufficient for this purpose ; the chain is passed through the wheels of the valves and padlocked up so that they cannot be turned.

Safety Valves

Every boiler should be fitted with a safety valve, which should be suitably weighted for its particular job, the makers should be notified of its particular duty, such as the size of boiler it has to be fitted to, and the height of the level of water in the feed tank. It will then be sent, suitably balanced, to ensure of its functioning when called upon.

Safety Pipes for Boilers

When boilers are coupled together, or when boilers have valves on the flow and return connections, it is desirable to have a " safety pipe " in addition to the safety valve. This consists of a separate pipe, taken direct off the top of the boiler and carried up in as direct a line as possible, to above the level of the water in the feed tank. This safety pipe is generally $1\frac{1}{4}$ in. or $1\frac{1}{2}$ in., according to the power of the boiler. The object of this pipe is that if in the event of forgetfulness the valves of a boiler were left closed, say, after repairs or overhauls had taken place, it would come into operation and relieve the safety valve somewhat.

Coupled Safety Pipes

When it is not desired to run a separate safety pipe up off each boiler, all the separate ones off each boiler can be connected into a main pipe ; each branch from the boilers, however, would have to be fitted with a non-return valve, which only lets water pass one way and would be fitted so that it opened to allow the water to pass from the boiler, and close so that no water can enter the boiler through it.

Importance of Regularly Testing and Operating Main Valves

When main valves on the boilers and those controlling the main circuits are not used for long periods they are liable to get pitted on their faces, also furred up so that they cannot be moved. Sludge also gets in the workings and prevents the valve closing. When a job has been well valved, and after it has had several years running, it is not at all uncommon to find that when one wants to make an inspection or repair the valves will not hold the water up, and the whole system has to be emptied down to attend to the faulty valves first.

This can be obviated by having all the valves operated a few times at stated periods, say every two or three months. This will help to keep the faces clean and ensure the valves being able to hold up when required.

Boiler-emptying Cocks

Plug cocks or gland cocks are fitted to all boilers and are only intended for use when the boilers (or any single boiler) need emptying out. If preferred, all the emptying pipes can be connected into one common pipe and run out to the nearest gully or drain, or the cocks can be fitted with a hose union and a length of hose attached, and run to drain.

Automatic Stokers.

Where automatic firing by solid rather than liquid fuel is to be provided, there is a number of automatic stoking machines now available. The most common type is the under-feed pattern, which conveys the coal from a hopper or container to a retort fixed below the fire inside the boiler. The conveyor is a large screw or worm, driven from a motor which also drives a fan for the air supply. The various components are assembled to form one unit, which is placed at the front or side of the boiler. The side is the better position, as it gives an unobstructed access to the firepot for the removal of clinker.

The hopper is of stout sheet steel, and should have a capacity equal to approximately twelve hours' fuel consumption. The worm conveyor passes through the hopper at the bottom and terminates at the retort. The coal is carried in a stream by the conveyor to the bottom of the

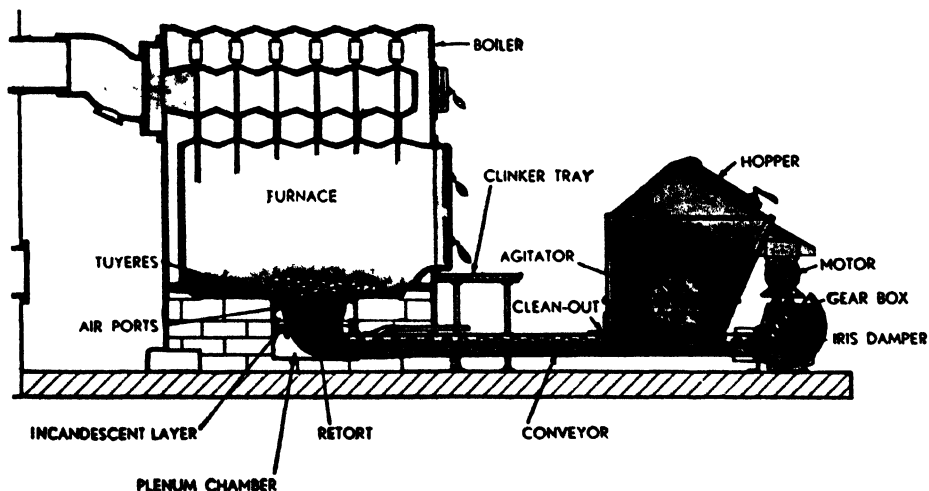

Fig. 11.—LAYOUT FOR AUTOMATIC STOKER FIRING OF SECTIONAL BOILER



Fig. 12.—CENTRAL HEATING BOILERS, AUTOMATICALLY STOKED, AT THE POOR LAW INSTITUTION, TAMWORTH

retort, where it is pushed upward. The fire is therefore fed from beneath the incandescent top layer, and the fresh fuel is gradually heated in its approach to the fire. An air supply is maintained through ports in the upper part of the retort, and this, mixing with the gases from the heated coal, forms a combustible mixture which is ignited on passing through the incandescent coals. The complete combustion thus obtained eliminates smoke and increases the efficiency of the plant.

Bituminous or anthracite coals can be burnt satisfactorily, and the only attention necessary is to fill the hopper and remove the accumulation of clinker once or twice daily.

Thermostatic and/or pressure controls and relay switches are provided to permit of automatic operation.

In addition, a time switch is usually fitted. This automatically starts the machine running for a few minutes at set intervals. By such means the fire is kept alight when the stoker has been cut out for long periods by the room thermostat. It is also used to operate the stoker intermittently during the night or week-ends.

Gravity Fed or Magazine Boilers : Fuel Storage

The gravity-fed or magazine type of boiler is being used where a fuel store can be placed above the boiler; a magazine is fitted to the boiler which can be made to hold fuel to last for 24 hours if needed. The firing is automatically controlled.

There are several types of magazine boilers obtainable, some of steel and some also made of cast-iron.

This is placed immediately over the boiler and the fuel runs down a chute into the magazine. The chute is fitted with a guillotine shutter, and when the boiler needs more fuel the sliding door on the top of the boiler is opened, the guillotine shutter is pulled aside and the fuel runs out of the chute into the magazine of the boiler.

When sufficient fuel is obtained the guillotine is closed and the sliding door on top of the boiler closed also until the next charging time.

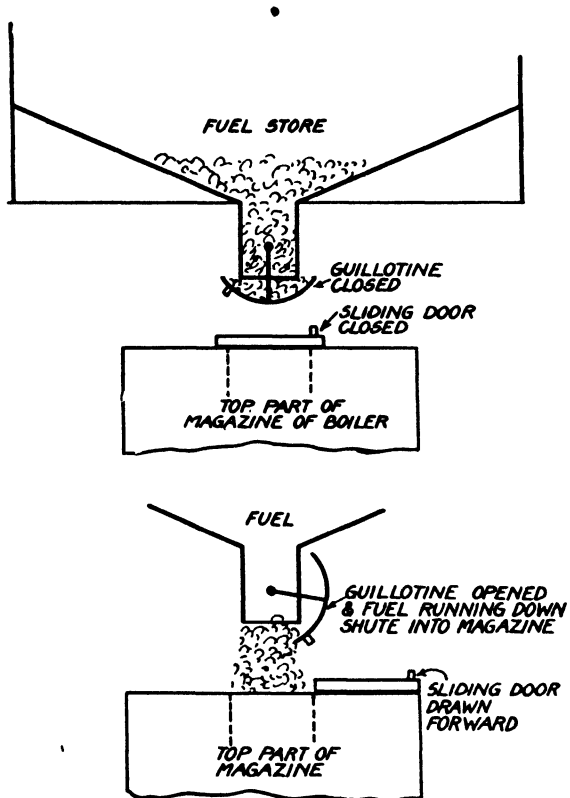

Fig 13. -- FUEL STORE FOR GRAVITY-FED BOILER

THE BOILER HOUSE

The boiler house is generally placed at a lower level than the radiators, such as in a basement or cellar. At times it is possible to situate it centrally within the building so as to shorten the length of the mains as much as possible. Failing this the boiler can, of course, be placed at ground level, and at the end of the building. The position of the boiler governs, to a large extent, the system to be adopted, whether a drop system, up-fed system, accelerated, or a forced circulating system.

There are many factors that have to be taken into account in choosing the site for the boilers.

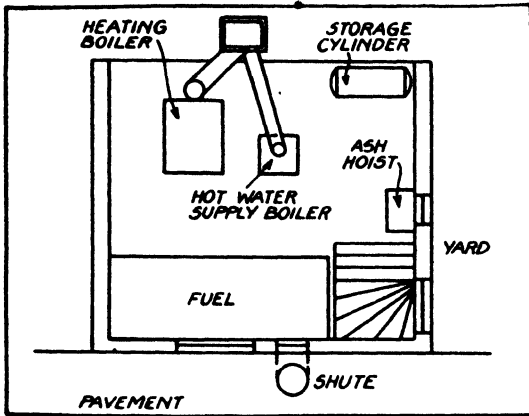

Fig. 14.—PLAN OF BOILER HOUSE IN MEDIUM-SIZED HOUSE

Plenty of room is allowed for stoking and sweeping chimney. Note provisions for handling fuel and ash. The window gives the necessary light and air.

is the most efficient, and if a square or rectangular flue is used, approximately 80 per cent. should be taken of the total area and regarded as effective. The ratio between the length and breadth of a rectangular flue should not be greater than 3 to 2.

The height and position of the chimney must be carefully considered, and if down-draughts are to be avoided the top should extend above the ridge level of the roof. Surrounding high buildings or trees may often be the unsuspected causes of down-draughts (Fig. 15).

It is very important that all joints in the brickwork are airtight and that this is understood by the builder employed to build in the iron smoke pipe from the boiler. Care should also be taken to see that the end of the smoke pipe does not project into the chimney and thereby restrict the area. Cleaning doors should always be kept tightly closed.

The use of an existing chimney is naturally the aim of the client who

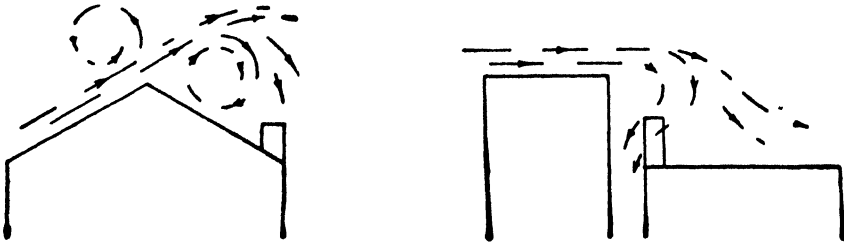

Fig. 15.—SHOWING HOW SURROUNDING HIGH BUILDINGS MAY BE THE UNSUSPECTED CAUSES OF DOWN-DRAUGHTS

Chimneys

The importance of a properly constructed chimney of adequate height and area must not be underrated if satisfactory results are to be obtained from the boiler. The chimney serves two purposes: one, to carry off the products of combustion; two, to create sufficient pulling power for the air to be drawn through the fire and flues of the boiler in order to maintain efficient combustion of the fuel.

A circular cross-section

wishes central heating to be installed with the least possible outlay, but the engineer should insist on an examination of any stack that it is proposed to use and should be quite certain that it will be satisfactory before definitely deciding to use it. If it is unsatisfactory, re-lining with fireclay may suffice, but the alternative of re-building has, at times, to be faced. If the chimney originally served a fireplace the entry from this should be sealed off.

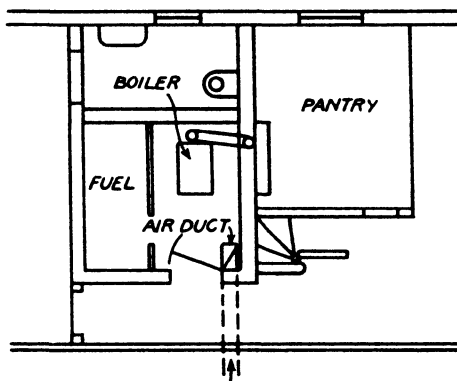

Fig. 16 — BOILER HOUSE AT A COUNTRY HOUSE

The house is at ground level, allowing fuel and ashes to be handled by wheelbarrow. Existing chimney flue is utilised and an air duct provides the necessary entrance of air from outside.

In arriving at the size and height of the chimney, the accompanying table may be usefully employed, but allowances must be made if there are any possibilities of undue resistance being offered to the passage of the gases.

TABLE I.—APPROXIMATE CHIMNEY CAPACITIES

Size of Flue in In.	Area in Sq. In.	Height of Chimney in Feet						
		25	30	40	50	60	70	80
		<i>Thousands of B.T.U.</i>						
---	30	40	43	50	57	56	70	75
---	50	85	100	115	130	144	152	158
9 × 9	81	170	200	230	252	266	280	295
14 × 9	126	260	290	330	375	400	430	460
14 × 14	196	---	---	580	650	720	800	860
18 × 14	252	---	---	800	860	940	1,000	1,080
18 × 18	324	---	---	1,080	1,150	1,240	1,330	1,440
24 × 18	432	---	---	1,500	1,600	1,670	1,750	1,800

The effect of the accumulation of soot must also be taken into account, particularly where small flues are used, as the effective area will be reduced considerably by such an accumulation after a comparatively short period of working.

The area of a cast-iron or steel chimney should be approximately 10 per cent. greater than a brick chimney for the same duty, because of the greater cooling effect of the metal as compared with brick.

Air Supply to Boiler House

A proper air supply to the boiler house is necessary to support combustion. Unless sufficient air enters the compartment the fires will not burn brightly, or when banked up for the night they will probably die out, or the whole place may become full of fumes and may have the same effect as if the chimney needed cleaning. When the boiler house is situated outside, or has an opening on the external wall, plenty of air is generally available, but should it be situated in a basement, then it may be necessary to run a special air duct to it, bringing fresh air from the outside.

Ventilation of the Boiler House

It is unpleasant to have to attend to boilers where the only means of getting rid of the fumes, etc., whilst clinkering, is through the boiler itself. Some of the fumes are sure to escape into the room and settle in the upper part. Should the boiler house be an internal one, the fumes will most likely get into the rooms of the house and be objectionable; when the chimney has a very good draught it is sometimes possible to fix a ventilator into it at a high level to get rid of the escaping fumes, or a separate shaft or duct could be arranged instead.

Facilities for Removal of Ashes and Clinkers

Ashes and clinkers have to be removed periodically, and if they cannot be dealt with easily, they are liable to accumulate due to neglect. It is easier to wheel the ashes away than to carry them, and for this reason an ash hoist is necessary, when one can be installed, or probably a sloping runway, where the stoker can wheel a barrow up, could be arranged.

Boiler House in Basement of Medium-sized House

Fig. 14 shows a boiler house in the basement of a medium-sized house. The fuel is deposited through a chute which is at ground level, and access to the boiler room is by the steps from the yard.

The heating boiler has a space in front the same distance as the length of the boiler which allows ample room for stoking. Both boilers are linear in front.

Plenty of room is allowed at the back for access to the sweeping door in the chimney. The window gives light and air to the compartment, and an ash hoist is provided to the yard level.

Boiler House at a Country House

Fig. 16 is of a boiler house at a country house. It is wholly internal and at ground level.

Handling Fuel and Ashes.—Fuel has to be brought in and the ashes removed by means of a wheelbarrow, which can pass along the passage to a yard outside.

The Boiler Flue.—The existing fireplace in the pantry was taken out and bricked up and the chimney utilised to take the boiler flue. Air is brought in from outside by means of a duct which is at a low level and supports combustion.

Ventilation.—There is also a ventilator in the chimney for taking away the fumes, all as previously mentioned.

Useful Method of Ventilation when New Chimney is Built

Another way of ventilating the boiler house when a new chimney is being built is to utilise the air space between the chimney and the outer casing of brickwork. It is usual to have 2 in. or more air space and an opening at ceiling level into this in the boiler house to take the fumes, and a grating at the top of the stack for exit will be found effective. (See Fig. 17.)

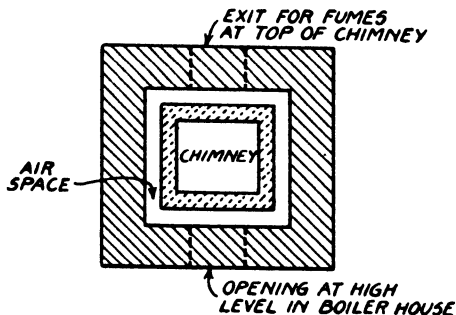

Fig. 17.—METHOD OF PROVIDING FOR VENTILATION OF BOILER HOUSE WHEN NEW CHIMNEY IS BEING BUILT

Boilers for Hand-firing

When boilers are arranged for hand-firing, sufficient space must be provided at the front so that the stoker can manipulate the firing tools, i.e. length of the boiler, plus 2 ft. 6 in. minimum. With oil-firing, however, much less space is needed, and quite a large boiler, oil-fired, need only have reasonable walking space in front of it.

Facilities for Handling Fuel

Another point to be studied when choosing the site for a boiler house is the facilities for handling the fuel.

If the fuel can be dumped off the lorry into the bunkers without any carrying, so much the better. This, of course, only applies to solid fuel, such as coal or coke, but they are the two most commonly used fuels for central-heating boilers and, as may be inferred, are probably the most satisfactory. Peat, wood, bituminous coal, and manufactured fuels are sometimes used, but their characteristics tend to rule them out for common use. Coke is always to be preferred.

PEAT varies greatly in its heating value and is used only when no other fuel is available.

WOOD has a very low heating value when compared with coal and is not often used except in such cases where wood dust or chippings are a waste product of some manufacturing process.

BITUMINOUS COAL is more suitable for use in boilers designed to give

smokeless combustion and where the constant services of a boiler attendant are available, such as in steam-raising plants. It can also be used satisfactorily in the underfeed type of automatic stoker which is described later in this section. Unless some such special provision has been made, its use is likely to result in large volumes of smoke being given off during the process of combustion with corresponding deposits of soot in the boiler flues and chimney.

ANTHRACITE contains a comparatively small proportion of volatile matter, a high carbon content, and has therefore a high calorific value. A good draught is necessary for its satisfactory combustion, which is characterised by an intense heat and the almost entire absence of smoke.

COKE is a fuel which also requires a good draught for its combustion. It is smokeless when being burnt and its calorific value is practically the same as the original coal from which it is obtained.

A mixture of anthracite and coke is often found to be a very satisfactory fuel under certain conditions.

The size of the fuel should be graded according to the size of the firebox. For small boilers the lumps should be from $\frac{3}{4}$ in. to $1\frac{1}{2}$ in. and for large boilers from 2 in. to 4 in.

The approximate calorific values and composition of different solid fuels are given below.

TABLE 2.—APPROXIMATE COMPOSITION OF VARIOUS SOLID FUELS

Kind of Fuel	Approximate Composition Per Cent.				Total B.T.U. per lb.
	Carbon	Total Hydrogen	Sulphur	Ashes and Incombustible Matter	
ANTHRACITE, best	95	1.5	0.5	3.0	} Average 14,700
.. ordinary	90	3.0	1.5	5.5	
.. poor	85	3.0	2.0	10.0	
COAL, best	84	5.0	2.0	9.0	14,150
.. ordinary	80	5.0	1.0	14.0	12,500
.. poor	75	6.0	1.0	18.0	10,000
COKE, best	97.5	—	0.8	1.7	14,000
.. ordinary	85	—	1.5	13.5	12,500
.. poor	65	—	1.5	33.5	9,000
PEAT, dried	60	<i>largely water</i> 6.0	0.3	<i>including water</i> 33.7	9,000
WOOD, dried	50	6.0	—	<i>including water</i> 44.0	7,800

Gas-firing

In spite of the obvious advantages it possesses—flexibility, freedom from the necessity of providing storage, ease of controlling thermostatically, and high thermal efficiency (83 per cent.)—price is the governing factor for the use of gas in all but special cases. The cost per therm of the ordinary town's gas supply compares unfavourably with solid fuel. In certain districts in the North of England, however, gas is quite largely used because supplies are available at an especially cheap rate.

Fig. 18 shows a gas fired boiler. The controlling mechanism and the combustion chamber are easily fitted and are compact and neat. The burner functions efficiently and requires little attention. Such a burner can be readily installed in the ordinary type of sectional boiler with little or no alteration. In central heating systems thermostatic control can be readily applied; a diaphragm type of valve is fitted in the gas service to the burner and operated by a thermocouple placed in the system at any desired point. Automatic air control is provided to meet the varying requirements of the thermostatically controlled gas supply and

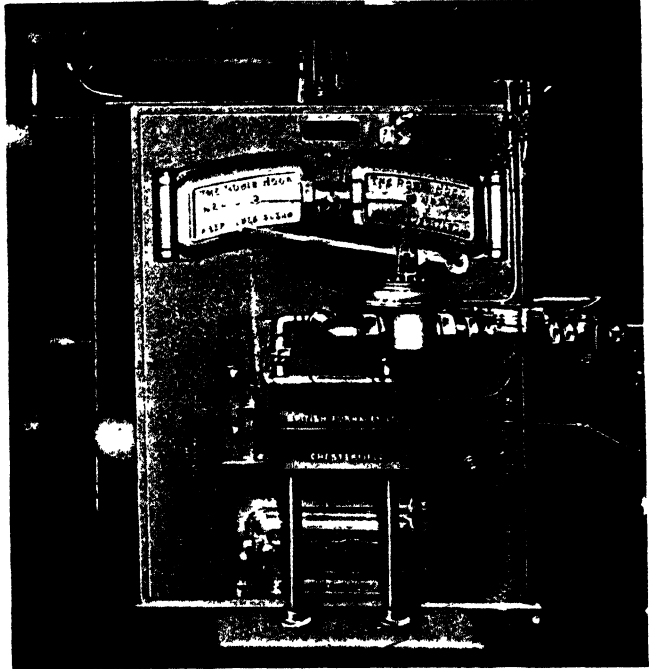

Fig. 18. ROBIN HOOD BOILER CONVERTED TO GAS-FIRING. FITTED WITH AUTOMATIC AIR LOUVRE CONTROL AND THERMOSTATIC GAS CONTROL

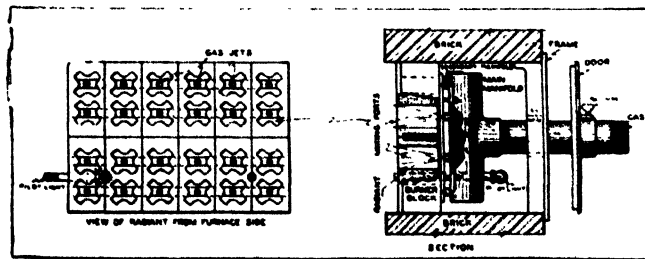

Fig. 19.—GAS COMBUSTION CHAMBER AND MIXING PORTS

consists of louvres on the front of the burner through which the air for combustion passes.

Fig. 19 shows the combustion chamber and the mixing ports. The flames can be either horizontal or vertical.

LIQUID FUEL FOR CENTRAL HEATING

The development in the use of liquid fuel for central heating purposes started in this country immediately following the first World War, when one or two pioneer British firms produced oil burners suitable for fitting to central heating boilers, including boilers of the cast-iron sectional type.

Most of these earlier plants were either arranged for hand control or were of the semi-automatic type, where the plant is first started up by hand but is thermostatically controlled whilst in operation. The majority were installed in office buildings where space was at a premium, as they gave the advantage of reducing the size of the boiler house, materially cutting down the space required for fuel storage and also the time taken for delivering fuel in congested city streets, as liquid fuel can be fed into the storage tanks through a pipe line very rapidly.

The success of these early installations led manufacturers to turn their attention to the design and development of the fully automatic oil burner, a type that was already gaining favour in the U.S.A., where oil, being a national fuel, is extensively used for central heating, steam-raising and other purposes.

The Oil Burner

The fully automatic burner, as its name implies, is under the complete control of a boiler or room thermostat, which starts and stops the plant automatically according to the demand for heat, hot water or steam. Most of these burners are arranged for electric ignition, although occasionally gas ignition is used.

A fully automatic oil burner comprises a fractional horse power electric motor driving a small fan for supplying the air for combustion, a small rotary pump for drawing the oil direct from the storage tank and delivering it to the pressure jet nozzle of the burner, a control box containing the timing relays for the control thermostat, room thermostat and safety flue thermostat, and a small step-up transformer coupled by means of high tension leads to the ignition electrodes which are situated just in front of the pressure jet nozzle. Such a fully automatic burner is capable of burning not only light distillates but medium heavy grades of oil and is, therefore, fitted with a thermostatically controlled electric immersion heater for heating the oil before it is delivered to the burner, thus lowering its viscosity so that it flows easily. When light oil only is used the electric heater is, of course, omitted.

The cycle of operations is as follows :—

When heat is required, the control thermostat makes contact through the timing relays in the control box and the electric ignition to the burner comes on automatically. After a lapse of a few seconds the main relay in the control box makes contact, starting the motor, fan and pump.

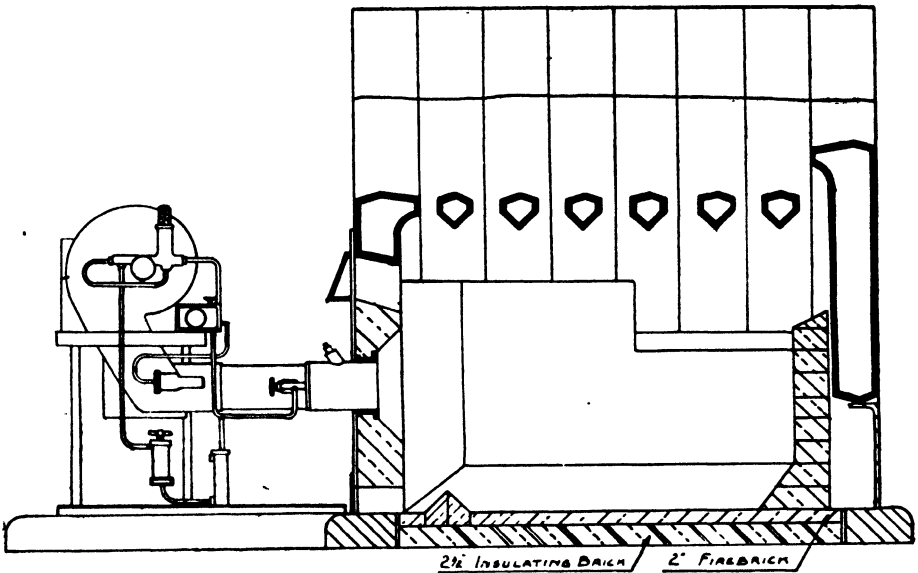

Fig. 20.— AUTOMATIC OIL BURNER APPLIED TO A SECTIONAL HOT-WATER BOILER

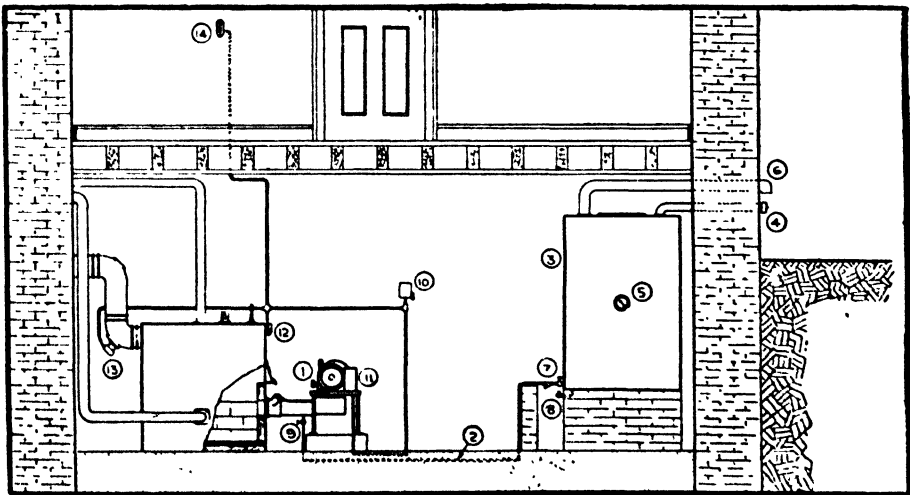

Fig. 21.— FULLY AUTOMATIC OIL-BURNING INSTALLATION

- | | | |
|---|---------------------------------------|---|
| 1. Automatic unit. | 6. Vent pipe. | 12. Boiler thermostat (tem-
perature regulator). |
| 2. Oil supply pipe. | 7. Valve and strainer on tank outlet. | 13. Fluestat (flame failure
safety device). |
| 3. Storage tank. | 8. Tank drain cock in catchpit. | 14. Room thermostat (room
temperature regulator) |
| 4. Filling pipe. | 9. Oil shut-off valve on unit. | |
| 5. Indicator gauge on
fuel storage tank. | 10. Main switch. | |
| | 11. Control box on unit. | |

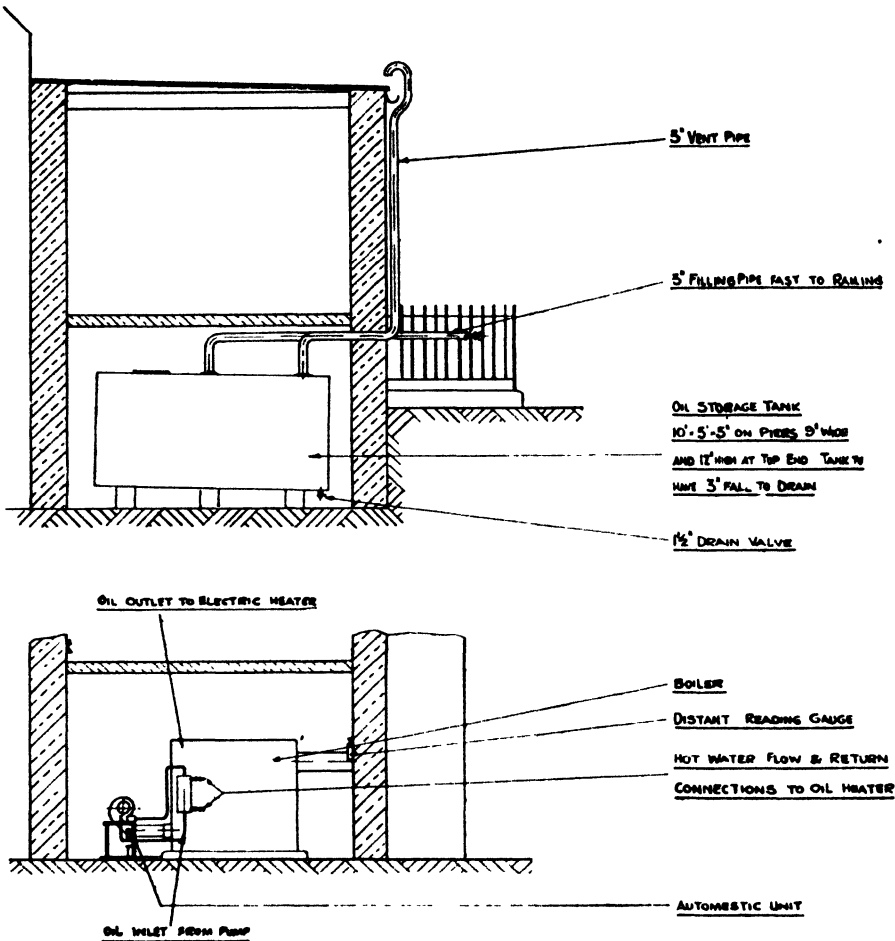

Fig. 22.— OIL STORAGE AND FEED TO BURNER IN AN AUTOMATIC OIL-BURNING PLANT

The finely divided spray of oil mixed with the correct amount of air for efficient combustion, then issues from the burner nozzle and is automatically ignited by the ignition electrodes.

The flame is projected into the boiler and continues to burn until the desired temperature or steam pressure is reached, when the control thermostat breaks contact and the plant shuts down automatically. This cycle of operations will continue so long as there is oil in the storage tank and the main switch in the boiler house is on.

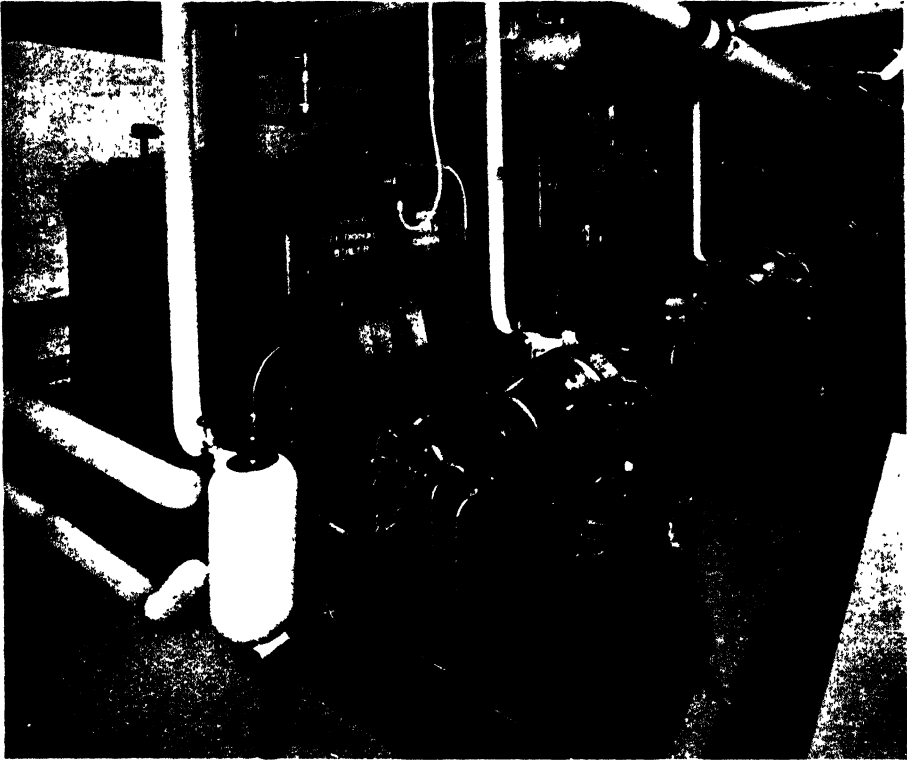

Fig. 23.— AUTOMATIC HEAVY OIL BURNERS FITTED TO TWO DAVEY PAXMAN STEEL SECTIONAL BOILERS, EACH RATED AT 1,250,000 B.T.U. HOUR AND ONE CRANE DOMESTIC SUPPLY BOILER RATED AT 250,000 B.T.U.

THERMOSTATIC CONTROL

If, for any reason, the plant fails to start when the thermostat makes contact, then a safety flue thermostat will break the circuit to the machine within a space of about 20 seconds. A red indicator lamp is provided either in the control box or the circuit to the control box, showing that the plant has been shut down by the action of the safety flue thermostat, and on the rare occasions when this happens the plant has to be re-started by hand.

Fully automatic burners of this type are generally used on small and medium-sized installations, but on the very large central heating plants semi-automatic burners are usually fitted, burners which are started up by hand but once set are controlled by means of a thermostat which automatically increases or reduces the size of the flame to meet varying demands for hot water or steam.

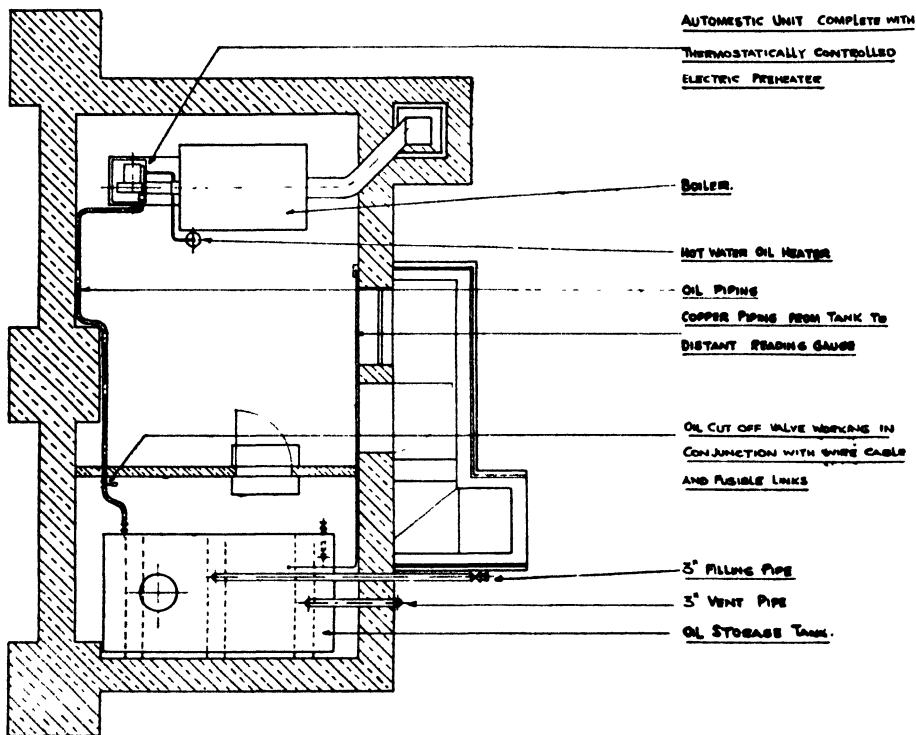

Fig. 24.—LAYOUT OF AUTOMATIC OIL-BURNING EQUIPMENT FOR A HEATING BOILER
Designed to burn heavy fuel oil. Scale: $\frac{1}{4}$ in. = 1 ft

The modern semi-automatic equipment is arranged so that both the air and oil supplies are reduced or increased in proportion, thus maintaining a practically constant CO_2 content of the gases and, therefore, a practically constant combustion efficiency, whether the boilers are operating at peak load or under light load conditions.

In principle, the up-to-date oil-burning plant, whether of the fully automatic or semi-automatic type, varies little from the original design, but in detail tremendous strides have been made particularly with regard to combustion efficiency, quietness in operation, reliability and low maintenance costs. To-day an oil burner, supplied by a reputable firm, is an efficient, reliable and handsome piece of apparatus. The appearance of the modern oil-fired boiler house, whose cleanliness and quietness are outstanding features, is striking.

Wide Varieties of Fuel

Burner manufacturers can now supply oil-burning plant which will handle a wide variety of fuel oils, starting with the small, fully automatic

burner for installation in private houses, churches, cinemas, etc., designed to burn Diesel oil or light distillate fuel oils up to but not exceeding 70 seconds viscosity Redwood No. 1 at 100° F. ; also the larger type of fully automatic burner which will usually handle distillate or blended oils up to but not exceeding 400 seconds viscosity ; the semi-automatic plants, many of which are capable of burning heavier grades of oil; including residual oils up to 2,000 seconds viscosity, and semi-automatic and hand-controlled plants, which will not only deal with heavy grades of fuel oil but also home-produced liquid fuels, namely, creosotes, creosot-pitch mixture and, in a few cases, straight pitch.

Creosote-pitch mixture has recently come to the fore ; a considerable number of plants have been converted so that they will use this home-produced fuel to replace imported petroleum oils. Creosote-pitch mixture usually has a maximum viscosity measured on the Redwood No. 1 Viscometer of :

5,000	seconds	at	80	deg.	Fahr.
1,500	„	„	100	„	„
100	„	„	200	„	„

The temperature at which this fuel is burned is usually between 180° and 200° F., heating of the fuel being obtained by means of thermostatically controlled electric or steam heaters.

Advantages and Disadvantages

The advantages of liquid fuel for central heating include the saving of space already referred to, both in the boiler house and fuel storage ; the ease and rapidity with which the fuel is delivered into the storage tanks ; the absence of grit, dust and smoke ; the accurate temperature or steam pressure control which can be obtained automatically ; the absence of fuel handling, bunker trimming and clinker removal with its consequent reduction in labour charges. In fact, it is claimed by those associated with the oil industry and the manufacturer of oil burners that liquid fuel gives the advantages of gas or electricity at a fraction of their cost.

The main disadvantage of the use of liquid fuel is the fact that in normal times most of the fuel has to be imported, and as it is marketed by international companies its price is subject to fluctuation following the trend of world markets.

Figs. 20 to 24 illustrate the subject and are self-explanatory.

Steam Boilers

Boilers of sectional type are also made for steam service at moderate pressures. Particulars can be obtained from the makers' catalogues. In general they are only used when steam is required for other purposes, such as kitchen or laundry service, and they are thus often found in

hotels, hospitals, etc. Hot water for heating or domestic supply can be obtained through calorifiers.

For large installations, boilers of Cornish, Lancashire, Economic or Vertical type are used. The steam is generated at higher pressures than are permissible with sectional boilers, and is passed through reducing valves before admission to heating systems. The detailed consideration of large steam boilers is outside the scope of this book.

Steam boilers require constant attention, and are thus generally less suitable for heating service, in moderate-sized installations, than sectional hot-water boilers, which in many cases only require attention at intervals of some hours.

Chapter V

GENERAL NOTES ON PIPEWORK

THE correct sizing of pipework is of the greatest importance in the design of heating systems, and methods of arriving at appropriate sizes for hot water or steam systems are explained in subsequent Chapters.

It should, however, be noted that there are fairly wide commercial tolerances in the sizes of pipes of the same nominal bore, so that mathematically exact design is hardly possible. In practice, valves are inserted into various branches of a pipework system in order to regulate the flow in accordance with requirements.

For pipes carrying water, it is useful to remember the appropriate formula :

$$G = 2d^2V$$

where G is quantity flowing, in gallons per minute,

d is bore of pipe in inches and

V is velocity of water in feet per second.

The maximum velocity of water in pipes is given by the formula :

$$V = \frac{10 + 4d}{3}$$

In heating practice, the velocities allowed rarely exceed half the values given by this formula, as friction becomes excessive.

Pipe Sizes

The sizes of pipes commonly used by the heating engineer are : $\frac{3}{8}$ in., $\frac{1}{2}$ in., $\frac{3}{4}$ in., 1 in., $1\frac{1}{4}$ in., $1\frac{1}{2}$ in., 2 in., $2\frac{1}{2}$ in., 3 in., and 4 in. The sizes given indicate the approximate inside diameter. Wrought iron or mild steel piping is obtainable in three weights : Gas, Water, and Steam being the terms used to distinguish them. Water-quality tube is of ample thickness for most low-pressure systems and is tested to 700 lb. per sq. in. by the manufacturers. The following Table gives some useful data in relation to it.

TABLE 1.—PARTICULARS OF PIPES

Nominal bore in.	$\frac{3}{8}$	$\frac{1}{2}$	$\frac{3}{4}$	1	$1\frac{1}{4}$	$1\frac{1}{2}$	2	$2\frac{1}{2}$	3	4
External diameter in. . .	$\frac{11}{16}$	$\frac{5}{8}$	$1\frac{1}{16}$	$1\frac{1}{8}$	$1\frac{1}{4}$	$1\frac{3}{8}$	$2\frac{1}{8}$	3	$3\frac{1}{4}$	$4\frac{1}{4}$
Thickness (Wire Gauge Nos.) . .	12	11	10	9	8	7	7	6	6	6
Approx. weight lb. per ft. . .	·644	·896	1·268	1·833	2·598	3·237	4·128	5·779	6·834	8·945
Screw threads per in.	19	14	14	11	11	11	11	11	11	11
Contents, gal. per ft.	·0047	·0084	·019	·0339	·053	·0763	·1356	·212	·305	·543
Square ft. surface per lineal ft. . .	·18	·221	·275	·346	·434	·494	·622	·753	·916	1·175

Steam Pipe-lines

The mains used in steam pipe-lines are usually of wrought iron or mild steel and are heavier than those used in hot-water heating; the thickness of the tube walls is increased by one wire gauge. The manufacturers always paint steam-quality tube red, so that it is easily distinguished from the "blue" water-quality tubing.

The joints may be screwed and socketed or flanged. Flanged joints only should be used on high-pressure work and where strains are likely to be set up in the pipe-line. The flanges should be of mild steel, and the thickness, diameters and drilling in accordance with the British Standard Table applicable for the particular working steam-pressure. They are either screwed on to the pipe ends, which are afterwards expanded, or welded. In making the joint, a corrugated brass ring is coated with jointing compound and inserted between the flanges. The bolts are then tightened.

Special Joint-rings

Asbestos and special compound joint-rings are often used instead of the brass corrugated rings. Where screwed joints are made, a thin coating of jointing compound is applied to the threads. Hemp wound on to the threads will not assist in making a permanent steam-tight joint, and should never be used.

Pipe Fittings and Supports

The fittings commonly used in the pipe lines are of malleable iron; those made to conform to the British Standards Institution specification have taper threads tapered to the same taper as the pipe threads. This makes it possible to obtain a metal-to-metal joint which may be used under the most exacting conditions. The use of standard fittings is of especial advantage to the draughtsman and pipe-fitter as by reference to the tables of dimensions published by the B.S.I. they are able easily to estimate the space occupied by the fittings in such places where the space available is limited.

Two tables of dimensions are published, one giving the sizes of what are termed "Short" ordinary fittings and the other the sizes of "Long Sweep" fittings. Elbows, for instance, come in the category of short fittings, while the term "bend" indicates a long sweep fitting. In gravity circuits it is advisable to use long sweep fittings wherever possible in order to minimise frictional resistance.

Various patterns of supports are available in all sizes, and the illustrations given in the makers' catalogues are of valuable assistance in helping the engineer to decide on the most suitable pattern. For schools and hospitals a pipe bracket built into the wall is preferable to a support from the floor, as it is desirable that there should be no obstruction to hamper the effective use of the sweeping brush.

Suitable intervals for pipe supports are :

Up to 1 in.	6 ft.
1½ and 1½ in.	8 ft.
2 to 3 in.	10 ft.
4 to 5 in.	14 ft.
6 in. and over	16 ft.

Expansion of Piping

Table 2 gives the linear expansion of various kinds of pipe per 100-ft. length for 100° difference in temperature.

In making provision for accommodating expansion the highest and lowest temperatures to which the piping will be subject must be considered. The low limit is normally 40° and the upper temperature depends upon the pressure of the steam or the temperature of the water.

TABLE 2.—AMOUNT OF EXPANSION IN INCHES PER 100 FT. OF PIPE PER 100° DIFFERENCE

Cast-iron	0.78 in.	Wrought-iron	0.8 in.
Steel	0.79 in.	Copper	1.13 in.

Thus, for a steam main operating at 135 lb. per sq. in. gauge, the temperature range is 358°—40° = 318°, so that for steel piping the amount of expansion to be dealt with is 3.18 × 0.79 = approximately 2½ in. per 100-ft. length. If proper provision is not made for dealing with expansion there may be disastrous results, damage to buildings, brackets torn from walls, fractured pipes or fittings and, at the very least, leaks at joints.

Provisions for Expansion

Where long runs of pipe take place, means of expansion must be provided. This is sometimes arranged by changing the direction of the run ; not always, however, can this be carried out, as for instance in a straight run of pipe the length of the building.

Various methods are adopted. One is to use expansion loops, which consist of a length of pipe bent to the form of A or B (Fig. 1).

The loops should have flanged ends for connecting to the main pipes. These expansion loops can be formed in wrought-iron or mild steel piping, but are better if made of copper, as that material will expand and contract more readily.

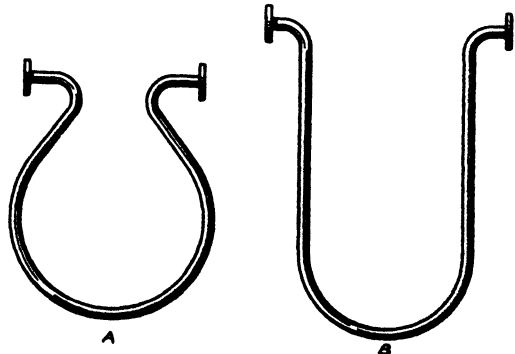

Fig. 1.—EXPANSION LOOPS

Expansion Bends or Loops

Four types of expansion bends are shown in Fig. 2 and the relative value for accommodating expansion is noted for each type. It will be seen that the amount accommodated is held to be in proportion to the length of pipe in the expansion loop or bend, the quarter bend being taken

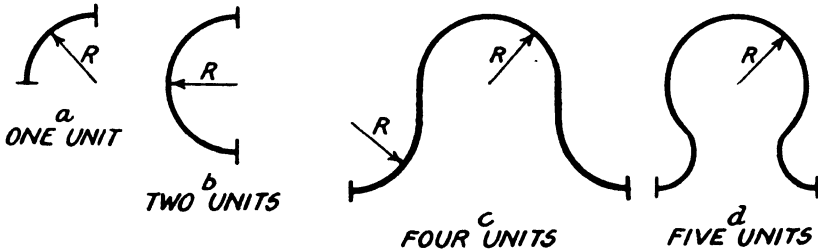

Fig. 2. - FOUR TYPES OF EXPANSION BENDS

as the unit. It is generally accepted that unless the radius of the bend is at least five times the diameter of the pipe the bend is valueless for expansion purposes.

The amount of accommodation provided by quarter bends of various radii is given in Table 3. From more recent investigations it would appear that after the first one inch of expansion accommodated each subsequent inch of expansion requires less pipe in the loop. This is

TABLE 3.—ACCOMMODATION FOR EXPANSION PROVIDED BY QUARTER WROUGHT-IRON BENDS

Diameter of Pipe	Radius of Bend, in inches			
	12	15	20	30
1 in.	1/4	3/8	1/2	1 1/4
2 in.	1/2	3/4	1	1
3 in.	—	—	—	—
4 in.	—	—	—	—
6 in.	—	—	—	—

indicated by the curves given in Fig. 3, and it will be seen that the figures tabulated above for the quarter bend all lie well in the left-hand corner of the graph so that the apparent disagreement in principle is largely superficial.

Expansion Joints

As an alternative to loops, standard expansion joints, of which there are several types available, may be used. The sliding type of joint consists of a spigot and socket with special packing and following ring and has the advantage of compactness, for which reason it is almost invariably used in trenches and tunnels where there would be difficulty in accommo-

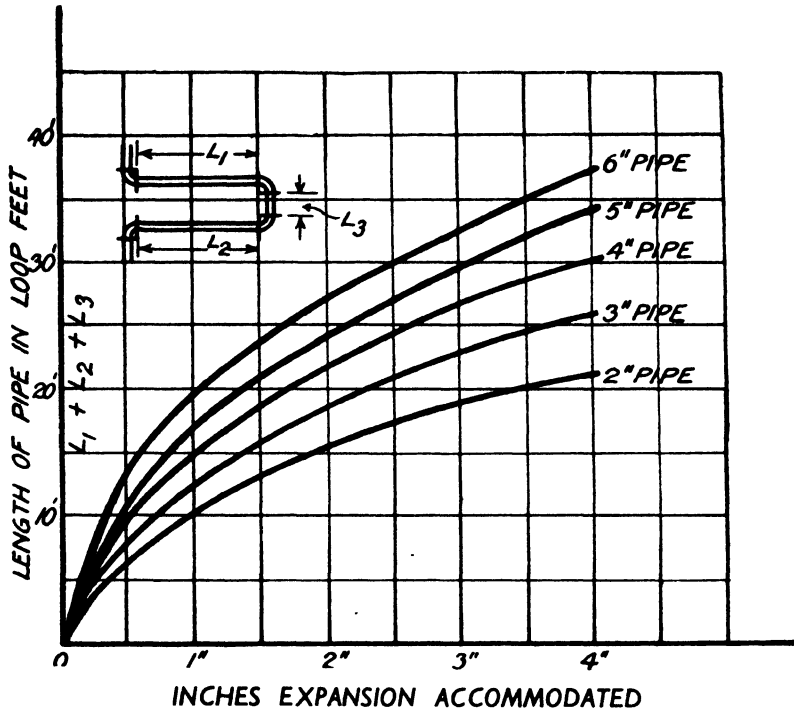
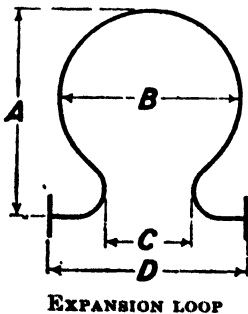

Fig. 3.—LENGTH OF PIPE REQUIRED IN LOOP TO ACCOMMODATE DIFFERENT AMOUNTS OF EXPANSION

The following diagram and Table give useful data in relation to a typical form of expansion bend.

TABLE 4

DIMENSIONS OF EXPANSION LOOPS



Diameter in.	A		B		C	D	
	ft.	in.	ft.	in.	in.	ft.	in.
1	1	1½	1	9	1½	1	3
1½	1	6¾	1	0	2½	1	8
2	2	0	1	3	2½	2	0
2½	2	5	1	6	3½	2	5½
3	2	10	1	9	4½	2	10
4	3	9	2	4	6½	3	8
5	4	9	2	11	8½	4	6
6	5	8	3	6	10	5	3½

dating an offset loop. Care must be taken to employ the correct packing, and even then difficulty may be experienced in obtaining a joint which is sufficiently tight at the gland to obviate leakage and at the same time free to accommodate expansion without setting up undue strain on the pipework. Expansion joints require considerable maintenance and are not favoured by most engineers.

Sliding expansion joints consist of two sliding parts, one inside the other and fitted with a gland with suitable packing to make them watertight. Some are fitted with security bolts to prevent the joint blowing out in the event of extra or abnormal movements. These sliding joints are made either in gun-metal or in cast-iron.

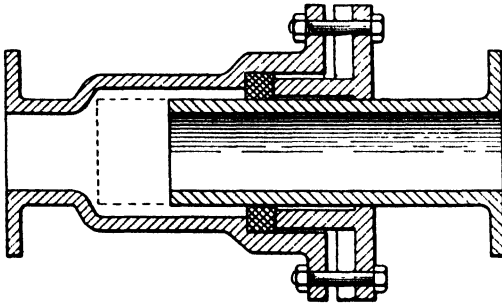

Fig. 4.—SLIDING EXPANSION JOINT

The dotted lines indicate the position of the inner sleeve when the pipe line has expanded.

In fixing sliding expansion joints, the inner sleeve should be well away from the bottom position when the pipe is anchored at the ends; for when expansion takes place the inner sleeve gets closer to the shoulder as shown in Fig. 4, thus allowing free

expanding movement of the main when it gets hot. On cooling, however, the pipe contracts and the joint takes up its normal position.

Anchor Allowing for Expansion.—When a pipe is fixed along a wall and returns at the ends as in Fig. 5, a substantial pipe bracket fixed on each of the two ends forms an anchor, holding the pipe at these two points, thus allowing for the free movement of the long length. The expansion is taken up in the sliding joint.

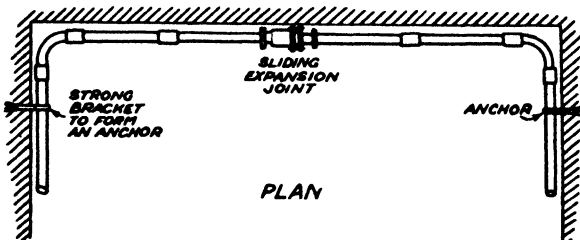

Fig. 5.—FIXING FOR LONG LENGTH ALONG A WALL

When pipe returns at the ends, strong pipe brackets fixed on each end hold the pipe and allow for expansion at the sliding joint.

If a loop is used it would be fixed horizontally as in Fig. 6 and a special bracket should be provided to support it.

Various styles of anchors are employed, each one having its special feature to suit the prevailing conditions.

Allowing for Expansion Where Pipes Pass Through Walls, Floors, etc.

Where pipes pass through walls, floors, and ceilings they should be kept free to move, due to expansion and contraction. If, however, they are built in solid, movement will take place and the pipe may develop a leak, or possibly the plaster on the wall will flake off.

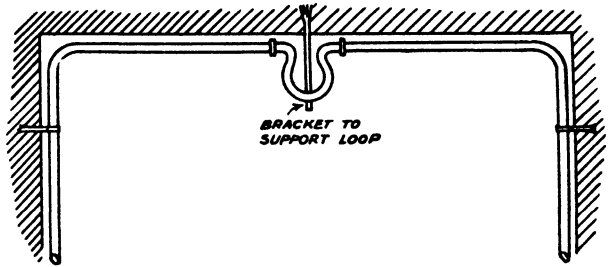

Fig. 6. - WHEN A LOOP IS USED A SPECIAL BRACKET SHOULD BE PROVIDED TO SUPPORT IT

Fitting Sleeves or Thimbles.—A metal sleeve or piece of pipe should be fixed through the whole thickness of the wall ; this is slipped on to the heating pipe before the latter is finally fixed and placed in position in the wall before the making good is commenced.

Sleeves can be either of cast- or wrought-iron pipe, copper, zinc, lead or sheet steel.

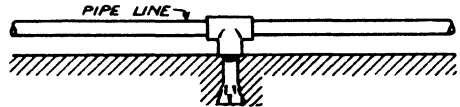

Fig. 7 - A SOLID IRON LEWIS BOLT SCREWED INTO A TEE IS SOMETIMES USED AS AN ANCHOR

To keep the sleeve concentric with the pipe it is usual to place a few wedges to hold it in position ; if, however, a length of spun yarn or cord is wound on the pipe before the sleeve is fixed it will make a better job and will ensure that the annular space between the pipe and sleeve is equal all round ; the cord can be easily removed when the sleeve has been built in.

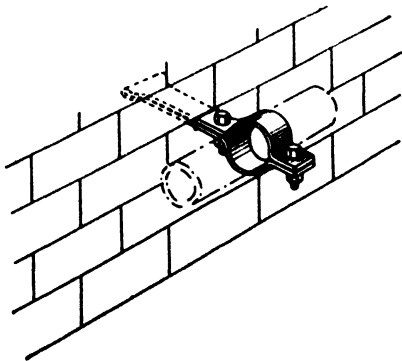

Fig. 8.— A STRONG IRON CLIP TO CLASP THE PIPE AND BUILT INTO THE WALL WILL FORM AN ANCHOR

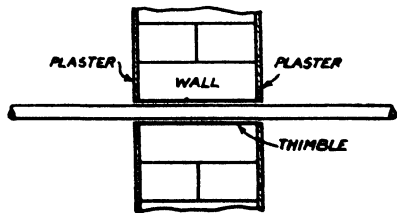

Fig. 9.— ALLOWING FOR EXPANSION OF PIPE THROUGH WALL

Plain thimble the whole thickness of the wall. The plaster finishes against the thimble, leaving the pipe free to move.

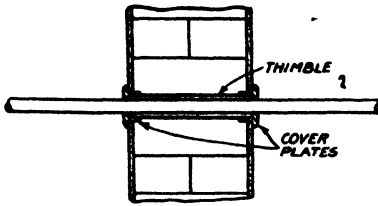

Fig. 10.—A SIMILAR THIMBLE TO FIG. 9, BUT WITH COVER PLATES SCREWED ON EACH SIDE OF THE WALL.

Felt or Paper Wrapping.—Sometimes instead of using metal sleeves a piece of felt or two or three thicknesses of brown paper are wrapped around the pipe before the wall is made good, thereby leaving the pipe free of contact with the wall, but this makes a poor job compared with a metal sleeve.

Where to Anchor Pipes

The position in which pipes are anchored is of extreme importance, especially where there are branches from the main on which the expansion joints or loops are fitted. Take, for example, the length of piping shown in Fig. 13 and assume a steam pressure of 135 lb. per sq. in. gauge, and steel piping for which the elongation is $2\frac{1}{2}$ in. per 100 ft. of pipe, giving

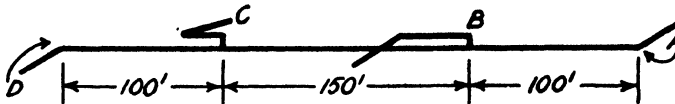

Fig. 13.—ILLUSTRATING WHERE TO ANCHOR PIPES IN RUN

a total of 8.75 in. to be accommodated. Assuming that for some reason the pipes are anchored at A and D, the most satisfactory method of dealing with the expansion of the piping between A and D is to use three loops or joints, one between A and B, accommodating $2\frac{1}{2}$ in., another between B and C, $3\frac{1}{2}$ in. in this case, and the third between C and D,

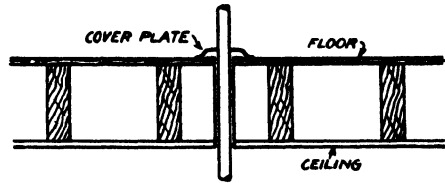

Fig. 11.—ALLOWING FOR EXPANSION OF PIPE THROUGH FLOOR AND CEILING

A sheet metal sleeve through floor and ceiling. The top is flanged over on to the floor and supports it. A cover plate is fixed over the flange to form a finish.

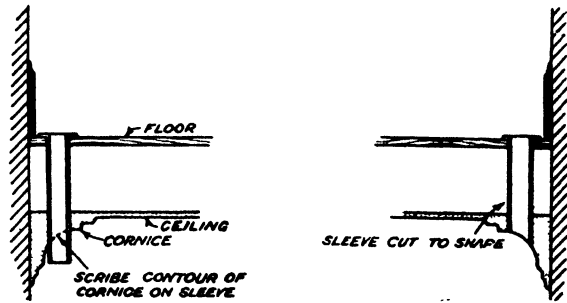

Fig. 12.—WHEN A SLEEVE PASSES THROUGH A CORNICHE The shape of the cornice should be scribed on it; the sleeve can then be cut to fit the curve as shown on the right.

this dealing with $2\frac{1}{2}$ in., whilst points B and C should be anchored in order to protect the branches at these points from strain.

It would be possible to provide a joint midway between B and C to accommodate the whole $8\frac{3}{4}$ -in. expansion, using A and D as fixed points, and also anchoring the expansion joint at its centre. In this case branches B and C would each move $2\frac{1}{2}$ in. toward one another, 5 in. in all, and the branches would have to be provided with means for accommodating this movement without straining the joints.

A point which must always be borne in mind is that the expansion of piping against resistance tends to cause bowing and it is not at all uncommon to hear of steam mains jumping their supports, so straps must be fitted to obviate this.

When Offsets May be Used to Allow for Expansion

On inspecting Fig. 14 it may at first be thought that the offset ABCD constitutes an expansion loop and that the whole of the piping comprising

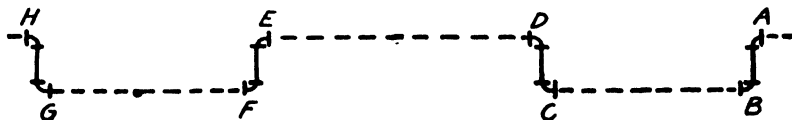

Fig. 14.— THE OFFSET ABCD IS AVAILABLE FOR ACCOMMODATING EXPANSION WHEN ONLY ONE CENTRAL SUPPORT IS REQUIRED ALONG BC. SIMILARLY WITH THE OTHER OFFSETS IN THE RUN OF PIPING.

this offset is free for accommodating expansion. This is true, however, only when the length BC is free to bow unobstructedly, and this obviously can apply only where BC is either so short that only one central support is required to prevent sagging or where the pipe is slung from above in such a manner that it is quite free to bend in a horizontal plane.

In general it may be taken that where BC or DE or FG are longer than 40 ft. it is safer to support the pipes in such a manner that they are kept in alignment without bowing, and that the short lengths CD, EF and HG, only are available for accommodating expansion and the pipe set sufficiently often to relieve the longer lengths of bending strain.

Erecting Pipes During Hot Weather

When piping is erected in hot weather it must be remembered that the pipes will probably, in fact almost certainly, be subjected to a much lower temperature during their lifetime, due either to the system being out of commission for some reason during cold weather, or when filled with cold water. If, for instance, provision for expansion over a range of 40° F. to 240° F. is provided by expansion loops or joints, and the pipes are erected during hot weather

when the temperature may be 90° , of the total movement a fraction will be subsequent contraction on cooling to 40° , i.e., 50° cooling, and the remainder expansion due to subsequent heating up to 240° , that is, an increase of 150 on 90° . Thus, of the total temperature range of 200° , one-quarter is cooling and therefore contraction, and three-quarters expansion. In such circumstances an expansion loop or joint having a total traverse of 4 in. should be so fixed that 1 in. will be absorbed in contraction and 3 in. in expansion. This means that in the case of a sliding type of joint, i.e., having a socket and sliding spigot, the spigot should be drawn out 1 in. before fitting into the line.

Even more severe conditions may arise where hot-water mains are run in a small tunnel in which steam pipes are hot at the time when the hot-water mains are erected.

Accommodation of Expansion Loops Due to Cold Springing

It is sometimes stated that if an expansion loop is sprung open before fixing by an amount equal to the expansion it is normally able to absorb, its capacity for accommodating elongation is double. This has every appearance of being the truth, but it is seldom the case in practice. In the first place, it is no simple matter to spring open an expansion loop for large piping without heating it, and the hot bending or forging gives the metal fibres a permanent set which obviously defeats the object in view. Secondly, it is very rare that the whole of the movement is due to expansion, for this presupposes that the erection of the pipework will always take place during the lowest temperature conditions to which the pipes will be subjected in their lifetime.

A Final Word on Anchoring Pipes

A final word with regard to anchoring pipes in order to direct the expansion thrust toward the appropriate joint or loop; as a general guide the best position for the anchor is midway between joints or loops, as this usually results in the minimum strain on branches connected to the moving pipe; where, however, there is only one branch between two expansion loops, it is at this point that the anchor should be fixed.

PIPE-BENDING—PASSOVER BENDS—PROVISIONS FOR EXPANSION OF PIPES

Sometimes after a pipe has been bent it is found that although the bends are made to the right degree, they have for some reason gone askew. This is shown in the case, for instance, of an offset; on plan the two bends are as intended, but when the pipe is laid on the floor, one end is not touching the floor—in other words, it is out of line horizontally (see Fig. 15).

To correct this, make the pipe hot between the bends at A (Fig. 15), lay it on the floor with someone holding down the end C, and then press down at B. By this means the bends will keep to their intended angle. Another way is after having heated at A, to put the end of the pipe C in the vice, and pull the other end round until the bends come into line.

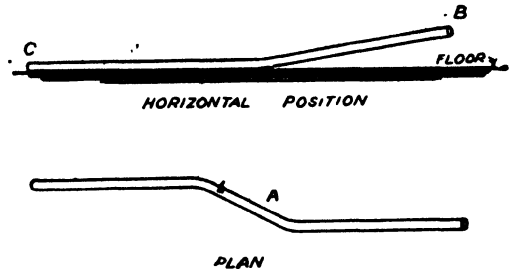

Fig. 15.—CORRECTING A BEND THAT HAS GONE ASKEW

Heat at A, hold down end C on floor and then press down at B.

Passover Bends

These take various forms and are used where pipes have to pass around piers, or other projections. Sometimes fittings are used as in Fig. 16. Bends are used in the internal angles and elbows on the external angles. Although this may be permissible at times, the elbows are not considered good practice and a better job is to make a double offset as in Fig. 17.

This eliminates many joints, reduces friction, and is less costly.



Fig. 16.—ONE METHOD OF FORMING A PASSOVER BEND, USING FITTINGS
Not considered good practice.



Fig. 17.—A BETTER METHOD, USING A DOUBLE OFFSET WHICH AVOIDS FITTINGS AND REDUCES FRICTION

For Passing Over Vertical Pipe

Another type of passover bend one often comes across is where a vertical pipe has to be crossed, taking the form shown in Fig. 18.

To make this it is best to form the centre bend first, giving the pipe almost a hairpin shape. This can then be laid on the drawing on the floor. Mark the pipe with chalk where the other bends are to take place, and proceed to make them as already described.

Sometimes a short bend is required very close up to the thread as in Fig. 19.

First, screw a socket on to the thread and a length of pipe into it. Then heat the pipe in the forge to a

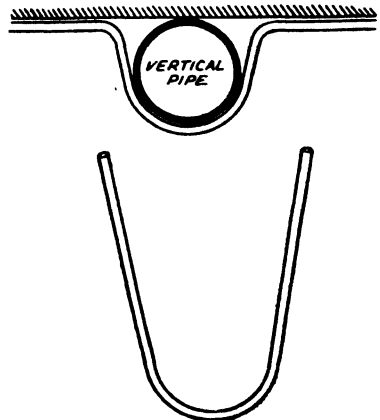

Fig. 18.—PASSOVER BEND FOR CROSSING VERTICAL PIPE
First make the centre bend almost a hairpin shape.

good red. The socket and thread may also get red hot; these must be cooled by pouring water over them before commencing to make the bend; if this precaution is not observed the thread may fracture. The cooling of the pipe must be carried out quickly so as to have as few heats as possible to make the bend.

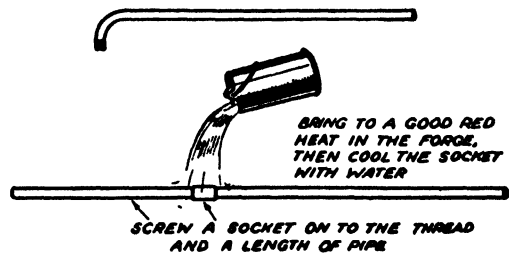

Fig. 19.—SHOWING SHORT BEND CLOSE UP TO THE THREAD AND HOW TO MAKE IT

How to Set Out Bends to a Drawing

Pipe bending plays such an extensive part in heating work that very careful "setting out" is necessary, otherwise the pipe when bent will not fit the position allotted for it.

The first step when forming an offset or any bend other than the simplest is to chalk out the pattern on the floor. This should be the standard practice, and to do this one has first of all to mark out the shape of the walls, etc., that it is desired to fit the pipe to, marking all the angles, etc., and chalk out the form of bend to suit. It is usual to have a pipe with four or five bends in it, so the importance of first making a full-size drawing of the pipe can be appreciated.

Making Bends to Templates

Although making bends to a drawing is strongly advised, there are times where it would be difficult to make a drawing profitably, say, where it is necessary to twist and turn to miss other pipes, or girders, etc., in which case it may take so long to make the drawing, and develop it, that a template would be far simpler.



Fig. 20.—THIS WOULD BE A DIFFICULT JOB TO SET OUT ON THE SHOP FLOOR

Make a template of the bends required out of a length of $\frac{1}{4}$ in. or $\frac{3}{8}$ in. iron rod and bend the pipe to suit the template.

To make such a template, take a length of $\frac{1}{4}$ -in. or $\frac{3}{8}$ -in. iron "rod" and bend it in the position that the pipe has to take. In reality the rod is bent as if it were the centre line of the pipe, or maybe the inside line, whichever is more convenient.

Then take the template to the shop and make the bend to suit this, taking care that the iron rod is carefully handled, so as not to get out of shape.

Making Long Radius Bends

Long radius bends, such as would be required to fit around a bow

window, or a rounded angle, call for much practice, and have to be heated up many times to ensure a regular curve. To make a bend to a half circle with a radius of about 6 to 8 ft. in any size pipe, it is necessary to have long heats, and every inch of the pipe would have to be bent, and considerable skill is required to get an exact and regular contour. When the bend is laid flat on the shop floor, it should be free from any straight parts. One length of pipe should be used if possible, thus avoiding a socket anywhere in the curved pipe.

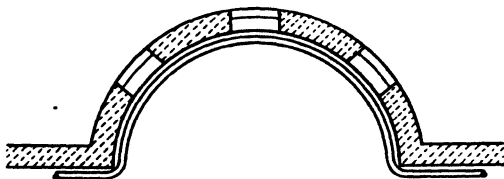

Fig. 21.—A LONG RADIUS BEND MADE BY MEANS OF THE FORGE TO FIT IN A BOW WINDOW

Making Connections to Long Radius Bend

Should any connections be required for a radiator or coil, these should be welded, instead of using tee pieces, as any screwed type of fitting will spoil the contour of the bend.

Chapter VI

RADIATORS

THE familiar cast-iron radiator so extensively used to-day has evolved from the rather ugly pipe coil commonly provided in the early years of hot-water heating. The pipe coil gave place to cast-iron radiators cast in one piece, which were superseded by sectional radiators in which the sections were assembled by the use of "push" nipples. A later development was the method of assembly at present in use, in which right- and left-hand threaded nipples are screwed into correspondingly tapped bosses at the top and bottom of the radiator sections. The tendency in the design of the modern radiator has been to reduce the

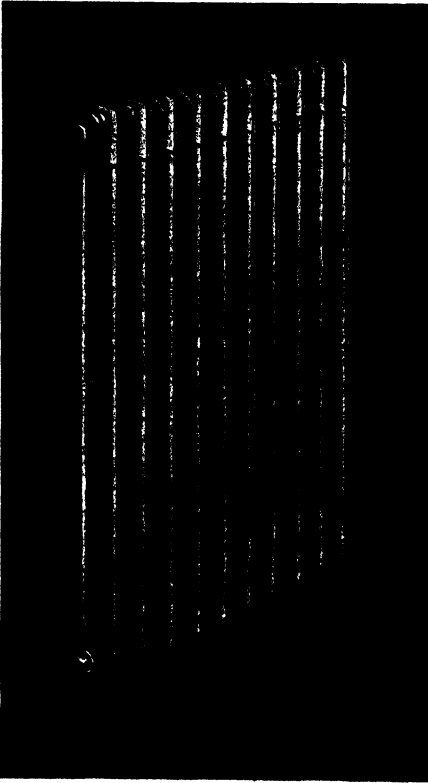

Fig. 1.—TYPICAL EXAMPLE OF RADIATOR
IN COMMON USE

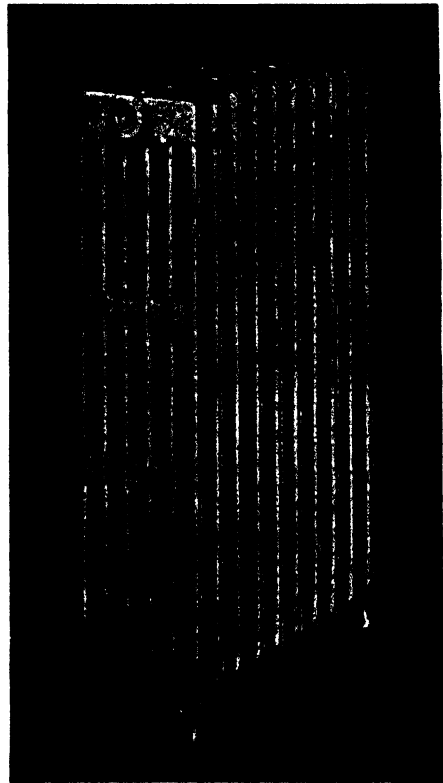

Fig. 2.—SIMILAR BUT DESIGNED FOR
MUCH HEAVIER DUTY

areas of the waterways, thereby making a reduction of the water content. This effects a saving in the space occupied and a quicker response to fluctuations in the temperature of the system.

Each radiator section may be divided into two, three, four or more columns and they are supplied in various heights from 13 in. to 36 in. A single-column radiator is available for positions such as passages and corridors where the space in front is restricted, and are usually termed wall radiators.

For hospitals and schools it is desirable to use radiators having all surfaces smooth and free from crevices or ledges, where an accumulation of dust would be difficult to remove. Such radiators are standard patterns of the manufacturers and are known as "Hospital" radiators.

The modern radiator affects the fuel consumption, and it is false economy to re-use old radiators when re-conditioning a building. The initial cost of new radiators is soon paid for by the lower fuel consumption.

The most usual type of radiator is made of cast-iron and is shown in Figs. 1 and 2 in various forms, from 2½ in. to 13 in. wide, and in height from 13 in. to 36 in. The length can be as required to suit any space available, being made in sections. Any number of sections can be fitted together as needed.

Fixing Floor Radiators

These radiators are fixed 1 in. or more away from the wall. Where fixed in front of panelling as much as 3 in. is sometimes allowed. This distance also facilitates cleaning behind them.

Fixing Radiators to Wall

When it is desired to keep the radiators off the floor, plain end sections are fitted without feet and the radiator is supported on cantilever brackets, as at A, Fig. 3, and a stay, B, at the top. Other types of brackets are made for fixing to woodwork, etc.

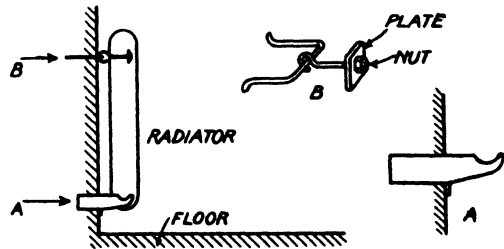

Fig. 3.—METHOD OF FIXING RADIATORS TO WALLS

Wall Radiators

Wall radiators are intended for use where space is limited, they are only 2½ in. wide and when fixed on the wall do not project much beyond the skirting; a good wall space, however, is essential to allow of sufficient size of radiator being fixed to cope with the conditions. The brackets shown in sketch make a very neat fixing.

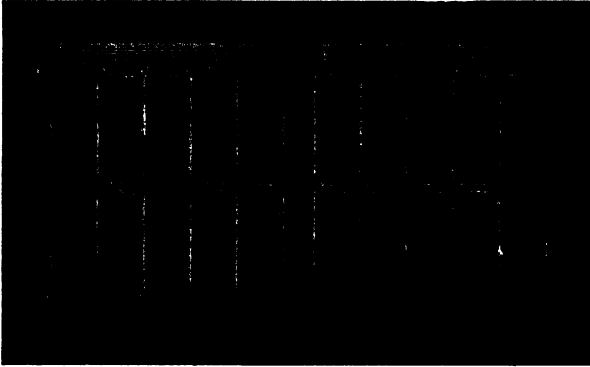

Fig. 4 —WALL TYPE RADIATOR
(Ideal Boilers and Radiators, Ltd.)

Panel radiators are designed to enable a flat finish to be obtained when required to meet the decorative design of a room; by adding sections together a long radiator can be made to suit any varying wall face. The bottom of the radiator can finish at skirting level if desired. A dado rail will finish the top

edge. Many variations are possible when dealing with this kind of radiator.

Insulating Radiator from Wall

It is necessary when using panel radiators to insulate the wall behind them so that the heat will be directed into the room. A sheet of asbestos or other insulation is placed on the wall and fastened securely before the radiator is fixed.

A panel can be fitted without chasing into the wall by using one or other of the moulded edge types. The illustration shows a Rayrad suitable for this purpose and the moulding can be had all round or, if preferred, on the top edge only. There is a Rayrad or panel radiator to suit any style of decoration.

A newer type of Rayrad having a curved edge finish is shown in Fig. 6. It has an asbestos packing around the back edge which makes a tight joint between the radiator and the wall, and keeps the face of the wall free from black marks.

It is easy to deduce that for so many forms of radiators the emission of heat from them will vary with the pattern. The coefficients of transmission published by the manufacturers in their catalogues are based on tests made in their laboratories and can be accepted without question for all practical purposes. The following table gives the B.T.U. per square foot per hour for "Ideal" radiators at various differences in temperature.

The painting of radiators and pipes by ordinary non-metallic paints does not affect the transmission, whatever the colour of the paint may be. Metallic paints such as bronze or aluminium reduce the heat emission by about 12½ per cent. Other conditions affecting the transmission are:—

(1) Radiator with flat deflecting shield fixed about 3 in. above; take 96 per cent. of figures given.

(2) Radiator fixed in open recess. Top of recess about 3 in. above radiator ; take 92 per cent. of figures given.

(3) Radiator encased or with metal hangings in front ; take 80 per cent. of the figures given. *

(4) Radiator fixed in front of open fresh-air inlet and under natural draught conditions ; increase figures in table by 30 per cent.

TABLE I.—TRANSMISSION
FOR RADIATORS PLACED 2½ IN. FROM WALL * †
BRITISH THERMAL UNITS PER SQUARE FOOT PER HOUR

Ideal Radiators	Temperature Difference (Degrees Fahrenheit)							
	Water				Steam			
	70	80	90	100	110	120	155	160
Neo-Classic No. 2 ..	116	139	162	185	208	234	327	340
.. .. 4 ..	106	128	149	170	192	215	300	312
.. .. 6 ..	100	120	140	160	180	202	282	294
.. Window	99	119	138	158	178	199	278	290
Hospital 3-in. ..	116	139	162	185	208	234	327	340
.. 5½-in. ..	99	119	138	158	178	199	278	290
.. 7½-in. ..	94	113	131	150	169	189	264	275
Classic Wall ..	106	128	149	170	192	215	300	312
Plain Wall :								
Fixed Horizontally	100	120	140	160	180	202	282	294
.. Vertically ..	64	77	90	103	116	130	181	189
Plain Single Col. ..	100	120	140	160	180	202	282	294
.. Two Col. ..	98	117	136	156	176	197	275	287

* The transmission is approximately the same when the radiator is placed 1½ in. or more from the wall.

† Exceptions are Classic Wall and Plain Wall fixed on standard brackets with 2-in. and 1½-in. centres.

It is not sufficient merely to state the heat transmission from low-temperature flat surfaces used in panel systems of heating, as the heating effect is quite different from that of the ordinary radiator installation. In the radiator system the thermometer is usually relied upon as an index to the comfortable condition of the heated room, but it is a common experience for one to feel chilly even with a room temperature of 63° F. or 64° F. on a cold, sunless, winter day. On a sunny day, especially if the room has a southern aspect, there is often experienced a much warmer effect, though the thermometer may register the same or perhaps a lower temperature.

The reactions of our bodies may be, and most probably are, due partly to the psychological effect of sunshine, but the chief reason for the increase in comfort is that we are benefiting from the radiant heat of the sun. It is on the radiant heat from the flat heated surfaces of the panel system that the heating engineer largely relies, rather than upon

convected heat, and makes this the basis of his calculations in arriving at the amount of heating surface required. Panel heating is a comparatively recent innovation in central heating, and although the success following its adoption has resulted in a wider application of it in one form or another, from which valuable experience has been gained, it will be necessary for further research and experiments to be made. Tentative rules of a sufficiently accurate character to enable the designer to estimate the correct amount of heating surface are given in Chapter VII.

METAL WARMING PANELS FLUSH WITH THE CEILING

A panel heating system which makes use of metal tanks not embedded in the walls or ceiling but mounted flush with them has certain applications and is well-suited to certain requirements. The "Sunzway" are typical and are essentially narrow all-steel radiators of welded construction for water or steam with plain flat heating surfaces, suitable for mounting on ceilings or walls, either on the surface or recessed with the radiating face flush with the adjoining surfaces. A large proportion of the heat from these radiators is emitted, particularly when fixed flush in the ceiling, in the form of low temperature radiation.

The radiators are supported at two points by clamping nuts screwed to adjustable cranked brackets firmly fastened to the ceiling or wall.

Fixing the Adjustable Cranked Brackets

The adjustable cranked brackets are fastened in several ways.

In a solid concrete ceiling a hole is drilled right through the concrete. The fixed arm of the cranked bracket is fastened back to the face of the ceiling by a through bolt and nut threaded through from above with a stiff washer plate at the upper end. If the concrete is unusually thick or cannot be drilled, a rag bolt or an expansion bolt is used.



Fig. 5.— ADJUSTABLE CRANKED BRACKET

For hollow block or hollow concrete ceilings a through bolt is used when the ceiling can be drilled readily, otherwise a toggle bolt carefully let into the lower member of the hollow tile or form is used. When a toggle bolt is used, the strength of its bearing should be tested by the dead weight of two men before attaching the cranked bracket.

For metal lathed suspended ceilings a hook bolt attached to the steel bars or supporting members takes the place of the through bolt.

For wood joist constructions the cranked bracket is fastened to the joists or framing by a strong coach screw, or by a hook bolt hooked on to a steel tube or bar fixed to or let in the timber members.

Marking Out the Position of the Supports for the Adjustable Cranked Brackets

The radiator is laid flat on the floor or on stools, radiating face downwards, and measurements are taken to mark out on the ceiling or wall the outline of the radiator and the position of points of support.

Filling the Luting Channel with Sealing Compound

The channel at the edges of the back of the radiator is filled with a sealing compound, such as Purimachos, tightly pressed in. All dust must be brushed out of the channel before applying the sealing compound.



Fig. 6. - RADIATOR FIXED AND CONNECTED

Placing the Radiator into Position

The radiator is lifted by two pairs of hands and the movable arms of the cranked brackets adjusted until the studs attached to the movable arms can pass through the corresponding holes in the radiator. In the case of a ceiling, two pairs of trestles are helpful, for one end of the radiator can rest on the head of one pair of trestles, while the cranked brackets are being adjusted. When the studs of the brackets have entered the holes in the radiator, the clamping nuts are screwed a couple of turns until a little more sealing compound has been added to the luting channel. Then the clamping nuts are screwed on further, and tightened up with a two-pin key. During this operation some of the excess sealing compound will be squeezed out on the outer edges. This is removed by a putty knife carefully, in order not to break the seal.

Fixing the Counter Flanges

Counter flanges to mate the rectangular flanged connections of the radiator are welded or screwed on to the feed and return pipes and the flanges are bolted together, using a coned bronze ring for making the joint.

Filling Sections for Single, Double or Treble Radiators

When two or three "Sunzway" Radiators are located side by side to form one large radiating surface, the flanged connections of the radiators are bolted together without any mating flanges. This leaves a space of 6 in. between the radiators, which is covered with steel filling sections to conceal the flanges. These filling sections are sprung into position after the flanged joints have been pulled up and tested.

Thermal Insulation

The surface of the back of the radiator is treated to reduce the transfer of heat. No insulating material, therefore, is necessary when the radiator is fixed tightly against intermediate floors or inner walls. On ceilings of flat roofs and on upper floors and on outer walls, a radiator, similarly fixed, should be insulated at the back with insulating material, such as slab cork. Insulating material should also be used whenever a radiator



Fig. 7.—CEILING FINISHED BUT NOT DECORATED
The finished ceiling is shown in *Fig. 8.*



Fig. 8.- "SUNZWAY" RADIATORS MOUNTED ON CEILING AND CEILING FINISHED AND DECORATED

is fixed clear of a ceiling or roof in order to prevent cooling by the circulation of air at the back of the radiator.

Running the Connecting Pipes

In factories, warehouses, printing works, stores and in most types of industrial buildings, "Sunzway" Radiators are fitted flat against the ceiling or wall with the connecting pipes run on the surface. In office buildings, public buildings, shops, showrooms, clubs, restaurants, etc., the radiators are generally either fixed in recesses or the surroundings are brought forward to line up with the radiating surface of the radiator but in these types of buildings they are often fixed, particularly when applied to walls, flat against the surface, and when applied to ceilings, recessed slightly, as shown by the illustrations.

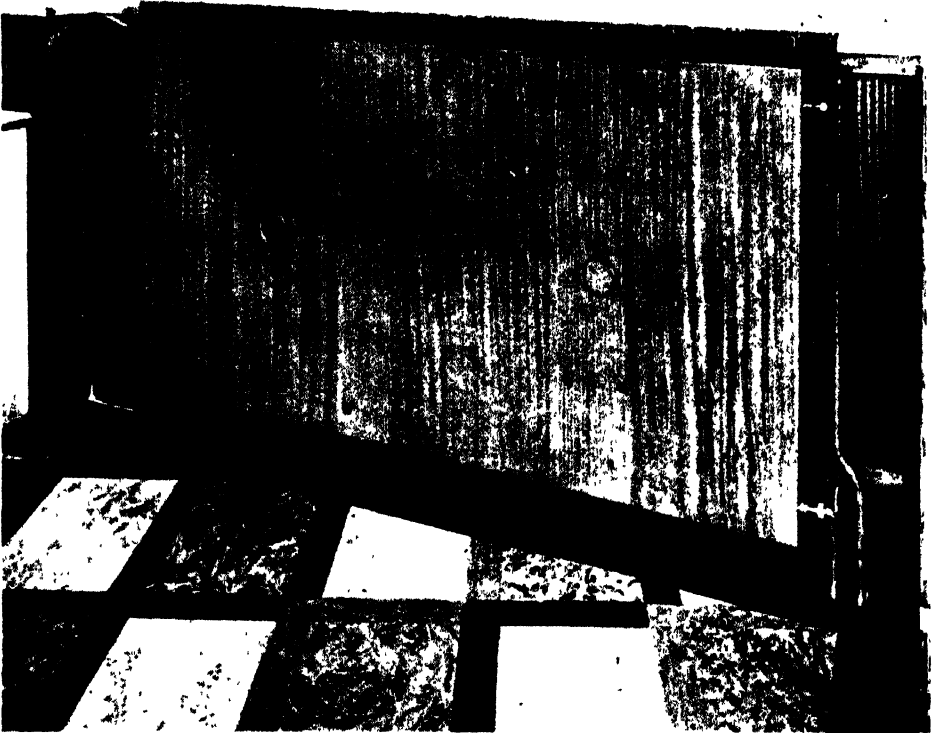

Fig. 9 -RADIATOR FIXED ON A TILED DADO

Decoration of the Radiating Face

For industrial work there is usually no objection to a black finish, but for other applications a black finish is not acceptable. White and other coloured paints possessing heat resisting properties can be freely used, but the paint manufacturers must be informed of the temperature of the water or steam in the radiator to ensure that a paint is supplied which will not discolour unevenly. Plastic paints can be applied to the radiating face and, when required to match surroundings, the radiating face of water radiators can be covered with a lining paper pasted on. Aluminium or bronze paints should not be used.

Chapter VII

HOT-WATER HEATING SYSTEMS

THE circulating pressure in any system of hot-water heating, where there is no mechanical device for circulating the water, is the excess of pressure in the return pipe over the pressure in the flow pipe due to the difference in density of water at different temperatures.

If we consider a simple circuit as shown in Fig. 1 and assume that the system has been filled but no heat applied, it is true to say the pressure in both flow and return pipes is equal at any common level.

In the horizontal return pipe the pressure will be equal to that induced by the height above it of the water in the feed tank. If the height is 16 ft. then the pressure in pounds per square inch is equal to $16 \times .433 = 6.928$. (The factor .433 is the pressure in pounds per square inch of a column of water 1 ft. high at a temperature of 62° F.) The pressure in the top horizontal pipe is $(15 - 10) \times .433 = 5 \times .433 = 2.165$ lb. per square inch. In the same way, the pressure at any other level is common to any part of the system.

The pressure in a low-pressure system is governed by the water level in the feed tank. If we consider a filled system where the tank is 30 ft. above the level of the boiler, the pressure at the boiler will be approximately 13 lb. per sq. in. above ordinary atmospheric pressure. Boiling-point at this pressure is 245.7° F. In the pipes and radiators situated on the upper floors of the building the pressure will naturally be less and the temperature correspondingly lower.

The usual maximum temperature allowed in the design of a low-temperature apparatus is 180° F.

The pressure or "static head" produced by a column of water is equivalent to 0.433 lb. per sq. in. for every foot in height.

The following table gives the corresponding pressure and boiling-points of water for various heights of water column :—

<i>Height of Column. Feet.</i>	<i>Pressure in pounds per square inch.</i>	<i>Boiling-point at Bottom of Column. ° F.</i>
2	0.866	214.9
4	1.732	217.6
6	2.598	220.3
8	3.464	222.8
10	4.330	225.3
15	6.500	231.0
20	8.660	236.2
25	10.830	241.2
30	12.990	245.7
35	15.160	249.9
40	17.320	253.8
45	19.490	257.7
50	21.650	261.3

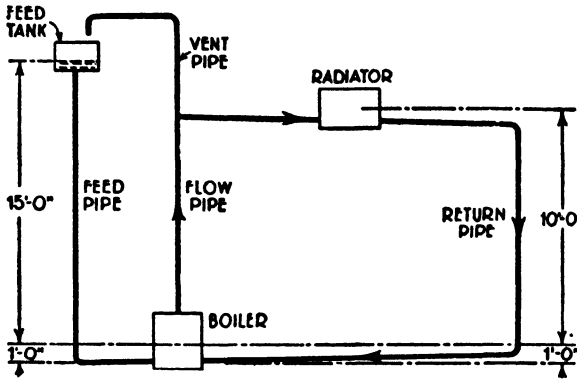

Fig. 1.—A SIMPLE HOT-WATER CIRCULATING SYSTEM

The circulating pressure is due to the difference in density of water at different temperatures.

If the boiler is fired, the water in it, on being heated, will expand, causing the density to become less. In this way the pressure conditions are made unequal and a circulation up the flow pipe and continuing through-out the system is set up.

The circulating head or pressure is usually expressed in inches of water column at 62° F.

TABLE 1.—DENSITY OF WATER AT VARIOUS TEMPERATURES

° F.	Lb. per Cu. Ft.	° F.	Lb. per Cu. Ft.	° F.	Lb. per Cu. Ft.
-32	62.418	130	61.571	180	60.560
-62	62.355	140	61.388	190	60.324
100	62.031	150	61.201	200	60.081
110	61.89	160	60.998	210	59.820
120	61.734	170	60.783	212	59.769

In the following table the values are given for a circuit height of 1 ft. and for various flow and return temperatures.

TABLE 2.—CIRCULATING HEAD

Mean Return Temperature	Mean Flow Temperature				
	150° F.	160° F.	170° F.	180° F.	190° F.
110° F.	.127	.165	.204	.244	.288
120° F.	.096	.131	.173	.211	.261
130° F.	.089	.108	.146	.186	.230
140° F.	.035	.072	.111	.152	.196
150° F.	..	.035	.077	.117	.161
160° F.038	.079	.123

Assuming that in the circuit shown in Fig. 1 the mean flow and return temperatures are 180° F. and 140° F. respectively, then the circulating head will be $.152 \times 10 = 1.52$ in., the factor 10 being the circuit height of the system, i.e. from the centre of the boiler to the centre of the radiator.

In one-pipe systems, radiator circulation is subsidiary to the main circulation so that heights are measured to the points where the return connections from the radiators join the mains. Such heights are shown in Fig. 2. Also with one pipe systems the water is cooled by the radiators in series and the mean height must be determined for each drop pipe or loop. The mean height is given by the sum of the products of the emission as the following Example will show.

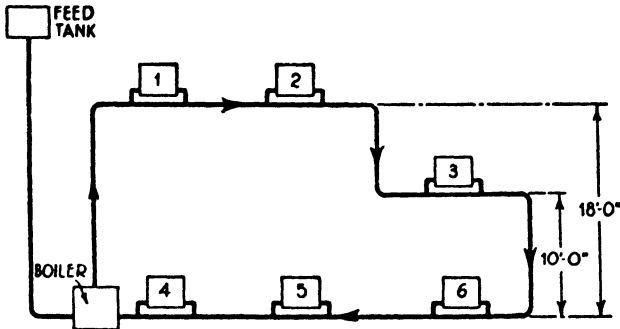

Fig. 2. - IN A SIMPLE SINGLE-PIPE CIRCUIT THE MEAN HEIGHT OF THE SYSTEM MUST BE ASCERTAINED

B.T.U.

Let the total emission from radiators 1 and 2 and pipe on same floor	.. = 15,000
Let the total emission from radiator 3 and pipe on same floor = 9,000
Let the total emission from 4, 5 and 6 and pipe on same floor = 21,000

then the mean circuit height will be the sum of the products of the height of each circuit and the radiation at that height, divided by the total radiation

$$\begin{aligned} \text{Thus } & \frac{15,000 \times 18 + (9,000 \times 10) + (21,000 \times 0)}{15,000 + 9,000 + 21,000} \\ & = \frac{270,000 + 90,000 + 0}{45,000} = \frac{360,000}{45,000} \\ & = 8 \text{ ft.} \end{aligned}$$

The circulating head, assuming the mean flow and return temperatures are 180° F. and 140° F., will be

$$8 \times .152 = 1.216 \text{ in.}$$

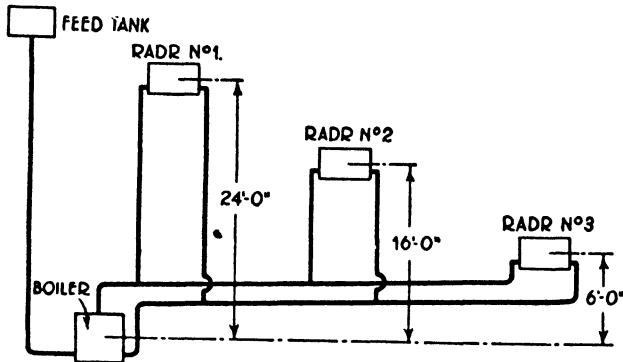

Fig. 3.—HOT-WATER CIRCULATING SYSTEM WITH ADDITIONAL RADIATORS AT DIFFERENT LEVELS

In less simple circuits, where additional radiators at different levels are involved, various circuit heights will have to be considered, as the example in Fig. 3 will show.

Here the circuit heights and the corresponding circulating heads, assuming the mean F. and R. temperatures to be 180° F. and 140° F., are :

	Circuit Height	Circulating Head
Circuit serving radiator No. 1	24 ft.	24 · .152 = 3.648 in.
Circuit serving radiator No. 2	16 ft.	16 · .152 = 2.432 in.
Circuit serving radiator No. 3	6 ft.	6 · .152 = .912 in.

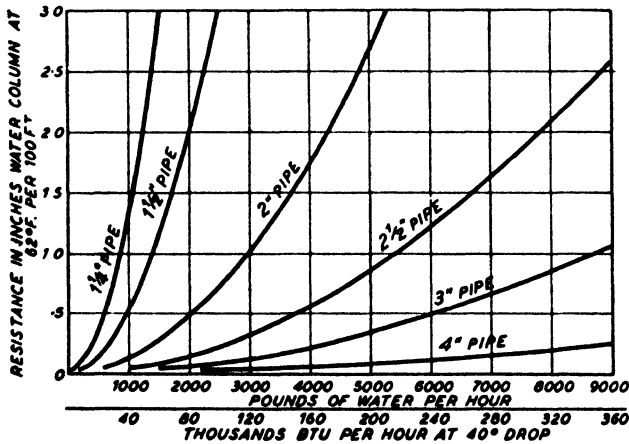

Fig. 4.—PIPE CAPACITIES FOR GRAVITY WATER-HEATING SYSTEM

Showing the resistance of different sizes of pipes for rates of flow varying from 500 to 9,000 lb. of water per hour.

In sizing the pipes for a gravity or accelerated system of heating sufficient water must be able to circulate through the system to convey the heat to the radiating surfaces. It is obvious that as the heat is given up by the water, so the temperature will drop, the actual number of degrees in the fall of temperature depending on the rate of flow through the system. For most gravity circuits the pipes are sized on a permissible drop of 40° F. between the flow and return temperatures at the boiler. We know that 1 lb. of water heated through 1° F. equals 1 B.T.U., therefore 1 lb. of water heated through 40° F. equals 40 B.T.U. If we

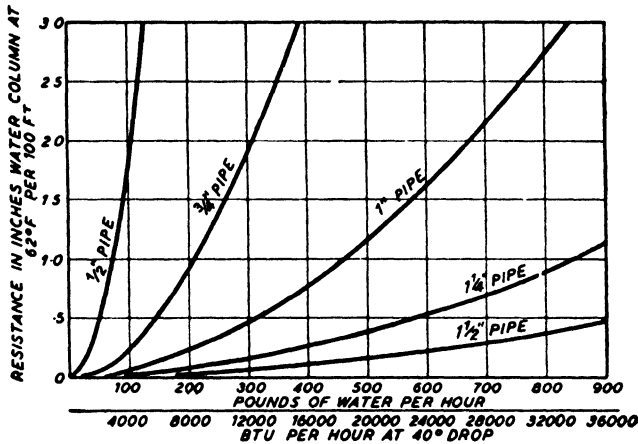

Fig. 5. — PIPE CAPACITIES FOR GRAVITY WATER-HEATING SYSTEMS

This gives the resistance and capacities for small-bore pipes, i.e. from $\frac{1}{2}$ -in. diam. to $1\frac{1}{2}$ -in. diam., and for deliveries of 0 900 lb. of water per hour.

consider a radiator capable of transmitting 40,000 B.T.U. at a temperature difference of 100° F. between it and the surrounding air, then, if the permissible drop is 40° F., the rate of flow through it must be equal to $40,000 \div 40 = 1,000$ lb. per hour, at a mean temperature of 100° F. above the temperature of the air. The selection of a pipe large enough to carry this quantity will be decided by considering the circulating head available and the resistance to the flow set up by the circuit.

Assuming that the length of the circuit, including an allowance for the extra resistance of various fittings, is 100 ft., and that the height of the radiator is 10 ft. above the centre of the boiler, then the circulating head for a flow temperature of 180° and return of 140° will be $10 \times .152 = 1.52$ in. The size of pipe must necessarily be one which will carry 1,000 lb. per hour through a length of 100 ft. with a total resistance of less than 1.52 in.

As will be seen from the chart in Fig. 4, a 1½-in. pipe will be required, since, with a flow of 1,000 lb. per hour the resistance through 100 ft. is 1.35 in.

It is useful to consider the capacity of pipes in terms of B.T.U., and since 40° is a common allowance for temperature drop, a second row of figures has been added to the chart, giving the B.T.U. capacities under such conditions. By this method the division of the B.T.U. load by 40 is rendered unnecessary.

In making allowance for the resistance of fittings in the pipe line, it is usual to consider this in terms of equivalent lengths of straight pipe.

The resistance of fittings may be allowed for in preliminary calculations by adding a percentage to the actual pipe length. For average installations 50 per cent. may be used. In more accurate calculations the equivalent length for each fitting should be taken from Table 3 and added to the measured pipe length.

TABLE 3.—FRICTION EQUIVALENTS OF FITTINGS

Fitting	Equivalent Length in Feet to be Added to Actual Length of Pipe					
	¾ in.	1 in.	1½ in.	2 in.	2½ in.	3 in.
Return bend	3	4	5.5	8	9.5	12
Long sweep bend (90°)	1	1.5	2.0	2.5	3	4
Short sweep bend (90°)	1.5	2	2.5	3.5	4.0	5
Short round elbow (90°)	2	3	3.5	5.5	6.5	8
Right-angle bend or tee	4	5.5	7.5	10.5	12.5	16
Gate valve (full open)	3	4	6	8	1.0	1.2
" " (½ open)	6.0	8.0	11.0	16.0	19.0	24.0
" " (¼ open)	51	68	93	136	162	220
" " (⅓ open)	296	392	538	784	932	1,178
Angle valve (full open)	3	4	5.0	7	8.5	11
Globe valve (full open)	6	8	11.0	16	19	24
Hot-water boiler	9	12	16.5	24	28.5	36

CIRCULATING PUMPS AND ACCELERATORS

The essential difference between an accelerator and a pump as used in heating circuits is that an accelerator has a by-pass which permits the circulation of the water to continue by gravity when the machine is stopped either deliberately or accidentally.

Both pumps and accelerators are commonly of the centrifugal type and are usually driven by an electric motor. Gas and oil engines are sometimes used in remote districts where electricity is not available. Where steam is obtainable at sufficient pressure, the steam turbine may be usefully employed as a prime mover and the exhaust steam from it

utilised for heating the water in the system by passing the steam through a calorifier.

Where the characteristics of the pipe circuit are such that little or no circulation can be obtained except by mechanical means, the provision of a by-pass is useless, and in order to maintain circulation it is advisable to provide duplicate pumps. In the event of the failure of one, the other can then be started up.

If there is no stand-by pump, there is a possibility, in the event of a breakdown, of the temperature of the water in the boiler rising to above steaming-point. The importance, in any case, of fitting a safety valve or open expansion pipe of adequate area to the boiler cannot be too strongly emphasised.

The centrifugal pump consists essentially of an impeller mounted on a driving shaft and surrounded with a casing designed to carry the water from the inlet to the impeller, and from the impeller to the discharge branch.

A pump must be carefully selected in order to ensure that it will operate with reasonable efficiency under the actual conditions of service.

The impeller is usually of gun-metal and the casing of cast iron. The driving shaft is supported by watertight bearings, and projects through them on one side of the pump. The shaft extension is fitted with either a pulley or half-coupling according to whether it is to be driven by a belt or directly from a motor or turbine.

It is not possible, commercially, to design a pump to work with a maximum efficiency under all the actual combinations of frictional resistance and gallons delivered which arise in practice. The percentage of efficiency, therefore, varies considerably and the best results depend upon how nearly the client's requirements coincide with the manufacturer's most efficient rating.

For small pumps an over-all efficiency of 30 per cent. may be considered good for an electrically driven unit, and for arriving at the electrical consumption the formula—

$$\frac{10 \times G \times H \times 100 \times .746}{33,000 \times E} \text{ will give kilowatts.}$$

G = Gallons per minute.

H = Head in feet.

E = Percentage of over-all efficiency of pump and motor.

Simplifying the formula we have :

$$\text{kW} = \frac{.0226 \times G \times H}{E}$$

The accelerator by-pass is usually fitted with a non-return valve, which is kept closed, when the machine is running, by the difference in

pressure on the inlet and delivery sides. This pressure difference ceases when the accelerator is stopped, and the valve swings open.

In the direct-driven accelerator or pump, the motor shaft is brought into alignment with the accelerator spindle and the two machines are coupled together to form one unit. Where the accelerator is fitted with a rope or belt drive, the motor is sometimes bolted to the top of the casting in order to effect a saving in floor space.

The engineer should be careful to ascertain particulars of the electric supply in all cases where an electrically driven accelerator is required. If direct current is available it is necessary to know only the voltage, but if alternating current is laid on particulars should be obtained of the voltage, phase and periodicity. For small units single-phase motors are satisfactory, but for larger machines a 3-phase supply should be brought in. The Supply Authorities should be consulted.

Regard should also be given to the conditions under which the motor is to operate. Damp or badly ventilated boiler houses and situations where dust or fumes are likely to impair the motor windings should be given consideration. If the manufacturers are advised, they will recommend and submit proposals for suitably protected equipment.

The most satisfactory position for the accelerator in the pipe circuit is in the return pipe, fairly close to the boiler. In this position the temperature of the water is relatively low and the boiler attendant is at hand for ready supervision.

Precautions are necessary at times to prevent the transmission of noise from the accelerator. In such instances it is advisable to introduce an anti-vibration base of cork or similar material under the machine, and the motor manufacturers should be informed of the necessity for silence in operation.

Sizes of Pipes for Heating Systems

The effect produced by an accelerator or pump in the circulating system is an increase in the circulating head, which, instead of being measured in inches or fractions of an inch can be stated in terms of feet. The carrying capacities of the pipes are thereby increased considerably, with the result that it is possible to use pipes of comparatively small diameters for large and extensive installations where circulation by gravity would be impracticable.

If we consider the comparative carrying capacities of a 2-in. diam. pipe circuit having a natural circulating head of 0.4 in. per 100 ft., and the same circuit fitted with an accelerator giving a head of 1 ft. per 100 ft., the corresponding flow of water will be : —

By gravity circulation, 1,820 lb. per hour.

By accelerated circulation, 9,150 lb. per hour.

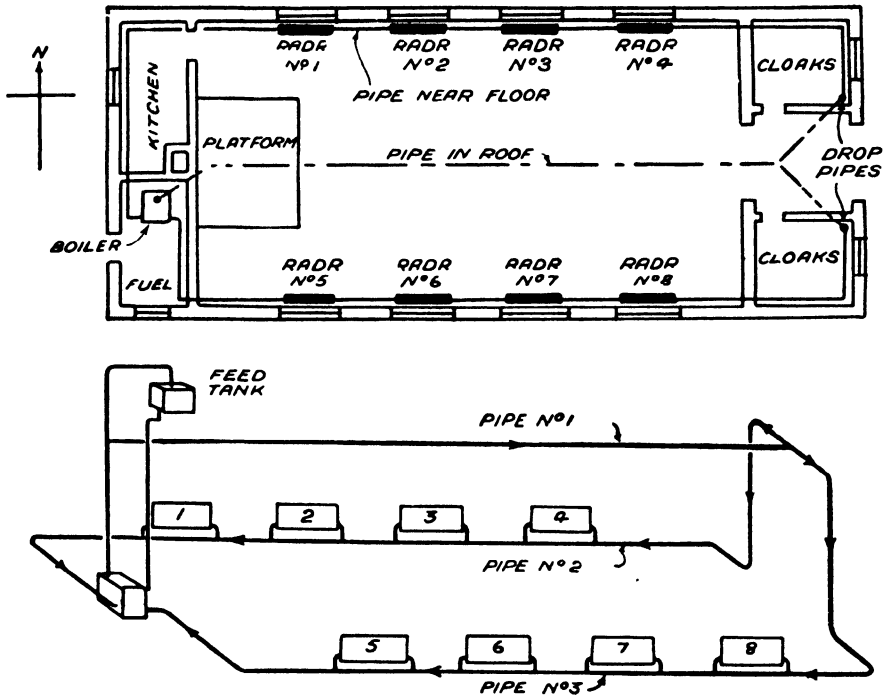

Fig. 6.—TYPICAL SINGLE-PIPE HEATING SYSTEM FOR A RECREATION ROOM OR SMALL ENTERTAINMENT HALL, USING PIPES AND RADIATORS SERVED BY A BOILER 18 IN. BELOW FLOOR LEVEL

A simple and reliable formula evolved by Thomas Box is one used extensively for determining the sizes of pipes for circulating systems. This gives:—

$$H = \frac{G^2 \times L}{(3d)^5}$$

Where H = Head in feet.

G = Gal. per minute.

L = Length of pipe in yards.

d = Diameter of pipe in inches.

From this formula the charts in Figs. 4, 5, 9, and 10 have been prepared, giving the flow of water in pounds per hour and the corresponding resistance in feet per 100-ft. run of pipe.

It is usual to allow an average resistance of from 1 to 2 ft. per 100-ft. run in accelerated systems, and on this basis the total head is determined against which the pump will be required to work. Assume, for example,

that the length of the longest circuit is 1,500 ft., then, by allowing $1\frac{1}{2}$ ft. per 100 ft., the total head will be :—

$$1\frac{1}{2} \times 1,500 \div 100 = 22\frac{1}{2} \text{ ft.}$$

Calculation of Pipe Sizes Required for Installations

The principles upon which the sizes of pipes are determined can now be applied in considering various heating layouts. The following examples are of common occurrence in general practice and will serve to illustrate some of the methods employed.

Before starting pipe sizing calculations it is necessary to realise that the aim is to achieve a balance between the circulating pressure and the pressure loss in the pipes. That is, the diameters must be such that the pressure loss when the required rate of flow obtains is equal to the circulating pressure. Some examples illustrating the method of achieving this follow.

Example 1.—It has already been determined that the mean height of the installation in Fig. 2 is 8 ft. For flow and return temperatures of 180° F. and 140° F., the circulating pressure is $8 \times 0.152 = 1.216$ in. The total emission from the installation has been given as 45,000 B.T.U. per hour. Hence the rate of water flow needed is $\frac{45,000}{40} = 1,125$ lb. per hour.

Let the actual length of the circuit be 100 ft. Adding 50 per cent. for the resistance of fittings the equivalent length is 150 ft., and the allowable average pressure drop per foot $\frac{1.216}{150}$ in. Figs. 4 and 5 charts are for a length of 100 ft. and for this length the allowable resistance will be $\frac{1.216 \times 100}{150} = 0.81$ in.

Referring to Fig. 4 it will be seen that with this resistance, a flow of 1,125 lb. per hour requires a 2 in. pipe. In more complicated systems, however, it is necessary to compute the actual circuit resistance and this will be carried out for Fig. 2 to show the method.

The illustration shows five long sweep bends, which together with the boiler have an equivalent length of 36.5 ft. (Table 3). Fig. 4 shows that a flow of 1,125 lb. of water per hour through 2 in. pipe involves a pressure loss of about .2 in. per 100 ft. The pressure loss in the circuit will be

$0.2 \div 100 (100 + 36.5) = 0.27$. This is considerably less than the circulating pressure of 0.963 in., which means that the installation would work well with a temperature drop less than 40° F.

The diameters of the radiator connections in one pipe systems may be determined from the formula $d = 0.01 \sqrt{E}$ where d is the diameter of the connection in inches, and E is the emission from the radiator in B.T.U. per hour. The diameter of the connections for a radiator with an emission of 5,000 B.T.U. would be given by $d = 0.01 \sqrt{5,000} = 0.707$. The nearest standard size is $\frac{3}{4}$ in. which would be used.

Example 2.—It is proposed to heat a recreation room or small entertainment hall by pipes and radiators served by a boiler fixed 18 in. below floor level. The temperature inside the room is to be maintained at 60° F. and circulation must be by gravity. The level of the boiler relative to the floor level limits the choice of a system to one in which the circuit height must be some distance above floor level in order to obtain a satisfactory circulation. A single-pipe system is therefore decided upon as shown in the plan and diagram (Fig. 6).

Assuming that the calculated heat losses are 40,000 B.T.U. per hour, then from a rough approximation it is considered that a 2-in. diameter flow pipe will be required. Taking the mean temperature difference of the pipe in the roof space to be 175° — 45° = 130° F., the length 60 ft., and the efficiency of the insulating covering 60 per cent., then the heat loss will be :—

$$\frac{40}{100} \times 60 \times 183 = 4,400 \text{ B.T.U. per hour.}$$

The factor 183 is the transmission in B.T.U. per hour per foot run of 2-in. pipe at 130° temperature difference.

Taking the height of the pipe above the boiler to be 15 ft., we can proceed to calculate the mean circuit heights and circulating heads.

Let the total transmission from pipe No. 2 = 21,000 B.T.U. and that from pipe No. 3 = 19,000 B.T.U. (Pipe No. 2 serves the N. wall.)

Then the mean height of the circuit formed by pipes 1 and 2 will be :—

$$(A) \quad \frac{(4,400 \times 15) + (21,000 \times 0)}{4,400 + 21,000} = \frac{66,000}{25,400} = 2.6 \text{ ft.}$$

Similarly for pipes 1 and 3.

$$(B) \quad \frac{(4,400 \times 15) + (19,000 \times 0)}{4,400 + 19,000} = \frac{66,000}{23,400} = 2.83 \text{ ft.}$$

The corresponding circulating heads for a flow temperature of 180° F. and return 140° F. are found by multiplying by .152 :—

$$(A) \quad 2.6 \times .152 = .395 \text{ in.}$$

$$(B) \quad 2.83 \times .152 = .43 \text{ in.}$$

The lengths of the various parts of the circuit are : Pipe 1, 86 ft. ; Pipe 2, 120 ft. ; Pipe 3, 100 ft.

As the total emission is 44,400 B.T.U. per hour with a temperature drop of 40° F., the weight of water flowing is $\frac{44,000}{40}$ or 1,100 lb. per hour. Since a gallon of water weighs 10 lb. this is equivalent to $\frac{1,100}{10 \times 60}$ or 1.85 gallons per minute.

This would be carried by pipe 1, and would divide between pipes 2 and 3 in proportion to their load. Thus pipe 2 would require a flow of $\frac{23,300}{44,000} \times 1.85$, or .97 g.p.m., and pipe 3, .88 g.p.m. Inspection of Figs. 4 and 5 indicates that suitable sizes might be 2 in. for pipe 1, and 1½ in. for pipes 2 and 3. The resistance in each branch can be found from the Box formula as follows :

$$\text{Pipe No. 1. } h \text{ (in inches)} = 12 \times (1.85)^2 \times \frac{86}{3} \times \left(\frac{1}{3 \times 2}\right)^5$$

or .152 in. Similarly, the resistances of pipes 2 and 3 are found to be .24 and .17 in w.g. respectively.

The loads on pipes 2 and 3 are obtained by proportioning the total load according to their radiation, thus :—

$$\text{Pipe No. 2. } 44,400 \times \frac{21,000}{40,000} = 23,300 \text{ B.T.U.}$$

$$\text{Pipe No. 3. } 44,400 \times \frac{19,000}{40,000} = 21,100 \text{ B.T.U.}$$

It is convenient now to tabulate the data as follows :—

Pipe No.	Radiation B.T.U.	Load B.T.U.	Length Ft.	Diam. In.	Resistance for 40° Drop. In.
1	4,400	44,400	86	2	.152
2	21,000	23,300	120	1½	.24
3	19,000	21,100	100	1½	.17

On comparing the circulating head with the resistance of the piping, we have :—

$$(A) \quad \text{Circulating head} = .392 \text{ in.} \quad \text{Resistance} = .392 \text{ in.} \quad (1 \ \& \ 2)$$

$$(B) \quad \text{,,} \quad \text{,,} \quad = .43 \text{ in.} \quad \text{,,} \quad = .322 \text{ in.} \quad (1 \ \& \ 3)$$

As the difference in circulating head is greater and the resistance is less in circuit (B) than in (A) it would be advisable to fit a lock shield regulating valve in pipe No. 3 in order to regulate the circuits.

The temperatures of the radiators on single-pipe circuits are usually taken at approximately 10° less than the temperature of the pipe, and the pipe temperature can easily be determined as follows:—

The difference in the temperatures of the flow and return pipes at the boiler, viz. 40° , is due to the loss by radiation of 44,400 B.T.U. The temperature drop, therefore, along any particular pipe can be found by multiplying the total drop by the radiation and dividing by the load.

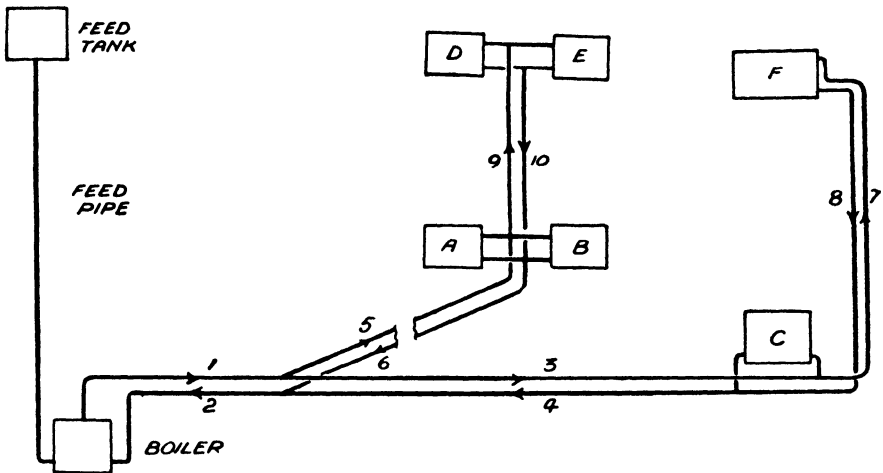

Fig. 7.— AN ARRANGEMENT OF A TYPICAL TWO-PIPE UP-FEED SYSTEM FOR A PRIVATE HOUSE INSTALLATION

The drops, for instance, in Example 1, will be:—

pipe No. 1, $40^{\circ} \times 4,400 \div 44,400 = \text{approx. } 4^{\circ}$; that along
 pipe No. 2, $40^{\circ} \times 21,000 \div 23,300 = 36^{\circ}$; similarly for
 pipe No. 3, $40^{\circ} \times 19,000 \div 21,100 = 36^{\circ}$.

The mean temperatures of the radiators will be:—

$$140^{\circ} + \frac{36}{2} = 148^{\circ} \text{ F.}$$

Example 3.—This is the more complicated installation shown in Fig. 7. Radiators A, B, and C are on the ground floor, their height above the boiler being 6 ft.; the height to the first floor radiators D, E, F is 15 ft. The corresponding circulating pressures for a flow temperature

of 180° F. and a temperature drop of 40° F. are :

Ground floor 6 × 0.152 = 0.912 in.

First 15 × 0.152 = 2.28 in.

The heat emissions from the radiators are, in B.T.U. per hour,

A 8,000 C 6,000 E 5,000

B 8,000 D 5,000 F 4,000

It is best in more complex installations such as this to tabulate the calculations as shown below. The first step is to determine the loads on the pipes starting with the most distant radiator on each branch, and working back to the boiler, adding in the emission of each radiator as it is reached. The result of doing this is shown in the second column of the table for the present installations, the emissions having been increased by 30 per cent. to allow for pipe losses. The lengths of the pipes, measured from the plans, are shown in the third column.

Number	Load B.T.U. per Hour	Pipe Length Ft.	Length for Fittings Ft.	Diam. In.	Pressure Drop In.	Total Pressure Drop In.
1 & 2	46,800	30	22.5	1½	0.37	—
3 & 4	13,000	30	—	1	0.17	—
Rad. C	7,800	6	14	¾	0.37	0.91
7 & 8	5,200	38	9.5	1½	1.42	1.96
5 & 6	33,800	40	17.5	1½	0.6	—
Rad. A.	10,400	4	12	1	0.05	1.02
9 & 10	13,000	27	—	¾	0.57	—
Rad. D	6,500	4	6	½	0.44	1.98

The calculations should always begin with the circuit of the "index radiator," that is, the radiator with smallest circulating pressure and longest circuit. In Fig. 7 either radiator A or C might be the index radiator. Choosing the latter it is seen that its circuit consists of pipes 1, 2, 3, 4, and its own connections, a total length of 66 ft. Allowing 50 per cent. for fittings resistance the equivalent length is about 100 ft. Knowing this, the circulating pressure and the loads on the pipes, the preliminary pipe sizes can be selected, with the aid of Figs. 4 and 5; they are shown in column 5 of the table.

Now the equivalent lengths for the fittings for the circuit of radiator C may be entered in the fourth column. Referring to Fig. 5 the actual

pressure drop for a ¾ in. pipe carrying $\frac{7,800}{40}$ lb. of water is 1.9 in. per 100 ft.

Hence the pressure lost in the connections to radiator C, equivalent length 20 ft., is $\frac{1.9 \times 20}{100} = 0.37$ in. This is shown in column 6.

In a similar way the pressure drop in pipes 1 and 2 is found to be 0.37 in. and in pipes 3 and 4, 0.17 in. The total resistance of radiator C circuit is 0.91 in. This is within 10 per cent. of the circulating pressure (0.912 in.) and may be accepted as satisfactory.

Radiator F has pipes 1, 2, 3 and 4 in common with radiator C. The pressure loss in these pipes has been computed as 0.54 in. which, subtracted from the circulating pressure 2.28 in., leaves 1.74 in. to be absorbed in pipes 7 and 8. Allowing for resistances the equivalent length of these pipes is about 50 ft. and the rate of flow through them is 130 lb. per hour. For a pressure loss of $\frac{1.74 \times 100}{50}$, that is, about

3.5 in. per 100 ft., Fig. 5 shows that $\frac{1}{2}$ in. pipe will be suitable.

The equivalent lengths for fittings in pipes 7 and 8 should now be shown on the calculation sheet. It is found from Fig. 5 that the actual pressure drop in $\frac{1}{2}$ in. pipe carrying 130 lb. per hour is 3 in. per 100 ft., so that the pressure absorbed in pipes 7 and 8 is 1.42 in. This figure added to the pressure loss in pipes 1, 2, 3 and 4 gives a total pressure loss for the circuit of radiator F of 1.96 in. The circulating pressure of 2.28 in. exceeds this figure by rather more than 10 per cent. suggesting that radiator F may need a little valve regulation in order to ensure a balanced circulation.

The circuits of the remaining radiators have been calculated in a similar way and the results are shown on the calculation sheet. In dealing with them it must be remembered that they have pipes 1 and 2 in common with radiators C and F. The pressure loss in these pipes must, therefore, be included in the calculations for radiators A to E.

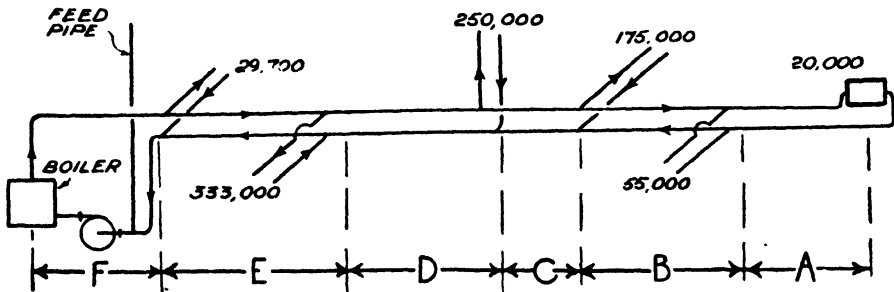

Fig. 8.—THE ACCELERATED SYSTEM

In which the pipes in the main trunk line are sized so that the total resistance approximates to the pump head.

Example 4.—In the accelerated system shown in the diagram, Fig. 8, the pipes in the main trunk line are sized so that the total resistance

approximates the pump head. If the sizing is done methodically, the total head and the head available at various points in the system can be easily ascertained. The branch circuits can then be sized according to the head available at the junction to the main pipe line.

Let the total length equal 1,000 ft. and the temperature difference at the boiler 30° F. Then allowing an average resistance of 1 ft. per 100-ft. run, we can size the pipes as in the table, from which we find that the total resistance is 10 ft. which is the head against which the pump must operate.

Section	Load * B.T.U./Hr.	Length Ft.	Diam. In.	Resistance Ft.	Head Available at Junction
A	24,000	150	¾	1.5	1.5
B	90,000	180	1¼	2.07	1.5 + 2.07 = 3.57
C	300,000	80	2	.94	3.57 + .94 = 4.51
D	600,000	200	3	1.26	4.51 + 1.26 = 5.77
E	1,000,000	240	3	4.17	5.77 + 4.17 = 9.94
F	1,350,000	150	4	1.13	

Total Resistance 10.00

* 20% added to net load for mains losses.

The gravity circulating pressure may in general be ignored with accelerated systems since it is but a small proportion of the total pressure. A pressure drop of 1 ft. per 100 ft. is quite a good figure to adopt for preliminary pipe sizing, but in the complete calculations some attention should be given to the resulting velocities in the pipes. In positions where lack of noise is important a velocity of 4 ft. to 6 ft. per second should not be exceeded. Quite often accelerated systems are designed for a temperature drop of only 15 or 20° F. This results in a higher mean temperature in the radiators for a given boiler temperature and also in pipes big enough to allow of some gravity circulation under favourable conditions when the pump is not running. This is desirable and should be borne in mind when the system is designed. The charts given in Figs. 9 and 10 may be used in the design of accelerated systems.

In the space available it is not possible to explore all the methods by which the sizes of pipes can be determined. The accurate sizing of pipes, moreover, is one which requires considerable attention on the part of the engineer, and the reader is referred to the works of such authorities as Reitchel and Weisbach for more comprehensive treatment of the subject.

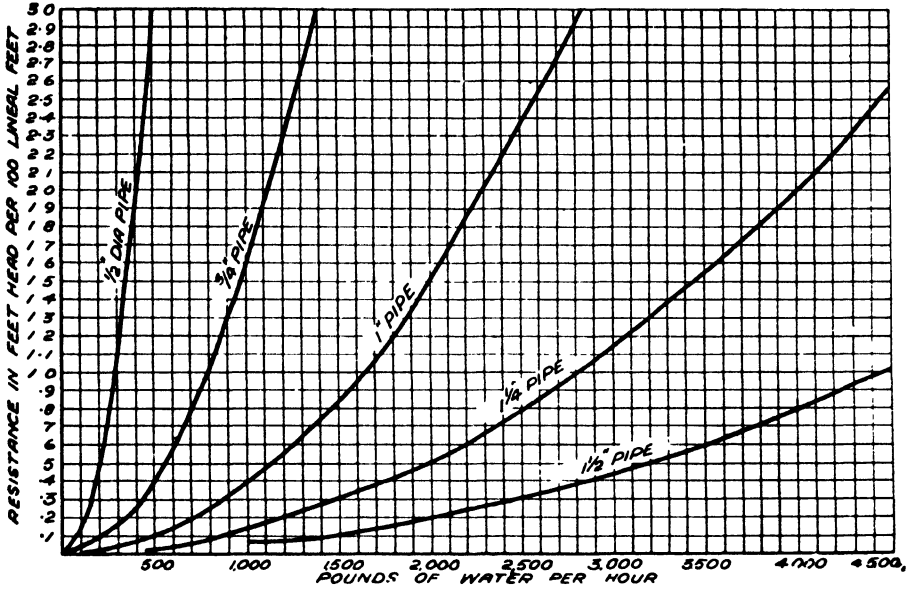

Fig. 9. CHART SHOWING FLOW OF WATER FOR ACCELERATED SYSTEMS

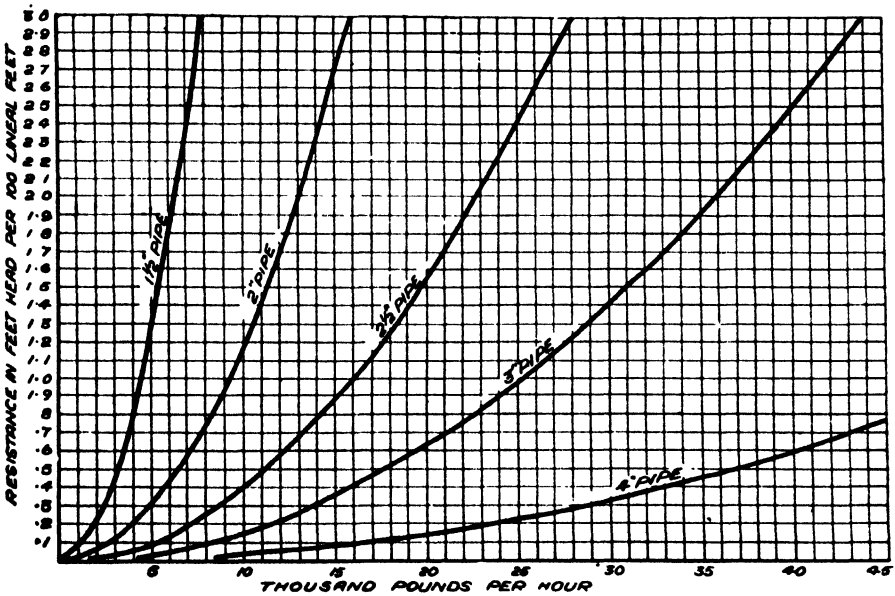

Fig. 10.—CHART SHOWING FLOW OF WATER FOR ACCELERATED SYSTEMS

Feed and Expansion Tanks

These are usually of galvanised mild steel and their capacity should be sufficient to hold the increase in the volume of water by expansion when heated. The water content of the system should be calculated, and the expansion will increase the bulk by about $\frac{1}{2}\%$.

The tank should be fixed well above the highest point of the system, and if a water supply is laid on, the ball valve should be adjusted so that the cold-water level is kept as low as possible.

The overflow pipe should not be less than $1\frac{1}{4}$ -in. diameter, and should be arranged to discharge outside the building, where, in the case of failure of the ball valve, any excessive overflow will be easily noticeable.

The feed pipe may be connected to any part of the system where there is no possibility of it being isolated from the boiler by the inadvertent closing of valves. In accelerated systems it is usual to connect it close to the inlet side of the accelerator or pump. It should not be less than $\frac{3}{4}$ -in. diameter, and for installations where the boiler is rated above 500,000 B.T.U. a 1-in. diameter pipe is recommended.

Sizing a Feed and Expansion Tank

The procedure in sizing the tank is first to ascertain the amount of water in the system. The water content of radiators and boilers is given by the various manufacturers in their catalogues, whilst the water content of the pipes can be found by the easily remembered rule, the number of pounds of water per yard of pipe equals the diameter of the pipe squared in inches. Thus, a 1-in. bore pipe contains 1 lb. of water per yard, a 2-in. pipe 4 lb. per yard, a 4-in. pipe 16 lb. per yard, and so on.

Fig. 11. — TWO-PIPE UP-FEED SYSTEM.—1

System adopted when there is a basement in which to place boiler and where it is possible to run pipes underneath ground floor. Risers are taken to radiators on upper floors. A shows method of connecting lowest radiator to ensure that it gets the proper amount of hot water.

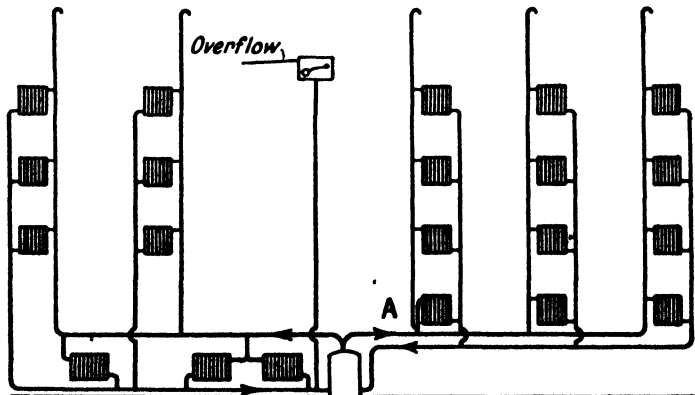

Having found the water content of the system as a whole, boiler plus pipes, plus radiators, one-twentieth of this volume should be accommodated between the lower and upper water levels of the feed and expansion tank, and an allowance of 6 in. to 12 in. made for the space occupied by the ball-valve and overflow connections.

TYPICAL LAYOUTS FOR HOUSES, FLATS, OFFICE BLOCKS AND FACTORIES

The method of calculating the pipe sizes for heating installations has already been dealt with and typical gravity and forced circuits were taken as examples. But, although there are not many systems of heating, each system can be varied and adapted to special requirements and a scheme evolved for any building, no matter what form it takes or what special problems it presents.

Low-Pressure Gravity System—Two-pipe Up-feed System

When there is a basement, so that a boiler can be placed at that level, and main circulating pipes run either in the basement or underneath the ground floor, then a two-pipe up-feed system may be the best to adopt. In the system shown in Fig. 11 the boiler and mains are so arranged. Risers are taken up to the radiators on the upper floors. When erecting the rising pipes it is sometimes possible to give the lowest radiators preference by connecting the flow as at A, in Fig. 11, otherwise the heat will rush up to the top radiators to the detriment of the lower ones.

Valves on Radiators.—All the radiators should be fitted with double regulating valves or two valves, one being of the lock shield type. The latter can be regulated and set so that each radiator gets its proper share and the whole warms up evenly.

Expansion Pipes.—At the extreme ends of the circuits, air pipes are shown which allow for the expansion of the water and also for the escape of air. When the radiators are connected at the top and bottom, all the air escapes through the air pipes. This avoids the necessity of opening the air valves on the radiators when charging up, and on a large installation the saving of time is considerable.

Fittings.—Air must not be allowed to collect in the horizontal mains and eccentric fittings should be used to ensure this. The use of concentric tees, etc., should only be permitted when the risers are placed so as to

release the air through the air pipes mentioned above.

The left side of Fig. 11 shows radiators fixed in the basement and the main return pipe fixed at a low level to accommodate them.

Two-pipe System with Central Mains

Fig. 12 shows a two-pipe system where the mains are carried along in a central passage or duct with branches taken to radiators on each side. These branches are continued up as risers to radiators fixed on the upper floors and follow the same lines as in Fig. 11.

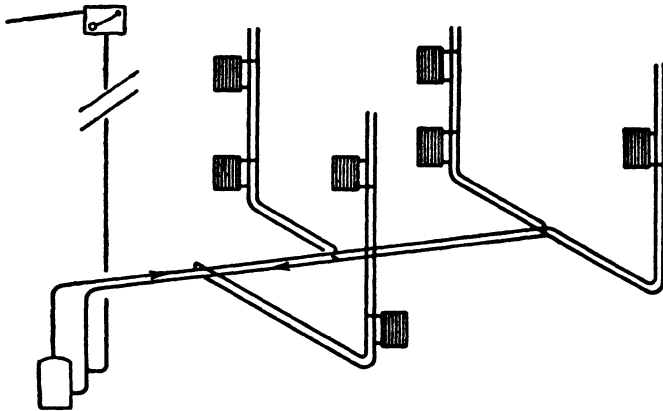

Fig. 12. TWO-PIPE UP-FEED SYSTEM. - 2

System adopted where mains are carried along a central passage or duct with branches taken to radiators on each side. These branches are continued up as risers to radiators fixed on the upper floors.

Fig. 13 is another two-pipe system with the main return pipe running in the same direction as the flow pipe but increasing in diameter on its way, until it eventually reaches the boiler where it will be the same size as the flow pipe at this point. In this arrangement short circuiting cannot take place as was described for Fig. 11. When it is possible to use this system it has many advantages.

Drop System

In this system, the main flow pipe leaves the boiler and ascends to a point above the highest radiator if possible (see Fig. 14). An expansion pipe is taken off at the highest point and acts as an air release. From here the main pipe falls to the position of the various drop pipes. These descend and are connected at a convenient position to the return main which is carried along back to the boiler.

Fig. 13. — TWO-PIPE UP-FEED SYSTEM.— 3

Another two-pipe up-feed system with the main return pipe running in the same direction as the flow pipe but increasing in diameter on its way until it eventually reaches the boiler where it will be the same size as the flow pipe at this point.

In this arrangement short circuiting, i.e., hot water starvation of the lowest radiator, cannot take place. When it is possible to use this system it has many advantages.

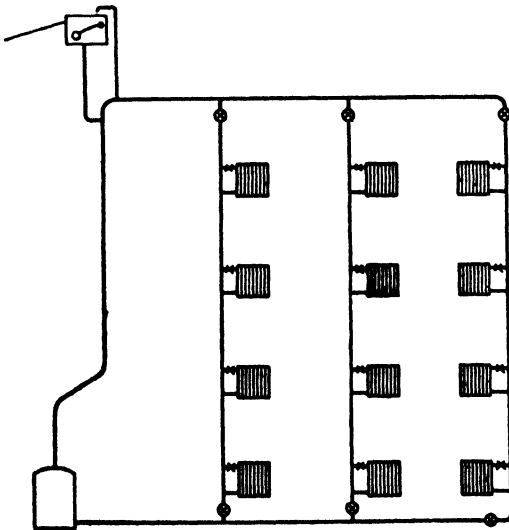
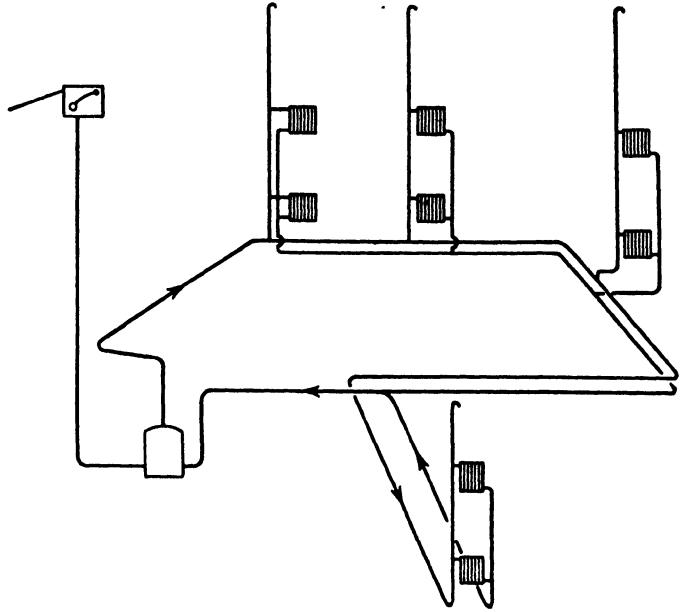

Fig. 14. — DROP SYSTEM

Radiators are fed off the drop pipes with top and bottom connections.

The feed tank is situated above the highest part of the system and the feed pipe is connected generally to the return main in the boiler room. However, it may be connected to the flow main near the top with satisfactory results.

When valves are fitted on the drop pipes at top and bottom, repairs or alterations can be carried out without putting the whole building out of action. They are also useful for regulating purposes.

It will be observed that the drop pipes nearest the boiler will have a tendency to race, to the detriment of those far away. The regulating

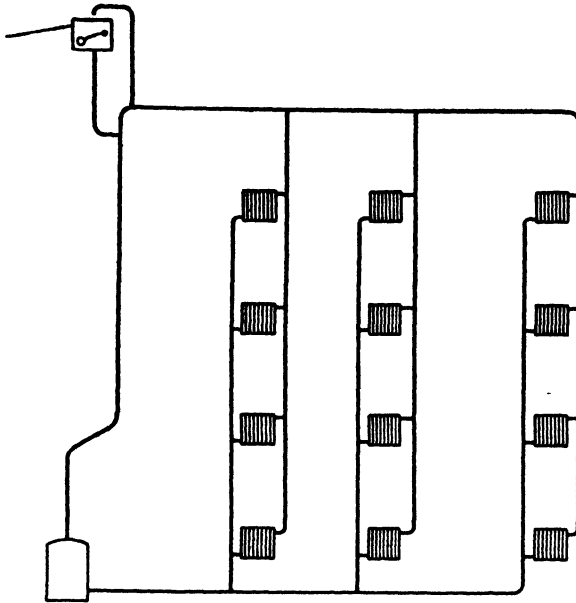

Fig. 15.- TWO-PIPE DROP SYSTEM

The drop pipes nearest the boiler in the drop system in Fig 14 will tend to rob the farthest radiators. Regulating the valves in the radiators would not overcome this. If, however, the drop pipes are arranged as in the illustration on the left, all the regulation could be managed at the lock shield valves on the radiator return connections. The position of the high level horizontal main varies according to the building. A position in the roof space above all the radiators is much to be preferred.

of the valves on the radiators would not overcome this. If, however, the drop pipes were arranged on the two-pipe drop system as in Fig. 15, all the regulation could be managed at the lock shield valves on the radiator return connections.

Position and Fixing of High Level Horizontal Main

The position of the high level horizontal main varies according to the building. Sometimes it can be in the roof space above all the radiators. This position is much to be preferred.

For Building with Flat Roof

If there is no space, such as in a building with a flat roof, it may be possible to suspend the pipe from the ceiling. Failing this it can be on the flat roof, supported on suitable stands or brackets. The whole must be insulated and made weatherproof, and where the drop pipes pass through the concrete roof they must be free to expand and contract. At the same time proper weathering must be provided to prevent any rain passing through the hole in the roof.

Horizontal Main in Small Roof Space

Another position for the horizontal main is in the small roof space on the

top floor level (see Fig. 16). Any radiators fixed on the same floor would have top and bottom connections, and as air is likely to accumulate in them, it would be an advantage to fix an air pipe in place of the usual air valve. This air pipe should be kept inside to a height above the level of water in the feed tank before turning outside, otherwise there would be a danger of freezing.

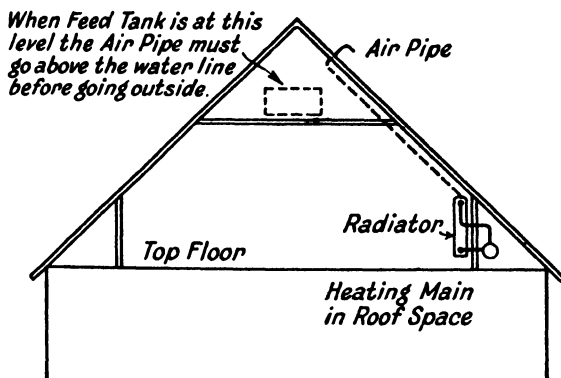

Fig. 16. DROP SYSTEM HORIZONTAL MAIN IN SMALL ROOF SPACE ON TOP FLOOR LEVEL

System which Eliminates Number of Drop Pipes

Fig. 17 is a system where the main flow riser is carried up at one end of the building and diminishes at each floor. A corresponding return main is at the other end and horizontal pipes taken along each floor to supply the radiators are connected to these vertical mains in the form of a grille.

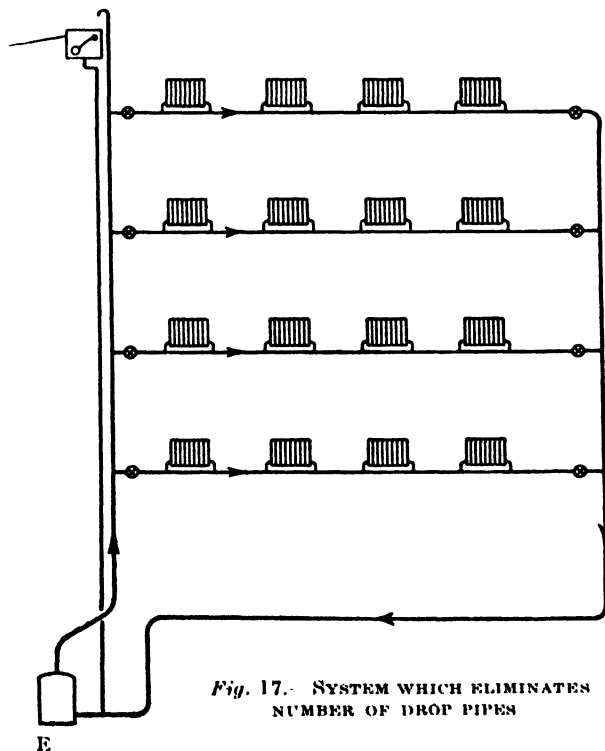

Fig. 17. SYSTEM WHICH ELIMINATES NUMBER OF DROP PIPES

The horizontal mains should have a valve at each end for controlling.

This form of heating obviates the number of drop pipes, and is sometimes preferred when a position for the horizontal piping is available.

It is possible also in this system to cut out a complete floor without affecting the others, and is adopted where buildings are let out in separate floors with or without heating.

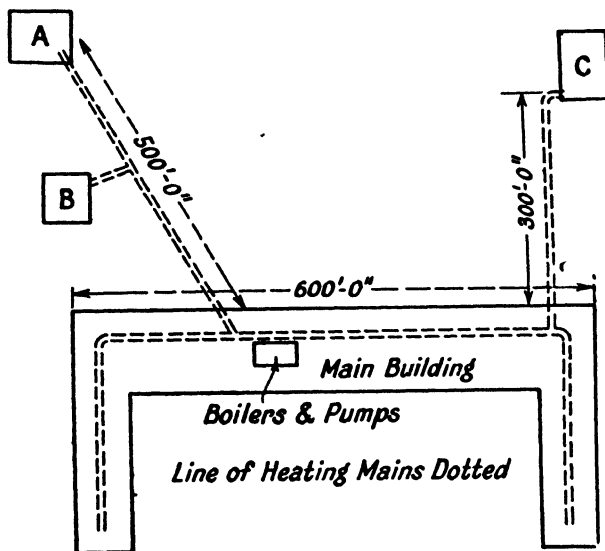

Fig. 18.-- TYPICAL EXAMPLES OF AN ACCELERATED SYSTEM

Showing the layout designed for heating a school which had return wings and, in addition, three independent buildings, A, B and C. These latter were on a lower level than the school itself. The two-pipe up-feed system was used and is illustrated in Fig. 11. A gravity feed system was ruled out, since there would have been heavy costs for trenching, etc.

Accelerated Systems and Forced Circulation

In medium and large size jobs an accelerator is a distinct advantage, either for assisting a gravity system or for a forced circulating system when it is not possible to design a gravity system.

Pipe sizes can be very much reduced, and the pipes run up and down irrespective of levels, thereby saving, in some cases, deep trenches. (Air venting must be considered.)

The mains need not be run at a low level with risers to the floors above, although this is usual practice. There are times, however, when the mains are run in the roof with drop pipes to the radiators below, the returns rising again into the main return in the roof.

There are many adaptations possible and the sketches indicate some systems in actual operation.

As it has already been said, when a system is not intended to work entirely by gravity, and a pump is fitted to make it a complete success, it is known as an accelerated system. Other means of accelerating are sometimes used, but these generally add some strain to the system or increase the fuel bill to maintain a very high temperature on the boiler. The motor-driven pump is distinctly to be preferred for not only doing the work, and the saving in fuel (due to less pipe surface) offsets the cost of current.

A forced circulating system, as its name implies, is a system where the water is forced throughout the whole of the piping and radiators. The pipes are kept smaller than in gravity or accelerated systems, and are run irrespective of levels. The heating up of the building is, therefore, dependent upon the pump to get the hot water round.

EXAMPLE OF ACCELERATED SYSTEM.—A typical illustration of where an accelerated system is used is shown in Fig. 18. This is of a school about 600 ft. in length, with return wings at each end. The three independent buildings, A, B, C, are at a lower level than the school itself, and some distance away.

The boilers and accelerators are situated in the basement of the main building and the pipes are suspended from the ceiling of the centre corridor and branches and risers are taken off as explained in sketch, Fig. 12.

The mains to the outlying buildings, A, B, C, are run in by trenches and each building has valves controlling it.

A gravity scheme would mean very expensive trenching and would not be considered.

EXAMPLE OF FORCED CIRCULATING SYSTEM.—Fig. 19 shows a forced circulating system to a block of offices, all on one floor and covering five acres. The boilers are on the same level and situated at one end.

All the boilers are coupled together into main flow and return headers, the flow main descends into a trench, the return main also in the trench runs side by side throughout the length and breadth of the building.

From these mains sub-circuits are taken off at convenient positions to supply the radiators and coils round the roof lights.

The main return pipe is carried into the pump room where pumps in duplicate are installed, thence back to the boiler return header.

Anchors and sliding expansion joints are used on the long mains in the trenches, as explained in Chapter V.

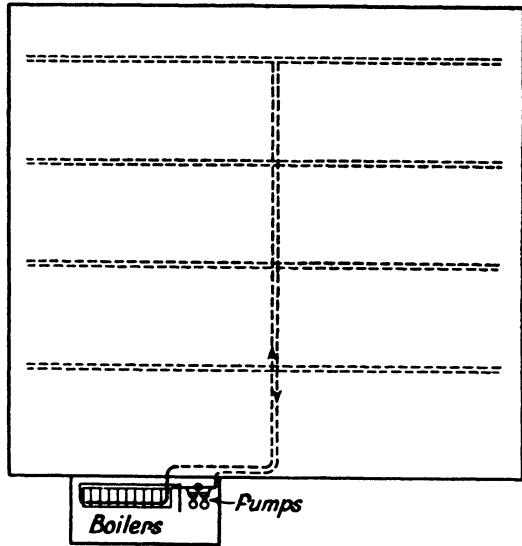

Fig. 19.—EXAMPLE OF FORCED CIRCULATING SYSTEM

CIRCULATION TO RADIATORS AT OR BELOW BOILER LEVEL

It is a well-known fact that stepping up the return main at the boiler, or dipping the return main into a trench in order to pass doorways, has a detrimental effect on the circulation of a gravity hot-water heating system, and there is the semblance of logic in supposing that, since

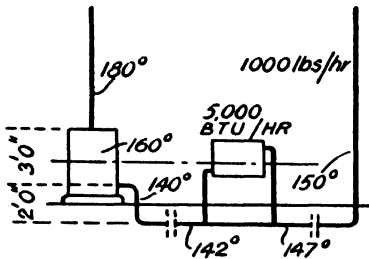

Fig. 20.—RETURN MAIN RISING FROM FLOW BELOW TO ENTER BOILER

whilst there is a retarding effect on the system when the return main is taken below the level of the boiler, the effect becoming more serious in proportion to the amount of heat emitted by the low-level return, and with the distance below the boiler.

Retardation when Return Main is below Boiler Level

The extent to which the heat emitted from a return main below boiler level retards circulation can be indicated by reference to Fig. 20. In considering such problems, it is convenient to pair off ascending and descending columns of water in preference to flow and return columns.

Where the ascending column of water is hotter than the corresponding descending column the height and temperature difference of the two are both in favour of promoting circulation; where, on the other hand, the ascending column is the cooler, the height and temperature difference both tend to retard circulation. Thus, in Fig. 20, the return at 140° F. stepping up into the boiler is an ascending column at a lower temperature than the corresponding descending column, which is at 150°, and is therefore retarding circulation to the extent of $2 \text{ ft.} \times (150 - 140) = 20 \text{ degree-ft.}$ The boiler represents an ascending column at a mean temperature of 160° (inlet 140°, outlet 180°), whilst the corresponding descending column is at 150°, and is therefore in favour of circulation to the extent of $3 \text{ ft.} \times (160 - 150) = 30 \text{ degree-ft.}$ The net balance in favour of circulation is $30 - 20 = 10 \text{ degree-ft.}$ To this should be added the amount provided by the ascending and descending columns above the top of the boiler, this clearly being in favour of circulation.

Had the return not been dipped below the level of the boiler, the circulating pressure due to that part of the system would have been 30 degree-ft. instead of 10 degree-ft.

Incidentally, it will be realised that the 30 degree-ft. is not produced by the emission of heat from the radiator indicated or the return main (the combined effect of which cools the water from 150° to 140° and contributes not at all to the circulating pressure), but by the heat emitted

this is an accepted fact, it follows that dips are always detrimental, and the steeper the dip the more adverse the effect on the system.

The fact is, however, that stepping up the return main is sometimes beneficial, and the greater the step, the greater the advantage.

It may safely be taken that stepping up to a level above the boiler is advantageous, and the farther this is done from the boiler the better,

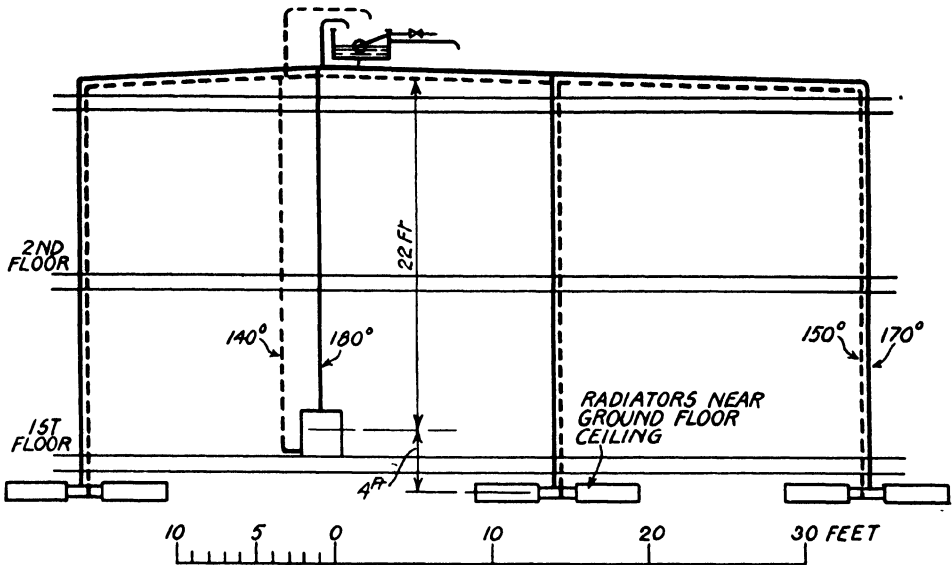

Fig. 21.— GRAVITY HOT-WATER HEATING SYSTEM WITH ALL RADIATORS BELOW THE BOILER

from the upper part of the system in which the water is cooled from 180° to 150° .

Effect of Heat Emitted on Circulating Pressure

This point provides a useful key in dealing with problems involving dips, or for that matter, any parts of the system below or at boiler level: the heat emitted at boiler level does not produce circulating pressure, whilst heat emitted *below* boiler level *retards* circulation and heat emitted *above* boiler level *promotes* circulation, the amount for or against depending on height above or depth below the boiler, and the amount by which the water is cooled at those levels.

Thus, where parts of a gravity heating system are necessarily below the boiler level, it follows that, in order to produce circulation, there must be sufficient cooling of the water above boiler level, not only to counter the retarding effect, but with a surplus for overcoming the resistance of the piping and local obstructions.

Heating System with all Radiators below Boiler

An extreme instance in illustration of this important principle is indicated in Fig. 21. The system shown was installed in a shop in which there was no space available for a boiler on the ground floor, and since there was no basement, the boiler had to go on the first floor, thus

presenting the unusual problem of a system having all the radiators below the boiler level. For some reason there was a strong prejudice against an accelerated circulation, so it was necessary to have the radiators fitted at the highest possible level on the ground floor and contrive a gravity circulation by making use of the heat emitted from piping above the boiler level.

Wall-type radiators about 13 in. high were fitted against rather deep beams supporting the ceiling of the ground floor, and the flow and return taken vertically from the boiler direct to the roof space from which vertical flow and return connections were taken down to the radiators. All the piping was left bare in order to obtain the required cooling effect from the upper part of the system.

CALCULATING CIRCULATING PRESSURE AVAILABLE.—It will be seen that the ascending return from the most distant radiator is 20° cooler than the descending flow, and since the height is 26 ft., the retarding effect is $26 \text{ ft.} \times 20^{\circ} = 520 \text{ degree-ft.}$, or $520 \times .004 = 2.08 \text{ in. W.G.}$, in opposition to circulation. But, as a direct result of taking the return from the radiator return into the roof space, there is a difference of 40° between the main flow and return ascending and descending columns for a height of 22 ft., giving $22 \text{ ft.} \times 40^{\circ} = 880 \text{ degree-ft.}$ in favour of circulation. Thus, there is a balance of 360 degree-ft. for maintaining circulation, against a resistance of 1.44 in. W.G. in the piping, as well as overcoming a retarding pressure of 2.08 in. W.G.

Had the returns from the radiators not been taken up into the roof space, but run at the level of the bottom of the radiators and stepped up at the boiler, the retarding effect would have been reduced to $4 \times 40 = 160 \text{ degree-ft.}$, but instead of a 40° drop between the main ascending and descending columns in favour of circulation, there would be only 10° , producing only $22 \times 10 = 220 \text{ degree-ft.}$, and a balance of only $220 - 160 = 60 \text{ degree-ft.}$, instead of 360 degree-ft. previously obtained.

Thus, the somewhat unusual system shown in Fig. 21 is vastly superior to the more conventional arrangement of Fig. 20 for application with radiators below boiler level.

Note.—It is important that the overhead return main be fitted with an open vent pipe as provided on the flow, and that the mains must pitch down from these vents as indicated, in order to allow air to escape freely from the apparatus.

System with Ceiling Panels Fitted below Level of Mains

Similarly, with the arrangement shown in Fig. 22, care must be taken to allow the horizontal piping to vent into the tank and thence, via the open pipe, to atmosphere. In this case, the return connections from the panels fitted to the underside of the ceiling are taken up vertically before

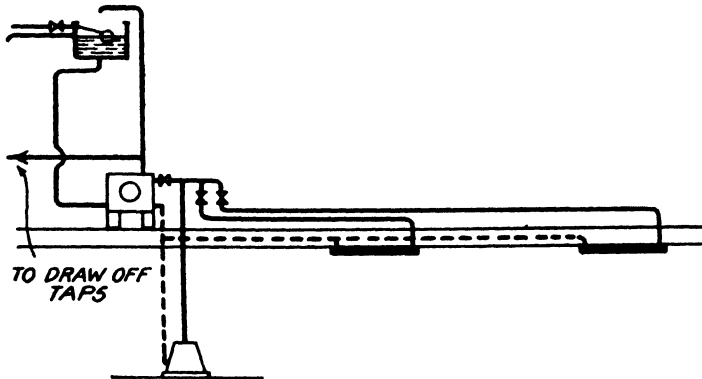

Fig. 22.—COMBINED HOT-WATER SUPPLY AND HEATING SYSTEM WITH CEILING PANELS FITTED BELOW LEVEL OF MAINS

returning to the boiler, but there is no adverse effect in doing so for the gain in the descending column more than counterbalances the local effect, so that the system as a whole gains rather than loses as a result.

The alternative arrangement of taking the return down from the panels and back to the boiler at floor level in a trench, would have meant less circulating pressure and either the expense of providing chases to conceal the returns or sacrifice of appearance, due to running pipes exposed to view in the rooms below. As it was, the pipes were, for the greater part, run between the joists in the floor of the first floor and were visible only in the kitchen and linen cupboard.

In order to make full use of the benefit that can be obtained from the heat emitted in the upper part of a system, the radiators must be coupled in series rather than in parallel.

Circulating Pressure with Two-pipe Dropping System

With the arrangement shown in Fig. 23, the cooling effect of the upper floor radiators is not utilised and only the heat emitted by the piping benefits the circulation to the lowest radiator. The circulating pressure for radiator No. 1 is due to the difference in temperature between the ascending flow at 179° and the descending flow, at an average temperature of 173° to 174° down to the radiator; to this there is to be added the circulating pressure produced by the return from radiator No. 1 as against the ascending flow from the boiler at 180° . The circulating pressure for radiator No. 4 is considerably more than that for radiator No. 1. The ascending column is the same as for No. 1, but the descending column averages 144° to 145° , i.e. 21° cooler than that for the index radiator. Thus, the connections to radiator No. 4 must be made considerably smaller than for No. 1, in order to dissipate the circulating pressure available without robbing the less favourably placed radiators.

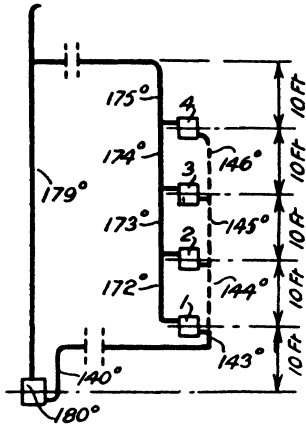

Fig. 23 —TWO-PIPE DROPPING SYSTEM

For those who may have difficulty in grasping why the cool column of water from radiator No. 4 does not benefit the circulation to the lowest radiator, it may be stated that any pressure due to the greater density of the descending return from the upper radiators is exerted in both directions and is, therefore, neutralised so far as the radiators below are concerned.

This may best be explained by reference to Fig. 20, where a radiator is connected to the return main in single-pipe fashion. No matter the height of this radiator above the main or the temperature difference between flow and return, the circulating pressure produced by the radiator is dissipated in the radiator connections, without the slightest benefit to the main circulation.

If the height of the radiator above the main and the temperature difference between flow and return were such as to produce a circulating pressure of 1-in. water gauge, that is to say, have the same effect as the vertical flow, being 1 in. shorter than the return, that 1 in. head would be exerted in both directions along the main and would therefore have a neutralising effect so far as the main circulation is concerned.

Single-pipe Dropping System and its Disadvantages

In Fig. 24, however, the heat emitted by each radiator contributes toward the circulating pressure for the main circuit and this pipe may be smaller in consequence, compared with that in Fig. 23, for equal output of heat from the various radiators. The average temperature of the descending column is seen to be considerably lower for the same flow temperature and same total temperature drop in the system as a whole.

The radiators in Fig. 24, however, have a slightly lower mean temperature than those in Fig. 23 and are required to be larger for a given heat output. It will be seen that all four radiators in Fig. 23 have a mean temperature of approximately 160° F., whereas in Fig. 24, the radiator served first would have a mean temperature of 165°, allowing a drop of 20° in the radiator itself, whilst the one served last would have a mean of 141°. Another disadvantage with the single-pipe dropping system is that the radiator connections are apt to present difficulties where there is a distance of more than a foot or two between the radiator and the vertical pipe, for the appearance of two pipes against a blank wall between a radiator under a window and the vertical pipe in the corner of the room, is apt to be objectionable.

The arrangement shown in Fig. 23 is much more flexible, radiator

connections being run less conspicuously against the skirting or below the floor, as convenient, even if the distance between the radiator and vertical pipes is several feet. Naturally, both flow and return drops may be kept close together if desired, and not necessarily placed each side of the radiator, as indicated in Fig. 23. Thus, the single-pipe overhead drop system is generally adopted only where essential for either dealing with radiators at low level, or where a system is required to work by gravity during mild weather or at night, the circulation being accelerated at other times.

How to Calculate the Approximate Temperatures of Various Parts of System

Before the effect of a dip can be determined it is necessary to calculate the approximate temperature of various parts of the system. This is done by first totalling the heat emission from the system as a whole, allowing an arbitrary loss in round figures for the pipes whose sizes have yet to be ascertained. The total heat given off by the system, divided by the total temperature drop on which the system is required to operate, 30° to 40° in the case of gravity systems, establishes the approximate total quantity of water to be circulated. This must then be proportioned out among the various circuits in proportion to their individual heat loss and the extent to which the water is cooled in transit through connecting mains. At any point in the system the temperature drop caused by the emission of heat, is found simply by dividing the amount of heat given off in B.T.U. per hour by the weight of water circulated, pounds per hour, through the radiator or pipe in question.

For instance, in the case of Fig. 20, the quantity of water circulated through the circuit indicated is 1,000 lb. per hour. The emission of 5,000 B.T.U. per hour from the radiator shown would cause this quantity of water to be cooled $5,000/1,000 = 5^{\circ}$, whilst a loss of 2,000 B.T.U. per hour from the main between the radiator and boiler will cause the same quantity of water to be cooled by a further 2° .

Low-level Radiator Connected to Two-pipe Up-feed System

In the case of the circuit shown in Fig. 25, which indicates a two-pipe up-feed system, modified to deal with a radiator at boiler level, it will be realised that the quantity of water to be circulated through each of the four upper radiators is considerably in excess of that required for individual radiators of the same size, connected in the manner shown in Fig. 23.

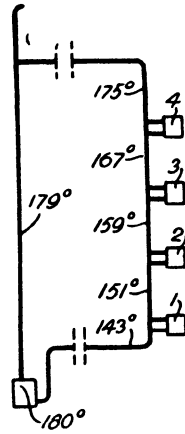

Fig. 24.— SINGLE-PIPE DROPPING SYSTEM

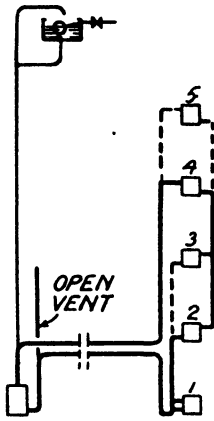

Fig. 25.—LOW-LEVEL RADIATOR CONNECTED TO TWO-PIPE UP-FEED SYSTEM

TRACING HOT-WATER PATH AND TEMPERATURE DROP.—If Fig. 25 is examined closely it will become apparent that the whole of the water for the entire loop must pass through radiators Nos. 4 and 5, roughly half through each, then through Nos. 2 and 3, again roughly half each, all radiators, of course, being assumed to be of the same size.

THE TEMPERATURE DROP IN RADIATORS.—Allowing the heat required from each of the five radiators to be 5,000 B.T.U. per hour, and the total piping, including radiator connections, to be 160 ft. with an average emission of 100 B.T.U. per foot run, the total heat to be given off by the system is $25,000 + 16,000 = 41,000$ B.T.U. per hour. With a total temperature drop of 40° , i.e. 180° flow and 140° return at the boiler, the total amount of water to be circulated is $41,000/40$ = say, 1,000 lb. per hour.

This divides into two paths on reaching radiator No. 4, 500 lb. per hour passing through each of the two radiators and the whole of the water being cooled $5,000/500$ or $10,000/1,000 = 10^\circ$ in doing so, after which the water again divides into two streams for radiators Nos. 2 and 3 and is cooled a further 10° ; radiator No. 1 causes a further drop of $5,000/1,000 = 5^\circ$. The radiators thus cause a total drop of 25° , the emission from the piping accounting for the balance of $40 - 25 = 15^\circ$. Actually this is $16,000/1,000 = 16^\circ$, making the total drop 41° , which would, in fact, be the case if the amount of water circulated were 1,000 lb. per hour, the round figure taken in preference to the more accurate one of 1,025 lb./hr.

Thus, whilst the lower radiators are supplied with water which has already passed through the upper ones, the quantity of water circulated is such that the water leaving the last radiator is no cooler than that leaving each individual radiator in Fig. 23.

The Retarding Effect of Lowest Radiator

The retarding effect of radiator No. 1, in Fig. 25, on the circuit as a whole is not serious, for by bringing the main down to the radiator causes the large amount of water to be cooled only slightly, 5° by the radiator and possibly 2° by the heat emitted by the vertical piping, so that the total retarding effect for a height of 10 ft. is $10 \times 6 = 60$ degree-ft., which is more than counterbalanced by the circulating pressure produced by the ascending and descending connections from the boiler to the horizontal mains, whilst in addition to this, there is the circulating pressure due to the remainder of the index circuit, this being indicated

by the heavy lines in Fig. 25. It is the temperature of these heavy lines which determines the circulating pressure for the index radiator; the broken lines indicate that the circulating pressure created by those verticals is not available for the index circuit, but is devoted solely to the individual radiators to which they are connected.

Determining which Ascending and Descending Columns Control Index Circuit

In determining which ascending and descending columns control the index circuit the procedure is to trace the shortest circulation from the boiler to the lowest radiator, selecting always the lower of two parallel paths, since the upper one invariably has the same effect as a radiator connected on the single-pipe principle, as explained in connection with Fig. 20.

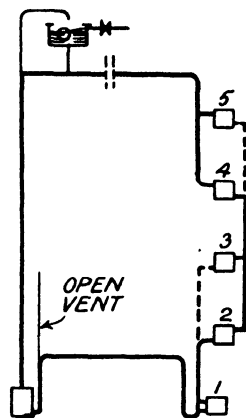

Fig. 26.—LOW-LEVEL RADIATOR CONNECTED TO TWO-PIPE DROPPING SYSTEM

LOW-LEVEL RADIATOR CONNECTED TO TWO-PIPE DROPPING SYSTEM.—Similar considerations apply in the case of Fig. 26. With this arrangement there is slightly more circulating pressure produced with a given total temperature drop than with Fig. 25, due to the cooling of the horizontal flow main at the higher level, and all the radiators vent automatically, whereas radiator No. 5, in Fig. 25, would require attention

LOW-LEVEL RADIATORS CONNECTED TO SINGLE-PIPE OVERHEAD DROP SYSTEM.—Fig. 27 illustrates a single-pipe overhead drop system, with each drop looped to

pick up a radiator at boiler level. This method gives the greatest possible amount of circulating pressure for a given temperature drop, this being calculated as explained for Fig. 24, except that the back pressure due to the cool ascending

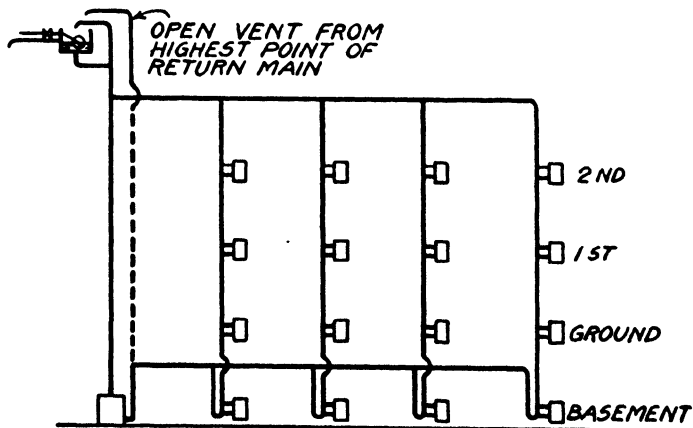

Fig. 27.—RADIATORS AT OR BELOW LEVEL OF BOILER CONNECTED TO AN OVERHEAD RETURN MAIN

column from each low-lying radiator must be deducted to arrive at the net circulating pressure available for overcoming the resistance to the flow of water.

In all the cases mentioned, having calculated the amount of water to be circulated and the pressure available, the sizes of the pipes are ascertained by reference to the charts.

EMBEDDED PANEL WARMING

Embedded panel warming is a low-pressure hot-water system where water is circulated at low temperature through jointless coils of piping embedded in the fabric of the building.

The pipe coils forming the warming panels are $\frac{1}{2}$ in. or $\frac{3}{4}$ in. diameter and are located in the ceiling, walls or floors. In whatever position they are located, they are embedded in and become part of the structure. Generally the coils are embedded in the ceiling construction, and after the shuttering has been removed the concrete soffit is plastered.

When the panel coils are located in the wall the surface may be plastered in the same manner as the ceiling or may be covered with glass, marble or tiles; when the coils are embedded in the floor they are covered with marble, stone mosaic, tiles or other similar material.

The Panel Coils

The panels are usually made up by bending the pipes as shown in Fig. 28. This type of panel is used only in forced circulation systems, where the pump creates sufficient head to overcome the resistance in the coils of continuous pipe forming the panel.

In the system where circulation must be by gravity, a grid pattern is used in order to reduce the resistance to the flow of water through it.

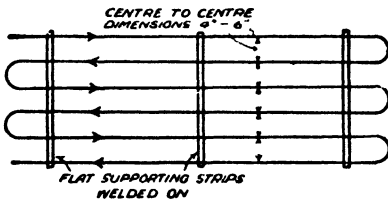

Fig. 28.—HAIRPIN TYPE OF EMBEDDED PANEL



Fig. 29.—GRID TYPE OF EMBEDDED PANEL
Note that there is less resistance to the flow of the hot water through the piping, compared with Fig. 28.

The difference in the length of travel can be easily noted by comparing Fig. 29 with Fig. 28. The resistance of the grid pattern is much less than in what is sometimes called the "hairpin" type.

Where the pipes forming a panel run in a vertical direction, the grid pattern must be used, otherwise it would be difficult to clear the air from the system.

Water Temperatures Employed in Panel System

The use of a pump allows the system to be designed for a low temperature drop, and the pipes serving the panels can be kept to comparatively small diameters. The maximum temperature drop usually allowed for in sizing the circuits is 15° F., and the mean temperature should be maintained at a level not above 100° F. Higher temperatures cause excessive expansion, and the resulting tendency of the plaster covering to crack is difficult to avoid.

Arrangement of Pipe Circuits

The arrangement of the pipe circuits should be designed to avoid the possibility of air locks, one of the most common faults in hot-water heating systems—and for this reason an up-feed system may be considered the most satisfactory.

Fig. 30 shows a typical arrangement, and the attention of the reader is directed to the method of connecting the panels to the mains.

It will be noted that the branches for the return connections are made above the level of the panels, and that the flow pipe is carried down to a control valve fixed at hand level, before the connection is made to the rising main. As the circulation is maintained by pump, the natural tendency for the water to flow in a downward direction is overcome, and any accumulation of air in the system is carried upward with the flow of water to the highest point of the circuit, where it escapes through the vent pipe.

It is the practice to weld all the pipe joints in panel warming schemes, as there is a risk of serious damage by water if a leak should develop in the embedded pipes.

The control valves are enclosed in boxes having removable or hinged covers. The boxes are fixed with the covers flush with the plastered wall face, and in this way the valves are accessible for adjustment or repairs.

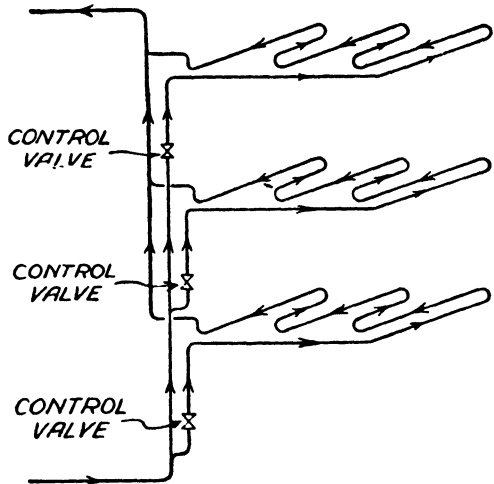

Fig. 30.—A TYPICAL ARRANGEMENT OF PIPE CIRCUIT FOR EMBEDDED PANEL WARMING

Floor Heating

The principle, taken broadly, of warming a room by heating the structure instead of the air in the room is old. In the early days of civilisation the Romans rendered their buildings and dwellings habitable in cold weather by heating the floors and sometimes, in addition, the walls. The floors were heated either by fires in the spaces beneath or by hot gases from the fires passing through ducts constructed in the floors and walls.

The floors were not warmed uniformly ; parts, near the fire particularly, became quite hot, but nevertheless the results were a great improvement on the former method of heating by open fires built on the floor in the middle of the room with apertures in the roof to allow the smoke and gases to pass away.

The warm floors provided local warmth and to a degree warmed the walls by radiation, but the main heating of the spaces was effected by the warm floors heating the air by convection. In the lofty public buildings of that period the convection currents of hot air probably caused draughts, which would not be tolerated to-day but were not considered uncomfortable then.

MODERN METHOD OF WARMING BUILDINGS BY WARMING THE CEILINGS

In the modern panel-warming system the floors are rarely warmed, the principal warmed area being the ceilings.

To many, warming a room from above at first appears to be a topsyturvy way of doing it, for within living memory hot-water or steam-heating pipes always have been placed near the floor. Having also in mind the boiling of a kettle of water, one protests, "but surely heat rises." In point of fact, the passage of heat is not confined to any direction but flows from the higher to the lower degree.

Warm Ceiling Warms Surroundings by Radiation

As explained elsewhere, heat can be transferred, transmitted or emitted in three forms—conduction, convection and radiation. It is the latter form, radiation, which enables the warm ceiling to warm the room. Actually it is the most natural way to warm a room from above, for the heat of the sun comes to the earth virtually from above by radiation through space, without sensibly warming the air through which it passes.

In a similar manner the heat from a warmed ceiling is emitted as radiant heat at low temperature and travels downwards and radially in all directions.

Absorption and Reflection of Radiant Heat

The radiant heat from the warmed ceiling passes through the air and strikes the floors and walls, part being absorbed at these surfaces and part reflected. That reflected is ultimately absorbed at some part of the surface of the floor or walls or is absorbed by the contents of the room, such as carpets, curtains and furniture. The temperature of the surfaces and contents of the room bear a relation to the amount of radiant heat absorbed.

The floor, which is directly beneath and parallel to the ceiling, absorbs most of the radiant heat that strikes it, and consequently the temperature of the floor is slightly higher than that of the other surroundings and the air in the room.

Some materials absorb more radiant heat than others, depending principally on the surface characteristic of the material. Window glass reflects more than it absorbs, whilst a black hearth-rug absorbs almost all, reflecting practically none. A wood block floor chiefly absorbs, reflecting more as it becomes polished. The angle at which radiant heat strikes a surface also affects the proportion of heat absorbed by or reflected from the surface.

Re-radiation of Absorbed Radiant Heat

All the reflected heat passes from surface to surface until it is eventually absorbed by some of the surroundings. Each surface as it absorbs radiant heat, re-radiates some of the heat absorbed to other surroundings, so that when a panel-warmed room is in a steady thermal condition, radiant heat is being emitted, reflected, absorbed, re-radiated and finally absorbed. As heat in any form flows from the higher to the lower degree, the ultimate tendency is to attain thermal equilibrium of the various surfaces, resulting in practically uniform conditions being obtained in all parts of the room.

Radiant Heat from Ceiling does not Directly Warm the Air

Since the radiant heat from the sun does not sensibly warm the air through which it passes, it may seem that the air in a room warmed by radiant heat from above, as from a ceiling, would not become warm at all. The air, however, is warmed, principally by absorption and convection.

Air, among other things, contains a varying amount of water vapour, dust and carbonic acid gas. Now, although radiant heat is not absorbed by pure air, it is absorbed by water vapour, dust and carbonic acid gas. The amount of heat absorbed by air in this way, however, is very small, unless the air contains an abnormal amount of moisture.

The major warming of the air is effected by convection, chiefly from the warm surface of the floor, which is at a slightly higher temperature than the walls. The difference is quite small, but it is sufficient to set up well-distributed convection currents, which cause the air to be warmed uniformly, maintaining a steady temperature balance. Because of the very small temperature difference of the surfaces, a few degrees, the convection currents are very gentle and the air is not overheated, being at a slightly lower temperature than the surroundings.

Distribution and Diffusion of Heat in a Panel-warmed Room

Therefore, in a panel-warmed room the radiant heat from the warmed ceiling, emitted at low temperature, about blood heat, warms the other surfaces in the room by direct radiation without sensibly warming the air. The warmed surfaces and contents re-radiate some of the heat absorbed from the warmed ceilings and also warm the air in the room by convection. In descending order of degree of temperature there is first the warm ceiling, then the floor, walls, furniture and furnishings, and lastly the air in the room.

Applying Radiant Heat from Ceiling

This grading of temperature differs from that of those other forms of heating which by various means primarily heat the air and utilise the air as a medium to raise and maintain the temperature of the surroundings. Consequently the air in such conditions is warmer than the surroundings. For example, in a plenum system the hot air blown into the room has to contain sufficient heat to warm the surroundings, and is, therefore, introduced at a comparatively high temperature.

The hot air as it enters is forced to the upper part of the room and does not commence to fall to the lower levels until it has given up much of its heat to the surroundings. The hottest air, therefore, is near the ceiling and the coolest air near the floor. When hot air is utilised for heating in this manner, windows, especially the upper hoppers, are usually kept closed ; otherwise a considerable quantity of the hot air would pass out through them before it had given up much of its heat to the room.

When a room is heated by steam or hot-water pipes or radiators, some of the heat from the pipes and radiators is transferred to the surroundings by direct radiation, but the greater proportion is transferred to the air by convection, and the heated air completes the warming of the room in a similar manner, but to a modified degree, as the hot air from a plenum system. The air at the higher levels of the room, however, is not so hot as plenum air because it does not have to convey so much heat to the room, since some of the heat is transferred by radiation.

When the warm ceiling of a room is the main source of heat, the greatest proportion of the heat is transferred to the surroundings in the form of radiation. The air, therefore, is not directly and excessively warmed, and any air that passes out through open windows at the higher levels does not involve serious loss of heat.

Features of the Panel System

The elimination of excessive losses of heat through leakage of hot air at upper levels is one of the reasons why low-temperature embedded ceiling panels are so economical in heat consumption. Another reason is that the human body can be maintained in comfort more readily by low-temperature radiant heat directly applied than by warm air. The difference in the amount of heat required to maintain the human body in a state of comfort by low-temperature ceiling panels and by warm air represents a substantial saving in the consumption of fuel or power. The saving with low-temperature ceiling panels generally is from 15 per cent. upwards.

This economic advantage undoubtedly has been a factor in the popularity of the invisible embedded panel warming system, though sometimes the system is used because it eliminates exposed pipes, heaters or radiators, with the attendant discoloration of walls. In buildings such as hospitals and schools, the hygienic advantages of the system and the facility with which comfort can be maintained with adequate ventilation are often the more important factors. In public buildings, particularly, the æsthetic advantage of no visible heating surfaces gives full scope for architectural design and interior decorative schemes.

MAKING THE PANEL COILS

The tubes for the panel coils are made from open-hearth steel of low carbon content suitable for bending and welding by both the electrical and the oxy-acetylene process. The seams are butt-welded and tested by air pressure to 700 lb. per square inch.

The ends of each tube are first prepared by grinding and then the tube is bent hot, electrically heated, in a quick-acting bending machine into serpentine form with two or more return bends, depending on the length of the tube.

The bent tubes are laid on a former and the ends are electrically butt-welded together. The internal scale formed by the bending and welding processes is loosened by hammering, progressively, the entire length of the coil with a pneumatic hammer, and is then blown out by compressed air. For convenience of handling during testing and transit the return bends are fastened together with binding wire.

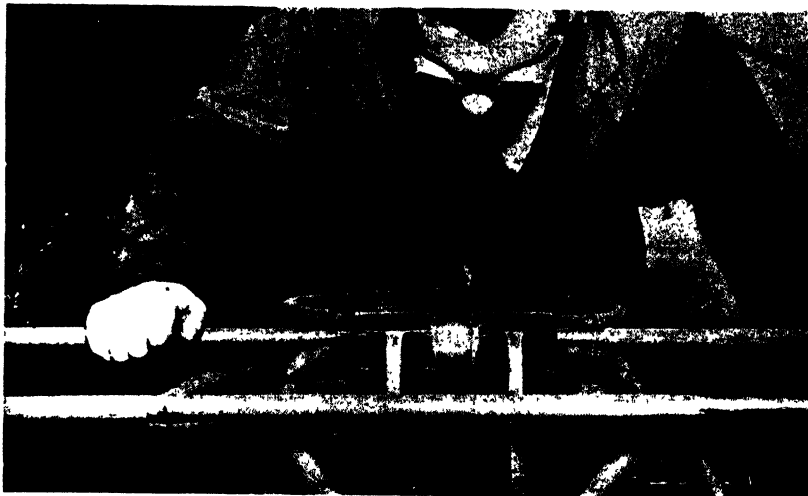

Fig. 31.—MAKING PANEL COILS

Electrically welding the bent panel tubes together to form coils. The bent tubes are laid on a former and the ends are butt-welded. The tubes for panel coils are made from open-hearth steel of low carbon content suitable for bending and welding by both the electrical and the oxy-acetylene process. The seams are butt-welded and tested by air pressure to 700 lb. per sq. in.

Testing.—The coil is then tested by air pressure to 500 lb. per square in. The open ends are covered with a quick-fitting cap and the complete coil is lowered into a tank of water. Compressed air is applied, when the slightest leak is disclosed by the presence of air bubbles. After testing, the testing caps are removed and in place light pressed steel caps are shrunk on to seal the ends of the coil during transit.

Erecting the Panel Coils and Connections

The panel coils are embedded at the soffits of all types of floor construction, hollow block, solid or hollow concrete, wood-joist construction, or embedded in suspended ceilings, including all the established patented types of floor or ceiling construction. In some patented types minor modifications are made to provide room for the panel coils, but the modifications do not involve special materials or forms.

Hollow block or hollow concrete construction is probably the most popular at the present time and the methods described principally apply to this type of construction.

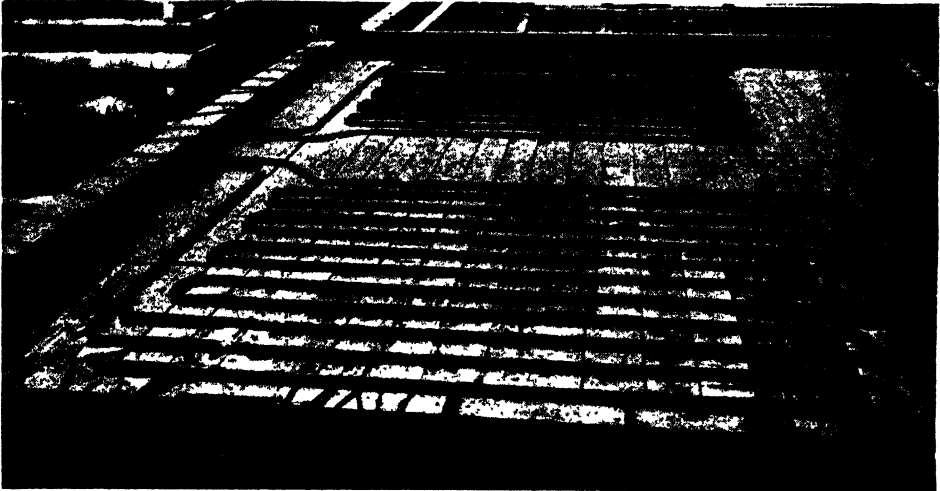

Fig. 32.—ERECTING PANEL COILS

Laying panel coils on the timber shuttering. After fixing in position the coils are connected to the vertical risers, the joints being welded.

Erecting the Risers

Generally, the first operation in the erection of the system is to fix in position the flow and return risers. In a steel-framed building these are run up the stanchions, the pipes being set where required around horizontal cross members and to follow any "set-backs" of the building.

Method of Joining Pipes Together

In tall buildings, the erection of the risers proceeds with the erection of the steelwork. Before the remote ends of the risers are completed the panel coils are connected at the various floors. All the pipe joints except those for the controlling and isolating valves are oxy-acetylene welded. Branches are similarly welded, the opening in the larger pipe being prepared by the cutting blowpipe.

When the timber shuttering has been fixed and levelled, the panel coil is fixed in position, and connected to the vertical risers, the joints being welded together.

Testing the Panel Group

As they are completed each group of panels with connections are tested by hydraulic pressure to 200 lb. per sq. in., for a period of six hours

or more. Generally the work can be arranged so that the pressure is applied at the end of the day and maintained overnight until the following morning. Quick-fitting caps and connections are fitted on to the open ends of the pipes. A hand test pump is attached to one of the connections, air is released from the other connection and pressure is applied. The reading of the pressure gauge is noted and another observation is made the following morning.

In large buildings the laying, connecting and testing of the panel coils has to follow promptly the laying of the shuttering, which may be a scattered procedure, so in order to ensure that every panel coil is tested after it has been connected to the risers, full details of each test are recorded.

Provision of " Key " for Plastering

After a section has been satisfactorily tested the pipes are embedded in the concrete. Before the concrete is poured, provision has to be made to ensure that when the shuttering is struck the face of the concrete offers a proper " key " for the plaster with which the ceiling is to be finished. There are several ways in which a proper " key " can be obtained. Of these the most widely used methods are slip tiles and cement retarders.

The slip tiles are laid on the shuttering between the loops of the panel pipes. Both faces of the tiles are grooved. The grooves on the top of the tiles hold them firmly to the concrete, and the grooves on the underside, when exposed after the shuttering is struck, form a satisfactory foundation to receive the plaster.

Use of Cement Retarder

Cement retarders are proprietary chemicals in liquid form applied to the upper face of the shuttering before the concrete is run. The liquid, applied with a brush, soaks into the skin of the timber shuttering and retards the setting of the Portland cement in contact with it. Immediately the shuttering is removed the face of the concrete is briskly brushed with a strong wire brush, whereby the retarded cement is loosened and brushed away, leaving the aggregate exposed, which presents a suitable surface to receive the plaster.

If the surface is not brushed immediately after the shuttering is removed, the retarded cement commences to harden by the action of the air. It is therefore essential that the brushing of the surface is not unduly delayed once the shuttering has been removed, otherwise the cement sets hard and becomes impervious to wire brushing.

Other Methods for Forming " Key "

Of the other methods of forming a " key " for the plaster there are zinc strips pressed into the form of tapered channel sections, which are

nailed diagonally on the shuttering between the panel pipes. As the shuttering is removed, the zinc strips come away easily leaving diagonal dovetail grooves imprinted on the face of the concrete. Rubber and composition strips in place of zinc are used in a similar manner. The "West" patent dovetail rubber key, in the form of rubber sheeting laid on the shuttering before the panel coils are laid, is also used. After the shuttering has been taken down, the rubber sheeting is pulled away leaving an imprint on the concrete face which offers a good "key" for the plaster.

Embedding the Panel Coils

The concrete is first poured to the predetermined level of the underside of the hollow blocks. The hollow blocks are then placed in position and bedded into the concrete base and the remainder of the concrete is spread and consolidated.

When the concrete has set, the shuttering is removed in the usual manner, leaving the surface free for plastering.

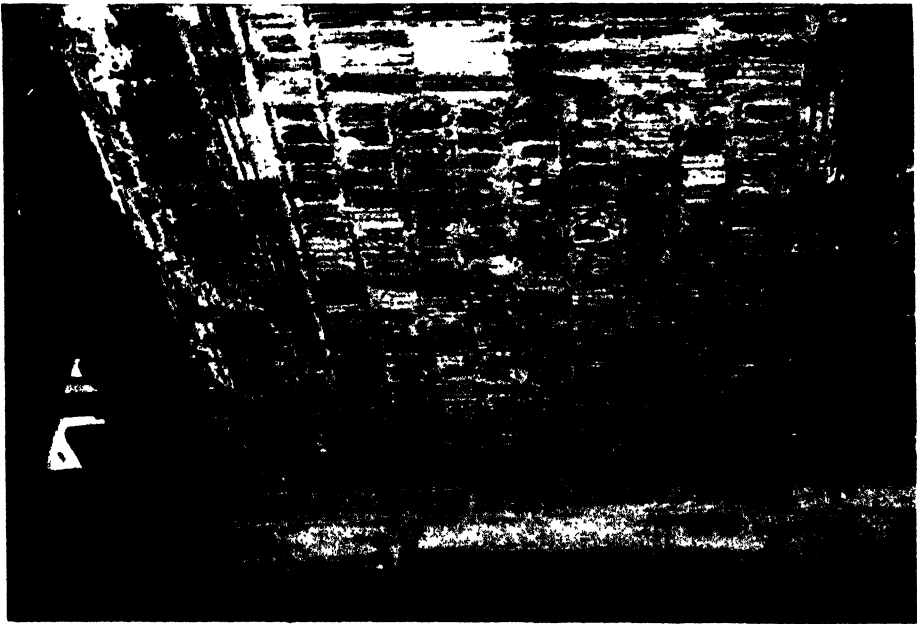

Fig. 33.—SOFFIT OF CEILING WITH PANEL COIL IMMEDIATELY AFTER REMOVAL OF SHUTTERING

Plastering

Specifications for plastering to suit different types of building are issued to contractors engaged in the work. Beyond the necessity to use materials of good quality and to employ a reasonably high standard of workmanship, there is nothing exceptional in the requirements. Certain elementary precautions must be taken, and the soffit of the ceiling must be properly prepared with the "key" previously described; if this is not done, failure of the plaster may occur.

When matured, the finished plaster is decorated as an ordinary plastered face. Good quality distemper or paints suitable for applying to warm surfaces are used. Distemper and paints should be brushed on, not sprayed, and high-gloss paints should be avoided.

Panel Controlling Valves and Devices

One of the connections from each panel group is carried down to a control valve to enable the warmth from the panel area to be regulated when required. The valve is fitted in the wall, usually just above the skirting. Gun-metal valves of the double regulating type with convertible bodies for either hand or automatic operation are commonly used.

One part of the double regulating device is set to regulate permanently the flow of water through the panel group, and the other is operated, when required, to turn the warmth on or off.

HAND OR AUTOMATICALLY OPERATED VALVES.—Convertible valve bodies are used because it is often desirable to be able to consider the manner in which a building is to be occupied before deciding on the type of controlling valve, either hand-operated or automatic, to be installed. For this reason the bodies when fixed in the pipelines are provided with temporary plugs in place of bonnets, and later, at any stage, the plugs are removed and a bonnet and spindle with either a hand-wheel or lock-shield or a solenoid headpiece is fitted.

With the solenoid headpiece the valve becomes a glandless magnetic valve, enabling the required degree of warmth to be maintained automatically in conjunction with a room or space thermostat. Room or space thermostats are electric switches opened or closed by the action of the temperature of the air on a bi-metallic strip or other element.

THERMOSTATIC OPERATION.—The thermostat is wired to the magnetic valve in the same manner as a tumbler switch is to an electric light, and when the temperature of the room rises above the desired point, as indicated by adjusting knob or pointer of the thermostat, the movement of the bi-metallic strip or expansive element operates a switch which closes the magnetic valve, thereby interrupting the supply of heat to the panel, causing the temperature of the room to fall. When this has fallen below the setting of the thermostat, the reverse action takes place, restoring the supply of heat. Thus the mean or average temperature of the room is kept at the desired value.



Fig. 34.—PANEL CONTROLLING VALVE
Convertible body, double regulating
type for hand operation.

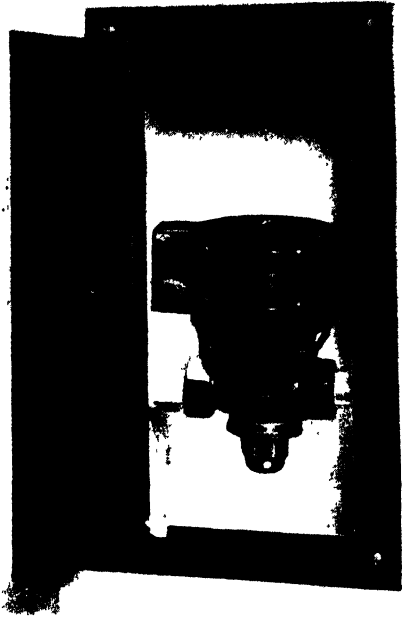

Fig. 34A.—MAGNETIC PANEL CONTROLLING
VALVE
Valve body as shown in Fig. 34, but
fitted with coil-case assembly for thermo-
stat control.

The thermostats are fixed on the walls, in suitable positions, mounted on timber seating blocks.

The object of the automatic valves is to maintain an almost uniform condition of comfort irrespective of external changes, and to avoid wastage of fuel or power when the rooms are receiving heat from sunshine or other sources.

The Heating System

The distributing mains in a panel warming installation are similar to those of a low-pressure hot-water system. The main flow and returns may be run horizontally at low level, feeding the flow and return risers, arranged on the two-pipe system, or horizontal mains may be run near the top of the building, with other horizontal mains near the bottom of the building.

The water is heated in standard types of boilers, burning coke, coal, anthracite, oil or gas, water or steam-heated calorifiers, or in electric immersion heaters or electrode boilers. Often storage cylinders are used

in conjunction with the boilers or heaters, particularly gas or electric boilers or heaters. The water then is heated to a high temperature during the night-time, or at times when the normal demand on the gas mains and electric power stations is low, when the gas or electric power can be supplied at special rates very much lower than ordinary rates.

The panel warming system is favourably suited to thermal storage heating, due to the low temperature--the water is rarely more than lukewarm--of the circulating water. This enables the capacity of the storage cylinders to be reduced to a minimum. For example, if water in a thermal storage cylinder, heated to 260° F. during the night, is serving radiators at 160° F., each pound of water stores 100 (260-160) heat units. Serving a panel warming installation at 100° F., each pound of water now contains 160 (260-100) units; therefore, less storage water is required enabling smaller storage cylinders to be used.

Controlling the Temperature of the Circulating Water

With thermal storage cylinders the required temperature of the circulating water is obtained by water mixing valves. Water taken from the top of the storage cylinder is mixed with a proportion of the return water from the system. This is done automatically, the mixing valve being operated by a thermostat placed in the main flow pipe to the panel circuits. When the temperature in the thermal storage cylinder is high, very little water is taken from the cylinder, the majority being recirculated water. But as the temperature of the water in the thermal storage cylinder becomes lower more water is taken from the cylinder and less is recirculated from the system. This is achieved automatically by the mixing valve.

Mixing valves are usually electrically controlled. Should the electric supply fail at any time, the mixing valve would be rendered inoperative and high temperature water might enter the panel system, where it would turn into steam at high levels on account of the reduction of the static pressure. To avoid this, an automatic isolating valve is fitted near the outlet of the mixing valve. If hot water passes through this isolating valve, a fusible link melts, causing a clack to fall, which closes the valve. When a link fuses, the valve cannot be opened until the link has been reset by hand.

In large panel warming systems the water is invariably circulated through the distributing mains and panels by centrifugal pumps, generally electrically driven, but in smaller installations thermo-syphonic or gravity circulation is often adopted.

The system is kept full of water by means of a feed and expansion tank located above the highest point of the system with ball-cock and overflow of exactly the same type as used for an ordinary low-pressure hot-water system.

In a building warmed by panels the whole of the internal part of the structure is maintained at an equable temperature which is not greatly affected by daily fluctuations of the external conditions. At the start and end of a heating season the water is circulated at the minimum



Fig. 35.—ERECTING PANEL COILS

After a section has been satisfactorily tested, the pipes are embedded in the concrete. Before the concrete is poured, however, provision has to be made to ensure that when the shuttering is struck the face of the concrete offers a proper "key" for the plaster with which the ceiling is finished. This shows one method of providing such a "key" — laying slip tiles on shuttering between the loops of the panel coil. Both faces of the tiles are grooved. The grooves on the top of the tiles hold them firmly to the concrete and the grooves on the underside, when exposed after the shuttering is struck, form a satisfactory foundation for the plaster.

temperature and in the depth of winter at the maximum temperature. The most suitable water temperatures vary to some degree in each building, depending on location and exposure. A typical example, a large office building in London during October and May, the flow main to the panels is 85° F. and in February 100° F. The adjustments to the water temperature between these extremes are gradual, except in cases of fog or high winds, when slight temporary increases are necessary to maintain the required comfort condition.

Drying Out New Buildings

A new building contains a considerable amount of moisture which has to be evaporated when the heat is applied. Since embedded panels are completed at a very early stage in the construction of a building the heat can be applied before any interior is started. This enables the



Fig. 36.— EMBEDDING THE PANEL COILS AND CONNECTIONS WITH CONCRETE

The concrete is first poured in to the predetermined level of the underside of the hollow blocks. The hollow blocks are then placed in position and bedded into the concrete base and the remainder of the concrete is spread and consolidated. When the concrete has set, the shuttering is removed in the usual manner, leaving the surface free for plastering.

system to be used for drying out the building, permitting earlier progress of the plastering, joinery and painting work, and obviously reducing the risk of injury to new work, particularly the woodwork, through dampness, etc.

Maintenance

To maintain a panel warming system no special precautions are necessary. The feed and expansion tank should be inspected regularly for correct level and working of the ball-cock. Air should be released weekly

from air bottles, or if automatic air-cocks are fitted these should be examined periodically. A little water should be run off regularly from the bottom of the boiler, calorifier or thermal storage cylinder, to remove any sludge. Boiler flues must be cleaned frequently and ashes and clinker removed daily. When required, the glands of pumps and valves have to be repacked. In the summer, when no heating is required, the system should be kept full of water; the boiler doors and dampers should be left wide open, pumps should be run for a short time once a fortnight, when the main switch isolating the electric supply to any automatic valves should be opened and closed several times in succession.

AIR TROUBLES IN HOT-WATER HEATING SYSTEMS

A small section of an embedded pipe panel heating system is shown in Fig. 37, and it affords a useful example of the difficulties met with in dealing with faulty circulation due to inadequate provision for removing air from the installation.

An Embedded Pipe Panel Heating System

In the present instance the panels were the standard flat serpentine grid coils formed of $\frac{1}{2}$ -in. bore piping looped at 6-in. centres. From the mains in the basement flow and return risers were taken up in chases through the rooms in which the panels were fitted, the flow branch to each panel being taken horizontally from the flow riser, and the return from each panel being led down to the skirting before joining the vertical main return.

This is to enable the occupant of each room to control the heat output of his panel by means of the valve at about skirting level. A second valve is provided on the return connection from each panel, this being of lock-shield pattern. The lock-shield valve is primarily for regulating purposes and when set, and the system regulated and an even circulation provided through each panel, it is not again operated except in certain contingencies. The occupant of the room uses the other valve for turning heat on or off, a hand-wheel being provided for this purpose. Both valves are usually fitted in a recess formed in the wall, and are concealed by a hinged timber door or metal plate. Sometimes a single valve of a double-purpose type is used, having a device for regulating, this being permanently set, so that when the hand-wheel is used to turn the panel fully on, only the amount of water found desirable when the system was regulated is allowed to circulate through the panel. Although the practice of using a double regulating valve, or two valves close together on the same pipe is quite common, the writer is convinced that it is fundamentally wrong in principle.

Incorrect Piping System

The following practical example will serve to illustrate the point ; it occurred in the case of a group of panels connected precisely as indicated in Fig. 37: Certain panels, particularly on the upper floor,

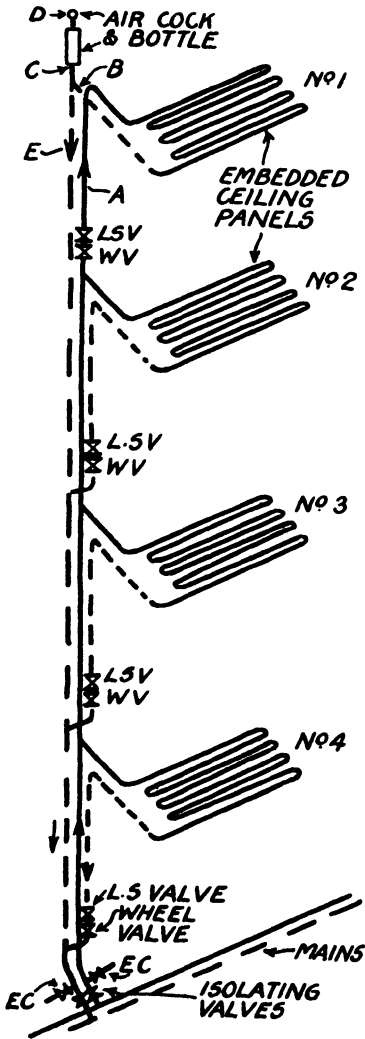

Fig. 37.—A SMALL SECTION OF AN EMBEDDED PIPE PANEL HEATING SYSTEM
The above is a common arrangement of piping but one with which air troubles are likely. L.S.V., lock-shield valve.

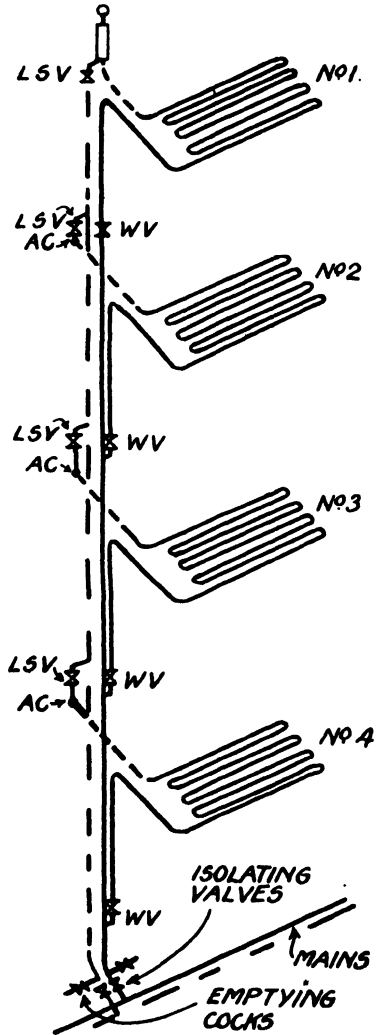

Fig. 38.—A BETTER ARRANGEMENT FOR EMBEDDED PIPE PANEL HEATING SYSTEM
Note flow of water is upward through each panel. Note air cock to each panel and arrangement of valves.

such as No. 1 in Fig. 37, had no circulation. A glance at the drawings shows that the trouble was not due to pipe sizing because panels more distant from the boiler, but similarly connected with pipes of identical sizes, functioned perfectly.

It was thought that the trouble was due to the presence of air in the pipes, and most probably in the panels. The air-cock at the top of a particularly troublesome tier of panels had been open for more than two hours, discharging water the whole of the time without the slightest sign of air.

There appeared to be no reason why, with the air-cock open, water from the return should not be discharged from the vent without bothering to displace any of the air there might be in the panels; furthermore, it was apparent that any air in the lower panels which tended to escape in an upward direction, due to buoyancy, air being very much lighter than water, must pass through the topmost panel in order to reach the air escape cock and so be ejected from the system. There was therefore reason to suppose that the uppermost panel contained a considerable quantity of air, but that opening the air-cock simply allowed water to be discharged from the vertical return pipe instead of venting the topmost panel. In other words, water was taking the course E, C, D, and so to atmosphere, instead of water and air taking the course A, B, C, D.

How Air was Driven Out of System

In order to test this theory it was arranged to make a further attempt at venting the system, adopting a procedure which, if theory were correct, promised success.

Thus the valves were shut off on all panel connections with the exception of panel No. 1, the uppermost of the four. The isolating valve on the return at the foot of the riser was also closed, the only valves remaining open being the flow isolating valve to the riser and the two valves on the flow to panel No. 1. Any water drawn off at the air-cock must now pass through the topmost panel, offering every prospect of clearing that panel of air, and this result was, in fact, obtained.

Objections to System of Connection

The necessity for closing the isolating valve on the vertical return, and also the valves on all other panels on each riser except the uppermost one, is in itself sufficient objection to this method of connecting the panels. In addition to this there is the fact that it is impossible to secure positive venting of the three lower panels. Another serious objection is that the air is expected to move against the direction of the flow of water in order to escape from the system.

A much better arrangement would have been provided had the flow to each individual panel been taken from skirting level, thus flowing up to the panel instead of down from it, air and water then both flowing

in the same direction. Positive venting of each individual panel would also then be possible by shutting off the return isolating valve and all panel valves except those on the one being vented.

There is still the objection that a number of panels are put out of commission while the apparatus is being vented, and many journeys from the air-cock to the various rooms while doing so, and to overcome this it is necessary to adopt the arrangement shown in Fig. 38.

It will be noted that (a) the flow of water is upward through each panel, (b) in addition to the air-cock and bottle at the top of the risers there is an air-cock to each individual panel, (c) at each venting point there is a valve to prevent water reaching the air-cock except from the desired direction, that is, through the panel, and (d) air from the lower panels does not necessarily pass through the topmost panel to escape from the system.

An arrangement such as that shown in Fig. 37 can only mean that the person responsible for its design has several misconceptions concerning the behaviour of air in a hot-water system.

Air Does Not Always Rise to Highest Point

Much of the trouble experienced through insufficient or improperly arranged venting facilities is traceable to an unquestioning acceptance of the generalisation "air always finds its way to the highest point of the system." Too often this is taken to mean that if an open pipe or air-cock is placed at the highest point of the system and the piping graded accordingly, that disposes of the subject.

Air certainly has a strong tendency to rise to the highest point in a vessel or system containing water, but only succeeds in doing so in the absence of other influences having even more powerful tendencies in the opposite direction. Innumerable everyday instances of air not rising through water could be cited.

Some Examples of Air-Water Behaviour

To take one very simple example: if a piece of metal is placed in an open vessel containing water, for instance, a washhand basin, it will be found that tiny bubbles of air adhere to the surface of the submerged metal, and that the rougher the surface of the metal the more numerous and larger are the bubbles. In the case of metal having a very smooth surface, such as brass, in places the air adheres in rather a curious manner, giving the shining appearance of a tinned surface. This probably happens only where the brass is dirty. Although the larger bubbles are readily dislodged by moving the metal rapidly through the water, the smaller ones adhere strongly to the metal. The small bubbles in time tend to merge into a larger bubble which is more easily dislodged and then rises rapidly through the water and disappears on reaching the surface.

Although numerical values of the surface tension and buoyancy of air are useless for present purposes, it is relevant to note that the surface tension or tendency to adhere is increased with roughness of the metal, whilst buoyancy increases with the size of bubble. The tendency for air to be swept from the surface of the metal by moving water also increases with the size of the bubble.

Tendency of Air to be Sucked Downwards

Another everyday indication of air-water behaviour is available whenever a washhand basin, bath or sink, is used. When the plug is removed in the ordinary way after the water has been used the water commences to run away without air bubbling up from the waste pipe, the air in this pipe being driven downward with the flow of water. Air can be caused to bubble up through the water by removing the plug violently, but not otherwise—that is, provided the waste pipe has an open discharge at the other end. The degree of violence necessary to draw air up out of the waste pipe by jerking out the plug is an indication of the strength of the tendency air has, under certain conditions, not to rise to the surface, but, on the contrary, to take a vertically downward direction.

When the level in the basin or bath has fallen to a certain point, there is usually a gurgling noise and a vortex formed over the outlet. Here again is an instance of air taking a downward course, for the noise is due to air being sucked into the waste pipe through the water and not due to air escaping upward from the pipe and through the water, although the latter condition can be produced by obstructing the lower end of the waste pipe. The fact that normally on emptying a bath the air is drawn in can be proved by holding a lighted match over the mouth of the vortex.

How Air May be Drawn into Hot-water Installation

These factors are of significance in connection with the air troubles one must expect to encounter in hot-water installations and it is useful to enumerate the effects they are likely to produce :

(1) If a vortex is allowed to occur in the feed and expansion tank when the system is being filled initially there is every prospect of difficulties arising as a result of the air drawn into the system.

How Air May Tend to Remain in System

(2) Even if the system is “ filled ” with water, there are innumerable air bubbles adhering to the inner surfaces of pipes and radiators. Some of these air bubbles will, in time, merge and, due to the increased buoyancy of the larger bubbles, rise to the surface of the system provided there is no more powerful factor operating in the reverse direction.

(3) When circulation commences the flow of water will dislodge some

of the bubbles which will then either rise to the highest point of the system, or be borne off in the direction of the flow of water, even being swept vertically downwards if the velocity of the water is sufficiently strong to do so.

(4) Air which has risen to the top of the apparatus due to its own buoyancy may, due to water velocity, be swept past the opening to the vent pipe if this is small and the water velocity high.

Air Drawn into System at Feed and Expansion Tank

The first point deserves amplification in view of the fact that trouble—small or great—can be expected from this direction in almost every system, cold-water supply systems no less than with heating or hot-water supply.

A typical feed and expansion tank is shown in Fig. 39. Water is admitted to the tank by means of a ball-valve and is led into the heating system by a pipe taken from or near the bottom of the tank.

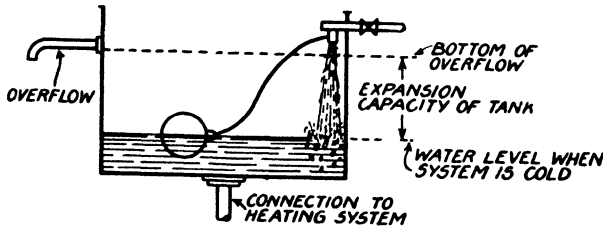

Fig. 39. - A TYPICAL FEED AND EXPANSION TANK

For normal working conditions the arm of the ball valve is set down and adjusted to close off the valve with the minimum depth of water in the tank to float the valve, so that when the water in the system is heated and expands in volume it does not rise above the overflow pipe as there would otherwise be a waste of water each time the system cooled off and was subsequently reheated.

Effect of Undersized Tank

Incidentally, if the tank were undersized, there would be introduced yet another possible source of air trouble, for not only does all fresh water contain a certain amount of air, but in passing through the vertical distance between the ball-valve outlet and the surface of the water in the tank there is a strong possibility of aeration of the water taking place, this being further aggravated by the agitation of the surface of the water due to the usually powerful jet from the ball-valve. Thus, from the standpoint of keeping the system clear of air it is desirable to provide adequate accommodation for the increase in the volume of water, due to expansion on heating, so that fresh water is not admitted to the system more often than strictly necessary.

The question of keeping the system free from air is one of the most important points to be borne in mind, particularly when a newly completed installation is first put into commission. As we have already seen one possible cause for the introduction of air into the water pipes may be an undersized feed and expansion tank. But even assuming that a tank of the requisite capacity has been installed, unless care is used in filling up the pipes in the system with water for the first time, air may be introduced by vortex action as explained below.

In the event of such an occurrence much unnecessary trouble may be caused owing to the fact that airlocks may form at bends in the pipework.

Filling Up the System—How Air is Drawn In

When filling up the system a vortex is more often than not likely to be caused because the ball-valve is seldom capable of allowing water to run into the system at as fast a rate as the outlet pipe can discharge it from the tank, consequently, the condition shown in Fig. 41 is likely to result, even if the ball valve is temporarily removed, as is often done to fill the system more rapidly.

The rate at which water can be emptied from a tank depends upon the vertical length of the discharge pipe, this being indicated as H_2 in Fig. 40. The rate at which water can enter the discharge pipe, however, depends upon the head of water in the tank itself, and where the head is insufficient to allow the water to enter the discharge pipe at the rate at which the discharge pipe can carry it away there is a vortex and air is drawn into the piping. In the case of a system which is largely closed, as is the case of a heating apparatus, even though the air-cocks on the radiators are kept open during filling until the water reaches the levels of the various radiators when they are closed off, floor by floor, the air drawn into the system usually results in a point being reached when no more water will flow into the pipes although the system is only partly filled. The water level then rises in the tank and closes off the ball-valve, or if this has been removed, the water overflows unless, as should be the case when the ball-valve is not used, someone has been standing by to close off the supply when necessary. The level in the tank then remains practically stationary, falling very slightly as a little

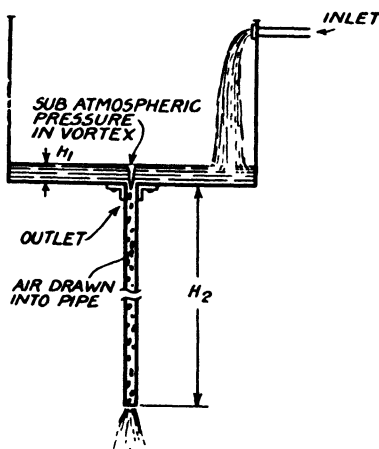

Fig. 40.—HOW AIR IS DRAWN INTO SYSTEM WHEN FILLING UP

air bubbles up from below, and giving the impression that there is a complete blockage of the piping. In fact, the writer knows of one instance where the fitter was so certain that the pipe was blocked that he dismantled the whole of the feed piping and rodded it through to make certain it was clear before re-erecting! When the pipe was refixed there was precisely the same result as before. The water refused to flow from the tank when about a tenth of the system was filled. A technical representative visited the job at this stage and was able to prevent still more piping from being disconnected for inspection.

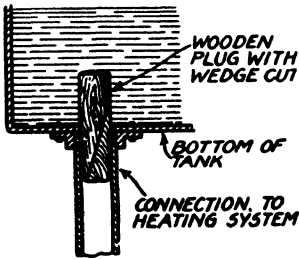

Fig. 41.—A USEFUL DEVICE TO ASSIST FILLING UP SYSTEM

Wooden plug with a wedge-shaped piece cut off, fitted in outlet, is adjusted to prevent water leaving tank at a faster rate than it enters, so that the water level builds up to sufficient height to prevent vortex from forming at outlet.

A Useful Device to Assist Filling Up System with Water

The system was then satisfactorily filled under his direction by using the device shown in Fig. 41, and the boiler emptying cock was left open to allow air to escape freely from rather a long horizontal run of feed piping between the bottom of the vertical feed and the boiler. The arrangement shown in Fig. 41 is almost self-explanatory: a wooden plug with a wedge-shaped piece cut off is fitted in the outlet at the bottom of the tank. This is adjusted to prevent the water from leaving the tank at a faster rate than it enters so that the water level in the tank builds up to sufficient height to prevent a vortex from forming.

Suitable Position for Open Vent in System

The important point to remember in filling a system is that after the apparatus has been partly charged and the remaining air in the pipes, etc., somewhat compressed, water will not enter at a faster rate than the air can be ejected, thus limited escape for the air in conjunction with an air-injecting vortex in the feed tank is bound ultimately to result in a stalemate of the sort that makes one convinced that there is a stoppage in the piping.

Thus, in deciding the position of an open vent, one must have in mind the question of its usefulness during the filling stage as well as later when dealing with what we will call secondary air.

Conditions During Filling

On referring to Fig. 42, it will be seen that the feed connection and open vent join the system at the same point. Now consider what will

happen when filling the system. Water is run in at the feed pipe and it is desired to have air escape via the open vent. Thus, at the junction, air and water are expected to move in opposite directions, the one trying to get in and the other out at a point where they meet. In addition to this, there is a tendency for the water to rise an inch or two into the open vent due to the level of the tank and the obstruction to the flow of water.

During Early Stage of Filling.—During the early stage of filling there is little doubt that some air at least will escape by means of the vent and some via the air-cocks on the radiators, these being opened, of course, in order to facilitate the removal of air, and then closed as the water level in the system rises.

When Topmost Radiators Have Been Filled.—When the topmost radiators have been filled and their air-cocks closed, the air remaining in the upper part of the system can escape only by means of the open vent pipe and the real difficulty now begins, for it is at this stage that the water level tends to rise into this open pipe due to the resistance the system now presents to the entry of further water. Ultimately, the high-level piping will be filled, but very slowly indeed.

Position of Vent to Allow Rapid Filling.—The advantage in positioning the vent at the point indicated in Fig. 43 now becomes apparent.

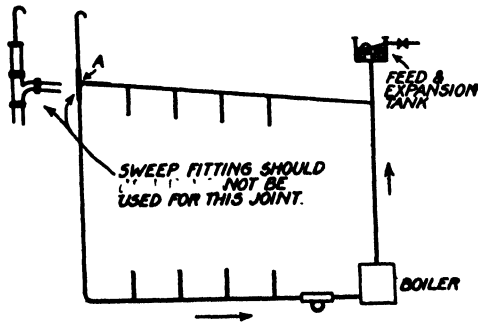

Fig. 43.—THE DRAWBACK OF THE ARRANGEMENT IN FIG. 42 IS ALMOST COMPLETELY OBIVIATED BY THE ABOVE ARRANGEMENT

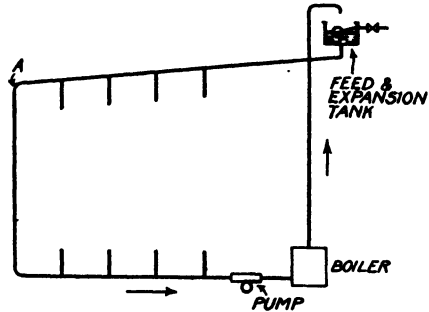

Fig. 42.—IN THE ABOVE ARRANGEMENT ANY AIR THAT MAY STILL BE IN THE OVERHEAD PIPE WHEN THE PUMP IS RESTARTED MUST THEN MAKE ITS ESCAPE AGAINST THE FLOW OF WATER WITH CONSEQUENT DANGER OF BLOCKAGE

The entering water and escaping air do not at any time obstruct one another and the system filled much more rapidly. Naturally, one would not use the sweep-type tee, shown in Fig. 43, in such a position, as the vent is then not taken strictly from the highest point of the system.

Position of Vent for Escape of Secondary Air.—By locating the open vent at A, in Fig. 43, there is also a pronounced advantage in dealing with the

secondary air, that is, the air which adheres to the internal surfaces in the form of bubbles and is dislodged in the course of time and with the circulation. Even with pipes adequately sloped upward toward the points at which vents are fitted and with quite high water velocities the complete clearing of air from the system is usually a process extending over a period of months, and the only conclusion one can draw from certain kinds of recurring air troubles is that the quantity of secondary air in most systems is very considerable indeed.

Thus, air which may tend to collect in the overhead pipe at night, when the pump is stopped, would gradually move toward the open vent at a pace which depends upon the slope of the pipe and the roughness of the metal. In the case of Fig. 42, any air that may still be in the overhead pipe when the pump is restarted, must then make its escape against the flow of water. The writer knows of one or two cases where, without any question of doubt, the air is actually driven partly down the last drop which in consequence fails to function. This possibility is almost completely obviated by fitting the vent as in Fig. 43. Water and air travel in the same direction toward the escape, the velocity of flow along the overhead main assisting rather than retarding the escape of air.

Connection at Point Where Vent Joins Main

At the point where the open vent joins the main, however, a high water velocity should be avoided lest the air be swept past the open vent and choke the circulation through the last vertical pipe. In cases where this particular trouble has been encountered it has been found necessary to provide a local enlargement in the pipe at the connection to the vent to promote separation of the air.

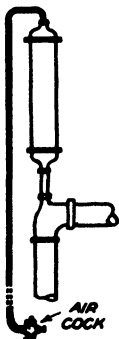

Fig. 44.—POOR ARRANGEMENT OF CONNECTION OF AIR BOTTLE TO MAIN

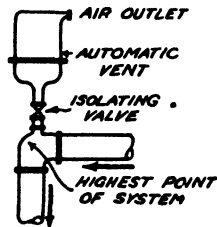

Fig. 45.—UNSATISFACTORY CONNECTION TO AUTOMATIC VENT

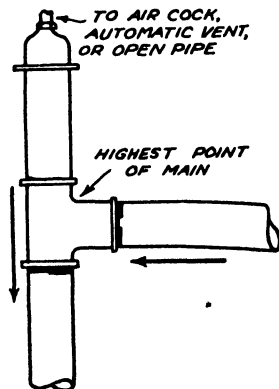

Fig. 46.—A MUCH MORE EFFICIENT CONNECTION TO VENT

Note branch from main to vent is of same size as main.

It is hardly necessary to point out the arrangement of the connection to the air bottle in Fig. 44 is very poor: the restriction considerably reduces the effectiveness of the vent, especially where the circulation is brisk, as in an accelerated system, and where, consequently, the greater part of the air is likely to be swept past the small entry to the bottle. Similarly with the connection to the automatic vent in Fig. 45. This would be very much more efficient if the branch from the main to the vent were of the same size as the main itself even if for only a very short distance, as indicated in Fig. 46. Even in the case of an open vent from a gravity system it is desirable to have a short length of large diameter piping direct from the main before reducing to the size of the vent pipe which is usually $\frac{1}{2}$ in. or $\frac{3}{4}$ in.

Venting Embedded Panel

In the case of a serpentine embedded panel where the panel itself requires venting, it is advantageous to use the method shown in Fig. 47. There is seldom space available to allow this arrangement to be adopted for panels on intermediate floors, but there is usually no difficulty in applying it for panels on the topmost floor where most needed.

Naturally, with all gravity systems, and with accelerated systems where the pump head will permit, open vent pipes should be used in preference to air bottles or automatic air valves, and in no event should an air-cock be fitted direct on the pipe from which it is intended to remove air.

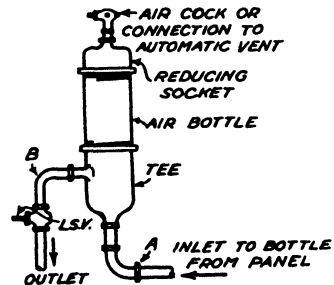

Fig. 47.—METHOD OF VENTING EMBEDDED PANEL

The Type of Vent to Use

Where a manually operated air-cock is adopted there should be a reservoir (see Fig. 46) for the storage of air which accumulates during the intervals between venting, and unless this storage space is provided the system becomes choked, unless air is drawn off very frequently.

Overhead mains are often provided with an air bottle from the top of which a small pipe, usually $\frac{1}{4}$ -in. diameter, is led down to about 4 ft. from the floor where the air-cock is fitted in order to be accessible. There is, however, the objection that the small-bore pipe is repeatedly filled with water which must be run off before air reaches the vent cock. In such cases it is much more satisfactory to use an automatic vent and so avoid the necessity for looping down from the highest point. Generally speaking, automatic vents are preferable to air bottles and take second place only to open vents, despite the fact that the automatic vents are not wholly free from trouble. Grit or deposit may cause the valve to remain

open or closed, but this difficulty can readily be remedied if an isolating valve is provided on the inlet to the automatic vent, as indicated in Fig. 45, enabling the fitting to be removed and opened up for inspection if dribbling takes place or if faulty circulation suggests that the valve may have seized in the closed position and has allowed a pocket of air to accumulate in the system.

Protection of Vents Against Frost

All vents, whether open pipes, bottles with pet cocks, or automatic valves, must be protected against the possibility of freezing. Coating with insulating material is not a complete safeguard. It is also necessary to keep the distance between the remote end of the vent and the hot-water circulation as short as practicable. Where a number of open vents are carried above a flat roof, and are exposed to the weather, they are sometimes connected by a small-bore pipe through which a slight circulation of hot water is allowed to take place. Since this connecting pipe is necessarily below the water-level in the system, it is essential to fit a valve on each vent branch, as otherwise it would not be possible to empty separate sections of the system should occasion to do so arise. In an accelerated system care should be observed in selecting the points from which vents are connected to a common air line, for if vents from flows and returns are taken into the same pipe serious short-circuiting may result. A separate air line for the flow vents and another for the return vents is recommended in such cases.

Notes on Venting into Radiators

It is a common practice to grade pipes in such a manner that mains are vented into radiators. Up to a point, this is a highly satisfactory method of dealing with air, for radiators form very efficient air bottles. There have been cases, however, where one, or perhaps two radiators in a large system require venting so frequently that a complaint has been made and open air pipes or automatic air vents have afterwards been fitted to these particular radiators. As one would expect, radiators on the topmost floor are often associated with this trouble, but not exclusively so. Similar difficulties are fairly common in the case of radiators on lower floors where connected directly to the top of vertical flow risers, even short ones, close to the boiler. Although the desirability of open or automatic vents at such points may be anticipated they may not all be found necessary in practice, so plugged tees may be left for future vents if found necessary.

Running additional open vents from a system after it has been completely installed, however, is not always a simple matter. The cost of installing open vents in the first place—some of them possibly not essential—must be weighed against the possibility of much greater cost of fitting additional vents found necessary when the system has been set to work.

Chapter VIII

STEAM HEATING SYSTEMS

IN estimating the quantity of steam required for a heating system, the B.T.U. requirements should first be determined. Then, since the latent heat of steam for pressures between 1 lb. and 100 lb. sq. in. is from 900 to 970 B.T.U./lb., for practical purposes and easy approximations it is sufficient to divide the B.T.U. by 1,000 to obtain the amount of steam in pounds per hour.

Heat given up by the steam-heated pipe results in the formation of water by condensation. It is important that this water should not collect in the main, or serious knocking known as water-hammer will develop. The pipes, therefore, should be fixed with a fall in the direction of the flow of steam of not less than $\frac{1}{4}$ in. in 10 ft., and at suitable intervals drain pockets should be provided.

The pipes are best supported on brackets fitted with rollers or designed to allow free movement when expansion takes place.

Formula for Sizing Steam Pipes

A formula in common use for sizing steam pipes is that which gives :—

$$W = 87.5 \sqrt{\frac{P y d}{L (1 + \frac{36}{d})}}$$

where W = lb. of steam per minute. y = Density of steam, lb./ft.
 P = Drop in pressure in length L . L = Length of pipe in feet.
 d = Diameter of pipe in inches.

In the following table, the flow of steam in lb. per hour is given for various sizes for steam-pressures from 1 to 100 lb./sq. in.

TABLE 1.—FLOW OF STEAM THROUGH PIPES

<i>Pressure lb./sq. in.</i>	<i>Diameter of Pipe</i>						
	$\frac{1}{4}$ in.	1 in.	$1\frac{1}{2}$ in.	2 in.	$2\frac{1}{2}$ in.	3 in.	4 in.
	<i>Weight of Steam in lb./hour with 1 lb. Drop/100 ft.</i>						
1 ..	26.9	55.4	186.9	390	654	1,180	2,515
10 ..	33.4	68.0	232.1	483	813	1,465	2,580
20 ..	39.5	81.0	275.5	567	955	1,717	3,660
30 ..	43.6	91.1	308.0	640	1,075	1,930	4,125
40 ..	48.8	100.3	338.0	703	1,183	2,125	4,540
50 ..	52.7	108.4	368.0	763	1,275	2,300	4,910
60 ..	56.4	115.7	390.0	811	1,365	2,455	5,240
70 ..	59.7	122.8	413.0	862	1,445	2,610	5,570
80 ..	62.9	129.2	436.0	905	1,523	2,735	5,830
90 ..	65.7	135.0	455.0	947	1,590	2,865	6,110
100 ..	68.5	140.8	475.0	985	1,653	2,980	6,370

Condense

The condensate water formed in any steam-heating system should, wherever possible, be carried back to the boiler. Failure to do so will result in uneconomic running costs, as cold fresh water must be supplied to make good the loss.

This water has, of course, to be heated up from, say, 50° F., and fuel costs, therefore, are unnecessarily high. By collecting the condensate, water consumption is lowered, and as the temperature is often as high as 180° F., the fuel consumption is also reduced. The formation of scale in the boiler, especially in hard-water districts, is also retarded.

It is advisable to use copper piping throughout the condensate pipeline because of the corrosive action of condensate upon mild steel. Cast-iron pipes do not suffer greatly from this corrosive action and are quite suitable for the larger sizes.

The quantity of condensate water is of course equal in pounds to the pounds of steam condensed; reference to the pipe-sizing charts for hot-water heating will assist in the determination of the sizes of the condensate mains.

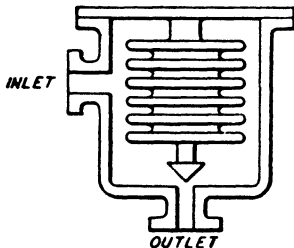

Fig. 1.—EXPANSION STEAM TRAP

This form of trap is fitted on steam radiators and heaters owing to its compact design.

In open-return systems the condensate gravitates to a tank or hot well in the boiler house, and this is used as a reservoir from which the boiler-feed pump obtains the water to be delivered to the boiler.

In low-pressure closed systems, the condensate is returned direct to the boiler without the assistance of the boiler-feed pump. Any losses of water are made good by the provision of an automatic boiler-feeder which maintains a constant water-level in the boiler.

Steam Traps

These important fittings are fitted to most steam-heating equipment with the exception of small, closed-return systems. In their action they serve a double purpose: (1) to drain the pipes and heaters of the condensed water, and (2) to prevent the escape of steam from the condensate outlet.

The types of traps in general use are those known as:—

- (1) The expansion type, and
- (2) The open- or closed-float pattern.

Expansion Type of Trap

In the expansion type, the trap valve is opened and closed by the contraction and expansion of an element sensitive to varying temperatures. Thus, as water is formed and becomes cooler than the steam, it flows out of the trap. Immediately steam reaches the trap, the increase in temperature causes the expansion of the element, and the trap closes.

This form of trap is fitted on radiators and heaters largely because of its compact design and neat appearance. They are usually fitted with a union connection on the inlet side, and can be supplied in polished chromium-plated finish.

Where there is a number of traps of this type in use on a particular installation it is advisable to provide spare elements, which can be used to replace any that may fail to operate satisfactorily after a long period of continual expansion and contraction.

Float Traps

One of the most commonly used closed-float patterns comprises a cast-iron vessel, with inlet and discharge branches for the connecting pipework, and a bolted-on cover. The float is of copper and is fixed to a lever, at

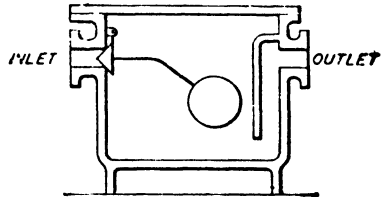

Fig. 2.—CLOSED-FLOAT TRAP

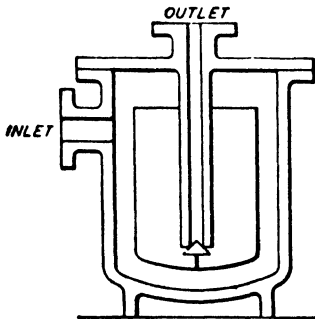

Fig. 3.—OPEN-FLOAT TRAP

the end of which a hinged valve is attached. A small V-notch is cut into the valve face. In action, the condensate trickles through the V-notch until sufficient water has accumulated in the trap to lift the float. The float, on lifting, opens the valve, and water flows through until steam enters. The pressure of the steam continues to discharge the water until the level drops, lowering the float and thereby closing the inlet. Steam is prevented from blowing through the trap by locating the outlet, internally, near the bottom, so that a

water seal is formed.

The area of the orifice at the inlet is calculated to prevent the steam pressure from forcing open the valve.

In the open-float trap, the float, or bucket as it is sometimes called, is attached to a valve which opens and closes the outlet as the float rises and falls. In some patterns the floats are inverted.

In action, water enters the trap until it overflows into the float and by reducing its buoyancy causes it to drop; the pressure of the steam then

forces the water up the discharge pipe. The float again becomes buoyant, and on rising closes the valve.

It is important that all traps should be suitable for the working steam pressure, and that they are of sufficient capacity. The manufacturers usually ask for full particulars of the conditions under which a trap has to work, and are then able to supply one most suitable for such conditions.

Siphon-pipe Trap

A device for trapping steam is shown in Fig. 4, which illustrates a simple siphon pipe. This arrangement is satisfactory for low pressures, and is favoured by many engineers, as there are no valves or moving parts which, through neglect or other causes, may result in the failure of a trap to operate satisfactorily.

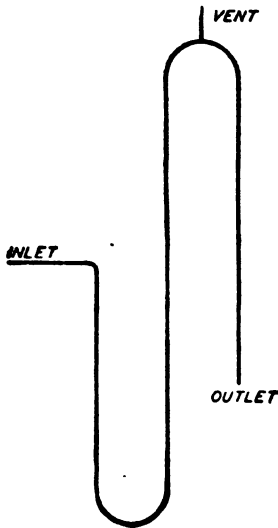

Valves

Steam stop-valves are generally of the screw-down pattern, and for small sizes are constructed throughout of bronze or gun-metal. Valves above 2½-in. diameter usually have cast-iron bodies, fitted with valves and seats of gun-metal or special alloy.

Fig. 4.—SIPHON-PIPE TRAP

Care is necessary in the selection of a valve, to be certain that it is suitable for the conditions under which it has to operate. It should not only be robust enough for the pressure, but also be designed to withstand the effects of the temperature, which, as will be seen by referring to steam tables, rises rapidly as the pressure increases. For instance, at atmospheric pressure the temperature is 212° F., but at 50 lb. gauge pressure the temperature is 297.5° F.

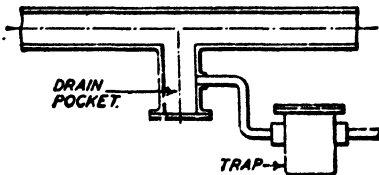

Fig. 5.—DRAIN AND DIRT POCKET STEAM MAIN

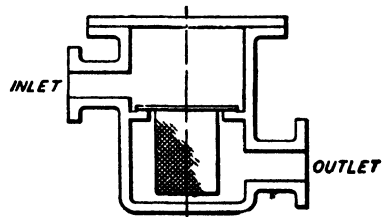

Fig. 6.—STRAINER IN STEAM MAIN.

The glands are packed either with asbestos cord, or with special packing which will not deteriorate when heated to the steam temperature.

Main steam valves should have flanged branches, and if subject to high pressure the screws on the spindles should be outside.

The hand wheels, especially on small control valves, are often made of some non-conducting material, in order that they remain sufficiently cool to handle comfortably.

Steam-pressure reducing valves are necessary where plant, not suitable for the higher pressure probably required elsewhere, is to be supplied with steam. There are numerous patterns available and, as with steam traps, it is advisable to supply the manufacturers with full particulars of the required duty of each valve. Every reducing valve should be fitted with a pressure gauge on the reduced-pressure side, and a pressure-relief valve. As periodical attention and examination are necessary, a stop-valve should always precede a reducing valve.

Drain and Dirt Pockets

The expansion and contraction of new steam pipes cause the flaking of scale from the internal sides, and this, with other matter such as small quantities of jointing compound, often results in the blocking of small steam and condense pipes unless precautions are taken to avoid it.

One method is to form a well or pocket in the steam main, similar to that shown in Fig. 5. This serves the double purpose of a receptacle for the condense and for any deposit of solids.

The outlet for the condense is placed about half-way down the pocket, and by the provision of a flanged joint or plugged outlet any accumulation of solids can be removed without breaking the joint of the connecting pipework to the trap.

The provision of perforated-metal or fine-mesh wire baskets in the steam main is sometimes desirable as a precaution against possible damage to reducing valves, meters, or other steam-operated fittings. Such baskets, or strainers as they are usually termed, are housed in special castings fitted with inspection covers which, on removal, allow the strainers to be taken out and cleaned. Fig. 6 illustrates a typical pattern.

Expansion Fittings

The coefficient of linear expansion of mild steel or wrought iron is 6.6×10^{-6} per degree F. Therefore, if a mild-steel steam pipe 100 ft. long is heated from, say, 50° F. to 300° F. (steam temperature at approximately 52 lb. gauge pressure), its increase in length will be :—

$$\begin{aligned} & \cdot 0000066 \times 100 \times (300 - 50) \\ & = \cdot 00066 \times 250 \\ & = \cdot 165 \text{ ft. or } 1.98 \text{ in.} \end{aligned}$$

It is necessary to make provision for an increase in length in long straight runs of steam-heated pipe by inserting suitable expansion joints or bends.

An expansion joint is made by permitting the free end of one pipe to slide in the socketed end of another, through a steam-tight gland. Such joints require frequent repacking of the glands, and are not favoured by most engineers.

Expansion loops are made by bending the pipes into the shape of a horseshoe, and although they take up more space than the sliding joint, are more satisfactory, particularly in pipe ducts and other places where access to them is difficult. They must, of course, be fixed horizontally and in high-pressure mains at intervals of 40–60 ft. For low-pressure mains, the distance between the expansion bends may be increased to 80–100 ft. (See Chapter V.)

VAPOUR-HEATING SYSTEM

Low-pressure steam- or vapour-heating, although not adopted so widely in this country as in America and on the Continent, can be successfully applied without causing the complaint, so often justified, of the dry, stuffy atmosphere usually associated with steam heating.

It is well known that the boiling-point of water is lowered at reduced pressures, as the table below shows. It will also be noted that the volume of steam increases rapidly as the pressure is reduced.

TABLE 2.—PROPERTIES OF VAPOUR

<i>Absolute Pressure lb. per sq. in.</i>	<i>Vacuum in. of Mercury</i>	<i>Boiling- point ° F.</i>	<i>Volume in cubic ft. per lb. of Steam</i>
14·7 (<i>Atmospheric Pressure</i>)	0	212	26·79
12	5·49	201·96	32·36
10	9·56	193·22	38·38
7	15·67	176·85	53·56
5	19·74	162·28	73·33
3	23·81	141·52	118·5
2·4	25	138	145·9

Knowledge of these facts is applied, therefore, in the design of vacuum systems of steam heating, where, by supplying steam at reduced pressures and carefully regulating the amount entering the radiators, it is possible to maintain them at temperatures considerably below 200° F.

The Boiler

The ordinary sectional-pattern boiler, similar to that used in hot-water heating, may be used, but care is necessary to make certain that the water level is maintained at the correct height. In addition to the usual water gauges, an automatic boiler feeder should be fitted to the boiler in systems where the return pipe is connected directly to the boiler. Where the condensate returns to a hot-well, automatic control gear fitted to the feed pump regulates the quantity of water fed to the boiler as required.

The arrangements of the pipe circuits do not differ very much from those in hot-water heating.

In the single-pipe system there is only one connection to each radiator, and this, as it has to carry the steam going in one direction and the condense flowing in the opposite direction, must be of an exceptionally large diameter. The circuit should rise to its highest point immediately above the boiler, and should fall from this point throughout its length to the return connection. Air relief valves are fitted approximately half-way up the radiators and are usually automatic in action, closing immediately steam reaches them. An air valve should also be fitted at the top of the vertical return pipe.

The two-pipe system is more generally adopted and embodies the provision of steam traps on the outlet of each radiator. On starting up, steam is generated at a pressure slightly above that of the atmosphere and flows through the steam main to the radiators. The steam, entering the radiators, condenses rapidly and thus induces the flow by the creation of a vacuum.

The air and water pass out through the traps which remain open until the radiator is filled with steam.

The Vacuum Pump

A vacuum pump connected to the return main enables the engineer to use smaller condense pipes and ensures a rapid flow of water from the traps. It may be steam- or electrically-operated, and is usually fitted with some form of automatic control.

There are a number of patented fittings manufactured and marketed by various firms who specialise in steam-heating equipment. Some of these fittings require a special arrangement of pipework, and their inclusion results in a name, after the patentee or firm, being given to the system.

Instructions and useful data for the installation of steam-heating systems embodying patented features are given in the manufacturers' lists.

Pipe Sizes

For sizing the steam pipes in low-pressure systems, reference to the following table will serve as a useful guide.

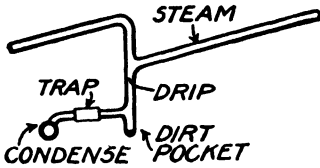

Fig. 7.—ARRANGEMENT OF RELAY IN STEAM MAIN AT LOWEST POINT OF TRAVEL

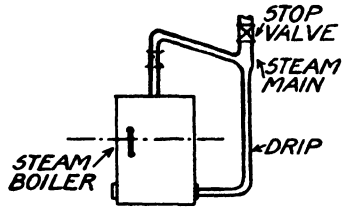

Fig. 8.—ARRANGEMENT OF DRIP PIPE AT BOILER TO REDUCE AMOUNT OF MOISTURE CARRIED OVER FROM BOILER

from the main being taken from the upper side of the pipe where dry steam is obtained.

The minimum pitch to be given piping for steam and condense flowing together is given in Table 4.

TABLE 4.—MINIMUM PITCH FOR RUNNING STEAM PIPING

Bore of pipe	Pitch per 10 ft.
$\frac{1}{2}$ in. and $\frac{3}{4}$ in.	$\frac{1}{8}$ in.
$1\frac{1}{4}$ in. and $1\frac{1}{2}$ in.	$\frac{3}{16}$ in.
$1\frac{3}{4}$ in. to $2\frac{1}{2}$ in.	$\frac{1}{4}$ in.
3 in. and over	$\frac{3}{8}$ in.

Where Relays are Required

It will be realised that grading the pipes to the extent given above will often mean that the steam main has pitched down to the lowest possible level before reaching the end of the travel. In such cases relays are required (see Fig. 7).

THE DRIP PIPE TO CONDENSE PIPE.—From each low point in the steam main a trapped drip pipe is taken into the condense main. It is important that the drip be taken from the extreme bottom of the relay, the vertical part of the drip being of large-bore pipe, preferably of the same size as the steam main, though not necessarily larger than 2 in. diameter, with a small horizontal branch, usually $\frac{1}{2}$ in., to the condense pipe.

DIRT POCKET ON DRIP PIPE.—The dirt pocket shown at the bottom of the drip is strongly to be recommended, for this often intercepts scale and jointing material that may otherwise interfere with the operation of the steam trap.

Strictly speaking, the steam trap on the drip branch should be fitted

with isolating valves to allow the trap to be cleaned or repaired without putting more of the apparatus out of commission than is essential, for in many cases leakage of steam into the condense mains has serious results even if originating from the small trap on a drip pipe.

DRIP PIPE AT BOILER TO REDUCE PRIMING.—Surplus water in steam mains is often caused by priming at the boiler, i.e. free moisture being carried out of the boiler with the steam. Whilst steps should be taken to reduce the risk of priming in the boiler, it is seldom completely eradicated, so a drip of the sort shown in Fig. 8 should be provided. It should be noted that when this drip is fitted the steam stop valve must be located beyond the point from which the drip branch is taken and not in the position indicated by broken lines, as otherwise when the valve is throttled as is often the case in starting up the apparatus, water would be forced up the drip connection and into the steam main. The drip connection at the boiler also serves another useful purpose when connected into the main condense line, as will be explained later.

How to Wash Out Boiler and Pipes Thoroughly Before Putting Plant into Operation

The procedure is to disconnect or leave disconnected the steam and condense mains at the boiler and plug the condense off from the boiler, a temporary steam pipe being taken from the boiler to a gulley or other point where hot water and steam may be ejected. If the boiler is fitted with a main steam stop valve this may be shut off and the temporary pipe taken from the safety valve tapping, this valve being removed for this purpose and also to allow ordinary washing soda to be dropped into the boiler, roughly 10 lb. of soda per 1,000 lb. of steam per hour the boiler is capable of generating.

Cleaning Out Boiler.—The boiler is then filled with water, the fire lighted and the water boiled. The highest possible steam pressure should be maintained consistent with the pressure for which the boiler is designed, the level of the tank feeding the boiler with cold water, and the facilities for getting rid of the water and steam ejected from the boiler. The water level in the boiler should be maintained at whatever height is found necessary to cause water as well as steam to issue from the temporary pipe.

After boiling out the water for about an hour the fire may be drawn and then the boiler emptied and refilled two or three times to remove the remaining soda.

Cleaning Out Steam and Condense Piping.—In order to clean out the steam and condense piping the steam main serving the radiators is reconnected to the boiler or the main steam stop valve opened, and the

condense main, which is still disconnected from the boiler, temporarily run to a drain. If the radiators are fitted with diaphragm type steam traps all the traps should be opened and the diaphragms removed temporarily and the traps reassembled. Having filled the boiler up to the normal working level, the fire is re-lighted and the maximum permissible steam pressure gradually generated, fresh water being admitted to the boiler from time to time to replace the condense ejected from the system. After running the apparatus for an hour or two in this manner the fire should be drawn, and when the steam pressure has died away the diaphragms are refitted in the steam traps and the condense main connected to the boiler and the system is then ready for normal use. While the steam traps are being reopened it is advisable to open and inspect dirt pockets so that they can be given a clean start.

Methods of Avoiding Moisture being Carried Over from Boiler

Even with a clean system there is still risk of priming if the steam leaves the boiler at too high a velocity and thus causes an ejector action to result. Any velocity above 40 ft. per second is likely to cause free moisture to leave the boiler with the steam.

To avoid this some boilers are fitted with a steam drum, this simply being a local enlargement causing a drop in velocity and consequent precipitation of the free moisture, whilst others are provided with an internal anti-priming pipe consisting of a horizontal tube in which there are a number of small holes through which steam enters at a low velocity due to the total area of the holes being considerably in excess of that of the steam main which is taken vertically from the centre of the tube and thence through the boiler shell.

In the case of cast-iron sectional boilers in which the half-sections are joined by headers, it is advisable to have a steam header at the front as well as the back of the boiler, the outlets being joined by a connecting pipe of the same size as the header outlets, and the main steam pipe or pipes being taken off from the centre of the connecting pipe. Not only does this appreciably reduce the risk of free moisture being carried off with the steam, but it results in a much more uniform water level in the boiler.

Size of Steam Main or Anti-priming Pipe Required

Table 5 will be found useful for ascertaining rapidly the size of steam main or anti-priming pipe required for a given quantity or pressure of steam.

TABLE 5.—SIZE OF STEAM MAIN OR ANTI-PRIMING PIPE REQUIRED FOR GIVEN QUANTITY OR PRESSURE OF STEAM

*Flow of Steam, pounds per hour, with a velocity of 10 ft. per second
Gauge Pressure, pounds per sq. in.*

<i>Diameter of Pipe</i>	0	5	10	15	20	30	50	75	100	150
$\frac{1}{8}$ in.	1.8	2.4	3.0	3.5	4.1	5.2	7.3	9.9	12.5	17.5
$\frac{1}{4}$ in.	4.1	5.4	6.7	7.8	9.1	11.8	16.7	22.5	28.6	40.0
$\frac{1}{2}$ in.	7.3	9.6	12.0	14.1	16.5	21.0	29.7	40.2	50.8	71.5
$\frac{3}{4}$ in.	11.5	15.2	18.9	22.2	25.9	33.0	46.6	60.4	76.4	112.0
$1\frac{1}{4}$ in.	16.4	21.6	27.0	31.8	37.1	47.0	66.0	89.8	114.0	159.0
2 in.	29.3	38.5	48.0	56.5	66.0	84.0	109.0	147.0	186.0	260.0
$2\frac{1}{2}$ in.	45.7	60.0	75.0	88.5	103.0	130.0	183.0	248.0	314.0	440.0
3 in.	66.0	87.0	108.0	127.0	148.0	188.0	266.0	360.0	455.0	640.0
$3\frac{1}{2}$ in.	90.0	118.0	147.0	173.0	202.0	246.0	348.0	471.0	595.0	840.0
4 in.	117.0	154.0	192.0	226.0	264.0	335.0	474.0	641.0	810.0	1,140.0
5 in.	183.0	240.0	300.0	353.0	412.0	523.0	740.0	1,000.0	1,265.0	1,780.0
6 in.	264.0	360.0	431.0	509.0	594.0	754.0	1,060.0	1,440.0	1,820.0	2,560.0
7 in.	360.0	471.0	587.0	693.0	808.0	1,025.0	1,450.0	1,960.0	2,480.0	3,480.0
8 in.	480.0	615.0	765.0	920.0	1,072.0	1,340.0	1,890.0	2,560.0	3,240.0	4,530.0

In order to illustrate the manner in which the table is used, let it be supposed that the steam main is to be sized for a boiler generating 1,200 lb. of steam per hour at a gauge pressure of 10 lb. per sq. in. and that the velocity of the steam leaving the boiler is not to exceed 40 ft. per second.

Since the table gives the quantity of steam carried with a velocity of 10 ft. per second, and as quantity is proportional to velocity for any given pressure or pipe diameter, it follows that for 40 ft. per second the quantities of steam given in the body of the table are quadrupled. Thus, a $2\frac{1}{2}$ -in. pipe will pass 60 lb. of steam per hour at 5 lb. pressure, with a velocity of 10 ft. per second and $60 \times 6 = 360$ lb. per hour if the velocity or speed is 60 ft. per second.

Thus, if we find the size of pipe required to pass $1,200/4 = 300$ lb. per hour at a velocity of 10 ft. per second, it also gives the size required for 1,200 lb. per hour at a velocity of 40 ft. per second. Referring to the column headed 10 lb. per sq. in. and following down we find 300 lb. per sq. in. against the size 5 in. diameter in the left-hand column. This is the size of pipe required for 1,200 lb./hr. at 10 lb. per sq. in. and 40 ft. per second.

As a further example, find the number of $\frac{1}{2}$ in. diameter holes to be provided in an anti-priming pipe for a boiler generating 5,000 lb. of steam per hour at 50 lb. per sq. in. gauge pressure, velocity not to exceed 40 ft. per second.

A $\frac{1}{2}$ -in. pipe or aperture will pass 7.3 lb. of steam per hour at 50 lb.

per sq. in. and a velocity of 10 ft. per second, and will thus deal with $7.3 \times 4 = 29.2$ lb. per hour at 40 ft. per second. The number of holes in the sparge pipe is therefore $5,000/29.2 = 172$.

The Velocity Method of Sizing Pipes

The velocity method of sizing pipes is sometimes recommended for steam-heating practice, and in such cases the permissible velocity may be taken as 10 ft. per second plus 10 ft. per second per inch of diameter up to 100 ft. per second. Thus, for $\frac{1}{2}$ -in. pipe, the permissible velocity is 15 ft. per second, for $\frac{3}{4}$ -in., 17.5 ft.; 1-in., 20 ft.; 2-in., 30 ft.; 3-in., 40 ft.; 4-in., 50 ft.; 5-in., 60 ft.; 6-in., 70 ft.; 7-in., 80 ft.; 8-in., 90 ft.; and 9-in. and over, 100 ft.

In the case of low-pressure work, where there is very little pressure available for overcoming the resistance to the flow of steam it is essential that the pressure loss be calculated to ensure that it is within the amount available. The steam velocities given above are those which, with normal grading of pipes and draining of steam mains at low points, are not likely to cause water hammer when in contact with condensation from vertical steam pipes connected to the mains and in which steam and condensate tend to flow in opposite directions. Where this happens in a horizontal pipe, that is, where the pipe is so graded that the condense runs back instead of forward, the velocities given above should be halved, whilst in cases where a large quantity of condense is flowing against the steam, as with a single pipe system, the velocity should be one-third of that given above.

An Easy Rule for Approximate Calculations

Referring again to Table 5, it will be seen that as the steam pressure is increased there is a greater weight of steam for a given velocity. This is because the volume of 1 lb. of steam becomes progressively smaller as it becomes compressed. Were saturated steam a perfect gas its volume would be directly proportional to its absolute pressure and temperature. As it is, for very approximate calculations, such as are sometimes necessary on the site, it may be taken that the volume of 1 lb. of steam is roughly proportional to its absolute pressure, so that if the volume of 1 lb. of steam at atmospheric pressure is memorised the volume at other pressures may be approximate in order to arrive at the velocity of the steam in a given case.

Properties of Steam

In Table 6 some of the properties of steam are given in order to explain some of the more general aspects of steam-piping problems.

TABLE 6.—PROPERTIES OF SATURATED STEAM

<i>Gauge Pressure, lb. per sq. in.</i>	<i>Absolute Pressure, lb. per sq. in.</i>	<i>Atmospheres</i>	<i>Volume, cu. ft. per lb.</i>	<i>Latent Heat, B.T.U. per lb.</i>	<i>Total Heat, B.T.U. per lb.</i>	<i>Temperature, ° Fahr.</i>
— 7.5	+ 7.5	0.5	50.0	990	1,138	180
— 10.0	+ 14.7	1.0	26.8	970	1,150	212
+ 15.0	+ 30.0	2.0	13.7	945	1,164	250
+ 30.0	+ 45.0	3.0	9.4	928	1,172	274
+ 45.0	+ 60.0	4.0	7.2	914	1,177	293
+ 60.0	+ 75.0	5.0	5.8	903	1,181	307
+ 75.0	+ 90.0	6.0	4.9	894	1,185	320
+ 90.0	+ 105.0	7.0	4.2	885	1,188	331
+ 105.0	+ 120.0	8.0	3.7	877	1,190	341
+ 120.0	+ 135.0	9.0	3.3	870	1,192	350
+ 135.0	+ 150.0	10.0	3.0	863	1,193	358

Gauge pressure means the pressure of the steam relative to that of the atmosphere which is usually taken to exert a pressure of 14.7 lb. per sq. in. Steam at 1 lb. per sq. in. gauge is therefore exerting a pressure of 1 lb. per sq. in. greater than that of the atmosphere, and a total, or absolute pressure of 15.7 lb. per sq. in. relative to a perfect vacuum. In other words, if there is steam at 1 lb. per sq. in. gauge pressure in a pipe or boiler, the tendency for outward leakage of steam into the room is 1 lb. per sq. in. With steam at an absolute pressure of $7\frac{1}{2}$ lb. per sq. in., there is a tendency for inward leakage of air to the extent of $14.7 - 7.5 = 7.2$ lb. per sq. in., since the steam in the pipe is this much less than atmospheric pressure.

Volume of Steam

It is sometimes convenient to refer to the pressure of steam in terms of the number of times it is greater than that of the atmosphere. Thus, 14.7 lb. per sq. in. or, say, 15 lb. per sq. in., is one atmosphere, and 30 lb. per sq. in. two atmospheres, and so on. In this connection it will be seen that steam at one atmosphere has a volume of 26.8 cu. ft. per lb., whilst steam at two atmospheres has a volume of 13.7 cu. ft., roughly half that of one atmosphere, and steam at ten atmospheres has, very roughly, one-tenth the volume, i.e., the same weight of steam has been compressed into one-tenth of the volume of steam at one atmosphere. By dividing the volume of steam to be handled, cubic feet per second, by the sectional area of the pipe in square feet, the velocity in feet per second is obtained.

The Latent Heat of Steam

The fifth column of Table 6 gives the latent heat of steam. This is the amount of heat given up when the steam is condensed into water at the temperature of the steam, thus steam at atmospheric pressure

gives up 970 B.T.U. for each pound condensed into water at 212° F.

When steam at a gauge pressure of 135 lb. per sq. in. is condensed into water at the temperature of the steam it gives up only 863 B.T.U. per lb. of water, but the water is at a temperature of 358° F. and not 212° F. If the condensate from the high-pressure steam were discharged into a pipe which was at atmospheric pressure, since the water is above atmospheric boiling-point, some of the water would be re-evaporated into steam, both steam and water taking up a temperature corresponding to the boiling-point of water at atmospheric pressure.

Since one B.T.U. is the amount of heat required to alter the temperature of 1 lb. of water by 1° F., it follows that the amount of heat causing re-evaporation is $358^{\circ} - 212^{\circ} = 146$ B.T.U. per lb. of water, and this corresponds to the latent heat of $146/970 =$ roughly, 0.15 lb. of steam at atmospheric pressure. Thus, 15 per cent. of the water is re-evaporated into steam at 212° F.

The Total Heat

The total heat represents the amount of heat required to produce 1 lb. of steam from water at 32° F. Thus, in the case of steam at atmospheric pressure the difference between the total heat and latent heat, $1,150 - 970 = 180$ B.T.U. per lb., represents the heat required to raise the temperature of 1 lb. of water from 32° to 212° F., i.e., a rise of 180° F.

The last column in Table 6 gives the temperature of dry saturated steam for various pressures or, looked at from another angle, the temperature at which water boils at different pressures.

Wet and Dry Steam

The term dry saturated steam requires explanation. Steam which contains free moisture, i.e., water which has not been evaporated into steam, is known as wet steam and its quality is said to be poor, or less than unity, since it contains less heat per lb. of water than that given in Table 6 according to its pressure. A mixture of steam and water from a boiler which is priming is less valuable weight for weight than dry steam free from moisture.

Similarly, exhaust steam from an engine or boiler feed pump has had so much heat extracted from it that partial condensation has taken place, and it may contain only 90 to 95 per cent. of the heat content of dry steam direct from a non-priming boiler. Such steam has a quality of 0.9 to 0.95 compared with dry steam having unit quality.

Superheated steam contains more heat per lb. than dry saturated steam, and it is produced by reheating the steam after it has left the boiler.

Effects of Passing Steam Through Reducing Valve

Steam also becomes superheated by passing through a pressure-reducing valve, or any throttling device (see Table 6).

If steam at 135 lb. per sq. in. gauge is passed through a restriction so that its pressure is reduced to 15 lb. per sq. in. gauge, since no heat is lost and no work performed there must be the same total heat per pound before and after the pressure is reduced. Thus, if the high-pressure steam were of unit quality, that is, dry saturated, with a heat content of 1,193 B.T.U. per lb., the low-pressure steam will also contain 1,193 B.T.U. per lb. instead of 1,164 B.T.U. per lb. The balance of 29 B.T.U. per lb. is absorbed in superheating the steam, and since the specific heat of steam is roughly half that of water, the amount of superheat is roughly 58°, the temperature of the low-pressure steam being 308° instead of 250° F. Had the low-pressure steam been less than 308° F. it would indicate that the high-pressure steam was poor in quality and contained free moisture. The throttling device is often used for determining the quality of steam and is known as a throttling calorimeter.

CONDENSE DIFFICULTIES IN LOW-PRESSURE GRAVITY STEAM-HEATING SYSTEMS

The troubles commonly encountered in connection with steam systems cannot be avoided unless both the designer and erector have a fair working knowledge of what is happening inside the boiler, pipes and radiators under the varying conditions of pressure and temperature.

Starting System Up for First Time

Let it be supposed that the system is being started up for the first time after having been cleaned out in the manner described. The boiler is filled up to the normal level in the water-gauge glass by means of the filling valve on the cold-water supply connection to the boiler.

When Check Valve is Required on Cold Feed

A check valve is shown in Fig. 9, but this is necessary only where the level of the filling tank is low by comparison with the pressure at which the boiler is operated. For each 1 lb. per sq. in. of boiler steam pressure, the tank must be at least 2½ ft. above the water level in the boiler if fresh water is to be added while steam pressure is maintained. Where the tank is less than this distance above the boiler water line cold water can be admitted only when the steam pressure has been let down, and the check valve indicated is necessary to prevent the steam from forcing the water out of the tank.

Conditions When Fire is Lighted

Having obtained the desired quantity of water in the boiler, the filling valve is closed and the fire lighted. There is water only in the boiler and

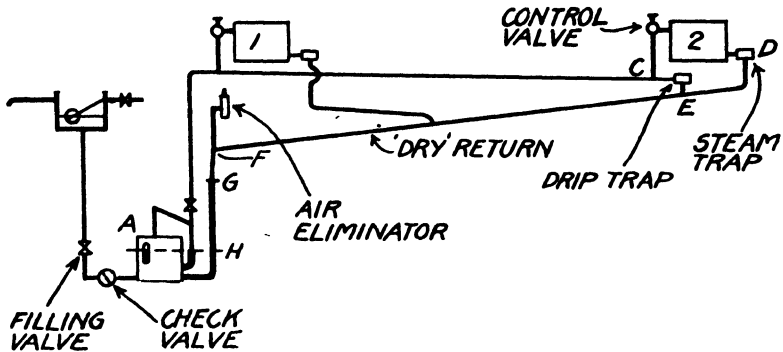

Fig. 9 - SIMPLE ARRANGEMENT OF STEAM BOILER, RADIATORS AND PIPING

in the short vertical section of the condense line up to the water level in the boiler. The radiators and the remainder of the piping are filled with air at atmospheric pressure. This will remain in the system until the generation of steam produces inside the system a pressure in excess of atmosphere in order to cause the air to be expelled through the eliminators indicated.

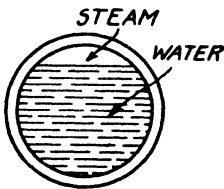

Fig. 10A.—SECTION THROUGH HORIZONTAL PIPE, THE LOWER PART OF WHICH IS FILLED WITH WATER AND THE UPPER PART LEFT OPEN FOR FLOW OF STEAM

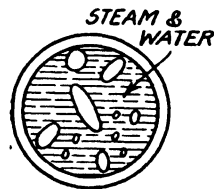

Fig. 10B.—AGITATED MIXTURE OF STEAM AND WATER CAUSED BY VELOCITY OF STEAM IN UPPER PART OF FIG. 10A—THE CAUSE OF CRACKLING

Air Eliminators for Expelling Air in Piping

One kind of automatic air eliminator, of which there are many types, is shown in Fig. 11. It will be seen that the eliminator consists of a small bellows containing volatile fluid, the bellows being fitted inside a float. The valve spindle is attached to the bellows and passes out through the top of the float chamber. The presence of water in the outer chamber causes the float to rise and the air outlet is closed. Similarly, the presence of steam in the outer chamber causes the volatile fluid to boil and a pressure is generated inside the bellows so that it opens concertina fashion

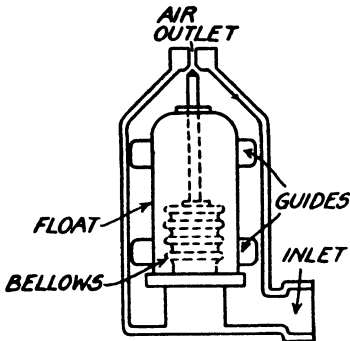

Fig. 11.—AN AUTOMATIC AIR ELIMINATOR

and the air-outlet port is closed. Thus, the valve opens automatically to air but closes when either steam or water is present. There are other types of trap, some having only the float and others only the bellows or diaphragm filled with volatile fluid. The former are used only where steam does not reach the part of the system where the air eliminator is fitted, such as, for instance, the remote end of a condense line some distance from the point into which a return is connected, and the latter on radiators where water is not present. Where there is any doubt as to the presence of steam or water at the point where the air eliminator is to be fitted the type with both bellows and float is used, and it should be realised that whilst the use of this type of eliminator safeguards against the discharge of steam or water from the system, air is not being expelled while the valve is closed, i.e. when either steam or water is present, so the proper clearing of the air from the system depends upon fitting the eliminator or eliminators in such a position that the action is not unduly interrupted by the intervention of steam or water. In Fig. 9, for instance, the return from the radiator near the eliminator on the condense main is taken back some distance so that any steam passing through the trap on the radiator has a chance of becoming condensed before reaching the automatic air valve.

Steam Expelling Air from System

When the water in the boiler reaches 212° and is subsequently vaporised, the steam tends to compress the air in the pipes, causing the air to be expelled from the system, and the water in the condense main to rise slightly.

Drawing Water from Steam Main

Meanwhile steam flows from the boiler through the piping to the radiator, part of the steam being condensed *en route* due to the heat emitted by the piping. It is necessary to provide a means of draining this water from the steam main at any low point at which it would otherwise collect. For this purpose a branch pipe is taken from the lowest part of the steam line, i.e., from point C on Fig. 9, and led through a drip steam trap before joining to the condense main.

Water-hammer and Crackling

Unless provision of this sort were made there would be serious noises from the system, either a crackling noise or a startlingly loud banging

usually described as water-hammer. Since water-hammer and crackling can occur under other conditions than those now considered, it is useful to know just how the noise is created.

WATER-HAMMER.—In Fig. 10A, there is shown the section through a horizontal pipe, the lower part of which is filled with water and the upper part left open for the flow of steam. Such a condition would arise at point C in Fig. 9, were the drip pipe not fitted. As the condensate accumulates the water level in the low end of the pipe rises higher and higher, gradually restricting the passage open for the flow of steam.

Now an interesting point arises at this stage. The quantity of steam flowing is not reduced in proportion to the restriction in the area of the pipe for the flow of steam. As the quantity of steam flowing is reduced, two things happen which tend to adjust the quantity back to the amount passing in the unrestricted pipe: first, with a smaller quantity flowing there is a tendency for the pressure to rise in the boiler, assuming the normal rate of heat input to continue, thus causing an increase in the pressure difference of the two sides of the restriction, and secondly, a reduced supply of steam to the radiator results in a lower pressure in the radiator. Thus, although the restriction may reduce the quantity of steam somewhat it is far from proportional to the reduction in steam space and there is therefore an increase in the velocity of the steam at the throttled point.

Now even a normal steam velocity is very considerably higher than the maximum velocity practicable in an accelerated hot-water system. For instance, the water rarely moves at more than 7 ft. per second, whereas with steam, velocities of up to 100 ft. per second are quite common. Supposing a pound of water were to be picked up by the steam and carried at a velocity of 100 ft. per second, what is likely to be the result? The momentum of a body weighing 1 lb. and moving at a speed of 100 ft. per second, or 6,000 ft. per minute, is 6,000 ft./lb. per minute, and this energy once generated must perform work of some sort, and in this case the energy is communicated to the pipework by impact. Some idea of the force of impact may be conveyed by recalling that one-horse power is 33,000 ft./lb. per minute, so that in the present case the amount of energy transmitted by impact is roughly one-fifth of a horse-power if the period over which hammer occurs is one minute. Since the mechanical equivalent of heat is 772 ft./lb. per B.T.U., it will be realised that a steam-heating system, the smallest of which has a capacity of several thousand B.T.U. per hour, has enormous power for providing the energy required for water-hammer, whilst the other factor, weight of water, is equally accessible, since a 3-ft. length of 1-in. diameter pipe, when filled, holds a pound of water.

CRACKLING.—Crackling occurs in somewhat similar circumstances to water-hammer except that there must be an obstruction to the flow of

condense, and since under these conditions the condense cannot be hurled against the walls of the pipe at considerable force, this is a less serious trouble, but one which, nevertheless, can and has often been the subject of complaint. Crackling occurs where there is a reduced flow of steam, due either to the throttling of a steam valve, or a hold up in the condense line. In circumstances which will be described later, the throttling of the steam supply, such as in the case of a thermostatically controlled calorifier or air-heating battery, does in fact cause a hold up in the condense line and so introduces the conditions favourable for crackling.

Referring again to Fig. 10A, with a throttled steam supply, the velocity in the upper part of the pipe, whilst not sufficiently strong to displace the standing water bodily and so cause hammer, may, when the space has become very restricted, cause turbulence of the water to such an extent as to produce the condition shown in Fig. 10B, that is, an agitated mixture of steam and water. As the steam bubbles impart their heat to the cooler water they condense and tend to leave small vacuum spaces into which the water collapses causing a series of crackling noises.

Reverting to the arrangement shown in Fig. 9, the steam, having been bled of superfluous moisture, passes into the radiators. According to the rate at which steam flows and the size of the radiator through which it passes, the steam is wholly or partly condensed.

Heat Emission of Low-pressure Steam Radiators

For low-pressure steam radiators it is usual to figure on a heat emission of 250 B.T.U. per hour per sq. ft. of radiator surface for rough calculations, and since the amount of heat given up by a pound of steam in condensing into water is, in round figures, 1,000 B.T.U., it may be taken that the whole of the steam is condensed into water when the amount passing through the radiator is one pound per hour for each 4 sq. ft. of radiator surface. These figures apply when once the radiator is hot and the room has reached the temperature the system has been designed to maintain. When steam is at first admitted to a cold radiator the steam is condensed temporarily at a much more rapid rate, and allowance must be made for this irregularity in the condensing power of steam radiators in the design of the system.

Regulating Quantity of Steam Admitted to Radiator, Calorifier or Unit Heater

It will be appreciated that if the control valve on the inlet to a radiator were to be employed to regulate the quantity of steam admitted to the point where the amount provided exactly equalled the condensing capacity of the radiator, not only would extreme nicety of adjustment be required, but the valve would have to be readjusted from time to time

on account of variations in steam pressure and room temperature. Some systems do, in fact, depend upon the accurate adjustment of radiator valves for their satisfactory operation, but it is much more usual and is now almost regarded as standard practice to provide a steam trap to each radiator, calorifier, unit heater, or other piece of apparatus in which steam is condensed, and the omission of steam traps is strongly deprecated.

Thermostatic Traps for Dealing with Condense from Radiators

Thermostatic traps are, by reason of their compactness and cheapness, eminently suitable for dealing with the condense from radiators. Such traps are made in countless types, each slightly different in shape, but all essentially of the same pattern. One such is shown in Fig. 12. As in the case of the automatic air valve, the working part is a bellows or diaphragm filled with a volatile fluid which when heated above a certain point causes the bellows to expand and thrust the valve tightly on the outlet port and so close the line. Traps are intended to allow condensation to pass but to close in the presence of steam. Since steam traps are a most important part of a steam-heating system it is important that their scope and limitations are fully understood.

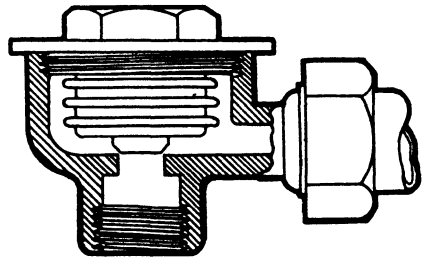

Fig. 12.—A THERMOSTATIC STEAM TRAP FOR DEALING WITH CONDENSE FROM RADIATOR

Principle of Volatile Fluid-operated Steam Trap

A volatile fluid is simply a liquid which has a lower boiling point than water. To cite some of the more well-known volatiles we may mention ether, alcohol, benzole, and the hydrocarbon compounds, having boiling points at atmospheric pressure of from 150° to 210° F.

The curves in Fig. 13 show the essential principle of a volatile fluid-operated steam trap. It will be seen that the lower curve gives the boiling point of water at various pressures, the temperature at which it boils at atmospheric pressure, i.e., 14.7 lb. per sq. in. absolute, or 0 lb. per sq. in. gauge pressure, is 212° F. If water is subjected to a pressure of 5 lb. per sq. in. above atmospheric pressure, that is, roughly, 5 lb. per sq. in. gauge pressure, it does not boil until it reaches a temperature of approximately 227° F. The upper curve shows the performance of a volatile fluid having a boiling point of about 180° at atmospheric pressure and 210° F. at 5 lb. per sq. in. Thus, if the bellows containing this volatile fluid are immersed in boiling water or water vapour, the volatile fluid becomes vaporised and generates an internal pressure greater than the external pressure by approximately 5 lb. per sq. in., and the bellows

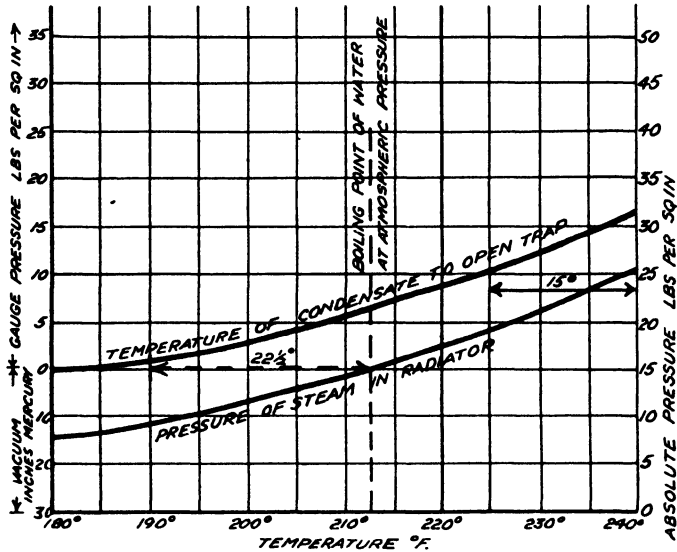

Fig. 13 — CURVES SHOWING PRINCIPLE OF A VOLATILE FLUID-OPERATED STEAM TRAP

will not contract until the water has cooled about 20° below its boiling point.

Example of Operation of Radiator Steam Trap

To take an example, assume that the steam pressure in a radiator is 10 lb. per sq. in. gauge pressure. This is the pressure of the water or steam on the outside of the bellows, and the temperature of the steam or boiling water is 240° F. The volatile fluid, when heated to this temperature, exerts a pressure of 16 lb. per sq. in. and so closes the steam trap. The bellows will not begin to contract and open the trap outlet until the water has cooled to below 225°, i.e., to more than 15° below the boiling point of water at a pressure of 10 lb. per sq. in. gauge, at which point the pressure inside the bellows tends to become less than that of the external pressure.

Thus, the trap holds back the condensate in the radiator until it is some 20° below the boiling point.

Amount of Condense Handled by Thermostatic Traps

The amount of condense a thermostatic trap is capable of handling depends upon the difference in pressure between the inlet and outlet as well as the size of the trap and is roughly proportional to the square of the diameter and the square root of the difference in pressure.

An Important Precaution—Traps of Adequate Capacity

The capacity of steam traps is sometimes given in terms of the number of square feet of radiation the trap is suitable for draining, and sometimes in output, pounds of condensate per hour. In the case of the latter, care should be taken to ascertain if the rating given is the actual capacity with continuous discharge, or if a margin has been allowed for intermittent overloading. There is a very large difference in the condensing capacity of a radiator when first steam is applied and when once the radiator has become hot, the range being roughly from 2.5 lb. per sq. ft. of radiator surface when starting up, down to 0.25 lb. when once the system has been running for a while. It is therefore important that traps of adequate capacity be provided to deal with the initial heating condition where, in addition to an abnormal quantity of condensate to be handled, there is usually available only a slight difference in pressure for ejecting the condensate through the trap.

Where the traps are on the small side the condensate collects in the bottom of the radiator at a much faster rate than the trap can handle, thus the water level in the boiler is lowered until such time as the radiators have become warm and the condensation rate reduced and the steam pressure increased in consequence. Then the water held in the radiators is gradually returned and the water level is built up again at the boiler.

Conditions in the Radiator

It is important to bear in mind the fact that a thermostatic trap does not discriminate between steam and water, but between one temperature and pressure and another temperature and pressure. It is temperature-pressure sensitive and not liquid-vapour sensitive.

TABLE 7.—RELATIVE CAPACITY OF THERMOSTATIC TRAPS—AMOUNT OF CONDENSATE HANDLED AT VARIOUS PRESSURE DIFFERENCES

Size of Trap	Pressure Difference, lb. per sq. in.						
	½	1	2	4	8	16	
	<i>Relative Amount of Condensate Handled</i>						
½ in. ..	1	1.4	2.0	2.8	4.0	5.6	8.0
¾ in. ..	2	2.8	4.0	5.6	8.0	11.2	16.0
1 in. ..	4	5.6	8.0	11.2	16.0	22.4	32.0

This has the result indicated in Fig. 14. Water is held back in the bottom of the radiator until it has cooled about 20° below its boiling point, or in other words, 20° below the temperature of the steam in the radiator.

The quantity of water in the radiator varies somewhat with the size and type of diaphragm and the properties of the volatile fluid with which it is charged. Since the water in the radiator is in contact with the steam, 2 in. or 3 in. of water may collect before the water is cooled to the extent necessary to be passed by the trap. The hotter water lies on the surface and insulates to some extent the water below.

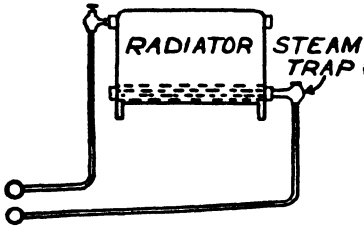

Fig. 14.—CONDITIONS WITH STEAM TRAP CONNECTED AT RADIATOR

An appreciable amount of water collects.

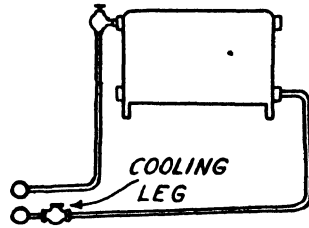

Fig. 15.—A SUPERIOR METHOD OF CONNECTION

Here the amount of water collecting is negligible.

Where to Put Radiator Steam Traps

Heating engineers have recently become aware of the advantages of fitting the trap a few feet from the radiator outlet in order to reduce the quantity of water lying in the bottom of the radiator or unit heater.

Allowing the heat emitted by a $\frac{1}{2}$ -in. condense pipe to be 100 B.T.U. per hour per ft. run when handling condense immediately after leaving a radiator, and allowing that the amount of condense from a 40-sq. ft. radiator (this being quite an average size), to be 10 lb. per hour, it will be seen that only 2 ft. of pipe are required between the radiator and the trap to cool the water 20° F. The method of connection shown in Fig. 15 is therefore considerably superior to that indicated in Fig. 14, as the quantity of water lying in the radiator provided with the cooling leg is almost negligible.

Level of Water at Boiler

The objection to having an accumulation of water in the bottom of radiators is chiefly that it introduces variations in the water level at the boiler, since this idle water gravitates back into the boiler when the fire is let out, and is again lost from the boiler for as long as steam pressure is maintained. Another cause of irregularity in the water level is the accumulation of condensation in pipes which are empty when the system is not under pressure.

For instance, the water level in the vertical condense line in Fig. 9 will be at H when the system is not in use, and will rise to G when pressure is

generated in the boiler, the distance between H and G being roughly $2\frac{1}{2}$ ft. for each pound of gauge pressure in the boiler. The "dry" return is dry only when the system is cold; when the apparatus is in use the pipe will be partly filled with condensate, much or little, depending upon the slope of the pipe and its diameter.

Thus, it will be appreciated that there are several factors all tending to cause the water level in the boiler to be lowered when the system is started up from cold, a good deal of the water being regained once the radiators have become hot, but the remainder held back in the pipes until the system has been allowed to become cold.

Where the steam boiler selected has a large water capacity and the system is well designed, the water stands at the top of the water gauge glass when the system is cold, and near the bottom when the system is in use.

Pressure of System

The pressure at which the system is worked depends upon the height of the air eliminator above the water level in the system. On no account may the boiler be run at a pressure which is so high that the water level in the condense rises to the air eliminator, for this would keep the valve closed and prevent air from being ejected.

Where Air Eliminator is Fitted

The distance between F, the point at which the automatic air valve is fitted, and G, the level at which the condense stands in the system, should be about 2 ft. to allow a little latitude in the boiler pressure, and even with this margin it is essential that the boiler be fitted with sensitive automatic damper regulator which should operate on the check-draught door in the smoke outlet, as well as on the air inlet flap on the ashpit door.

Level of Condense

If after allowing ample slope on the steam and condense mains the point at which the air eliminator is fixed is 6 ft. above the boiler water level, point G, the level of the condense in the return leg, should be not more than 4 ft. above the boiler water line, so the permissible pressure on the boiler is $4/2.5 = 1.6$ lb. per sq. in. gauge, one pound of which could be used in overcoming the resistance of the piping to the flow of steam from the boiler to the radiators and the remainder, 0.6 lb. per sq. in., in forcing the condensate through the steam trap.

Sizing of Trap

The trap should be sized, however, on a differential of not more than a $\frac{1}{4}$ lb. in order to deal with the starting up condition when excessive condensation will take place at a low boiler pressure.

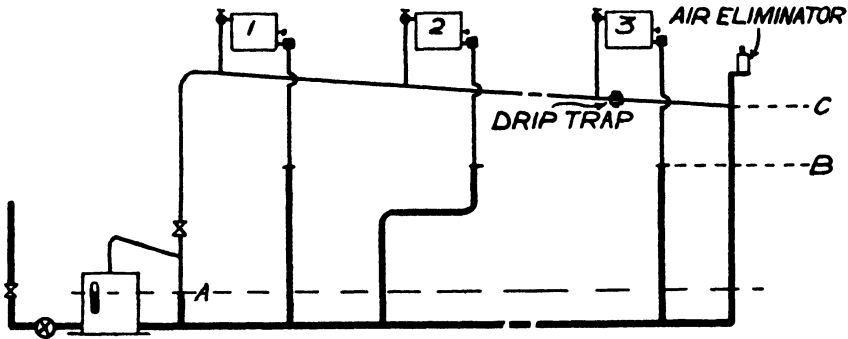

Fig. 16.—WET RETURN STEAM HEATING SYSTEM
Heavy lines indicate pipes filled with water.

Wet Return System

A wet return system such as that shown in Fig. 16 is sometimes advocated as a means of maintaining a more steady water line in the boiler, but it is very doubtful if the gain in this direction is sufficient to offset disadvantages which arise in clearing the system of air.

WHERE THE WET RETURN SHOULD BE PLACED.—A wet return is a condense line run below the water level in the boiler and is therefore filled with condensate whether the boiler is alight or not. With a system where there is a long horizontal run of condense piping and the vertical returns are relatively few, there is a smaller variation in the boiler water line by having the wet return.

A horizontal condense pipe at an intermediate level between that at which the water stands when the system is in use and the lower level when the apparatus is out of commission is to be avoided. Such a pipe is shown on the return from radiator No. 2 in Fig. 16. This horizontal pipe becomes empty when the system is cold and refills when normal working pressure is maintained at the boiler.

AUTOMATIC AIR VALVE AT EACH RADIATOR.—It will be seen that an automatic air valve is provided for each radiator in the case of the wet return system as well as the eliminator at the remote end of the steam main, whilst with the dry return system there is only the one eliminator, this being fitted on the condense main where it is coolest.

Thermostatic steam traps will allow air to pass as well as water, provided the temperature of the air is sufficiently below the steam temperature. Thus the traps in Fig. 9 are virtually air-eliminators so far as the radiators are concerned, inasmuch as the air passes out into the condense line from which it ultimately escapes to atmosphere.

In the case of the wet return system, air which is passed out of the traps does not readily escape via the condense line and does, in fact, introduce difficulties for it tends to bind the system.

AIR-ELIMINATION PROBLEMS.—When the boiler is allowed to go out, the radiators, steam mains and dry condense lines ultimately become filled with air at atmospheric pressure. This is because it is practically impossible to make a joint which is perfectly airtight. When steam is condensed in a closed vessel from which the air has previously been exhausted, a cessation of the steam supply causes a partial vacuum to be produced and if the vessel were completely airtight the vacuum would be maintained; but in a system in which there are a number of joints it is exceedingly difficult to maintain a pressure lower than one-half to one-third of atmospheric pressure even when a powerful vacuum pump is kept running to deal with the inward leakage of air. Thus, all steam spaces in heating systems become completely filled with air at atmospheric pressure shortly after the fire is allowed to go out, so that the problem of getting rid of the air in the system arises every time the apparatus is put into commission.

It is hardly necessary to state that radiators will not become hot until the air has been expelled in order to allow the space to be filled with steam, and that therefore the time required to get the radiators satisfactorily hot depends upon the rapid release of air from the system.

TYPE OF AUTOMATIC AIR VALVES REQUIRED AT RADIATORS.—In the case of the wet return system, therefore, it is important that each radiator be provided with a dependable type of automatic air valve. Although normally the water level is well below the radiators it is wise to use an eliminator which has a float as well as a thermostatic bellows lest at any time the boiler pressure is accidentally allowed to cause the water level in the system to rise to the point where it reaches the automatic air valves. This can happen if the damper regulator develops a defect in mild weather.

Corrosion Possibilities

Another claim sometimes made in favour of the wet return system is that the condense line is less susceptible to corrosion. On the theoretical grounds that a pipe always completely filled with water is less likely to be attacked than one containing both air and water and is sometimes wet and sometimes dry, the claim appears feasible, but in fact recent investigations show that the wet return is in most cases no less readily affected by corrosion.

Since air passes out through the thermostatic traps but cannot as a gas negotiate the vertical pipe which acts as a seal, the vertical condense piping above the working water level tends to become filled with air, allowing the possibility of dissolved oxygen to be introduced into the condense line. The fact that wet returns are as susceptible to corrosion as dry returns is fairly convincing evidence that this does actually occur.

Safeguarding Against Corrosion Troubles

The corrosion of piping is far too extensive a subject for more than a brief reference, but it is important to understand roughly what happens so that reasonable steps may be taken to safeguard against trouble from this source.

Condense water is notoriously associated with corrosion and difficulty in understanding why this should be so is often expressed and reference made to the fact that condensate is virtually distilled water, containing a minimum of impurities.

Actually, water which has been boiled is much more likely to be associated with corrosion than crude water, for very definite reasons.

Corrosion takes place most rapidly with water containing an unsatisfied acid, less rapidly with distilled water, and least rapidly of all with hard water containing lime, an alkali which satisfies acids, and the most common cause of scale in boilers and pipes. There are, of course, many other alkalies which tend to satisfy acids and therefore reduce the tendency for water to act as a medium in corrosion. One of the acids most commonly associated with corrosion is carbon dioxide or CO_2 . Incidentally, this can be removed from water by lime treatment, the CO_2 being thrown down as carbonate of lime.

Corrosive Agents in the Water—Carbon Dioxide and Oxygen

In the process of corrosion the metal dissolves and hydrogen is produced. Now if the hydrogen film is allowed to adhere to the surface of the metal it tends to insulate the metal against further corrosion. Oxygen, however, combines with hydrogen to form H_2O , or water. Thus, the presence of oxygen breaks down the protective film of hydrogen and therefore is a factor which stimulates corrosion. The presence of oxygen is, in fact, far more serious in its effect on corrosion than is CO_2 . Indeed, it has been stated that a given quantity of oxygen is as harmful as thirty times the amount of CO_2 .

CO_2 is very often present in condense lines for it leaves the boiler as a gas mixed with the steam, but where really serious corrosion is encountered in condense lines it is usually found that there is also oxygen in the water; in fact corrosion is very mild as a rule where oxygen is excluded. The use of a vacuum pump on a steam system is sometimes said to be responsible for rapid corrosion of the condense piping due to the continual inward leakage of air into the pipe lines.

Materials for Use as Condense Pipe Lines

Different metals have differing tendencies to go into solution, that is, become destroyed by corrosion, in a given set of conditions as to acidity or alkalinity of the water and oxygen content. Galvanised piping, i.e., zinc-coated piping, whilst suitable for a number of applications, is not proof against condense water and plain ungalvanised pipes

are rather better, though still very susceptible to corrosion. Puddled wrought-iron piping is often mentioned as suitable for use with condense water, but according to the authorities on corrosion it is only minutely superior to steel piping in the case of underwater corrosion but puts up more resistance to external corrosion such as when buried in earth. In this connection, on no account should pipes be buried in earth without the protection of an impregnated coating, preferably applied by specialists in this class of work.

The only kind of pipe that can be expected to put up a prolonged resistance to the corrosive qualities of condense water is copper, and even this often wastes away so rapidly that the tubes of calorifiers have to be replaced in less than ten years in certain cases where there are exceptionally powerful corrosive agents, CO_2 and oxygen, at work.

Requirements of Dry Condense Line System

Reverting to the question of dry and wet condense lines it may be taken that in general the dry return system is preferable and that complete freedom from water-hammer and a reasonably restrained variation in boiler water level can be maintained if the following points are strictly observed :—

- (1) Sensitive damper regulator on boiler set for safe pressure, having regard to level of air eliminator.
- (2) Low outlet steam velocity from boiler and drain branch for dealing with free moisture carried over with the steam.
- (3) Adequate pitch to all steam and condense pipes.
- (4) Trapped drip at each low point in steam main.
- (5) Traps of adequate capacity on all radiators.
- (6) Automatic air eliminators of float and thermostatic type at all points from which air must be released, and the positioning of the main air eliminator so that interruption in operation due to the presence of steam is reduced to a minimum.
- (7) Sizes of pipes, steam and condense, based on the amount of steam pressure available and height of condense leg.

Connections of Main Eliminator

A further word with regard to the main eliminator ; this should be connected to the end of the condense main by means of a vertical pipe about 12 in. to 18 in. long and of the same diameter as the condense main except for the short horizontal connection to the eliminator casing.

The object of fitting the eliminator somewhat above the level of the condense main is to provide a safety margin for the starting up of the system when the condensation rate is momentarily so heavy that the resistance to the flow of this excessive quantity may cause the water level in the condense line to rise considerably above normal at the time when it is desirable to allow the air to escape without hindrance. Under

these conditions large quantities of air and water are simultaneously discharged through the radiator traps and it is important to safeguard against the air eliminator closing to the escape of air at this critical stage due to the presence of water.

RETURNING CONDENSE FROM LOW LEVEL RADIATORS AND CALORIFIERS

It has already been pointed out that returning condensate to a steam boiler by gravity depends upon the vertical distance between the boiler water line and the lowest radiator on the system, and also upon the boiler pressure.

In Fig. 17 a radiator is shown at approximately the same level as the boiler and it will be seen that any attempt to return the condensate from this radiator by gravity in the normal manner would result in the radiator becoming completely filled with water. This is due to the

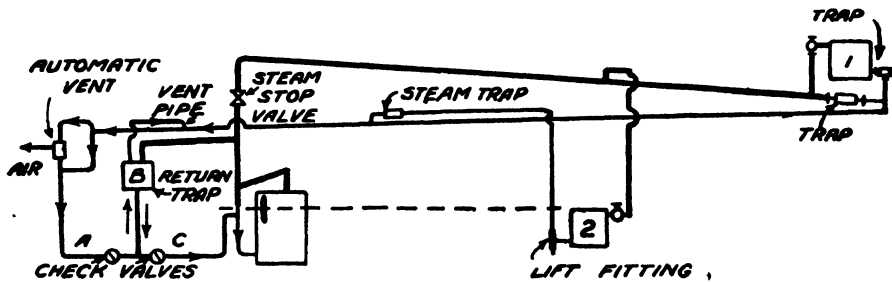

Fig. 17.—SYSTEM WITH RADIATOR ON SAME LEVEL AS BOILER

fact that the pressure in the boiler is exerted downwards on the water and is thus communicated to the condensate line. For this reason the condensate piping from low-lying radiators or calorifiers must be isolated from the boiler.

Operation of Return Trap

A piece of mechanism, sometimes called a return trap and sometimes a super-lifting trap, is often used for this purpose. Although somewhat complicated in construction, return traps are simple in principle, and consist mainly of two valves both operated by a float, one valve being open when the other is closed. Each valve is fitted with a weight so that the action is rapid once the float reaches the tripping position and both valves are open simultaneously for an infinitesimal period. One valve controls the steam supply to the trap and the other the vent from the trap. While the vent valve is open, water flows into the trap until

sufficient has accumulated to raise the float to the level at which it operates the valves. The vent valve is then rapidly closed and the steam valve rapidly opened. Steam pressure plus the head of water due to the position of the trap above the boiler water line causes the condensate to be forced into the boiler.

With the vent valve open, the return trap is virtually an open tank into which the condensate is free to flow without any retarding influence due to back pressure from the boiler.

Path Taken by Condense

The path taken by the condense is as follows : from the radiators it flows along a well-pitched return line to the automatic vent indicated, the pipe branching two ways at this point, to the top of the vent fitting for the clearing of air, and to the bottom connection of the vent fitting for the flow of condensate which then passes from A up the vertical pipe into the return trap B, until there is sufficient to operate the float and mechanism. Then condensate ceases to flow into the return trap, which is now under pressure, due to the opening of the steam valve and the closing of the vent. The condense is now forced down the vertical pipe from B to C and so into the boiler. A check valve is fitted to prevent the condensate being forced back to A and thence back along the return line. A second check valve is shown at C to prevent the boiler back pressure from retarding the flow of condensate into the return trap at times when the steam valve is closed and the vent open. These two check valves are not open simultaneously but operate in step with the float-operated valves, check valve A being open with the vent and C with the steam valve. The proper working of the system depends upon the satisfactory performance of these two check valves, so every care must be observed in their installation, and unions or flanges should be provided to facilitate their removal for cleaning or repairs.

The steam connection to the return trap must obviously be at full boiler pressure, so should be taken off the main close to the boiler, and on no account should the steam stop cock be fitted on the main between the boiler and this branch. This can be seen from Fig. 15, in which the steam piping is indicated by a heavy line.

The vent from the return trap or super-lifting trap is taken into the top of the condense line, so that the vapour is both free to leave the trap after it has discharged and does not retard the flow of condense in the return main.

Automatic Vents for Return Traps

Automatic vents for use in conjunction with return traps usually have only a float and in this respect differ from the more normal automatic vent which usually has a volatile fluid-filled diaphragm to prevent the escape of vapour. With a return trap, however, a certain amount

of vapour or low-pressure steam is unavoidable immediately after the trap has discharged, and it is necessary to clear this from the system as rapidly as possible, for otherwise it would hold back the flow of condensate. The quantity of vapour can be reduced, however, by running the vent back a few feet, as shown, before connecting to the top of the return main. In spite of this it is advisable to run the discharge from the automatic vent to a point where puffs of vapour are not likely to be objectionable.

The vertical distance between the boiler water level and the bottom of the return trap is of considerable importance. The greater this distance the more rapidly does the trap discharge the condensate into the boiler, so the intervals between each operation are reduced. Thus a return trap of a given size will handle a greater amount of condensate hourly by increasing this distance. Since the condensate handling capacity of the trap is associated with its distance above the water line, manufacturers usually state the level at which it should be fitted, having regard to the amount of condensate it has to handle.

It is also important to have the automatic vent fitted several inches above the return trap to enable it to act as a receiver during the second or so the return trap is discharging, when clearly it is unable to accommodate fresh condensate.

The main return should also be so sized and graded that it does not normally run full bore and is thus free to store condensate when the operation of the return trap causes check valve A to close momentarily and tends therefore to hold up condensate in the radiators and return piping.

Path of Condensate from Low-level Radiators

The condensate from radiator No. 2 is shown rising vertically to above the return main into which it subsequently discharges after passing through a trap fitted at high level. Although a "wet" or low-level return could have been run from this radiator to point A, this would not be as satisfactory as the arrangement shown. In the first place, a greater length of piping would be required, and in the second, a difficulty would arise in connection with venting the radiator. The air would have to rise against the descending condensate if the automatic vent shown were the only means of venting the system. It is unlikely that air would be removed satisfactorily under these conditions and with a wet return from radiator No. 2, it is probable that a second automatic vent would become necessary.

There are advantages attached to fitting the steam trap at the top of the vertical lift from radiator No. 2 instead of at the radiator itself.

Return Traps and Steam Traps

Since the terms return trap and steam trap both occur in this chapter, to prevent confusion it may be stated that a return trap has a steam

inlet connection as well as a condense inlet and outlet connection, whereas a steam trap has only a condense inlet and outlet and in the case of a thermostatic steam trap, it closes when steam or water at boiling point enters.

If the steam trap were fitted at the bottom of the vertical jump, there is less pressure available for raising the condense to high level.

This follows from the fact that a radiator steam trap, which is usually of thermostatic type, closes in the presence of steam, whilst steam is necessary to force the condense up the vertical pipe. Thus, with the trap at the top of the lift, steam is not intercepted until it has done the work of elevating the condense to the level required.

Steam Pressure Required to Lift Condense

The steam pressure required to lift condense is usually taken to be 1 lb. per sq. in. for every 2 ft., this allowing a slight margin to the resistance to the flow of condensate in the piping. If, in the case of radiator No. 2 in Fig. 15, the condense has to be elevated 10 ft., the steam pressure required at the bottom of the vertical rise is 5 lb. per sq. in. With a lower steam pressure the radiator tends to become waterlogged and the water level falls. Where there are many radiators at low level this is a serious matter, for if the water is allowed to reach a very low level in the boiler there is the possibility of it being damaged beyond repair. A low-water alarm is a necessity in such a case, no matter if the system is relatively a small one.

Lift Fittings

Lift fittings of the sort shown in Fig. 18 are useful in this connection, in so far as they allow water to be elevated with less pressure than $\frac{1}{2}$ lb. per ft. of vertical lift. Unfortunately, however, there are not available dependable figures for the performance of these fittings, not even, so far as the writer is aware, in American or Continental publications in which steam problems are more general than in this country. The writer is of opinion that by using these fittings condense can be elevated quite 3 ft. for each pound of steam pressure available, and under favourable conditions appreciably more than 3 ft. The principle involved is simply that the condense is caused to rise, not as a solid rod of water, but in short pistons interspaced with steam. Thus, the back pressure exerted is considerably less than that of a solid column of water and the steam pressure required correspondingly less.

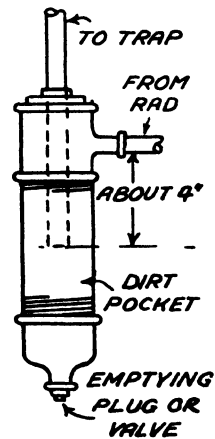

Fig. 18.—A USEFUL CONDENSE LIFT FITTING

Favourable Conditions for Elevating Condense

The most favourable conditions for elevating condense with a lift fitting and a minimum steam pressure are an insulated vertical pipe (in order to prevent the steam from condensing and thereby reducing the multi-piston effect), in conjunction with a bare horizontal pipe between the top of the lift and the steam trap (in order to condense the steam and cool the water to the required degree before reaching the trap, so that it remains open and allows a continuous flow to be maintained).

Length of Horizontal Uninsulated Pipe Required

The amount of horizontal uninsulated pipe required may be calculated sufficiently accurately by allowing a heat emission of, say, 100 B.T.U. per hour per ft. run and by figuring to cool the water by 25° F., this including an allowance for condensing the steam. Actually, the amount of heat to be removed from the latter source is quite a small fraction of the whole, due to the fact that the density of steam is so low. If, for instance, we take the case of equal volumes of steam and water in the vertical pipes, the water weighs about 62 lb. per cu. ft., whereas the steam weighs only 1 lb. for 25 cu. ft. at slightly above atmospheric pressure. Thus, water weighs about 1,500 times as much as the same volume of steam, and although the amount of heat to be abstracted from 1 lb. of steam to condense it into water is about 1,000 B.T.U., for equal volumes it amounts to only less than one B.T.U. per lb. of water, or, in other words, to cooling the water by an additional 1°.

For a radiator of 60 sq. ft. of heating surface, from which the condense is normally about 15 lb. per hour, the amount of heat to be removed before reaching the trap is $15 \times 25 = 375$ B.T.U. per hour, requiring roughly 4 ft. of pipe.

With a lift of 10 ft., even if insulated with non-conducting composition of 80 per cent. efficiency, the heat loss would be 200 B.T.U. per hour, which would cause a good deal of the steam to disperse as condensate, although not all of this amount of heat is abstracted from the steam, for part is taken from the water.

Construction of Lifting Fitting

A lifting fitting comprises a bushing at the top screwed into a tee-piece with a long nipple forming the body and a cap the bottom. The tail of the vertical pipe is taken down through the bushing to a point about 4 in. below the branch inlet from the radiator. Instead of having a cap on the bottom, it is a good plan to substitute a reducing socket with a plug so that the lower part of the fitting serves as a dirt pocket. The plug also enables the low point to be drained of water at any time when the system may be out of commission in severe weather and liable to become frozen.

Steam Pressure Must be Maintained for Satisfactory Operation

Any system having low-lying radiators from which there are condense lifts, has the disadvantage of requiring a certain minimum pressure for satisfactory operation, this pressure depending upon the magnitude of the lift. Thus, the steam pressure cannot be regulated to suit the weather, nor should the apparatus be left unattended at night even though there is no pumping apparatus which is likely to give trouble.

Maintenance of Return Traps

Return traps are usually fairly dependable, but there are working parts which are subject to wear and sometimes to corrosion, so that a breakdown is quite inevitable and is simply a matter of time unless the apparatus is regularly opened for inspection and overhaul.

Even under these conditions it is not advisable to leave a steam system for any length of time unattended where there are low-lying radiators which could cause a dangerously low water level in the boiler if the steam pressure fell off for any reason.

Boiler Feed Pumps for High-Pressure Systems

Although return traps are made suitable for high-pressure as well as low-pressure work, they are more commonly used for the latter, whilst boiler feed pumps are in general use for work with high-pressure steam.

Fig. 19 illustrates the application of boiler feed pumps. The condensate flows by gravity (in many cases with the assistance of steam pressure) into an open tank, usually termed a hot well, from which it is pumped into the boiler or boilers. A calorifier is shown in this illustration, but the principle is precisely the same where the steam-using appliances are radiators, steam jacketed boiling pans, such as are used for cooking vegetables, or making jam, or steam jackets attached to presses, or coils or pads in process work or in hot closets, in fact, any piece of apparatus in which steam is condensed and the condensate returned to the boiler.

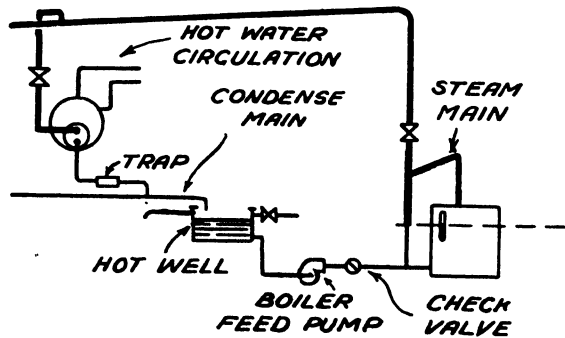

Fig. 19.—APPLICATION OF BOILER FEED PUMP FOR STEAM SYSTEM

Position of Hot Well Tank

The hot well tank is shown fitted at a higher level than the pump. This is an important point. When pumps are handling hot water it is desirable to have as much head of water as possible on the inlet side.

The suction effect of the pump causes the boiling point of the water to be lowered, and it can well be imagined that a pump has greater difficulty in handling a mixture of steam and water than water alone. On the other hand, the boiling point of the water is increased by raising the level of the tank. Where the water is at 160° F. and there is only a foot or two of suction piping between the hot well and the pump, it will suffice if the bottom of the tank is 18 in. above the top of the pump, but where the water is 180° , this distance should be increased to 4 ft. and where 190° to 7 ft. or 8 ft., whilst the hot well should be raised a further foot for each 12 in. W.G. resistance where there is an appreciable horizontal distance between the tank and the pump.

Objectionable Noise

The arrangement shown in Fig. 20, whilst quite common, is one which is bound to give rise to complaint where noise is at all objectionable. It will be seen that there is a vertical lift, H , in the condense line whilst the calorifier is fitted with a thermostatic valve which is normal practice. Now in order to discharge condense from the calorifier through the trap and so into the condense main, it is necessary to have in the calorifier a steam pressure slightly in excess of that obtaining in the condense line at the point of junction. This will depend upon the head, H , and the resistance of the condense piping from A to B (see Fig. 20).

But with thermostatic control of the steam supply to the calorifier (or other apparatus; the principle holds), the supply of steam is regulated according to the temperature at the point where the thermostat is fixed.

Thus, if the calorifier were providing hot water for a heating system on a mild day, a pressure of only, say, 1 lb. per sq. in. may be all that is necessary in the calorifier to maintain the desired temperature, whereas in severe weather 20 lb. or 30 lb. per sq. in. may be required. In the latter case there would clearly be no difficulty in getting rid of the condensate, but with only 1 lb. pressure in the calorifier, it would become waterlogged and there would be noise as well as a shortage

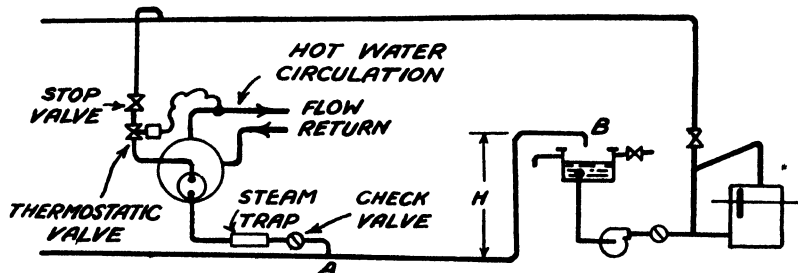

Fig. 20.—ARRANGEMENT WHICH MAY GIVE RISE TO OBJECTIONABLE NOISE

of water in the hot well and possibly in the boiler by the amount withheld from circulation.

The same thing could happen with a domestic hot water calorifier where thermostatically controlled, as is usually the case, or with any thermostatically controlled, condensing apparatus. And since all such steam-heated apparatus is almost invariably so controlled, for obvious reasons, this problem is encountered almost daily.

Use of Snap Acting Thermostatic Valve

One method of overcoming the difficulty is to use a snap acting thermostatic valve, i.e., one which is either open or closed and which does not take up an intermediate position, the thermostat being fitted in the return and not in the flow. The time lag introduced causes steam to be wholly on or entirely off and so obviates waterlogging.

It may be thought that the check valve shown is itself sufficient safeguard against waterlogging inasmuch as it prevents water from backing up into the calorifier, but it must be borne in mind that even if the check valve is tightly closed when the pressure in the calorifier is low, there is still the fresh condensation which is accumulating to con-

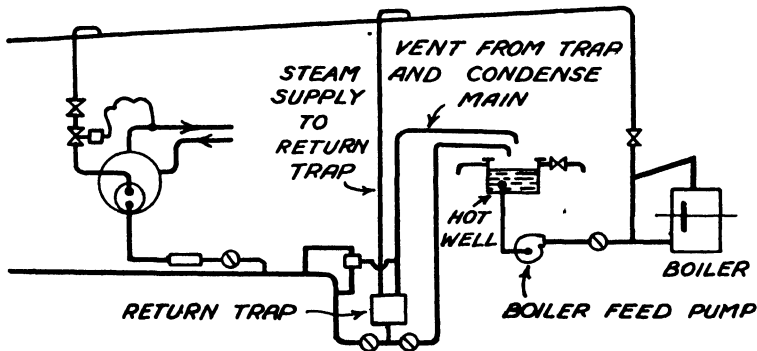

Fig. 21.—ARRANGEMENT IN WHICH A RETURN TRAP IS USED TO ELEVATE WATER FROM LOW POINT INTO WHICH CONDENSATE CAN FLOW BY GRAVITY AND THENCE INTO HOT WELL

sider. This will remain in the calorifier until such time as the thermostat calls for a sufficiently high pressure to clear the condensate, if and when it does, in fact, do so on certain days or during mild months, or in other contingencies, according to the purpose of the calorifier.

In cases where there is no secondary circulation from the calorifier and no other means of obtaining intermittent on and off conditions as produced by the time lag and snap acting valve, it may be necessary to adopt the arrangement shown in Fig. 21, in which a return trap is used to elevate the water from a low point into which the condensate can flow by gravity regardless of how low the pressure may be in the calorifiers, and thence into the hot well.

Chapter IX

ELECTRIC WARMING APPLIANCES AND INDIRECT ELECTRICAL HEATING SYSTEMS

THE only term, in addition to those given in the sections on "Heating and Ventilation," with which it is necessary to be familiar in connection with electric heating, is the term "load." The term is used to denote in electrical measure the quantity of heat available for a room or building, and is, for this purpose, equivalent to a boiler rating in B.T.U. The load is measured in kilowatts, or 1,000 watts, and is the product of amperes and volts.

The standard method of calculating the quantity of heat required by rooms has been explained in detail in Chapter III of this Volume; the same method is used for estimating the electrical load required. Each coefficient given can be converted to electrical measure and load calculated direct, but the more usual procedure is to work in B.T.U. and then convert to kilowatts by dividing by 3,410, this being the heat equivalent of 1 kilowatt hour, or a load of 1 kilowatt in use for 1 hour.

This method of calculating load applies primarily to buildings which are warmed continuously: the load so calculated takes place when a steady internal temperature has been reached. It is to be remembered, however, that when dealing with electric heating systems the ease with which an installation may be switched on and off almost invariably leads to intermittent use—heating by day only. With a normal load, as calculated for steady-state losses, long pre-warming periods are likely on cold days. If this annoyance is to be avoided and reasonably short pre-heating periods obtained, the load calculated for steady-state losses must be increased by about 25 per cent.

Electric Fires

The use of electric fires, while very extensive, cannot be described as central heating any more than the ordinary open coal fire, and is not therefore subject to the same method of load calculation.

Under this heading comes a wide range of electric fires of every conceivable design, from the portable types to the fixed-tile type. We have not space to describe all types, if indeed any description is needed, as they can be seen in any electricity showrooms, but some remarks upon the two distinctive designs will perhaps be helpful.

The distinction between designs of electric fires is that one class is provided with a polished metal reflector, and the other with ordinary panel, fire-clay type element. The heating elements of electric fires consist

either of a nickel-chromium spiral wound upon a threaded rod, as in most reflector fires, and fitted at the focal centre of a parabolic reflector or carried in grooves to form a panel, or of a solid rod, similarly mounted. The purpose of the polished reflectors is to direct the heat emitted as radiation in one direction, and their use results in a concentration of heat in one intense beam. Such fires—which are most fashionable to-day, and while they may be preferred, and have definite advantages in large rooms—are not best suited for warming small rooms. The concentrated radiation renders the space in front of the fire rather too hot for continual occupation. The ordinary luminous radiator of the same loading will emit exactly the same quantity of heat as the reflector type, but the radiation is spread over a larger area with less intensity, and will therefore be more effective in thoroughly warming a room and not merely providing hot spots.

Installation of Electric Fires

When electric fires are used as the only heat source in a room, care should be taken to see that there is not an open flue immediately above the fire, for—no matter whether the fire installed is of the reflector or the panel type—there is heat emission by convection, and much of this heat will pass directly into the flue and be lost. While some form of ventilation other than windows is very necessary in all rooms, the average chimney is more than sufficient. To obtain the best and most efficient results from an electric fire, the flue should be partly blocked, and the air entry lowered to below the level of the top of the fire.

Slot-meter Fires

There is one type of electric fire which is of special interest, as it is frequently used in hotels and boarding houses. This fire is fitted with a shilling-in-the-slot meter, and is eminently suited to situations where rooms are not in constant occupation.

Loadings Required for Fires

The usual practice in estimating the loading required for rooms, when luminous radiators are used, is to allow from 1.00 to 1.50 watt per cu. ft. of space. For bedrooms the lower value gives satisfactory results, while for a lounge or dining-room, where quick heating is required, the higher loadings are better.

Low-temperature Installations

The low-temperature installation is the electrical counterpart of the central hot-water system, and should be treated as such. For this type of installation there are on the market tubular heaters, convectors, panel heaters and thermal-storage plant. Each of these and its particular characteristics is considered below.

TUBULAR HEATERS

This type of heater, which consists of a 2-in. round metal tube, or sometimes an oval tube, carrying an element internally, is a very useful type of heater for direct electric heating of buildings. It is designed to fix horizontally at the base of walls by either floor- or wall-fixing brackets. The element consists of a low-temperature—"black heat"—spiral mounted on mica or porcelain supports, and the loading is such as to result in a tube-surface temperature of approximately 190° F. within about 10 minutes of switching on; thus the temperature is slightly above that of a freely supplied hot-water radiator.

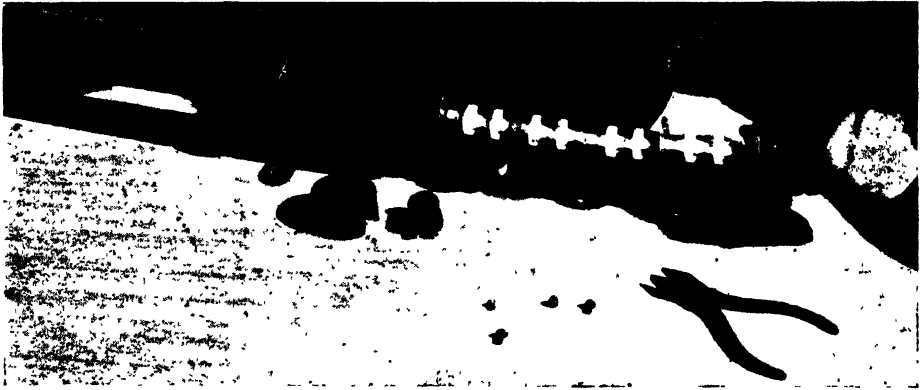

Fig. 1.—AN ELECTRIC TUBULAR HEATER

It consists of a 2-in. metal tube within which a low-temperature "black-heat" element is carried. Note the spiral element is mounted on mica and porcelain supports. The working tube-surface temperature is slightly above that of a hot-water radiator.

Loadings

When used for ordinary situations the surface temperature is of course proportional to the loading per foot length, which is standardised at 60 watts per ft. The low surface temperature of tubular heaters gives rise to very low-velocity convection currents, thus there are very small temperature differences between floor and ceiling levels in a room, and an even temperature distribution throughout the heated space.

Where tubes with other than standard loadings are used, as in tubes fixed overhead, the approximate surface temperatures are as follows :—

<i>Watts per Ft. Run</i>						<i>Approximate Surface Temperature for 2-in. Painted Steel Tube</i>
20	75° F.
40	140° F.
60	190° F.
80	260° F.
100	300° F.

Lengths Available

Tubular heaters are available in all lengths from 2 to 17 ft., or from 120 watts to 1,020 watts in single lengths. It is generally not possible to install the required load with only one row of tubes. Tubes in banks must therefore be used, and these are available in up to four tiers. When tubes are used in tiers there is a small increase in surface temperature. Tiers are made up by mounting tubes horizontally above each other with a common terminal box, so that only one electrical connection is required. The conduit entry is on the under side, thus permitting a very neat finish by bringing cables up through the floor straight into the terminal box.

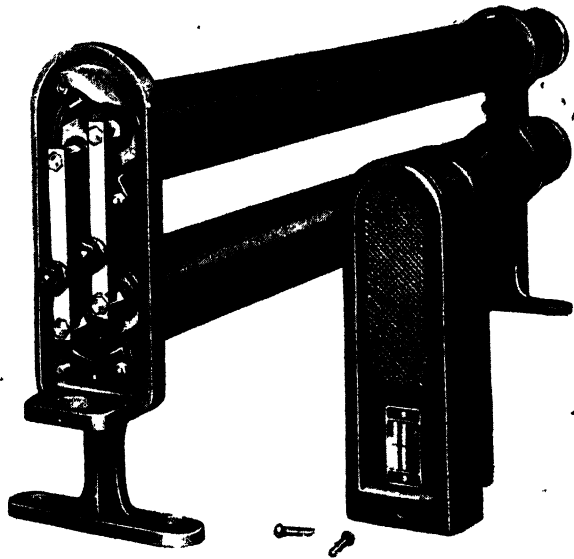

Fig. 2.—TWO-TIER TUBULAR HEATER
Showing the terminal box. Note the hole at the base of the box to allow entry of the electric cables. (*General Electric Co.*)

Decoration

The relatively low surface temperature of tubular heaters permits decorative finish to be applied, in order that the tubes may harmonise with the surroundings. The only surface treatment to be avoided is metallic paint. This surface finish causes excess surface temperatures due to interference with the free emission of heat by radiation. On the same score, the standard loading should be reduced to about 40 watts per ft., if the usual surface temperature of about 190° F. is not to be exceeded with nickel- or chromium-plated tubes. While on the subject of decorations it might be mentioned that with tubular heaters there is little or no risk of "dusting." The large, massed surface of a hot-water radiator often gives rise to black marks upon a wall. This marking is known as dusting.

Supplementary Heating

As a supplementary source of heat, tubular heaters are extremely useful in long rooms heated by open fires. A short length of tube fitted

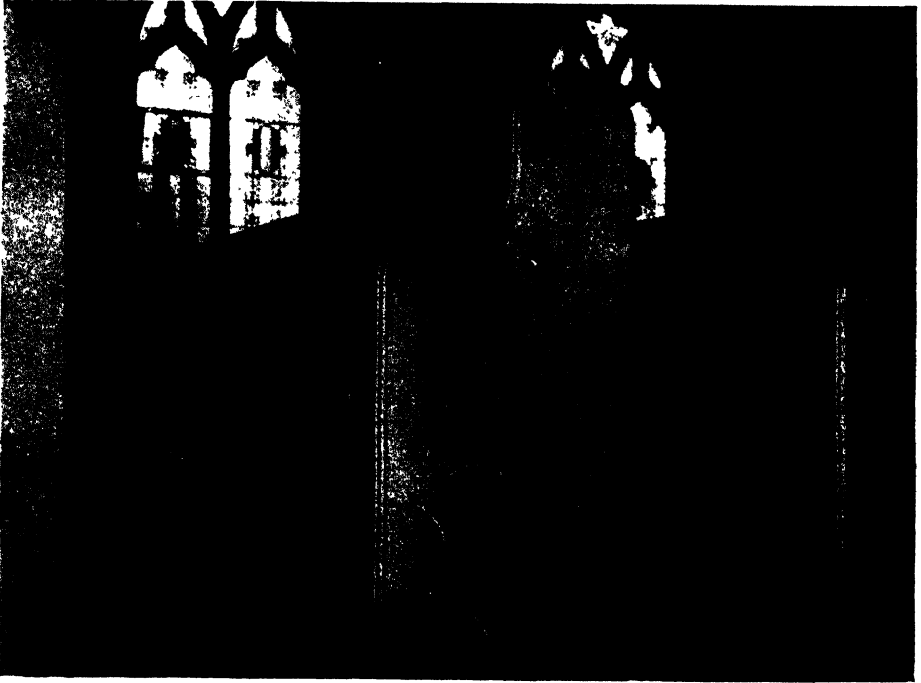

Fig. 3.—TUBULAR HEATER INSTALLATION IN A CHURCH

The usual procedure, as shown above, is to fix the tubes under the pews.

under a window or in a skylight is most effective in suppressing down draught. Further, relatively a small load in such a room will prevent a fall to a low temperature when the fire is not in use. They also prevent the room becoming damp by causing air movement due to convected currents rather than by causing temperature rise.

Layout of Tubular Heaters

The layout of tubular heating systems in ordinary rooms should be made with reference to the cold or exposed sides. Some lengths should always be placed under windows. In this position the cold down draught from the windows is checked, thus removing one of the most fruitful causes of discomfort in an artificially warmed room.

Tubular Heaters in Churches

In churches the usual procedure is to fix tubes under the pews. This is generally the only way in which the necessary load can be installed, and it is a layout which permits conditions of comfort to be obtained

most quickly without thoroughly warming the building. Where intermittent warming is used in churches, care is required to see that the heaters are evenly distributed, otherwise down draughts result in positions where there is a scarcity of heating surface. This applies particularly to the chancel. The large quantity of warm air rising from the heaters in the body of the church is replaced by cooler air from the upper regions, which becomes a bad draught unless checked by additional heaters. Down draughts from tall windows can be eliminated by fixing tubes at a level of about 20 ft. from the floor, or immediately under the window. High-level tubes are frequently loaded to 70 or 80 watts per ft. In modern churches, with their relatively low roofs, the ordinary wall positions are satisfactory, but the pre-warming period with this arrangement is slightly longer than with the pew position. The duration of the pre-warming period is of course proportional to the load, but averages about 2 to 3 hours.

Cinemas

Tubular heaters have been fitted under seats in cinemas, but for this type of installation reference must be made to local regulations, as many authorities will not permit this layout unless a very low surface temperature is used. In modern cinemas, with air requirements proportional to the seating capacity, tubular heaters are used only to offset building heat losses, the heat required by the ventilating or air-conditioning plant being supplied by a battery of heating elements fixed in the ducting close to the ventilating fan.

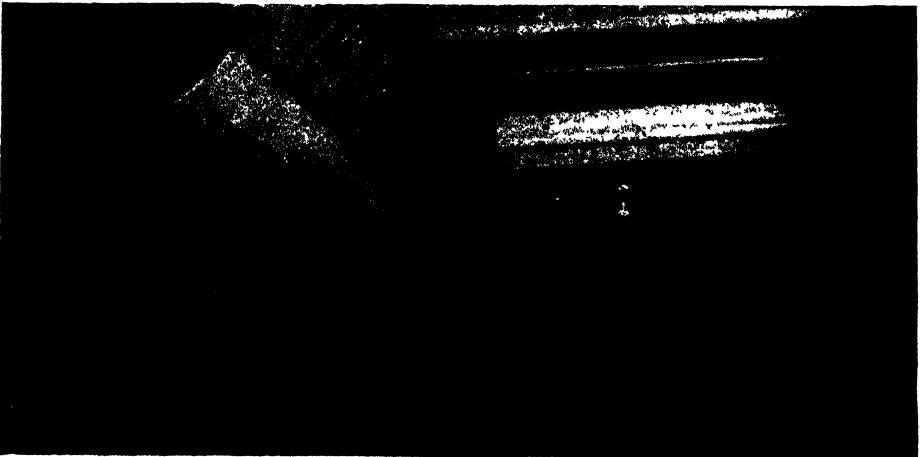

Fig. 4.—TUBULAR HEATER INSTALLATION IN A CHURCH
The thermostat control fixed behind the pulpit.



Fig. 5.—OFFICE FITTED WITH TUBULAR HEATERS

This shows a view of a cashier's office from the clerk's side of the counter. The tubular heaters will be seen at the foot of the counter, and the thermostats on the pillars.

Schools

For schools, generally infants' schools, it is frequently necessary to provide guards, or alternatively to use tubes of about 50 watts per ft., as the normal surface temperature is considered too high to be freely exposed to children. Tubular heaters are not suited for open-air schools, panel heaters, as later described, being used.

Factories, Workshops, and Garages

The robust design of tubular heaters renders them particularly suitable for this type of building, but rarely can the floor position be used. An alternative is to fix overhead to roof ties and use high loadings. The maximum load for a standard 2-in. tube is about 90 watts per ft. length. When heaters are fixed overhead there is a loss of effectiveness of about 20 per cent., and the installed load should be increased accordingly.

CONVECTORS

Convactor is the name given to that class of appliance in which low-temperature elements are surrounded by a rectangular, plain or ornamental metal case. Most designs are fitted with deflector plates and air-chutes to direct the hot air forward and prevent overheating of the

top of the convector. The advantage of this type of heater is that it can be made to look far more attractive than tubes, and allows for relatively high loadings to be fitted in small spaces, and in situations where tubes cannot be accommodated, such as in staircase wells.

Fitting Flush with Wall Surface

It will be seen from the design of this type of appliance that convectors can be sunk flush with a wall surface. When this is done, grilles are provided at top and bottom, but the area of the outlet must not be reduced so as to hinder the free flow of air through the grille. There is some small temperature rise in the element when used in this position.

Some designs of convectors are fitted with adjustable thermostats. The heat-sensitive strip is at the bottom of the heater casing. In this position it is subject to the lowest air temperature in the room, which is



Fig. 6.—A CONVECTOR

The method of operation will be clear from Fig. 7.

(Unity Heating Ltd.)

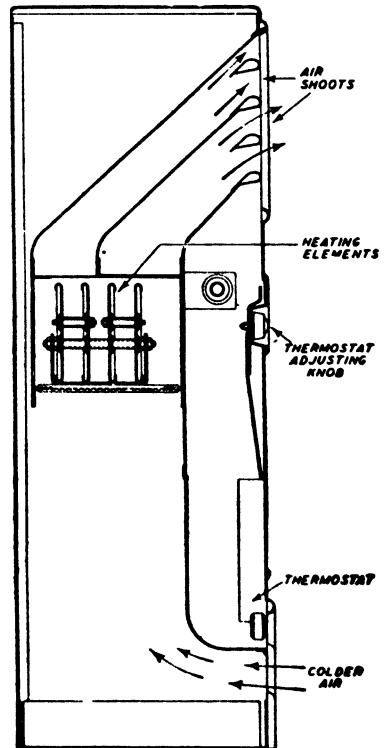

Fig. 7.—SECTION OF CONVECTOR

Colder air enters at bottom, passes over and is heated by the heater elements, and leaves through top grille.

that which has circulated around the room and is approaching the heater to be reheated and recirculated.

Hot-Water and Vapour Radiators

Although the word radiator is part of the name of this appliance it is actually a convector, and may therefore be mentioned here. There are two types—water and vapour. Both types consist of ordinary cast-iron radiator fitted with immersion heater, safety valve, and filler cap. The water-type radiator is, except for a small air space at the top,

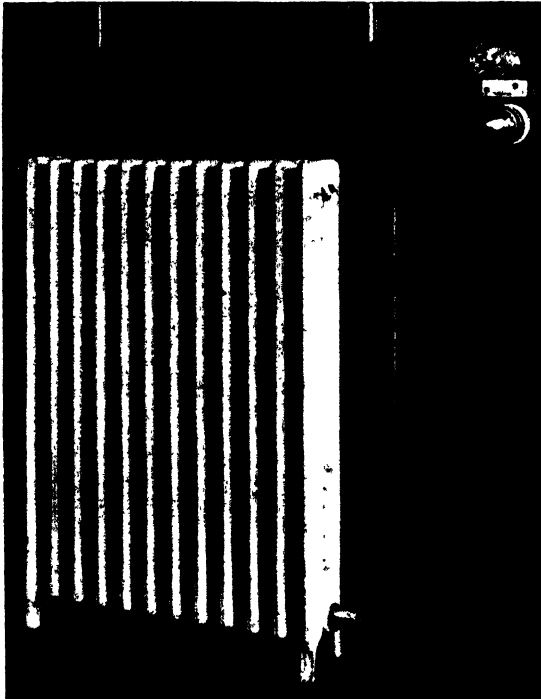

Fig. 8.—HOT-WATER RADIATOR FITTED WITH ELECTRIC IMMERSION HEATER
(National Radiator Co., Ltd.)

filled with water, and has a working temperature of about 180° F. The vapour type is actually a steam radiator, for it contains only a small quantity of water. Under working conditions the upper part becomes filled with steam at low pressure; working temperature is of the order of 215° F. The table below gives the loadings required for radiators of different sizes, and is also useful in cases where it is desired to substitute direct electric heaters of any type for existing hot-water central heating. In these cases the electrical load required can be estimated by finding the extent of the existing radiator surface and referring to the table.

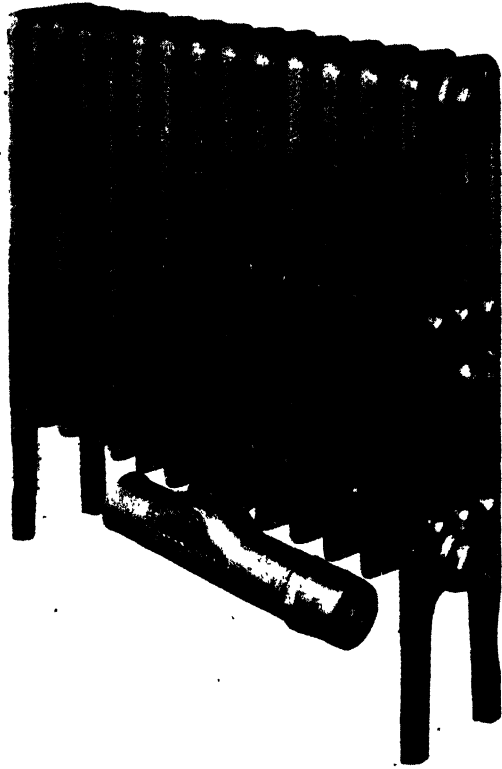

Fig. 9.—ELECTRO-VAPOUR RADIATOR

Under working conditions, the upper part becomes filled with steam. Temperature about 215° F. (*Benham & Sons Ltd.*)

TABLE I.—ELECTRICAL LOADINGS REQUIRED FOR HOT-WATER RADIATORS

<i>Type of Radiator</i>	<i>Height in In.</i>	<i>Watts per Section for 160° F. with Air at 60° F.</i>	<i>Height in In.</i>	<i>Watts per Section for 160° F. with Air at 60° F.</i>
"Classic" 4 column ..	36	140	24	94
	30	120	18	70
"Classic" 6 column ..	36	200	24	133
	30	170	18	100
Plain single column ..	38	140	26	95
	32	120	23	75
Plain double column ..	45	230	26	120
	38	182	20	91
	32	150		
Hospital	36	135	24	92
	30	115		

PANEL HEATERS

This type of heater gets its name from the fact that it presents to the room a flat surface and is frequently framed in moulding. Panel heaters can be used in the ceiling, floor, or wall position, but in any case must be provided with thermal insulation at the back in order to prevent loss of heat.

Surface Temperature

In the ceiling position, facing downwards, a panel may be said to emit more of its heat by radiation, for in this position the heat loss by convection is largely suppressed. For a panel set in the floor or in a wall there is a larger component of heat loss by convection. Convection is highest in the floor position. From these considerations it will be seen that for panels of equal loading, which emit the same total quantity of heat, the surface temperature in the ceiling position is higher than for the wall position, while the floor-position temperature is lower than for a wall panel.

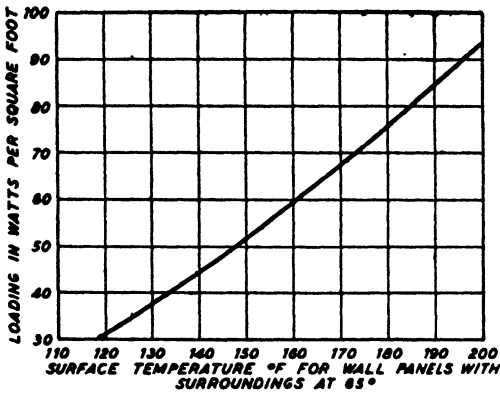

Fig. 10—VARIATION IN SURFACE TEMPERATURE WITH LOADING OF VERTICAL WALL PANELS

The variation in surface temperature with loading is shown in Fig. 10. This curve is for vertical wall panels with surroundings at 65° F.

Application of Panels

Panel heaters or radiators can be used in almost any room, but when fitted to ceilings in single-storey buildings extra insulation at the back is required to prevent excessive heat loss. Where the ceiling of one room corresponds to the floor of a room above, heat loss from normal panel insulation contributes to warming the room above.

Floor panels, which should not exceed a surface temperature of about 68° F., are used in churches and large rooms with high roofs. For these buildings, the panel is fitted in a position similar to the gratings which usually cover hot-water pipe trenches.

For open-air schools, churches, or open balconies, panels have great advantages over the ordinary convector heater, in that they emit radiation direct and provide some degree of comfort irrespective of air temperature.

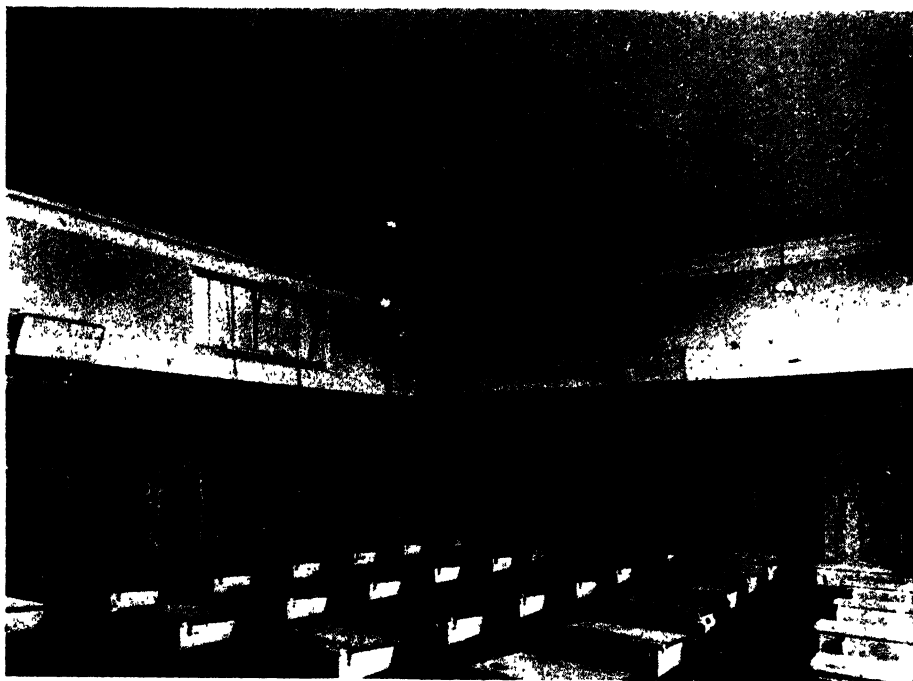

Fig. 11.— ARRANGEMENT OF HIGH-TEMPERATURE PANELS IN A SCHOOL

The panels will be seen hung at an angle to the walls. Temperature 400° F. The centre pendant is a radiation thermostat, specially for use with electric radiant heating. (*Unity Heating Ltd.*)

Skirting Panels

Skirting panels, which are made to take the place of the ordinary skirting board, are used as a subsidiary source of heating, for the relatively low temperature required for this position generally prevents installation of the necessary load for complete heating of a room.

Construction

Panel heaters are constructed of either cast-iron or sheet metal, and although cast-iron is a slightly better emitter of radiation than sheet metal, cast-iron panels are necessarily more heavily constructed and must therefore be properly supported. In the cast-iron type, elements are carried in ducts in the casting, while in the sheet-metal type they are clipped to the back of the panel face. The element is, of course, of nickel-chrome wire operating at a low temperature. Panels may be decorated with any type of finish except metallic paint.



Fig. 12.—THIS ROOM IS HEATED BY THE “DULRAE” SYSTEM OF LOW-TEMPERATURE RADIANT HEATING

The ceiling has a covering of insulating paper into which an electric heating wire is woven. (*Richard Crittall & Co. Ltd.*)

Determination of Load for Panel Warming Installations

The method of determining heat required for panel warming is to calculate carefully the heat loss from the room in the usual way, with due allowance for exposures, but whereas for a small room with convection warming 2 air changes per hour would be allowed for, where ceiling-type panels are to be used the calculation would be made for between .5 and 1 air change per hour. This method allows for the increased effectiveness of direct radiation in providing comfort. The method is perhaps somewhat illogical, but experience has proved it most satisfactory, and it can be used with confidence until one of the newly proposed methods has been proven.

Warming by Radiation

Panel heating has come to be known as radiant heating, and it is claimed that by its use the same conditions of comfort can be obtained with a lower air temperature than for warming by convection. This results in a lower load per room because of a decreased temperature difference between inside and outside air, and therefore a lower annual consumption of energy.

There is still some controversy as to the merits of warming by radia-

tion or convection, but whatever be the final answer the fact remains that panel warming is rapidly gaining popularity, and for solidly constructed buildings offers definite economies over heating by convection.

High-temperature Panels

There is a further type of panel which is particularly useful for open-air schools or sanatoria and the like. This panel operates at a temperature of the order of 400° F., and is hung either horizontally high up in a room or at an angle to the walls. It is also incorporated in light fittings.



Fig. 13.—INSTALLING "DULRAE" SYSTEM OF HEATING

"Dulrae"

The panel heaters just described are constructed of metal; there is, however, a further type, which consists of insulating paper into which an electric heating-wire is woven. This wire operates at a very low temperature, and the paper is pasted to the ceiling. A covering of ceiling board is then applied and the ceiling finished in the usual way. This type of warming equipment is marketed under the name of "Dulrae," and its installation is essentially a specialist's undertaking.

The "Dulrae" method of warming rooms approaches as near as any method to the ideal. It is well known that most discomfort in artificially warmed rooms is due to cold walls. "Dulrae" not only emits low-temperature radiation, but it contributes very largely to warming the fabric of the building itself, and gives a thoroughly warmed room without excessive air temperatures.

Methods of Thermostatic Control

In small rooms, with loads of up to about 3 kW., or currents of 15 amp., it is customary to control all heaters by thermostat, so that when temperature is reached the whole of the heaters are switched off. In larger rooms and halls this is not necessary. It is sufficient to place about 80 per cent. of the load on automatic control, the balance being hand switched. This arrangement not only reduces capital cost, but

eliminates considerable wear on the thermostats. At all times during the winter some heat is required by a building, and all regularly occupied buildings should be partly warmed over-night. If about 15 per cent. or 20 per cent. of full load is left connected, and the main, thermostatically controlled load switched off, then an over-night temperature of about 50° F. could be maintained, and the margin of about 25 per cent. additional allowance for pre-warming, referred to at the beginning of the chapter on electric heating appliances, could be reduced to about 10 per cent. to 15 per cent., with a consequent saving in expenditure. The main heating load can be switched on by time switch.

Heaters for Thermostatic Control

All heaters placed under thermostatic control should have low thermal capacity. All electric heaters except the hot-water type can be so controlled. With this latter type, the heat stored in the radiator is such that there will always be a temperature rise after thermostats have cut off, and the temperature of the room varies over a range of from 6° to 8° F., which is sufficient to cause discomfort.

Electric fires, of course, should not be thermostatically controlled.

INDIRECT ELECTRIC HEATING

Occasions frequently occur where it is necessary to convert an existing hot-water central-heating system to work with electric heat. This can be accomplished by substituting for the solid-fuel boiler a circulator, which is a cylinder fitted with a suitable number of immersion heaters. This is a method often employed in conjunction with slot-meter fires in hotels. A circulator is used to heat hot-water radiators fitted in public rooms. A combined heating system such as this is generally more expensive to operate, has no advantage over the direct, automatically controlled method, but the use of a circulator in place of a solid-fuel boiler makes available for other purposes what would normally be required for a boiler room, as circulators can be fitted with wall brackets if required, but no upheaval of normal routine is caused by re-wiring the building for direct electric heaters.

The load required by circulators is of course proportional to the pipe and radiator surface in the system, and can be found from the table on page 181.

Automatic Control of Indirect Systems

Automatic control of these systems is by temperature control of either air or water or both. One or more thermostats fitted in a room may be connected to cut off sections of the circulator load, or alternatively a thermostat can open or close an electrically operated valve in the flow pipe to the radiators. In either case such controls, when

judged from the viewpoint of an occupant of a room, are sluggish, and an even temperature is difficult to obtain.

Direct Electric Heaters with Heat Storage

In many districts special low rates for electricity are available provided heating plant is switched off for a few hours. This type of tariff is described as an off-peak tariff, and the peak period—the time during which heaters must be switched off—varies from 2 to 12 hours' duration. In most districts the peak period does not commence until after 4.30 p.m. When electric heaters supplied under an off-peak tariff are installed in, say, offices which are occupied till about six o'clock, some means of storing heat for upwards of 2 hours must be used. For solidly built and well-heated buildings, the temperature drop in 2 hours may not be sufficient to cause inconvenience, but in others the heating plant must be capable of carrying over the period.



Fig. 14 --THERMAL STORAGE PLANT

500 kW, 400 volts 3-phase fully automatic electrode water circulator (working pressure 60 lb. per sq. in.) together with thermal storage equipment and warm water panel system used for central heating of Mersey Tunnel offices.

There are at the moment only two types of plant capable of doing this. The first of these is a heater built of soapstone, which becomes heated and liberates its heat after the element is switched off. This appliance can be used where short peak periods exist.

The second type of plant is known as thermal storage plant, and can be designed for any size building and for any off-peak period.

Thermal Storage Plant

In this type of equipment the heat-storage means is water. Large volumes of water are heated to a high temperature, the current supply cut off, and the heat liberated during cooling is used for warming purposes. This equipment is best suited to big buildings, because higher storage temperatures can be used. To appreciate this point a more detailed knowledge of the design of the plant is required.

Electric energy from high- or low-voltage mains, taken during the night hours, is used to heat water stored in heavily insulated cylinders. The heating means is either an electrode boiler working direct upon high- or low-tension supplies, in which the water is used as the resistance

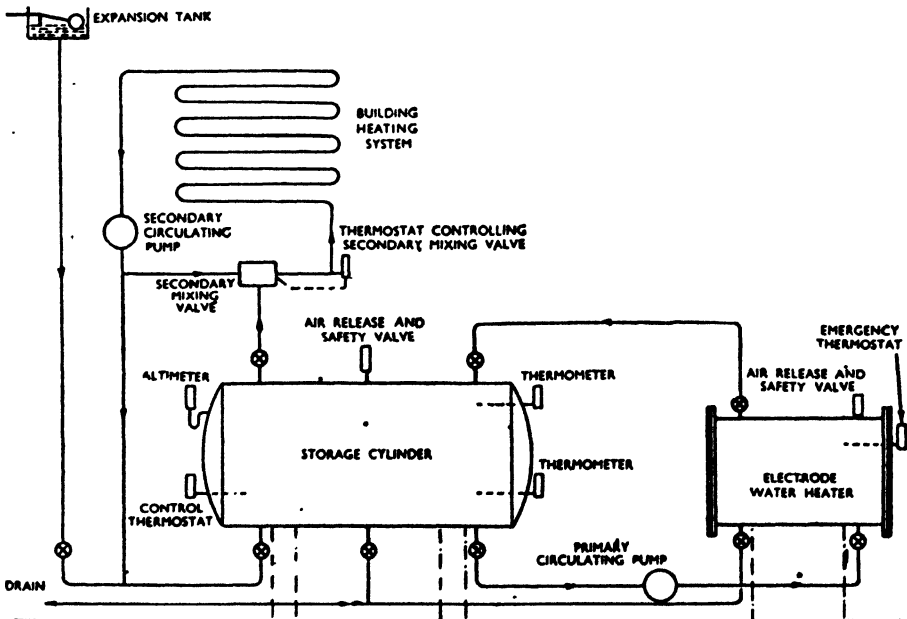

Fig. 15.—GENERAL ARRANGEMENT OF AN ELECTRODE THERMAL STORAGE PLANT

Note that it consists essentially of a water heater connected to a storage cylinder. Hot-water circulation between heater and storage cylinder and the circulation for warming the building are induced by motor-driven pumps. (*General Electric Co. Ltd.*)

medium, or immersion heaters. Immersion-heater installations are limited to loads of about 100 kW. or 340,000 B.T.U. per hour.

Layout of Plant

A diagram showing the layout of the plant is given in Fig. 15. It can be seen that there are two sections—primary and secondary. The primary side is at work only when energy is being consumed: the secondary side is responsible for delivering heat to the building.

The diagram shows only the heating side of the installation, but the electrical equipment provided is generally such that the plant is entirely automatic as regards temperature control and time factors.

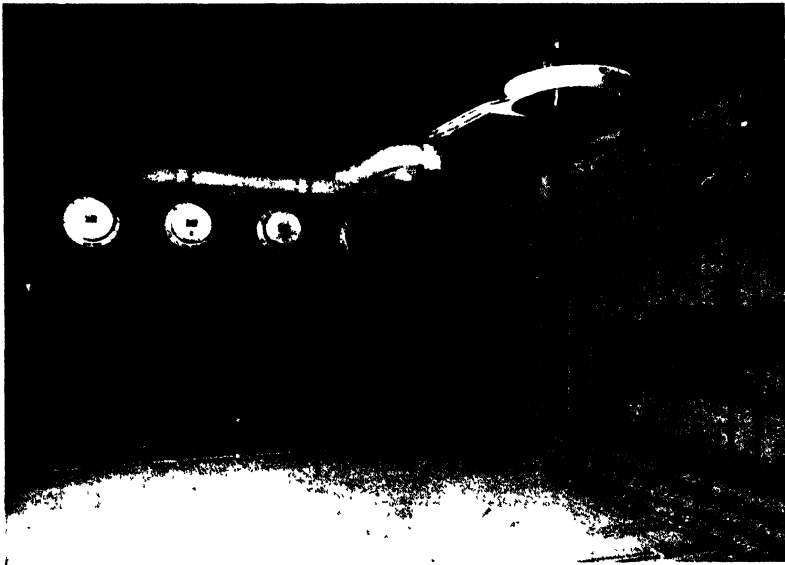

Fig. 16.—THERMAL STORAGE CYLINDER FITTED WITH FOUR 30 kW. IMMERSION HEATER BANKS

Installed in West Ham Corporation offices. Compare with electrode heater installation, Fig. 14, where the heater is separate from storage cylinder. (*A. Reyrolle and Co. Ltd.*)

Calculation of Storage

In storing a fixed quantity of heat between definite temperature limits, it is obvious that the higher the maximum temperature the smaller the volume of water required. The boiling-point of water rises as the head or pressure to which it is subjected. At atmospheric pressure the boiling-point of water is 212° F., but under a head due to an overhead supply cistern, say, 100 ft. above the storage cylinder, boiling-point is about 290° F., thus under these circumstances the water could be raised to a temperature of 270° without generation of steam.

HEATING AND VENTILATING

The variation in boiling-point of water with pressure is as follows :—

Head in Ft.	Pressure in Lb. per Sq. In.	Boiling-point ° F
20	8.6	236
30	13.0	246
40	17.0	254
50	21.0	261
60	26.0	267
70	30.0	274
80	35.0	280
90	39.0	286
100	43.0	290

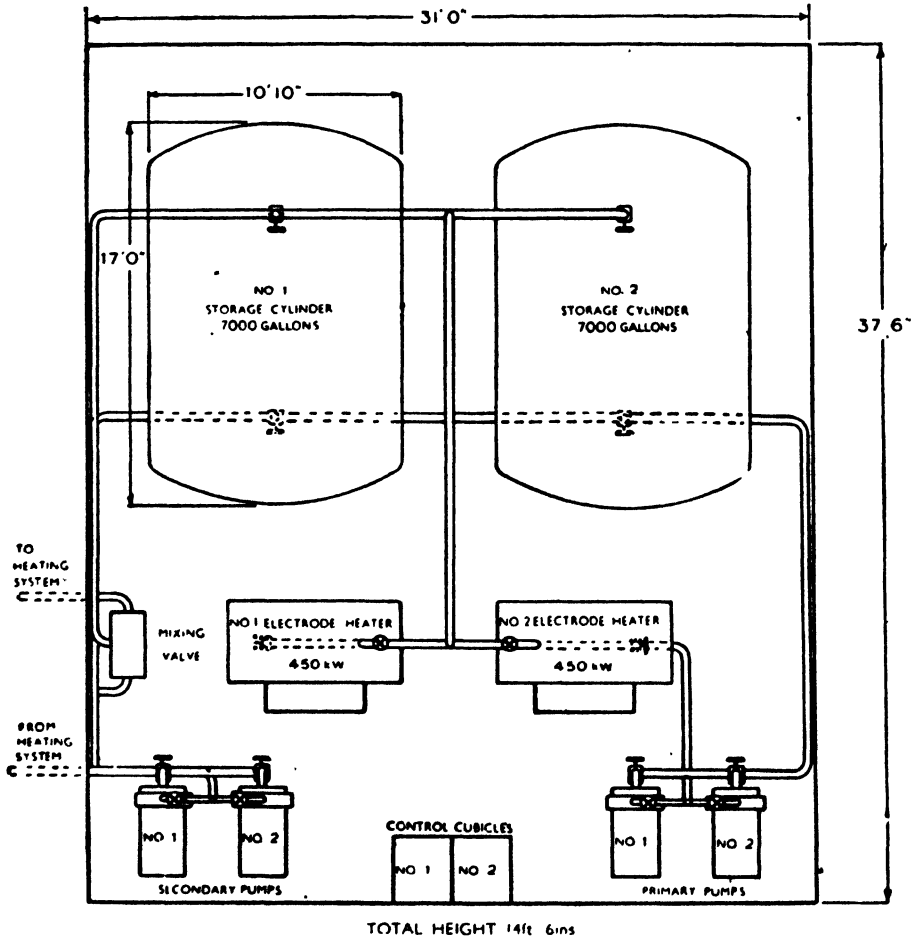

Fig. 17.—TYPICAL BOILER-HOUSE LAYOUT OF ELECTRODE THERMAL STORAGE PLANT FOR HEATING BUILDINGS

A flow diagram is shown in Fig. 18.

For Radiator Systems

Most radiator heating systems are designed to work with a flow temperature of 180° F., and a return temperature of 150° F. To maintain this flow, the lowest temperature to which the stored water may fall is 180° F. If storage cylinders were worked at a maximum temperature of 270° F., each gallon of water can cool 90° F., in doing which, $90 \times 10 = 900$ B.T.U. will be liberated. The total storage volume required for any building can be obtained by dividing the total heat storage required by the heat liberated during the permissible temperature drop. Take the case of a building requiring .5 million B.T.U. per hour for the maintenance of a temperature of 65° F., and current available for 12 hours at night. The total heat storage in this case must be 6 million B.T.U. With the temperature limits of 270° and 180° F., the total capacity of the storage cylinders must be:—

$$\frac{6,000,000}{10(270 - 180)} = 6,700 \text{ gals. approximately.}$$

The temperature of the stored water at the end of the day's run is about 160° F.—the return temperature of the system, and the storage must be reheated during the 12 night hours to 270° F. To do this an

electrical input of $\frac{6,700 \times 10 \times 90}{3.410 \times 12} = 150 \text{ kW.}$ is required.

Operation of the Plant

Thermal storage plants can be made entirely automatic. When the current is switched off, the primary pump is stopped and the secondary pump attached to the heating system is started, and the hot water from the storage pumped around the building. Sometimes, where the period of warming the building overlaps the off-peak hours, both sets of pumps may be running.

Now it is quite impracticable to send high-temperature water through a radiator system. An automatic mixing valve is inserted in the main-flow pipe, through which some water from the return pipe is by-passed and mixed with water from the storage cylinder. These valves are thermostatically controlled, so that if there is very little temperature fall between flow and return pipes, very little water is taken from the storage cylinders.

Panel Warming with Thermal Storage

It has been stated elsewhere (Chapter VII) that the average flow temperature of hot-water ceiling panels is about 100° F. The advantage of using panels in conjunction with thermal storage plant is that smaller storage cylinders are required. Take, for example, the case outlined above. The total heat requirements of the building are stored between

temperature limits of 270° F. and 180° F. for a radiator system ; for a panel system the temperature limits would be 270° to 110°. In this case, each pound of water now contains $(270 - 110) = 160$ B.T.U. and each gallon, therefore, $160 \times 10 = 1,600$ B.T.U., and the total capacity of the storage cylinders must be $\frac{6,000,000}{1,600} = 3,750$ gals.

Estimating Consumption

In Chapter XI the variation in the outside winter temperature in England is indicated, and it will be remembered that the heat loss from a building is calculated for a definite temperature difference of, say, 30° F. between inside and outside temperatures. If the outside temperature is above 32° F., then—assuming automatic control—the thermostats will cut off the heaters for certain periods. As the outside temperature rises, the operation of thermostats becomes more frequent. It is known from experience that the average demand of a building over a season is approximately 55 per cent. of the maximum possible, the maximum being represented by 200 days' or 5,000 hours' heating season, multiplied by the net calculated load—exclusive of extra allowances—of the building under consideration.

Continuous *v.* Intermittent Warming

It is often claimed that the provision of a time-switch, for switching on the installation at some pre-determined time in the early morning, thermostatic control also being used, results in appreciable economies over continuous warming. While this is true when considered purely from annual consumption point of view, the conditions of comfort produced by 24-hour warming are always greatly superior to those ever obtained by any intermittent heating. A comparison between the two

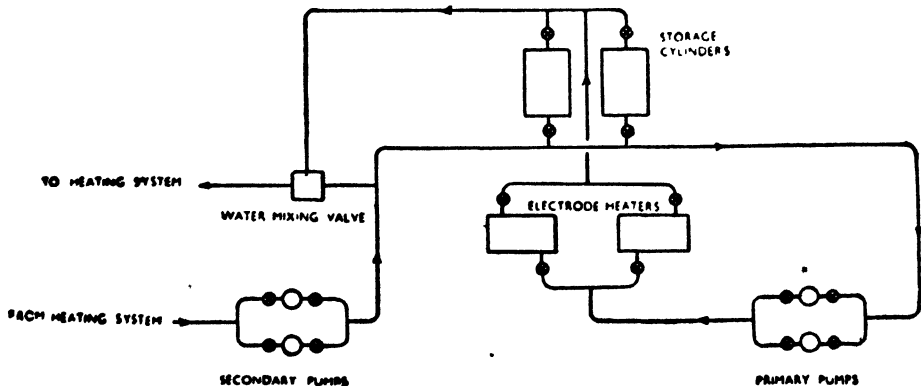

Fig. 18.—FLOW DIAGRAM OF PIPING FOR PLANT SHOWN IN FIG. 17

results is therefore not justified. Although a thermometer may show equal readings for air temperatures, the fabric of an intermittently heated building can never become thoroughly warmed. The temperature of the walls plays an important part in producing comfortable conditions, and these never become warm enough for ideal conditions in intermittently heated buildings.

For the best and most economical results some heat should always be delivered to a regularly used building over-night. The maintenance of a temperature of about 50° F. to 55° F. during the unoccupied hours brings the temperature rise to, say, 60° F., well within the power of a normal load.



Fig. 19.—Two ELECTRODE WATER HEATERS OPERATING AT HIGH VOLTAGE

Here we see two 1,000-kW. 6,000-volt type water heaters and control panel, installed for Knightswood Bus Garage thermal storage heating. Two heaters are often desirable in preference to one larger heater, as this allows one to be shut down during summer. Note that more headroom is required for high-tension heaters. (*A. Reyrolle and Co. Ltd.*)

This is what happens with a hot-water central-heating installation when the fire is banked over-night, and can be made entirely automatic with either direct or storage electric-heating systems.

Chapter X

UNIT HEATERS

A UNIT heater consists of an electrically driven fan and a battery of pipes or finned heating surface, over which air is blown at a high velocity, thus obtaining a large heat output from a comparatively small amount of surface.

The unit heaters may be stood upon the floor, the outlets being carried to above head level, as in Fig. 1, or they may be suspended from the ceiling, as shown in Fig. 2.

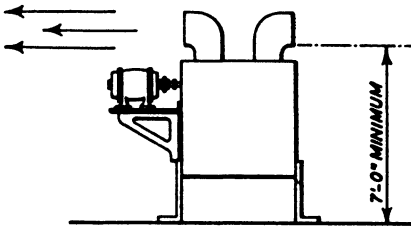

Fig. 1.—FLOOR TYPE UNIT HEATER

Electrically driven fan blows air at high velocity over battery of heating pipes and discharges it above head level.

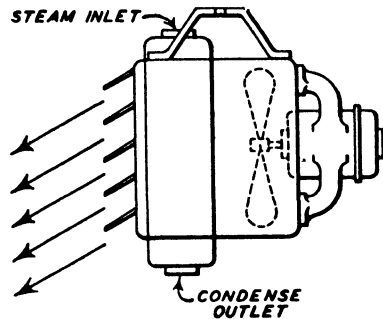

Fig. 2.—TYPE OF UNIT HEATER SUSPENDED FROM CEILING

Air is blown through heater and is directed downwards.

The floor type discharge practically horizontally and the main air stream is thus above head level throughout its travel, and this type can therefore operate at much higher discharge velocities than the suspended type, which discharge diagonally downwards and therefore direct the main stream to body level. For this reason the floor type can distribute warmed air over a much greater amount of floor space than can the suspended type; further, the floor type may have four discharge outlets delivering in different directions, so that the effective range of a floor unit is many times that of an overhead unit.

Other claims made in favour of the floor-mounted unit heater are greater uniformity of temperature in the building, due to the air being taken into the heater at floor level, where it is coolest, and, owing to the powerful horizontal blast, less tendency for the hot air to rise toward the roof, a short distance from the heater.

Air Temperatures with Two Types of Heater

In connection with the tendency for air to rise toward the roof, investigators agree that low-velocity suspended units cause pronounced irregularities in temperature compared with the floor type, and that whilst the average temperature increases at the rate of 1° to 2° F. per ft. height above floor in the case of the floor units, it increases at the rate of $1\frac{1}{4}^{\circ}$ to $2\frac{1}{4}^{\circ}$ F. per ft. in the case of suspended units. Although this difference

may at first seem small, it will be realised that in a factory 15 ft. high an average temperature of 55° F. at body level, i.e. 3 ft. from floor, would mean a temperature of $55 + (12 \times 1\frac{1}{2}) = 73^{\circ}$ F. near the roof, with floor units, and $55 + (12 \times 1\frac{3}{4}) = 76^{\circ}$ F., with suspended units. These temperatures affect the heat loss from the walls as well as from the roof, and, since a large part of the air change heat loss is by outward leakage of air through the roof, also the ventilation heat loss.

On the other hand, with floor units there is the risk of cold draughts at floor level, due to the position of the air intake to the unit, and the disadvantage of one unit discharging in four directions, which causes difficulty in applying thermostatic control.

Suspended unit heaters distributed judiciously, so that the more local effect is turned to advantage rather than being an objection, have much in their favour.

Speed of the Fans

Both types of unit heaters are usually obtainable in two speeds; for floor units, high-speed fans are usually employed where high-pressure steam is the heating medium, and low-speed fans where the batteries are supplied with low-pressure steam, or high-temperature hot water. The suspended type should have a slow-speed fan where hot water is used, or where the units are within 6 ft. of head level. Where both head room and water temperature are limited it may be necessary to use especially low-speed fans.

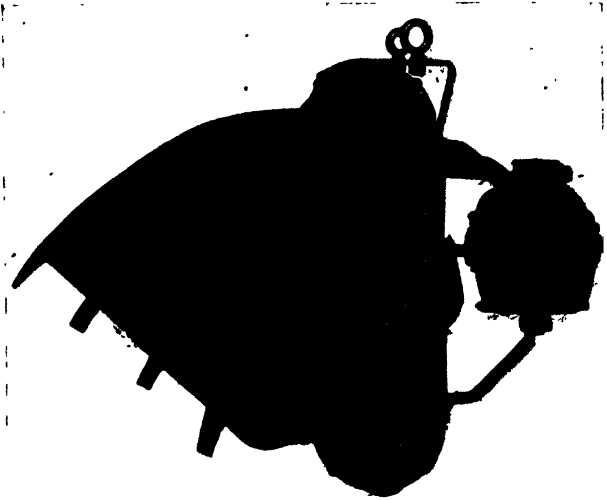

Fig. 3.—UNIT HEATER WITH ADJUSTABLE LOUVRES ON COWL

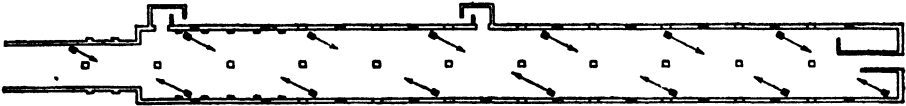

Fig. 4.—TYPICAL LAYOUT OF UNIT HEATERS IN LONG RECTANGULAR TYPE OF WORKSHOP OR FACTORY

Advantages of Unit Heaters, compared with Radiators

The advantages of unit heaters compared with radiators for warming factories, workshops, warehouses and garages are as follows:—

- (1) No encroachment on floor space in the case of overhead units and only 50 per cent. of that required for radiators in the case of floor units.
- (2) Lower installation costs.
- (3) Simple and cheap means of thermostatic control may be provided, in which case a saving of from 10 to 30 per cent. of the fuel bill may be effected.
- (4) Quick heating from cold.
- (5) With the heating turned off and the fans running in summer, a freshening effect is produced by air movement.

When compared with heating by means of overhead coils, unit heaters show a further advantage in that the fuel consumption is much reduced, as is also the time lag in heating up from cold.

Since in most factories, warehouses and garages radiators are pre-

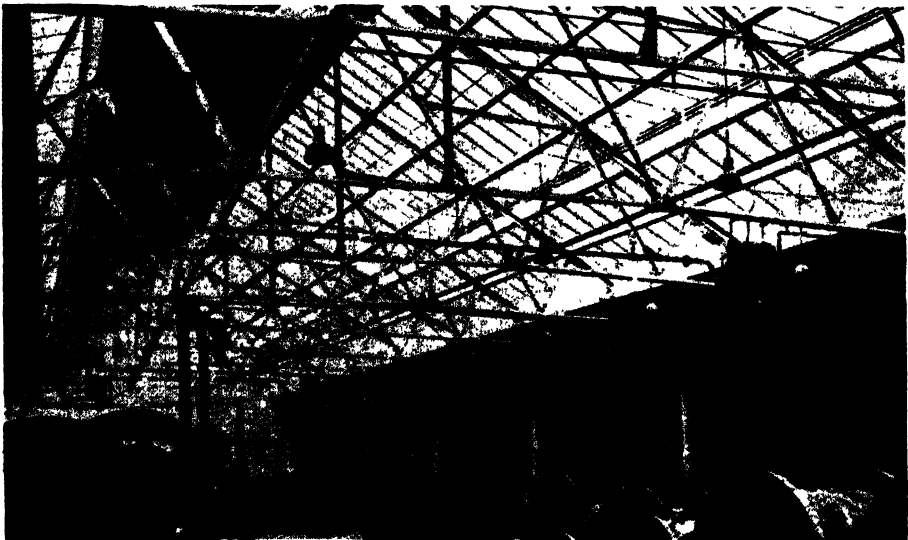

Fig. 5.—UNIT HEATER INSTALLATION IN A LARGE CABLE STORAGE

Four steam-heated unit heaters are in the roof space. Note that the supply and return pipes are installed as high as possible, necessitating a lift-type steam trap in each condense return.

cluded on account of benches, fixtures, or possible damage by cars or lorries, the choice must often be made between overhead coils and overhead unit heaters, in which case the latter are strongly to be recommended, unless there is the possibility of the space being divided up into small areas at a later date, or process work renders air movement undesirable, as in the case of paint-shops, where dust particles may be caused to impinge on painted surfaces, or printing shops, or similar places, in which air movement would cause fluttering of papers. Overhead pipe coils should be adopted, however, only as a last resort.

Losses of Heat

Since heated air has a strong tendency to rise, and does, in fact, rise after the momentum imparted by the fan in a unit heater has died away, it follows that overhead coils deliver the greater part of their heat to the unoccupied space above head level instead of at body level.

For this reason it is usual to calculate on only 75 per cent. of the heat being usefully employed, the balance being wasted in excessive losses from the roof.

This is in addition to the usual height factor which must be taken, as in the case of unit heaters and radiators.

Time Taken to Heat Up the Space

There is also a much longer time lag between the time the heater starts to operate and the time the space is heated in an overhead coil system than in a radiator or unit-heater system, especially where hot water is the heating medium. Since factories are of generally light construction, it does not usually pay to run the heating system at night at reduced output; in order to facilitate heating up in the morning, thus the heat contained in the water and metal of the overhead coils is wasted at the end of each day and the storage capacity of the apparatus imposes a burden on the system when cold in the morning.

DESIGNING A UNIT-HEATING SYSTEM

In designing any heating system the first step is to ascertain how much heat must be put into the building each hour to maintain the desired temperature.

For this purpose it is necessary to know the rate at which heat will be lost by leakage through the various materials of which the walls, roof, etc., of the building are composed. The method of doing this is explained in Chapter III.

A difficult problem facing the heating engineer is estimating the hourly amount of air that is likely to pass through a given building. This depends upon so many factors that it is quite impossible to predict the quantity with any degree of accuracy. The variables are airtightness or otherwise of windows, doors and roof, the shelter, if any, provided by

nearby buildings, the number of times doors must necessarily be opened, wind force, and so forth.

The rate of leakage is usually expressed in terms of the number of times per hour the air is changed, i.e. replaced by fresh air from indoors.

Table 1 gives the generally accepted rates of air change:—

Room, without window or outside door	Air Changes per Hour
Room, without window or outside door	$\frac{1}{2}$ to $\frac{2}{3}$
„ with one side exposed	1
„ „ two sides exposed	$1\frac{1}{2}$
„ „ three or four sides exposed	2

These figures apply with windows and doors closed.

AIR CHANGE IN CLASSROOMS. Three or four air changes are allowed in classrooms where, due to the number of persons assembled in a confined space, it is necessary to keep certain of the windows open.

FACTORIES. In factories it is necessary to ascertain if process work vitiates the air to such an extent that an increased rate of air change is required.

As an extreme example, it may be mentioned that rooms in which cellulose spraying is carried out are required by regulations to have 30 air changes per hour, and the degree of draught caused by this amount of air movement necessitates a temperature of 70° F. instead of the more normal 55° to 60° F. Incidentally, all motors and starters in cellulose spraying rooms, garages, and similar spaces in which there are explosive gases must be of completely enclosed flashproof type.

Other factors which must be taken into account in computing the amount of heat required in a given building are the allowances for aspect and exposure, and for intermittent heating, as explained in Chapter III.

Intermittent Heating

The factors for intermittent use are usually covered by allowing a margin on the boiler power only, no increased heating surface being required for the heating-up condition, since the output of a radiator, coil or unit heater is a function of temperature difference between the water or steam in the system and the air in the room.

Thus, with the air in the room initially at 30° and ultimately 60°, with a mean temperature of 160° in the pipes the emission would be in the ratio of roughly $160^\circ - 30^\circ = 130^\circ$ at commencement to $160^\circ - 60^\circ = 100^\circ$ when 60° has been attained: thus, provided a margin of 30 per cent. were available at the boiler, the heating surface would respond accordingly. It should be observed, however, that the output of radiators or unit heaters is not 30 per cent. in excess of normal throughout the whole of the preheating period, but averages 15 per cent., and any allowance required in excess of this figure involves additional heating surface as well as boiler power.

UNIT HEATERS REQUIRED FOR FACTORY

The amount of heat required for the factory, shown in Fig. 6, may be calculated as 347,800 B.T.U. per hour. We will assume that a temperature of 55° F. is required inside when 32° F. outdoors. The walls are of 9 in. brickwork, unplastered, windows and north lights of single glass, roof otherwise of corrugated asbestos on boarding, doors of braced sheet metal and floor of concrete on earth.

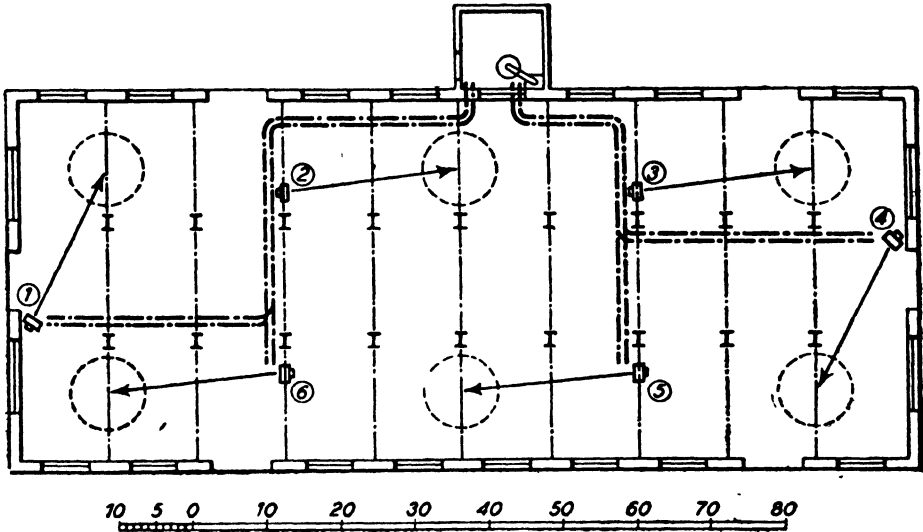

Fig. 6.—PLAN OF TYPICAL FACTORY HEATED BY SUSPENDED UNIT HEATERS

Note the positions of the six unit heaters. The dotted circles indicate the places where the maximum heating effect is desired. A heater is positioned at about 20 to 30 ft. from each area to give this maximum heating effect. Note position of boiler and run of piping. The same factory could be heated by a smaller number of floor heaters, if first cost is a consideration. (See Fig. 8.)

Deciding on Number and Size of Unit Heaters

Unit heaters are made in a range of sizes down to about 20,000 B.T.U. per hour, so for a total output of 347,800 B.T.U. per hour there is a large number of combinations which would meet requirements as to output, from 1 unit at 347,800 down to 17 units at about 20,000 B.T.U. per hour each. The deciding factor is distribution.

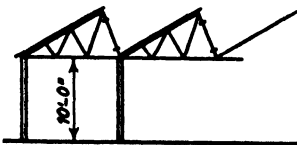

Fig. 7.—PART SECTION OF FACTORY IN FIG. 6, SHOWING HEIGHT

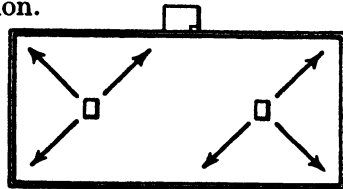

Fig. 8.—THE FACTORY SHOWN IN FIG. 6 HEATED BY TWO FLOOR UNIT HEATERS INSTEAD OF SIX CEILING UNITS

Amount of Floor Space Dealt With by One Unit

Although claims have been made that the floor type of unit can deal with areas up to 15,000 sq. ft. of floor per unit, and the ceiling type up to 2,500 sq. ft., it is generally recognised that such spacing is likely to give rise to complaints of excessive draught and unequal heating, whilst from his own experience the writer would not care to recommend attempting more than 8,000 sq. ft. per floor unit and 1,000 sq. ft. of floor per ceiling unit. An outlet velocity of 600 ft. per minute should not be exceeded in the case of a suspended unit unless fitted 15 ft. from the floor.

Either Six, One or Two Units may be Selected

The amount of floor space in the factory considered is 5,760 sq. ft., so six ceiling units are to be recommended, or, if initial cost is sufficiently important to run the risk of cool draughts at floor, a single floor unit, although the shape of the building is such that two smaller floor units, each discharging in three directions, would give much better results and justify the additional expense. (See Fig. 8.)

Selecting the Positions of Ceiling Units

In positioning ceiling units it should be borne in mind that the maximum heating effect at floor level takes place at a distance of about 20 to 30 ft., depending upon the height of the unit and initial velocity, thus it is advisable to mark on the plan roughly the positions in which it is desirable to have the maximum heating effect and then to position the units to suit, as indicated in Fig. 6.

Hot Water or Steam ?

The next point to decide is whether the heating medium is to be hot water or steam.

Steam has fallen somewhat into disfavour of recent years, but for reasons which affect unit-heater systems much less than radiator or pipe-coil systems. The objections usually raised against the use of steam for heating are as follows :—

- (1) Difficulty in regulating the output of heat in the milder winter months.
- (2) Necessity for greater attention to the boiler and risk of damage if boiler is left banked for the night.
- (3) Smell caused by the baking of dust particles on steam heated surfaces.
- (4) Attention to and replacement of steam trap accessories.
- (5) Corrosion of condense piping.

Objections to Steam, which do Not Apply with Unit Heating

These disadvantages have resulted in the general use of hot water for heating residences, flats and offices, whilst in factories steam is seldom

used for radiator systems unless it is required in any case for process work,

With unit heaters, however, objection No. 1 does not apply because the fan motors may be thermostatically controlled and the temperature regulated much more readily and inexpensively than hot-water radiators.

The second objection need not apply in the case of unit heaters where the system would not, in any event, be banked for the night because unit heaters produce a warm condition within an hour or so of obtaining steam pressure. If automatic damper control is applied to the boiler and precautions taken against condensate trouble the boiler plant need not require more than casual attention during the day.

There is also less smell of scorched dust with steam unit heaters than with steam radiators working at the same pressure, due to the cooling effect on the metal of the high velocity of the air and the small amount of heating surface as well as the time-contact factor.

The fourth and fifth objections remain, and against them may be set the reduced initial cost of a steam-heating system, compared with hot water.

Hot Water v. Steam for Heating

Thus, there is little to choose between steam and hot water where unit heaters are used, whilst in some cases there is a greater risk of cool draughts from the units where hot water is used and the boiler flow temperature allowed to fall off since it is seldom practicable to have a flow temperature of more than 200°, which means that there is very little latitude either way. In this connection, where hot water is used, the unit heaters should have such an outlet velocity and delivery air temperature that cold draughts are not likely to arise when the boiler flow temperature falls 20° below normal, whilst an automatic damper regulator should always be installed.

Steam should therefore be selected as the heating medium where initial cost is of more importance than the avoidance of repairs and replacements. Hot water should be employed where trouble-free service is a vital necessity.

Steam should also be used in very lightly constructed buildings having corrugated metal walls and roof and where consequently there would be the risk of water freezing in pipes and unit heaters at night, when the system is not in use; neither should hot water be used where the units communicate with outdoor air, as is the case when used for mechanical ventilation; wet returns and dips in condense lines should also be avoided in such cases where there is a likelihood of the standing water becoming frozen.

In the present instance the factory is reasonably well built from a heat-retaining standpoint, so hot water is quite feasible. We will assume, however, that steam is preferred on account of lower initial cost, and that the nature of the work done in the factory is such that part of the system being turned off for repairs would not be regarded as serious.

The Low-pressure Gravity Steam System

The steam pressure for which the system is designed depends upon the method of returning the condensate to the boiler. The cheapest method is by gravity, since this avoids the necessity of a pump, and as the maximum boiler pressure for gravity return is determined by the height of the unit heaters above the water level in the boiler the system would be a low-pressure one, employing an inexpensive cast-iron boiler.

Fig. 9 illustrates in simple form the essential features of a gravity steam system. The steam main is taken to the highest point from which it slopes downward to the various units, so that steam and condensate flow in the same direction. It will be appreciated that the heat loss from the steam piping causes some of the steam to be condensed before reaching the units and that, where the length of steam main is likely to cause much condensate, this should be drained off before reaching the unit heater. A drip for this purpose is shown joined to the condensate line through a steam trap.

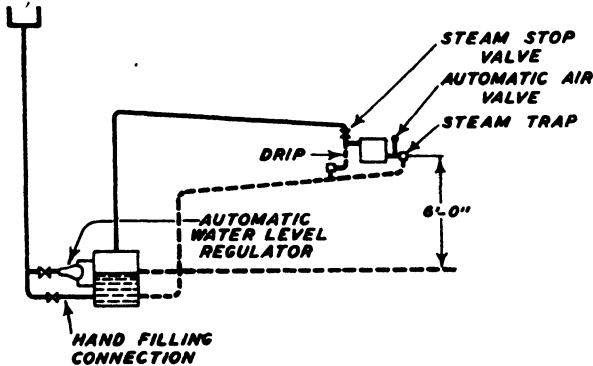

Fig. 9.—THE ESSENTIAL FEATURES OF A GRAVITY STEAM SYSTEM FOR UNIT HEATERS

trap.

The condensate line is similarly sloped back to the boiler, and the recommended slope is $\frac{1}{2}$ in. in 10 ft. for steam and dry condensate lines. A dry condensate means where carried horizontally above the water level in the boiler, that is, not completely filled with water. This would be the case with Fig. 9.

Calculating Steam Pressure Required for Gravity System

Where the condensate returns to the boiler by gravity, the boiler pressure must be limited according to the pressure or head exerted by the vertical condensate pipe. It will be appreciated that the steam pressure in the boiler is exerted downwards on the water, so that for each 1 lb. per sq. in. pressure exerted by the steam the water in the condensate piping rises approximately 2.5 ft. Furthermore, the level in the condensate line must be slightly higher than that corresponding to the steam pressure in the boiler, in order to provide the head to overcome the resistance to the flow of air, steam and condensate in the piping. Thus, with 6 ft. head available we must allow, say, 1 ft. for the head required to return the water to the boiler, and a further $1\frac{1}{2}$ ft. for margin, since the boiler pressure cannot be kept perfectly steady, leaving $3\frac{1}{2}$ ft. as the head corresponding to normal boiler pressure. This represents about $1\frac{1}{2}$ lb. per sq. in.

Avoiding Boiler Emptying

Running at even this low pressure allows only a small margin of reserve, for it will be realised that if the boiler pressure were allowed to reach 3 lb. per sq. in. the condensate would be forced to back up into the unit heaters, since 3 lb. corresponds to $7\frac{1}{2}$ ft. above boiler water level, and a still higher pressure would cause partial flooding of the steam line until in the limit the boiler would become completely empty.

The fitting of a check valve on the condense main at the boiler would not remedy this trouble or in any way reduce the risk, except by introducing a time lag. Although the water would not back up along the return direct from the boiler, the check valve would not open until the water level in the system had reached a level equal to that corresponding to the boiler pressure, so that although evaporation of water at the boiler continues the amount evaporated is not replaced, but builds up on the inlet side of the check valve.

An automatic water level regulator is often fitted to the boiler to safeguard against the boiler running dry. In a gravity system where the boiler pressure is allowed to exceed that corresponding to the normal condensate level, the operation of the water level regulator would cause the system to become overfilled since the regulator automatically allows water to enter when the level is low in the boiler, but does not allow water to escape when the level is too high.

Boiler Pressure

Having too much water in the system is preferable to the boiler being burned out through becoming dry while under fire, but the automatic make up can often become a nuisance, so the writer favours a suitably low normal boiler pressure relative to the height of the condense, e.g. with a reliable automatic damper regulator on the boiler to keep the pressure under reasonable control.

With a pressure of $1\frac{1}{2}$ lb. per in. at the boiler, the steam mains may be sized for a pressure loss of $\frac{1}{2}$ lb. sq. in.

Suitable Table for Pipesizing

Table 2, based on the Babcock formula, will be found very convenient for ascertaining the sizes of steam pipes. To find the quantity of steam at a given pressure and drop for any size or length of pipe, the appropriate figures from each of the four columns are simply multiplied together; thus $W = a \times b \times c \times d$.

The other variables may be calculated from the following :—

$$\text{Pressure drop, } b, = W/a \times c \times d. \quad \text{Pipe size, } d, = W/a \times b \times c.$$

Allowance for Local Resistance

The allowance to be made per elbow resistance is given in Table 3.

The relative resistance of other local resistances compared with elbows are as already given for hot water (Ch. VII).

TABLE 2.—FACTORS FOR DETERMINING CARRYING CAPACITY OF STEAM MAINS, POUNDS OF STEAM PER HOUR

<i>Steam Pressure, lb. per sq. in. gauge</i>	<i>Factor a</i>	<i>Pressure Loss, lb. per sq. in.</i>	<i>Factor b</i>	<i>Length of Pipe in Ft.</i>	<i>Factor c</i>	<i>Diameter of Pipe in In.</i>	<i>Factor d</i>
0.0	0.193	0.125	153.8	20	2.24	$\frac{1}{2}$	0.063
0.3	0.195	0.25	217.5	40	1.58	$\frac{3}{4}$	0.205
1.3	0.201	0.375	266.4	60	1.29	1	0.536
2.3	0.207	0.50	307.6	80	1.12	$1\frac{1}{4}$	1.178
5.3	0.223	0.75	376.7	100	1.00	$1\frac{1}{2}$	1.828
10.3	0.248	1.00	435.0	120	0.912	2	3.710
15.3	0.270	1.5	532.8	140	0.841	$2\frac{1}{2}$	6.11
20.3	0.290	2.0	615.2	160	0.793	3	11.18
30.3	0.326	3.0	753.5	180	0.741	$3\frac{1}{2}$	16.71
40.3	0.358	5.0	972.7	200	0.71	4	23.63
50.3	0.388	10.0	1376.0	250	0.632	5	43.72
60.3	0.415	20.0	1945.0	300	0.578	6	71.76
75.3	0.452	30.0	2383.0	350	0.538	—	—
100.3	0.507	—	—	400	0.500	8	149.4
125.3	0.557	—	—	450	0.477	—	—
150.3	0.603	—	—	500	0.447	10	272.6
200.3	0.685	—	—	—	—	—	—

Sizing of Condense Piping

The sizing of condense piping can be done by means of the data employed for sizing hot-water pipes, with an appropriate correction for the additional resistance of the air and vapour flowing with the condense water; it may safely be taken that with a wet return, the water, air and vapour have the same resistance as would four times the quantity of water by itself, and for a dry return, eight times the actual condensate.

We may now proceed with the sizing of the pipes shown in Fig. 6. The total amount of heat to be delivered into the factory is 347,800 B.T.U. per hour, and since practically the whole of the piping is useful heating surface, this is the quantity the mains are required to carry, the amount of heat given off by the steam and condense lines being deducted from the total heat loss from the factory to ascertain the balance required from the unit heaters.

TABLE 3.—EQUIVALENT LENGTH OF PIPE PER ELBOW RESISTANCE

<i>Size of Pipe</i>	<i>Ft. per Elbow</i>	<i>Size of Pipe</i>	<i>Ft. per Elbow</i>	<i>Size of Pipe</i>	<i>Ft. per Elbow</i>
$\frac{1}{2}$ in.	1	$1\frac{1}{2}$ in.	3.5	$3\frac{1}{2}$ in.	11
$\frac{3}{4}$ in.	1.5	2 in.	5.0	4 in.	13
1 in.	2.0	$2\frac{1}{2}$ in.	6	5 in.	19
$1\frac{1}{2}$ in.	3.0	3 in.	9	6 in.	24

It may be taken that in condensing from steam at $1\frac{1}{2}$ lb. per sq. in. to condensate at about 180° F., each pound of steam gives up one thousand B.T.U. per hour. In heating practice where extreme accuracy is not required, it is usual to take the heat given up by steam in condensing as a thousand B.T.U. per hour, regardless of steam pressure or condensate temperature.

Weight of Steam

The total weight of steam to be carried through the pipes and unit heaters and condensed into water is therefore $347,800/1,000 =$ say, 348 lb. per hour for the six unit heaters. Each individual unit heater therefore requires slightly more or less than $348/6 = 58$ lb. per hour, according to distance from the boiler, whilst a pipe serving two units must carry 116 lb. per hour, and three, 174 lb. per hour.

The travel to the most distant unit is approximately 100 ft., to which 75 per cent. should be added for local resistances.

We have now ascertained the following factors :—

$W = 58$ lb./hr. per unit ; 116 for two ; 174 for three.

Factor $a = 0.201$ corresponding to a boiler pressure of 1.3 lb.

Factor $b = 307.6$ corresponding to a loss of $\frac{1}{2}$ lb.

Factor $c = 0.74$ corresponding to 175 ft. travel.

Size of Steam Pipes

To determine factor d in order to arrive at the size of pipe required, the following calculation must be made for each amount of steam carried :

$$d = W/a \times b \times c.$$

The product of a , b , and c , or $0.201 \times 307.6 \times 0.74$ is 45.7, so for 58 lb. per hour factor d is $58/45.7 = 1.27$ and from Table 2 the corresponding pipe size is $1\frac{1}{4}$ in. ; for 116 lb. factor d is 2.54, corresponding to $1\frac{1}{2}$ in. much more closely than 2 in., whilst for 174 lb. per hour d is 3.81, indicating a 2-in. pipe. If the six units were supplied from a single pipe from the boiler factor d for this pipe would be $348/45.7 = 7.6$ and its size $2\frac{1}{2}$ in. diameter.

Size of Condense Pipes

Having sized the steam pipes we will now deal with the condense.

The travel may be taken at 175 ft. as for the steam and the head available for overcoming the resistance to the flow of condense vapour and air is 12 in. of water column at a temperature of about 180° to 200° F. This should strictly speaking be converted into inches head at standard temperature 62° F. by multiplying by the constant 0.97 but usually the full head is taken. The permissible rate of pressure loss is therefore $12/175 = .0685$ in. W.G. per ft. run. Since by far the greater part of the condense piping is above the water line and is "dry" the quantity of water having the same resistance as the air vapour and

condense water from each unit is $58 \times 8 = 464$ lb. per hour, 928 lb./hr. for two units, 1,392 for three and 2,784 lb. per hour for six, and the sizes found from hot-water pipe sizing data are $\frac{3}{4}$ in., 1 in. and 1 in. for one, two and three units, whilst the common main from all six is $1\frac{1}{2}$ in.

Heat Emitted by Steam and Condense Piping

The heat emitted by the steam and condense pipes may be calculated from Table 4.

TABLE 4.—HEAT EMITTED, B.T.U. PER HOUR PER FT. RUN OF PIPE, WITH ROOM TEMPERATURE OF 55° F.

Size of Pipe	Condense at Average of 190°	Steam at 1.3 lb. per sq. in.	Size of Pipe	Condense at Average of 190°	Steam at 1.3 lb. per sq. in.
$\frac{1}{2}$ in.	85	105	$2\frac{1}{2}$ in.	240	285
$\frac{3}{4}$ in.	110	130	3 in.	295	345
1 in.	125	145	$3\frac{1}{2}$ in.	325	385
$1\frac{1}{4}$ in.	150	180	4 in.	360	425
$1\frac{1}{2}$ in.	170	200	5 in.	430	520
2 in.	200	240	6 in.	510	610

Thus by multiplying out the lengths of pipe by the heat emitted per ft. run, the total heat given off from the piping can be determined and the heat required from the unit heaters established.

Making Steam and Condense Connections to Unit

The steam and condense connections to the unit heater should be made as shown in Fig. 10. Care should be taken to allow freely for expansion and contraction of the piping by the introduction of bends and springs at the unit heaters, as otherwise leaky joints will result no matter how well made they may be in the first instance.

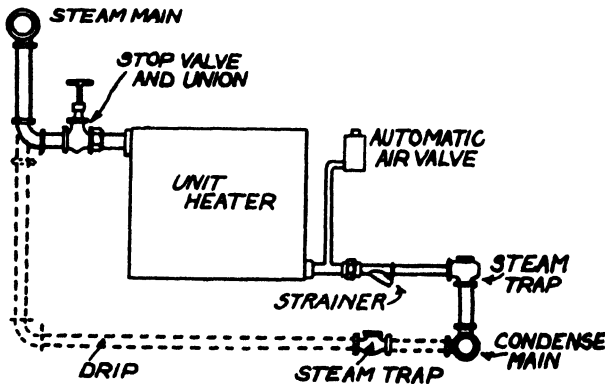

Fig. 10.—STEAM AND CONDENSE CONNECTIONS TO UNIT HEATER

So long as the steam main has a continuous pitch down and intermediate units served from the top of the main, only the end units need have the drip pipes and traps indicated.

As an alternative to the automatic air vent at each individual unit heater, a single automatic air eliminator may be fitted on the common condense main near the boiler.

The strainer indicated on the inlet to the steam trap is of importance because dirt or jointing material can completely upset the working of traps and allow a pressure to be generated in the condense main and retard the output of other units as well as introducing water-hammer.

A stop valve or reliable check valve should be fitted on the outlet from each steam trap to allow inspection or repairs without having to shut down the whole system.

Where unit heaters are supplied with hot water, thermostatic control is highly desirable for other reasons than saving fuel by avoiding over-heating.

How Control of Heat Output is Effected

It will be appreciated that air in motion feels cold when at temperatures which would be regarded as comfortably warm were the air not moving. For instance, air moving at a speed of 100 ft. per minute and a temperature of 75° F. feels no warmer than air at 62° F. and a speed of 30 ft. per minute. The sensation of coldness when in a fast-moving car may be recalled in this connection. Thus, if the steam supply to unit heaters were shut off when the desired temperature was reached in the factory and the fans left running, they would deliver air at a temperature of 55° F. or 60° F. at a high velocity and the result would be a most objectionably chilly blast.

It is therefore impracticable to control the output of unit heaters by means of throttling the valves or, in the case of hot water, by running the boiler at a lower temperature in less severe weather; neither is it desirable to shut off half the unit heaters when only half heat is required because this would cause unequal distribution.

Thermostatic Control

Where unit heaters are thermostatically controlled, therefore, the thermostat shuts off the fan or fans and the heat output is reduced to a negligible quantity. When the temperature in the building falls a degree or so the thermostat automatically restarts the fan or fans. Not only is this method superior to thermostatic valving, but it is also less expensive.

Another method of obtaining reduced heat output from unit heaters without causing cold draughts is to provide variable speed motors and run the units at low speed in mild weather when only part of the heat is required. With alternating current graduated speed control is somewhat costly, but two fixed speeds, high and low, for severe and mild weather respectively, is quite a simple and inexpensive feature for both single-phase and three-phase supplies.

Combined Hot-Water Unit Heater and Radiator

A hot-water system in which unit heaters and radiators are both supplied from the same boiler presents difficulties because it is not practicable to reduce the boiler flow temperature on account of the unit heaters, so the rooms served by radiators tend to become overheated in all but really severe weather. This difficulty can be overcome by running a separate low-temperature circulation to the radiators in the manner indicated in Fig. 11, or, alternatively, the circuits on which the radiators are connected may be thermostatically controlled.

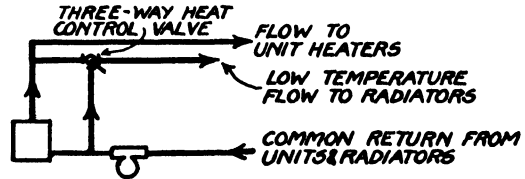

Fig 11.--COMBINED HOT-WATER UNIT HEATER AND RADIATOR SYSTEM

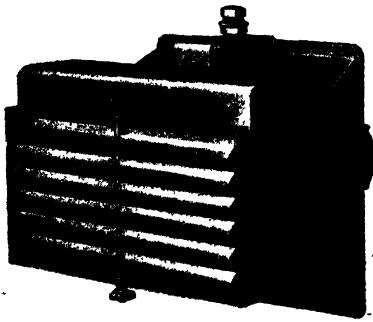

Fig. 12.- ELECTRIC UNIT HEATER WITH ADJUSTABLE LOUVRES

the ease and rapidity with which they can be mounted and brought into action in the case of new factories and workshops which have to get into production quickly, and, in the case of older factories, their installation involves no major structural alterations. When once put in, maintenance is merely a matter of periodical inspection and adjustment and replacement of components where necessary. A further advantage is the ease with which thermostatic

Electric Unit Heaters

A typical electric unit is shown in Fig. 12—simple, sturdy, efficient and reliable, consisting of a heating unit and a fan mounted in a sheet steel casing fitted with curved adjustable louvres. Fig. 13 shows the wall bracket for mounting which goes with it, but the essentials are rigidity of construction and accommodation for the mounting sheet.

The obvious advantages of electric unit heaters are

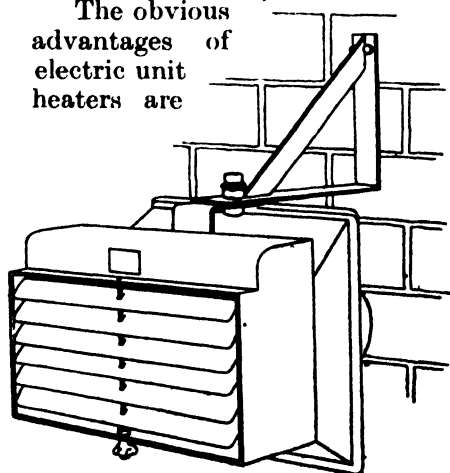

Fig. 13.—WALL BRACKET MOUNTING OF ELECTRIC HEATER

control can be applied. In the particular unit shown the heater battery is of the open coil block heat type and is protected against overheating by a fusible metal safety link in the circuit. A suitable mounting is 8 ft. 6 in. from the floor to the centre of the heater. Thermostatic control is desirable, as always, to give uniformity and reduce consumption to a minimum. A suitable height for the thermostat is 6 ft. from the floor.

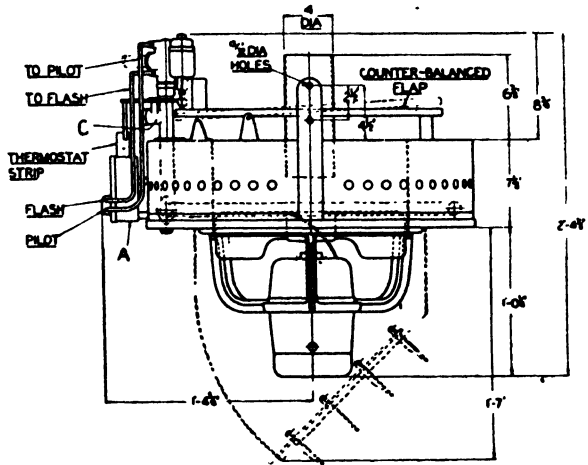

Fig. 14.- VERTICAL SECTION THROUGH GAS UNIT HEATER

Flueless Gas-fired Unit Heaters

Gas may also be used as the source of heat, and in Fig. 15 is shown the design of one such gas unit heater with a screen protected battery of luminous burners. The requirements are a supply of gas at ordinary town pressure and electric current to drive the fan motor.

In the unit in question the fan is mounted below the main body and discharges the warm air downwards in the form of a rotary cone. There is also a small supplementary air inlet to the fan which permits, in suitable conditions, the introduction



Fig. 15.—OVERHEAD GAS UNIT HEATER WITH LOUVRES

of a certain amount of outside air, if desired, useful in summer to improve ventilation. The unit is arranged for overhead suspension at heights up to 14 ft. above floor level, and the directly effective area, when slung, is that given by a circle approximately 25 ft. diameter. In corner position louvres enable the warm air stream to be deflected in any desired direction. The louvred casing can be adjusted to any radial position.

The burners consume one therm of gas per hour and give 90,000 B.T.U. output ; the fan circulates 81,000 cu. ft. of air per hour with a consumption of energy of approximately 150 watts. With the supplementary air inlet in use, 7,000 cu. ft. of this air is fresh and not recirculated air.

Providing the by-pass is kept alight, the burners light up automatically when the fan is switched on and a device is incorporated which switches off the gas immediately the fan stops. For economy, a thermostat operating at the required room temperature should be fitted. A $\frac{3}{4}$ -in. gas supply, dropped from the roof, is connected into the gas valve of the heater, and a stopcock should be fitted so that it can be cut off completely for overhaul or when out of use in the summer. The motor should be connected by suitable wiring with the switch in a convenient position.

Chapter XI

AUTOMATIC TEMPERATURE CONTROL IN HEATING AND VENTILATING

CONSIDER the heating of any body, whether it be liquid in a tank, the air in a room or factory workshop. The body will receive heat from whatever source that may be chosen and will lose heat due to radiation, convection and conduction; in many applications heat will also be lost by removal of a portion of the heated substance and replacement by fresh cold material. At the commencement of the heating process all the heat input will go to raise the temperature of the body; as the temperature rises the heat losses due to the first three factors just mentioned will increase and the rate of rise in temperature will decrease until finally a point is reached where the losses balance the heat input and a steady temperature results. Theoretically, this latter position only obtains after infinite time but for all practical purposes it can be considered to take place after a finite time which will depend upon the rate of heat input, the rate of heat loss and the capacity for heat of the body considered.

Thermal Equilibrium

Assuming that all the conditions remain constant, a steady temperature will be obtained; if such an assumption were correct there would be no need for temperature control. However, in practical heating applications many factors obtain which prevent the above-mentioned ideal conditions from being fulfilled, and so make necessary means of control. It is clear that increased input or decreased losses will cause an increase in temperature, and *vice versa*, and in practice it is very seldom possible to ensure that either the heat input or losses are constant. Furthermore, in many applications heat exceeding the amount necessary to overcome the losses at the required temperature has to be provided at frequent intervals to give quick increase of temperature to the required value; it is often inconvenient to have the increasingly retarded rate of temperature rise which is the characteristic obtained when the heat input just balances the losses at the required final temperature.

Variable Heat Losses

As a simple example let us take the case of a factory building. The one factor which decides the capacity of the heating plant which is put in is the amount of the heat losses from the building. These losses are

made up of radiation and convection losses from the outside walls and the heat which is expended in heating the air which is continually circulating through ventilation plant or through the windows to provide fresh air for the occupants. These losses are calculated for the worst possible condition, usually considered as being an outside temperature of 30° F., and the heating plant is made of sufficient capacity to give the required inside temperature when this condition prevails.

However, outside temperatures, and consequently the losses, continually vary from day to day, even from hour to hour; in this country in mid-winter outside temperatures may one day be 50° F., a day later 30° F. (actually averaging about 43° F.). If a constant temperature inside the building is to be maintained, the heat output from the heating system must be continually varied either by hand or automatically so that it is exactly equal to the varying losses.

If one takes the common instance of a hot water central heating installation, its heat output can be varied by valving off the radiators and by damping down the fire in the boiler. If this be done by hand it is a duty falling to the boiler attendant which is usually fulfilled only when complaints from inside the building demand a change in the output of the plant and this is invariably too late to avoid wide variations in the temperature of the building. Here there is a definite justification for temperature control, not only because of the increased comfort given to the occupants of the building, but also on account of the very great economy of fuel which is thereby obtained.

This latter point is readily appreciated since losses vary approximately directly with the temperature difference. Therefore to heat a building to 64° F. instead of 63° F. from the average outside temperature of 43° F. requires a 5 per cent. additional expenditure in fuel. It is quite common for the application of temperature controls to result in a 15 per cent. to 20 per cent. saving in fuel consumption.

The examples above mentioned are just two of many which illustrate the justification for some form of temperature control to the great majority of heating problems.

Basic Principles

Generally speaking, a thermostat, or temperature control device, consists essentially of an element, sensitive to temperature, which is located in the medium to be controlled. The sensitive element transforms changes in temperature into changes of mechanical dimension which, in turn, cause one of the following functions to be performed indirectly :

(i) Reduction of heat input immediately to zero when the temperature of the sensitive element slightly exceeds the required value, and then

re-establishment of heat input when the temperature falls by a slight amount. This is conveniently termed an "on-off" system of control.

(ii) Gradual decrease of heat input as long as the temperature of the sensitive element exceeds the required value by a small amount, and increase of heat input when the opposite is the case. Such a system, the increase and decrease in heat input normally being effected at a constant rate, is described as "floating" control.

(iii) Decrease of heat input with rise of temperature and *vice versa*, the heat input being proportioned to temperature difference above and below the required temperature. This system is termed one of "modulating" or "proportioning" control.

Meaning of the term "Differential"

From a consideration of the above an important factor comes to light, and that is that it is only by an actual change in temperature of the medium taking place and being transmitted to the thermostat that the latter can operate to effect the change of heat input necessary to counteract the change in temperature.

This leads to an important definition, namely the "differential" of the temperature control system. With an "on-off" system the differential is the temperature difference between the temperature at which the sensitive element causes the heat input to be reduced to zero with rising temperature, and that at which it causes it to be resumed with falling temperature. With a modulating system the differential is the difference between the temperature at which no heat input is given and that at which full input is given, between which temperatures heat input is varied proportionally.

It will be noted that in considering the above, care has always been taken to refer to changes in the temperature of the sensitive element, and not to changes of the temperature of the medium being controlled. The differential referred to above has always been the theoretical or operating differential.

Actually the temperature of the medium being controlled may or may not be the same as that of the sensitive element, and, what is an exceedingly important practical point, the reading of a thermometer immersed in the medium may be yet again different. Factors causing this discrepancy are :

(i) Difference in position of the sensitive element and the thermometer coupled with a temperature gradient between these two positions in the body being controlled.

(ii) If the medium being heated is air, it may be that the thermometer and sensitive element are either subject to different amount of radiant heat or the nature of their surfaces may differ, resulting in their receiving and reflecting different amounts of heat.

(iii) When change in temperature occurs, the temperature of the sensitive element (and of the thermometer), will always change at a slightly later time than the temperature of the medium, since time is taken for heat to be transmitted from the medium to the sensitive element and *vice versa*.

Under what may be termed ideal conditions for temperature control, rates of change of temperature are slow, and temperature is even throughout the bulk of the medium heated. Transmission of temperature changes to the sensitive element of the thermostat is sufficiently rapid in comparison with the time required for further change of temperature to take place in the medium that the temperature of the sensitive element may be said to follow exactly the temperature of the medium controlled.

The differential measured by a thermometer in the medium will then be identical with the operating differential of the thermostat.

In practice conditions differ widely from the above and to some degree at any rate, it is usual for the change in temperature of the thermostat to lag behind the change in temperature of the medium controlled. When this occurs it is clear that the thermostat will operate only after a change in the temperature of the medium larger than the differential of the thermostat has obtained. A similar effect may be experienced due to the heating means provided having a large heat capacity. For example, for heating an oven, heavy electric elements may be employed, which even though switched off by a thermostat, still retain sufficient stored heat to impart a further rise in temperature to the air in the oven.

In such circumstances, which obtain to a greater or lesser degree in almost every temperature control application, it will be seen that the actual differential obtained and measured by a thermometer will always exceed the theoretical differential of the temperature control device.

Modulating Control

In certain circumstances rates of temperature change may be so rapid when full heat input is provided or heat input reduced to zero, that no practical temperature control could follow the change.

A case in point is air conditioning work in which a continual stream of air passes through a heating battery of low heat capacity. Shutting off the heat supply completely will cause an immediate rapid fall in the temperature of the issuing air.

In such a case "on-off" control of the heat input is unsatisfactory; full heat input must be provided only when the temperature of the medium is well below the required temperature; heat input must be gradually reduced with increase of temperature near the control point; and the heat input must be reduced to zero only when the temperature is well in excess of the required temperature. This requires the use of a modulating system of control.

Heat Acceleration

Consideration of "on-off" control, and the difference between the theoretical differential of a thermostat and the actual differential obtained in practice, suggest that if by any means the sensitive element of the thermostat could be made to receive heat from the source more directly than by conduction from the medium being controlled, then the increase in differential due to the inherent lag of the sensitive element could be avoided. This is often arranged in practice either by placing the thermostat relatively close to the heat source, so that it receives heat directly, or as is done with electrical thermostats, particularly for the control of air temperature, by providing a separate electric heater in the thermostat, the heater being energised when the thermostat is calling for heat.

Such special arrangements have to be made with great care, as unless the additional heating effect given to the thermostat is kept within certain close limits the effect may be to give effective control of the temperature of the heating source, and hence constant heat input, rather than control of the medium.

Design of the Thermally Sensitive Member

The sensitive element of any temperature control is invariably a matter for exceedingly careful consideration by the manufacturer and the attributes which are important are, firstly, that its physical properties are such that when located in intimate contact with the medium to be controlled it shall respond as quickly as possible to changes of temperature in that medium; and secondly that such changes of temperature shall provide mechanical movement and force to give the maximum possible amount of work for indirectly performing one of the functions mentioned earlier.

In ordinary commercial temperature control work, the thermally sensitive element of temperature controls can be divided into the following two classes:

Bimetallic Systems.—Bimetallic systems are those in which force and movement are obtained by virtue of the difference in expansion of two dissimilar metals. Usually, the arrangement consists of a tube of brass or other metal having large expansion co-efficient in respect of temperature and a rod of a nickel iron alloy having an exceedingly small expansion co-efficient; alternatively the same two metals may be used rolled together in the form of a strip, the expansion of one side of the strip with increasing temperature causing the strip to bend and enabling work to be performed.

In a bimetallic system of the rod and tube type, the movement obtained with change of temperature is small—a brass tube 12 in. long

expands only 0.001 in. for a change in temperature of 10° F. To offset this the force available is exceedingly large.

Filled Systems.—A filled system consists of a sealed bulb, which forms the sensitive element proper, and which contains a liquid having either large volumetric expansion or large change of vapour pressure with change of temperature. The sealed bulb is usually connected by capillary tubing to a sealed metallic bellows, and changes in temperature at the bulb results in a corresponding change in pressure and volume of the charged system, so making the bellows expand or contract. Movement of the bellows against a spring causes operation, according to temperature, either of an electric switch or of a valve directly.

In some types of instrument, e.g. for room temperature control, the sealed bellows expansion chamber is actually the sensitive bulb itself, no capillary tube being involved.

Function of the Thermally Sensitive Member

In the above consideration of the design of the thermally sensitive member, it will have been noted that variation of temperature produces force and movement, i.e. an amount of work which can be used to control the heating means in a number of ways.

One of the most common is the operation of an electric switch. The electric switch may control electric heating loads directly or through the medium of a relay; it may switch the electric current to a magnetic or motor operated hot water or steam valve so providing “on-off” control to whatever means of heat input is employed; or it may similarly control a motor operating to open or close dampers on a boiler for example.

The design of the electric switch is exceedingly important since if control of temperature within close limits is required, the mechanical work available to operate the switch is limited to a small value. The operating movement normally provided in hand or relay operated electric switches for breaking heating load of say 2 to 3 kW. can be obtained only at the expense of a reduction in operating force.

The development of the “Satchwell” or micro-gap switch just over ten years ago, brought to the temperature control field a method of switching which is ideal for thermostatic work, and in the temperature control field is the most widely employed means of switching alternating current heating loads up to 3 kW. The microgap switch depends for its operation upon the use of heavy contacts of high electrical and heat conductivity which are separated to a small distance only (of the order of 0.005 in.). The small amount of heat generated by the short arc formed when the contacts separate is conducted away so quickly from the point of striking of the arc that with alternating current the contacts are sufficiently cool at the instant the current reaches zero in the A.C. wave, that the current does not persist after this point.

Only small amplification of the movement available from the direct expansion of a brass tube is required to provide the necessary movement of the contacts. This amplification can be obtained by the flexing of a spring lever without recourse to pivots. Pivots are undesirable in thermostat design because they introduce points of wear, and the movement available for a given change of temperature is usually so small that wear is fatal to the continued accuracy of calibration of the instrument.

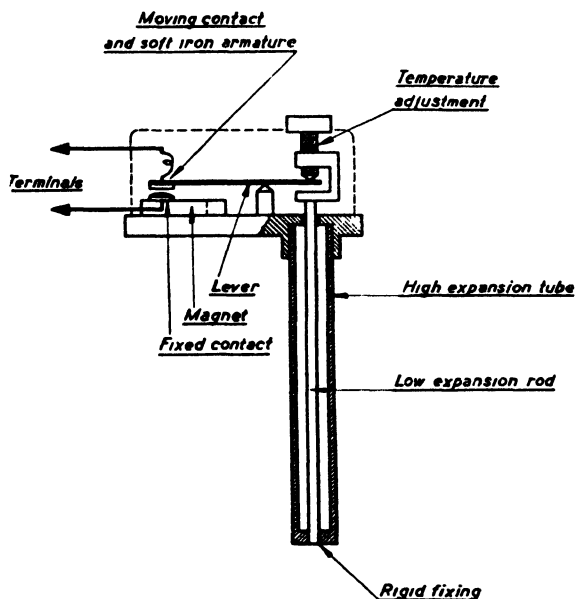

1000

By courtesy of the Rheostatic Co., Ltd.

Fig. 1.—DIAGRAMMATIC VIEW OF BIMETAL MICRO-GAP SWITCH THERMOSTAT

Flick action of the contacts is essential and this is most readily obtained by the employment of a magnet, which enables the necessary constraining forces to the contact arm to be applied again without recourse to pivots. Fig. 1 shows diagrammatically the mechanism of a thermostat of this type; the diagram itself is self-explanatory except that it should be noted that the pivot shown in the figure does not exist in practice, but the necessary lever amplification is obtained by the flexing of the lever over a rigid portion of the instrument.

When the sensitive element comprises a piece of bimetallic strip, one of the contacts may usually be mounted direct on to the flexible strip, so providing an exceedingly simple and robust arrangement, particularly suitable for room temperature control.

Another form of switch, employed to a lesser extent, is the mercury tube type which has certain advantages when handling electric heating loads on direct current supply. Amplification of the movement obtained from a bimetallic system is usually necessary, and involves the disadvantage of lever and pivot arrangements mentioned earlier.

Mercury tube switches are often allied to temperature sensitive elements of the liquid expansion or vapour pressure type where the

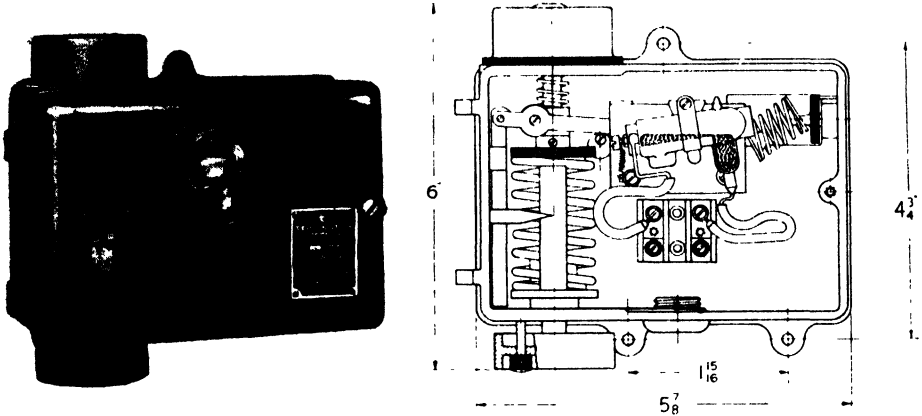
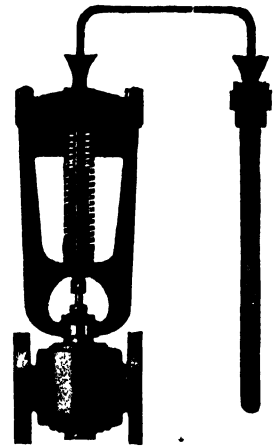

Fig. 2.—VAPOUR PRESSURE MERCURY TUBE THERMOSTAT

movement obtainable is larger. Fig. 2 shows a typical instrument of this type.

Vapour Pressure Elements

The mechanical work obtained from the sensitive element may be employed to operate a valve on a gas, hot water, or steam supply line directly. In the construction of such a thermostatic valve, the vapour pressure or liquid expansion form of sensitive element is used in practically all except the smallest form of gas controls. Fig. 3 shows a typical vapour pressure operated thermostatic valve of this type. Referring to this figure, it will be seen that the trapped vapour resulting from the heating of the volatile liquid in the bulb exerts pressure in the bulb, this pressure corresponding exactly to the temperature. The capillary tube transmits the pressure to the bellows which is connected directly to the valve, but movement of which is opposed by a spring. Alteration of spring tension alters the temperature at which the vapour pressure overcomes the spring reaction and closes the valve. Such a device provides modulating control, since the valve takes up a throttling position dependent on temperature.



By courtesy of the Drayton Regulator and Instrument Co., Ltd.
Fig. 3.—SECTIONED VIEW OF STEAM VALVE DIRECTLY OPERATED BY VAPOUR PRESSURE SYSTEM

Fig. 4 shows a further form of direct acting control, viz., the type of regulator employed for domestic and industrial hand-fired boilers. Expansion of a liquid filled bellows operates directly by means of linkage or chain, the main draught damper.

Modulating, etc.

For the purpose of providing modulating control by electrical means, the sensitive element may be used to move a contact over a slide wire resistance or potentiometer; here the sensitive element chosen is usually a filled system because of the large movement required by the slider. A thermostat of this type is shown in Fig. 5. The slider resistance so operated is incorporated in an electric circuit of the Wheatstone Bridge type, in such a way that a motorised valve is caused to take up a position corresponding with that of the slider

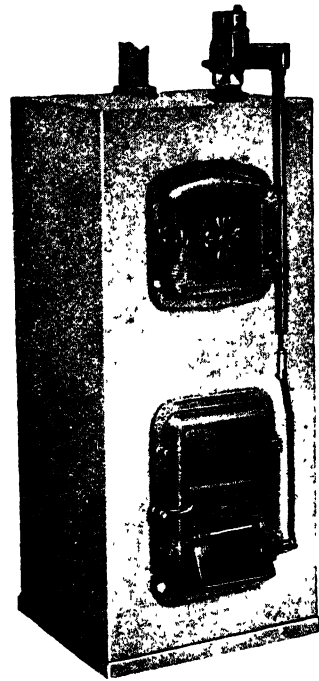

By courtesy of the Rheostatic Co., Ltd.

Fig. 4. — DIRECTLY OPERATED THERMOSTATIC DAMPER CONTROL FOR DOMESTIC HAND-FIRED BOILER

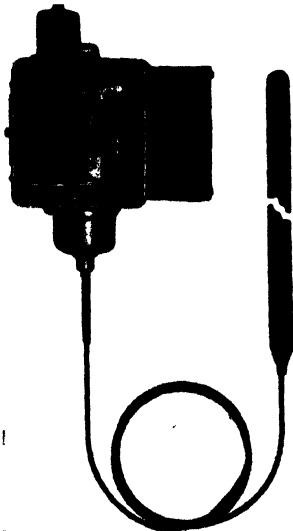

By courtesy of Honeywell-Brown, Ltd.

Fig. 5. — INTERIOR VIEW OF VAPOUR PRESSURE OPERATED MODULATING THERMOSTAT

on the resistance, i.e. dependent upon temperature; alternatively, a set of motor operated contacts may be operated in sequence to switch on more or less sections of an electric heating load according to temperature.

Direct acting thermostatic valves, similar in principle to those described earlier may be used, not to control steam, gas or hot water supplies directly, but as pilot valves providing increase or decrease of air or water pressure to a diaphragm, i.e. pressure operated valve of much larger size. Fig. 6 shows a system of this type, and it will be seen that the air or water pressure is piped to the diaphragm valve through a small orifice, and via the

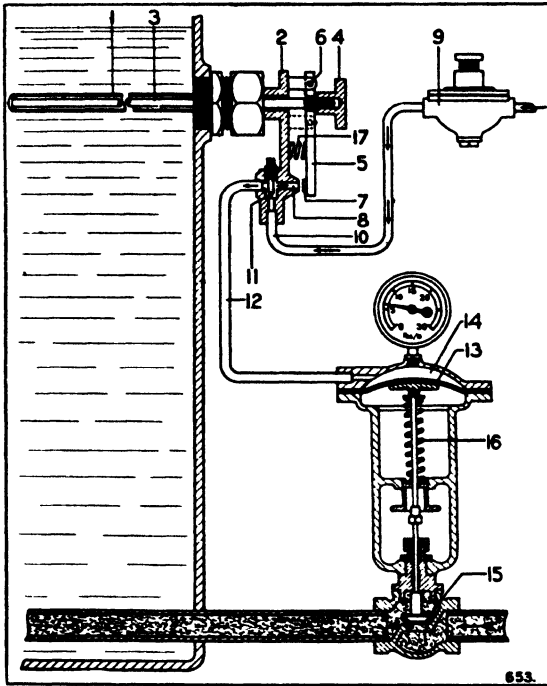

Fig. 6.—DIAGRAMMATIC VIEW OF ARRANGEMENT OF AIR OR WATER OPERATED CONTROL SYSTEM

controlling instrument. At low temperature, the thermostatically operated pilot valve allows full pressure to apply to the diaphragm operated valve so opening it, while as the temperature increases, the pilot valve directs more and more of the operating medium to a leak pipe or drain, so reducing the pressure on the diaphragm and allowing the valve to close.

Such an arrangement naturally requires a source of air or water under pressure for its operation.

In a further development of the above system, the temperature sensitive element, a motor for providing oil pressure for valve operation, and the valve itself, are all built into one self-contained unit.

Such a unit is shown in diagrammatic form in Fig. 7. The motor drives an oil pump which, when the thermostatic element demands heat, provides pressure on the large bellows which holds the main valve open. Increase in the temperature of the sensitive element causes this to open a small relief or pivot valve permitting release of oil from the large bellows chamber, and allowing the main valve to close. The position taken up by the valve varies exactly in accordance with the temperature.

Compensated Control

There are certain systems used in specialised fields, particularly in those of central heating and air conditioning, which are entirely different in basic principle from those dealt with earlier, in that no element whatsoever is located in the medium under control. Instead the sensitive element is located in a position where it is acted upon by a measure of the losses of the body it is desired to control.

A simple form of such control for central heating comprises two liquid filled bulbs, one of which is located outside the building, one in

the central heating flow main. Both bulbs are connected by capillary tubing to a Bourdon tube operating a switch controlling the automatic stoker or other firing means. Increase of outside temperature results in the temperature at which the second bulb controls the flow water being decreased and *vice versa*, so maintaining a reasonably uniform temperature inside the building. An instrument of this form is shown in Fig. 8.

A later form of inside/outside controller is all electric in operation and is unique in that the outside element is sensitive, not only to temperature, but also wind, rain and sun.

The Outside Pilot

As applied to a hot water central heating system an outside unit or pilot, of the form shown in Fig. 9, is mounted on an exposed wall of the building, usually the north wall, this outside unit containing a temperature sensitive element of the liquid filled bellows type, which with change of temperature moves a slider over a potentiometer resistance.

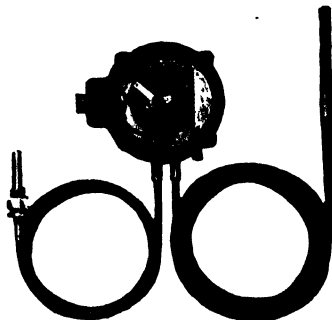

By courtesy of the Drayton Regulator and Instrument Co., Ltd.

Fig. 8.—INSIDE-OUTSIDE TEMPERATURE CONTROL FOR CENTRAL HEATING PLANT

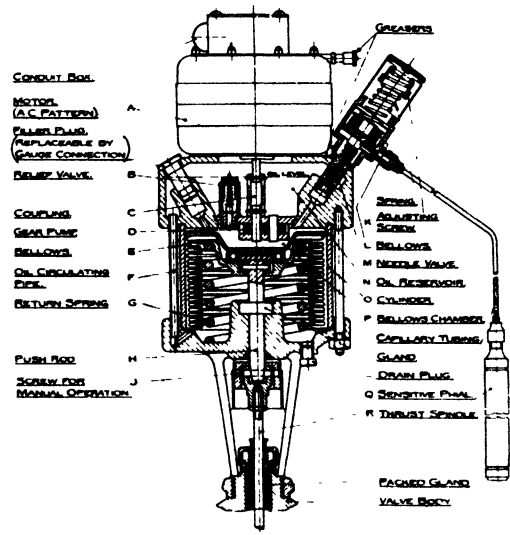

ELECTRO-MECHANIC POWER UNIT
MODEL HQ (TEMPERATURE SENSITIVE INSIDE) (SERIES I) 11673

By courtesy of the British Thermostat Co., Ltd.

Fig. 7.—DIAGRAMMATIC VIEW OF SELF-CONTAINED ELECTRICALLY AND OIL PRESSURE OPERATED MODULATING VALVE

By virtue of a heating element mounted in the same case as the liquid filled bellows, the latter is made sensitive, not only to outside temperature, but also to such effects as wind, rain, sun and frost, all of which have similar influence upon the outside unit as far as heating losses are concerned as they have upon the building itself.

Since it is required to vary the heat input to the central heating system, the criterion to be operated on is the flow water temperature. A special form of thermostat is employed as the controlling instrument for flow temperature, this

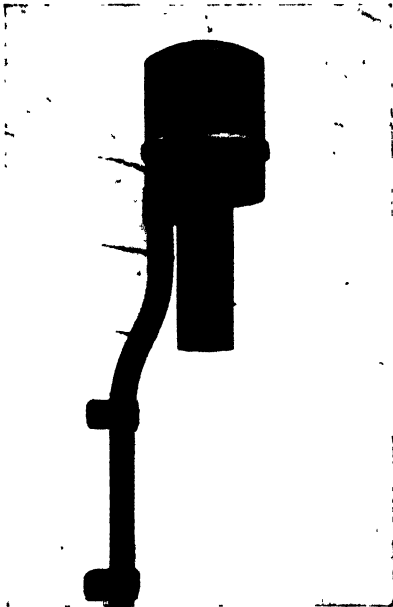

By courtesy of the Rheostatic Co., Ltd.

Fig. 9.—OUTSIDE PILOT OF ALL ELECTRIC COMPENSATOR FOR CENTRAL HEATING CONTROL

thermostat switching on and off the mechanical stoker, or whatever other means is provided for heating the boiler. The temperature of operation of this instrument is varied electrically according to the dictates of the outside instrument referred to above.

For the usual central heating system, a flow temperature of 180° F. is automatically provided with an outside temperature of 30° F., and a flow temperature of 120° F. with an outside temperature of 60° F. and proportionately within these limits.

Apart from the advantage of response to factors other than outside temperature, viz., wind, rain, etc., the electric compensator control is much more flexible in that (i) there is no limit to the distance from the boiler that the outside unit may be fixed—its position may be chosen entirely from thermal considerations, and (ii) ready means of adjustment of the temperature compensation can be obtained

by variable resistances in a suitable control panel or "calibrator" box.

Choice of Type of Instrument

In considering what appears to be a large number of types of controls fulfilling similar purposes it may be difficult to decide upon the merit or otherwise of a particular system, especially where the application is such that a number of different types will all fulfil the functions required. Dealing with the various types in order:

Bimetallic operated controls with short break switches are the direct means of controlling electric heating particularly on alternating current circuits and they are therefore almost universally applied for the control of domestic electric water-heaters and for the control of electric space heating. Owing to their inherent simplicity and robustness, thermostats of similar type, and similar to that shown in Fig. 1, are widely used for all general purposes, e.g. boiler and calorifier control, operation of motorised valves, etc.

Bimetallic instruments incorporating mercury tubes are advantageous where a low priced control is required for direct current use, e.g. for the

control of D.C. electric water heaters. The reliability is not so great as that obtained with a bimetallic thermostat of the microgap switch type used with a relay.

Liquid expansion or vapour pressure instruments incorporating various forms of electric switch are useful where the space available for the sensitive element is small, or where it is impossible to accommodate the switch portion near the sensitive element.

Thermostatic valves of the direct operation type, as shown in Fig. 3, are generally employed for small sizes of steam-heated tank and calorifiers; smaller types of directly operated valves in which the expansion of a bimetallic tube operates a valve directly are used in domestic gas appliances such as cookers and water heaters.

Electrical thermostats operating motorised valves are applied where the valve size or the pressure of the heating medium, steam, hot water, oil or gas, as the case may be, demand the application of more power than is available from direct operation. When employed in this way a sensitive thermostat can command an electric motor capable of developing a high torque and operating valves or dampers of large sizes. Such a system is also invaluable when the sensitive element is located at a considerable distance from the valve to be controlled. Motorised valve operation, which can be either of the on-off, floating or modulating type, can be considered the general purpose method of providing temperature control of steam or hot water heating systems. Fig. 10 shows a motorised valve of the butterfly type commonly used for the control of hot water central heating.

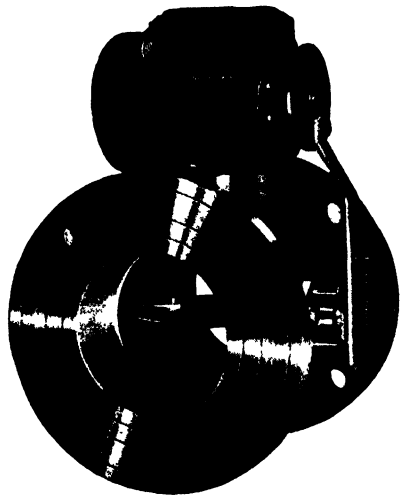

By courtesy of the Rheostatic Co., Ltd.

Fig. 10.—BUTTERFLY VALVE FOR USE ON HOT WATER HEATING SYSTEM, CONTROLLED BY ELECTRIC MOTOR

Air or water pressure operated valves such as that shown in Fig. 6 have the same field of application as modulating electric controls and are advantageous where it is necessary to be independent of electric supply, and where air or water pressure is available. Such systems are often employed for the control of gas heated boilers or ovens.

Automatic Operation of Drying Plants

An interesting indirect application of temperature control or, more

correctly, of temperature sensitive devices, is in the provision of automatic operation in drying plants incorporating the absorbent material known commonly as silica gel. Many silica gel drying plants are entirely automatic in operation, regeneration of the gel at the necessary periods being carried out by passing hot air through the gel. As long as moisture remains in the gel, the temperature of the air passed out is considerably cooler than that of the entering air but the temperature rises as regeneration becomes complete and the gel becomes dry.

Fuel Oil Burning

Temperature control plays an important part in the handling and burning of special liquid fuels. In reducing the consumption of the usual grades of fuel oil, use is now made of cruder fuels such as mixtures of creosote and pitch, and these for their successful handling and combustion have to be stored and distributed, and also burnt, at definite temperatures.

Such fuels become too viscous to handle below a certain temperature, while at slightly higher temperatures sludge is deposited which clogs filters and again prevents satisfactory handling. Delivered warm, the fuels are stored in electrically or steam heated tanks with straightforward temperature control. From the storage tank the fuel is then pumped around a distributing ring main to the various burners in a factory, heat loss during the passage round the ring main being offset by running alongside the ring main a steam tracer line or electric heating cable. Temperature control is essential since the losses will vary according to outside conditions and is most satisfactorily effected by a thermostat inserted in the return from the ring main. This thermostat controls the electric heating load directly or the steam heating through a motorised valve. One thermostat in the return gives effective control of the temperature of the oil throughout the ring main and is in effect better than a number of thermostats controlling various portions of the ring main.

Before passing to the actual burner nozzles the fuel oil mixture has to be heated to a satisfactory temperature for combustion and here at the final step temperature control plays an important part in ensuring efficiency.

Central Heating

The nature and use of buildings, and the types of heating systems vary to an extent which made the application of temperature control to any particular building a problem which is well worth while considering in detail. The economy of the heating plant during years of service may depend on the selection of suitable controls.

The control of any heating system requires essentially a means of controlling the rate of combustion in the boiler, as it is obviously im-

possible to attempt to apply any form of control unless the prime source of heat is controlled as a first step.

Boiler Control

The smaller sizes of hand fired boiler up to about 150,000 B.T.U. are readily controlled by means of direct acting regulators as shown in Fig. 4. Larger hand fired boilers require more positive control than can be effected by control of the air inlet under the ashpit only, and such boilers are often provided with special arrangements of both primary ashpit damper and check draught damper suitable for simple motor operation. The former may be opened and the latter closed by a small electric motor when the controlling thermostat demands heat.

Modern developments in boiler firing have contributed much to the ease of thermostatic control, particularly automatic gravity feed boilers, automatic coal stokers and automatic oil burners, the two latter being capable of direct control by electrical switching.

When considering any of the means described above for providing control of the prime source of heat it must be clearly borne in mind that control of boiler temperature or boiler pressure alone is useless since constant temperature or pressure will provide sensibly constant heat input to the building. Constant boiler temperature is only required where the same boiler has to provide hot water for domestic purposes or for separate industrial use.

In the simplest case, viz., that of a boiler supplying central heating only, control may usually be carried out by the compensating control system described earlier, varying the boiler temperature in accordance with outside temperature. The electrical switch of the controlling device controls directly, or through a motor starter, the damper controlling motor, or the motor driven coal stoker or oil burner as the case may be. In certain types of installations such as those where the buildings involved are likely to have varying numbers of occupants, e.g. cinemas, restaurants, public halls, control of the compensating form alone is not adequate. Apart from variable losses, one has to contend with a variable amount of incidental heat from the occupants, and control must be obtained by reference to the air temperature in the building. To obtain this a room thermostat in the space heated may be used as a limiting control in conjunction with the compensated control mentioned above.

Private Houses and Offices

A common type of installation used in private houses or offices is that shown in Fig. 11. Here one boiler is employed to supply both central heating and a calorifier for domestic hot water. Due to the demand for the latter a constant boiler temperature is necessary, and is ensured by a direct acting control, as shown in the diagram, if the boiler

is a small hand fired one ; or on a larger boiler, or one fired by an automatic stoker or oil burner, by an electrical boiler thermostat.

The varying heat input required for the central heating is then obtained by use of a motorised valve in the central heating circuit, the valve being controlled by a room thermostat in a convenient spot in the building. This room thermostat, by opening and closing the valve, automatically permits just the right amount of heat to be fed to the central heating system during all conditions of outside weather, even though boiler temperature is maintained constant.

Modern controls, by employment of the heat acceleration feature previously described earlier in the paper, permit the heat input, even with simple on-off motorised valves, to be given in sufficiently frequent impulses to prevent any marked alternation of heating and cooling periods.

Large Buildings

A further development of control in this way applies to buildings which are of such a size or nature that different sections of the building will be subjected to differing heat losses. A typical example of this is

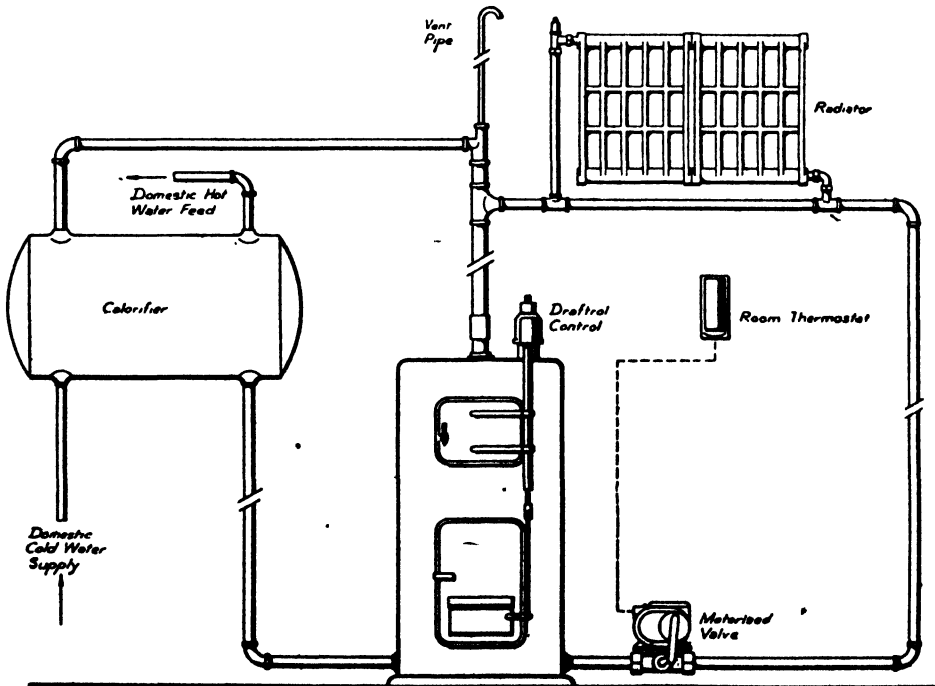

[By courtesy of the Rheostat Co., Ltd.]

Fig. 11.—DIAGRAMMATIC ARRANGEMENT OF CONTROLS FOR TYPICAL CENTRAL HEATING AND HOT WATER SUPPLY SYSTEM

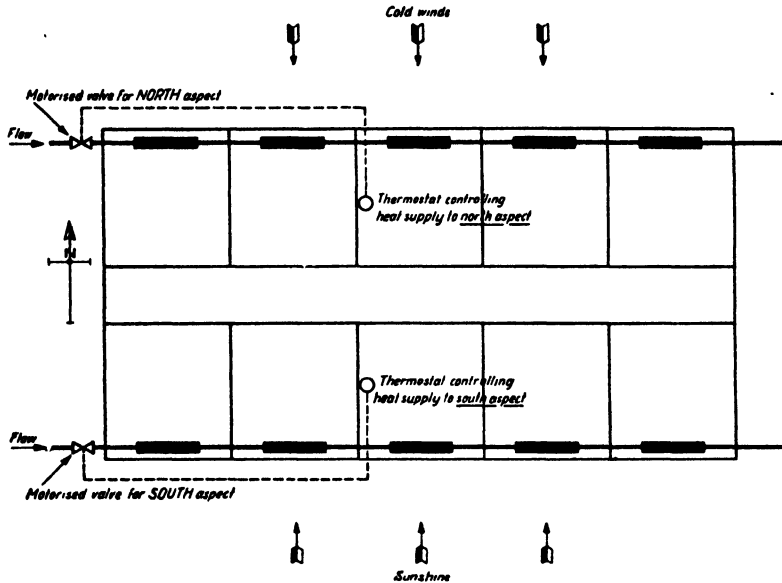

Schematic diagram illustrating the principle of aspect control.

THE RHEOSTATIC CO. LTD
SLOUGH-BUCKS

By courtesy of the Rheostatic Co., Ltd.

Fig. 12.—DIAGRAM ILLUSTRATING ASPECT CONTROL

shown in Fig. 12, where a building is shown in plan having one face subject to sun, and the other to occasional cold north winds. The heat requirements of the two sides of the building are manifestly different, and control as a complete unit is inadequate. Fig. 12 shows the solution, which is to split the heating into two sections, one circuit feeding the north side, one the south, controlling each by an appropriately placed room thermostat and motorised valve; or alternatively by a control of the compensating type sensitive to the losses of each section.

Many combinations of the above-mentioned schemes of control are possible incorporating time switches for night and week-end cut-out to provide a completely automatic heating scheme which cannot fail to give the maximum possible economy in operation.

Chapter XII

THERMAL INSULATION

THERMAL insulation, both of pipes and vessels containing heated fluids, and of structures themselves, has been somewhat neglected in this country, although insulation is one of the most obvious ways of saving heat. This neglect is no doubt due to the abundance and cheapness of fuel in the past, but increased costs of heat production have rendered the subject of the greatest importance.

It is not always realised how much heat is lost from uninsulated hot surfaces: some figures of heat emission were given in Chapter I, and the fuel wastage, due to bare pipes in still air at 70° F., is shown in Fig. 1.

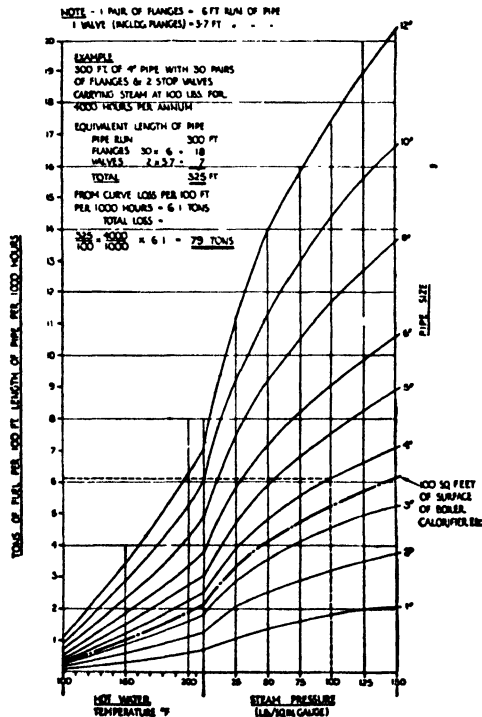

Fig. 1.—FUEL WASTAGE ON EXPOSED PIPES
WITH SURROUNDING TEMPERATURE 70° F.

Thus the amount of fuel wasted by loss from 100 ft. of 6 in. pipe carrying steam at 50 p.s.i. would be about 7 tons per 1,000 hours of operation: for a pipe in constant service the loss would be about 60 tons

per annum, which would be approximately doubled if the pipe were exposed to open air conditions. Yet such cases are not unknown. Nearly all this loss could be prevented by efficient insulation, and in general all hot surfaces from which heat emission is not required should be insulated.

With hot water heating systems, the loss is of course less than with steam, but here again the cost of insulation is rapidly recovered by the resulting saving in fuel.

In this Chapter some notes are given on the insulation of pipes, etc., and of structures.

THE INSULATION OF PIPES, BOILERS, ETC.

The rates of heat loss from bare pipes at various temperatures are given in Chapter I, in which it is also stated that bright metallic surfaces do not lose heat at the same rate as surfaces with ordinary finishes.

Insulating Materials

The main characteristics of insulating materials are well known. As already stated, metallic insulators depend upon reduction in radiation. Of these, crumpled aluminium foil held in a rigid casing is very efficient, particularly where lightness is of paramount importance. Even aluminium paint will save about half the normal radiation losses. Jackets of planished steel combine good insulating properties with excellent appearance; they are, however, expensive, and their use is generally confined to high-pressure steam installations.

Ordinary non-metallic insulating materials depend for their properties upon the presence of numerous small air cells in their structure and upon the heat reflecting properties of the walls of these cells. The following are notes on some materials in common use as insulators:—

Asbestos.—Asbestos is of mineral origin with a comparatively high conductivity in its natural state. In the process of manufacture, however, it is finely carded and a small amount of binding material (usually about 15 per cent. of sodium silicate) is added. It is made in many forms of slab and section and is also made up in the form of blankets and ropes. It withstands high temperature and is non-corrosive. Where lightness is of importance, sections made up of cellular asbestos paper can be used; these, however, are not very efficient owing to the convection currents which are set up in the comparatively large air cells. Asbestos blankets and mattresses for cylinder covers, etc., have considerable mechanical strength and can be removed and replaced without suffering damage. Special moulded shapes for flanges, bends, etc., are also made.

Plastic asbestos can also be used in a composition as a hard-setting coat to form a protective finish to some other insulating materials of a flocculent nature.

Magnesia.—Magnesia is very widely used as an insulator. The material consists of 85 per cent. of hydrated magnesium carbonate with 15 per cent. of asbestos fibre added as a binder. In the process of manufacture innumerable small air pockets are formed in the crystalline structure. It is very fragile and a hard-setting finishing coat is used for appearance, and where mechanical protection is necessary. It is usually applied in successive layers in plastic form, but can only be satisfactorily applied to surfaces at a temperature of at least 125° F. It is also made in block, sectional and mattress form, with paper or canvas backing.

Glass Fibre.—Glass fibre has in recent years been largely used as an insulator. It is very efficient, due to the polished surface of the fibres bounding the air cells. It also has the advantage that it is non-hygroscopic and non-corrosive. It is usually applied in the form of mattresses made of 1 in. thickness of the material, with paper or scrim cloth stitched on one or both sides. It can be readily cut to shape and with the addition of wire netting it forms a very convenient method of insulating flanges and valve bodies, which too often are neglected when pipework is covered. Glass fibre is also made up in rigid sectional form.

Slag Wool.—Slag wool is made by blowing steam through molten blast furnace slag. Its use as an insulator requires some care as it is liable to 'pack' and its conductivity varies with its density. It is, however, supplied in blanket form, the blanket being 30 in. in length and of the necessary width to wrap once round the pipe. It is also obtainable in long narrow strips of $\frac{1}{2}$ in. or 1 in. thickness; these are applied by winding spirally round the pipe.

Some forms of slag wool are hygroscopic and in the wet state can cause corrosion. Water repellent varieties are, however, obtainable.

The conductivity of insulating materials varies with the temperature, as shown by the following figures:—

TABLE 1.—VARIATION OF CONDUCTIVITY WITH TEMPERATURE

Mean Temperature (deg. Fahrenheit)	Conductivity		
	Magnesia	Asbestos (sectional)	Glass Fibre (rigid)
100	0.405	0.362	0.270
200	0.450	0.394	0.300
300	0.490	0.405	0.330
400	0.540	0.525	0.366

Average values of conductivities of various insulating materials are given in Table 2; these relate to a mean temperature of 200° F.

TABLE 2

<i>Material</i>	<i>Density lb. per cubic ft.</i>	<i>Conductivity k</i>
Asbestos, plastic	14	0.67
„ sectional	9	0.42
„ blanket	9	0.65
Magnesia	12	0.45
Glass Fibre (rigid).. .. .	8	0.30
Slag wool	15	0.33
„ „	19	0.48
Hard-setting composition	40-50	1.40

Detailed particulars of various materials can be obtained from the respective makers, and the conductivity values are usually based on the results of tests at the Natural Physical Laboratory.

Thickness of Insulation

The results of applying various thicknesses of insulation are shown below : they relate to pipes carrying water at 165° F., with still air and surroundings at 65° F. and with magnesia insulation.

Pipe bore, 1 inch—					
Thickness of insulation	nil	½"	¾"	1"	1½"
Temp. at surface (deg. Fah.).. ..	165	91	85	80	77
B.T.U. loss per sq. ft. per hour ..	244	49	34	25	20
„ „ per foot run per hour	86	30	25	22	20
„ „ per cent.	100	35	29	26	23
Pipe bore 3 inch—					
Thickness of insulation	nil	½"	¾"	1"	1½"
Temp. at surface (deg. Fah.).. ..	165	94	87	82	79
B.T.U. loss per sq. ft. per hour ..	244	56	39	30	23
„ „ per foot run per hour	224	66	51	43	36
„ „ per cent.	100	30	23	19	16
Pipe bore 6 inch—					
Thickness of insulation	nil	½"	¾"	1"	1½"
Temp. at surface (deg. Fah.).. ..	165	95	88	83	80
B.T.U. loss per sq. ft. per hour ..	244	57	41	31	25
„ „ per foot run per hour	415	112	86	69	59
„ „ per cent.	100	27	21	17	14

The results show that a given thickness of insulation is more effective on a large pipe than on a smaller one, this, of course, being due to the comparatively large increase in surface area. "Insulation" with unsuitable materials may actually increase the heat loss from small diameter pipes.

Another obvious deduction from the figures is that the first layer of insulation is more effective than subsequent layers, and this despite the fact that a greater volume of insulating material is required in each

successive concentric ring. Thus, for the cases considered, the reductions in heat loss are as follows :—

Pipe bore	Reduction as percentage of bare pipe loss	Successive increments of insulation			
		$\frac{1}{2}$ "	$\frac{3}{4}$ "	1"	1 $\frac{1}{4}$ "
1 in.	Due to layer	65	6	3	3
	Per cubic inch of layer ..	1.86	0.26	0.10	0.09
3 in.	Due to layer	70	7	4	3
	Per cubic inch of layer ..	0.93	0.16	0.08	0.66
6 in.	Due to layer	73	6	4	3
	Per cubic inch of layer ..	0.55	0.08	0.05	0.04

It is obviously uneconomical to apply too much insulation, but the figures clearly show that even a thin layer of insulation is very much better than nothing.

Tables 3 and 4 show the most economic thicknesses of various materials under different conditions of service. (By the "most economic thickness" is meant the thickness for which the sum of the value of the heat lost through the insulation and the capital charges—interest and sinking fund—on the cost of insulation is a minimum.)

TABLE 3.—RECOMMENDED THICKNESSES OF INSULATION FOR LOW PRESSURE HOT-WATER HEATING INSTALLATIONS

Bore of Pipe	Magnesia (excluding hard-setting finish)	Sectional Asbestos	Plastic Asbestos (excluding hard-setting finish)	Glass Fibre or Slag Wool
in.	in.	in.	in.	in.
Up to 3 ..	$\frac{3}{4}$	$\frac{3}{4}$	$\frac{3}{4}$	$\frac{3}{4}$
Over 3 to 8 ..	1 $\frac{1}{4}$	1 $\frac{1}{2}$	1 $\frac{1}{2}$	1
Over 8 to 10 ..	1 $\frac{1}{2}$	1 $\frac{1}{2}$	1 $\frac{1}{2}$	1 $\frac{1}{2}$
Over 10 to 12 ..	1 $\frac{1}{2}$	1 $\frac{1}{2}$	1 $\frac{1}{2}$	1 $\frac{1}{2}$

The above Table relates to water at a mean temperature of 140° F. and a system in operation for the full heating season (5,000 hours per annum).

Table 4 shows the corresponding figures for a low-pressure steam heating system.

TABLE 4.—RECOMMENDED THICKNESSES OF INSULATION FOR LOW-PRESSURE STEAM HEATING INSTALLATIONS

<i>Bore of Pipe</i>	<i>Magnesia (excluding hard-setting finish)</i>	<i>Sectional Asbestos</i>	<i>Plastic Asbestos (excluding hard-setting finish)</i>	<i>Glass Fibre or Slag Wool</i>
<i>in.</i>	<i>in.</i>	<i>in.</i>	<i>in.</i>	<i>in.</i>
Up to 3 ..	1½	1½	1½	1
Over 3 to 8 ..	1¾	2	2	1½
Over 8 to 10 ..	2½	2½	2½	2
Over 10 to 12 ..	2¾	3	2¾	2½

For boilers, cylinders, etc., the thicknesses should be as for the largest pipes.

The values given in Tables 3 and 4 relate to pipes, etc., under indoor conditions. For work exposed to open air conditions, the thicknesses should be increased by ½ in.

The Insulation of Pipes, Boilers, etc.

The application of insulation is a fairly simple matter, but some precautions should be observed. Plastic insulation is applied in layers to a hot surface, and it is important that each layer should be allowed to dry thoroughly before the next is added. For boilers, cylinders, and pipes of 3-in. bore and upwards, a lacing of coarse canvas, scrim, or netting should be applied, and finally the hard-setting coat. All insulation should be finished as smoothly as possible; rough finishes increase the surface area and thus the losses.

It is inadvisable to cover pipe flanges with plastic material; not only has this to be broken away if the flanges have to be disconnected, but it is sometimes found that the nuts have seized on the bolts. Where plastic covering is decided upon, however, the insulation of the pipe should be bevelled and painted on either side of the flange; moisture leaking from the joint will not then travel along the pipe surface, and the flange insulation can be easily broken away if required. Detachable flange boxes, filled with loose asbestos, are preferable, and special moulded forms are also available.

As already mentioned, glass fibre with wire-netting is a very satisfactory form of insulation for flanges or valve bodies; it can be rapidly applied and removed as required.

Sectional insulation can be rapidly applied by unskilled labour. It is usually clipped round the pipe by metal bands, but if necessary string or wire may be used for fixing. It is of importance that the sections fit, both radially and longitudinally, as closely as possible, as the insulating effect is greatly reduced if air can circulate between the hot surface and

the insulation. Special care in this respect is necessary when using mattresses or strip forms of insulation.

Generally speaking, steam apparatus of all sizes should be adequately insulated. As regards hot water pipes and appliances, these should also be insulated except where heat is required to be emitted,

Plastic magnesia is supplied in powder form, and is first mixed into a stiff paste with water. The plastic mixture is applied in rough layers, each about $\frac{1}{2}$ in. thick, leaving deep grooves to serve as a key for subsequent coats. Each layer must be allowed to dry thoroughly before the next is added and the surface must therefore be hot enough to dry out the insulation; the initial temperature of the surface should be about 120° F. and this may be increased as further layers are applied.

A protective coating of hard-setting composition, not less than $\frac{1}{2}$ in. thick, is then added. A layer of galvanised wire netting, $\frac{1}{2}$ in. mesh, should be applied, before the finishing coat is fixed, to pipes of 3 in. bore and over, and to boilers, cylinders, etc. The finishing coat should be finished smooth, as a rough surface increases the area and thus the heat loss, and for indoor work should be painted. (Colours for identification are laid down by the British Standards Institution as follows: Steam services: crimson; Hot-water heating: bright green; Hot water service: sky blue.) Paint should not be applied until the insulation is thoroughly dry. In some cases, aluminium paint may be used, with bands of colour at suitable intervals. For outdoor work, or any work exposed to damp conditions, insulation of any type should be covered with waterproof roofing felt, wrapped round with galvanised netting, and then given two coats of tar or bituminous paint.

Cold Water Pipes

Cold water feed and safety vent pipes should be wrapped with hair felt at least $\frac{1}{2}$ in. thick inside buildings. Where they are exposed to open air, the felt wrapping should be at least 1 in. thick, covered with roofing felt and finished as already described.

Emergency Insulation

Occasionally, orthodox insulating materials or the labour to apply them may be difficult to obtain, but reference has already been made to the comparatively large effect of even a thin layer of insulating material applied to a hot surface, and considerable savings may be achieved by simple emergency measures. Such measures may be untidy, but in most cases appearance is of negligible importance; fuel-saving is the only consideration.

Hair felt ($k = 0.241$) is very useful for insulating pipework. It is best used in strips about 4 in. wide, bound spirally on the pipe by means of string or wire. Care must be taken that gaps are not left between the turns.

Corrugated paper is also useful. It should be wrapped in layers round the pipe, with the corrugations inside, and the edges and ends sealed by means of adhesive tape. Bends and fittings should be wrapped with felt. Also straw (k about 0.5) can be bound round pipes, although this should not be used on steam pipes or in positions where fire risk exists.

All such emergency forms of insulation should be protected if exposed to damp conditions, and roofing-felt, if available, is suitable for this purpose.

Boilers are more difficult to treat in an emergency manner, although if old sheets of iron or tin plate are available a jacket may be made with a little ingenuity, and the space—not less than 3 in.—between the boiler and the jacket filled with dry sand, or gravel (k about 2.0 to 2.5), or with flue dust.

For tanks and cylinders, felt or corrugated paper may be used: in the latter case the corrugations should be horizontal. Also strips of old carpet, pile inwards, are very useful. They should be bound round the cylinder so that the edge projects about 3 in. above the top, and the space thus formed can be filled with sawdust. Alternatively, a casing may be made of old matchboarding, wall board, etc., and the space between the sides filled with sawdust (k about 0.4).

Even the simplest measure of emergency insulation may save half or more of the heat otherwise lost.

THE INSULATION OF STRUCTURES

Modern methods of building involve comparatively light structures and render the question of heat loss of great importance. It is not merely a matter of heat transmission through the fabric of a building to the outer air, but, owing to the fact that walls and roofs may be comparatively cold, higher internal air temperatures are necessary to counteract the effect. Each ° F. of average temperature maintained over a period increases the fuel consumption by about 3 per cent., yet many buildings have been erected with uninsulated flat concrete roofs, while flimsy lath-and-plaster ceilings, surmounted by a roof of open tiles, are often the rule rather than the exception in domestic construction: many householders have come to regard the annual freezing of tanks or pipes in roof spaces with something akin to resignation. This comparative apathy is probably due to mildness of English winters: the mean temperature throughout the winter in London is about 43° F. and the number of occasions on which the mean day temperature is below 30° F. is on the average only four per annum. Such cold spells, however, can be productive of much discomfort.

The insulation of structures is a comparatively simple operation, consisting in the application of an inner lining to the walls and roof, and, in the case of concrete floors laid direct on earth, the incorporation of a layer of some insulating medium.

In an ordinary office building the approximate ratio of heat loss is as follows :—

Transmission through glass windows	1.5
Transmission through walls and roof	2.5
Air interchange	4.0

It is thus obvious that there is a limit to the economies which structural insulation may achieve, particularly having regard to the tendency towards larger glass areas. Insulation finds a particularly valuable field of application in the case of single-storey buildings with roofs of corrugated asbestos and similar light materials : the heat loss in these cases can be enormous.

Thermal Resistance

It was explained in Chapter III that the thermal transmittance (U) of structural materials was usually calculated from the thermal resistance (R). (Some useful information, with charts, on the subject is contained in Fuel Efficiency Bulletin No. 12 entitled "Thermal Insulation of Buildings," issued by the Ministry of Fuel and Power, and extended tables of values of U, etc., for various materials and types of construction are given in "The Computation of Heat Requirements for Buildings," published by the Institution of Heating and Ventilating Engineers.)

The "resistivity" (i.e. the reciprocal of the conductivity) per inch thickness of various insulating materials is as shown in Table 5.

TABLE 5

<i>Material</i>	<i>Resistivity</i> ($= \frac{1}{k}$)
Cork slab	2.33-3.45
Fibre board	2.86
Laminated wallboard	1.89
Wood wool cement	1.72
Hardboard	1.41
Asbestos cement sheet	0.53
Plaster	0.25

Some examples of calculation of U for composite building materials are given below :

(a) 6-inch concrete wall, directly lined with wood wool cement 1 inch thick.

<i>Component</i>	<i>Resistance</i>
6 in. concrete	1.85
1 in. wood wool cement	1.72
Total resistance	3.57

The wood wool cement approximately halves the heat transmission. If an air space were incorporated the resistance would be increased to 4.57, and the heat transmission reduced to 1.85/4.57 or about 40 per cent. of the uninsulated value.

(When the insulation of buildings is under consideration it is always advisable to calculate the most economic thickness of material or type of structure to be employed. Such calculations are extremely simple but may show, for example, that a greater thickness of insulating material is justified.)

(b) Corrugated asbestos cement roof, lined with fibre board $\frac{1}{2}$ in. thick, to form air space $\frac{3}{4}$ in. wide.

<i>Component</i>	<i>Thickness of Material L</i>	<i>Con- ductivity k</i>	<i>Resistance $R\left(= \frac{L}{k} \right)$</i>
External surface (corrugated)	—	—	0.20
Asbestos cement (corrugated area = 1.2 × plane area)	$\frac{1}{4}$ in.	1.2×1.9	0.12
Air space	—	—	0.90
Fibre board	$\frac{1}{2}$ in.	0.35	1.43
Internal surface (plane)	—	—	0.60
	Total resistance ..		<u>3.25</u>

$$\therefore U = \frac{1}{R} = \frac{1}{3.25} = 0.31$$

Thus the addition of the insulating material reduces the heat transmission to 0.31/1.50, or about one-fifth of the uninsulated value.

Insulating Materials and Methods

The following notes describe briefly some materials suitable for structural insulation.

Wall boards.—These are made in a variety of forms from wood waste, cane fibre, paper, etc. They have the advantage that they can be readily sawn to size and attached by simple means. They are particularly suitable for insulating roofs of light construction as they add very little to the weight carried by the steelwork ; they are also suitable for use in dwelling-houses.

Some types of wall board have the disadvantage that they are combustible and special treatment with fire-resisting solution may be desirable. It is important from this point of view as well as from the necessity of preventing air currents (which reduce the insulating effect) to seal all joints ; this may be done by means of adhesive tape.

Wall boards should, if possible, be fixed so that an air space exists between the board and the wall or roof; this is most conveniently done by nailing to wood battens.

Wall boards are very suitable for ceiling construction, in place of the normal lath and plaster. The cost is approximately the same, but the thermal qualities are greatly improved. It may be mentioned that it is better to provide an insulated ceiling with an uninsulated attic than a plaster ceiling with a boarded roof above, but in this case pipes, etc., in the roof space must be adequately insulated.

Wood Wool Cement.—Wood wool shavings, etc., are cast into slabs with cement in several forms. The conductivity is comparatively high, but such slabs form a rigid boundary to an air space. Some types of wood wool cement slabs are porous and it is advisable to seal the surface by means of cement slurry or plaster in order to prevent the passage of air. If warm and comparatively humid air passes through such a slab, condensation is likely to occur in the cool space between the slab and the structure. One great advantage of wood wool cement slabs is that they are comparatively incombustible.

Cork.—Cork board slabs are made in various grades and thicknesses and find their chief application in the insulation of concrete roof slabs and floors.

✓ *Asbestos.*—Asbestos slabs resemble fibre board in their insulating properties, and are incombustible. (Moulded asbestos sections are also made to fit round structural steelwork, and provide a high degree of protection against damage and collapse through fire.)

✓ *Rigid Board, Asbestos Cement, etc.*—These are not true insulating materials, but can be used to form a sealed air space, which provides a high degree of insulation irrespective of the material used. Air spaces so formed can, if a higher degree of insulation is required, be filled with some loose material such as slag wool, asbestos, or sawdust, but this is not generally necessary.

Aluminium Paper.—Aluminium paper combines extreme lightness with good insulating properties. Some tests showed comparative transmittances as follows :

Corrugated asbestos cement	1.41
Corrugated asbestos cement with one sheet aluminium paper	0.39
Corrugated asbestos cement with two sheets aluminium paper	0.19

This material can also be used with advantage behind radiators placed against outer walls.

Blanket Insulations.—Blankets of slag wool, glass fibre, etc., as already described, have a field of application in structural work, particularly in the insulation of ceilings under pitched roofs. Even thick paper is useful in this respect.

As in the case of insulating materials for heat apparatus, detailed particulars and advice on the application of structural insulation can be obtained from the suppliers. It should be mentioned that some modifications to normal methods of fixing may sometimes be necessary.

Economy in Heating

Important fuel economies can be obtained by the thermal insulation of buildings, and the savings can be readily illustrated by a simple example. It has been shown above that the thermal transmittance of a corrugated asbestos cement roof is as follows: Uninsulated, 1.50; insulated with fibre board $\frac{1}{2}$ in. thick, with air space, 0.31. Take the case of a factory having a roof area of 10,000 square feet, and assume that an internal temperature of 60° F. is to be maintained by means of a central heating system throughout the winter (5,000 hours). The effect of insulating the roof is shown by the following figures:

	<i>Uninsulated</i>	<i>Insulated</i>
Heating surface to provide for heat transmission through roof (30-60 deg. Fahrenheit)	2,250 sq. ft.	470 sq. ft.
Approximate cost of do.	£750	£155
Approximate weight of iron and steel in do.	10 tons	2 tons
Approximate fuel consumption per annum (43-60 deg. Fahrenheit)	80 tons	17 tons
Annual fuel cost (at £3 per ton)	£240	£50

The cost of insulating the roof would probably be about £500, so that a very substantial return is obtained on the capital outlay.

The economies obtained by the insulation of walls are not so marked, but in average practice about one-half of the heat lost through the walls may be saved.

The Effect of Insulation on Comfort

It has long been realised that the ordinary thermometer is not a true indicator of comfort conditions: the reason is, of course, that the thermometer bulb is comparatively unaffected by radiation, which has a great effect on human comfort. If walls, etc., are at a low temperature,

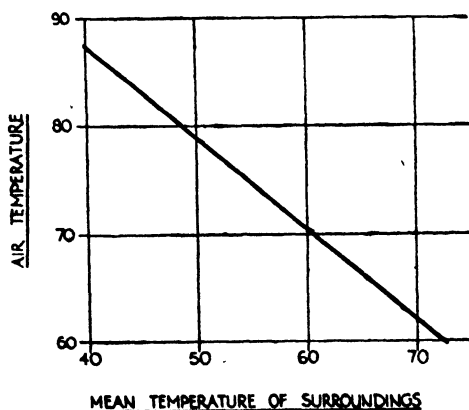

Fig. 2. — AIR TEMPERATURE CORRESPONDING TO A GIVEN BOUNDARY TEMPERATURE; FOR AN EQUIVALENT TEMPERATURE OF 64° F.

there is a correspondingly increased loss of heat by radiation from the surface of the body with a consequent feeling of cold. In order to take this factor into account, the concept of "equivalent temperature" was introduced by Dufton, who devised the "eupatheoscope" as an instrument which records the actual temperature experienced under various conditions of air temperature, air movement and boundary temperatures. If boundary temperatures are low, the air temperatures must be correspondingly increased in order to maintain comfortable conditions. Fig. 2 is adapted from a diagram prepared by Bedford, and shows the air temperature corresponding to a given boundary temperature for an equivalent temperature of 64° F. (It may be mentioned that this value seems to be that required for persons engaged in clerical and similar sedentary occupations, although Bedford found that an equivalent temperature of 62.7° F. was the optimum value for light manual work.)

As the majority of structural insulators have low thermal capacity they rapidly warm up when the contiguous air temperature is raised. This entails several advantages. A lower air temperature will suffice for comfort, and the heating-up period is greatly reduced, and both these factors are reflected in a reduction in fuel consumption.

The cost of wall insulation is in some cases partially offset by the consequent omission of plaster.

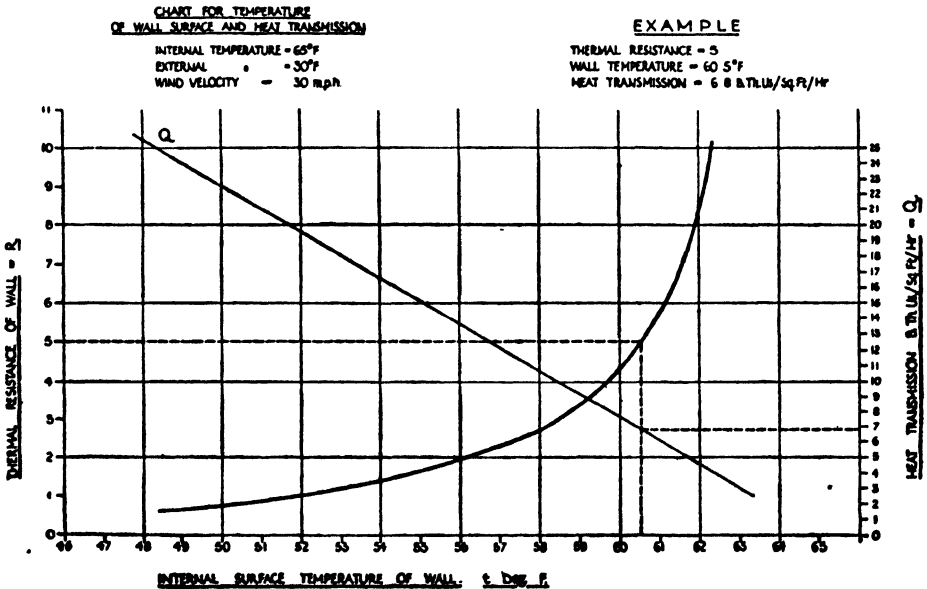

Fig. 3.—INNER SURFACE TEMPERATURE IN RELATION TO THE THERMAL RESISTANCE OF A WALL, ETC.

Fig. 3 shows the inner surface temperature in relation to the thermal resistance of a wall, etc.; external conditions are assumed as 30° F., with a 30 m.p.h. wind, and internal conditions are taken as 65° F. with still air. Under these conditions the surface temperature (*t*) and heat loss (*Q*) through a 6-in. concrete wall would be as follows:

	R	<i>t</i> Deg. Fahrenheit	<i>Q</i> B.T.U./ sq. ft./hr.
6 in. concrete	1.85	53.8	17
do. do. with 1 inch wood wool cement	3.75	59.4	8.5
do. do. with ½ inch air space	4.57	60.2	7.2

The temperature of glass windows will, of course, have an important bearing on the mean radiant temperature to which the occupants of a room are exposed. For internal and external temperatures of 60° and 30° F. respectively, tests showed the following temperatures of glass windows:

Single glazing—

Still air : 45° F.

Wind : 40° F.

Double glazing—

Still air : 52° F.

Wind : 51° F.

Other Advantages of Insulation

In addition to its thermal results, the insulation of buildings has other advantages. One of the most important is that, owing to the higher surface temperature, condensation is minimised; this, otherwise, may be a source of considerable trouble in factories, etc. Insulation used uniformly behind plastered ceilings will also do much to minimise "pattern staining," which is due to the transfer of dust from the warmer to the colder areas of plaster and can be very troublesome, particularly in the case of ceilings incorporating metal lathing.

Most insulating materials are also effective in absorbing sound or reducing sound transmission.

An important aspect is that insulation of concrete roofs reduces expansion, which has in some cases caused structural damage. The best means of preventing this is, of course, the provision of an insulating layer in the exterior surface. This may present practical difficulties, but a compromise between the advantages of exterior and interior insulation may be effected by the provision of a heat-reflecting surface to the exterior, with cork or other insulating material below the roof slab. The amount of solar radiation reaching the roof may approach 300 B.T.U.'s per square foot per hour, but a substantial portion of this will be reflected from whitewash, or from white material rolled in to the asphalt coat.

The insulation of a roof slab greatly enhances comfort in summer.

Chapter XIII

WARM AIR HEATING

WARM Air Heating Systems can be broadly divided into two classes : indirect and direct. The former comprises systems in which warm air passes through ducts formed in the structure of the building, which thereby becomes warmed : the air itself does not enter the space to be heated. This is a very ancient system, and was used extensively by the Romans during their occupation of Britain. In recent times it has been revived, and is utilised with great success at the new Anglican Cathedral at Liverpool. Direct systems, in which warmed air actually enters the space to be heated, can be divided into those which depend upon natural convection currents, and those in which fans are used in order to propel the air mechanically. The latter, when employing duct work, are generally referred to as the Plenum System.

Unit Heaters, already described in Chapter X, are a special application of warm air heating.

Advantages and Disadvantages of Warm Air Heating

The advantages of using air for heating is that very rapid results are obtained, and the system is thus very suitable for large spaces such as Churches, or Concert Halls, which are only required for occasional use. Also, a plenum system provides the ventilation necessary in such cases, and can be used, without the heaters in action, solely for this purpose in summer. Plenum heating is of particular value in industrial work.

The heating of dwelling-houses by means of a furnace is largely employed in Canada and the U.S.A., and is making some headway in this country : a furnace in the basement delivering hot air through a grill in the flooring of the hall greatly enhances the comfort of a house in winter. An advantage of heating by means of furnaces is that there is no danger of damage should freezing occur.

Heating by means of warm air, however, has several disadvantages. If the air is the sole means of heating, comparatively high temperatures are necessary : for example, in the case of the Workshop and Office block considered in Chapter III the necessary temperature of the air would be 100° F. in the case of the Workshop, and 186° F. in the case of the Office floor. This latter figure would be quite impracticable and some supplementary means of heating would be necessary in this case, or the amount of air introduced would have to be increased in order to keep the temperature within reasonable limits. The usual maximum temperature of a hot-air system is 120° F. : at temperatures of 150° F. or above, the air is "scorched," and any suspended particles disintegrated, with

very unpleasant effects. (The L.C.C. regulations for the ventilation of places of public assembly provide that the temperature of any surface used for warming air should not exceed 250° F.).

A further disadvantage of heating by means of warm air is that very steep temperature gradients between floor and ceiling levels are produced. Tests have actually shown that the gradients are more severe with this type of heating than with any other. Also, the walls tend to remain comparatively cold, and the combination of warm air with cooler boundary surfaces does not provide the conditions of greatest comfort.

Unless some type of filtering apparatus is fitted, hot-air systems can circulate troublesome amounts of dust, which are particularly objectionable in factories or stores in which delicate materials are handled. Finally, a plenum system is comparatively bulky, requiring more space in the building than any other form of heating, and it is also more expensive in first cost than ordinary systems of central heating.

Hot Air Furnaces

Fig. 1 shows a type of direct air heating furnace. It consists essentially of a cast-iron combustion chamber, surrounded by a steel jacket, and air is drawn by convection through the space between the two, rising vertically through a grille in the floor above. Control of air currents in such a case as this is difficult, but some re-circulation is frequently arranged by allowing the heated air to escape upwards through one part of the grille only, the remainder of the grille being connected to the air inlet at the base of the furnace : this ensures a considerable degree of re-circulation, with a consequent economy in running costs. The raising of air to a high temperature results in excessive dryness, which may be a cause of complaint by the occupants, or even of structural damage due to the shrinking of wood-work, etc. A pan of water is, therefore, often included in the design of a hot-air furnace, in order to counteract this effect. As mentioned above, this system is very widely used in North America, the furnace being adapted to burn wood or oil fuel. In order to secure the maximum effect the ground floor rooms are not provided with doors, but remain open in order that the warm air can circulate. Bedrooms frequently have trap-doors in the floor which can be opened at night in order that the warmth can ascend.

The success of a furnace of this type depends very largely upon the air-tightness of the structure. If in-leakage can occur, the tendency is for the windward side of the building to be too cold, as the hot air tends to drift towards the lee-side.

Plenum System

A plenum heating system comprises an air inlet in a suitable position (preferably at high level) together with a heater battery, a centrifugal fan, and a duct system for distributing the air throughout the heated

HEATING AND VENTILATING

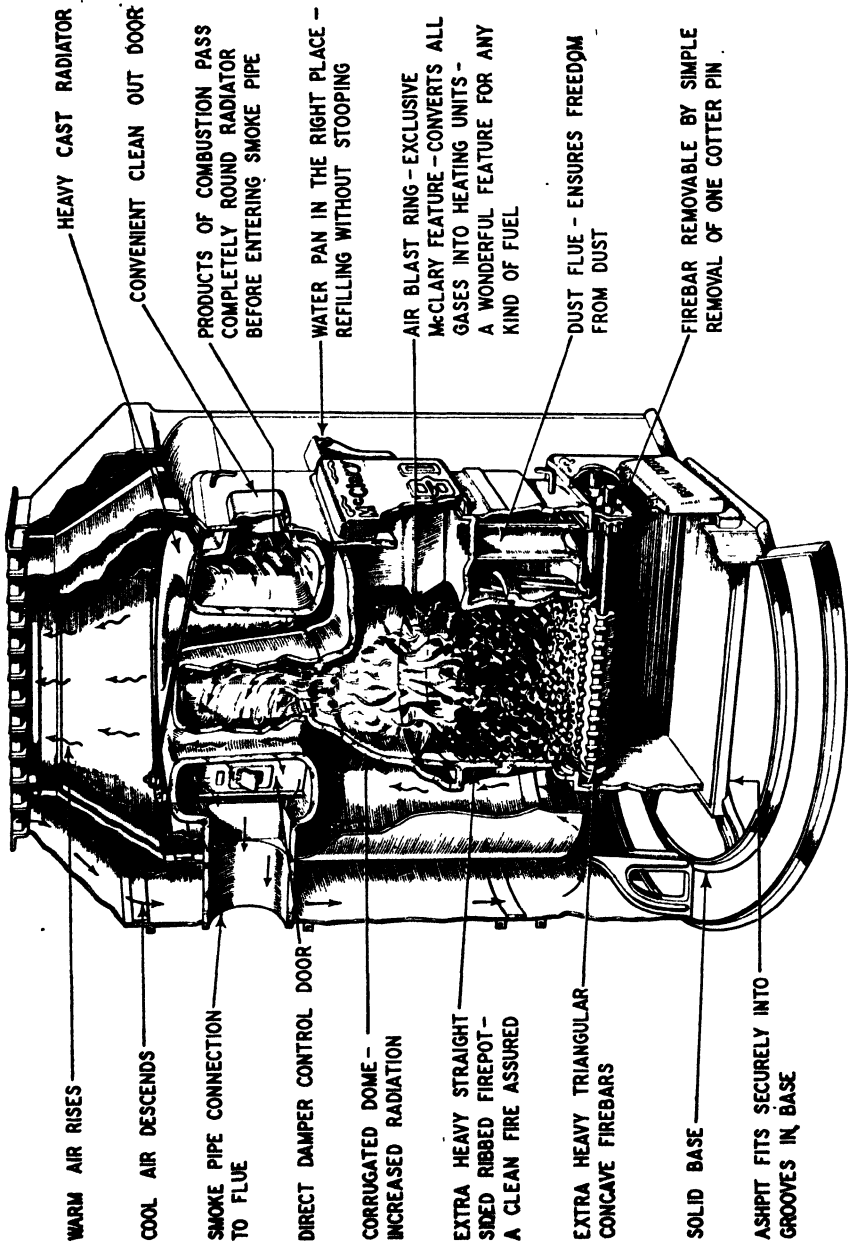

Fig. 1—DIRECT HEATING FURNACE

(McClary Pipeless Heaters)

space. The majority of such systems employ re-circulation for economy in working, and this frequently involves a separate duct system. The amount of air re-circulated does not generally exceed 75 per cent., as it is found that if an attempt is made to re-circulate more than this amount, part of the building is liable to be at less than normal atmospheric pressure, and cold draughts are the result. In any case, a considerable addition of fresh air is necessary: the L.C.C. regulations mentioned above prescribe 1,000 cubic feet of fresh air per hour for each occupant, and the minimum amount to be provided in any case should not fall below 600 cubic feet per head per hour.

In setting out a plenum system due attention must be paid to the velocities at various points, and usual air velocities are shown in the following Table :—

TABLE 1.--AIR SPEEDS IN PLENUM SYSTEMS

Fresh air intake	8-12 feet per second.
Heater battery	10-25

temperature of 60° F. The loss through the structure is $(4,088 - 1800) \times 1.03 \times (60 - 30) = 2,357 \times 30$ B.T.U./hr.

Thus if t be the entering temperature

$$2 \times 45,000 \times (t - 60) \times 0.02 = 2,357 \times 30$$

whence $t = 100^\circ$ F. approximately.

In sizing a heating battery it is usual to allow a temperature rise to 10 degrees more than the actual temperature required, in order to compensate for losses from ducts, etc. Thus, in the case above, the temperature of the air leaving the heater battery would be $100 + 10 = 110^\circ$ F.

If 75 per cent. of the air is recirculated, and the remainder is fresh air from outside at 30° F., the heat to be supplied by the heater battery is

$$0.75 \times 2 \times 45,000 \times (110 - 60) \times 0.02 = 67,500$$

$$\text{plus } 0.25 \times 2 \times 45,000 \times (110 - 30) \times 0.02 = 36,000$$

Total .. 103,500 B.T.U./hr.

Filters

Many types of air filter are in use. Textile filters are probably the most popular, and the arrangement shown in Fig. 2 provides a very large area of filter material in relation to the volume passing. The disadvantage of textile filters is that, in urban localities, they rapidly become dirty and reduce the volume passing. The life in service can be greatly prolonged by the frequent use of a vacuum cleaner. A further type of dry filter takes the form of two perforated plates between which glass fibre or metal wool is held. These can be partially cleaned by removal and shaking, but they are comparatively inexpensive, and are usually termed the "throw-away" type, as it is customary to replace dirty units by new ones.

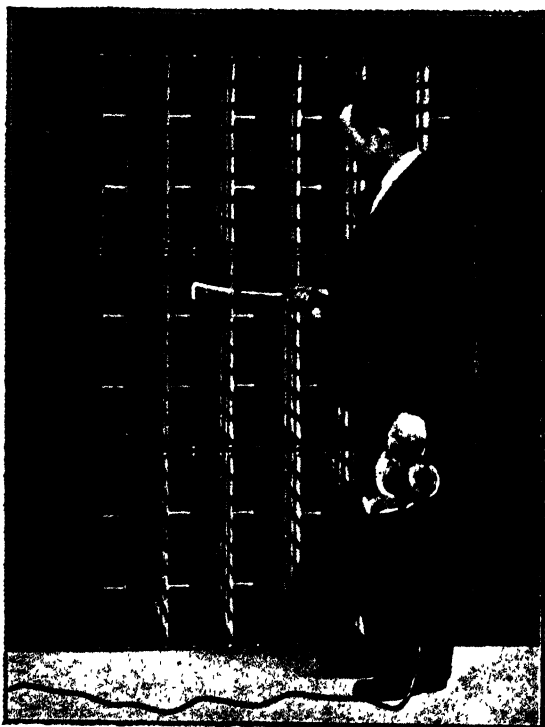

Fig. 2.—15,000 C.F.M. INSTALLATION OF SIX FOUR SQUARE FOOT UNITS SHOWING SIMPLE CLEANING EQUIPMENT AND METHOD OF CLEANING
(Messrs. Vokes, Ltd.)

Viscous filters also form an important group. These consist of plates which are dipped in a viscous liquid before erection in the filter frame: the liquid removes practically all dust, and the units can be washed in a hot solution of soda and dipped in the viscous liquid before re-erection. Fig. 3 shows the appearance and principle of one type of viscous filter.

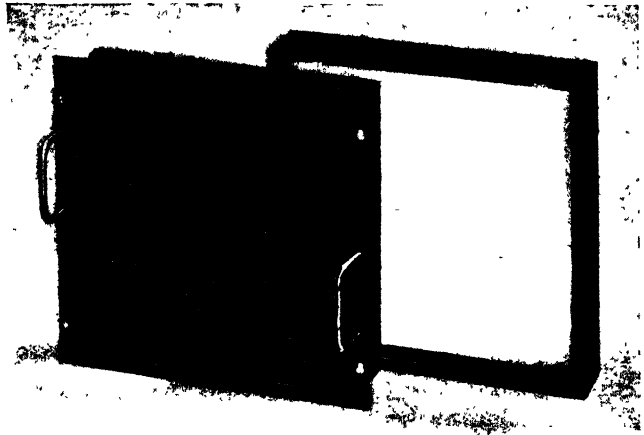

Fig. 3.—“VENTEX” VISCIOUS FILTER
(Messrs. Ozonair, Ltd.)

A further form of dust filter consists of fine copper gauze over which a stream of water is allowed to trickle: this is a very satisfactory arrangement. In deciding on the type of filter to be used, consideration

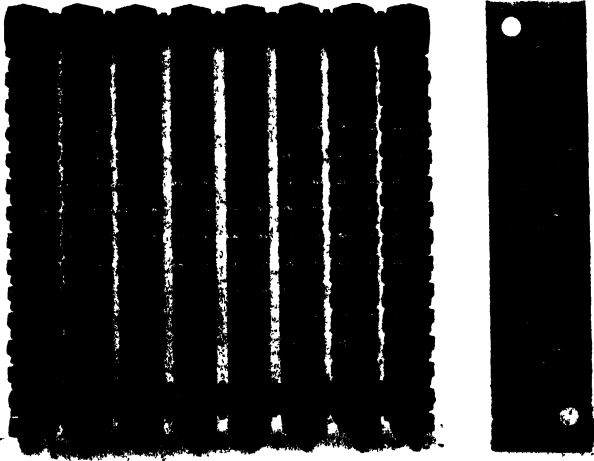

Fig. 4.—“VENTO” CAST-IRON HEATER
(Messrs. Ideal Boilers & Radiators, Ltd.)

should be given to fog conditions, as, in some instances, e.g. cinemas, the admission of fog would be very troublesome. For this purpose a textile filter is probably the best, and in emergency good results have been obtained by interposing a layer of blanket material in the system during foggy weather.

Air Washers

In important installations air washers are used. These consist of a chamber in which a fine mist is produced by means of water pumped under pressure through specially shaped jets. Air washers can serve the triple purpose of cleaning, cooling and humidifying the air. A washer, however, is not very effective in removing sooty particles which are found to be only slightly affected by water spray. Some dry type of filter in addition is desirable under these conditions, but in this case the washer should be placed before the dry filter in order to extend the useful life of the latter. Fig. 18 of Chapter XIV shows a typical air washer. Air first passes through an air heater where its temperature is raised in very cold weather to prevent freezing of the spray water. The spray water is heated in accordance with the final humidity required. At the exit from the spray chamber eliminator plates are fixed to remove any entrained moisture from the air, which then passes through the heater battery. Further details of air washers are given in Chapter XIV.

Heaters

Many types of air heaters are used, including stacks of ordinary pipe and of specially manufactured pipe with gills to increase the heat transmission. Figs. 4 and 5 show two types of proprietary air heaters suitable for use with either water or steam. The advantage of the proprietary type is that less space is required for a given duty than with a heater formed of ordinary pipe. Table 2 shows the final temperature of air entering at 30° F. and passing through a "Vento" heater at a mean speed of 1,000 feet per minute.

TABLE 2.—PERFORMANCE OF VENTO HEATER
(At an Air Speed of 1,000 ft. per minute)
Air entering at 30° F.

No. of Stacks Deep	Final Temperature of Air	
	Hot Water at 180° F. Mean Temperature	Steam at 5 p.s.i. (227° F.)
1	51° F.	60° F.
2	68° F.	83° F.
3	83° F.	103° F.
4	95° F.	120° F.
5	105° F.	134° F.
6	114° F.	145° F.
7	122° F.	155° F.
8	129° F.	163° F.

The final temperature of the air decreases as the air velocity increases although the demand on the heater battery is greater, due to the forced convection effect.

Gilled copper tube has the advantage of cheapness and lightness, combined with comparatively high thermal conductivity: particulars can be obtained from makers' catalogues.



Fig. 5.—“EXCELSIOR” GILLED HEATER
(Messrs. Ideal Boilers & Radiators, Ltd.)

Conclusion

A useful compromise between ordinary central heating and full plenum heating is to provide radiators adequate to take care of the heat loss through the structure, plus those due to one air change: the latter is found to occur in most buildings under conditions of normal occupation without any mechanical means of ventilation. The air required for ventilation purposes, additional to this single air change, is delivered through a plenum system, and in this case only requires heating to the desired final temperature in the room. With this system the building does not cool down completely when the plenum system is not in use during periods of non-occupation, and the plenum system, as stated above, can also be used for ventilation purposes during the summer.

Chapter XIV

VENTILATION AND AIR CONDITIONING DUST AND FUME EXTRACTION—DRYING PLANTS

It is almost impossible to over-estimate the importance of an adequate supply of clean air. The greatest care is rightly exercised in ensuring that food and water supplies of the community reach a high standard of purity, but little statutory recognition has so far been given to the equally important question of ensuring suitable atmospheric conditions. The average amount of air breathed by an adult is about 20 cubic feet per hour and some nine million inhalations are made per annum. The effect of air on health and comfort depends on a variety of factors, including its temperature, humidity and velocity. The chemical composition within conditions ordinarily met with is not of such importance as freedom from dust; it is not always realised to what extent the atmosphere can be polluted in industrial areas, but in densely populated districts the amount of dust and other solid matter deposited from the atmosphere may exceed 400 tons per square mile per annum.

Necessity for Ventilation

Ventilation is necessary in order to prevent unduly high concentrations of CO₂ and moisture and to provide for the removal of bacteria, odours, products of combustion, etc. Normally, 600 cubic feet of fresh air per hour ensures satisfactory conditions, but, in some cases, it may be necessary to exceed this figure considerably. In general, however, too great a rate of air change should not be provided as the expense of warming large volumes of incoming air is considerable.

The average quantity of air inhaled by a healthy man is about 30 cu. in., and if this amount is taken in by the respiratory organs sixteen times per minute, it follows that only about 16½ cu. ft. of air are required per hour to support life.

In addition to the air we breathe, a movement of air over the surface of the body is also necessary to remove the surplus heat, water vapour, carbon dioxide, and organic vapours given off by the body. As much as ½ lb. of water vapour may be emitted hourly from a man engaged upon a strenuous task, and the emission of carbon dioxide under similar conditions may be 1½ cu. ft. per hour. It is evident, therefore, that apart from a supply of fresh air, it is necessary, especially in confined spaces, that there should be an appreciable movement.

Values of "metabolic" or body heat may vary from 220 B.T.U. per hour when sleeping up to 1,000 or more during short spells of hard work : some figures are given on p. 10.

In ordinary ventilation work it is usually assumed that 300 B.T.U. per hour are produced per person, so that if the air supply is at the rate of 600 cu. ft. per head per hour, the temperature rise in the air would be 25° F., since 0.02 B.T.U. will raise the temperature of 1 cu. ft. of air 1° F. In practice, of course, the full temperature rise is not attained, owing to leakage of heat from the structure.

The total amount of heat produced must, of course, be dissipated from the body, and, when the normal loss by one means is prevented, the loss due to others must be correspondingly increased. Thus, if the surroundings are hot and humid, the loss by radiation and evaporation is greatly reduced, and that by convection must be correspondingly increased. This may be effected by the provision of local fans, either of the desk or ceiling type, which create sufficient air movement to give relief in conditions which would otherwise be very oppressive. It may be noted that the actual velocity of the air in a room ventilated by means of a ductwork system is very small and in most cases does not exceed 6 in. per second. (To double the air velocity at any part of a room remote from the ventilation system involves increasing the number of air changes between ten and twenty times.)

An air velocity of 2 ft. per second would in most cases be regarded as an objectionable draught and, for the same degree of comfort, it would necessitate an increase in air temperature of 4° F.

Composition of Air

Air consists of approximately one-fifth by volume of oxygen and four-fifths of nitrogen. Carbon dioxide is also present to the extent of about four parts in ten thousand.

The amount of CO₂ in the atmosphere was formerly taken as a criterion of good ventilation, but this is now to a large extent discredited.

CO₂ is quite harmless in concentrations up to 2 per cent. which is an extreme condition sometimes reached in industrial processes. The only effect of such an atmosphere is to deepen the breathing and persons generally are quite unaware of the increase. In some cases the CO₂ content is still taken as a standard, e.g. the L.C.C. regulations relating to the ventilation of theatres, etc., include a proviso that the amount of CO₂ shall not exceed 10 parts in 10,000 and in textile mills the legal maximum is 9 parts per 10,000. This, however, must be taken as an indication of the number of times per hour that the atmosphere is renewed by the ventilation system, and in themselves these percentages have no value as a standard.

If deleterious fumes are produced, however, the chemical composition of the air may be of the greatest importance. For example, 5 parts in 10,000 of carbon monoxide may be fatal and concentrations well below this figure can give rise to very unpleasant effects. This is of

importance in the ventilation of underground garages: the average production of CO when a car is starting is at the rate of 2 cubic ft. per minute, and ventilation at the rate of 5 air changes per hour is usually necessary.

Humidity and its Measurements

The humidity of the atmosphere exerts a very appreciable influence on comfort, and is also of great importance in many industrial processes.

The figures in Table 1 are extracted from "Tables of Hygrometric Data for Air," published by the I.H.V.E. (2s. 9d.).

TABLE 1—HYGROMETRIC DATA
For Air at 60° F.

Relative Humidity per cent.	Vapour Pressure in millibars	Dew Point in Deg. F.	Per Pound of Dry Air			Wet Bulb	
			Moisture in Grains	Total Heat B.T.U.	Volume in Cu. Ft.	Screen Deg. F.	Sling Deg. F.
100	17.68	60.0	78.4	18.92	13.53	60.0	60.0
80	14.14	53.8	62.5	16.45	13.48	56.6	56.3
60	10.61	46.1	46.7	14.00	13.43	53.0	52.4
40	7.07	35.6	31.0	11.57	13.39	49.1	48.1
20	3.54	20.2	15.5	9.15	13.34	45.0	43.5

The two values of wet bulb temperatures given in the Table relate to stationary (screen) and moving (sling) conditions respectively: the latter is the better indication, and calculations are usually based upon the sling temperature.

If air is not "saturated" the amount of moisture actually present, expressed as a percentage of the "saturation" amount, is known as the "relative humidity," the actual weight being the "absolute humidity."

It is obvious that the amount of water vapour actually present in air is comparatively small, but its effect on health and comfort appears to depend upon relative humidity rather than the absolute humidity. The relative humidity decreases rapidly as the temperature rises. For example, saturated air at 40° F. contains 2.9 grains of moisture per cubic foot, and, assuming that no more water is added, the relative humidity at higher temperatures would be as follows:—

40° F.	100%	relative humidity
50°	71%	„
60°	50%	„
70°	36%	„
80°	26%	„
90°	19.5%	„
100°	14.5%	„

If air at any temperature is not saturated, the lower temperature at which the amount of moisture it contains would cause saturation is called the "Dew Point."

Thus, if air at 60° F. contains 2.9 grains of moisture per cubic foot, its relative humidity will be 50 per cent. If cooled to the dew point (40° F.), the relative humidity will rise to 100 per cent., and, if further cooling occurs, some of the vapour will be condensed out in liquid form. Cooling below the dew point is thus one method of reducing atmospheric humidity—this will be referred to later.

The optimum level of relative humidity for health and comfort has not been definitely established, and is probably immaterial over a fairly wide range provided that the other factors of temperature and air movement are such as to maintain a comfortable heat balance.

In the U.S.A. "effective temperature" is commonly used to denote the conditions of comfort in a warm space. Effective temperature is defined as the temperature of still air saturated with moisture which would give the same degree of comfort as the actual environment. Effective temperature does not take radiation into account. Equivalent temperature, used for the same purpose in this country, ignores the effect of humidity, but relative humidities up to 70 to 75 per cent, can be tolerated without discomfort at normal temperatures.

Natural variations of humidity in this country are very wide, ranging from 30 per cent. to saturation. Usually the air contains between 4 and 5 grains of vapour per cubic foot in summer, and between 2 and 3 grains in winter. Normal humidity in the U.S.A. is very much lower, and this is one reason why American heating practice employs higher temperatures than are common in this country—the increased loss of heat by evaporation must be compensated by a lower rate of convection loss.

Under normal sedentary conditions, an adult gives off by evaporation and respiration about 0.11 lb. of water vapour per hour. The tendency of an unventilated occupied space to become saturated is obvious, and one of the principal reasons for providing adequate ventilation is to ensure that the surplus moisture is removed.

The relative humidity of the atmosphere can be readily ascertained by observing the simultaneous readings of wet and dry bulb thermometers. A wet bulb thermometer is an ordinary thermometer, but with the bulb surrounded by wetted muslin. As water evaporates from the muslin, latent heat is absorbed from the bulb which therefore shows a lower reading than the dry bulb thermometer. The two thermometers are mounted so that they can be rapidly rotated by hand, thus giving the "sling" wet bulb reading. From the difference in the dry and wet bulb readings, the relative humidity of the air can be ascertained by reference to standard tables or to a Hygrometric Chart. One form of this chart is shown in Fig. 1. It is useful to remember that saturated air at 64° F. contains 6.4 grains of moisture per cubic foot.

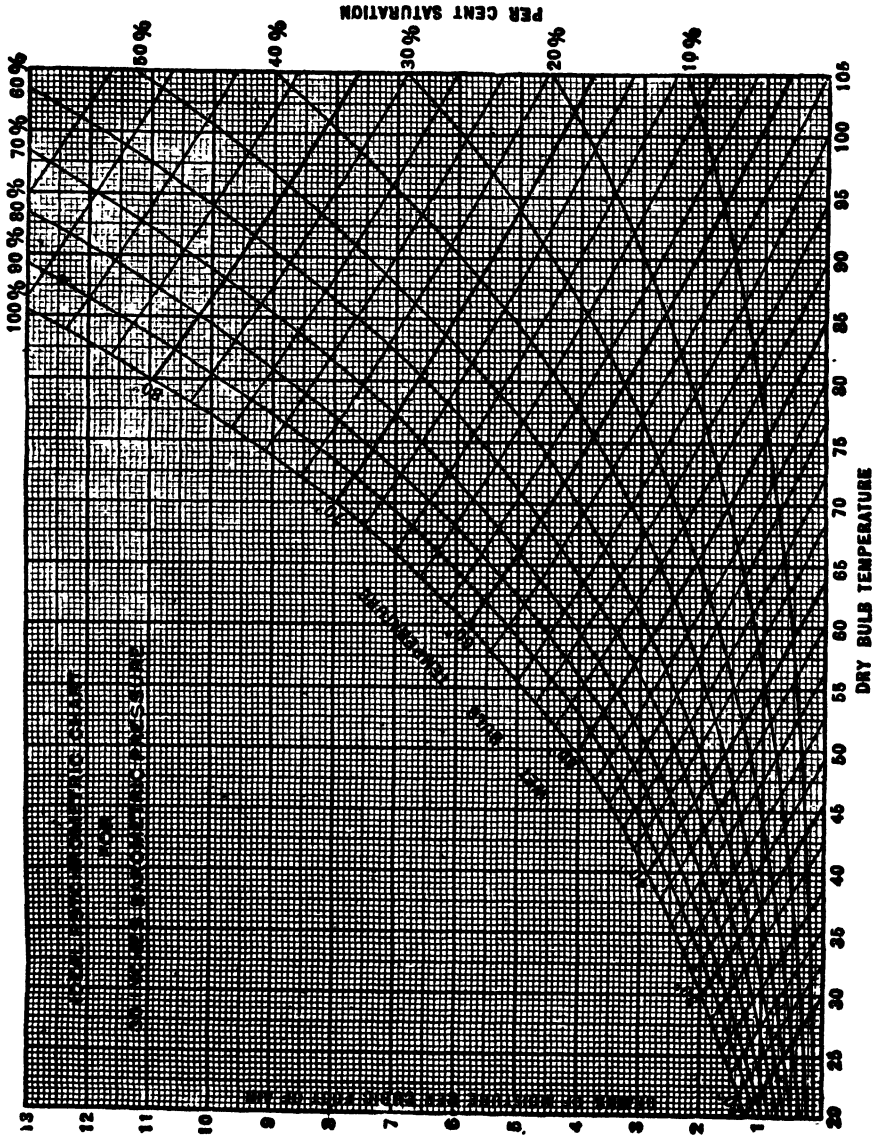

Fig. 1.—PSYCHROMETRIC CHART (Messrs. Davidson & Co., Ltd.)

Standards of Ventilation

In some industrial processes high humidities are necessary and, in these cases, limits may be prescribed by Home Office regulations. For example, in textile mills, the relative humidity allowed varies from 89 per cent. with a dry bulb temperature of 50° F. to 80 per cent. with 80° F.

Wherever possible, ventilation rates should be calculated on the basis of the amount of fresh air to be supplied for each occupant : this should be from 600 to 1,000 or even more cubic feet per hour. In cases where the occupation cannot be determined, ventilation rates should be based on the number of complete air changes to be provided. Table 2 shows the number of air changes to be provided in various buildings where the number of occupants cannot be ascertained.

TABLE 2.—RATES OF AIR CHANGE WITH MECHANICAL VENTILATION

<i>Nature of Building</i>	<i>Air Changes per Hour</i>
Offices generally	3
Kitchens	10-40
Restaurants	6
Hotel Rooms	3-5
Lavatories	5
Assembly Halls	5-10
Hospitals—Wards	3
Operating Theatres	10
X-ray Rooms	10

The ventilation of factories and workshops is governed by the Factories Act, 1937, and various other official regulations. Much depends upon the size of the factory, both as regards floor area and height, in relation to the number of occupants, and on the nature of the process. Air changes may vary from 4 to 30 per hour, but it is generally advisable to consult the Factory Inspection Department of the Home Office.

Air Change

A considerable degree of air change occurs in most buildings even if no mechanical system of ventilation is provided. This is due to infiltration around windows and doors, which is, of course, greatly increased by wind, and to the convection currents set up by the heating apparatus. The following figures of ventilation rates were obtained during tests at the Building Research Station in an ordinary room with a fireplace and flue :—

<i>Method of Heating</i>	<i>Air Changes per Hour</i>
None	1.7
Anthracite Stove	0.7
Hot Water Radiator	2.0
Electric Convector	2.4
Electric Radiator	2.7
Gas Fire	3.1
Coal Fire.. .. .	4.5

Natural ventilation through roof openings is often used in the case of small assembly halls, etc., and many patterns of ventilators for use in these conditions are available. They consist of arrangements of cones and hoods, and extraordinary claims are sometimes made as to their efficacy. They depend, however, mainly upon the differences in buoyancy between the temperature of the air inside and outside the building and, on hot, still days when the outside temperature may be higher than that inside, they do not function. With high winds, however, the effect is increased as some patterns have an "ejector" which greatly improves the performance. Table 3 shows the amount of air discharged under various conditions owing to differences in internal and external temperatures.

TABLE 3.—AIR DISCHARGE BY GRAVITY
In Cu. Ft. per Hour per Sq. In. of Air Outlet (with Free Inlet)

<i>Difference in Temperature Between Internal and External Air</i>	5° F.	10° F.	15° F.	20° F.
Difference in levels of air inlet and outlet :—				
10 ft.	50	69	81	94
20 ft.	69	94	119	137
30 ft.	81	113	144	163
40 ft.	94	137	163	188

In the above Table, the theoretical discharge figures have been reduced by 25 per cent. to allow for friction and obstruction.

Natural ventilation is erratic in effect and has the disadvantage that air to replace that leaving the building may find its way in from vitiated sources or through crevices, thus causing draughts and discolouring decoration.

✓ Mechanical Ventilation

Mechanical ventilation systems should invariably be installed when a definite rate of ventilation is necessary or when it is desired to have the conditions within the building under control.

Mechanical systems of ventilation can be classified as below.

✓ Extract Ventilation

This is cheap both to install and operate but, while ensuring that a definite volume of air is removed from the building, the air entering to replace it is not controlled. Fig. 2 shows the system applied to an office building, and Fig. 3 to a small cinema.

✓ Plenum Ventilation

This consists in introducing the air under pressure through a duct-work system, and allowing it to escape through other openings.

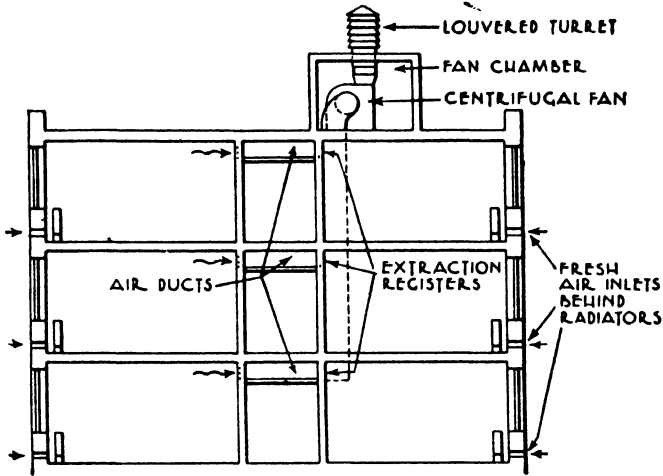
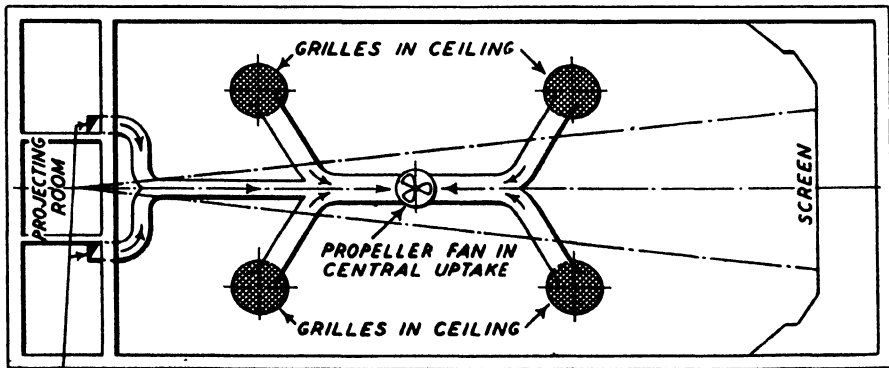
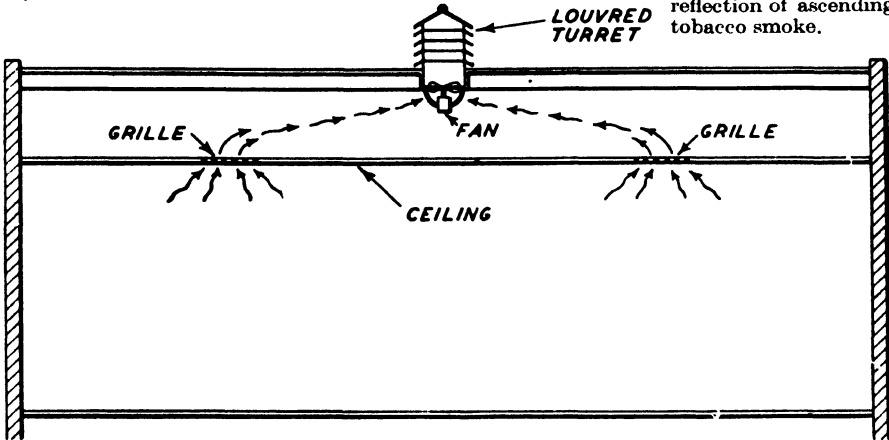

Fig. 2. — MECHANICAL VENTILATION OF OFFICE BUILDING

A convenient method of forming air ducts is to construct false ceilings in the corridors and to connect the ducts so formed to a vertical shaft leading to the fan chamber.

Fig. 3 (below). — EXTRACT VENTILATION OF CINEMA

NOTE. — Grilles positioned outside width of light-beam to avoid reflection of ascending tobacco smoke.



VENTILATING DUCTS FROM UNDER BALCONY

Balanced Ventilation

This comprises both plenum and extract systems and is the only method which can be relied upon to give satisfactory results under all conditions, as the air movement can be definitely regulated at all points from inlet to extract. Also, this system lends itself to re-circulation which results in very considerable economies, particularly if a comparatively expensive method of air conditioning treatment is used. A disadvantage of the balanced system is that it is dependent for successful operation on the closing of all windows and this is liable to cause complaint in offices and other buildings where normally the windows may be opened at the discretion of the occupants.

Air delivery by a plenum system may enter :—

- (a) Upwards with extract at high level ;
- (b) Downwards with extract at floor level ;
- (c) Horizontally from ductwork at high level being extracted either vertically or horizontally.

There is no ideal arrangement and each case must be decided on its own merits. In America, downward plenum is commonly used for theatres, etc.: this is no doubt due to the fact that air conditioning is necessary during the summer months and the natural tendency of cooled air is to fall. Also the introduction of cold air at low level may produce discomfort. In this country upward plenum is in general use in such cases. (The House of Commons was ventilated in this way whereas the U.S. Senate has a downward plenum installation). In most commercial cases, however, compact ventilation systems are necessary and good results are often obtained by running plenum and extract ducts together : by suitably adjusting the velocities of the air at the inlet and outlet gratings, satisfactory circulation can be obtained.

One advantage of plenum systems at high level is that much higher air velocities can be permitted than if the inlet gratings are in the vicinity of the occupants.

Fans

Fans for use in mechanical ventilation systems are made in great variety. The correct choice of the fan is of great importance as, otherwise, inefficiency in operation with increased operating cost or an objectionable amount of noise, or both, may easily occur. It is the practice of some designers, after making preliminary calculations, to select from makers' catalogues the exact type of fan which they propose to use, and then proceed to design the installation so as to suit the characteristics of the fan.

Propeller Fans

Fans of ordinary propeller type are only used for simple extract systems. They cannot work against the frictional resistance of an

extensive ductwork system and $\frac{1}{8}$ inch of water gauge is usually assumed to be the limit of their satisfactory performance, although some makers list them for higher duties. When propeller fans are fixed to discharge through outer walls, etc., it is advisable to provide them with automatic shutters: these open under the action of the fan, but close again when the fan is stopped, thus preventing air from blowing direct through the fan into the building. (Should this happen, the fan spins in the reverse direction and, if then switched on, is liable to blow its fuses and thus remain ineffective).

A suitable method of fixing propeller fans is shown in Fig. 4, and an enlarged view of the corner of the timber frame indicated in Fig. 5. It will be seen that the metal frame carrying the fan and motor is isolated from the timber frame by means of a felt seating ring,

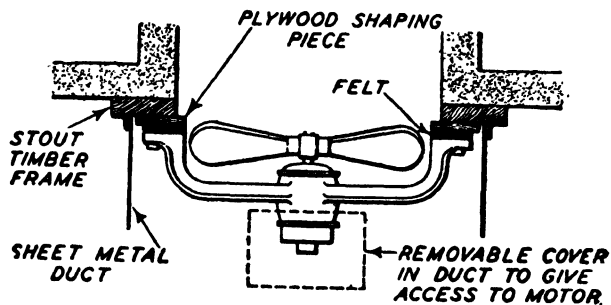

Fig. 4.—A SUITABLE METHOD OF FIXING EXTRACT PROPELLER FANS

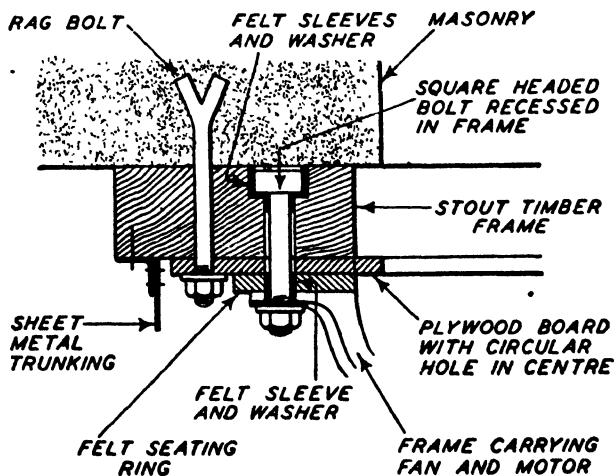

Fig. 5.—ENLARGED VIEW OF CORNER OF TIMBER FRAME FOR FIXING EXTRACT PROPELLER FAN



Fig. 6.—BLOWING DUCTWORK CONNECTED TO CENTRIFUGAL FAN WITH FLEXIBLE CONNECTIONS (*Airducts, Ltd.*)

the bolts being fitted with felt sleeves and having square heads recessed into the back of the timber frame in order to avoid direct contact with the building. The timber frame is secured to the masonry by a separate set of bolts, so that there is no metallic continuity from the metal frame to the building structure.

Centrifugal Fans

For moving air against the normal resistance of a ductwork system, a fan of centrifugal type, such as shown in Fig. 6, is necessary. The duty of the fan is usually expressed in the number of cubic feet of air which it will handle against a definite pressure, usually measured

in inches of water gauge. The energy of the air leaving the fan is due partly to its velocity and partly to the pressure set up by the action of the runner within the fan casing. The relationship between the velocity and the pressure of the air leaving a centrifugal fan depends upon the design of the fan: with a runner with blades curved forward in the direction of rotation, the air velocity leaving the runner will be higher than the peripheral speed, but with blades curved backward, it will be lower. The former type of fan is, therefore, used when a high velocity is required and the latter when high pressure has to be used to overcome comparatively high resistance. By suitably shaping duct connections, however, velocity can be converted into pressure or vice versa with but little loss.

Fig. 7 shows characteristic curves of one type of centrifugal fan. Curves of this type are supplied by fan makers and should always be consulted before a fan is selected for any particular purpose in order to

ensure that it will operate at reasonably high efficiency. Other things being equal, fans should run as slowly as possible. The volume delivered by a centrifugal fan varies as the speed. The pressure head produced in the air varies as the square of the speed and the power required to

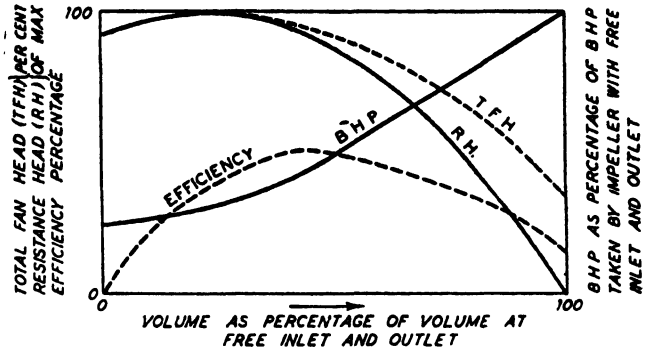

Fig. 7.—CHARACTERISTIC CURVES FOR CENTRIFUGAL FANS

drive the fan, external conditions remaining unaltered, varies as the cube of the speed. Thus if a particular make of fan delivers 6,000 cubic feet of air per minute through a ductwork system when running at 500 r.p.m., requiring 1.5 horse power to drive it, the volume delivered at 1,000 r.p.m. would be 12,000 cubic feet per minute, but the power required would be $(1,000/500)^3 \times 1.5 = 12$ h.p. Alternating current motors are in general use for fan drives: these run at comparatively high speeds, and do not lend themselves to speed regulation. It has, therefore, become common practice to provide belt or rope drives for centrifugal fans.

Fans running at slow speeds are much quieter in operation than high speed fans. No definite rules can be laid down on this point, but, where silent operation is of importance, it is desirable that the peripheral speed of the fan runner should not exceed 45 feet per second and the total water gauge against which it works should be limited to 1 inch.

Fixing Centrifugal Fans

Methods of insulating this type of fan are shown in Figs. 8 and 9.

Where the fan is small, up to about 10,000 cu. ft. of air per minute, it is sufficient to have a bedding of 2-in. anti-vibration cork below the concrete base on which the fan is mounted, the thickness of the concrete being not less than 8 in.

The cork effectively damps out solid vibration and prevents its transmission to the floor.

Where the anti-vibration material is of a kind which could be injured by wafer, it is usual to form a plinth an inch or so high to raise the material above the level of the general floor, and to lay waterproof building paper over it before the concrete base is cast.

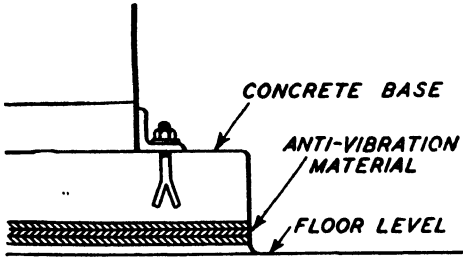

Fig. 8.—METHOD OF INSULATING CENTRIFUGAL FAN

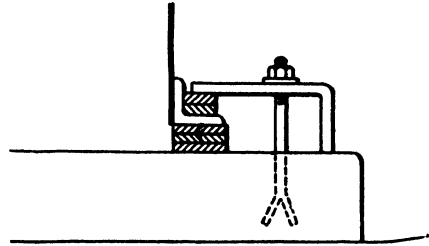

Fig. 9.—ANOTHER METHOD OF INSULATING CENTRIFUGAL TYPE OF FAN

Showing alternative methods of insulating centrifugal fans in ventilation systems, in order to damp down vibration and noise. The method shown on the left is preferable for smaller types of fan ; that on the right in the case of larger units.

With larger fans, the arrangement shown in Fig. 9 is to be preferred, as this allows the compression of the cork to be controlled, the damping properties of all anti-vibration materials being influenced by the compression loading. Care must be taken, however, that the machine is not thrown out of alignment due to unequal tightening of the various clamps.



Fig. 10.—AXIAL FLOW TYPE OF FAN

Where very exact performance is called for the impeller blades can be varied in angle, chord and solidity whilst the number of blades can also be varied. (*Airscrew & Co., Ltd.*)

Axial Flow Fans

Axial flow fans have been increasingly developed in recent years, and are now widely adopted. At medium and low pressures they are in common use and have certain very definite advantages. On the one hand there is the saving in power and on the other their convenience, for they can be incorporated in the ducting without interfering with the straight run of ducts. In fact from the external appearance there is no indication that a fan exists. The high peripheral speeds (over 7,500 revs. per minute) needed at higher ranges of pressure are against their use when a low sound level is required, although they are to be found quite commonly working against 8 in. or 10 in. w.g. where the sound level is unimportant ; but up to 1 in. w.g. the noise is not objectionable.

They are available as wall fixtures where no ducting is necessary on the motor side of the fan; ducting may be fixed on the impeller side. Also as a short casing type for duct mounting and as a long casing type where periodic dismantling for cleaning is necessary. With the addition of a strongly reinforced sheet metal cradle, with either direct or V drive they can be fixed on the floor. When the sound level is unimportant multi-stage axial flow fans enable comparatively high pressures to be worked against.

Noise from Fans and How to Avoid It

Special provision is necessary to minimise noise in all cases except perhaps in factory premises. The fan should be carefully chosen with

this in mind, and a slow-running rope-driven fan should be selected in preference to a direct-driven one, where the impeller wheel is mounted on the motor shaft. Flexible connections between the trunking and fan at the inlet and outlet should be provided. These can be of either leather or stout canvas. The fan and motor should also be mounted on anti-vibration bases of cork or similar material.

There are three sources from which noise may arise.

Motor Noise. This may be magnetic hum due to the nature of the electric supply, or vibration due to mechanical movement, or both. Motor manufacturers usually have machines especially designed for quiet running in ventilation work, and these are known as "super-silent" as distinct from the commercially silent type. Apart from stressing the importance of absence of noise when ordering the fans and motors, there is very little that can be done to safeguard against noise from this source.

Air Noise. This is due to the cutting action of the fan blades in moving through the air. The magnitude of the noise in this case is in part dependent upon the shape of the blades, and also upon the tip speed, i.e. the product of the speed and radius of the blade. The greater

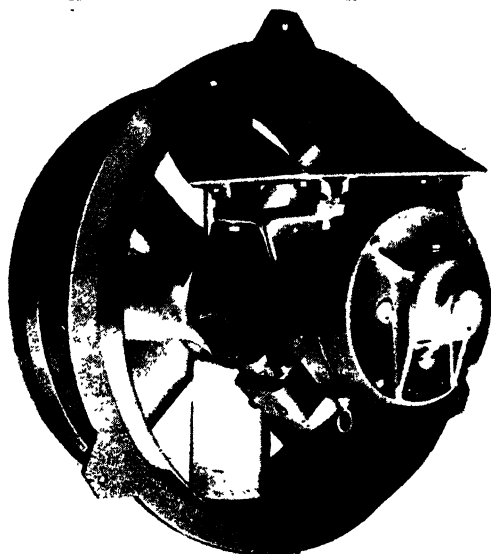

Fig. 11.—AXIAL FLOW TYPE FAN FOR FITTING
IN DUCTING

The unobtrusiveness of this type is one of its chief advantages. (*Airscrew Co., Ltd.*)

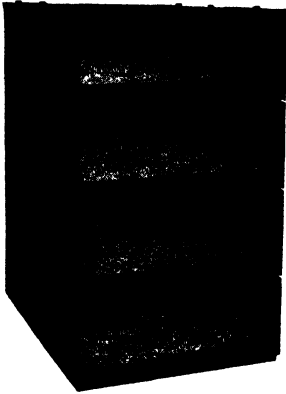

Fig. 12.—DRY COTTON WOOL
FILTER
(Messrs. Matthews &
Yates, Ltd.)

the resistance against which the fan has to move the air, the greater the tip speed, and therefore risk of noise. For this reason the path of air flow must be made as easy as possible, and the discharge louvres provided with adequate free area in order to avoid a high velocity through the apertures. A cone or pyramid, with the point directed downwards is sometimes fitted to streamline the air flow through the louvres and thus avoid turbulence with attendant increase in resistance.

Solid Vibration. This is the transmission of movement due to imperfect bearings on fan and motor. Vibration transmitted to the structure of a building causes the emission of sound vibrations from the part of the building affected; vibration and noise are almost synonymous, at least, there cannot be vibration without noise or noise without vibration.

Thus, it is necessary to absorb the vibration of the fan and motor before it can be transmitted to the building. Any elastic or resilient material, e.g., cork, felt, rubber or steel springs, may be employed to absorb vibration.

Air Filters

Air Filters have already been referred to in the chapter on Warm Air Heating. The selection of a satisfactory filter is of great importance in a ventilation or air conditioning scheme, as the efficiency of a filter is liable to vary considerably in service, also the rating and testing of filters is not yet satisfactorily standardised in this country. All filters are efficient to the extent of removing about 98 per cent. of suspended matter in the atmosphere, but the real criterion of the performance of a filter is, of course, the amount of dust which it passes.

If particles down to 5 microns (a micron is 0.001 millimetres) are adopted as the standard for test, makers will guarantee efficiencies up to 99.9 per cent. but the difference in cost between highly efficient apparatus of this type

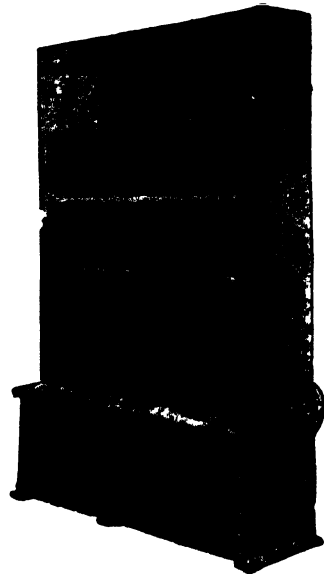

Fig. 13.—ROTARY OIL-COATED FILTER
(Messrs. Matthews & Yates, Ltd.)

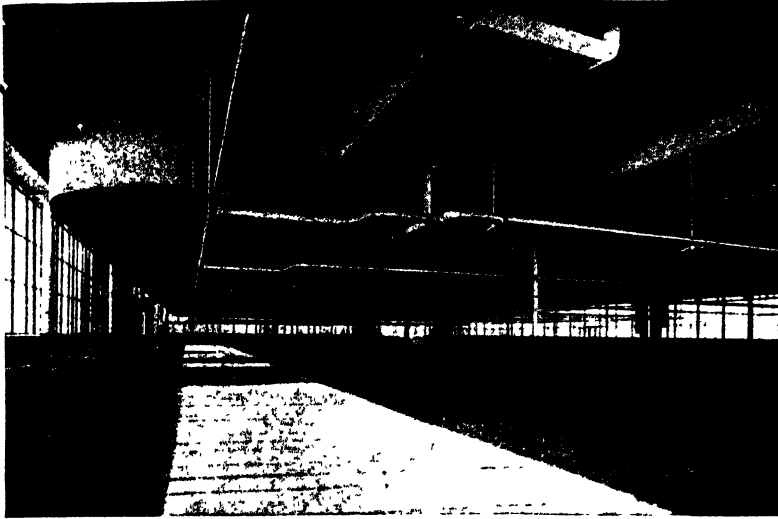

Fig. 14.—RANGE OF DUCTWORK IN A BISCUIT FACTORY, AIR CONDITIONED BY
 "SIROCCO" PLANT
 (Messrs. Davidson & Co., Ltd.)

and a filter removing say 98 per cent. of the suspended matter may be considerable. The exclusion of the maximum possible amount of dust is not of great importance in ordinary industrial ventilation, and in the ventilation of offices, cinemas, etc., but may be essential in some industrial processes, such as the manufacture of photographic films.

Some air filters are illustrated in Chapter XIII, and Figs. 12 and 13 show a dry cotton wool "throw away" type, and a rotary oil coated filter respectively.

Air Heaters

Air heaters are described in Chapter XIII. The rate of heat transmission will depend upon the temperature of the steam or water used as the heating medium, and on the mean temperature and velocity of the air passing through the heater. Makers' lists must be consulted for details. In designing a heater battery, the resistance should, if possible, be limited to 0.2 inches of water gauge.

Ductwork

Ventilation ductwork is usually formed in galvanised sheet steel. If it is intended for use in a laundry or other situation where it would be liable to corrosion, the ductwork should be galvanised after manufacture, but this involves additional cost.

Table 4 shows the minimum thickness of plate for ducts of various sizes.

HEATING AND VENTILATING

TABLE 4.—THICKNESS OF METAL DUCTS

	<i>S. W. G.</i>
Circular Ducts :	
Below 18 in. diameter	24
18 in. and below 30 in.	22
30 in. and below 42 in.	20
Over 42 in.	18
Rectangular Ducts :	
Longer side below 12 in.	24
12 in. and below 18 in.	22
18 in. and below 30 in.	20
30 in. and below 48 in.	18
Over 48 in.	16

Large ducts should be suitably strengthened by means of angle iron bands.

Ductwork formed in brick or concrete should be finished with as smooth a surface as possible.

As with fans, the manner of supporting the trunking must receive particular attention if the avoidance of transmission of noise from vibration is of importance. Felt is a useful material to break a metal-to-metal contact, and is inserted between the supports and ductwork for this purpose.

Fig. 14 shows a range of ductwork distributing conditioned air in a factory.

Design of Ventilation Systems

In designing a ventilation scheme it is essential to draw the proposed duct system to scale with the volume of air in each part of the system marked on. Reference to a standard chart such as that shown in Fig. 15 will then enable the resistance head from the fan to the farthest point to be determined, including any ductwork on the suction side. In this way, suitable duct sizes can be selected.

In the ideal design the total head between the fan and each outlet, when passing the required quantity of air, would be the same, but design on strict aero-dynamical lines is often impracticable and dampers are installed to enable the flow in various sections to be regulated. It is, however, of great importance that a ductwork system should be designed on a rational basis and some consideration given to the head required to overcome losses by friction and obstruction. Ductwork sized merely on considerations of volume and velocity, may give very unsatisfactory results.

Air Velocity

The "Velocity Head" or the pressure required to set up velocity in air is proportional to the square of the air velocity. It is useful

to remember that 1 inch of water gauge is equivalent to a velocity of 4,000 feet per minute : thus a velocity of 2,000 ft. per minute would require a water gauge of $\frac{1}{4}$ in. The power required to operate ventilation systems is thus approximately proportional to the square of the air velocity in the ducts. With small ducts, capital costs are lower, but the running costs are high and, as a general rule, ducts should be made as large as circumstances permit.

The velocities corresponding to various values of water gauge are shown in Table 5.

TABLE 5.—VELOCITY HEADS
PRESSURE OF DRY AIR AT 60° F. AT VARIOUS VELOCITIES

Water Gauge	Velocity ft./min.	Water Gauge	Velocity ft./min.	Water Gauge	Velocity ft./min.	Water Gauge	Velocity ft./min.
·1 in.	1250	·6 in.	3070	1·1 in.	4170	1·6 in.	5020
·2 in.	1760	·7 in.	3320	1·2 in.	4350	1·7 in.	5170
·3 in.	2170	·8 in.	3550	1·3 in.	4590	1·8 in.	5330
·4 in.	2520	·9 in.	3770	1·4 in.	4700	1·9 in.	5470
·5 in.	2800	1·0 in.	3950	1·5 in.	4860	2·0 in.	5620

The air velocities usual in ventilating systems are given in Table 1, Chapter XIII.

Velocity head, in inches of w.g., is given approximately by the expression $0\cdot000225v^2$, where v is the velocity in feet per second.

Frictional Resistance

The head in inches w.g. required to overcome the frictional resistance of ducts is given by the expression—

$$\frac{Lv^2}{14,500 d}$$

where L is the equivalent length of duct in feet,

v is the air velocity in feet per second ;

d is the diameter of a circular duct or the side of a square duct.

Calculations are greatly facilitated by the use of a chart such as shown in Fig. 15.

The equivalent length of duct due to various types of bends is shown in Table 6.

TABLE 6.—ALLOWANCE FOR BENDS IN DUCTWORK

Type of Bend	Equivalent Straight Length No. of Diameters X
Radius = 2 diameters	5·5
1 diameter	6·5
$\frac{1}{2}$ diameter	12·5
Sharp right angle	75·0

For bends of less than 90°, the resistance is proportional to the angle of the bend.

For square and rectangular shapes, the friction loss may be found from the chart by multiplying that for a circular duct of the same cross-sectional area by the following factors:—

<i>Ratio of sides</i>							<i>Factors</i>
1 : 1	1.15
1 : 2	1.23
1 : 3	1.36
1 : 4	1.50
1 : 5	1.65

For ducts formed in brickwork or concrete, the friction loss is increased by from 10 to 30 per cent., depending on the smoothness of the surface. With glazed tiles the loss is the same as with galvanised iron.

For preliminary designs, it is useful to assume a friction loss of 0.1 inches of w.g. per 100 ft. run of duct.

Other Resistances

Other resistances which have to be allowed for in the design of the system are the resistances through the main air intake, the filter and/or washer, the heater battery, and the discharge gratings.

Approximate allowances for these are as follows:—

Main air intake : 0.3 × velocity head at intake.

Filter : 0.25 in. w.g. or 6 × velocity head in duct.

Washer : 0.25 in. w.g.

Heater battery : up to 0.2 in. w.g.

Branch duct at 30° to main : 0.17 × velocity head in branch.

Branch duct at 45° to main : 0.22 × velocity head in branch.

Discharge gratings (free area = $\frac{1}{2}$ gross area) : 1.5 × velocity head through grating.

Total Fan Head

The total fan head (T.F.H.) to be developed by the fan will be the sum of the losses by friction and obstruction in the suction and discharge ducts, plus the velocity head at the farthest outlet.

The "air horse power" is given by the following expression:—

$$\frac{\text{F.H.} \times \text{Vol. of air in cubic ft./min.}}{6,380}$$

The size of the motor driving the fan should be about double the air horse power.

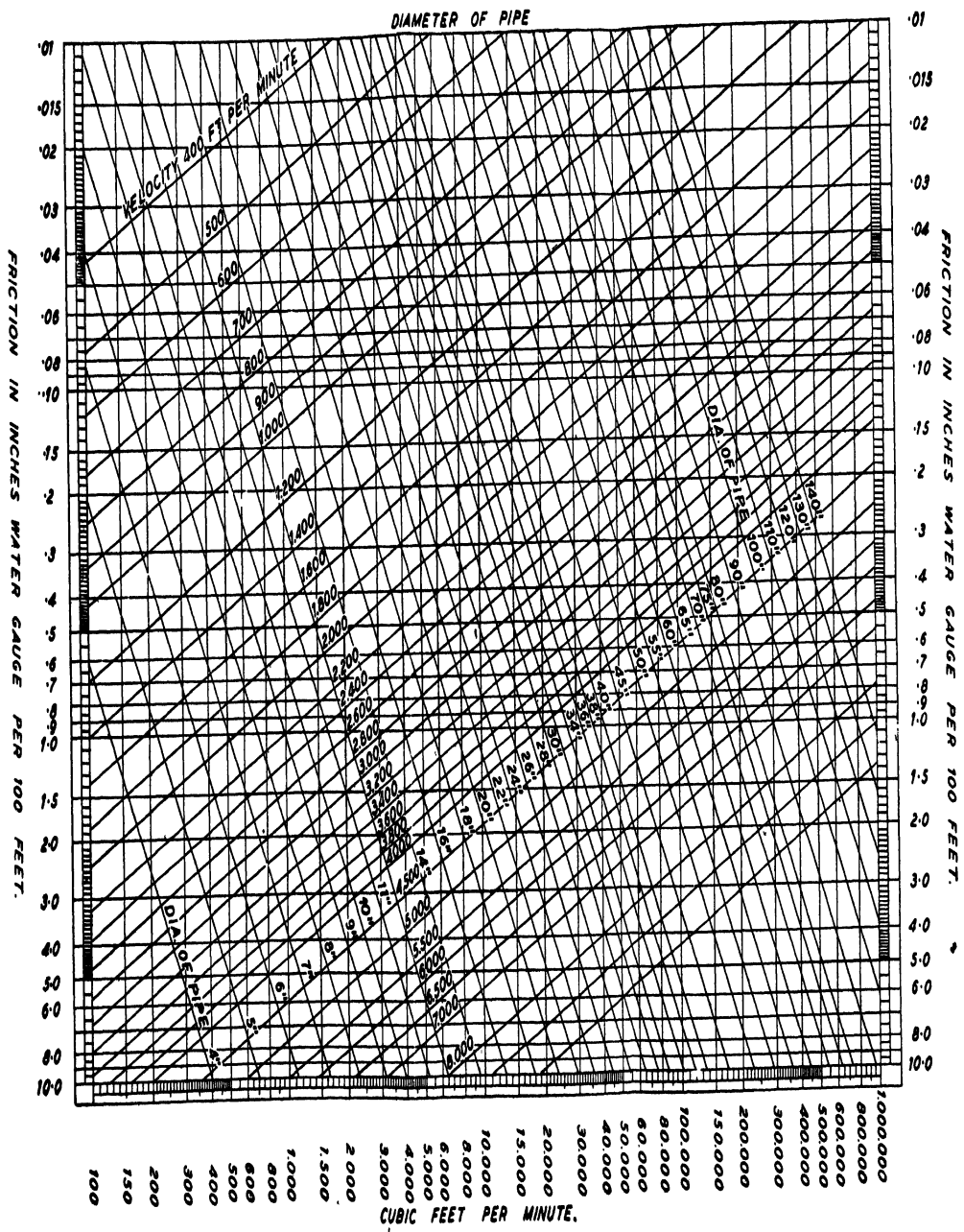

Fig. 15.—CAPACITIES AND RESISTANCES OF GALVANIZED IRON DUCTWORK

[To face page 269]

Example of Calculation

As a simple example of ventilation calculation, consider a system delivering 8,000 cubic feet of air per minute through ductwork 30 ins. in diameter. The duct has two 90° bends of 30 in. mean radius and the length of the duct, measured along the axis, is 120 ft.

The air velocity at the intake is 10 ft. per second, and a heater and filter are installed.

From the Chart, the velocity in the duct is 1,600 ft. per minute and the friction loss is 0.15 in. of water gauge per 100 ft. of length.

The equivalent length of each bend (from Table 6) is 6.5×30 in., or 16.2 ft.

The total length on which friction has to be calculated is thus :—

Length of duct	120 ft.
2 bends @ 16.2 ft., say			..	32 ft.
			Total	<u>152 ft.</u>

The friction loss is thus :

$$\frac{152}{100} \times 0.15 = 0.278 \text{ in. w.g.}$$

Assuming that the duct has a straight discharge, the velocity head is then :

$$0.000225 \times \left(\frac{1,600}{60}\right)^2 = 0.16 \text{ in. w.g.}$$

The velocity head at intake is $0.000225 \times 10^2 = 0.0225$ and the loss of head is thus 0.3×0.0225 or, say, 0.007 in w.g.

The total head can therefore be tabulated as follows :

At intake	0.007 in w.g.
Loss through filter	Allow	0.25	„ „
Loss through heater	„	0.20	„ „
Friction loss in duct	0.278	„ „
Velocity head at discharge	0.16	„ „
			Total	<u>0.845</u>	„ „

There will also be some loss in the connections to the heater casing and the fan, and the total head against which the fan will work can be estimated as 0.9 in w.g.

The air horse-power will be :

$$\frac{0.9 \times 10,000}{6,380} \text{ or } 1.4$$

A motor of 3 B.H.P. will probably be necessary to drive the fan.

THE VENTILATION AND AIR-WARMING OF CINEMAS, RESTAURANTS AND SMALL ASSEMBLY HALLS

In systems where good ventilation is to be maintained it is usual to allow an air change of not less than 1,000 cu. ft. per person per hour. This allowance, if made for a hall or cinema capable of seating an audience of, say, 1,500 persons, will necessitate the installation of a ventilation system capable of supplying and removing $1,000 \times 1,500 = 1,500,000$ cu. ft. per hour.

The design of a system for handling such a large volume of air requires the careful and expert attention of the engineer, who must plan the air inlets and outlets so that the air is delivered and removed uniformly to and from all parts of the room.

Let us take a specific case, a medium-sized cinema, designed for accommodating about 1,000 people. Obviously there are times when it is comparatively empty and for the most part needs warming. But in the evenings and at week-ends it is probably packed to capacity and will become intolerably hot and stuffy unless the system installed is sufficiently pliant to cope with the demands for heat in the right amount and for fresh air. This cinema is quite typical of the problems which confront the heating and ventilating engineer in dealing with theatres, restaurants, assembly halls, canteens, etc. In each there is what may be called a peak load. Empty, they need to be warmed so that arrivals are not chilled and air must be capable of being aspirated or forced through, without draughts, so that there is neither pollution of the atmosphere, due to a large number breathing too little fresh air, nor excessive warmth owing to the heat from 1,000 people being added to that supplied for warming. Not too simple a problem. Certainly one not solved by merely cutting off heat and opening ventilators.

The air circulated to carry away the body heat from the occupants must not be allowed to enter at too low temperature as this would result in objectionably cold draughts. Thus, paradoxically, often more heat is required to keep the building cool than to keep it warm, even in the coldest weather.

Temperature of Incoming Air

The lowest temperature at which air may safely be allowed to enter a crowded hall or auditorium depends, to some extent, upon the location of the points of entry relative to the arrangement of the seats, and also upon the velocity of the incoming air. Only under the most favourable conditions of low velocity and ideal positioning of inlets should the incoming air be at a lower temperature than 60° F. and in no circum-

stances should it be cooler than 55° F. Thus, it will be appreciated that more heat may be required to temper the air to render it a suitable cooling medium than is required to maintain the empty building in a comfortably warm condition. In short, body heat from occupants, far from being "free heat," and thus of assistance in warming the building, is, in fact, more often an additional problem.

Two sets of calculations become necessary: the amount of heat needed to keep the building warm in cold weather and the amount required to temper the air necessary to prevent overheating when the building is occupied. The intermediate condition of a partly filled building must also be considered.

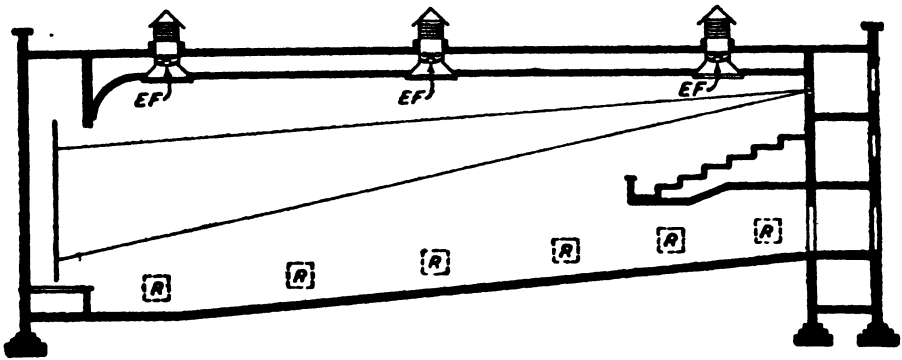

Fig. 16.—A SMALL CINEMA

With accommodation for 1,000 persons, a volume of 160,000 cu. ft. and heat losses from walls, roof, etc., of 6,000 B.T.U. per hour per 1° F. difference between indoors and outdoors. R, Radiators. EF, electric extract fans.

Positioning the Radiators to Make Contact with Incoming Air

There emerges from these facts a fundamental principle that must always be remembered: all radiators or other heating surface in halls or auditoriums where large numbers of people are assembled, and where consequently the problem of cooling arises, must be so positioned that they are available for tempering incoming cool air. Radiators not so placed simply add to the amount of heat to be removed when the building becomes crowded.

In Entrance Halls and Vestibules. Where extract ventilation is employed, thus producing inside the building a mild sub-atmospheric pressure and so causing a general infiltration of air from outdoors, radiators placed in entrance halls and vestibules are usefully employed, for under such conditions a large proportion of the air supply for the building invariably enters at such points due to the opening and closing of doors and also to the lack of air-tightness of swing doors, even when fully closed.

Near Exits Quite frequently draughts are too perceptible to the occupants of seats near the back in cinemas, because this point has not been given proper consideration in the design of the heating and ventilating system. Similarly, radiators near exits are not quite as useless as they may appear superficially; with the building under suction due to an extract system, possible draughts from such doors must be taken into account.

In Body of Hall. Radiators in the body of the hall should stand in front of fresh-air inlet openings in order to serve a useful purpose when excess body heat from occupants must be removed; where not provided with fresh-air inlets, or otherwise positioned to deal with incoming cool air, radiators should be so arranged that they can readily be shut off, preferably from some central point from which all such radiators can be controlled.

Amount of Air Required

The amount of air required for a given building does not depend solely upon the number of people accommodated. The length of time the people are likely to be assembled must be taken into account, and also the amount of space provided per person.

Churches. To take an extreme case, churches rarely require mechanical ventilation. This is because the congregation are assembled for a relatively short space of time and since such buildings are usually both lofty and spacious, there is neither serious vitiation of the air nor overheating of the building during the service, even if the air is completely unchanged during this period. At most, it is seldom necessary to do more than leave the doors open for part of the time between services, so that the air is fresh at commencement.

Assembly Halls. These are, to some extent, comparable with churches as to ventilation requirements, but the possibility of concerts of perhaps three hours' duration, must be considered.

Canteens. When attached to factories, canteens are seldom populated heavily for periods of more than two to three hours, but the necessity for mechanical ventilation frequently arises owing to the low space allowance per person and the heat from cooking apparatus as well as from the occupants. Vitiation of the atmosphere from tobacco smoke and food odours are factors which must not be overlooked.

Cinemas. In the case of cinemas, the space allowed per person is considerably less than in the other buildings mentioned, whilst full occupancy is continuous over many hours, so the necessity for mechanical ventilation invariably arises.

The L.C.C. Regulations provide that the temperature in the building before the admission of the audience shall be at least 55° F. Cinemas present an important problem to the ventilating engineer, owing to the intensity and duration of the occupation, and the fact that smoking is permitted.

Regulations Regarding Ventilation

The L.C.C. requirements are for 1,000 cu. ft. of fresh air per hour per person in the case of new buildings licensed as places of public entertainment, while 750 cu. ft. per head is usually allowed in the case of existing buildings voluntarily reconstructed. The regulations also cover control of temperature and humidity, and distribution and filtration of the air. Proposed schemes must be approved before the work is commenced.

Authorities in other districts have their own regulations or adopt those of the L.C.C. In many cases ventilation to the extent of only 500 cu. ft. per head per hour is regarded as satisfactory, and plenum plant with air washer and temperature and humidity control is not deemed essential.

The low allowance of 500 cu. ft. per head should, however, not be adopted without first making a check calculation, in order to be sure that serious overheating will not result.

Fig. 16 illustrates a small cinema, having accommodation for 1,000 persons and having heat losses from walls, roof, etc., of 6,000 B.T.U. per hour per 1° F. difference between indoors and outdoors, and a volume of 160,000 cu. ft.

Calculation of Heat Requirements

WHEN HALL IS EMPTY. If it is desired to maintain an internal temperature of 60° in the empty building when 32° outside, the amount of heat required in the auditorium will be $6,000 \times 28 = 168,000$ B.T.U. per hour, plus the amount required for warming the air. With the building closed and the ventilating plant out of commission, as would be the case when the empty building is being kept warm in preparation for the admission of the public, the infiltration usually amounts to about three-quarters of an air change per hour, *i.e.*, a displacement or renewal of $160,000 \times 0.75 = 120,000$ cu. ft. of air per hour, requiring a further $120,000 \times .02 \times 28 = 67,000$ B.T.U. per hour.

The total amount of heat required in the auditorium is therefore $168,000 + 67,000 = 235,000$ B.T.U. per hour when empty.

BUILDING FULLY OCCUPIED. If all the radiators are so arranged that the heat is available for warming the incoming fresh air to 60° when the fans are running and the building fully occupied, the amount of heat required to raise the temperature of $1,000 \times 500 = 500,000$ cu. ft. of air per hour is $500,000 \times .02 = 10,000$ B.T.U. per degree, or 280,000 B.T.U. per hour for the 28° rise from 32° to 60°. Thus, rather more heat is required for dealing with the fresh air than for maintaining the empty building at 60°. Although this is quite a usual result, it is not without exceptions, and it would be unsafe to assume that the air-heating requirement is bound to cover the empty building demand.

The question now arises as to what the indoor temperature will be for different weather conditions.

Influence of Varying Outdoor Temperatures. It will be appreciated that the total heat generated in the building will ultimately equal the amount lost from the building, and that the heat given up in the auditorium is the sum of the body heat from the occupants and the heat imparted to the fresh air to raise it from the outdoor temperature to the lowest safe temperature at which it is allowed to enter the hall, in this case 60° F.

On the average, an adult at rest gives about 300 B.T.U. per hour by convection and radiation, and about one-tenth of a pound, or 700 grains, of moisture per hour by respiration and evaporation from skin surface.

Thus the total body heat when the building is fully occupied is 300,000 B.T.U. per hour. When the outdoor temperature is 32° the amount of heat required for tempering the air is $10,000 \times (60 - 32) = 280,000$ B.T.U. per hour giving a total internal heat generation of 580,000 B.T.U. per hour.

The fabric losses are 6,000 B.T.U. per hour per 1° F., and the heat corresponding to a rise of 1° in the temperature of the air circulated through the building at the rate of 500 cu. ft. per person is 10,000 B.T.U. per hour. Thus, for each degree by which the temperature in the building is higher than outdoors, there will be a loss of $6,000 + 10,000 = 16,000$ B.T.U. per hour, the air escaping from the auditorium at the average temperature in that part of the building.

Thus, with an outdoor temperature of 32° the indoor temperature with full occupation will be $32^\circ + (580,000/16,000) = 32^\circ + 36^\circ = 68^\circ$.

OUTDOOR TEMPERATURE OF 40° F. When 40° outdoors, the amount of heat required to temper the air is reduced to $10,000 \times (60^\circ - 40^\circ) = 20,000$, and the total generated in the auditorium is then 50,000, and the resultant temperature is $40^\circ + (50,000/16,000) = 40^\circ + 31^\circ = 71^\circ$ F.

OUTDOOR TEMPERATURE OF 50° F. For an outdoor temperature of 50° the inside temperature is $50^\circ + (400,000/16,000) = 50^\circ + 25^\circ = 75^\circ$, and for an outside temperature of 60° or over the inside temperature will be $300,000/16,000 = 19^\circ$ higher than outdoors.

It will be seen that there is much more likelihood of the cinema in question being considered too warm rather than not warm enough, thus showing that 500 cu. ft. per head is far from generous.

Bearing in mind the fact that the outdoor temperature in summer may be as high as 75° in late afternoon or early evening, a rise of 19° in the building gives 94° F., a decidedly uncomfortable condition, to say the very least.

With an allowance of 1,000 cu. ft. per head, the temperature rise in the building would be reduced to, say, 10°, and a corresponding indoor temperature of 85° F.

Effect of Sunshine on Building

Since the effect of sunshine on the building has not been considered, it is not surprising that refrigeration working in conjunction with air conditioning is adopted in some of the densely occupied buildings in this country.

In the present instance, fans capable of 1,000 cu. ft. of air per hour per person are strongly to be recommended for summer use, with speed regulation to reduce the volume to 500 per head in winter when fuel consumption must be taken into account.

It may be thought that since there are three fans, indicated EF in Fig. 16, it would be practicable to run one, two or all three, according to the outdoor temperature; there is, however, an objection to doing this, for the tendency would be to draw air down through the fan or fans not running and so short-circuit the path of air flow. Automatic shutters on the discharge from each fan are not usually successful with a vertical upward discharge, whilst the upward discharge is itself a desirable feature as it obviates the risk of a facing wind on a horizontal discharge opening causing a loss of efficiency. With the arrangement indicated, it is much more satisfactory to have all three fans controlled by the one variable speed starter, with an isolating switch on each unit in order to deal with repairs.

Care must be taken to avoid complaints of noise from the fans.

The Trunking from Fans to Ceiling

The trunking from the gratings in the ceiling to the extract fans should be connected either direct to the masonry or to the timber frame. On no account should it be in direct contact with the metal framework of the fan. Where there is any risk of the trunking picking up vibration a sailcloth connection is inserted to break the path of the vibration.

Where, as is often the case, the propeller fan is fitted in a square opening, the timber frame is provided with a stout plywood board in which a circular hole is formed to suit the size of the fan blades, as shown in Fig. 5.

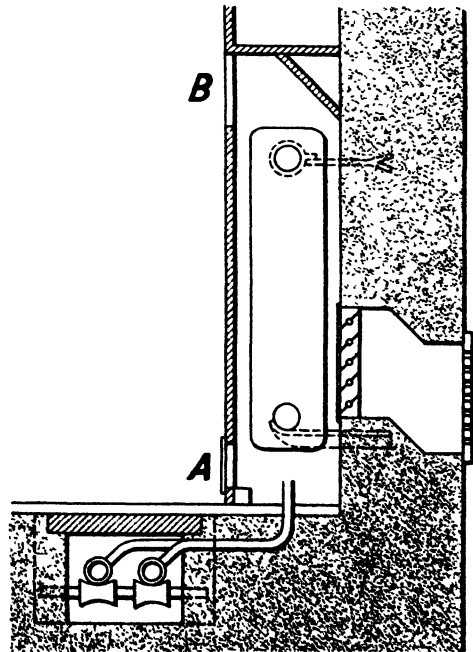

Fig. 17.—How FRESH AIR IS ADMITTED TO AUDITORIUM BEHIND RADIATORS

Fresh Air Admitted Behind Radiators

Fresh air is admitted to the auditorium behind the radiators, marked R on Fig. 16, a side view being given in Fig. 17. The fresh air enters via the grating, C. A register with adjustable louvres allows the fresh-air inlet to be closed when desired.

Operation of the System

When the building is empty and the fans are not running, the air enters the opening, A, at the bottom of the radiator (see Fig. 17), and the heated air escapes into the auditorium via opening, B, the fresh air inlet, C, being closed. It is important that adequate openings be provided above and below the radiator for the air to circulate freely, an opening 4 in. high by the length of the radiator should be secured if at all possible, and in any case, neither should be less than 3 in. high. The heat emitted by a radiator encased in this manner is about 70 to 80 per cent. of that of a radiator freely exposed to the room.

A damper at the opening, A, is to be recommended in order to prevent air from the inlet, C, being drawn into the room without passing over the whole of the radiator and thus causing cold draughts.

The emission from a radiator over which cold air is drawn by fans, as in the present instance, is about 25 per cent. more than if freely exposed to air at room temperature. Thus if the basis emission from the type of radiator considered were 160 B.T.U. per hour per sq. ft., the output under the empty condition is about 120 B.T.U. per sq. ft. against 200 B.T.U. per sq. ft. with the fans running, and 32° outdoors.

Amount of Heating Surface to be Provided

The amount of heating surface to be provided is therefore $235,000/120 = 1,960$ sq. ft., since clearly the figure is controlled by the empty condition; $280,000/200 = 1,400$ sq. ft. would have sufficed for dealing with the air required when the building is fully occupied and the fans in commission. The fact that 1,960 sq. ft. is provided means that an emission of only $280,000/1,960 = 143$ B.T.U. per sq. ft. is required with the fans running, consequently a lower boiler flow temperature will be the result. This fact should be taken into account in sizing the radiators for the entrance hall, lounge, pay-box, and other places where the low boiler flow temperature may adversely affect the room temperature. Such radiators, not in front of fresh-air inlets, will have a reduced emission in the ratio $143/200 = 70$ per cent.

The Boiler Power Required

The boiler power required is 280,000 B.T.U. for the auditorium, plus the heat required in other parts of the building, with an allowance for losses from the mains and a margin of reserve boiler power for intermittent heating.

Size of Fresh-air Inlets

In sizing the fresh-air inlets a velocity of 300 ft. per minute over the free area of the inlet gratings may be taken, the amount of air entering by the vestibule and other doors first being deducted from the total required, *i.e.*, from $1,000 \times 500 = 500,000$ cu. ft. per hour, or 8,300 cu. ft. per minute.

Air Entering Through Doors

Doors may usually be taken to allow one-third of the total air volume to enter the building, and this should be taken into account in arriving at the amount of heat to be provided in the vestibule.

Amount of Air Admitted by Fresh-air Inlets

The amount of air to be admitted via the fresh-air inlets behind the auditorium radiators is therefore 5,500 c.f.m., requiring $5,500/300 = 18$ sq. ft. of free area, *i.e.*, unobstructed area, or, if the gratings have 60 per cent. full or clear area, 30 sq. ft. of grating area. As there are twelve radiators in the auditorium the grating behind each radiator must have an area of 2.5 sq. ft.

Output of the Fans

Each of the three propeller fans must, of course, deal with $8,300/3 = 2,800$ cu. ft. per minute, or if the recommendation of 1,000 cu. ft. per head in summer is adopted, 5,600 c.f.m. each.

Fixing the Radiators

With regard to the fixing of the radiators, it may be thought that it would be simpler to have radiators fitted with feet, these being provided free of cost, and so save the expense of bottom brackets and the trouble of supervising the grouting in of these brackets.

There are, however, a number of points in favour of using radiators without feet, and more often the expense of bottom brackets is justified by savings in erection costs. In the present instance, the sloping floor is in itself enough to justify radiators supported clear of the floor on brackets. Even were the floor level, it is often difficult to ascertain the precise level of the finished floor, this normally being one of the last parts of a building to be completed. Thus there is difficulty in fitting the branch connections from the mains to each individual radiator.

Where the radiators are fitted clear of the floor on wall supports, they can be connected up regardless of the exact level of the future finished floor, and temporary blocks are obviated, together with subsequent disconnection of the radiator to allow the flooring to be completed. The argument that the radiators need not be fitted until the final floor finish is completed will not stand inspection in practice, for it would mean that a large part of the heating engineer's work would be delayed to such an extent that it would adversely affect progress of other trades.

A further point in favour of keeping the radiators well clear of the floors is that by so doing there are better facilities for cleaning under the radiators, and freedom for running connecting pipes under the radiator and above the floor when desired.

Supporting Main Pipes in Trenches

Work on the mains in the trenches will be simplified if thought is previously given to the method of supporting the pipes. Since the cinema floor slopes quite as much as, and considerably more than, the minimum required for allowing air to be expelled from the pipes, the pipe supports can all be the same distance from the bottom of the trench. Where, however, the bottom of the trench is level and the pipes are sloped for venting purposes, the distance from the bottom of the trench to the pipe rollers varies at intervals along the trench. It will be found convenient in such cases to have the builders leave small recesses opposite one another and about 2 in. by 2 in. for the full depth of the trench at intervals of 8 ft. on an average, the cross supports being propped temporarily and afterwards grouted in at the correct levels.

INSPECTION COVERS.—Nowadays pipes are often fitted in trenches which are afterwards permanently sealed so that the pipes are inaccessible except by smashing in the top of the trench. Needless to state, such pipes are thoroughly tested considerably in excess of the normal working pressure on the system before finally covered in. Inspection covers should be provided, whenever possible, at intervals of about 50 ft., so that in the event of a leak the origin of it can be roughly ascertained by lifting the covers and noting where the water flows. This is mentioned because quite recently there have been cases where water has been known to be lost from systems in large quantities, without any visible sign except from the feed and expansion tanks. This, of course, is a serious matter where there are so many pipes in closed trenches that the floor may have to be damaged in many places before the leak is located.

AIR CONDITIONING

Air conditioning is essentially the production and automatic maintenance of suitable atmospheric temperature, relative humidity, freshness, air motion at a desirable rate, and elimination of airborne dust and dirt. The object is the creation of the most favourable atmospheric conditions within an enclosure for manufacturing requirements, or for human comfort, regardless of outdoor climatic fluctuations.

To-day an air conditioner consists essentially of a chamber in which air is cleaned by being brought into intimate contact with water, with the object of

- (a) Cleaning it ;
- (b) Regulating its moisture content ;
- (c) Regulating to a certain degree its temperature.

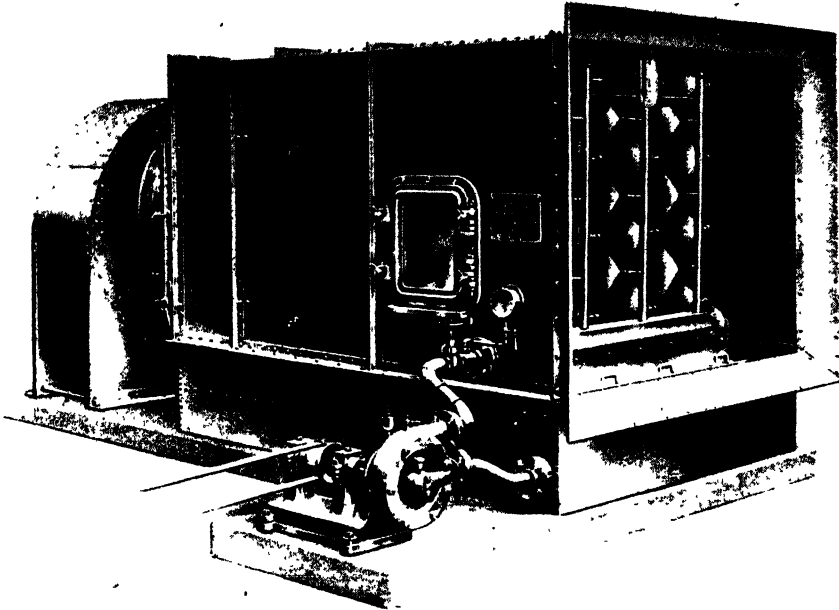

Fig. 18.—WASHER OF AIR CONDITIONER, SHOWING SPRAY CHAMBER AND NOZZLES. (*Messrs. Davidson & Co., Ltd.*)

Construction of Spray Type Air Conditioners

The spray type air conditioner is usually constructed entirely of metal, but occasionally builders' materials are used. It is made in two parts, the lower part being a tank, which, if metal, is galvanised after manufacture, and if of builders' work is asphalted. The upper part, if of metal, is again galvanised, but is erected in sections, the joints being made with lead; occasionally it is built in brick or concrete and asphalted.

The tank is normally made about 18 in. deep, and contains water, the level of which is maintained by a ball valve.

Water is drawn from the tank by means of a centrifugal pump and discharged through special spray nozzles fixed at regular intervals on vertical sparge pipes normally arranged at centres approximately equal to the distance between the nozzles on each pipe.

It is necessary for the air to enter the conditioner evenly, or otherwise excessive localised velocities will be set up through portions of the spray mist giving rise to poor cleaning or imperfect humidification. In practice it is difficult to arrange an even flow to a conditioner in most cases, except when it is fixed on the roof, so that a perforated plate is frequently fixed at the inlet to the conditioner to even out the air flow. The plate is

perforated with holes generally $1\frac{1}{2}$ in. to 2 in. in diameter at $2\frac{1}{2}$ in. to 3 in. centres, and in certain instances a further precaution is taken and the areas of the holes reduced in those portions of the conditioner inlet where velocities are likely to be highest and the biggest artificial resistance is thus required.

Air Washers

Air-washers have already been referred to in Chapter XIII and a typical example is shown in Fig. 18. The temperature of the spray is regulated to that corresponding to the dew point of the final condition required, whether this is greater or less than that of the incoming air, and the air passing through the washer is approximately saturated at this temperature. The air then passes through the re-heater battery, where the temperature is raised to the final required level, the relative humidity being correspondingly depressed. The performance of the apparatus is thus regulated by the relative temperatures of the spray water and the heater. These are usually controlled automatically by means of thermostats and thus air-conditioning plant is simple in principle and satisfactory in result.

For controlling conditions in a cinema or other locality in which temperature and humidity are likely to be affected by occupation, the regulating thermostats are placed in the room under control ; in such a case, the temperature of the spray water may be governed by differential humidity control, *i.e.*, a constant difference is maintained between the dry and wet bulb temperatures and the relative humidity will then be unaffected by the amount of water vapour actually given off by the occupants. Many other arrangements are possible. By reducing the temperature of the spray water below that of the dew point of the incoming air, moisture is condensed from the air and the paradoxical effect is thus obtained of air being dried by passing through the washer.

Full air conditioning requires refrigeration in order to reduce the spray temperature to dew point. If refrigeration is not provided and the spray water is recirculated, it will rapidly rise to the wet bulb temperature of the air passing through the washer. The dry bulb temperature will be reduced by about three-quarters of the difference between the wet and dry bulb temperature. For example, air entering at 80° F. dry bulb and 60° F. wet bulb would leave at about 65° F. saturated. The wet bulb temperature would remain unaltered but the moisture contained would increase from 3.4 to 6.8 grains per cubic foot. The heat given up by the fall in dry bulb temperature is absorbed by evaporating the additional amount of moisture, and the total heat content of the air passing through the washer would, therefore, not be altered and the effect on comfort would be negligible. If, on the other hand, a constant supply of deep well water, which has a normal temperature of 52° F., is available for the washer,

the air would leave the washer at about 59° F. saturated, and thus would provide a considerable degree of cooling.

The Efficiency of the Air Washer

The percentage saturation can be controlled to a large extent by varying the number of banks of sprays and their direction of operation. The

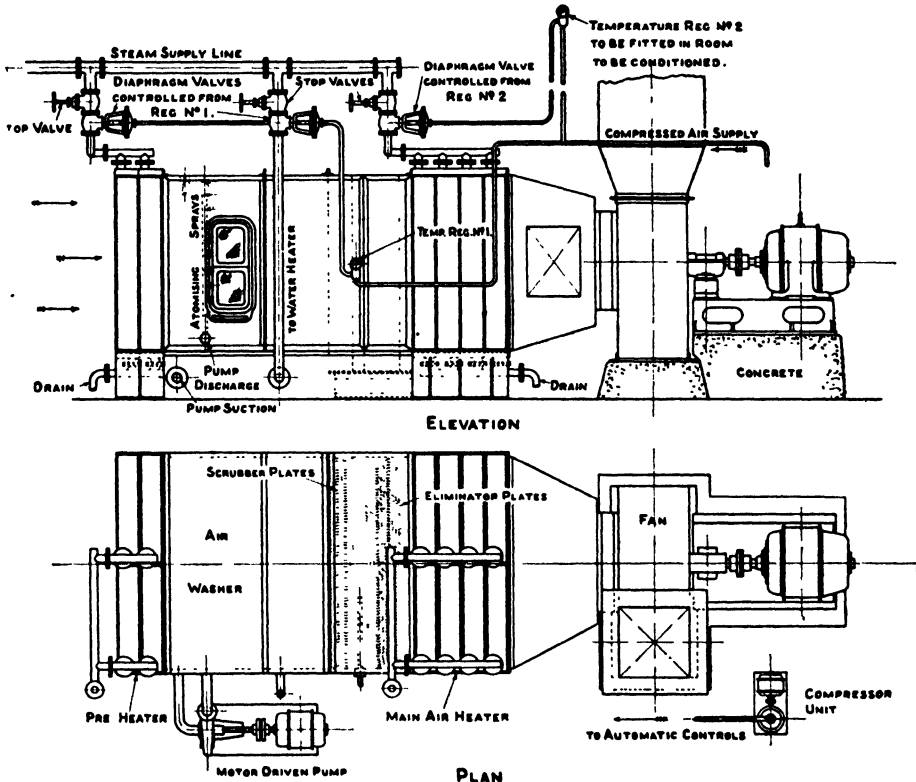

Fig. 19.—GENERAL ARRANGEMENT OF AIR CONDITIONING PLANT
(Davidson & Co., Ltd.)

following table can be taken as a general guide towards the saturations which can be expected :—

		<i>Saturation Efficiency</i>
3 banks—2 upstream—1 downstream 100%
2 " 2 " 95%
2 " 1 " 1 " 85%
1 bank 1 " 80%
1 " 1 " 65%

(Proc. Am. Soc. H. and V. Eng.)

For air washers the cleaning efficiency of one bank of sprays—usually discharging downstream—is frequently sufficiently high for general ventilation purposes and it is rare to use two banks.

The Sprays—Arrangement and Capacity

The sprays are usually fixed at from 8 in. to 12 in. centres depending upon the atmospheric conditions and the performance required. The capacity of the sprays varies according to the make, but 300 gallons per hour per spray is an average figure. A typical spray arrangement is illustrated in Fig. 18.

How the Air is Cleaned

The cleaning action takes place owing to the formation of a water film round the dirt particles in the air which act as nuclei. At the outlet from the washer a series of zigzag plates is arranged usually about 18 in. long and fixed at 1 in. to 1½ in. centres. Above these plates—they are called eliminator plates—water is supplied through a sparge pipe to a series of jets from which it flows down the plates in a continuous stream. The moisture particles containing the particles of dirt as nuclei impinge upon the eliminator plates, and are held by the surface tension of the water film, and the dirt is gradually washed down to the tank beneath.

The water as it passes to the pump is made to pass through a fine mesh gauze filter which holds up most of the dirt.

The filter must be cleaned at frequent intervals, or the output of the pump will be reduced and the performance of the apparatus lowered. It is also necessary occasionally to clean out the tank, an access door being frequently supplied for this purpose.

Air Conditioners—Construction and Operation

The air conditioner is similar in construction to the air washer with the exception that two or more banks of sprays are usually provided. Furthermore, heat is either added to or abstracted from the spray water. In each case the air tends to become saturated at the temperature of the spray water as it falls back into the tank. The heat added to or given up by the air is again equal to the heat given up by or absorbed by the spray water as it is circulated through the conditioner. The relation between the outlet temperature of the air and the spray water is a guide to the effectiveness of the apparatus; the closer the temperatures the better the performance.

For heating and increase of humidity, the spray water is heated usually by a coil in the conditioner tank itself.

For cooling and dehumidification, however, owing to the comparatively large cooling surfaces generally necessary, the spray water is cooled outside the conditioner by circulating it through external coolers or even directly over the evaporator coils of the refrigerator unit.

Air Washer and Conditioner Capacities

Makers usually rate their air washers on air speed of 400 to 500 f.p.m. through the gross cross sectional area of the spray chamber, measuring from the roof to the level of the water in the tank. For air conditioners the air speed is usually taken at 300 f.p.m., so that a wider and taller unit is necessary. The length of air washers is usually about 7 ft. 6 in. and conditioners 10 ft. or more depending upon the number of banks of sprays. Air washers and conditioners will handle about 5 gallons of water per minute per 1,000 cu. ft. of air per minute for each bank of sprays.

Evaporative Cooling

For reasons outlined above an air washer or conditioner can itself provide no effective cooling, although it may effect a reduction in the dry bulb temperature of the air. This lowering of dry bulb temperature causes no appreciable change in comfort conditions for it is inevitably accompanied by an increase in humidity. For effective cooling it is, therefore, necessary to provide definite refrigeration, except in localities where the relative humidity of the incoming air is comparatively low, in which circumstances "evaporative cooling" can be employed.

According to this method, the spray water is withdrawn from the conditioner and circulated through a subsidiary conditioner, through which air, drawn from outside, is blown by means of a fan and then discharged again to atmosphere. The spray water being circulated through this second conditioner is cooled slightly since a portion is evaporated, and a part of the latent heat is withdrawn from the water itself. The spray water is then circulated back to the main air conditioner cooling the air supplied to the building at a few degrees lower temperature than it left, and has in turn a cooling effect on the air passing through that conditioner.

This method is useful in certain parts of America where constantly low humidities are common, in fact, it is employed at the Capitol at Washington. It is of no value in England since relatively high humidities often accompany hot spells. For the same reason its application is not to be advised in India where the most oppressive conditions occur during the humid monsoon season.

Total Heat of Air

The total heat of air is strictly dependent upon a quantity known as the Temperature of Adiabatic Saturation ; but, for ordinary purposes, it is sufficiently accurate to estimate the total heat in terms of the wet bulb temperature. Air at any given wet bulb temperature has the same total heat content irrespective of the dry bulb temperature. Some values of total heat are given in Table 1. In this case, total heat is measured from 32° F. but, as in air-conditioning work, the difference between the total

heat values of air is required to be known, the actual datum from which the values are measured is immaterial.

The use of total heat values in estimating air-conditioning requirements is best illustrated by an example.

Take the case of an air-conditioning plant which is required to deliver 10,000 cu. ft. per minute of fresh air at 65° F. and 52 per cent. relative humidity. Extreme outside conditions can be taken as 78° F. and 54 per cent. relative humidity in summer, and 30° F. and 100 per cent. r.h. in winter. It is required to find the rating in B.T.U. per hour of :

- (a) The washer circulating water heater for winter use.
- (b) The refrigerator for summer use.
- (c) The reheater.

In solving problems of this kind, values of total heat, etc., can be obtained from hygrometric tables or charts.

The air volume to be handled is 10,000 cu. ft. per minute at 65° F. and 52 per cent. r.h. From Tables, the volume per lb. of dry air is found to be 13.57 cu. ft. The weight of dry air to be handled is thus :

$$\frac{10,000 \times 60}{13.57} = 44,300 \text{ lb. per hour.}$$

The dew point of air at 65° F. and 52 per cent. r.h. is 47° F., and the air must therefore be brought to this condition in the washer before being reheated to its final dry bulb temperature.

- (a) The heat to be added by the washer (assuming 100 per cent. humidifying efficiency) in winter :

$$\begin{aligned} &= 44,300 \text{ (total heat at } 47^\circ \text{ F. and saturated—T.H. at } 30^\circ \text{ F. and saturation).} \\ &= 44,300 (11.09 - 3.26) = 44,300 \times 7.83. \\ &= 346,000 \text{ B.T.U. per hour.} \end{aligned}$$

(Note. Part of this heat can be supplied by a pre-heater, but if the washer water is maintained at 47° F., the final result will be the same.)

- (b) Heat to be abstracted by the washer in summer :
 - = 44,300 (T.H. at 78° F. and 54 per cent. r.h.—T.H. at 47° F. and saturated).
 - = 44,300 (23.4—11.09) = 44,300 × 12.31.
 - = 545,000 B.T.U. per hour.

The refrigerating plant should be capable of this duty.

- (c) Heat to be added by the re-heater, both in winter and summer.
 - = 44,300 (T.H. at 65° F. and 52 per cent. r.h.—T.H. at 47° F. and saturated).
 - = 44,300 (15.47—11.09) = 44,300 × 4.38.
 - = 194,000 B.T.U. per hour.

Refrigeration

When full air conditioning is required, refrigerating plant must be installed of sufficient capacity to reduce the air to the required dew point. This involves the elimination of the heat due to occupation, lighting and machinery and also the amount of solar radiation which may be appreciable: transmissions of 150 B.T.U. per sq. ft. per hour for glass and 6 B.T.U. for a 13-in. brick wall have been quoted.

The majority of mechanical refrigerating plants operate on the compression principle. The working substance, such as ammonia or methyl-chloride, is first highly compressed. In this process its temperature is raised considerably and the hot compressed gas is then discharged into a "condenser." The condenser is cooled by water or air and the contained gas is liquified as the latent heat is absorbed. From the condenser, the liquid refrigerant passes into the "evaporator" where it again is transformed to the gaseous state, absorbing the necessary latent heat from the surroundings, and thus producing cold.

Refrigerating plants are often rated on a "ton" basis: 1 ton being equivalent to heat removal at the rate of 200 B.T.U. per minute. As a rough rule, the power required to drive refrigerating plant is 1 b.h.p. per ton.

It may be mentioned that in this country refrigeration can hardly be regarded as a necessary amenity except in cases where the nature of the occupation renders it desirable. The occurrence of really hot weather is comparatively rare, the shade temperature at Kew normally exceeding 70° F. for only 80 hours per annum. Refrigerating plant is expensive but is commercially justified in densely occupied buildings, such as restaurants.

If refrigeration is used, too great a degree of cooling should not be aimed at, and 10° F. should be regarded as the maximum. Ventilation in crowded places quickly resolves itself into a cooling problem, but the introduction of cold air requires great care as it will cascade from an outlet in a very similar manner to a stream of water and cause great discomfort. If a large degree of cooling is required it is better to increase the volume of air rather than to effect a drastic reduction in its temperature.

DUST AND FUME EXTRACTOR

It is generally conceded that the old-fashioned method of removing dust by sweeping is, to say the least of it, inefficient. The popularity of the household vacuum cleaner is not solely due to the intensive selling organisations created by some manufacturers, but to the recognition on the part of the public of the need for an apparatus that would *collect* this "matter in the wrong place," as dust has been aptly described.

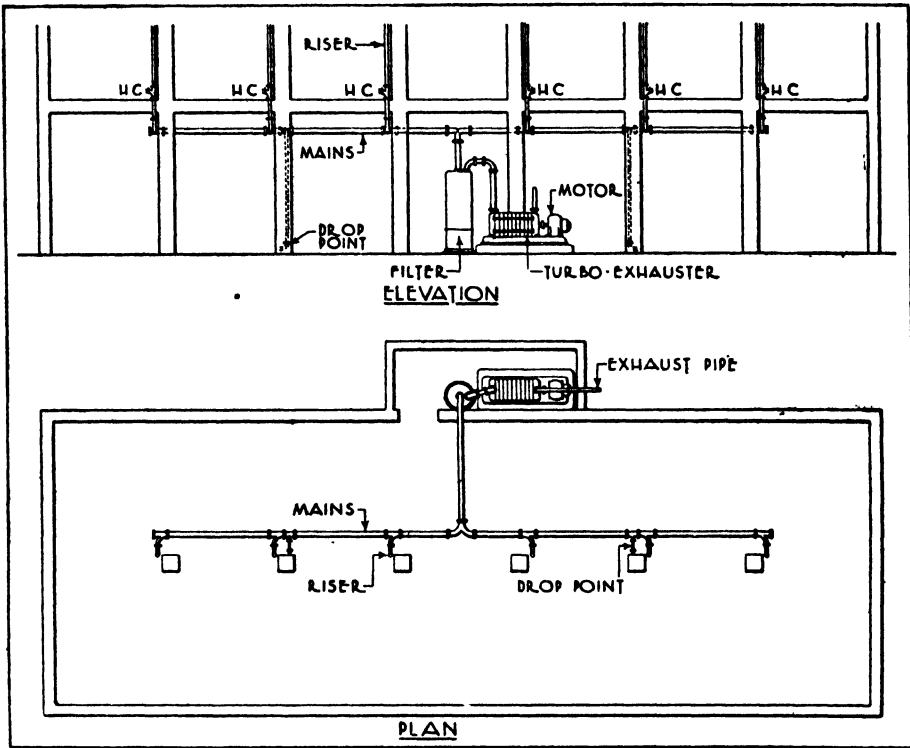

Fig. 20.—THE ARRANGEMENT OF A CENTRAL VACUUM CLEANING PLANT

The exhauster and motor are placed in as central a position as possible, to ensure well-balanced distribution of suction. The suction pipes are distributed on the basement ceiling and give off rising mains in suitable positions. Each riser has a gun-metal hose-connection fitting just above each floor.

Effective dust-removing systems are desirable on the grounds both of cleanliness and of hygiene, not only in public gathering places, but particularly in factories, where dust from the materials may be harmful to the health of the workers. Asbestos dust, for instance, is, if inhaled, highly injurious, causing a disease of the lungs known as asbestosis. This disease is of an insidious nature, rendering the provision of adequate safeguards essential.

Central Suction Plants in Large Buildings

Portable types of vacuum cleaners are often replaced in some of the larger buildings by centralised suction plants. These usually comprise, in each case, a motor-driven fan of high exhausting capacity, to which is connected a system of tubes which extend to all floors and departments.

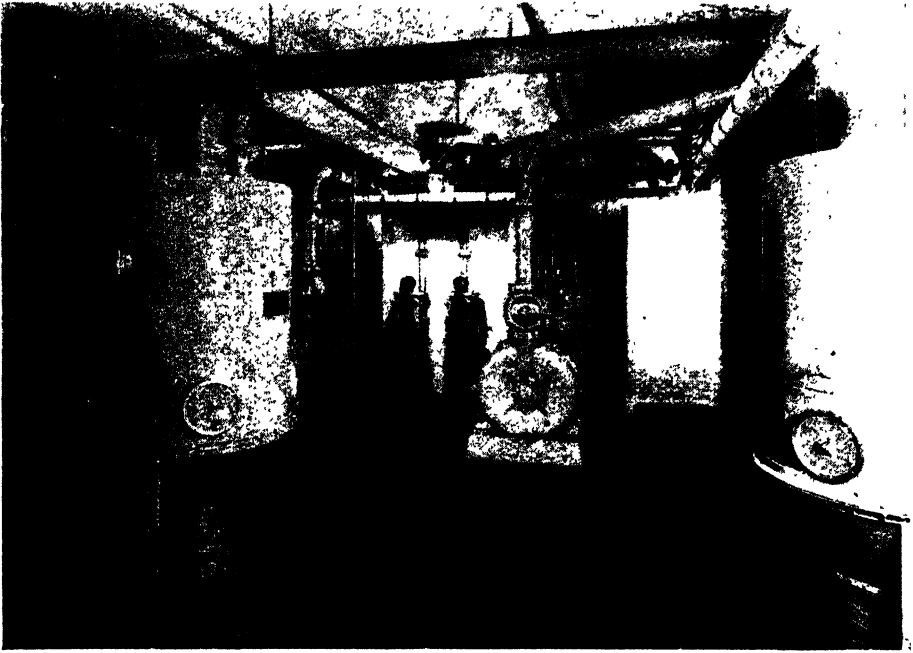

Fig. 21 —VACUUM CLEANING PLANT

This shows a 2-set installation in the London County Hall, giving a capacity of 24 operators distributed over the building, the pipe line serving 104 hose-connection points. (*The British Vacuum Cleaning & Engineering Co. Ltd.*)

The tubes terminate in convenient positions, usually at the skirting levels, where hinged caps, fitted to the tube ends, keep them closed when not in use. Flexible lengths of tube, fitted with suitable nozzles, are attached when cleaning operations are commenced, and the dust from the furniture, carpets, etc., is carried by the powerful suction action of the fan, through the system of tubes to the dust container.

Dust Extraction in Industry

Mechanical dust extraction in industry is applied in all branches where the increased amount of dust, resulting from the greater output made possible by the introduction of machinery, has made necessary its rapid and effective removal.

The extraction system includes a fan, separator, and collector, and the dust-conveying trunking.

The fan is of the centrifugal type, specially designed to create high velocities in the ductwork, and to overcome the corresponding high

resistances. As the fan wheel must revolve at a high speed, a belt drive is usually employed, the drive being arranged from an independent motor or, if convenient, from the line shafting in the factory.

Separating Dust from the Air

In the design of the separator, the velocity of the air is allowed to drop to a speed at which it cannot hold the solid particles of material in suspension. The air then passes out at the top, and the collected refuse falls through an outlet at the bottom into a container.

Conveyor Piping

The conveyor pipes are usually constructed of galvanised sheet metal, and care is necessary to ensure that the inner surfaces are free from obstructions. All bends and junctions should be of a large radius, and where joints are made in the pipe line, the lapping end should always be arranged to face the air stream.

Swivel-pattern dampers should not be used, but those of the sliding, cut-off type, which should be as airtight as possible, and designed to cause no restriction in the area of the duct when fully open.

Air Velocities Required and Sizes of Pipes

The air velocities required depend largely upon the specific gravities of the materials handled, and upon the percentage of solid matter to the air volume. Only by experiment can the most satisfactory speeds be determined, but the following list indicates the average speeds found necessary in practice for various materials :—

	<i>Ft. per Min.</i>
Fine coal	4,400
Fine brass turnings	4,200
Grain	3,200
Wood chippings and shavings	3,000
Rubber dust	2,000
Fibrous jute dust	1,900
Metal dust	1,800
Wood dust	1,300

The sizes of the pipes are governed by the quantity of material to be removed and the volume of air necessary per pound of material. For the removal of the refuse from woodworking machines, the sizes required may be : 4 in. diameter for 18 in. circular saws ; 6 in. diameter for 24 in. to 42 in. circular saws ; 7 in. diameter for planing machines ; and for sanding machines, 8 in. diameter.

Extraction Hoods

The design of the hoods which form the inlets to the conveyor pipes needs careful consideration, as they must not interfere with the working of the machine, nor prove an inconvenience to the operator.

The static suction required at the hoods depend upon many factors, such as the kind and quantity of the material to be removed, and the



Fig. 22.—INSTALLATION VIEW OF CENTRIFUGAL DUST COLLECTORS WITH A WIDE VARIETY OF INDUSTRIAL APPLICATIONS

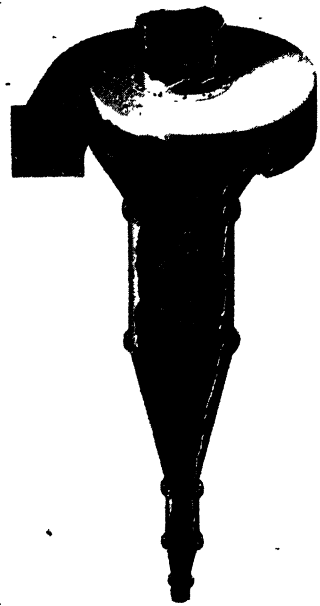

Fig. 23.—PHANTOM VIEW OF DAVIDSON CENTRIFUGAL DUST COLLECTOR, SHOWING SEPARATING ACTION

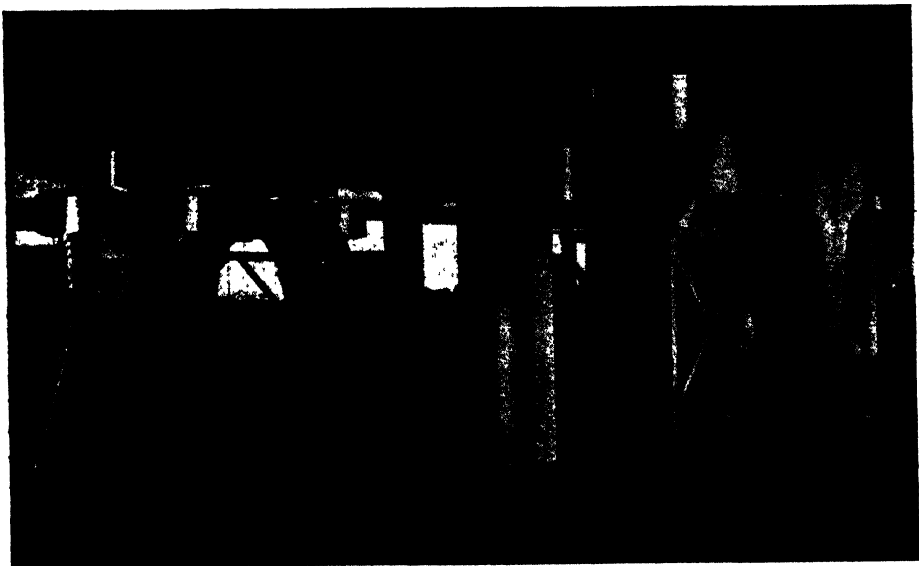

Fig. 24.—INSTALLATION OF "SIROCCO" DUST COLLECTORS IN A TEA PACKING WAREHOUSE
L

relative sizes of the hoods and their connections. For comparatively light materials, 1 in. to 2 in. water gauge may be sufficient, whereas 3 in. to 5 in. w.g. may be necessary for the conveyance of bulky and heavy substances.

Fume Removal

Fume-removal equipment is necessary wherever fumes may be produced in sufficient volume to become either obnoxious, or dangerous to health. In chemistry laboratories, the provision of fume cupboards enables experiments in chemicals giving off dangerous gases to be made in safety, and without inconvenience to the experimenter. A fume cupboard is fitted with a vertical flue discharging above the roof; when necessary a propeller fan is provided to improve the draught.

Kitchens

In the kitchens of hospitals, large hotels, and restaurants, large canopies or hoods are fixed over the boiling pans for the collection and removal of vapour. The outlets from the canopies are connected to convenient chimney flues, or so arranged as to discharge outside the building. Here again, propeller fans may be required to assist in the removal of the vapour. The cooling effect of the hoods necessitates the provision of small gutters, which are fixed inside at the bottom and piped to drain.

Chemical Fumes

The effective removal of chemical fumes produced in industrial processes must receive individual consideration. Some have a corrosive action on metals, and special treatment is therefore necessary for the protection of the ductwork and fans.

Where the fumes or gases are of such a character that rapid diffusion occurs, and there is difficulty in removing them by the provision of ventilating hoods and ductwork, increase in the rate of ventilation of the workshop is sometimes essential to maintain the air at a healthy degree of purity. As many as thirty changes of air per hour may be necessary in some cases, which require carefully designed air-heating systems for the incoming air, and the installation of large exhausting fans.

DRYING-PLANTS

The removal of moisture from materials is usually effected by artificially increasing the movement of the air over the materials by the use of fans. By applying heat also, more rapid vaporisation of the moisture is obtained, thereby increasing the rate of drying. It is important, however, to use restraint in applying heat to certain materials, as damage is easily caused by excessive temperatures and too-rapid drying.

Drying Materials

For the drying of any material, the total heat required is equal to the sum of the following quantities :—

- (1) Heat required for the evaporation of the moisture—approximately 1,000 B.T.U./lb.
- (2) Total heat losses of the drying-chamber.
- (3) Heat required to raise the temperature of the incoming material to the outgoing temperature.
- (4) Heat required to raise the temperature of the ventilating air to the temperature at the point of extraction.

In arriving at the first quantity, it is necessary to learn the moisture content of the material, and this is found by weighing samples before and after drying. The weight of the material in the dry state should be taken in calculating the third item, and the specific heat of the particular substance must also be known.

The quantity of air required to carry away the evaporated moisture is found by dividing the quantity of water evaporated by the amount of water absorbed per lb. or per cu. ft. of air passing through the chamber.

For example, assume that in drying a quantity of material 30,000 grains of moisture have to be removed per hour, and that the entering air has been raised to a temperature of 100° F. and has a moisture content of 6 grains per cu. ft. Reference to hygrometric tables will show that this can be increased to 15 grains per cu. ft. at a relative humidity of 75 per cent. with air at 100° F. It follows, therefore, that the quantity of

air required is equal to $\frac{30,000}{(15 - 6)} = 3,333$ cu. ft. per hour.

The temperatures not to be exceeded, in the process of drying various materials, are given below :—

Leather	68°- 78° F.
Dough wares (large macaroni, etc.)	68°- 78° F.
" " (small macaroni, etc.)	104° F.
Horsehair and substitutes	86° F.
Starch at the beginning	68°- 86° F.
" " end	140°-158° F.
Glue	68°- 86° F.
Wood	212° F.

In Laundries

In laundry practice, continuous drying machines are used for the rapid drying of the linen in its transit from the washing department to the ironing and finishing departments. An endless-chain conveyor, fitted with clips, carries the articles to be dried from one end to the other of a heated chamber. Fans are used to blow the air over the heating battery into the drying chamber, and to distribute and exhaust the air as it becomes saturated.

Chapter XV

BUILDER'S WORK INCIDENTAL TO THE INSTALLATION OF SYSTEMS—PREPARATION OF ESTIMATES AND SPECIFICATIONS—RUNNING COSTS

THE amount of builder's work required in connection with heating installations varies considerably, and should always be carefully considered by the designer of the proposed installations, not only from the point of cost but with regard to the practical difficulties that may be encountered.

In an existing building that is to be centrally heated, the amount of cutting away should be kept to a minimum, as there may be unsuspected obstacles to fixing the pipe runs as planned unless a very careful survey has previously been made. This applies particularly to pipes intended to be fixed below floors.

Where the building is a new one, close collaboration between the architect, builder, and heating engineer is essential, especially when dealing with some of the larger buildings. Electric conduits, gas and cold-water pipes, and other sub-contractor's fittings have all to be accommodated in the building, and a little co-operation among the parties will often result in a considerable reduction in the number of chases and pipe trenches.

Plans showing the position and sizes of holes through walls and floors, etc., should be prepared at the earliest possible moment after the contract has been placed, and copies sent to the architect, clerk of works, and builder. Arrangements can then be made for suitable provision for pipes during the construction of the building, which will eliminate cutting chases and holes in the walls after they are built.

Boiler Chambers

The builder's work in the boiler chamber includes the construction of a boiler base, which should be of blue brick and of a size suitable for the boiler. Most boiler manufacturers give details of boiler bases which they recommend, but the dimensions are often at variance with the sizes possible to obtain by using stock-size bricks, and an endeavour should be made to assist the bricklayer in such instances by making some modifications to the boiler-maker's dimensions.

Boiler Bases

Boiler bases for sectional boilers are usually constructed as shown in Fig. 1, from which it will be noted that the bricks are set on edge, 3 in. above floor and 1½ in. below. By fixing the bricks 1½ in. below floor level, the base is strengthened, as the possible loosening of the bricks from knocks by the shovel or poker is prevented. After the boiler has been erected, any possible air leakages to the ashpit should be stopped by a cement grouting round the base. This is very important.

Smoke Pipe

In building in the smoke pipe, care must be taken to see that the end of the pipe does not project beyond the inner face of the brickwork into the flue, as this may restrict the area to an extent beyond that necessary for the required volume of gases to pass out from the boiler (see Fig. 2).

A thoroughly airtight joint between the brickwork and smoke pipe is also essential for the maintenance of an effective draught.

Provision for sweeping the chimney is made by building in a cast-iron door and frame either below or above the smoke pipe. If below the smoke pipe, the height from the floor to the level of the cleaning-door must be sufficient for the sweeping rods to enter the chimney at an angle of not more than, say, 30° from the vertical.

If the cleaning-door is built in above the smoke pipe, provision must be made for cleaning the pocket so formed from cleaning-doors fitted to the smoke pipe.

The chimney should never extend below the smoke pipe or cleaning door, whichever is the lower.

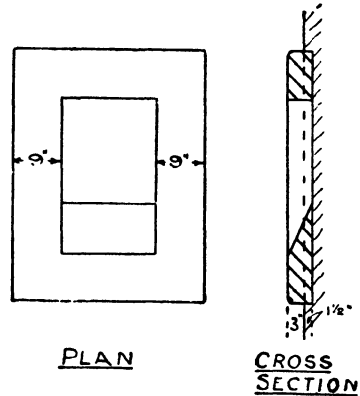

Fig. 1.—TYPICAL ARRANGEMENT OF BASE FOR HEATING-BOILER

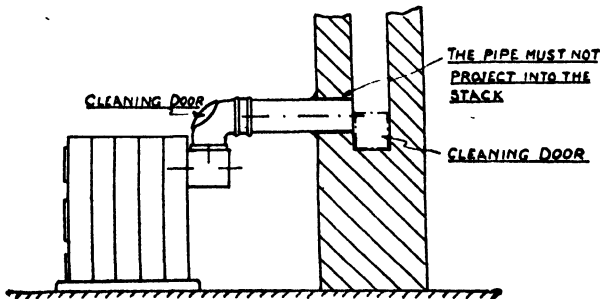

Fig. 2.—SMOKE-PIPE CONNECTION TO BRICK CHIMNEY

Bases for Pumps

Bases for pumps or accelerators are usually of concrete, and where silent operation is necessary are often insulated from the floor by some sound-absorbing or anti-vibration material, such as cork. The engineer's instruc-

tions to the builder in this respect should be quite clear, and it is the rule for the engineer to supply whatever anti-vibration material is required. Any holes necessary for holding-down bolts should be left for the bolts to be grouted in after the machine is in position.

The position and horse-power of any electrical equipment to which the electricians must carry mains and make connections should be indicated on the drawings submitted to the architect and general contractor, in order that a clear understanding shall exist that such work—outside the heating engineer's contract—will be necessary.

Drain

One other item of importance in the consideration of the boiler-house is the drain. A drain is necessary to carry away any water that may be drawn off from the boiler when the system is emptied down for alterations or repairs, and the gully should be so positioned that it will not be covered over with fuel or ashes.

Naturally, the floor surface should slope downward slightly toward the gully, which should be at the lowest point.

In some basement boiler chambers, the floor level is below the main drainage system, and it is then advisable to form a sump, not less than 18 in. \times 18 in. \times 18 in., which can be emptied either by a small electrically operated pump or by a hand-operated semi-rotary pump.

Trenches, Creeping-ways, and Chases

Where pipes are fixed under solid floors, suitable trenches or creeping-ways must be formed. In fairly large systems a subway may have to be constructed for the accommodation of the pipes for all the services and electric mains. A subway differs from a duct or creeping-way in that it is of sufficient height for a man to stand upright in it, and is therefore not less than 6 ft. high.

A pipe duct or creeping-way is also used for electric mains and the pipes for services other than the heating system. It should not be less than 3 ft. high, and 2 ft. 6 in. should be regarded as a minimum width. If pipes are fixed on both sides, the width may have to be 3 ft. 6 in. or 4 ft. to permit the unrestricted use of pipe wrenches, etc.

SIZES OF PIPE TRENCHES. The minimum dimensions of pipe trenches must be considered to be 6 in. \times 6 in., which is large enough for one pipe of, say, not more than 2-in. bore; if larger, or more than one pipe is to be fixed in the same trench, the size must necessarily be increased. In determining the sizes of trenches, accessibility to the bottom pipe must be considered, also the space occupied by lagging or flanges.

TRENCH COVERS. Trench covers may be of removable metal plates or of pre-cast concrete slabs. Metal covers are usually of cast-iron or mild-steel chequer plates, supported by cast-iron rails built in on each side of the trench, as shown in Fig. 3.

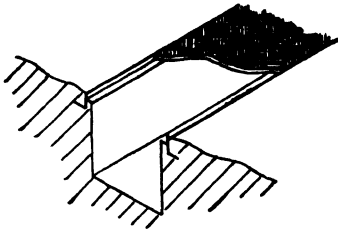

Fig. 3.—CHEQUER-PLATE TRENCH COVER AND RAILS

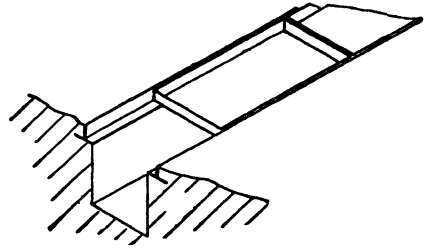

Fig. 4.—DISHED-PATTERN TRENCH COVERS

Another pattern is the dished cover or tray (Fig. 4), which can be filled with the same material as that used in the finish of the remainder of the floor. This is obviously a more suitable pattern for important rooms or corridors, as, except for the metal edges of the rails and trays, the finished surface of the floor is not marred by a cast-iron track 9 in. or 12 in. wide.

Pre-cast concrete covers are suitable for trenches in passages or yards, and for outdoor purposes. After the pipes are in position, the covers are set in cement and are not readily removable. Access covers should be provided at suitable intervals, and at points where valves are fixed.

In all cases, accessibility to the pipes is an advantage, and will save time and temper if repairs or alterations are necessary.

CREEPING-WAYS. If pipes have to be fixed in creeping-ways after these have been covered down, the builder should be instructed to leave holes either at the end or at other convenient points so that lengths of approximately 15 ft. or so can be passed through. Such holes must be left in each straight run of duct if the width is insufficient to permit a corner being turned.

The attention of the builder must be drawn to the importance of the effective draining of subways, ducts, and trenches by the provision of suitable gullies.

PIPE CHASES. For the concealment of vertical pipes, chases are cut or left in the walls. The minimum size suitable for, say, a $\frac{3}{4}$ -in. pipe, and allowing sufficient space for the pipe wrench, is $4\frac{1}{2}$ in. \times $4\frac{1}{2}$ in. The width must of course be increased where more than one pipe is to be fixed in the same chase.

Chases are usually formed in the corners of rooms in the main wall, and may be covered either by a removable board fixed flush with the plaster and fastened by screws, or by expanded metal, wood-fibre boarding, or similar material which can be permanently plastered over.

Pipe and Radiator Brackets

These are usually built in to the engineer's instructions on site. Pipe

brackets should be carefully lined if they are not of an adjustable pattern, or the weight of the pipe will be taken by only a proportion of the brackets, which will then have to bear a load greater than that for which they were designed.

Radiator brackets should be built in so that the radiator supported by them stands vertically, and if fixed under a window or in a recess takes up a central position.

Deflecting Shelves

These are sometimes fixed above radiators to prevent discoloration of the wall. If of sheet metal the shelves are usually supplied by the engineer, but if of hardwood they are supplied and fixed by the builder. An airtight joint between the wall and shelf is essential, and if there is any irregularity in the plaster surface, a suitable jointing material should be provided.

Holes through Floors and Walls

Where pipes pass through floors and ceilings, and plastering is done after the pipes are fixed, care should be taken to make sure that a space is left between the pipe and plaster. If the plasterer fails to do this, the movement of the pipes, due to expansion and contraction, will undoubtedly result in the formation of cracks in the plaster, if not in more serious damage.

Sleeve pipes should always be built in where pipes pass through walls. These may be of odd lengths of pipe of a size large enough to slip over the heating pipe. Galvanised sheet-metal sleeves are commonly used, but perhaps the pattern most favoured by consulting engineers is that known as Hall's pipe sleeve and thimbles. This consists of a short piece of iron pipe of the required length, screwed at each end, and fitted with specially designed cast flanges or thimbles, as they are termed (Fig. 5).

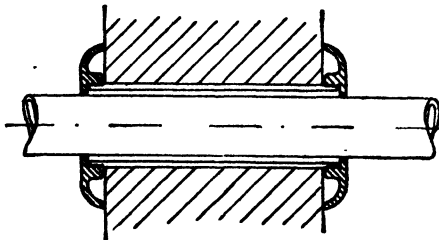

Fig. 5.—SECTIONAL ARRANGEMENT OF PIPE SLEEVES AND HALL'S THIMBLES

Feed Tanks

It may be necessary to build in brackets for supporting the feed tank, and although these are usually provided by the engineer, the builder should make certain that they are built in firmly enough to carry the tank when filled. A cold-water supply pipe must be carried to the tank, and a connec-

tion made to the ball-valve fitted by the engineer. The provision of this pipe is usually part of the builder's work, which should also include the fixing of a suitable stop-tap.

If the overflow pipe is carried through the roof, the necessary lead flashing must be provided to prevent any possible leakage of rain-water.

As a precaution against freezing, it is sometimes advisable to encase the tank with a wood enclosure, and to pack the space between with sawdust or other material having good non-conducting properties.

Painting

All exposed pipes and radiators require at least two coats of good heat-resisting paint, and in some cases it is left to the builder to paint the non-conducting composition that has been applied to the boiler and pipes. The colour of paint makes little difference to the heating effect of radiators, but as pointed out in Chapter XII, paints having a metallic base, such as bronze or aluminium, reduce the heating effect by about 22½ per cent.

When considering the painting of mains in subways and boiler-houses on large contracts where there may be a number of pipes of similar size, it is a good plan to give the various services distinguishing colours. It is then possible to recognise, say, a gas main or cold-water pipe immediately, and dispenses with the necessity for labels or the laborious tracing of pipes from or to recognised points. The British Standards Institution has published a list of colours which it recommends be used, but provided colours of sufficient contrast are chosen, and the maintenance engineer is supplied with a suitable chart, any selection may be made.

VENTILATING SYSTEMS

The amount of builder's work necessary in connection with ventilating schemes depends largely on the type of installation. If a simple extraction system, comprising a propeller fan discharging the air from a small hall, is under consideration, all that may be necessary on the part of the builder will be the provision and building in of a suitable wooden frame against which the fan is to be bolted.

More elaborate schemes will obviously require the assistance of the builder to a greater extent, and this may include: the cutting of holes through walls, and building in gratings and registers to form fresh-air inlets; the formation of air-ducts in either brickwork, concrete, woodwork, or plaster; the construction of fan chambers and turrets, and the manufacture of specially designed extraction grilles if these are of fibrous plaster. If the grilles are of metal, they are usually supplied by the engineer and fixed by the builder.

Particulars of the electrical power required must be given, if, as is commonly the case, the fans are electrically driven.

When Builder's-work Ducts are Used

It is frequently desirable to construct in builder's work a proportion of the ducts in a large modern building. Although usually more costly than metal, such ducts may be desirable for three purposes :—

(1) Under floors, where metal ducts would be unacceptable and liable to external dampness and corrosion.

(2) Vertical shafts, where builder's-work casings would in any event have to be provided around metal ducts, to which access would be difficult.

(3) For purposes of noise elimination.

Builder's-work ducts are frequently used underneath the basement floors of large hotels, cinemas, theatres, etc., and for main air-ducts.

One of the difficulties encountered by the heating engineer when this type of ductwork is used, lies in the difficulty of ensuring that a reasonably smooth internal finish is provided by the builder. When the finish is rough, considerable friction is set up, causing a wastage of power and regulation difficulties, since in the calculations for the system sufficient allowance will probably not have been made.

A more serious difficulty occurs if roughly finished ducts are used for extract air, for the sides of the ducts become covered with dirt.

Where Builder's-work Ducts Should Not be Used

On no account should builder's-work ducts be used in the extraction systems from kitchens or press-rooms, for in each case a considerable amount of grease is carried into the system and the ducts in time become coated with a thick layer which not only reduces the volume of air dealt with but introduces a serious fire risk. Full provision should be made for cleaning in positions where extracted air is laden with greasy particles which are likely to coat the ducts.

Uralite or Asbestos Ducts

In certain instances extracted air will contain fumes which cause corrosion to metal, and in these cases Uralite or some form of asbestos construction is desirable.

Generally

The heating and ventilating engineer, in common with other specialist sub-contractors, must give the building contractor full details, at an early date, of any special requirements for the accommodation and successful performance of his plant.

The builder is expected to provide all scaffolding and ladders for the use of the engineer, and to clear the site of all rubbish on completion.

PREPARATION OF ESTIMATES, SPECIFICATIONS AND RUNNING COSTS

After the completion of his calculations and the layout of the proposed installation, the preparation of the estimate will engage the attention of the engineer. In this, much time will be saved if the quantities are set out and priced methodically. There will also be less risk of costly omissions if the items are grouped into sections, and the sections dealt with in the same order as they occur in the specification.

A brief indication of the type and size of each article, and, when necessary, the manufacturer's name, will be found of use at a later date if the contractor is successful in obtaining the order. Although the particular type and make of an article may be clearly understood at the time of estimating, some months *may* elapse before it will be necessary to order the goods, and by then the particular requirements of the customer will have been forgotten.

It is not sufficient, for example, to write down "1 $\frac{3}{4}$ -in. valve," without also stating the pattern, finish, or other characteristics. If it is a radiator control valve, it is advisable to include it in the group of items in the section headed "Radiators," so that the reason for its inclusion will be apparent. A sufficient description will probably be: "1 $\frac{3}{4}$ -in. Brown's Fig. 249 Ch.Pl. Angle Pat. Valve"—to show that a $\frac{3}{4}$ -in. diameter angle-pattern radiator valve in chromium-plated finish, and of Messrs. Brown's Fig. 249 type, is required.

A Typical Estimating Sheet

A typical estimating sheet is shown on the following pages, from which it will be noted that the sheet is headed with the name of the building, the inquiry number, and the date—which should be that of the day when the estimate is submitted. The estimate is numbered and a short description of what it is for is given before the actual quantities are commenced.

The numbering of estimates is advisable, because it frequently happens that one or more revisions may have to be submitted before the order is placed and reference to them at a later date is simplified by this method.

At the end of the quantities of material a total is made to which is added the estimated cost of labour, items for carriage and/or cartage, staff expenses, and to the sum of these the percentages for overhead charges and profit. Any provisional sums should then be entered, and the final total determined.

TYPICAL ESTIMATING SHEET

Inquiry No. 12,345.

Date

Name : House at Southend.

Estimate No. 1.

LOW-PRESSURE HOT-WATER HEATING

		£	s.	d.	£	s.	d.
Boiler							
1	C.I. boiler (maker's name and pattern) rated at 450,000 B.T.U.	54	0	0			
1	8-in. diam. smoke bend with cleaning door		10	0			
3	ft. 8-in. diam. smoke pipe		12	6			
1	set stoking tools		17	6			
					56	0	0
Mountings							
1	¾-in. deadweight safety valve		10	6			
1	thermometer		5	0			
1	¾-in. emptying cock		4	6			
1	automatic damper regulator		18	6			
					1	18	6
1	9-in. by 9-in. C.I. soot door					6	0
Mains							
400	ft. run 3-in. diam. mild-steel water tube @ -8	13	6	8			
250	ft. " 2½-in. " " " " " " @ -7½	7	16	3			
180	ft. " 2-in. " " " " " " @ -5½	4	2	6			
200	ft. " 1½-in. " " " " " " @ -4	3	6	8			
140	ft. " 1¼-in. " " " " " " @ -3	1	15	0			
60	ft. " 1-in. " " " " " " @ -2½		12	6			
50	ft. " ¾-in. " " " " " " @ -2		8	4			
20	ft. " ½-in. " " " " " " @ -1½		2	11			
					31	10	10
Fittings and Supports							
20	3-in. diam. black malleable bends @ 8/-	8	0	0			
12	2½-in. " " " " " " @ 5/-	3	0	0			
16	2-in. " " " " " " @ 4/-	3	4	0			
18	1½-in. " " " " " " @ 3/-	2	14	0			
10	1¼-in. " " " " " " @ 2/-	1	0	0			
12	1-in. " bends @ 1/6	18	0				
12	¾-in. " " " " " " @ 1/1	13	0				
6	½-in. " " " " " " @ -8	4	0				
6	3-in. " black mall. tees @ 7/-	2	2	0			
4	2½-in. " " " " " " @ 6/-	1	4	0			
4	2-in. " " " " " " @ 3/3	13	0				
8	1½-in. " " " " " " @ 2/5	19	4				
6	1¼-in. " " " " " " @ 1/10	11	0				
2	1-in. " " " " " " @ 1/2	2	4				
3	¾-in. " " " " " " @ -10	2	6				
					25	7	2
2	3-in. diam. long screws @ 3/6	7	0				
3	2½-in. " " " " " " @ 2/9	8	3				
3	2-in. " " " " " " @ 1/6	4	6				
6	1½-in. " " " " " " @ 1/-	6	0				
4	1¼-in. " " " " " " @ -9½	3	2				
2	1-in. " " " " " " @ -7	1	2				
2	¾-in. " " " " " " @ -6	1	0				
2	½-in. " " " " " " @ -4½	9					
					1	11	10
46	3-in. diam. pipe brackets @ 1/2	2	13	8			
24	2½-in. " " " " " " @ 1/-	1	4	0			
20	2-in. " " " " " " @ -8	13	4				
20	1½-in. " " " " " " @ -6	10	0				

Carried to next page 5 1 0 118 14 4

NOTE.—The prices shown are for the purpose of illustration only.

TYPICAL ESTIMATING SHEET—*continued*

<i>Fittings and Supports—contd.</i>		<i>Brought forward</i>	£	s.	d.	£	s.	d.
16	1½-in. diam. pipe brackets	@ -/6	5	1	0	116	14	4
12	1-in. ,, and below pipe brackets ..	@ -/4½			8			
					4			
	1 item for pipe sleeves					5	13	6
	1 item for floor and ceiling plates ..						10	0
						1	10	0
<i>Radiators</i>								
210	sq. ft. 18-in. high 4-col. radiators ..	@ 1/4	14	0	0			
170	.. ,, 24-in. ,, ,, ,, ..	@ 1/3½	10	19	7			
80	.. ,, 30-in. ,, ,, ,, ..	@ 1/3	5	0	0			
225	.. ,, 24-in. ,, 3-col. ,, ..	@ 1/6	16	17	6			
40	.. ,, 24-in. ,, 2-col. ,, ..	@ 1/6	3	0	0			
40	top stays	@ -/9½	1	11	8			
40	pairs bottom radiator brackets ..	@ 1/4	2	13	4			
8	1-in. diam Ch.Pl. angle valves ..	@ 6/4	2	10	8			
12	¾-in. ,, ,, ,, ,, ..	@ 5/-	3	0	0			
20	½-in. ,, ,, ,, ,, ..	@ 3/-	3	0	0			
8	1-in. ,, ,, elbow unions ..	@ 2/-			16			
12	¾-in. ,, ,, ,, ,, ..	@ 1/6			18			
17	½-in. ,, ,, ,, ,, ..	@ 1/2			19			10
3	½-in. ,, ,, L.S. valves ..	@ 3/-			9			0
	1 key for lockshield valves				1			2
<i>Valves</i>								
	1 2½ in. G.M. fullway valve	@ 11/3			11			3
	2 2-in. ,, ,, ,, ..	@ 9/-			18			0
	3 1½-in. ,, ,, ,, ..	@ 5/4			16			0
	1 2½-in. ,, L.S. valves	@ 11/3			11			3
	2 2-in. ,, ,, ,, ..	@ 9/-			18			0
	3 1½-in. ,, ,, ,, ..	@ 5/4			16			0
	3 keys, 1 for each size lockshield valve ..	@ 1/2			3			6
<i>Feed Tank</i>								
	1 40-gal. galvd. cistern 12 gauge with 16-gauge cover ..		2	10	0			
	1 ½-in. ball-valve				3			0
	2 brackets				6			0
	15 ft. 1½-in. overflow pipe	@ -/4			5			0
	45 ft. ¾-in. feed pipe	@ -/2			7			6
	1 item for pipe fittings and spts.				8			0
<i>Covering</i>								
	65 sq. ft. boiler surface 1½ in. thick and painted @ 1/3		4	1	3			
	30 ft. run 3-in. diam. pipe 1 in. thick and painted @ 1/6		2	5	0			
	20 ft. ,, 2½-in. ,, ,, ,, ,, @ 1/3		1	5	0			
						7	11	3
Total net material costs						206	9	4
	Labour, 420 hours fitter and helper	@ 2/9	57	15	0			
	Travelling expenses				3			0
	Lodging allowances				10			0
						70	15	0
	Item carriage and staff expenses					277	4	4
							2	0
						279	4	4
	20 per cent. overhead charges		55	16	0			
	10 per cent. profit		27	18	0			
						83	14	0
Total						£362	18	4

Labour Estimates

The estimation of the number of man hours needed to erect a heating installation is important because in many cases the labour cost amounts to from one third to one half of the total cost. A number of methods may be used in making the estimate, but whichever is adopted it should be based on records of jobs actually carried out, and not on theoretical figures.

The most accurate but most complicated method consists in apportioning to each item, however small, the time which it is estimated that item will take to fix. At the other extreme the labour cost may be taken as a percentage of the material cost. This method will give reasonable results provided that the percentage is varied according to the type and size of the installation.

A common way of estimating labour is to deal with sections of the installation rather than individual items, e.g. piping is priced including all fittings rather than dealing with each fitting separately. This is not so tedious as the first method, and not so liable to error owing to a deviation from the normal as the second method. Some typical figures are given below but it must be emphasised that they should be modified as required from records of installations actually carried out.

TABLE 1.—TIME REQUIRED FOR INSTALLATION

Sectional boilers, including mountings and smoke pipe	..	9 hours + 1 hour per 25,000 B.T.U.
Expansion tank with valve	6 hours + 1 hour per 10 gall. capacity.
Radiators with valves, including disconnecting for painting	..	3 hours.
Pump and motor	9 "
Isolating valves	½-1 hour.
Overhead piping, including all fittings :		
Diam. ½ in. to 1 in.	6 ft. per hour.
1¼ in. to 2 in.	4 ft. "
2½ in. to 4 in.	2 ft. "
Piping at floor, including all fittings :		
Diam. ½ in. to 1 in.	8 ft. per hour.
1¼ in. to 2 in.	5 ft. "
2½ in. to 4 in.	2½ ft. "
Unloading and handling material, setting out, and testing		5% to 10% of total labour.

Specifications and Estimates

The specification and estimate should be accompanied by an explanatory letter giving the reasons for the inclusion of any particular type of boiler or radiator, etc., and the method of heating proposed.

Any special features or conditions should be mentioned, in order that the possibility of such points being overlooked may be removed.

The estimate may be quoted as an item independent of the specification, or it may be included in the specification simply as a price clause. Where a number of prices have to be given as additions or alternatives, a summary sheet will assist the client in seeing at a glance and without confusion the amounts and totals.

In drafting the specification, care should be taken to describe clearly and succinctly the materials included and the extent of the work which the engineer proposes to undertake. Any work incidental to the installation, but not within the province of the engineer, should be referred to so that there may be no misunderstanding on such matters. It is, of course, the practice of most firms to send with their tenders a printed form of conditions upon which they are prepared to accept orders.

In a number of instances orders are given to the heating engineer by the general contractor acting on the instructions of the architect. If this is likely, the engineer should state clearly that the price quoted either includes a commission for the builder or is strictly net. In the latter case, any percentage which the architect thinks should be included for the general contractor must be added by him.

SPECIFICATION

The following specification may be considered as typical of one for a low-pressure hot-water heating installation :

The heating installation included in Estimate No. 1 to be a low-pressure hot-water system with circulation by gravity, and to be capable of maintaining a temperature of 60° in the heated rooms, when the outside temperature is 32°, and with a flow temperature at the boiler not exceeding 180° F.

The material to be supplied would be as follows :—

Boiler.—One cast-iron sectional boiler rated at x B.T.U., complete with smoke pipe and stoking tools.

Mountings.—The boiler to be fitted with one deadweight safety valve, thermometer, altitude gauge, emptying cock, and automatic damper regulator.

Soot Door.—One cast-iron soot door and frame.

Mains.—The circulating mains fixed as shown on plan No. — to be of "blue" water-quality mild-steel tube of standard weights and dimensions.

Fittings.—The pipe fittings to be of malleable iron easy-sweep pattern.

Supports.—The pipe supports of an approved pattern arranged to support the pipes at suitable intervals.

Pipe Sleeves.—Pipe sleeves to be provided wherever pipes pass through walls or partitions.

Floor and Ceiling Plates.—Fit chromium-plated floor and ceiling plates where pipes pass through floors.

Radiators.—Each radiator to be of an approved pattern and of a height and size suitable for its position. Each radiator to be securely stayed, supported on cast-iron brackets, and fitted with control valve and air tap.

Valves.—Each branch circuit to be fitted with gun-metal stop-valves on the flow and return pipes close to the junctions at the mains. The valve on the return to be of the lockshield regulating type. A suitable key for each size of lockshield valve.

Feed Tank.—One galvanised mild-steel cistern of — gal. capacity, complete with cover, and carried on suitable brackets. The tank to be fitted with ball-valve, overflow pipe, and feed pipe to boiler.

Covering.—The boiler and circulating mains in the boiler-house to be coated with plastic non-conducting composition, trowelled smooth and painted on completion.

In considering the specification given above, it should be understood that it is meant to convey the general method of setting out, and that more detailed descriptions of the plant offered may be necessary, especially if the tender is to be submitted to an architect or consulting engineer who will require the work to be of a certain standard.

In such cases, makers' names and Fig. Nos. should be stated, as well as test pressures, thicknesses of tank plates, and quality of lagging, etc.

RUNNING COSTS OF HOT-WATER SUPPLY SYSTEMS

Running costs, to the discriminating buyer, are frequently of more importance than the initial expenditure, and, as might be expected, the engineer is often asked, when submitting proposals for a hot-water heating installation, to give a fairly accurate estimate of the annual charges to be met.

It is generally sufficient if the fuel costs alone are given, and by sound reasoning and a little calculation it is possible to state the amount of coal or coke that is likely to be used during the heating season. It is not difficult to approximate very closely to the actual quantity of fuel that will be used, and a little trouble will enable the engineer to give figures which will prove reasonably correct.

If, as a result of guesswork, the estimated consumption is excessive, the customer may reject the scheme because of his inability or unwillingness to pay the fuel bills. On the other hand, if the figures given prove to be too low, the client is bound to feel that he has been deliberately misled.

Cost of Labour

The amount of fuel consumed does not, of course, cover all the running costs, and if these are to be complete, labour charges, maintenance, and insurance, interest on capital expenditure, and allowances for depreciation must be included.

On a small installation these items will not be considerable, as stoking will probably be part of the duties of a gardener or odd man who would be employed in any case.

For larger installations, where one or more stokers might be necessary, the cost of labour may be an item of sufficient importance to induce the client to consider automatic firing, either by mechanical stokers for solid fuel, oil burners, gas-heated boilers, or by using electricity. The engineer may then be asked to submit alternative balance sheets showing the difference in annual expenditure resulting from the use of fuels other than coal or coke.

Heating Requirements of Different Kinds of Buildings

In estimating the probable amount of fuel that will be used, consideration must be given to the type of building that is to be heated, and the heating requirements peculiar to that building.

In private houses, for example, the heating demands will be continuous from early in October until late in April, generally a period of thirty weeks.

In schools, the maximum internal temperatures are required only during school hours, usually from 9 a.m. to 4.30 p.m., and at week-ends and during the Christmas holidays the consumption of fuel will drop, as it will be necessary only to bank up the fires during these periods.

Many of the smaller churches and some of those in country districts are heated only at week-ends, but the saving effected is often negligible, because of the greater rate of stoking necessary when the fires are lit, to obtain satisfactory conditions by the time services commence.

Offices require to be fully heated only during office hours, and from say, 6 p.m. until 7.30 or 8 a.m. the boilers can be banked up. At week-ends the banking-up period may be assumed to be between the hours of 1 p.m. on Saturday and 7.30 a.m. on the following Monday.

Although the average heating installation is designed to give the required internal temperature with an outside temperature of 30° F., the mean temperature for the winter months in England is approximately 43.5° F., so that it will be sufficient if two-thirds the maximum capacity is taken for the daytime requirements. In well-managed installations, one-fifth of the maximum may be considered sufficient for the banking-up periods, and the average daily consumption can be computed in the manner shown below.

Estimating Cost of Heating

Office building having maximum heating load = 650,000 B.T.U. per hour, using coke as fuel at 12,500 B.T.U./lb., and assuming boiler efficiency = 60 per cent.

$$\text{Then lb. coke per hour} = \frac{650,000 \times 100}{12,500 \times 60} = 86.6.$$

Also, lb. coke per day :—

From	8 a.m. to 6 p.m.	= 10 hours @ 86.6 × $\frac{2}{3}$	=	577
	,, 6 p.m. to 8 a.m.	= 14 hours @ 86.6 × $\frac{1}{5}$	=	243
				Total 820

From Mondays to Fridays,	5 days @ 820	=	4,100
Saturdays	8 a.m. to 1 p.m., 5 hours @ 86.6 × $\frac{2}{3}$	=	289
,,	1 p.m. to 8 a.m., 19 hours @ 86.6 × $\frac{1}{5}$	=	329
Sundays	— 24 hours @ 86.6 × $\frac{1}{5}$	=	415

Total lb. coke per week 5,133

Say, 5,140 lb./week.

$$\text{Total for 30 weeks} = \frac{5,140 \times 30}{2240} = 68.8 \text{ tons. Say, 70 tons.}$$

The fuel bill with coke at 55s. per ton will be £192 10s.

To this, in order to give the total annual costs, it may be necessary to add an item for labour, say £1 per week, as part of a porter's or commissionaire's wages to be debited against the heating system, and an annual sum for interest and repayment on the capital expenditure, usually calculated at £8 7s. 4d. per cent.

Setting this out in tabular form, and including a further item for maintenance and insurances, we have :—

	£	s.	d.
Estimated cost of fuel	192	10	0
,, ,, of labour	30	0	0
Interest and repayment on capital expenditure of, say, £800			
at £8 7s. 4d. per cent.	66	18	8
Maintenance and insurance, say	10	11	4
Total	£300	0	0

Operation of Coke-fired Boilers

The economic operation of coke fired boilers depends upon the observation of several rules : inefficient stoking and management may easily double the fuel consumption.

Draught is of vital importance and should be regulated by the chimney damper rather than by the ash-pit damper. If the latter is closed and the chimney damper widely opened, there is considerable suction over the fire which will draw air into the furnace through any crevices around the door. Air admitted over the fire is termed "secondary air." This is necessary in some quantity when burning coal (which should never be used on a sectional boiler), but, owing to the small amount of volatile matter in coke, can be very much reduced. A little is necessary as some of the CO₂ formed in the hot lower part of the fire breaks down the CO as it passes through the coke bed and some air is essential for its recombination. (Carbon burning to CO₂ produces 14,544 B.T.U.'s per lb. but, if CO is formed, only 4,351 B.T.U.'s are produced, resulting in a loss of more than two-thirds of the heat available in the fuel).

Firing doors should fit closely and should not be left open, during firing or cleaning, for longer than is necessary. The entire grate surface should be covered with fuel as bare portions allow a large volume of air to enter the furnace and carry heat into the chimney.

Best conditions are obtained with a burning rate of about 8 lb. per square foot of grate area per hour and, if the grate is too large, it should be shortened by means of fire bricks set in fireclay at the rear end. (These should not butt tightly against the furnace sides or cracked sections due to expansion may result).

If instruments are available, combustion conditions should be regulated to give a flue temperature at exit of 300-400° F. and a CO₂ content of 14-16%.

With coke up to 2 in. in size, the depth of the fire bed should be from 6 in. to 10 in. and, with larger coke, up to 15 in., but the furnace should never be filled to more than three-quarters of its capacity, or about half-way up the firing door.

The internal flues and the sides and crown of the furnace should be kept free from dust and grit which may reduce the heat transmission by about as much as 30 per cent. Every degree of internal temperature maintained in the building throughout the winter accounts for about 5 per cent. of the total fuel consumption so that overheating must be avoided if economical working is to be achieved. In most cases it will be found that the following flow temperatures provide adequate heating :

Outside shade temperature	55	50	45	40	35	30° F.
Boiler flow temperature	105	120	135	150	165	180° F.

Running Costs with Fuel other than Coke

The annual costs when using gas, electricity or oil are estimated as in the same way for coke, but there are some important considerations in these cases.

The actual capital cost of the installation, as compared with ordinary coke fired boilers, may be somewhat higher, but, against this may be set the absence of bunkers, when using gas or electricity, and also of a chimney in the latter case. The boiler house may be smaller as no stoking space is required, and no ash-handling facilities are necessary. The absence of dust or noise may also be an important factor, which, however, cannot be assessed in monetary terms.

All three types of fuel lend themselves to accurate thermostatic control, and it is possible to regulate consumptions in accordance with the actual daily requirements in a much greater degree than is possible with a solid fuel boiler, however well this may be managed.

The adoption of any fuel other than coke will, in most cases, depend upon prices in the particular locality and, for this reason, it is difficult to give typical estimates.

If such an installation is proposed, it is very advisable to discuss the matter with the manufacturers of oil burners or with the gas or electricity supply authorities who will, from their experience of previous installations, be able to give valuable assistance in the framing of reliable estimates. In some cases, costs will be higher than those of a similar solid fuel installation, but other advantages may decide the issue.

It should, however, be pointed out that the coke fired boiler is a thoroughly tried and proved appliance which will function for many years on reasonable efficiency and with the minimum of attention, and is not so immediately susceptible to interruption of the source of supply as are, at any rate, gas or electric boilers.

INDEX

A

Absorption and reflection of radiant heat, 5, 111
Accelerated system, 80, 98
Accessories for hot-water boilers, 29
Air :—
 amount required, 272
 bottles, 123
 breathed, 250
 change, 21, 198, 255, 272
 cleaning of, 283
 composition of, 251
 conditioning, 279 *et seq.*
 conductivity of still, 4
 discharge by gravity, 256
 eliminators, 93, 151, 159, 161
 entering at doors, 278
 filters, 246, 264
 heaters, 248, 265
 inlets, 245
 noise, 263
 secondary, 310
 space, thermal resistance of, 20
 specific heat, 2
 speeds, 245
 supply to boiler house, 42
 total heat of, 284
 troubles in panel systems, 123 *et seq.*
 valves, 141, 161
 velocities in handling materials, 289
 velocity head of, 266
 washers, 248, 281
 water behaviour, 126
 water vapour in, 252
Altitude gauge for boiler, 29
Aluminium paper, as insulator, 238
American Society of Heating and Ventilating Engineers, 282
Anchoring pipes, 58, 60
Anthracite, 44
Anti-priming pipe, 145
Anti-vibration base, 82, 261
Asbestos :—
 ducts, 298
 dust, 287
 pipe rings, steam, 54
 specific heat, 2
 thermal properties, 229 *et seq.*
Ashes, removal, 42
Aspect, allowance for, 22
Aspect control, 227
Assembly hall, ventilation, &c, 272
Automatic :—
 air valve, 160
 boiler control, 225
 damper regulator, 30
 stokers, 37
 temperature control, 211
 vents for return trap, 165
Axial-flow air fans, 262

B

Babcock formula, 203 *et seq.*
Balanced ventilation, 258
Ball valves, 92
Bedford (Eupatheoscope), 240
Bends in pipes, 62 *et seq.*
Bi-metallic thermostats, 215, 222
Bituminous coal, *see* Coal
Blanket heat insulators, 238
Body heat, &c., disposal of, 10, 250
Boilers :—
 capacity, 23
 cleaning of, 144
 control, 225
 coupling of, 30, 35
 efficiency of, 13, 27
 electrode, 187, 188
 emptying cocks, 37
 erection of, 31, 292

feed pumps, 169
 fittings, 28
 gas firing, 45
 heating surface, 26
 insulation of, 233
 magazine, 13, 27, 39
 oil firing, 46
 operation of, 305
 pressure, 203
 ratings, 27
 safety pipes, 36
 sectional, 26, 30
 steam, 51, 141
 testing of, 26, 34
Boiler house(s) :—
 air supply to, 42
 builders' work, 292
 draining of, 294
 position of, 39
 ventilation of, 42
Boiling point of water, 2, 75, 190
Bottles, air, 123
Bourdon tube, 221
Box, Thomas, formula of, 83
Brackets, fixing, 70, 295
Brass, specific heat, 2
Breathing, 250
Brickwork :—
 in boiler chamber, 292
 specific heat of, 2
 thermal conductivity, 4
British Standards Institution (B.S.I.), 54
British Thermal Unit (B.T.U.)
 defined, 1
BUILDER'S WORK, &C., CHAP. XV,
 p. 292
Building materials, thermal properties, 18
BUILDINGS, HEAT REQUIREMENTS OF, CHAP. III, p. 17
Buoyancy of air, 256
Burners, oil, 46
By-pass in accelerator, 80, 81

C

Calculations, see Examples
Calorifiers, 52, 81, 119, 170, 171, 225
Canteens, ventilation, &c, 272
Capacity of boilers, 23
Carbon dioxide, 162, 250, 251
Cast-iron, specific heat, 2
Ceiling panel-warming, 102 *et seq.*
Cellulose spraying and ventilation, 198
Cement retarders, 116
Central heating, 12, 224
Centrifugal fans, 260
Centrifugal pumps, 81
Changing the air in buildings, 21, 198, 255, 272
Characteristic curves of fan, 261
Charts :—
 Capacities and Resistances of Galvanised Iron Ductwork :—
 facing p. 269
 Flow of water for accelerated systems :—
 Chart 1 (0-4,500 pounds per hour)
 Chart 2 (0-45,000 pounds per hour), p. 91
 Pipe capacities for gravity water-heating systems :—
 Chart 1 (0-9,000 pounds per hour), p. 78
 Chart 2 (0-900 pounds per hour), p. 79
 Psychrometric chart, p. 254
Chases, 294
Check valve, steam, 150
Chemical fume removal, 292
Chimneys, 39, 298

Churches :—
 tubular electric heaters for, 176
 ventilation, &c., 272
Cinemas :—
 L.C.C. Regulations, 16, 251, 272, 273
 tubular electric heaters and air-conditioning, 177
 ventilation, 272
 warning, &c., 270
Circuit heights, water heating, 76 *et seq.*
Circulating head, water heating, 76
Circulating pressure, 75, 101, 103
Circulating pumps, 80
Classrooms, air changes in, 272
Cleaning of air, 283
Cleaning boilers and pipes, 144
Coal, 11, 12, 43
Colls, pipe, 15
Coke, 11, 12, 44
Coke-fired boilers, operation of, 307
Colours for painting, distinguishing (B.S.I.), 234, 297
Column-type radiators, 67
Combined hot-water unit heater and radiator, 208
Comfort and the thermometer, 239
Comfort heating, 10
Comparison of thermostats (q.v.), 222
Compensated control, 220
 "Computation of Heat Requirements for Buildings" (Institution of Heating and Ventilation Engineers), 17
Concrete, thermal properties, 4
Condensate water :—
 difficulties, 150
 in steam mains, 135, 150
 piping, 136, 162, 204
 return of, 164 *et seq.*
Conditioners, air, 283
Conduction, 3
Conductivity, thermal, of materials (k), 3, 230
Convection, 4
 and radiation, 6
 forced, 5
 from electric panels, 182
Convectors, electric, 12
Cooling in air conditioning, 284
Copper, gilled tube, 249
 specific heat, 2
Cork, as insulator, 238
Corrosion, pipe, from condense, 161, 162
Corrugated paper as heat insulator, 235
Costs, running, 307, 311
Coupled boilers, 30, 35
Coupled safety pipes, 36
Crackling, 152
Creeping-ways, 294
Cresote as fuel, 51

D

Damper regulation, automatic, 30
Data, tabulation of, 86
Dehumidification of air, 283
Density of water, 76
Design of unit heaters, 195
Dew point, 253
 "Differential" of temperature control system, 213
 Dirt pocket on steam pipes, 139
Domestic supply, 208, 225
Doors :—
 air entry through, 278
 of sectional boilers, 33
 value of, U, 18
Dough wares, limit of temperature in drying, 294

Down draught removal, 15
 Drain and dirt pockets, steam, 139, 143
 Drainage for boiler room, 294
 Draughts, 177, 251, 272
 Drawings, setting-out bends, 64
 Drip pipes, steam, 143
 Drop system, water, 94 *et seq.*
 Dry condense line system, 163
 Dry steam, 149
 Drying:—
 buildings, 122
 plants, 293
 plants, automatic operation of, 223, 224
 temperature limits for, 294
 Ducts, builder's work, 298
 Ductwork, 265 (Chart for sizing, facing p. 259)
 Duffton (the Eupatheoscope), 240
 "Dulrae" system, electric, 184, 185
 Dust, 250, 264
 and fume exhausting, 286
 extraction in industry, 288
 "Dusting" marks, 175

E

Eccentric fittings, water, 93
 Economy, due to insulation, 239
 Effective temperature, 253
 Elbows, pipe, resistance of, 204
 Electric:—
 fires, 12, 172
 heating, 12, 172
 unit heaters, 208
 Electrical thermostat, 215
 ELECTRICAL WARMING, CHAP. IX, p. 172
 Electrode boilers, 187, 188
 Eliminator, air, 93, 151, 159, 161
 Embedded panel warming, 108 *et seq.*
 Equivalent temperature, 10, 240, 253
 Erection of panels, 114, 121
 Erection of pipes, 61
 Erection of sectional boilers, 31 *et seq.*
 Estimates, &c., 299
 Eupatheoscope, 240
 Evaporative cooling, 284
 Examples of calculation:—
 air conditioning, 285
 circulating height, 77
 circulating pressure, 102, 103
 heat requirements of buildings, 23
 heating and ventilating for cinema, 273
 pipe sizing, accelerated hot-water heating, 89
 pipe sizing, gravity hot-water heating, 84, 85, 87
 plenum heating, 245
 unit heating system, 197
 ventilation system, 269
 Exhaust steam utilisation, 149
 Exits and draughts, 272
 Expansion:—
 fittings, steam, 139
 in pipes, loops and joints, 55 *et seq.*, 139
 offsets, 61
 pipe, 93
 steam trap, 136, 137
 tanks, 92, 128
 Exposure, allowances for, 22
 Extract ventilation, 256
 Extraction hoods for dust, 289

F

Factory:—
 heating, electric, 178
 heating calculations, 198
 ventilation, 197, 256

Fall of steam pipes, 135
 Fans (Chap. XIV *passim*):—
 axial, 262
 centrifugal, 260
 propeller, 258, 259
 Feed pumps, 169
 Feed tanks, 92, 128; erection of, 290
 Felt, insulating properties, 234
 Fibre board, thermal properties, 236
 Filled system thermostat, 216
 Filling-up water system, 129 *et seq.*
 Filters, air, 246, 264
 Fires, open, 11
 Fire bars, fitting, 33
 Fittings, boiler, 28
 friction equivalent of pipework, 80, 204
 Flick action, 217
 Float steam traps, 137
 "Floating temperature control," 213
 Floor(s):—
 heating, 110
 pipes passing through, 59, 296
 radiators, 67
 space dealt with by unit heater, 200
 values of U, 18
 Flues, *see* Chimneys
 Forced circulation, 98, 99
 Forced convection, 5
 Foundations, for sectional boilers, 31, 292
 Friction equivalent of fittings, 80, 204
 Frictional resistance of ducts, 267
 Frost danger and protection, 134, 201
 Fuel:—
 anthracite, 44
 coal, 11, 12, 43
 coke, 11, 12, 44
 composition of, 44
 creosote, 51
 estimating cost of, 309
 gas (*q.v.*), 45
 handling, 43
 liquid, 46
 oil, 46, 224
 peat, 43
 pitch, 51
 storage, 39
 wood, 43
 Fume extraction, 286
 Furnaces, hot air, 15, 243
 Fusible link as safety device, 120

G

Garage heating, electric, 178
 Gas:—
 fired boilers, running cost, 311
 fired unit heaters, 209
 fires, 12
 firing of boilers, 45
 Glass:—
 heat losses through, 18
 specific heat, 2
 thermal conductivity, 4
 Glass fibre as heat insulator, 230
 Glazing, single and double, temperature of windows, 241
 Glue, temperature limits in drying, 294
 Granite, specific heat, 2
 Gravity, air discharge by, 256
 Gravity-fed boilers, 13, 27, 39
 Gravity steam unit heating system, 202
 Gravity system, 84 *et seq.*

H

Hair felt as heat insulator, 234
 Hall's pipe sleeve and thimbles, 59, 296
 Hand-firing boilers, 43

Handling fuel, 43
 Hardboard, thermal properties, 238
 Head, circulating, 76
 Header or trunk for boilers, 35
 Heat:—
 acceleration, 215
 body, 10, 251
 emission from hot-water radiators, 69
 emission from panels, 14
 emission from pipes, 6, 7, 206, 228
 emission from steam radiators, 154
 for drying, 293
 latent, 2, 148
 loss from buildings, 17
 measurement of, 1
 of occupation, 17
 radiant, 111 *et seq.*
 sensible, 1
 specific, 1
 total, of air, 284
 total, of steam, 3, 149
 transfer, in still and moving air, 6
 transmission of, 3
 HEAT, TRANSMISSION OF, CHAP. I, p. 1
 HEAT REQUIREMENTS OF BUILDINGS, CHAP. III, p. 17
 Heaters, air, 248, 265
 Heating:—
 central, 12, 224
 cost of, 304
 dry condense system, 163
 economy in, 239
 floor, 110
 intermittent, 23, 198
 local, 11
 low-pressure hot water, 13
 low-pressure steam, 14, 202
 panel, 108
 panel electric, 182
 plenum, 16, 242
 requirements, 303
 space and comfort, 10
 surface of boilers, 26
 vapour, 140
 wet return system, 160
 HEATING, METHODS OF, CHAP. II, p. 10
 HEATING, WARM AIR, CHAP. XIII, p. 242
 Height of rooms and heat required, 22, 197
 High-level water mains, 9
 High-temperature hot water, 15
 Home Office Regulations, 255
 Hoods, dust-extracting, 289
 Horsehair, temperature limit in drying, 294
 Hospital radiators, 67
 Hot-air furnaces, 15, 243
 Hot-water heating:—
 accelerated system, 80, 98
 drop system, 95
 electric radiators, 180
 hot water *v.* steam, 201
 one-pipe systems, 77
 single-pipe drop, 104
 two-pipe drop system, 96, 103
 two-pipe upfeed, 92
 two-pipe with central mains, 94
 unit heaters, 200, 201
 HOT-WATER HEATING SYSTEMS, CHAP. VII, p. 75
 Hot well, 169
 Humidity, atmospheric, 252
 Hygrometric data, 252

I

Ignition of oil fuel, 46
 Immersion heaters, 180, 186
 Index radiator, 88
 Indirect electric heating, 186

Indirect thermostatic control, 217
 Inside-outside temperature control, 221
 Institution of Heating and Ventilating Engineers, 17, 252
 Insulating materials, 229 *et seq.*, 237
 thermal conductivity, 4, 230
INSULATION, THERMAL, CHAP. XII, p. 228
 Insulation, thickness of, 9, 21, 231
 Intermittent heating, 23
 Iron, specific heat, 2; thermal conductivity, 4.

J

Joint rings, steam, 54
 Joints, expansion, 56

K

k (thermal conductivity), 3
 "Keys" for plastering, 116
 Kilowatt-hour, 172
 Kitchens, ventilation of, 292

L

Labour estimates, 300
 Latent heat of steam, 2, 148
 Laundries, 294
 Leather, temperature limits in drying, 294
 Lengths of tubular electric heaters, 175
 Lift fittings, 167, 168
 Liquid fuels, 46, 224
 "Load" (electric) explained, 172
 Loading of electric heaters, 174.
 for hot-water radiators, 181
 Local heating, 11
 Lock-shield water valve, 87
 London County Council (L.C.C.) and ventilation, 16, 251, 272, 273
 Long-radius bends, 64
 "Long-sweep" water-pipe fittings, 54
 Low-level radiators and two-pipe up-feed, 105
 Low-pressure hot water, 13, Chap VII, *passim*
 Low-pressure steam, 14, Chap VIII, *passim*
 Low-temperature electric heating, 173
 Luminous electric radiators, 173

M

Magazine boilers, 13, 27, 30
 coupling of, 30
 Magnesia as heat insulator, 230
 Magnetically operated valves, 119
 Mains, *see* Pipes
 Maintenance of panel system, 122
 Marble, specific heat of, 2
 Measurement of heat, 2
 Mechanical ventilation, 256
 Mercury:—
 specific heat of, 2
 tube switches, 217
 well, for thermometer, 29
 Metabolic heat, 250
 Metal warming panels, 70
 Metallic paints, avoidance of, 6, 74, 176, 297
METHODS OF HEATING, CHAP. II, p. 10
 Micro-gap switch, 216, 223
 Ministry of Fuel and Power, 236
 Mixing valves, thermal storage, 120
 "Modulating" temperature control, 218, 214, 219
 Motor noises, hum, &c., 263
 Motors, pump, 81

N

Natural ventilation, 256
 Nickel-chrome wire, 173, 183
 Nickel-iron in thermostat (*q.r.*), 215
 Noise from fans, 263
 Non-return valve, 82

O

Off-peak tariffs, 13, 120, 187
 Offsets and expansion of pipes, 61
 Oil fuel, 46, 224
 "On-off" temperature control, 213, 215
 One-pipe systems, 77
 Open fires, 11
 Open vent in water system, 130
et seq.
 Operation of coke-fired boilers, 310
 Outdoor temperature, 235
 Outside pilot of thermostat, 221
 Overflow pipes, 92
 Oxy-acetylene welding, 115
 Oxygen, corrosion from, 162

P

p.s.i., 2
 Painting, 68, 74, 234, 297
 Paints, metallic, avoidance of, 6, 74, 175, 297
 Panel:—
 heating, 14
 electric, 182
 radiators, 68
 system, ceiling, 108 *et seq.*
 with thermal storage, 191
 Parabolic reflectors, 173
 Pass-over bends in pipes, 63
 Peat fuel, 43
 Perkins' high-pressure system, 15
 Pipe coils, 15
 Pipe(s):—
 anchoring of, 58, 60, 62
 bending, 62
 brackets, 58, 295
 chases, 288
 cleaning of, 144
 coils, 15
 condense, sizing of, 204, 205
 conveyor, 289
 drip to condense, 143
 erection of, 61
 expansion, 93
 expansion of, 55, 139
 fall of steam, 135
 feed, 92, 234
 fittings, 54
 resistance of, 80, 204
 heat transmission, 6, 7, 206, 228
 in trenches, 279
 insulation of, 229
 joining, 115
 length in expansion loop, 57
 materials for, 162
 overhead, 92
 painting of, 297
 particulars of, 53
 planning of runs, 292
 pressure loss in, 84
 radiator connections, 85
 safety, 36
 sizing for hot-water heating, 79, 82
 sizing for steam, 135, 141, 145, 203, 205
 supports, 54
 thimbles, 59, 299
 trenches, &c., 279, 294
 velocity of steam in, 147
 velocity of water in, 53
 vent, 102, 130, 234
 welding, 109

PIPEWORK, GENERAL NOTES ON, CHAP. V, p. 53

Pitch, minimum for laying steam pipes, 143
 Pitch as fuel, 51
 Plane surfaces, heat losses, 6
 Plaster, thermal properties, 4
 Plastering, over panel coils, 118
 Plenum heating, 16, 242, 243
 Pollution of air, 250
 Pressure of water, 75
 Primary and secondary heating surface in boilers, 26
 Priming in boilers, 144, 145
 Process steam, 201
 Propeller fans, 258
 Properties of steam, 147
 "Proportioning" temperature control, 213
 Pumps:—
 and accelerators, 80
 boiler feed, 169
 foundations for, 293
 motors, 82
 semi-rotary, 297

Q

Q (amount of heat per square foot per hour), 4

R

R (thermal resistance) and U (=1/R, thermal transmittance), 19, 236
 Radiant heat, 6, 69
 Radiation, 5, 70
 from heated ceiling, 112
RADIATORS, CHAP. VI, p. 66
 Radiator(s):—
 and unit heaters compared, 194
 below level of boilers, 100, 101
 connections, 85
 electric, 172 *et seq.*, 180; *see* Electric heating
 emission from, 69
 index, 83
 "Rayrad," 68
 steam, 154
 with thermal storage (*q.r.*), 191
 Ratings for boilers, 27
 "Rayrad" radiators, 68
 Reducing valves, steam, 139, 150
 Redwood viscometer, 51
 Refrigeration, 281, 286
 Reitchel (pipe sizing), 90
 Relative humidity, 252
 Relays in steam pipes, 143
 Relays in thermostats, 219, 220, 223
 Resistance, thermal, 19, 236
 Resistance of pipe bends, &c., 80
 Retardation of circulation below boiler level, 100
 Retarding effect of low-level radiator, 105
 Return trap for condense, &c., 164, 166, 169
 Risers for panels, 115
 Roman floor-heating, 110, 242
 Roofs and ceilings, values of U, 19
 surface resistance, 20
 Running costs of heating, 304, 306

S

Safety valves and pipes, 29, 36
 "Satchwell" micro-gap switch, 216
 Sawdust, insulating properties, 235
 Schools, heating in, 178
 Secondary air, in combustion, 310
 Secondary heating surface of boiler, 26
 Sectional boilers, 80; erection of, 31
 Sensible heat, 2

Sheet-metal trunking, 265
 Short and long water-pipe fittings, 54
 Silica gel drying, 224
 Single-pipe drop water system, 104
 Single-pipe vapour heating, 141
 Siphon-pipe steam trap, 138
 Sirocco dust collectors, 290
 Skylights, value of U, 18
 Slag wool, as heat insulator, 230
 Sleeves for pipes, 59, 296
 Sliding expansion joints, 58
 Slot-meter electric fires, 173
 Sludge removal, 123
 Smoke pipes, 293; *see* Chimneys
 Snap-acting thermostatic valve, 171
 Soapstone electric heater, 188
 Soffit of ceiling, keying to, 110
 Solar radiation on roof, 241
 Space heating, 10
 Specific heat, 1, 2
 Specifications, &c., 299, 301
 Speed of fans, 261
 Spray-type air conditioner, 280 *et seq.*
 Starch, temperature limit in drying, 294
 Steam:—
 boilers, 51
 condense, 130, 155
 disadvantages of, 200
 dry, 2, 149
 in laundries, 294
 in unit heaters, 200
 latent heat, 2, 148
 main, size of, 145
 pipe lines, 54, 203
 pressure, 187, 202
 properties of, 147
 specific heat of, 2
 superheated, 3, 149, 150
 throttling, 150
 total heat, 3, 149
 traps, 186, 155, 166
 velocity in pipes, 147
 volume of, 148
 weight of, 205
 wet, 149
 STEAM-HEATING SYSTEMS, CHAP. VIII, p. 135
 Steel, specific heat, 2; thermal conductivity, 4
 Stokers, automatic, 37
 Stone, building, specific heat, 2
 Stop valves, 138
 Stoves, slow-combustion, 11
 Strainers, steam, 138
 Straw as heat insulator, 235
 Structural insulation, 21, 235
 Sunshine, warming by, 69, 241, 275
 "Sunway" panels, 70
 Superheated steam, 3, 149, 150
 Surface resistance, 19, 20

T

Tanks, feed and expansion, 92, 128
 Tariffs, off-peak, 13, 120, 187
 Temperature:—
 drop in radiators, 106
 effective, 253
 equivalent, 10, 240, 253
 flow and return, 76, 90
 flue, 26, 310
 gradients, 243
 in buildings, 17
 in cinemas, 272
 in drying, 294
 in hot-water heating, 75
 in panel systems, 109
 of electric panels, 182
 of glass windows, 241
 of heating surface, 16

of incoming air in cinemas, 270
 of oil fuel, 51
 of tubular heaters, 174
 of vapour, 15
 of walls, 240
 outdoor, 212, 235, 274, 305
 range for pipework, 61
 wet bulb, 252
 Templates for bends, 64
 Testing heating boilers, 26, 34;
 panel coils, 113, 114
 Textile mills, humidity in, 2:5
 Theatres, ventilation of, 251
 Thermal:—
 conductivity (k), 3, 280
 equilibrium, 211
 resistance, resistivity, 4, 236
 storage, 13, 120
 and electrical heating, 187 *et seq.*
 transmittance (U), 4, 18, 236
 THERMAL INSULATION, CHAP. XIII, p. 228
 Thermally sensitive member of thermostat, 215, 216
 Thermometer, comfort and the, 69, 239
 on boiler, 29
 THERMOSTATIC CONTROL, CHAP. XI, *passim*
 comparison of types, 222, 223
 of air conditioning, 281
 of automatic stokers, 38
 of boiler draught, 28
 of electric heating, 185
 of gas boilers, 45
 of oil burners, 46
 of panel system, 118
 of steam supply, 170
 of unit heaters, 207
 Thimbles, &c., for pipes, 59
 Throttling steam, 150
 Time lag in heating up, 197
 Time switches, 38
 Total heat of air, 284
 Total heat of steam, 3, 149
 TRANSMISSION OF HEAT, CHAP. I, p. 1
 Transmittance, thermal, 4, 18
 Traps, steam, 136 *et seq.*, 155, 157, 159, 166
 Trenches for pipes, 294
 Tubular electric heaters, 12, 174
 Two-pipe up-feed hot-water system, 92, 93, 105
 Two-pipe vapour heating, 141

U

U (thermal transmittance), 18, 236
 UNIT HEATERS, CHAP. X, p. 104
 Unit heaters, 15
 electric, 208
 gas, 209
 number required for factory, 199
 Uralite ducts, 301

V

Vacuum:—
 cleaners, 287
 flask, principle of, 5
 pump, 141
 Valves:—
 air relief, 141, 161
 ball, 128
 check, 150, 171
 control, panel system, 109, 118
 lockshield, 87
 magnetic, 119
 main, 35
 mixing, 120
 non-return, 81
 radiator, 93

reducing, 139, 150
 safety, 29, 36, 81
 specification, 307
 steam, 138
 testing of, 36
 thermostatic, 171
 Vapour:—
 electric radiators, 180
 heating system, 15, 140
 pressure elements in thermostat, 218
 temperature of, 15
 Velocity:—
 head of air, 266
 method of sizing steam pipes, 147
 of air in handling materials, 289
 of air in ventilation systems, 245
 of steam in pipes, 147
 of water in pipes, 53
 Ventilation:—
 balanced, 258
 builders' work, 297
 cinema, 270
 design of, 266
 ductwork, 265
 extract, 256
 L.C.C. Regulations, 16, 251, 273
 mechanical, 256
 natural, 256
 necessity for, 250
 of boiler house, 42
 plenum, 256
 standards of, 255
 VENTILATION AND AIR CONDITIONING, CHAP. XIV, p. 250
 Ventilators, roof, 256
 Vents, open, in water system, 130 *et seq.*
 Vibration from motors, 263
 Viscometer, Redwood, 51
 Viscous filters, 247
 Volatile fluid trap, 155
 Volume of steam, 148

W

Wall(s):—
 boards, 237
 heat losses through, 18
 pipes passing through, 290
 radiators, 67
 surface resistance, 20
 value of U, 18
 WARM AIR HEATING, CHAP. XIII
 Washers, air, 248, 281
 Water:—
 boiling point, 2, 75, 190
 condense, 136
 density of, 76
 hammer, 135, 152
 level at boiler, 158
 pressure of, 75
 vapour from body, 253
 vapour in air, 252
 velocity in pipes, 53
 Weight of steam in pipes, 205
 Weisbach on pipe sizing, 90
 Welding pipe joints, 109
 Wet and dry steam, 149
 Wet bulb temperature, 252
 Wet return steam system, 160
 Window, value of U for, 12
 Windows, temperature of, 241
 Wood:—
 fuel, 43
 temperature limits in drying, 294
 thermal conductivity, 4
 Wood-wool cement, thermal properties, 238
 Workshop heating, electric, 178

Z

Zinc for plastering keys, 116

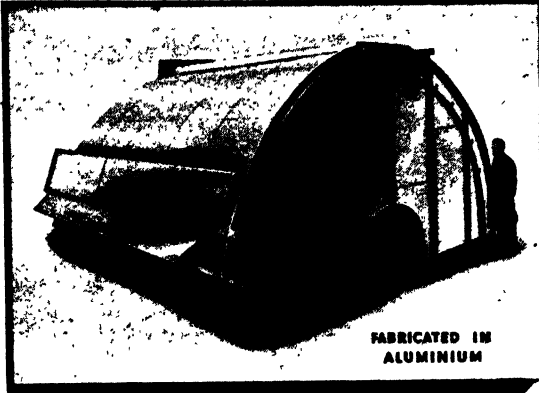

FABRICATED IN
ALUMINIUM

**SHEET METAL
WORK**
**AND STEEL PLATE
CONSTRUCTIONS**
for **EVERY**
Engineering Requirement

STRUCTURAL ENGINEERS



ROOF TRUSSES
**LIGHT STEEL FRAMED
BUILDINGS**

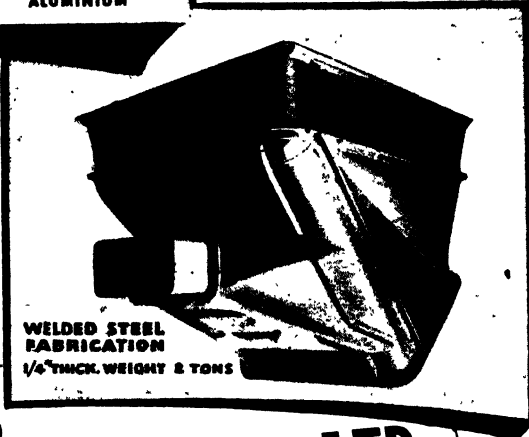

**WELDED STEEL
FABRICATION**
1/4" THICK. WEIGHT 2 TONS

Telephone
Sydenham 6080 (7 lines)

J. GARDNER & CO LTD
KENT HOUSE LANE, BECKENHAM, KENT
& DOCKHEAD, LONDON, S.E.1

ESTABLISHED SEVENTY YEARS

WE INVITE YOUR ENQUIRIES

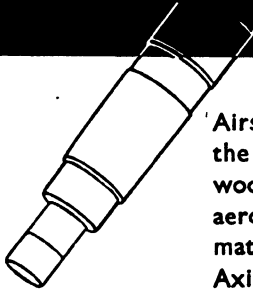
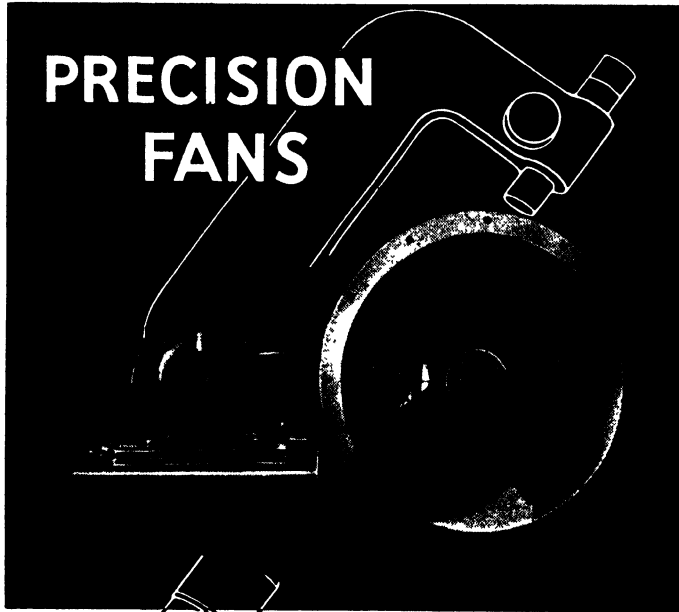

Fuller details and
Performance
Tables F.103 sent
on application

Airscrew Fans are designed on exactly the same aerodynamic principles as our wooden aircraft propellers, with true aerofoll section and made in the same material. They are of the high efficiency Axial-Flow type; robust and giving reliable performances over long periods of heavy duty. For ventilation, drying, steam, dust or fume removal, we guarantee volume and power consumption against designed pressures. They occupy less space and are easier to install than the centrifugal type. Sizes range from 12 ins. to 24 ft. diameters

AIRSCREW FAN SYSTEMS

THE AIRSCREW COMPANY, LIMITED, Grosvenor Gdns. House, London, S.W.1

Telephone: V1Ctoria 4537

Telegram: Airscrew, Bowent, London

SPIRAL TUBE

AIR HEATERS OF ALL KINDS

PLENUM TYPE AIR HEATER

22 ft. x 9 ft., to handle 6,300,000 c. ft./hr.
installed in the State Cinema, Kilburn.
Made in a wide range of types and sizes.

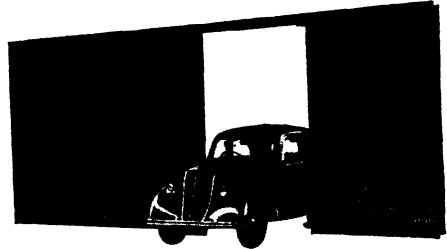
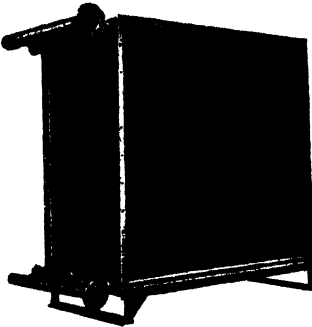

AIR HEATERS FOR PROCESSING

Supplied for all duties. Using hot water or steam at pressures up to 500 lb./sq. in., to Lloyd's specification and giving air temperatures up to 450°F.

MOTOR-DRIVEN UNIT HEATERS

Manufactured in wide range of sizes and types for all types of installations. Range includes Downward Diffuser Units, also Turbine-Driven Type.

Spiral Tube Drying, Processing and Defogging Plants are in use in every Industry.

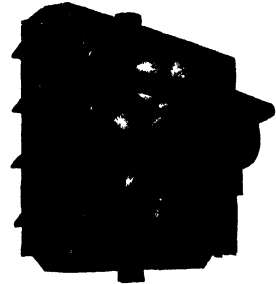

We specialise in the manufacture of heat transmission equipment of all kinds : Plenum Air Heaters, Air Coolers ; Water and Oil Coolers for Diesel Locomotives, Commercial Vehicles, Tractors, Power Plants and Internal Combustion Engines of all kinds ; Refrigerator Coils ; Compressed Air Coolers ; Heat Exchangers, etc.

The
SPIRAL TUBE & COMPONENTS
COMPANY LTD.

OSMASTON PARK ROAD, DERBY

Telephones : Derby 46067/8

LONDON OFFICE : HONEYPOT LANE, STANMORE, MIDDLESEX

Telephones : Edgware 4658/9

HUNT & MOSCROP LTD.

MIDDLETON, MANCHESTER

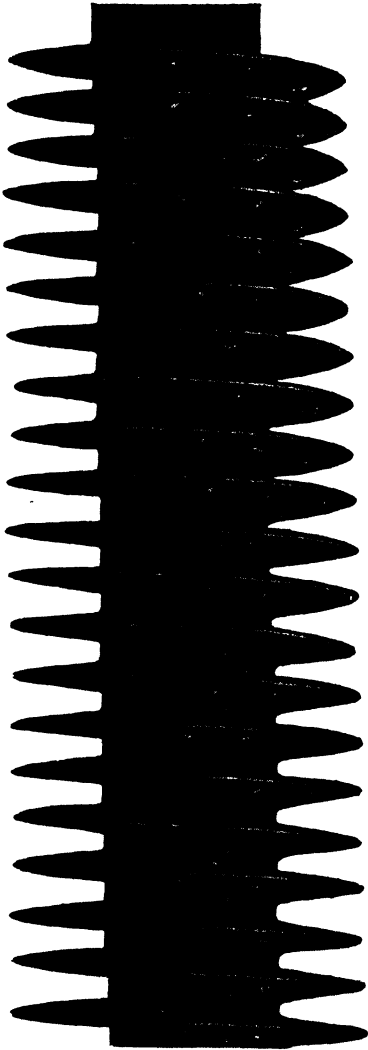

New and highly developed methods of production have enabled us to supply finest quality Gilled Tubes and Batteries at very advantageous prices.



**G I L L E D
T U B E S &
B A T T E R I E S
I N C O P P E R
& S T E E L**



PHURNOD

SMOKELESS COAL

Produced in South Wales by

POWELL DUFFRYN LTD.



PHURNOD — prepared in the most modern types of coal preparation plants; is cleaned to remove extraneous ash-forming material and mechanically graded to ensure uniform size.

PHURNOD combines high heating value with a low ash content, cleanliness and adaptability to burn slowly or to give intense heat as required.

There is a grade of PHURNOD suitable for every type of coal-burning appliance, from the smallest domestic boilers and stoves to the large hand-fired central heating plants, as well as automatic and mechanical stokers of all types.



Technical information regarding PHURNOD and particulars of sizes recommended for a variety of appliances in common use will be sent to Heating Engineers, Architects and others on request to:

POWELL DUFFRYN LTD.

40 LIME STREET, LONDON, E.C.3

MIXING VALVES

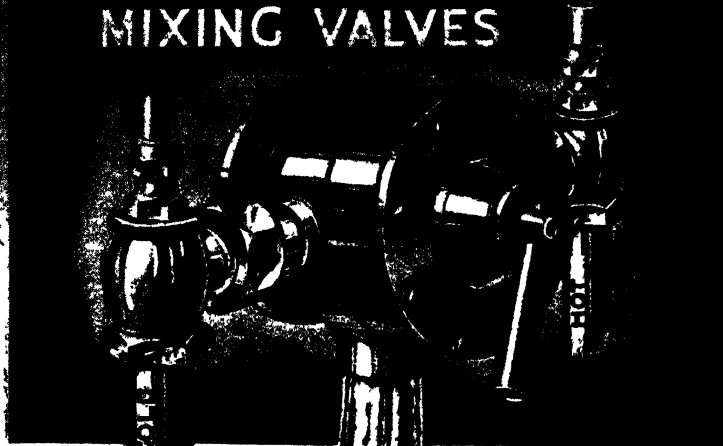

FOR EQUAL OR UN-EQUAL PRESSURES.

— SPECIAL FEATURES —

1. CHECK VALVES ARE CONTROLLABLE AND ACT ALSO AS SHUT OFF COCKS.
2. OUTLET MAY BE ABOVE OR BELOW TO SUIT CONDITIONS ON SITE.
3. THERE ARE 8 DIRECT ACTING ELEMENTS OF NON-CORROSIVE METAL.
4. INLETS MAY ALSO BE ARRANGED FOR SUPPLIES FROM ABOVE OR BELOW.
5. WE ARE ABLE TO OFFER COMPLETE WITH SHOWERS AND OTHER SPECIAL EQUIPMENT.

GUMMERS LTD.,

STROUD VALVE WORKS,

Consult the **G.E.C.** **ON VENTILATION**



A "Genalex" standard ring mounting fan

Below—
A "Genalex" flameproof
exhaust fan, for use in
hazardous situations

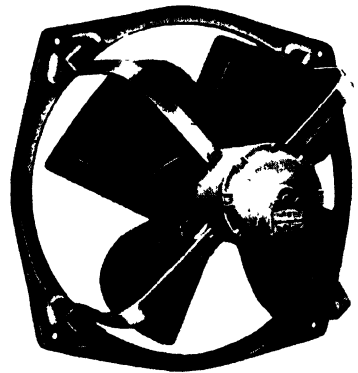

"Genalex"

ELECTRIC EXHAUST FANS

The safe and sound choice for every situation. "Genalex" exhaust fans are extraordinarily robust—electrically and mechanically. Silent running and outstandingly reliable.

There is a type and size to suit every purpose.

FLAMEPROOF type can be used safely in petrol stores, spray booths, dry cleaning plants and similar situations where inflammable atmospheres are prevalent.

The motors are of special Flameproof design, certified by the Mines Dept. testing station, Buxton, and comply fully with Home Office regulations.

G.E.C. technical representatives are at your service to give advice on any application of Electric Exhaust Fans

SAVE LABOUR!



The vital need continues, and play an increasing part in the battle

ever a Mirrlees Stoker is installed labour is released for more essential work, while the actual efficiency of all Heating and Steam Raising is increased considerably. Automatic temperature control ensures the highest quality in output and the labour involved is but a few minutes of one man's time a day.

to save labour Mirrlees Stokers are increasingly important for fuel. Where-

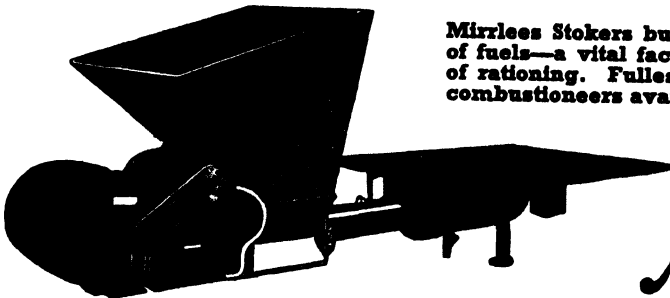

Mirrlees Stokers burn a wide variety of fuels—a vital factor in these days of rationing. Full details of these combustion engineers available on request.

Mirrlees

**MIRRLEES, BICKERTON & DAY, LTD., HAZEL GROVE, STOOKPORT.
THE MIRRLEES WATSON CO. LTD., SCOTLAND STREET, GLASGOW C5.**

High Pressure Hot Water

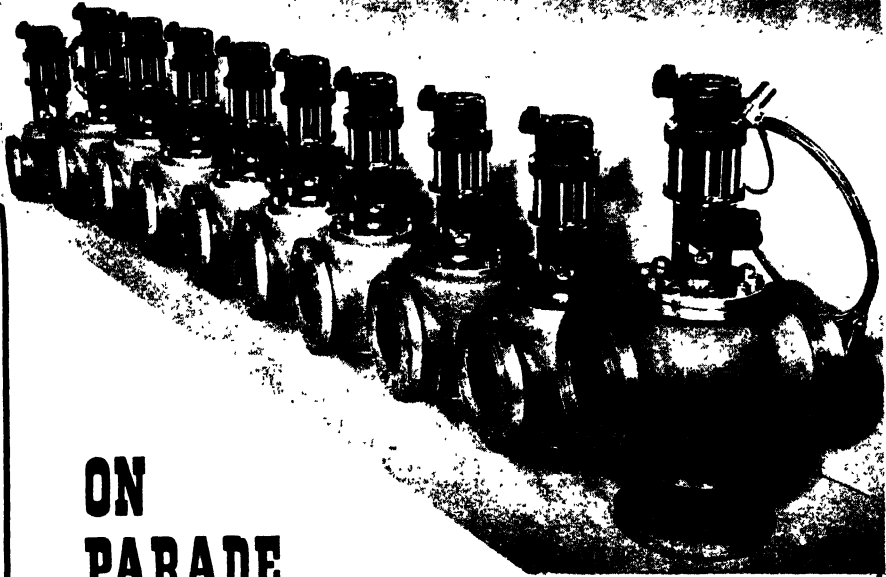
**ON
PARADE**

In close order, ready for active service, is shown a squad of H.P.H.W. valves, fitted with *Feddington* Electro-Hydraulic Power Units, going out to "do their bit" in one of Britain's war factories.

These controls will not only save time and man power by automatically maintaining correct processing temperatures, but will help to

"Save fuel IN the Factories"

THE BRITISH THERMOSTAT CO. LTD.

Everything for Automatic Temperature Control

SUNBURY, MIDDLESEX. TELEPHONE SUNBURY-ON-THAMES 756



**UNIONS FOR ANY PIPE LINE
GAS, WATER, STEAM, OIL, AIR, ETC.**

MADE IN "HIGH TENSILE" MALLEABLE IRON
BRONZE SEATS SECURELY "LOCKED IN"
BRITISH STANDARD TAPER THREADS
HEXAGON ENDS FOR EASY FIXING
INDIVIDUALLY AIR-TESTED

WALTER SLINGSBY & CO., LTD.
WOODHOUSE ROAD, KEIGHLEY, YORKS

'Phone : Keighley 3749 (2 lines)

'Grams : Malleable, Keighley

CONSULT THE **G.E.C.**

ON
**SPACE
HEATING**

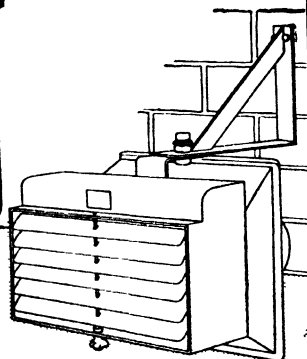
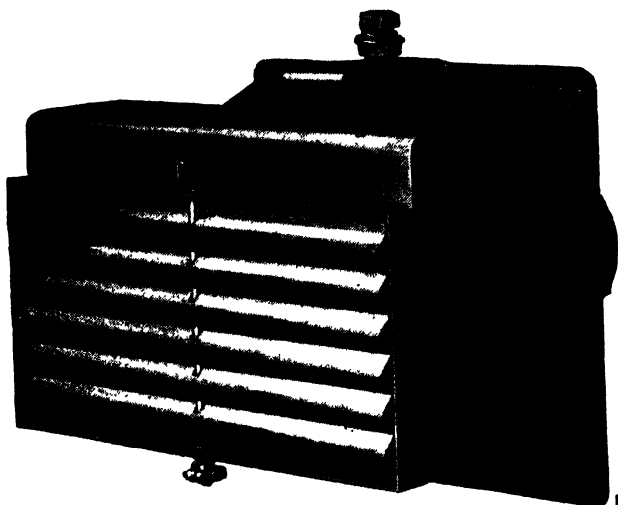

G.E.C.
ELECTRIC UNIT HEATERS

- THE HEATING SYSTEM THAT NEEDS NO FLOOR SPACE, NO BOILER HOUSE, NO FUEL, AND NO OPERATING LABOUR.
- IN RELATION TO HEAT OUTPUT THEY ARE OF THE SMALLEST SIZE AND USE THE LEAST AMOUNT OF METAL.
- LOWEST CAPITAL COST. LOW OPERATING COST.
- EACH UNIT CAN BE WORKED INDEPENDENTLY, WITH OR WITHOUT THERMOSTATIC CONTROL.

The G.E.C. Unit Heater System is widely used both for emergency buildings and for supplanting old and inefficient heating systems. The units are available in 5-10, 15 and 20 kW. loadings, or larger sizes to order.

G.E.C. heating engineers are always available to advise and prepare schemes.

SUNSTAR

INDEPENDENT HOT WATER BOILERS

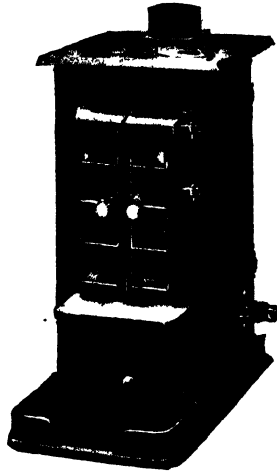

**FOR SMALL INSTALLATIONS UP TO
50,000 B.T.U.**

Makers of Steel Sectional Boilers for H.W.S.,
Central Heating, Low Pressure Steam up to
Four Million B.T.U. per hour.

Also, H.W.S. Cylinders and Calorifiers in Steel,
Plain and Galvanized and Copper up to any
power or strength.

BEANESS Automatic Mechanical Underfeed STOKERS
for all and every make of Boilers.

All these products detailed in one list and sent to you by—

BINNS & SPEIGHT LTD., BRADFORD.

We design and
manufacture
all types of
UNIT HEATERS

Send for our
WAR-TIME
CATALOGUE

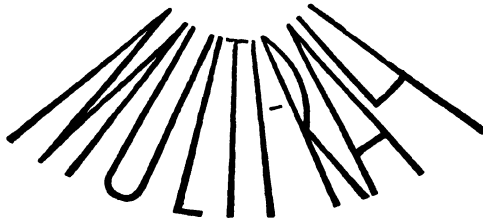
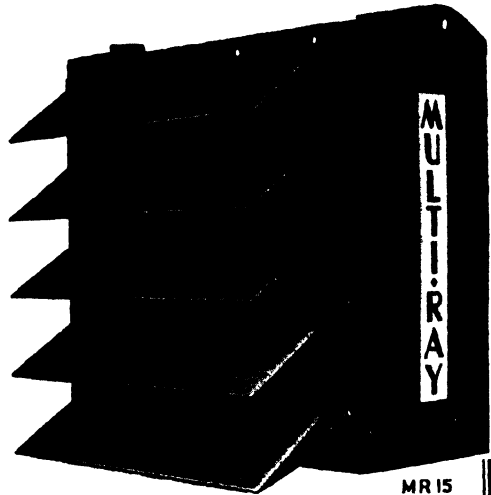

UNIT HEATERS

**MULTI-RAY
HEATERS L^{TD.}**

PRINCES END WORKS, TIPTON, Staffs.
London Office : 149 Leadenhall Street, E.C.3

VENTILATING



**DUST
EXHAUST**



**FUMES
REMOVAL**



**FAN
MAKERS**

STANDARD & POCHIN BROS. LTD.

LEICESTER · ENGLAND

LONDON · GLASGOW · NEWCASTLE ON TYNE · LEEDS

BRONZE PARALLEL-SLIDE VALVES

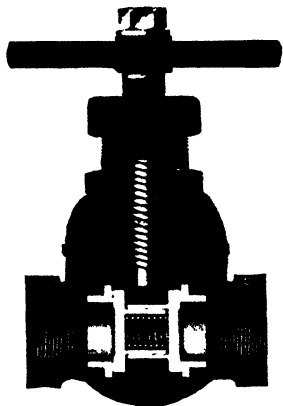

The ideal type of stop valve for low-pressure installations: available in sizes up to 2" as a wheel-operated type, or a quick-opening Link Valve

The wheel-operated type is suitable as a general-purpose stop valve for hot water heating installations

The Link Valve opens with less than $\frac{1}{4}$ turn of the handle and is suitable as a drain valve or a quick-shut-off-valve

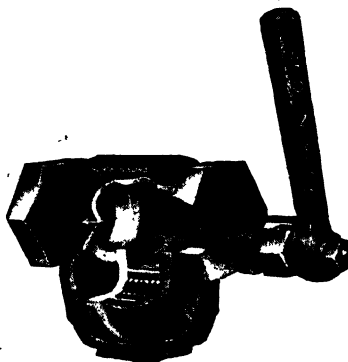

- ◆ Easy to operate under all conditions
- ◆ Fluid tightness unaffected by "wire-drawing"
- ◆ Long, trouble-free service
- ◆ No mechanical stress exerted between discs and seats
- ◆ No dangerous strains in opening or closing
- ◆ Robust construction: high quality materials

HOPKINSONS LIMITED, HUDDERSFIELD

London Office: 34 Norfolk Street, Strand, W.C.2

LYELONE

FILTERS SOLVE A PROBLEM

Illustrated is the
**GOTTON WOOL
FILTER** (Throw-
away type) for
filtering air sup-
plied to Public
Buildings, Indus-
trial and Food
Factories, etc.
Provides dust-
free atmosphere.
Details on request.
Quote Ref. HVP.

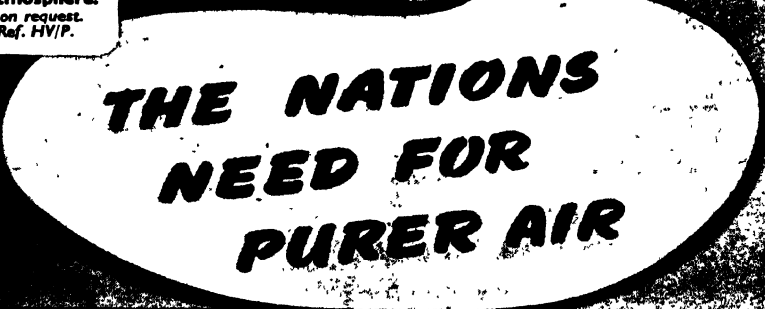

**THE NATIONS
NEED FOR
Purer AIR**

MATTHEWS & YATES LTD
SWINTON (LANCS) AND LONDON
GLASGOW - LEEDS - BIRMINGHAM - MANCHESTER



Planning the future

Visions of clean design, neat walls and ceilings—how often they are spoiled by the intrusion of ugly metal flues and ducts. But now ducts of Incorrosible Urastone can be "built in," or applied neatly to walls and ceilings, their smooth stonelike surfaces being no more obtrusive than pilasters or beams.



Incorrosible Urastone is a fine heat insulator, suitable for all normal flue work. It is a sound insulator, too, and when used in ventilating systems it does not reverberate the noise of fans or motors.



If you have a flue or air duct problem, we ask you to consider the advantages of URASTONE. In any case, please let us send you the detailed URASTONE Reference Catalogue for your files.

URASTONE is at present available only under Control by the Minister of Works and Planning. Information gladly supplied on request.

CELLACTITE & BRITISH URALITE LTD

Terminal House, 52, Grosvenor Gardens, London, S.W.1

Phone : SLOane 5127

Telegrams : Cellactite, Sowest, London

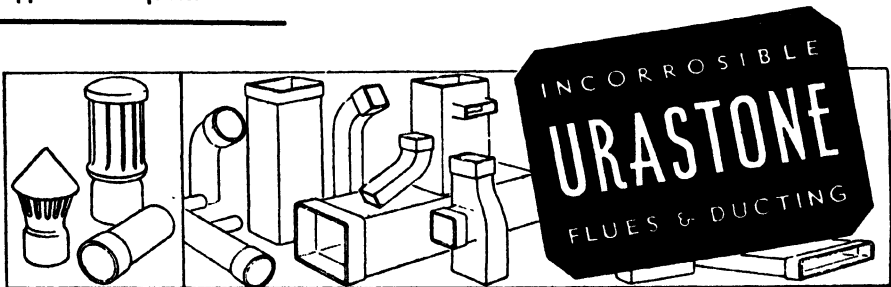

CENTRIFUGAL PUMPS

FOR THE
HEATING AND
AIR CONDITIONING
TRADES



SUPER SELFIX full
bore silent circulator

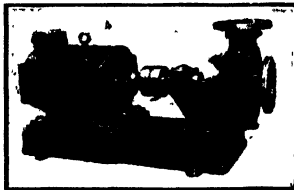

TYPE BR for silent operation
on air conditioning services

OTHER MANUFACTURES INCLUDE
CALORIFIERS, OIL SEPARATORS,
INJECTORS, EJECTORS, STEAM TRAPS,
SMALL STEAM TURBINES,
WELDED STEAM TANKS, ETC.

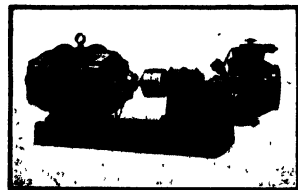

TYPE AQ quiet running
direct coupled pump for low
pressure heating circuits.

HOLDEN & BROOKE LTD.

SIRIUS WORKS
MANCHESTER, 12

&

66 VICTORIA ST.
LONDON, S.W.1



Pipe Fittings are judged against the **GF** standard—because **GF** are specially made for Heating Engineers and have served the profession well for over 40 years

BRITISH



MADE

DISTRIBUTORS:

LE BAS TUBE COMPANY LTD.

23 MONTAGU SQUARE, LONDON, W.1

WAREHOUSES: LONDON, MANCHESTER, GLASGOW, BELFAST

SPECIALITIES

FOR THE

HEATING

TRADE

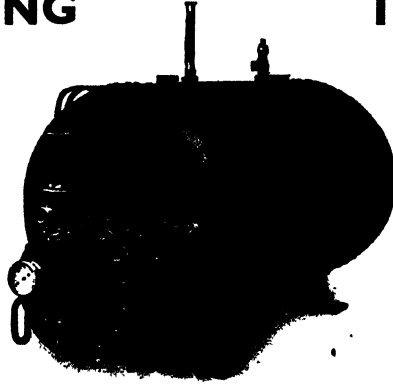

CALORIFIERS

STEAM TRAPS

REDUCING VALVES

FEED WATER HEATERS

TWIN AND SINGLE STRAINERS

FLOAT OPERATED CONTROLS

THERMOSTATIC CONTROLS

BOILER FEEDING

APPARATUS



The Name to Remember for
ELECTRIC WATERHEATING
is
SANTON

Thermal Storage Heaters
Water Boilers
Geysers
Immersion Heaters
Circulators and Belts

Drawings, Specifications & Installation Requirements
SANTON LTD., NEWPORT 12 (Mon)

BEESTON ROBIN HOOD BOILERS AND RADIATORS

In your specifications will
ENHANCE YOUR REPUTATION

DESIGNED for DURABILITY
EFFICIENCY and ECONOMY

Domestic
Central Heating &
Steam Boilers

ALL SIZES FOR ALL PURPOSES

RADIATORS of all types

suitable for all Installations

SEND US DETAILS OF
YOUR REQUIREMENTS

Catalogue on Request

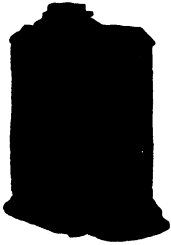
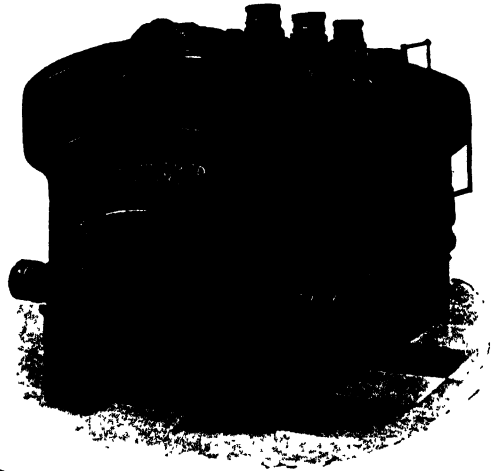

**ROYAL OPEN FIRE
BOILER**

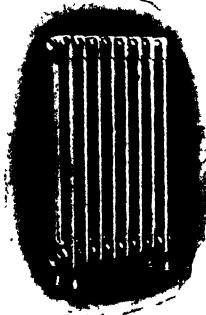

**NEW ROYAL
RADIATOR**

38,400 B.Th.U. to
2,280,000 B.Th.U.
per hour

THE BEESTON BOILER CO., Ltd.
BEESTON, Nr. NOTTM.

Telegrams : FOUNDRY BEESTON NOTTS.

Telephone : 54271 (4 lines)



'SATCHWELL'
Motorised Valves for
AUTOMATIC
TEMPERATURE
CONTROL

THE RHEOSTATIC COMPANY LIMITED
SLOUGH ● **BUCKS**

Telephone: SLOUGH, 28811/6. Telegrams: RESISTANCE, SLOUGH

HEATERS FOR
ANY DUTY
IN STEEL
OR COPPER

AFRICA HOUSE
KINGSWAY
LONDON
W.C.2

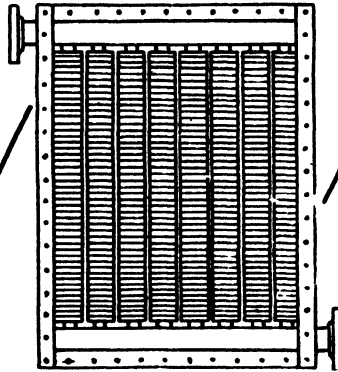

THERMO
ENGINEERS LTD.
TEL. HOLBORN 7440

STEEL GILLED
TUBES
UP TO 6" BORE



