

Birla Central Library

PILANI (Jaipur State)

(Engg College Branch)

Class No :- 697

Book No :- 5391 R

Accession No :- 30480

1

Acc. No

ISSUE LABEL

Not later than the latest date stamped below.

--	--	--

RADIANT HEATING

*The quality of the materials used in the manufacture
of this book is governed by continued postwar shortages.*

RADIANT HEATING

by

Richard Woolsey Shoemaker

*Fellow, AIEE; Member, ASME
and ASHVE; Consulting Engineer on Radiant
Heating and Hydro-Electric Problems, Oakland, Calif.
Formerly Consulting Engineer for Chase Brass & Copper Co.
Waterbury, Conn.; Electrical and Consulting Engineer
for the Turlock, Merced, and Imperial Irrigation
Districts in California*

FIRST EDITION

McGRAW-HILL BOOK COMPANY, INC.

New York : Toronto : London

1948

RADIANT HEATING

COPYRIGHT, 1948, BY THE
MCGRAW-HILL BOOK COMPANY, INC.

PRINTED IN THE UNITED STATES OF AMERICA

*All rights reserved. This book, or
parts thereof, may not be reproduced
in any form without permission of
the publishers.*

THE MAPLE PRESS COMPANY, YORK, PA.

PREFACE

The purpose of this book is to explain and clarify the general subject of radiant heating, not only for the benefit of prospective home-builders, but also for architects, consulting engineers, and contractors, who may want to have accurate information on the practical features of radiant-heating application, installation, and design.

Many examples of radiant-heating constructions are illustrated in order to demonstrate clearly the wide scope of practical applications, not only for all types of buildings, but also for any climate.

In order to explain the difference between radiant heating and conventional methods of heating, it seemed desirable to explain first as clearly as possible the physiological reactions to temperature conditions, including a development of the basic reasons why a person feels "cold," "hot," or "comfortable." Then, with an understanding of the individual's reaction to temperature, the advantages of radiant heating are explained fully from all viewpoints, including that of comfort, convenience, efficiency, and practicability. The text and accompanying illustrations will show the extent and magnitude of the applications of this modern and most acceptable method of providing not only warmth where needed but also comfort in areas of excessive heat.

Although no attempt has been made to produce an exhaustive treatise on the design of radiant-heating systems, a subject that would far exceed the space allotted for this work, enough has been outlined to guide technical personnel in the quest for complete engineering information, and at the same time sufficient data are given to enable those reasonably experienced in conventional heating installations to make acceptable radiant-heating designs that can be depended on to function properly in the average one- or two-story residential or business structure of good present-day design.

For radiant-heating applications in multistoried buildings or where large areas, high ceilings, severe exposures, or other unusual circumstances are involved, including radiant cooling, competent

architectural or engineering services should be obtained by prospective builders, although all who are interested in such constructions, as owners, architects, engineers, or contractors, will find helpful and authoritative information in the following pages.

RICHARD W. SHOEMAKER

OAKLAND, CALIF.

January, 1948

ACKNOWLEDGMENTS

The author wishes to acknowledge gratefully the courtesies extended by the Chase Brass & Copper Co. of Waterbury, Conn., in the preparation of this book, especially to the people of this company who have worked with him for many years in the development of radiant heating in theory and practice. These include Mr. Lorenzo Hamilton (architect), Mrs. V. Hazen (mathematician), Messrs. R. L. Maher (heat flow engineer), Wm. Mullholland (constructional engineer), S. R. Osborne (heating and ventilating engineer), C. L. Perkins (patent research), S. A. Selby (heating and air conditioning engineer), and R. C. Vanderweil (heat flow engineer).

Further acknowledgment is made to the following companies who have provided illustrations and data with respect to their products:

American Iron & Steel Institute, New York, N.Y.
Mr. Ames Aksila, Builder and Contractor, Worcester, Mass.
R. H. Allen, Allen Copper Coil Manufacturing, Seattle, Wash.
American Radiator & Standard Sanitary Corporation, Pittsburgh, Pa.
Robert Bruen & Son, Oakland, Calif.
Bell & Gossett Company, Morton Grove, Ill.
Bundy Tubing Company, Detroit, Mich.
Bethlehem Steel Company, Bethlehem, Pa.
A. M. Byers Company, Pittsburgh, Pa.
Chase Brass & Copper Co., Inc., Waterbury, Conn.
Crane Company, Chicago, Ill.
Richard Crittall & Co., Ltd., London, England, and New York, N.Y.
Delco Appliance Division, General Motors Corporation, Rochester, N.Y.
The Fairbanks Company, New York, N.Y.
Gilbert & Barker Manufacturing Company, West Springfield, Mass.
Hoffman Specialty Company, Indianapolis, Ind.
Johnson Service Company, Milwaukee, Wis.
International Heater Company, Utica, N.Y.
Iron Fireman Manufacturing Company, Cleveland, Ohio
Minneapolis-Honeywell Regulator Company, Minneapolis, Minn.
Penn Boiler and Burner Mfg. Corp., Lancaster, Pa.
Standard Oil Development Company, Elizabeth, N.J.
Stoker Manufacturers Association, Chicago, Ill.
The H. B. Smith Company Incorporated, Westfield, Mass.

Sarcotherm Controls, Inc., New York, N.Y.

Timken Silent Automatic Division, The Timken-Detroit Axle Company, Jackson Mich.

H. A. Thrush & Co., Peru, Ind.

Taco Heaters, Inc., New York, N.Y.

Bradford S. Tilney, Architect, New Haven, Conn.

National Supply Company, Pittsburgh, Pa.

A. O. Smith Corporation, Milwaukee, Wis.

CONTENTS

<i>Preface</i>	v
<i>Acknowledgments</i>	vii
I. GENERAL CONSIDERATIONS.	1
II. STRUCTURAL AND OTHER ADVANTAGES	12
III. PANEL LOCATION IN COMMERCIAL BUILDINGS.	33
IV. PANEL LOCATION IN RESIDENCES.	57
V. THE RADIANT HEATING PLANT	74
VI. CONTROL SYSTEMS FOR RADIANT HEATING	119
VII. DESIGN OF RADIANT HEATING SYSTEMS.	146
VIII. INSTALLATION OF RADIANT HEATING SYSTEMS	184
IX. RADIANT COOLING	224
X. PRECISE METHOD OF DESIGNING RADIANT HEATING SYSTEMS.	239
<i>Appendix</i>	275
<i>List of Symbols.</i>	297
<i>Index.</i>	301

CHAPTER I

GENERAL CONSIDERATIONS

The necessity for supplying heat in some form to promote human comfort as required by climatic conditions in many parts of the inhabited world is well known, although the factors involved in providing comfort conditions are not always fully understood. With advancing civilization the desire for increased comfort, including such matters as cleanliness, sanitation, freedom from disease, freedom from petty and repetitive duties, becomes increasingly important, with the result that living conditions, as evidenced in housing design and construction, are continually being improved to meet popular demand.

One of the desired improvements in living conditions has to do with the method of supplying heat to or removing heat from enclosed spaces occupied by human beings in order to produce conditions of maximum comfort. To consider this problem in detail, it will be necessary first to consider one by one all the factors entering into the problem.

The question immediately arises: What is comfort? The expressions often used are "feeling hot," "feeling cold," or "feeling comfortable," without a clear understanding of the elements that are involved in these simple statements. To visualize these states, it must be realized first that the human body is a self-repairing heat engine, capable of performing work, and as such it is directly comparable in many ways to an internal-combustion engine, such as in automobiles. Engines of this type take in air and fuel, convert them into heat energy, deliver some of this energy as work, and reject the remainder, either through radiation and convection from the engine itself or by convection air currents through the radiator and by discarding some of the heat through the exhaust gases. If the engine is deprived of air or fuel or allowed to over-heat, operation ceases.

The human being, as with all warm-blooded animals, functions in exactly the same manner. In order to perform work, the animal

must be alive and active. To be so, it must draw in air and fuel as represented by food and convert these quantities into energy whereby to repair and maintain the organism and be ready to perform work as required. The minimum normal heat developed by a human being approximates 500 Btu per hr. (A Btu is a measure of heat and is an abbreviation of British thermal unit, which is defined as the amount of heat required to raise the temperature of 1 lb of water 1°F.) Of this amount, 100 Btu are used up in maintaining the body in operation and making repairs. The remaining 400 Btu have to be dissipated; otherwise, the body would overheat and trouble would develop exactly as with an internal combustion engine. Under normal conditions, nature maintains a proper balance in accordance with the following table of heat dissipation:

(1)	190 Btu per hr by radiation
(2)	110 Btu per hr by convection and evaporation
(3)	100 Btu per hr by exhalation
	<hr/> 400 Btu

The body has other methods of disposing of heat, but these are of negligible importance. With heat being dissipated at the previously mentioned rate and in the proportions indicated, the temperature of the body will remain normal at 98.6°F.

Assume now that a subject is exposed to an environment of normal conditions, such as 70°F air temperature, 50 per cent relative humidity, no direct radiant heat, no air currents, and that the subject is suitably clothed. Assume further that the Btu radiated, dissipated, and lost by convection, evaporation, etc., are in accordance with the preceding table. Under these conditions it can be assumed that the subject is comfortable. In other words, he has no sensation of either heat or cold.

Now assume that the environment changes so that it is not possible any longer with the amount of Btu radiated to continue at 190 Btu per hr. Then with other conditions remaining the same, the temperature of the body will tend to go up because as the body is continuing to generate heat, and if the flow of heat away from the body is impeded, the temperature of the body must go up. This tendency will be noted by the nerves on the surface of the skin, which is one of the body's methods of sensing its environment. Other methods are, of course, through the eyes and ears. The

tendency toward a temperature increase is reported to that section of the brain believed to be in the thalamus area, which is presumed to be the center of temperature control. Following receipt by the brain of the tendency to temperature increase, the nerve center takes the necessary steps to make the proper corrective efforts: first, it causes the blood vessels leading to the surface of the body to expand, with the expectation that the increased blood circulation will tend to halt the increase in temperature; then it may increase the rate of breathing so that the loss by exhalation will be increased; and lastly, it may stimulate the sweat glands in order to increase the losses by evaporation. These corrections are all made automatically, without conscious effort on the part of the subject, and have been caused by the sensation of feeling warm.

Consider now the chain of events that takes place should the environment change from the previous comfort condition of 70° temperature, 50 per cent humidity, no radiation or air currents, and assume that radiation or other losses increase by reason of lower external temperatures or for other causes. The rate of heat loss from the body will increase, and the fall in temperature will be noted by the nerves of the skin, with the result that the thermal center of the brain takes cognizance of the fact that the heat losses are above normal, thus automatically setting up suitable corrective measures, such as reducing heart action, thus reducing the flow of blood to the surface of the body and thus directly reducing the loss by radiation and convection. In order to assist further in the reduction of loss of heat by the flow of blood to the surface of the body, the blood vessels are contracted so as to retard the delivery of blood to the skin and body surface. By these means and concomitant measures, proper body temperature is maintained.

If these corrective factors are insufficient, then the body resorts to the phenomenon known as shivering, which is merely using up muscular energy, and by doing so produces heat, attempting in this way to maintain heat balance in face of excessive loss by generating more heat.

If all the above-described normal corrective measures available to the nervous system of the body are insufficient to maintain proper body temperature, then further corrective measures for the protection of life are obtained by the nervous system by accenting the feeling of discomfort to such an extent that the individual

concerned takes the necessary steps to adjust or modify the environment so that bodily heat loss will be reestablished to normal values. Such steps would include putting on more clothing, building a fire, etc.

In the same manner, insufficient loss of heat would be first normally compensated for internally; then if these corrections were insufficient, uncomfortable heat sensations would eventually cause the individual to correct his environment by means of some physical action such as removing clothing, turning on a fan, etc., in such a manner as to restore normal heat balance.

It would now appear to be quite obvious what is meant by comfort: it seems to be that condition to which an individual might be exposed which would render the temperature-correcting elements of the brain quiescent.

It is to be observed that the combination of nerves in the skin, together with the thermal nerve center in the brain, is, in effect, a thermostat provided for maintaining proper body temperatures. When this center is neither calling for an adjustment to correct a tendency for the body to overheat, nor calling for an adjustment to correct an abnormal loss of heat, then we can very correctly say that we have comfort temperature conditions.

It would appear, therefore, that any artificial methods of heating or cooling to provide maximum conditions of comfort should function in such a manner as to prevent the thermostat in the body from being called upon to make adjustments.

While it is possible for the body to make heat-correcting adjustments as among the three means of loss by radiation, convection, and exhalation, it is entirely obvious that if an artificial environment has to be provided for bodily comfort, such as a warmed room, the body's rate of heat loss while in a heated room should be in accordance with the body's normal rate of loss through the three channels provided. This means that, in general, a person is more comfortable in a room of relatively lower air temperature than wall temperature, including the floor and ceiling, than in areas where the reverse is the case, *i.e.*, where the air is at a higher temperature than the walls, floor, or ceiling. As the former condition just outlined is the condition that exists in radiantly heated rooms, this explanation apparently gives the reason why persons living in radiantly heated buildings so often say that they

experience an unusual sensation of comfort without being able exactly to explain or define just why this condition exists. Of course, the environment in a radiantly heated room more nearly approximates natural and normal outdoor conditions where the air temperature is below radiant temperature with the sun visible.

So far consideration has been given only to the minimum loss of 400 Btu per hr. This loss increases rapidly if the individual is performing work. As the amount of work produced by the body increases, the consumption of fuel increases. Part of the resulting energy is, of course, represented by the work done, but the remainder has to be dissipated, together with the normal loss, through the channels previously mentioned.

The human machine is not too efficient. If it is producing work at the rate represented by 4000 Btu per hr, it can be regarded as a measure of reasonable maximum activity on the part of a man; then the total Btu that have to be dissipated amount to approximately 2000 per hr, with the result that although radiation does increase, most of the heat loss must be dissipated through convection, evaporation, and exhalation. Consequently, when a human being is performing heavy work, he must be provided with an environment such as to allow the dissipation or absorption of a relatively large bodily Btu output. This is the reason why rooms occupied by people engaged in heavy manual work must be maintained at lower average temperatures than rooms occupied solely by mental workers.

Radiant heating and cooling are directed toward the control of comfort by influencing the radiant component of bodily heat output rather than by adjusting the convection and evaporative elements to secure bodily heat balance as is the method used by conventional systems; hence, radiant heating is not simply another type of heating but is a distinctly different method of providing comfort from any or all of the presently known conventional methods.

If the preceding discussion is reduced to the simplest terms, it can be observed that in a conventional system, the determining factor for comfort in the enclosure to be heated is the air temperature in this enclosure. In a radiant-heating system, comfort can be had independently of the air temperature. This is not true of any other method of heating.

Another way of illustrating the difference between conventional methods of heating and radiant heating resides in the fact that in all conventional methods, the subjects present in the space to be heated or cooled are immersed in the heating or cooling medium, the air; whereas in a radiant system, the necessary effects are supplied or removed by radiation independently, if necessary, of the air temperature.

As an illustration of this subject of heat balance with respect to human beings within an enclosed controllable environment, consider Fig. 1-1, which represents an individual standing within a space having an air temperature of 65° and a mean radiant

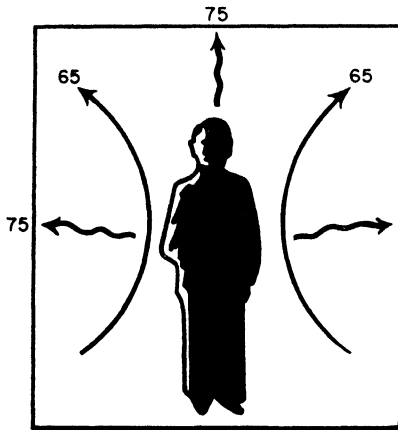

FIG. 1-1.—Normal temperature conditions.

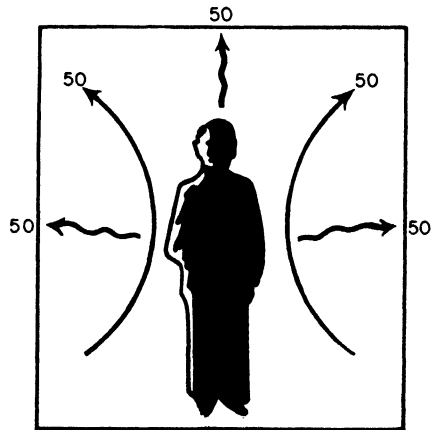

FIG. 1-2.—Cold air and cold environments.

temperature of 75° . Heat is lost by the body by radiation and convection in proper balance, and it can be assumed that comfort conditions, as have been defined, are maintained.

Consider now the condition that would exist in the same space with air temperatures of 50° and mean radiant temperatures of the same value (Fig. 1-2). This would be the normal temperature relationship between air temperature and mean radiant where the air changes less than once in an hour and either the air or mean radiant temperatures are held constant. An individual exposed to these conditions as illustrated in Fig. 1-2 would, of course, experience discomfort owing to feeling cold, bodily heat losses being much above normal through both convection and radiant channels. However, in Fig. 1-3, if the walls of the room could be heated to a

temperature of 88° with the air temperature maintained slightly higher than in Fig. 1-2, or at 52° , comfort would be reestablished, the increased loss by convection and exhalation being made up by a decrease in radiation resulting from an increase in mean radiant temperature. This diagram indicates the reasons why it is physically possible to maintain comfort conditions in a room of any air temperature that may be desired. It is not ordinarily feasible, however, to carry out in practice such discrepancies as are here indicated without elaborate equipment and expensive controls; nor should the temperatures given be regarded as precisely accurate, but rather as reasonably correct.

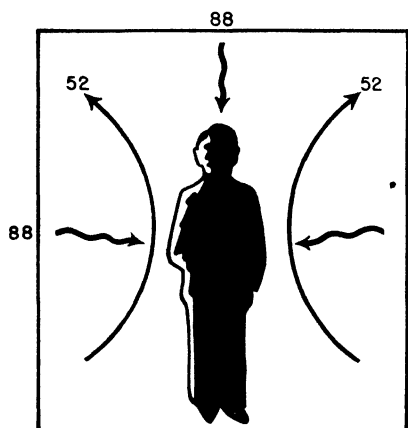

FIG. 1-3.—Cold air with high temperature radiation.

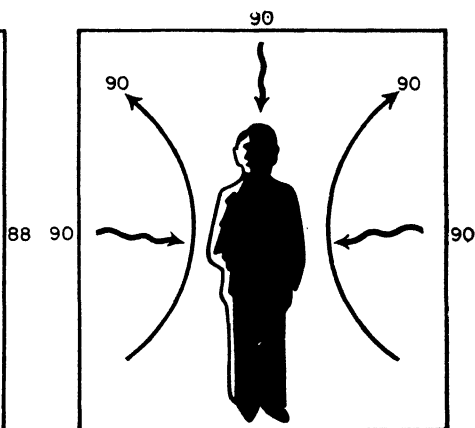

FIG. 1-4.—Uniformly high temperature.

Consider now the reverse set of conditions (Fig. 1-4)—that of excessive heat. Assume that the individual is in a room with an air temperature of 90° and wall temperatures of the same value. Radiation and convection losses will be almost eliminated, and the only way that body losses can be maintained will be by increased exhalation and evaporation through the lungs, this being brought about by an increased rate of breathing. Also, the sweat glands will be called into action, and the losses by evaporation will increase. The sweat glands are efficient in increasing bodily heat loss because of the relatively large number of Btu that are absorbed by the latent heat of evaporation. If the relative humidity in the room indicated by Fig. 1-4 were sufficiently low, as for example, less than 60 per cent, together with a small amount of air move-

ment, the body could very readily dispose of its surplus heat; but if on the other hand the humidity inside the room were over 90 per cent, the temperatures indicated would be intolerable.

It is possible, however, to have comfort conditions in a room having an air temperature of 90° . This is shown in Fig. 1-5, where the mean radiant temperature is 50° . In this case, loss by convection is practically zero, while the loss by radiation is sufficiently increased so as to restore the proper value of total heat loss.

It might be pointed out, however, that under the conditions existing in Figs. 1-3 and 1-4,

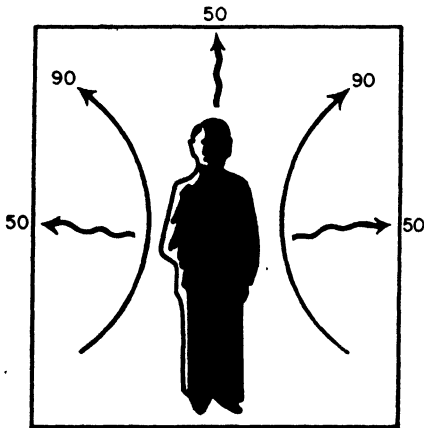

FIG. 1-5.—Warm air with radiation to cooled surfaces.

which can probably be regarded as conditions of comfort, it is probable that any individual exposed to these environments will not feel precisely comfortable as might be the condition under the example shown in Fig. 1-1, because although proper total values of heat losses are obtained under the conditions of Figs. 1-3 and 1-5, they are not in balance with respect to the normal channels or rates of dissipation through radiation and

convection. Consequently, a certain amount of action will have to be taken by the nervous system. Despite the fact that such a system may be regarded as producing a normal effect, the individual will be conscious to some extent of nerve action and hence will not be ideally comfortable as defined in the preceding part of this chapter.

It is desirable now to consider the term "radiant" and its meaning with particular reference to radiant heating. Heat is a form of energy and is transmitted by radiation, convection, or conduction from any substance that is at a higher temperature than the material surrounding or adjacent to it, so that eventually there would be no temperature difference between associated material objects. The transfer of heat by convection is due to the fact that when any liquid or gas is warmed, it expands and consequently becomes lighter in unit weight as a result of being heated. The

heated gas or liquid by reason of this difference in weight rises with respect to the colder gases or liquids. As a result, it carries away from warmed surfaces a definite quantity of heat which it again loses to some colder surface with which it comes in contact through its change in location. This is the basis of the common misconception often stated that heat rises.

Heat is also transferred by conduction; *i.e.*, when any two substances of different temperatures are brought into actual physical contact, heat flows from the hotter to the cooler, with the result that eventually both objects will come to the same temperature.

Returning to the definition of radiation or radiant heat, this is the means by which heat is transferred from the sun to the earth. This heat travels in straight lines and at the same speed as light and in the same manner. When the temperature of the ceiling, walls, or floor or of any object in a room is higher than the average surrounding objects, heat is then transferred to those areas by radiation and also, to a certain extent, by convection. When a floor in a room is at a temperature in excess of the surrounding air and objects, heat will be radiated from the floor to the other surfaces of the room and the temperature of these surfaces will be raised. At the same time, the air in contact with the floor will be heated, and it will rise to help in the transmission of heat from the floor to objects or surfaces of the room.

When the ceiling is heated at a temperature above that of other objects in the room, then heat will be radiated from the ceiling to the objects, wall, or floor of the room in an attempt to bring these parts to the same temperature as the ceiling. The air in immediate contact with the ceiling will be brought to approximately the same temperature, but this air cannot rise, as it is already at the top of the room. However, the temperature of the objects in the room, being increased by radiation from the ceiling, will cause a slight amount of convection currents to be set up in the room, resulting in a gradual circulation of the air with the transfer of heat by convection, the net result being a tendency to bring all objects within the room to the same ultimate temperature if normal rate of air change is not exceeded.

With floor construction, the amount of heat transferred by convection is greater than that transferred by ceiling construction; consequently, radiant heat transfer is less. With wall construc-

tion, the convection transfer is less than by the floor and greater than by the ceiling. The relative percentages of heat transfer by radiation and convection, with reference to ceiling, wall, and floor construction, are given in the following table:

Type of surface	Heat transfer by convection, per cent	Heat transfer by radiation, per cent
Floor	50	50
Wall	43	57
Ceiling	30	70

To visualize more clearly the meaning of radiant heat, reference can be made to a common electric light, which has a hot filament sealed in a glass bulb from which the air is removed. Electrical energy delivered to the filament is transformed into radiation, a small part of which is perceived by us as light, whereas 99 per cent of the energy so released is radiant heat and is transmitted from the filament in exactly the same manner as the light. The glass bulb, however, allows the light energy to pass through with little diminution, but a relatively large fraction of the radiant heat is absorbed by the glass. Consequently, the glass surface increases in temperature and would increase to destruction if it were not for the fact that, being immersed in air, heat is lost by convection because the relatively cooler air sweeps the surface of the bulb and carries away the heat.

Not all of the radiant heat is intercepted by the glass bulb. A fraction does pass through and proceeds in a straight line exactly similar to the light until it strikes some solid object, which, in turn, is increased in temperature by the absorption of the radiant-heat energy that it has intercepted.

For the purpose of illustrating the flow of radiant heat, let us imagine a room fitted with a glass floor under which is a uniform source of light illuminating the entire room. The light from the illuminated floor will strike the ceiling and from there be reflected to the walls and furniture within the room. Of course, the furniture and other objects would cause shadows on the ceiling; hence, sections of the ceiling would not receive any direct light from the floor but would receive it from the counterreflection that would

occur in the room from the walls and furniture. Extending the analogy to a ceiling installation, imagine a room fitted with a glass ceiling behind which is a uniform source of light, there being no obstruction on the ceiling. The result would be that all the light from the ceiling would strike the floor, walls, and furniture within the room, from which surface reflection would take place, thus illuminating the entire room.

Photographs have been taken of the interior of rooms illuminated by a multiplicity of lights at ceiling level, which approximate conditions just outlined of a luminous ceiling. The resulting photographs show the almost complete elimination of shadows caused by furniture. This elimination of shadows could have been caused only by the many reflections and counterreflections from the room surfaces of wall and floor, in addition to the illumination obtained from the ceiling.

The same thing occurs exactly with a radiantly heated room where ceiling construction is used. The heat radiates in direct lines from the ceiling, striking the floor, wall, and objects in the room and raising the temperature. The radiant heat from either the ceiling or the floor does not raise the temperature of the air directly. Increase in air temperature can come only through convection air currents originating from surfaces heated directly or indirectly by radiant energy.

It can be assumed, therefore, that regardless of whether the radiant heating coils are in the floor, ceiling, or wall, with the exception of the first 10 or 12 in. from the heated surface of the ceiling, wall, or floor, the remaining temperature or distribution of temperature throughout the room will be constant. In general, it can be said that the chief advantage of a floor installation is in the first cost. The principal advantage of a ceiling installation is in the fact that a greater output of radiation can be obtained from a ceiling installation than a floor installation, because higher ceiling temperatures are permissible than floor temperatures. The chief advantage of a wall installation is that it provides a space for adding to the heat input to a room if a floor or ceiling installation is insufficient and additional heat is required, or if for some constructional reason extra delivery of heat is required at a specific point adjacent to a wall, as, for example, underneath exceptional window construction where the heat loss may be excessive.

CHAPTER II

STRUCTURAL AND OTHER ADVANTAGES

Radiant heating installations give greater comfort to the occupants in the heated area owing to the improved temperature relationship and absence of noticeable air currents. The reason for this is best illustrated in the following examples:

Figure 2-1 shows the direction of air currents and the approximate resulting temperatures within a room heated by a conventional method of concealed type of convector placed beneath the windows. With the heat-transfer surfaces of convectors at a

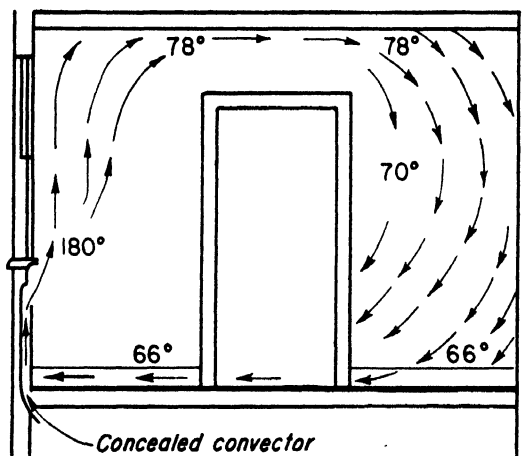

FIG. 2-1.—Air current from convector.

temperature approximating 180°, air warmed to a temperature considerably above average will rise from the convectors and pass up in front of the windows, with the result that air at maximum temperature will pass areas of high heat conductivity exposed on the other side to low outdoor temperature, thereby resulting in a maximum rate of heat transfer and loss at this point. The rising air will circulate up to and along the ceiling and down toward the floor at points most distant from the radiators. This will result in air, ceiling, and floor temperatures approximately as indicated.

In addition, heat will be radiated from any areas within the room that are above average surface temperature to those areas having less than average temperature. This flow of heat is not shown in the illustration for the sake of simplicity because under the conditions shown the amount of heat so transferred would be relatively small in comparison with the total amount of heat being transferred by convection.

It is also to be noted that Fig. 2-1 would illustrate equally well the flow of air currents if the room were being heated by hot air from a furnace and delivered through grilles placed below the windows as indicated for the convector.

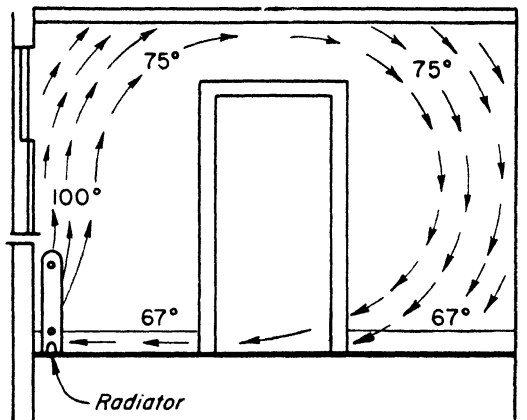

FIG. 2-2.—Air current from radiator.

Figure 2-2 shows the air currents and approximate temperatures that might exist in a room having a standing open type of radiator beneath the window. The same unfavorable condition of maximum air temperature rising from the radiator and being exposed to conditions resulting in a maximum rate of heat loss applies to this figure as in Fig. 2-1.

Figure 2-3 gives the variation in temperature between the floor and ceiling of a room heated by conventional methods and making use of standing radiators or convectors. In making the measurements on which these curves are based, room temperature was held constant at 70° at a height of 5 ft above the floor. This is the reason why all curves pass through this point.

It is to be remembered in viewing these curves that con-

ventional hot-water radiators operate at the lowest surface temperatures with a corresponding larger area than either steam radiators or convectors and that convectors operate at higher temperatures and with higher velocity of convection current than either of the other two types. In this connection, it is also to be observed that the percentage of radiant heat with respect to convection heat is greater with a hot-water radiator than with the convector type, which operates with an absolute minimum of radiant heat transfer.

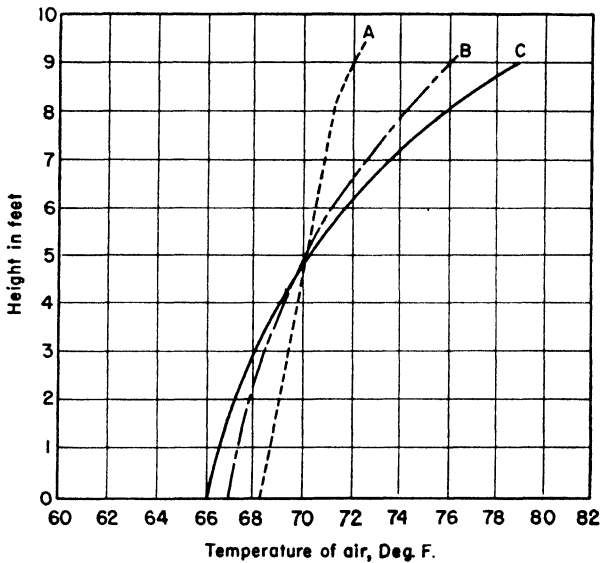

FIG. 2-3.—Room air temperature.

These curves definitely show the advantage of using larger heating areas at low temperatures over the reverse condition, an advantage that applies directly to radiant installations. The advantage of radiant installation with particular respect to variation in room temperature between floor and ceiling is shown in Fig. 2-4, which gives the approximate temperatures that should exist in a radiantly heated room at varying distances from the floor by means of floor, wall, and ceiling constructions when a comparison temperature of 64° is maintained at a height above the floor of approximately $5\frac{1}{2}$ ft. This curve indicates that with radiant installation in either ceiling, floor, or wall, there is very little temperature difference with respect to height at distances of

18 in. below the ceiling or above the floor. Although it is not shown in the curve, it can be assumed that with wall installation, there would be no material temperature differences at distances from the wall beyond 18 in.

Figure 2-5 shows the temperature and direction of radiation that may be presumed to be present in a room radiantly heated from the floor.

Figure 2-6 shows the same condition existing in the room where use is made of the ceiling as a heating medium.

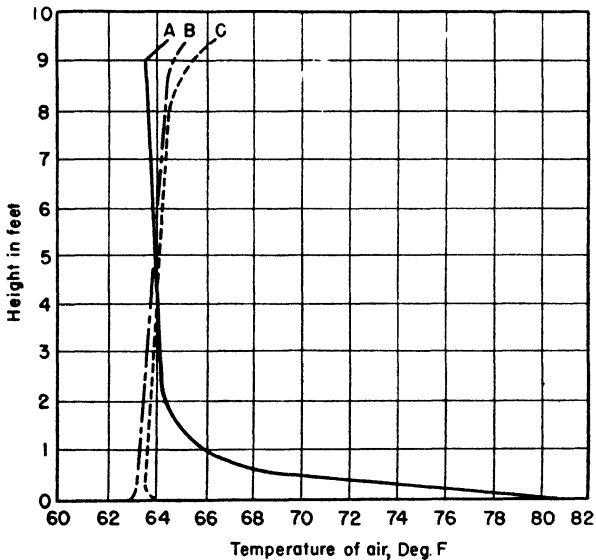

FIG. 2-4.—Air temperature in radiantly heated rooms.

Figure 2-7 shows the direction of radiation and convection currents when use is made of the space below a window for installing the radiant heating coils. It is to be noted that the construction shown is open, to a certain extent, to the same objections which have been discussed where conventional radiators are placed underneath a window, in that rising convection currents of maximum temperature are exposed to conditions of maximum loss. In viewing Figs. 2-5 to 2-7, it must be remembered that every infinitesimal area of the heat-transferring surface, such as the floor, wall, or ceiling, radiates heat in all directions to any surface that is below the temperature of the radiating source and that the lines

shown as indicating the path of radiant energy are to be regarded only as illustrating a principle.

(It is to be noted that radiation from a strictly flat surface would be along parallel lines at right angles to such a surface.

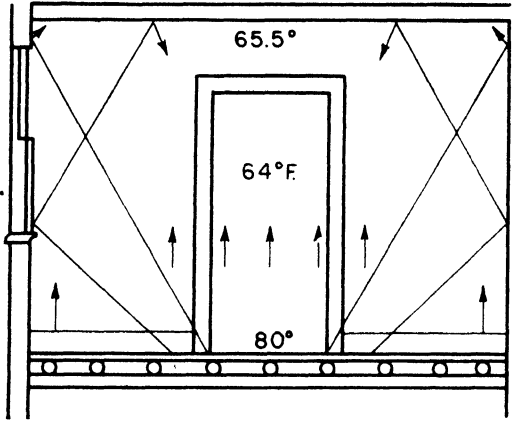

FIG. 2-5.—Radiant heat from floor panel.

No practical room surface could be finished to such a degree of accuracy.)

It is to be observed that in the preceding figures, the temperature of 64° is assumed within the warmed spaces. This assumption

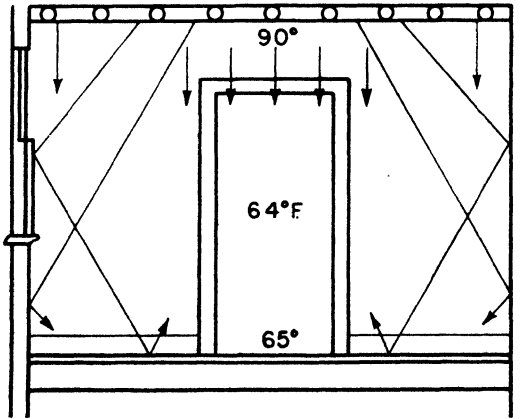

FIG. 2-6.—Radiant heat from ceiling panel.

is based on the fact that in a radiantly heated room, comfort is obtained with air temperatures lower than with conventional systems. Therefore, a radiantly heated room of 64° air tempera-

ture is correctly comparable to conventional systems where the use of 70° air temperature is required to give comfort.

In addition to the greater comfort obtainable with installations of radiant heating, there are a great many advantages having to do with the mechanical construction and operation of the system.

In the first place, there is the saving in floor space effected through the elimination of radiators. In fact, if a proper consideration is given to the space lost in a room: by reason of standing radiators, it will be found that the cost of installing a radiant system is largely offset by this saving. If this advantage be given its full value, it will be noted that it is not only the actual space taken by the radiators but more often the space represented

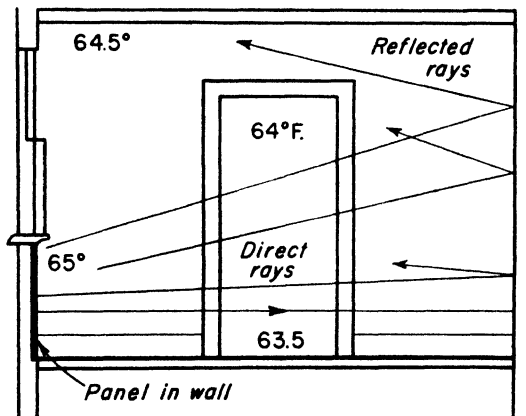

FIG. 2-7.—Radiant heat from wall panel.

by the depth of the radiators and the entire length of the wall on the side of the room affected, which often results in considerable difficulty in placing furniture where really desired. Other locations of less desirability have to be selected, solely on account of the projection of the radiator.

As an example of the amount of space lost by the use of conventional radiators, consider a 12- by 14-ft room with an 8-ft 6-in. ceiling; an ordinary radiator will project into the room about 12 in., and the length of the radiator will be on the order of at least 4 ft. Consequently, as an absolute minimum, at least 32 cu ft of the room in question are lost for occupational purposes. This represents a minimum loss of almost 3 per cent of the room area; but in many cases, the radiator extending out into a room 12 in. will

interfere with the desired furniture arrangement to such an extent that the whole side of the room in which the radiator is located will be lost for the placing of furniture. In this particular case, the loss in available space will amount to over 7 per cent of room volume, referred to the 12-ft side.

In the same manner, if concealed radiators with grilles are used, furniture cannot be placed in front of these areas, which are often the very places that convenience dictates as the proper location.



FIG. 2-8.—Radiantly heated living room. (Courtesy of Ames Aksila.)

Of course, there is the aesthetic side of the question, as a radiator to perform its function cannot be entirely concealed. It must, of necessity, constitute a disturbing factor. All of these difficulties are eliminated with radiant heating.

Another very great advantage is that with radiant heat there is full freedom of decorative treatment. This applies particularly to draperies. Conventional location for radiators is underneath the windows so that the most efficient functioning of the devices can be obtained, and it is obvious, of course, that such a location interferes with window draperies.

Figure 2-8 shows a radiantly heated room making use of ceiling construction, and it is to be particularly noted that the wall on the left-hand side of the picture is entirely free of obstruction of any kind that might interfere with the venetian blind, draperies, furniture, or bric-a-brac. It will be observed that this living room opens into a vestibule and into a room beyond; and although the left-hand wall is largely of glass extending throughout the building,



FIG. 2-9.—Radiantly heated rumpus room. (Courtesy of Ames Aksila.)

no difficulty was experienced with the heating system at temperatures approximating 15° below zero.

Figure 2-9 shows the recreation room in the same residence from which Fig. 2-8 was taken. Attention is called to the location of the divan in Fig. 2-9 and also to the fact that although winter conditions exist, as indicated by the snow showing through the window, no sensation of cold was felt by occupants on the divan. It might be noted further that this room has a beamed ceiling. In this case, the coils run lengthwise in the spaces between the beams; and in the last space next to the window, the spacing of the

coils has been reduced so that there is a greater output of radiant heat at the end of the room.

Figure 2-10 shows the western exterior of the residence shown in Figs. 2-8 and 2-9, clearly indicating the large amount of glass exposure with the resulting high heat loss, which is fully compensated by the proper arrangement of coil spacing.

Figure 2-11 of another residence also shows the advantages of ceiling radiant heating in the location of furniture and draperies. If conventional construction had been used, the location of the settee and the draperies would have been impossible.

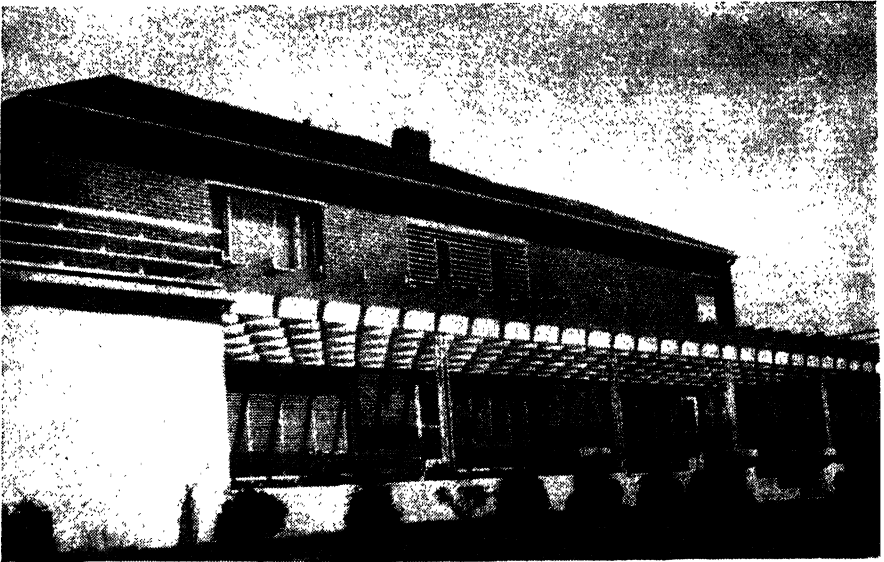

FIG. 2-10.—Radiantly heated residence. (Courtesy of Ames Aksila.)

A further advantage of radiant heating resides in the fact that greater cleanliness in enclosed spaces is obtained. This is because with the lower temperature and greater areas involved in radiant heating, there are very low velocity convection currents. Everyone has noticed the discoloration that appears on walls and ceilings above conventional radiators. This effect is caused by high convection currents resulting from the temperature concentration present in the radiator. The absence of these high convection currents entirely eliminates streaking and dust deposit on walls and ceiling; and with the elimination of the radiator under the window, the draperies are kept far cleaner, so that actually the time and expense

involved in winter housecleaning can be reduced two-thirds with radiant systems.

The suppression of air currents throughout the room, as effected by radiant heating, has a direct bearing on health, not only from the standpoint of eliminating noticeable drafts, especially along floors, but also because there is far less tendency for germ-laden dust particles to be picked up from the floor and circulated about the house.



FIG. 2-11.—Radiantly heated living room. (Courtesy of B. S. Tilney.)

With the elimination of radiator recesses, duct spaces, air passages, etc., the latter as required by hot-air systems, a simplified structural building design results which very definitely reduces fire hazards present in any type of duct structure and simplifies architectural and constructional problems.

The use of a ceiling or floor radiant heating construction enables the relocation of interior partitions at any time without reference to the heating system. This is of great advantage in any office or commercial building. It is almost inevitable in these types of structure that sooner or later, after having been originally designed for one purpose, changes take place in economic

conditions, causing alterations to become necessary. A partition has to be removed or added; spaces have to be opened up, or large rooms cut up into numerous small ones; and all of this work can be done without reference to the heating system if radiant heating was originally installed.

Another great advantage of radiant heating which is often overlooked is that in the erection of a building, the complete heating system is installed in its entirety while the building is in the rough construction stage; and with the installation finished at



FIG. 2-12.—Veterans' housing development. (*Robert Bruen & Son.*)

this time, the work of a heating contractor is completed. This is not the case with conventional methods, where the contractor has first to install his piping during the initial construction of the building, close off the openings, perhaps also provide for temporary settings, and then return after the building is nearing completion to make the setting of the radiators. It is obvious that the contractor, having to do his work in two installments in proper relationship to other work, has a more difficult organization problem than the contractor having to make only one appearance on the job; and furthermore, when the workmen return to a partially completed building, there is a greater probability that they will

inadvertently damage the finished work, thus causing unexpected additional expense to the heating contractor.

It is often represented that radiant heating installations cost more than conventional methods. Experience shows that this should not be the case. When the heating contractor becomes familiar with the technique of installing pipe or tubing in the floor, walls, or ceiling, he will find that the total cost will be no more than properly designed conventional methods of hot-water heating. This is especially true if he takes into account the savings



FIG. 2-13.—Remodeling a New England dwelling. (*Chase Brass & Copper Co.*)

effected by being able to do the job at one time and not having to make a second trip for installing equipment. Consequently, his balance sheet will show that, although he will have spent more for labor on the job, he will have spent less on material. Therefore, his possibility for profit will be increased.

The cost of operating a radiant system is less than that of conventional methods to the extent of 20 to 30 per cent, basically for the reason that comfort is obtained with lower indoor temperatures. With lower indoor temperatures there is less temperature differential between indoors and outdoors; consequently, less heat is lost through the walls.

This applies particularly to the conventional methods of placing radiators under the windows, which is done to compensate, at least partially, for the increased heat loss through the windows. With the high temperature of the surface of the radiators, naturally relatively high velocity of ascending air currents results so that this high-temperature air is exposed to that section of the room which has a particularly high heat transmission. Therefore, a very large percentage of the radiator's efforts to obtain the proper room temperature is expended and lost outdoors. This is a factor



FIG. 2-14.—Installing copper coils in residence of Fig. 2-13. (*Chase Brass & Copper Co.*)

which is often overlooked so that the relatively small difference in temperature indoors of, say, 5 to 10° in favor of radiant versus the conventional system only partially represents the saving that is being effected by radiant construction. This reduction in heat loss, by the elimination of high-velocity and high-temperature air currents sweeping past window surfaces, is an important factor in the reduction of operating cost that is obtained with radiant systems.

Radiant installations greatly reduce local air currents and

stratification; and with properly designed ceiling or floor coils, there is very little difference in temperature anywhere within the room or space being heated.

The foregoing discussion has been more or less confined to conventional methods of construction combined with conventional methods of installing radiant heating, but recently there has been a great advance in the idea of building basementless homes, by placing a concrete floor slab directly on the earth and erecting the



FIG. 2-15.—Radiantly heated pre-Revolutionary residence. (*Chase Brass & Copper Co.*)

walls and partitions of the building on the floor slab. With this method of construction, radiant heating is almost a necessity, with the coils installed in the floor. It is, therefore, obvious that this type of construction effectively disposes of any problem connected with cold floors. With the basementless type of building, the heating boiler can be placed at ground level and even in the attic, should the design of the house be such that there is sufficient unused space available for this purpose.

As an illustration of a basementless five-room house construc-

tion, Fig. 2-12 shows floor slabs being laid with radiant heating coils imbedded in them. This is part of a veterans' housing development in California totaling over 100 houses.

Another method of providing a particular type of radiant heating in a basementless house, especially one using wood floors of conventional construction, is to leave a space between the ground and the floor level, commonly known as a crawl space, and provide for forcing warm air down into this space. Then either through

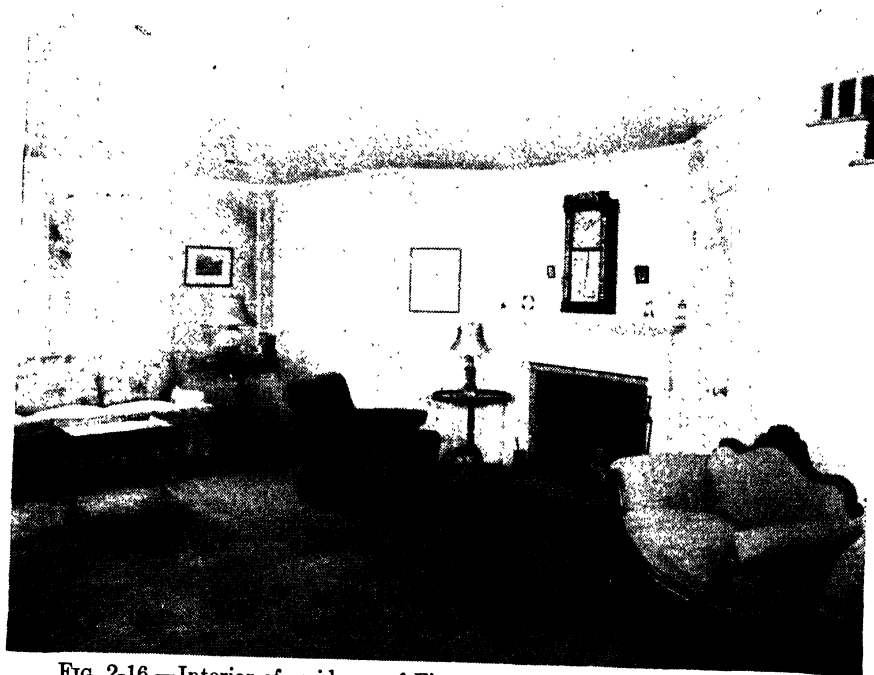

FIG. 2-16.—Interior of residence of Fig. 2-15. (Chase Brass & Copper Co.)

grilles in the floor or through ducts within the walls, warmed and partly recirculated air is delivered to the space to be heated, after first having warmed some or all of the room surfaces. This system provides some of the advantages of radiant heating, together with the inexpensive installation cost of hot-air systems. It is apparent that proper insulation must be provided around the wall below the floor line and connecting with the foundation so that heat is not radiated to the outside or lost by conduction through the earth and foundation. It is also desirable to lay down a thin cement

coating on the ground to prevent the formation of dust and its delivery to the occupied space.

One special application of radiant heating is in asylums or prisons. The advantage over other systems resides in the fact that it is totally enclosed within the building proper. There are no projections or equipment to be tampered with or to cause possible injury to the inmates.

It is generally recognized that in hospitals and schools it is



Fig. 2-17.—Pre-Revolutionary residence equipped with radiant heating. (*Chase Brass & Copper Co.*)

particularly desirable to maintain as high a rate of ventilation as feasible. This is particularly true in hospitals designed for the treatment of tubercular patients, and with the application of radiant heating it is possible to provide proper comfort temperatures without reference to the ventilating problem. It is necessary, however in order to achieve comfort conditions with less than normal comfort temperatures, to provide rather elaborate control systems to apportion properly the amount of circulating

air; otherwise, the air temperature in the enclosed places will tend to become equal to the radiant temperatures.

A further advantage of radiant heating consists in the ease with which it can be installed in old buildings. This is particularly true in instances where it is desirable to install heating in a building of the historical type, where the heating was originally by fireplaces and the presence of a radiator in such an environment would be an architectural incongruity.



FIG. 2-18.—Interior of shipping room of Chase Brass & Copper Co.

Figure 2-13 shows the exterior of an old New England house in the process of being modernized, including the installation of radiant heating. Figure 2-14 shows the interior of this building during the alteration and after the radiant heating tubing had been installed.

Figure 2-15 shows a residence of prerevolutionary age in which it was desired to install a modern heating system and at the same time adhere rigidly to architectural features of the period. Figure 2-16 shows the interior of this building after the radiant heating

installation had been made, and it will be noted how completely the room conforms to the period in which the house was built. Attention is again called to the fact that the divan can be placed directly opposite a window and that there is no interference with the heating system by either the draperies or the divan.

Figure 2-17 shows the exterior of a historical building at Annapolis, which was purchased for reconstruction as an officers' club, and it was desired that all the original architectural features



FIG. 2-19.—Radiantly heated garage and shop. (*Bethlehem Steel Co.*)

be retained. Radiant heating fitted into this program perfectly and made it possible for the architect to provide an efficient heating system without disturbing elements appearing in the interior decorations.

Figure 2-18 shows the interior of a shipping office that was built as an addition to a factory and radiantly heated, so that comfort conditions might be maintained in spite of the continual passage of people into and out of the room through open doors.

In factory and other occupational areas where workmen are required to spend a certain amount of time on or near the floor, as in garages, floor installation has the effect of making a very material saving in workmen's time during the winter season. It can be well appreciated that men reporting for work on cold winter mornings will be reluctant to get in contact with cold concrete floors, this being the normal condition in garages working on the



FIG. 2-20.—Installing steel pipe coils for radiantly heating a firehouse. (*Bethlehem Steel Co.*)

maintenance and repair of automobiles. On the contrary, when the men report for work, if the warmest place in the building is in close contact with the floor, the workmen experience no reluctance in attending to their duties.

As an example of radiant construction in a garage, reference is made to Fig. 2-19, which shows a grid type of floor construction using steel pipe laid on a heat-insulating layer of inorganic material for resisting the flow of heat in a downward direction. The floor

is to be completed with a layer of concrete including reinforcing bars.

Figure 2-20 shows the first story of a two-story firehouse and the area to be occupied by the fire engines. Warming the floor ensures that the equipment standing thereon is adequately heated and in condition for prompt starting as occasion requires. Figure 2-21 shows the completed building.

Radiantly heated enclosures of the type represented by firehouses, garages, and airplane hangers which have large door

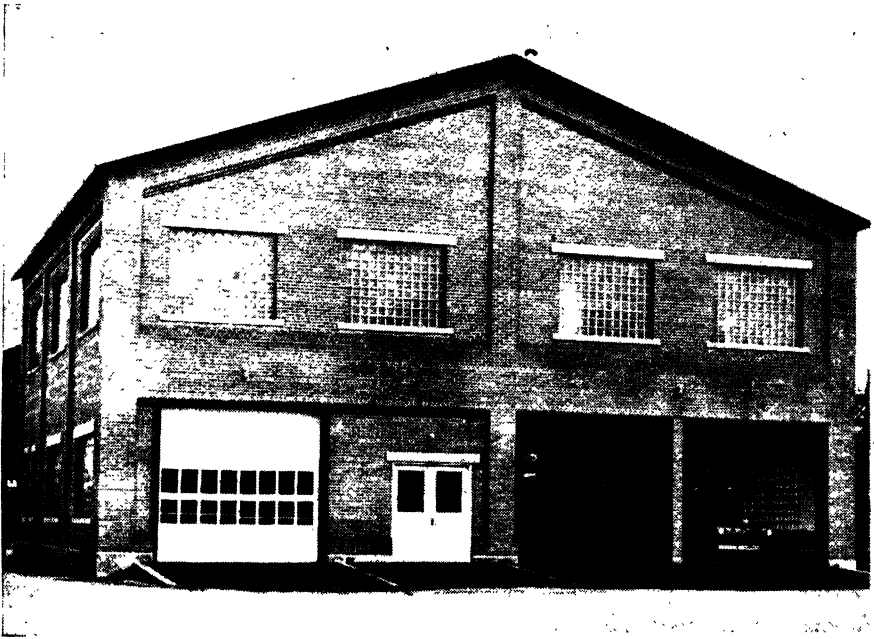

FIG. 2-21.—Exterior of fire house shown in Fig. 2-20. (*Bethlehem Steel Co.*)

openings, as shown in Fig. 2-21, for the use of bulky equipment are subject to a minimum variation of temperatures occasioned by the opening of large doors as compared with conventional methods of heating, owing to the considerable reservoir of heat in the floor available for immediate use.

In addition to these advantages, there is a further one which experience has proved, in that the foot discomfort resulting from working on concrete floors, commonly thought of as being due to the hardness of the floor, is really due to floor temperature. The

flow of bodily heat from the foot to the floor causes the tiring effect that is experienced under these conditions; whereas if the floor is sufficiently warm so that the heat flow is from the floor to the foot, but at the same time not too much elevated above foot temperature, the sensation attributed to hardness of the floor disappears.

CHAPTER III

PANEL LOCATION IN COMMERCIAL BUILDINGS

The proper location of heating panels in commercial buildings should be given careful study in each application. In offices intended for normal business use, where the desk area is not in excess of 8 per cent of the floor area, ceiling construction would probably be most desirable; whereas if the office is intended to be filled with desks, spaced as close together as may be regarded feasible for clerical operations, the ideal method would be to provide both floor and ceiling construction. Floor heating in this instance is desirable because people sitting at desks will have necessary warmth for their feet, as, with the multiplicity of desks, reflected radiation from the ceiling would be unable to provide suitable warmth to the floor underneath the desks.

Heat for this purpose could be derived either from floor coils or from the upward flow of heat obtained from the ceiling below. The latter, of course, is open to the objection that the occupants of the space below might not desire heat in sufficient quantity to allow proper delivery to the floor above through the building structure.

Floor installation is almost always desirable in factories, especially those of one-story construction. It can be presumed that the designer will take into account the net heat load which must be supplied by the radiant system and will make proper allowances for the occupancy involved. For example, in foundries, forging shops, and other similar applications, the amount of heat supplied to a given area may be quite moderate; but in such applications, it is quite probable that the building contains no true ceiling but is open to the roof trusses. Consequently, there is no suitable location for ceiling coils, so that floor coils must be used; and if accurate estimates of heat requirements indicate that sufficient heat cannot be obtained from the floor without exceeding the temperature of 85°F along areas that will be continually traversed by workmen, auxiliary sources of heat will have to be supplied

either from radiant coils installed along the walls and below the windows or by the use of blast heaters or their equivalent.

Figure 3-1 shows radiant heating by means of grids being installed in a large factory having a ground floor area of approximately 380,000 sq ft, with additional office space amounting to 35,000 sq ft, making a total floor space of over 400,000 sq ft. Most of the radiant coils were constructed of wrought iron with some use of copper and Bundyweld tubing. A general average of 1 ft of pipe or tube was installed per square foot of panel surface, and



Fig. 3-1.—Floor-slab construction using grid coil. (*A. O. Smith Corporation.*)

in the design, consideration was given to various heat-producing factory operations as affecting radiant heating requirements.

Figure 3-2 shows a factory application where it is the intention to lay a concrete slab directly on the earth floor. This illustration shows a method of design where the tubing is laid on wooden strips and fastened to them with clips so as to maintain proper relationship between the individual coils and at the same time to maintain the tubing in proper depth relationship to the surfaces of the slab.

Figure 3-3 shows the construction of a floor installation that is one of six independent units; in this instance, it will be noted

that reinforcing steel netting is first laid down on a prepared base, after which the tubing is placed in position and wired to the netting at intervals of approximately 5 ft. The walkway on the right side of the illustration is provided for the use of wheelbarrows in transporting cement from the point of delivery to the pouring location in the building. This precaution ensures against damage to the tubing after it has been put in place and before it is fully imbedded in the concrete. With the method of construction

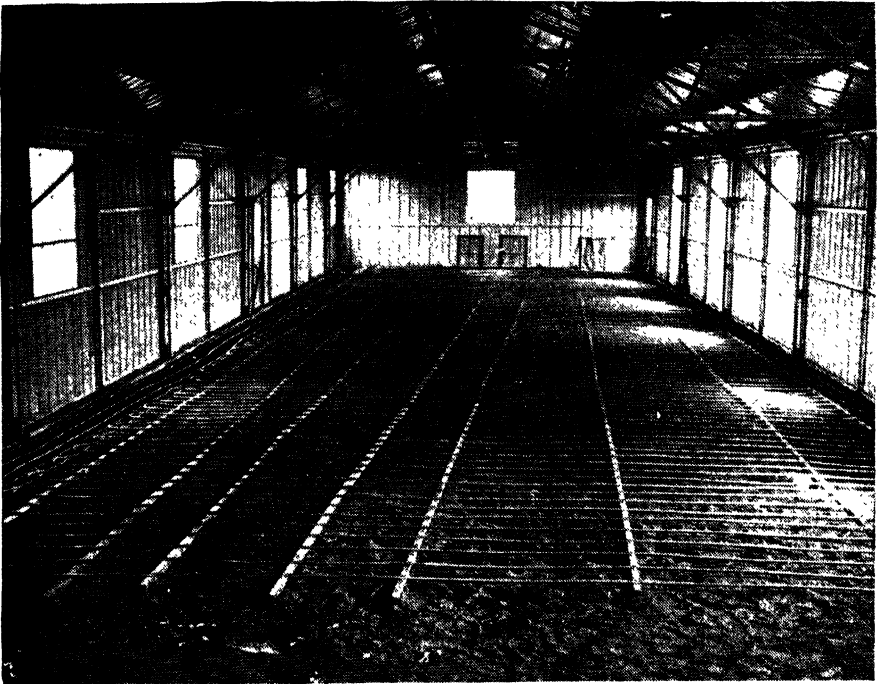

FIG. 3-2.—Floor-slab construction with sinuous coils. (*Chase Brass & Copper Co., Inc.*)

shown in this illustration, workmen provided with suitable hooks follow along after the cement is poured; and by engaging the reinforcing netting with their hooks, they elevate the netting and tubing to the proper location with respect to the top and bottom of the concrete slabs. With a mixture of proper consistency, tubing and netting once placed in position will not settle to any material extent. No other means than the judgment of the operator is necessary to determine the actual position of the tube and

netting in the slab. Attention is directed particularly to the controls and distribution manifolds shown in the upper left-hand center section of this illustration.

These manifolds are seen in greater detail in Fig. 3-4, where two manifolds are shown: supply and return, one directly behind the other and each consisting of a series of reducing T's graduated in accordance with the changing rate of flow in the manifold. The supply manifold is at the rear with the return



FIG. 3-3.—Reinforced floor slabs with sinuous coils. (*Robert Bruen & Son.*)

manifold in front. The gate valve at the right of the structure controls the supply of hot water from the boiler, while the plug cock in the return manifold to the left of the assembly provides an adjustment for water flow in this group of coils with respect to similar groups in other buildings supplied from a single source. It will be noted also that in each return there is a shutoff valve and just below it an adjusting cock used in balancing the heat delivery from each coil. After each coil is balanced and the unit as a whole is also balanced with respect to other units, further adjustment

or opening and closing of the cocks is not necessary. The gate valve to the right of the assembly provides means for shutting off the system as a whole, while the individual gate valve on each coil enables a particular coil to be shut off from the rest of the system. The valve shown to the left of the tubing group and below the iron

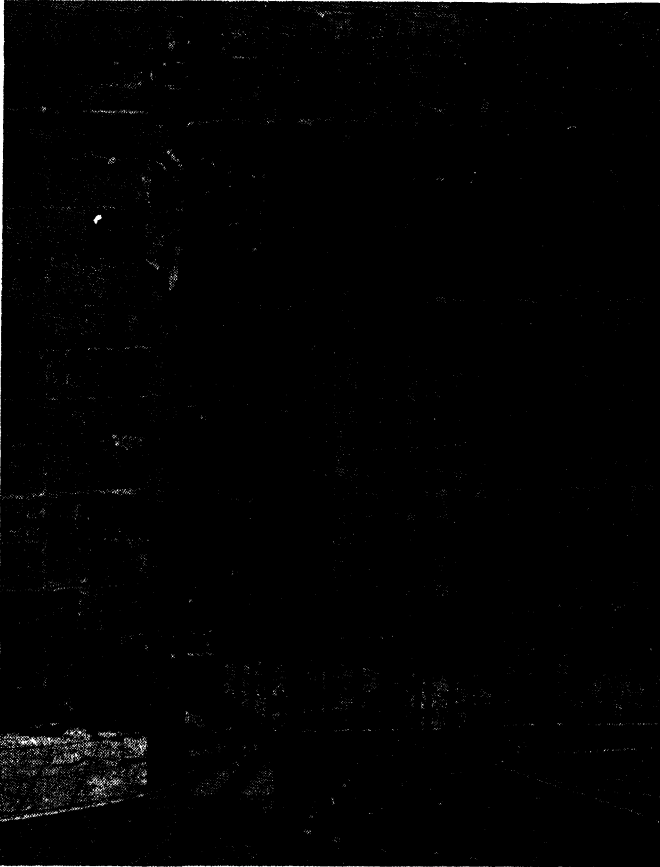

FIG. 3-4.—Manifold construction. (*Robert Bruen & Son.*)

band is for the purpose of venting the system of air, as is the small valve to the right of the illustration and just above the main gate valve.

Figure 3-5 shows a floor construction in progress in a large building to be used in manufacturing calculating machines. This particular building is 250 by 750 ft and is one of several units, all making use of floor construction. Attention is directed in this

installation to the fact that the floor slabs are constructed as panels with provision for expansion between the units. The space between the panels was utilized during construction for transporting cement and materials; and after the completed unit was sufficiently hard to support traffic, the intermediate spaces were filled, making use of those sections already poured and hardened. In this way, an area of any given size can be constructed with



FIG. 3-5.—Large factory installation. (*Robert Bruen & Son.*)

coils in the floor without the necessity of transporting cement and other materials along or across pipes or tubing already in position.

In applying radiant heating to schools, the most desirable location for the coils is probably in the floor, as the close spacing of school desks would interfere with the even distribution of radiant heat received from the ceiling, and as it is necessary to keep the children's feet and legs from remaining chilled after returning to the schoolroom from outdoors. If the schoolroom is to be supplied with acoustical ceiling and walls, as is the present tendency in

school design, floor coils provide the only practical solution for constructions of this type. This is for the reason that materials most suitable for use in acoustical applications are the ones least suitable for heat transmission that would be required in ceiling installations. Any type of acoustical plaster tends to reduce substantially heat flow from the imbedded pipes or tubing to the



FIG. 3-6.—Grammar-school installation. (Robert Bruen & Son.)

surface of the ceiling. This fact should be considered in all radiant heating applications.

Figure 3-6 shows a grammar school under construction where use is made of a floor application of radiant heating, using the same methods of construction as explained for Fig. 3-3.

Figure 3-7 shows an application of radiant heating for which there is practically no alternative; *i.e.*, in school buildings intended for the education of young children. The floor is the warmest area within the room; consequently, children are not exposed to

floor-level drafts, and all the disadvantages of cold floors are eliminated.

As a further example of school application, reference is made to Fig. 3-8, which shows an exterior view of an open-air school in Amsterdam. Attention is called to the extreme open-air conditions present in the corner room. Glass shields are provided to divert wind currents, but otherwise the rooms are entirely open.

Figure 3-9 shows the interior of one of the rooms of the school in Fig. 3-8, including the arrangement of the desks.

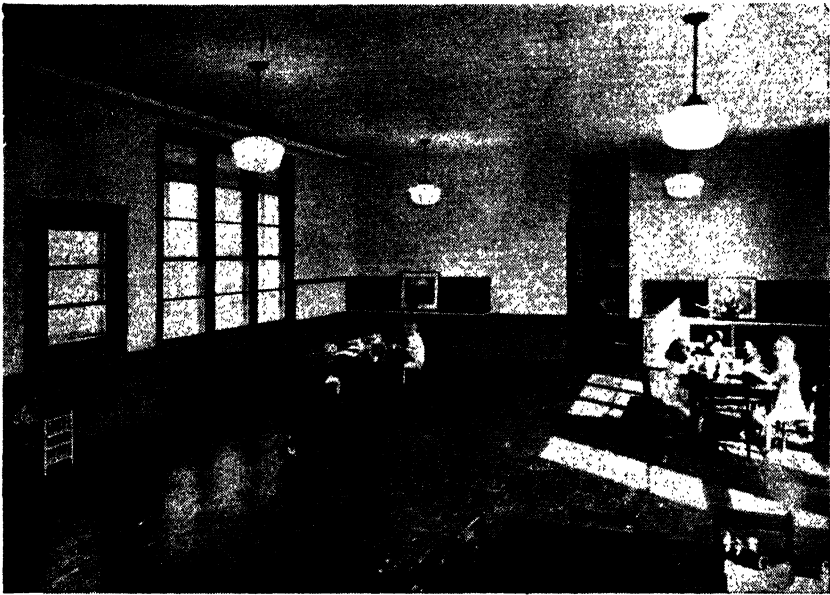

FIG. 3-7.—Kindergarten with floor installation. (A. M. Byers Company.)

Figures 3-10 and 3-11 show the exterior and interior of the Ranworth Square School at Liverpool, England. Note that one exterior wall of each classroom can be fully opened to the outdoors.

Garages constitute an interesting application of radiant heating, as the installation of heating coils in the floor provides maximum comfort conditions for the personnel working in or about the cars. Of necessity, persons concerned with the repair or maintenance of automobiles have to be in close contact with the floor in order to carry out their duties. As might be expected, it has been found from experience that with radiantly heated floors,

an hour to an hour and a half is saved each day as a result of the convenience of warm floors. It has also been observed in both garages and airplane hangars that there is less disturbance of room air temperature with radiant installations when outside doors have to be opened for the entrance or exit of automobiles or airplanes.

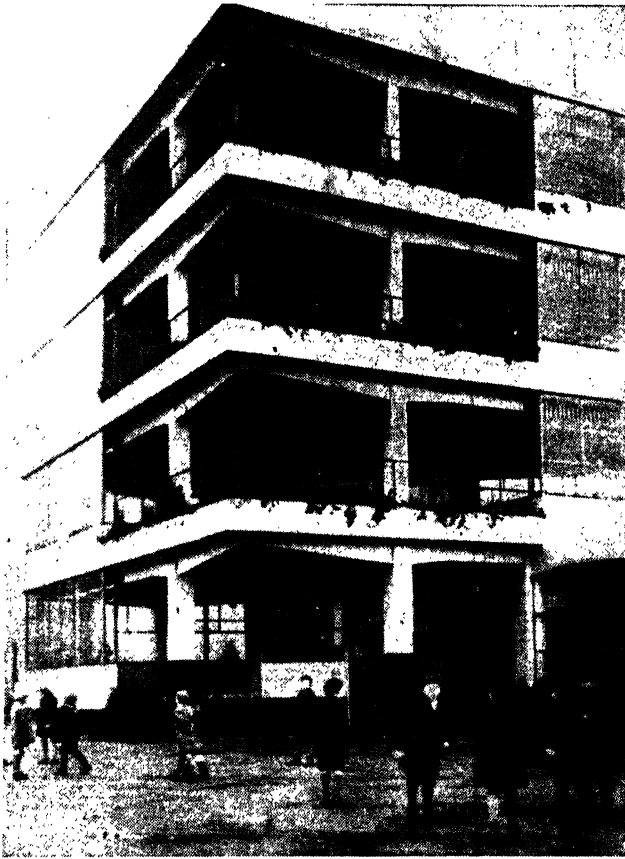

FIG. 3-8.—Open-air school in Amsterdam, Holland. (*Richard Crittall & Co., Ltd.*)

Figure 3-12 shows a garage under construction that makes use of floor heating in the area devoted to shop work and automobile repairs, while in that section of the building devoted to a showroom and office space, ceiling construction is used. This is partly because the large glass area indicated as being installed in the showroom required a large heat input which was more readily

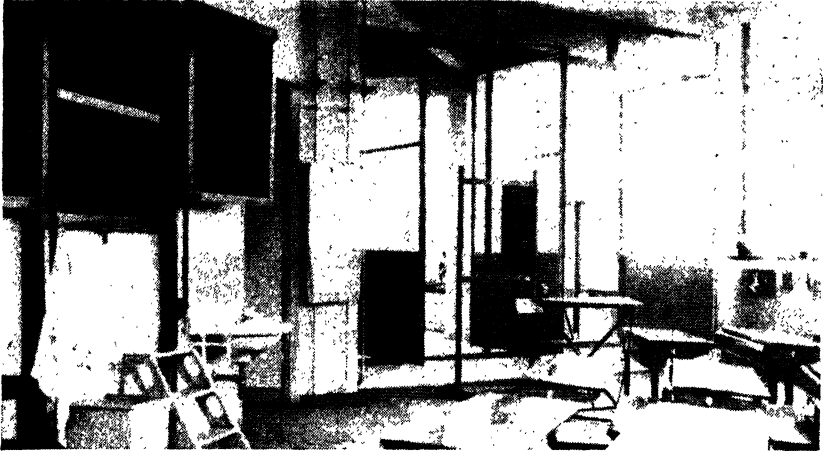

FIG. 3-9.—Interior of open-air school in Amsterdam, Holland. (*Richard Crittall & Co., Ltd.*)

delivered from the ceiling than from the floor, as the latter could not be used without exceeding comfort floor-surface temperature.

Figure 3-13 shows the ceiling construction in the display room of the garage shown in Fig. 3-12. This photograph clearly shows the furring strips to which the metal lath is attached and above which can be seen the ceiling insulation. Half-inch outside diameter tubing is shown strapped below the lath. It can also be

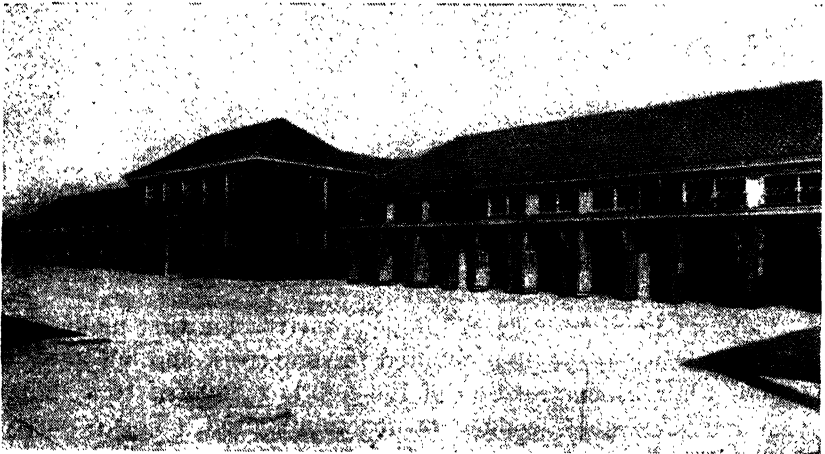

FIG. 3-10.—Ranworth Square School, Liverpool, England. (*Richard Crittall & Co., Ltd.*)

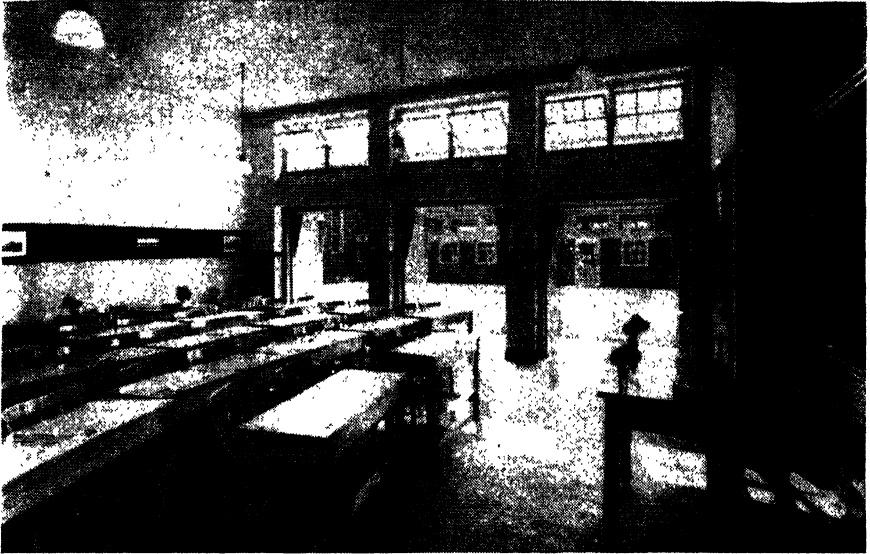

FIG. 3-11.—Interior of Ranworth Square School. (*Richard Crittall & Co., Ltd.*)

observed that the large windows shown in Fig. 3-12 are on the left side of Fig. 3-13 and that the tubing runs at right angles to the windows. This is not a proper arrangement of the tubing,



FIG. 3-12.—Automobile showroom and garage. (*Chase Brass & Copper Co., Inc.*)

although there is an auxiliary floor coil directly underneath the window. As constructed, there will be no way, except possibly at the far end of the room where there are two coils, of adjusting the amount of heat delivered over the windows without at the same time cutting down heat delivered to the interior wall at the right. Obviously, reducing the flow in any coil will reduce the output throughout its length; whereas if the coils had been laid parallel to the greatest exposure and with proper spacing at this point, there could have been reduced spacing on the left-hand

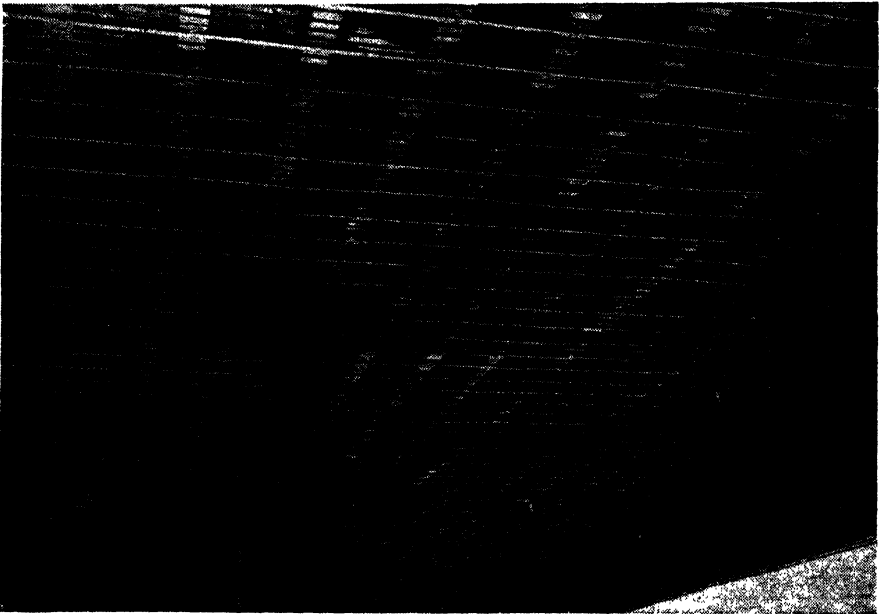

FIG. 3-13.—Details of showroom ceiling. (*Chase Brass & Copper Co., Inc.*)

side of the room; then, with coils running lengthwise of the room, and adjusting valves on each one, the proper delivery of heat could be had in accordance with room demands.

Figure 3-14 shows an interesting manifold construction for the ceiling coils shown in Fig. 3-13. It will be noted here that each coil has its shutoff valve as well as a purging valve, the latter leading into a small-diameter purging line, which, in turn, leads to a sewer connection. This is a very desirable construction, as full water-supply pressure can be impressed on the opposite end of the coils here shown. Then with all valves leading to the manifold

closed, as well as with all air purging valves closed, and by opening the purging valves one at a time, the effect of water flowing from the surface main at relatively high pressure will result in sufficient velocity in the coils to sweep out all entrained air. Air bubbles will not remain in pipes or tubing irrespective of bends in either horizontal or vertical lines if the water velocity is definitely in excess of 30 ft per min.

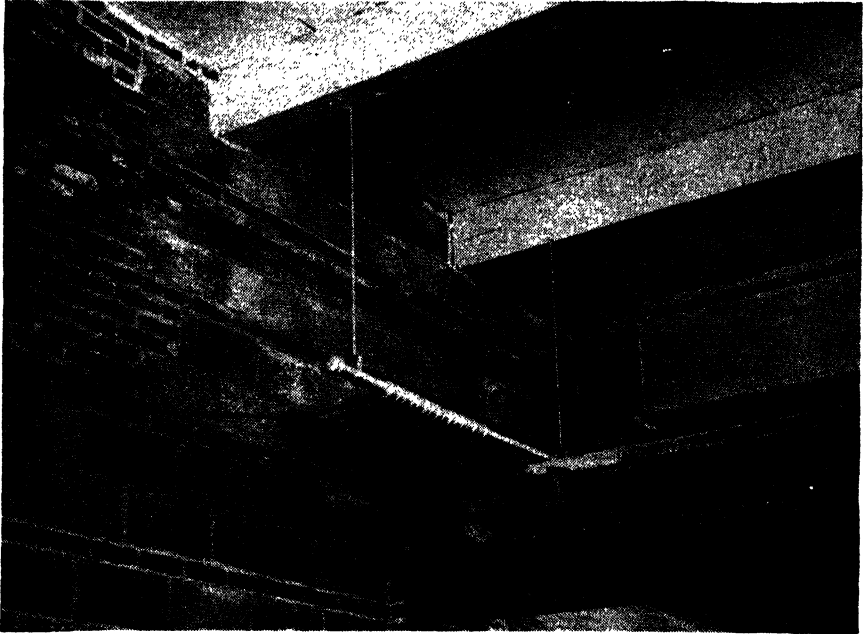

FIG. 3-14.—Manifold construction. (*Chase Brass & Copper Co., Inc.*)

Figure 3-15 shows an airplane hangar that is radiantly heated with wrought-iron floor coils. This type of construction is particularly advantageous for buildings of this type, as considerable space is required for servicing airplanes and the necessary presence of large doors that have to be opened from time to time for the admittance or exit of planes makes the application of radiant heat particularly desirable. Experience has indicated that in radiantly heated airplane hangars there is a prompter return to normal temperature conditions following the opening and closing of doors in the normal course of business.

Figure 3-16 shows construction in progress on a multistory

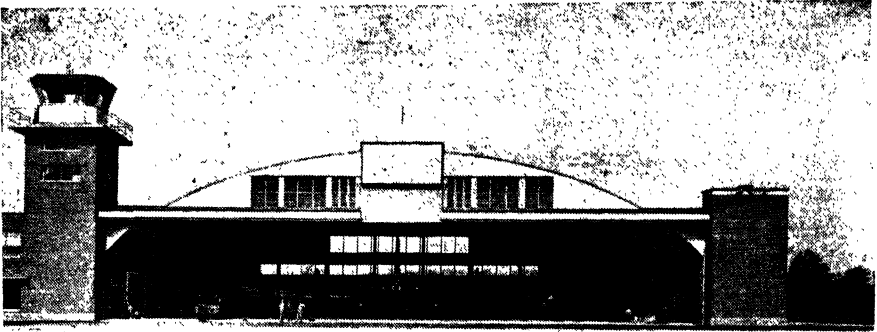

FIG. 3-15.—Radiantly heated airplane hangar. (A. M. Byers Company.)

office building where the wrought-iron pipe coils are laid directly on floor blocks composed of lightweight concrete. The relationship among the piping, reinforcing bars for the concrete girders, and the conduit system for the electrical wiring is clearly shown. A finished layer of concrete will, of course, be poured over the entire area.



FIG. 3-16.—Radiantly heated floor construction. (A. M. Byers Company.)

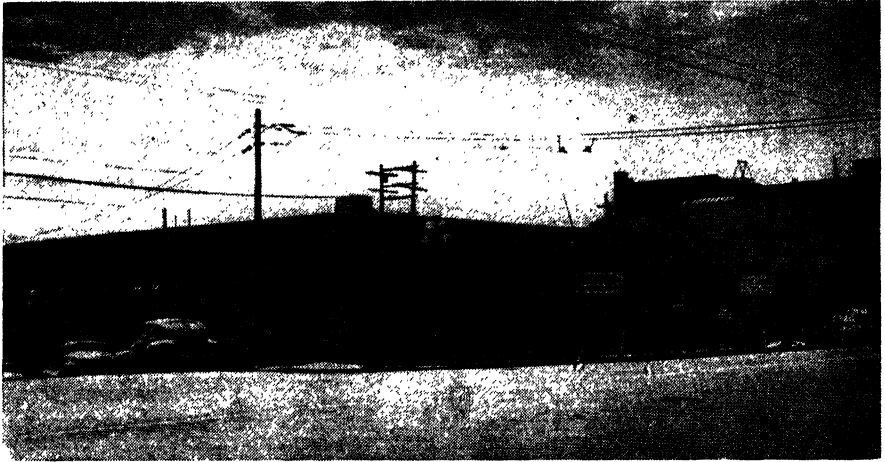

FIG. 3-17.—Radiantly heated stores. (*Courtesy of R. H. Allen, Allen Copper Coil Manufacturing.*)

As an example of a commercial building designed for occupancy by a number of independent stores or small businesses, Fig. 3-17 shows such a building where use was made of radiant heating employing floor construction with small-diameter tubing. Each

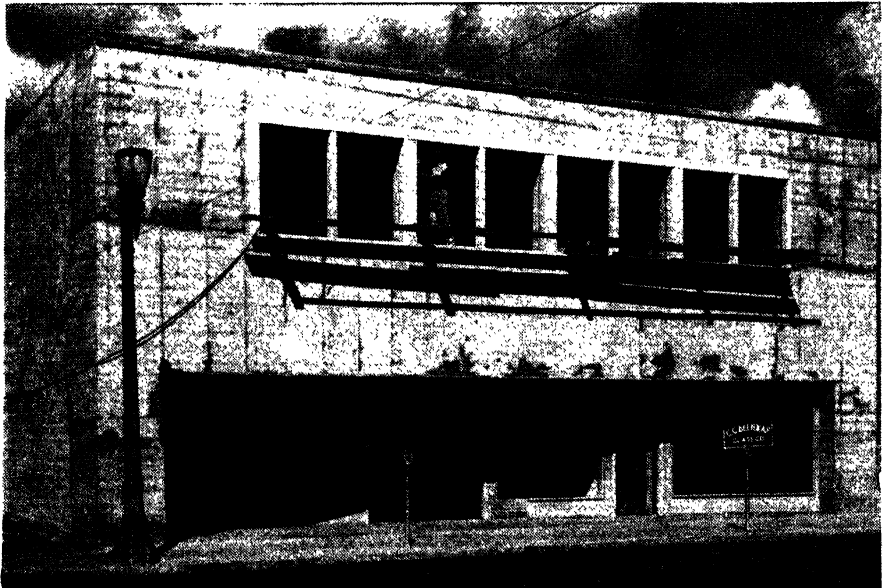

FIG. 3-18.—Combination office building and apartments. (*Courtesy of R. H. Allen, Allen Copper Coil Manufacturing.*)

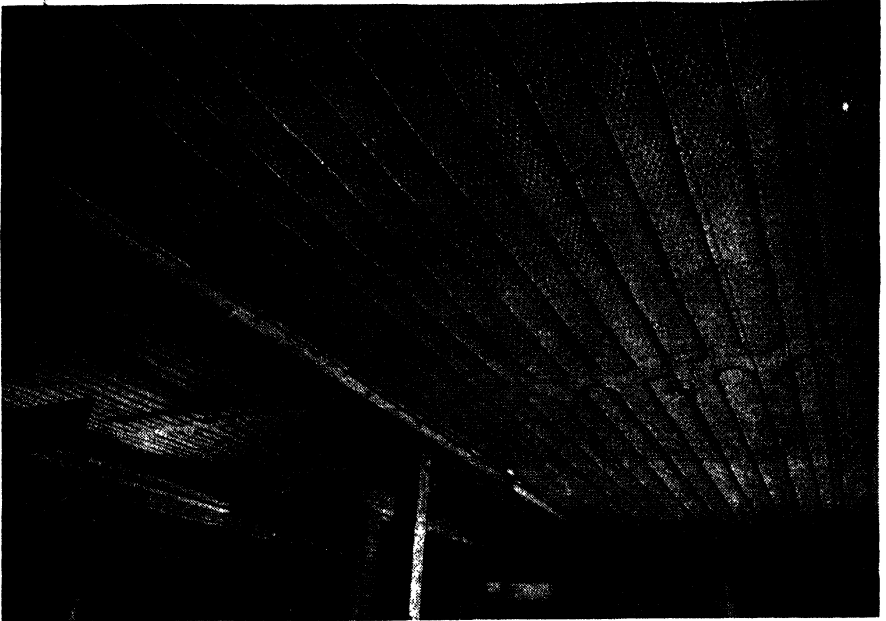

FIG. 3-19.—Ceiling construction on insulating board. (Courtesy of R. H. Allen, Allen Copper Coil Manufacturing.)

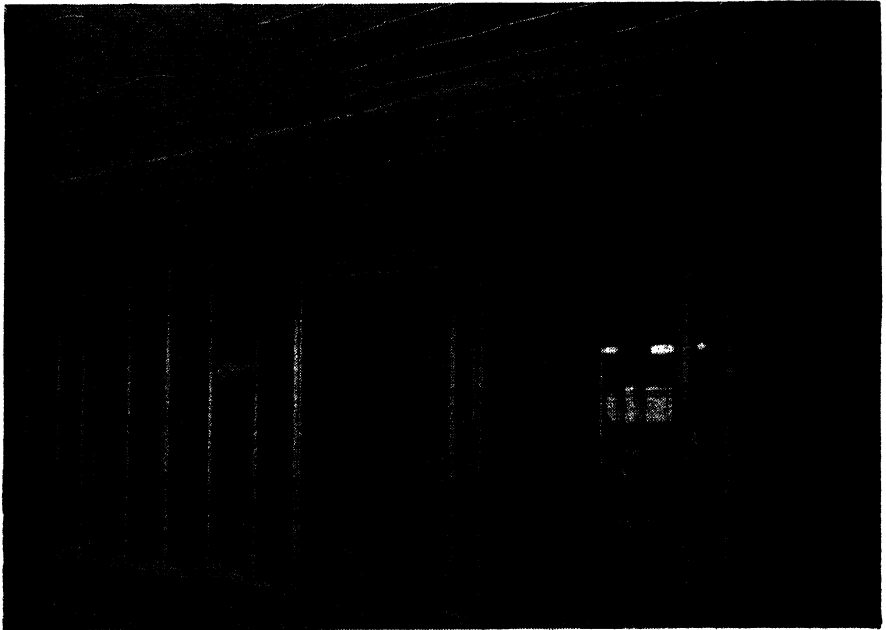

FIG. 3-20.—Ceiling construction. (Courtesy of R. H. Allen, Allen Copper Coil Manufacturing.)

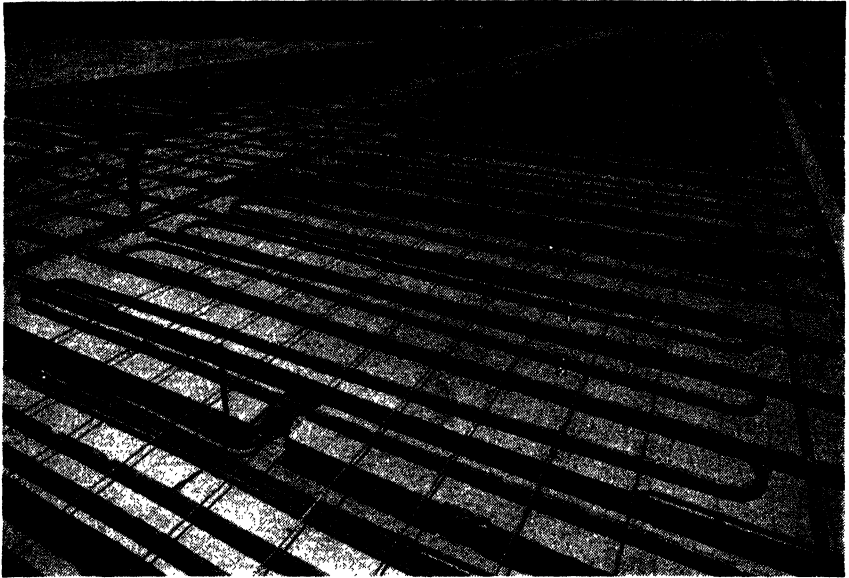

FIG. 3-21.—Hospital-floor construction. (*A. M. Byers Company.*)

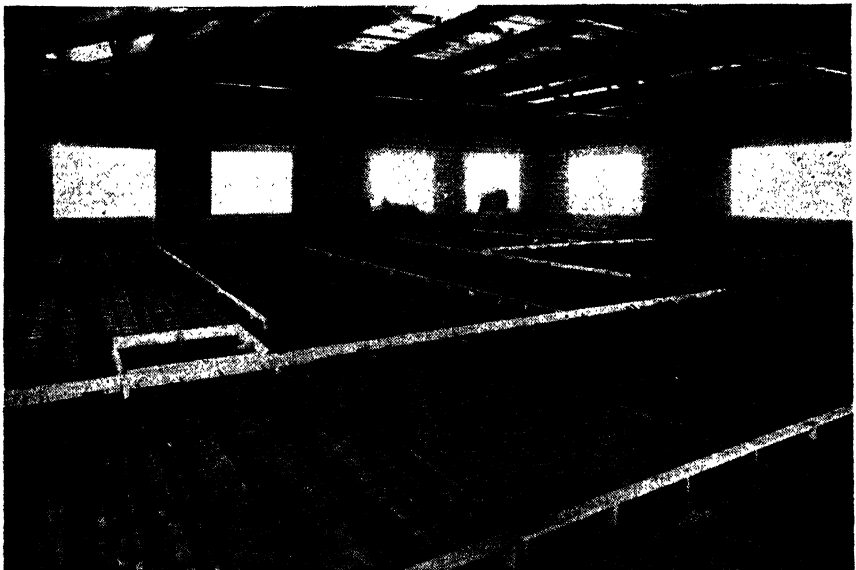

FIG. 3-22.—Second-story floor installation. (*Bethlehem Steel Company.*)



FIG. 3-23.—Floor coils in service station. (*Chase Brass & Copper Co., Inc.*)



FIG. 3-24.—Ceiling construction in entrance lobby. (*A. O. Smith Corporation.*)

of the store units derives its heat from an all-copper type of heating boiler manufactured by the Allen Copper Coil Manufacturing of Seattle, Wash.

Figure 3-18 shows an interesting example of the flexibility that can be obtained with radiant heating. The first story in this building consists of two stores, while in the second story there are a number of apartments, an assembly hall, and a restaurant and kitchen. The building is very completely zoned, there being five



FIG. 3-25.—Floor installation in chapel. (*A. M. Byers Company.*)

separate control areas upstairs and two downstairs. An illustration of the control panel will be found in Chap. VI.

On examination of Fig. 3-19, which is the interior of the building shown in Fig. 3-18, it will be noted that a very interesting type of construction is shown. Insulating material is fastened directly to the joists to which is strapped the copper tubing. Over the tubing and insulation is placed wire netting for the purpose of making a firm bond between the plaster and insulating board.

Figure 3-20 shows the copper tubing in place on the insulating board before the application of the wire netting.

Figure 3-21 shows the use of wrought-iron pipe in the floor construction of a large hospital. The floor blocks are of light-

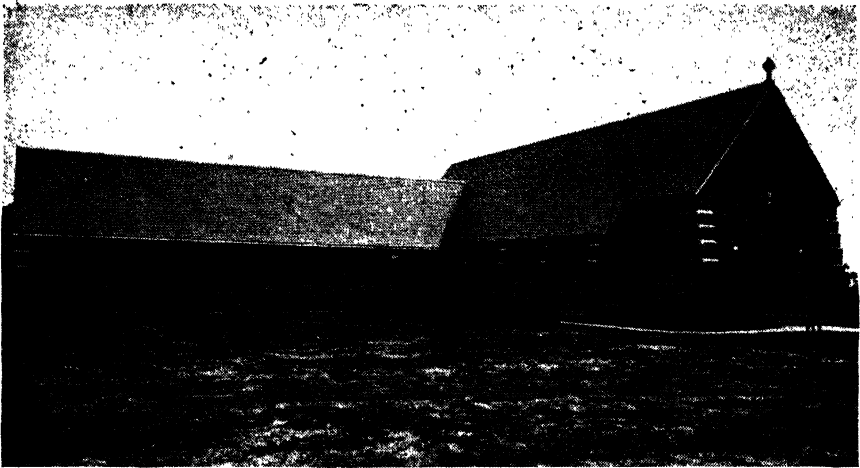

FIG. 3-26.—Radiantly heated church. (*A. M. Byers Company.*)

weight concrete, and the general arrangement of reinforcing bars and electric conduits is clearly shown. Adequate reinforcing is necessary in this construction, as there is a basement under the entire area.

Figure 3-22 shows the use of Rayduet steel pipe in reinforced concrete floor construction as provided in the second story of a

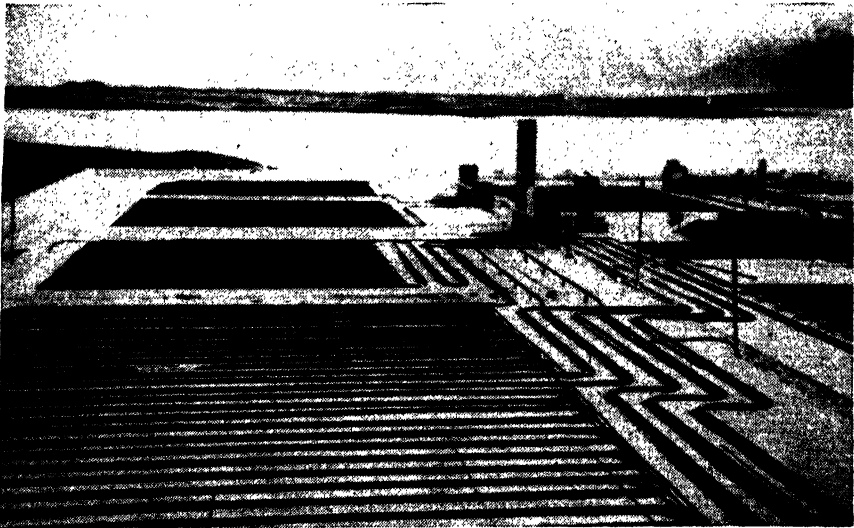

FIG. 3-27.—Radiantly heated hospital in Iceland. (*Richard Crittall & Co., Ltd.*)

building in Harrisburg, Pa. It will be noted that the steel pipes are laid directly on top of the steel reinforcing bar and that it is more economical, under particular conditions, to form coils by welding return bends to straight lengths of pipe than by forming the coil by conventional methods. It is to be noted particularly that this large room will be divided up into a number of relatively small units and that it will be provided with an over-all ceiling. This combination illustrates one of the great advantages of radiant heat, in that it will be perfectly possible at any time after the build-

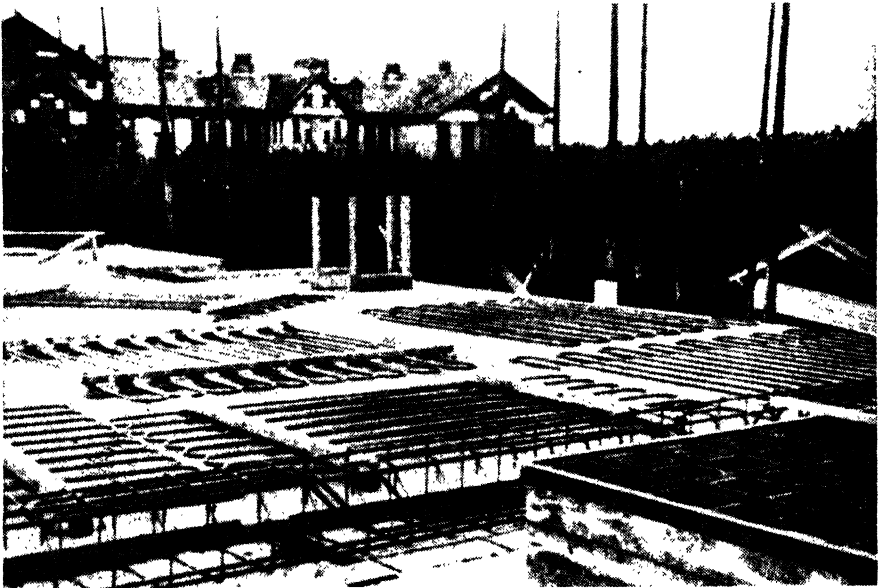

FIG. 3-28.—Radiantly heated hospital, Holland. (*Richard Crittall & Co., Ltd.*)

ing is completely constructed, and perhaps after many years of use for the purpose originally intended, to take down, rearrange, or entirely remove all the partition walls and make use of the space without any reference to or consideration of the heating system. If a conventional method of heating had been employed and radiators installed in each of the partition spaces indicated in the illustration, the steps involved in making a rearrangement of occupancy would necessarily result in considerable expense and difficulty.

Figure 3-23 shows the installation of a floor coil in the show window of an oil station. In this construction, a floor slab was

first laid down, on which was placed the copper tubing separated from the base slab by means of insulation. Attention is called to the riser shown at the left center, which was installed for the purpose of supplying convectors. The necessity for this split method of construction was due to the large expanse of glass on three sides of the display room, which made it difficult to supply the necessary heat in any other manner. Construction of the building was such that ceiling installation was not practical.



FIG. 3-29.—Dorset House, London, England. (*Richard Crittall & Co., Ltd.*)

Figure 3-24 shows the use of ceiling construction as a solution to a somewhat similar problem. The ceiling coil is in a rather exposed entrance lobby where considerable traffic is expected and in which a liberal area of floor coils is also installed. When finished, the coils (which are Bundyweld tubing) will be completely imbedded in plaster.

Care should be taken in floor designs of high output, as may be required in large factory buildings, to reduce the heat output

underneath low mezzanine floors; otherwise, discomfort in such areas will result.

The use of radiant heating in church buildings is an important application, floor designs being particularly suitable, as the heat is delivered in close proximity to the occupants.

Figure 3-25 shows the interior of a chapel at the U.S. Naval Air Station in Florida. A grid system of piping is shown being welded, preparatory to being imbedded in a concrete floor slab directly on the ground.

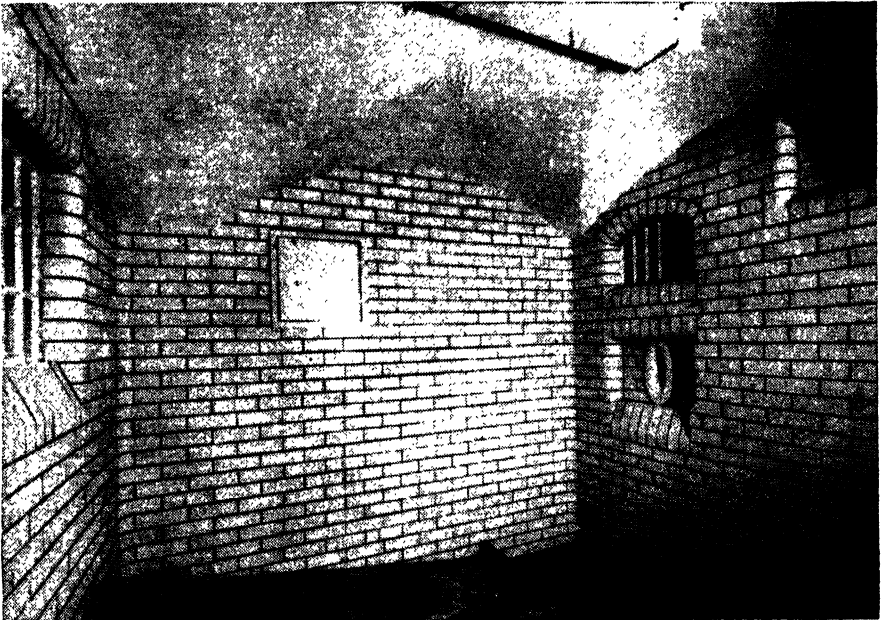

FIG. 3-30.—Chester police station, London, England. (*Richard Crittall & Co., Ltd.*)

Figure 3-26 is an exterior view of a church using floor radiant heating.

As an example of hospital construction in a climate quite far removed from Florida, Fig. 3-27 shows a portion of the Klettur Hospital at Reykjadia, Iceland. From the illustration, it would appear that sinuous types of steel coils are being laid in a floor construction, but this is not the case. Actually, the coils will be placed in the ceiling of the first floor; or in other words, they will be on the underside of the floor slab for the second story. Owing to the severe climate, special care and attention have been given to

the insulation of the hospital so that heat loss will be reduced to a minimum.

Figure 3-28 shows a floor installation using steel pipes in a very large hospital at Dakkum, Holland.

Figure 3-29 is an example of radiant heating application to a multistory apartment and office building, known as the Dorset House of London, England.

In a previous chapter on the advantages of radiant heating, mention was made of its application to institutions, such as prisons, asylums, etc., where there is a definite advantage in the complete inaccessibility of the heating devices, whereby occupants might become injured or engage in some kind of wanton destruction. Figure 3-30 shows the interior of a prison cell set aside for the detention of the more troublesome type of inmate, in which radiant heating is installed.

CHAPTER IV

PANEL LOCATION IN RESIDENCES

In residential constructions of conventional types, it will usually be found that the ceiling is the most favorable location for the radiant heating panel because a greater output can be had from the ceiling per square foot than from either the floor or walls, and in locations of low or severely low temperatures, heat-loss calculations will indicate that there is not sufficient output from a floor to supply the necessary heat without exceeding reasonable temperatures of the floor surface. However, where extreme conditions exist, such as with large glass exposures, especially when located unfavorably with relation to the direction of storms, it is quite often necessary to supplement ceiling treatments with a certain amount of floor installation. In this case, the tubing should be run along the areas adjacent to the increased exposure, and any deficiency in Btu requirement, as evidenced by the ceiling limitation, can be made up in the floor.

The use of ceiling installations in the living room and on the first floor, including dining room, kitchen, etc., has the particular advantage that in a two-story construction, without extra insulation between the ceiling of the first floor and the floor of the second, there will be sufficient heat input to the room above, such as a bedroom, so that as a rule additional heat is not necessary.

By reason of the heat being delivered to the floor above, it will ordinarily be slightly above skin temperature, with the result that in no case will it feel cold to the feet. This condition should not be relied upon, however, to supply sufficient heat to the second story, but suitable ceiling coils should also be installed. In computing the necessary amount of tubing to be used, consideration should be given to the heat that will be delivered from the room below. Methods for obtaining this value are discussed in the chapter on design.

The bathroom should always be provided with a certain amount of floor treatment, so that the occupants will not have to be

exposed to cold floors when using this room. In the same manner, children's playrooms should be given additional consideration, and a certain amount of floor treatment be provided, although for this purpose the temperature of the floor should not exceed 70° .

Vestibules leading from outdoors to living rooms and other similar first-floor spaces, such as cloak rooms, should be provided with both ceiling and floor construction to overcome the chilled condition that usually exists when people arrive from outdoors before proceeding into the living room. Clothes closets provided for the hanging of coats, overcoats, etc., regularly in use during winter, should be supplied with either floor or ceiling treatment so that such clothing is never at an uncomfortably low temperature.

In a kitchen, coils directly over the stove should be omitted, as a certain amount of heat is always generated during cooking, even with the efficient equipment available at present. The assumption is made that coal or wood stoves will not be used.

In the garage, a moderate amount of pipes should be installed in the space or floor that will be just underneath the car when the latter is in position. If a maximum floor temperature of approximately 60° is provided for this area under minimum outdoor conditions, convection air currents, together with the heat radiated upward from the floor, will keep the engine in good condition for prompt starting. Additional heat will have to be provided if it is desired that the car body and space within the body itself be raised in temperature.

The use of coils buried in concrete, as shown in Fig. 4-1 where Rayduct is being installed, to bring about the melting of snow and ice on walks, driveways, etc., should always be included in any radiant heating residential installation, although, of course, the melting of snow and ice in this manner is not radiant heating but heating by conduction. As considerable heat has to be delivered (but only for a short time), and as the question of the pipes freezing has to be taken into consideration, it is not advisable to connect permanently a snow-melting application to the radiant heating system. A separate circulating pump should be provided. Either the difficulty of freezing can be overcome by using a nonfreezing liquid in the pipes, which would involve a heat exchanger connected with the heating boiler, or a less troublesome method would be to provide a sump to include a cellar drainage type of pump which

would withdraw water from the sump and pass it through a heat exchanger in conjunction with the boiler and out through the ice melting tubes. The circulation would continue as long as the pump operated; but as soon as its services were no longer required, shutting down the pump would enable all the water in the heating coils to drain back into the sump. In this manner, no difficulty



FIG. 4-1.—Snow-melting application. (*Bethlehem Steel Company.*)

would be experienced from freezing, provided the coils had been installed with proper slope back to the sump.

Figure 4-2 shows a ceiling installation of copper tubing where use is made of straight lengths of hard-drawn tube that are limited to 20 ft as distinct from the more conventional methods of using an annealed copper tube in coils approximating 100 ft. The advantage claimed in the use of hard tubing is that it is less difficult

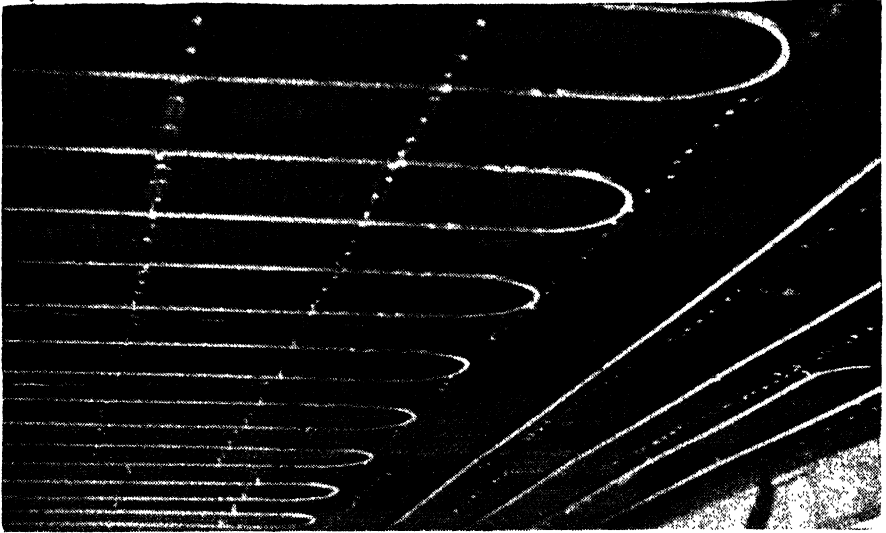

FIG. 4-2.—Hard-drawn copper tube in ceiling construction. (*Chase Brass & Copper Co., Inc.*)

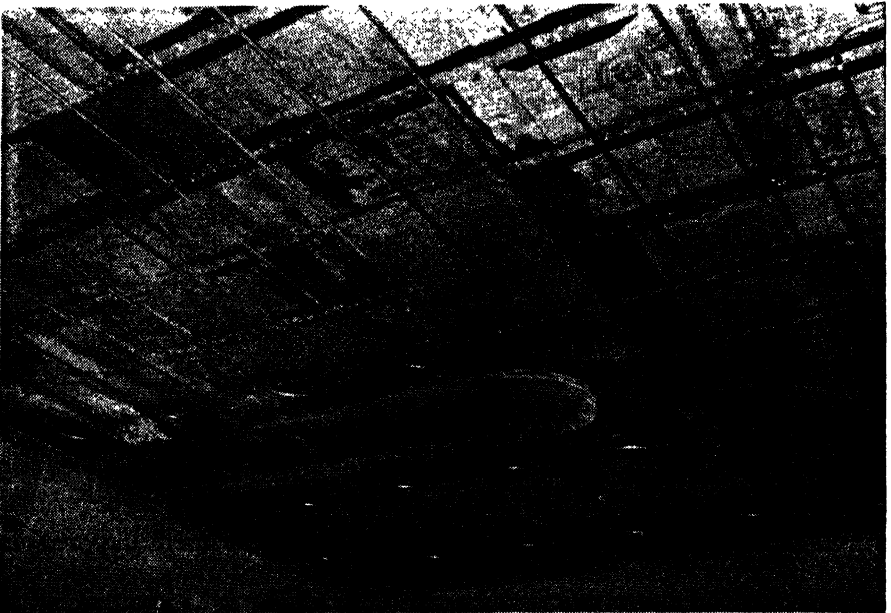

FIG. 4-3.—Insulated ceiling construction. (*Chase Brass & Copper Co., Inc.*)

to install and, although return bends have to be made from preformed elements with two coupling sleeves and two soldered joints for each return bend, less time is perhaps required for this type of construction than is required for the more conventional method using long lengths of soft tubing. An additional advantage may be presumed to reside in the fact that with straight lengths of hard tubing, it is possible to put it more accurately in place, with the result that less plaster is required. The illustration shows a very



FIG. 4-4.—Combination grid and sinuous coils. (*A. M. Byers Company.*)

proper use of straight lengths of tubing along and close to the exterior walls of the room with the more protected areas of the room covered by sinuous coils.

Figure 4-3 is a further example of the use of hard tubing with soldered return bends. It also shows the method to be used in clearing projected divisional partitions and the use of insulating material put in place on top of the metallic lath.

Figure 4-4 shows a basementless floor system being installed with pipe and tube. In the center of the room it will be noticed

that a grid type of construction is used, with supply pipes extending between the supply and return manifolds, while in other parts of the room, sinuous coils are used, although connected with different sets of supply mains in order to control heat distribution more properly (a very important provision).

Figure 4-5 is a further example of basementless floor construction combining the use of wrought-iron pipe in a grid with sinuous coils. This illustration shows the pipes being laid on a crushed rock foundation, over which a concrete floor slab is to be poured.



FIG. 4-5.—Wrought-iron floor installation. (A. M. Byers Company.)

The use of hollow tile around the periphery of the building, as shown, will tend to reduce heat loss from the floor slab to the ground outside.

Figure 4-6 shows an interesting application of radiant heating in a residence having a ceiling construction involving flat and curved surfaces. This illustration has several points of interest. The first thing to be noted is that in the far end of the room, which happens to contain a considerable window area, the tubing is run parallel to the windows and with closer spacing than exists away from the exposure. In order to obtain this desirable feature, it



FIG. 4-6.—Arched ceiling construction. (*Chase Brass & Copper Co., Inc.*)

was necessary to install furring strips as, with the direction of tubing determined by the window exposure, it had to be installed parallel to the ceiling joists. On the curved sections of the ceiling, rather than attempting to form the tubing to conform with the



FIG. 4-7.—Floor slab on insulating base. (*Robert Bruen & Son.*)

curved surface, it was run at right-angles to the curve, thus making it unnecessary to curve the tubing which with this modification could be laid as straight lengths. Throughout the room, the tubing is laid below the lath.

Figure 4-7 shows the construction of 166 five-room houses in a veterans' housing development. These are of the basementless type, with floor slabs laid directly on the ground. The reason for the sinuous type of coil in the foreground is to assist in main-

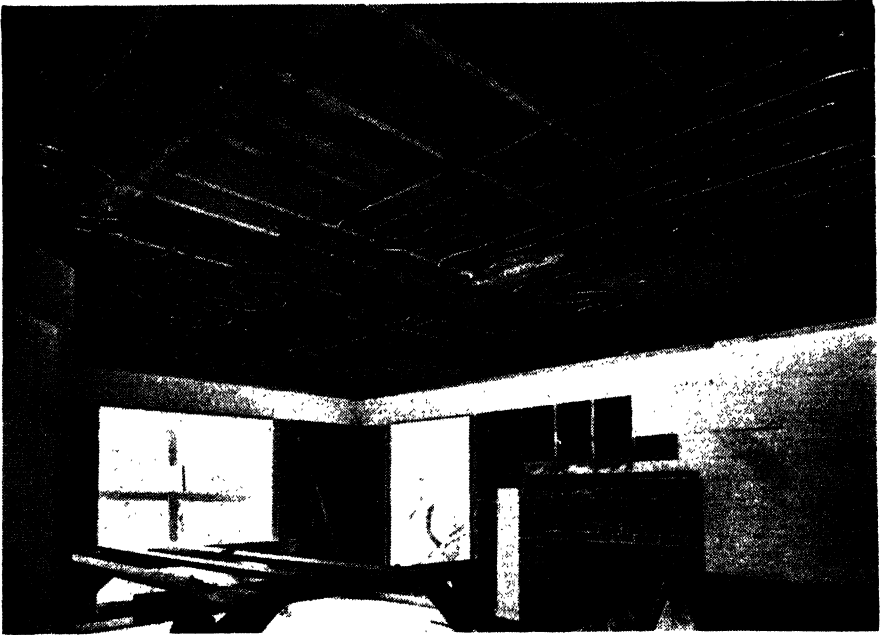

FIG. 4-8.—Prefabricated ceiling coils. (*Robert Bruen & Son.*)

taining approximately equal lengths of tubing in the individual coils, irrespective of their individual distances from the manifold. The use of vapor seals in floor construction of this type is also indicated in order to reduce the possibility of having damp floors.

Figure 4-8 shows the residential use of a novel form of prefabricated ceiling coil construction as developed by Robert Bruen & Son of Oakland, Calif. With this type of construction, the sections of coils of various dimensions come permanently attached to the metal lath, and each section is manufactured as a complete unit. As indicated in the illustration, some sections come with

straight lengths of tubing while others include a sinuous type of coil. A panel of the latter type is indicated in the lower right-hand corner of the illustration. The concentration of tubing adjacent to the areas of window exposure will be particularly noted, whereas parts of the room remote from windows are entirely devoid of tubing. The difference in amount of tubing indicated in this illustration as compared with some of the previous ones showing ceiling installations is due to the fact that this particular illustration is of a residence constructed in a warmer area of California where a temperature difference of only 40° between indoors and outdoors under winter conditions need be considered.



FIG. 4-9.—Modest radiantly heated homes. (Courtesy of Ames Aksila.)

As an example of the use of radiant heating in the more modest type of house, Fig. 4-9 shows the exterior appearance of a group of five-room houses using the type of radiantly heated ceilings shown in Fig. 8-22.

As an excellent example of some of the advantages of radiant heating, we have Fig. 4-10, which shows construction in progress of a two-story residence in Pennsylvania. The coils shown are of Rayduct and will be used to heat the floor of the second story. As may be seen in the illustration, the first floor is heated by means of coils laid on a subfloor of brick and will be covered with cement. Of particular interest in this illustration is the visual example of one of the advantages of radiant heating discussed in a previous



FIG. 4-10.—Residential second-story floor construction. (*Bethlehem Steel Company.*)

chapter, where it was pointed out that once a heating contractor has his radiant coils installed, he will not have to appear on the job again to do further work with the various attending disadvantages that were outlined. As the illustration shows, there is a



FIG. 4-11.—Residential floor-slab construction. (*Chase Brass & Copper Co., Inc.*)



FIG. 4-12.—Residence in Worcester, Mass. (Courtesy of Ames Aksila.)

considerable amount of piping installed for a bathroom, provided with temporary capped outlets. At a later period in the building construction, the plumber will have to reappear on the job and set and connect the various appliances that have been provided for in

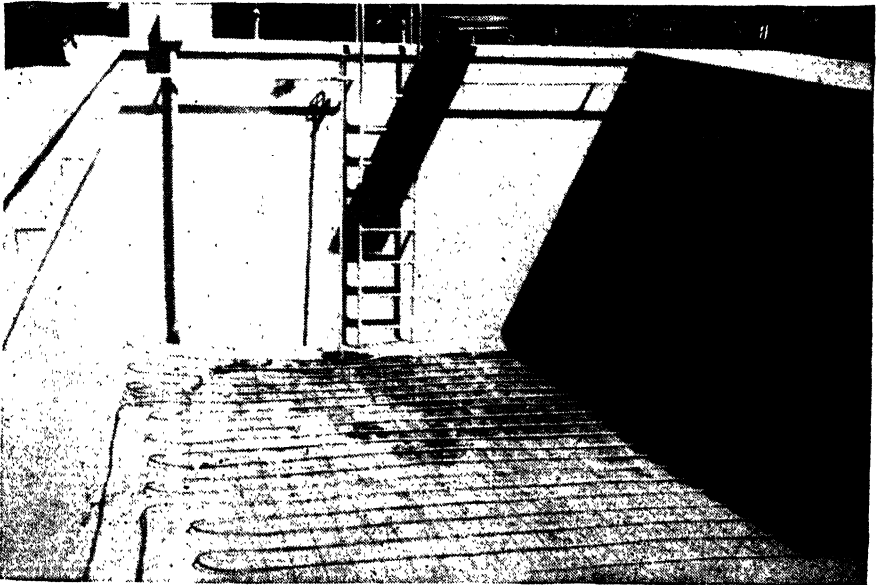

FIG. 4-13.—Swimming-pool construction. (Robert Bruen & Son)

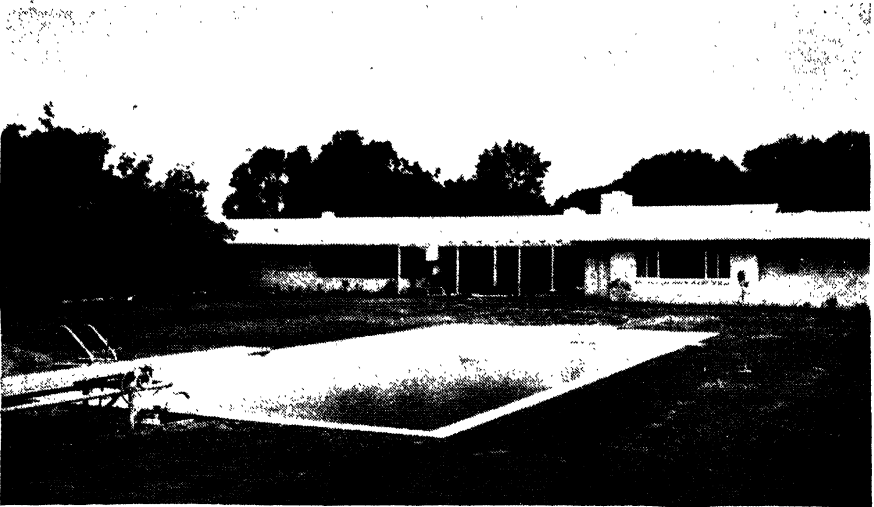

FIG. 4-14.—Heated swimming pool and radiantly heated residence. (*Robert Bruen & Son.*)

the bathroom, whereas the heating contractor will not have to return, as his work was entirely finished at the time of his first appearance.

As a further example of a basementless type of installation



FIG. 4-15.—Nine-room California residence. (*Robert Bruen & Son.*)

using a floor slab, Fig. 4-11 shows construction in progress in a nine-room house. To the right of the picture there will be a room having a three-sided exposure. As the glass area in this room will be considerable, resulting in a rather high estimate of heat loss, the use of wall panels was resorted to as supplementary to the floor coils. In the bathroom there will also be a supplementary wall panel installed to ensure an adequate supply of heat. There being no basement, space for the boiler was provided in conjunction with the garage.



FIG. 4-16.—Wrought-iron pipe in floor construction. (*A. M. Byers Company.*)

Reference is made to Fig. 4-12 as an example of a large and modern residence making use of radiant heating. The finished interior of this residence was shown in Chap. II, and the installation of radiant heating coils during construction is shown in Chap. VIII. This residence was constructed by and for Mr. Ames Aksila of Worcester, Mass., and is an excellent example of the acceptance of radiant heating for use in the larger and more important residences being erected in this country.

As an interesting exemplification of the use of sinuous coils, Fig. 4-13 shows an installation of heating pipe in a swimming pool. Although this is not radiant heating but purely heating by con-

duction, it is of importance when considering the various devices for convenience and comfort that can be included in and around residential construction. The coil shown in Fig. 4-13 will be covered with 2 or 3 in. of concrete. It has been found in practice, that swimming pools so outfitted have an almost perfectly uniform distribution of temperature from water on the top of the pool to water at the greatest depth. Swimming pools heated in this manner were first constructed by Robert Bruen & Son of Oakland, Calif. A result that was not anticipated but was obtained with

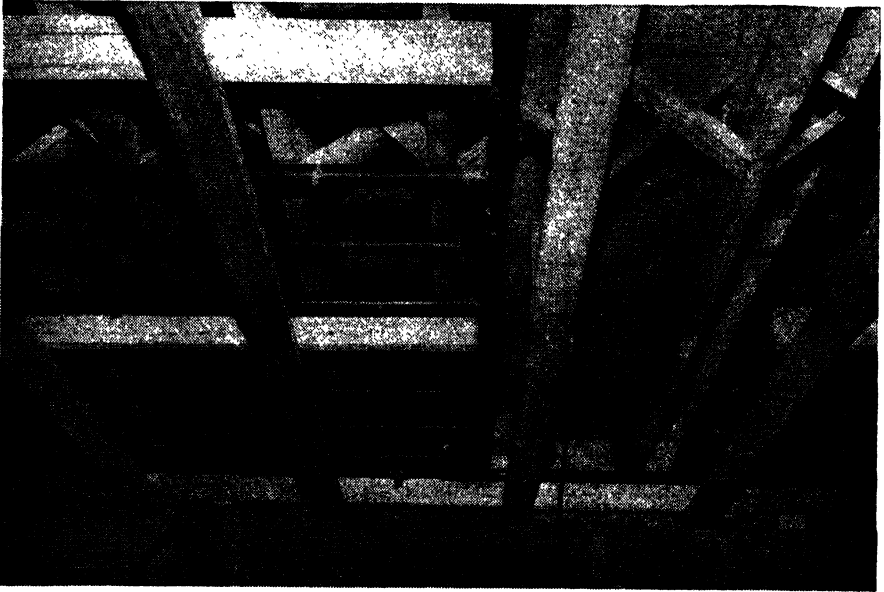

FIG. 4-17.—Subfloor construction. (*A. M. Byers Company.*)

pools heated from the bottom in this manner and exposed to the sun was that about half the heat required by the pool to raise the water from entering temperature to the desired value was actually obtained from the sun, the other half being furnished by the fuel. The reason for this was that with heat applied to the bottom of the pool, the accumulation of hot water on the top surface from heat derived from the sun was eliminated. Thermal circulation resulting from the coils at the bottom of the pool not only maintained a uniform temperature but prevented the otherwise rather disagreeable layer of hot water at the top of the pool with colder water below.



FIG. 4-18.—Wrought-iron ceiling installation. (*A. M. Byers Company.*)

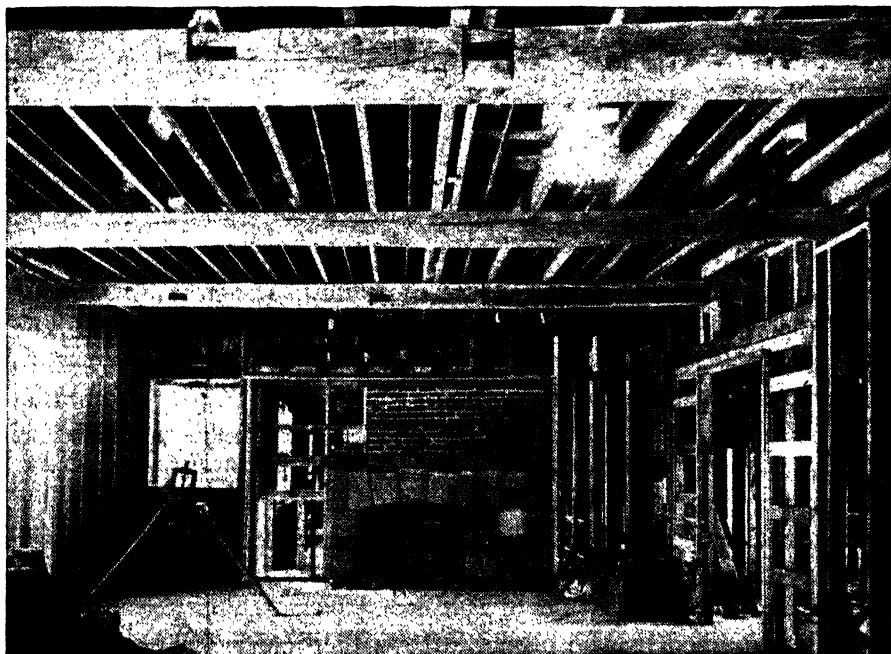

FIG. 4-19.—Pipe coils installed above beamed ceiling. (*A. M. Byers Company.*)

Figure 4-14 shows a large residence in California complete with swimming pool. The residence has 6500 sq ft of floor heating surface and is divided into five zones under thermostatic control. Heat is supplied by natural gas, making use of Burkay heaters.

Figure 4-15 shows a nine-room house in California, using ceiling construction with Thermapanel.

Figure 4-16 shows wrought-iron pipe coils laid on top of a concrete slab with sleepers provided for supporting hardwood floors.

Figure 4-17 shows a subfloor installation of a wrought-iron pipe grid made after the floor was completed. Mention was made

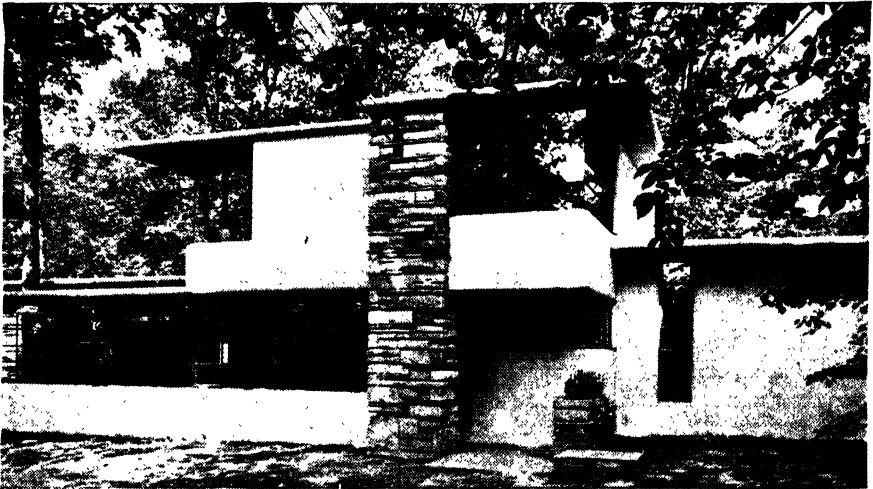

FIG. 4-20.—Modern-type residence with steel floor coils. (*Bethlehem Steel Company.*)

previously to running radiant pipes parallel to the joists and in the joist space. In the construction shown in this illustration, the grid runs at right angles to the joists; consequently, means had to be provided for placing a compound insulating barrier, including reflective insulation and insulating board suspended beneath the piping to direct the heat output effectively to the floor and prevent dissipation into the cellar.

Figure 4-18 shows a wrought-iron pipe ceiling construction photographed just after the radiant coils were fastened in position and before the application of the metal lath, which was fastened to and supported by the piping, after which conventional coats of plaster were applied in the usual manner. Care had to be taken,

however, to apply extra pressure to the first coat so that it would flow up through the lath and cover the piping for at least half the diameter.

Figure 4-19 shows a wrought-iron pipe ceiling construction placed above a beamed ceiling. Metal lath will be used between the beams and fastened to the joists. This will bring the lath into intimate contact with the radiant pipes, so that with the partial envelopment of the pipe by means of the plaster, good heat conductivity between the pipe and the plaster surfaces will be assured.

Figure 4-20 shows the exterior of a very attractive residence making use of floor coils fabricated from Rayduct pipe of the Bethlehem Steel Company. This residence is in Pennsylvania, and the large amount of glass exposure should be noted particularly. Very satisfactory results were obtained with this installation.

CHAPTER V

THE RADIANT HEATING PLANT

The methods of radiant heating that have been discussed so far have all been based on the principle of using imbedded pipe or tubing. With constructions of this type, hot water is the most effective means of transferring the heat energy from the fuel to the space to be heated, the chief reason being the high thermal capacity of hot water and the ease with which its temperature can be regulated and controlled to suit the conditions of the radiant heating installation.

Due to the fact that very moderate temperatures are required, steam at normal pressure does not lend itself to radiant heating application. The maximum temperature required for hot water in a radiant system is on the order of 160°F, whereas the normal temperature in a conventional steam system is about 220°. This difficulty with high temperatures in connection with the use of steam can be overcome by using steam at less than atmospheric pressure; but in order to get the required minimum temperature suitable for a radiant heating system, a very high degree of vacuum would have to be carried in the piping. This means that suitable vacuum pumps would have to be installed and difficulty would be experienced, to some extent, with the grading of the tubing and pipes throughout the installation in order to avoid water hammer. If low-cost steam is available and it is desired to use a radiant heating system, the best plan is to use the steam in a heat exchanger so that while steam supplies the heat, it is actually delivered into the coils by means of hot water. Suitable exchangers are built by the Bell & Gossett Company of Morton Grove, Ill., and others, in sizes appropriate for any ordinary application.

Figure 5-1 shows such an exchanger manufactured by the above-mentioned company. The illustration shows the heater attached to a heating boiler, but any steam supply can be made to act as a source of heat.

As radiant systems involve relatively low temperatures, not

only of the actual heat-transfer surfaces, floor, walls, or ceiling, but also of the heat-transfer medium, it would appear that warm air would be suitable for this purpose. Before discussing in detail the equipment needed for the more conventional methods of radiant heating involving the circulation of hot water, attention should be directed to a method using warmed air for radiant heating that has been a subject of considerable study and investigation by the International Heater Company of Utica, N. Y. They have developed a procedure of design, installations, and construction that is definitely a radiant heating system entirely removed from

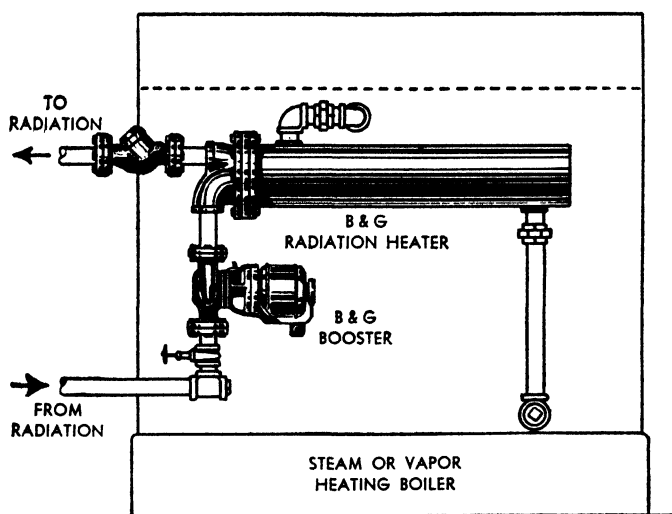

FIG. 5-1.—Radiation heater. (*Bell & Gossett Company.*)

the conventional hot-air system as the term is usually understood. The International Heater Company describe their method of radiant heating in a publication entitled "PANELAIRE—The Warm Air Panel Heating System." This recently issued bulletin includes not only a full description of their method of construction and operation, but also a complete outline of their methods of design.

The principles involved in Panelaire heating are disclosed in U.S. Patent 2,240,991, controlled by the International Heater Company. In brief, their method of heating is to circulate warmed air over the ceiling, which is built of metal lath and plaster in the conventional manner, with provision for circulating the warmed air over the ceiling structure so that the ceiling itself is warmed as

in conventional radiant heating practice. Suitable barriers are provided within the circulating air space so as to ensure complete circulation of warmed air over the entire ceiling area. Insulation is provided above this warmed-air space in order to make sure that the heat is delivered downward through the plastered ceiling. Suitable boiler equipment is described later in this chapter.

With all systems of heating, the boiler is probably the most essential element, the reason, of course, being that at this point, the heat energy present in the fuel is converted into a form of heat suitable for transmitting to the room or spaces to be heated. With an inefficient or unsuitable boiler, even though fully adequate in capacity for the requirements of the system to which it is connected, it is obvious that satisfactory operation of the entire heating plant cannot be attained.

Boiler manufacturers have formed associations that have established for their respective industries certain rules for determining the capacity of boilers manufactured by the members of the association. For the builders of steel boilers, there is the Steel Heating Boiler Institute, which in cooperation with the Bureau of Standards, U.S. Department of Commerce, has established methods of determining the proper rating for their specific type of boilers. The manufacturers of cast-iron boilers have their association, known as The Institute of Boiler and Radiator Manufacturers, who, in turn, have their methods of determining boiler ratings and the safe output that can be expected from boilers, either when coal-fired by hand or when used with automatic-firing devices, such as oil burners, coal stokers, or gas. In addition to the industrial regulating codes, there are the codes on boilers established by the American Society of Heating and Ventilating Engineers; and in the case of cast-iron heating boilers, there is a code established by the American Society of Mechanical Engineers.

Boilers are ordinarily rated on a basis of both hand-fired and mechanically fired. Ratings are given in square feet of steam radiation that may be connected to the boiler, in square feet of water radiation that may be connected, and also in Btu per hour. In addition, these capacities are usually given in net values, as well as gross. The difference is that the net figure is intended to represent the efficient capacity of the boiler that will be available after the house to which it is connected is fully heated. The gross

figure represents the maximum amount of heat that may be available during the warming-up period.

With radiant heating, the capacity figures, as usually given, relating to square feet of steam or square feet of water, cannot be used. The only rating figure to consider is the gross and net Btu per hour that may be expected from any given boiler. For net ratings up to about 150,000 Btu per hr, the gross rating should be about 1.62 times the net; whereas up to 500,000 Btu per hr net and above, the gross should be approximately 1.54 times the net. The net load should always be the net heating load plus the estimated domestic hot-water load if domestic hot water is going to be supplied from the heating boiler. In addition to capacity rating, such tables also give the minimum area required in the stack or chimney.

The relative efficiency of boiler operation after installation can be determined by measuring stack temperature and the percentage of the gas CO_2 as determined by samples from the gases of combustion. CO_2 is the product of the combustion of carbon in oxygen; and in general, the percentage of CO_2 in the flue gases is a measure of boiler efficiency. Of equal importance with the percentage of CO_2 is the stack temperature, which should be measured close to the heating boiler. Neither the measure of stack temperature nor percentage of CO_2 taken separately constitute a proper determination of boiler and burner efficiency, because there may be a considerable excess of air passing through the furnace which would give low stack temperatures. However, if this is the case, the percentage of CO_2 will be low, thus indicating that there is too much air passing through the furnace with the result that combustion efficiency is low. For example, with an automatic coal- or oil-burning equipment, a flue gas temperature of 600°F , together with a CO_2 content of only 6 per cent, a loss of 43 per cent of the fuel value results through the chimney. On the other hand, if by making proper adjustments the flue gas temperature is reduced to 400°F and at the same time the CO_2 content raised to 9 per cent, the fuel loss through combustion gases is reduced to 18 per cent, thus making an effective saving of 25 per cent in the cost of fuel.

The 18 per cent loss mentioned is a practical minimum, and further improvement should not be expected; nor is it desirable to have lower flue gas temperature than 400° , as condensation troubles

may develop due to the presence of moisture in the chimney penetrating through to wall surfaces and damaging the finish. Then, too, excessive corrosion of boiler elements may ensue.

While the preceding discussion is correct as to boiler efficiency with respect to burner or stoker operation, true boiler efficiency is the ratio between heat output from the boiler, as determined from pounds of water circulated for a given period times its temperature rise, and the heat input as measured by pounds of oil or coal supplied to the boiler during the same period. This over-all efficiency is adversely affected by the ratio of "off" to "on" periods. The longer the "off" periods are with respect to "on" periods, the lower will be the over-all boiler and burner efficiency. This means that it is not economical to install too large a burner for given heat requirements because during periods of minimum outdoor temperature, the oil burner, stoker, or gas burner should be operating at least 90 per cent of the time.

One of the common causes of the loss in efficiency with domestic boiler installation is air leakage into the boiler above the fire so that it does not take any part in the combustion of fuel. All air entering a boiler structure, except through air channels provided for burner operation, constitutes a definite loss which is continuous throughout the entire heating season. For this reason, every effort should be put forward to ensure that the boiler structure is completely airtight. Some boilers have a multiplicity of cleaning doors, and quite often these are indifferently fitted; consequently, in this circumstance, they do more damage than good. To ensure airtightness, all openings into a boiler structure above the furnace up to the smoke pipe attachment should be sealed with fire clay or some type of asbestos cement.

The value of 9 per cent of CO_2 in the flue gases mentioned previously, although rather low for industrial installation, is a very satisfactory figure for domestic boilers. The better class of burner service organizations has the equipment necessary for making CO_2 determination, and no installation is properly complete unless this measurement is made and furnace adjustments or modifications made in accordance with the results indicated.

When the available boiler equipment as built by various manufacturers is reviewed, consideration will be given first to the cast-iron boiler. This was the first domestic or exclusively heating

type in the field, having been manufactured over one hundred years ago, when the idea of central heating was entirely new and when sheet metal boilers for power use were not entirely satisfactory. This caused the development of cast-iron boiler designs that resulted in a much better product than could be manufactured at that time from sheet metal.

As the first requirement was for relatively small boilers, invariably hand-fired with coal, the natural design was of the round type where a series of various types of sections were built up one on top of the other to form a completed boiler. For example, the lower section comprised the ash space and grate supports, the second section comprised the firebox, and on top of these sections were other elements providing proper water passages to absorb the heat from the fuel. In the case of a steam boiler, a suitable top section of sufficient cubical content was provided to allow for the separation of the steam from the water. The round type of boiler was fitted with combustion chambers ranging from 14 to 28 in. in diameter with capacities up to approximately 180,000 net Btu per hr. (Some special types had combustion chambers as small as 10 in. in diameter.) Boilers of this type were constructed more from the standpoint of cost than efficiency in the use of fuel, as the latter was relatively inexpensive. The result was that the heat passageways were rather short and stack temperatures relatively high, and all were intended for hand firing.

With the advent of mechanical firing devices and the use of more expensive fuels, necessity for improved designs became apparent. The outcome of this was that the design of small cast-iron boilers changed from the assembly of round sections, stacked vertically for obtaining a proper design output, to boilers made of sections with vertical separations and assembled horizontally. The latter construction had previously been used only for large boilers. This arrangement enabled the designer to apportion more accurately the passageways for the hot combustion gases and also to redesign the furnace section in such a way as to give larger cubical content to the furnace volume. The larger volume is a necessity in the use of gas or oil fuel and a desirable factor in the use of either anthracite or bituminous coal in conjunction with an automatic stoker.

Assemblies of boilers of this type included a front section which

carried the fire and ash doors, additional sections forming the furnace chamber, and, if required, further sections for providing the necessary heat-transfer service, followed by an end section which contained the smoke pipe outlet. Each section had top and bottom machined holes for the admittance of assembly nipples, commonly called push nipples, thus providing proper continuity of volume throughout the entire assembly. With this type of construction, it is obvious that in case of the failure of any one unit in the assembly, the entire structure would have to be dismantled for the replacement of a single unit.

A second method of assembling the horizontal type of cast-iron boiler construction is to connect each section separately to headers, one running at the top and two at the bottom—one on both sides of each unit. With this method of construction, any individual unit can be replaced without disturbing the complete assembly.

Cast-iron boilers are manufactured in capacities ranging from approximately 35,000 net Btu per hr up to net outputs of over 4,000,000 Btu per hr. An ASME Standard provides that cast-iron boilers for hot-water heating may be used with working pressures up to 30 lb if capable of withstanding a test of 60 lb and for higher pressures if tested to two and a half times working pressure. Cast-iron boilers are generally all-purpose boilers which operate on any of the three fuels, *i.e.*, coal, oil or gas, and can be suitably arranged for changing from one fuel to another without materially changing construction details.

The advantages of cast-iron boilers include the fact that cast iron is highly resistant to corrosion, and with the lack of experienced technical supervision which usually obtains in a domestic installation, this fact of corrosion-resistant qualities is very advantageous. The life of cast-iron boilers can be assumed to be in excess of 40 years, if given reasonable care as is ordinarily available in domestic installations. Should damage to one section occur through freezing, or other reasons make repairs necessary, it is a relatively simple matter to substitute a new section for the damaged part. This fact also makes it possible to make repairs should the entrance to the boiler room be restricted in such a manner as to prevent the removal and the replacement of an entire assembled unit.

The disadvantages of a cast-iron boiler include the extra weight of this type of equipment and the necessity for expert assembly on the location. This, of course, does not apply to completely packaged units comprising a cast-iron boiler assembled with a suitable burner inside a sheet steel casing. With this type of equipment, assembly on location may or may not be required, depending on the design. Examples of this type of boiler construction are available either completely disassembled during shipment and assembled on the job or completely assembled, together with all necessary auxiliary equipment and controls properly wired, so that very little technical assistance is needed to complete an installation.

The advantages of the assembled or so-called "packaged" type include the neater appearance of the assembled equipment and the elimination of expert assembly labor at the point of installation. The disadvantage of this type of construction resides chiefly in the fact that it is not ordinarily possible to change from the fuel originally intended for the unit to some other type of fuel as may be required by fuel market limitations. For example, a packaged type of boiler intended for the use of oil is quite difficult to change over to the use of a coal stoker. On the other hand, if such a boiler had been purchased as an independent unit and a suitable automatic-firing device installed separately, the change from one fuel to another—gas, oil, or coal—could readily be made after installation as changing conditions require. Of course, this feature relating to the advantages and disadvantages of packaged units applies equally to cast-iron or steel boilers. Once either of these two types of equipment is designed and installed for a given use of fuel, it is always difficult and sometimes impossible to convert to other types.

Considering in greater detail available types of cast-iron boiler construction, reference is made to Fig. 5-2, which shows the internal construction of a cast-iron boiler manufactured by The H. B. Smith Company, Incorporated of Westfield, Mass., and which clearly shows the general arrangement of furnace space, gas, and water passages and the assembly of various individual sections by means of push nipples into a complete unit. The illustration also shows a tankless domestic hot-water connection. This construction provides for a sufficient quantity of copper coils,

extending into the hot-water spaces in the boiler, and of sufficient area in relation to the volume of hot water in the boiler to enable the ordinary supply of hot water to be obtained without the use of a storage tank. To supply the proper amount of heat to the tank-

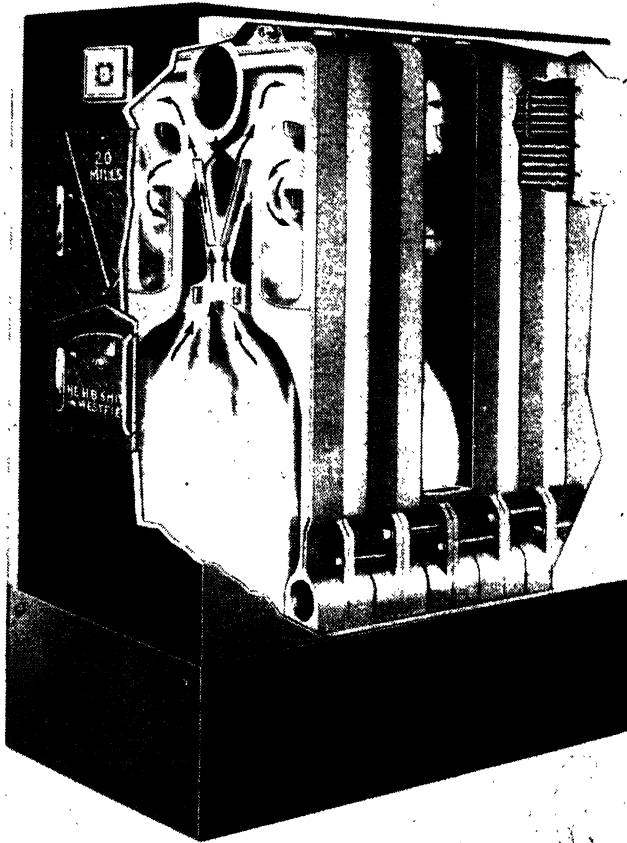

FIG. 5-2.—Sectional view of cast-iron boiler. (*The H. B. Smith Company, Inc.*)

less heater coils, the water in the boiler must be maintained at least at 180°F . This in turn means that with a radiant system, a proper mixing valve must be employed in the control system to ensure that water of boiler temperature does not reach the radiant coils. It can be seen that each section is firmly clamped to adjacent sections by means of bolts. As shown, the cast-iron boiler is

assembled inside a sheet metal case, including insulation between the boiler proper and the outside casing, all for the dual purpose of conserving heat and improvement in appearance. This boiler can be fitted with any type of automatic burner.

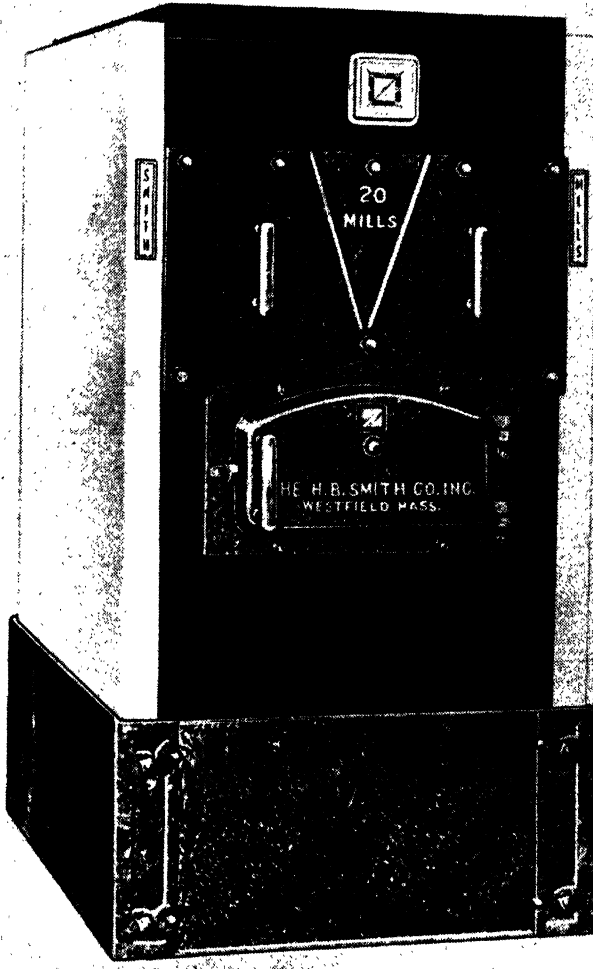

FIG. 5-3.—Encased cast-iron boiler. (*The H. B. Smith Company, Inc.*)

Figure 5-3 is the external appearance of the boiler shown in Fig. 5-2, showing the equipment as intended for hand firing, but any type of oil or coal stoker can be fitted in place of the firing door shown.

Figure 5-4 shows a packaged unit assembled in an ornamental, insulated steel case, the boiler unit being similar to Fig. 5-2.

Figure 5-5 is a picture of the header type of cast-iron boiler where each section is individually connected to top and bottom

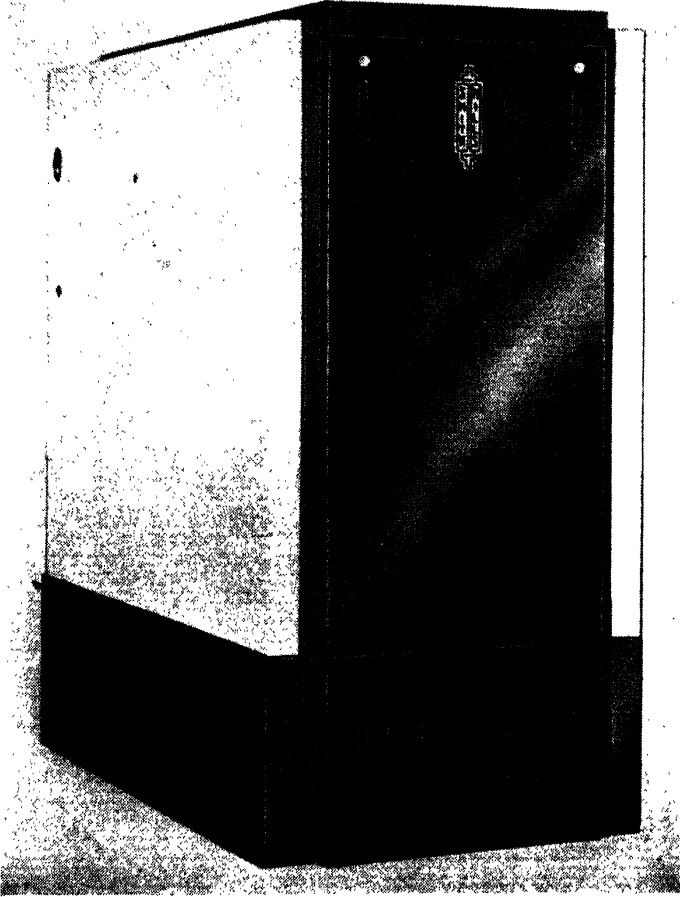

FIG. 5-4.—Packaged type of cast-iron boiler. (*The H. B. Smith Company, Inc.*)

headers. It is obvious that any one section is entirely independent of all other sections and can be individually replaced should the occasion require. Boilers of this type can also be supplied as a packaged unit. Cast-iron boilers are manufactured by numerous companies, and reliance can be placed on their various products if such products conform to the various standards previously out-

lined. In making a selection among boilers from different manufacturers and of equal ratings, net weights of such boilers, exclusive of auxiliary equipment, casing, etc., are of advantage in making the decision. This factor of net weight applies equally to boilers of either the cast-iron type or the types fabricated from steel plate.

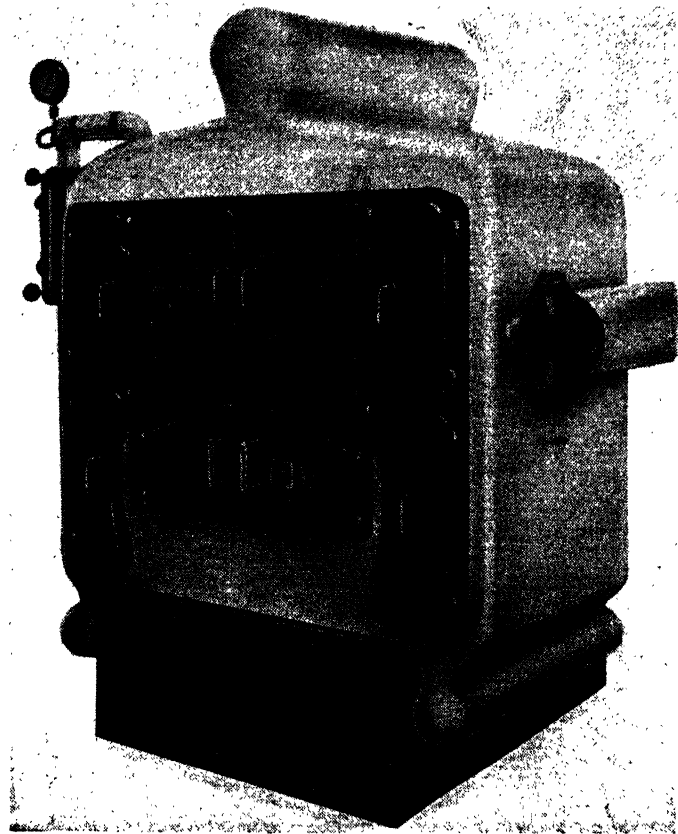

FIG. 5-5.—Header type of cast-iron boiler. (*The H. B. Smith Company, Inc.*)

Other things being equal, the boiler having the greatest net weight can be regarded as the one capable of giving the longest life, extra weight having no influence on operating efficiency. However, weight comparisons should not be made between boilers of markedly different types.

As another example of the modern type of encased cast-iron boiler, we have Fig. 5-6, which shows a general-purpose type of

boiler suitable for gas, oil, or coal, manufactured by the Crane Company of Chicago and designated as their No. 14. The indicating pressure gage at the top of the boiler, as used with hot-water

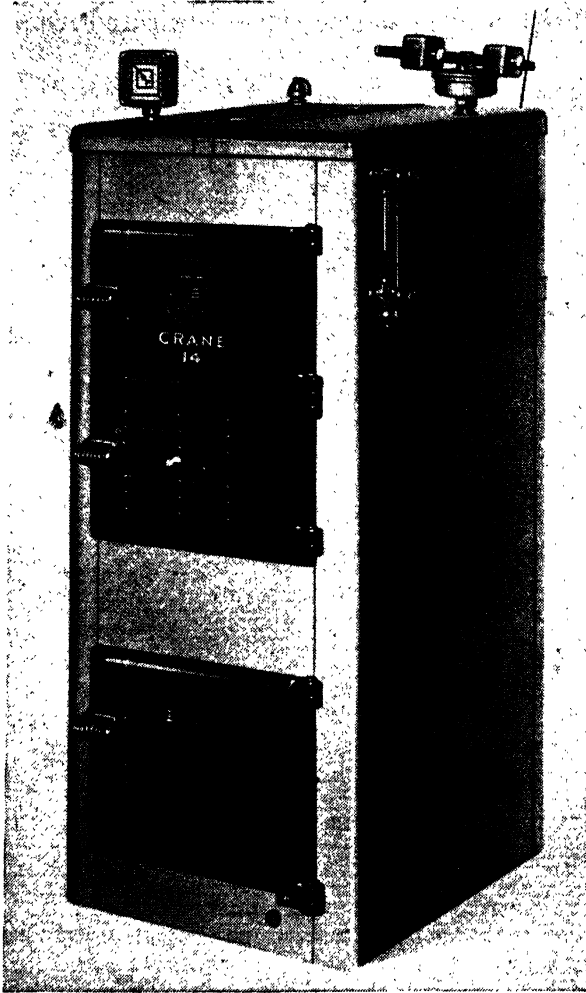

FIG. 5-6.—Universal type of cast-iron boiler. (*Crane Company.*)

boilers, has two hands, one colored red and the other black. The purpose of this is to give a direct indication as to whether or not the water pressure in the boiler approximates normal. One hand is set manually to the proper indication, while the other hand moves in accordance with the pressure of water in the boiler. When all

conditions are normal with, all the radiant heating coils properly filled with water, these two hands coincide in position. If the position of the two hands does not coincide, then existing conditions should be looked into and necessary corrective measures taken.

Figure 5-7 shows a gas-fired boiler of the Crane Company under their designation "Basmor Boiler." All necessary automatic controls are mounted on the face of the unit and are readily accessible for adjustment or repair. With automatic gas-fired

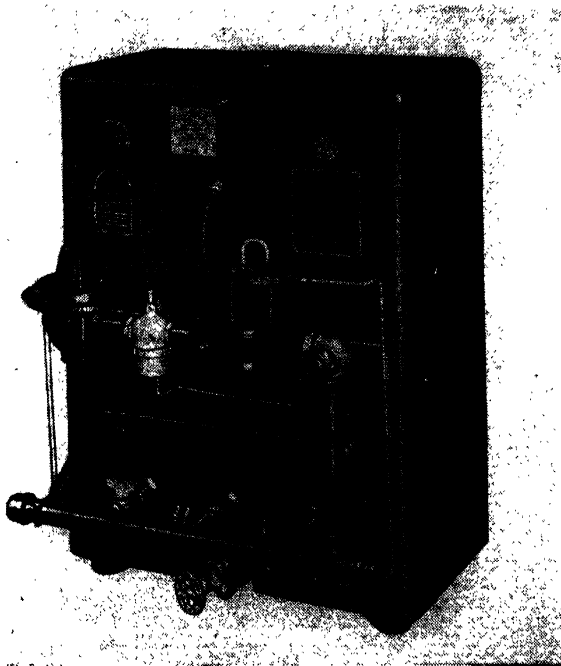

FIG. 5-7.—Gas-fired boiler. (*Crane Company.*)

equipment, it is necessary that every precaution be taken against possible explosion. This requires that means must be provided to ensure that gas cannot be admitted to the burners without being ignited. The "Basmor Boiler," as shown, is provided with the necessary devices to ensure against any improper condition of operation.

Crane boilers can be obtained for automatic firing in sizes ranging from approximately 60,000 net Btu per hr up to and including a maximum of approximately 1,700,000 Btu per hr.

For an example of a cast-iron boiler furnished as a packaged unit, together with the oil burner which is of the centrifugal type, reference is made to Fig. 5-8, which shows the external appearance, and Fig. 5-9, which shows the internal construction of a packaged unit as furnished by the Timken Silent Automatic Division of The



FIG. 5-8.—Packaged-type of boiler with oil burner. (*Timken Silent Automatic Division, The Timken-Detroit Axle Company.*)

Timken-Detroit Axle Company, Detroit, Mich. In the construction shown, there is the advantage obtained by using cast-iron surfaces where they are exposed to heat and flame on one surface and water on the other, with the boiler unit insulated and enclosed in a sheet metal cabinet. ³For insulation, the Timken Company uses spun glass of the blanket type which is nondeteriorating and

nonhydrosopic. The oil burner used with this equipment is further described in the section of this chapter dealing with burners. The boiler illustrated has a capacity of 65,000 Btu per hr, and provision is made for attaching an indirect water heater for

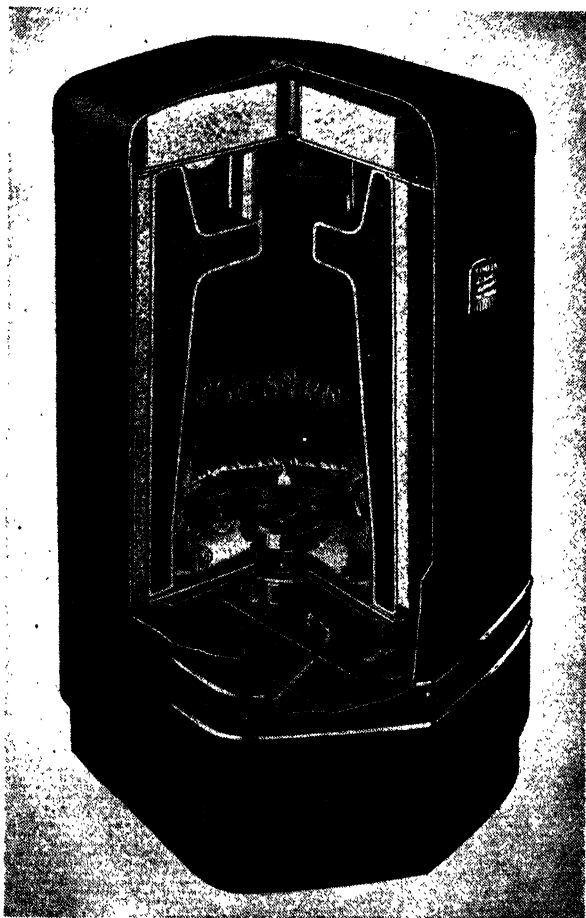

FIG. 5-9.—Sectional view of boiler and oil burner. (*Timken Silent Automatic Division, The Timken-Detroit Axle Company.*)

domestic use in the event that the heating load plus the domestic hot-water load do not exceed the rated capacity. Timken units are manufactured in ratings extending from a minimum of 65,000 to a maximum of 625,000 Btu per hr. Figures 5-10 and 5-11 give the external and internal views of the Timken type of hot-water heater. These can be used in radiant heat installations for the

supply of domestic hot water where it is not desirable for some reason to operate the heating boiler throughout the entire year for

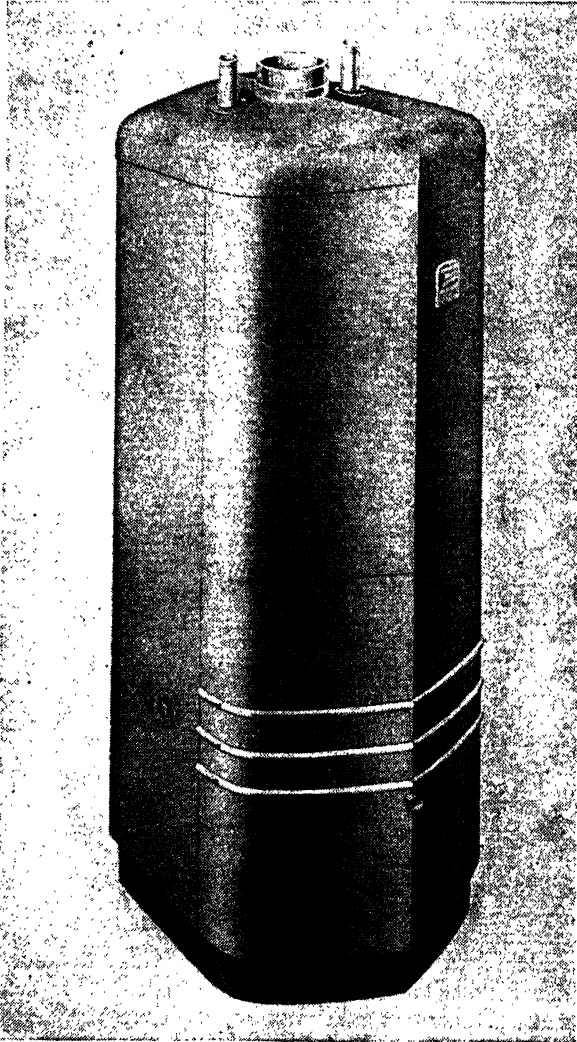

FIG. 5-10.—Packaged-type of domestic water heater. (*Timken Silent Automatic Division, The Timken-Detroit Axle Company.*)

the purpose of supplying this service. Conditions requiring such an arrangement might exist, for example, in those areas where the winter heating season is relatively short and the installation of separate units justifiable from the standpoint of operating economy.

Steel boilers are of many types and manufactured by a large number of concerns. Designs range from those following conventional types of power boilers to those designed particularly for

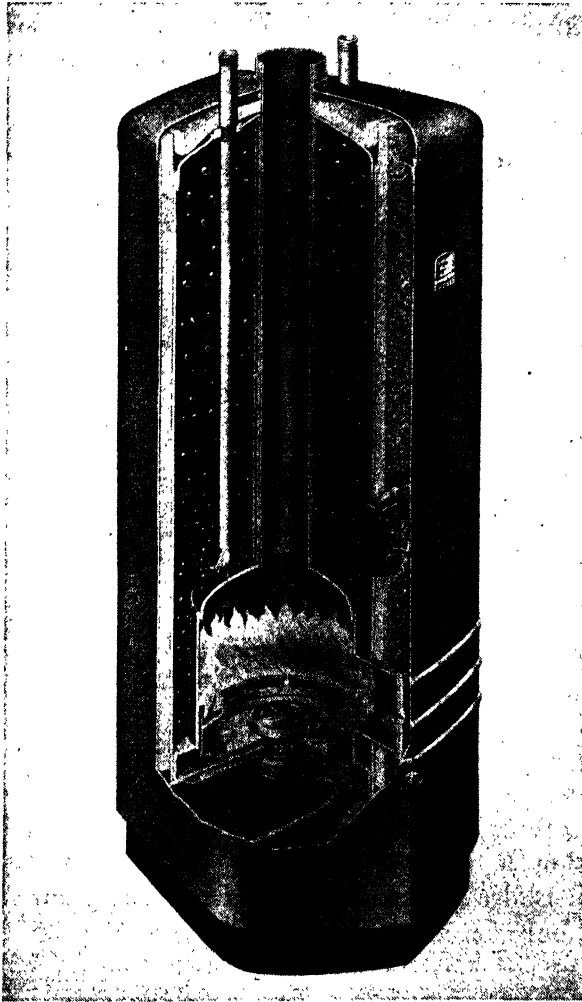

FIG. 5-11.—Internal view of domestic water heater. (*Timken Silent Automatic Division, The Timken-Detroit Axle Company.*)

domestic use. Of these general types, there are two kinds: one known as fire tube and the other as water tube. The oldest type of steel boiler was of the fire-tube type and consisted of a cylindrical shell transversed longitudinally by iron or steel tubes,

through which the products of combustion passed. The tubes were arranged to be completely submerged in water with steam space in the encircling drum above the water level. In water-tube boilers there are usually one or more relatively small-diameter cylindrical drums connected by means of small-diameter iron or steel tubes, the assembly being completely full of water in the case of hot-water boilers. Other types are modifications of the conventional locomotive type of fire-tube boiler, in which there is a rectangular section, comprising the firebox, connected to the cylindrical drum of the boiler proper, containing the fire tubes through which the products of combustion pass. Usually the walls of the rectangular firebox are provided with water circulation to absorb heat and prevent overheating of the respective parts. Any of these various types of boilers can be incorporated in a packaged type of design, together with the necessary form of mechanical burner, an over-all steel casing, and suitable insulation.

As an example of a packaged type of steel boiler of the fire-tube type, reference is made to Figs. 5-12 and 5-13, which show a steel boiler as manufactured by the Penn Boiler and Burner Mfg. Corp. of Lancaster, Pa. Figure 5-12 shows the over-all appearance of a completely packaged unit, and Fig. 5-13 shows its interior construction. It is to be noted that the design includes hot-water coils suitable for use in tankless domestic hot-water application. On the front of the boiler, concealed beneath the removable front plate of the casing, are the necessary controls, circulator, and oil burner, together with a light for facilitating inspection. The relatively large amount of hot water is available in the upper part of the boiler to supply the necessary heat storage for the satisfactory operation of the tankless heater coils. It will be noted that in the Penn Boiler design, the firebox is entirely surrounded with water, not only on the top and sides but also on the bottom. With this type of construction, heat losses from the boiler are held to a minimum. The firebox and fire-tube elements are constructed of stainless steel to resist more effectively the tendency to corrosion, and suitable ports are provided, as the illustration shows, for the purpose of cleaning those areas exposed to the products of combustion. The aquastat controlling burner operations is so located as to respond promptly to temperature variations due to the operation of the tankless heater coils. The oil burner manu-

factured by the Penn Boiler and Burner Mfg. Corp. is of the pressure vaporizing type with electric ignition and includes a properly proportioned blower to supply the necessary air to the burner and at the same time to assist in its atomization.

Figure 5-14 shows a packaged type of air heating unit as manufactured by the Penn Boiler and Burner Mfg. Corp., which makes use of a tube and plate type of heat exchanger for warming air with steam as a source of heat. In the illustration, it will be

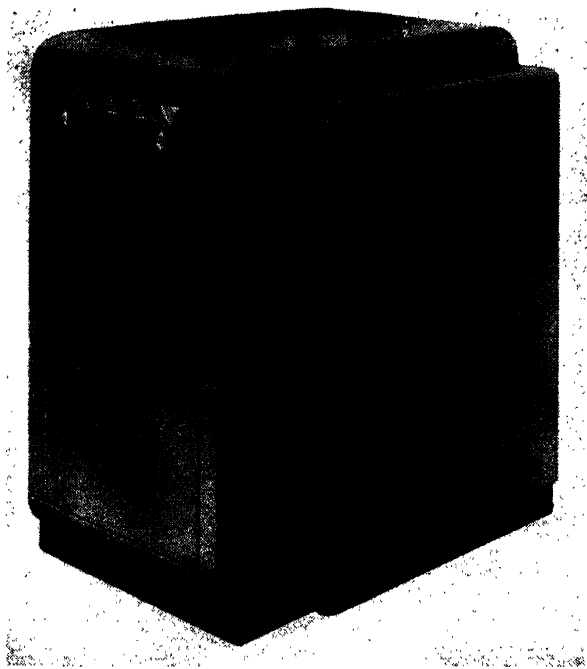

FIG. 5-12.—Packaged steel boiler. (*Penn Boiler and Burner Mfg. Corp.*)

noted that there is a blower type of fan, driven by a small electric motor, which directs the blast of air over the steam-heated exchanger. This equipment is mounted on top of a steam boiler manufactured by the same company. This type of equipment is desirable where warmed air is to be used as a means of transferring heat to room surfaces instead of the more usual method of circulating hot water. As the air is indirectly heated through the medium of steam, the possibility of excessive air temperatures is automatically avoided; and with the use of a packaged-steam

boiler equipment as shown, a supply of domestic hot water can be provided through the medium of the heating boiler. In the illustration, a tankless heater type of domestic hot-water coil is shown installed in the boiler water space. As in Fig. 5-13, the oil burner and all the controls are arranged within the sheet metal case for convenience in installation as well as for improving the appearance.

As an example of an entirely different type of heating boiler,

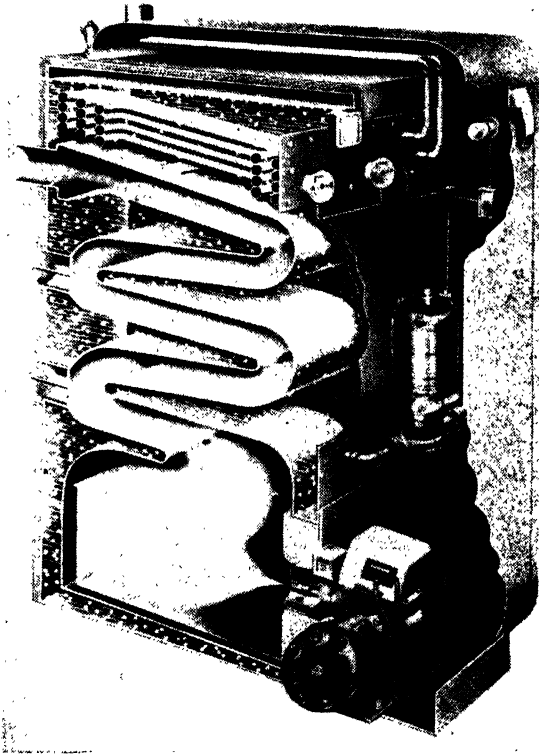

FIG. 5-13.—Internal construction of packaged steel boiler. (*Penn Boiler and Burner Mfg. Corp.*)

reference is made to Fig. 5-15, which gives the details of a hot-water boiler or heater constructed of copper and using gas as a fuel. This type of heating unit, which is commonly known as a "Burkay Heater," is manufactured by the A. O. Smith Corporation of Milwaukee. The illustration shows very clearly the gas burner within a coil of copper tubes, and on the top of this coil a heat exchanger of the extended surface type is located, consisting of a

series of copper plates through which are threaded lengths of copper tubing bonded to the copper plates. Regulating and control valves are shown on the left side of this heater. A large installation of this type of heater is shown in Chap. VIII.

Of equal importance to the boiler is the automatic burner unit associated with the boiler, by means of which the heat energy

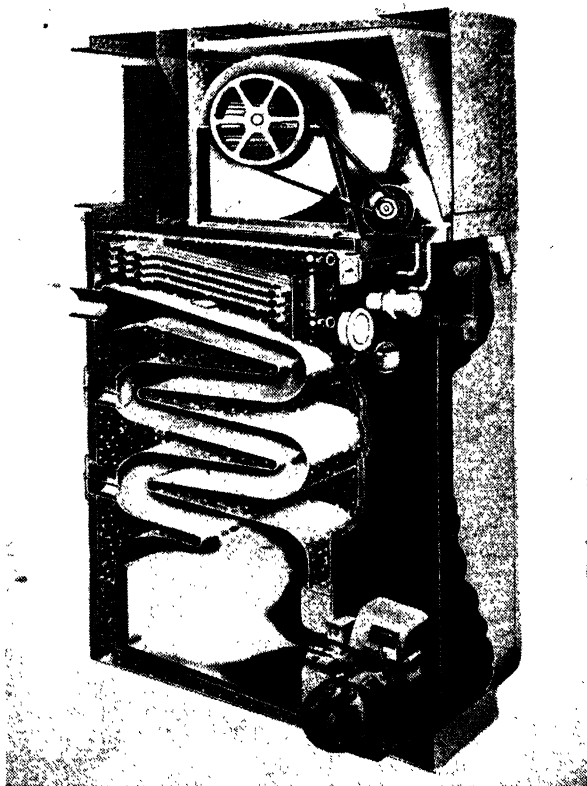

FIG. 5-14.—Sectional view of steam air-heating boiler. (*Penn Boiler and Burner Mfg. Corp.*)

present in the fuel is converted into heat and transmitted through the boiler to the radiant heating coils. Automatic burners are supplied for use in conjunction with gas, oil, or coal. Of these three types, the gas burner is the simplest and usually consists of an enlarged model of the type of gas burner present in the ordinary gas stove. The essential features of this burner are to provide adjustable means for mixing the proper amount of air intimately

with a jet of gas so that it burns with a nonluminous flame, thus giving maximum efficiency for the combustion of natural or artificial gas.

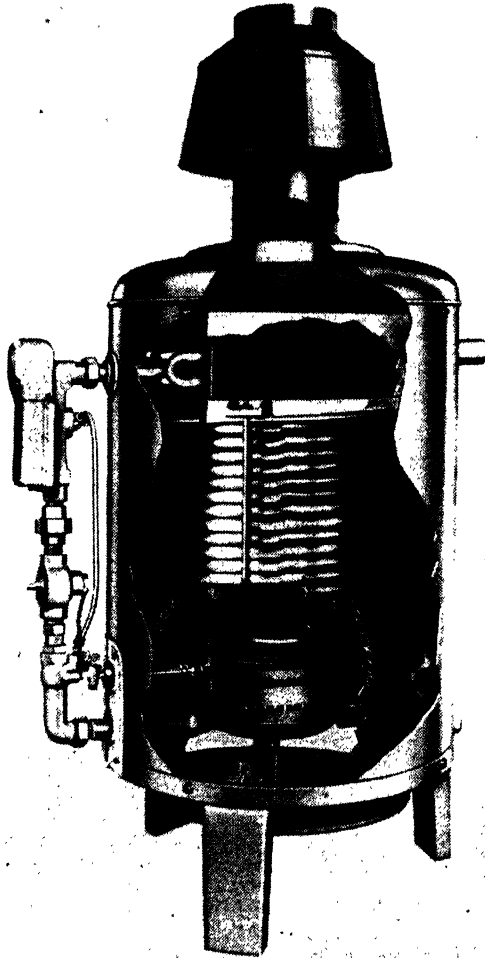

FIG. 5-15.—Copper-coil gas-fired boiler. (A. O. Smith Corporation.)

Gas is probably the most desirable fuel to be used in connection with a domestic heating system. It is delivered through underground pipes, metered and paid for monthly in accordance with actual use. Regulation is obtained with a maximum simplicity of equipment, although means must be provided to ensure the

discontinuance of gas supply in case the burner is not ignited promptly after the automatic control devices open the automatic gas-supply valve in an attempt to increase the production of heat. Gas pipes should be thoroughly sealed where they enter a building, because if this precaution is not taken, gas escaping from a defective street main sometimes follows along the outside of the pipe seeking an escape to the atmosphere, with the result that it can actually leak into the basement of a building, in which case it is possible for an explosion to ensue.

Next to the convenience of gas comes the use of oil fuel. This type of fuel is ordinarily delivered by truck without the necessity of entering the building. It is delivered to the burner from storage without the intervention of manual labor, and, of course, there are no ashes or other products of combustion to be disposed of following the combustion of the fuel. There are two general types of oil burners suitable for burning the less expensive grades of fuel oil, both of them operated by an electric motor. One type is known as the pressure atomizing type, and the other as the rotary atomizing type, which may employ either a vertical or horizontal rotating element. The first type involves a unit consisting of an electric motor, air blower, oil pump, burner tube, and nozzle so arranged that the oil pump takes oil from the supply tank, which may be below the level of the boiler, raises the oil to a considerable pressure on the order of 20 to 50 lb per sq in., and delivers this oil under pressure to the burner nozzle, which is so designed that the oil will leave the nozzle as a very fine spray rather than a stream. The blower delivers air through the burner tube in proper amounts and usually with a whirling motion with respect to the atomized oil so as to mix air and the fine oil particles thoroughly, with the result that efficient smokeless combustion can be attained.

The second type of burner, comprising the rotary atomizing vertical burner, is shown by Figs. 5-9 and 5-11. It will be noted therein that a horizontal rotating plate which acts as an oil distributor also acts as a fan. The driving motor is situated with its shaft vertical at a suitable distance below the burner proper. When the burner is put into operation, the oil blower and fan operate at relatively high speed, and oil is fed to the center of the revolving plate. This causes the oil to be thrown out and atomized somewhat in the manner ordinarily employed by rotating lawn

sprinklers. Ignition is obtained by means of an electric spark; and when the oil-air mixture passes through and is heated by the grilles indicated in the illustrations, surrounding the revolving element, the mixture is superheated and the oil vaporized while mixed with the air provided for combustion. This design of burner results in a very satisfactory operation; and as the load on the electric motor is only that of rotating the disk, a minimum electric consumption is necessary for its operation. Also, with this burner it is possible to obtain very high percentages of CO₂ in the combustion gases.

It is to be noted that with the Timken burner, oil supply to the burner must be by gravity. Therefore oil storage must be located above the level of the burner; or if the main storage is below the level of the burner, then auxiliary pumping equipment must be provided, such as a Teesdale wall pump and tank installed in the boiler room. This equipment is a unit assembly of pump and tank with a capacity of approximately one gallon, which is sufficient for burner operation. The pump unit in the assembly takes oil from the main storage tank, located below the burner level, and supplies it to the auxiliary tank, where a predetermined level is held for maintaining suitable oil delivery to the Timken burner.

All oil burners should be certified by the manufacturer as complying with the requirements of commercial standards CS 75-42 as issued by the National Bureau of Standards of the U.S. Department of Commerce; and from the oil companies' viewpoint, an ideal burner should be relatively insensitive to variation in fuel characteristics, such as specific gravity, paraffinicity, and viscosity, and should be capable of burning clean distillate oil, having low API gravity, a Saybolt universal viscosity at 100°F of 45 maximum, and burning rates as low as 0.5 gal per hr. This specification is important from the oil supplier's viewpoint because with ever increasing demands for domestic heating oils, as well as kerosene and diesel fuels, which compete for the same part of the crude oil supply, it is sometimes necessary from the oil refiner's viewpoint to include components in the heating oil from the widest possible number of refinery operations in order to meet demands for readily available low-cost fuel. Not all of the present-day oil burners are capable of meeting this condition without the need for delicate adjustments to meet oil-composition changes in view of market demands.

Although it is true that all presently constructed oil burners operate on an intermittent basis which may be required to maintain desired temperature, this is not an ideal condition. The perfect burner should operate more or less continuously with a varying amount of oil supply as temperature conditions dictate, but no presently constructed burner is capable of this refinement. Another desirable feature on the part of automatic oil burners is the means provided to prevent incomplete combustion accompa-

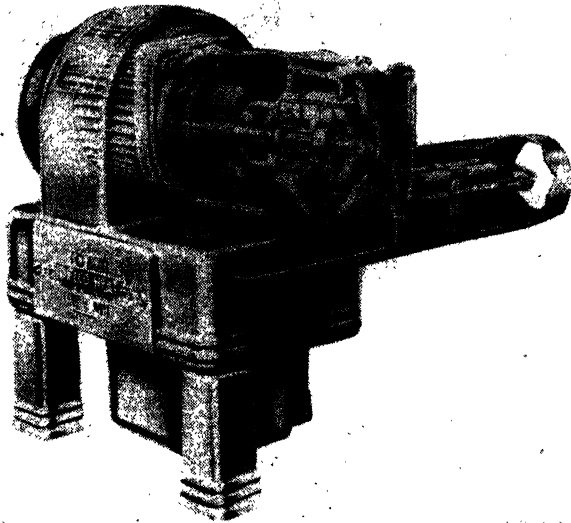

FIG. 5-16.—Sectional view, atomizing oil burner. (*Delco Appliance Division, General Motors Corporation.*)

nied by smoke and soot at the start and finish of the burner cycle, particularly with reference to the end of the cycle. If proper operation is not obtained at this point, the tip of the atomizing burner tends to become clogged externally with a deposit of carbon which interferes with its operation. With some burners, the relationship between the tip of the atomizing burner and its location with respect to the blast of air delivered by the burner tube must be adjusted to the correct position as specified by the manufacturer; otherwise, difficulty will be had with the formation of carbon deposits on the end of the atomizing tube.

Fuel oils are ordinarily supplied in six classifications: Nos. 1 to 6 inclusive. Number 1 is a kerosene type of fuel somewhat more expensive than Nos. 2 and 3 and is intended for the smaller type of domestic burner, including the wick type, which is not considered suitable for domestic heating. Oil fuels Nos. 2 and 3 are the general all-purpose heating oils for domestic applications. These fuels differ in viscosity, and only burners capable of handling No. 3 fuel oil should be installed in domestic boilers. Oil Nos.

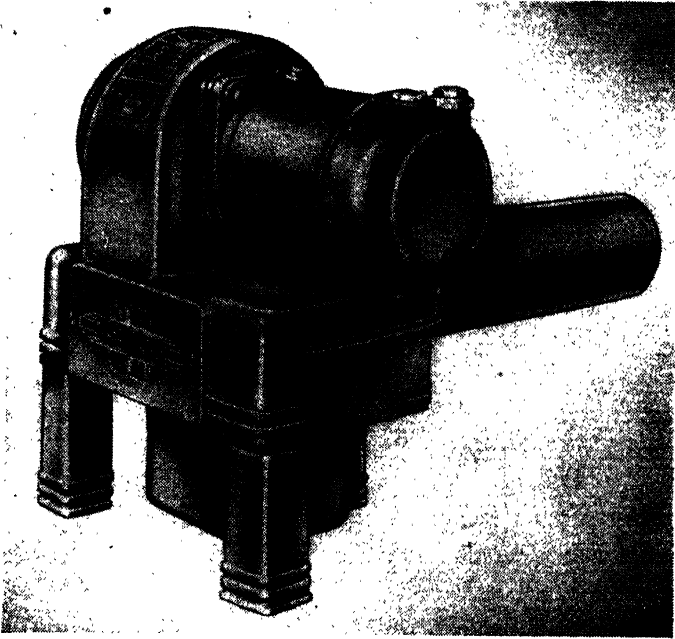

FIG. 5-17.—External view, atomizing oil burner. (*Delco Appliance Division, General Motors Corporation.*)

5 and 6 are not suitable for the usual domestic installations and can be applied only to commercial applications where suitable equipment and supervision are available for their use.

As an example of the pressure atomizing type of burner, reference is made to Fig. 5-16. This burner is manufactured by the Delco Appliance Division of the General Motors Corporation in Rochester, N. Y. The illustration shows the relationship among the electric motor, oil pump, air blower, burner tip, ignition points, and burner tube, including the air-deflecting vanes which give a whirling motion to the air stream to mix the oil spray more

thoroughly with the air stream. Figure 5-17 shows the external appearance of this equipment. These burners are furnished in five sizes for attachment to suitable boilers and have maximum capacity rating in Btu per hour from approximately 129,000 in the smaller size to 550,000 in the larger size. Of course, with intermittent operations, they can work efficiently at less than the Btu deliveries just mentioned. These burners will take oil from tanks



Fig. 5-18.—General purpose oil burner. (*Crane Company.*)

situated below the level of the burner up to a maximum of 8 ft, so that in no case should the bottom of the oil supply tank be over 8 ft below the level of the burner oil pump.

As a further example of a pressure atomizing type of oil burner, Fig. 5-18 shows a burner manufactured by the Crane Company of Chicago, Ill., that is suitable for use with any general-purpose type of boiler. The mechanism proper is shown mounted on an adjustable pedestal so that the height of the burner above the floor can be adjusted to suit the boiler to which it is to be attached. The illustration indicates the location of the driving motor, oil pump, and ignition transformer. An oil-pressure gage is included as a standard element of the construction so that the operator can always check the existence of proper oil pressure when the burner is operating. This point is essential in the pressure atomizing type

of oil burner because with less than designed pressure, improper combustion results.

A type of pressure vaporizing burner embodying an unusual feature is that manufactured by the Gilbert & Barker Manufacturing Company of West Springfield, Mass., and known as their "Gilbarco Burner." Figure 5-19 shows the general arrangement of this burner, the novel feature of which is the inclusion of a

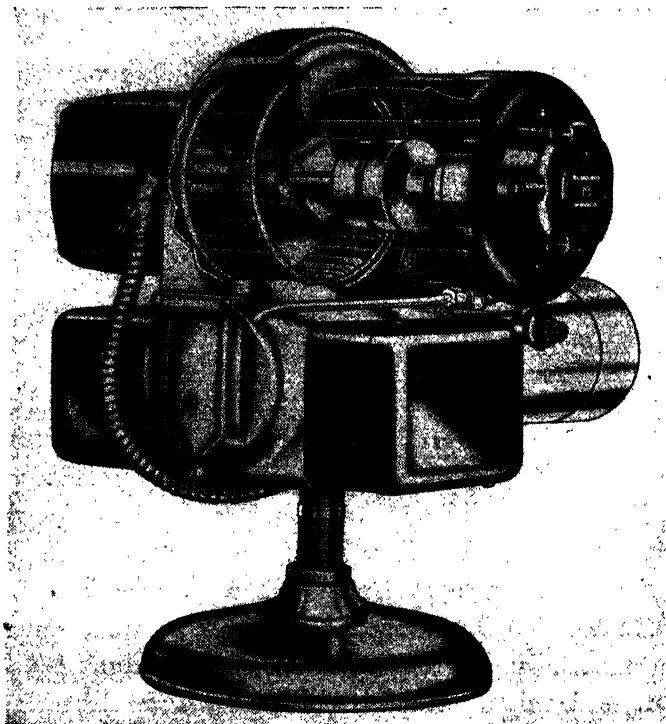

FIG. 5-19.—Special type of oil burner. (*Gilbert & Barker Manufacturing Company.*)

centrifugal type of clutch between the fan element and the oil pump. Inclusion of this clutch gives a somewhat different cycle of operation to the Gilbarco Burner from that of conventional types, for the reason that with the latter the connection between the driving motor, fan, and oil pump is continuous, so that when the motor starts to operate, oil starts to flow from the burner tip before the blower is up to full speed, and in reverse order, when power is cut off, the oil pump continues to deliver oil to the burner tip after blower speed has been reduced to a point where its effectiveness

has become lost. With the Gilbarco Burner, owing to the presence of the centrifugal clutch between the blower elements and the oil pump, the starting of the driving motor develops an appreciable air blast before the oil pump comes into operation and starts delivering oil to the burner tip. The reverse action, of course, takes place when power is shut off from the driving motor, and the blower fan continues to operate for a short time owing to the inertia of the system after the centrifugal clutch has disconnected the oil pump. Consequently, oil burners embodying this principle of operation should have less difficulty with carbonizing on the burner tips and also will have a purging action on the combustion chamber to ensure the elimination of combustible gases that may be present for any reason, thus preventing the formation of smoke puffs which sometimes occur with conventional burners, particularly if not properly adjusted.

For the convenient burning of solid types of fuel, a suitable form of automatic stoker is a necessity. As with other equipment, these devices come in a number of designs and with various attachments intended to increase their desirability and at the same time to decrease the attention required on the part of the operator.

There are two broad types of automatic stokers available for domestic use; one type is known as the overfeed, and the other type as the underfeed. The designations are practically self-explanatory; overfeed stokers supply the fuel bed from above, and the underfeed supply it from below. Each type has its particular application. Overfeed stokers are especially adapted to burning refuse fuels, such as sawdust and tanbark. For burning coal, either anthracite or bituminous, underfeed stokers are usually preferred.

Figure 5-20 shows the over-all appearance of a coal stoker as manufactured by the Delco Appliance Division of the General Motors Corporation of Rochester, N. Y.

Figure 5-21 shows the constructional details of this device, which is of the hopper type; *i.e.*, coal has to be carried manually from the coal bin to the hopper on the stoker, access to the hopper being through the hopper lid indicated in the illustration. The motor shown in the center right of the illustration drives the air blower and also the transmission shown at the bottom right. This transmission drives the coal screw, also shown, which delivers coal

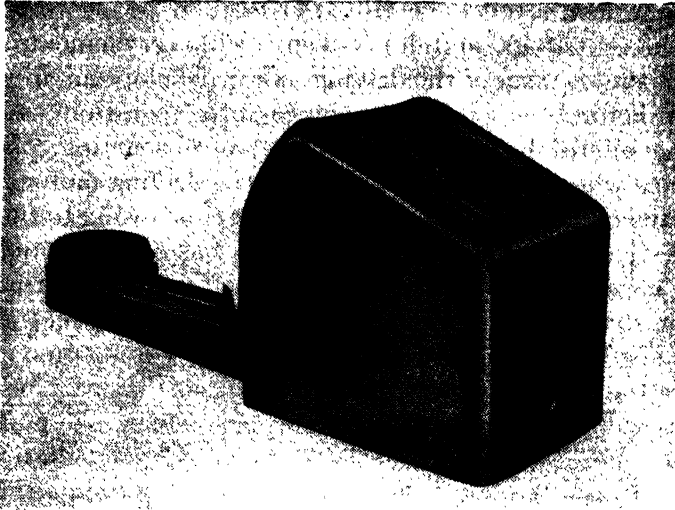

FIG. 5-20.—Hopper-style coal stoker. (*Delco Appliance Division, General Motors Corporation.*)

from the hopper to the burner proper; running parallel to the coal screw will be observed the air ducts. Air-volume adjustments are made by means of the device indicated in the illustration to the left of the blower. The burner proper is composed of five elements,

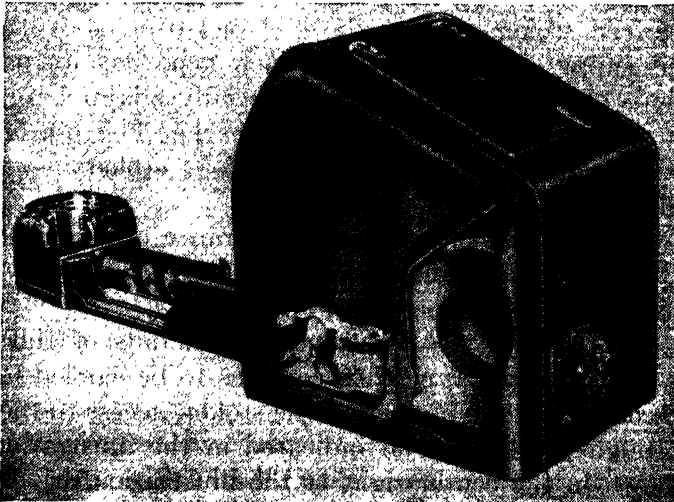

FIG. 5-21.—Sectional view of coal stoker. (*Delco Appliance Division, General Motors Corporation.*)

known as the wind box, retort, retort shell, tuyère, and ash ring. In the illustration the tuyère is inside the retort shell, and both are capped by the ash ring. Adjustments are provided so that proper relationship can be had among the burning rate desired (pounds of coal per hour), the proper associated feed for the coal screw, and proper air pressure and delivery, for the purpose of maintaining a proper volume of incandescent coal in the burner while the stoker is not in operation and at the same time ensuring that all coal delivered to the retort by the coal screw will be completely burned

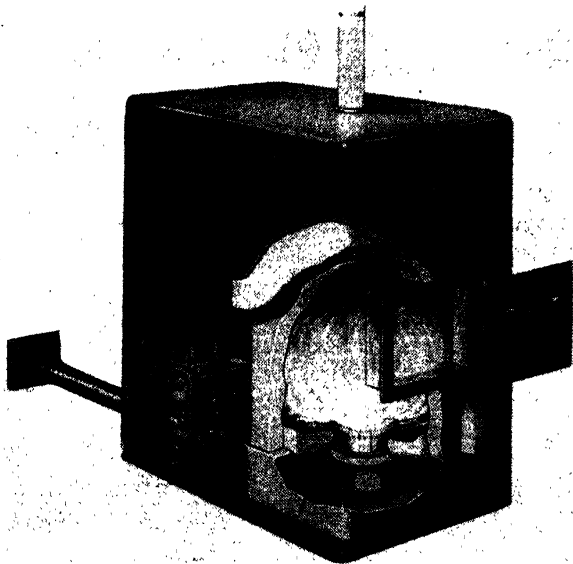

FIG. 5-22.—Bin-feed coal stoker. (*Iron Fireman Manufacturing Company.*)

before the residue falls over the ash ring. These stokers are built in three sizes having maximum capacities varying from a minimum of 144,000 Btu per hr to a maximum in the largest size of 360,000 Btu per hr. The smallest size requires a $\frac{1}{2}$ -hp motor and delivers from 10 to 20 lb of coal per hour to the retort. The largest size stoker is equipped with a $\frac{1}{2}$ -hp motor and has a maximum delivery of approximately 51 lb per hr.

Figure 5-22 shows the application of a stoker as manufactured by the Iron Fireman Manufacturing Company of Cleveland, Ohio. The illustration shows an application of bin feed. In this

application coal is automatically withdrawn from the bin by means of a coal screw and delivered to the burner as required. The illustration clearly shows the relationship among the wind box, retort, and furnace volume. In addition to automatic feed, it is possible to arrange for automatic ash disposal so that the stoker not only withdraws its necessary coal supply from the bin but also deposits ashes in a suitable removable container, thus reducing to an absolute minimum the manual labor required by its owner. However, even with all automatic devices installed, it can be

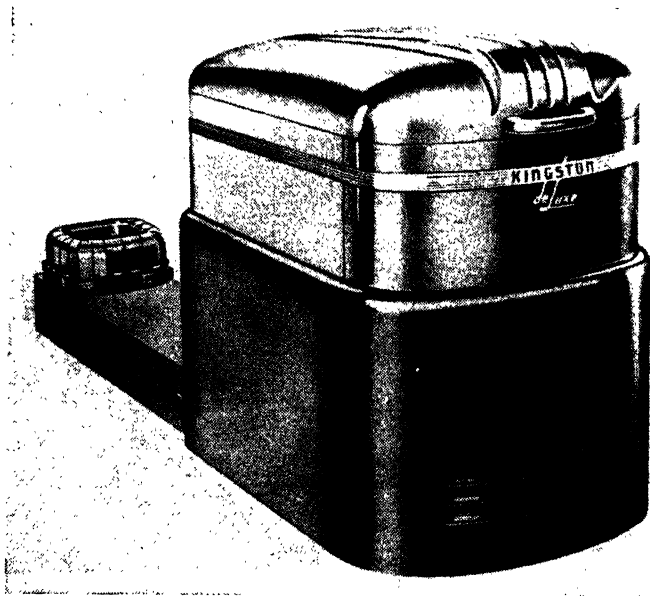

FIG. 5-23.—Stoker suitable for bituminous coal. (*Crane Company.*)

assumed that more attention will have to be given any type of automatic stoker than is required by an oil or gas burner.

Figure 5-23 gives an exterior view of the Kingston Stoker, supplied by the Crane Company of Chicago, which is suitable for the burning of anthracite or bituminous coal.

One distinguishing difference between automatic burners using gas or oil and stokers using coal is that with both gas and oil, when no more heat is momentarily required, the burner goes out entirely and generation of heat ceases, but this is not possible with a coal stoker. A minimum amount of fire must be continuously maintained so that when the aquastat or room thermostat calls for heat,

the stoker responds within a reasonably short time. The device for preventing the fire in a stoker from becoming completely extinguished is included in the controls in such a manner that, regardless of the calls for heat, the burner will be subjected to intermittent short-time operation of such magnitude as to ensure that the fire is kept in suitable condition for responding to control requirements.

Following the boiler and burner, the third most important item in plant equipment is the circulator, this being the electric-driven pump that forces the water to the boiler and up to the radiant

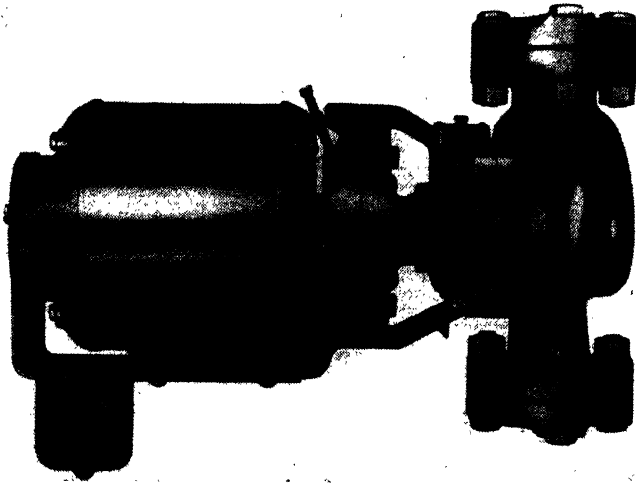
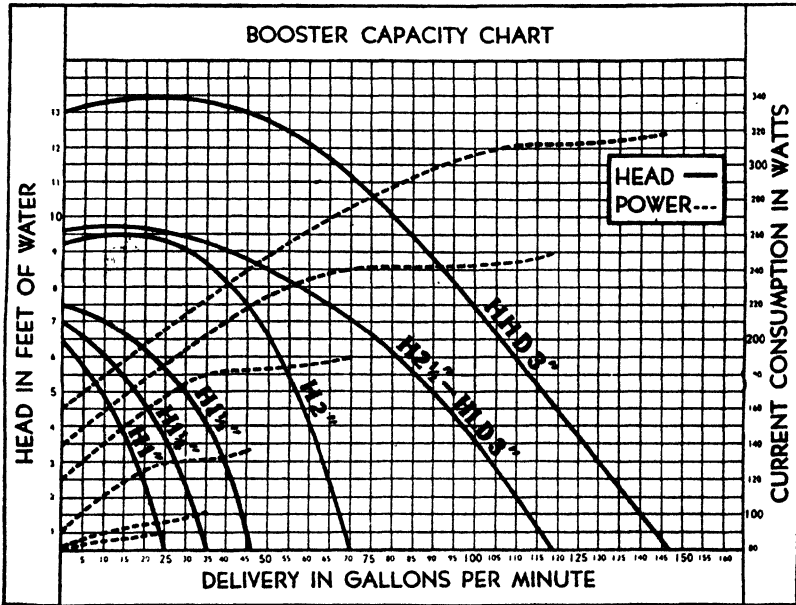

FIG. 5-24.—Horizontal circulating pump. (*Bell & Gossett Company.*)

heating coils. Circulators are manufactured and sold by a large number of companies. The essential features of circulators are electric motors connected to a centrifugal type of pump through some form of flexible coupling which is required not only for the purpose of correcting inequalities in alignment between the pump and the motor but also for the purpose of ensuring silence in operation.

Figure 5-24 shows the type of circulator manufactured by the Bell & Gossett Company of Morton Grove, Ill., and designated by them as a "booster pump." Figure 5-25 gives the capacity in gallons per minute of various sizes of Bell & Gossett boosters and also the head in feet of water, so that from this chart the proper

circulator can be selected for any given set of conditions; for example, the $1\frac{1}{4}$ size will deliver 35 gal per min against zero head, and the maximum height to which it will raise water is 7 ft. At this point, there will be no delivery in gallons per minute, but it will deliver 20 gal per min against a head of $4\frac{1}{2}$ ft. The same chart also gives the power consumption in watts of the various sizes of pumps; and from the example just quoted, that is, 20 gal per min against a $4\frac{1}{2}$ -ft head, it will be observed that the power consumption



tively larger diameter are used, it is probable that the standard type of booster would be more suitable.

Figure 5-27 shows another type of circulator as manufactured by H. A. Thrush & Co. of Peru, Ind. This type of circulator operates with the rotating axis vertical instead of horizontal, and the illustration clearly shows the spring type of flexible coupling that is employed by the Thrush Company as well as the spring mounting of the motor itself on its supporting bracket, the object being, of course, to minimize the transmission of motor noises into the circulating system.

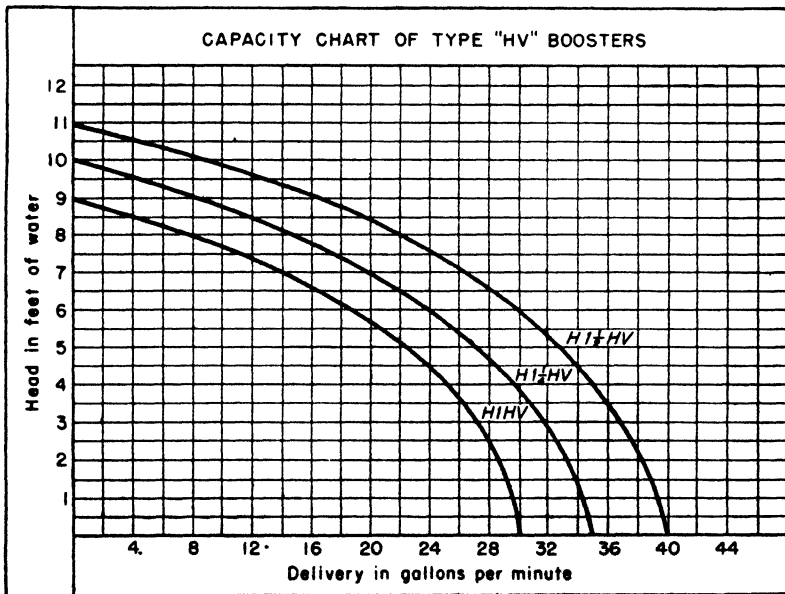

FIG. 5-26.—Capacity chart, high-head circulators. (Bell & Gossett Company.)

Figure 5-28 gives the capacity curves of the Thrush circulator in gallons per minute referred to delivery head in feet. Curve A in Fig. 5-28 gives the capacities of the largest size 3-in. circulator, and it will be observed that the maximum delivery of 125 gal per min at zero head also provides a maximum head of $9\frac{1}{2}$ ft at zero delivery. The smallest size of Thrush circulator is the 1-in. with a maximum delivery of 25 gal per min at zero head. Other deliveries and head relationships follow the general form of Curve A. For installations requiring higher delivery heads than that furnished by their standard circulator, the Thrush Company

advocates the use of two or more circulators in series. Curve *B* shows the effect of using two circulators in series; Curve *C* shows the effect of using three. Curve *D* shows the effect of using two circulators in parallel. It is to be particularly noted that in those cases where one circulator does not give a sufficient delivery in gallons per minute against a required head, the solution lies in placing two circulators in series so that their respective heads are

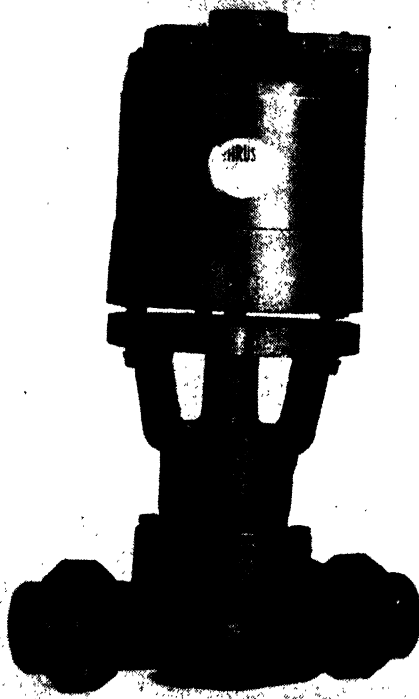

FIG. 5-27.—Vertical type of circulating pump. (*H. A. Thrush & Co.*)

added and not in placing the circulators in a parallel relationship. For example, if a delivery of 75 gal per min is required, against a head in excess of 8 ft, two circulators in parallel will just make this delivery, whereas two circulators in series with their heads added will result in a delivery of 75 gal per min against a possible head of 13 ft, and three in series would give a 75-gal per min delivery against a head of 20 ft. One advantage in using two circulators in series against a relatively high head rather than a single circula-

tor especially designed for the higher head resides in the fact that in the event of motor failure to a single circulator, the equipment becomes entirely inoperative and failure of the entire heating system results, whereas when two circulators are used in series, the failure of one circulator will not put the system entirely out of commission. For example, with a required delivery of 75 gal per min against a head of 10 ft, two circulators in series will be fully capable with considerable reserve of supplying this specification. The curve shows that two circulators will be capable of delivering either 75 gal per min against a head of 13 ft or 85 gal per min against a head of 10 ft. In the event that one circulator fails for

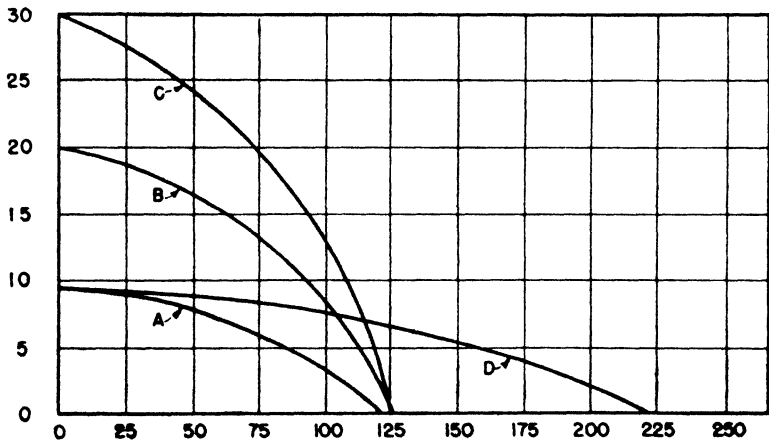

FIG. 5-28.—Capacity-curve circulators in series and parallel. (H. A. Thrush & Co.)

any reason, one circulator in service would still remain which would probably deliver 20 gal per min against the resulting lower friction head, thus preventing a total loss of the heating equipment during such times as one circulator was inoperative.

In addition to the main elements necessary in any radiant heating installation, *i.e.*, boiler, burner, and circulator, various secondary auxiliary devices are necessary or desirable, and these items are manufactured by several companies, including the Bell & Gossett Company of Morton Grove, Ill.; Sarcotherm Controls, Inc., of New York; Taco Heaters, Inc., of New York; and H. A. Thrush & Co. of Peru, Ind. One of the essential items that should always be installed is some form of relief valve to prevent excessive pressures from appearing in the heating system. Another

item is a reducing valve through which make-up water is supplied to the boiler from the city water system, which usually carries higher pressures than are suitable for introduction into the boiler. This discrepancy is corrected by a reducing valve which, together with a relief valve, absolutely prevents excessive pressures from appearing in the boiler and connected circuits.

Another device of importance is a flow check. This is a special type of check valve which closes when the circulator is not in operation and prevents thermal circulation from taking place when the circulator is stopped. If this device is not employed, hot water will tend to circulate through the system when such circulation

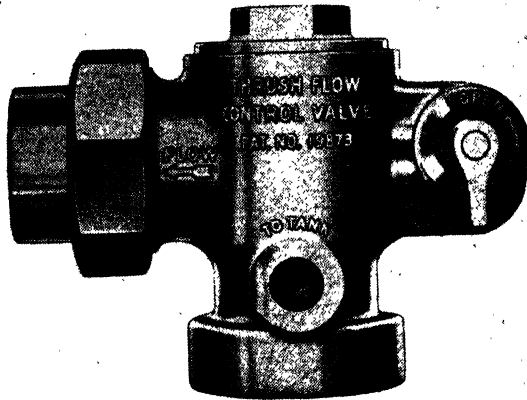

FIG. 5-29.—Flow-check valve. (H. A. Thrush & Co.)

is not desired or called for by the thermostatic controls. It is very necessary that a flow check be always included in any radiant system. Figure 5-29 shows such a valve manufactured by H. A. Thrush & Co. This valve is provided with an outlet for connection to a pressure tank.

In regard to tankless types of devices for supplying domestic hot water, it is desirable that some form of automatic tempering valve be included. Figure 5-30 shows such a valve as manufactured by Taco Heaters, Inc. It is obvious that if domestic hot water has not been drawn for some time through the tankless heater coils, the temperature of the water in the coils will approximate that in the boiler, with the result that without a tempering valve, the first draught of hot water from the domestic system will be excessively hot and, after the first installment of water is taken

from the heater, the temperature will continue to fall. An automatic tempering valve takes care of this situation and is placed in the line extending from the tankless heater coils to the house service line; in addition, a third connection to the valve from a source of cold water is also supplied. The valve acts partially to close the supply of hot water from the coils if it is too hot and allows the deficiency in the requirements to be made up with cold

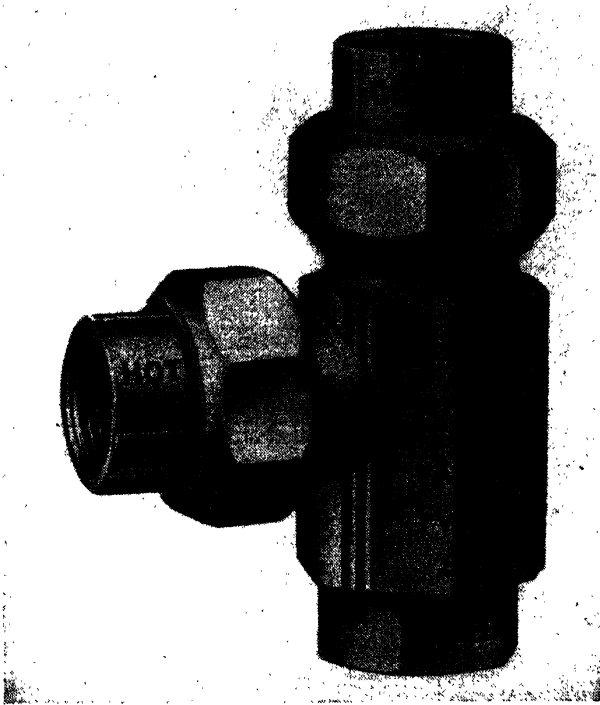

FIG. 5-30.—Tempering valve. (*Taco Heaters, Inc.*)

water. These valves can be adjusted so that regardless of the maximum temperature of water in the boiler, water not hotter than 135 to 145°F will be supplied to the domestic system.

For heating boilers not equipped with domestic hot-water coils, either of the tank or tankless type, suitable heat-exchanger units are obtainable which can be piped to the heating boiler for a supply of domestic hot water.

In the exchanger will be a series of pipe coils which will enable this heat to be transferred to the domestic system. A tankless

type of domestic hot-water heater suitable for attachment to hot water boilers, as manufactured by Taco Heaters, Inc., is shown in Fig. 5-31. This heater is of the four-pass type; *i.e.*, the copper tubes are arranged in four groups, through which the water flows

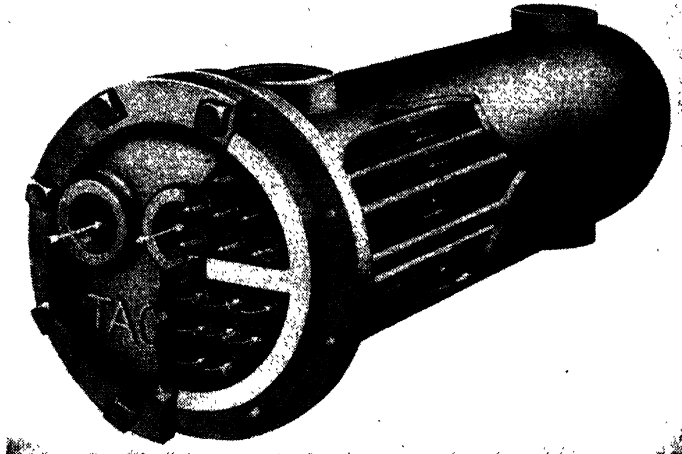

FIG. 5-31.—Domestic hot-water heater. (Taco Heaters, Inc.)

in sequence. The use of external heaters usually requires the installation of a storage tank for maintaining a supply of adequately heated water in quantities suitable for domestic requirements. This type of heat exchanger is available from many companies; and in addition, local sources of supply are sometimes available.

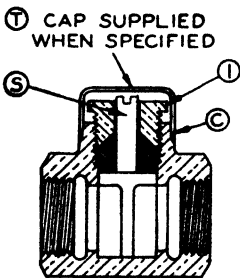

FIG. 5-32.—Flow-control valve. (Sarcotherm Controls, Inc.)

All radiant heating coils should be equipped with a valve at each end of the coil for the purpose of disconnecting it from its source of supply and return headers. In addition to the shutoff valves, there should be supplied at one end of the coil, preferably on the discharge end, a valve of the rotating plug type, not readily adjustable without the help of tools, in order to control the rate of flow of water through the individual coils

and in this manner to control the rate of heat delivery. Figure 5-32 shows a flow-control valve as manufactured by Sarcotherm Controls, Inc.

After a system is installed and while it is being tested, it may be discovered that some areas connected with certain coils are somewhat hotter than expected whereas others perhaps are somewhat cooler. The difficulty is that a larger quantity of water is flowing through the coils delivering too much heat and not enough water is flowing through the coils representing areas that are somewhat cool. The correction to be made lies in the adjustment of the

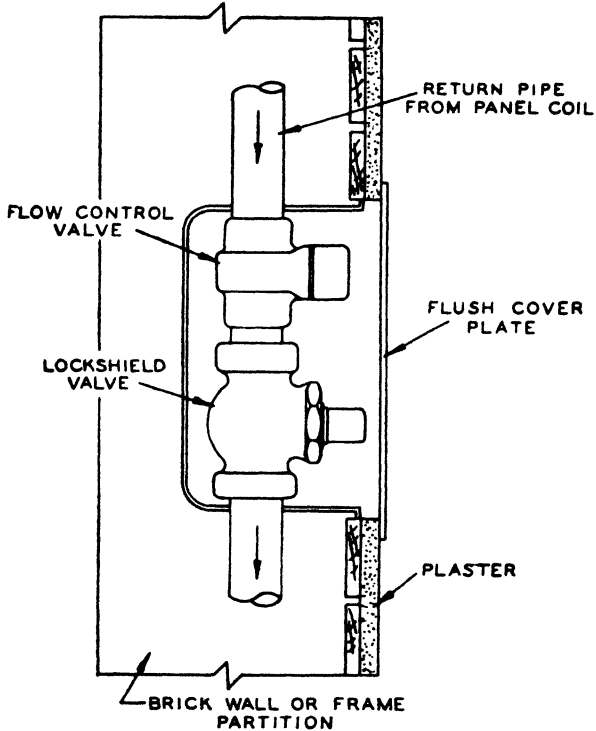

FIG. 5-33.—Flow-control and shutoff assembly. (*Sarcotherm Controls, Inc.*)

flow-control valve. This process is called “balancing.” After the system has been adjusted for balance, no further change in the balancing valves should be made; and if it becomes necessary or desirable for any reason to shut off the flow of water in any coil, either the inlet or the outlet valve can be completely closed. If, on the other hand, it is desirable to disconnect the coils completely from service, both valves can be closed, but it is not necessary in any event to change the adjustment of the balancing cock. Figure 5-33 shows a combination shutoff valve and flow-control valve as

manufactured by Sarcotherm Controls, Inc., for the above purposes, which is intended to be built into the wall or ceiling structure, accessible through a removable cover plate.

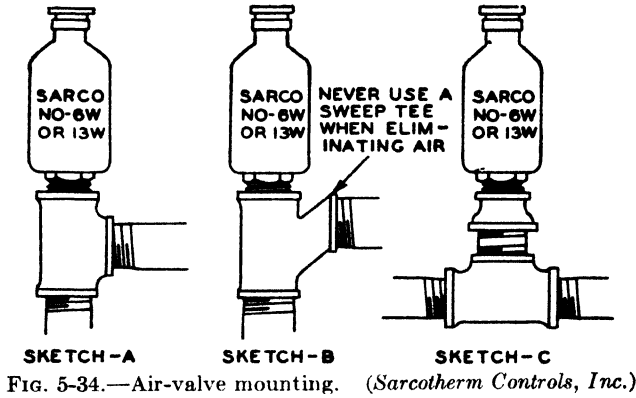

FIG. 5-35.—Air valve. (Bell & Gossett Company.)

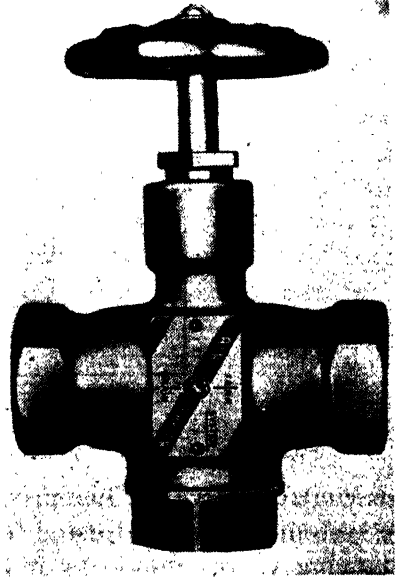

FIG. 5-36.—Air-charger valve. (Bell & Gossett Company.)

An air trap is a desirable device to install in the main leading from the boiler to the heating coils and consists simply of an enlarged section of the piping so arranged that all the water leaving the boiler passes through this section at such a rate as to allow any

entrained air to separate. This air accumulates in the top of the device and can be drawn off either manually by a petcock or automatically through an air valve. Devices of this type are manufactured by Sarcotherm Controls, Inc., as shown in Fig. 5-34, and by many others, including the Bell & Gossett Company, whose type of air valve is indicated in Fig. 5-35. In addition to an automatic air vent located adjacent to the boiler, additional air vents should be supplied at the top of both the supply and return risers. If desirable, the discharge from these air valves can be prevented from damaging upstairs ceilings by running small-size tubing from the air vent discharge to the basement or boiler space, where any flow of water and air from the automatic vent can be taken care of without injury or disfigurement to the building structure.

For installations making use of an air cushion or compression tank as distinguished from an open type of tank installed above the highest point of the heating system, it is desirable to provide an air charger and tank drainer valve for the purpose of properly keeping the compression tank partially filled with air to provide sufficiently for expansion.

The use of one of these valves makes it a very simple matter to keep the compression tank properly charged with air; and without its use, a multiplicity of valves and operations are required to perform this necessary service to the compression tank.

Figure 5-36 shows an air charger valve as manufactured by the Bell & Gossett Company and also shows its method of connection to the compression tank.

Figure 5-37 shows a motor-operated valve as manufactured by the Bell & Gossett Company, which is useful in connection with installations requiring zoned controls.

Figure 5-38 shows a construction involving 11 circuits to radiant coils, divided into three groups and each group under the control of an electrically operated valve arranged with a by-pass to ensure



FIG. 5-37.—Motor-operated valve.
(Bell & Gossett Company.)

continuity of operation, but not including means for removing the valve while the system is in operation, the assumption being that there will be ample time during the off-peak period to make such repairs as might become necessary.

It is to be particularly noted that in this chapter a number of manufacturers of various types of equipment have been mentioned

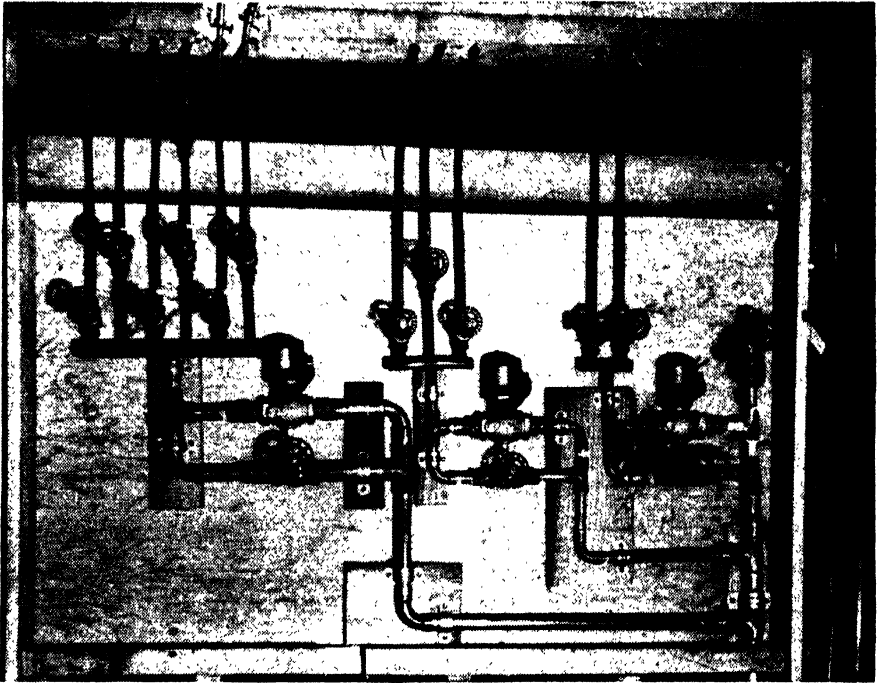

FIG. 5-38.—Zoning-valve assembly. (Courtesy of R. H. Allen, Allen Copper Coil Manufacturing.)

and their particular types of equipment have been described. It is not to be inferred that the omission of any manufacturer or of any special equipment is to be regarded as indicating that they are not suitable for the purpose intended. Limitation of space made it necessary to limit severely the number of manufacturers that could be mentioned, as well as the various devices suitable for radiant heating application as manufactured by the concerns listed and the many efficient and acceptable devices that are generally available in the market.

CHAPTER VI

CONTROL SYSTEMS FOR RADIANT HEATING

Any method of space heating for human comfort necessarily requires some method of automatic control; otherwise, individual attention would be required from time to time to keep conditions within proper limits. This condition is well exemplified in the use of common stoves. Continual attention must be given these devices either to add fuel or open up or shut down the drafts; otherwise, extreme conditions of heat or cold ensue, or possibly the device ceases to operate.

In order to understand the factors involved in selecting the most suitable method of control for radiant heating, it is advisable to review the simpler methods of controlling heat systems, which, although they can be used for radiant heating, do not give so efficient a result as would be desirable for this advanced method.

On this basis, the simplest method of heating by hot water, together with the simplest controls, would consist of a hot-water boiler connected with suitable radiators or convectors, natural thermal circulation being depended on to supply the radiators with hot water from the boiler and to return cooled water. For the time being the question of hand firing is neglected, but it is assumed that there is some limiting device on the boiler which prevents the water from getting excessively hot. (This device is ordinarily known as an aquastat.) It acts to shut off the burner when the temperature of the water within the boiler reaches a predetermined limit and allows the burner to function when the water temperature has been sufficiently reduced. The aquastat does not necessarily reestablish burner operation when the temperature of the boiler water has fallen to a predetermined point below that of the maximum allowable temperature but permits the burner to start, if desirable, by the operation of other controls.

To maintain the proper air temperature within the space to be heated, a thermostat is installed in some central location. This is a device which, either through electrical or mechanical means,

causes the burner to start when the temperature of the air surrounding the thermostat approaches a predetermined low and shuts off the burner when this temperature reaches a certain maximum. Consider a simple hot-water system with thermal circulation, together with a control such as has been described, which is normally referred to as "off and on" control, and also assume that the temperature in the room approximates 68° and that the thermostat is set for 70° . This means that the control has caused the burner to operate and the boiler and the radiator and the piping system are full of water at some elevated temperature, such as, for example, 150° , it being assumed that the aquastat in the boiler is so adjusted that it will not shut off the burner until a temperature of 190° has been attained. With the passage of time, the temperature in the room reaches 70° , the thermostat reaches its adjusted point at 70° , and the device automatically sets in motion the necessary chain of events that cause the burner to shut down.

The condition now existing is that the room temperature has reached a desired point, there is no heat being supplied to the system by the combustion of fuel, but the boiler, pipes, and radiators are full of water at a temperature somewhat in excess of 150° . The temperature of 150° was assumed to exist at the time that the room temperature was 68° ; therefore, as the burner was continually operating, the temperature of the water in the boiler must necessarily have risen above that of 150° . Obviously, with a considerable mass of water in the system as outlined at an elevated temperature in excess of 150° and the room temperature of 70° to which the radiators are exposed, continual thermal circulation will inevitably take place and would continue until the temperature of the water in the system equals that of the surrounding space if it were not for the action of the controls.

This means that, inevitably, with a thermal circulating system, the actual temperature of the air in the space to be heated will vary considerably, perhaps as much as 5 or 6° above a desired point, as well as the same amount below the desired average. The certainty that it will fall below the average is due to the fact that when the thermostat sets in motion the desired chain of events to cause the reestablishment of delivery of heat to the room, the temperature of the water in the boiler and system will have fallen below that

required to maintain an average heat delivery, and the first efforts of the burner will be to elevate the temperature of the water in the system, so that heat delivery will be at least equal to heat loss. Until this point is reached, the temperature of the room will continue to fall, although the thermostat will be endeavoring to make a correction. Thermostats have been designed which at least partially compensate for this difficulty, so that by means of their use a more even approach to constant temperature can be obtained with thermal circulation than is possible with a simple type of thermostat.

Consideration of the factors involved, however, points to a more satisfactory solution of the problem. If a quicker response to the requirements of the thermostat could be arranged, so that heat would be quickly delivered upon call for heat by the thermostat and quickly discontinued when the thermostat was satisfied, obviously a more satisfactory operation could be obtained. This consideration brings us directly to the forced water system, which is highly desirable for conventional systems and particularly so for radiant heating installations.

With the simplest method of forced circulation, the water in the boiler is maintained at a constant temperature by means of the aquastat, and the circulator is under control of the thermostat. If the sequence of events with a forced circulating system is now considered under the conditions previously outlined, *i.e.*, a thermostat setting of 70° and actual room temperature of 68° , the aquastat will maintain a constant average boiler temperature independently of heating requirements. Then with the room thermostat calling for heat, it will cause the circulator to operate, thereby delivering hot water from the boiler to the radiators or convectors. Just as soon as the room temperature reaches 70° , the thermostat will put into effect a chain of events that will cause the circulator to stop operating, thus interrupting the supply of heat to the space under control of the thermostat. As devices are provided in the system to prevent thermal circulation, this means that when the thermostat is satisfied, circulation of hot water through the system stops and no heat from the boiler can reach the space involved, so that the only heat which will be introduced into the room or space after the thermostat is satisfied will be that represented by the mass of metal and water in the radiator or convector, which will be at a

considerably elevated temperature and for this reason will continue to deliver some heat into the room.

The system just described is referred to as "off and on forced hot-water" circulation. The desire for further improvement in the operation of this heating system resulted in the development of a method of operation whereby a practically continuous flow of water is maintained, the temperature of the circulating water being varied inversely with outdoor temperature, so that under ideal conditions, no indoor thermostat is really necessary. Sometimes this method of control is referred to as an anticipatory control, the meaning being that it does not have to wait for a change in indoor temperature to effect some adjustment of heat supply but does so immediately on a change in outdoor temperature.

In any system of radiant heating, it is obvious that there is a mass of material which has to be heated before a flow of heat can take place into the desired space. This is particularly true in floor installations where the pipes are buried in a mass of concrete. The deeper these pipes are placed in the concrete slab the greater is the mass of material that has to be heated before heat can flow into the required space and, conversely, the longer heat will continue to flow after the source of heat is disconnected. In the same manner with installations in the walls or ceilings, there is a considerable mass of material—plaster, lath, backing, joists, etc., which are reservoirs of heat—that must be brought up to temperature during the heating period and continue to deliver heat after the source of supply is shut off. It is obvious, therefore, that if a control system can anticipate the heat requirements within the space to be heated, a more satisfactory operation will be had than if the controls have to wait until a change in temperature is recognized by the control system.

This method of control, which provides for a continuous circulation of water adjusted to outdoor temperature, is subject to additional refinement when a room thermostat is added and so adjusted that it limits the maximum temperature which can exist in the room over which it has control. With this refinement the occupant of any room can regulate the temperature conditions within that room at any point below the maximum temperature for which the system is designed. It is not possible to arrange controls so that the temperature in any one specified room is

higher than the designed average. To obtain this feature would require that the designed average temperature be raised as a whole. For example, in a room with a temperature-limiting thermostat, when operating in conjunction with a system designed to maintain a comfort temperature of 70° , the room thermostat can be set for any temperature below 70° but cannot be set to maintain a temperature above 70° , so that if in any specific room, which is a part of a system designed for 70° , it should be required to maintain 75° , the design operating temperature would have to be adjusted to 75° . Then other rooms with temperature-limiting thermostats could be set at any lower figure as desired. This method of individual room control can be applied to any of the systems of anticipatory controls. An additional refinement to this general method provides that when there is no demand for heat from any part of the system, the circulating pump automatically shuts down and starts up again with the first demand for heat.

Consideration will now be given to the particular type of control that is suitable for installation in connection with radiant heating systems, restricting the discussion to those types of controls which make use of the continuous circulation of water, the temperature of which is continuously adjusted in accordance with outdoor conditions.

Attention is first drawn to the fact that there are three basic types of controls which function in the above manner. These three types refer to the means whereby temperature indication, as given by the thermostat or equivalent temperature-measuring device, is translated into the mechanical action necessary to open, close, or adjust the regulating valves or modify in some way the flow of heat.

One of these three basic methods involves the direct mechanical coupling of an expansible member affected by temperature to the necessary valves controlling the flow of heat. Obviously, this is the simplest possible method, as it does not employ auxiliary sources of energy such as are employed by the other two principles.

As to the other two types of basic controls mentioned, one employs electrical energy as a connecting link between the thermostatic device and the valves or controls to be moved, and the remaining method involves the use of compressed air or vacuum

to supply the necessary mechanical energy for manipulating these devices under the direction of the thermostatic elements.

All three types can be made to work very efficiently and with the necessary degree of precision. The selection of instruments embodying any one of the three systems is entirely a matter of individual preference. All commercial control devices that are intended to operate as described have adjustments so that for any given range of outdoor temperatures, such as, for example, from 30 to 70° or 0 to 70°, the water temperature will vary between some minimum occurring during periods when the outdoor temperature is at a maximum to a suitable maximum temperature of circulating water when the outdoor temperature is at a minimum.

Illustrating the first method of control are the devices manufactured by the Sarcotherm Controls, Inc., of New York, the essential features of which are shown in Fig. 6-1. In this figure, the bulb of the outdoor thermostat is connected to the valve proper by means of the capillary tube *E*. Hot water from the boiler enters the lower port at the point marked 1. Return water from the radiant coils enters at the port marked 2, while water at the proper temperature in relation to outdoor conditions leaves the device at the

FIG. 6-1. — Sarcotherm valve.
(Sarcotherm Controls, Inc.)

port marked 3 on its way to the radiant coils. With the valve in the position shown, hot water from the boiler would be delivered at full temperatures to the coils while the return from them through port 2 would be shut off. This is apparent from the position of the valve. In understanding this action of water flow, it must be remembered that the circulating pump obtains its supply from the water returning from the radiant coils and by means of two pipe lines delivers the water either to the port

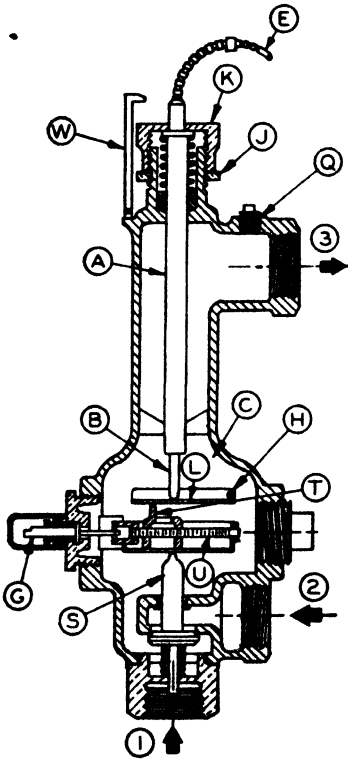

marked 2 on the valve or directly to the boiler. If port 2 is closed, then obviously the water returning or being delivered by the pump must flow to the boiler and from there enters port 1 of the valve as water at boiler temperature and leaves through port 3 to the coils.

In doing so, the hot water passes around the thermostatic element *A* and causes the element to expand and increase in length. This increase in length is transmitted to the adjustable lever arm indicated as *L* and *T* to the valve stem *S*, causing it to move downward and in this way adjust the relative amount of water returning from the coils at reduced temperature to mix with a sufficient quantity of hot water coming from the boiler so that the temperature of the mixture leaving through port 3 is at the desired adjusted value. Knob *K* provides a means for adjusting maximum temperature, while the stem *G* permits an adjustment to be made of the range through which the valve will function. With this control it would be perfectly possible to have a boiler water temperature of 180°F as being suitable for supplying domestic hot water and at the same time to have water going to the radiant heating system at a temperature of 140°F, which might be the required temperature that would be desired with the outdoor temperature standing at minus 10°F. Then as the outdoor temperature increased, the temperature of the water going to the coils would fall, although the boiler water temperature would remain at 180°F, so that, for example, with the approach of spring and the outdoor temperature increasing to 60°F, the temperature of water being diverted to the radiant coils might be at a reduced temperature of 80°F. In this case, the regulating valve would be in a nearly closed position, and there would be a very small amount of water entering through port 1, while the return from the radiant coils through port 2 would be at a maximum. Figure 6-2 shows the Sarcotherm valve installed.

To this system there can be added the refinement of individual room thermostatic control, whereby the temperature of any given space can be adjusted to a point lower than the desired average room temperature. In applications requiring further refinement of control, the Sarcotherm Controls, Inc., has a modified form of the valve already described, which includes a room thermostat that functions in conjunction with the outdoor bulb as well as a

thermostatic element in the valve itself, so that the temperature of the circulating water not only is modified by outdoor temperature but is also adjusted in accordance with the requirements of the room thermostat. In this way, a maximum degree of temperature control is attained with the advantages attendant upon

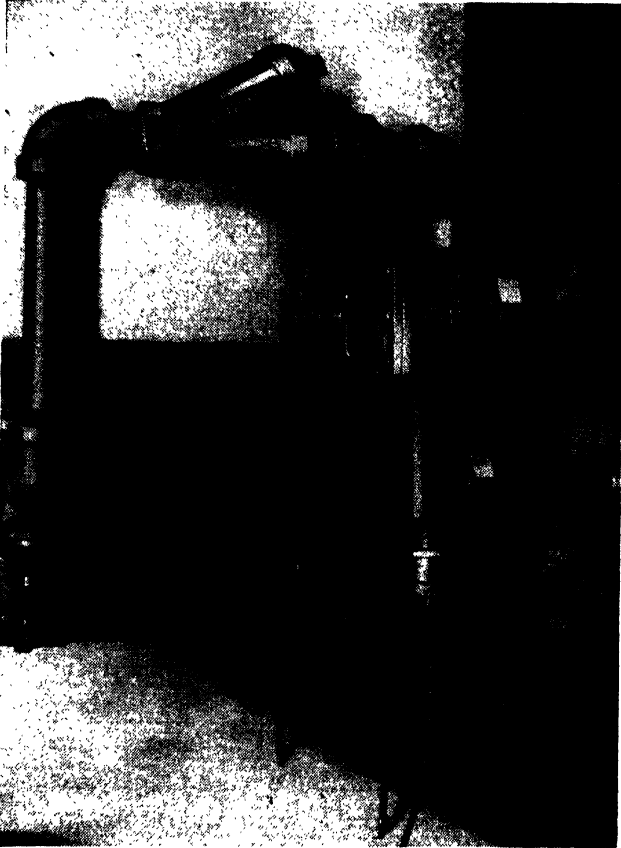

FIG. 6-2.—Sarcotherm installation. (*Sarcotherm Controls, Inc.*)

an anticipating type of control system. It is possible, of course, to supply any number of rooms through one Sarcotherm valve which is a type responsive to a room thermostat and will supply temperature-adjusted circulating water to all rooms on the basis of the requirement of the room in which the thermostat is located. If in a large building further refinements are required, it is, of course, perfectly possible to supply any number of circuits and

Sarcotherm valves from one boiler; in this way, varying heat requirements as affected by different building exposures can be taken care of.

In exposures subject to considerable variation and intensity of winds, the Sarcotherm Controls supply a special type of outside bulb which provides additional compensation as might be caused by winds of high velocity and low temperature but which also provides a correcting influence for variations in radiant energy as may be received from the sun and intercepted by the presence of clouds. Conventional outdoor bulbs are influenced by sensible temperature only, whereas this particular bulb, as produced by Sarcotherm Controls and designated as their "Thermoradiation Outside Bulb," will take cognizance of the different heat requirements as evidenced by a bright sunny day and a cloudy day, although the sensible outdoor temperature may be the same in both cases.

While conventional thermostats are usually employed in radiant heating systems, Sarcotherm Controls, Inc. builds a particular type of thermostat designed especially for radiant heating systems. This device is known as a Thermoray Comfortstat and consists of a blackened sphere about 5 in. in diameter, mounted on a stem approximately 7 in. high, and in its most refined form contains an electrical heating element so that under a normal condition of comfort the surface of the sphere is maintained at 80°F, which is equivalent to the surface temperature of the human body. This device can be placed on the wall in ceiling-heated rooms or on the ceiling of rooms having floor installation of radiant heating coils; or if necessary, the device can be placed in a box built into the wall so that there are no projections into the room space.

This device, therefore, more nearly senses comfort conditions than an ordinary thermostat when applied to radiant installations, since it is affected not only by room temperature but by air currents and heat delivered by the radiating surface, as well as the average surface temperature of the walls, windows, ceilings, etc., thereby sensing temperature conditions in a manner similar to the nervous system of the human body. Consequently, the Thermoray will sense a condition of cold caused by an unusually low surface temperature existing on any of the room surfaces and

modify the heat requirement as affected by this condition so as to obtain comfort temperature independently of room air temperature.

Figure 6-3 shows the exterior appearance of the Sarco Thermoray, and Fig. 6-4 shows the interior construction, wherein an electric heater *Z* is used to maintain an elevated temperature of 80°F on the black bulb. The effect of air temperature on the outside of the bulb as well as the effect of radiant heat impinging on



FIG. 6-3.—Sarco thermostat. (Sarco-therm Controls, Inc.)

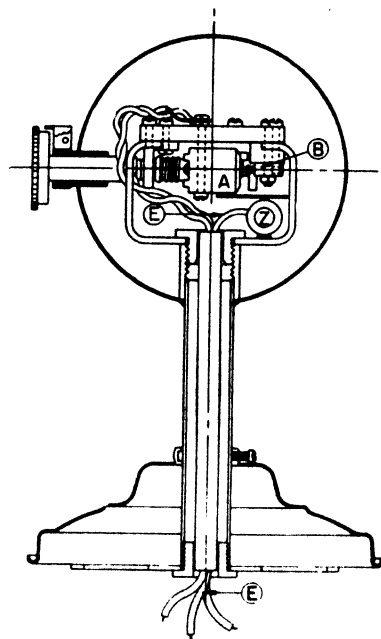

FIG. 6-4.—Details, Sarco thermostat. (Sarcotherm Controls, Inc.)

the bulb affect the temperature inside the sphere and through the thermostatic element *A*, which, in turn, controls the action of the Sarcotherm valve. Desired temperature adjustments are made through the knob at the left of the sphere. Figure 6-5 shows the exterior appearance of the panel type of Thermoray which can be substituted for the spherical type if desired for the sake of appearance.

As an example of the second method of control, which makes use of a separate source of energy to interpret the requirements of the thermostat for a temperature change to the control devices

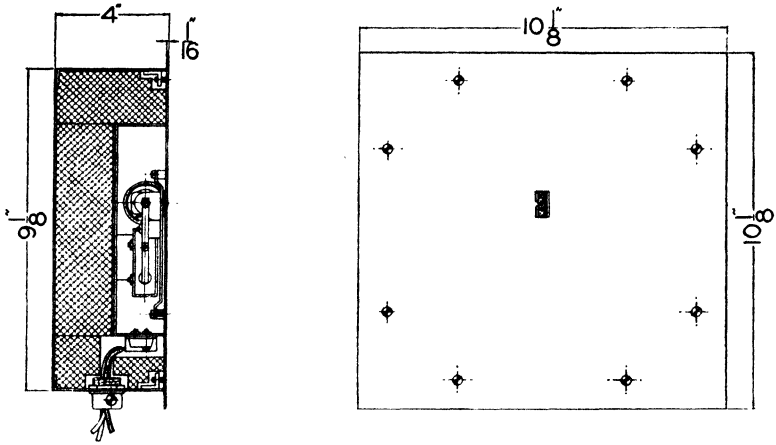

FIG. 6-5.—Panel type of thermostat. (*Sarcotherm Controls, Inc.*)

that effect the change, attention is directed to a system of controls operating in this manner as manufactured by the Johnson Service Company of Milwaukee. This system makes use of an outdoor thermostatic bulb for measuring outdoor temperature and a

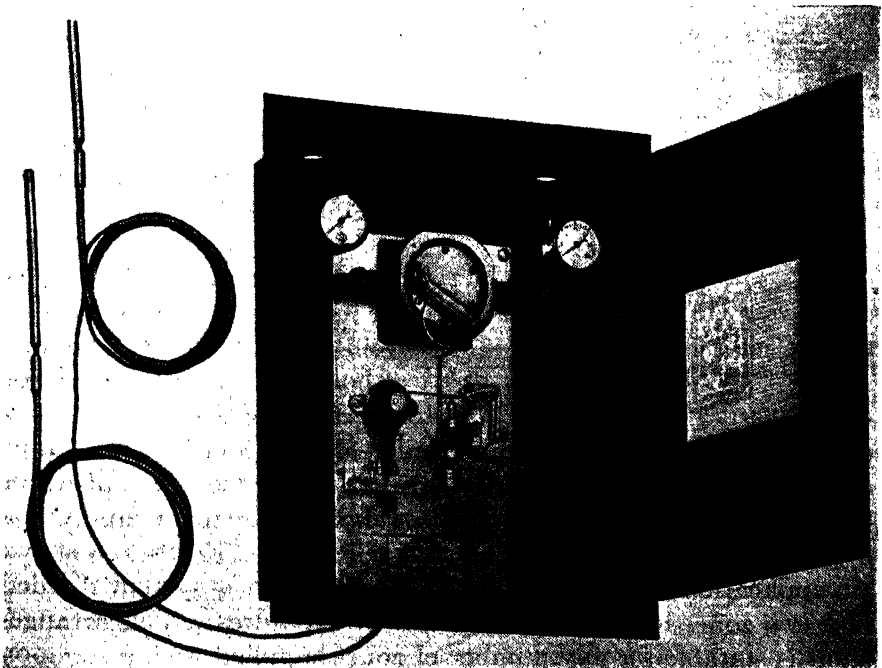

FIG. 6-6.—Pneumatic Duo-Stat. (*Johnson Service Company.*)

second thermostatic bulb located in the hot-water supply to the radiant coils. The bulb in the hot-water supply acts as the "control" bulb, maintaining the water temperature at the value dictated by the outdoor bulb. Both bulbs are connected to an instrument known as a Duo-Stat, of which there are three types: pneumatic, electric, and electronic.

The pneumatic Duo-Stat (Fig. 6-6) is used for application

where proportional (gradual) operation of a device, such as the three-way mixing valve shown in Fig. 6-7, is required. Compressed air is the source of energy for operating the valve and is supplied to the Duo-Stat at a constant pressure. The Duo-Stat, in turn, reduces this pressure to a value dictated by the two thermostatic bulbs, as described in the preceding paragraph, and transmits it to the top of the rubber diaphragm 1 (Fig. 6-7). The air pressure on the top of the diaphragm operates against the resistance of the spring 4 and moves the valve disk 9 so that the proper relationship between the volume of water returning from the coils and the volume of hot water from the boiler or

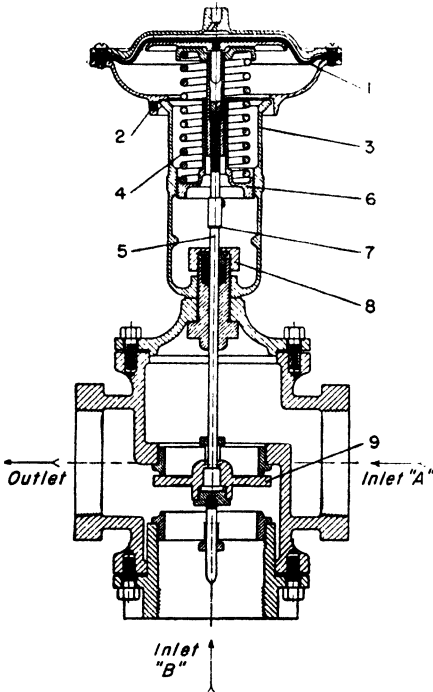

FIG. 6-7.—Pneumatic modulating valve. (Johnson Service Company.)

water heater is maintained. The temperature of the hot water supplied to the mixing valve is controlled at a fixed value by a high-limit thermostat operating the automatic-firing device if a hot-water boiler is used or operating a steam valve in the steam supply line if a steam-heated hot-water converter is used. Figure 6-8 shows an application of this arrangement applied to a system divided into two zones having different outdoor exposures. This arrangement is suitable for any number of zones supplied with a common source of hot water. A separate Duo-Stat, three-way mixing valve, and circulating pump are required for each zone.

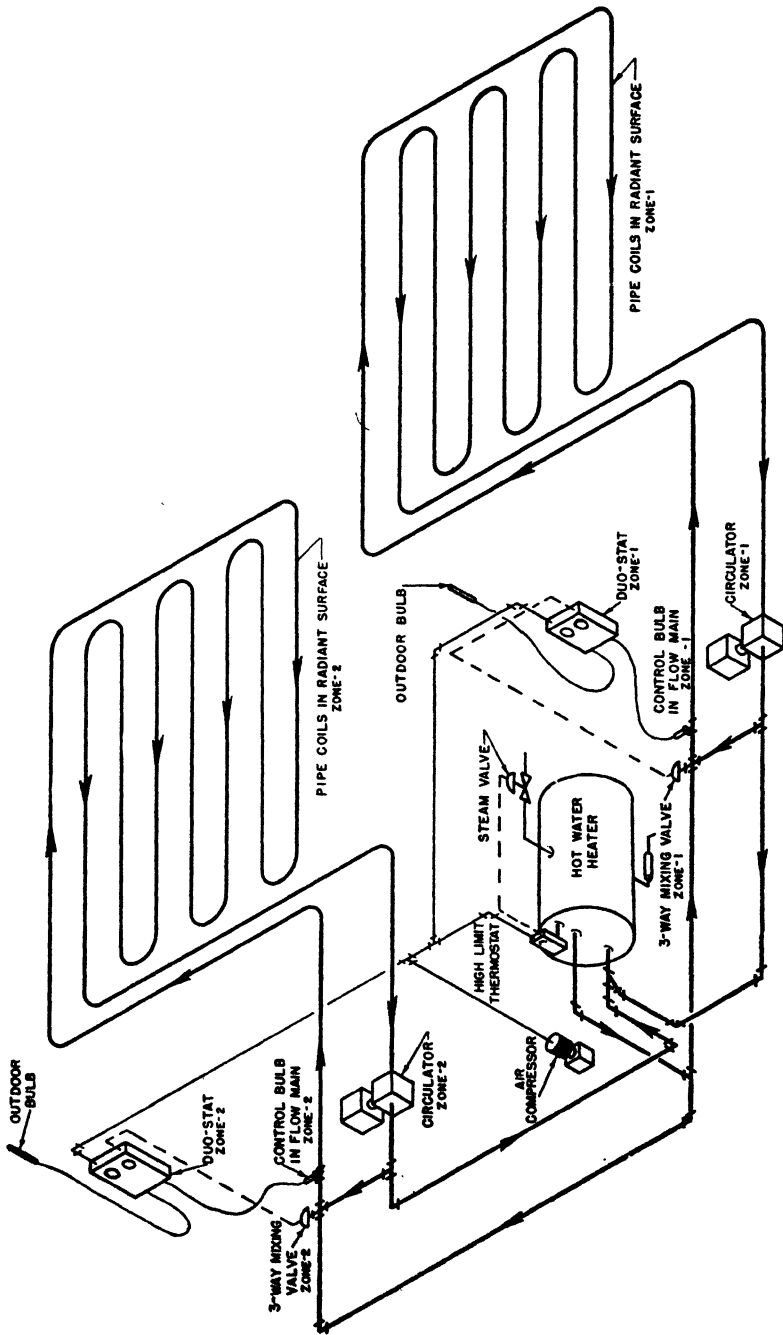

Fig. 6-8.—Zone control. (Johnson Service Company.)

On installations having only one zone, the Duo-Stat may be used to control the source of heat directly. If a steam-heated hot-water heater is used, the Duo-Stat should control a pneumatically operated valve in the steam supply line, and the three-way mixing valve is omitted. In all cases, continuous circulation of hot water is assumed.

The electric Duo-Stat (Fig. 6-9), is used for single-zone installations to operate the stoker, oil burner, or gas valve on a hot-water boiler. This instrument is of the two-position, or "on-off," type,

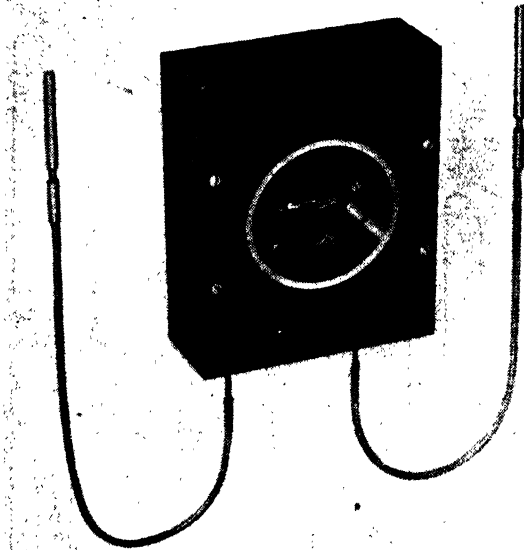

FIG. 6-9.—Electric Duo-Stat. (*Johnson Service Company.*)

making and breaking an electric circuit at the dictates of the thermostatic bulbs. The safety controls and, in the case of the stoker, the hold-fire controls ordinarily used with automatic-firing devices should be employed in addition to the Duo-Stat. This arrangement is shown in Fig. 6-10.

Both the pneumatic and the electric Duo-Stats have liquid-filled thermostatic bulbs connected to the Duo-Stat proper by capillary tubing. The electronic Duo-Stat has electrical resistance bulbs, connected to the Duo-Stat proper by electric wires. The electronic Duo-Stat is a two-position instrument that performs the same functions as the electric Duo-Stat but is not limited as to

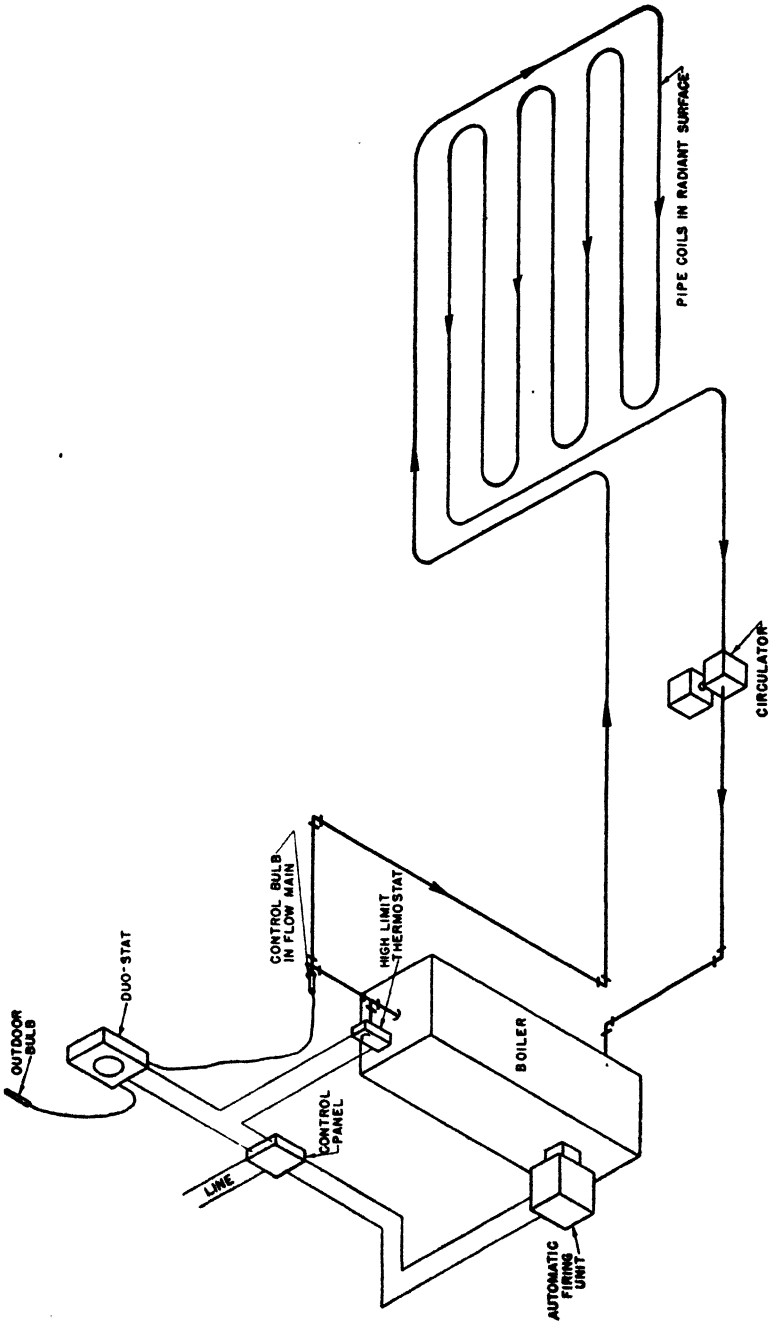

Fig. 6-10.—Two-position Duo-Stat. (Johnson Service Company.)

the distance between the bulbs and the instrument proper. Both the electric and electronic Duo-Stats are available for use with single-pole single-throw or single-pole double-throw circuits.

The advantage of using instruments of this type, in which pneumatic or electric energy is used to perform the work of actuating the controls, is that a relatively large amount of energy is available, the application of which is determined by the thermostatic bulbs. These thermostatic bulbs are not required to furnish any of the energy needed to actuate the valve or similar device.

In addition to the use of Duo-Stats as the primary means of controlling radiant heating systems, it is often desirable to employ room thermostats to ensure satisfactory and uniform temperature conditions throughout the heated spaces. Since the electric and electronic Duo-Stats are usually employed for single-zone installations, the usual practice is to install a single electric room thermostat in a representative location somewhere in the heated space. This thermostat is wired in series with the control circuit of the Duo-Stat and shuts off the source of heat whenever the space temperature exceeds the thermostat setting.

For installations on which pneumatic Duo-Stats are used, there are three different methods of making use of room thermostats:

1. A pneumatic room thermostat may be connected in series with the pneumatic Duo-Stat and act as a high limit, as described above in connection with electric and electronic Duo-Stat.
2. A pneumatic room thermostat may be employed to modify the control point of the Duo-Stat rather than to act as a high limit. The outdoor bulb of the Duo-Stat functions in the normal manner to determine the temperature to be maintained by the control bulb. Under conditions of constant internal heat gain from uncontrolled sources of heat, such as lights, people, etc., the Duo-Stat will maintain a constant space temperature. However, if these uncontrolled sources of heat vary considerably, the space temperature will be affected. The room thermostat, under this arrangement, responds to these changes in space temperature caused by uncontrolled sources of heat and transmits this response to the Duo-Stat. The Duo-Stat, in turn, corrects the water temperature to meet the new requirements.

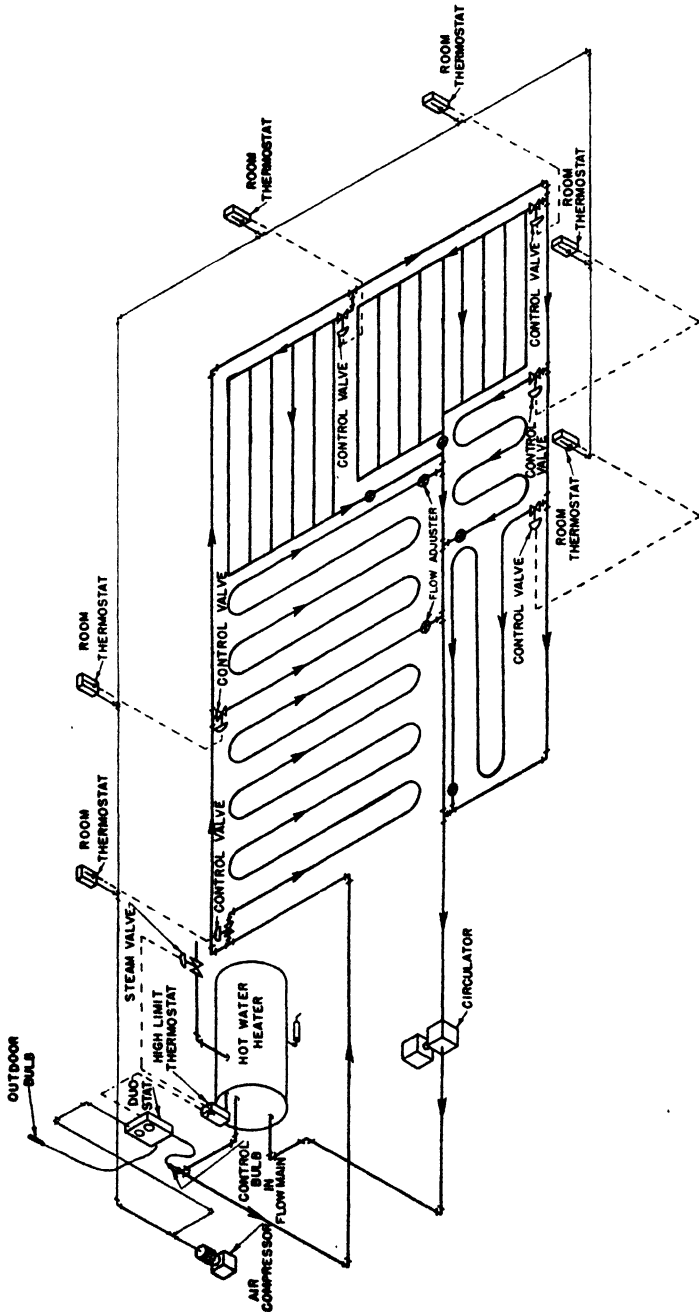

FIG. 6-11.—Individual-room control. (Johnson Service Company.)

3. Both of the above methods of employing room thermostats in addition to Duo-Stats require only one room thermostat per heating zone. It is assumed that the heating requirements throughout each zone are uniform and that there is a suitable location for the room thermostat which will reflect average space temperature. This is not always the case, and the use of a single room thermostat per zone will not always result in uniform temperatures throughout the zone. To overcome this, the third method of employing room thermostats makes use of a separate thermostat in each room. These room thermostats are arranged to control pneumatic valves in the water-supply lines to the coils serving the respective rooms. The pneumatic Duo-Stat functions in the normal manner to control the temperature of the water supplied to each zone, while the room thermostats control the volume of that water in accordance with the requirements of each room. This arrangement is shown in Fig. 6-11.

Figure 6-12 shows a type of pneumatic room thermostat that may be used with any of the three above methods. The thermostat is provided with an adjusting dial for setting the desired temperature and is available with a shutoff lever, if desired, for discontinuing the supply of heat to the area under control of the thermostat.

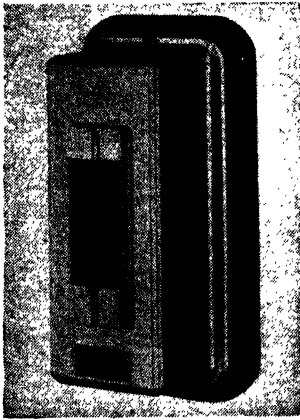

FIG. 6-12.—Pneumatic room thermostat. (*Johnson Service Company.*)

In this discussion of Duo-Stat control for radiant heating systems, mention has been made of the use of zoning. Zoning may be defined as the practice of dividing a building into sections for heating purposes so that each section is relatively uniform as to heating requirements. One of the chief considerations in zoning a building is weather exposure. In a multistory apartment building, for example, having a principal axis extending north and south with groups of apartments to the east and west, it would be logical to have an east zone and a west zone. Manifestly, heating requirements for these two zones will vary with the time of

day, and a zone control arrangement as indicated in Fig. 6-8 would be very useful in maintaining comfort conditions with a maximum efficiency in the use of heat. Of course, each zone may consist of several radiant coils instead of the one indicated. With the addition of room thermostats, each controlling a valve located between the supply main and the radiant heating coils covering the area under domination of the room thermostat, maximum conditions of comfort and efficiency could be attained.

Large multistory buildings are often provided with several zones, each zone equipped with an individual Duo-Stat controlling

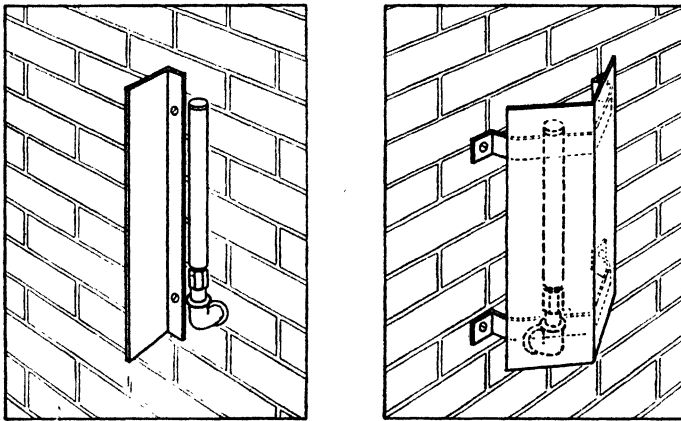

FIG. 6-13.—Outdoor bulb location: *Left*, sunshield for outdoor bulb on east or west face of a building. *Right*, sunshield for outdoor bulb on south face of a building. NOTE: Bulbs mounted on a north exposure requires no sunshield. (*Johnson Service Company.*)

its own mixing valve. The outdoor bulb for each Duo-Stat must be located in an exposure similar to the exposure of the zone that it serves, and bulbs on all except north zones should be provided with sun shields. In cases where the bulb location is conspicuous, the sun shield should be painted to harmonize with the building. Figure 6-13 shows typical mountings for the outdoor bulbs, with sun shields.

A third type of control suitable for radiant heating systems is that manufactured by the Minneapolis-Honeywell Regulator Company of Minneapolis. The essential part of this system is known as an "automatic reset controller." Figure 6-14 shows an external view of this device and also the thermostatic bulb which must be located so as to sense the temperature of the water leading

to the radiant coils. The method recommended by the Minneapolis-Honeywell Regulator Company is to install this bulb in a suitable well located in the hot-water supply main so that it will be directly affected by hot-water temperatures. Figure 6-15 shows the internal arrangement of the automatic reset controller and also gives an idea as to the operating principles.

Operation of this controller is best explained by commencing with that part of the device indicated as "supply water tempera-

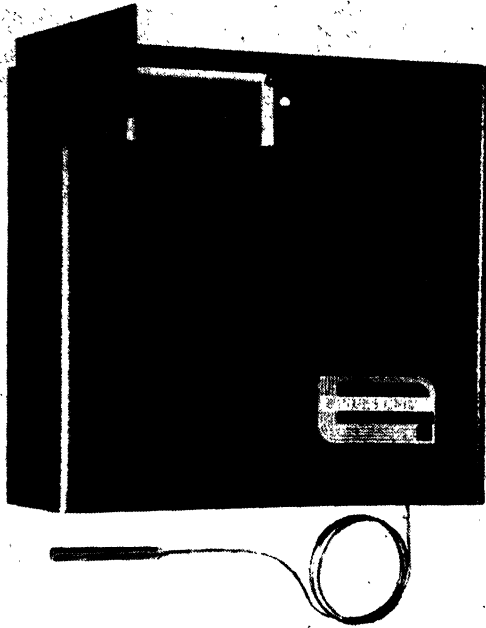

FIG. 6-14.—Minneapolis-Honeywell control panel. (*Minneapolis-Honeywell Regulator Company.*)

ture controller." This part of the apparatus senses the temperature of the water flowing to the coils by means of the thermostatic bulb previously mentioned and through the electrical connections indicated. It controls the burner on the heating boiler or the modulating steam valves on a converter or a three-way mixing valve, as may be required by the design of the system, in such a way as to maintain a fixed water-supply temperature. The section of the device indicated as a Modutrol motor is caused to rotate in accordance with changes in outdoor temperature, which are trans-

mitted through a device known as an "outdoor controller." The cam indicated in the upper center of Fig. 6-15 is mounted on the motor shaft, and its rotation varies the spring pressure on the contact within the supply-water temperature controller first mentioned so as to maintain the proper relationship between the

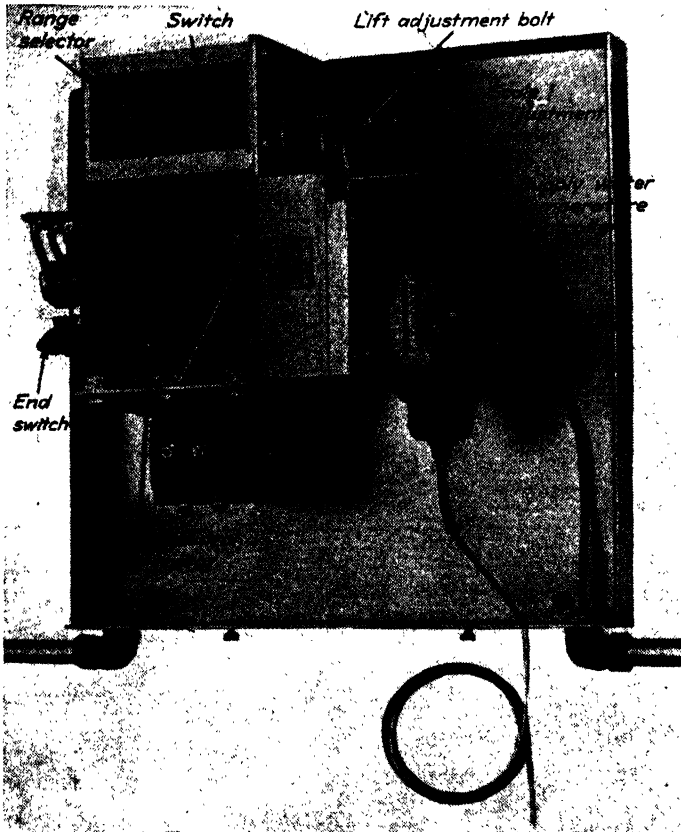

FIG. 6-15.—Details, Minneapolis-Honeywell regulator. (*Minneapolis-Honeywell Regulator Company.*)

hot water going to the radiant coils and the heat requirements as represented by outdoor temperature conditions.

Figure 6-16 shows the relationship among all the elements in this type of control. To the left of the illustration there is indicated the outdoor thermostatic bulb connected to the outdoor controller by means of a capillary tube. The controller itself is placed indoors and adjacent to the automatic reset controller,

which is located reasonably adjacent to the three-way valve, and the controller bulb well is located in the hot-water supply pipe. It will be noted that this three-way valve accepts return water from the coils through a bottom outlet, also receives hot water from the boiler at an outlet to the right, and delivers hot water to the coils at the proper modulated temperature through the opening to the left.

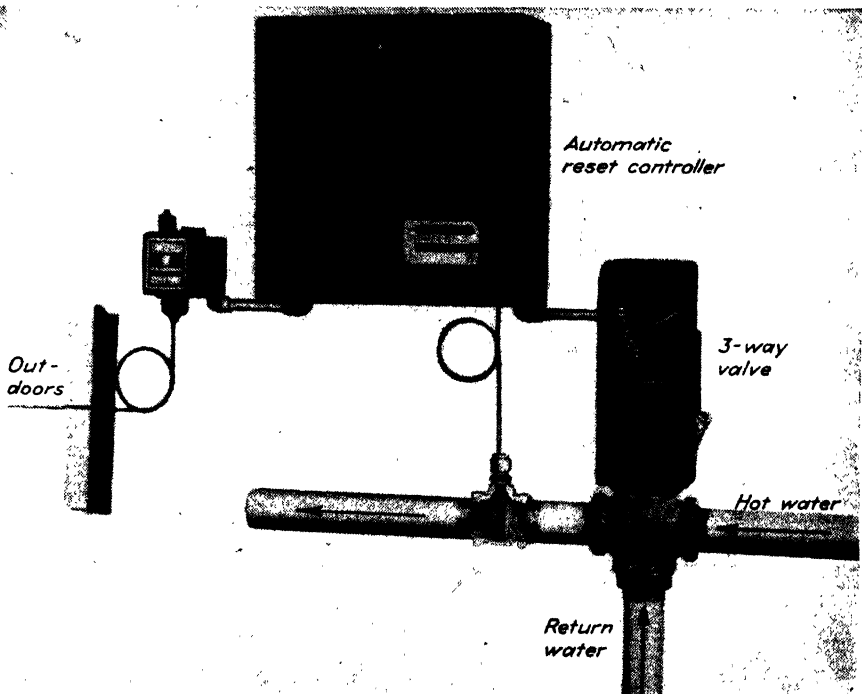

FIG. 6-16.—Assembly view, Minneapolis-Honeywell regulator. (*Minneapolis-Honeywell Regulator Company.*)

One of the advantages of a Minneapolis-Honeywell system is the ease with which adjustments may be made. The desired range of minimum and maximum temperatures that may be required for a radiant heating system can be obtained by adjusting the lever arm which bears on the rotating cam (Fig. 6-15), provided only that the desired temperatures come within the range of the particular controller. For example,² one particular controller has a range from 65 to 140°. This means that it can be adjusted to provide a

minimum water temperature of any value in excess of 65° and any maximum water temperature to any point less than 140°. Other types are available that have greater or smaller ranges.

In addition to the adjustments just described, which are necessarily of a permanent nature for any given installation, there are two adjustable knobs shown in Fig. 6-14 and more clearly in Fig. 6-15. The range selector provides means whereby the maximum temperature may be elevated a few degrees if particular occasion requires and also allows the average temperature to be lowered a few degrees at the discretion of the owner. These adjustments might be very desirable, as, for example, in the case of a cold day with high winds, the owner might like to raise temporarily the indoor temperature a few degrees. In the same manner, other unusual conditions might make it desirable to depress the average temperature, and this can be done by rotating the left-hand knob away from the normal position to the amount shown on the panel.

In addition to the range selector, there is another knob which operates through three positions: one "automatic" and the other two "minimum" and "maximum" heats, respectively. With this control knob on "automatic," the system will operate as described and maintain the temperature of the water circulating through the radiant heating coils at the proper and predetermined value as governed by outdoor conditions. If, however, this control knob is turned to the position indicated as "minimum" heat, the controls will function to maintain a constant minimum water temperature without regard to outdoor temperatures. This adjustment becomes convenient when it is necessary for any reason to leave a building vacant and unattended for a few days, the minimum temperature being sufficient to maintain the premises at a high enough temperature to prevent freezing. If, however, the adjusting knob is turned to the position of "maximum" heat, the system will operate continuously at the maximum possible temperature without reference to outdoor temperature. This feature may be of advantage in some cases where use has been made of the minimum temperature adjustment and the premises vacated until indoor temperatures have fallen so low as to become uncomfortable. By adjusting the maximum heat position, the premises may be returned to comfortable temperature in minimum time.

Any of the Minneapolis-Honeywell automatic reset controllers can be connected to a room thermostat, such as that shown in Fig. 6-17. With this device installed, indoor temperatures are maintained with a great degree of accuracy as a result of the modulated temperature control of the circulating water under the supervision of the thermostat. A desirable attachment which can be furnished with the automatic reset controller is the switch shown in Fig. 6-15, which has the function of shutting down the circulator if conditions are such that the desired minimum temperatures of the circulating water have been reached. In this case, no further circulation is necessary; so if the pump is shut off, a saving results in the use of electrical energy for circulator operation. If, however, temperature conditions justify it, the circulator is automatically restarted.

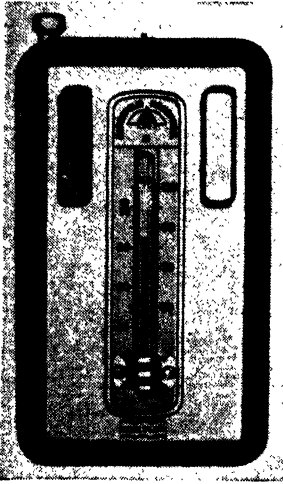

FIG. 6-17.—Room thermostat. (Minneapolis-Honeywell Regulator Company.)

A somewhat simpler method of control suitable for use with radiant heating systems is that advocated by the Hoffman Specialty Company of Indianapolis, Ind., in their Series 90 system. This system provides for a continuous circulation of hot water through the radiant coil at a temperature in proper relationship to the outdoor temperature. The essential features of the system are indicated in Fig. 6-18. When the control valve is closed, the boiler is by-passed; *i.e.*, the circulator pumps water through the Hoffman circulating pipe, through the supply main, through the heating coils, and back to the circulator.

As is indicated, a water-temperature bulb is in the supply water. Another temperature bulb is located outdoors. Both of these bulbs with their capillaries are part of the Hoffman Series 90 temperature controller (Fig. 6-19). Just as soon as the supply-water temperature is no longer correct for the corresponding outdoor temperature, the temperature controller starts opening the control valve, and part of the return water will then go into the boiler, forcing out a corresponding amount of hot boiler water. The balance of the return water goes through the circulating pipe and mixes with the hot boiler water.

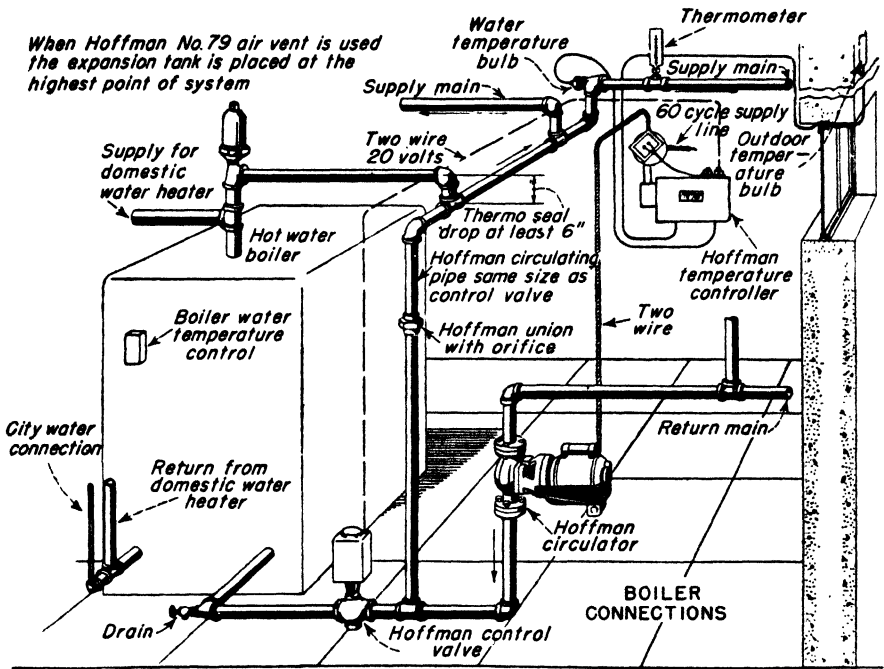

FIG. 6-18.—Hoffman control system. (Hoffman Specialty Company.)

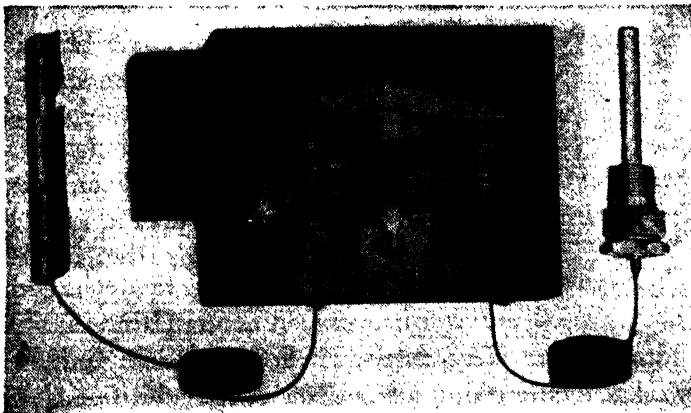

FIG. 6-19.—Hoffman controller. (Hoffman Specialty Company.)

When the temperature of this mixed water passing the water temperature bulb is again corrected to meet outdoor temperature conditions, the temperature controller starts closing the control valve. If it closes entirely, then the circulation is again as previously described. The control valve, however, operates very

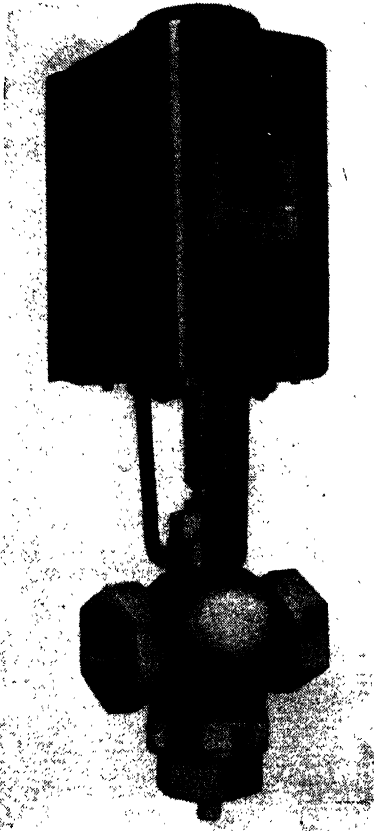

FIG. 6-20.—Hoffman regulating valve.
(Hoffman Specialty Company.)

slowly, taking approximately four minutes for opening and just as long for closing, and it need not open or close entirely before it can be reversed. It is therefore quite possible that there will be another call for heat before the control valve has closed, and it will start opening before it has completely seated. Indeed, it may float during quite some period, *i.e.*, never opening wide and never entirely closing, before the controller sends a new impulse to it and reverses its direction. The valve itself is similar to an ordinary globe valve and for sizes not larger than 2 in. is operated by a heat motor as is shown in Fig. 6-20. The larger sizes use a reversible electric motor submerged in oil. For large pressure differentials, a balanced valve is furnished.

An orifice of the proper size is placed in the circulating pipe so that when the control valve opens, the proper amount of water goes through the boiler and through the circulating pipe. When the control valve is completely closed, the water circulation is reduced a small amount. This, of course, happens more frequently when the outdoor temperature is high; by this small reduction of water circulation, the control is made somewhat more sensitive, which is desirable under those conditions.

The temperature controller has two main adjustments. One is easily made by the owner and raises or lowers the water temperature throughout its range. The other adjustment is easily made by a man familiar with heating devices. It changes the ratio between outdoor temperature and supply water. The controller is set at the factory to meet the specifications of the engineer. It frequently happens, however, that some adjustment is necessary in the field due to the fact that the heat losses from the house may not be quite as calculated. In that case, the controller may supply water to the coils at the proper temperature for one set of outside conditions but not for another. In that case, the ratio arm adjustment can easily be moved according to well-established charts and this apparent discrepancy corrected. After the controller has been set once to meet the actual house conditions, no further adjustment is ever necessary.

In addition to its function of manipulating the control valve, the controller also embodies another switch which cuts out the circulator when the outdoor temperature reaches 65°. This cutout temperature is also subject to some adjustment either way to meet the requirements of the owner.

It is important that the water in the boiler be maintained at a temperature at least 10° higher than that required in the supply main for maximum conditions. This means that the temperature of the boiler water can be kept at a temperature high enough for heating water for domestic purposes.

The Hoffman Specialty Company, from their experience over several years, do not believe that it is necessary to make use of individual room thermostats.

CHAPTER VII

DESIGN OF RADIANT HEATING SYSTEMS

Greater care must be employed in planning radiant heating systems designed with buried tubing than with conventional systems, for the obvious reason that after installation it is not possible to make major changes. With conventional systems, it is a relatively simple matter to increase the size of a radiator or perhaps to augment its output during severe weather by subjecting it to a blast of air from an electric fan. Also, in conventional systems, it usually is not possible to raise materially the temperature of the circulating medium, as this has already reached about the practical maximum.

With a radiant system in which the pipes or tubing are buried in the floor or ceiling, it is obvious that few changes can be made, as far as mechanical additions to the system are concerned; but owing to the fact that the ordinary operating temperature is quite moderate, the output of the radiant system can be increased to some extent, if necessary, by either slightly increasing the water temperature or increasing the rate of flow by increasing the capacity of the circulating pump.

This latter procedure has the effect of reducing the temperature drop through the system and thus raising the average temperature. For example, if under maximum conditions water temperature reaching the coils is 140° and leaving the coils 110° (a temperature drop of 30°), it is possible to increase the output even with the same maximum temperature of 140° by increasing the rate of flow. This will have the effect of increasing the temperature of the water leaving the coils and thus increasing the average temperature and consequently the output of the system. Therefore, from a practical standpoint, there are two ways of increasing the effectiveness of an installed radiant system, which can be applied independently or together.

One is the raising of the temperature of the water flowing to the coils. The second method consists in raising the average tempera-

ture of the circulating water by increasing the rate of flow. This can be accomplished either by opening the balancing cocks, if they are not all fully open, or by adding a booster pump to increase the hydrostatic head on the circulating system.

Therefore, it would appear that from a practical standpoint, considerable leeway is available in radiant heating installations to correct either errors in design or varying requirements in occupancy with respect to temperature by making changes in operating characteristics as here indicated. For this reason, it is believed that the simplified methods of design presented later in this chapter can be satisfactorily used in the majority of cases involving customary construction for residential or commercial application.

Considering now the practical method of making an actual design, a great deal has been written on the temperature relationship, viewed from a theoretical standpoint, that exists in a room to which there has been applied radiant heating, from the floor, ceiling, or wall, whereas very little has been written on the subject of the flow of heat that occurs in the floor or ceiling with reference to the heated coils imbedded in this structure. It is very important that this phase of the matter be thoroughly understood.

Imagine a metallic tube 1 in. in diameter, buried in the center of a concrete slab 7 in. thick. There will be, therefore, 3 in. of concrete between the surface of the tube and the external surface of the slab in two directions. Let us assume, further, that this slab is horizontal in an enclosed space with an air temperature approximating 65° , with no air currents, and then assume that water having a temperature of 140° starts to flow through this tube. Also, assume that the temperature of the slab itself was at room temperature throughout its volume. The first effect of the increase in temperature of the pipe due to the circulating water will be the increase in temperature of the concrete directly surrounding the pipe due to the relatively high heat conductivity of metal as compared with concrete. The temperature on the inside of the tube and the outside of the tube or pipe will be approximately equal and also equal to the temperature of the water circulated. However, with the passage of time the temperature of the concrete surrounding the tube will gradually increase until at points on the surface of the slab nearest the pipe the surface temperature of the slab will begin to increase and, up to this time, the flow of heat in all

directions from the tube outward into the concrete will be uniform. However, as this flow of heat reaches the surface of the slab, conditions will be altered owing to the convection air currents that will be formed as a result of the heated surfaces. On the upper surface of the slab, increase in temperature will be restricted by reason of the convection air currents removing heat. On the under surface of the slab, air currents cannot be so readily formed; consequently, the temperature of the under surface of the slab will tend to increase at a greater rate than the temperature of the upper surface of the slab, although the heat delivery in Btu will be greater on the upper surface.

It is fairly obvious that by increasing the diameter of the tube buried in concrete floors or plaster ceilings, such procedure will tend to increase the heat output by reason of the increased area of contact between the relatively high conductivity of a metal tube and the lower conductivity of the surrounding cement. It is also obvious that if two tubes are used in place of one and spaced a considerable distance apart, say on the order of 2 ft, twice as much heat will be delivered to the slab as with one tube; but if the distance between the tubes is shortened until they are only, say, 3 in. apart, then they are not much more effective than one tube because the two semidiameters of the tubes, facing each other, are necessarily restricted in their ability to transfer heat to the enveloping material.

Returning to further consideration of the concrete panel with a tube buried in the center, it is obvious that if additional resistance to heat flow, such as wood flooring or carpet, be placed on the upper surface of the slab, the tendency will be for the temperature on the under surface to increase and the flow of heat upward to decrease by reason of the resistance to heat flow imposed by the wood and carpet covering. This can be partially compensated for by moving the tubes from the central location in the slab to the uppermost location commercially or practically feasible, which might be with the upper surface of the tube 1 in. below the upper surface of the concrete. In this case, there would be 5 in. of concrete below the under surface of the tube which would represent an increase in resistance to heat flow which might partially, at least, compensate for the additional resistance that would be present in any type of floor covering, such as wood or carpet, placed on top of the slab.

It should be mentioned at this point, however, that the slab under consideration is wholly a theoretical one, and the example outlined should not be considered a practical construction applicable to reinforced concrete buildings.

It also might be appropriate to point out that from a heat-transfer standpoint, there is no difference in suitability among any of the metals capable of being made into pipes or tubes. If one method of design calls for a certain number of feet of a given diameter of pipe or tube composed of one specific metal, a pipe of equal or approximately equal length and diameter but of some other metal will function equally well in any radiant heating design insofar as heat transfer is concerned.

Obviously from the preceding discussion of heat flow in a structure in making any radiant heating design, it is very necessary to consider the direction of heat flow that will occur in any given design as between flow of heat in the desired direction and the flow that will occur in an opposite direction which may be used in some instances but which will, in other cases, have to be regarded as a total loss; but the quantity of heat involved in such loss will have to be added to the amount of useful heat needed in order to arrive at the proper size of boiler and circulating equipment.

The purpose of design in any heating system is to make sure that there is sufficient inflow of heat to the space to be heated so that, in spite of the inevitable loss of heat flowing from the space to be heated, comfort temperatures can be maintained. As an analogous example, suppose that there is a barrel having a number of various sized holes in its side and bottom which has to be kept filled with water up to a certain definite level; it is obvious that a small flow of water into such a barrel would not result in the filling of the barrel. The water would all run out owing to the various openings. With the rate of flow into the barrel increased, it is obvious that the level of the water in the barrel will rise; and finally, if the flow of water into the barrel is sufficiently increased, a point will be reached where the level of the water in the barrel will remain constant. In other words, the outflow will exactly equal the inflow. If the level of water in the barrel does not reach the desired point with any given inflow, then it is obvious that an increased flow will be required; if the flow is too great, the level will be higher than that desired.

This analogy exactly illustrates the problem before the designer of a heating installation. In the analogy, increases in height of water within the barrel and increases in the size of the escape openings increase the amount of water delivery that will be required to maintain any given level. In exactly the same manner, in a heating installation, the higher the temperature required inside the rooms the greater the opportunity for the loss of heat and the greater will be the heat input required and necessarily the increased fuel consumption with the accompanying increased operating costs.

In any enclosed and heated space, heat is lost through the room surfaces if the temperature of the inside of the surfaces is higher than the outside, and the amount of heat loss is proportional to the difference in temperature between inside and outside and also proportional to the conductivity of the walls or surfaces. In addition to the heat loss by conduction through the walls or surfaces, there is a heat loss by air infiltration.

No living space can be entirely airtight; there must be a certain amount of incoming air. This is ordinarily assumed to be not less than one complete change of air per hour in any given space. Necessarily, if the outside air is at a lower temperature than the air inside the space, the incoming air must be heated to indoor temperatures. Heating design must therefore take into account the amount of heat that is lost through the walls, floor, windows, etc., and is usually represented as a conductivity factor for the entire room, which factor multiplied by the temperature difference between the inside and outside of the room, also by the total room area, gives the desired heat requirement in Btu's. For example, a desired temperature of 70° inside, with minus 10° outside, means that there is a temperature difference of 80° , which multiplied by the conduction factor and by the square feet of room area, gives the total amount of Btu's necessary to be supplied to the room to maintain an inside temperature of 70° with an outside temperature of minus 10° .

With a radiant installation, consideration has to be given to the heat loss in a reverse direction; *i.e.*, for example, in a room heated with a ceiling construction, a certain amount of heat will flow to the room above. If this space is intended to be occupied, then this heat is not lost but is used, so that in the design of the room above, the heat to be supplied will be the difference between

the total determined heat loss minus the amount of heat received from the room below.

When all these factors involving heat loss from a heated space are considered, it is clear that in severe climates, regardless of the type of heating employed, reasonable amounts of insulation should be included in all outside walls and ceilings; and as the heat loss through single glass windows is considerable and much higher than through other parts of the room, the use of double glass or storm sashes is also desirable. With radiant installations in either floor or ceiling, insulation must be placed underneath floors and over ceilings if the flow of heat is not desired in reverse direction. This feature is much more necessary in radiant installations than in conventional heating systems because the floor, walls, or ceiling are being used as a heat source. Particularly, if the heating coils are installed in outside walls, the insulation to be provided back of the coils must be of adequate quantity and quality to prevent what otherwise might be a serious loss.

Proceeding now with detailed methods of designing radiant heating installations, consideration will be given first to the methods shown by the A. M. Byers Company of Pittsburgh, Pa., which was among the first to promote radiant heating in the United States. Its preferred method of construction is to place wrought-iron pipes in the floor of the area to be heated, although in some cases the ceiling is used with equal facility. The Byers bulletin P.O. 7122 dated March, 1946, and entitled "Byers Wrought Iron for Radiant Heating" is an informative publication covering the principles of radiant heating, as well as the principles of design. This bulletin outlines two general methods of approach to radiant heating design problems and calls attention to the 18th ed. of "Heating, Ventilating, Air-conditioning Guide," Chap. 45, wherein is described one method of approach by which the temperature and area of a warmed surface necessary to establish a given mean radiant temperature may be calculated. To supplement the MRT calculation, it is necessary to compute the air temperature that will be maintained as a result of a total heat loss from the panel by radiation and convection.

The second method of approach, referred to by the A. M. Byers Company, is that which appeared in a series of articles in the June, July, August, and September issues of *Heating, Piping and*

Air-conditioning for the year 1940, written by Dr. F. E. Giesecke. This method is based on a calculation of the panel area and temperature needed to maintain a predetermined air temperature, after which the MRT is figured as a check. In some cases, more than one set of calculations must be made before suitable values of temperature area and location of the required warmed surfaces can be selected.

A later article on design, prepared by Dr. Giesecke, appears in the September, 1941, issue of *Plumbing & Heating Business*, entitled "A Working Method for Calculating a Floor Type Radiant Heating System." The method described is exceedingly simple and lends itself very well to the requirements of practical heating and includes, for example, a composite curve showing the relationship between pipe size and spacing, water temperature and total heat output per square foot of floor surface.

Design procedure as advocated by the Byers Company is based on Dr. Giesecke's articles of August, 1940, previously mentioned. With this design procedure the assumption is made that a practical output is 3.5 Btu per hr per square foot of external pipe surface per degree temperature difference between circulating water and room air. When this rule is applied to standard iron pipe sizes, it appears that for each linear foot of 1-in. standard-weight pipe, 1.2 Btu can be transmitted per degree temperature difference, water to air, and for $\frac{3}{4}$ -in. pipe, the transmission is 1 Btu per ft, and for $\frac{1}{2}$ -in. standard pipe, this value becomes 0.80. It is to be noted that these rates of heat delivery from a given length of pipe include the cement or plaster envelope surrounding the iron pipe. To facilitate practical work, the Byers Company suggests the use of the following formula for determining the quantity of pipe required for any given space:

$$P = \frac{HL}{3.5 \times A \times dT}$$

where P = linear feet of pipe

HL = total heating load (in all directions from panel)

A = external pipe surface area per linear foot

dT = temperature difference, water to room air

To make use of this formula, choice must first be made of pipe size and mean operating water temperature. As radiant heating

systems usually consist of a number of coils connected to supply and return mains, the proportioning and location of which are essential features in design, the Byers publication has the following suggestions to make relative to this phase of the design problems:

Design work is usually simplified if a tentative system of supply and return mains for a multiroom structure is worked out before any time is spent designing the elements for the individual rooms. As a general thing, the best results will be obtained by placing the supply main around the periphery of a structure in order to take advantage of the warmest water in the coldest areas and thus create a more uniform heating effect.

In a system where long main runs are involved or where many individual elements are fed from one set of mains, it is considered good practice to reverse either the supply or return and thus tend to equalize the total pressure drop due to frictional resistance in the mains serving each element. The system thus becomes largely self-balancing, and danger of "short-circuiting" is avoided.

Proper pipe size in mains can be quickly and easily chosen from the tables given in Chap. 16, 22d ed., of the ASHVE "Guide." It is obviously important that this design detail be carefully considered. Otherwise, the system may be unduly restricted with resultant poor performance.

The Byers publication points out that with radiant installations the heating effect of the supply and return mains can be included in computing the total amount of piping needed for any given area, also pointing out that if a 2-in. main, 20 ft long, runs through a room in which it is intended to use 1-in. coils, the equivalent length of main that could be deducted from the calculated quantity of 1-in. pipe required would not be the actual length of 20 ft but would be 36 ft. This value is obtained by multiplying 20 ft by the ratio between the two pipe diameters, 1 in. nominal and 2 in. nominal, resulting in a factor of approximately 1.8.

As it is sometimes desirable to calculate the inside surface temperature of a wall exposed to outdoor air, the Byers publication suggests the following formula for making this determination:

$$T_s = T_a - \frac{C(T_a - T_o)}{f}$$

where T_s = inside surface temperature, °F

T_a = temperature of air in room

T_o = temperature of outside air

C = over-all heat transfer coefficient, Btu per square foot per hour per degree of temperature difference between inside and outside air

f = film coefficient for inside wall surface, expressed in Btu per square foot per hour per °F difference in temperature between inside air and inside wall temperature. A value of 1.65 is commonly used for this coefficient

The design procedure developed by the Chase Brass & Copper Co., Inc., of Waterbury, Conn., proceeds along a somewhat different line and is based on the validity of two assumptions, one being that the heat input to a radiantly heated space is equal to the heat loss as determined for that space by conventional methods, outlined in the ASHVE "Guide," and the other assumption being that the MRT (mean radiant temperature) will be approximately equal to the air temperature within the space heated. This cannot always be exactly true, as to render a space livable there will have to be a certain amount of air change. The air temperature will be somewhat below that of the MRT but will not be materially different if the rate of infiltration is not greater than one and one-half or two times the room volume per hour.

As radiant heating makes use of relatively large areas operating at low temperatures, and as these areas are part and parcel of a building structure, it is not possible by any simple method to calculate the amount of heat that will flow into a given space from pipes buried within the structure, without taking into account a large number of independent quantities.

The extent to which higher mathematics can enter into this problem of radiant heating design is indicated in Chap. X of this book, where a complete mathematical discussion is presented in detail on the design of radiant heating applicable to all conditions.

In order to devise a practical method for radiant heating design which would cover any type of building construction, the Chase Co.'s method provides for a series of charts, of which three give the basic relationship between heat output and temperature for ceiling, wall, and floor installations, and a more detailed series of charts, each referring to a particular type of construction, from which, with values obtained from the basic charts, a complete evaluation of tube size, spacing, water temperature, and heat loss in the reverse direction can be obtained with a minimum amount of mathematical computation.

As an example of the Chase method of design, we will assume

that we have a room 10 by 15 ft of ordinary frame construction and that it is on the first floor of a two-story building with a room above to be occupied. The first step to be taken is to determine the heat loss in this room in Btu's in accordance with conventional methods, and it is to be observed that the determination of heat loss takes into account relative room exposure and minimum outdoor temperatures, so that in the Chase method of design, no consideration is given to whether a given room is 10 by 15 ft, for example, or 12 by 12½ ft, as in both these cases the area is 150 sq ft.

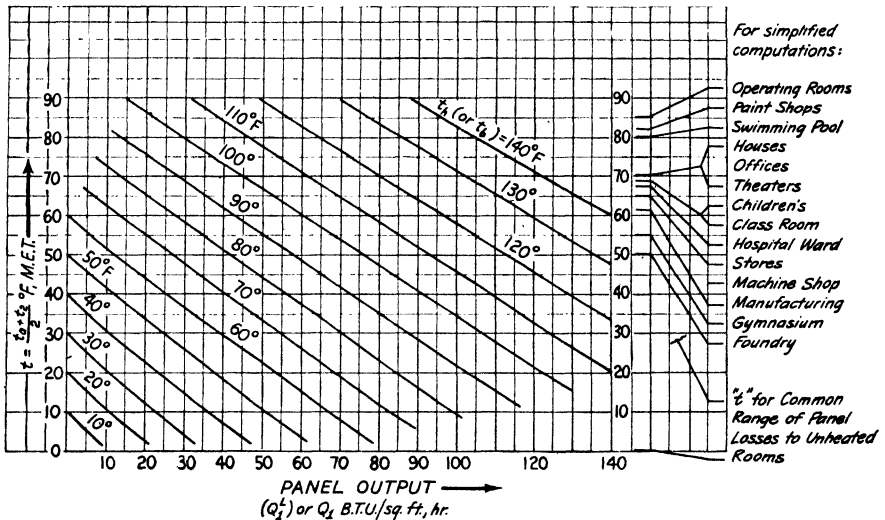

FIG. 7-1.—Ceiling output chart. (Chase Brass & Copper Co., Inc.)

Neither does it take into account room height. All of these factors are present in the calculations necessary to determine heat loss.

The heat loss having been determined, which for the purpose of this example will be assumed to be 7500 Btu, it is then divided by the available square feet of ceiling or floor surface to obtain a required input of 50 Btu per sq ft. Assume that a ceiling installation is desired; the next step is to consult Output Chart C (Fig. 7-1). As it is safe to design a radiant heating system with a comfort temperature 5° less than can be assumed with a conventional system, enter this chart from the left-hand side with the value of 65° for MET (mean effective temperature), continue to the right and make an intersection with the value of 50 Btu per sq ft, and it will be noted that the chart gives a panel temperature

of approximately 99°. This means that if the room in question, *i.e.*, 10 by 15 ft, with a heat loss of 7500 Btu, has its ceiling heated to a temperature of 99°, in that room will exist a comfort temperature of 65°, which will be the equivalent of a comfort temperature of 70° as might be experienced from a conventional system. The reason for this is that in a radiantly heated room, the temperature of the room surfaces will be above that of the air and the heat

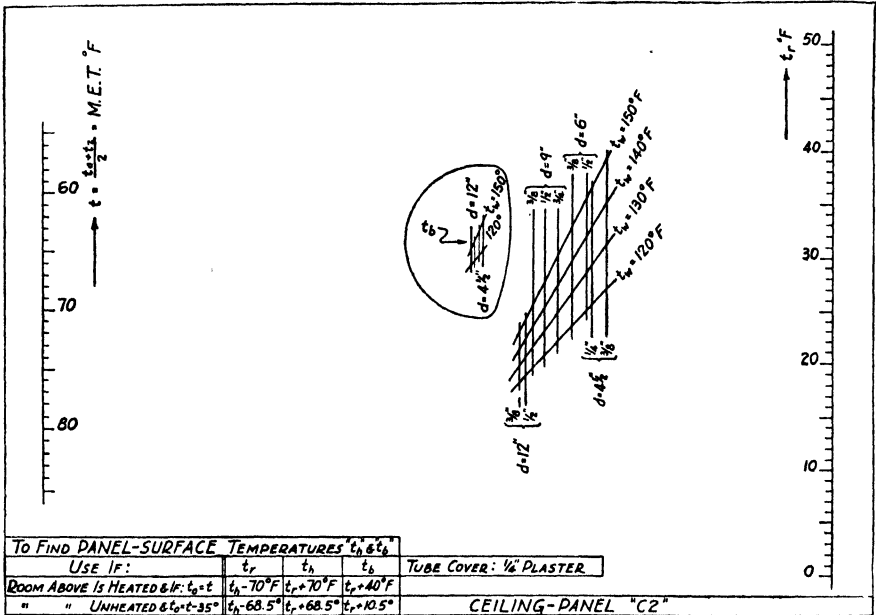

FIG. 7-2.—Ceiling panel chart. (Chase Brass & Copper Co., Inc.)

loss from the body will be governed more by the radiantly heated surfaces than by convection losses to room air.

The desired ceiling temperature being known, the next step is to determine tube size, spacing, and water temperature that will provide the proper ceiling temperature. For this purpose, select the proper design chart which will apply to the type of construction to be used in the proposed building. Let it be assumed that the ceiling coils will be in gypsum plastered ceilings and that there will be no insulation above the plaster, it being permissible to allow heat to flow in the reverse direction into the room above. In this case, Ceiling Panel Chart C2 (Fig. 7-2) is the one to be used.

On the left-hand side of the chart, there is a temperature scale representing MET, for which in this case we have assumed a value of 65° ; on the right-hand side of the chart is a scale representing reference temperatures. These have no direct bearing on the problem, but it will be noted that the reference temperature is the temperature of the ceiling which has been determined from Chart C minus an arbitrary figure of 70° , which is to be applied if the room above is heated, as is true in this particular problem.

As the ceiling temperature has been determined to be 99° , subtracting 70° from this value, we have a result of 29° for the reference temperature. If a line is drawn from the value 65 on the left-hand side to 29 on the right-hand side, it will be observed that this line crosses the hatched figure at several points. For example, there is an intersection which shows that the desired ceiling temperature can be obtained with $\frac{1}{4}$ -in. nominal tubing, spaced $4\frac{1}{2}$ in. on center, with a water temperature of 130° ; also, there is a further intersection with $\frac{3}{8}$ -in. nominal tubing, spaced 6 in. on center, with a water temperature of 140° . There is also an intersection with $\frac{3}{4}$ -in. nominal tubing, spaced 9 in. on center, and the water temperature is approximately 148° . In an actual design problem, the procedure would be to determine the desirable water temperature in the room having maximum heat loss and then for other rooms to determine the tube size and spacing for the water temperature that has already been selected for the room of maximum loss. In this way, all the rooms in a given structure will be supplied with water at the same temperature, necessary variations in heat delivery being taken care of by variation in tube size and spacing.

The next step is to determine the amount of heat that will be delivered to the space above the room for which a ceiling installation has been designed. To make this determination, use is made of the small hatched figure enclosed in circular lines to the left of the main diagram and indicated by T_b . Locate a point in this small diagram corresponding to one of the intersections already obtained, as, for example, $\frac{3}{8}$ -in. tubing with a 6-in. spacing and a water temperature of 140° , estimate the position of this point in the small diagram; then assuming that the desired temperature in the room above is the same as has been provided for in the room in question, namely, 65° , draw a line extending from 65 to the left, through the small diagram at the approximate point estimated,

and it will be noted that it strikes the reference temperature scale to the right of the diagram at 31°. From the instruction table at the lower part of the diagram, it will be noted that the value for T_b , the temperature of the floor above, is the reference temperature plus 40, or in this case 40 plus 31, or a total of 71°.

To obtain the heat input to the room above, reference is now made to Floor Panel Output Chart A (Fig. 7-3). With the conditions outlined, we have for the upstairs room a radiantly heated space receiving some heat from the floor. As we have determined the floor temperature to be 71°, we enter Floor Output Chart A along the lines representing 65° until we find an intersection with the

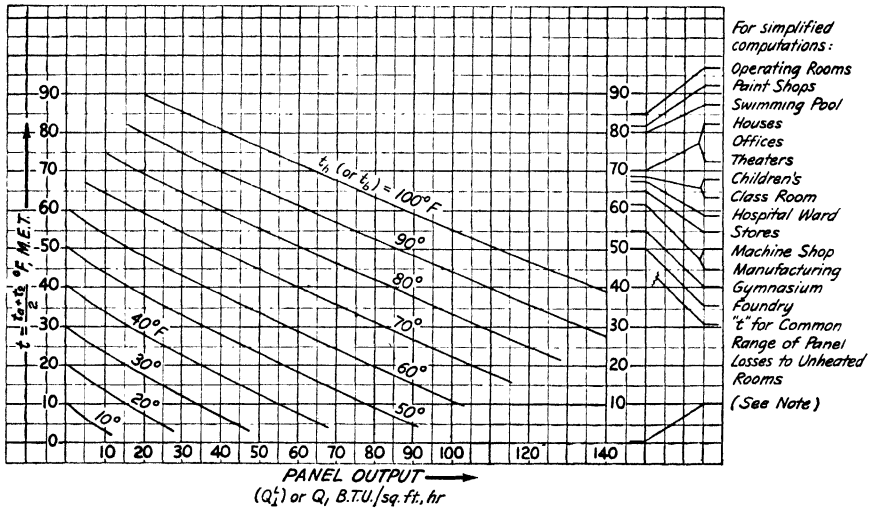

FIG. 7-3.—Floor output chart. (Chase Brass & Copper Co., Inc.)

diagonal line representing 71°. This appears to be at a point, if projected down to the output scale, showing that the panel output will be approximately 11 Btu per sq ft per hr.

At this point in our design, we have determined the tube size, spacing, and water temperature to be used in a ceiling construction to provide a given heat input to the designed space and have also determined the amount of heat that will be transmitted into the space above the ceiling of the room in question, which is 11 Btu times 150 sq ft, or 1650 Btu, and consequently will not be available to produce comfort conditions in the designed area.

Proceeding now with a detailed design for the room above,

which we will assume to be 9 by 12 ft with a heat loss of 5000 Btu, in this case there will be a heat loss of 46 Btu per sq ft; but as 11 Btu are received from the room below, it means that there will be required a net input to the room of 35 Btu per sq ft from the ceiling.

As there should be insulation over the plaster, a different chart should be used, in this case, Ceiling Panel C4 (Fig. 7-4) which provides for an insulated construction making use of gypsum

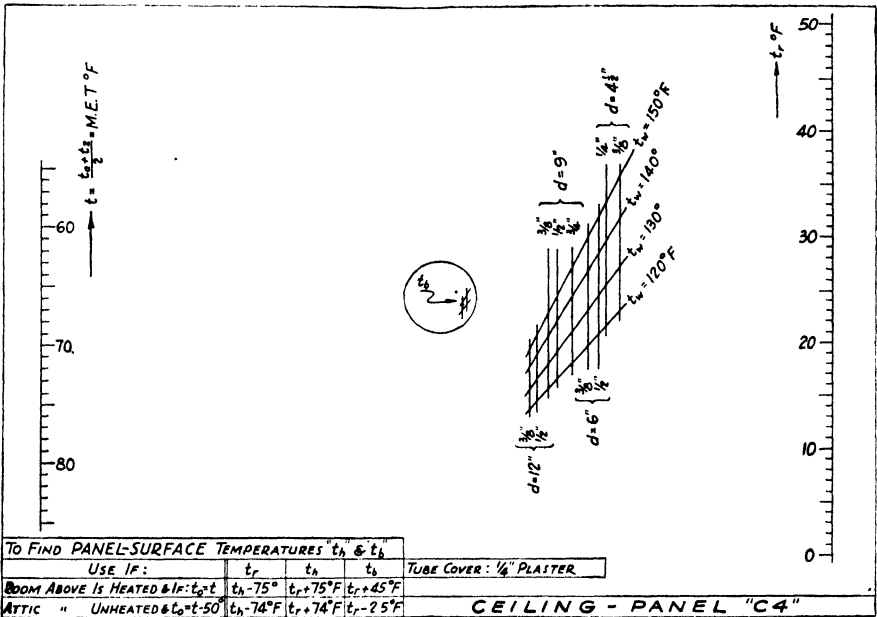

Copyright 1933 Elmer Reed & Co., Inc., Boston, U.S.A.

FIG. 7-4.—Ceiling panel chart. (Chase Brass & Copper Co., Inc.)

plaster. To return now to the Ceiling Panel Chart C (Fig. 7-1), it is determined that for a comfort temperature of 65° and a panel output of 35 Btu per sq ft, a ceiling temperature of 90° is necessary. Now refer to the table at the bottom of Ceiling Panel Chart C4; the reference temperature for an unheated attic above an insulated ceiling is the ceiling temperature minus 74, or in this particular case, 90 minus 74, giving a value of 16 for reference temperature. Drawing a line across the chart from 65 to 16, we find an intersection of 1/4-in. nominal tubing, spaced 4 1/2 in., with a water temperature of 130°, or with 3/8-in. nominal tubing, spaced 6 in., there would

be required a water temperature of about 117° . As our previous design has indicated that a desirable water temperature is 140° , the intersections on this chart would indicate that a $\frac{3}{8}$ -in. nominal tubing, spaced approximately 10 in., would give the desired output for the water temperature of 140° .

Next, the heat loss to the attic should be determined; and as the small figure T_b is quite minute, it will be satisfactory to place the reference point in the center of this figure. Then drawing a line from the MET of 65 through T_b , we find a reference temperature of 22° . Next, with reference to the table at the bottom of the curve, the temperature of the attic floor can be assumed as reference temperature minus $2\frac{1}{2}^{\circ}$, or approximately 20°F . This figure is based on the assumption, as indicated in the table, that the air temperature in the attic is the comfort temperature minus 50, or in this case 15° . Next, entering the Floor Panel Output Chart A (Fig. 7-3), with an air temperature of 15° and a floor temperature of 20° , there is indicated an approximate Btu output under these conditions of 7 Btu per sq ft. When all these results are totaled for the second-story room having an area of 108 sq ft and a Btu loss of 5000, it will be found that the total gross Btu input to the room from the hot-water circulating system will be 4568, of which 756 Btu will be dissipated in the attic and 3812 will be transmitted to the room, which together with the heat input from the floor as derived from the heat input to the lower room of approximately 1188 Btu, will provide the necessary total 5000 Btu input.

As an example of the effect of omitting insulation, assume that the plastering of the ceiling in the second-story room was exposed to the attic. In this case Ceiling Panel Chart C2 (Fig. 7-2) would be used instead of C4 (Fig. 7-4), in which case the reference temperature would be 90 minus $68\frac{1}{2}$ instead of 74 previously used, and this modification would give a reference temperature of 21.5° . When the necessary line is drawn connecting 65 MET to reference temperature 21.5° , it will be observed at once that $\frac{3}{8}$ -in. tubing on 10-in. centers, with 140° water temperature, is no longer sufficient; but with this size tube and spacing, the water temperature would have to be in excess of 150° . With the previously designed water temperature of 140° , $\frac{3}{8}$ -in. tubing on 8-in. center spacing would be necessary. The reference point in figure T_b originally used would have to be slightly raised, so that the new reference temperature

for determining the upward heat loss will be 32°. Now referring to the table at the bottom of Fig. 7-2, it will be found that the temperature of the floor above will be the reference temperature plus 10½, or in this case 42½°. With an attic air temperature of *T* minus 35 as shown in the table (65 to 35 or 30°), reference to the Floor Panel Chart shows that with an air temperature of 30° and a floor temperature of 42½°, there will be a loss of 22 Btu per sq ft, or a total loss of 2380 as against only 750 if insulation had been used.

In all cases of ceiling design, care must be taken not to have ceiling temperature in excess of those permitted by room height in accordance with the following table:

MAXIMUM ALLOWABLE CEILING TEMPERATURES FOR VARIOUS HEIGHTS OF ROOMS
(Air temperature 65°F)

Ceiling height	Desirable Btu per sq ft	Desirable temperature limit	Maximum Btu per sq ft	Maximum permissible temperature
7'	45	95	52	100
7'6"	50	98	62	105
8'	55	102	70	110
8'6"	63	107	78	115
9'	75	113	95	121
9'6"	87	119	105	127
10'	100	125	115	133

Study of the Chase charts shows very clearly that with some types of construction, such as multistory, reinforced concrete buildings, improper design might convert an intended floor heating installation into actually a ceiling installation for the rooms below and, conversely, it might be quite possible for a ceiling installation to be rather ineffective owing to the amount of heat that would be transmitted to the space above.

For the solution of other radiant heating problems, reference is made to the "Radiant Heating Manual" published by the Chase Brass & Copper Co., which includes design charts for all normal types of building constructions.

A third method of designing radiant heating systems is that developed by the Revere Copper and Brass Incorporated, of New York, and outlined in their publication entitled "A Graphical

Design Procedure for Radiant Panel Heating." The Revere method of design follows a different approach from that of either the A. M. Byers Company or the Chase Brass & Copper Co., and their bulletin states that their plan of radiant heating design is to determine first the minimum area of a specified type of heating panel to provide comfort conditions in a structure of any specifications. Following this determination, pipe sizes, spacing, water temperature, and heat loss can then be determined.

The Revere method of designing a heating system for a given room consists in starting with the room dimensions, including the height, the minimum outdoor temperature, and an estimate of the volume of air in cubic feet per minute that will be introduced from the outside at the corresponding minimum temperature. Estimates are made of the areas and values of the heat-transfer coefficient of the various room surfaces; also an estimate is made of the square feet of unheated room area. The cubic feet of outside air introduced to the room are reduced to a figure representing the number of air changes per hour. Thus, in a room of 1000 cu ft, the introduction of 1500 cu ft of air per hour would be an air change of 1.5. After these various estimates are tabulated, entry is made on a "geometry chart," a number of which are included in the Revere publication, each chart applying to one given height of room. When this chart is entered with the width and length of the room in question and the rate of air change, a value for two constants is determined. Next, reference is made to a design chart, of which there are three general classes illustrated in the Revere book: one set for floor installation, one for wall, and one for ceiling. In each class there are various charts for assumed panel surface temperatures and assumed minimum outdoor temperatures. Select a desired chart as applying to the proper location—floor, wall, or ceiling—and also most nearly approximating the desired temperature of radiating surface, as well as the probable minimum temperature that will be involved. Then enter upon the chart the over-all coefficient of heat transfer, as well as the values obtained from the geometry chart first consulted. A value is thus obtained for air temperature as well as the Btu output per square foot from the heated area of the ceiling and the percentage of that area with reference to the total ceiling area.

If the value of air temperature, heat output, panel area, etc.,

represents values inconsistent with the assumptions originally made on entering the design chart or appears to be inconsistent in any way with the factors involved, then a new set of assumptions must be made and the procedure repeated until values are obtained for air temperature, ceiling output in Btu per square foot, panel area, and heat loss that are consistent. When these calculated values are obtained and represent reasonable conditions, then reference may be made to a table, from which can be obtained the size and spacing of copper tubing to be used in the ceiling panel that will give the desired radiating surface temperature with a suitable temperature of circulating water. Next, entering a flow-rate chart with panel area and Btu output, together with an estimated value for temperature drop in the circulating water, the amount of circulating water in gallons per minute per square foot of panel area is obtained. The result gives the Btu output to the room in question, but to the calculated value must be added the estimated amount of heat loss in the reverse direction, from which figure a determination of boiler capacity is obtained. The MRT in the room as designed is obtained by subtracting from 140 the calculated air temperature as obtained in the preceding step, the difference being the MRT. After the individual room requirement of water volume and temperature has been obtained by the Revere method, the remaining features of design can be obtained by following conventional methods or by methods to be described later in this chapter.

In short, the Revere method provides for a radiant heating design by first making a series of estimates, then entering the various charts published by Revere to determine a number of calculated values. If, following the determination of the calculated values, a recheck from the calculated to the assumed values indicates that both are consistent, then the complete design including estimated and calculated values is correct. If a discrepancy exists, then a different set of estimated values must be assumed and a recalculation made, and this process is continued until the calculated values and estimated values can be made to check or at least come within close approximation. When this result is obtained, then it can be assumed that all values, both estimated and calculated, are correct and consistent.

After the required heat delivery of each panel to the room being

designed, plus the heat lost in a reverse direction, has been determined by any of the previously described methods of panel design the total sum of these deliveries should equal the total estimated heat loss. It is to be presumed that in designing the individual coils, consideration has been given to the allowable temperature drop in the circulating medium, recognizing that the greater the temperature drop or difference in temperature between incoming and outgoing water from a coil, the smaller the amount of water that will have to be circulated, with a corresponding decrease in size of tube and main that will be needed.

To determine the size of circulating pump required, capacities of which are usually given in gallons per minute at various specified heads, it is necessary to take the total Btu requirements and divide

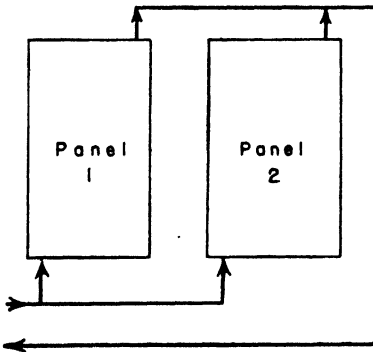

FIG. 7-5.—Connections to radiant panels.

by the selected temperature drop. This directly gives the pounds of water per hour that must be circulated. Dividing the pounds of water per hour by 8.33, being the pounds of water per gallon, and again dividing by 60, pounds of water per hour are converted into gallons per minute. This figure determines the capacity of the circulator required in gallons per minute but leaves the question of necessary head to be determined later.

With the location and size of the various heating coils decided, it is now necessary to lay out the distribution piping system so that water may be delivered to the coils from the boiler and return to the boiler through the circulating pump. The most desirable way of planning the distribution piping is in accordance with Fig. 7-5, where it will be noted that the length of the supply and return pipes from each panel is approximately the same. This would not be true if, for example, the feed for panel 1 was taken at the nearest point of delivery from the boiler and then as the return flow from panel 1 is directed immediately to the return main, the length of supply and return pipe to panel 1 will be much less than if the piping is run in accordance with the diagram. With the piping

laid out in this manner, there will be less difficulty for proper balance of the entire system after it is completely installed.

As an actual example in practice, note Fig. 3-1, which shows very clearly the supply and return mains to the right of the illustration, both fastened to an H column of the building. One main leads directly to the corner of the grid nearest the column; the other main runs to the far end of the grid attached to the left-hand side. The small pipe connection shown at the end of the left-hand main is the air venting connection, which, however, is incorrectly connected as shown. It should have been made at the very upper edge of the main and not at the bottom, so that all air could be readily purged from the grid.

In order to arrive at the most economical design of a distribution system supplying a multiplicity of heating coils, it is necessary to determine the amount of water flowing in each part of the distribution piping and adjust the size of the pipe so that there is a reasonable pressure drop in the distribution system and the entire pressure drop comes within the range of available circulators. A table in the Appendix gives the pressure drop in inches of water per foot of main when carrying a given flow of water in pounds per hour. In addition to the friction drop in each coil and in the mains, the additional friction due to elbows, valves, fittings, and bends in the tubing has to be properly taken into account. Another table in the Appendix gives the pressure drop in terms of feet of straight pipe or tubing for standard L's, T's, and return bends. Provision must also be made for friction of various valves that are necessary for controlling temperatures.

Figure 7-6 illustrates the proper procedure for determining feeder sizes on the assumption that there are nine coils to be supplied with water and that the output of each coil in Btu per hour is in accordance with the table shown on page 166.

If it is assumed that a 30° temperature drop would be suitable, the pounds of water per hour are obtained directly by dividing the Btu by 30, the desired temperature drop. This is the maximum desirable figure and results in minimum practical flow with the resulting minimum pipe sizes required. Figure 7-6 is laid out to illustrate design procedure for determining feeder sizes and could represent a three-story building application or three groups of three coils on one floor. In either case, the proper procedure is

outlined. From the following table, the pounds per hour for coils 1, 2, and 3 are noted, the sum being 2700 lb. Consequently, this is the volume which has to pass through feeder *B* as well as feeder *G*. The total pounds of water required for coils 4, 5, and 6 amount to 2300 lb; thus, feeder *C* must carry this amount with the result that return feeder *H* has to carry 5000 while feeder *E* supplying the second group has to carry 5400. In the same manner, the sum of the requirements of coils 7, 8, and 9 amounts to 3100 lb, so that feeders *F* and *D* have to be proportioned for this volume, while the feeder *I* carries 8100, being the total return

TABLE REFERRING TO FIG. 7-6

Coil No.	Btu output	Water, lb circulated at 30° drop	Water, lb flow in group header
1	27,000	900	2700
2	36,000	1200	
3	18,000	600	
4	24,000	800	2300
5	15,000	500	
6	30,000	1000	
7	48,000	1600	3100
8	18,000	600	
9	27,000	900	

Total water, lb circulated per hour..... 8100

Dividing by 8.3 gives gallons per hour..... 978

Dividing by 60 gives gallons per minute..... 16.3

A value within the range of a 1½-in. circulator

volume. Obviously, the supply main *K* also carries 8100 lb. Selection of the proper size mains and feeders can now be directly obtained from the table of pressure drop. It is good practice to maintain between 0.20 and 0.25 in. of pressure drop per foot of pipe length; so from the table is to be noted that for feeders *D* and *G*, carrying 2700 lb, a 1-in. nominal tube or 1¼-in. pipe will be suitable and these sizes will also be suitable for feeder *C* and probably *D* if it is not too long. Main *E* carrying 5400 lb will require 1¼-in. nominal tube or pipe, which will also be suitable for main *H*. For the main risers *K* and *I*, carrying 8100 lb, 1½-in. pipe will be ample, which also happens to coincide with the most desirable circulator capacity.

Figure 7-6 also shows a diagrammatic arrangement of the equipment necessary or suitable for a radiant heating system involving a number of panel coils. Number 1 indicates the boiler. Controls for the burner are not shown. It is assumed that the boiler will be operating at constant water temperature for the purpose of supplying domestic hot water through a heat exchanger 5, water entering the exchanger for the domestic system at 6 and leaving at 7. Number 2 indicates an air trap which should be located approximately as shown to ensure that no air entrained by the circulating water enters the radiant system. Number 3 is some type of mixing valve or the equivalent as is required by desirable control systems whereby water temperature is modified in accordance with existing outdoor temperature. Number 4 is the circulating pump. Number 10 is a drain to clear the entire heating system. Number 9 is a pressure gage with two hands, one of which should be set for the pressure that will exist when the system is properly full. The second hand should show water pressure and should coincide exactly with the set hand when the system is completely filled. Number 8 is the supply riser which should go the full height of the building with an air valve 11 at the top. The main which supplies the uppermost floor or group of panels, should extend to an open type of expansion tank if this method of expansion compensation is used.

If a closed type of expansion tank is installed, the open tank 14 can be omitted and the closed type indicated by 15 can be located near the boiler. This tank should be provided with necessary means for recharging with air and should have a capacity of 25 to 50 per cent of the volumetric requirements of the entire system. The open type tank 14, if used, should be provided with a drain and overflow 16 leading to the sewer and can be provided with a float valve 17 in order to keep the system automatically filled to the proper level. If automatic filling is provided, capacity of the tank should not be less than 50 per cent of the total volume of the system; otherwise, the tank will overflow during periods of heating, and fresh water will be added as the system cools down, thus continually bringing in an unwanted supply of fresh water. The float valve should be adjusted so that only water lost by evaporation is admitted to the tank. If the bottom of the open tank is located 3 ft above the highest point in the supply system,

this will be sufficient. In an unheated attic, if a reasonable amount of insulation is placed about the tank, temperatures below freezing will not cause trouble. The natural flow in and out of the tank of hot water occasioned by variation in temperature will ordinarily supply enough heat to keep the water above 32°F. It is believed that ordinarily less trouble will be experienced with the open type of tank installed as described than with the closed tank, which always must contain at least 20 per cent of its volume of compressed air. If this air is lost, difficulty results.

The down riser is indicated by 17, and No. 18 is an air valve at its top. Each branch from the risers should be fitted with a valve, and each attachment from the panels to the branches should have valves at each end and also a regulating cock for use in establishing proper heat balance in the various coils. All horizontal runs should be graded toward the boiler so that the system can be drained at the point 10.

If the panel coils do not completely drain, and if it is necessary to shut the system down through a winter period with outdoor temperatures below freezing, no damage will result if the coils are installed with sufficient accuracy, so that with the drain valve 10 open, there is no coil section completely filled with water. With pipes buried in a cement floor, the same rule holds true, with the advantage in this case that the strength of the concrete will tend to assist the pipe in resisting any expansion forces present and will tend to cause the forming ice to move longitudinally for relief, provided, of course, there is sufficient air space available for this method. With tubing in the ceiling and not fully drained, freezing might not break the tube walls but certainly would result in cracking the plaster.

While Fig. 7-6 shows a possible layout for a multistory building with one supply riser and one return, it would be perfectly possible in a large building to have as many supply risers or returns as convenient. With the multiplicity of supply risers, the building could be zoned. For example, a building with its major axis northwest and southeast and with the general direction of storms from the northwest, it might be desirable to have the northwest half of the building zoned separately from the southeast half, in which case water could be taken from the boiler through two separate control valves 3, each leading to the proper zoned section.

In addition, the group of floors supplied from a common riser could be separately zoned, as, for example, in the drawing, 19 might represent a modulating valve ordinarily taking its supply from the riser and a reduced temperature supply from the main 20, leading from the down riser 17. The temperature of the water leaving the modulating valve 19 to the upper group of panels would, therefore, be at a lower temperature as desired by outdoor conditions than the lower panels as shown in the diagram.

Although it is preferable to check every design with the most reliable methods that may be available, yet in some cases a simplified procedure may be justified, provided the user of such simplified methods is thoroughly familiar with heating problems in general and radiant heating in particular.

The following simplified methods are intended to be used only by experienced personnel who from previous experience fully understand the elements that are being approximated or ignored. These simplified methods are based on the assumption that the construction to which they are to be applied are of a normal one- or two-story residential type, suitable for the latitude or exposure to which they will be subjected, and are to be properly insulated against heat losses. In particular, it will be assumed that the ceiling below the attic will invariably be insulated, proper wall construction will be used, double windows or the equivalent installed in areas of extreme cold, and all construction requirements suitable for a first-class job in the proposed location will be observed.

Four shortened methods of design are here presented—two for floor constructions and two for ceiling installations. For each class, one method of design is based on first computing the heat loss. The second and simpler short method omits this computation and proceeds on the theory that the designer is well aware of the general problem of designing a heating system of conventional type and has had sufficient previous experience with radiant installations to justify his use of the shortened method as applying to the type of building and the exposure to which it will be subjected and for which he requires a radiant installation but would not otherwise attempt to use the shortened method. If the designer has become generally familiar with radiant heating designs by the more accurate method of determination, the shortened method

will save a great deal of time and labor; and with experience previously obtained by the use of accurate designs, the heating contractor or architect will know at once whether or not the results produced by a shortened method are reasonably accurate and can be expected to function as required. The shortened methods can also be used as a check on the more accurate methods to make sure that there has been no error in the arithmetic of such calculation.

Considering first the more accurate of the shortened methods as applying to ceiling construction, the first step is to estimate, as nearly as possible, the Btu losses in each room being considered, preferably by the method of calculation shown in the ASHVE. After a loss figure is thus obtained, add to it the amount of Btu that may be expected to be transmitted to other areas in the manner of reverse loss. For example, with a ceiling installation, a certain amount of heat will be transmitted to the room above, the amount transmitted being dependent on whether or not there is insulation between the ceiling and the floor above, and this, in turn, is affected by whether or not the room above is heated. If the space above a ceiling-heated room consists of an unheated attic, then insulation must be provided over the ceiling, and these short methods are all based on the assumption that proper construction is used. If the space above a heated ceiling constitutes a second floor and it, in turn, is heated, the heat delivery from the room below to the space above will be about the same whether it is insulated and not heated or not insulated and heated. For this purpose, an allowance of 15 per cent is sufficient.

With floor construction, the loss of heat is downward and into the space below. In the case of a heated floor above a basement, insulation should be provided in the joist spaces to limit the downward flow of heat. In this case, 10 per cent is ample. With concrete floor slabs laid directly on the ground and used for radiant heating construction, the loss downward may be considerable; and unless insulation is provided, as described in the chapter on construction, the downward loss allowed should be on the order of 30 per cent.

Considering now in detail the shortened method of ceiling design and having ascertained the total Btu loss that occurs in a given area, divide this figure by 32. The result will be the lineal

feet of tubing ($\frac{1}{2}$ in. OD) that will have to be placed in the ceiling of the room being considered, whereby the proper number of Btu will be delivered to the room with water circulating in the tubes at an average temperature of 140° . Note that this diameter is the actual outside diameter of the tubes being considered and not the nominal diameter. Trade practice causes considerable confusion on this question of diameter. If tubes have outside diameters different from $\frac{1}{2}$ in., the following corrections can be applied to the length of tubing just determined:

TUBE OR PIPE OTHER THAN $\frac{1}{2}$ IN. IN OUTSIDE DIAMETER	
Diameter of Tube to Be Used	Multiplying Factor
$\frac{3}{4}$ in. OD	1.31
$\frac{7}{8}$ in. OD	0.80
$\frac{1}{2}$ in. OD	0.67
1 in. OD	0.55
1.3 in. OD	0.45

Although from the above table it would appear that only about half as much 1- or 1.3-in. pipe would be required as would be used if $\frac{1}{2}$ -in. tubing were installed, this factor must be applied with some caution, as to be perfectly equivalent the 1-in. pipe would have to be buried in the plaster with the same efficiency as the $\frac{1}{2}$ - or $\frac{3}{8}$ -in. tubing. Therefore this table applies only to those cases where the ceiling tubing is completely and thoroughly buried in the plaster construction. If values of water temperature other than 140° are required, multiply the required length of tubing as now determined by the following factors:

Water Temperature	Multiplying Factor
150	0.90
140	1.00
130	1.17
120	1.40
110	1.78
100	2.85
90	4.15

It must be remembered that in designing the heat output from a ceiling or floor, a uniform output over the entire area should never be assumed. The values obtained from design formulas are always average values, and higher temperatures should be arranged along the more exposed areas of the room. Areas far removed from maximum exposure should have a heat input approximating

only 50 to 75 per cent of average in the cases of ordinary construction. This variation in heat delivery is provided for by means of suitable tube spacing, being closer together than average near exposed areas and farther apart elsewhere, even to the possible extent of omitting coils entirely in areas well protected and remote from excessive exposure.

In fact, the proper location and arrangement of radiant heating coils are more important than accurate estimates of heat loss. An error in this figure can be corrected in several different ways, as has been pointed out, but an error in coil direction or location cannot be corrected after the building is completed without considerable expense.

As an example of a short method of calculation, let us assume that a room of 11 by 22 ft, having an area of 242 sq ft, is to be heated with pipe in the ceiling. Assume further that this room has a Btu loss of 14,440 per hr, the assumption being that it will be exposed to a minimum temperature of minus 10°F. To the loss figure just ascertained, add 15 per cent or 2160 Btu as representing the reverse flow of heat that will flow to the space above if this space is unheated and insulation is provided or if it is heated and no insulation is provided, the upward flow being assumed to be the same in each case. Consequently, the sum of these two figures gives 16,600 as the Btu input required to the room. If this value is divided by 32, a figure of 519 results, representing the feet of $\frac{1}{2}$ -in.-OD tubing required.

Should it be desirable to use larger pipe than $\frac{1}{2}$ -in. tube, for example, $\frac{3}{4}$ in. nominal IPS, which has a diameter of approximately 1 in., the table giving correction factors shows that for 1 in. the factor is 0.55, which multiplied by 519 gives 286 as the footage of IPS pipe that would be required in place of 519 ft of $\frac{1}{2}$ -in.-OD tube.

Attention is directed at this point to the fact that insofar as radiant heating design is concerned, the type of metal used in the piping, whether iron, copper, or steel, has no bearing on the required water temperatures, spacing of pipes, or diameter. If, for example, the design calls for 100 ft of 1-in.-OD pipe, with 12-in. spacing, and a water temperature of 120°, the pipe actually used can be of wrought iron, steel, or copper, and no corrections for relative heat conductivity are required.

Assuming that the excessive loss in a room of this size is due to the presence of windows along the longer dimension, it is apparent that 25 runs of tubing, 21 ft long, will be of sufficient total length. When the width (11 ft) of the room in inches is divided by 25 as representing the number of runs, it is apparent that the average spacing between tubes will be 5.3 in. In order to get a greater heat input to the room opposite the cold exposure, it would be desirable to run a band of tubing about 3 ft in width with a closer spacing than average, say 4 in. Ten rows of tubing would, therefore, occupy 40 in., and the remaining 15 rows would occupy the remaining distance of 92 in., or an average spacing of 6 in. If the type of construction adopted were such as to interfere with the spacing of the tubes exactly as given, an approximation should be arranged, the principle involved being simply to concentrate to some extent the runs of tubing parallel to the most exposed surface. To find the quantity of circulating water necessary, divide the total Btu requirements by 30, as representing a reasonable temperature drop, resulting in a requirement of 550 lb of water per hour, or 11 gal per min at a maximum temperature of 140 plus 15, or 155° water-entering temperature, the return being 140 minus 15 or 125°. Pressure drop and flow tables will probably indicate that the coils in this room will have to be made in three parts, each 171 ft long in order to come within reasonable pressure drops, all as outlined in the preceding part of this chapter.

A still further simplified method of design is here shown, but it must be applied with a little more caution than the preceding simplified method. With this procedure, which is to be applied only to residential constructions of conventional types, it is necessary to know only the room dimensions, type of construction, and the minimum outdoor temperature involved. It will also be assumed that the building is of proper design for the exposures to which it will be subjected, properly insulated and protected against all extraordinary infiltration, and in northern climates also provided with double windows or the equivalent.

Reference is now made to the design chart of Fig. 7-7, which enables the designer to determine the number of feet of $\frac{1}{2}$ -in.-OD tubing required per square foot of ceiling with outdoor temperatures ranging from minus 20 to plus 40°. Lines *A*, *B*, and *C* are

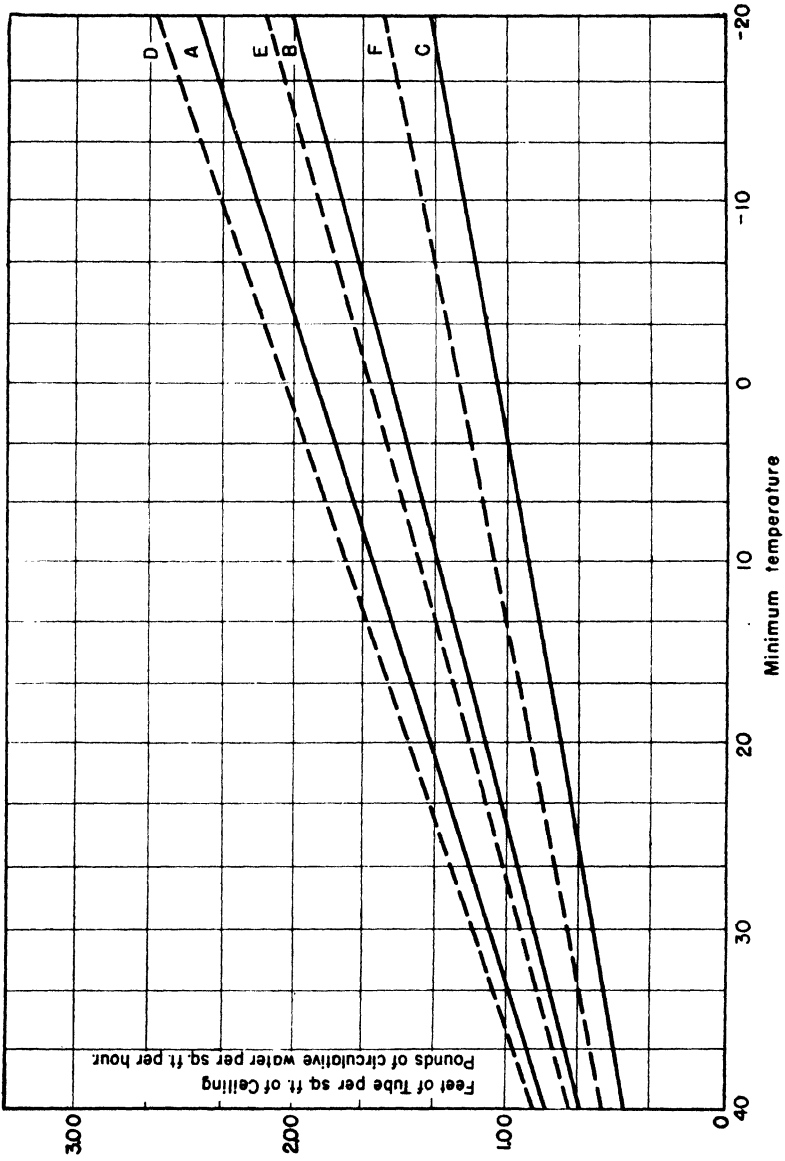

FIG. 7-7.—Design chart for ceiling installation.

to be used for determining the feet of tubing required per square foot of ceiling, and the dash lines *D*, *E*, and *F* give the pounds of water per hour that have to be circulated per square foot of ceiling, using water at an average temperature of 140° , with room comfort temperatures of 65° and outdoor temperatures as indicated. In this chart, the line *A* is to be used for rooms having excessive exposures, as, for example, a room with two outside walls and plenty of glass and located in the direction of usual storms. Line *B* is to be used for rooms having normal exposures, and *C* for rooms having only one outside wall and that corresponding to the minimum room dimension. The water-requirement lines *D*, *E*, and *F* are to be used in conjunction with the corresponding *A*, *B*, and *C* curves. As an example, assume that a room is 10 by 12 ft with two outside walls and located in the most exposed corner of the house and that a minimum temperature of 0° is the limiting temperature factor; under these conditions, we select curve *A*, which shows that 1.90 ft of tubing must be installed per square foot of ceiling. This figure multiplied by 120, the ceiling area, gives us a total tube requirement of 228 ft. When the tubing is run parallel to the longest room dimension, it is indicated that 20 lengths of tubing will be required, spaced approximately on the average of 6 in. If this room had been designed for a minimum outdoor temperature of minus 20° , 2.45 ft of tubing per square foot of ceiling area would have been required.

Continue with this method of design, and next assume that there is a room 12 by 14 ft in a protected corner of the house, with customary glass areas. For this room, line *B* would be selected, which for an outside temperature of 0° there is indicated 1.55 ft of tubing per square foot of ceiling, or a total of 260 ft. Placing the tubing, as before, parallel to the long length of the room, 20 runs would be required, spaced to cover the 12-ft room dimensions. This indicates that an average spacing of 7.2 in. is required. Assume now that there is a room 8 by 12 ft with only the 8-ft dimension applying to an outside wall. In this case, line *C* would be used for determining the feet required, and an inspection indicates that only 1.05 ft of tubing per square foot of ceiling area will be needed. In this case, the tubing should be laid parallel to the short dimension. Thirteen runs across the 8-ft dimension will take care of 100 ft required for this room. Con-

sequently, an average spacing of a little less than 12 in. is indicated.

To determine the amount of hot water required for circulation through the coils, line *D* is used for the room having the maximum exposure; and for zero outdoor temperature, 2.00 lb of circulating water per hr per square foot will be required for this room, a total of 240 lb or 0.48 gal per min. For the 12- by 14-ft room, having an average exposure, curve *E* should be used, which indicates a requirement of 1.65 lb; and for the 8- by 12-ft room, curve *F* is used indicating a requirement of 1.2 lb per hr. As these water-requirement curves are based on a temperature difference of 30°, it is a simple matter to check back and determine from the weight of the water circulated per hour, multiplied by 30, the Btu input to the room that will be made available by the use of this shortened method. If the Btu delivery as determined by this method appears from experience to be out of line with a reasonable value of heat loss, corrections can be made in accordance with the designer's experience. With either of these short methods of design, final check should be made with the table on page 161 to determine whether or not the Btu output per square foot of ceiling is in excess of the limit shown in this table, which if exceeded, would result in higher temperatures than would be desirable.

If it is desired to design a radiant system making use of a floor installation, the following simplified method may be used, subject to all the limitations outlined in the simplified design for ceiling systems. In consideration first of the more accurate simplified method, it is necessary to compute the heat loss for each room in Btu per hour. To this figure add 20 per cent for downward loss, and divide the resulting figure by 50, this being the maximum Btu output per square foot of floor area that results in a floor temperature of approximately 85°F, with a comfort temperature in the room of 65°. It is not desirable to design a floor system having temperatures much in excess of 85° in areas that are going to be continually traversed by the occupants.

If the result obtained by dividing the total Btu output by 50 results in a figure that is less than the room area, it is safe to proceed with the determination of coil design. If, however, the resulting value is more than room area, this indicates that additional heat output will have to be provided for. One method of obtaining this extra output is by heating a strip, not over 3 ft

wide, extending all or partly around the room, on the theory that the occupant of the room will not be traversing this strip to any great extent and, consequently, its temperature can be in excess of 85°, but in any case it should not be in excess of 95°. To determine the feasibility of supplying the maximum heat to the room from the floor, proceed by multiplying the sum of the length and breadth of the room by 6 and again by 15, the latter being the maximum permissible additional Btu floor output from a room having a comfort temperature of 65° and with the central part of the room heated to 85° with a corresponding output of 50 Btu per sq ft. If the figure thus obtained by multiplying the length and breadth of the room by 6 and by 15 and adding in the Btu output of the floor based on 50 Btu per sq ft is greater than the estimated heat loss plus 20 per cent, then a floor installation may be designed, and it will be possible to supply all the necessary heat from the floor.

Proceeding now with the details of the design on a basis of the first-mentioned characteristic, *i.e.*, a room 12 by 14 ft, with a loss of 6000 Btu, including 20 per cent downward loss of 1000 Btu, reference should be made to the following table which gives certain arbitrary design factors based on pipe or tube outside diameters and tube spacing and on the further assumption that the pipes will not be buried deeper than 3 in. from the surface of the concrete floor and that the top of the concrete is the finished surface.

DESIGN FACTORS FOR DETERMINING LENGTH OF PIPE OR TUBE REQUIRED
FOR VARIOUS BTU OUTPUTS, 3-IN. BURY—6-, 12-, AND 18-IN. SPACING

Iron pipe size, in.	Tube OD	6 in.	12 in.	18 in.
½	0.750	0.85	0.685	0.485
	0.840	0.96	0.770	0.531
	0.875	1.00	0.800	0.550
¾	1.000	1.14	0.915	0.630
	1.050	1.20	0.960	0.660
	1.125	1.28	1.020	0.705
	1.250	1.43	1.140	0.785
1	1.315	1.50	1.200	0.825
1¼	1.660	1.92	1.520	1.040
1½	1.900	2.16	1.730	1.180

In the use of this table, the first step to be taken is to decide on the average water temperature that will be used in the coils. For floor installations, this is usually taken as 120° . From the selected water temperature, which in this case we will assume to be 120° , subtract the room comfort temperature, which in this case we will assume to be 65° ; the difference is, therefore, 55. Divide the 6000 Btu by 55, which is the actual temperature difference between room air and circulating water, and the quotient obtained is 109. If this quotient is again divided by one of the selected values in the above table, necessary length of feet of tubing or piping is at once obtained. For example, as $\frac{3}{4}$ -in. iron pipe with a diameter of 1.05, as shown in the table, is a suitable diameter in many cases; and assuming a spacing of 12 in., which is also common, we find a design factor of 0.96. By dividing 109 by the factor 0.96, we obtain 113 ft of $\frac{3}{4}$ -in. iron pipe, spaced 12 in., buried not over 3 in. below the surface; and when supplied with circulating water at an average temperature of 120° , there will be delivered into the room 5000 net Btu. If a water temperature of 110° had been desired instead of 120° , subtracting 65° would leave 45; 6000 divided by 45 gives a quotient of 133. Then, if it should be desired to use $1\frac{1}{4}$ -in. iron pipe, with a spacing of 18 in., the factor to be used would be 1.04. Dividing 133 by this factor, there is obtained 128 ft of $1\frac{1}{4}$ -in., spaced 18 in.; or if 12-in. spacing should be desired, then dividing 133 by 1.52, there is obtained 88 ft. Checking with the room dimensions, it would be at once determined that it is not possible to place in the room 128 ft of pipe, spaced 18 in., but it is possible to place the required amount of tubing indicated by this method of calculation when shorter spacings are used. If the required length of pipe of a given diameter and given spacing can be placed within the area available, actual spacing and arrangement can be as dictated by areas of excessive exposure.

Assume the actual Btu loss to have been 7500, which plus 20 per cent or 1500 Btu equals a total of 9000. Then 9000 divided by 50 equals 180, a figure larger than the square feet of room area, indicating that additional heat will be required around the periphery of the room.

If the rule previously given is applied, the room length of 14 ft plus the width of 12 ft, multiplied by 6 and again by 15,

gives the additional heat of 2340 Btu per hr that can be delivered by the strip over and above the safe rate of 50 Btu per sq ft as applying to the entire area, which is 168 sq ft times 50, or 8400 Btu. The sum of these values is 10,740 Btu—a figure larger than the estimated heat loss of 9000; hence, a floor design will be satisfactory for this particular problem.

To determine the pipe footage required, assume that a border strip 3 ft wide, with an area of 120 sq ft is to be heated above 85°; this leaves 48 sq ft having normal heat. Multiplying 48 by 50 gives 2400 Btu to be supplied from a center coil, while 9000 minus 2400 (or 6600) gives the Btu to be supplied from the border strip at a rate of 55 Btu per sq ft.

Following the directions previously given, it will be found that with 65° room temperature and 120° water, 100 ft of 1-in.-IPS pipe spaced 12 in. will be required in the border, and 46 ft of $\frac{3}{4}$ -in.-IPS pipe spaced 12 in. will be needed in the center of the room—a total coil length of 146 ft, which is an amount of pipe that can be placed in a 12- by 14-ft room with 12-in. spacing.

As provided in the simplified method of ceiling design, there is a further simplified method for ground-based concrete slab floor design making use of the curve of Fig. 7-8, which is to be applied in exactly the same manner as the similar curve provided for ceiling construction and with similar precautions. This curve gives the feet of buried 1-in.-OD tubing or pipe required per square foot of floor surface for various minimum outdoor temperatures, assuming that the pipe is buried not over 3 in. below the surface of the floor, spaced 12 in., and the water temperature averages 120°F. As with previous curves on ceiling designs, the line *A* indicates the amount of pipe required for an insulated room having maximum exposure. *B* is an average room, and *C* is for an insulated room having less than average exposures, while dotted lines *D*, *E*, and *F* give the pounds of circulating water required per hour at a temperature averaging 120°. Assume that we have a room 12 by 13 ft, an area of 156 sq ft, with a maximum outside exposure, and it is desired to determine the floor design for a minimum outdoor temperature of zero degrees. When the intersection of zero degrees on line *A* in the curve is found, it is discovered that 0.84 ft of 1-in. pipe is required and that 3.25 lb of water per square foot will be necessary. Multiplying these figures by the

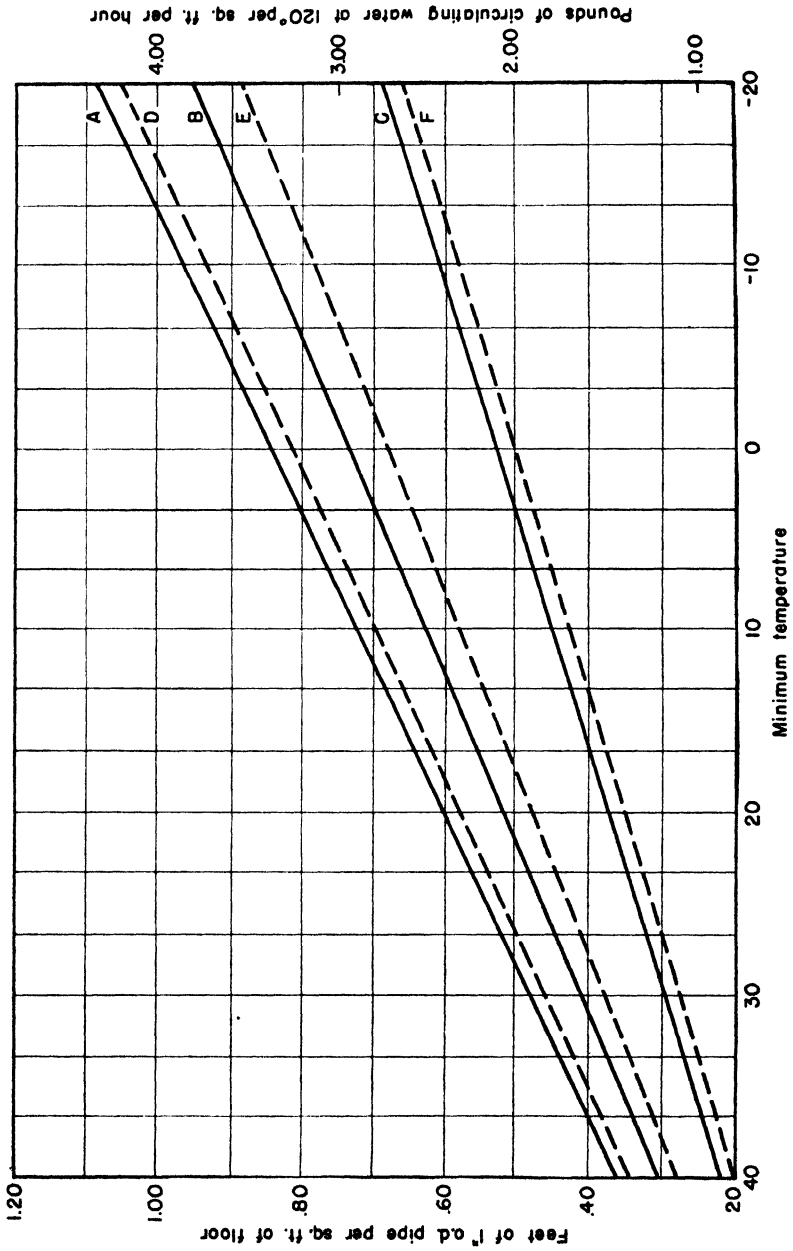

Fig. 7-8.—Design chart for floor installations.

room area, we find that 131 ft of pipe and 507 lb of water per hour⁴, which is about 1 gal per min, are required. As these curves are based on a temperature drop of 20°, multiplying the 507 lb total water required by 20 gives a Btu input of 10,140. Dividing this figure by the room area of 156 ft indicates that the Btu output will be on the order of 64 Btu per sq ft, which figure is somewhat high. This would mean that in this particular condition, a further check of heat loss in this room is indicated and that if a careful check indicates that the figure of 10,140 is approximately correct, the design should be more carefully checked.

On the other hand, if this room is in a location where a minimum outside temperature of only 20° is required, then it will be observed that smaller quantities of pipe as well as circulating water are required, and a further check on total Btu delivery compared with square feet of floor area will indicate that in this room, in localities having a minimum outside temperature of 20°, the floor output per square foot will not be excessive. Considering that average conditions apply to this room of 156 sq ft, then the curve would be entered with reference to line *D*, and it will be found that 116 ft of pipe and a total water poundage of 350 lb per hr are required, which times 20°, the design temperature drop, indicates a Btu loss of heat in this room under normal exposure to be on the order of 7000 Btu. This figure divided by the room area of 156 sq ft gives an average output of 45 Btu per sq ft, which is entirely reasonable for floor construction. If it is desired to use other pipe sizes than 1 in. OD, the following correction table applies:

Standard iron pipe sizes, in.	Correction factor	Nominal copper tube sizes, in.	Correction factor
$\frac{1}{2}$	1.170	$\frac{1}{2}$	1.60
$\frac{3}{4}$	1.000	$\frac{5}{8}$	1.31
1	0.755	$\frac{3}{4}$	1.14
$1\frac{1}{4}$	0.600	1	0.80
		$1\frac{1}{4}$	0.73
$1\frac{1}{2}$	0.530	$1\frac{1}{2}$	0.67

For example, if 100 ft of pipe are required, as determined from the curve in Fig. 7-8, and it is desired to use 1 in. IPS, then

100 × 0.755 gives 75½ ft as the desired length of 1 in. IPS to substitute for 100 ft of 1 in. OD, which is almost the exact diameter of ¾ in. IPS.

If it is necessary to allow for coverages on the concrete slab, such as a wooden floor, tile, etc., multiply the required footage of tubing or pipe in accordance with the following table:

Material on Slab	Multiply Footage by
Ceramic floor tile.....	1.04
Linoleum	1.06
One-inch wood	1.66

If a correction for slab covering is required and it is not desired for any reason to increase the footage of pipe, then as an alternative method, the temperature of the water can be increased, using the same factors as are in the table, but these factors should not be applied to total water temperature but only to the difference between room temperature and water temperature. For example, with water temperature at 120° and room temperature at 65°, the difference being 55, if a correction is desired of water temperature to 1-in. wood, a factor of 1.66, the procedure would be to multiply 55, the difference between design water temperature and room temperature, by 1.66, which gives a result of 91°. This added to the room temperature of 65° gives a total of 156°, which would be the average temperature of water to compensate for a 1-in. wood floor on top of the concrete slab. Then with a 20° temperature differential between incoming and outgoing water, it would mean that the temperature of the water going to the slab would be 166° and leaving the slab 146°.

Before closing the subject of radiant heating design, it is desirable to call attention again to the very great importance in all radiant heating work to proportion and locate correctly the pipe coils and the points of supply and return to each coil in relationship to the building exposures and, second, to make proper provision for the elimination of air throughout the system. If these features are taken care of properly, any reasonable error in Btu requirements can be corrected easily.

CHAPTER VIII

INSTALLATION OF RADIANT HEATING SYSTEMS

The numerical design of a radiant heating system having been determined, the next problem is to select the equipment and materials to be used in the actual construction; and as the principal and unique feature in a radiant heating system is the burying of a considerable quantity of pipe or tubing within the structure, it would appear that the first and most important question to be determined before starting work is the material to be used for the radiant heating coils.

It has already been pointed out in the chapter on design that insofar as heat transfer itself is concerned, the metal of which the pipes or tubes are made is of no moment; but when the question of installation arises, then it is necessary to select the particular type of tube or pipe that will be suitable from the standpoint of first cost, ease of installation, and freedom from deterioration.

When all the various types of material that are on the market are considered, apparently in view of the use of pipe as a means of transferring heat from circulating hot water to the mass in which it is imbedded, only a metallic pipe will answer the purpose. This being the case, pipes made of steel, wrought iron, or copper would seem to have the properties necessary for use in fabricating radiant heating coils. Other metals would appear to be too soft or too expensive for this purpose.

From the standpoint of cost alone, it would appear that iron and steel would be the least expensive as compared with copper; but as their threaded type of mechanical joints are not accepted as wholly satisfactory construction when used in buried piping, some form of fusion process should be used in making connections. With ferrous materials this means that all joints should be welded.

With copper, soft solder is satisfactory; and although silver soldering can be used, it is not generally satisfactory, as special skills are necessary in making up silver-soldered joints to ensure that they are tight. As copper tubing comes in long lengths,

there are usually fewer joints in an installation using copper tubing than in one making use of ferrous materials. Copper tubing having more flexibility and less strength than steel, more care has to be used in its handling to prevent damage.

It is claimed that the net result of the relative advantages and disadvantages of ferrous versus copper materials more or less balance out, so that with mechanics efficient in the handling of ferrous materials including welding and mechanics equally familiar with the handling of copper, there is little difference in net cost between installations of either type. As a rule, a greater footage of copper tubing of relatively smaller diameter will be required when compared with ferrous materials where the total length of installed pipe will be less and its diameter larger. With ceiling installations, the relatively small diameter of copper tubing and its flexibility would seem to give its use somewhat the advantage over ferrous material. On the other hand, in floor constructions with coils imbedded in concrete, the greater resistance of ferrous piping to damage that might be caused by the handling of other materials, such as reinforcing steel or the use of wheelbarrows for transporting cement, brick, etc., would seem to give a definite advantage to wrought iron or steel at this location.

A recent addition to the materials available for radiant heating installation is a type of steel tubing known as Bundyweld manufactured by the Bundy Tubing Company of Detroit, Mich. This tubing is made by forming a strip of copper-plated steel into a tube so that there are two thicknesses of this material. After forming, the tube is heated to a high temperature in a suitable furnace, with the result that the layers of steel forming the tubes are thoroughly and permanently bonded together while the inside and outside surfaces of the tube are actually composed of a copper-iron alloy. Furthermore, as this tube comes in outside dimensions equal to copper tubing, it can be soft-soldered into copper or brass fittings as easily as copper. A table of sizes, weights, dimensions, etc., of Bundyweld tubing appears in the Appendix.

There is one remaining factor to be considered in connection with materials to be used for radiant heating coils, and that is the question of corrosion. With metal pipe or tubing carrying liquids generally at less than 150°F temperature, the question of corrosion is not pertinent. Destructive action can take place inside as well

as outside a pipe; but with a properly designed radiant heating system, the same circulating water is used over and over again, so that even if, originally, it did contain substances that would have a corrosive effect on the metal of the pipe or tube, once the strength of the substance had become exhausted, then no further action could take place provided there were no regenerative action present, a circumstance that is possible but not probable. Consequently, it can be expected that in any radiant heating installation no difficulty need be experienced from internal corrosion regardless of the type of metal used, whether wrought iron, steel, copper, or Bundyweld tubing. On the other hand, external corrosion may be a source of difficulty.

If the pipe or tubing is in a structure that is kept continuously dry, the probability is that no difficulty will be experienced. If moisture becomes present, it is possible that difficulty may be had irrespective of the type of metal used. For this reason cinders should never be employed with any type of pipe or tubing, as cinders contain sulphur in such a form as to enable it to combine with water and form a corrosive acid. The relatively thin walls of copper or Bundyweld tubing would not be able to resist very long the corrosive action that would result from burying tubing in cinders or cinder cement. All ferrous materials in the grades normally used for heating pipes corrode at approximately the same rate. Certain steel pipe manufacturers have developed a special low-carbon steel particularly adaptable for radiant heating applications. Therefore, from a practical standpoint, the question of corrosion is not a factor in radiant heating installations, either internally or externally, if such installations have been properly designed.

After the character, size, and the amount of tubing or pipe that is required for any given installation have been determined and also its location, *i.e.*, ceiling, wall, or floor, the next problem is to determine just how the tubing is to be laid and connected.

There are two general plans for installing radiant heating pipe coils: One is the grid system which provides straight-run pipe between headers; the second type provides a sinuous coil. Both types are illustrated in Figs. 8-1 and 8-2, and either type is suitable for installation in any location.

With all installations, the warmest water should be conducted

through tubes located parallel to the greatest exposure. For example, in Fig. 8-1 a grid-type coil is shown in a space having five windows; consequently, the piping is laid parallel to the greatest exposure, and the spacing between coils is perhaps somewhat closer than in the remaining part of the room. As shown, the water enters a header at the point *C* from a supply main running parallel to the header, so that increased heat output is obtained opposite the two-window exposure, crosses through the grid to the opposite header, and leaves at the point *D*. This is a common method of installation, although it does not readily lend itself to adjustment of flow between various sections of the coil. With adjusting cocks in the center of the coil as shown at *B*, a means is provided for regulating the relative amount of heat delivery in the two coils. For example, with water entering at *A*, if the right-hand regulating valve *B* is partly closed, the tendency will be to force more than the normal supply of water through the coils facing the three windows. Of course, the left-hand adjusting valve *B* would be left wide open. On the other hand, if the left-hand valve *B* is partially closed with the right-hand valve *B* wide open, the quantity of water flowing through the grid adjacent to the window will be reduced. In order to control a grid construction having more than two sections, it would be necessary to have each section discharge into an auxiliary header, which, in turn, would communicate with the main header through an adjusting valve. With large heated areas involving various degrees of exposure, a means for properly balancing heat delivery into the various panels should be provided.

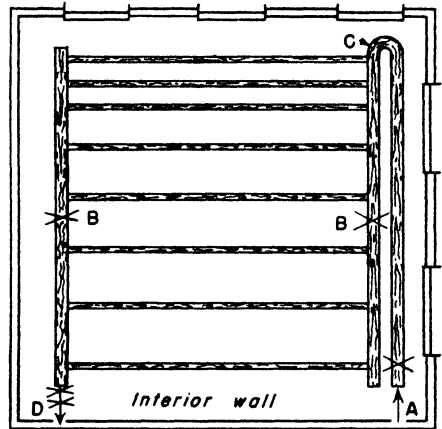

FIG. 8-1.—Grid type of coil.

A sinuous coil design is shown in Fig. 8-2. Here again, the tubing is laid out parallel to the greatest exposure with the entering hot water delivered to the coil on the exposed outside edge of the room and with a second coil indicated as having a greater

spacing. Each coil is provided with two shutoff valves and one regulating cock which can be on either the delivery or the return side. The question as to whether to use one, two, or more coils in any given space is determined by the amount of tubing required and the desired limit of pressure drop. The use of small-diameter pipe or tubing is an economy from the standpoint of first cost but will result in increased friction head and the accompanying increased pumping costs, which are proportional to friction head and operating time.

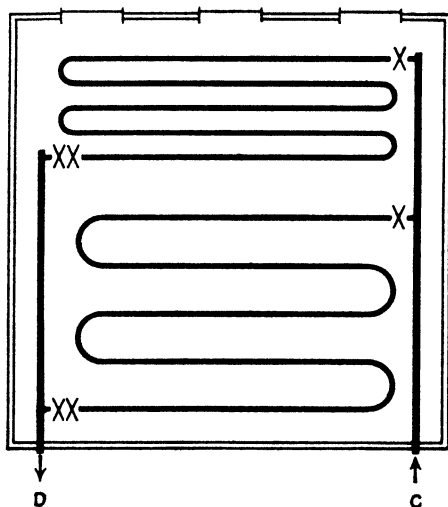

FIG. 8-2.—Sinuous coil.

This relationship indicates that in areas having moderate temperatures, the tendency should be more toward small-diameter pipe or tubing with increased operating cost, whereas, in areas of low temperatures where the system will be operating a considerable portion of the total time, greater investment costs incurred by using larger tubing with reduced friction head will result in low operating costs and represent the most economical design.

A third type of coil is shown in Fig. 8-3 as suitable in principle for floor or ceiling construction in rooms having excessive exposures on two sides. Entering hot water is along the exposed periphery with the return at the most protected corner, where the cooler circulating water will be present. At this corner are the

shutoff valves and regulating cocks, which should be constructed so as to require special tools for adjusting.

The type of welded connections required in Fig. 8-3 are shown in Fig. 8-4, where welded tee connections are made in 2-in. wrought-iron pipe.

A recent experimental type of coil embodying features of both the coil and grid types is shown in Fig. 8-5, where a multiplicity of closed loops are connected to supply and return mains so that water entering a loop from the left-hand main at one point flows both ways to enter the right-hand return main at another point. It will be noted in the illustration that each main has a short

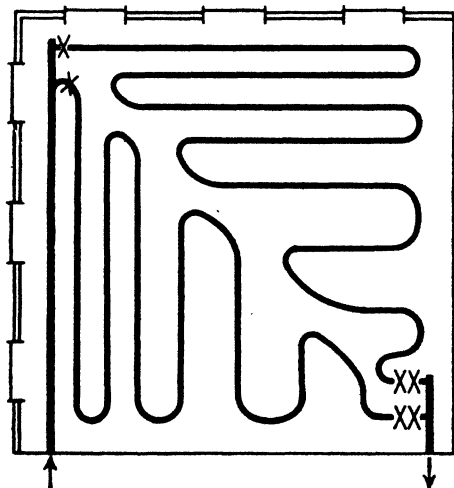

FIG. 8-3.—Special sinuous coil.

piece of tube welded to its lower half and that the coil is formed between ends of the short branch; hence, there are six welds per coil. The construction shown is for an entrance lobby using wrought-iron pipe.

The actual installation of pipe and tubing in connection with radiant heating systems presents no constructional difficulty not present in any pipe or tubing installation subject to ordinary working pressures, except perhaps that threaded joints imbedded in plaster or concrete should be avoided. All buried connections with either iron or steel should be welded, and joints in copper tubing or thin-wall copper-plated steel tubing should be soldered. In all cases, hydrostatic test pressure should be applied for at

least, 12 hr with a minimum pressure of 150 psi in order to detect any possible leaks.

Iron or steel pipe can be welded by either the metallic arc or carbon arc, but preferably by the oxacytelene process, all of which are in common use with competent expert workmen readily available. If a welded joint will stand the suggested hydrostatic test, it can be assumed to be equal in permanency to the pipe itself.

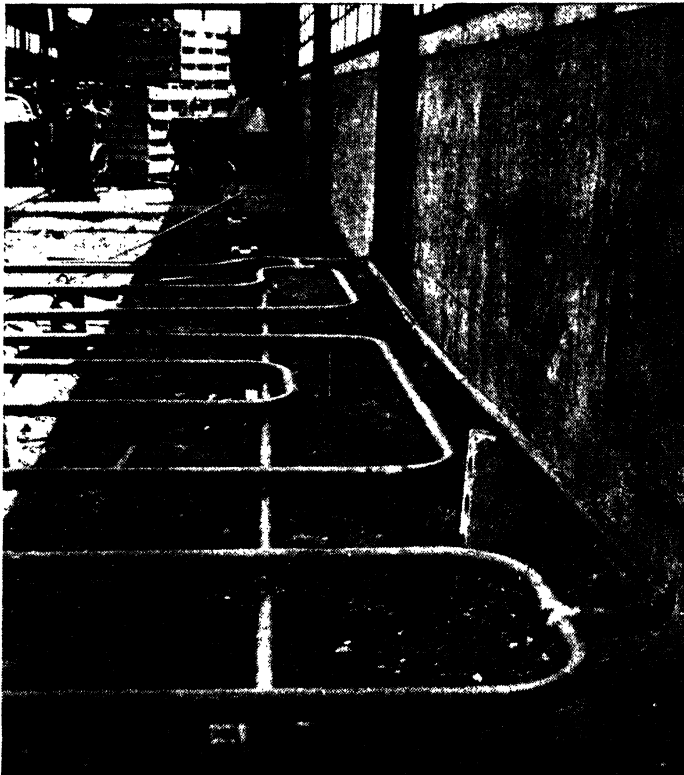

FIG. 8-4.—Welded wrought-iron pipe connections. (A. O. Smith Corporation.)

Suitable rods to use for gas welding are No. 5 Oxweld, Hi-Test No. 1 or Airco No. 4 or No. 7 as manufactured by the Air Reduction Sales Company. For the electric arc General Electric Company's rod types W-20 and W-23 are satisfactory, as are also Lincoln Electric Company's Fleetweld Nos. 5, 7, 8, and 9. Many other types of rods are satisfactory, but the types mentioned have been proved by experience to give good results. The approximate time required to make a weld involving $\frac{3}{4}$ - or 1-in. pipe is on

the order of 5 min, not including set-up time, with either the electric or gas method.

All welds in ferrous pipe should be struck three or four firm blows with a 2-lb hammer or the equivalent while being subjected to the hydrostatic pressure test in order to discover unsound joints. The same test can be applied to soldered joints, using a hammer of much less weight. Of course, these tests should be made before the pipe is buried in the cement or plaster.



FIG. 8-5.—A unique grid construction. (A. O. Smith Corporation.)

All types of coils should be subjected to a flow test in addition to the pressure test to ensure that there are no obstructions in the passageways. The ball test, sometimes specified, is impractical.

With grid coils care should be taken that the supply and return feeders are attached to opposite diagonal corners. It is obvious that if these connections are made at the same end of the coil, the tendency of the circulating water will be through the shortest route, and the element of the grid farthest removed from the supply and return connections will not have a proper flow of

heating water and, consequently, the panel in which they are buried will be cool at one end.

When work is commenced on an actual installation, it is to be presumed that adequate plans and construction details are available which clearly show the requirements of the designer. These should be followed explicitly. If the elements of a coil are shown parallel to a given wall, they should be so installed. It cannot be assumed that if a given space required, for example, 100 ft of pipe, it is immaterial in which way these 100 ft are disposed. Presumably the designer has taken into account the location and amount of maximum heat loss in any given area and has determined the point of supply and the direction of flow in each coil. Any deviation from designed plans will change the operating condition; if the design was correct in the first place, the changes will have the effect of adversely affecting the expected results.

Sinuuous coils should be installed reasonably level within practical limits, including a maximum variation of not over one-half internal diameter from a true plane, especially in climates where the possibility of freezing exists if the plant is to be shut down. With a grid type of coil, a slight grading from inlet to outlet can be provided to assist in draining, but the necessity for air venting must be kept in mind; presumably this has been taken care of by the designer.

With installations of iron or steel pipe, advantage can be taken of its relative rigidity; and if the coil is not actually resting on a properly prepared surface, as, for example, the top of a rough-floored base slab, small wooden or cement blocks can be used to support the coil at a proper height above the surface. The inherent resistance of an iron or steel pipe to deformation due to blows is a definite advantage when coils are being placed in reinforced concrete structures where otherwise they might be subject to injury by passing workmen with heavy equipment. Another advantage with respect to iron and steel pipe installations is the fact that the coils can be bent in a shop suitably equipped for the purpose, thus reducing the amount of work that has to be performed at the construction site. This is of a particular advantage in the construction of a multiplicity of similar installations.

It is possible to reduce the dimension of an iron or steel coil of the sinuous type, measured in a direction at right angles to the

axis of the pipe, by compressing the formed coil accordionwise and tying the loops together with wire. After this type of compressed coil is delivered on location, the wires can be removed and the coil stretched back to its original dimension.

Figure 8-6 shows a power-operated machine for bending ferrous pipe coils; and although the machine is shown as a portable device,



FIG. 8-6.—Power coil-bending machine. (A. M. Byers Company.)

the same principle can be advantageously used in a permanent structure for shop use.

Figure 8-7 shows a hand tool suitable for bending wrought-iron pipe.

Wrought-iron and steel pipes of standard thickness can be formed cold into 180-deg return bends by experienced personnel

without injury if the radius of the bend from the center of bend to the center of the tube is not less than the dimensions given in the following table:

Nominal Size of Pipe, In.	Minimum Bending Radius, In.
$\frac{1}{2}$	3
$\frac{3}{4}$	4
1	5
$1\frac{1}{4}$	7
$1\frac{1}{2}$	9
2	12

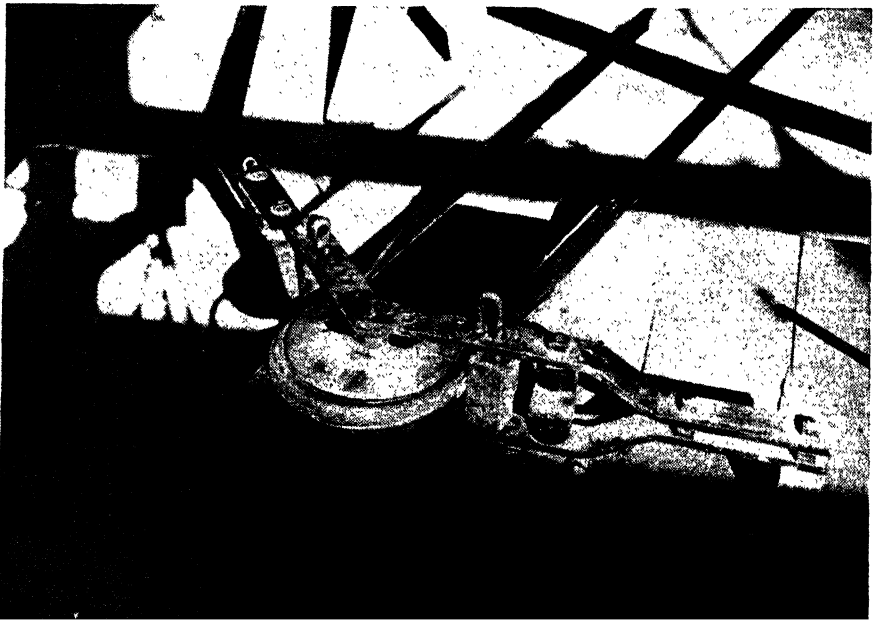

FIG. 8-7.—Manual pipe-bending tool. (A. M. Byers Company.)

Ordinarily, the question of expansion as between wrought-iron and steel pipe imbedded in concrete or plaster structures is of no moment, as there is very little difference in the temperature expansion coefficient between these materials. In addition, there is the fact that ordinarily very little difference in temperature exists between the metal of the tubes and the cement or plaster in the imbedding structure, so that no attention need be given to this phase of the problem. Even though slab construction may be provided with crack lines in large slab areas, it is desirable that

expansion or relative movement be allowed for between the slabs themselves. This type of construction appears in Fig. 8-8, which shows a large floor area being laid in sections.

If design requirements are such that feeder lines have to cross panel dividing lines, means should be provided for allowing a small amount of displacement in all directions. A convenient way of doing this is to provide a conventional type of bent tube expansion joint. This can be in the form of a complete 360-deg bend, or a combination of two 90-deg bends with one 180-deg bend.



FIG. 8-8.—Pouring floor slab in sections. (*A. O. Smith Corporation.*)

The expansion loop should occupy an open space which should not be filled with cement unless the pipe is wrapped with a soft tape $\frac{1}{4}$ in. thick. With respect to ferrous pipe installations in wooden floor constructions or in walls or ceilings, no special precautions are necessary other than to follow the plan as prepared by the designer. With ceiling installations where the pipe is necessarily placed above metallic lath, the first plaster coat should be applied with considerable pressure underneath the tubing so as to ensure a considerable flow of plaster around and about the tube to at least a 50 per cent envelopment.

Gypsum plaster used with metal lath should be fibered with

the scratch coat mixed somewhat richer than normal and warmed so that it can be pushed through the lath and into good contact with the tubing. The brown or second coat need be mixed only a little richer than normal, but not so plastic as the first coat. The application should be screeded and should cover the bottom of the tubing by at least $\frac{1}{8}$ in. The third, or finish, coat is mixed the same as any normal job to give a hard white finish, sand finish, or as required. This coat should be at least $\frac{1}{8}$ in. thick.

If gypsum plaster is to be applied against the underside of concrete, tile, or similar material, one coat of bond plaster should first be applied, followed by one coat of unfibered gypsum, and the third coat could be regular hard white finish.

Present experience in actual work indicates that the additional gypsum plaster and labor required on the first two coats run approximately 10 to 15 per cent more than standard coats. There is no additional cost on the finished coat, which is exactly the same as any standard plaster installation. One of the more serious problems that occur with the use of modern Portland cement plasters has been the volumetric change occurring in mortars and concrete due to initial hydration. This difficulty can be somewhat overcome by avoiding overrich mixtures, maintaining a minimum water content, and employing a method of placement that will not cause a segregation of the constituents of the mixture and give long-continued hydration. Should a mixture, as specified, be applied with a trowel and shortly thereafter sealed with a finished coat, it will be difficult to meet the condition of prompt dehydration, with the result that an exceptionally long drying-out period will be required; otherwise, trouble will result.

Copper tubing for use in radiant heating systems should be type L supplied in accordance with Government Specification WWT-799. Solder type of fittings should be used exclusively in all locations where the tubing is buried in cement or plaster and preferably should be used in open work. Solder type of fittings are commonly referred to as sweat fittings and come in two styles: one cast fittings and the other wrought fittings. Either type is suitable for radiant work, perhaps with a slight preference for cast fittings, as these are not so easily distorted while being handled. A table of tube and fitting dimensions is given in the Appendix.

Soft solder for copper tube is entirely acceptable for radiant ceiling installations, the best type being an alloy consisting of 95 per cent tin and 5 per cent antimony. This solder is commonly referred to as 95-5. It has a somewhat higher melting point than the common lead-tin solder and responds particularly well to capillary action. In making up soldered joints involving copper tube, it is desirable that in addition to taking all previously mentioned precautions, care should be taken to ensure full entry of the tube into the fitting so that the tube end will abutt the shoulder provided in the fitting for this purpose. The following table gives safe working pressures and temperatures as applied to copper tubing and fittings when joints are made with 95-5 and 50-50 solder.

MAXIMUM WORKING PRESSURE IN POUNDS PER SQUARE INCH FOR TYPE L COPPER WATER TUBE AT TEMPERATURES INDICATED

Size	0-100°F	100-150°F	150-200°F
Tin-antimony Solder			
Up to 2 in. nominal	800	600	450
Over 2 in.	700	450	300
Tin-lead 50-50 Solder			
Up to 2 in. nominal	170	120	90
Over 2 in.	140	100	65

For Silver Solders
(Condensed table)

Sizes up to	Temperatures below 250°, safe pressure, lb
1 in. type L nominal	800
2 in. type L nominal	600
3 in. type L nominal	500

Silver solder can also be used in making up joints with copper tube and fittings and should always be used wherever copper-tube joints are to be buried in concrete. Very special care and tests must be taken with silver solder owing to the fact that a proper joint cannot be made except with relatively high temperatures

such as are involved with the use of silver solder. Should the workman perceive the melting of the solder under the effects of the torch, this does not necessarily mean that a proper joint has been obtained. The only proper method of testing soldered joints, either with soft solder or silver solder, is the hydrostatic test of at least 150 psi continued for at least 12 hr; dependence should not be made on a visual inspection of the joints but rather on observation of any changes in pressure that may occur after the system is brought up to test pressure and the valves closed. Any reduction of pressure once established that cannot be attributed to change in temperature must be investigated, and its source located and repaired.

Fluxes for use with soft solder should be of the noncorrosive variety and are most generally found on the market in low proportions of zinc and ammonia chloride in petroleum or water vehicles. It is recommended that the more commonly known brands be chosen, as a flux having a high concentration of corrosive agents may in time cause some difficulty.

Preparatory to making a sweat or soldered joint with copper tube and fitting, the areas to be joined must be thoroughly cleaned mechanically with either double 0 steel wool or a fine-grained sand or emery paper; files should not be used. After cleaning, a small amount of flux should be applied to both surfaces of the tube and of the part to be joined; and then with the fitting telescoped into position, either heat should be applied with a common plumber's gasoline torch, or, more efficiently, use should be made of the acetylene type of equipment. In some cases the electric plier type of resistance heating tools has been successfully used in locations where open flames were prohibited, as might be the case around oil refineries or similar exposures.

With the fittings cleaned, fluxed, and assembled, heat should be applied to the joints with a sweeping action of the flame directed to the fittings rather than to the tube. Care should be taken not to overheat the joints preparatory to the introduction of solder, the proper method being to test the end of the joints with wire solder from time to time as the heating progresses, making sure that the flame does not play directly on the solder. Just as soon as proper temperature is reached, flow of the solder into the joints will be readily observed, and it will also be noted that a meniscus

of solder will be visible entirely around the joints. The presence of any globules of solder will indicate that the operation has not been entirely successful. Overheating of the joints will render the flux ineffective, at least to some extent, and a complete uniform flow of solder throughout the joints will not be attained with the accompanying tendency to leak.

The advantage of using tubing in long coils resides in the reduction in joints that may be obtained by their use. In fastening pipe or tubing in place, necessary straps or supports should be of the same material as the tubing or pipe. For example, galvanized pipe straps should not be used on copper tubing, but only copper straps. In making return bends in copper tubing, it is not necessary that the bend be made in the same plane which it will occupy when attached. If, for example, a bend can be made more conveniently in a vertical plane than in a horizontal, although the latter is the plane in which it will be installed, it can be formed vertically and then twisted 90 degrees into horizontal position.

After a coil of annealed copper tubing is in place and fastened, it is probable that it will have minor irregularities so as to cause traps for air bubbles. These should be eliminated by means of a dressing stick or other device to ensure, as far as possible, that the tube does not deviate from grade more than one-half the tube diameter. With wrought-iron or steel pipe, the natural inherent straightness of these products renders the problem of leveling much easier of accomplishment than with the more flexible copper or Bundyweld tube.

It is not necessary to eradicate entirely all traps or air crowns in an installation because if the water velocity in a tube is in excess of 30 ft per min, air bubbles will be swept along with water flow until they reach a point where the velocity is less than 35 ft per min, at which point they will tend to separate. If an air trap is provided where water velocity can be reduced materially below 30 ft per min and suitable air valves provided at such a point, then entrapped air will be automatically eliminated from the system. Velocities of 30 ft per min will not, however, remove air from vertical U bends, valve reducing T's, bushings, etc., but air can be swept out from these devices if a velocity of 60 ft per min is attained. By reason of this fact, all air can be purged from any radiant system if sufficient pressures are available to

ensure purging velocities of 60 ft per min or over in all parts of the system.

Various methods of installing the radiant coils will now be considered, commencing with the simplest method of making use of a concrete slab directly on the earth.



FIG. 8-9.—Installing copper tube in floor construction. (*Robert Bruen & Son.*)

Figure 8-9 shows the construction of such a method, wherein the ground is first leveled off and compacted, then covered with a reinforcing netting, on top of which the coils are laid and secured to the netting at a distance of every 5 ft or so in order to retain proper relationship between the netting and tubing during the time that the slab is being poured.

Figure 8-10 shows the construction of a large slab of this type and also the pouring of alternate sections with expansion joints between. In practice, after the slab is poured and while it is in a very plastic state, an operator with a hook raises the reinforce-

ment and necessarily the tubing attached thereto to approximately the desired position within the slab structure, which would ordinarily be within 1 or 2 in. of the ground level. This procedure causes no difficulty in the clearing of the coils of air, as with sufficient velocity, all air will be swept out of the tubes; and with the use of proper venting and air traps, no difficulty will be experienced in operating a structure of this type.

In constructions involving the use of copper tube in concrete floors, care must be taken to prevent the tube from being bent,



FIG. 8-10.—Illustrating proper procedure with large floor areas. (*Robert Bruen & Son.*)

kinked, or partially closed through the activities of the various trades engaged in or about the building. This difficulty can be at least partially overcome by maintaining a rather high hydrostatic head on all coils while they are exposed to unavoidable rough treatment. In addition, an inspector should always be present when the tubing is being covered to ensure that there are no serious malformations being covered up in the concrete. This inspector should have the authority to immediately suspend pouring if it appears that repairs to the tubing are necessary.

With steel or wrought-iron pipe, the use of a supporting pressure is not necessary, but inspectors should be provided as with copper tubing.

Another method of construction is indicated in Fig. 8-11, where the base concrete slab is already in place and hardened. Coils may be laid down directly on its surface and buried in a cover layer which should not be thinner than one pipe diameter over the coil pipe or

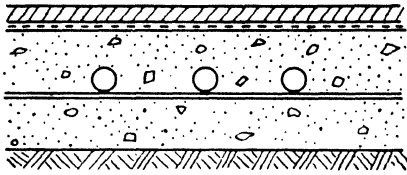

FIG. 8-11.—One type of floor construction.

tubing. As with the ground slab in large installations, provision should be made for expansion by laying the covering in sections and making sure that the pipe or tubing does not cross an expansion joint at right angles without the inclusion of an expansion loop

or the equivalent. This type of construction makes it possible as shown in this figure to include insulation between the coils and the base slab to retard the passage of heat downward.



FIG. 8-12.—Coils laid on floor slab with insulation. (Chase Brass & Copper Co., Inc.)

Figure 8-12 shows this type of construction actually being installed. On top of a base layer of concrete was placed insulation that consisted of sheets of inorganic material which had been rejected by the manufacturer for defects and was obtainable at a very reasonable price. Copper tubing was laid on top of this

insulation and fastened to it with clips as shown. Tubing was leveled down with a strip of wood as shown in front of the fire-place, after which the finish layer of concrete was poured. The matter of heat loss downward from a heated floor slab placed directly on the earth deserves careful consideration. It is obvious that any ground water circulating beneath such a construction

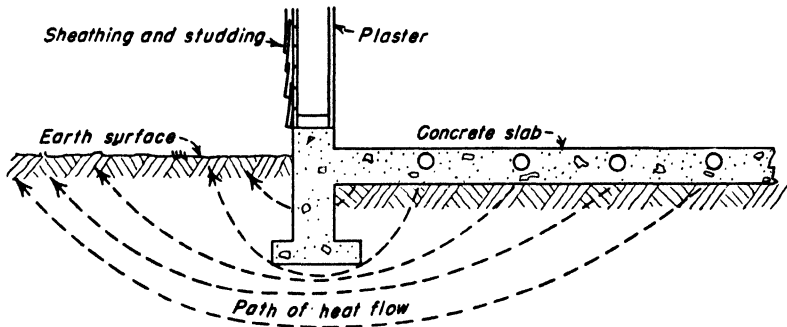

FIG. 8-13.—Heat flow in floor slab.

will very materially reduce the heat effectiveness; consequently, every provision must be made to ensure the absence of ground water beneath radiantly heated concrete floor slabs.

Figure 8-13 is intended to show the path of heat flow from beneath a floor slab to the outside of the building with the earth

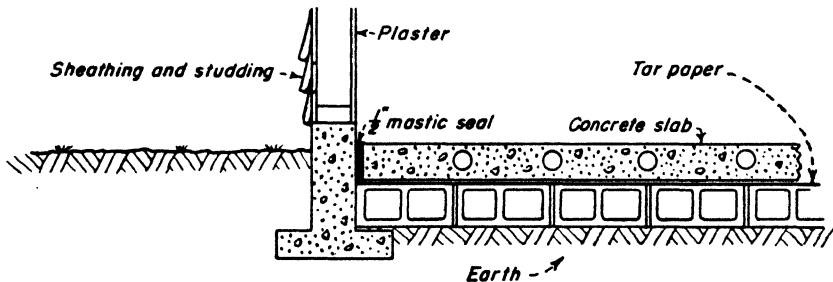

FIG. 8-14.—Best type of floor-slab construction.

surface just outside the foundation wall having temperatures approaching zero and with concrete floor slabs attempting to maintain a temperature of 65°. For example, there will be a very considerable heat flow extending from the area below the slab out through and underneath the foundation to a distance of probably 8 or 10 ft from the building wall. As this heat continues to be

lost throughout the entire heating season, any reasonable expense is justified to reduce the extent of this loss.

Figure 8-14 indicates a very effective construction method not only for insulating the floor slab from the ground but also for preventing contact of the ground water with the underside of the concrete slab. With this type of construction, the earth is leveled off and compacted inside the foundation walls and a layer of partition tile placed over the entire area with provision for positive drainage of the space occupied by the tile. On top of the partition tiles should be placed a layer of tar paper or the equivalent

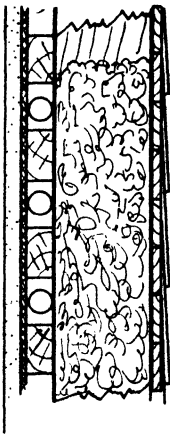

FIG. 8-15.—Coils in plastered wall.

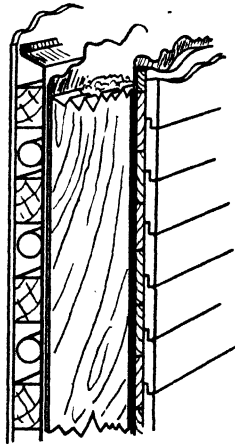

FIG. 8-16.—Coils in dry-wall construction.

to act as a moisture seal and on which can be laid the concrete slab carrying the radiant heating pipe. Between the slab and the concrete foundation, as indicated, there should be a mastic seal at least $\frac{1}{2}$ in. thick to act as insulation between the warmed slab and the cold foundation wall.

Figure 8-15 shows a method of installing tubing in a wall where the tubing is strapped directly to the studding with metal lath furred out from the studding, but only to such a distance as will allow the lath to clear the tubing. The studding space should be completely filled with insulation, and every precaution taken to prevent the loss of heat outward as will be the tendency, for in this construction we have the most exposed surface in close assembly to the surface having the maximum temperature. Also, means should be provided at the upper termination of the coil to pre-

vent the circulation of air up through the studding space. Unless this circulation of air is prevented, heat will be lost upward and the panel will not give the expected output as counted on by the designer.

Figure 8-16 shows another type of wall installation where some type of panel is used on the inside wall area other than plaster. This surface might be some type of laminated wood, plasterboard, or other wall material which is rapidly being brought out by various manufacturers. The design shown in Fig. 8-16 provides a metal sheet extending parallel to the tubes and between them and the studding. At the top of the coil area, this metal sheet is bent over and brought into close contact with the panel. Insulation

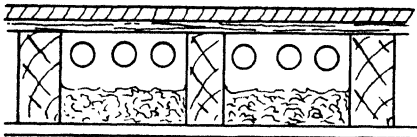

FIG. 8-17.—Floor installation for existing buildings.

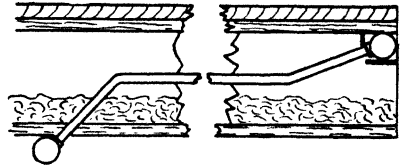

FIG. 8-18.—Header location.

is provided in studding space and around the metal sheet as indicated, all for the purpose of minimizing outward heat loss and preventing upward circulation of air in the studding space. Thin copper sheets will be very effective for this purpose, as copper has a high reflective value for heat waves so that the indicated construction will tend to assist the flow of heat through the panel.

Figure 8-17 shows a floor construction that can be used in wooden buildings and is particularly advantageous for the application of radiant heat to existing wood frame constructions. The piping is shown running in the joist space and parallel to the joists and is much easier of construction than attempting to run the pipes at right angles to the joists. Two or three runs of pipe per joist space will ordinarily be required, and these may be fastened in any convenient manner; it is not necessary to locate them rigidly in place. Two or three inches of good insulation should be provided, as indicated, with the pipes located about one inch above the insulation. This is to assist in the formation of convection currents. If iron or steel pipe is used, the natural finish is sufficient. If copper tubing is used, it should be painted some

dark color, preferably black. With the tubing and insulation in place, the joists should be sealed off with some type of wallboard, such as cellotex, and means provided to prevent the circulation of air in and out of the joist space.

Figure 8-18 shows a method of connecting the pipe located in the joist space to supply headers spaced below the joists, the return headers being led through notches at the upper edge of the joist and below the floor from one joist space to the next.



FIG. 8-19.—Ceiling construction in a concrete building. (*Chase Brass & Copper Co., Inc.*)

Figure 8-19 shows a type of radiant construction applying to a reinforced concrete building where the space between the concrete beams is filled with hollow tile and the tubes are fastened to the tile by cutting holes through the tile for the passage of supporting wires. This construction has been used without making any special provision for bonding the plaster to the cement or tile surfaces. It would have been better to provide a bonding coat extending over the entire area and underneath the tubing.

A safer method of constructing a ceiling installation in a reinforced concrete building would be to provide a subceiling as indicated in Fig. 8-20. In this case, the tubing could be lashed to the underside of the metal lath, which would be the preferred

location, or it could be located on top and supported by the lath; but even in this case, it should be wired down and into firm contact with the lath by means of wire loops. Then in plastering, it would be advisable to force additional material through the lath along the tube location so as to assist in heat transfer from the tubing to the plaster construction.

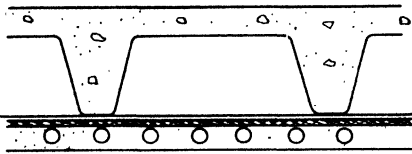

FIG. 8-20.—Proper ceiling construction for a concrete building.

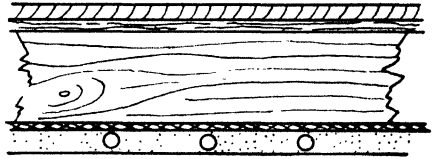

FIG. 8-21.—Ceiling construction for a wooden building.

Figure 8-21 shows the normal construction to be provided where metal lath is used in conjunction with wooden joists. With this type of application, there are several methods of procedure. One is to fasten a metal lath in place first, after which the tubing is placed. Another method is to fasten the tubing in place first directly to the joists and then support the lath on furring strips.

Figure 8-22 shows a similar type of construction which probably can be erected more quickly than the one illustrated in Fig. 8-21; but when the first coat of plaster is applied, extra trowel pressure must be applied at points underneath the tubing so as to ensure that a certain amount of the plaster flows up around

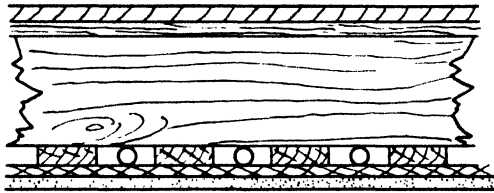

FIG. 8-22.—Modified ceiling construction for a wooden building.

and about the pipe or tubing. However, it is not necessary to have the plaster entirely cover the pipes. If it extends up to at least a half of the diameter, so that the pipe is a little more than half covered, this will be sufficient.

A new method of construction is that developed by Robert Bruen & Son of Oakland, Calif., where metal lath, together with

copper tubing permanently attached, is supplied as a manufactured product and known by the trade name of Thermapanel. Figure 8-23 shows a number of such panels with sinuous coils located in place. This method of construction very readily provides for increased heat output opposite exposed glass areas, as indicated in the illustration. Although not clearly shown, it will be noted that the tubing is on the upper surface of the lath and actually fits into a depressed channel in the lath so as to economize

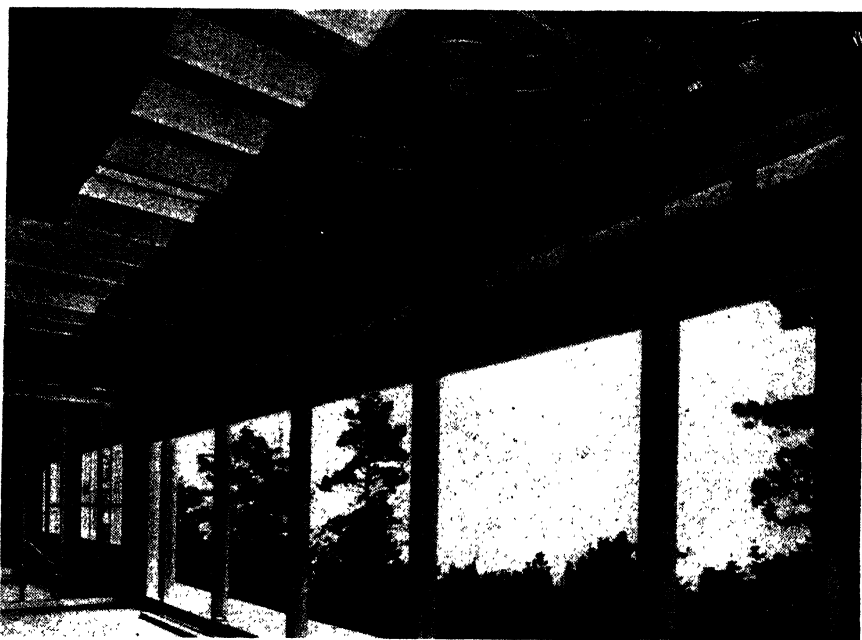

FIG. 8-23.—Preformed ceiling coils with metal lath. (*Robert Bruen & Son.*)

on plaster and effect a good bond at this point. With the tubing in intimate contact with the metal lath, the latter definitely assists in the flow of heat throughout the panel. In the upper left-hand corner of this illustration, a Thermapanel with straight tubing will be noted.

Figure 8-24 shows a further application of Thermapanel being used in conjunction with a beamed ceiling.

There are two basic methods of forming coils for ceiling construction; one is to work from the floor forming the return bends in a jig as indicated in Fig. 8-25. The coils can be formed entirely on the floor or on a low elevated structure as convenient and,

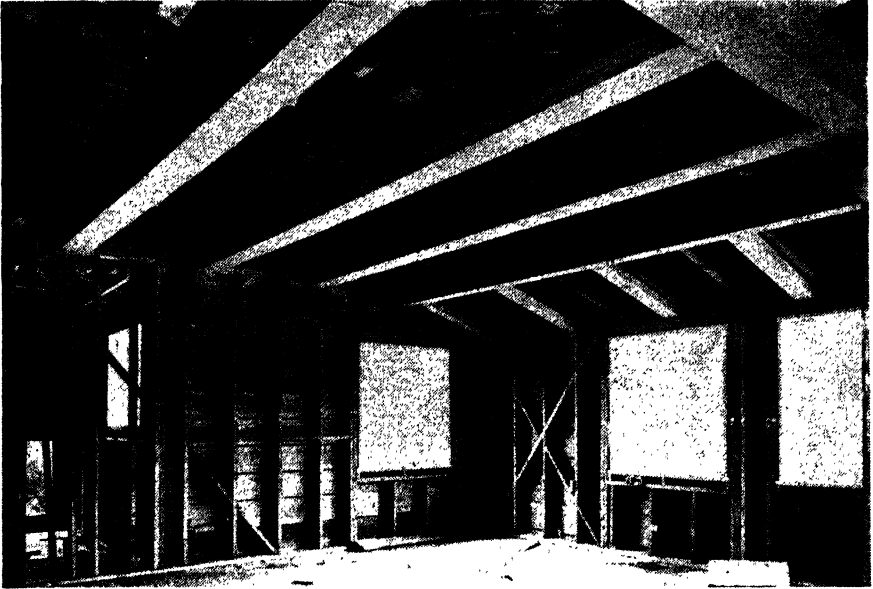

FIG. 8-24.—Beamed ceiling with preformed coils. (*Robert Bruen & Son.*)



FIG. 8-25.—Forming copper-tube coils. (*Chase Brass & Copper Co., Inc.*)

after being fully formed, are raised into place by means of light wooden supporting strips, the complete coil being held in place while fastenings are applied. The second method of application is shown in Fig. 8-26, where it will be observed that the metal lath is already in place and supported by furring strips, the reason for this being that it was desired to run the tubing parallel to the joists so as to provide proper support. After the metal lath was put in place, tubing was served directly to location from a coil as



FIG. 8-26.—Forming copper-tube coils in place. (*Chase Brass & Copper Co., Inc.*)

required. The illustration shows the workmen making a return bend with no other tool than a coiled steel spring which is slipped over the copper tubing to assist in the prevention of kinks. Where straight lengths of hard tubing are used, no attempt should be made to fabricate short radius return bends, but fittings of this type should be obtained and soldered into position. Figure 4-2 shows an installation of this type.

Figure 8-27 shows the application being made of the first plaster coat. This illustration is from the same building shown in Fig. 8-26, while Fig. 2-8 shows part of the interior of the completely finished structure.

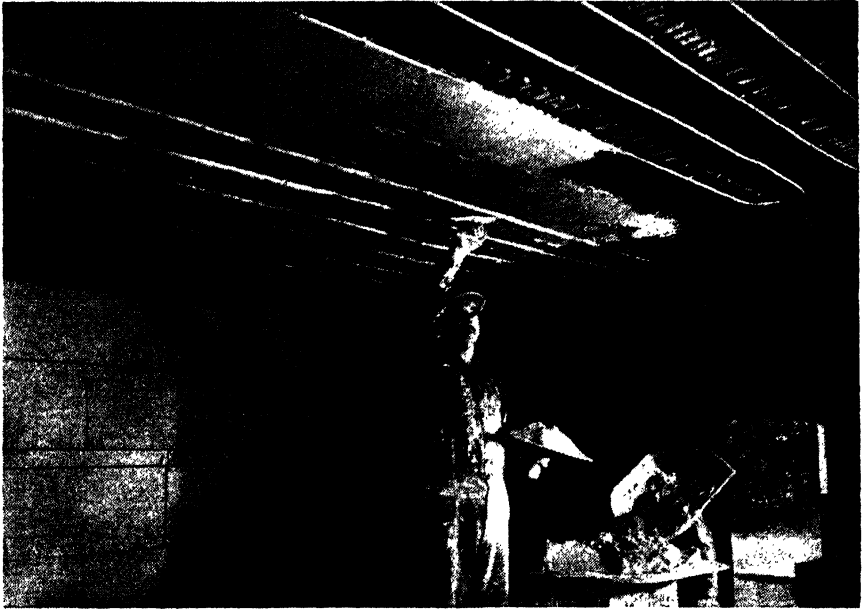

FIG. 8-27.—Installing first plaster coat. (*Chase Brass & Copper Co., Inc.*)

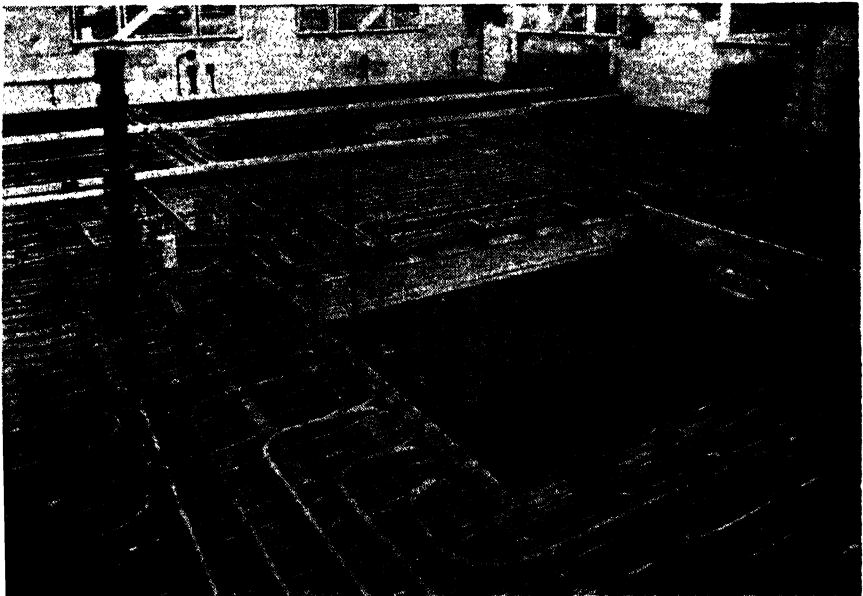

FIG. 8-28.—Steel-pipe coils in place. (*Bethlehem Steel Company.*)

Figure 8-28 shows the application of Bethlehem Steel Company's Rayduct in both the first and second floors of an office building at Olyphant, Pa. Coils on the first floor are laid on crushed rock on which the finished concrete slab will be placed. The second-floor construction is clearly shown, and the manner will be noted in which coils along the periphery of the room are located with their lengths parallel to the wall surfaces. Floor reinforcing netting is laid across the top of the supporting I-beams, with the pipe coils on top of that. Attention is particularly

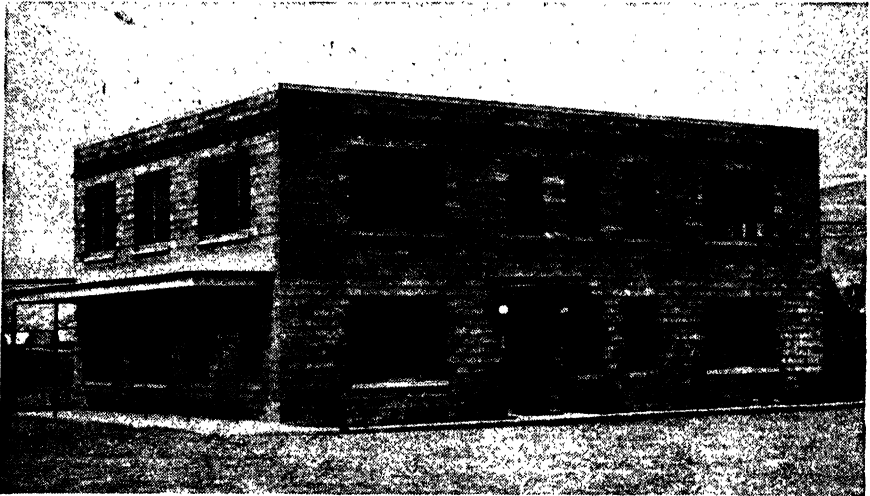

FIG. 8-29.—Office building using steel-pipe coils. (*Bethlehem Steel Company.*)

directed to the method of welding small tubing into the coils as an air venting connection.

Figure 8-29 shows the finished exterior of the building shown in Fig. 8-28.

Figure 8-30 shows a mezzanine floor installation making use of $\frac{1}{2}$ -in.-OD Bundyweld tubing. Joints in this tubing, as indicated in the foreground, were made by expanding the end of one tube sufficiently to allow the second tube to be inserted, somewhat on the order of a bell and spigot joint. The assembly was then silver-soldered. This type of joint was adopted because suitable sleeves for use with soft solder were not available.

Reviewing suitable procedure for commencing work on a radiant heating installation, it is to be assumed, of course, that suitable detailed drawings have been furnished the contractor by the

architect or engineer showing the respective areas to be embraced by each coil, the size of pipe or tubing, and the spacing between turns, as well as indicating whether a sinuous or grid type of coil is to be used. Detailed drawings should be followed explicitly by the contractor, as it cannot be assumed that the coils can be placed in a haphazard manner. If coils are not located as specified in the plans, the expected results from the heating system may not be obtainable.

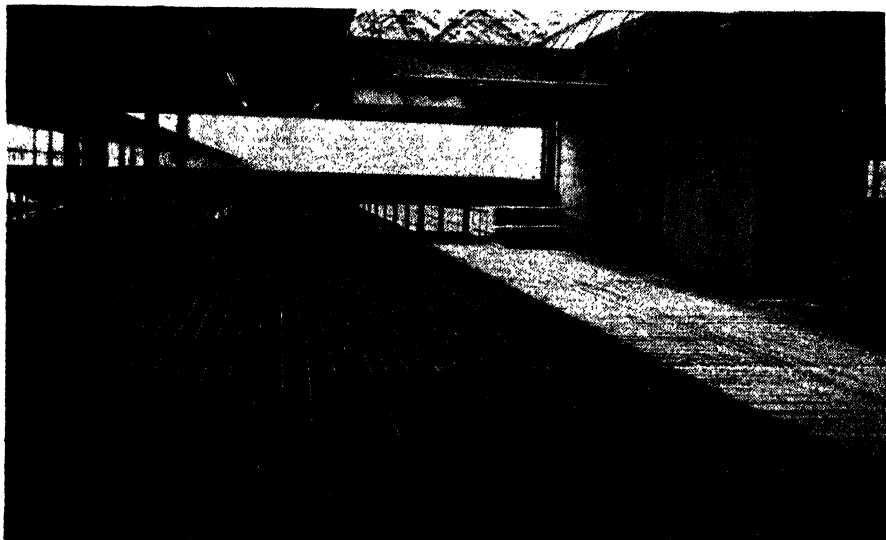

FIG. 8-30.—Use of Bundyweld tube. (A. O. Smith Corporation.)

With plans and material on hand, the first step is to distribute materials as nearly as possible to the exact location where they will be installed. Figure 8-31 is an example of the proper procedure, and it will be noted that the headers with the first length of pipe properly welded thereto are in place and that the grid piping is laid out in location and resting on elevated supports for convenience in handling. At the far end of the panel, welding is in operation with the pipe supported on sawhorses for convenience. The coil to the left of the picture is completed, and the panel still farther to the left has been poured and finished.

Figure 8-32 shows a novel form of sinuous coil construction. It will be noted that each coil has its supply and return pipes leading up an H column in the building structure.



FIG. 8-31.—Installation of grid coils. (*A. O. Smith Corporation.*)



FIG. 8-32.—Sinuous coil with terminals on column. (*A. O. Smith Corporation.*)

Figure 8-33 shows this same installation in a later stage of construction. It will be noted that instead of one large boiler plant for supplying heat, use is made of a multiplicity of small inde-

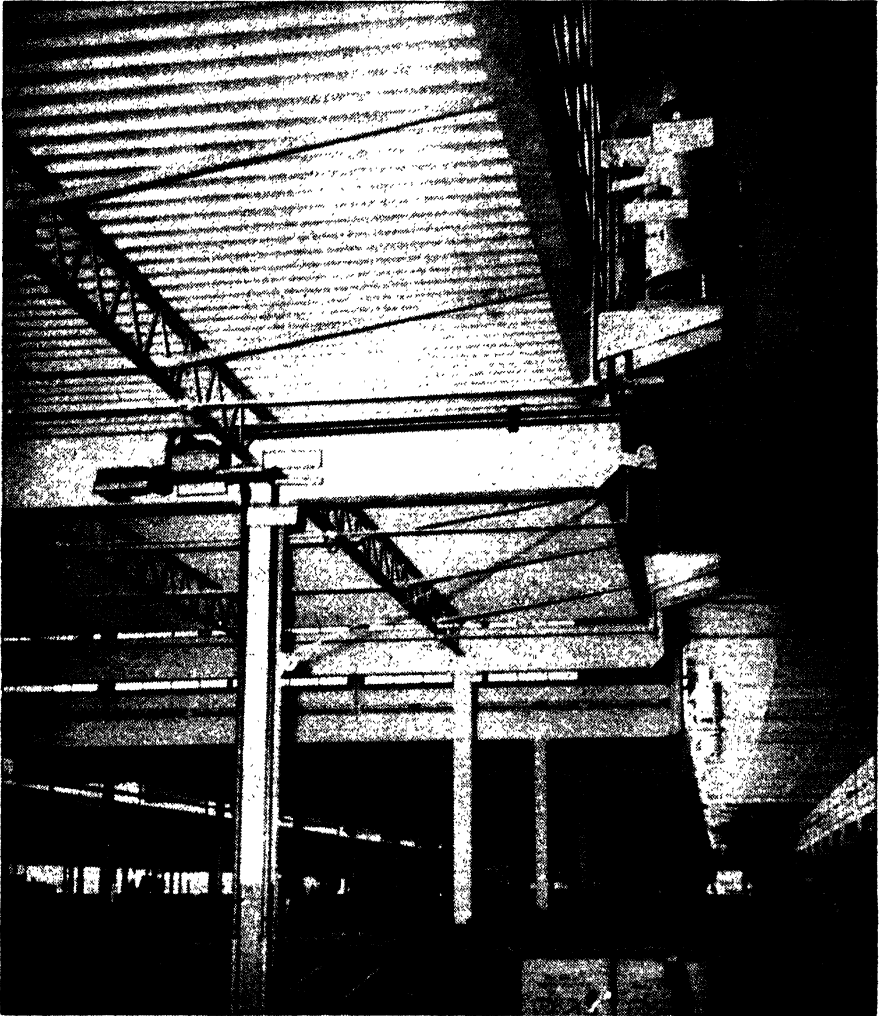

FIG. 8-33.—Individual coil heaters. (*A. O. Smith Corporation.*)

pendent heat generators, each supplying its own particular section. As can be inferred from the illustration, there were many of these independent units; and in many cases, there were different types of coil construction within the various panel areas. The use of independent heaters made it possible to provide for a comprehen-

sive series of test results, whereby operating costs, efficiencies, etc., could be accurately determined. The heaters shown are of the Burkay type manufactured by the A. O. Smith Corporation of Milwaukee. Details of this heater are shown in Fig. 5-15.

Figure 8-34 shows a very interesting method of construction whereby precast concrete joists are placed on supporting walls and precast concrete slabs fitted into supporting grooves in the precast concrete joists. Following the placing of the floor slabs, wrought-iron radiant heating piping was placed directly on the



FIG. 8-34.—Prefabricated concrete-floor construction. (A. M. Byers Company.)

prefabricated concrete joist floor construction as shown in Fig. 8-35, which also shows the location of a balancing valve accessible for adjustment through a hole in the floor slab. Following the laying of the radiant heating piping, a finished layer of concrete was poured directly on the precast slab to a sufficient depth to bury the piping properly.

Figure 8-36 shows construction in progress on a floor installation of radiant heating, using Bethlehem Steel Company's Ray-duct. It will be noted that there is a provision for the delivery of extra heat along the side of the room facing the street, the intention being that there will be large glass areas at this point.

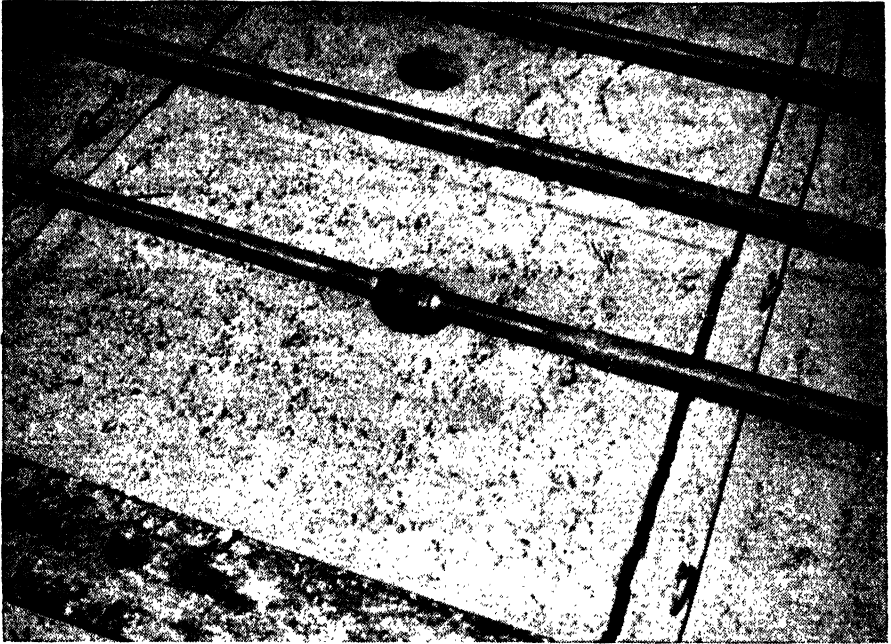

FIG. 8-35.—Wrought-iron pipe coils laid on prefabricated floor slab. (*A. M. Byers Company.*)



The extra heat delivery is accomplished by laying pipes close together and at the same time increasing their diameter. It cannot be expected, however, that the heat delivery by reason of these three pipes laid close together will be three times the delivery of one pipe, as there will not be sufficient conductivity in the concrete existing between the pipes to conduct this heat properly to the floor surface.

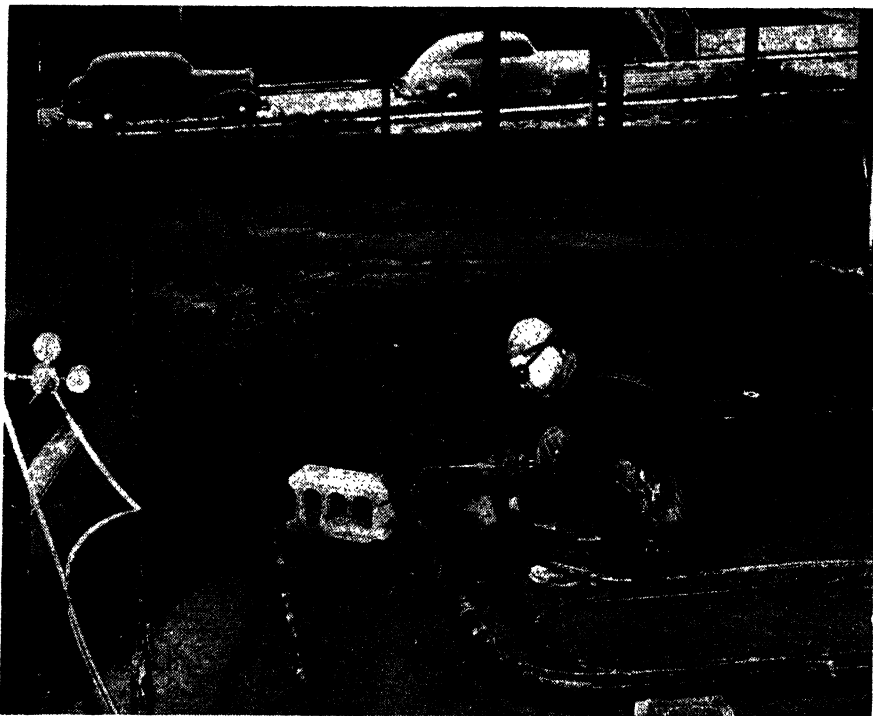

FIG. 8-37.—Welding connections in steel pipe. (*Bethlehem Steel Company.*)

Figure 8-37 is taken from the rear of this same location and looking out toward the street. The group spacing of the radiant heating coils in this illustration is due to the fact that this room will be occupied by a supermarket, and the reason for the particular grouping of the radiant coils throughout the room area is to compensate properly for the display counters that will be installed in this area and will run parallel to the coils. It will be further observed that the return mains shown on the left side of the illustration will provide an area where the floor Btu output is

much less than in other parts of the room. This is owing to the fact that along the left-hand side of the room, as shown, refrigerated cabinets will be installed, and it is therefore highly desirable to reduce heat delivery in this area and in this way reduce to some extent the cost of refrigeration operation. These two illustrations, Figs. 8-36 and 8-37, are excellent examples of the flexibility inherent in radiant heating installations. With conventional sys-



FIG. 8-38.—Snow-melting application in driveway. (*National Supply Company.*)

tems, it would be necessary to produce a uniform delivery of heat throughout the entire area; but with the radiant system as shown, the delivery of heat can be restricted to those limited areas where heat is actually desired as distinguished from other areas where an equal delivery is not required. It is probable that the economy of operation in this installation will result in a saving of at least 40 per cent over the cost of providing equal comfort by conventional methods.

Figure 8-38 shows the use of buried steel piping in a snow-melting application where it was important to keep a driveway

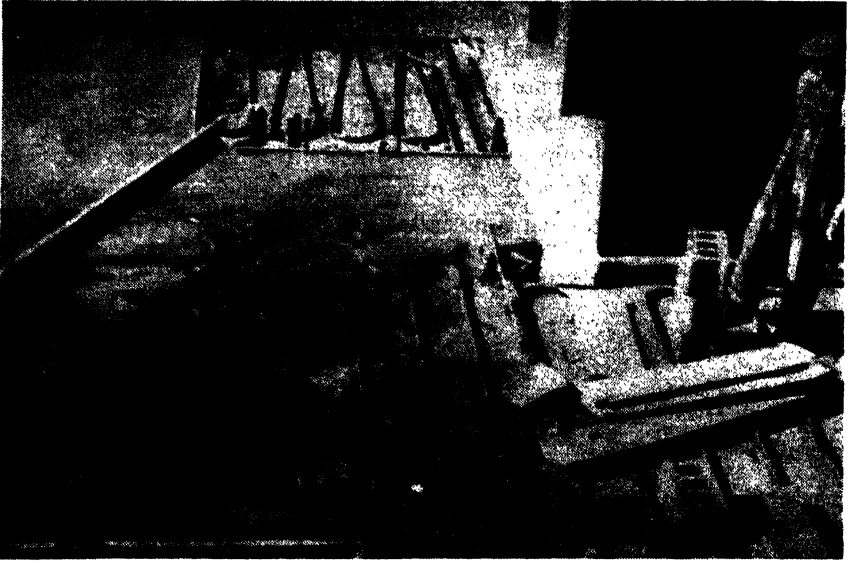

FIG. 8-39.—Practical method of decreasing coil spacing. (*Bethlehem Steel Company.*)



FIG. 8-40.—Installing steel pipe in domed ceiling. (*Richard Crittall & Co., Ltd.*)

clear of snow and ice so that constant use of the driveway for trucking could be had throughout the winter season.

Figure 8-39 shows a particular method of increasing output from a floor coil by simply squeezing the loops together accordion-wise and in this way avoiding the necessity of attempting to make return bends with radii too short.

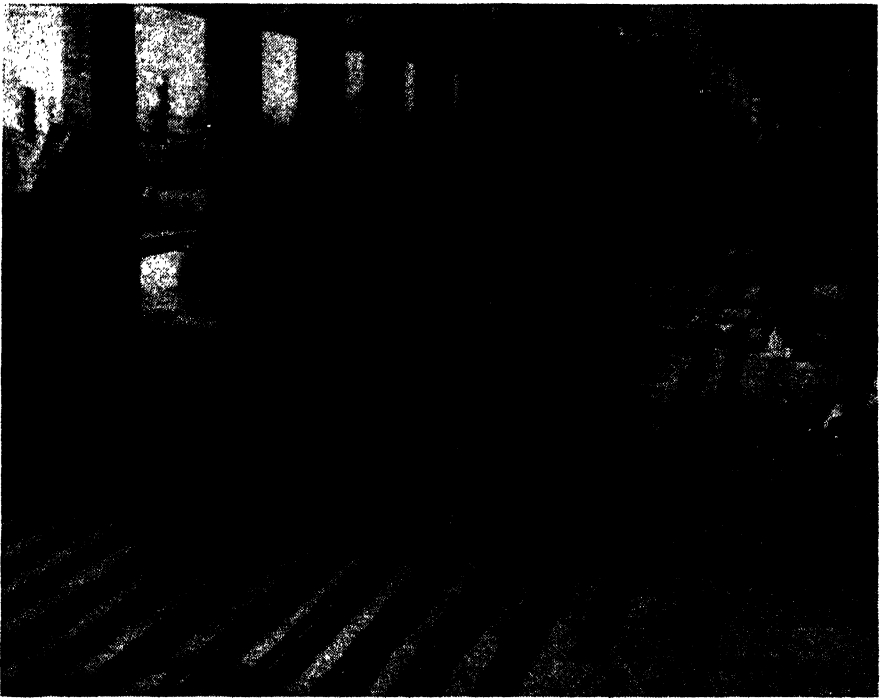

FIG. 8-41.—Floor coils in French hospital. (*Richard Crittall & Co., Ltd.*)

Figure 8-40 shows the construction and installation of steel radiant heating coils in a dome ceiling for the Royal Hospital School Chapel in Holbrook, England.

Figure 8-41 shows steel floor coils being installed in a hospital being built at Lorient, France. The direction of the axis of these coils in relation to the window and door opening should be particularly noted, the intent being by means of this construction to provide necessary warmth and at the same time ample quantities of fresh air for the patients whose beds will be located along the outside wall of this space.

Figure 8-42 shows the installation of steel piping in a radi-

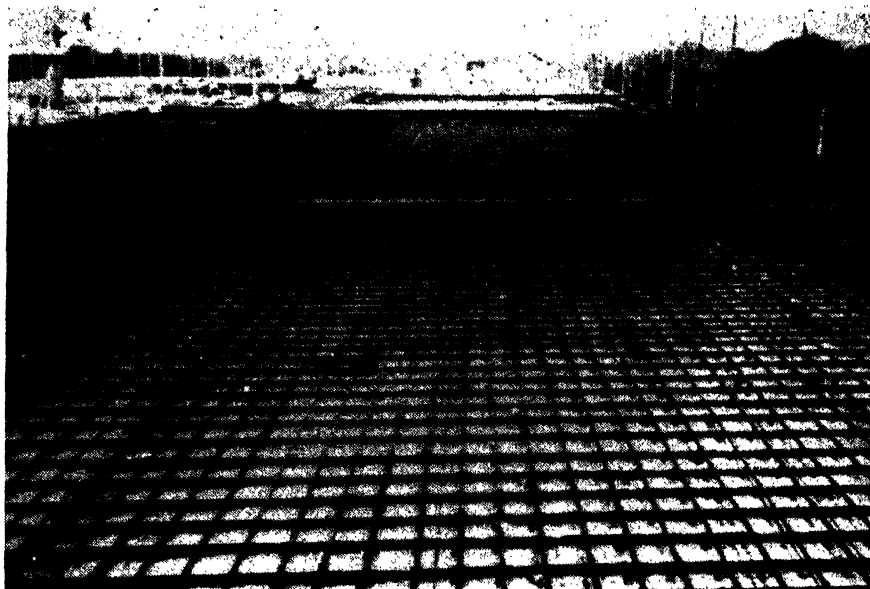

FIG. 8-42.—Steel pipe used both for heating and reinforcement. (*Richard Crittall & Co., Ltd.*)

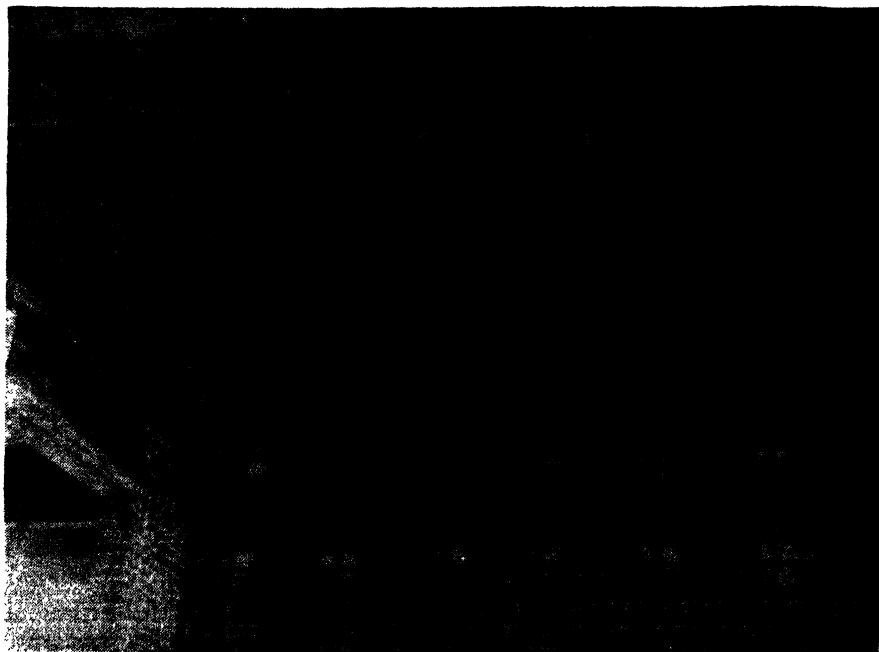

FIG. 8-43.—Combined ceiling and wall installation. (*Richard Crittall & Co., Ltd.*)

ant heating application for the Provincial Hospital at Bakkum, Holland. The magnitude of this installation as evidenced by this illustration needs no further comment.

Figure 8-43 shows the use of wall coils to supplement a ceiling treatment. Of particular interest is the fact that the wall coils are placed at the top of the room so that the heat output from these coils, while being added to the output from the ceiling, will not cause discomfort to occupants standing near the wall, as the lowest length of wall pipe is more than 6 ft from the floor.

In all radiant heating installations, it is very important that the location of coils, the direction of coil convolutions, and the points of hot-water supply and return be correctly determined. Errors in heat load estimates can be readily taken care of by varying circulating water temperatures, but errors in improper location of coils cannot be corrected without considerable expense. The successful application of radiant heating depends very largely on coil design and location.

CHAPTER IX

RADIANT COOLING

Radiant heating installations lend themselves very readily to radiant cooling; but before the subject is considered further, attention must be given to the difference between air conditioning and radiant cooling.

With air conditioning as applied in summer, it is customary to supply cooled and dehumidified air to the spaces involved at such temperatures as may be desired in order to provide summer comfort conditions. In order to ensure that no difficulty be had with the condensation of water on cooled surfaces within the cooled space, all air entering the room is dehumidified sufficiently so that there is no possibility of trouble due to condensation forming. This method of cooling is very effective but requires considerable apparatus; and owing to the necessity of dehumidifying the air, considerable power is required, particularly in areas having relatively high humidity.

The use of a radiant heating installation to perform the function of cooling is open to the serious objection that if the surfaces in the room are cooled below the dew point, as determined by the relative humidity of the air in the room, then those surfaces will condense moisture and become wet; hence, radiant cooling as produced by circulating cooled water through the coils of a radiant heating system cannot fully and completely take the place of conventional summer air conditioning because of the difficulty with condensation.

Radiant cooling can, however, be used in those areas having high temperatures and relatively low humidity. The map (Fig. 9-1) shows the approximate location of those areas in which radiant cooling can be considered. In other areas of relatively high humidity, radiant cooling can be considered in combination with summer air conditioning at a probable reduction in installation cost and operating expense if provision is made for supplying air sufficiently dehumidified to the rooms so that condensation will

not take place. Caution must be observed with respect to comfort temperatures produced either by radiant cooling or by summer air conditioning to prevent too great a difference between

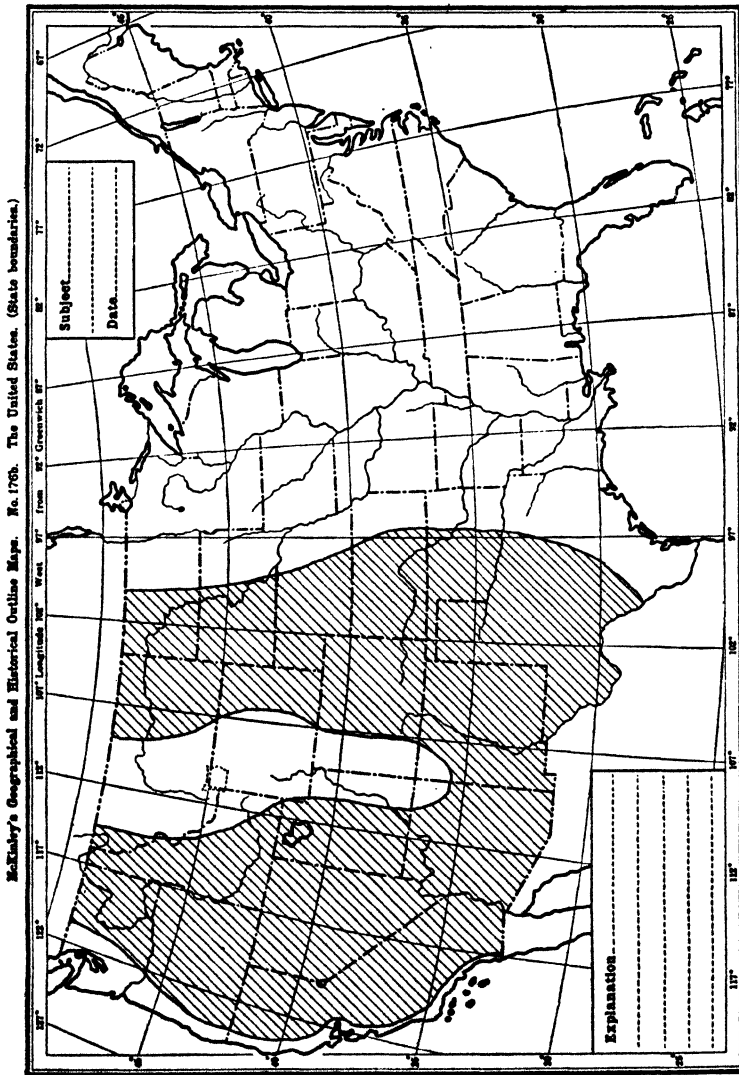

Fig. 9-1.—Radiant cooling is generally applicable in shaded area.

indoor and outdoor temperatures. If this difference is too great, persons entering or leaving the cooled area sense a condition of shock when subjected to a sudden change in environment, particularly in excess of 20°F. Ordinarily, the maximum tempera-

ture difference between cooled and outside temperatures should be on the order of 5 to 10°. Under these conditions and subject to proper control with respect to the dew points, radiant cooling can be a very effective means of providing summer comfort.

It is obvious that if the floor or ceiling temperature is lower than the air temperature in the room, radiation from the body to the cooler surfaces will increase and a sensation of coolness will result. With a radiant system of coils, circulators, etc., already installed, additional expense of making use of this equipment for providing summer comfort conditions is relatively small, being confined chiefly to the cost of necessary controls. It is to be noted that in radiant cooling, the flow of heat is from the outside spaces through the walls and to the rooms to be cooled, just the opposite from the conditions existing in radiant heating. Consequently, the question of cooling loads as applied to radiant cooling (but definitely not to air conditioning) makes use of the same factors that are involved in computing the heat loads, but to a much lower value. The element involved is simply the heat loss computed in the same manner used for determining Btu requirements for heating, but with a low value of temperature difference. The cooling loads in Btu will consequently be much less than the Btu required for heating in the ratio of the temperature differences involved.

For example, if a heating system is intended to operate between 0 and 70°F, there is a temperature difference of 70° for which heating must be applied and for which the system must be designed. On the other hand, as has been explained, it is not practical to have a fixed indoor temperature for cooled areas, but rather it is more practical to have a fixed temperature difference. This difference may have any value up to 10 and possibly 15°; therefore, the Btu involved in a cooling system originally designed for a maximum temperature difference of 70°, when used for heat, would only be $\frac{10}{70}$, or 14.3 per cent, of the heating load in Btu as necessary for a cooling load.

In practically all cases, the coil installation suitable for heating a particular building will be ample for cooling. The exception might be in areas where a small amount of heating is required; for example, where the minimum temperature is not lower than 40°F, the heating system being designed for only 30° temperature

difference, the cooling Btu would be $\frac{1}{30}$, or $33\frac{1}{3}$ per cent, representing a much larger percentage of cooling requirements than in those areas where the heating load is proportioned for temperatures of zero or lower.

There are three methods of supplying cooled water for circulation to the radiant system in order to provide the necessary removal of heat. Obviously, the simplest method of supplying this water would be from wells; and in many sections of the country this is perfectly feasible. The chart of Fig. 9-2 from the U.S. Geological Survey shows the temperature of water that may be expected from wells having a depth of 30 to 60 ft. Increased depth does not necessarily bring about lower water temperatures. If water is withdrawn from wells for circulation through the cooling system, provision must be made for its disposal, and it is not always safe to assume that the warmed water can be returned to the underground storage through another well in the same general locality, as it cannot be assumed that a well will accept water at the same rate at which it will deliver water.

A second method of supplying cooled water for circulation is likely more expensive but may be more generally applicable in those areas in which radiant cooling can be used. This method can be best described as evaporative cooling and results in the fact that if air at less than 100 per cent humidity comes in contact with wet surfaces, such air tends to absorb moisture or vapor from the surfaces until it reaches the saturation point. For the air to absorb moisture, it must vaporize; and in doing this, there is a certain amount of heat absorbed known as "latent heat of vaporization." Consequently, water surfaces will fall in temperature when protected from the sun's radiation and at the same time subjected to the circulation of air, at less than 100 per cent relative humidity. This is the principle involved in cooling towers, the object being to bring the greatest area of water into contact with the air. The best method of doing this is by allowing thin films of water to flow over material surfaces, such as strips of wood, and past which air is being circulated either by natural ventilation or by forced ventilation.

In hot dry climates, space cooling has been effected by blowing air over wet surfaces, such as blankets, allowing this cooled air to permeate the areas that it is desired to cool. To some

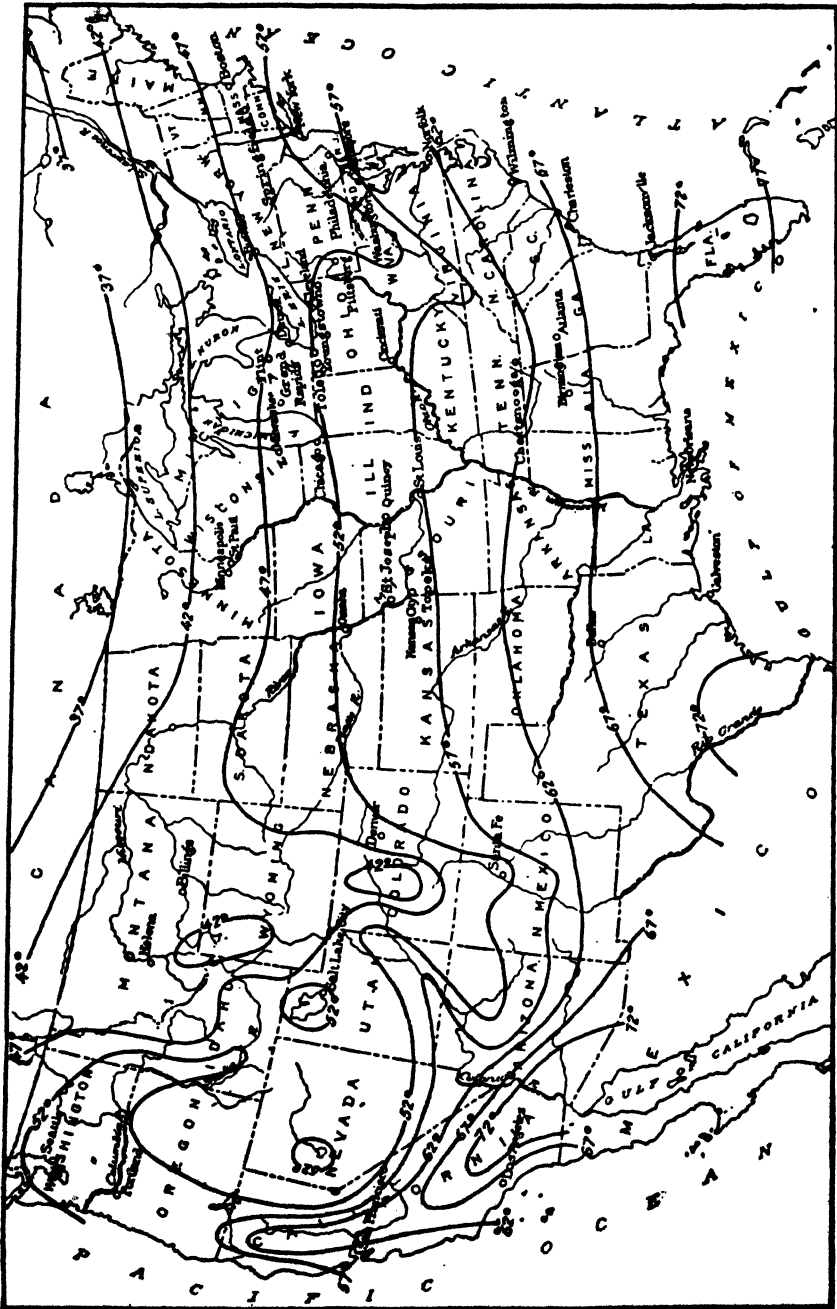

Fig. 9-2.—Well-water temperatures. (U.S. Geological Survey.)

extent the process defeats itself because the cooled air necessarily increases in relative humidity and the cooling effect of such air on the body is decreased with increased humidity. Radiant cooling through the use of a cooling tower as described, with the circulation of the water so cooled through the radiant coils, separates these effects and gives the full benefit of cooling as applied to comfort conditions without the disadvantage of increasing the relative humidity.

One particular advantage of this method of providing cooled water is that it is automatically and entirely self-regulating by reason of the fact that water cooled by evaporative cooling can never be reduced to wet bulb temperature. If a cooling tower delivers water at a temperature of 5° above the dew point, maximum efficiency of the tower can be assumed. Consequently, with water being circulated through the coils at a temperature above the dew point, it will not be possible for the cooled surfaces to arrive at dew-point temperature and result in condensation. The only possible exception to this rule would be under those circumstances where there is a sudden change of temperature and relative humidity. The approach of such a condition would be very easy to detect; and if necessary, correction could be made at once by allowing slightly warmed water to circulate through the coils and thus prevent the cooled surfaces from arriving at temperatures less than the dew point. Controls would have to be supplied, however, to prevent the indoor temperature from becoming lower than 5 to 10° below the outdoor temperature.

A third method of supplying the necessary cool water involves a minimum of installation cost but a somewhat higher operating cost than methods previously outlined and involves the use of ice as a cooling medium. With this method, blocks of ice are placed inside a suitable container, and the water for the coils suitably circulated through this container and reduced in temperature. Since no attempt is made to dehumidify the air for radiant cooling, this method of developing summer comfort is reasonably practical as far as operating expense is concerned.

A fourth method to supply the necessary cooled water is the obvious one of making use of artificial refrigeration equipment, using motor-driven compressors and a refrigeration medium. This method will not be further explored for the reason that if motor-

driven compressors are necessary, it is probable that radiant cooling would not be practical owing to humidity conditions.

Considering now actual methods of design, we will assume that a radiant heating system has been planned and that for a given room 10 by 16 ft, with conditions of 20° minimum outdoor temperature and 70° indoor, a temperature difference of 50°, there is a maximum Btu loss of 4000 per hr. Consequently, not less than 125 ft of $\frac{1}{2}$ -in.-OD pipe or the equivalent have been installed. To determine operating conditions of a radiant heating system as described, when converted for cooling, it will be assumed that a temperature difference of 10° constitutes a safe differential between outdoor and indoor temperatures for radiant cooling operations. Consequently, if the Btu heating load is 4000 Btu per hr with a temperature difference of 50°, the cooling load will only be $\frac{10}{50}$ of 4000, or 800 Btu.

Attention is now directed to the fact that when a ceiling radiant heating installation is used for cooling, the relative values of radiation and convection are reversed and compare with a floor installation. Heat flow from a ceiling functions in the same manner for cooling as a floor installation functions for heating. This results from the fact that with a cold ceiling, air currents will be downwardly, increasing convection transmission in exactly the same manner as in a floor-heating installation, where convection currents will rise, with an increase in heat transfer by convection. Thus the ratio of heat transfer by radiation to convection, as applying to heated floors, is the correct ratio to apply to cooled ceilings.

In predicting the results obtainable with a system designed as a ceiling radiant heating installation when used for summer cooling, it is to be assumed that doors and windows are closed in the same manner as they would be closed in winter if heating were in effect rather than cooling. Consider, therefore, the ceiling application for cooling in the same manner as a floor installation is considered in heating. It will be noted that in the problem of cooling, the effect of using a fixed temperature difference indoor to outdoor, with a variable indoor temperature instead of a variable indoor-outdoor difference and a fixed indoor temperature, as is the condition existing with a heating problem, there results a constant value for Btu absorption per square foot of ceiling. Fur-

thermore, as has been explained, the coil dimensions, if planned for heating, are much in excess of those required for cooling, so no particular design problem is involved; consequently, a very simple relationship results between desired temperature difference inside to outside and Btu absorption per square foot of ceiling surface. If a maximum 10° differential inside to outside is maintained, the ceiling will absorb approximately 25 Btu per sq ft per hr. Dividing the heat-absorption figure of 800 Btu per hr by 25, the Btu absorption rate gives a moderate result of only 32 sq ft as being actually required to remove 800 Btu per hr from the room under consideration, or only 20 per cent of the available area; consequently, accurate estimates of other factors are not absolutely required.

For convenience in checking necessary water temperature, the following table giving the relationship among water temperature, panel temperature, and Btu absorption per square foot in the ceiling surface is appended:

DEPRESSION TEMPERATURES OF CIRCULATING WATER

(For given ceiling absorption in Btu per hour where a radiant heating installation has been made and designed for a minimum outdoor-indoor winter temperature difference of not less than 40°)

Btu per sq ft per hr	Panel depression temperature	Approximate water depression tempera- ture leaving coils
5	3	5
15	7	10
20	9	12
25	12	16
30	15	20

To continue with the example outlined where an absorption of 25 Btu per sq ft per hr will absorb the required heat loss, and assuming that the outdoor temperature is 100° , which minus 10 gives 90° as a suitable room temperature, inspection of the above table of depression temperatures shows that the panel depression temperature is 12° . When this value is subtracted from 90° , the desired room temperature, the result of 78° is the desired ceiling temperature. To obtain a 78° ceiling, the water depression temperature from room temperature of 90° is given as 16° ; conse-

quently, the temperature will have to be 74° when it leaves the radiant cooling coils.

To determine water temperature entering the coils, it will be remembered that as the system was originally designed as a radiant heating installation for a 50° temperature difference, a circulating pump had to be provided of sufficient capacity to meet winter heating conditions, which would mean that 133 lb. of circulating water had been already provided. Thus with this quantity of water flowing in the radiant cooling coils and only 800 Btu per hr having to be transferred, a difference of only 6° between entering and leaving water temperature is required. Consequently, 74° leaving water temperature, minus 6, indicates the entering water temperature to be 68° or an average of 71° . With increasing outdoor temperature, and a differential of 10° , the temperature of the circulating water entering the cooling coils will go up, a circumstance that increases the practicability of finding natural well water suitable for radiant cooling application. Of course, a differential of 10° is not absolutely the limit; and if a sufficient quantity of cooled well water is available, radiant cooling to a practical degree is quite possible.

The chart of Fig. 9-2 definitely indicates that in those areas of the country where radiant cooling is reasonably practical, low-temperature well water is readily available. The only probable exception would be in the lower central part of California, where cooling towers might have to be resorted to, or in the lower western part of Texas, where the probability is that humidity conditions would preclude the use of radiant cooling.

Where suitable supplies of well water are not available, the use of a small cooling tower would be an effective substitute and at the same time might render the use of special controls unnecessary, since unreasonably low temperatures could not be obtained from a cooling tower, nor would it be possible for the system to operate too close to the dew point, as in a cooling tower, the temperature never approaches closer than 5° on the high or safe side.

A practical design for a cooling tower is illustrated in Fig. 9-3. This tower consists of a comparatively shallow reservoir indicated by the designation *B*. Standing in the reservoir is a completely enclosed wooden tower with its bottom edge extending below the surface of the water in the reservoir *B*. In the upper section of

the tower there is a latticework composed of wood strips spaced about 2 in. apart, each layer at right angles to the one below, with the elements staggered as indicated in the sketch, Item *D*. Section *X-Y* shows the location and arrangement of the first two layers, there being a total of nine layers of lattice. A power-driven fan is located at the point *F*, while a circulating pump *A* takes the supply from the reservoir and delivers it to spray nozzles at the top of the tower. Water from this spray falls on the checkerwork or lattice grid and drops from one layer to another,

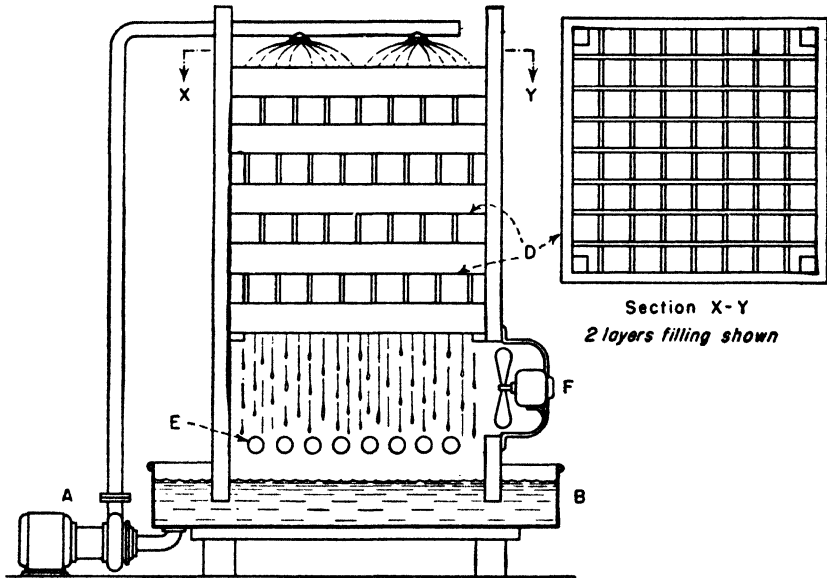

FIG. 9-3.—Cooling-tower design.

while at the same time, air from the fan *F* is blowing up through the tower. The result is that the water falling from the last grid will be cooled to within 3 to 5° of the wet-bulb temperature, and this temperature will be practically independent of dry-bulb temperature. Located in the path of the falling spray from the lattice are shown coils *E*, through which water for circulating through the radiant cooling coils will be passed; and with sufficient coil area, the temperature of the water from the radiant cooling coils can be reduced to within 5 to 8° of wet-bulb temperature.

For a residence of six or seven rooms, the size of a cooling tower, such as described, located in the arid section of the West

need be approximately only 3 ft square and 6 ft high. One-eighth horsepower motors in the fan and pump will be sufficient. In the operation of this tower, it will be noted that while in operation there will be continual evaporation of the circulating water from the pan and also a continual increase in percentage of dissolved salts. Suitable sources of supply of water to reservoir *B* together with a drainage connection and overflow pipe should be provided, although for simplicity they are not shown in the illustration.

The cooling tower can be located in any convenient place, even inside the house or basement, provided an escape pipe of ample size is furnished for the warm and highly saturated air leaving the top of the tower. This air should be so diverted as to preclude its entry into the house through open windows or doors.

Consider now the question of controls that will be required to make any radiant cooling system satisfactory. The element necessary in all cases will be a thermostat control recognizing outdoor, indoor, and ceiling temperatures and functioning to start a circulating pump which will take a supply of cooled water provided by any of the methods previously outlined, the exact temperature of such cooled water being relatively immaterial. It will not be necessary to provide thermostatic control of water temperature as with heating systems. The control thermostat should start the circulating pump in operation whenever the temperature indoors becomes more than the minimum value set by the desired differential; *i.e.*, with an outdoor temperature of plus 90 and a differential of 10, the circulating pump should start up when the indoor temperature approaches 81°. The thermostat should stop the motor when the indoor temperature approaches 80° if the outdoor temperature has not changed; otherwise, the pump should continue to operate, attempting to maintain an indoor temperature of 10° less than outdoor.

With cooled water coming from a well or from a cooling tower, no attention whatever need be paid to the temperature of the cooled water arriving at the pump. With water cooled either by ice or by mechanical refrigeration, a modulating valve should be provided for efficiency purposes to control the arriving temperature somewhat and prevent it from becoming unduly low and, particularly with an ice system, to ensure that no loss occurs in

the temperature of the discharged water. In all cases, with the exception of the use of a cooling tower, means will have to be provided to prevent the ceiling temperature from approaching too close to the dew point. In some sections of the country, it may be assumed that the dew point is so low that no consideration need be given to this feature; but otherwise, it is a factor of great importance. This control device will have to recognize wet-bulb temperature as well as dry-bulb temperature and function to stop

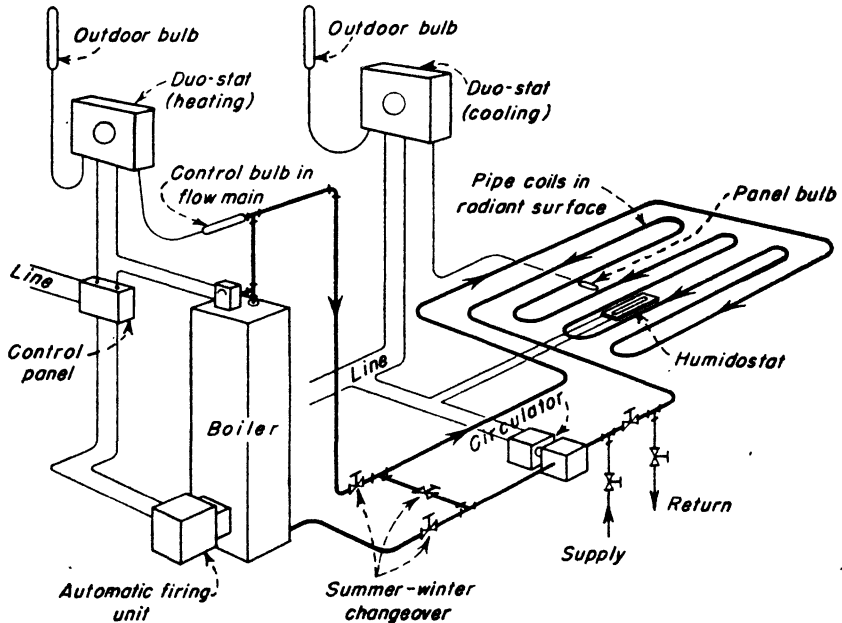

FIG. 9-4.—Control system for radiant heating and cooling.

the pump operation whenever these two temperatures approach too closely together. A practical limit would be 5° . The device should also be self-restoring, so that when conditions change within the area controlled, causing the dew-point or wet-bulb temperature to become sufficiently separated from the dry-bulb temperature, the cooling functions can be resumed without attention on the part of the occupants.

Figure 9-4 shows an arrangement of controls suitable for a combination of radiant heating and cooling as manufactured by the Johnson Service Company of Milwaukee, Wis. To the left of

the illustration are the heating Duo-Stat, outdoor bulb, and control bulb in the flow main. As shown, the heating controls operate to vary the temperature of the boiler water. Obviously, the Duo-Stat could control a three-way mixing valve if such type of operation was desired. The additions to a normal heating system provide for radiant cooling as indicated in the diagram and consist only of a cooling Duo-Stat with its own outdoor temperature bulb; but instead of having the second bulb in the flow main, it is located in the ceiling so that it will be influenced by both ceiling and indoor temperatures. Piping from the boiler to the radiant coils is arranged with a set of three valves which act as a by-pass and boiler shutoff. There is also shown a second set of three valves which act as by-pass and shutoffs for the cold-water supply in a manner similar to the boiler by-pass. It will be noted that with this plan, the circulator functions to drive hot water to the radiant coils in winter, taking its supply from the boiler, while in summer, it serves to force cooled water through the radiant coils, taking the water from any suitable source, such as wells or a cooling tower. The additional device indicated as a humidostat is located close to the underside of the ceiling and functions to discontinue operation of the cooling system if the temperature of the ceiling approaches the dew point. At least a 5° separation between dew point and ceiling temperature should be maintained. The illustration indicates that cold water is supplied from a well to the circulator. Caution must be exercised at this point for the reason that the standard type of hot-water circulators are not intended to operate with negative pressures on the suction side. Therefore in an actual installation, cooled water from any source to be circulated through the radiant system should be supplied to the circulator at a minimum pressure of at least 2 psi. Also, the return from the radiant coils should be arranged so as to prevent any siphoning action; and with multistoried buildings, it may be necessary to make use of a three-way mixing valve to ensure that the circulator operates only under friction head.

To operate the combination heating and cooling system in winter, the controls to the cooling Duo-Stat should be opened and those to the heating Duo-Stat closed; the boiler by-pass closed, and the two associated valves opened; the cooling by-pass should be opened, and the associated valves closed. The system

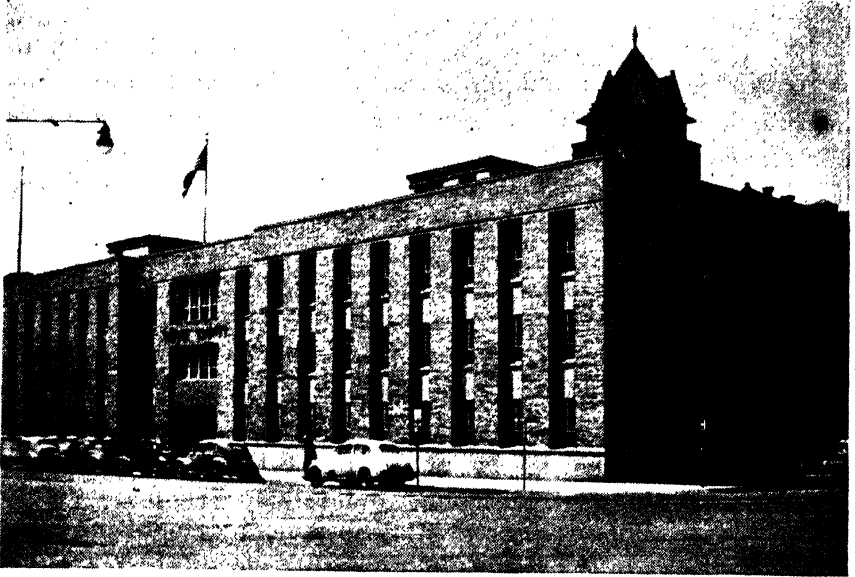

FIG. 9-5.—Radiantly heated and cooled courthouse at Yakima, Wash. (*F. H. Fassett, Architect, and E. L. Weber, Consulting Engineer, Johnson Service Company.*)



FIG. 9-6.—Radiantly heated and summer air-conditioned bungalow. (*Bethlehem Steel Company.*)

will then be ready for winter operation. In summer, the operations would be just reversed.

Figure 9-5 shows the Yakima County Courthouse in the state of Washington, which is equipped with a radiant system for heating in winter and cooling in summer. Necessary cooling water is taken from wells. The coils were constructed of steel pipe, and no trouble has been experienced from condensation because the dew point has never been higher than 45°. This installation was constructed under the supervision of Mr. F. H. Fassett, an architect in Yakima, with the cooperation of Mr. E. L. Weber, a consulting engineer in Seattle. The control system was furnished by the Johnson Service Company of Milwaukee.

In those areas where radiant cooling is not feasible owing to the presence of high humidity, summer cooling and air conditioning can be installed with a radiant heating system so as to get the full benefits of air conditioning and radiant heating. Figure 9-6 shows a residence erected in Pennsylvania that is provided with a radiant heating system using Bethlehem Steel Company's Rayduct for the heating coils; and in addition, a conventional type of air conditioning and cooling is provided for summer operation.

In applying radiant cooling, the use of floor coils should never be considered under any circumstances. It has been pointed out previously that cold floors have an adverse effect on foot comfort; consequently, artificial floor cooling would accentuate this difficulty.

CHAPTER X

PRECISE METHOD OF DESIGNING RADIANT HEATING SYSTEMS

Previous methods of design have made a large number of assumptions, usually including the condition that the room temperature is approximately equal to the average of the unheated surfaces. This condition is not necessarily true.

One of the great advantages of radiant heating is that the temperature of the air in the heated space can be very much lower than normal and at the same time occupants can be comfortable; for example, in a hospital—particularly one for tubercular patients—the air in the room can be down to a temperature of 50°F, while the patients can be perfectly comfortable in light hospital clothing. This feature has a distinct advantage in the curing of tuberculosis. Whenever it is necessary to maintain an average temperature as described, extra ventilation other than normal will be required; otherwise, the air temperature will approach the average unheated wall temperature. Therefore to make a design for the condition outlined, it is necessary to go into rather complete detail as to the volume of air that has to be passed through the heated space and also the proper floor or ceiling temperature that has to be used in order to obtain the desired results. There is no simple method by which the various factors under these conditions can be ascertained.

The following method of calculation has been developed for this purpose: The first section of this method develops the necessary ceiling or floor temperatures which have to be determined in order to meet given conditions of comfort with depressed air temperature, so that the first step is to find the ceiling temperature necessary to meet the given set of conditions. After the ceiling temperature has been found, it is then necessary to discover the desirable piping arrangement, water temperatures, etc., that will give the proper ceiling or floor temperatures previously ascertained. The four different channels through which the heat is transferred

have been previously mentioned; and for the purposes of this discussion, it is necessary to consider only heat transfer by radiation and convection.

Most processes of heat transfer may be expressed by the simple equation:

$$Q = fA(t_1 - t_2) \quad (1)$$

where Q = total heat transfer, Btu per hr or Cal per hr

f = a coefficient representing the heat transfer of a unit area per unit difference of temperature, Btu (sq ft) ($^{\circ}$ F) (hr) or Cal (m^2) ($^{\circ}$ C) (hr)

A = the area participating in the transfer process, sq ft or m^2
 $(t_1 - t_2)$ = the difference in temperature causing the heat exchange between the two materials, $^{\circ}$ F or $^{\circ}$ C

Consideration of convection will be restricted to natural convection in a "draftless" room where air motion is generated by the action of warm enclosures. The boundary layer of air touching a warm surface is primarily heated by conduction and owing to its lighter specific gravity starts to move upward and away from the wall, thus transmitting its heat to the room air.

For the computation of heat transfer through natural convection a formula may be set up similar to Eq. (1). The heat-transfer coefficient or "film conductance" for convection is designated by β . This coefficient varies with the mean air velocity of the boundary layer, which in turn, in the absence of forced air motion, varies with the difference of temperature between wall and room air, Δt . The relation between β and Δt , is given by

Nusselt and Henky as $\beta = 2.8 \Delta t^{0.25}$ Cal(m^2)($^{\circ}$ C)(hr) for floors

Nusselt and Henky as $\beta = 2.2 \Delta t^{0.25}$ Cal(m^2)($^{\circ}$ C)(hr) for walls

Max Hottinger as $\beta = 1.3 \Delta t^{0.25}$ Cal(m^2)($^{\circ}$ C)(hr) for ceilings.

In American units (see F. E. Giesecke articles on "Radiant Heating & Cooling") the approximate values are

$\beta = 0.48 \Delta t^{0.25}$ Btu/(sq ft)($^{\circ}$ F)(hr) for floors

$\beta = 0.38 \Delta t^{0.25}$ Btu/(sq ft)($^{\circ}$ F)(hr) for walls (2a)

$\beta = 0.22 \Delta t^{0.25}$ Btu/(sq ft)($^{\circ}$ F)(hr) for ceilings

According to Griffith and Davies (see MacAdams, "Heat Transmission") the convective surface coefficients are

$$\beta = 0.38 \Delta t^{0.25} \text{ Btu}/(\text{sq ft})(^\circ\text{F})(\text{hr})$$

$$\beta = 0.27 \Delta t^{0.25} \text{ Btu}/(\text{sq ft})(^\circ\text{F})(\text{hr})$$

$$\beta = 0.21 \Delta t^{0.25} \text{ Btu}/(\text{sq ft})(^\circ\text{F})(\text{hr})$$

A number of European investigators have set up further similar equations. Newer American investigations (Wilkes and Peterson) seem to indicate that Griffith's data are rather low. Also, the values given by Nusselt and Henky were used exclusively in Continental European literature describing computation methods of radiant heat systems; and since many European systems have

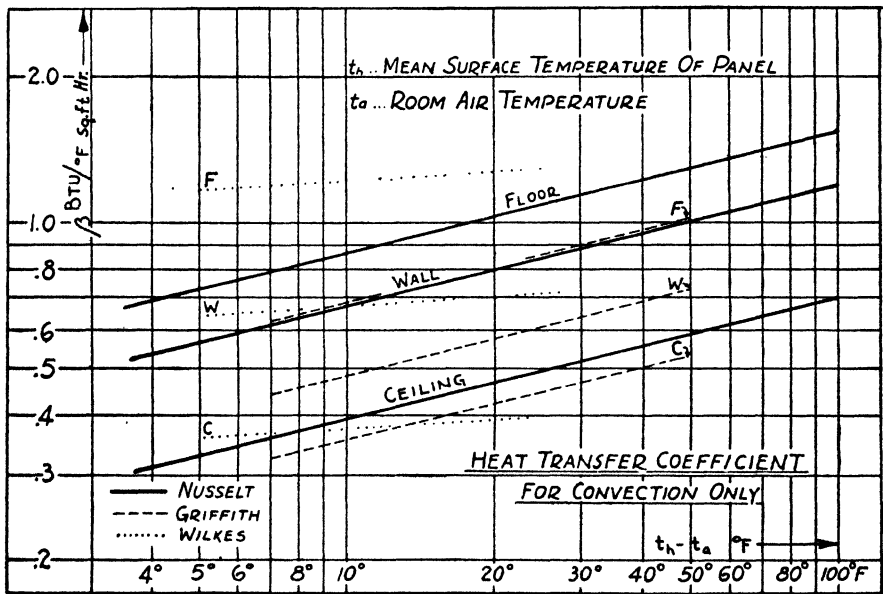

FIG. 10-1.—Heat-transfer coefficient for convection only.

been in satisfactory operation for a number of years, it was decided to base further computations on the Nusselt values, as shown by solid lines in Fig. 10-1. With the coefficient β known, the heat transfer by natural convection can be computed by

$$C_h = \beta A \Delta t \tag{2}$$

where β is computed according to Eq. (2a)

C_h represents the total heat transfer through convection

A number of radiant heating computation systems calculate

the temperature of the inside surface of the outside wall. This temperature can be readily found by application of the laws of heat conduction. The heat flow Q through a wall of surface A is given by

$$Q = UA(t_a - t_o), \quad \text{or} \quad Q_1 = U(t_a - t_o) \quad (3)$$

The coefficient U is named "transmittance." Its reciprocal $1/U$, or R , over-all air to air resistance, consists of the individual resistances according to Fig. 10-2:

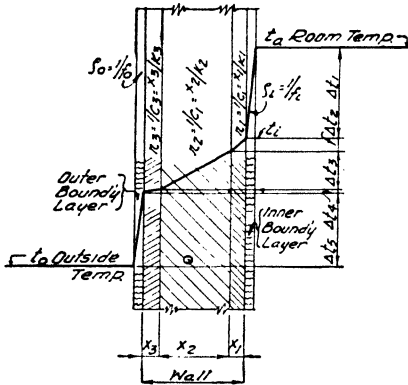

$$R = \rho_i + r_1 + r_2 + r_3 + \rho_o \quad (4)$$

The values r represent the resistance of the individual "wall layers," and ρ the resistance against heat flow through the boundary layers, or the "film resistance."

$$\rho = \frac{1}{f}$$

FIG. 10-2.—Temperature gradient in wall.

The values $1/r = k/x = C$ are named "conductance," k is the "conductivity" or the "conductance per inch of thickness," and x the thickness of the material in inches.

Equation (3) in connection with Fig. 10-1 is used to compute the temperature of the inner wall surface t_i of Fig. 10-2:

$$\left. \begin{aligned} t_a - t_o &= Q_1 R = \frac{Q_1}{U} \\ t_a - t_i &= Q_1 \rho_i = \frac{Q_1}{f_i} \\ \frac{t_a - t_i}{t_a - t_o} &= \frac{U}{f_i} \quad \text{and} \quad t_i = t_a - \frac{U}{f_i} (t_a - t_o) \end{aligned} \right\} \quad (5)$$

The amount of energy—or heat—emitted by a body is governed by its temperature. Stefan and Boltzmann proved that this emission is proportional to the fourth power of the temperature. Thus if two surfaces of the same area and emissivity are in close proximity (Fig. 10-3), the heat transmitted by radiation from the

warmer to the cooler surface is

$$R_{1,2} = (A_1\sigma T_1^4) - (A_1\sigma T_2^4) = \sigma(T_1^4 - T_2^4)A_1 \tag{6}$$

where $R_{1,2}$ = energy radiated per hour, from A_1 to A_2

σ = heat emission per unit area of the body, Cal/(m²) (hr)(°K)⁴

T = temperature in degrees absolute or Kelvin

To eliminate the Kelvin degrees and the fourth power, Eq. (6) is rewritten as

$$R_{1,2} = C_r\zeta(t_1 - t_2)A_1 = \alpha(t_1 - t_2)A_1 \tag{7}$$

where $\alpha = C_r\zeta$

C_r = the emissivity constant, Cal/(m²)(hr.)(°K/100)

$$\zeta = \frac{\left(\frac{T_1}{100}\right)^4 - \left(\frac{T_2}{100}\right)^4}{t_1 - t_2}, \text{ according to Eqs. (6) and (7)}$$

$1/\alpha A_1$, of Eq. (7) represents the resistance against the “flow of radiation” from area A_1 to area A_2 .

Equation (7) again is of the general form of Eq. (1), and the values C_r and ζ are nearly constant over the whole range of practical room temperatures. α of Fig. 10-4 and all later computations are based on $C_r = 4.4$, a highly conservative value.

In practice, we meet conditions where bodies of various shapes radiate energy in all directions (Fig. 10-5a), but only a small part of the total radiation participates in the “heat exchange.”

This portion of the radiation is indicated by H in Fig. 10-5a. The differential equation for the heat exchange between infinitely small areas dA_1 and dA_2 (see Fig. 10-5b) is expressed by

$$dr = \frac{\sigma}{\pi} (T_1^4 - T_2^4) \frac{dA_1 dA_2 \cos \delta_1 \cos \delta_2}{d^2} \tag{8}$$

because the “emission per unit space angle” is $(\sigma/\pi)(T_1^4 - T_2^4)$ and the radiation exchange of the two areas dA_1 and dA_2 is proportional to the magnitude of the areas projected upon a plane perpendicular to the distance d . Also the heat exchange decreases with the square of this distance.

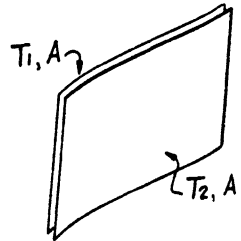

FIG. 10-3.—Heat exchange between areas in close proximity.

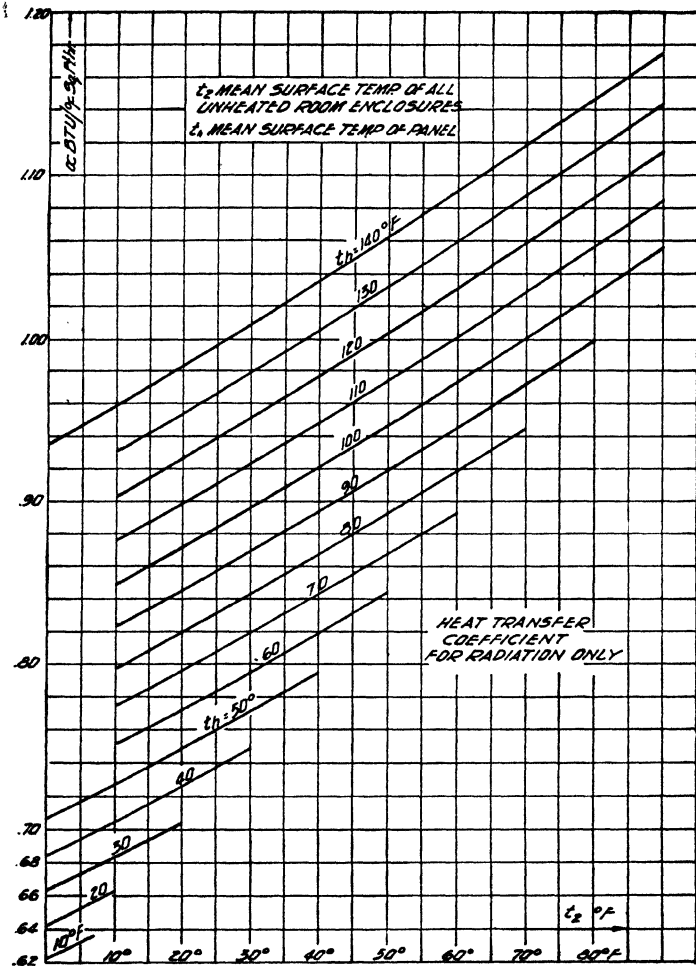
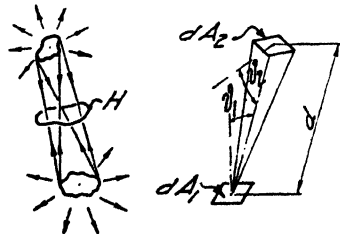

FIG. 10-4.—Heat-transfer coefficient for radiation only.



a) RADIATION & HEAT EXCHANGE b) HEAT EXCHANGE BETWEEN dA_1 & dA_2

FIG. 10-5.—A general case of heat exchange by radiation.

In general (Fig. 10-6) the solution of Eq. (8) can be found for the heat exchange between the surfaces A_1 and A_2 by integrating Eq. (8) over both areas A_1 and A_2 :

$$R_{1,2} = A_1 \sigma (T_1^4 - T_2^4) \left[\frac{1}{\pi} \left(\int_{A_1} \int_{A_2} \frac{\cos \delta_1 \cos \delta_2}{d^2} dA_1 dA_2 \right) \frac{1}{A_1} \right]$$

which according to Eq. (7) can be rewritten as

$$R_{1,2} = A_1 (C_r \zeta_{1,2}) (t_1 - t_2) F_{1,2} = \alpha_{1,2} (t_1 - t_2) F_{1,2} A_1 \tag{9}$$

if

$$F_{1,2} = \frac{1}{\pi A_1} \int_{A_1} \int_{A_2} \frac{\cos \delta_1 \cos \delta_2}{d^2} dA_1 dA_2 \tag{9a}$$

The integration of Eq. (8) is quite complicated. It has been carried out by various authors and for various conditions (see H. C. Hottel,

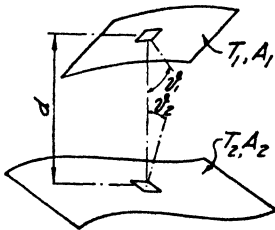

FIG. 10-6.—A general case of heat exchange between areas.

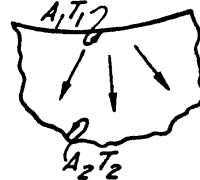

FIG. 10-7.—Heat exchange between concentric areas.

“Heat Transmission between Surfaces Separated by Non-absorbing Media”; Gerbel, “The Basic Laws of Radiation”; M. Jacob in “Der Chemie Ingenieur,” Bd. 1, 1933, etc.). Only one special case results in a simple solution, *i.e.*, the case where one surface A_2 continuously encloses another surface A_1 and each element of A_1 can see nothing but the enclosing surface A_2 . This case is shown in Fig. 10-7 and may be reduced to the case shown in Fig. 10-3. Its solution is given by Eq. (7) representing the “total radiation, R_t , emitted to a space of temperature T_2 by the area A_1 of temperature T_1 .”

By comparing Eq. (7) with Eq. (9), it can be stated that

$$F_{1,2} = \frac{R}{R_t} \tag{10}$$

F represents the ratio of actual heat exchange between A_1 and A_2 of Fig. 10-6 to the total heat loss of A_1 to an area A_2 of tempera-

ture t_2 , and fully enclosing A_1 , as shown in Fig. 10-7. It also represents the ratio of heat radiated from A_1 to A_2 to the total heat radiated from A_1 with temperature t_1 to a space of temperature t_2 . The value of F according to Eq. (9a) is dependent only upon the geometry of the system, *i.e.*, the shape of both areas A_1 and A_2 and their relative location. In the future it will be referred to as "form factor."

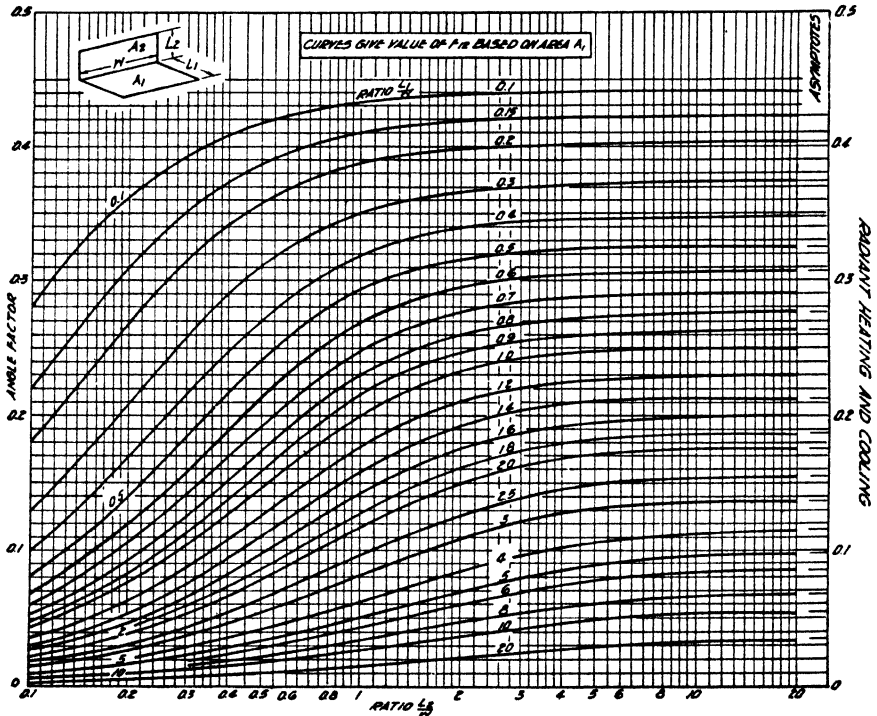

FIG. 10-8.—Form factors for two planes at right angles.

Several authors have computed these form factors for various areas (Hottel, etc.) and represented the solution in form of graphs.

Figures 10-8 and 10-9 show two of these graphs taken from Mackey Wright, Clark, and Gay, "Angle Factors for Calculation of Radiant Heating and Cooling," Cornell Bulletin 32, one for radiant heat exchange between two areas including an angle of 90° , the other one for heat exchange between two parallel areas.

Various authors have treated the problem of radiation between several planes, and only the more important solutions will be dis-

cussed. In 1937, K. Kalous in his "General Theory of Radiant Heating" attempted to derive a rational method for computing the radiant-heat exchange in rooms. In 1939, the first fully rational method was published in the *Gesundheits Ingenieur* in an article "Heat Transfer by Radiation in Ceiling Panel Heat Systems" by Dr. M. van der Held. In the United States this prob-

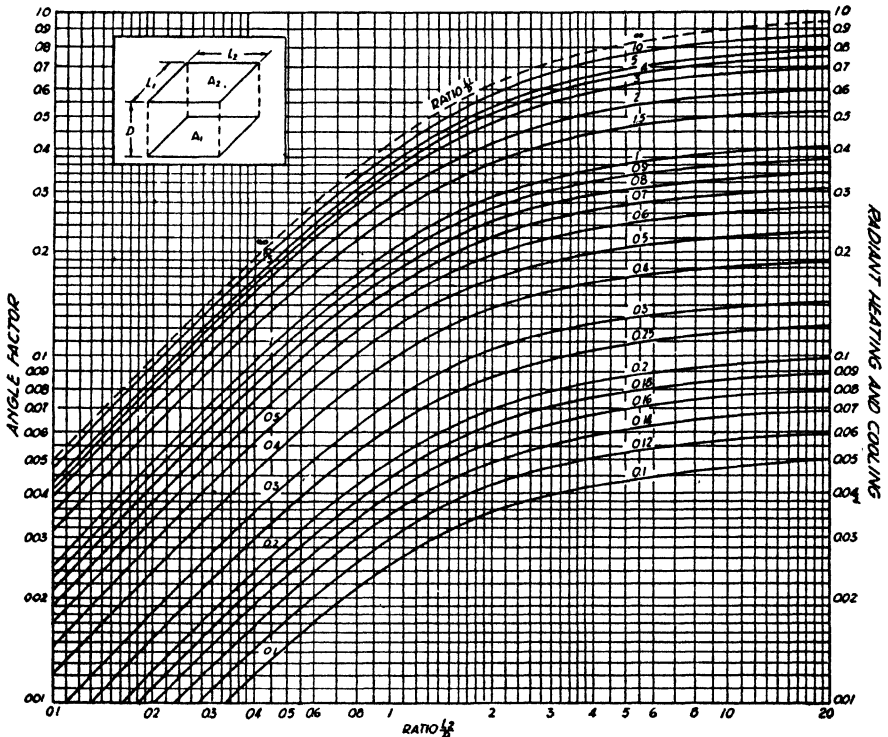

FIG. 10-9.—Form factors for parallel planes.

lem was treated by Raber and Hutchinson in their paper "Panel Heating and Cooling Analysis," ASHVE Transaction, Vol. 47, 1941.

Kalous computed the practical values of the form factor F for a cubical room with the "ceiling square" heated. Disregarding "secondary" radiation and convection, he plotted these values according to Fig. 10-10. In practice, the secondary radiation of the unheated walls as well as the convection heat transfer are of great influence upon the temperature distribution, and more uni-

form heat influx into the various parts of the wall will be met. In his derivations, Kalous considers the influence of these secondary radiation components called "reflections" as well as the influence of the convective heat flow but in the latter part of his paper includes so many simplifying assumptions that his solutions cannot be considered as rational.

Shortly after K. Kalous, van der Held published an analytical method. His simplifying assumptions are (1) Emissivity of all room enclosures equals 90 per cent of black-body emissivity. (2) Coefficients " α " (Fig. 10-4) and " β " (Fig. 10-1) for radiation and convection are alike for all enclosures. (3) To simplify the equations, the transmittance U of the dissipating surface is computed as an average of the transmittance for glass and wall:

$$U = \frac{U_g A_g + U_w A_w}{A_g + A_w} \quad (11)$$

where U_g and U_w represent the transmittance of glass and wall of area A_g and A_w . Van der Held considers a room, according to Fig. 10-11, where wall 1 represents the

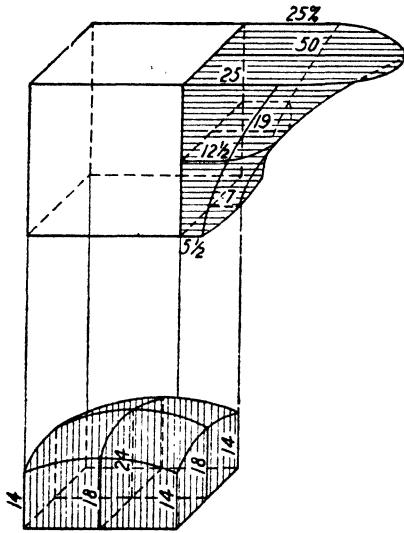

FIG. 10-10.—Form factors showing the changes of radiation directed from the ceiling to the walls and floor of an article.

heated panel and 6 the dissipating area or outside wall plus glass. The heat-exchange equations are now computed by the following reasoning:

1. It can be stated in general that for mutual radiation between two areas a and b , the following relation must hold true:

$$F_{ab}A_a = F_{ba}A_b \quad (12)$$

[For F see Eq. (9a) and Figs. 10-8 and 10-9]

2. Hence for Fig. 10-11, due to room symmetry,

$$\left. \begin{aligned} F_{1,2} &= F_{1,5} = F_{4,2} = F_{4,5} \\ F_{1,3} &= F_{1,6} = F_{4,3} = F_{4,6} \\ F_{2,3} &= F_{2,6} = F_{5,3} = F_{5,6} \end{aligned} \right\} \quad (12a)$$

3. Because all radiation of the heating panel is dissipated by all other enclosures, the following relation must hold true:

$$F_{1,1} + F_{1,2} + F_{1,3} + F_{1,4} + F_{1,5} + F_{1,6} = 1 \quad (13)$$

$F_{1,1}$ is zero wherever the heating panel is located in one plane only.

4. If any three of the F values of Fig. 10-11 were found in Figs. 10-8 and 10-9, all other form values can be computed by Eq. (12a) and (13).

5. After the form values are computed, the heat-balance equations are set up. For the wall 2, for instance, it can be stated that the sum of radiation and convection received must equal the heat lost by conduction through this wall. Wall 2 is an inside wall, and the conduction transfer equals zero: hence according to Eqs. (9) and (2),

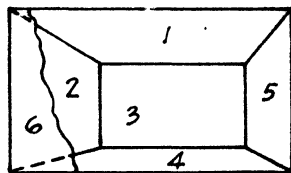

FIG. 10-11.—A panel-heated room.

$$\alpha F_{2,1}(t_1 - t_2) + \alpha F_{2,3}(t_3 - t_2) + \alpha F_{2,4}(t_4 - t_2) + \alpha F_{2,5}(t_5 - t_2) + \alpha F_{2,6}(t_6 - t_2) + \beta(t_2 - t_a) = 0$$

By setting up further equations for other walls and substituting, van der Held obtains, for instance, the temperature of the surfaces 2 and 5:

$$(t_2 - t_a) = (t_5 - t_a) \frac{1 - \Sigma(2 + \gamma - 2F_{1,2} - 2F_{1,3})[(1 + \gamma)F_{2,1} + F_{3,1}F_{2,3}](t_1 - t_a) + (2 + \gamma - 2F_{3,1} - 2F_{3,2})[(1 + \gamma)F_{2,3} + F_{2,1}F_{1,3}](t_6 - t_a)}{2(1 + \gamma)^2 F_{2,1} + (1 + \gamma)^2 F_{2,3} - (1 - \Sigma)(1 + \gamma)F_{1,2}F_{2,1} - (1 - \Sigma)(1 + \gamma)F_{2,3}F_{3,2} - F_{2,1}F_{1,3}F_{3,1} - F_{1,3}F_{3,1}F_{2,3} - 2(1 - \Sigma)F_{2,1}F_{1,3}F_{3,1}}$$

where $\gamma = \beta/\alpha$ and $\Sigma = \gamma/2F_{2,1} + 2F_{2,3} + \gamma$.

Further equations are set up and solved simultaneously for computation of the temperatures. The solutions (presented by three equations) are in good agreement with actual conditions and resemble Hutchinson's solution; but when one considers that each of these equations is composed of over 30 symbols, it appears that their practical application is limited.

Raber and Hutchinson in their paper "Panel Heating and

Cooling Analysis," after discussing the general phenomena of radiant heat transfer between planes, derive equations for the computation of radiant heated rooms. In order to obtain correct results they separately treat wall and glass areas. Their simplifying assumptions are (1) The emissivity of all walls is alike. (2) All neutral walls are of same temperature, and (3) the coefficient α is substantially constant for the room and may be assumed. Their solution is represented in the form of six equations whose simultaneous solutions give the temperatures and heat conditions of the room. Raber and Hutchinson's paper is published in United States periodicals and therefore need not be discussed further.

All practical computation methods are based upon the following principle: The entire energy radiated by the panel is taken up by the room enclosures. If a "mean temperature t_2 " of all unheated enclosures could be found, the form value would equal unity, since the walls of such temperature t_2 would entirely enclose the panel, and the general Eqs. (9) may be reduced to the simple Eq. (7). To compute the hypothetical temperature t_2 , the rational method would have to be referred to. However, it was found in a great number of practical installations that for all rooms of natural ventilation, the unheated MRT (t_2) as well as the neutral temperature (t_n) (see index of symbols) differ by only a few degrees from the air temperature, so that t_2 or t_n may be assumed.

Of the two groups of practical computations, the first one assumes the room air temperature as equal to the unheated MRT (t_2); the second one as equal to the temperature t_n of the neutral enclosures. This second group computes t_2 for the assumed t_n ; and with t_2 known, Eq. (7) may be evaluated.

The methods assuming $t_a = t_2$ are less complicated, which may be the reason why they are used exclusively in European literature. Also, if proper assumptions are made (such as $t_a = t_2 = CT$), their results are fairly conservative. For most rooms with natural ventilation, both methods are in such close agreement with the rational method that their use for "everyday computation" seems feasible.

All practical methods, after making their basic assumptions as to surface temperatures, employ the simple Eqs. (7) and (2) to compute the panel output, which, when added, result in

$$Q = A_h[\alpha(t_h - t_2)^3 + \beta(t_h - t_a)] \quad (14)$$

where t_h = mean panel temperature

t_a = air temperature

t_2 = mean temperature of all unheated surface.

In practice, each panel in one building is supplied with water (or vacuum steam) of the same temperature. If this common water temperature (t_w) and the panel structure are given, the mean panel surface temperature (t_h) is unequivocally determined. With t_h known, t_a and t_2 assumed, and the room heat loss Q computed according to the guide, Eq. (14) may be solved for the panel area A_h .

The following table gives the Btu output by radiation and convection from ceiling, wall, and floor panels.

Panel and panel temperature	Surface coefficient, Btu/(F°)(sq ft)(hr)			Total heat output, Btu/(sq ft)(hr)	Radiation of total output, per cent
	Convection β	Radiation α	Total f	Q	$= \frac{R}{Q}$
Ceiling 115°.....	0.58	1.050	1.63	73.5	64.4
Wall 105°.....	0.93	1.010	1.94	68.0	52.0
Floor 90°.....	1.03	0.955	1.98	39.5	48.2

Also owing to the lower temperature used in wall and floor panels, the total heat output of ceilings exceeds the wall panel output slightly and the floor panel output appreciably. These are two definite advantages of the ceiling system. The most apparent disadvantage of this system is the relatively high radiation rate between the ceiling and the top of the occupants' head.

When discussing this disadvantage two facts should be considered: (1) The average surface temperature of the top of the head is 90°F; the temperature of the sole of the foot 76°F; thus, the radiation transfer to the head is smaller with the same panel temperature. (2) When computing the heat influx into the human skull, according to Raber and Hutchinson's paper "Optimum Surface Distribution of Panel Heating and Cooling Systems," it will be found that this influx is extremely small in rooms of a ceiling height of 8.5 ft or more and that the decrease of room air temperature in ceiling-heated rooms will easily compensate for this

influx. This statement seems to be confirmed by the following data, taken from "OIAV 1937," Max Brandt, "The Ceiling Panel Heating," describing the heating systems installed by Richard Crittal & Co., Ltd., London, and their licensees. (Crittall held many of the early panel heating patents. Their first system was built in London in 1908.): "In spite of the slow progress of radiant heating systems in the early years, a total of 10,000 km (6200 miles) of piping was installed in ceilings throughout Europe at the end of 1936."

With normal humidity conditions, it was found that all sets of temperatures provide for comfort where the difference between MRT and comfort temperature equals the difference between comfort temperature and air temperature.

Raber and Hutchinson have made interesting investigations as to the change of comfort conditions in "abnormal rooms," *i.e.*, within enclosures of low absorptivity. Tests were made within enclosures of highly polished copper; and owing to its high reflectivity, comfort is found at much lower MRT'S. For all practical conditions, however, the temperature relations cited above are true.

The MRT is the temperature of each point of a hypothetical room enclosure that entirely encloses the occupant of the room and transmits the same amount of heat to the occupant as is transmitted by the actual walls (of areas A_h , A_n , and A_d) due to their individual temperatures t_h , t_n , and t_d . Expressed in mathematical terms, the radiation interchange of the hypothetical room with the occupant has to be equated to the total interchange of the actual room enclosures:

$$R = A_B \alpha (t_B - \text{MRT}) = A_B [F_{Bh} \alpha_{Bh} (t_B - t_h) + F_{Bn} \alpha_{Bn} (t_B - t_n) + F_{Bd} \alpha_{Bd} (t_h - t_d)] \quad (15)$$

However, in the following, an approximate and simplified equation will be used.

$$\text{MRT} \Sigma A = t_h A_h + t_n A_n + t_d A_d \quad (16)$$

The use of this equation seems feasible if we consider that in the correct equation the expression $F_{Bi} \dots$ the form factors governing the heat exchange between human body and wall area A_i change appreciably with the location of the human body (with

surface A_B) within a heated room. Variations of F from 10 to 50 per cent and, in unfavorable cases, of 100 per cent and more are usual. Thus, the error introduced by computing the MRT according to Eq. (16) is not larger than the errors introduced by "approximating" the shape factors of the previous equation. Further assumptions would include

The panel covers the greater part of either one wall, the ceiling or the floor.

The single outside wall and the windows are replaced by an equivalent "dissipating" surface of mean transmittance as approximated by Eq. (11).

No conduction takes place between walls of different temperature.

The emissivity of all enclosures is alike (89 per cent of black body).

The variation of the surface temperature of all neutral areas is small, so that the computations may be based on a "mean

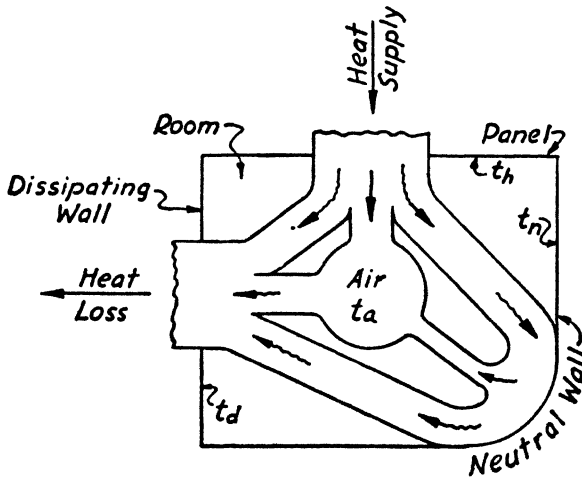

FIG. 10-12.—Heat flowing as a liquid.

neutral temperature." This assumption is a successive step in the assumption made in prior rational methods (namely, that the variation of the surface temperature of all points of one or more walls is small enough to base the computations on a common mean wall temperature) and will result in an appreciable simplification

of the computations and in the simplified heat flow diagram of Fig. 10-12. (The heat flow representing the ventilating loss is not indicated in this figure.)

This last assumption requires that a mean convection coefficient β_n be computed by

$$\left. \begin{aligned} \beta_n &= (A_c^n \beta_c^n + A_w^n \beta_w^n + A_f^n \beta_f^n) / A_n \\ \text{where} \quad A_n &= A_c^n + A_w^n + A_n^n \end{aligned} \right\} \quad (17)$$

$A_{c,w,f}^n$ represent the areas of the sections of the ceiling, wall, and floor that are not heated, and A_n the neutral area.

With the assumption of only three surface temperatures, the computation of the form factors F is simplified, and from the general Eqs. (12) and (13) follow

$$\left. \begin{aligned} F_{hn} &= 1 - F_{hd} \\ F_{nd} &= \frac{A_d}{A_n} - \frac{A_h}{A_n} F_{hd} \\ F_{hd} \text{ and } F_{dh} &\text{ are read off Figs. 10-8 and 10-9} \end{aligned} \right\} \quad (18)$$

The form factors for rooms of two dissipating enclosures (two outside walls) are derived in a similar manner and computed by

$$\left. \begin{aligned} F_{h,d} &= F_{h,d1} + F_{h,d2} \\ F_{d,h} &= F_{d1,h} + F_{d2,h} \\ F_{dd} &= F_{d1,d2} + F_{d2,d1} \\ F_{hn} &= 1 - F_{hd} \\ F_{nd} &= \frac{A_{d1}}{A_n} + \frac{A_{d2}}{A_n} (1 - 2F_{d2,d1}) - \frac{A_h}{A_n} F_{hd} \end{aligned} \right\} \quad (18a)$$

where index $d1$ signifies one of the two dissipating walls and $d2$ the other. F_{hd1} , F_{d2h} , etc., are found by reading the form factors of the individual walls off Figs. 10-8 and 10-9, F_{hn} and F_{hd} are computed according to Eq. (18a).

The error introduced by assuming "one" neutral area of common temperature is partly compensated for by using actual individual heat-transfer coefficients α and β instead of assumed average transfer coefficients as used in previous computation methods.

The heat flow conditions according to previous assumptions are shown in Fig. 10-13 and are fully defined by the three inde-

pendent equations

$$Q = R_1 + R_3 + C'_c \tag{a}$$

$$Q_v = C'_a + C'_c - C'_c \tag{b}$$

$$0 = R_2 - R_3 - C'_b \tag{c}$$

where the heat loss of the room Q equals

$$Q = \Lambda A_d(t_d - t_o) \tag{19}$$

if

$$\Lambda = \frac{1}{\left(\frac{1}{U} - \frac{1}{f_i}\right)} \tag{19a}$$

and the ventilation heat loss equals

$$Q_v = j(Vc_p)(t_a - t_o) \tag{20}$$

where $c_p \sim .019$ Btu/(°F)(cu ft). See index for other symbols.

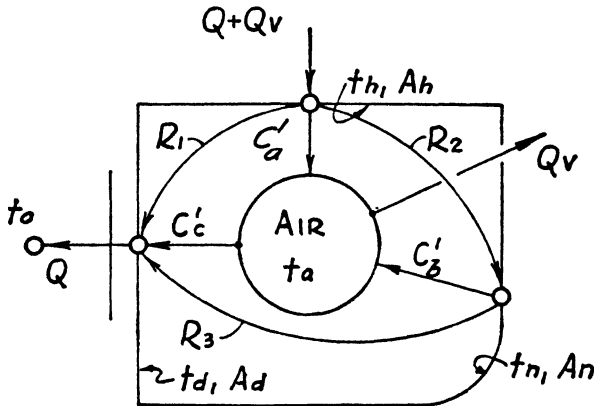

FIG. 10-13.—Components of heat flow in a ventilated and radiantly heated room.

According to Eqs. (2) and (9), the heat-transfer components through convection C and radiation R equal

$$\left. \begin{aligned} C'_a &= \beta_h A_h(t_h - t_a) & R_1 &= \alpha_{hd} F_{hd} A_h(t_h - t_d) \\ C'_b &= \beta_n A_n(t_n - t_a) & R_2 &= \alpha_{hn} F_{hn} A_h(t_h - t_n) \\ C'_c &= \beta_d A_d(t_a - t_d) & R_3 &= \alpha_{nd} F_{nd} A_n(t_n - t_d) \end{aligned} \right\} \tag{d}$$

The final equations should express the temperatures of the panel of the neutral and dissipating wall as well as the hourly air change j as a function of the known temperatures t_o , t_a , and MRT. In most cases of forced ventilation, it will be desirable to assume

an air temperature lower than the CT and herewith the MRT is given by:

$$\text{MRT} = \text{CT} + \Delta t$$

if

$$t_a = \text{CT} - \Delta t \quad (21)$$

and Δt is the desired "temperature depression."

To obtain the results in terms of the required MRT we note

$$\text{MRT } \Sigma A = t_h A_h + t_n A_n + t_a A_d \quad (16)$$

Further on, by substitution of the values for Q , R , and C of Eqs. (19) and (d) into Eq. (a) we obtain

$$\Lambda A_d (t_a - t_o) = \alpha_{hd} F_{hd} A_h (t_h - t_d) + \alpha_{nd} F_{nd} A_n (t_n - t_d) + \beta_d A_d (t_a - t_d) \quad (e)$$

also by substituting the values for R and C of Eq. (d) into Eq. (c),

$$0 = \alpha_{hn} F_{hn} A_h (t_h - t_n) - \alpha_{nd} F_{nd} A_n (t_n - t_d) - \beta_n A_n (t_n - t_a) \quad (f)$$

Rearranging Eq. (16), as well as Eqs. (e) and (f), and substituting as follows:

$$\left. \begin{array}{l} a_1 = A_h \\ a_2 = \alpha_{hd} F_{hd} A_h \\ a_3 = \alpha_{hn} F_{hn} A_n \end{array} \right\} \left. \begin{array}{l} b_1 = A_n \\ b_2 = \alpha_{nd} F_{nd} A_n \\ b_3 = -(a_3 + b_2 + \beta_n A_n) \end{array} \right\} \left. \begin{array}{l} c_1 = A_d \\ c_2 = -a_2 - b_2 - A_d (\beta_d + \Lambda) \\ c_3 = b_2 \end{array} \right\} \left. \begin{array}{l} d_1 = \Sigma A \cdot \text{MRT} \\ d_2 = -A_d (\Lambda t_o + \beta_d t_a) \\ d_3 = -\beta_n A_n t_a \end{array} \right\} \quad (22)$$

we have

$$\left. \begin{array}{l} t_h a_1 + t_n b_1 + t_d c_1 = d_1 \\ t_h a_2 + t_n b_2 + t_d c_2 = d_2 \\ t_h a_3 + t_n b_3 + t_d c_3 = d_3 \end{array} \right\} \quad (k)$$

Equations (k) and (b) represent the final solution and may be solved for any desired comfort conditions. Owing to the previous assumptions, the number of simultaneous equations defining the room temperatures was reduced from five to three, which simplifies considerably the practical solution. Also the equations

result immediately in the desired comfort condition. To reduce the work of the designing engineer, the simultaneous equations will be transformed:

Solving Eqs. (k) by determinants and since $c_3 = b_2$ we have

$$\left. \begin{aligned} t_h &= \frac{1}{\Delta} [d_1(b_2^2 - b_3c_2) - d_2(b_1b_2 - b_3c_1) + d_3(b_1c_2 - b_2c_1)] \\ t_n &= \frac{1}{\Delta} [a_1(b_2d_2 - c_2d_3) - a_2(b_2d_1 + c_1d_3) + a_3(c_2d_1 - c_1d_2)] \\ t_a &= \frac{1}{\Delta} [a_1(b_2d_3 - b_3d_2) - a_2(b_1d_3 - b_3d_1) + a_3(b_1d_2 - b_2d_1)] \end{aligned} \right\} \quad (23)$$

with $\Delta = a_1(b_2^2 - b_3c_2) - a_2(b_1b_2 - b_3c_1) + a_3(b_1c_2 - b_2c_1)$

With all temperatures known, the hourly air change j is computed from Eqs. (b), (20), and (d) as follows:

$$j = \frac{(t_h - t_a)\beta_h A_h + (t_n - t_a)\beta_n A_n + (t_d - t_a)\beta_d A_d}{(t_a - t_o)Vc_p} \quad (24)$$

and all unknowns may be computed as described in the following paragraph.

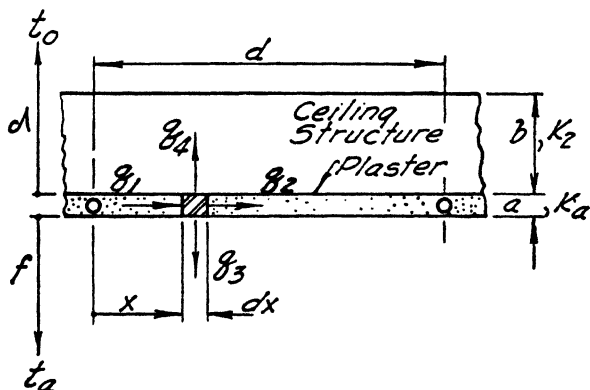

FIG. 10-14.—Kalous' simplified panel-heat-flow assumptions.

In Eqs. (k) and (24) the plus sign indicates flow in the direction shown in Fig. 10-13. A method for determining the necessary panel temperature having been now outlined, whereby certain definite temperature results can be obtained within a given space, the problem of providing the necessary piping and water temperature will now be considered.

K. Kalous in his "General Theory of Radiant Heat" has developed approximate equations which are based on the following theory: In a panel as shown in Fig. 10-14, the heat increment q_1 is supplied to the section dx of the plaster and from there on is partly conducted into the ceiling structure q_4 and partly into the room q_3 . The remaining heat q_2 is supplied to the neighboring ceiling element. This theory represents a good approximation for panels of small a and of a conductivity k_a much higher than the

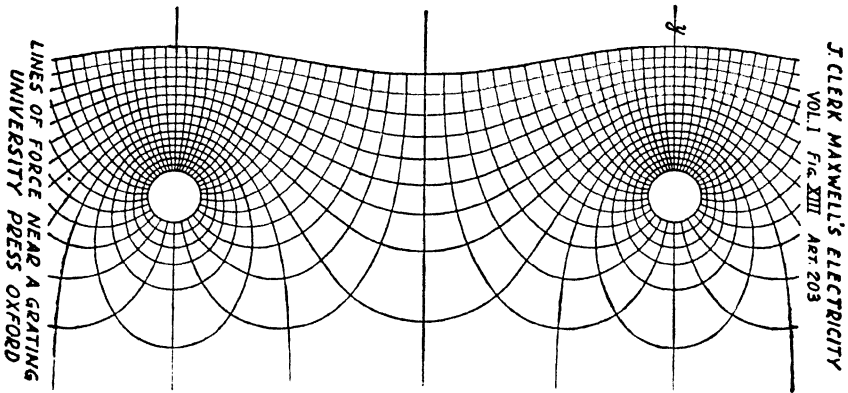

FIG. 10-15.—Maxwell's lines of force near a grating.

conductivity k_b and the surface conductance f . For the general case, however, the flow conditions are different, as may be seen in Fig. 10-19. Kalous also assumes that the panel surface temperature at $(x = 0)$ is equal to the water temperature, an assumption that by no means holds true. For these assumptions, the minimum temperature is derived as

$$t_{\min} = t_w \frac{1}{\cosh\left(m \frac{d}{2}\right)} + \frac{\phi}{f_i + \phi} t_o \left(1 - \frac{1}{\cosh\left(m \frac{d}{2}\right)}\right) \quad (25)$$

where

$$m = \sqrt{\frac{f_i + \phi}{ak_a}}$$

and

$$t_{\min} = \text{panel temperature} \quad \text{at} \quad x = \frac{d}{2}$$

$1/\phi = b/k_b + 1/f_o =$ flow resistance through layer b and to outside air. $f_i, f_o =$ film conductances to spaces of temperature t_a and of temperature t_o . For other symbols see Fig. 10-14.

Having computed the minimum panel temperature and with the maximum temperature assumed equal to the water temperature, Kalous finds the mean panel temperature by

$$t_h = t_{\min} + \frac{1}{3}(t_{\max} - t_{\min}) \quad (26)$$

This equation is based on the assumption that the change of the panel surface temperature is parabolic, an assumption met in other discussions and in fair agreement with test results.

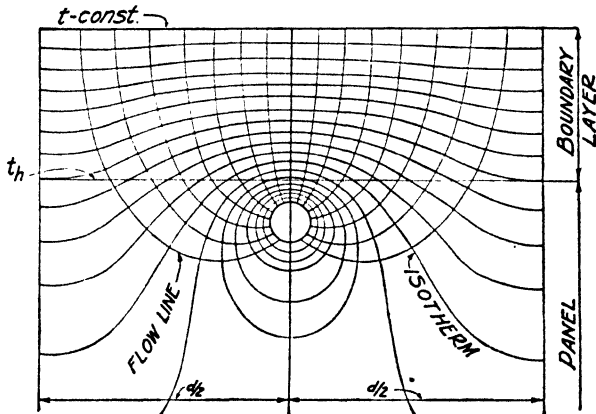

FIG. 10-16.—In a panel heat-flow lines are similar to lines of force.

The results obtained by Eq. (25) as well as temperatures computed according to a method assuming radial heat flow originating at the tube center compared favorably with panel test readings in a few cases only, and it seemed necessary to develop more general equations giving satisfactory results for any desired panel.

During the latter part of the nineteenth century, J. C. Maxwell developed the equations for the electric field of a wire grating (Fig. 10-15), and the similarity of this field to the temperature field of the panel (Fig. 10-16) suggested the application of a similar method of computation to the panel.

Figure 10-16 represents in approximation the heat flow lines and isotherms in the boundary layer and in the actual structure of a floor panel between $x = -d/2$ and $x = d/2$. The ground,

The resulting flow lines are represented in Fig. 10-19 and are discontinuous at the plaster surface.

It is known that the panel surface temperature is mainly a function of the tube distance d , depth of bury a , and conductivity k . Also since f of Eq. (29) changes with the panel surface temperature, the thickness of the boundary layer x_i of Fig. 10-19 changes with d and a and is different for various points of the panel surface. This relation suggested a modification of the preliminary assumption by supposing continuous heat flow at the plaster surface ($y = a$) as shown in Fig. 10-20. In this figure the difference ($l' - l$) may be expressed in terms of d and a , k and f and presents

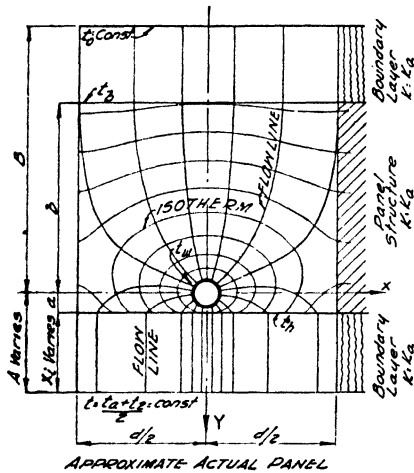

FIG. 10-19.—Originally assumed boundary conditions.

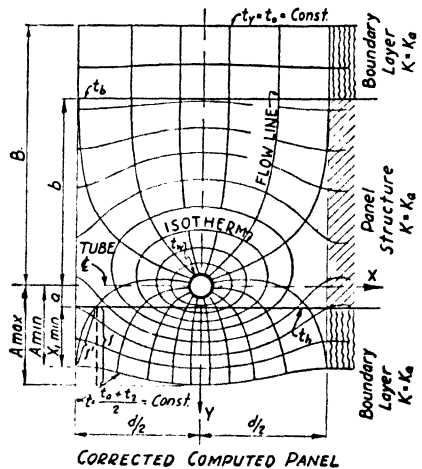

FIG. 10-20.—Final assumed boundary conditions.

nothing but the deviation of the "continuous" heat flow from the "vertical" heat flow. Since both assumptions do not agree with actual conditions and both may be expressed as functions of the same variables, it appeared essential to evaluate the depth of the equivalent boundary layer by tests rather than by analysis, and the assumption of continuous heat flow was finally selected as the base of further computations (Fig. 10-20). In order to find the depth of the equivalent boundary layer, tests were performed on panels of widely different construction, with various depth of cover a , tube distance d , tube radius r , various conductivity k , panel insulation b , and room and opposite outside temperatures t and t_0 .

As was to be expected, the depth of the boundary layer $x_{i,\max}$ and hence the total thickness of the equivalent panel A_{\max} , at $x = 0$ evaluated from test results was in good agreement with the computed depth. It was found by

$$x_{i,\max} = \frac{k_a}{f} \quad \text{and} \quad A_{\max} = a + \frac{k_a}{f} \quad (30a)$$

At the points of minimum panel temperature, $x = \pm d/2$, the tested over-all depth of the panel equals

$$A_{\min} = A_{\max}E \quad (30b)$$

where E proved to be a complex function of f/k and a/\sqrt{d} and was found by coordinating and plotting the test results.

The difference between test readings and computed panel temperatures in all cases was less than 5°F and less than 3°F for the greater part of the readings, a result well within the range of errors met by assuming "mean conductivities" of building materials, according to the ASHVE "Guide" and by neglecting the influence of the panels' heat inertia in the test readings, etc.

All panels met in practice are relatively "well insulated" or "high," *i.e.*, in Fig. 10-20, $B > d$. Such panels are treated in the following section; and when computing their surface temperature at the "opposite panel surface," E of Eq. (30b) equals unity.

When comparing Fig. 10-16 with a panel of lesser insulation (Fig. 10-20) we see a distinct difference in flow conditions. Figure 10-16 represents a panel with an infinite layer of insulation at the "opposite" panel surface. A panel according to Fig. 10-20 whose opposite surface temperature is a few degrees lower than the water temperature would have flow lines quite similar to those shown in Fig. 10-16, since in both cases all heat flow is diverted to the panel surface with temperature t_h and room temperature t . If we were to remove the greater part of the opposite panel insulation, Fig. 10-16 would change and conform to Fig. 10-20, *i.e.*, part of the heat particles would flow into the "opposite" panel surface. Thus, with the same water temperature and room temperature and for the same panel, more heat is delivered to the room if an insulation layer is applied to the opposite panel surface, and consequently the panel temperature t_h rises. A decrease of the outside temperature t_o in a not too well insulated panel would divert

a number of heat particles into the opposite direction and cause a decrease in the panel temperature t_h .

For steady-state heat flow it is known that the temperature in a heated body (panel) must satisfy Laplace's equation. For rectangular coordinates in two dimensions that is

$$\frac{\partial^2 t}{\partial x^2} + \frac{\partial^2 t}{\partial y^2} = 0$$

It is further known (see Carslaw's "Mathematical Theory of the Conduction of Heat" and W. R. Smythe's "Static and Dynamic Electricity") that the boundary conditions for temperature in steady-state heat flow are formally identical with those for electrostatic potential.

Any two-dimensional potential problem can be greatly simplified by the introduction of complex functions, since the real (designated by "Re" in the following) or imaginary (Im) part of a function of a complex variable is always a solution of Laplace's equation.

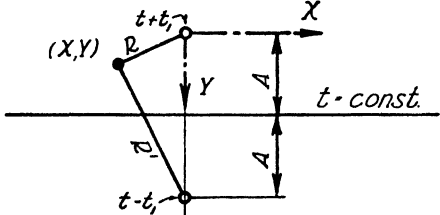

FIG. 10-21.—The image.

In fact, if the real part is considered to give the equipotentials (isothermals), the imaginary part gives the

lines of force (heat flow). Under very general restrictions, these solutions are unique for each complete set of boundary conditions. For a more extended discussion see Rothe, Ollendorff and Pohlhausen, "Theory of Functions," Part 1, Section A.

The usual device for attaining an equipotential (or isothermal) surface along a given straight line is to introduce the image of a given source—a negative source of same intensity at the image point, *i.e.*, at $y = 2A$, of Fig. 10-21. To simplify the theoretical treatment of the heating panel, it is convenient to replace a multi-layer construction of different heat conductivity (layers of panel and surface boundary layer) by a single layer of suitable conductivity with suitably adjusted thickness, as described in previous paragraphs (Fig. 10-17). In Fig. 10-22, A and B are such equivalent layers.

For a single source as in Fig. 10-21, the temperature function that satisfies Laplace's equation for unity intensity is $\ln(1/R)$ and,

if combined with an image, $\ln (1/R) - \ln (1/R')$. To represent an infinite string of sources—*i.e.*, the tubes in the panel of Fig. 10-22—we need a periodic function with similar singularities; this is known to be (Rothe, Ollendorff and Pohlhausen, page 95) $\ln \sin z$, where $z = K(x + iy)$. For our panel a value for K has to be found that provides for singularities d units apart. If we consider that $\sin x = 0$ for $x = n\pi$, we find that $\sin (\pi x/d) = 0$, for $x = nd$, and $K = \pi/d$. Hence, $\sin (x + iy)\pi/d$ has singularities d units apart as desired. Let $f(x,y) = \text{Re} \ln \sin (x + iy)\pi/d$, then $f(x,y)$ represents the temperature function for an infinite set of sources of unit strength. Next, to make the room temperature constant, *i.e.*, ($y = A$) of the panel (Fig. 10-22), an isothermal, these sources are combined with an infinite set of sinks of unit strength along the line $y = 2A$ (images). The sum of the corresponding temperature functions gives a constant temperature on the line $y = A$. If for any point (x,y) this sum is denoted by $\theta_o(x,y)$, then

$$\theta_o(x,y) = f(x,y) - f(x,2A - y) \tag{m}$$

where

$$\left. \begin{aligned} f(x,y) &= \text{Re} \ln \sin \frac{\pi(x + iy)}{d} = \frac{1}{2} \ln \\ &\quad \left(\sin^2 \frac{\pi x}{d} \cosh^2 \frac{\pi y}{d} + \cos^2 \frac{\pi x}{d} \sinh^2 \frac{\pi y}{d} \right) \\ f(x,2A - y) &= \frac{1}{2} \ln \left[\sin^2 \frac{\pi x}{d} \cosh^2 \frac{\pi}{d} (2A - y) \right. \\ &\quad \left. + \cos^2 \frac{\pi x}{d} \sinh^2 \frac{\pi}{d} (2A - y) \right] \end{aligned} \right\} \tag{n}$$

Equation (m) represents the temperature function for the sources and sinks represented in Fig. 10-22. If B of this figure is sufficiently great, the isothermals of $\theta_o(x,y)$ near $y = -B$ are very nearly lines parallel to the x -axis. In practice, this condition holds for $B > d$ and is not too seriously in error even down to $B > d/2$. Assuming, then, that the line ($y = B$), representing the opposite surface of constant outside temperature of the equivalent panel, is nearly an isothermal, we impose the conditions $t_{xy} = t$ for ($y = A$); $t_{xy} = t_o$ for ($y = -B, x = nd$) and hence $t_{xy} \sim t_o$ at ($y = -B$ for any x); $t_{xy} = t_w$ for ($y = 0, x = nd \pm r$).

To represent the actual panel conditions, we have to superimpose the heat transfer across the panel, from the room of temperature t to the space of temperature t_o , caused by the difference of temperatures $(t - t_o)$. Hence, a linear flow function $\beta y + \gamma$ is superimposed over a multiple of $\theta_o(x, y)$, the function defining the field for sources of unit strength:

$$t_{xy} = \alpha \theta_o(x, y) + \beta y + \gamma \quad (p)$$

To evaluate α , β , and γ we apply the boundary conditions to Eq. (p) and get three linear equations for these three coefficients. These are

$$\left. \begin{aligned} \text{At } (y = A): \\ t = \beta A + \gamma \text{ [since } \theta_o(x, y) \text{ is 0 on } y = A, \text{ by construction]} \\ \text{At point } (x = r, y = 0): \\ t_w = \alpha \theta_o(r, 0) + \gamma \text{ (since } \theta \text{ is periodic, } y = 0) \\ \text{At } (y = -B): \\ t_o = \alpha \theta_o(0, -B) + \beta(-B) + \gamma \end{aligned} \right\} \quad (q)$$

Furthermore, Eqs. (m) and (n) result in

$$\begin{aligned} \theta_o(x, y) = & \frac{1}{2} \ln \left(\sin^2 \frac{\pi x}{d} \cosh^2 \frac{\pi y}{d} + \cos^2 \frac{\pi x}{d} \sinh^2 \frac{\pi y}{d} \right) \\ & - \frac{1}{2} \ln \left[\sin^2 \frac{\pi x}{d} \cosh^2 \frac{\pi}{d} (2A - y) + \cos^2 \frac{\pi x}{d} \sinh^2 \frac{\pi}{d} (2A - y) \right] \end{aligned} \quad (31)$$

and the constants $\theta_o(r, 0)$ and $\theta_o(0, -B)$ of Eq. (q) are computed by

$$\left. \begin{aligned} \theta_o(r, 0) = \ln \sin \frac{\pi r}{d} - \frac{1}{2} \ln \\ \left(\sin^2 \frac{\pi r}{d} \cosh^2 \frac{2\pi A}{d} + \cos^2 \frac{\pi r}{d} \sinh^2 \frac{2\pi A}{d} \right) \quad \text{for} \\ x = r; \quad y = 0 \end{aligned} \right\} \quad (32)$$

And

$$\left. \begin{aligned} \theta_o(0, -B) = \ln \sinh \frac{\pi B}{d} - \ln \sinh \frac{\pi}{d} (2A + B) \quad \text{for} \\ x = 0; \quad y = -B \end{aligned} \right\}$$

Solving (q) by determinants we have, if Δ is defined as follows,

Then

$$\Delta = (A + B)\theta_o(r,0) - A\theta_o(0,-B)$$

$$\alpha = \frac{1}{\Delta} [A(t_w - t_o) + B(t_w - t)]$$

$$\beta = \frac{1}{\Delta} [\theta_o(r,0)(t - t_o) + \theta_o(0,-B)(t_w - t)]$$

$$\gamma = \frac{1}{\Delta} [A\theta_o(r,0)t_o + B\theta_o(r,0)t - A\theta_o(0,-B)t_w]$$
(33)

where the constants $\theta_o(r,0)$ and $\theta_o(0,-B)$ are computed according to Eq. (32).

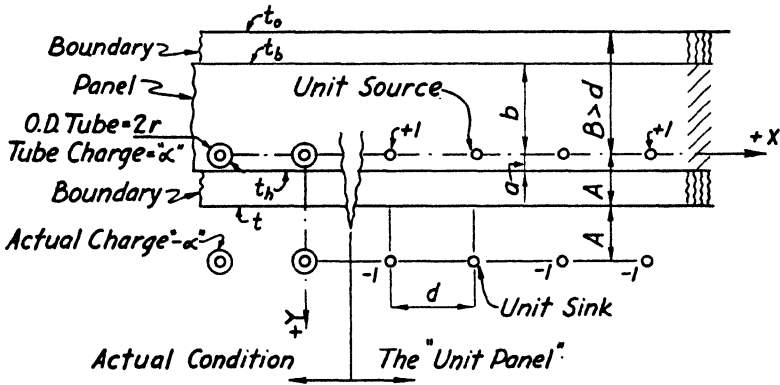

FIG. 10-22.—Physical construction replaced by mathematical positive and negative sources.

To find the panel temperature $t_{xa} = t_h$ of Fig. 10-22 for any point of the actual panel surface ($y = a$), Eq. (p) is to be solved for ($y = a$ and $0 < x < d/2$); hence

$$t_h = \alpha\theta_o(x,a) + \beta a + \gamma \tag{34}$$

The minimum temperature on $y = a$ occurs by obvious symmetry for $x = d/2$, and similarly the maximum temperature for $x = 0$, and Eqs. (34) and (31) result in

$$\left. \begin{aligned} t_{h,\max} &= \alpha \left[\ln \left| \sinh \frac{\pi a}{d} \right| - \ln \left| \sinh \frac{\pi(2A - a)}{d} \right| \right] + \beta a + \gamma \\ t_{h,\min} &= \alpha \left[\ln \left| \cosh \frac{\pi a}{d} \right| - \ln \left| \cosh \frac{\pi(2A' - a)}{d} \right| \right] + \beta a + \gamma \end{aligned} \right\} \tag{35}$$

where $\pi a/d$, etc., is noted in radians.

Finally, computing the maximum and minimum temperatures of the opposed panel surface, for $y = -b$, we have

$$\left. \begin{aligned} t_{b,\max} &= \alpha \left[\ln \left| \sinh \frac{\pi b}{d} \right| - \ln \left| \sinh \frac{\pi(2A + b)}{d} \right| \right] - \beta b + \gamma \\ t_{b,\min} &= \alpha \left[\ln \left| \cosh \frac{\pi b}{d} \right| - \ln \left| \cosh \frac{\pi(2A + b)}{d} \right| \right] - \beta b + \gamma \end{aligned} \right\} \quad (36)$$

Eqs. (35) and (36) present the actual panel temperatures with the constants computed according to Eqs. (33) and (32). Note that the correction E for the equivalent panel thickness was disregarded in these equations. To compute the minimum temperature $t_{h,\min}$ in Eq. (35), all constants and Eq. (35) have to be computed for $A' = EA$.

The general equations (m) and (n) are unchanged, but not so Eq. (p). In this special case no heat is transmitted through the panel due to a temperature difference $t - t_o$, and we can state

$$t_{xy} = \alpha \theta_o(x, y) + \gamma \quad (r)$$

The boundary conditions are

At ($y = A$):

$$t = \gamma, \text{ [since } \theta_o(x, y) = 0, \text{ by construction]}$$

At a point ($r, 0$) of the tube surface:

$$t_w = \alpha \theta_o(r, 0) + \gamma$$

Eqs. (31) and (32) do not change, but $\theta_o(0, -B)$ of Eq. (32) becomes zero. Equations (33) for the new boundary conditions read

$$\left. \begin{aligned} \gamma &= t \\ \alpha &= \frac{t_w - \gamma}{\theta_o(r, 0)} = \frac{t_w - t}{\theta_o(r, 0)} \end{aligned} \right\} \quad (37)$$

The panel temperature for a point (x, a) computes by

$$\text{and} \quad \left. \begin{aligned} t_h &= \alpha \theta_o(x, a) + t \\ \frac{t_h - t}{t_w - t} &= \frac{\theta_o(x, a)}{\theta_o(r, 0)} \end{aligned} \right\} \quad (38)$$

Temperatures		Areas	F values for		
Given	Assumed		One outside wall	Two outside walls	
$CT = \dots$ $t_a = \dots$ $\Delta t = \dots$ $MRT = CT + \Delta t = \dots$ $t_a = CT - \Delta t = \dots$	$t_h = \dots$ $t_d = \dots$ $t_a = \dots$ For second approx. use $t_{a,d,h}$ as computed in first approx.	$A_h = \dots$ $A_d = \dots$ $A_n = A_d + A_n = \Sigma A$ $A_f = \dots$ $A_r = \dots$	$F_{h,d} = \dots$ $F_{h,n} = \dots$ $F_{n,d} = \dots$	$F_{h,d} = \dots$ $F_{h,n} = \dots$ $F_{n,d} = \dots$	
Values of α		Values of β		Values of λ	
$t_h = \dots$ $t_d = \dots$	$\alpha_{hd} = \dots$	$t_h - t_a = \dots$ $t_a - t_d = \dots$	$\beta_h = \dots$ $\beta_d = \dots$	$U_g = \dots$ $U_w = \dots$	Wall
$t_h = \dots$ $t_a = \dots$	$\alpha_{ha} = \dots$	$t_n - t_a = \dots$	$\beta_{nr} = \dots$ $\beta_{nf} = \dots$	$U = \dots$ = for all outside wall and glass	Ceiling
$t_n = \dots$ $t_d = \dots$	$\alpha_{nd} = \dots$	$\beta_n = \dots$	$\beta_{nc} = \dots$ $\beta_{nd} = \dots$ $\beta_{nd} = \dots$	$U = \dots$ = for all outside wall and glass	Floor
Values of α		Values of β		Values of λ	
$a_1 = \dots$ $b_1 = \dots$ $c_1 = \dots$ $d_1 = \dots$	$a_2 = \dots$ $b_2 = \dots$ $c_2 = \dots$ $d_2 = \dots$	$\beta_n = \dots$	$a_3 = \dots$ $b_3 = \dots$ $c_3 = \dots$ $d_3 = \dots$	$a_1 = \dots$ $b_1 = \dots$ $c_1 = \dots$ $d_1 = \dots$	Wall
$b_1 b_2 = \dots$ $(b_1)^2 = \dots$	$b_1 c_2 = \dots$ $b_2 c_1 = \dots$ $b_2 c_2 = \dots$	$b_1 d_2 = \dots$ $b_1 d_3 = \dots$ $b_2 d_1 = \dots$ $b_2 d_2 = \dots$	$b_1 d_3 = \dots$ $b_2 d_1 = \dots$ $b_2 d_2 = \dots$	$c_1 d_1 = \dots$ $c_1 d_2 = \dots$ $c_2 d_1 = \dots$ $c_2 d_2 = \dots$	Ceiling

Fig. 10-23.

Tables I, II, III

Tables IV, V, VI

Table VII

Table VIII

Eqs. (35) read accordingly

$$\left. \begin{aligned} \frac{t_{h,\max} - t}{t_w - t} &= \frac{\ln \left| \sinh \frac{\pi a}{d} \right| - \ln \left| \sinh \frac{\pi(2A - a)}{d} \right|}{\theta_o(r,0)} \\ \frac{t_{h,\min} - t}{t_w - t} &= \frac{\ln \left| \cosh \frac{\pi a}{d} \right| - \ln \left| \cosh \frac{\pi(2A - a)}{d} \right|}{\theta_o(r,0)} \end{aligned} \right\} \quad (39)$$

The correction factor E and $\theta_o(r,0)$ of Eq. (32) have to be used in connection with Eqs. (37) to (39).

In order to simplify the application of the preceding theory to actual practice, a procedure that inevitably is laborious and time-consuming, Fig. 10-23 is provided as a guide to follow in making an actual computation.

The following references to Tables I, II, III, etc., refer particularly to details in Fig. 10-23.

Compute a sample room of given dimensions, for instance, a corner room 15 by 20 ft and 8 ft high. Net area of both outside walls is 155 sq ft. Transmittance of wall is $U = 0.20$. Net glass area and glass transmittance are 125 sq ft and $U = 1.13$. This room should be designed for a comfort temperature of $CT = 70^\circ F$ and an air temperature of $t_a = 60^\circ F$ at an outside temperature of $0^\circ F$. The full ceiling area (300 sq ft) should be heated.

With the method in question, it is necessary not only to know the outside temperature t_o , room design, or comfort temperature CT , and the depression of the air temperature under the comfort temperature Δt but also to make a preliminary guess of the temperature of the heated panel t_h , of the dissipating wall t_d , and of the neutral walls t_n —all being provided in Table I. Naturally, it is practically impossible properly to guess the surface temperatures t_h , t_d , and t_n . However, this method of computation will result in said temperatures, and these results when used as assumption for the second approximation will give closer results. Under certain conditions, it may be necessary to derive a third approximation, but this may be avoided in most cases if the temperatures t_n , t_d , and t_h are properly assumed. To facilitate this, the temperatures to be assumed may be found by interpolation from the following approximate values:

$t_n = 72$ for one air change or $\Delta t = 3^\circ\text{F}$

$t_n = 75$ for six air changes or $\Delta t = 10^\circ\text{F}$

$t_d = 45$ for poorly insulated walls and large single glass areas at 0°F outside temperature

$t_d = 50$ for average structures and 10°F outside temperature

$t_d = 60$ for well-insulated walls, small double sash, and 30° outside temperature

t_h may be computed from Fig. 7-1—if the heat loss is approximated by use of the method given in the ASHVE "Guide"—or estimated from previous experience. The values assumed in this example are more or less arbitrary and differ some from those recommended above. They are $t_h = 120$, $t_d = 46.5$, $t_n = 76$.

In Table II, the areas are noted. A_h is the heated ceiling area; A_d , the sum of outside wall and outside glass area; and A_n , the sum of all remaining room surfaces, *i.e.*, unheated walls and floor. All these values are generally taken from the working drawings; for our example, they are given in the "assumptions." Furthermore, Table II gives the summation of all area ΣA and the individual size of glass (A_g) and wall area (A_w).

The next step in the computation is to find the form or angle factors F according to Table III. Since our room has two outside walls, the right-hand side of the table is used. Let us see how we find the first form factor F_{d1} , F_{d2} , *i.e.*, the one governing the heat flow relations between dissipating areas (outside wall) 1 and 2. Since these walls are perpendicular to each other, Fig. 10-8 is used. (For parallel walls, use Fig. 10-9.) The common section of these walls w according to Fig. 10-8 is equal to the room height, or $w = 8$. The length of one wall L is equal to 20 ft; the length of the other $L_2 = 15$ ft. Then $L_1/w = 2.5$, and $L_2/w = 1.87$. For these fractions, we find the form or angle factor to be 0.125. In similar manner, the factors F_{h1d1} and F_{h1d2} are found—which define the heat flow between heated panel and both outside walls—and added in Table III. F_{Rn} and F_{nd} are computed according to the formula given in this table. All form factors appearing in these equations are found in the upper lines of the table, and all wall areas, etc., are taken from the working prints or Table II.

In order to find the values α that are noted in Table IV and designate the heat-transfer coefficients by radiation, we must know the surface temperatures of the various room enclosures

which are noted in Table IV and taken from Table I. Let us now find the radiation coefficient governing the heat transfer between panel h and dissipating area d . For $t_h = 120$ and $t_d = 46.5$, we find in Fig. 10-4 $\alpha = 0.995$. The same figure is used to obtain the coefficients α_{hn} and α_{nd} .

In similar manner, the values of β , the coefficient of convection (film coefficient), are found in Table V by noting the temperatures of the various surfaces and of the air and reading the coefficient from Fig. 10-1. For instance, $t_h = 120$, $t_a = 60$, $t_h - t_a = 60$. Figure 10-1 gives $\beta = 0.62$ for ceilings where $t_h - t = 60$. The lower part of Table V is concerned with the neutral area, composed in our case of walls and floors. Since the two kinds of surfaces (vertical and horizontal) have different film coefficients, these are found individually and averaged by the equation at the bottom of Table V. For example, neutral temperature $t_n = 76$, air temperature $t_a = 60$; then $t_n - t_a = 16$, and for this difference we find in Fig. 10-1 for the floor $\beta_{n1f} = 0.96$ and for the walls $\beta_{nw} = 0.75$.

Next we are concerned with the insulating qualities of the dissipating areas. The transmittance U of glass and wall—as found in the ASHVE “Guide”—are noted in Table VI. The average transmittance of glass and wall is computed by equation and is $U = 0.61$. Next, we find by equation the average resistance $1/\Lambda$ against heat flow of the wall and outer boundary layer but exclusive of the inner boundary layer of our dissipating area. The reciprocal of this value is the conductance of dissipating wall exclusive of the inner boundary and is given in the last line of the Table VI.

Table VII, finally, is concerned with finding the numerical values of the constants required to solve for the temperatures given in Eqs. (23). The constants $a_1b_1c_1d_1 - a_2b_2 : \dots$, etc., all may be found by simple arithmetic and according to the equations given in Table VII. All areas, factors, and coefficients found in these equations have been previously computed and noted in Tables I to VI.

Table VIII further facilitates the use of Eqs. (23) by giving the products required for their solution. The computation of these products closes the preliminary work, and all that remains to be done is to substitute the values* of Tables VII and VIII in Eqs. (23).

The first one of the Eqs. (23) to be computed is that for Δ :

$$\begin{aligned} \Delta &= a_1(b_2^2 - b_3c_2) - a_2(b_1b_2 - b_3c_1) + a_3(b_1c_2 - b_2c_1) \\ &= 300(18,152 - 603,300) - 85.07(78,140 - 241,800) + \\ &\quad 230.6(-405,200 - 37,720) = -304.9 \times 10^6 \end{aligned}$$

and in a similar manner we find

$$t_h = 121.8^\circ\text{F} \quad t_n = 74.5^\circ\text{F} \quad \text{and} \quad t_d = 46.7^\circ\text{F}$$

compared with our original assumptions which were

$$t_h = 120^\circ\text{F} \quad t_n = 76^\circ\text{F} \quad t_d = 46.5^\circ\text{F}.$$

It so happened that our assumptions were close enough and we could immediately use the results found in our first computations. However, in order to show the trend of the complete computation, a second approximation might well be made.

Proceeding a second time with the computation, but using the values $t_h = 121.8^\circ\text{F}$, $t_n = 74.5^\circ\text{F}$, and $t_d = 46.7^\circ\text{F}$, obtained in the first calculation as a basis instead of the assumed values, and noting that the values for areas and form and angle factors do not change, but those for β and α in Tables IV and V have to be recomputed as well as the numerical values in Tables VII and VIII, there results a second set of values for t_h , t_n , and t_d , the original assumed values with the two sets of computed values being shown in the following table:

Quantities	t_h	t_n	t_d
Assumptions for first approximation	120.0	76.0	46.5
Result first approximation and assumption for second approximation	121.8	74.5	46.7
Result of second approximation (final)	121.6	74.4	46.8

This table indicates that wherever the assumptions were close to the results of the first approximation, it is not required to proceed with a second approximation, but more often it will be found that second approximations must be computed.

The last step in this method is to find the air change and room heat loss called for to guarantee the desired depression and comfort conditions. Substituting all known temperatures, area coefficients, etc., in Eq. (24), we find an hourly air change of $j = 6.12$ times per hour; and substituting the temperatures and other values

from Fig. 10-23, etc., into Eqs. (19) and (20), we find the loss by wall transmittance as

$$Q = \Lambda A_a(t_d - t_o) = 12,820$$

and by ventilation as

$$Q_v = \underline{j(Vc_p)(t_a - t_o) = 15,860}$$

The total heat loss is then

$$Q = \quad Q + Q_v = 28,680$$

APPENDIX

I. PRESSURE DROP TABLES

(Pressure drops in inches of water per lineal foot of copper or Bundy tube for various flows of 140°F water, pounds per hour)

Nominal tube diam- eter, in.	Pressure drops, in. of water															
	0.025	0.050	0.075	0.100	0.125	0.150	0.175	0.200	0.250	0.300	0.350	0.400	0.500	0.600	0.700	0.800
$\frac{1}{4}$	25	50	62	71	77	84	90	97	109	120	130	140	160	177	192	209
$\frac{3}{8}$	83	112	130	155	174	190	208	225	255	285	310	332	375	415	455	490
$\frac{1}{2}$	142	200	235	285	325	360	395	425	485	535	580	630	715	800	870	940
$\frac{5}{8}$	240	350	420	515	580	645	700	760	860	955	1,040	1,120	1,270	1,400	1,530	1,650
$\frac{3}{4}$	370	540	650	800	900	1,000	1,100	1,190	1,325	1,490	1,610	1,730	1,980	2,180	2,380	2,580
1	770	1,120	1,410	1,660	1,900	2,100	2,270	2,450	2,780	3,100	3,330	3,600	4,100	4,500	4,950	5,350
1 $\frac{1}{4}$	1,400	2,050	2,550	3,000	3,400	3,750	4,130	4,450	5,000	5,600	6,100	6,550	7,400	8,100	9,000	9,700
1 $\frac{1}{2}$	2,180	3,200	4,000	4,750	5,400	6,000	6,500	7,000	8,000	8,800	9,600	10,200	11,800	13,000	14,000	15,200
2	4,650	6,800	8,500	10,000	11,400	12,600	13,700	14,800	16,800	18,500	20,200	21,800	24,700	27,200	30,000	32,200
2 $\frac{1}{2}$	8,300	12,100	15,200	17,900	20,200	22,500	24,500	26,500	30,000	33,000	36,000	39,000	44,000	48,500	53,000	57,000
3	13,500	19,800	24,800	29,000	32,500	36,400	40,000	42,800	48,500	53,500	58,000	63,000	71,000	79,000	86,000	93,000

(Pressure drops in inches of water per lineal foot of wrought iron or steel pipe for various flows of 140°F water, pounds per hour)

Nominal pipe size, in.	Pressure drops, in. of water									
	0.100	0.150	0.200	0.250	0.300	0.350	0.400	0.600	0.800	
$\frac{1}{4}$	395	495	585	660	735	800	860	1,080	1,800	
$\frac{3}{8}$	665	830	980	1,100	1,240	1,340	1,430	1,800	3,000	
1	1,820	2,300	2,700	3,040	3,400	3,650	3,950	4,950	8,100	
1 $\frac{1}{4}$	3,330	4,250	4,900	5,640	6,200	6,750	7,150	9,150	15,200	
1 $\frac{1}{2}$	6,150	7,800	9,100	10,400	11,400	12,500	13,200	16,900	28,000	
2	12,400	15,600	18,300	20,900	23,000	25,800	27,000	33,800	55,000	
2 $\frac{1}{2}$	34,000	42,500	50,200	56,600	62,500	68,000	73,500	92,500	150,000	

2. HEAT VALUES OF VARIOUS FUELS, BTU

Fuel oil grade	Btu per gal	Lb per gal	Btu per lb
1	136,000	6.8	20,000
2	138,000	7.0	19,700
3	141,000	7.3	19,500
4	144,000	7.5	19,200
5	147,000	7.8	18,600

		Btu per lb
Arkansas.....	Anthracite	13,700
Colorado.....	Anthracite	13,700
Pennsylvania.....	Anthracite	12,700
Virginia.....	Anthracite	12,000
Alabama.....	Bituminous	13,500
Colorado.....	Bituminous	13,000
Illinois.....	Bituminous	12,000
Indiana.....	Bituminous	11,500
Pennsylvania.....	Bituminous	13,400
West Virginia.....	Bituminous	14,300
North Dakota.....	Lignite	7,000

3. FUEL EQUIVALENT VALUES

(Equivalent gallons of oil of the three grades, 2, 3, and 4, suitable for use in heating boilers, or thousands of cubic feet of gas of two heat contents, required to equal 1 ton of coal, of specified heat values, burned under average conditions in a heating boiler fitted with a mechanical stoker)

Btu values per lb. of coal	Gal of oil required to equal 1 ton of coal			Thousands of cu ft of gas required to equal 1 ton of coal	
	Grade 2	Grade 3	Grade 4	Btu per cu ft 550	Btu per cu ft 1100
10,000	139	136	131	32.0	16.0
11,000	152	149	144	35.0	17.6
12,000	166	163	157	38.4	19.2
13,000	179	177	171	41.5	20.8
14,000	193	190	183	45.0	22.4

4. DESIRABLE FURNACE VOLUME FOR COAL STOKERS

Size stoker, lb coal per hr	Net maximum available output Btu per hr using 12,000 Btu coal	Desirable furnace volume, cu ft	Minimum permissible volume, cu ft
15	117,000	4.9	3
20	156,000	6.6	4
40	312,000	13.3	8
60	468,000	20	12
80	622,000	26.6	16.5
100	780,000	33	20
125	970,000	41	25
150	1,250,000	50	30
200	1,680,000	66	40
300	2,520,000	100	60

5. DIMENSIONS OF STANDARD WEIGHT IRON PIPE

Size	Outside diameter	Inside diameter	Wall thickness	Weight per ft	External sq ft per lin ft	Lb water contained in 1 ft of pipe
$\frac{1}{2}$	0.840	0.622	0.109	0.850	0.22	0.131
$\frac{3}{4}$	1.050	0.824	0.113	1.130	0.275	0.232
1	1.315	1.0490	0.133	1.678	0.344	0.378
$1\frac{1}{4}$	1.660	1.380	0.140	2.272	0.435	0.65
$1\frac{1}{2}$	1.900	1.610	0.145	2.717	0.498	0.895
2	2.375	2.067	0.154	3.652	0.622	1.46
3	3.500	3.068	0.216	7.575	0.917	3.22
4	4.500	4.026	0.237	10.790	1.178	5.55

6. TYPES, SIZES, AND WEIGHTS OF COPPER TUBE

Standard water tube size	Actual outside diameter, in.	Nominal wall thickness, in.			Theoretical weight, lb per ft		
		Type K hard or soft	Type L hard or soft	Type M hard	Type K	Type L	Type M
$\frac{3}{8}$	0.250	0.032	0.025	0.025	0.0849	0.0685	0.0685
$\frac{1}{4}$	0.375	0.032	0.030	0.025	0.134	0.126	0.107
$\frac{3}{8}$	0.500	0.049	0.035	0.025	0.269	0.198	0.145
$\frac{1}{2}$	0.625	0.049	0.040	0.028	0.344	0.285	0.204
$\frac{5}{8}$	0.750	0.049	0.042	0.030	0.418	0.362	0.263
$\frac{3}{4}$	0.875	0.065	0.045	0.032	0.641	0.455	0.328
1	1.125	0.065	0.050	0.035	0.839	0.655	0.465
$1\frac{1}{4}$	1.375	0.065	0.055	0.042	1.04	0.884	0.682
$1\frac{1}{2}$	1.625	0.072	0.060	0.049	1.36	1.14	0.940
2	2.125	0.083	0.070	0.058	2.06	1.75	1.46
$2\frac{1}{2}$	2.625	0.095	0.080	0.065	2.93	2.48	2.03
3	3.125	0.109	0.090	0.072	4.00	3.33	2.68

Lengths:

The standard length for copper tube furnished in straight lengths is 20 ft.

The standard lengths for copper tube furnished in coils are 40 and 60 ft, and tubes up to $1\frac{1}{4}$ in. diameter can also be furnished in 100-ft coils.

6a. WEIGHT OF WATER CONTENT PER FOOT LENGTH IN TYPE L COPPER TUBE, POUNDS

Nominal Diameter		Nominal Diameter	
$\frac{1}{4}$	0.034	2	1.340
$\frac{3}{8}$	0.063	$2\frac{1}{2}$	2.066
$\frac{1}{2}$	0.101	3	2.950
$\frac{5}{8}$	0.151	$3\frac{1}{2}$	3.989
$\frac{3}{4}$	0.210	4	5.186
1	0.357	5	8.082
$1\frac{1}{4}$	0.544	6	11.618
$1\frac{1}{2}$	0.770		

7. COMPARISONS IN DIMENSIONS OF COPPER TUBE AND IRON PIPE*

1	2	3	4	5	6	7	8	9	10	11	12
0.25	$\frac{1}{4}$	0.25	0.186	0.027
0.375	$\frac{1}{4}$	0.315	0.078	$\frac{1}{8}$	0.405	0.269	0.057	$\frac{5}{16}$	0.312	0.248	0.0485
0.500	$\frac{3}{8}$	0.430	0.145	$\frac{1}{4}$	0.540	0.364	0.104	$\frac{1}{2}$	0.500	0.430	0.145
0.625	$\frac{1}{2}$	0.545	0.234	$\frac{3}{8}$	0.675	0.493	0.191	$\frac{5}{8}$	0.625	0.555	0.241
0.75	$\frac{5}{8}$	0.666	0.35	$\frac{1}{2}$	0.840	0.622	0.304				
0.871	$\frac{3}{4}$	0.785	0.486								
1.00	$\frac{3}{4}$	1.05	0.824	0.533				
1.125	1	1.025	0.828								
1.250											
1.375	$1\frac{1}{4}$	1.265	1.26	1	1.315	1.049	0.864				
1.50											
1.625	$1\frac{1}{2}$	1.505	1.78	$1\frac{1}{4}$	1.660	1.380	1.495				
1.75								
2.00	$1\frac{1}{2}$	1.9	1.61	2.036				

* Bundywell tubing is available in various wall thicknesses.

Col. 1. Outside diameters, for comparison.

Col. 2. Nominal copper water tube size.

Col. 3. Actual inside diameter type L copper water tube.

Col. 4. Passageway area, square inches.

Col. 5. Standard iron pipe size (IPS).

Col. 6. Actual outside diameter.

Col. 7. Actual inside diameter.

Col. 8. Passageway area, square inches.

Col. 9. Bundywell tube size.

Col. 10. Actual outside diameter.

Col. 11. Actual inside diameter.

Col. 12. Passageway area square inches.

8. EQUIVALENT LENGTHS OF FITTINGS AND VALVES
(Feet of pipe)

Nominal pipe size, in.	Nominal copper tube size, in.	Globe valve	Angle valve	Gate valve	Elbow	Return bend	Straight tee
$\frac{1}{2}$	$\frac{3}{8}$	14	6	0.30	0.85	0.80	
	..	15	7	0.30	0.90	0.88	
	$\frac{1}{8}$	17	8	0.35	1.00	0.90	
	$\frac{3}{4}$	21	8	0.40	1.00	1.00	
$\frac{3}{4}$..	21	9	0.45	1.25	1.30	1.4
1	1	28	12	0.64	1.60	1.64	1.75
$1\frac{1}{4}$	$1\frac{1}{4}$	36	17	0.89	2.4	2.5	2.3
$1\frac{1}{2}$	$1\frac{1}{2}$	40	20	1.00	3.0	2.9	

RADIANT HEATING

9. COPPER TUBE SWEAT FITTINGS
Valves

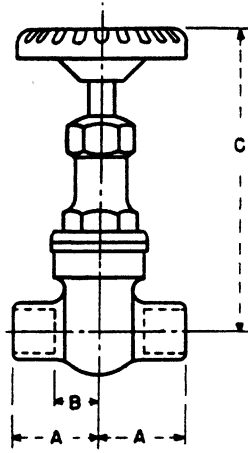

Gate valve.

(Roughing-in measurements)

Nominal size, in.	A	B	C*
$\frac{3}{8}$	$1\frac{1}{8}$	$\frac{7}{16}$	$4\frac{1}{2}$
$\frac{1}{2}$	$1\frac{3}{8}$	$\frac{3}{8}$	$5\frac{5}{8}$
$\frac{3}{4}$	$1\frac{5}{8}$	$\frac{5}{16}$	$5\frac{1}{2}$
1	$1\frac{7}{8}$	$\frac{9}{16}$	$7\frac{5}{8}$
$1\frac{1}{2}$	$1\frac{3}{4}$	$\frac{3}{4}$	$8\frac{3}{4}$
$1\frac{1}{2}$	$1\frac{11}{8}$	$\frac{3}{4}$	$9\frac{1}{2}$
2	$2\frac{1}{4}$	$\frac{7}{8}$	$12\frac{1}{4}$
$2\frac{1}{2}$	$2\frac{5}{8}$	1	15
3	$3\frac{1}{8}$	$1\frac{1}{16}$	$17\frac{1}{4}$

* Open.

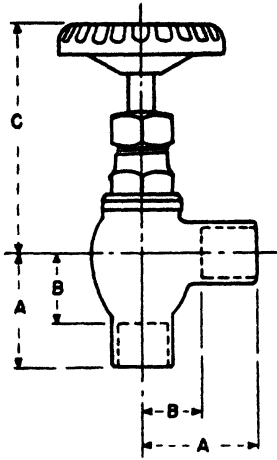

Angle valve.

Nominal size, in.	A	B	C*
$\frac{3}{8}$	$1\frac{5}{16}$	$\frac{11}{16}$	$3\frac{1}{8}$
$\frac{1}{2}$	$1\frac{3}{4}$	$\frac{3}{4}$	$3\frac{1}{4}$
$\frac{3}{4}$	$1\frac{3}{4}$	1	$4\frac{1}{8}$
1	$2\frac{1}{8}$	$1\frac{1}{8}$	$4\frac{1}{4}$
$1\frac{1}{4}$	$2\frac{3}{8}$	$1\frac{5}{8}$	$5\frac{3}{8}$
$1\frac{1}{2}$	$2\frac{3}{8}$	$1\frac{7}{8}$	$6\frac{3}{8}$
2	$3\frac{3}{8}$	$2\frac{1}{8}$	$7\frac{1}{2}$

* Open.

RADIANT HEATING

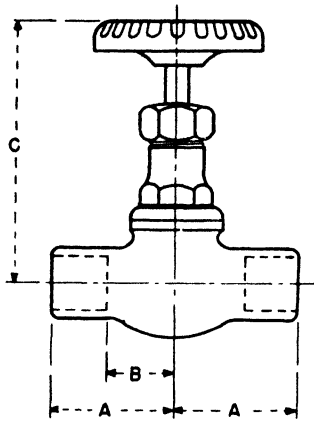

Globe valve.

Nominal size, in.	A	B	C*
$\frac{3}{8}$	$1\frac{5}{16}$	$\frac{13}{16}$	$3\frac{1}{2}$
$\frac{1}{2}$	$1\frac{5}{8}$	1	4
$\frac{3}{4}$	$1\frac{15}{16}$	$1\frac{1}{16}$	$4\frac{11}{16}$
1	$2\frac{3}{16}$	$1\frac{3}{16}$	5
$1\frac{1}{4}$	$2\frac{1}{2}$	$1\frac{7}{16}$	$6\frac{1}{2}$
$1\frac{1}{2}$	$2\frac{11}{16}$	$1\frac{13}{16}$	$6\frac{15}{16}$
2	$3\frac{1}{2}$	$2\frac{3}{16}$	$8\frac{3}{4}$

* Open.

COPPER SOLDER FITTINGS

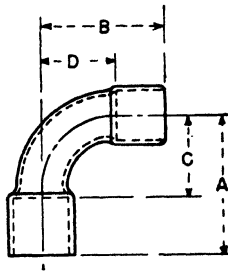

Wrought 90-deg. elbow.
Roughing-in Measurements

Nominal size, in.	A	B	C	D
$\frac{1}{8} \times \frac{1}{8}$	$\frac{13}{16}$	$\frac{13}{16}$	$\frac{1}{2}$	$\frac{1}{2}$
$\frac{1}{4} \times \frac{1}{4}$	1	1	$\frac{5}{8}$	$\frac{5}{8}$
$\frac{1}{4} \times \frac{3}{8}$	1	$\frac{15}{16}$	$\frac{5}{8}$	$\frac{5}{8}$
$\frac{3}{8} \times \frac{3}{8}$	$1\frac{1}{4}$	$1\frac{1}{4}$	$\frac{3}{4}$	$\frac{3}{4}$
$\frac{3}{8} \times \frac{1}{2}$	$1\frac{3}{16}$	$1\frac{1}{16}$	$\frac{11}{16}$	$\frac{11}{16}$
$\frac{1}{2} \times \frac{1}{2}$	$1\frac{9}{16}$	$1\frac{9}{16}$	$\frac{15}{16}$	$\frac{15}{16}$
$\frac{1}{2} \times \frac{3}{4}$	2	$1\frac{7}{8}$	$1\frac{3}{8}$	$1\frac{3}{8}$
$\frac{1}{2} \times \frac{1}{4}$	$1\frac{1}{4}$	$1\frac{1}{16}$	$\frac{5}{8}$	$\frac{5}{8}$
$\frac{5}{8} \times \frac{5}{8}$	$1\frac{7}{8}$	$1\frac{7}{8}$	$1\frac{1}{8}$	$1\frac{1}{8}$
$\frac{3}{4} \times \frac{3}{4}$	$2\frac{1}{4}$	$2\frac{1}{4}$	$1\frac{1}{4}$	$1\frac{1}{4}$
$\frac{3}{4} \times \frac{1}{2}$	$2\frac{3}{8}$	$2\frac{1}{4}$	$1\frac{1}{2}$	$1\frac{1}{2}$
$\frac{3}{4} \times \frac{3}{8}$	$2\frac{1}{4}$	$1\frac{7}{8}$	$1\frac{3}{8}$	$1\frac{3}{8}$
$\frac{7}{8} \times \frac{7}{8}$	$2\frac{7}{16}$	$2\frac{7}{16}$	$1\frac{7}{16}$	$1\frac{7}{16}$
1 × 1	$2\frac{1}{2}$	$2\frac{1}{2}$	$1\frac{1}{2}$	$1\frac{1}{2}$
1 × $\frac{7}{8}$	$2\frac{7}{16}$	$2\frac{1}{2}$	$1\frac{7}{16}$	$1\frac{7}{16}$
1 × $\frac{3}{4}$	$2\frac{5}{8}$	$2\frac{1}{4}$	$1\frac{5}{8}$	$1\frac{5}{8}$
1 × $\frac{5}{8}$	$2\frac{1}{2}$	$2\frac{1}{4}$	$1\frac{3}{2}$	$1\frac{3}{2}$
1 × $\frac{1}{2}$	$2\frac{1}{2}$	$2\frac{1}{8}$	$1\frac{1}{2}$	$1\frac{1}{2}$
1 × $\frac{3}{8}$	$2\frac{3}{8}$	$1\frac{7}{8}$	$1\frac{3}{8}$	$1\frac{3}{8}$
$1\frac{1}{4} \times 1\frac{1}{4}$	$3\frac{1}{16}$	$3\frac{1}{16}$	2	2
$1\frac{1}{4} \times 1$	2 $\frac{1}{8}$	$2\frac{11}{16}$	$1\frac{11}{16}$	$1\frac{11}{16}$
$1\frac{1}{4} \times \frac{3}{4}$	$2\frac{11}{16}$	$2\frac{1}{2}$	$1\frac{5}{8}$	$1\frac{5}{8}$
$1\frac{1}{4} \times \frac{5}{8}$	$2\frac{7}{16}$	$2\frac{1}{4}$	$1\frac{1}{2}$	$1\frac{1}{2}$
$1\frac{1}{4} \times \frac{1}{2}$	$2\frac{9}{16}$	$2\frac{1}{8}$	$1\frac{1}{2}$	$1\frac{1}{2}$
$1\frac{1}{2} \times 1\frac{1}{2}$	$3\frac{5}{16}$	$3\frac{5}{16}$	$2\frac{3}{16}$	$2\frac{3}{16}$
$1\frac{1}{2} \times 1\frac{1}{4}$	$3\frac{1}{2}$	$3\frac{1}{16}$	2	2
$1\frac{1}{2} \times 1$	$2\frac{11}{16}$	$2\frac{11}{16}$	$1\frac{11}{16}$	$1\frac{11}{16}$
$1\frac{1}{2} \times \frac{3}{4}$	$2\frac{3}{4}$	$2\frac{1}{2}$	$1\frac{5}{8}$	$1\frac{5}{8}$
2 × 2	$3\frac{3}{16}$	$3\frac{3}{16}$	$2\frac{9}{16}$	$2\frac{9}{16}$
2 × $1\frac{1}{2}$	$3\frac{11}{16}$	$3\frac{5}{16}$	$2\frac{3}{16}$	$2\frac{3}{16}$
2 × $1\frac{1}{4}$	$3\frac{1}{2}$	$3\frac{1}{16}$	2	2
2 × 1	$2\frac{11}{16}$	$2\frac{11}{16}$	$1\frac{11}{16}$	$1\frac{11}{16}$
$2\frac{1}{2} \times 2\frac{1}{2}$	4 $\frac{1}{2}$	4 $\frac{1}{2}$	$3\frac{1}{16}$	$3\frac{1}{16}$
3 × 3	$5\frac{1}{16}$	$5\frac{1}{16}$	$3\frac{1}{16}$	$3\frac{1}{16}$

RADIANT HEATING

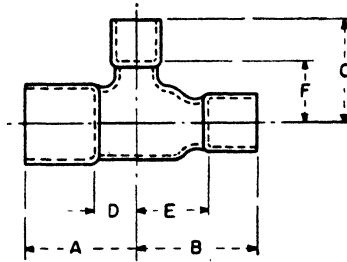

Wrought tee.

Nominal size, in.	A	B	C	D	E	F
$\frac{3}{8} \times \frac{3}{8} \times \frac{1}{2}$	$1\frac{1}{32}$	$1\frac{1}{32}$	$1\frac{5}{32}$	$\frac{23}{32}$	$\frac{23}{32}$	$\frac{13}{32}$
$\frac{3}{8} \times \frac{3}{8} \times \frac{3}{8}$	$\frac{33}{32}$	$\frac{33}{32}$	1	$\frac{13}{32}$	$\frac{13}{32}$	$\frac{9}{32}$
$\frac{3}{8} \times \frac{3}{8} \times \frac{1}{4}$	$\frac{33}{32}$	$\frac{33}{32}$	$1\frac{1}{32}$	$\frac{13}{32}$	$\frac{13}{32}$	$\frac{7}{32}$
$\frac{1}{2} \times \frac{1}{2} \times \frac{3}{4}$	$1\frac{3}{32}$	$1\frac{3}{32}$	$1\frac{3}{4}$	$1\frac{3}{32}$	$1\frac{3}{32}$	$\frac{7}{16}$
$\frac{1}{2} \times \frac{1}{2} \times \frac{1}{2}$	$1\frac{1}{8}$	$1\frac{1}{8}$	$1\frac{1}{8}$	$1\frac{9}{16}$	$1\frac{9}{16}$	$\frac{9}{16}$
$\frac{1}{2} \times \frac{1}{2} \times \frac{3}{8}$	$1\frac{1}{16}$	$1\frac{1}{16}$	$1\frac{1}{4}$	$\frac{5}{8}$	$\frac{5}{8}$	$\frac{3}{4}$
$\frac{1}{2} \times \frac{1}{2} \times \frac{1}{4}$	$1\frac{5}{32}$	$1\frac{5}{32}$	$1\frac{1}{8}$	$\frac{23}{32}$	$\frac{23}{32}$	$\frac{3}{4}$
$\frac{1}{2} \times \frac{1}{2} \times \frac{1}{2}$	$1\frac{1}{8}$	$1\frac{1}{16}$	$1\frac{1}{4}$	$\frac{9}{16}$	$\frac{3}{4}$	$1\frac{1}{8}$
$\frac{1}{2} \times \frac{1}{2} \times \frac{3}{4}$	$1\frac{1}{16}$	$1\frac{1}{4}$	$1\frac{1}{16}$	$\frac{5}{8}$	$\frac{7}{8}$	$\frac{5}{8}$
$\frac{1}{2} \times \frac{1}{2} \times \frac{3}{8}$	$1\frac{3}{32}$	$1\frac{1}{4}$	$1\frac{1}{4}$	$\frac{13}{32}$	$1\frac{1}{8}$	$1\frac{1}{8}$
$\frac{3}{8} \times \frac{3}{8} \times \frac{3}{8}$	$1\frac{3}{8}$	$1\frac{3}{8}$	$1\frac{3}{8}$	$1\frac{1}{8}$	$1\frac{1}{8}$	$1\frac{1}{8}$
$\frac{3}{8} \times \frac{3}{8} \times \frac{1}{2}$	$1\frac{13}{32}$	$1\frac{13}{32}$	$1\frac{1}{2}$	$\frac{23}{32}$	$\frac{23}{32}$	$\frac{1}{2}$
$\frac{3}{8} \times \frac{3}{8} \times \frac{3}{8}$	$1\frac{3}{8}$	$1\frac{3}{8}$	$1\frac{1}{2}$	$1\frac{1}{8}$	$1\frac{1}{8}$	1
$\frac{3}{8} \times \frac{3}{8} \times \frac{1}{4}$	$1\frac{3}{8}$	$1\frac{3}{8}$	$1\frac{1}{2}$	$1\frac{1}{8}$	$1\frac{1}{8}$	$1\frac{1}{8}$
$\frac{3}{4} \times \frac{3}{4} \times 1$	$2\frac{1}{16}$	$2\frac{1}{16}$	$2\frac{1}{16}$	$1\frac{3}{8}$	$1\frac{3}{8}$	$1\frac{1}{16}$
$\frac{3}{4} \times \frac{3}{4} \times \frac{3}{4}$	$1\frac{11}{16}$	$1\frac{11}{16}$	$1\frac{11}{16}$	$\frac{7}{8}$	$\frac{7}{8}$	$\frac{7}{8}$
$\frac{3}{4} \times \frac{3}{4} \times \frac{5}{8}$	$1\frac{23}{32}$	$1\frac{23}{32}$	$1\frac{11}{16}$	$\frac{23}{32}$	$\frac{23}{32}$	$1\frac{1}{16}$
$\frac{3}{4} \times \frac{3}{4} \times \frac{1}{2}$	$1\frac{23}{32}$	$1\frac{23}{32}$	$1\frac{7}{8}$	$\frac{23}{32}$	$\frac{23}{32}$	$1\frac{1}{4}$
$\frac{3}{4} \times \frac{3}{4} \times \frac{3}{8}$	$1\frac{3}{4}$	$1\frac{3}{4}$	$1\frac{11}{16}$	$1\frac{1}{8}$	$1\frac{1}{8}$	$1\frac{1}{16}$
$\frac{3}{4} \times \frac{3}{4} \times \frac{1}{4}$	$1\frac{11}{16}$	$1\frac{11}{16}$	$1\frac{3}{4}$	$\frac{7}{8}$	$\frac{7}{8}$	$1\frac{1}{8}$
$\frac{3}{4} \times \frac{3}{4} \times \frac{3}{4}$	$1\frac{3}{4}$	$1\frac{11}{16}$	$1\frac{3}{4}$	$1\frac{1}{8}$	$1\frac{1}{16}$	$1\frac{1}{8}$
$\frac{3}{4} \times \frac{3}{4} \times \frac{1}{2}$	$1\frac{3}{4}$	$1\frac{11}{16}$	$1\frac{3}{4}$	$1\frac{1}{8}$	$1\frac{1}{16}$	$1\frac{1}{8}$
$\frac{3}{4} \times \frac{3}{4} \times \frac{3}{8}$	$1\frac{3}{4}$	$1\frac{11}{16}$	$1\frac{3}{4}$	$1\frac{1}{8}$	$1\frac{1}{16}$	$1\frac{1}{8}$
$1 \times 1 \times 1$	$2\frac{3}{4}$	$2\frac{3}{4}$	$2\frac{1}{16}$	$1\frac{5}{8}$	$1\frac{5}{8}$	$1\frac{1}{16}$
$1 \times 1 \times \frac{3}{4}$	$2\frac{3}{4}$	$2\frac{3}{4}$	$2\frac{1}{16}$	$1\frac{5}{8}$	$1\frac{5}{8}$	$1\frac{1}{16}$
$1 \times 1 \times \frac{5}{8}$	$2\frac{3}{4}$	$2\frac{3}{4}$	$2\frac{1}{2}$	$1\frac{5}{8}$	$1\frac{5}{8}$	$1\frac{1}{8}$
$1 \times 1 \times \frac{1}{2}$	$2\frac{3}{4}$	$2\frac{3}{4}$	$2\frac{1}{2}$	$1\frac{5}{8}$	$1\frac{5}{8}$	$1\frac{1}{4}$
$1 \times 1 \times \frac{3}{8}$	$2\frac{3}{4}$	$2\frac{3}{4}$	2	$1\frac{5}{8}$	$1\frac{5}{8}$	$1\frac{1}{2}$
$1 \times \frac{3}{4} \times 1$	$2\frac{1}{16}$	$2\frac{1}{4}$	$2\frac{1}{16}$	$1\frac{1}{16}$	$1\frac{1}{8}$	$1\frac{1}{16}$
$1 \times \frac{3}{4} \times \frac{3}{4}$	$2\frac{1}{8}$	2	$2\frac{1}{8}$	$1\frac{1}{8}$	$1\frac{1}{8}$	$1\frac{1}{16}$
$1 \times \frac{3}{4} \times \frac{1}{2}$	$2\frac{1}{8}$	2	$2\frac{1}{8}$	$1\frac{1}{8}$	$1\frac{1}{8}$	$1\frac{1}{8}$
$1 \times \frac{1}{2} \times 1$	$2\frac{1}{4}$	2	$2\frac{1}{16}$	$1\frac{1}{4}$	$1\frac{1}{4}$	$1\frac{1}{16}$
$1 \times \frac{1}{2} \times \frac{3}{4}$	$2\frac{1}{8}$	2	$2\frac{3}{8}$	$1\frac{1}{16}$	$1\frac{1}{8}$	$1\frac{1}{16}$
$1 \times \frac{1}{2} \times \frac{1}{2}$	$2\frac{1}{16}$	$1\frac{1}{8}$	$2\frac{3}{8}$	$1\frac{1}{16}$	$1\frac{1}{4}$	$1\frac{1}{16}$
$1\frac{1}{2} \times 1\frac{1}{2} \times 1\frac{1}{2}$	$2\frac{1}{2}$	$2\frac{1}{2}$	$2\frac{1}{2}$	$1\frac{1}{2}$	$1\frac{1}{2}$	$1\frac{1}{2}$
$1\frac{1}{2} \times 1\frac{1}{2} \times 1$	$2\frac{3}{4}$	$2\frac{3}{4}$	$2\frac{1}{16}$	$\frac{3}{4}$	$\frac{3}{4}$	$1\frac{1}{16}$

WROUGHT TEE (Continued)

Normal size, in.	A	B	C	D	E	F
$1\frac{1}{4} \times 1\frac{1}{4} \times \frac{3}{4}$	$1\frac{1}{8}$	$1\frac{1}{8}$	2	$\frac{7}{8}$	$\frac{7}{8}$	$1\frac{1}{8}$
$1\frac{1}{4} \times 1\frac{1}{4} \times \frac{1}{2}$	$1\frac{3}{8}$	$1\frac{3}{8}$	$1\frac{1}{8}$	$\frac{3}{4}$	$\frac{3}{4}$	$1\frac{1}{8}$
$1\frac{1}{4} \times 1\frac{1}{4} \times \frac{3}{8}$	$1\frac{1}{8}$	$1\frac{1}{8}$	$1\frac{9}{16}$	$\frac{3}{4}$	$\frac{3}{4}$	$1\frac{1}{8}$
$1\frac{1}{4} \times 1 \times 1\frac{1}{4}$	$2\frac{1}{16}$	$2\frac{1}{16}$	$2\frac{1}{16}$	$1\frac{1}{4}$	$1\frac{5}{16}$	$1\frac{1}{4}$
$1\frac{1}{4} \times 1 \times 1$	$1\frac{3}{8}$	$2\frac{1}{8}$	$2\frac{5}{8}$	$\frac{3}{4}$	$1\frac{1}{8}$	$1\frac{5}{8}$
$1\frac{1}{4} \times 1 \times \frac{3}{4}$	2	$1\frac{1}{8}$	2	$\frac{1}{16}$	$\frac{1}{16}$	$1\frac{1}{8}$
$1\frac{1}{4} \times \frac{3}{4} \times 1\frac{1}{4}$	$2\frac{1}{4}$	$2\frac{1}{16}$	$2\frac{1}{4}$	$1\frac{1}{4}$	$1\frac{1}{4}$	$1\frac{1}{4}$
$1\frac{1}{4} \times \frac{3}{4} \times 1$	$1\frac{3}{4}$	$2\frac{3}{8}$	$2\frac{3}{8}$	$\frac{3}{4}$	$1\frac{3}{8}$	$1\frac{3}{8}$
$1\frac{1}{4} \times \frac{3}{4} \times \frac{3}{4}$	$1\frac{3}{8}$	$2\frac{1}{16}$	2	$\frac{3}{8}$	$1\frac{1}{16}$	$1\frac{1}{8}$
$1\frac{1}{2} \times 1\frac{1}{2} \times 1\frac{1}{2}$	$2\frac{1}{8}$	$2\frac{5}{8}$	$2\frac{5}{8}$	$1\frac{1}{2}$	$1\frac{1}{2}$	$1\frac{1}{2}$
$1\frac{1}{2} \times 1\frac{1}{2} \times 1\frac{1}{4}$	$2\frac{9}{32}$	$2\frac{9}{32}$	$2\frac{1}{4}$	$1\frac{3}{32}$	$1\frac{3}{32}$	$1\frac{1}{16}$
$1\frac{1}{2} \times 1\frac{1}{2} \times 1$	$2\frac{1}{4}$	$2\frac{1}{4}$	$2\frac{3}{16}$	1	1	$1\frac{1}{16}$
$1\frac{1}{2} \times 1\frac{1}{2} \times \frac{3}{4}$	$2\frac{1}{4}$	$2\frac{1}{4}$	$2\frac{1}{16}$	1	1	$1\frac{1}{16}$
$1\frac{1}{2} \times 1\frac{1}{2} \times \frac{1}{2}$	$1\frac{3}{8}$	$1\frac{3}{8}$	$1\frac{1}{8}$	$\frac{3}{4}$	$\frac{3}{4}$	$1\frac{1}{16}$
$1\frac{1}{2} \times 1\frac{1}{4} \times 1\frac{1}{2}$	$2\frac{3}{8}$	$2\frac{3}{4}$	$2\frac{3}{8}$	$1\frac{1}{8}$	$1\frac{1}{8}$	$1\frac{1}{2}$
$1\frac{1}{2} \times 1\frac{1}{4} \times 1\frac{1}{4}$	$2\frac{3}{8}$	$2\frac{3}{8}$	$2\frac{1}{16}$	$1\frac{1}{32}$	$1\frac{1}{32}$	$1\frac{1}{4}$
$1\frac{1}{2} \times 1\frac{1}{4} \times 1$	$2\frac{3}{8}$	$2\frac{1}{4}$	$2\frac{3}{8}$	$1\frac{1}{32}$	$1\frac{3}{16}$	$1\frac{3}{8}$
$1\frac{1}{2} \times 1\frac{1}{4} \times \frac{3}{4}$	2	$2\frac{3}{8}$	$2\frac{1}{4}$	$\frac{7}{8}$	$1\frac{3}{8}$	$1\frac{1}{4}$
$1\frac{1}{2} \times 1 \times 1\frac{1}{2}$	$2\frac{3}{8}$	$2\frac{3}{8}$	$2\frac{3}{8}$	$1\frac{1}{8}$	$1\frac{1}{8}$	$1\frac{1}{2}$
$1\frac{1}{2} \times 1 \times 1\frac{1}{4}$	$2\frac{7}{32}$	$2\frac{1}{16}$	$2\frac{1}{8}$	$1\frac{1}{32}$	$1\frac{1}{16}$	$1\frac{3}{8}$
$1\frac{1}{2} \times 1 \times 1$	$2\frac{1}{4}$	$2\frac{1}{8}$	$2\frac{1}{16}$	$1\frac{1}{8}$	$1\frac{1}{32}$	$1\frac{1}{16}$
$2 \times 2 \times 2$	$2\frac{1}{8}$	$2\frac{1}{8}$	$2\frac{3}{8}$	$1\frac{7}{8}$	$1\frac{7}{8}$	$1\frac{1}{8}$
$2 \times 2 \times 1\frac{1}{2}$	$2\frac{1}{8}$	$2\frac{1}{8}$	$2\frac{1}{4}$	$1\frac{1}{4}$	$1\frac{1}{4}$	$1\frac{1}{8}$
$2 \times 2 \times 1\frac{1}{4}$	$2\frac{3}{8}$	$2\frac{3}{8}$	$2\frac{1}{4}$	$1\frac{1}{8}$	$1\frac{1}{8}$	$1\frac{1}{8}$
$2 \times 2 \times 1$	$2\frac{7}{32}$	$2\frac{7}{32}$	$2\frac{1}{8}$	$1\frac{1}{16}$	$1\frac{1}{16}$	$1\frac{3}{8}$
$2 \times 2 \times \frac{3}{4}$	$2\frac{7}{32}$	$2\frac{7}{32}$	$2\frac{1}{2}$	$1\frac{1}{16}$	$1\frac{1}{16}$	$1\frac{1}{8}$
$2 \times 2 \times \frac{1}{2}$	2	2	$2\frac{1}{4}$	$\frac{3}{4}$	$\frac{3}{4}$	$1\frac{1}{2}$
$2 \times 1\frac{1}{2} \times 2$	$3\frac{1}{32}$	$3\frac{1}{8}$	$2\frac{3}{8}$	$1\frac{1}{4}$	2	$1\frac{1}{8}$
$2 \times 1\frac{1}{2} \times 1\frac{1}{2}$	$2\frac{1}{8}$	$2\frac{1}{2}$	$2\frac{1}{8}$	$1\frac{1}{32}$	$1\frac{1}{8}$	$1\frac{1}{2}$
$2 \times 1\frac{1}{2} \times 1\frac{1}{4}$	$2\frac{1}{16}$	$2\frac{1}{4}$	$2\frac{1}{8}$	$1\frac{1}{32}$	$1\frac{1}{8}$	$1\frac{1}{16}$
$2 \times 1\frac{1}{2} \times 1$	$2\frac{1}{8}$	$2\frac{1}{8}$	$2\frac{9}{16}$	$1\frac{1}{32}$	$1\frac{1}{2}$	$1\frac{1}{16}$
$2 \times 1\frac{1}{4} \times 1\frac{1}{4}$	$2\frac{1}{16}$	$2\frac{1}{8}$	$2\frac{1}{8}$	$1\frac{1}{16}$	$1\frac{1}{4}$	$1\frac{1}{8}$
$2 \times 1 \times 2$	3	$3\frac{1}{16}$	$2\frac{3}{8}$	$1\frac{3}{8}$	$2\frac{1}{8}$	$1\frac{1}{8}$
$2\frac{1}{2} \times 2\frac{1}{2} \times 2\frac{1}{2}$	$3\frac{1}{8}$	$3\frac{1}{8}$	$3\frac{1}{2}$	$2\frac{1}{16}$	$2\frac{1}{16}$	$2\frac{1}{16}$
$3 \times 3 \times 3$	$4\frac{1}{32}$	$4\frac{1}{32}$	$4\frac{1}{32}$	$2\frac{1}{8}$	$2\frac{1}{8}$	$2\frac{1}{8}$

RADIANT HEATING

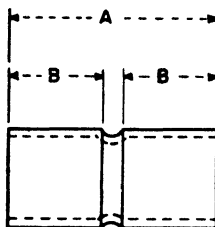

Wrought coupling.

Nominal size, in.	A	B
$\frac{1}{8}$	1	$\frac{11}{8}$
$\frac{1}{4}$	$1\frac{1}{4}$	$\frac{3}{2}$
$\frac{3}{8}$	$1\frac{1}{2}$	$\frac{5}{8}$
$\frac{1}{2}$	$1\frac{3}{8}$	$\frac{3}{4}$
$\frac{5}{8}$	$1\frac{5}{8}$	$\frac{3}{4}$
$\frac{3}{4}$	$1\frac{7}{8}$	$\frac{7}{8}$
$\frac{7}{8}$	2	$1\frac{1}{8}$
1	$2\frac{1}{8}$	1
$1\frac{1}{4}$	$2\frac{5}{16}$	$1\frac{1}{16}$
$1\frac{1}{2}$	$2\frac{7}{16}$	$1\frac{1}{8}$
2	$2\frac{13}{16}$	$1\frac{3}{16}$
$2\frac{1}{2}$	$3\frac{1}{8}$	$1\frac{7}{16}$
3	$3\frac{1}{2}$	$1\frac{3}{8}$

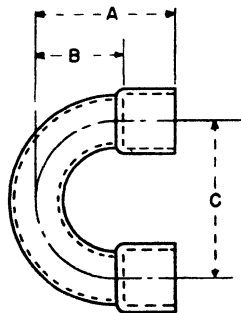

Return bend.

Nominal size	Wrought			Cast		
	A	B	C	A	B	C
$\frac{1}{4}$	1	$\frac{5}{8}$	$1\frac{1}{4}$			
$\frac{3}{8}$	$1\frac{1}{4}$	$\frac{3}{4}$	$1\frac{3}{8}$	$1\frac{1}{4}$	$\frac{3}{4}$	1
$\frac{1}{2}$	$1\frac{9}{16}$	$1\frac{1}{8}$	$1\frac{1}{2}$	$1\frac{1}{4}$	$\frac{5}{8}$	$1\frac{1}{2}$
$\frac{5}{8}$	$1\frac{7}{8}$	$1\frac{1}{8}$	$2\frac{1}{8}$			
$\frac{3}{4}$	$2\frac{1}{8}$	$1\frac{1}{4}$	$2\frac{3}{8}$	$1\frac{11}{8}$	1	$1\frac{1}{2}$
1	$2\frac{1}{2}$	$1\frac{1}{2}$	$2\frac{7}{8}$	$2\frac{1}{8}$	$1\frac{1}{16}$	$1\frac{3}{4}$
$1\frac{1}{4}$	$3\frac{1}{4}$	$2\frac{1}{16}$	4	$2\frac{3}{8}$	$1\frac{1}{2}$	2
$1\frac{1}{2}$	$3\frac{1}{16}$	$2\frac{1}{16}$	$4\frac{1}{2}$	$2\frac{11}{16}$	$1\frac{1}{2}$	$2\frac{1}{2}$
2	$3\frac{11}{16}$	$2\frac{1}{2}$	$5\frac{1}{2}$	$3\frac{1}{4}$	$1\frac{3}{4}$	3

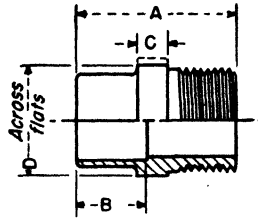

Wrough male adapter.

Nominal size, in.	A	B	C	D
$\frac{1}{8}$ C \times $\frac{1}{4}$ IPS	1	$\frac{5}{16}$	$\frac{1}{4}$	$\frac{9}{16}$
$\frac{1}{8}$ C \times $\frac{1}{8}$ IPS	$\frac{3}{4}$	$\frac{5}{16}$	$\frac{3}{16}$	$\frac{7}{16}$
$\frac{1}{4}$ C \times $\frac{3}{4}$ IPS	1	$\frac{3}{8}$	$\frac{1}{4}$	$\frac{11}{16}$
$\frac{1}{4}$ C \times $\frac{1}{4}$ IPS	$\frac{15}{16}$	$\frac{3}{8}$	$\frac{1}{4}$	$\frac{9}{16}$
$\frac{1}{4}$ C \times $\frac{1}{8}$ IPS	$\frac{13}{16}$	$\frac{3}{8}$	$\frac{3}{16}$	$\frac{1}{2}$
$\frac{3}{8}$ C \times $\frac{3}{4}$ IPS	$1\frac{1}{4}$	$\frac{1}{2}$	$\frac{5}{16}$	$1\frac{1}{16}$
$\frac{3}{8}$ C \times $\frac{1}{2}$ IPS	$1\frac{1}{4}$	$\frac{1}{2}$	$\frac{5}{16}$	$\frac{7}{8}$
$\frac{3}{8}$ C \times $\frac{3}{8}$ IPS	$1\frac{1}{8}$	$\frac{1}{2}$	$\frac{1}{4}$	$\frac{11}{16}$
$\frac{3}{8}$ C \times $\frac{1}{4}$ IPS	$1\frac{3}{4}$	$\frac{1}{2}$	$\frac{1}{4}$	$\frac{5}{8}$
$\frac{1}{2}$ C \times 1 IPS	$1\frac{3}{4}$	$\frac{5}{8}$	$\frac{3}{8}$	$1\frac{3}{8}$
$\frac{1}{2}$ C \times $\frac{3}{4}$ IPS	$1\frac{1}{2}$	$\frac{5}{8}$	$\frac{5}{16}$	$1\frac{1}{16}$
$\frac{1}{2}$ C \times $\frac{1}{2}$ IPS	$1\frac{3}{4}$	$\frac{5}{8}$	$\frac{5}{16}$	$\frac{7}{8}$
$\frac{1}{2}$ C \times $\frac{3}{8}$ IPS	$1\frac{9}{16}$	$\frac{5}{8}$		
$\frac{1}{2}$ C \times $\frac{1}{4}$ IPS	$1\frac{1}{4}$	$\frac{5}{8}$	$\frac{3}{8}$	$\frac{3}{4}$
$\frac{5}{8}$ C \times 1 IPS	$1\frac{11}{16}$	$\frac{3}{4}$	$\frac{3}{8}$	$1\frac{3}{8}$
$\frac{5}{8}$ C \times $\frac{3}{4}$ IPS	$1\frac{7}{8}$	$\frac{3}{4}$	$\frac{3}{8}$	$1\frac{1}{8}$
$\frac{5}{8}$ C \times $\frac{1}{2}$ IPS	$1\frac{7}{16}$	$\frac{3}{4}$	$\frac{5}{16}$	$\frac{11}{16}$
$\frac{3}{4}$ C \times 1 IPS	$1\frac{7}{16}$	$\frac{7}{8}$	$\frac{7}{8}$	$1\frac{1}{16}$
$\frac{3}{4}$ C \times $\frac{3}{4}$ IPS	$1\frac{3}{4}$	$\frac{7}{8}$	$\frac{5}{16}$	$1\frac{1}{16}$
$\frac{3}{4}$ C \times $\frac{1}{2}$ IPS	$1\frac{11}{16}$	$\frac{7}{8}$	$\frac{5}{16}$	1
$\frac{3}{4}$ C \times $\frac{3}{8}$ IPS	$1\frac{9}{16}$	$\frac{7}{8}$	$\frac{5}{16}$	1
$\frac{7}{8}$ C \times 1 IPS	2	$1\frac{1}{16}$	$\frac{7}{8}$	$1\frac{3}{8}$
1 C \times $1\frac{1}{2}$ IPS	$2\frac{5}{16}$	1	$\frac{7}{16}$	$1\frac{11}{16}$
1 C \times $1\frac{1}{4}$ IPS	$2\frac{1}{16}$	1	$\frac{7}{16}$	$1\frac{11}{16}$
1 C \times 1 IPS	$2\frac{1}{16}$	1	$\frac{3}{8}$	$1\frac{3}{8}$
1 C \times $\frac{3}{4}$ IPS	$1\frac{11}{16}$	1	$\frac{3}{8}$	$1\frac{5}{16}$
1 C \times $\frac{1}{2}$ IPS	$1\frac{11}{16}$	1	$\frac{3}{8}$	$1\frac{1}{16}$
$1\frac{1}{4}$ C \times $1\frac{1}{2}$ IPS	$2\frac{3}{8}$	$1\frac{1}{16}$	$\frac{7}{16}$	$1\frac{11}{16}$
$1\frac{1}{4}$ C \times $1\frac{1}{4}$ IPS	$2\frac{3}{16}$	$1\frac{1}{16}$	$\frac{3}{8}$	$1\frac{11}{16}$
$1\frac{1}{4}$ C \times 1 IPS	$2\frac{1}{16}$	$1\frac{1}{16}$	$\frac{3}{8}$	$1\frac{1}{16}$
$1\frac{1}{4}$ C \times $\frac{3}{4}$ IPS	$2\frac{1}{16}$	$1\frac{1}{16}$	$\frac{3}{8}$	$1\frac{1}{16}$
$1\frac{1}{4}$ C \times $1\frac{1}{2}$ IPS	$2\frac{5}{16}$	$1\frac{1}{8}$	$\frac{7}{16}$	$1\frac{11}{16}$
$1\frac{1}{4}$ C \times $1\frac{1}{4}$ IPS	$2\frac{1}{16}$	$1\frac{1}{8}$	$\frac{7}{16}$	$1\frac{11}{16}$
$1\frac{1}{4}$ C \times 1 IPS	$2\frac{1}{16}$	$1\frac{1}{8}$	$\frac{7}{16}$	$1\frac{11}{16}$
2 C \times 2 IPS	$2\frac{9}{16}$	$1\frac{3}{16}$	$\frac{3}{8}$	$2\frac{1}{16}$
2 C \times $1\frac{1}{2}$ IPS	$2\frac{3}{8}$	$1\frac{1}{16}$	$\frac{7}{16}$	$2\frac{1}{16}$
2 C \times $1\frac{1}{4}$ IPS	$2\frac{9}{16}$	$1\frac{5}{16}$	$\frac{7}{16}$	$2\frac{5}{16}$
$2\frac{1}{4}$ C \times $2\frac{1}{4}$ IPS	3	$1\frac{1}{16}$	$\frac{9}{16}$	3*
3 C \times 3 IPS	$3\frac{5}{16}$	$1\frac{1}{8}$	$\frac{3}{8}$	$3\frac{1}{16}$ *

* These dimensions across flats are octagon, all the rest are hexagon.

RADIANT HEATING

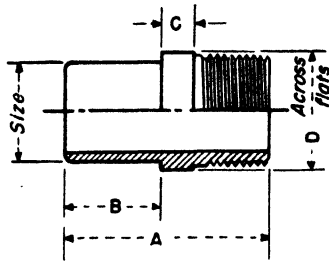

Wrought male strut adapter.

Nominal size, in.	A	B	C	D*
$\frac{3}{4}C \times \frac{3}{4}IPS$	$1\frac{3}{8}$	$1\frac{3}{8}$	$\frac{1}{4}$	$1\frac{11}{16}$
$\frac{1}{2}C \times \frac{1}{2}IPS$	$1\frac{1}{4}$	$\frac{3}{4}$	$\frac{5}{16}$	$\frac{7}{8}$
$\frac{3}{4}C \times \frac{3}{4}IPS$	$2\frac{1}{16}$	1	$\frac{5}{16}$	$1\frac{1}{16}$
1 C × 1 IPS	$2\frac{3}{8}$	$1\frac{1}{8}$	$\frac{3}{8}$	$1\frac{3}{8}$
$1\frac{1}{4}C \times 1\frac{1}{4}IPS$	$2\frac{5}{8}$	$1\frac{3}{16}$	$\frac{7}{16}$	$1\frac{11}{16}$
$1\frac{1}{2}C \times 1\frac{1}{2}IPS$	$2\frac{11}{16}$	$1\frac{1}{4}$	$\frac{7}{16}$	$1\frac{13}{16}$

* Across flats of hexagon.

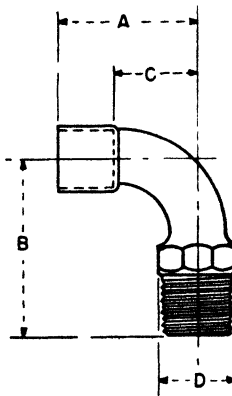

Wrought 90-deg. male elbow.

Nominal size, in.	A	B	C	D*
$\frac{3}{4}C \times \frac{3}{4}IPS$	$1\frac{1}{4}$	$1\frac{9}{16}$	$\frac{3}{8}$	$1\frac{1}{8}$
$\frac{1}{2}C \times \frac{1}{2}IPS$	$1\frac{5}{16}$	2	$1\frac{1}{8}$	$\frac{7}{8}$
$\frac{3}{4}C \times \frac{3}{4}IPS$	$2\frac{5}{8}$	$2\frac{5}{16}$	$1\frac{1}{4}$	$1\frac{1}{8}$
1 C × 1 IPS	$2\frac{1}{2}$	$2\frac{1}{4}$	$1\frac{1}{2}$	$1\frac{1}{4}$

* Across flats of octagon.

10. BRONZE GLOBE, ANGLE, AND CROSS VALVES

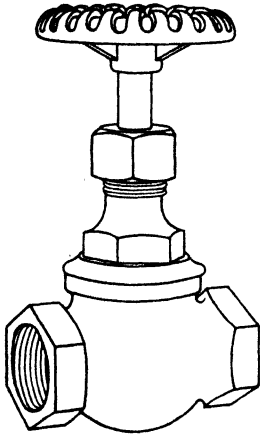

Screwed globe valve.

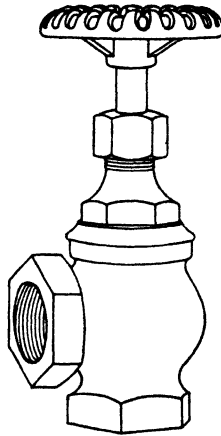

Screwed angle valve.

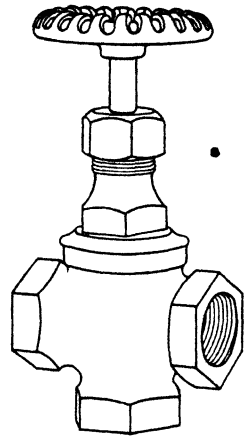

Screwed cross valve.

DIMENSIONS, IN.

Size	$\frac{1}{8}$	$\frac{1}{4}$	$\frac{3}{8}$	$\frac{1}{2}$	$\frac{3}{4}$	1	$1\frac{1}{4}$	$1\frac{1}{2}$	2	$2\frac{1}{2}$	3
End to end, globe.....	$1\frac{2}{16}$	$1\frac{11}{16}$	2	$2\frac{1}{2}$	$3\frac{1}{16}$	$3\frac{11}{16}$	$4\frac{1}{4}$	$4\frac{11}{16}$	$5\frac{11}{16}$	$6\frac{7}{16}$	$7\frac{5}{16}$
Center to end, angle and cross.....		$\frac{11}{16}$	$1\frac{1}{32}$	$1\frac{7}{16}$	$1\frac{5}{8}$	$1\frac{11}{16}$	$2\frac{3}{16}$	$2\frac{1}{2}$	$2\frac{11}{16}$	$3\frac{1}{4}$	$3\frac{7}{8}$
Center to top, globe, open.....	$2\frac{1}{8}$	$3\frac{1}{32}$	$3\frac{1}{2}$	$4\frac{1}{8}$	$5\frac{1}{2}$	$5\frac{3}{4}$	$6\frac{3}{4}$	$7\frac{7}{16}$	$8\frac{1}{2}$	$9\frac{1}{2}$	$10\frac{1}{4}$
Center to top, angle and cross, open.....		$3\frac{1}{16}$	$3\frac{7}{32}$	$4\frac{9}{16}$	$5\frac{11}{16}$	$6\frac{1}{2}$	$7\frac{3}{32}$	$7\frac{3}{4}$	$9\frac{3}{16}$	$10\frac{1}{2}$	$11\frac{1}{4}$
Diameter of handwheel.....	$1\frac{1}{2}$	$1\frac{3}{4}$	2	$2\frac{1}{2}$	$2\frac{7}{8}$	3	$3\frac{1}{2}$	4	$4\frac{1}{2}$	$5\frac{1}{4}$	$6\frac{1}{2}$

RADIANT HEATING

Bronze Gate Valves
Nonrising Stem, Solid Wedge, Taper Seat

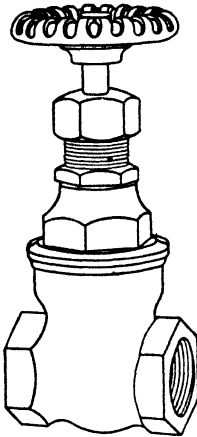

Screwed gate valve.

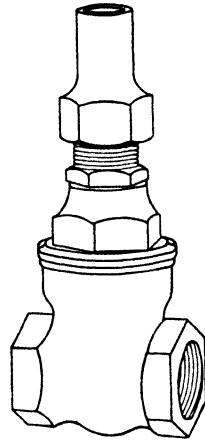

Screwed-lock gate valve.

DIMENSIONS, IN.

Size	$\frac{1}{4}$	$\frac{3}{8}$	$\frac{1}{2}$	$\frac{3}{4}$	1	$1\frac{1}{4}$	$1\frac{1}{2}$	2	$2\frac{1}{2}$	3
End to end.....	$1\frac{3}{4}$	$1\frac{7}{8}$	$2\frac{3}{16}$	$2\frac{3}{8}$	$2\frac{3}{4}$	$3\frac{1}{8}$	$3\frac{1}{2}$	$4\frac{1}{8}$	$4\frac{1}{2}$	5
Center to top of wheel.....	$3\frac{3}{4}$	$3\frac{3}{4}$	$4\frac{7}{16}$	$5\frac{1}{16}$	$5\frac{7}{8}$	$6\frac{5}{8}$	$7\frac{1}{4}$	$8\frac{5}{8}$	$10\frac{1}{16}$	$11\frac{1}{4}$
Center to top of lock shield.....	$3\frac{11}{16}$	$3\frac{11}{16}$	$4\frac{9}{16}$	$5\frac{5}{16}$	$6\frac{1}{4}$	$6\frac{7}{8}$	$7\frac{7}{8}$	$8\frac{13}{16}$	$10\frac{7}{16}$	$11\frac{11}{16}$
Diameter of handwheel.....	$1\frac{3}{4}$	$1\frac{3}{4}$	$2\frac{1}{8}$	$2\frac{1}{4}$	$2\frac{5}{8}$	3	$3\frac{1}{2}$	4	$4\frac{1}{2}$	5

11. "HITENSIL" GLOBE AND ANGLE VALVES

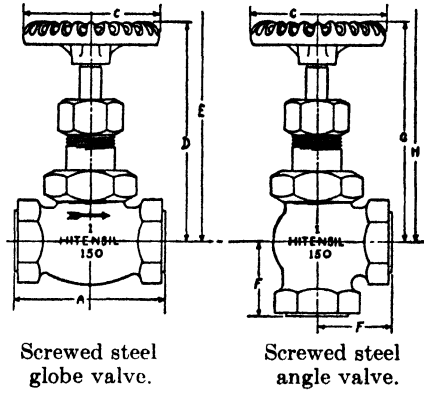

DIMENSIONS, IN.

Size	$\frac{1}{4}$	$\frac{3}{8}$	$\frac{1}{2}$	$\frac{3}{4}$	1	$1\frac{1}{4}$	$1\frac{1}{2}$	2
A	$2\frac{3}{8}$	$2\frac{3}{8}$	$2\frac{7}{8}$	$3\frac{3}{8}$	$3\frac{11}{16}$	$4\frac{1}{2}$	$5\frac{1}{16}$	$6\frac{1}{8}$
C	$2\frac{1}{2}$	$2\frac{1}{2}$	$2\frac{5}{8}$	3	$3\frac{1}{2}$	4	$4\frac{1}{2}$	5
D	$4\frac{9}{16}$	$4\frac{9}{16}$	$4\frac{7}{8}$	$5\frac{1}{2}$	$5\frac{3}{8}$	$6\frac{1}{8}$	$7\frac{1}{16}$	$8\frac{5}{16}$
E	$4\frac{1}{8}$	$4\frac{1}{8}$	$5\frac{5}{32}$	$5\frac{1}{8}$	$6\frac{1}{4}$	$6\frac{1}{8}$	$7\frac{1}{8}$	$8\frac{3}{8}$
F	$1\frac{9}{32}$	$1\frac{9}{32}$	$1\frac{3}{8}$	$1\frac{7}{8}$	$1\frac{7}{8}$	$2\frac{3}{8}$	$2\frac{1}{16}$	$2\frac{7}{8}$
G	$4\frac{9}{16}$	$4\frac{9}{16}$	$4\frac{7}{8}$	$5\frac{1}{2}$	$5\frac{3}{8}$	$6\frac{1}{8}$	$7\frac{1}{8}$	$8\frac{3}{8}$
H	$4\frac{1}{8}$	$4\frac{1}{8}$	$5\frac{5}{32}$	$5\frac{1}{8}$	$6\frac{1}{4}$	$6\frac{3}{8}$	$7\frac{1}{8}$	$8\frac{1}{8}$

12. Iron Body Globe, Angle, and Cross Valves

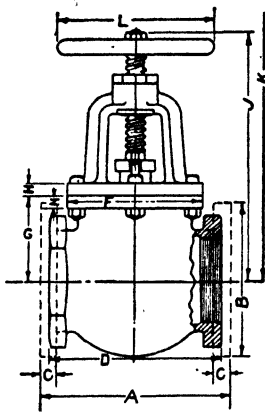

Large iron globe valve.

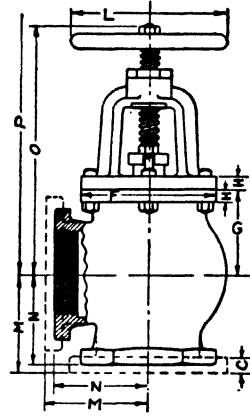

Large iron angle valve.

DIMENSIONS, IN.*

Size	2	2½	3	3½	4	5	6	8	10	12
A, face to face, globe and cross, flanged	8	8½	9½	10½	11½	13	14	19½	22½	25½
B, diameter of end flanges	6	7	7½	8½	9	10	11	13½	16	19
C, thickness of end flanges	⅝	⅞	¾	⅞	1⅛	1⅜	1	1½	1⅞	1¼
D, end to end, globe, screwed	6¾	7⅞	9	10	10¾	12	14	17¼	21¼	25
end to end, cross, screwed	6¾	8½	9¼	9¾	10½	12	14			
F, diameter of body and bonnet flange	5⅝	6	7	7½	8⅞	9⅞	11⅞	13¾	16½	19¼
G, center to top of body flange	3⅞	3⅞	3½	3⅞	4½	5⅞	6	8⅞	9⅞	11¼
H, thickness of body and bonnet flange	⅝	⅞	⅞	¾	¾	7⁄8	1⅞	1	1⅞	1⅞
J, center to top of stem, globe, closed	9⅞	10⅞	11	11⅞	13⅞	15⅞	17⅞	21⅞	28⅞	31
K, center to top of stem, globe, open	10⅞	11⅞	12¼	13⅞	15⅞	17⅞	19⅞	24⅞	31	34¼
L, diameter of handwheel	6½	6½	7½	7½	9	10	12	14	20	22
M, center to face, angle and cross, flanged	4	4¼	4¾	5¼	5¾	6½	7	9¼	11¼	12¾
N, center to end, angle and cross, screwed	3¾	4¼	4¾	4¾	5¼	6	7	8⅞	10⅞	12¾
O, center to top of stem, angle and cross, closed	9⅞	10⅞	11	11⅞	13⅞	15⅞	17⅞	21⅞	27	29¾
P, center to top of stem, angle and cross, open	10¾	11⅞	12¾	13⅞	15½	17⅞	19¾	25⅞	31⅞	34¾
Diameter of bolt circle on end flanges	4¼	5½	6	7	7½	8½	9½	11¼	14¼	17
Diameter of bolt holes in end flanges	¾	¾	¾	¾	¾	7⁄8	7⁄8	1	1	1
Number of bolt holes in end flanges	4	4	4	8	8	8	8	8	12	12

* Cross valves not made above 6-in. size.

13. NAMES OF PARTS
Bronze globe, angle and cross valves

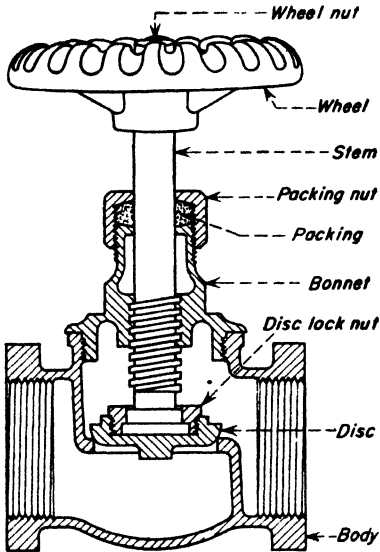

Parts of globe valve.

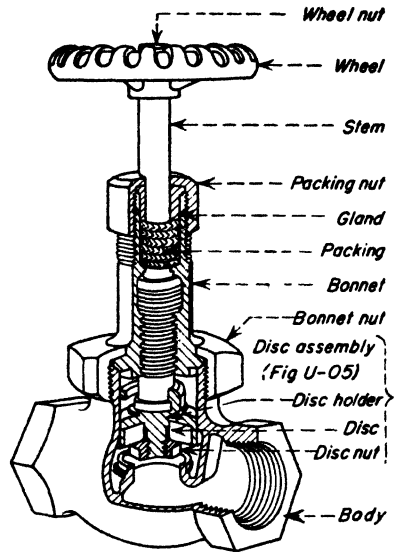

Parts of globe valve with composition disc.

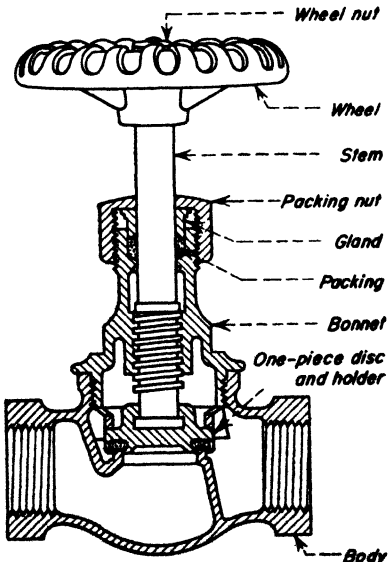

Parts of screwed-bonnet globe valve.

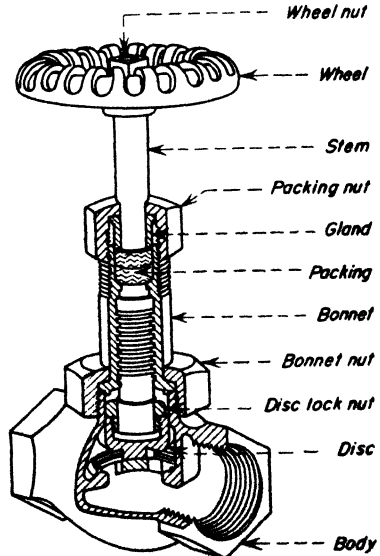

Parts of globe valve with regrinding bronze disc.

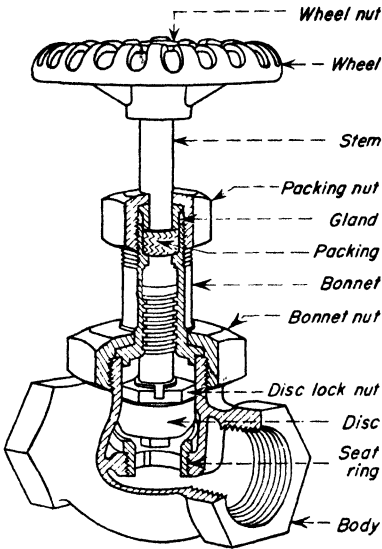

Parts of globe valve with renewable seat and disc.

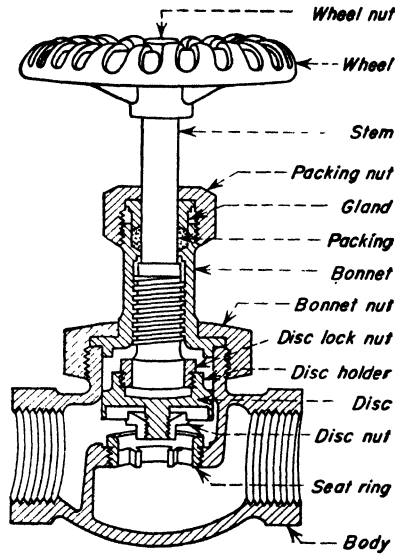

Parts of globe valve with composition disc and bronze seat.

Bronze gate valves

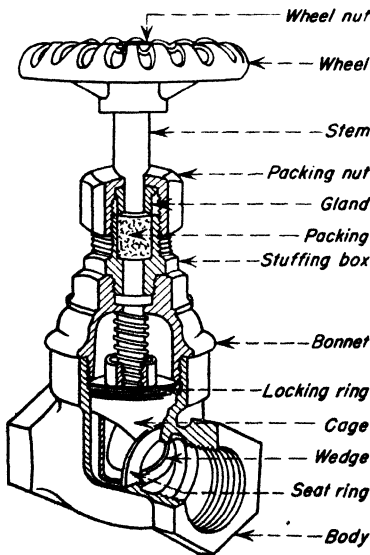

Parts of nonrising-stem gate valve.

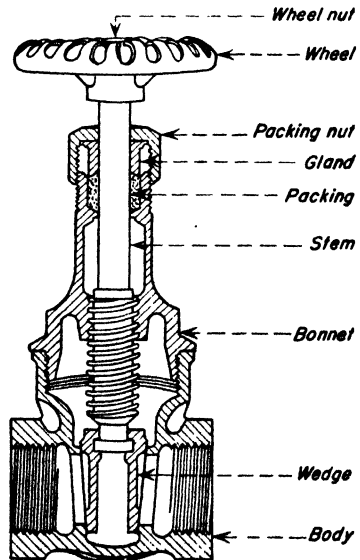

Parts of rising-stem gate valve.

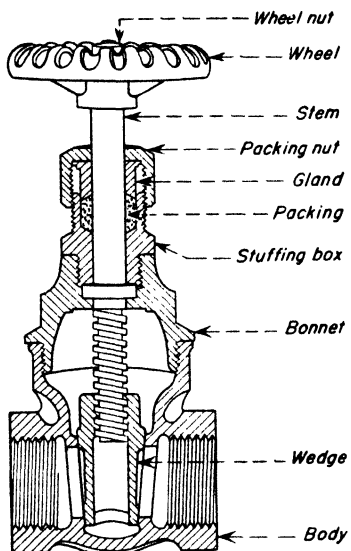

Parts of nonrising-stem gate valve.

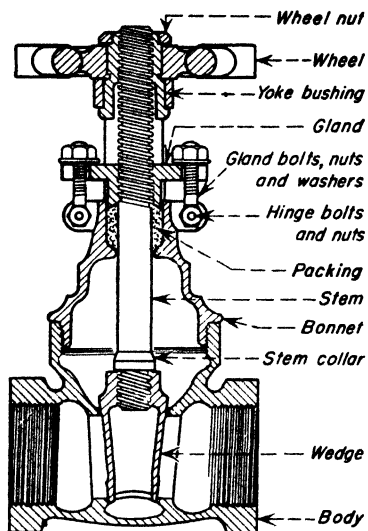

Parts of outside screw and yoke gate valve.

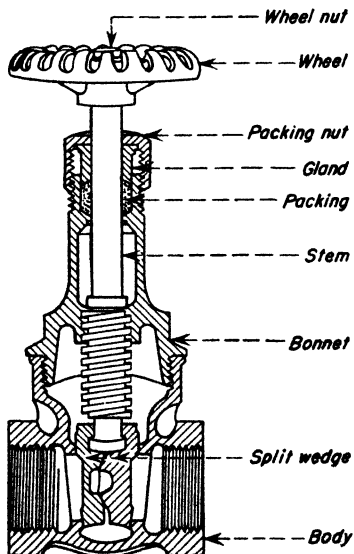

Parts of gate valve having split wedge.

14. PROCEDURE TO FOLLOW IN DESIGNING A RADIANT HEATING INSTALLATION

1. List all rooms with designations 1, 2, 3, etc.
2. Decide on required room temperature for radiant heating; 65° is appropriate.
3. Decide on a practical value for minimum outdoor temperature as a basis for computing heat loss in conjunction with Item 2. Many publications give U. S. Weather Bureau figures for minimum temperatures in various localities, but it is not necessary to give these minimums full value. The designed minimum can be selected at a somewhat higher figure as experience dictates. A suggested method of determining minimum design temperature is to add to Weather Bureau minimums 0.15 of 1 per cent of the published figures for degree days for the locality in question and use the resulting figure for design minimum.
4. Calculate Btu losses for each room by conventional methods and tabulate.
5. Reduce to Btu per square foot panel area.
6. Decide on coil location, ceiling or floor. Consider wall installations only in exceptional cases.
7. Determine panel temperatures to suit requirements.
8. Determine Btu transmission to other areas and include such transmitted values in design where appropriate.
9. Determine total Btu input to area.
10. Calculate pipe or tube size, spacing, and footage.
11. Select suitable circulating water temperature drop.
12. Obtain pounds of circulating water required for each area.
13. Check Item 10 to see that excessive pressure drops are not present in coil design and record pressure drop each area.
14. Select pipe sizes for distribution branches if any and record pressure drops. Include pressure drop through pipe fittings.
15. Select pipe sizes for mains; record pressure drops including fittings, valves, and control devices.
16. Determine total pressure drops, being sum of maximum value of one item in Steps 13, 14, and 15. Add 15 per cent factor of safety.
17. Determine total G.P.M. in circulation.
18. Select proper size circulator to deliver item 17 against head determined in item 16.
19. Specify motor required volts, phase, and cycles, the latter usually 60.

LIST OF SYMBOLS

<i>Symbol</i>	<i>Dimension</i>	<i>Definition</i>
A_i sq ft	m ²	Area of surface i
A_h sq ft	m ²	Area of heating panel
A_d sq ft	m ²	Dissipating area, an area of same size and heat loss as outside wail and glass combined
A_n sq ft	m ²	Neutral area, the combined areas of all "nonheating and nondissipating" walls
ΣA sq ft	m ²	Sum of all room enclosures
A_B sq ft	m ²	Surface of human body
a in.	cm	Depth of bury of tubes or distance tube center line—panel surface
A in.	cm	Total depth of equivalent panel, including the boundary layer
b in.	cm	"Opposite depth" of panel or distance tube center line—opposite panel surface
B in.	cm	Total "opposite depth" of panel including the "opposite" boundary layer
$a + b$ in.	cm	Panel thickness
$A + B$ in.	cm	Total thickness of equivalent panel
C Btu/(hr)(sq ft)(°F)	Cal/(hr)(m ²)(°C)	Conductance, $C = x/k$
C_r Btu/(hr)(sq ft) $\left(\frac{^\circ K}{100}\right)^4$	Cal/(hr)(m ²) $\left(\frac{^\circ K}{100}\right)^4$	Emissivity constant
C_h Btu per hr	Cal per hr	Heat transfer through convection by area h
c_p Btu/(°F)(cu ft)	Cal/(°C)(m ³)	Specific heat of air
CT °F	°C	Comfort temperature
d in.	cm	Distance between tubes
E 1	1	A correcting coefficient for A
f Btu/(hr)(sq ft)(°F)	Cal/(hr)(m ²)(°C)	Heat-transfer coefficient
f_i Btu/(hr)(sq ft)(°F)	Cal/(hr)(m ²)(°C)	Film conductance or surface-transfer coefficient from wall to room
f_o Btu/(hr)(sq ft)(°F)	Cal/(hr)(m ²)(°C)	Surface-transfer coefficient from wall to "outside" air (film conductance)
$F_{\theta,i}$ 1	1	Form factor—a factor giving the ratio of the energy radiated from body g to body j

Symbol		Dimension	Definition
			over the total energy radiated by body <i>g</i> to a space of temperature of the body <i>j</i>
$F_{B,i}$	1		The shape factor giving the ratio of energy radiated from the human body to surface <i>g</i> over the total energy emitted by the body to a space of same temperature as surface <i>g</i>
<i>j</i>			Number of hourly air changes of room
<i>k</i>	Btu/(hr)(sq ft)(°F/in.)	Cal/(hr)(m ²)(°C/cm)	Conductivity (or conductance per in. thickness)
MET			Mean equivalent temperature (see <i>t₂</i>)
MRT	°F	°C	Mean radiant temperature; the mean temperature of all enclosing surfaces of room or area
MRT (unheated)			(see <i>t₂</i>)
<i>r</i>	—	—	Symbolizing the resistance against the heat flow, $r = 1/C$
$2r$	in.	cm	Outside tube diameter
$R_{o,j}$	Btu per hr	Cal per hr	Radiation heat flow from <i>g</i> to <i>j</i>
<i>Q</i>	Btu per hr	Cal per hr	Total heat flow or heat transfer
Q_1	Btu/(hr)(sq ft)	Cal/(hr)(m ²)	Total heat flow per 1 sq ft of area
<i>t</i>	°F	°C	Symbol for temperature in general or a mean of air temperature and unheated MRT
			$t = (t_a + t_2)/2$
<i>t_o</i>	°F	°C	Outside air temperature
<i>t_a</i>	°F	°C	Room air temperature
<i>t_h</i>	°F	°C	Mean surface temperature of heating panel
<i>t_b</i>	°F	°C	Mean surface temperature of opposite panel side
<i>t_d</i>	°F	°C	The "dissipating" temperature that is the mean temperature of all surfaces, transmitting heat out of the room
<i>t_n</i>	°F	°C	The neutral temperature, or the mean radiant temperature of all walls that neither generate nor dissipate heat
<i>t_B</i>	°F	°C	Average surface temperature of human body

<i>Symbol</i>		<i>Dimension</i>	<i>Definition</i>
t_2	$^{\circ}\text{F}$	$^{\circ}\text{C}$	The mean surface temperature of all unheated room enclosures
Δt	$^{\circ}\text{F}$	$^{\circ}\text{C}$	A difference of two temperatures
T	$^{\circ}\text{K}$	$^{\circ}\text{K}$	Temperature measured in centigrade above absolute zero point
U	$\text{Btu}/(\text{hr})(\text{sq ft})(^{\circ}\text{F})$	$\text{Cal}/(\text{hr})(\text{m}^2)(^{\circ}\text{F})$	Over-all heat-transfer coefficient through a wall $U = 1/f_i + \Sigma(x/k) + 1/f_o$
V	cu ft	m^3	Volume of room
x	—	—	Abscissa of coordinate system
x	in.	cm	Thickness of one layer of material
α	$\text{Btu}/(\text{hr})(\text{sq ft})(^{\circ}\text{F})$	$\text{Cal}/(\text{hr})(\text{m}^2)(^{\circ}\text{C})$	Radiation-transfer coefficient
$\beta_{c,w,f}$	$\text{Btu}/(\text{hr})(\text{sq ft})(^{\circ}\text{F})$	$\text{Cal}/(\text{hr})(\text{m}^2)(^{\circ}\text{C})$	Convection-transfer coefficient for ceiling, wall, and floor
Λ	$\text{Btu}/(\text{hr})(\text{sq ft})(^{\circ}\text{F})$	$\text{Cal}/(\text{hr})(\text{m}^2)(^{\circ}\text{C})$	A conduction coefficient
ζ	—	$(^{\circ}\text{K})^4/^{\circ}\text{C}$	A conversion factor
ρ	—	—	Film resistance, $\rho = 1/f$
σ	$\text{Btu}/(\text{hr})(\text{sq ft}) \left(\frac{^{\circ}\text{K}}{100}\right)^4$	$\text{Cal}/(\text{hr})(\text{m}^2) \left(\frac{^{\circ}\text{K}}{100}\right)^4$	Absolute emissivity
sinh, cosh			Hyperbolic sin and cos
$z = f(x,y)$ or $\Theta(x,y)$			Symbolizing z as a function of the variables x and y
Re			A symbol designating the real part of a function
Im			A symbol designating the imaginary part of a function
ln			Natural logarithm
i			$\sqrt{-1}$

INDEX

A

- Absorbivity, low, space of, 252
- Acoustical plaster, 39
- Advantages of radiant heating, 12-32
 - cleanliness, 20
 - constructional advantages, 21, 22, 53
 - decorative freedom, 18, 19
 - elimination of basement, 25
 - for fire houses, 31
 - fuel savings, 23, 24
 - for garages, 29
 - health, 21
 - for hospitals, 27
 - for old buildings, 23-27
 - for prisons, 55, 56
 - space saving, 17, 18
- Air-charger valve, 116
- Air crowns, 199
- Air currents, from convectors, 12
 - from radiators, 13
- Air elimination, 44
 - by purging valves, 45
 - suitable water velocities for, 199
- Air trap, 117, 199
- Air valve, 116
- Air vents, 165
- Airplane hangar installation, 46
- Anticipatory control, 122
- Apartment buildings, 47, 48, 54
- Aquastat, 119
- Automatic reset controller, 137, 140
- Auxiliary devices, 111-117

B

- Balancing of heat delivery, 36-115, 169
 - from grid-type coils, 187
 - for large areas, 187
- Bathrooms, 58
- Bell & Gossett Co., 107-109, 116, 117
- Bethlehem Steel Co., 40, 49, 59, 66, 72,
211, 212, 217, 218, 220
- Body, 1-4
 - as heat engine, 1
 - heat developed by, 2

- Body, temperature control by, 3
 - temperature corrective action by, 4
- Boilers, 76-95
 - cast-iron, 79-89
 - advantages of, 80
 - disadvantages of, 81
 - encased, 83
 - header type, 84, 85
 - life of, 80
 - sizes of, 80
 - types of, 81-88
 - universal type, 83-86
 - copper coil, Burkay, 96
 - efficiency of, 77
 - gas-fired, 87, 96
 - oil-fired, 88, 93-96
 - packaged (assembled), 81, 84, 88, 93,
96
 - ratings of, 76
 - steel, 91-95
 - for air heating, 93, 95
 - packaged type, 92-95
 - Timken, 88-91
 - ratings of, 89
 - water bottom, 92
- Bundy Tubing Co., 185
- Bundyweld tubing, 50, 54, 212, 213, 279
- Burkay heaters, 96, 216
- Byers, A. M., Co., 40, 46, 49, 51, 52, 59,
61, 62, 69-71, 151-153, 216, 217

C

- Carbon dioxide, proper values of, 77, 78
- Ceiling heat output, 155, 156, 175
- Ceiling installations, advantages of, in
residences, 57
 - for arched ceilings, 63
 - concrete and hollow tile, 206
 - effect on room above, 57
 - for hospital, 52, 55
 - for office lobby, 50, 54
 - omission of ceiling insulation in, 160
 - in insulating board, 48
 - plastering of, 195, 196, 210
 - with subceiling, 206

- Ceiling installations, use of hard-drawn copper in, 60, 61
 on wood frame and metal lath, 207
- Cooling temperatures, 161
- Chase Brass & Copper Co., 154-161
 design procedure of, 155
- Children's play rooms, 58
- Chimney, moisture in, 78
- Churches, 51, 52, 55
- Circulators, capacity of, 108, 109, 111
 determination of size of, 164
 high-head, 108, 109
 horizontal, 107
 vertical, 110
- Coils, bending of, 193, 194, 200, 209, 210
 radius of bends, 194
 construction, close spacing, 216, 217, 220
 for domed ceiling, 221
 group spacing, 218
 savings effected by, 219
 forming of, 208-210
 types of, 186
- Combination office and apartment building, 47, 48
- Comfort, definition of, 1
 from radiant heating systems, 12
- Commercial buildings, 54, 55
- Comparison of sizes, copper tube and iron pipe, 279
- Compression tank, 117
- Control problems, 122-124
- Control systems, Hoffman Specialty, 142-145
 Johnson Service, 129-137
 Minneapolis-Honeywell, 137-142
 Sarcotherm, 124-129
- Controller, automatic reset, 137, 140
- Controls, 119-145
 "off and on," 120, 122
 outdoor, 139
 outdoor-indoor, 124-145
 supply water temperature, 138
 temperature control, necessity of, 119
 zone controls, 117-118, 130-138
- Cooling, evaporative, 227, 229
 with radiant installations, 224-238
 distinguished from air conditioning, 224
 limitations of, 226
- Cooling with radiant installations, localities suitable for, 225
 method of design, 226, 230-235
 sources of cooling water for, 227-229
- Cooling tower, 232
 design details of, 233
- Copper tubing, 184, 185, 196, 197, 201, 202, 209, 210
 precautions in using, 197, 201
 sizes of, compared with iron pipe, 279
 specifications for, 196
 standard sizes of, 278
- Correct design, importance of, 223
- Corrosion, 186
- Cost, installation, 22, 184, 185, 188
 operation, 23, 24
 of plastered ceilings, 196
- Crane Co., 86, 87, 100, 101
- Crushed rock foundation, 62
- D
- Decorative treatment, 18
- Delco Appliance Division, General Motors Corp., 99, 100, 103, 104
- Depression temperatures of circulating water, 231
- Design, importance of, 223
 precise, 270-274
- Design calculations, 151-183
 for ceiling, 171-177
 precise, example of, 270-274
 for floor, 177-183
- Design procedures, 296
 of A. M. Byers Co., 151-153
 of Chase Brass & Copper Co., 154-161
 of Giesecke, Dr. F. E., 152
 precautions, 146
 in locating grid coils, 187
 in locating sinuous coils, 188
 precise method, 239
 of Revere Copper & Brass Inc., 162-164
 Shoemaker's simplified procedure, 170-183
- Deviation from grade, 199
- Distribution mains, 164
- Domestic hot-water systems, 82, 90, 94, 113, 114
- Down riser, 169

Duo-Stat, electric, 132
 electronic, 132, 134
 pneumatic, 130

E

Efficiency, loss of, 78
 End switch, 139, 142
 Evaporative cooling, 227, 229
 Expansion joints, 194, 195
 installation of, 195, 200
 Expansion tank, 168

F

Factories, 33-36, 38, 195, 200, 201, 214
 Fire houses, 31, 49, 52
 Fittings, for copper tubes, 196
 dimensions of, 283-288
 equivalent lengths of, 279
 Floor heat output, 158, 181
 Floor installations, 16
 construction methods for, 35, 192-195
 grid coils for, 187, 191
 in chapels, 51, 55
 in factories, 34, 214
 in residences, 61, 62
 sinuous coils for, 188, 189
 in factories, 35, 36, 38, 195, 200, 201,
 214
 in fire houses, 49, 52
 in garages, 41, 43
 in hangars, 46
 in hospitals, 49, 52, 53, 221, 222
 in kindergartens, 40
 with lightweight concrete, 46, 49, 51
 in office buildings, 49, 50, 211, 212
 on prefabricated concrete construc-
 tion, 216, 217
 in residences, 202, 220
 in schools, 39, 40-43
 in service stations, 50, 53
 in super-markets, 217, 218
 in wooden buildings already con-
 structed, 205, 206
 Floor slabs, 200-204
 desirable construction of, 195, 201, 203
 insulation in, 202
 Flow-check valves, 112

Flow-control valves, 114
 Forced circulation, 121
 Form factors, 246-248
 Forming coils for ceiling construction,
 208-210
 Foundation, crushed rock, 62
 Fuel, heat values of, 276
 equivalent values, 276
 Fuel oil, specification for, 98, 100
 Furnace volumes, 277

G

Garage installations, 40, 41, 43
 residential, 58
 Gas fuel advantages of, 96, 97
 precautions in use of, 97
 Giesecke, F. E., 240
 Gilbert & Barker Mfg. Co., 102
 Grid and sinuous coils, combined, 61, 62
 Grid feed points, 191

H

Hangars, 46
 Health and radiant heating, 21
 Heat, 1-11
 developed in body, 2
 flow of, analogy of, 149, 150
 coefficients for convection, 241
 coefficients for radiation, 244-249
 in an enclosed space, 240-257
 from floor slab, 203
 by infiltration, 150
 inside panel, 257-269
 loss from building, by conduction,
 150
 by reverse loss, 150
 radiant heat, 10, 11
 transmission per sq. ft. of pipe, 152
 Heat balance, 68
 Heat exchangers, 74
 Heat output, floor, 158, 181
 Heat transfer, 10
 Heat-transfer coefficients, for convection,
 241
 for radiation, 244-249
 Heating coil material, 184
 Held, M. van der, 247

Hoffman Specialty Co., 142-145
 control valve, 144
 temperature controller, 142
 Hospitals, 27, 46, 49, 52, 53, 221, 222
 Hot water systems, domestic, 82, 90, 94,
 113, 114
 Hutchinson and Raber, 247, 251, 252
 Hydration of plaster, 196

I

Inside surface, temperature of, 242-250
 method of calculation of, 153
 Inspection during construction, 201
 Installation procedures, 213
 for coils in concrete floors, 200-203,
 212-223
 Installations, elements required in, 168,
 169
 The Institute of Boiler & Radiator
 Manufacturers, 76
 Insulation in floor slabs, 202
 Internal temperatures, concrete slabs, 147
 International Heater Company, 75
 Iron Fireman Mfg. Co., 105
 Iron pipe, dimensions of, 277
 compared with copper tubing, 279
 Isotherms inside panels, 262

J

Johnson Service Co., 129-137
 Joints, for floor slab and foundation
 wall, 204
 in pipes and tubes, 189
 methods of making, 184, 185
 soldered, procedure for, 197-199
 welded, time and procedure for, 190,
 191

K

Kalous, K., 247, 257, 259
 Kitchen applications, 58

L

Laplace's equation, 264
 Living room, 18
 Low absorbtivity, space of, 252

M

Mains, size of, 166
 Manifolds, construction of, 36, 37, 44
 Maxwell, J. C., 258, 259
 Minneapolis-Honeywell Regulator Co.,
 137-142
 Modulating valve, 124
 electric, 140, 144
 pneumatic, 130
 Modutrol motor, 138
 Moisture in chimney, 78
 Motor-operated valve, 117

N

National Supply Co., 219
 Neutral and dissipating walls, 253

O

"Off and on" control, 120, 122
 Office buildings, 33, 46, 49, 50, 52, 53,
 211, 212
 Oil burners, atomizing, 99-103
 essential elements of, 100
 rating of, 101
 specifications for, 98, 100
 Timken, 97, 98
 Oil fuel, advantages of, 97
 burner for, 98-100
 specifications for, 98, 100
 Oil pump, 98
 Old buildings, radiant heating for, 23-27
 Outdoor controller, 139
 Outdoor-indoor controls, 124-145

P

Panel location, 33, 43, 45, 48-50
 for churches, 51, 52
 for commercial buildings, 54, 55
 for factories, 33
 for hospitals, 46, 49, 52, 53
 for offices, 33
 for residences, 61-64, 66, 69-71
 for schools, 41-43
 for sidewalks, 58, 59
 Panel temperatures and heat output, 251
 Panelaire, 75

- Penn Boiler & Burner Mfg. Corp., 92
 Pipes or tubes, effect of changing diameter of, 148
 effect of changing location of, 148
 effect of changing spacing of, 148
 linear feet required, 152, 158-160, 163
 Plaster, acoustical, 39
 ceiling, 210
 composition of, 196
 hydration of, 196
 Precautions in radiant heating design, 146
 importance of correct design, 223
 location of grid coils, 187
 location of sinuous coils, 188
 Pressure drops, 166, 275
 Prisons, 55, 56
 Purging air, 45
 Purging valve, 45
- R
- Raber and Hutchinson, 247, 251, 252
 Radiant cooling, 225-238
 distinguished from air conditioning, 224
 Radiant cooling controls, 234-238
 Radiant heat, definition of, 5-10
 increasing effectiveness of, 146, 147
 flow of, from floor and ceiling panels, 16
 from wall panels, 17
 Range selector, 141
 Rayduct, 212
 Reducing valves, 112
 Relief valves, 111
 Residential garages, 58
 Residential installations, ceiling construction in, 60, 63, 64, 71, 208-211
 examples of modern homes, 65-72
 floor-slab construction, 61-63, 66, 69, 202, 220
 insulated, 63
 second-story construction, 66
 subfloor construction, 70, 72
 wood floor construction, 66, 69
 Revere Copper & Brass Inc., 161-163
 method of design used by, 162
 Reverse heat flow, from ceiling, 157, 164, 171, 175
 from floor, 158, 160, 171, 181
 Richard Crittall & Co. Ltd., 41-43, 52-55, 220-222
 Robert Bruen & Son, 200, 201, 208, 209
 Room air temperatures, conventional, 14
 radiant, 15
 Rumpus room, 19
- S
- Sarcotherm Controls, Inc., 114-116, 124-129
 Schools, open-air, 40-43
 panel location for, 41-43, 40
 Service stations, 50, 53
 Shutoff valves, 115
 Sidewalks, 58, 59
 Silver solder, 197
 Simplified design methods, 170-183
 for ceiling construction, 171-174
 chart of, 175
 explanation of use, 176-177
 for floor construction, 177-180
 chart of, 181
 explanation of use, 182, 183
 precautions to observe, 170
 Sinuous and grid coils, combined, 61, 62
 Size of mains, 166
 Smith, A. O., Corp., 94, 96, 213-215
 Smith, H. B., Co., 81-86
 Snow, melting of, 58, 219
 Soldered joints, electric heating of, 198
 fluxes for, 198
 procedure for making, 198, 199
 strength of, 197
 testing of, 198
 types of, 197
 Space, of low absorptivity, 252
 saving of, 17
 Steam generators, 215
 use of, 74
 Steel heating boiler, 76
 Steel pipe, 184, 211, 214, 217-222
 comparison of sizes, 277
 Stokers, coal, 103-105
 bin feed, 105
 bituminous, 106
 furnace volume for, 277
 overfeed, 103
 rating, 105
 underfeed, 103

Sun shield, 137
 Supermarkets, 217, 218
 Supply mains, 165
 Supply water temperature controller, 138
 Swimming pools, 67, 68
 saving in heat for, 70

T

Temperature control, necessity for, 119
 types of, 123
 Temperature depression, 256
 Temperatures, inside surface, of exposed
 wall, 153
 lag in, 120
 required, for ceiling, 155
 for floor, 158
 for flue gas, 77
 for water, 156, 159, 172, 177
 Tempering valves, 112
 Testing pipe or tube coils, 189-191
 at soldered joints, 198
 at welded joints, 191
 Thermapanel, 208, 209
 Thermoradiation Outside Bulb, 127
 Thermoray, 128
 Thermostat, 134, 136
 room, 119-122, 125, 126
 electric, 142
 pneumatic, 134, 136
 Thermostatic elements, 123, 124
 Thrush, H. A., & Co., 109-112
 Timken oil burner, 97, 98
 Timken Silent Automatic Division, 88-92

V

Vacancy control, 141
 Valves, air, 116
 air charger, 116
 balancing, 36-115, 169
 dimensions of, 280-282, 289-292

Valves, flow check, 112
 flow control, 114
 Hoffman control, 144
 modulating, pneumatic electric, 140,
 144
 motor-operated, 117
 nomenclature, 293-295
 purging, 45
 reducing, 112
 relief, 111
 shut-off, 115
 tempering, 112
 Van der Held, M., 247
 Vestibules, 58

W

Wall installations, 204, 205
 Walls, neutral and dissipating, 253
 Water flow, determination of, 165
 increasing velocity of, 147
 Water heaters, exchanger, 75, 114
 oil-fired, 90, 91
 tankless, 82, 94, 95
 Water temperature, effect of changing,
 146
 Water temperature controller, supply,
 138
 Weight of water in pipes, 278
 Welded joints, procedure for making, 190
 time required for, 191
 Welding, time required for, 191
 Welding materials, 190
 Wrought-iron pipe, 184, 189-195, 216,
 217
 comparison of sizes, 277

Z

Zone controls, 117-118, 130-138
 Zoning, 169

