

BIRLA CENTRAL LIBRARY

PILANI (RAJASTHAN)

Call No.

621.373

K 885

Accession No.

38373

CENTRAL LIBRARY
B. I. T. S.
PILANI

Acc. No. _____

1. **Books are issued for 14 days.**
2. **Books lost, defaced or injured in any way shall have to be replaced by the borrowers.**

Acc. No 38373

ISSUE LABEL

Not later than the latest date stamped below.

--	--	--

ELECTRIC POWER METERING

ELECTRIC POWER METERING

A Textbook of Practical Fundamentals

BY

ARCHER E. KNOWLTON, M.S., E.E.

*Associate Editor, "Electrical World"; Fellow, American Institute of
Electrical Engineers; Formerly Associate Professor of Electrical
Engineering, Yale University; and Electrical Engineer,
Public Utilities Commission of Connecticut*

FIRST EDITION
EIGHTH IMPRESSION

McGRAW-HILL BOOK COMPANY, INC.

NEW YORK AND LONDON

1934

COPYRIGHT, 1934, BY THE
MCGRAW-HILL BOOK COMPANY, INC.

PRINTED IN THE UNITED STATES OF AMERICA

*All rights reserved. This book, or
parts thereof, may not be reproduced
in any form without permission of
the publishers.*

THE MAPLE PRESS COMPANY, YORK, PA.

PREFACE

Metering of electrical power and energy appears in its most extensive and intensive form in the registration of the energy consumption of millions (some 25 millions in this country) of users of electricity. Superficially the technique seems to be a simple routinized process as prosaic as using yardsticks, quart measures, or grocers' scales to vend the common commodities. Actually, however, there is a wealth of underlying technology comparable in scope with that fundamental to generators, motors, transformers, and circuits of all voltages. A watthour meter is essentially a motor with highly refined characteristics; an instrument transformer is merely one of low kilovolt-ampere rating but designed to have better regulation than transformers in general. There are many other parallels, a fuller appreciation of which cannot fail to aid meter engineers better to attain the accuracy and proficiency expected of them. As for the technical student the converse benefit is afforded. Attainment of accuracy and reliability in metering forces consideration of factors that can often be ignored in grosser pieces of electrical apparatus. Since these details are in no sense closely limited in scope, a comprehensive study of the technique of power and energy metering can justifiably serve as an alternative to conventional treatment of electrical machinery and circuits. For one thing, vectorial manipulation and symmetrical component analysis here demand a respect for exactitude that is not always developed by abstract approach and mere confirmatory application.

What is here presented had its beginnings in advanced short courses for electrical meter engineers conducted by the author for several years at Yale University at the instance of and in cooperation with the successive meter committees of the former National Electric Light Association. The aim there was and here is to pass over the routine matters of technique and concentrate upon clarification of the problems which call for a knowledge of the principles underlying the desired performance characteristics of metering devices. Having held to this plane, it was natural that the condensed presentation in the short

courses should be expanded to constitute a prescribed course for seniors in electrical engineering at the university. Incorporated in the text is also experience gained in conducting the standardizing and supervisory laboratory of the Connecticut Public Utilities Commission at which the master meters of the utilities in the state are certified at regular intervals.

Under such an evolution it is evident that the author must acknowledge the stimulus and aid of many associates too numerous to mention—fellow members of the Committee on Instruments and Measurements of the American Institute of Electrical Engineers, faculty associates, National Electric Light Association committee members, and manufacturers' engineers. Especial acknowledgment of indebtedness is given to T. A. Abbott, H. B. Brooks, R. C. Lanphier, F. B. Silsbee, and R. G. Warner. To Margaret Mittwollen the author is obligated for painstaking skill in transcribing the manuscript.

A. E. KNOWLTON.

SHORT BEACH, CONN.,

October, 1934.

CONTENTS

	PAGE
PREFACE.	v
CHAPTER I	
POWER BY INDICATING INSTRUMENTS	1
Analysis of the limitations to accuracy arising from the connections employed and from the electrical characteristics of the instruments themselves. Problems.	
CHAPTER II	
INSTRUMENT TRANSFORMERS.	18
Contrasted with power transformer. Effect of instrument burden on accuracy. Correction factors for ratio departure and phase angle at any load power factor. Ways of improving performance of instrument transformers. Problems.	
CHAPTER III	
CALIBRATION OF INSTRUMENT TRANSFORMERS	48
Absolute methods for high precision. Relative methods for ordinary tests. Calibration by interchanged watt-hour meters. Technique of commercial test sets in detail. Problems.	
CHAPTER IV	
POLYPHASE SYSTEMS AND VECTOR RELATIONS.	64
Merits of polyphase circuits. Three-phase systems evolved from single-phase. Vector representation of Y and Δ systems. Three-phase unbalance treated. Other polyphase circuits. Problems.	
CHAPTER V	
POLYPHASE POWER MEASUREMENT	77
Three-wire single-phase errors. Expressions for two-phase and three-phase power. Three-phase power by two wattmeters. Power factor derived from wattmeter readings. Ways of metering mixed loads at different voltages and from various phases. Problems.	
CHAPTER VI	
EVOLUTION OF THE WATTHOUR METER	95
Tracing the steps by which Gardiner's clock meter of 1872 became today's induction watt-hour meter. Appreciation of this history aids understanding of operating principles in modern designs.	

CHAPTER VII

DIRECT-CURRENT WATTHOUR METER 106

Driving torque by motor action. Braking torque by generator action. Friction can be compensated. Adjustment for errors at full and light load. Watthour meter constants correlated. Problems.

CHAPTER VIII

PRINCIPLE OF INDUCTION WATTHOUR METER. 121

Torque developed in disk affected by several factors. Various components of both driving and braking torque establish characteristic load curve of meter. Problems.

CHAPTER IX

INDUCTION WATTHOUR METER PERFORMANCE 135

Vector analysis shows why lagging is necessary. Methods of compensating for friction. Effect of variation in voltage, load, frequency, and wave form. Correction for temperature errors.

CHAPTER X

TECHNIQUE OF METER TESTING 156

Ways of obtaining precise timing, of avoiding energy waste in testing, and of creating low power factor artificially. Means available for checking phase sequence. Problems.

CHAPTER XI

THE POLYPHASE METER. 168

Factors to be observed in addition to those of single-phase meter. Systematic sequence of test simplifies testing task. Characteristics can be correlated with those of instrument transformers in large power metering. Permissible burdens. Fusing and grounding practice in polyphase metering. Problems.

CHAPTER XII

VERIFICATION OF POLYPHASE METERING CONNECTIONS 184

Errors from incorrect connections can be large. Methods available for checking connections discussed in detail. Scope, limitations, and advantages of each enumerated and tabulated. Problems.

CHAPTER XIII

REACTIVE METERING 207

Power factor ascertainable through instrument readings or through reactive metering. Schemes for establishing voltage phase shift to quadrature for reactive metering purposes. Cross-phasing and phasing transformer. Reactive metering on four-wire circuits. Problems.

	PAGE
CHAPTER XIV	
ACCURACY OF REACTIVE METERING. SYMMETRICAL COMPONENTS. . .	232
Under unbalanced conditions reactive metering entails errors. Technique of symmetrical components developed to reduce unbalanced systems to balanced equivalents. Expressions developed for errors of reactive metering. Means of metering symmetrical components and unbalance factor. Problems.	
CHAPTER XV	
KILOVOLT-AMPERE METERING	262
Kilovolt-ampere meters of phase-shift and vector-addition types. Angus, Lincoln, overrunning register, Aron, rectification, Sangamo, pantograph, rolling-sphere, and trivector types of meters described in principle and action. Problems.	
CHAPTER XVI	
DEMAND METERING.	280
Justification for demand metering. Three principal types of demand meters discussed and characteristic forms described in detail. Thermal demand meter compared with block interval type as to interval, splitting the peak, and performance under widely varying load.	
CHAPTER XVII	
LOAD TOTALIZING. TELEMETERING.	300
Scattered loads summated by multicurrent-coil meters, by parallel current transformers, by multielement meters, by impulse relays, and by thermal conversion to direct current. Telemetering accomplished by current balance, by duplicated position, by counting impulses, by use of voltage dividers, and by thermal conversion.	
APPENDIX	325
Factors and design principles which influence accuracy and sensitivity of instruments. Friction torque of bearings. Spring characteristics. Torque equations. Damping.	
INDEX.	335

ELECTRIC POWER METERING

CHAPTER I

POWER BY INDICATING INSTRUMENTS

Energy is a more basic physical quantity than power, which is the time rate of converting energy into work. But from the standpoint of measurement power appears a bit easier to measure because the time divisor is also inherently a component of the current factor in the equation *power = volts* \times *amperes*. To multiply by time and thus establish the energy magnitude carries an added complexity involving rotation or some other means of integration of power variation during the elapsed time. This is one reason for discussing power measurement before energy measurement.

Another reason is that precision, sensitivity, torque, bearing friction, and energy losses, while characteristics held in common by both the rotating and deflecting types of electrical meters, have magnitudes in general smaller or of more refined nature in the indicating instruments employed for power measurement than in the rotating forms employed in energy registration.

1-1. Energy and Power.—Electricity is the name for an incompressible something which can be made to flow from point to point in an electric circuit for the purpose of converting energy into useful work. Electricity is the quantity factor Q of the energy W . The voltage, or difference in potential, E between the points is the intensity factory of the energy. If Q is in coulombs and E in volts, then W is in joules or watt-seconds in the equation $W = Q \cdot E$.

Power is the rate at which energy is generated or converted or applied or transmitted past a given cross section of the electrical circuit. Current I in amperes is the rate of flow of the electricity Q in coulombs per second. Thus $P = E \cdot I$ watts and

these are measured by obtaining the product of the amperes I and the voltage or electromotive force E which at each instant is the cause of the current flow.

1-2. Power by Voltmeter and Ammeter.—Power in a d-c. circuit is simply $E \cdot I$ and, therefore, the voltmeter reading times the ammeter reading should give as the product the watts consumed by the load. But in any actual measurement either the voltmeter will register the voltage drop through the ammeter in addition to the voltage impressed across the load or else the

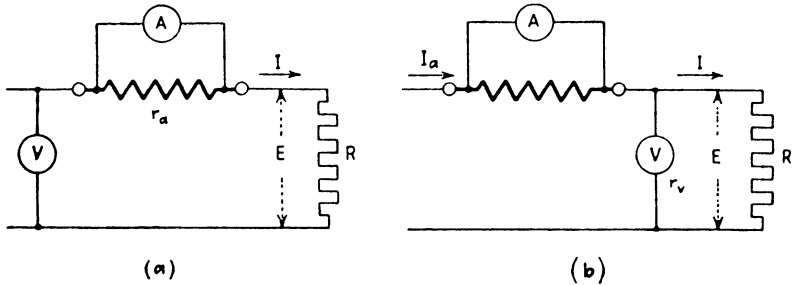

FIG. 1.

ammeter will register, in addition to the load current, the current taken by the voltmeter. The degree of error will depend on the relative values of the resistances of the two meters and the load.

In Fig. 1a the voltmeter registers the drop through the ammeter and its shunt as well as through the load. Let P represent the watts consumed in the load and U_1 the apparent watts obtained from the product of voltmeter and ammeter readings.

E_v is the voltmeter indication, r_a the resistance of the ammeter, and r_v the resistance of the voltmeter.

$$P = EI = \frac{E^2}{R}$$

$$U_1 = E_v I = (E + Ir_a)I = EI + I^2 r_a = \frac{E^2}{R} + I^2 r_a$$

The proportional error is

$$\frac{U_1 - P}{P} = \frac{I^2 r_a}{\frac{E^2}{R}} = \frac{r_a}{R} \quad [1]$$

The error is thus least when r_a is small relative to R or when R is large and I is therefore small.

In Fig. 1b the ammeter registers the current taken by the voltmeter in addition to that taken by the load resistance R . Let U_2 represent the apparent watts obtained in this instance from the product of voltmeter and ammeter readings.

$$U_2 = E_v I_a = E \left(I + \frac{E_v}{R_v} \right) = EI + \frac{E^2}{r_v} = \frac{E^2}{R} + \frac{E^2}{r_v}$$

The proportional error is

$$\frac{U_2 - P}{P} = \frac{E^2/r_v}{E^2/R} = \frac{R}{r_v} \quad [2]$$

The error is thus least when r_v is large relative to R or when R is small and I is therefore large.

The errors by the two methods of instrument insertion will be equal when

$$\frac{r_a}{R} = \frac{R}{r_v} \quad \text{or} \quad R = \sqrt{r_a r_v} \quad [3]$$

With given ammeter and voltmeter resistances the connection of Fig. 1a is preferable (if the errors and corrections are to be ignored) when $R > \sqrt{r_a r_v}$ and that of Fig. 1b when $R < \sqrt{r_a r_v}$.

1-3. Power by Wattmeter.—By applying the corrections indicated by the analysis of errors in the preceding paragraph,

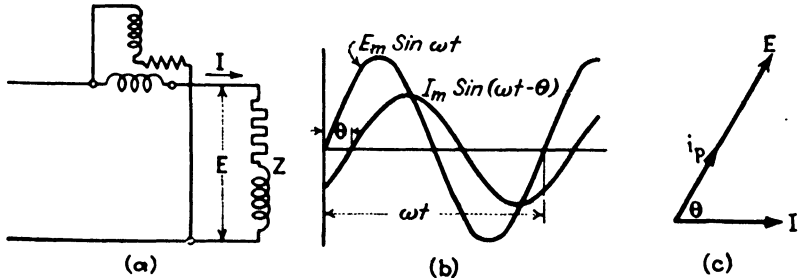

FIG. 2.

power in d-c. circuits can be determined adequately through the medium of voltmeter and ammeter indications. In a-c. circuits the uncertainty as to phase relations (and therefore power factor) between load voltage and load current, as established by inductive or capacitive elements in the load, makes resort to the wattmeter necessary for a-c. power determinations. The wattmeter indicates the mean value of the products of instantaneous

values of voltage and current. The inertia of the moving element is relied upon to give a steady indication of the average value of this varying product just as the inertia of the a-c. voltmeter and ammeter do for the alternating quantities which they measure.

The wattmeter registers the power delivered to the load impedance Z in Fig. 2a.

$$\begin{aligned} e &= E_{\max} \sin \omega t \\ i &= I_{\max} \sin (\omega t - \theta) \end{aligned}$$

But the current through the voltage circuit of the wattmeter, if it is assumed it has resistance R_p and complete freedom from inductance and capacitance, is

$$i_p = \frac{E_m \sin \omega t}{R_p}$$

The torque developed by the wattmeter is

$$\text{Torque} = K_1 \times \frac{E_m \sin \omega t}{R_p} \times I_m \sin (\omega t - \theta)$$

$$\begin{aligned} \text{Average torque } T &= K' \times \text{average of product } [E_m \sin \omega t \times I_m \sin (\omega t - \theta)] \\ &= K' E_m I_m \times \text{average } [\sin \omega t (\sin \omega t \cos \theta - \cos \omega t \sin \theta)] \\ &= K' E_m I_m \times \text{average } [\sin^2 \omega t \cos \theta - \sin \omega t \cos \omega t \sin \theta] \\ &= K' E_m I_m [\text{average } (\sin^2 \omega t \cos \theta) - \text{average } (\sin \omega t \cos \omega t \sin \theta)] \\ &= K' E_m I_m (\frac{1}{2} \cos \theta - 0 \sin \theta) \\ &= \frac{K' E_m I_m \cos \theta}{2} \\ &= KEI \cos \theta. \end{aligned}$$

The average torque is thus proportional to E , to I , and to $\cos \theta$. The deflection will be proportional to the watts if K remains a constant. Under this ideal assumption, a control spring of linear characteristics results in a linear scale. In the torsion-head type of electrodynamic wattmeter, the deflecting torque is opposed by spring torque sufficient to hold the coils at the time of reading in the position of equilibrium corresponding to no current in its coils. But in the deflection type of instrument K changes when the coils change their relative positions under deflection and the scale is therefore not inherently uniform. By proper choice of shape and location of the fixed and moving coils, K can be kept nearly constant and the scale of the wattmeter nearly uniform.

1-4. Accuracy in Wattmeter Indications.—In connecting a wattmeter for power measurement its voltage circuit may be

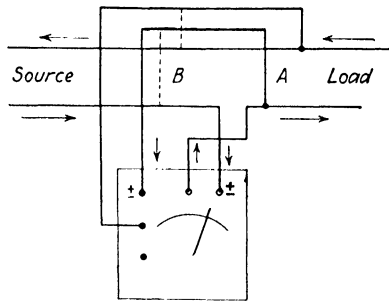

FIG. 3.

connected on the line side or on the load side of its current coil. The latter connection as shown in Fig. 3 is preferable because,

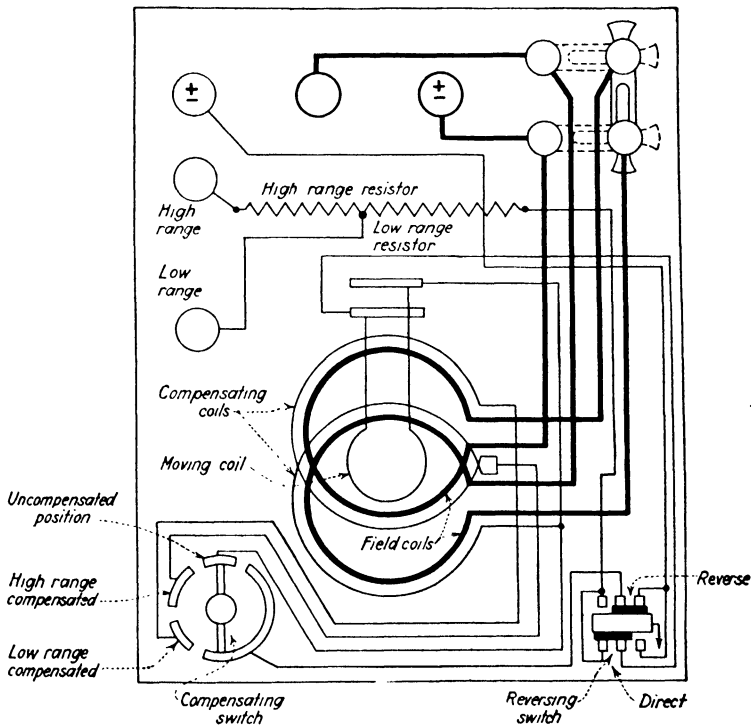

FIG. 4.

while the watts lost in the potential circuit are included in the instrument indication, this error is small relative to most loads

and usually negligible. At least it is constant at constant voltage, whereas with the voltage coil connected on the line side (as at *B*) the instrument records the variable watts lost in the current coil with variable load.

For wattmeters designed for measurements at low power factor the error arising from registration of the watts lost in the voltage circuit of the instrument becomes more serious. The Weston Model 310 (Form 2) low power-factor wattmeter is provided with an ingenious arrangement of compensation which deducts these watts from the instrument indication. The compensation is effected by means of a winding connected in the voltage circuit having the same effective number of turns as the (current) field winding and wound in such a direction that the current in it is opposite to that in the field winding. The voltage-circuit current in this supplementary winding then exactly neutralizes the torque effect of that same current as a component of the total current in the field winding. When the instrument is used in connection with instrument transformers to register loads beyond its direct-connected range, it should be employed uncompensated and the registration corrected for this error along with those introduced by the ratio and phase-angle departures of the transformers.

Further, in connecting any wattmeter the electrostatic capacity effects and the risk of insulation breakdown between voltage and current coils should be avoided by connecting that voltage terminal (usually marked \pm) to which the moving coil is connected to the line wire in which the current coil is inserted. If the deflection is then reversed, it should be the current leads (not the voltage leads) which are to be reversed. Some wattmeters are provided with switches in the voltage circuit which reverse the voltage coil, still leaving it at minimum difference of potential with respect to the current coils (see Fig. 4). If an external multiplier is used to extend the voltage range, it should be connected between the unmarked post and the line.

1-5. Effect of Inductance in Voltage Circuit of Wattmeter.—Inductance of the voltage element of the electrodynamic wattmeter arises from the relatively large number of coil turns required to develop adequate torque with minimized value of current in the voltage circuit. The result of this inductance is twofold: (1) It prevents the current through the voltage circuit of the wattmeter being strictly in phase with the voltage applied to it and (2) the magnitude and phase angle of that current will

be different for different values of the frequency of the applied voltage. The first consequence is to be investigated because the torque formula $T = KEI \cos \theta$ implies that the reacting currents in the fixed (current) and movable (voltage) coils are strictly in the same phase relation to one another as the E and the I in the load circuit. Any lag of current in the inductive voltage circuit prevents this conformity and leads to error in watt indications that are more serious the lower the values of load power factor.

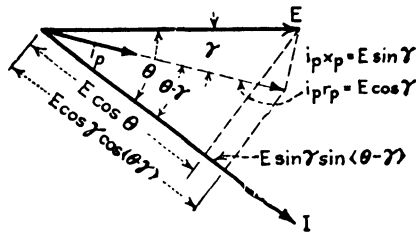

FIG. 5.

Let E and I be the load voltage and current, respectively, with power-factor angle θ . Let the voltage circuit of the wattmeter have resistance r_p and inductive reactance $x_p = 2\pi fL_p$ ohms. The current i_p in the voltage coil lags γ° behind E , and the phase angle within the instrument has become $(\theta - \gamma)$ rather than the true θ .

$$\text{True power } P = EI \cos \theta$$

$$\text{Wattmeter reading } U = EI \cos \gamma \cos (\theta - \gamma)$$

The latter is derived from taking the component of E in the direction of I in Fig. 5. The wattmeter reading is then the true power only under two circumstances: (1) when $\gamma = 0$, *i.e.*, when the voltage circuit of the meter has been rendered non-inductive, or (2) when $\gamma = \theta$, *i.e.*, when the power factor of the voltage circuit of the wattmeter is identical with the power factor of the load circuit.

The permissible value of x_p and γ can be derived from a study of the error, $\Delta = U - P$, of the watt indication

$$\begin{aligned} \Delta &= U - P = EI \cos (\theta - \gamma) \cos \gamma - EI \cos \theta \\ &= EI \sin \gamma \sin (\theta - \gamma) \quad (\text{from Fig. 5}) \end{aligned}$$

For an acceptable instrument γ will be small and also, for values of power-factor angle θ at which the errors will be significant, γ will further be small relative to θ . Then

$$\Delta = EI \sin \gamma \sin \theta \text{ (approximately)}$$

For low-load power factors $\sin \theta$ approaches unity and the wattmeter error approaches $EI \sin \gamma$, which means that it behaves at all load power factors as if its zero had been shifted by an amount $EI \sin \gamma$.

Also since

$$\begin{aligned} \Delta &= EI \sin \theta \sin \gamma \\ &= EI \sqrt{1 - \cos^2 \theta} \sin \gamma \\ &= EI \sqrt{1 - (W/EI)^2} \sin \gamma \\ &= \sqrt{(EI)^2 - W^2} \sin \gamma \end{aligned}$$

Or the error will be greatest when W is small relative to EI , *i.e.*, at the lowest lagging power factors.

The difficulty in designing a wattmeter which will have an error as low as 0.1 per cent at low-load power factors can be sensed from the following:

$$\begin{aligned} \Delta &= EI \sin \gamma = EI \tan \gamma \text{ (approximately)} \\ &= EI \frac{2\pi fL}{R} \end{aligned}$$

With full-scale values of E and I the error will be reduced to 0.1 per cent only if

$$\frac{2\pi fL}{R} = 0.001$$

At 60 cycles $2\pi f = 377$ and $377 \frac{L}{R} = 0.001$.

In other words, the resistance in the potential circuit should be at least 377 ohms for each millihenry of self-inductance of the potential coil.

With the constants of the voltage circuit of the wattmeter known, the true watts can be obtained by applying the following correction factor to the indicated watts:

$$F = \frac{1 + (2\pi fL)^2/R^2}{1 + \frac{2\pi fL}{R} \tan \theta} \quad [4]$$

1-6. Instrument Characteristics.—Electrical indicating instruments in general have an unusually wide range of applicability within, of course, the specific range of indications for which they

are designed. The relatively high degree of independence which their indications have of their internal characteristics gives them this broad usefulness. But there is a considerable tendency to overlook the fact that those internal characteristics cannot always be ignored in making precision measurements. Some accuracy is therefore sacrificed by not selecting the instrument best suited to the circuit conditions encountered.

To show how these characteristics influence performance, Table I has been prepared from data supplied by manufacturers. It has no pretension of inclusiveness or completeness. It merely embraces a selected group of ranges and types from which general conclusions can be drawn as to the extent to which best design for general purposes results in mechanical and electrical properties that should be considered when the devices are used for specific or special purposes. The table provides the basis for contrasting different types of instruments with regard to their losses, resistances, impedances, the burden which they create on instrument transformers, and the extent to which their characteristics point to the desirability of applying corrections to their indications in precision measurements.

Some of the comparisons based on the actuating principle employed and on the limitations imposed by the different ranges provided are as follows:

1. Moving-iron *vs.* electrodynamic *vs.* permanent-magnet moving-coil types.
2. Voltmeters *vs.* ammeters.
3. Wattmeters *vs.* ammeters and voltmeters.
4. Low capacity *vs.* high capacity.
5. Portable *vs.* laboratory standard design.
6. Normal *vs.* low power factor wattmeters.

The Appendix (page 325) discusses design principles upon which the most advantageous combinations of characteristics are chosen in the design of indicating instruments.

1-7. Weight, Inertia, and Damping.—In the first place it is evident from the table that the manufacturers have standardized the characteristics so that these are either uniform for all capacities or else in general proportional (in the case of the electrical properties) to the rated capacities.

The weights of the moving elements of moving-iron and permanent-magnet moving-coil instruments are of the same order of magnitude. Those of the electrodynamic type are in general

TABLE I.—MECHANICAL AND ELECTRICAL CONSTANTS OF TYPICAL INSTRUMENTS

Number	Instrument	Maker	Class	Model	Range		Weight, grams	Moment of inertia, g-cm. ²	Moving element			Damping	
					E	I			G-cm. full scale	G-cm. per radian	Factor A.I.E.E.	G-cm. per rad. per sec.	Percentage of critical
Permanent magnet moving coil (d.c.):													
1	Ammeter	General Electric	P	DP-2	0.15	2.0	2.0	2.0	0.24	0.15	20	0.0145	71
2	Ammeter	General Electric	P	DP-2	5	2.0	2.0	0.24	0.15	0.023	69
3	Ammeter	General Electric	P	DP-2	500	2.0	2.0	0.173	0.099	0.022	78
4	Ammeter	Westinghouse	P	PX-4	1/5	1.5	1.5	0.206	0.137	0.022	78
5	Ammeter	Weston	P	1	0.0003	2.16	2.0	0.163	0.109	0.022	78
6	Ammeter	Weston	P	1	5	1.69	1.8	0.163	0.109	0.022	78
7	Ammeter	Weston	P	1	500	1.69	1.8	0.163	0.109	0.022	78
8	Ammeter	Weston	P	1	500	1.4	2.0	0.09	0.057	0.022	78
9	Voltsmeter	General Electric	P	DP-2	0.02	2.0	2.0	0.50	0.32	0.0145	71
10	Voltsmeter	General Electric	P	DP-2	150	2.0	2.0	0.26	0.17	0.022	78
11	Voltsmeter	General Electric	LS	DL-2	0.05	2.0	0.50	0.32	0.034	73
12	Voltsmeter	General Electric	LS	DL-2	150	2.0	1.08	0.173	0.099	0.034	73
13	Voltsmeter	Westinghouse	P	PX-4	15/150	1.69	1.8	0.163	0.109	0.034	73
14	Voltsmeter	Weston	P	1	0.01	1.73	1.9	0.276	0.177	0.034	73
15	Voltsmeter	Weston	P	1	150	1.73	1.9	0.413	0.276	0.034	73
Electrodynamic (a.c., d.c.):													
16	Ammeter	Weston	LS	326	5/10	3.4	24	0.29	0.193	0.051	37
17	Ammeter	General Electric	LS	PL-2	0.25/0.5	8.2	55	0.26	0.17	0.051	37
18	Voltsmeter	Weston	LS	326	300/150/75	3.45	24	0.29	0.193	0.051	37
19	Voltsmeter	General Electric	P	P-3	150	4.8	15	0.24	0.15	0.051	37
20	Voltsmeter	General Electric	LS	PL-2	150	5.2	15	0.35	0.22	0.051	37
21	Voltsmeter	Westinghouse	LS	PV-5	150/300	5.2	15	0.47	0.279	16.5	0.0357	67	
22	S.P. Wattmeter	Weston	LS	326	5/10	3.85	24	0.29	0.193	0.051	37
23	S.P. Wattmeter	Weston	P	310	100/50	2.03	4	0.19	0.127	0.026	57
24	S.P. Wattmeter	Weston	P	310	150/75	1/2	2.03	0.14	0.093	0.02	52
25	S.P. Wattmeter	Weston	P	310P2*	150/75	1/2	2.03	0.14	0.093	0.02	52
26	S.P. Wattmeter	Westinghouse	P	PV-5	150/300	5/10	4.06	0.12	0.0791	16.5	0.0357	67	
27	S.P. Wattmeter	General Electric	P	P-3	100	4.8	15	0.26	0.17	0.0357	67
28	S.P. Wattmeter	General Electric	LS	PL	150	5.2	15	0.40	0.25	0.0357	67
Moving iron (a.c.):													
29	Ammeter	Westinghouse	P	PV-5	2.5/5	2.38	2.73	0.11	0.0715	12	0.0176	62.7	
30	Ammeter	Weston	P	155	0.02	1.67	2.5	0.145	0.097	0.012	36
31	Ammeter	Weston	P	155	500	1.67	2.5	0.125	0.083	0.012	36
32	Ammeter	Weston	P	155	500	1.67	2.5	0.125	0.083	0.012	36
33	Ammeter	General Electric	P	P-3	3	4.67	15.5	0.50	0.32	0.012	39
34	Voltsmeter	Weston	P	155	30	1.67	2.5	0.125	0.083	0.012	39
35	Voltsmeter	Weston	P	155	150	1.67	2.5	0.125	0.083	0.012	39

P = portable. L.S. = laboratory standard. SP = single phase.

* Low power-factor wattmeter. Data given for lower or higher range of multiple-range instruments as indicated by boldface figures.

greater as a result of the greater length and weight of copper coil required to produce the requisite torque with the weaker magnetic fields producible. The weights of the moving elements for laboratory standard instruments are greater than for the corresponding portable instruments.

The moment of inertia of electrodynamic instruments is much higher than for the other two types; this is due in part to the greater weight of the moving element and in part to the greater diameter of the moving coil as needed to aid in torque production. Although the weight of the element is usually the same for low and medium capacities, the low-capacity instrument presents difficulty in developing the requisite torque. There is therefore in general a sacrifice in the ratio of torque to weight, a ratio which serves somewhat as an index of sensitivity and quality of design (see Appendix, page 328). The laboratory standard instruments have a higher ratio of torque to weight than the corresponding portables.

The damping of permanent-magnet moving-coil instruments is readily brought to the most effective point, *i.e.*, 70 to 80 per cent of critical damping, with an "overshoot" of 1 to 3 per cent. The damping torque of electrodynamic and moving-iron instruments is of the same order of magnitude as in permanent-magnet moving-coil instruments, but the "per cent of critical" is lower owing to the influence of the high values of moment of inertia in offsetting the lower values of restoring torque of the control spring.

1-8. Electrical Proportions in Indicating Instruments.—In the case of millivoltmeters used with shunts to form an ammeter combination the instrument resistance is a single value for all ranges in a given type. The shunt has a resistance inversely proportional to the current rating, thus creating a uniform value of volts-drop at all the rated capacities. On the other hand, the resistance, inductance, and impedance of electrodynamic instruments vary approximately inversely as the square of the rating; thus low-range instruments inevitably have high impedance and large voltage drops. For this reason practically no gain in accuracy is acquired by substituting a 1-amp. ammeter for a 5-amp. meter connected through a current transformer to indicate current values below the 1-amp. mark on the 5-amp. meter scale unless correction is applied for the greatly increased ratio and phase-angle error of the transformer resulting from the greatly

increased burden on it. Step-up ratio current transformers are available for measurements of such magnitude.

Watts dissipated in heating the shunt of a d-c. ammeter are proportional to the current rating. Large-capacity shunts should therefore be well ventilated to dispose of the higher losses. In all but the very low ranges the resistance of d-c. voltmeters is of the order of 100 to 200 ohms per volt. Impedances of a-c. voltmeters are about one-tenth to one-twentieth the resistances of the corresponding d-c. meters and consequently their draft of current from the line is ten to twenty times as great as in the case of the d-c. meters. Failure to observe this point often leads to erroneous power-factor determinations in condenser tests and also faulty values in resonance studies. Double-range a-c. voltmeters as a general rule draw more current from the line on their upper range than do corresponding single-range instruments.

The resistance, inductance, and impedance of voltage-element circuits in wattmeters are greater, the current from the line less and watts lost less, than for voltmeters of the same voltage rating. In the case of the current-element circuits of wattmeters the impedances are less, the voltage drops less, and the losses at rated current less than for ammeters of the same current rating. Wattmeters, therefore, constitute a lesser burden on instrument transformers than the voltmeters and ammeters of the same range and type.

1-9. Precautions in Placing and Reading Instruments.—A pointer attached to the moving element moves over a circular scale graduated in volts, amperes, watts, etc. This pointer must be as light and rigid as possible and is, therefore, often made of tubular aluminum. For some a-c. instruments trussed pointers are desirable in order to minimize the vibration due to the cyclic variation of the deflecting torque experienced by the moving element.

The center of gravity of the moving element should be on the axis of the shaft of a spring-controlled instrument in order that the indications may be independent of the position in which the instrument is placed. Balancing weights are provided to accomplish this but their weight and that of the pointer are kept to a minimum so that the inertia of the system and the load on the pivots shall be minimized. Despite the balancing adjustments, instruments should be used only in the horizontal (*i.e.*, portable) or vertical (*i.e.*, switchboard) position for which they are designed.

To facilitate accurate reading of the scale indications the pointer is commonly flattened and a mirror mounted parallel to the scale, thus making elimination of parallax possible by having the line of sight perpendicular to the scale when the pointer covers its own image in the mirror.

1-10. Effect of Temperature upon Instrument Indications.—The effect of temperature variations resulting from external heat or from losses within the instrument can be sensed from consideration of a permanent-magnet moving-coil instrument such as a d-c. voltmeter. A rise in temperature reduces the flux in the air gap in which the moving element acts; the torque and deflection tend to be reduced and the meter reads low (usually about 0.02 per cent per degree centigrade). But the springs are also weaker at higher temperatures; the controlling torque is less and the deflection tends toward high reading (about 0.04 per cent per degree centigrade). For minimum weight of moving coil, it is wound of copper which increases resistance (0.4 per cent per degree centigrade) with rise in temperature; the current through the coil and, therefore, the deflection will be less at higher temperatures even though the impressed voltage be unchanged. In general the effect of these three temperature changes is compensated by diluting the largest item (copper-coil resistance) to the point where it adds enough reduction in deflection to that produced by weakened magnets so that the total reduced value equals the tendency toward increased deflection created by the weakened spring. The dilution is accomplished by inserting a zero temperature-coefficient resistance in series with the moving copper coil; its ohmic value is made some twenty times that of the coil. Repairs to damaged voltmeters can readily result in a meter accurate at only one value of temperature unless this proportion is preserved. More difficulty is encountered with d-c. ammeters because of the low permissible value of total resistance. Moving-iron instruments for alternating current are only slightly affected by temperature.

Shunts for ammeters must have a low temperature coefficient and, in addition, a low value of thermoelectromotive force with respect to copper. Manganin meets both requirements. The leads from the shunt to the instrument terminals must be of fixed low resistance value inasmuch as their resistance is part of the instrument circuit which must bear a fixed resistance relation to the shunt with which it is in parallel. Self-contained instru-

ments often have ventilated cases to dissipate the heat arising from watts lost in the shunts and series resistors.

1-11. Effect of Magnetic Field and Frequency.—Stray magnetic fields are seldom of high enough value, except in large d-c. stations, to affect the accuracy of permanent-magnet moving-coil instruments. Electrodynamical instruments usually have to be shielded from the effect of possible stray fields; the shielding is accomplished by enclosing the working fields of the instrument inside an iron shell. Stray alternating fields do not affect an a-c. instrument unless they are of the same frequency as the quantity being measured. The accuracy of many types of a-c. instruments employing iron in their construction will be affected by departure from sinusoidal wave form. Moving-iron (soft-iron) meters are, however, relatively free of wave-form error and of frequency error (up to 500 or 1,000 cycles), to which basis wave-form error is largely reducible.

For higher frequencies, such as those employed in radio, the thermocouple type of instrument has practically superseded the former hot-wire type of instrument.

Problems

1-1. It is common practice to make d-c. ammeters of 50-millivolt shunts and millivoltmeters having (plus leads) a resistance of 10 ohms. Compute and tabulate the following values for ammeters of 1-, 5-, 10-, 50-, 200-, 5,000-amp. range—parallel resistance (shunt, instrument, instrument leads), shunt resistance, watts loss in shunt at full scale.

1-2. The watts taken by a 200-ohm resistance at 100 volts are to be measured by means of a 150-volt d-c. voltmeter having a resistance of 15,000 ohms and a d-c. ammeter having 50-mv. shunts for 1-amp. and 100-amp. ranges.

- a. Determine the percentage error in watts if the voltmeter reads the drop through the ammeter.
- b. Determine the percentage error in watts if the ammeter reads the current taken by the voltmeter.

Substitute a 2-ohm load for the 200-ohm load.

- c. Determine the error as in a.
- d. Determine the error as in b.
- e. Which is the preferable connection for small wattage values?
- f. Which is the preferable connection for large wattage values?

1-3. An electrodynamic wattmeter (150 volts, 1 amp.) has the following circuit constants:

voltage-circuit resistance = 6,543 ohms; field-coil resistance = 0.648 ohm;
voltage-circuit L_p = 3.4 mh.; field-coil L_c = 9.5 mh.

It is used to determine the watts taken by a 200-ohm resistance with 100 volts direct current applied to the load.

- a. Determine the percentage error with the voltage connection made at the load side of the current coils.
- b. Determine the percentage error with the potential connection made at the line side of the current coils.
- c. Which is the preferable way of measuring small values of d-c. watts—by d-c. ammeter and voltmeter or by electrodynamic wattmeter?
- d. Which is the preferable connection of the wattmeter voltage circuit, on the "line" side or "load" side of the current coils, when measuring small values of watts?

1-4. The electrodynamic wattmeter of Prob. 1-3 is to be used to determine the watts taken by the 200-ohm resistance with 100 volts at 60 cycles applied at the load.

- a. What is the percentage error in watts due to inductance in the voltage circuit of the wattmeter, if the preferable connection chosen in *d* of Prob. 1-3 is used?
- b. What would be the percentage error at 10 per cent power factor lagging?

1-5. In addition to the wattmeter of Prob. 1-3, a 1-amp. electrodynamic ammeter and a 150-volt electrodynamic voltmeter are used to determine the watts, volt-amperes, and power factor of a load having, at 60 cycles, $R = 200$ ohms, $X = 200$ ohms. Assume 100 volts applied at the load.

Ammeter resistance = 2.36 ohms; voltmeter resistance = 1,795 ohms;
 ammeter L_c = 3.68 mh.; voltmeter L_p = 62 mh.

The order of instruments from line to load is ammeter, voltmeter, wattmeter (connected as decided in *d* of Prob. 1-3).

- a. What is the percentage error in watts due to the voltage circuit reactance of the wattmeter?
- b. What is the percentage error in volts as indicated by the voltmeter?
- c. What is the percentage error in amperes as indicated by the ammeter?
- d. What is the percentage error in power factor as computed from the readings of the three meters?

[For the following problems see Appendix, page 325]

1-6. In a Weston Model 1 d-c. portable voltmeter (150 volts) the weight of the moving system is 1.73 g., the torque to produce full-scale deflection is 0.413 g-cm., $\mu = 0.2$, and $p_s = 150$ kg. per square millimeter.

- a. What should be the radius of the area of contact of the pivot bearing to provide a factor of safety of 1.5?
- b. Will the pointer shift position when the voltage changes by 0.5 volt?
- c. To how small a change is it sensitive?
- d. The resistance of the instrument is 15,000 ohms. What is the current for full-scale deflection?
- e. What watts are consumed in the instrument at 150 volts?

1-7. Assume that the instrument of Prob. 1-6 has a scale length of 86.5 deg. and is controlled by a single phosphor-bronze spiral spring of five complete convolutions, inner radius = 3 mm., outer radius = 8 mm.,

$E = 12 \times 10^8$ g. per square centimeter. Determine the requisite dimensions of cross section of the spring.

1-8. Assume further that the instrument of Prob. 1-6 has the following constants affecting the promptness of its response: $I = 1.9$ g-cm.², damping = 73 per cent of critical.

- a. Determine the undamped periodic time.
- b. Determine the requisite damping constant D (in dyne-centimeters per radian per second) for critical damping.
- c. Determine the time in seconds required for the pointer to be within 1 per cent of its final deflection (critical damping, see Appendix).
- d. The damping ratio is the ratio of the amplitudes of consecutive swings and its value corresponding to 73 per cent of critical damping is about 0.035. Plot a damping curve (see Appendix) for this value and estimate the time taken by the pointer to be within 1 per cent of final deflection.

CHAPTER II

INSTRUMENT TRANSFORMERS

Four reasons may be cited for the use of instrument transformers in conjunction with indicating instruments, watt-hour meters, etc.

1. Voltage transformers permit the employment of low-voltage instruments on high-voltage circuits.
2. Current transformers provide a means for reducing large values of line currents to lower values in the meter circuits. Items 1 and 2 together provide for standardization on meter ratings of 110 volts and 5 amp. for the measurement of any current at any voltage.
3. The transformers supply the insulation, which avoids the necessity of having the meters assume the potential of the line. The safety of employees is further promoted by connecting the meter circuit to ground.
4. The transformers provide a large degree of flexibility in locating the instruments independently of the location of the high-voltage buses, transformers, etc.

The function of instrument transformers in a-c. measurements is comparable to that of shunts and multipliers in d-c. measurements. The latter are in general unsuited to a-c. measurements because they do not provide insulation of the instruments from the higher voltage circuits and because it is more difficult than with transformers to control or correct for the effects of inductance of the shunts, multipliers, and instruments.

2-1. Ideal Instrument Voltage Transformer.—The ideal instrument voltage transformer would give a secondary voltage equal to $1/N$ of the primary voltage (where N is the marked ratio) for all reasonable values of primary voltage, frequency, wave form, and secondary burden of instruments. It would also deliver to the instruments a voltage always differing by 180° in phase from the impressed primary voltage. Actual instrument voltage transformers depart from this ideal principally because of the magnetizing component and to some extent from the copper and core losses and the leakage-flux reactance of the windings.

In fundamental principle of action the instrument voltage transformer is identical with the common constant-potential power transformer. That it differs from it primarily in reduction and control of the ratio and phase-angle departures can be

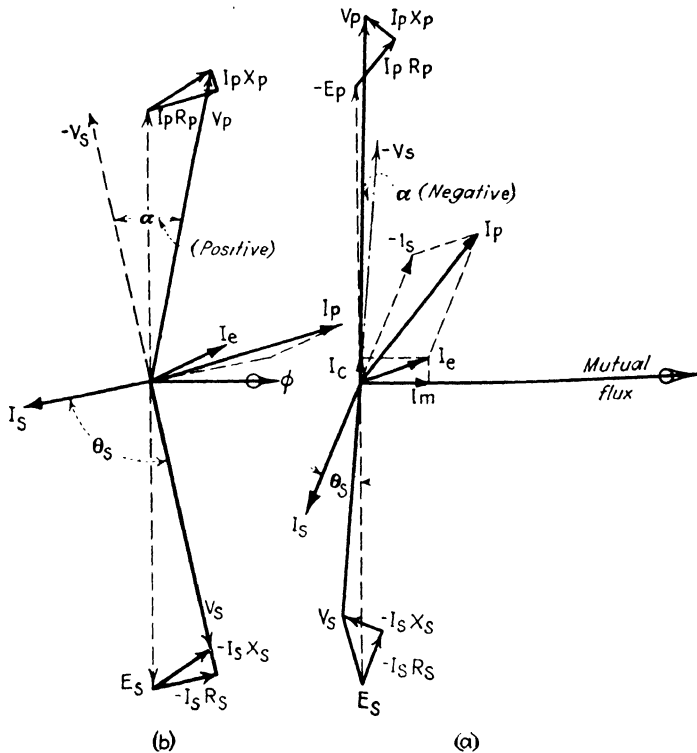

FIG. 6.

- I_m = magnetizing component of exciting current.
- I_c = iron loss component of exciting current.
- I_e = exciting current.
- $-E_p$ = counter induced e.m.f. in primary winding.
- E_s = direct induced e.m.f. in secondary winding.
- $n = E_p/E_s$ = ratio of turns, here 1:1.
- I_s = total secondary current to load.
- I_p = total current in transformer primary.
- r_p, x_p, r_s, x_s = resistances and leakage reactances of the windings.
- V_p = voltage impressed on transformer primary.
- V_s = terminal voltage of transformer secondary.
- θ_s = phase angle of load on transformer secondary.
- α = angle between primary and reversed secondary voltages.

observed from a study of the power transformer. The appropriate modifications in design of a transformer which will have accuracy for measurement purposes can be inferred from the factors which render the transformer designed primarily for economical efficiency of power conversion inadequate for precise-measurement requirements.

2-2. Transformer Regulation and Phase Angle in General.—Transformer performance is usually represented by the vector diagram of Fig. 6, drawn for a 1:1 ratio of turns and with exaggerated values of the exciting current and the resistances and leakage reactances of the windings.

For secondary loads of slightly lagging power factors, as represented in Fig. 6a, the following characteristics may be noted;

1. The primary current is greater than the secondary because of the presence of the exciting current in the primary.
2. The angle of current lag in the primary is greater than in the secondary because of the large angle of lag of the exciting current.
3. The secondary terminal voltage is less than the impressed primary voltage; *i.e.*, the ratio of transformation is greater than 1:1.
4. The secondary terminal voltage lags more than 180° behind the impressed primary voltage. The excess is α .
5. The resistance of the windings is principally responsible for the departure from the 1:1 ratio in voltage aimed at in the 1:1 ratio of turns. For low values of load power factor (Fig. 6b) the resistance of the windings has more effect on the phase angle α .
6. The leakage reactance of the windings is principally responsible for the departure of α° from phase opposition (180°). For low values of load power factor, the reactance has more effect on the ratio.
7. The exciting current contributes to both ratio and phase-angle departures.

VOLTAGE TRANSFORMER

2-3. Voltage Transformer.—In order that a transformer shall conform closely to the ideal for measurement purposes it will be necessary to minimize the influences which, in the power transformer, result in departures in ratio and phase angle of the voltages of the two windings. First, the resistances of the windings must be relatively low; this tends toward increase in cross section and weight of copper. Second, the leakage reaction must be kept at relatively low values. Third, the exciting current must be kept at low values; this tends toward the employment of larger cross section and weight of the iron core and also toward

the employment of relatively more turns of primary (and also of secondary) windings. In short, the instrument voltage transformer will weigh much more in pounds per volt-ampere of rated capacity than a comparable power transformer as a result of the efforts to approach the ideal for measurement purposes. Recent developments of high-permeability low-loss iron for instrument-transformer cores have improved the characteristics and at the same time reduced the weights.

The secondary "load" of instrument voltage transformers consists of such instruments as voltmeters and the voltage coils of

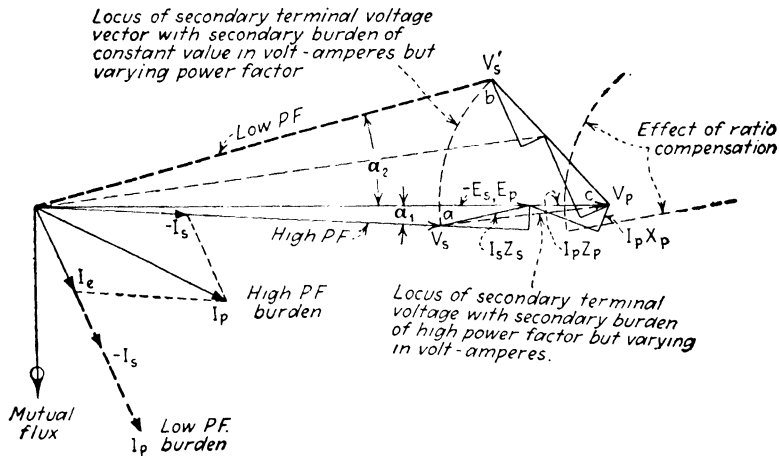

FIG. 7.

wattmeters, watthour meters, power-factor meters, relays. To distinguish this instrument load from the line load which is being metered, the former is preferably denoted as a "burden."

2-4. Effect of Burden on Performance.—The effect of different kinds and magnitudes of burden of instruments connected to the secondary terminals of a voltage transformer is shown in Fig. 7. In this figure the secondary values of current and voltage have been reversed to facilitate simultaneous observations on the effects of the resistances and reactances of the two windings. In fact it is probably much nearer the truth to acknowledge the existence of but one leakage reactance and a diagram on this basis would be an improvement on Fig. 6.

If the burden is of high power factor it is seen that, in general, the effects of decreasing value of burden volt-amperes (*i.e.*, less secondary current to instruments or fewer instruments or instruments of higher impedance) are:

1. A ratio value which improves as the burden volt-amperes decrease. The locus is *ac*.
2. A phase angle α_1 which is small and usually lagging and, therefore, called negative.
3. Phase angle decreases with burden volt-amperes.

If the burden is of low power factor (which is the case with voltage elements of induction watt-hour meters, synchrosopes, and some power-factor meters and relays) the following effects are noted:

1. The ratio is nearer unity than with burden of high power factor (non-inductive instruments). The locus is *bc*.
2. The phase angle α_2 is leading and, therefore, called positive.
3. The phase angle is much larger than with burden of high power factor but, of course, decreases as the burden volt-amperes decrease.

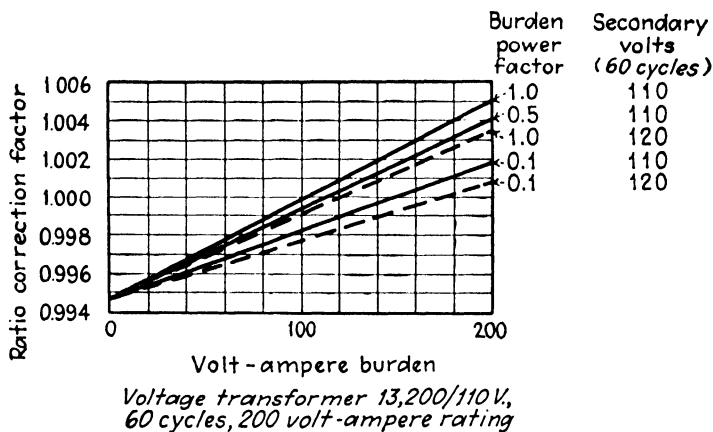

FIG. 8.

2-5. Voltage Transformer Ratio Curves.—The locus of the secondary voltage vector V_s for all values of lagging burden power factor and within the volt-ampere rating of the transformer will be on or within the sector boundaries *abc* in Fig. 7. It is evident that it will not be possible to present for a particular voltage transformer all the values of ratio and phase angle which will ensue from all the possible combinations of power factor and volt-ampere magnitude of the secondary instrument burdens. It can readily be done for all volt-ampere values of burden at a few representative values of burden power factor as shown in Fig. 8.

In this instance the transformer has been compensated for ratio by adding a few extra turns to the secondary winding or removing a few from the primary winding. This results in increasing the secondary induced and terminal voltages, the loci *ac* and *ab* in Fig. 7 being shifted outward along V_p . Then V_s can exceed V_p and $V_s/V_p < 1$ or > 1 depending on the magnitude of the volt-ampere burden. In Fig. 8 the effect of compensation has been to move the scale of the ratio correction factor upward. Thus for a volt-ampere burden of less than 100 at p.f. = 1.0 the secondary voltage is more than 1/120 of the primary and

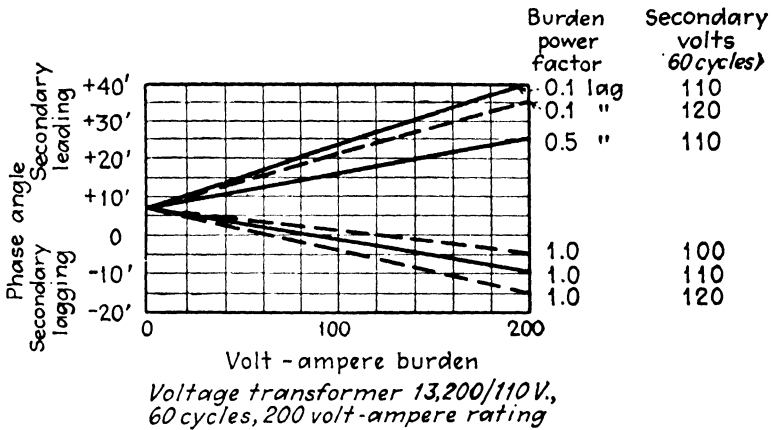

FIG. 9.

the ratio correction factor is less than 1. For more volt-amperes of burden V_s drops and the ratio correction factor exceeds 1.

It should be noted that higher secondary (and therefore primary) voltage lowers the ratio curve for all power factors of burden; also that the effect on the ratio of decreasing value of burden power factor is more rapid after passing 50 per cent value of power factor (lagging).

2-6. Voltage Transformer Phase-angle Curves.—In Fig. 9 are shown the phase-angle data for the same transformer as that for which the ratio curves are given in Fig. 8. Again the lagging phase angle (reversed secondary behind primary) is small for burdens of high power factor; the phase angle is large and leading for low power-factor burdens. Higher than normal voltage tends to decrease the departure in phase angle. The change in phase angle is more rapid between 1.0 and 0.5 values of burden power factor than between 0.5 and 0.1. This circumstance makes it

difficult to interpolate in reading from the curves the true phase angle (and similarly the ratio from Fig. 8) for other values of power factor than those plotted. This particular transformer was evidently so designed as to have zero value of phase angle for about the same value of volt-ampere burden (p.f. = 1) for which the compensating turns rendered the ratio correction factor unity.

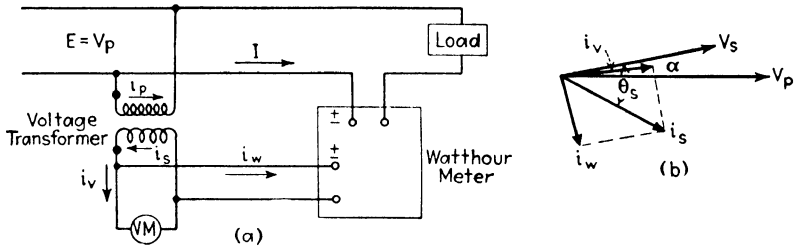

FIG. 10.

2-7. Voltage Transformer with Voltmeter.—The secondary burden on the voltage transformer in Fig. 10a consists of the voltmeter and the voltage coils of the watt-hour meter. The voltmeter is nearly non-inductive and the current i_v taken by it is nearly in phase with V_s . The voltage coil of the watt-hour meter is highly inductive and the current i_w taken by it lags nearly 90° behind V_s . The total current i_s supplied by the secondary of the transformer lags θ_s deg. behind V_s . It should be noted that the total volt-amperes of burden, $V_s i_s$, is the vector sum rather than the numerical sum of the individual volt-amperes supplied to the separate instruments.

The current i_s in the secondary at the phase angle θ_s creates a phase angle α (shown leading) and a ratio departure with respect to the primary voltage V_p . The voltmeter reading will be in error to the extent of this departure from equality if the ratio of turns is 1:1 or from the nominal ratio if other than 1:1. The true voltage of the line can be derived from the voltmeter reading by multiplying it by $K_v R_v$ in which R_v is the nominal ratio and K_v the ratio correction factor corresponding to these particular values of burden volt-amperes and power factor (Fig. 8). The phase angle α is not significant in the case of the voltmeter indications.

$$\text{Voltage transformer ratio factor} = K_v R_v$$

2-8. Voltage Transformer with Wattmeter.—Replacing the voltmeter and watt-hour meter of Fig. 10 by an indicating wattmeter (say of the electrodynamic type nearly non-inductive but with small voltage-circuit phase angle γ), the total transformer secondary current i_s would be nearly in phase with V_s (Fig. 11). The transformer phase angle α will be small and lagging and, therefore, called negative (Fig. 7). The true power

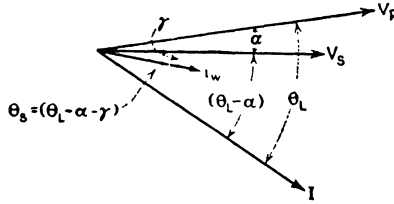

FIG. 11.

delivered to the load is $EI \cos \theta_L$. The wattmeter reading will not be wholly correct because:

1. Of the departure in ratio of the transformer with this particular burden.
2. The phase angle α of the transformer will make the apparent phase angle between E and I (or V_s and I) at the wattmeter differ from the true value θ_L for the load.
3. The inductance of the voltage element of the wattmeter will introduce an error inherent in the wattmeter. This phase angle is γ .

Let R_v = nominal ratio of voltage transformer.

K_v = ratio correction factor, voltage transformer.

K_{wv} = correction factor, wattmeter with voltage transformer.

α = voltage transformer phase angle, positive when reversed secondary leads.

γ = phase angle of voltage circuit of wattmeter.

$\cos \theta_L$ = power factor in line to load.

$\cos \theta_s$ = apparent load power factor, observed in meter circuit.

$\theta_s = \theta_L - \alpha - \gamma$, for lagging secondary voltage.

The true power is

$$EI \cos \theta_L = V_p I \cos (\theta_s + \alpha + \gamma)$$

The wattmeter indicates

$$R_v V_s \times I \cos \theta_s$$

But

$$V_p = K_v R_v V_s$$

Therefore, the wattmeter correction factor, to offset the error introduced by its own phase angle and that of the voltage transformer as well as the ratio error of the transformer, is

$$K_{wv} = \frac{K_v R_v V_s I \cos(\theta_s + \alpha + \gamma)}{R_v V_s I \cos \theta_s} = K_v \frac{\cos(\theta_s + \alpha + \gamma)}{\cos \theta_s} \quad [5]$$

If the burden were of low power factor (say the watt-hour-meter voltage coil of Fig. 10), the reversed secondary voltage would probably lead the primary voltage and the phase angle α would be positive. The correction factor then becomes

$$K_{wv} = K_v \frac{\cos(\theta_s - \alpha + \gamma)}{\cos \theta_s} \quad [6]$$

The correction factor for the two cases condenses into

$$K_{wv} = K_v \frac{\cos(\theta_s \pm \alpha + \gamma)}{\cos \theta_s} \quad [7]$$

in which the plus sign for α applies to high power factor of burden (which makes the reversed secondary voltage lag the primary voltage) and the minus sign to low power factor of burden which makes it lead.

Some handbooks use the plus sign for transformer phase angles which tend to make the wattmeter reading larger than the true value. This practice is to be deplored because it is inconsistent, the leading angle being called negative for voltage transformers and positive for current transformers.

CURRENT TRANSFORMER

2-9. Ideal Current Transformer.—The ideal current transformer would give a secondary current equal to $1/N$ of the primary current (where N is the marked ratio) for all reasonable values of primary current, frequency, wave form, and secondary instrument burden in volt-amperes and power factor. It would also deliver to the instruments a secondary current always differing by 180° in phase from the line current through its primary winding. On account of the ampere-turns required as a magnetizing component to establish the working flux which induces the secondary voltage, the secondary ampere-turns effective are less than the primary ampere-turns and

$$n_2 I_2 < n_1 I_1$$

or

$$\frac{I_2}{I_1} < \frac{n_1}{n_2}$$

and the transformer inherently requires a correction factor greater than unity to obtain primary from secondary values of

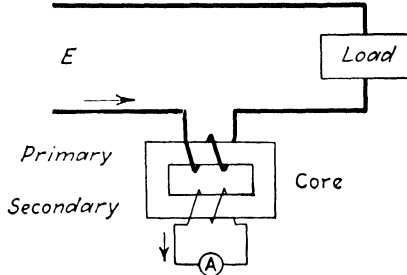

FIG. 12.

amperes unless some compensation is obtained by judicious modification of the ratio of turns n_1/n_2 .

2-10. Theory of Current Transformer.—In fundamental principle of action the instrument current transformer is identical with the common power transformer. The vector diagram of

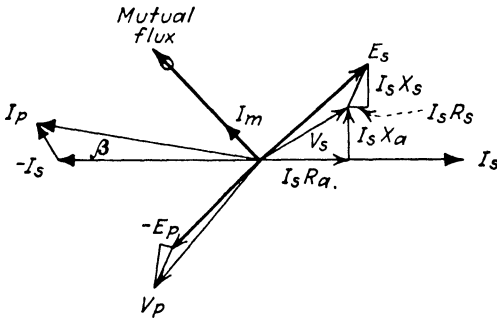

FIG. 13.

Fig. 6 applies then with equal force to current and voltage transformers.

But in the power transformer on a constant-potential line the secondary load current determines the primary current. In the current transformer, however, the primary current is determined by the constants of the main circuit and practically not at all by the variations in secondary burden on the transformer. The fact that the current transformer is inserted in the line in series

with the load (rather than in parallel with the load as is the case with the voltage transformer) places the emphasis on the current relations, the voltages of the windings being of relative unimportance.

Consider the 1:1 ratio current transformer of Fig. 12 with merely an ammeter in the secondary circuit indicating, say, 5 amp. of secondary current I_s . The low impedance of the ammeter involves small $I_s R_a$ and $I_s X_a$ drops which necessitate the application of a small voltage V_s to its terminals (Fig. 13). The impedance of the secondary winding of the transformer will absorb voltage drops of $I_s R_s$ and $I_s X_s$ through the resistance and leakage reactance. The induced secondary voltage must be E_s and this is established by the mutual flux in the core. The mutual flux is in turn established by an exciting current I_m which must, of course, be a component of the line current through the primary. The flux densities employed in current transformers are so low as to involve only negligible core losses; therefore the entire exciting current I_e may be considered to be applied to magnetization ($I_c = 0$, $I_e = I_m$). The other component of the primary current is $-I_s$, offsetting the demagnetizing effect of I_s in the secondary. The total primary current, *i.e.*, the line current under measurement, exceeds the secondary current; also the reversed secondary current leads the primary by the transformer phase angle β . A leading (reversed) secondary current is called a *positive phase angle*.

The impedance voltage drop in the primary results in a terminal voltage, V_p , which is only slightly greater than V_s and is, therefore, also small. Being small it may be admitted as a series voltage drop in the line along with the drops in the line conductors. If the ratio of primary to secondary current is large, the voltage drop across the primary of the current transformer will be approximately in inverse proportion to the currents and therefore of still less consequence as a line-drop factor.

2-11. Factors Affecting Current Transformer Performance.—Several factors are involved in the ratio and phase-angle performance of current transformers, *viz.*, the magnitude of primary (and secondary) current, the frequency of the supply, the volt-ampere burden of secondary instruments, and the proportions of its resistance and reactance (*i.e.*, the power factor of the burden).

It appears at first glance as if the ratio and phase angle would be constant and independent of the magnitude of the current. Thus in Fig. 13, with the resistances and reactances of the burden and transformer windings assumed to be constant, an increase or decrease in I_s would create proportional resistance and reactance drops in the burden and both windings and therefore the necessary values of induced secondary voltage E_s and terminal primary voltage V_p would be proportional to I_s . The mutual flux in turn would also be proportional to I_s . With a straight magnetization curve for the iron of the core the exciting current I_m would also be proportional to I_s . Therefore, all elements in Fig. 13 would appear to change proportionally with the primary or secondary current and the ratio and phase angle would be constant. Actually, however, the flux densities employed in current transformers are so low as to accentuate the effect of the hook at the lower end of magnetization curves; this hook is usually obscured in curves

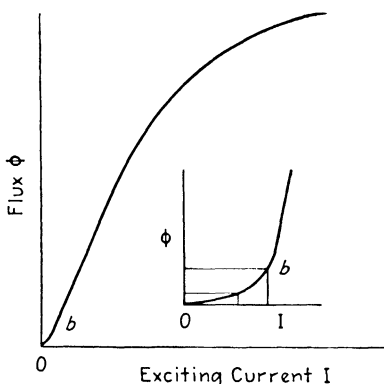

Exciting Current I
FIG. 14.

scaled to embrace the saturation region. Thus in Fig. 14 it is seen that, for the very low flux densities accompanying low values of primary and secondary currents, the magnetizing current is relatively larger than for currents nearer the rated value. This accounts for the characteristic rise in ratio correction factor and phase angle with decreasing secondary current.

The flux (and with it the exciting current) must be greater at the lower frequencies to induce the same voltage. On the other hand, the leakage reactance of the windings will be decreased as will the reactive component of the secondary volts for the same inductive instrument burden. On the whole the effect is to make the current transformer less satisfactory on 25 cycles than on 60 cycles as to both ratio and phase angle.

2-12. Effect of Burden on Performance.—The burden on current transformers consists of current windings of instruments in series. The induced and secondary terminal voltages must be increased to meet the increasing impedance of added instruments;

this demands an increase in mutual flux and exciting current with consequent influence on the ratio and phase angle as seen from Fig. 13. Likewise the varying power factor of the burden will influence both ratio and phase angle, the latter in general more pronouncedly than the former. Table I (Chap. I) shows the impedance characteristics of various types of instruments; in

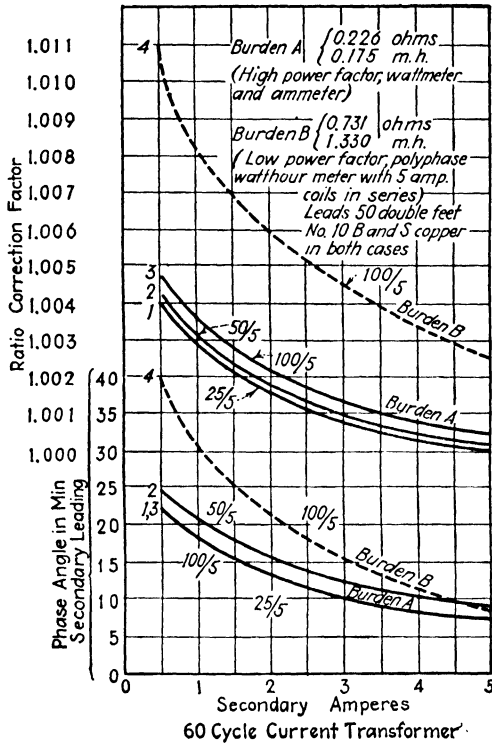

FIG. 15.

general the induction-type instruments, both indicating and integrating (including watt-hour meters), will show higher inductances than electrodynamic instruments and, therefore, involve more departure in ratio and phase angle of transformers. Figure 15 shows typical performance for a 60-cycle current transformer. The scales are enlarged to emphasize the characteristics. There is no simple manner of interpolating for other values of burden in volt-amperes (always expressed at the 5-amp. value of secondary current) or for various values of burden power factor. The laboratories which calibrate current

transformers have standardized certain combinations of ohms and millihenries which approximate the actual burdens experienced in practice; the calibration is reported for these standard burdens unless some specific instrument burden is stipulated.

A word of caution is essential in connection with the use of current transformers. An open-circuited secondary approaches an infinite burden. The whole primary current produces flux because the demagnetizing effect of the secondary current is zero. The resultant flux and flux density rise to high values and induce a voltage at the secondary terminals which may be high enough to be dangerous to life. The usual step-down in current ratio is attended with a step-up in voltage and the secondary terminal voltage is several times the impedance drop through the primary; the latter may be a sizable fraction of the circuit voltage because of the high impedance of the primary with the secondary open. The iron loss, increasing almost as the square of the flux density, may cause breakdown from excessive heating. The secondary of a current transformer should always be closed through the instruments or through a short-circuiting jumper whenever there is current flowing through the primary winding.

Another word of caution concerns the region below one-tenth current value, the limit at which the calibration curves are usually terminated. This region is also one that involves the condensed portion of the scale of ammeters, moving iron and electrodynamic. The substitution of, say, a 1-amp. ammeter for the 5-amp. meter on the secondary would appear to give more accurately the reading of fractional secondary amperes and, therefore, the low values of primary amperes. This is a delusion, first, because the ratio curves rise rapidly to high values as the current approaches zero and, second, the much higher impedance (see Table I, Chap. I) of low-current instruments increases the burden and raises the level of the ratio curve. Considerable error in wattmeter reading would result because the phase angle also rises to large and uncertain values. The error from biased magnetization of the core is also of greatest effect in this region.

2-13. Current Transformer with Ammeter.—The total impedance of the burden is the vector sum of the impedances of the instruments in series on the current transformer secondary. If the transformer has been calibrated for this particular impedance, the ratio curve gives the ratio correction factor K_c . The true ratio is the nominal ratio R_c times K_c .

$$\left. \begin{array}{l} \text{Current transformer} \\ \text{ratio correction factor} \end{array} \right\} = K_c R_c$$

Primary current = $K_c R_c \times$ secondary current

The phase angle β is not significant in the case of ammeter indications.

2-14. Current Transformer with Wattmeter.—Replace the ammeter of Fig. 12 by an indicating wattmeter (say of the electrodynamic type, having a small voltage-circuit phase angle γ) with voltage applied directly from the line. The secondary current I_s to the wattmeter leads the primary (line) current by the transformer phase angle β . The current i_p in the voltage coil of the wattmeter lags behind the voltage by the wattmeter phase angle. The apparent phase angle within the wattmeter is $\theta_s = (\theta_L - \beta - \gamma)$ instead of the true phase angle θ_L of the load circuit.

Let R_c = nominal ratio of current transformer.

K_c = ratio correction factor of current transformer.

K_{wc} = correction factor, wattmeter with current transformer.

β = current transformer phase angle, positive when reversed secondary current leads.

$\theta_s = \theta_L - \beta - \gamma$ (see Fig. 16).

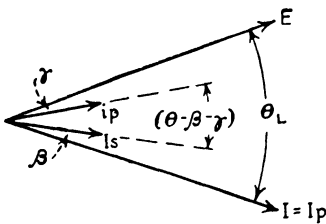

FIG. 16.

The true power is

$$EI_p \cos \theta_L = EI_p \cos (\theta_s + \beta + \gamma)$$

The wattmeter indicates

$$R_c EI_s \cos \theta_s.$$

But

$$I_p = K_c R_c I_s$$

Therefore the wattmeter correction factor, to offset the error introduced by its own phase angle and that of the current transformer as well as the ratio error of the transformer, is

$$K_{wc} = \frac{K_c R_c EI_s \cos (\theta_s + \beta + \gamma)}{R_c EI_s \cos \theta_s} = K_c \frac{\cos (\theta_s + \beta + \gamma)}{\cos \theta_s} \quad [8]$$

The angle β usually involves the reversed secondary current leading the primary current and is therefore positive.

2-15. Current and Voltage Transformers with Wattmeter.—When the wattmeter is used in conjunction with both current

and voltage transformers, there are five factors introducing errors: the ratio departures of the two transformers, their phase angles, and the phase angle γ of the wattmeter voltage circuit. The apparent phase angle θ_s within the wattmeter in Fig. 17b, where the load is inductive (I lagging E by θ_L°) and the wattmeter burden on the voltage transformer creates a lagging phase angle, is $(\theta_L - \alpha - \beta - \gamma)$.

Let K_{wvc} = correction factor, wattmeter used with voltage transformer and current transformer.

$$\theta_s = (\theta_L - \alpha - \beta - \gamma) \text{ (Fig. 17ab).}$$

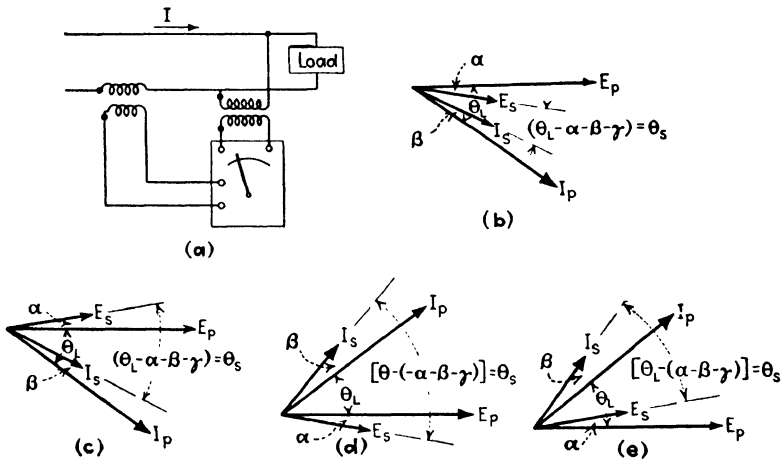

FIG. 17.

The true power is

$$EI \cos \theta_L = V_p I_p \cos (\theta_s + \alpha + \beta + \gamma)$$

The wattmeter indicates

$$R_v V_s R_c I_s \cos \theta_s.$$

True volts

$$V_p = K_v R_v V_s$$

True amperes

$$I_p = K_c R_c I_s$$

Therefore, the wattmeter correction factor, to offset the ratio and phase-angle errors of both current transformer and voltage transformer and its own phase angle, is

$$\begin{aligned}
 K_{wvc} &= \frac{V_p I_p \cos(\theta_s + \alpha + \beta + \gamma)}{V_s I_s \cos \theta_s} \\
 &= \frac{K_v R_v V_s \times K_c R_c I_s \cos(\theta_s + \alpha + \beta + \gamma)}{R_v V_s \times R_c I_s \cos \theta_s} \\
 &= K_v K_c \frac{\cos(\theta_s + \alpha + \beta + \gamma)}{\cos \theta_s} \quad [9]
 \end{aligned}$$

If the instrument had had a more highly inductive voltage winding (say a watt-hour meter) than the indicating wattmeter of Fig. 17a, the voltage transformer would have had a leading secondary voltage (reversed); α would tend to increase θ_s over θ_L and thus be positive in $\theta_s = \theta_L + \alpha - \beta - \gamma$ and negative in Eq. [9]. Then

$$K_{wvc} = K_v K_c \frac{\cos(\theta_s - \alpha + \beta + \gamma)}{\cos \theta_s} \quad [10]$$

Another possibility to consider is a leading load current (Fig. 17d) with a wattmeter as burden; in this case

$$\theta_L = \theta_s - \alpha - \beta - \gamma = \theta_s - (\alpha + \beta + \gamma)$$

and

$$K_{wvc} = K_v K_c \frac{\cos[\theta_s - (\alpha + \beta + \gamma)]}{\cos \theta_s} \quad [11]$$

All the foregoing expressions, Eqs. [5] to [11], may be consolidated into one:

$$K_{wvc} = K_v K_c \frac{\cos[\theta_s \pm (\pm \alpha \pm \beta + \gamma)]}{\cos \theta_s} \quad [12]$$

in which the plus sign before the parenthesis applies when the load current lags and the minus sign when it leads the load voltage; the plus sign with α applies when the reversed secondary voltage lags the primary voltage and the minus sign when it leads; the plus sign is used with β when the current transformer secondary current leads and the minus sign in case it lags; the phase angle γ of the wattmeter is always lagging and given the positive sign in Eq. [12].

In the case of watt-hour meters the phase angle corresponding to γ for indicating wattmeters is either eliminated by the so-called "lagging" adjustment (see 9-4) and therefore γ disappears from the foregoing expressions, or else an over-all calibration and adjustment are made.

2-16. Instrument Transformer Correction Tables.—Convenient tables computed by Dr. H. B. Brooks have been included in the Code for Electricity Meters (approved by the American Standards Association and published by the National Electric Light Association and Association of Edison Illuminating Companies). These tables (II and III) are reproduced here by permission with modification only as to the conventional sign of α .

Linear interpolation for correction factors corresponding to values of $(\alpha + \beta)$ lying between those given in the table may be made without error. Interpolation for correction factors corresponding to values of $\cos \theta_s$ lying between those tabulated may be made without exceeding an error of 0.0010 in the region of the table between the heavy lines; below or across the lines the linear interpolation will result in errors exceeding 0.0010.

2-17. Compensation of Current Transformers.—The ratio correction factor of a current transformer can be made unity for some particular combination of values of current, burden, and frequency by simply removing a few of the secondary turns. This will have practically no effect, however, on the phase angle and for low power factors an appreciable phase angle will introduce errors of some consequence in the wattmeter or watt-hour meter. Thus a phase angle of 20 min. will create an error of 0.3 per cent in watts when the power factor of the load is 86.6 per cent lagging and of 1.0 per cent when the power factor is 50 per cent lagging.

Various schemes have been used to reduce the phase-angle error of current transformers. (1) A non-inductive shunt can be connected across the secondary winding to divert and subtract an appropriate amount of current from the burden. This shunted current is in a phase position tending to restore the remainder to phase opposition to the primary current and thus reduce the leading phase angle. The disturbed ratio can then be corrected by choice of turn ratio. (2) An auxiliary winding can supply this corrective current to a circuit containing appropriate values of R , L , and C to compensate for the disturbing effects of the exciting current. (3) An auxiliary transformer may be connected in series with, say, the secondary of the principal transformer and given a ratio and phase angle that will supply to the burden a corrective current of such magnitude and phase position as to establish minimum ratio and phase departure of the

TABLE II.—INSTRUMENT TRANSFORMERS
 $\frac{\cos(\theta + \alpha + \beta)}{\cos \theta}$ for Lagging Current When $(\beta - \alpha)$ Is Positive or for Leading Current When $(\beta - \alpha)$ Is Negative

Net phase angle $(\beta - \alpha)$	Observed power factor $\cos \theta$, in meter circuit													
	0.10	0.15	0.20	0.25	0.30	0.40	0.50	0.60	0.70	0.80	0.90	0.95	0.99	1.00
5'	0.9855	0.9904	0.9929	0.9944	0.9954	0.9967	0.9975	0.9981	0.9985	0.9989	0.9993	0.9995	0.9998	1.0000
10'	0.9711	0.9808	0.9857	0.9887	0.9907	0.9933	0.9950	0.9961	0.9970	0.9978	0.9986	0.9990	0.9996	1.0000
15'	0.9566	0.9712	0.9786	0.9831	0.9861	0.9900	0.9924	0.9942	0.9955	0.9967	0.9979	0.9986	0.9994	1.0000
20'	0.9421	0.9616	0.9715	0.9775	0.9815	0.9867	0.9899	0.9922	0.9940	0.9956	0.9972	0.9981	0.9992	1.0000
25'	0.9276	0.9520	0.9643	0.9718	0.9768	0.9833	0.9874	0.9903	0.9926	0.9945	0.9965	0.9976	0.9989	1.0000
30'	0.9131	0.9424	0.9572	0.9662	0.9722	0.9800	0.9848	0.9883	0.9911	0.9934	0.9957	0.9971	0.9987	1.0000
40'	0.8842	0.9232	0.9429	0.9549	0.9629	0.9733	0.9798	0.9844	0.9881	0.9912	0.9943	0.9961	0.9983	0.9999
50'	0.8552	0.9040	0.9286	0.9436	0.9536	0.9666	0.9747	0.9805	0.9851	0.9890	0.9929	0.9951	0.9978	0.9999
1° 0'	0.8262	0.8848	0.9143	0.9323	0.9444	0.9599	0.9696	0.9766	0.9820	0.9868	0.9914	0.9941	0.9974	0.9998
10'	0.7972	0.8656	0.9000	0.9209	0.9350	0.9531	0.9645	0.9726	0.9790	0.9845	0.9899	0.9931	0.9969	0.9998
20'	0.7682	0.8464	0.8857	0.9096	0.9257	0.9464	0.9594	0.9687	0.9760	0.9823	0.9885	0.9921	0.9964	0.9997
30'	0.7392	0.8271	0.8714	0.8983	0.9164	0.9397	0.9543	0.9648	0.9730	0.9800	0.9870	0.9911	0.9959	0.9997
40'	0.7102	0.8079	0.8571	0.8869	0.9071	0.9329	0.9492	0.9608	0.9699	0.9778	0.9855	0.9900	0.9954	0.9996
50'	0.6812	0.7886	0.8428	0.8756	0.8978	0.9262	0.9441	0.9568	0.9668	0.9755	0.9840	0.9890	0.9949	0.9995
2° 0'	0.6521	0.7694	0.8284	0.8642	0.8884	0.9194	0.9389	0.9529	0.9638	0.9732	0.9825	0.9879	0.9944	0.9994
10'	0.6231	0.7501	0.8141	0.8529	0.8791	0.9127	0.9338	0.9489	0.9607	0.9709	0.9810	0.9869	0.9939	0.9993
20'	0.5941	0.7308	0.7997	0.8415	0.8697	0.9059	0.9287	0.9449	0.9576	0.9686	0.9795	0.9858	0.9934	0.9992

TABLE II.—INSTRUMENT TRANSFORMERS.—(Continued)

Net phase angle ($\beta - \alpha$)	Observed power factor $\cos \theta$, in meter circuit													
	0.10	0.15	0.20	0.25	0.30	0.40	0.50	0.60	0.70	0.80	0.90	0.95	0.99	1.00
30°	0.5650	0.7115	0.7854	0.8301	0.8603	0.8991	0.9235	0.9409	0.9545	0.9663	0.9779	0.9847	0.9928	0.9990
40°	0.5360	0.6923	0.7710	0.8187	0.8510	0.8923	0.9183	0.9369	0.9515	0.9640	0.9764	0.9836	0.9923	0.9989
50°	0.5069	0.6730	0.7566	0.8073	0.8416	0.8855	0.9132	0.9329	0.9483	0.9617	0.9748	0.9825	0.9917	0.9988
3° 0'	0.4779	0.6537	0.7422	0.7959	0.8322	0.8787	0.9080	0.9288	0.9452	0.9594	0.9733	0.9814	0.9912	0.9986
10'	0.4488	0.6344	0.7279	0.7845	0.8228	0.8719	0.9028	0.9248	0.9421	0.9570	0.9717	0.9803	0.9906	0.9985
20'	0.4198	0.6151	0.7135	0.7731	0.8134	0.8651	0.8976	0.9208	0.9390	0.9547	0.9701	0.9792	0.9900	0.9983
30'	0.3907	0.5957	0.6991	0.7617	0.8040	0.8583	0.8924	0.9167	0.9359	0.9523	0.9686	0.9781	0.9894	0.9981
40'	0.3616	0.5764	0.6847	0.7503	0.7946	0.8514	0.8872	0.9127	0.9327	0.9500	0.9670	0.9769	0.9888	0.9980
50'	0.3326	0.5571	0.6702	0.7388	0.7852	0.8446	0.8820	0.9086	0.9296	0.9476	0.9654	0.9758	0.9882	0.9978
4° 0'	0.3035	0.5378	0.6558	0.7274	0.7758	0.8377	0.8767	0.9046	0.9264	0.9452	0.9638	0.9746	0.9876	0.9976
10'	0.2744	0.5185	0.6414	0.7160	0.7663	0.8309	0.8715	0.9005	0.9232	0.9429	0.9622	0.9735	0.9870	0.9974
20'	0.2453	0.4991	0.6270	0.7045	0.7569	0.8240	0.8663	0.8964	0.9201	0.9405	0.9605	0.9723	0.9864	0.9971
30'	0.2163	0.4798	0.6125	0.6930	0.7474	0.8171	0.8610	0.8923	0.9169	0.9381	0.9589	0.9711	0.9857	0.9969
40'	0.1872	0.4604	0.5981	0.6816	0.7380	0.8103	0.8558	0.8882	0.9137	0.9357	0.9573	0.9699	0.9851	0.9967
50'	0.1581	0.4411	0.5837	0.6701	0.7285	0.8034	0.8505	0.8841	0.9105	0.9333	0.9556	0.9687	0.9844	0.9964
5° 0'	0.1290	0.4217	0.5692	0.6586	0.7191	0.7965	0.8452	0.8800	0.9073	0.9308	0.9540	0.9675	0.9838	0.9962
10'	0.0999	0.4034	0.5548	0.6472	0.7096	0.7806	0.8400	0.8759	0.9041	0.9284	0.9523	0.9663	0.9831	0.9959
20'	0.0708	0.3830	0.5403	0.6357	0.7001	0.7827	0.8347	0.8719	0.9008	0.9260	0.9507	0.9651	0.9824	0.9957

TABLE III.—INSTRUMENT TRANSFORMERS
 $\frac{\cos(\theta_s + \alpha + \beta)}{\cos \theta_s}$ for Lagging Current When $(\beta - \alpha)$ Is Negative or for Leading Current When $(\beta - \alpha)$ Is Positive

Net phase angle $(\beta - \alpha)$	Observed power factor, $\cos \theta_s$, in meter circuit													
	0.10	0.15	0.20	0.25	0.30	0.40	0.50	0.60	0.70	0.80	0.90	0.95	0.99	1.00
5'	1.0145	1.0096	1.0071	1.0056	1.0046	1.0033	1.0025	1.0019	1.0015	1.0011	1.0007	1.0005	1.0002	1.0000
10'	1.0289	1.0192	1.0142	1.0113	1.0092	1.0067	1.0050	1.0039	1.0030	1.0022	1.0014	1.0010	1.0004	1.0000
15'	1.0434	1.0288	1.0214	1.0169	1.0139	1.0100	1.0075	1.0058	1.0044	1.0033	1.0021	1.0014	1.0006	1.0000
20'	1.0579	1.0383	1.0285	1.0225	1.0185	1.0133	1.0101	1.0077	1.0059	1.0043	1.0028	1.0019	1.0008	1.0000
25'	1.0723	1.0479	1.0356	1.0281	1.0231	1.0166	1.0126	1.0097	1.0074	1.0054	1.0035	1.0024	1.0010	1.0000
30'	1.0868	1.0575	1.0427	1.0338	1.0277	1.0200	1.0151	1.0116	1.0089	1.0065	1.0042	1.0028	1.0012	1.0000
40'	1.1157	1.0766	1.0569	1.0450	1.0369	1.0266	1.0201	1.0154	1.0118	1.0087	1.0056	1.0038	1.0016	0.9999
50'	1.1446	1.0958	1.0711	1.0562	1.0461	1.0332	1.0251	1.0193	1.0147	1.0108	1.0069	1.0047	1.0020	0.9959
1°	1.1735	1.1149	1.0853	1.0674	1.0553	1.0398	1.0301	1.0231	1.0177	1.0129	1.0083	1.0056	1.0023	0.9998
10'	1.2024	1.1340	1.0995	1.0787	1.0645	1.0464	1.0351	1.0269	1.0206	1.0151	1.0097	1.0065	1.0027	0.9998
20'	1.2313	1.1531	1.1137	1.0898	1.0737	1.0530	1.0400	1.0308	1.0235	1.0172	1.0110	1.0074	1.0030	0.9997
30'	1.2601	1.1722	1.1279	1.1010	1.0829	1.0596	1.0450	1.0346	1.0264	1.0193	1.0123	1.0083	1.0034	0.9997
40'	1.2890	1.1913	1.1421	1.1122	1.0921	1.0662	1.0500	1.0384	1.0292	1.0214	1.0137	1.0091	1.0037	0.9996
50'	1.3178	1.2104	1.1562	1.1234	1.1012	1.0728	1.0549	1.0421	1.0321	1.0235	1.0150	1.0100	1.0040	0.9995
2°	1.3466	1.2294	1.1704	1.1346	1.1104	1.0794	1.0598	1.0459	1.0350	1.0256	1.0163	1.0109	1.0044	0.9994
10'	1.3755	1.2485	1.1845	1.1457	1.1195	1.0859	1.0648	1.0497	1.0379	1.0276	1.0176	1.0117	1.0047	0.9993
20'	1.4043	1.2675	1.1986	1.1569	1.1286	1.0925	1.0697	1.0535	1.0407	1.0297	1.0189	1.0126	1.0050	0.9992

TABLE III.—INSTRUMENT TRANSFORMERS.—(Continued)

Net phase angle ($\beta - \alpha$)	Observed power factor, $\cos \theta_s$, in meter circuit													
	0.10	0.15	0.20	0.25	0.30	0.40	0.50	0.60	0.70	0.80	0.90	0.95	0.99	1.00
30'	1.4331	1.2866	1.2127	1.1680	1.1377	1.0990	1.0746	1.0572	1.0435	1.0318	1.0202	1.0134	1.0063	0.9990
40'	1.4618	1.3056	1.2268	1.1791	1.1469	1.1055	1.0795	1.0610	1.0464	1.0338	1.0215	1.0142	1.0055	0.9989
50'	1.4906	1.3246	1.2409	1.1902	1.1560	1.1120	1.0844	1.0647	1.0492	1.0359	1.0227	1.0150	1.0058	0.9988
3°	1.5194	1.3436	1.2550	1.2013	1.1650	1.1185	1.0893	1.0684	1.0520	1.0379	1.0240	1.0158	1.0061	0.9986
10'	1.5481	1.3626	1.2691	1.2124	1.1741	1.1250	1.0942	1.0721	1.0548	1.0399	1.0252	1.0166	1.0063	0.9985
20'	1.5768	1.3816	1.2832	1.2235	1.1832	1.1315	1.0990	1.0758	1.0576	1.0419	1.0265	1.0174	1.0066	0.9983
30'	1.6056	1.4005	1.2972	1.2346	1.1923	1.1380	1.1039	1.0795	1.0604	1.0439	1.0277	1.0182	1.0068	0.9981
40'	1.6343	1.4195	1.3113	1.2456	1.2013	1.1445	1.1087	1.0832	1.0632	1.0459	1.0289	1.0190	1.0071	0.9980
50'	1.6630	1.4384	1.3253	1.2567	1.2103	1.1509	1.1136	1.0869	1.0660	1.0479	1.0301	1.0197	1.0073	0.9978
4°	1.6916	1.4573	1.3393	1.2677	1.2194	1.1574	1.1184	1.0906	1.0687	1.0499	1.0313	1.0205	1.0075	0.9976
10'	1.7203	1.4763	1.3533	1.2788	1.2284	1.1638	1.1232	1.0942	1.0715	1.0519	1.0325	1.0212	1.0077	0.9974
20'	1.7489	1.4952	1.3673	1.2898	1.2374	1.1703	1.1280	1.0979	1.0742	1.0538	1.0337	1.0220	1.0079	0.9971
30'	1.7776	1.5141	1.3813	1.3008	1.2464	1.1767	1.1328	1.1015	1.0770	1.0558	1.0349	1.0227	1.0081	0.9969
40'	1.8062	1.5329	1.3953	1.3118	1.2554	1.1831	1.1376	1.1052	1.0797	1.0577	1.0361	1.0234	1.0083	0.9967
50'	1.8348	1.5518	1.4092	1.3228	1.2644	1.1895	1.1424	1.1088	1.0824	1.0596	1.0373	1.0241	1.0085	0.9964
5°	1.8634	1.5707	1.4232	1.3337	1.2733	1.1959	1.1472	1.1124	1.0851	1.0616	1.0384	1.0248	1.0086	0.9962
10'	1.8920	1.5895	1.4371	1.3447	1.2823	1.2023	1.1519	1.1160	1.0878	1.0635	1.0396	1.0255	1.0088	0.9959
20'	1.9205	1.6083	1.4510	1.3557	1.2912	1.2086	1.1567	1.1196	1.0906	1.0654	1.0407	1.0262	1.0089	0.9957

current from the principal secondary. This correction can be effected over a wider range of current, frequency, and burden conditions than method 2. (4) The use of higher permeability, lower loss iron for the core, reduces the ratio and phase-angle departure and therefore avoids the necessity of anything more than ratio compensation. (5) The Brooks* multistage current transformer. (6) General Electric compensated transformer.

2-18. Two-stage Current Transformer.—The two-stage current transformer consists in principle of two distinct transformers, the principal and the auxiliary. The principal transformer effects transformation in the ordinary way, supplying to the instrument burden a current which is approximately correct as to magnitude and phase angle. The auxiliary transformer has a ratio of turns equal (none omitted for ratio compensation) to the desired ratio of primary to secondary current. The primary (line) current and the secondary current from the principal transformer are passed through the respective windings of the auxiliary transformer (Fig. 18a) so that their ampere-turn magnetizing effects upon the core tend to oppose each other. The auxiliary transformer is provided with a supplementary winding called the *auxiliary secondary*; this winding has approximately the same number of turns as the secondary winding of the principal transformer.

If the secondary current from the principal transformer were in exact ratio and phase opposition to the primary current, these currents in the true-ratio auxiliary transformer would annul each other with resulting zero magnetization in the core and zero voltage in the auxiliary secondary winding of the auxiliary transformer. When, however, the secondary current from the principal transformer deviates in ratio and phase angle from the primary current, the difference in phase and magnitude of the ampere-turns impressed on the auxiliary transformer establishes a flux which induces a voltage in the auxiliary winding of the latter. If the auxiliary secondary be connected to an external circuit, the induced voltage will establish a current which will tend to reduce the flux in the auxiliary core to zero. With proper design this auxiliary secondary current closely approximates, in magnitude and phase, the current which should be added vectorially to the principal secondary current to attain a

* BROOKS and HOLTZ, The Two-stage Current Transformer, *Trans. A. I. E. E.*, vol. 41, p. 382, 1922.

resultant current equivalent to that which would be given by an ideal transformer of exact ratio and zero phase angle (Fig. 18b).

The vector relations for the principal current transformer are shown in Fig. 18c and for the auxiliary in Fig. 18d. The

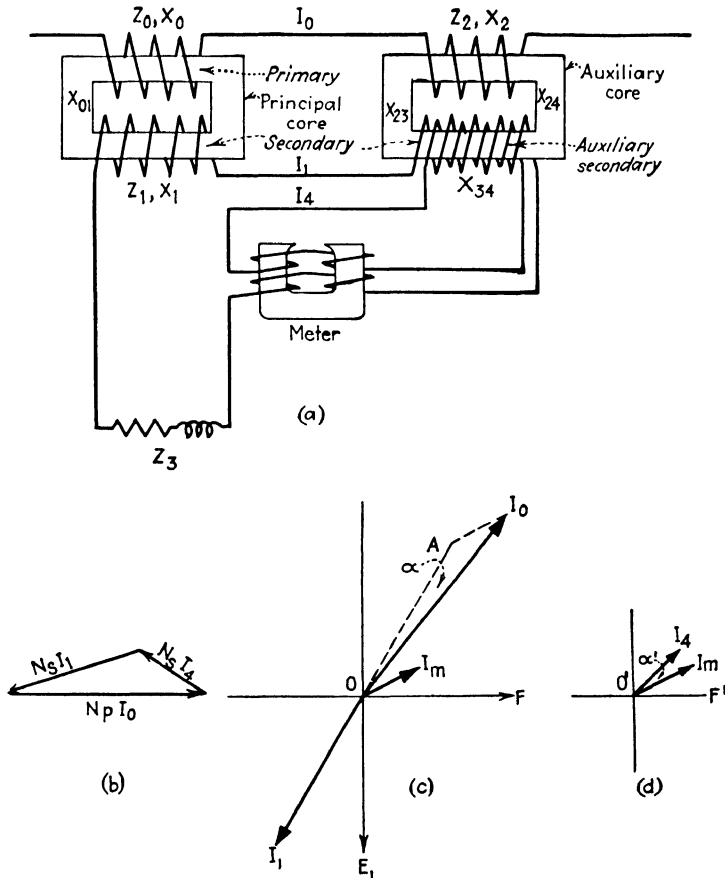

FIG. 18.

vector addition of the corrective current is accomplished by adding its ampere-turn effect through a supplementary winding in the wattmeter or watt-hour meter, this supplementary winding having the same number of turns as its regular current coil which is connected to the secondary of the principal transformer.

Instead of two physically distinct transformers as shown in Fig. 18 it is more convenient to use a single primary winding

and a single secondary winding circling both cores, with the auxiliary secondary winding and a few turns of the principal secondary winding (Fig. 19) surrounding the auxiliary core only.

This scheme in effect adds to the secondary current an equivalent of the exciting current, ordinarily present only in the

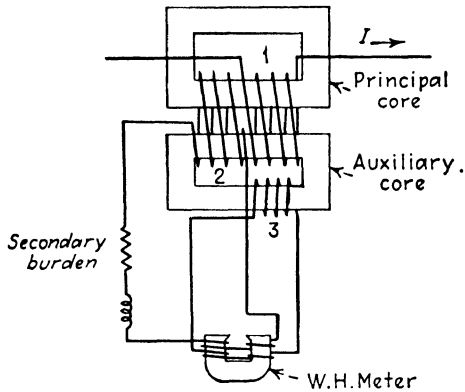

FIG. 19.

primary and, as has been pointed out, the prime cause for departure in ratio and phase angle. The result is a very considerable improvement in the over-all accuracy of watt-hour meters on the lower values of load power factor where the phase angle of the single-stage current transformer makes the registration depart materially from its desired value. Of course, the necessity of providing special windings in the wattmeter or watt-hour meter has tended to restrict its adoption to situations where high accuracy is imperative.

2-19. General Electric Compensated Transformer.—A more recent development* avoids the necessity of dividing the core and also the requirement of a supplementary winding in the wattmeter or watt-hour meter as called for by the multistage transformer. Holes are provided (Fig. 20) through two legs of the core and secondary turns wound through them to embrace a portion of the core on each leg. At the lower values of primary and secondary current the flux will divide in certain proportions between the areas AA' and BB' . With larger current the demagnetizing effect of the secondary ampere-turns of compensation will result in a greater proportion of the flux passing through the BB' sections. The decreasing permeability there will cause

* See M. S. WILSON, *Trans. A.I.E.E.*, vol. 48, 1929.

a relative decrease in induced secondary voltage and current; the ratio may thus be raised for the larger currents to the inherent level for the lower currents. The level of the nearly horizontal ratio curve is then adjusted by dropping main secondary turns. The effect, briefly, is one of changing the effective secondary turns.

Phase-angle characteristics are simultaneously improved by resort to a short-circuited turn through the same holes. Its effect is like that of the lag coil in the watt-hour meter (see 9-4). The mutual flux is slightly lagged and the secondary current is brought more nearly in phase with the primary current (Fig. 13), thus reducing the phase angle of the transformer. The effect is greater at small currents

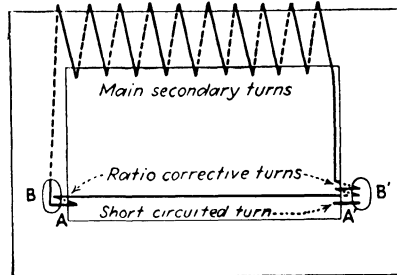

FIG. 20.

than at large currents for the same reason as in the case of the ratio-correcting turns in series with the secondary.

2-20. Miscellaneous Forms of Current Transformers.—So-called “three-wire” current transformers are made for use with two-wire meters on three-wire single-phase circuits. The primary winding consists of two equal sections connected in the outside mains with one reversed with respect to the other. The secondary supplies to the meter the same vector sum of the line currents that would result (in ampere turns) in a three-wire two-winding meter served from two independent current transformers (see 5-2 and Fig. 56).

Current transformers in which the core is made in ring fashion, the secondary wound toroidally about the core and the primary passed through the hole in the core, are called *through type*, *ring type*, or *hole type*. The primary conductor may be passed through the core once or several times but, if several, the turns should be bunched at the center and the return loops on the outside kept a considerable distance from the ring if the best results are to be obtained. Current transformers in general require, for best performance and economical design, 1,000 ampere-turns more or less in the primary. The through type is therefore more feasible for the higher ratios and current capacities. The cores may, of course, be rectangular as well as annular.

Transformers with hinged or split cores are especially useful when it is inconvenient or unfeasible to break the primary circuit to insert the transformer. Such transformers should not be used with wattmeters or watthour meters on account of their relatively large phase angle. The phase angle is large because the exciting current is proportionally larger owing to the increased reluctance introduced by the air gap in the magnetic core. Also the full-load ampere turns are in general low (of the order of 125 to 250). Split or hinged-core transformers are to be relied upon for use only with ammeters with which they have been calibrated; the combination is then satisfactory for approximate measurement of feeder currents.

The bushing type of current transformer has limitations similar to both the through type and the hinged-core type because of the low full-load ampere-turns and the greater length of magnetic circuit.

Current transformers, of course, should not be used in inverted manner to increase low values of primary current to larger values for the sake of obtaining the advantages of 5-amp. range instruments. The adjustment of turn ratio to compensate for the inherent ratio error and to bring the ratio correction factor close to 1 will produce considerable error when the transformer is inverted because the turn adjustment acts in the wrong sense. "Inverted" current transformers are available which are designed and compensated for giving ratios of primary to secondary currents in values less than unity.

2-21. Chart for Instrument Transformer Corrections.—The effect of α , β , K_v , K_s and θ_s in Eq. [12] can be seen from a nomograph presented by D. R. Laib in *Electrical World*, March 3, 1934. As reproduced in Fig. 21 it provides one scale for the ratios of both the current and voltage transformers and another for their phase angles. The correction factor for the current transformer for any load power factor is the intersection with the proper power-factor line of a straight line joining the phase angle and ratio values for the current transformer. Similarly for the voltage transformer.

The composite error should strictly be obtained by multiplication (as in Eq. [12]) but resort to addition for such small departures leads to accuracy in general within 0.5 of 1 per cent. Thus a 12-min. current transformer phase angle and an 8-min. voltage transformer phase angle (both leading but in opposite sense on

the chart) will be equivalent to 4 min. in the direction of the greater. Similarly the equivalent ratio is 100.05, obtained by adding the 100.25 of the current transformer and the 99.8 of the

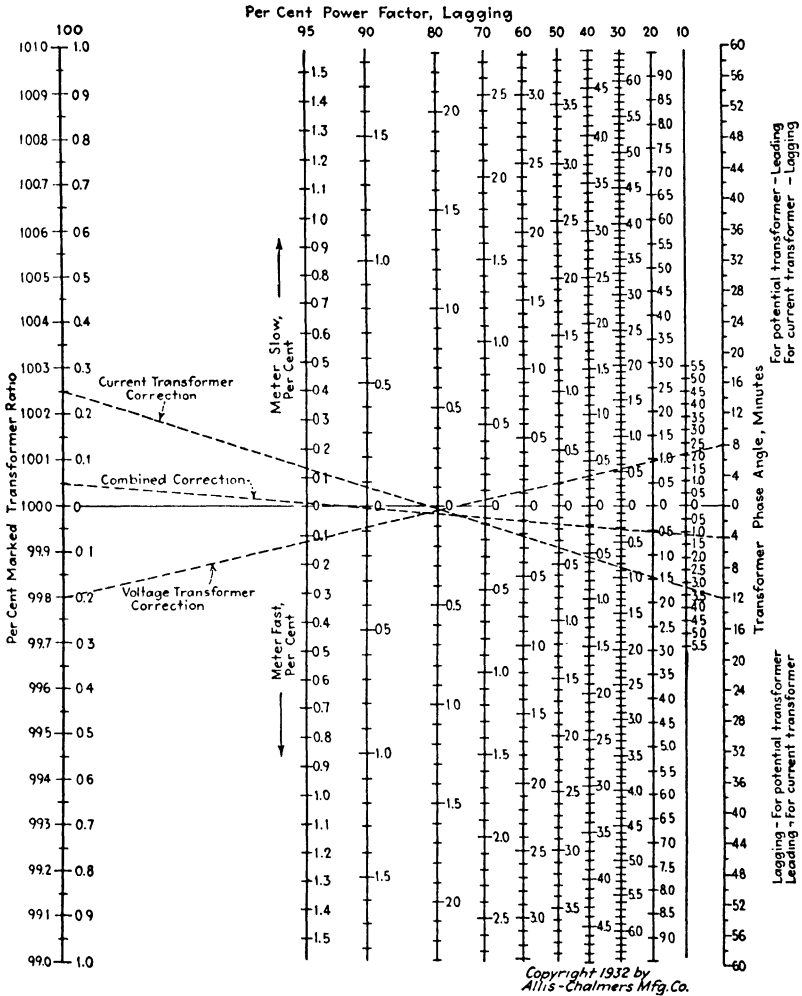

FIG. 21.

voltage transformer and subtracting 100. A line joining these composite ratio and phase-angle points gives the combined correction at any power factor of load.

Problems

- 2-1. a. What would be the volt-ampere value and power factor for the burden imposed on a voltage transformer supplying the voltage

circuits of instruments 24 and 21 of Table I (Chap. I) at 110 volts, 60 cycles?

- b. What would be the nominal ratio of the voltage transformer of Figs. 8 and 9?
- c. What actual ratio would it give with the burden of *a* and what would be the line voltage on the primary?
- d. What would be the over-all correction factor for watts due to the voltage transformer departures if the load is 86 per cent lagging power factor?

2-2. Consider the transformer of Figs. 8 and 9 supplying 110 volts, 60 cycles, to the wattmeter 24, voltmeter 21, and a watt-hour-meter voltage coil taking 1.5 watts at 20 per cent lagging power factor. Take power factor of load as 0.707.

- a. Determine the burden volt-amperes and power factor.
- b. Determine approximately the ratio and phase angle of the transformer for this burden.
- c. Determine the over-all correction factor for the registration of the watt-hour meter assuming that it and the necessary current transformer have zero phase angle.

2-3. How long a run of doubled No. 10 B. & S. leads could be run from the transformer of Prob. 2-1 to the distantly located pair of meters before substantial error would be incurred in the meter indications? How much would a 500-ft. run (1,000 ft. of wire) add to the burden?

2-4. Given a single-phase circuit carrying 100 amp. and two identical $2\frac{1}{2}$ current transformers inserted successively in the three ways indicated in the Fig. 22. The crosses represent simultaneously identical polarities.

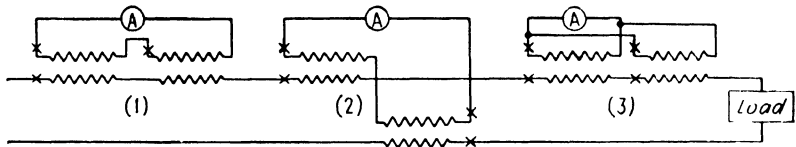

FIG. 22.

- a. In which case will the ammeter read 5 amp.?
 - b. In which case will it read zero and what will be the magnitude of the voltage across each transformer secondary?
 - c. In which case will the ammeter read 10 amp.?
- 2-5.**
- a. Compute the volt-amperes of burden at 5 amp. represented by burden *A* of Fig. 15.
 - b. How long a run of doubled No. 10 B. & S. leads could be run from the transformer to distant burden *A* before the total burden exceeded its rated value of 10 volt-amp.?

2-6. What error in wattmeter reading would be incurred by the burden *A* on the 60-cycle current transformer of Fig. 15 with nominal ratio 50/5 and 2.5 amp. of secondary current? Load is 86.6 per cent lagging power factor and wattmeter has phase angle of 1.3 min. Assume 110-volt line voltage applied direct to wattmeter.

2-7. Assume the current elements of an ammeter and a wattmeter have the combined burden *A* of Fig. 15 and that this current transformer is

used in conjunction with the voltage transformer of Figs. 8 and 9 to register a 100-amp. single-phase load of 13,200 volts and 86.6 per cent lagging power factor.

- a. What error in volts would be incurred if the ratio and phase-angle errors of the voltage transformer were ignored?
- b. What error in amperes, if the current transformer departures were ignored?
- c. What error in watts if both were ignored?
- d. What error in power factor if both were ignored?

CHAPTER III

CALIBRATION OF INSTRUMENT TRANSFORMERS

For several years the comparatively high accuracy of instrument transformers and the lack of convenient means for testing them, especially in the field, resulted in their subjection to less testing than was accorded the instruments and meters connected to their secondaries. More recently, however, the growth in magnitude and importance of power loads and the constant rise in the standards of accuracy required in electrical measurements have occasioned the development and extensive use of calibration schemes and field apparatus for checking the accuracy of the ratio and the phase-angle departure of instrument transformers. This in spite of the fact that modern transformers have better characteristics and can stand short circuits and open circuits and even d-c. excitation without appreciable permanent change in ratio and phase angle.

3-1. Classification of Instrument Transformer Calibration Methods.—Calibration of instrument transformers may be classed as either (1) absolute or (2) relative. In the absolute calibration the ratio and phase angle of a transformer are obtained through the indications of (*a*) deflection instruments (electrodynamic ammeters, voltmeters, or wattmeters) or (*b*) null methods involving the balancing of e.m.f. arising from potential drops in calibrated resistances or induced in mutual inductances. The absolute methods may be viewed as restricted to standardizing laboratories where high precision is necessary for certification purposes; the absolute method also is adapted to approximate determinations.

In the relative methods the constants of the transformer under test are contrasted with those of a similar transformer previously tested by one of the absolute methods. Relative methods also may be (*a*) deflection (*e.g.*, by interchanging voltmeters, ammeters, wattmeters, or watthour meters between the two secondaries) or (*b*) null (*e.g.*, differential electrodyname-ters or bridge circuits which are virtually a-c. potentiometers).

3-2. Absolute Calibration of Voltage Transformers.—The quantities to be determined are the ratio V_1/V_2 and the phase angle α as shown in the skeleton diagram (Fig. 23). It would appear that V_1 might be applied to an appropriate magnitude

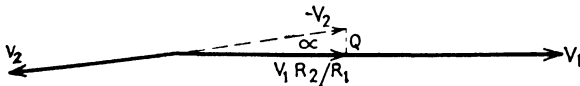

FIG. 23.

of standard resistance and the potential tap (Fig. 24) shifted until the detector G gave minimum indication. Under these conditions $V_2 = (R_2/R_1) V_1$ and the magnitude Q of the indication of G would give the phase angle α in the form $\tan \alpha = Q/V_2$

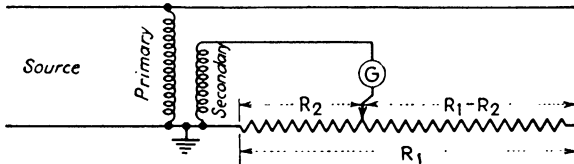

FIG. 24.

(approximately). However, Q will in general be so small as to require a voltmeter capable of reading to 0.001 volt with accuracy but such an a-c. instrument is not available. Thermogalvanometers or vibration galvanometers can be employed in null

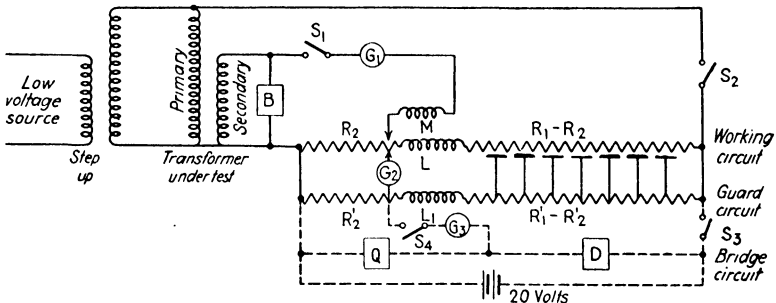

FIG. 25.

fashion to balance Q against a known small voltage from a source in quadrature with that shown in Fig. 24 but they leave something to be desired in ease of manipulation.

The null method* of Fig. 25 overcomes the defects of the deflection method shown in Fig. 24. A vibration galvanometer

* See SILSBEE, *Sci. Paper* 516, Bur. Standards.

G_1 is placed in series with the secondary of an adjustable mutual inductor M ; the primary is inserted between R_2 and $R_1 - R_2$. These resistor units should be of negligible inductance and distributed capacitance. First, the frequency, secondary voltage, and burden B are adjusted to the desired values. A balance is obtained by shifting the tap on R_2 and adjusting M until the a-c. galvanometer does not deflect. For low-voltage transformers the voltage ratio is then $V_1/V_2 = R_1/R_2$ and the phase angle in minutes

$$= 3,438 \frac{\omega M}{R_2} \quad [13]$$

The values of R_1 and R_2 are chosen so that the primary and secondary currents are about 0.05 amp. For a 33,000/110-volt transformer, then, $R_2 = 2,000$ ohms and $R_1 = 600,000$ ohms. Capacitance effects are serious with voltages of such magnitude and resistors of such physical dimensions; the resistors must be provided with a guard circuit of equal resistances R'_2 and R'_1 and inductance L' . The balance cited above is merely preliminary, in the case of the higher voltage tests; the guard circuit must be balanced against the working circuit and this can be accomplished by means of the detector G_2 , which may be G_1 shifted by convenient switches. The energy dissipated in the working resistor circuit is considerable (nearly 2 kw. at 33,000 volts). It is, therefore, desirable to measure the resistance values as promptly as possible after a balance has been obtained. To facilitate this a Wheatstone-bridge circuit is provided, Q being 10 or 100 or 1,000 ohms and D a precision decade resistance. Switches S_1 and S_2 are opened, switches S_3 and S_4 closed, and the balance obtained on the d-c. galvanometer.

$$\text{True ratio} = N = \left(1 + \frac{D}{Q} \right) \cos \alpha \quad [14]$$

$$\text{Phase angle} = \alpha = \frac{3,438\omega}{R_2} \left(M - \frac{L_w}{N} \right) \text{min.} \quad [15]$$

where L_w = total inductance of the working circuit in henries.

M = mutual inductance in henries.

The Bureau of Standards is constructing an attracted-disk electrometer which will be capable of measuring, directly in terms of force attraction, voltages up to 300,000 with high precision.

3-3. Relative Calibration of Voltage Transformer.—As a practical matter errors in ratio or phase angle which would not produce an observable difference in the indications of a good indicating wattmeter would be too small to be of significance. The wattmeter accuracy available is, therefore, a criterion of the accuracy demanded in the voltage transformer comparison. It is furthermore appropriate under these circumstances to employ the wattmeter as the indicator in a relative method.

The primary windings of the transformer to be tested and of a standard transformer, previously calibrated by an absolute

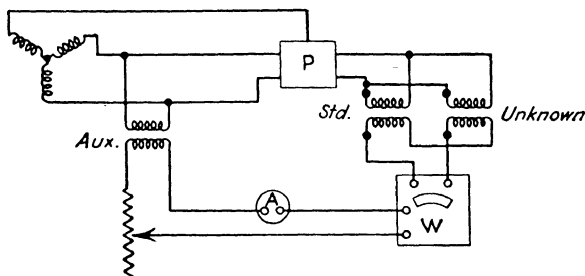

FIG. 26.

method, are connected to the same phase of a two-phase supply or through a phase shifter P to the same phase of a three-phase source (Fig. 26). The secondary windings are connected in opposition through the voltage winding of a wattmeter, preferably of lower voltage range than the secondary voltage of the transformers. The 5-amp. current coil of the wattmeter is energized by passing 5 amp. through it from an auxiliary transformer; some variation in this current is permissible. The wattmeter functions as a differential voltmeter. A 30-volt 5-amp. wattmeter with 150 scale divisions will have 1 watt per division; at 5 amp. this scale division will represent a difference of 0.2 volt between the secondary voltages. By estimating tenths of divisions the voltage difference can be read to 0.02 and this is nearly 0.02 per cent of 110-volt secondary values.

The phase shifter is set to advance the voltage on the two primaries by 90° . If there is doubt about the preciseness of the quadrature of the voltages from the phase shifter, it will be necessary to bring the two secondary voltages to numerical equality by burdening the one having the higher voltage until its value drops to equality with the other, *i.e.*, no deflection with

the phase shifter reset at zero shift. With the secondary voltages equalized and the phase shifted 90° , the wattmeter indications represent the quadrature component of the vector difference of the two voltages (unequalized). Taking the tangent of α' as equal to α' in radians, α' in minutes is 3438 times the deflection interpreted in volts. The angle α' is the difference between the phase angles of the two transformers, for the standard carrying the non-inductive burden necessary to equalize the voltages and the transformer under test carrying any desired burden. So-called "comparator voltmeters" have been made available for convenient use in connection with this method of test.

Neither test in itself indicates which is the larger of the two unequal voltages or phase angles. To determine which is the larger voltages: If the up-scale reading of the wattmeter increases when the non-inductive (lamp) burden on the transformer under test is increased, then its voltage is lower than that of the standard and *vice versa*. Likewise which secondary voltage is leading the other can be determined by use of the fact (see 2-4 and Fig. 7) that increasing the non-inductive burden on the transformer under test will make its secondary voltage lag more and more behind its primary voltage and also lag relative to the secondary voltage of the standard transformer. If in doing so the up-scale reading of the wattmeter increases, it shows the secondary voltage of the transformers under test is already lagging that of the standard and *vice versa*.

The Leeds and Northrup voltage transformer testing set is similar in principle and portability to the Silsbee current transformer testing set described in detail in 3-11.

3-4. Absolute Calibration of Current Transformers.—The absolute methods of calibration of current transformers may be classified* as follows:

1. Deflection.
 - a. Two-ammeter method.
 - b. Two-wattmeter method.
2. Null.
 - a. Mutual-inductance method.
 - b. Resistance method.

The two-ammeter method is the simplest of all. The ratio of transformer is the ratio of the readings of two ammeters, one

* SILSBEE, Methods for Testing Current Transformers, *Trans. A. I. E. E.*, 1924.

measuring the primary current and the other the simultaneous value of the secondary current. The method has little practical value because (1) the accuracy is limited to the accuracy of calibration of the ammeters and this is very poor at the low values of secondary current on account of the crowded nature of the scale of the 5-amp. secondary ammeter below 2 amp., (2) self-contained ammeters are not available above 500-amp. capacity for insertion in the primary circuit, (3) it gives no indication of the relative polarity of the windings, and (4) no index of the phase angle.

The two-wattmeter method has somewhat more value because it checks the polarities and gives the phase angle as well as presenting higher accuracy (0.2 per cent at full current) and loses less in accuracy as the currents are decreased because the deflection is proportional to the current rather than to the square of it as in the ammeter indication. The method involves the use of two wattmeters of appropriate current range, one in the primary, the other in the secondary, and their voltage circuits excited in common from an auxiliary voltage. If the auxiliary voltage is in phase with the secondary current, the ratio of the transformer is given by the ratio of the watt readings. If the phase of the auxiliary voltage is more or less accurately in quadrature with the primary current, then

$$\beta = \tan^{-1}\left(\frac{W_1 - NW_2}{EI_1}\right)$$

in which E is the value of the auxiliary voltage, I_1 the primary current, N the nominal ratio of the transformer, and W_1 and W_2 the respective readings of the primary and secondary wattmeters. Available wattmeters limit the range of the method to about 200 primary amperes.

The null or balanced methods are superior.

3-5. Mutual-inductance Method.—This method as used by the Westinghouse Company* covers the range from 5 to 5,000 amp. with a ratio accuracy of 0.01 per cent. The primary and secondary currents, respectively, are sent through the primary windings of two large toroidally wound mutual inductors. The inductances of the two mutual inductors are inversely propor-

* FORTESCUE, The Calibration of Current Transformers by Means of Mutual Inductance, *Trans. A. I. E. E.*, vol. 34, 1915.

tional to the currents (nominal rated values of the transformer windings) in their primary windings; hence the induced secondary e.m.f. are approximately equal. A detector measures the difference of these secondary voltages applied in opposition to its terminals. One inductor is finely adjustable so that an exact balance may be obtained. The phase-angle departure of the current transformer is compensated for in the balancing and ascertainable in magnitude from the value of the few hundredths of an ohm of resistance inserted in series with the secondary of the transformer under test, the voltage drop across a known portion being inserted in the detector circuit to effect the balancing. The toroidal construction renders the system unsusceptible

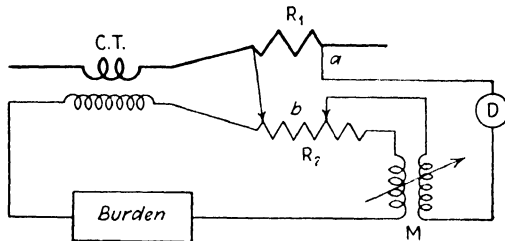

FIG. 27.

to stray fields provided the marble cores of the inductors are accurately machined and the windings properly disposed.

3-6. Resistance Method.—The method employed by most of the governmental standardizing laboratories and several of the university and commercial laboratories is the calibrated resistance method. In this the primary and secondary currents of the transformer are passed through resistance standards of such values that the potential drops across the two are equal, usually 1 volt or less for rated values of transformer current. The potential drops are connected in series opposition to the detector (Fig. 27).

In general the transformer phase angle will introduce the out-of-phase component e.m.f. of Fig. 23 and no adjustment of the resistances will give zero deflection of the detector. The most common way of compensating for the phase angle and at the same time ascertaining its magnitude is by inserting in the secondary (or the primary) circuit an air-cored adjustable mutual inductor of low resistance and low inductance M . The e.m.f. induced in the secondary of the mutual inductor will be in quadra-

ture with the current through its primary and, therefore, supply the Q of Fig. 23 required for balance.

$$\text{Transformer ratio} = \frac{R_2}{R_1}$$

$$\text{Phase angle } \beta = \tan^{-1}\left(\frac{2\pi f M}{R_2}\right)$$

The method is capable of an accuracy of 0.01 per cent in ratio determination provided an adequately sensitive detector is employed and the resistors R_1 and R_2 (especially the former) are carefully constructed to minimize residual inductance, skin effect, and spurious capacitances. Resistors suitable for more than 1,000 amp. present considerable difficulty in conforming to these requirements.

3-7. Relative Methods of Calibrating Current Transformers.—In the relative methods the characteristics (ratio and phase angle) of the transformer under test are contrasted to those of a standard transformer of the same nominal ratio which has been calibrated by one of the absolute methods.

The relative methods may be classified in the following manner:

1. Deflection principle.
 - a. Interchanged-ammeter method.
 - b. Interchanged-wattmeter method.
 - c. Interchanged-watthour-meter method.
2. Null principle.
 - a. Differential-wattmeter method.
 - b. Bridge-circuit method.
 - c. Silsbee method

The interchanged-ammeter method is the “relative” adaptation of the two-ammeter absolute method described in 3-4 and has similar limitations. The primaries of the two transformers are connected in series and the desired burden and a 5-amp. ammeter inserted in each of the secondary circuits. The ammeters are read simultaneously and then interchanged and again read. The interchange compensates for scale errors of the ammeters. The ratios of the two transformers are inversely proportional to the average readings of the two ammeters successively connected to each secondary. No information is obtained about the phase angle.

The interchanged-wattmeter method is the "relative" equivalent of the two-wattmeter method described in 3-4 and has similar value and limitations.

3-8. Interchanged-watthour-meter Method.—This method, devised by Dr. P. G. Agnew at the Bureau of Standards, employs two similar induction watthour meters in place of two indicating electrodynamic wattmeters. The superiority of the method rests in the possibility of attaining a higher percentage accuracy from the revolutions made by the meters in a run of several

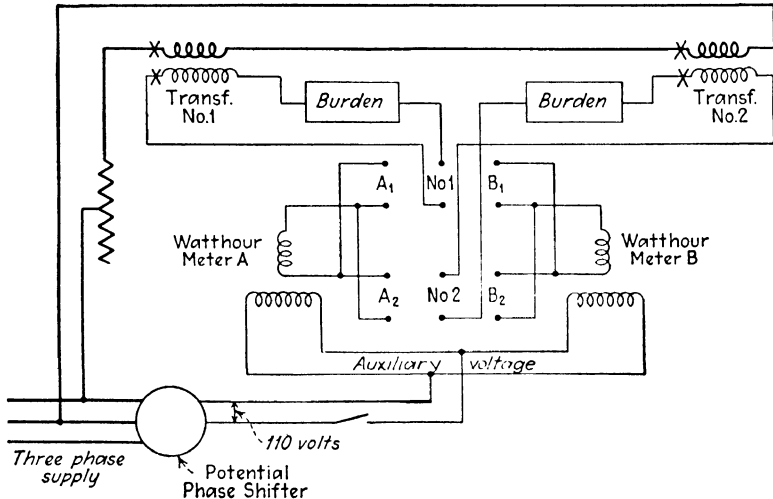

FIG. 28.

minutes' duration than is attainable by instantaneous readings of the indicating wattmeters. This accuracy is better than 0.1 per cent if the test is carefully conducted and the watthour meters do not creep and have not more than 2 per cent difference in speed at power factor of 1.0 and 0.5 (Fig. 28).

The primaries of the two current transformers are in series and supplied with requisite values of current from one phase of a three-phase supply. The current coils of the two watthour meters are connected alternately to the secondaries of the two transformers by means of the two double-throw switches 1 and 2. An auxiliary voltage is impressed on the voltage coils of the two watthour meters and its phase relation to the current in the transformer primaries is controlled by a phase-shifting transformer.

The same principle may be used to compare two voltage transformers by supplying them in common with an auxiliary

current and connecting their voltage windings successively to each of the voltage transformer secondaries.

3-9. Formulas for Interchanged Watthour-meter Method.

Let k = watthours (nominal) per revolution of the two watthour meters.

m_a, m_b = their respective percentage registrations.

R_1, R_2 = the respective transformer ratios.

α_1, α_2 = the respective transformer phase angles (considered positive with reversed secondary leading primary).

A_1, A_2 = revolutions of meter A when connected to transformers 1 and 2, respectively.

B_1, B_2 = revolutions of meter B when connected to transformers 1 and 2, respectively.

$\cos \theta$ = apparent power factor within the watthour meters.

While making A_1 revolutions, meter A records A_1k watthours, the corrected value of which is A_1k/m_a . In terms of primary amperes through transformer 1 this represents A_1kR_1/m_a watthours. Taking into account the phase angle α_1 of the transformer, the apparent primary watts for meter A on transformer 1 are

$$\frac{A_1kR_1 \cos \theta}{m_a \cos (\theta + \alpha_1)}$$

or

$$\frac{A_1kR_1}{m_a \cos \alpha_1 (1 - \tan \alpha_1 \tan \theta)}$$

The phase angle α_1 is small enough to permit placing $\cos \alpha_1 = 1$ and the foregoing becomes

$$\frac{A_1kR_1}{m_a (1 - \tan \alpha_1 \tan \theta)}$$

But meter B is indicating the same fictitious energy and therefore

$$\frac{A_1kR_1}{m_a (1 - \tan \alpha_1 \tan \theta)} = \frac{B_2kR_2}{m_b (1 - \tan \alpha_2 \tan \theta)}$$

When the meters are interchanged,

$$\frac{A_2kR_2}{m_a (1 - \tan \alpha_2 \tan \theta)} = \frac{B_1kR_1}{m_b (1 - \tan \alpha_1 \tan \theta)}$$

If now the phase shifter is set to bring the auxiliary voltage into close phase agreement with the secondary currents, θ will be small and $\tan \theta$ nearly zero. Then

$$\frac{R_1}{R_2} = \sqrt{\frac{A_2 B_2}{A_1 B_1}} \quad [\text{Ratio formula}] \quad [16]$$

If the phase of the auxiliary voltage is then shifted to assume a considerable angle θ between it and the meter currents and we divide the first equation by the second and place all tangent terms on the left,

$$\frac{(1 - \tan \alpha_2 \tan \theta)^2}{(1 - \tan \alpha_1 \tan \theta)^2} = \frac{A_2 B_2 R_2^2}{A_1 B_1 R_1^2}$$

Since the α 's are much smaller than θ

$$\frac{1 - 2 \tan \alpha_2 \tan \theta}{1 - 2 \tan \alpha_1 \tan \theta} = \frac{A_2 B_2 R_2^2}{A_1 B_1 R_1^2}$$

and this is approximately

$$1 + 2 \tan \theta (\tan \alpha_1 - \tan \alpha_2) = \frac{A_2 B_2 R_2^2}{A_1 B_1 R_1^2}$$

or

$$\tan \alpha_2 - \tan \alpha_1 = \frac{1}{2 \tan \theta} \left(1 - \frac{A_2 B_2 R_2^2}{A_1 B_1 R_1^2} \right) \quad [\text{Phase-angle formula}] \quad [17]$$

3-10. Summary of Absolute and Relative Methods.—The various methods described so far in this chapter have in some cases more academic than practical value; some are capable of high precision but are expensive and laborious, and some involve delicate detectors and calibrated members which require frequent rechecking. Those which involve a null method, whether absolute or relative, are in general capable of greater accuracy than deflection methods. Any method which aims to measure the *difference* in ratio and phase angle between the transformer under test and a standard transformer will be capable of higher accuracy than one which measures the full absolute values. Thus, when the differences are balanced through a circuit containing calibrated resistance and mutual inductance, an error of 1 per cent in adjusting them for balance would represent only 1 per cent of, say, a 1 per cent difference between the transformers and, therefore, only 0.01 per cent of the absolute value of the unknown ratio or phase angle.

Any device capable of meeting the requirements of field testing in the hands of meter-department employees of average technical ability should have certain well-defined properties

if it is to promote the testing of current transformers on a plane commensurate with the well-established routine of watt-hour- and demand-meter testing in the field or laboratory. These requirements briefly stated are that the method and device should:

1. Be adequately accurate.
2. Be simple in manipulation and adjustment.
3. Be quick in manipulation.
4. Be rugged in character.
5. Not require special accessories.
6. Give a direct check on polarities.
7. Permit replacement of detector without recalibration.
8. Be insensitive to stray fields.
9. Not be affected seriously by varying system voltage.
10. Preferably not require a polyphase source of supply.

3-11. Silsbee Current Transformer Testing Set.—The scheme devised by Dr. F. B. Silsbee of the Bureau of Standards meets

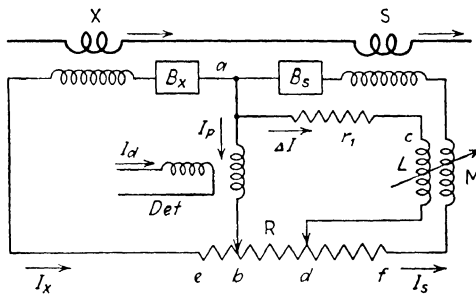

FIG. 29.

most of the requirements imposed in the previous paragraph. It employs a bridge circuit and null use of the detector, the standard and test transformer primaries in series and their secondaries also in series in such a direction that both transformers tend to circulate current in the same direction through both secondary burdens (Fig. 29). Any difference in the secondary current of the two transformers tends to flow across the bridge ab and can be measured by a suitable detecting instrument placed in the arm ab . In order to gain the advantages of a null method, a second bridge circuit acd is made to carry all the difference in current of the two transformers by a suitable adjustment of the resistance r_1 and mutual inductance M .

When a balance is thus obtained and the detector shows no deflection, the difference of potential between a and b must be zero. The potential difference between a and d (due to the

differential current ΔI through r_1 and the e.m.f. induced in M) and between b and d (due to I_x through R) must be equal and in phase. From the values of r_1 , R , and M the difference in the ratios and phase angles of the two transformers may be computed or, with proper magnitudes chosen, indicated directly on the scales.

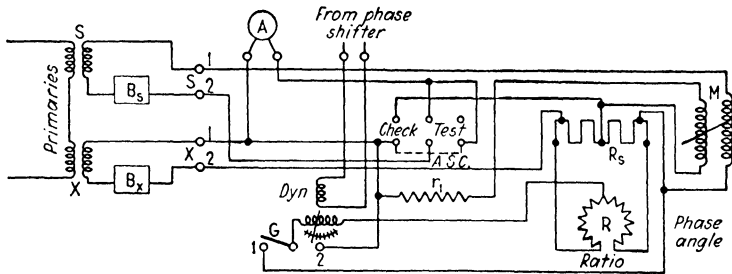

FIG. 30.

The electrical connections of the set are shown in Fig. 30. The detector is a separately excited electro-dynamometer instrument, supplied with current from a phase-shifting transformer. The double-pole double-throw switch is of the rocking type with plate which in the horizontal position short-circuits the ammeter A , as shown by the ammeter short-circuiting line $A.S.C.$

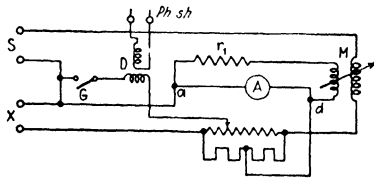

FIG. 31.

Setting the switch in the "check" position and leaving switch G open establishes a circuit arrangement which can be simplified in the manner of Fig. 31. If the transformer secondaries are circulating current in the same direction around their series

circuit, A will indicate a very small current, if in the opposite direction a large current, and then the leads from transformer X should be interchanged. The polarity of X is then known.

3-12. Preliminary Adjustments of Silsbee Set.—A necessary preliminary move is to adjust the detector (1) to zero and (2) to quadrature space relation of its coils. The first is done with the set deenergized. The second is performed with no current in the primaries, the secondaries, however, connected to the set, ammeter switch in "test" position, phase-shifter switch closed, and switch G in position 2. The detector is

restored to zero by adjusting the direction of the flux from the stationary coil of the detector. The electrical connections are as in Fig. 32. The ratio dial is next set at 1.00 and switch *G*

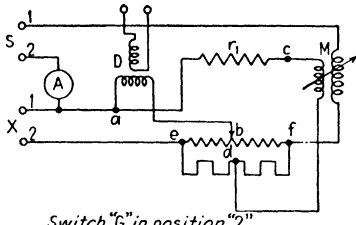

Switch "G" in position "2"
FIG. 32.

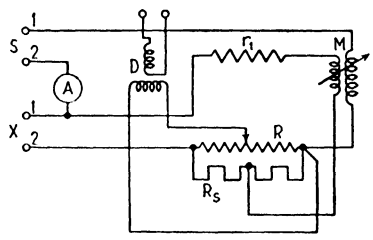

FIG. 33.

changed to position 1 which establishes the circuit of Fig. 33. Adjust the angular position of the rotor of the phase shifter so that the detector again reads zero. The object is to simplify the subsequent balancing by bringing the current I_D through the stationary coil of the detector into quadrature with I_s . The vector relations are in part those of Fig. 34.

3-13. Determination of Ratio and Phase Angle.—The switch *G* is now set in position

2, establishing again the circuit relations of Fig. 32. In Fig. 34, E_{ab} sends I_p through the movable coil of the detector, which will probably deflect as is seen by the torque-producing phase

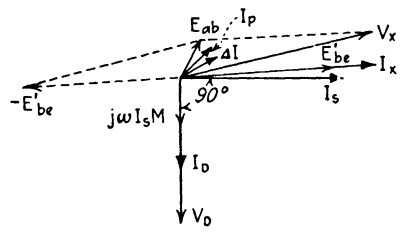

FIG. 34.

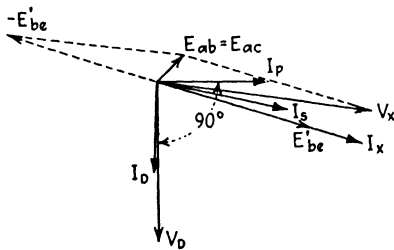

FIG. 35.

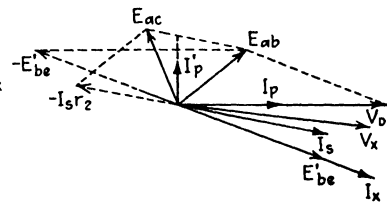

FIG. 36.

relation of I_D and I_p . The detector is restored to zero by adjusting the mutual inductance M ; the quadrature induced voltage $j\omega I_s M$ is thereby given a value which, when added to E_{ab} , brings I_p into quadrature with I_D and reduces the deflection to zero.

The phase relations are now as in Fig. 35. The phase positions of V_D and I_D are next brought into phase with I_p by turning the phase-shifter rotor through 90° . The vector relations are as in Fig. 36. The deflection of the detector is brought to zero by adjusting the ratio dial; this inserts the resistance drop $-I_s r_2$ into the circuit containing the detector (Fig. 37). The voltage across the movable coil becomes E_{ac} in Fig. 36 and the current through the movable coil of the detector is I'_p ; when this is in quadrature with I_D the deflection will be zero.

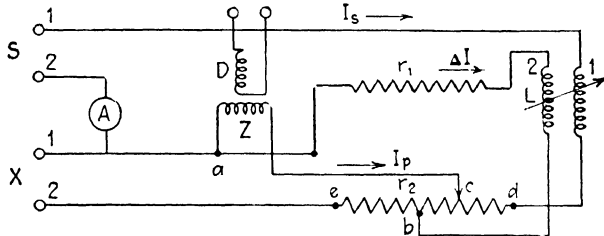

FIG. 37.

The phase shifter is rotated back through 90° to indicate the remaining value of I'_p and the mutual inductance M readjusted still further to reduce I'_p . The operations described above are then carried through in full until no deflection is obtained when the phase shifter is in either position. This means that I'_p has been reduced to zero and that r_2 is a measure of the in-phase difference (in ratio) between I_x and I_s and that M is a measure of the out-of-phase (phase-angle) difference between them for the particular current value and burdens used.

The procedure is the same for the other values of current and burden for which calibration is desired.

Problems

3-1. Draw a connection diagram for the two-watt-hour meter method of testing voltage transformers analogous to that shown in Fig. 28 for current transformers.

3-2. In a two-watt-hour meter test of two $1\frac{1}{2}\%$ current transformers, meter A made 45.005 revolutions when connected to a standard transformer and meter B made 44.811 when connected to a second transformer; when interchanged, A made 44.963 and B made 45.019. The secondary current in both cases was 2 amp. and the phase shifter was set to make $\theta = 0^\circ$; the ratio correction factor of the standard transformer at this current value and burden is 0.9949.

a. Determine the ratio correction factor of the second transformer.

When the phase of the auxiliary voltage was shifted 60° meter A made

45.004 revolutions on the standard transformer and meter *B* made 44.957 on the second. When interchanged *A* made 45.101 and *B* made 45.007. The phase angle of the standard transformer for the given current and burden is +11 min.

b. Determine the phase angle of the second transformer.

3-3 The Kirchhoff equations for the circuits of Fig. 37 when the balance is perfected are

$$\begin{aligned} \Delta I &= I_s - I_s \\ \Delta I(r_1 + j\omega L_1) + j\omega I_s M &= I_s r_2 \end{aligned}$$

Let

$$a = \frac{r_2}{r_1}, \quad b = \frac{\omega M}{r_1}, \quad c = \frac{\omega L_1}{r_1}$$

and show that

$$\frac{R_x}{R_s} = 1 \pm a$$

and

$$\alpha_x = \alpha_s - 3,438b$$

3-4. Show how in Fig. 27 two auxiliary current transformers in parallel and in opposition to the transformer under test can be used to relieve it of the burden of the resistor R_2 so that its determined ratio and phase angle will be strictly that due to the specific burden inserted in the test circuit (see *Electrical World*, page 575, May 6, 1933).

CHAPTER IV

POLYPHASE SYSTEMS AND VECTOR RELATIONS

The measurement of polyphase power and energy presents many opportunities for erroneous procedure because of the multiplicity of the voltages and currents involved and the chance of associating them incorrectly with one another in the torque-producing elements of the meters. The ability to verify the correctness of the connections and assure the proper inclusion of all portions of the power depends upon a clear conception of the foundations of the various polyphase systems. At the risk of repetition here of some elementary principles of electrical apparatus and circuits, the vector relations of the three-phase system will be evolved from those of the simpler single-phase system.

4-1. Vector Conventions, Single Phase.—In considering first only the single coil $a'a$ of the single-phase bipolar alternator of Fig. 38a, the voltage induced in that coil by the rotation of the armature can be represented by the vector E_a of Fig. 38b. The end of a' in view is negative in polarity and of a is positive.

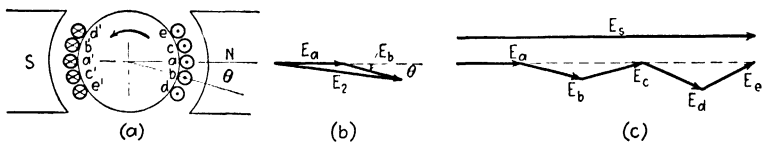

FIG. 38.

The vector E_a signifies the amount by which the potential of a exceeds that of a' when the two are connected in series at the remote end of the armature; in direction its significance is, first, $E_{a' \rightarrow a}$ and, second, parallel to the plane of the coil, to indicate its time phase with respect to the other coils in their passage through the magnetic field.

Consider now a second coil $b'b$, displaced from $a'a$ by the angle θ with the consequence that the voltage of $b'b$ reaches its maximum later than that of $a'a$ by the amount of time required for the

armature to revolve through the angle θ . The voltage of $b'b$ is E_b of Fig. 38b. The polarities are the same, at the instant shown, as those found for $a'a$. If the two coils are now connected in series so that the order of conductors is $a'ab'b$, the difference of potential between a' and b will be the vector sum of E_a and E_b , i.e., E_2 , for the two coils. By successively adding the coils $c'c$, $d'd$, and $e'e$ the total voltage E_5 for the five coils is that shown in Fig. 38c. It is evident that less is being gained in total voltage as additional coils are included at increasing angles from the original $a'a$. The inference constitutes one of the reasons for employing polyphase systems.

4-2. Reasons for Superiority of Polyphase Systems.—Three reasons may be cited for the very general resort to polyphase systems:

1. Higher ratings possible for machines.
2. Economy in weight of line conductors.
3. Uniformity of torque in generator and motor.

The idle area of the armature in Fig. 38a could very profitably be devoted to additional coils, not added to the group

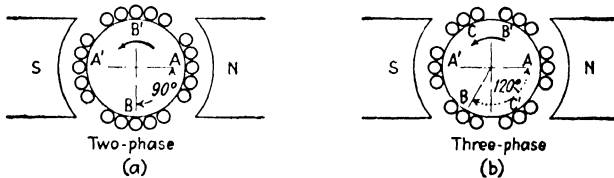

FIG. 39.

$a'ab' . . . e'e$ but similarly connected in series and serving an independent load. The resulting two-phase machine is indicated in Fig. 39a where the separate coil groups are displaced by 90 deg. The principle may be extended as in Fig. 39b to three windings displaced successively 120 deg. For the same amount of copper and iron greater output may be obtained by employing more phases, thus:

	Percentage
Single phase.....	100
Two phase.....	140
Three phase.....	130
Six phase and three phase.....	148
Direct current.....	141

The polyphase systems utilize line copper more efficiently. Thus with given voltage between conductors, given power

delivered at a given distance with given percentage of line losses, the copper required for various systems is

	Percentage
Two wires, single-phase.....	100.0
Three wires, two-phase.....	145.7
Three-phase.....	75.0
Four wires, two-phase.....	100.0

The torque reactions within the single-phase alternator will be pulsating and with inductive load there will be reversals of torque. The flow of power over a polyphase circuit with balanced load will, on the other hand, be uniform and also the torque in the alternators and motors will be uniform.

4-3. Evolution of Three-wire Three-phase System.—The three-phase arrangement of Fig. 39b is exhibited in more complete

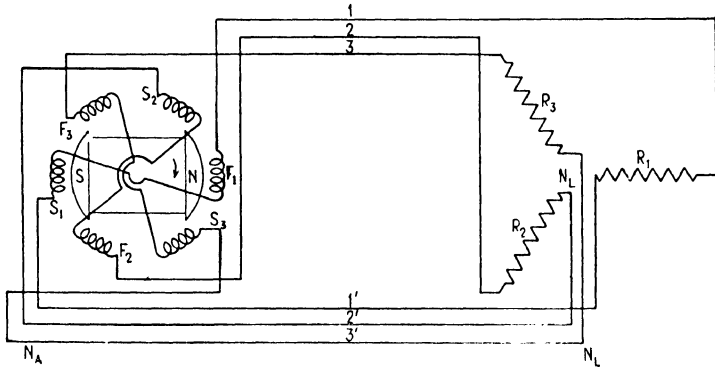

FIG. 40.

fashion in Fig. 40 with the difference that the armature is stationary and the field revolves (in the opposite direction). Each phase winding is connected independently to its own load resistance, six wires being required to effect the outgoing and return paths. The sinusoidal voltages of the respective windings are those of Fig. 41a. The corresponding vector diagram of the voltages is Fig. 41b, in which E_2 lags E_1 by 120° and E_3 lags E_2 by 120° . Likewise the currents are displaced by 120° but each is in phase (Figs. 41a and 41c) with the voltages establishing it in the resistor. Either current diagram shows that the sum of I_2 and I_3 is equal and opposite to I_1 . In fact the sum of the three currents (resulting from three equal voltages and three equal resistances) would be zero at any time and at all times at any cross section of the line; *i.e.*, $\Sigma I = 0$.

This means that the actual current would have zero value in any single conductor which might be employed to replace the three individual and electrically independent return conductors 1', 2', and 3' in Fig. 40. Further, if the current is zero there will be no difference of potential or drop in voltage between the end junctions.

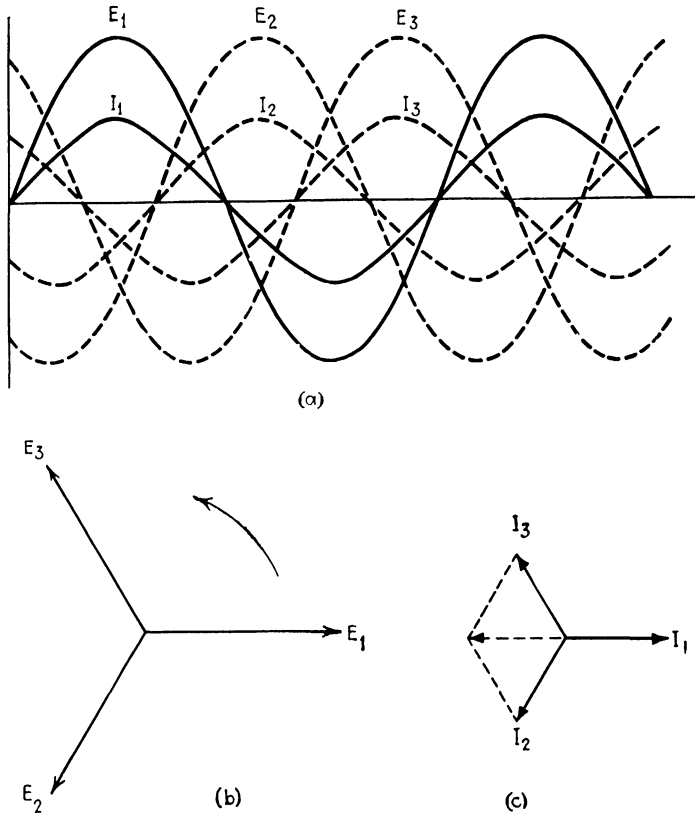

FIG. 41.

This means that the common return wire can be dispensed with and the junction (or neutral) at the load will be at the same potential with balanced voltages and currents as that of the junction (or neutral) at the generator. The three outgoing conductors 1, 2, and 3 suffice as outgoing and return paths of all three currents; any one conductor at any instant is the return path for the outgoing currents in the other two.

In the three-wire three-phase system, then, the return conductors 1', 2', 3' are omitted. The alternator neutral N_A is ordinarily not accessible nor is it accessible in the case of three-phase motors.

4-4. Three-phase Y Voltage Relations.—Schematically Fig. 42a represents the same situation as Fig. 40 with neutral con-

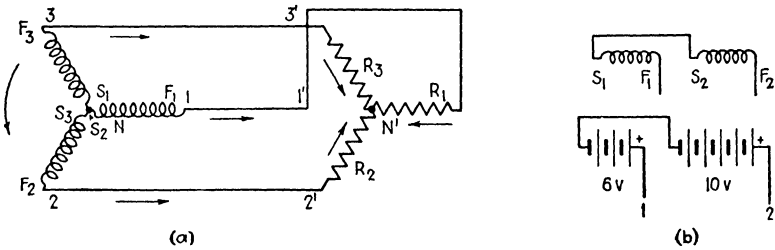

FIG. 42.

ductor omitted. In both figures S and F stand for the “start” and “finish” terminals of the respective windings. It is important to notice that the Y-connection of Fig. 42a involved tying the start end of all windings together, leaving the finish ends free for connection to the load terminals. It is evident that this results in the voltage between F_1 and F_2 , *i.e.*, E_{12} , being the

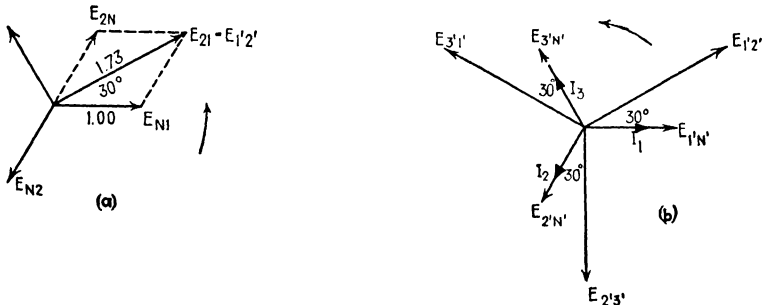

FIG. 43.

difference rather than the *sum* of the two voltages. This is comparable to the 4-volt difference in potential between the terminals 1 and 2 of 6- and 10-volt batteries having their negatives tied together. In the case of the battery E_{12} is positive and 2 is at higher potential than 1 because in proceeding *from 1 to 2* we obtain

$$-6 + 10 = +4 = E_{12}$$

By operating with the voltages of windings 1 and 2 of Fig. 42a in similar manner but effecting the subtraction vectorially as in Fig. 43, the voltage from 2 to 1, *i.e.*, E_{21} , is $-E_{N2} + E_{N1}$ or $E_{2N} + E_{N1}$ or E_{2N1} or E_{21} . Tracing the path of the current which flows (in Fig. 42a) as a consequence of E_{N1} , we find that it proceeds from 1' to N' in the external load circuit (Fig. 42a) and, therefore, viewed from the load end, the difference of potential between 1' and N' at the load is $E_{1'N'}$. Likewise E_{21} at the generator is identical with $E_{1'2'}$ at the load. The successive pairs of voltages, when similarly subtracted, produce the other three line voltages $E_{2'3'}$ and $E_{3'1'}$. It is important to observe that the three line voltages are:

1. Equal to one another and 120° apart.
2. 73 per cent greater than the phase voltages.
3. Displaced from them by 30° .

Also, from Fig. 40, it should be clear that the consolidation, and finally the elimination, of the three return conductors in no

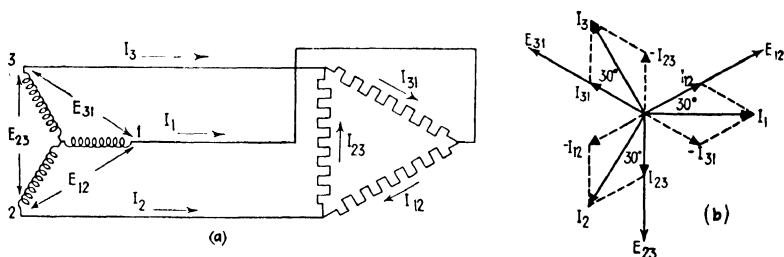

FIG. 44.

way disturbed the status of the currents in the outgoing wires to the load. Each of these currents was in phase with the respective phase voltage because each single-phase load was non-inductive resistance. These currents in the line wires are the phase currents and are still in phase with $E_{1'N'}$, $E_{2'N'}$, and $E_{3'N'}$ in Fig. 43. To the three significant items about the three-wire three-phase voltages with balanced Y-load may now be added an equally significant one, *viz.*, that even with resistance load (100 per cent power factor) the three *line* voltages are not in phase with the line currents but are displaced 30° from them. This has a bearing on the behavior of polyphase wattmeters and watt-hour meters.

4-5. Three-phase Δ Current Relations.—Replace the Y-connected resistance load of Fig. 42 by the Δ -connected balanced

resistance load of Fig. 44. The current I_{12} in the branch 12 will be E_{12}/R_1 where E_{12} is the voltage between wires 1 and 2 as found in Fig. 43b. Similarly the current $I_{23} = E_{23}/R_2$ and $I_{31} = E_{31}/R_3$. The current I_1 in wire 1 will be the difference between I_{12} and I_{31} since by Kirchhoff's law for the junction 1 the current equation is $I_1 - I_{12} + I_{31} = 0$ and $I_1 = I_{12} - I_{31}$. The subtraction has been performed in Fig. 44b with the result that I_1 is displaced 30° from E_{12} . Also I_1 is 1.73 times I_{12} .

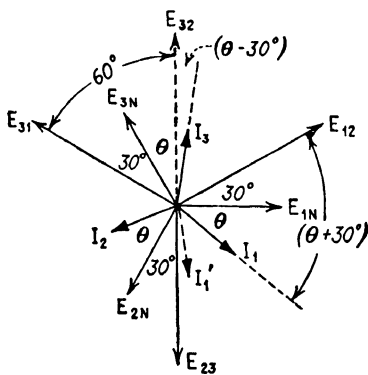

FIG. 45.

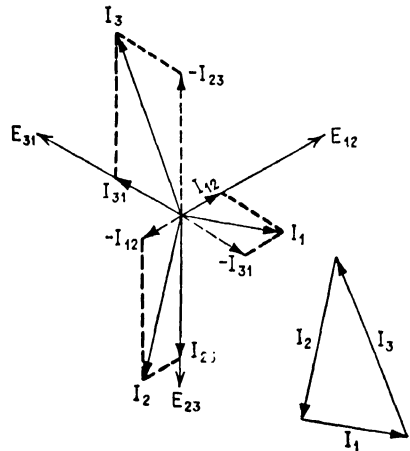

FIG. 46.

The load-phase voltages are identical with the line voltages, the phase and line currents differ.

It is, therefore, true of both Y-connected and Δ -connected resistance load that there is a 30° displacement between each line current and the voltage from that line wire to one of the other two wires.

4-6. Balanced Inductive Loads, Y and Δ .—If the impedances R_1 , R_2 , R_3 of Fig. 40 are not non-inductive resistances but comprise inductive or condensive reactances, the current in each phase will not be in phase with the corresponding phase voltage as shown in Figs. 41b, 41c, and 43b. If the impedance is predominantly inductive in its reactance, the current will lag its own phase voltage by an angle θ (Fig. 45). With respect to the voltages between pairs of line wires the former angle of 30° has been increased by θ to $(\theta + 30)^\circ$. If the lag θ exceeds 60° (*i.e.*, the power factor in each phase of the load is less than 0.50),

then $(\theta + 30)^\circ$ exceeds 90° . A wattmeter or watthour meter responding to the line voltage E_{12} and line current I' under these conditions will experience negative torque.

There are two line voltages, E_{23} and E_{31} , involving the phase voltage E_{3N} associated with I_3 . If I_3 is considered in conjunction with E_{31} , the relations are the same as between I_1 and E_{12} . If I_3 is considered in conjunction with E_{23} , or preferably with E_{32} as will be found significant in the next chapter, the angle between them is $(\theta + 30)^\circ$ minus the 60° between E_{31} and E_{32} or $(\theta + 30 - 60)^\circ = (\theta - 30)^\circ$.

4-7. Unbalanced Y- and Δ -loads, Three Wire.—If the three Δ -resistances of Fig. 42a are unequal, the respective currents I_{12} , I_{23} , and I_{31} will be unequal, the larger appearing in the smaller resistance. Also the line currents I_1 , I_2 , and I_3 will be unequal and the angles between them (Fig. 46) will no longer be 120° . The system is called unbalanced. The three line currents will, however, have zero for a vector sum as is seen by transferring them to the closed triangle. The three separate phase currents, of course, do not add to zero because their return values are not represented in the diagram. These return values do appear, however, in each of the line currents in the subtraction process employed in deriving them.

If the Y-connected resistors of Fig. 42 are unequal and the three balanced line voltages E_{12} , E_{23} , and E_{31} are applied, the three line currents will be unbalanced and the three voltages to the load neutral will be unbalanced. Two conditions will automatically be met and these may be used to determine the location of the neutral point and the values of the three voltages and three currents:

1. Each pair of voltages to neutral will have the corresponding line voltages as their vector sum.
2. The vector sum of the three currents must be zero.

As a specific instance, let the three line voltages be 100 volts and the Y-load resistances as follows:

$$R_{OA} = 20; \quad R_{OB} = 10; \quad R_{OC} = 5$$

Place the three line voltages in the triangular arrangement of Fig. 47. Recognizing that the largest resistance will involve the largest voltage drop, assume some point, such as O , as the neutral fitting the relation $OA > OB > OC$.

$$\begin{aligned}
 E_{OA} &= -(100 - a) - jb & I_{OA} &= \frac{-(100 - a) - jb}{20} = \\
 & & & -5 + 0.05a - j(0.05b) \\
 E_{OB} &= -(50 - a) + j(86.6 - b) & I_{OB} &= \frac{-(50 - a) + j(86.6 - b)}{10} = \\
 & & & -5 + 0.1a + j(8.66 - 0.1b) \\
 E_{OC} &= a - jb & I_{OC} &= \frac{a - jb}{5} = +0.2a - j(0.2b) \\
 \text{Sum} &= -10 + 0.35a + & & \\
 & & & j(8.66 - 0.35b)
 \end{aligned}$$

Separately equating to zero the real and quadrature components of the sum of the three currents gives

$$\begin{aligned}
 0.35a &= 10 & a &= 28.58 \\
 0.35b &= 8.66 & b &= 24.74
 \end{aligned}$$

This locates the neutral point and establishes the voltages as

$$E_{OA} = 76; \quad E_{OB} = 65; \quad E_{OC} = 38$$

The currents are then $I_A = 3.8$, $I_B = 6.5$, $I_C = 7.6$.

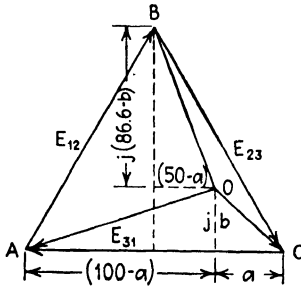

FIG. 47.

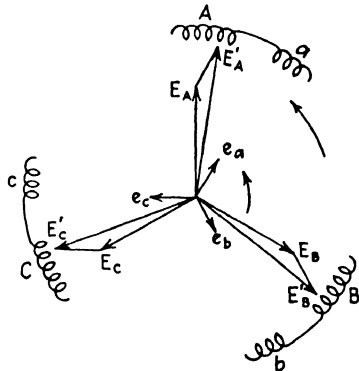

FIG. 48.

If a fourth wire were now run from the load neutral to the generator neutral, the three voltages to neutral would become equal, the three line currents would be the line-to-neutral voltages divided by the respective impedances, and the unbalance in current would flow over the neutral wire of the four-wire system.

4-8. Unbalanced Three-phase Voltages and Currents.—If the three windings A , B , C of Fig. 48 are equal and 120° apart, the resulting voltages E_A , E_B , E_C will constitute a symmetrical

three-phase system. If the smaller windings a, b, c are equal and displaced equal amounts, respectively, from A, B, C , their voltages e_a, e_b, e_c will constitute another symmetrical three-phase system. If now the pairs Aa, Bb, Cc are similarly connected in series, the resulting voltages E'_A, E'_B, E'_C will constitute a new symmetrical system.

But if A and a, B and c, C and b are paired and connected in series as in Fig. 49, the resulting voltages E'_A, E'_B, E'_C will no longer (Fig. 50) constitute a symmetrical system. The resulting unbalanced or unsymmetrical system may then be said to be the resultant of two balanced systems but one of forward (positively) and the other of backward (negative) phase sequence.

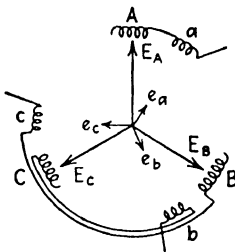

FIG. 49.

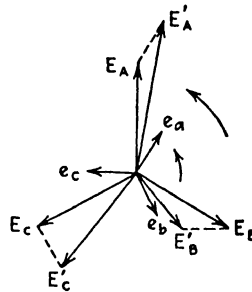

FIG. 50.

C. L. Fortescue* has shown that any dissymmetrical system of three-phase voltages or currents may be resolved by vector methods into a pair of symmetrical systems, one of forward or positive phase sequence and the other of backward or negative phase sequence. The ratio of the numerical values of the magnitude of the negative to the positive system is called the *unbalance factor* of the system (see Chap. XIV).

4-9. Various Three-phase Distribution Systems.—The three-phase Y-connected four-wire system finds use in both the 2,300/4,000-volt primary distribution and the $120\frac{1}{2}/208$ -volt secondary distribution. The neutral wire is carried through and makes available three 120-volt single-phase lighting circuits and single-phase or three-phase 208 volts for 220-volt motors. The neutral of the secondary system is almost invariably grounded (Fig. 51).

A Δ -connected source, with a middle tap provided on one secondary winding, is suitable for a moderate amount of lighting

* *Trans. A.I.E.E.*, 1918.

load on a single-phase three-wire basis (lines 1, 4, 2, of Fig. 52) in conjunction with a predominating three-phase load. As the 110-volt load assumes greater proportions, it is usually placed on a three-phase basis. This may be done in two ways: by

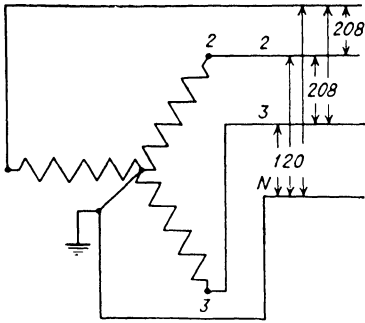

FIG. 51.

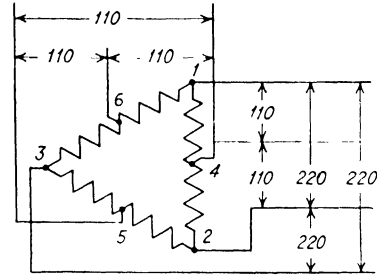

FIG. 52.

using an additional middle tap, 5, and one of the 220-volt line wires, 2. Another way which more nearly balances the currents in the windings of the transformers is 4, 5, 6.

4-10. Two Phase and Six Phase.—A three-phase supply to Scott-connected transformers (Fig. 53) will provide a source

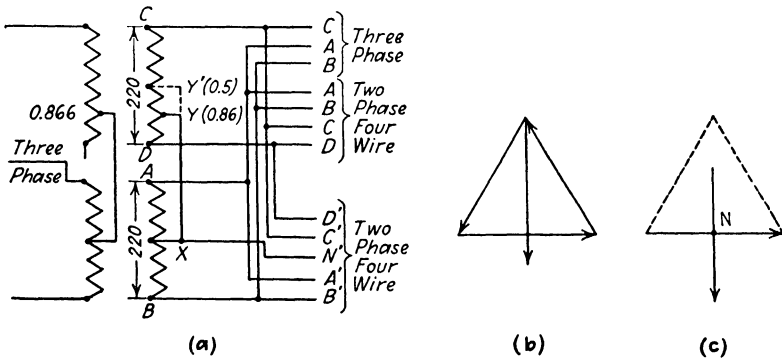

FIG. 53.

for two-phase distribution; if the connection *XY* is omitted it becomes a four-wire two-phase service with the two phases electrically independent. If the secondary connection is made from *X* to *Y*, the two-phase four-wire service may still be delivered to motors in which the windings are not interconnected and a three-phase supply *ABC* may simultaneously be obtained. The vector relations are those of Fig. 53b. If the tap to *AB* is

shifted from the 86.6 per cent point to the 50 per cent point, the common middle point becomes the neutral of a two-phase five-wire system, the vector relations for which are shown in Fig. 53c. This is occasionally called a "quarter-phase system." In this case the three-phase service is not simultaneously available.

Six-phase synchronous converters are common because the greater number of taps to the winding promotes more effective use of the copper. The six-phase supply is obtained from the usual three-phase service by one of the two methods indicated in Fig. 54. At *a* each transformer is supplied with duplicate secondaries and these are connected into two independent deltas;

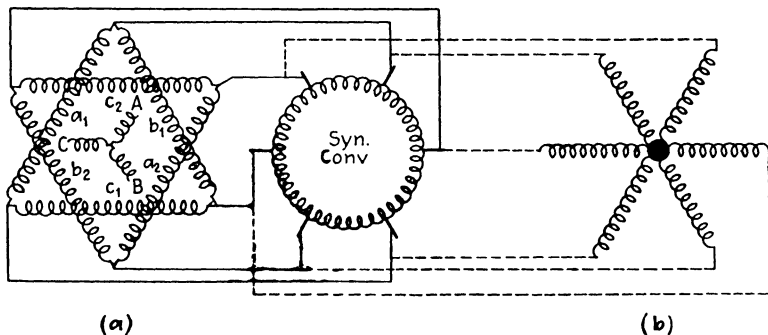

FIG. 54.

the scheme is called "double delta." At *b* the three single secondaries are connected at the midpoints and the terminals of each connected to diametrically opposite points on the converter winding; this is called "diametral."

Problems

4-1. Take the voltages of Fig. 44 as 120 volts and the resistors $R_{12} = 6$, $R_{23} = 8$, $R_{31} = 12$. Find the values of the line currents and their phase position. Draw the vector diagram.

4-2. Again referring to Fig. 44, let Z_{12} consist of $R = 4$, $X = 3$; Z_{23} consist of $R = 3$, $X = 4$; Z_{31} consist of $X = 5$, $R = 0$. Determine the three line currents and draw vector diagram.

4-3. Referring to Fig. 42, take the line voltages as 200. Let Z_1 consist of $R = 400$, $X = 0$; Z_2 consist of $R = 400$, $X = 0$; Z_3 consist of $R = 0$, $X = 500$.

- Determine the currents and their phase position. Assume the phase sequence is 1, 2, 3. Draw vector diagram.
- Assume the phase sequence is 1, 3, 2 and determine the currents and their phase position. Draw vector diagram.

4-4. Referring to Fig. 52, consider the transformer 2, 5, 3 omitted, *i.e.*, operating open Δ . The voltage is 220 volts and at the end of the line is a balanced three-phase load of 5 amp. at 0.8 p.f. lagging in each phase element. Between the transformer bank and the three-phase load is an unbalanced single-phase load consisting of 5 amp. at 1.0 p.f. between wires 1 and 4 and 8 amp. at 0.8 p.f. lagging between wires 4 and 2. Ignore line and transformer impedances and (1) find by complex algebra and (2) represent on a vector diagram:

- a. The line currents beyond the single-phase load.
- b. The line currents at the transformer bank.
- c. The currents in each portion of the transformer windings.

4-5. Draw the vector diagram for Fig. 54a in the case of a synchronous converter operating at 0.95 leading power factor.

4-6. Draw the vector diagram for Fig. 54b in the case of a synchronous converter operating at 0.95 lagging power factor.

CHAPTER V

POLYPHASE POWER MEASUREMENTS

In the case of a two-wire circuit, either direct current or alternating current, insertion of the current element in one of the conductors will suffice to register the power delivered over the circuit. When one side of the circuit is grounded at the entrance, as most secondaries are required to be for the sake of safety, it is imperative to insert the current element in the ungrounded side; otherwise an inadvertent ground on the load side of the meter might result in a portion of the current being unmeasured owing to its return path in the ground.

For circuits of more than two wires, one meter element will, in general, not suffice.

5-1. Theorem of Blondel.—The fundamental principle upon which power measurement in a multiconductor or polyphase distribution circuit is based was enunciated by Blondel in a paper delivered at the International Electrical Congress in Chicago, 1893.

The total power delivered to a load system by means of n conductors is given by the algebraic sum of the indications of n wattmeters so inserted that each of the n wires contains one wattmeter current-coil, its potential coil being connected between that wire and some point of the system in common with all the other potential coils; if that common junction of all the potential leads is on one of the n wires, the total power is obtainable from the indications of $n - 1$ wattmeter elements.

To substantiate the theorem, consider a circuit having n wires denoted 1, 2, 3 . . . $(n - 1)$, n , carrying at a particular instant currents $i_1, i_2, . . . i_{n-1}, i_n$, and at potentials to earth-zero at that instant of $v_1, v_2, v_3 . . . v_{n-1}, v_n$, respectively. Let the potential of some particular point x of the system be v_x .

The rate of work done in displacing electricity of current value i_1 under the pressure of the potential v_1 and against the potential v_x is $p_1 = i_1(v_1 - v_x)$; therefore, the total instantaneous power is:

$$p = i_1(v_1 - v_x) + i_2(v_2 - v_x) \cdot \cdot \cdot i_{n-1}(v_{n-1} - v_x) + i_n(v_n - v_x)$$

Strictly the rate of doing work in each conductor is $p_1 = i_1 v_1$ but

$$i_1 + i_2 + \dots + i_{n-1} + i_n = 0 \text{ (see 4-3)}$$

and therefore

$$i_1 v_x + i_2 v_x + \dots + i_{n-1} v_x + i_n v_x = 0$$

which means that

$$p = i_1(v_1 - v_x) + i_2(v_2 - v_x) \dots + i_{n-1}(v_{n-1} - v_x) + i_n(v_n - v_x)$$

is identical with

$$p = i_1 v_1 + i_2 v_2 + \dots + i_{n-1} v_{n-1} + i_n v_n$$

The total average power over a time T as registered by the wattmeters is

$$P = \frac{1}{T} \int_0^T i_1(v_1 - v_x) + \frac{1}{T} \int_0^T i_2(v_2 - v_x) + \dots + \frac{1}{T} \int_0^T i_{n-1}(v_{n-1} - v_x) + \frac{1}{T} \int_0^T i_n(v_n - v_x) \quad [18]$$

Each term represents the indication of a wattmeter. If x is taken on one of the wires, say the n th, then $v_n - v_x = 0$ and this

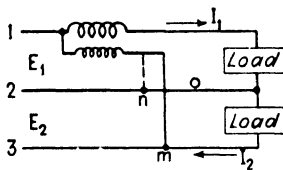

FIG. 55.

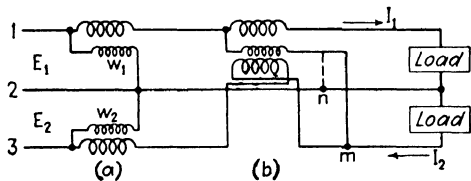

FIG. 56.

wattmeter indicates zero, the other $(n - 1)$ wattmeters registering all the power.

5-2. Three Wire Single Phase (or Direct Current).—If a three-wire load is balanced, *i.e.*, the two currents I_1 and I_2 of Fig. 55 are equal and the two voltages are equal, there is no error in the wattmeter reading whether its potential coil is connected across 13 as at m or connected across 12 as at n and the reading multiplied by 2. In general, however, the currents and voltages will not be balanced and Blondel's theorem requires two separate wattmeters as in Fig. 56a. Watthour meters are made in so-called "three-wire form" employing two separate current coils (Fig. 56b) in conjunction with a single armature (direct

current) or a single potential electromagnet (alternating current). Under these circumstances some degree of error will be experienced when the quantities are unequal but, in general, the accuracy is adequate for commercial energy metering.

The magnitude of the error in the case of direct current (or of a-c. loads of unity power factor) can be determined from the following considerations. The true total load in Fig. 56*b* is

$$W = E_1 I_1 + E_2 I_2$$

The load registered by the three-wire meter, when potential connection is made at *n*, is

$$W_n = E_1 I_1 + E_1 I_2$$

The discrepancy is

$$\begin{aligned} W - W_n &= E_1 I_1 + E_2 I_2 - E_1 I_1 - E_1 I_2 \\ &= I_2 (E_2 - E_1) \end{aligned} \quad [19]$$

and this is zero, or the registration correct, only when $E_2 = E_1$. The lesser voltage will usually be on the side supplying the heavier current and thus, if $I_2 > I_1$, $E_1 > E_2$ and the error will be negative which means the meter will overregister and be "fast." If some other load has caused the voltage unbalance, I_2 may be greater than I_1 but E_2 may simultaneously be greater than E_1 . In this case the error will be positive and the meter will underregister and be "slow." Note that the registration will be correct even if the currents are unbalanced as long as the voltages are equal.

When the voltage coil is connected across the outside mains, as at *m*, the total actual load is still

$$W = E_1 I_1 + E_2 I_2$$

but the registration of the meter is

$$W_m = \frac{1}{2}(E_1 + E_2)(I_1 + I_2)$$

The coefficient $\frac{1}{2}$ represents the allocation of half the voltage to each of the current coils. The error in this case is

$$\begin{aligned} W - W_m &= E_1 I_1 + E_2 I_2 - \frac{1}{2} E_1 I_1 - \frac{1}{2} E_1 I_2 - \frac{1}{2} E_2 I_1 - \frac{1}{2} E_2 I_2 \\ &= \frac{1}{2} E_1 I_1 - \frac{1}{2} E_1 I_2 - \frac{1}{2} E_2 I_1 + \frac{1}{2} E_2 I_2 \quad [20] \\ &= \frac{1}{2} (E_1 - E_2) (I_1 - I_2) \end{aligned}$$

This error is zero only when either $E_1 = E_2$ or $I_1 = I_2$. If the voltage unbalance is due to the unbalanced load being metered and $I_1 > I_2$, then $E_1 < E_2$ and the error will be negative or the meter will overregister and be fast. This is the usual situation. Note that this still holds if $I_2 > I_1$ and $E_2 < E_2$.

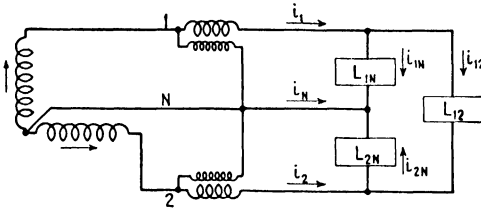

FIG. 57.

Since the error in the case of the potential connection from main to neutral (n) is proportional to the whole of the current on that side of the line, whereas in the case of the potential connection across the mains (m) it is proportional to half the difference between the unequal currents, the latter is, from the standpoint of accuracy, the preferable connection.

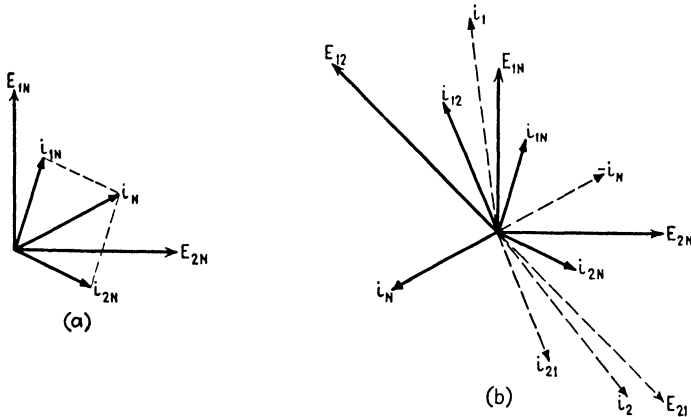

FIG. 58.

A three-wire current transformer (two primaries and a single secondary winding) in conjunction with an ordinary two-wire meter accomplishes the same purpose as the three-wire meter and introduces the same errors discussed above.

5-3. Two-phase Power Measurements.—The two-phase four-wire system consists of two distinct single-phase systems in

quadrature. Power measurement requires a two-wire meter in each single-phase circuit or the equivalent, a polyphase wattmeter. In case each phase is a single-phase three-wire circuit, the separate meters or elements of the polyphase meter (especially in the case of watt-hour meters) are commonly three-wire elements.

Two-phase three-wire load can also be metered, in accordance with the Blondel theorem, by means of two single-phase instruments or a polyphase instrument connected as shown in Fig. 57. That the total load is correctly registered even when a load is connected across the outside main can be seen from the following considerations. The true power is

$$P = e_{1N}i_{1N} + e_{2N}i_{2N} + e_{12}i_{12}$$

The power registered is

$$P' = e_{1N}i_1 + e_{2N}i_2$$

But

$$\begin{aligned} i_1 &= i_{1N} + i_{12} = i_{1N} - i_{21} \\ i_2 &= i_{2N} + i_{21} = i_{2N} - i_{12} \\ e_{12} &= e_{1N} + e_{N2} = e_{1N} - e_{2N} \end{aligned}$$

Thus

$$\begin{aligned} P' &= e_{1N}(i_{1N} - i_{21}) + e_{2N}(i_{2N} - i_{12}) \\ &= e_{1N}i_{1N} - e_{1N}i_{21} + e_{2N}i_{2N} - e_{2N}i_{12} \\ &= e_{1N}i_{1N} + e_{2N}i_{2N} + (e_{1N} - e_{2N})i_{12} \\ &= e_{1N}i_{1N} + e_{2N}i_{2N} + e_{12}i_{12} \end{aligned}$$

The instantaneous power registered by the meters is thus identical with the true instantaneous power at all times and, therefore, the average power is also correctly registered. Note that the sum of i_1 , i_2 , i_N is zero. In a later section it will be shown that the same meter connections serve when three-phase loads are supplied from a three-phase source over three wires.

The five-wire two-phase system of Fig. 53 can be metered in several ways which are practically identical in principle. In Fig. 59a a polyphase meter consisting of two three-wire single-phase elements is used in conjunction with four independent current transformers. In Fig. 59b a single polyphase meter consisting of two-wire single-phase elements is used in conjunction with two three-wire current transformers; and in Fig. 59c the same type of meter is used in conjunction with four transformers, the two in each phase having their secondaries

additively connected in parallel. In *a* the summation is effected electromagnetically within the meter, in *b* it is effected by adding the ampere-turns in the transformers, and in *c* by adding the amperes electrically external to both meter and transformers.

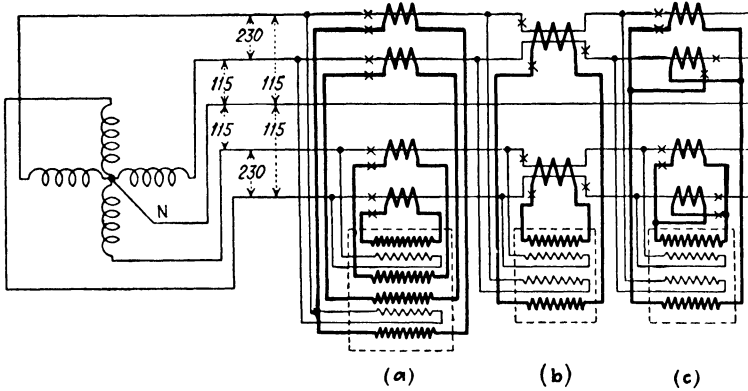

FIG. 59.

5-4. Power in Y-connected Load.—The power delivered to the three-phase three-wire Y-connected load of Fig. 60 may, of course, be metered by three single-phase meters. As shown at *a*, a current coil in each line wire and the corresponding voltage

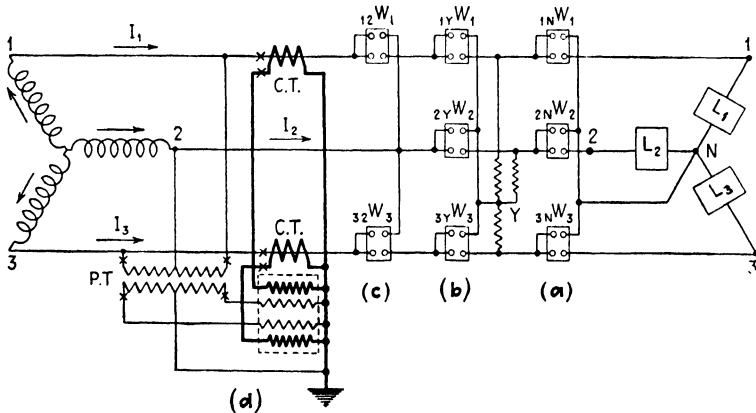

FIG. 60.

coil connected from that same line wire to the accessible neutral *N* of the Y. The line current is identical with the current in the leg of the Y and, therefore, the line insertion of the current coils is equivalent to three meters registering three independent single-

phase loads. If the loads are identical in impedance and power factor, the total load may be taken as three times the reading of only one meter.

The neutral of the Y is not always accessible, so, resorting to the Blondel theorem, we may obtain an independent junction point for common connection of all potential leads by connecting three auxiliary resistors in Y as at *b*. This is known as the *Y-box method* and as before it permits reliance on a single meter if the three loads are known to be identical.

The accessory Y-box may be dispensed with and the resistances of the voltage circuits of the three wattmeters be employed to establish the requisite "point of the system in common with all the other potential coils."

In any of the three methods the total power will be obtained correctly regardless of the degree of unbalance or of the power factor of each load, provided the three meters are employed.

With loads balanced and each of phase angle θ the total power may be expressed in terms of line value of current and line-to-line value of voltage. Thus, each phase load is

$$W_p = E_p I_p \cos \theta_p$$

Total load

$$\begin{aligned} W &= 3W_p \\ &= 3E_p I_p \cos \theta_p \end{aligned}$$

But

$$I_L = I_p \quad \text{and} \quad E_L = \sqrt{3}E_p \quad \text{or} \quad E_p = \frac{E_L}{\sqrt{3}}$$

Therefore

$$\begin{aligned} W &= 3 \frac{E_L}{\sqrt{3}} I_L \cos \theta_p \\ &= \sqrt{3} E_L I_L \cos \theta_p \end{aligned} \quad [21]$$

This means that with power factor known the power may be computed from voltmeter and ammeter indications of line values but not that it may be indicated by a single wattmeter subjected to line value of E and I as this will be demonstrated later to be unreliable.

5-5. Power in Δ -connected Load.—When the loads are connected Δ the total power may be obtained by inserting a wattmeter in each leg of the Δ as in Fig. 61. Again if the loads are balanced one wattmeter will suffice and its indications may

be tripled for the total power. Again the total power may be expressed in terms of line value of current and line-to-line value of voltage if the three loads are identical as to magnitude and

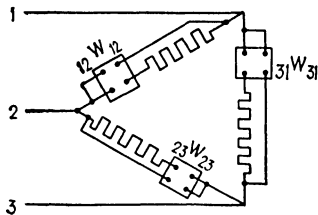

FIG. 61.

power factor.

Thus each phase load is

$$W_p = E_p I_p \cos \theta_p$$

Total load

$$\begin{aligned} W &= 3W_p \\ &= 3E_p I_p \cos \theta_p \end{aligned}$$

But

$$E_L = E_p \quad \text{and} \quad I_L = \sqrt{3} I_p \quad \text{or} \quad I_p = \frac{I_L}{\sqrt{3}}$$

Therefore

$$\begin{aligned} W &= 3E_L \frac{I_L}{\sqrt{3}} \cos \theta_p \\ &= \sqrt{3} E_L I_L \cos \theta_p \end{aligned} \quad [22]$$

This expression is identical with that derived for Y-connected load and it is, therefore, immaterial whether the load is Y or Δ .

Likewise the load of Fig. 61 could be metered by either of the *b* methods of 5-4.

5-6. Two-wattmeter Method for Three Wire Three Phase.—

Once more the Blondel theorem may be cited as justification for recourse to one less meter element than there are wires employed for the power circuit. The connections of the two wattmeters for registering either Y- or Δ -loads is shown in Fig. 60c. Notice that the wattmeters are connected so that each voltage coil is connected *from* the wire in which *its* current coil is inserted *to* the wire in which *neither* current coil is connected.

Observance of the polarities in Fig. 60d will disclose that the same rule has been followed in the installation of a polyphase meter in connection with voltage and current transformers. Incidentally, it should be noted that it is good practice to ground the secondary circuits of all the instrument transformers and that this may be effected by tying the outgoing leads to a common bus and grounding it. It should be recognized that in either *c* or *d* there are several incorrect connections possible

and, while the instrument may register apparently reasonable values, great care must be exercised, especially when instrument transformers are used, to verify the connections. The methods are discussed in the chapter on verification of polyphase watt-hour meter connections (Chap. XII).

5-7. Vector Relations for Two-wattmeter Method.—The vectors for the three line voltages and currents of a balanced non-inductive load, either Y or Δ , are shown in Fig. 62. Each line

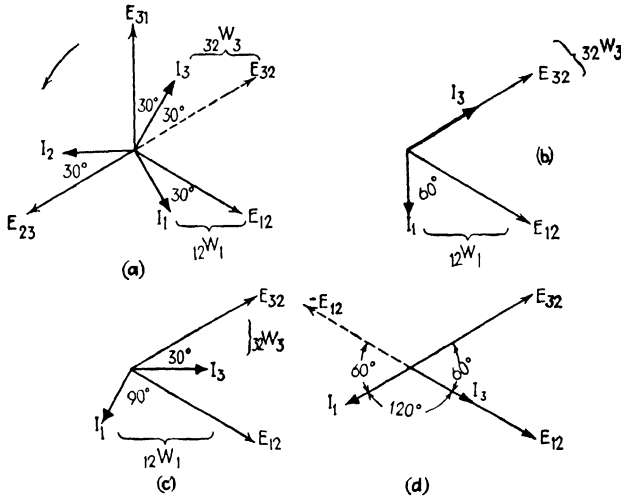

FIG. 62.

current is displaced 30° from a corresponding line voltage as was demonstrated in connection with Fig. 43. The upper wattmeter of Fig. 60c has line current I_1 and line voltage E_{12} ; the wattmeter may be identified as ${}_{12}W_1$ with adscript 12 for the voltage and subscript 1 for the current. Its current lags its voltage by 30° . The lower wattmeter has voltage E_{32} and current I_3 and may be called ${}_{32}W_3$. Its current leads its voltage E_{32} ($= -E_{23}$) by 30° . The two wattmeter readings are equal, if the loads are balanced.

Consider the effect of progressively increasing the inductive component of the load and, therefore, decreasing the power factor. All currents will lag more and more behind their time positions in Fig. 62a. Thus if a balanced load of 86.6 per cent power factor (30° lag) is imposed, I_3 will now be in phase with E_{32} but the lag of I_1 behind E_{12} will have increased from 30° to a 60° value. The reading of ${}_{32}W_3$ will have increased while

that of ${}_{12}W_1$ will have decreased. Actually, for balanced loads, ${}_{32}W_3 = 2({}_{12}W_1)$.

If the load power factor drops to 50 per cent (*i.e.*, 60° lag), I_3 will lag 30° behind E_{32} and I_1 will lag 90° behind E_{12} . The torque and registration of the latter wattmeter will be zero and all the power will be registered on the wattmeter ${}_{32}W_3$.

In case the lag in the load exceeds 60° (power factor less than 50 per cent) I_1 will lag more than 90° behind E_{12} and its reading will be negative. Of course, the negative magnitude can be ascertained by reversing the voltage connections but annoying errors are likely if this is not done and restored systematically. In the case of the polyphase wattmeter the subtraction is effected within the meter and no reversal of voltage connections is necessary.

When the load power factor decreases to zero the load is zero and the wattmeters or polyphase wattmeter should have zero resultant. Figure 62*d* shows this condition, I_3 lagging E_{32} by 60° and I_1 lagging E_{12} by 120° which is the same in effect as a lead of 60° and negative deflection. The algebraic sum is zero as required.

Thus there are significant relations between the magnitudes of the wattmeter readings and the power factor of balanced loads.

Power factor	Load phase angle, degrees	Relation
1.0	0	${}_{32}W_3 = {}_{12}W_1$
0.866	30	${}_{32}W_3 = 2({}_{12}W_1)$
0.50	60	${}_{12}W_1 = 0$
<0.50	>60	${}_{12}W_1$ is negative
0	90	${}_{32}W_3 = -{}_{12}W_1$

This discussion makes it evident that one wattmeter element is insufficient to indicate the total load except in the single case of balanced non-inductive load, in which instance the reading is one-half the total; also that one element of the meter will usually be working at a lower power factor than the power factor of the three-phase load being metered. The latter circumstance will be seen to have its bearing on the importance of the so-called "lag adjustment" of polyphase watt-hour meters (see 9-2 and 11-3).

5-8. Power Factor with Balanced Load from Wattmeter Readings.—The relation which holds for the foregoing and all other values of power factor but only with balanced load may be found as follows, designating the two wattmeter readings simply as W_a and W_b :

$$W_a = EI \cos(\theta + 30^\circ) = EI [\cos \theta \cos 30^\circ - \sin \theta \sin 30^\circ]$$

$$W_b = EI \cos(\theta - 30^\circ) = EI [\cos \theta \cos 30^\circ + \sin \theta \sin 30^\circ]$$

$$\frac{W_a}{EI} = \frac{1}{2}\sqrt{3} \cos \theta - \frac{1}{2} \sin \theta$$

$$\frac{W_b}{EI} = \frac{1}{2}\sqrt{3} \cos \theta + \frac{1}{2} \sin \theta$$

$$\frac{W_a + W_b}{EI} = \sqrt{3} \cos \theta$$

$$\frac{W_b - W_a}{EI} = \sin \theta$$

$$\tan \theta = \sqrt{3} \frac{W_b - W_a}{W_a + W_b} \quad [23]$$

$$\text{Power factor} = \cos \theta = \cos \left[\tan^{-1} \sqrt{3} \frac{W_b - W_a}{W_a + W_b} \right] \quad [24]$$

The power factor for balanced load is also expressed directly in terms of the wattmeter indications without the medium of trigonometric ratios by

$$\text{Power factor} = \frac{W_a + W_b}{\sqrt{(W_a + W_b)^2 + 3(W_b - W_a)^2}} \quad [25]$$

5-9. Metering Four-wire Y-circuits.—The Blondel theorem requires three metering elements to measure correctly for all conditions the power or energy delivered by a three-phase four-wire system in which the fourth wire is the Y-neutral. A three-wire system which has its neutral grounded on both sides of the metering installation is the equivalent of the foregoing four-wire system because the earth may carry the unbalance current which in the four-wire instance is carried by the fourth wire. The meter connections are shown in Fig. 63.

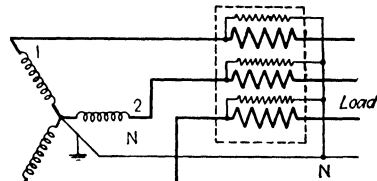

FIG. 63.

An alternative method employs a polyphase meter comprising two three-wire single-phase elements connected as shown in Fig. 64. The current coils inserted in the wire from which no potential tap is taken are wound in the reverse direction from those connected in the other two wires. The effect of this reversal is to reverse the vector I_2 of Fig. 65 so that it makes the angle $(60 - \beta)$ with E_1 and $(60 + \beta)$ with E_3 . The vector diagram has been drawn for the general case of unequal phase currents at different phase angles with their phase voltages but with the voltages symmetrical and equal. The reversed current

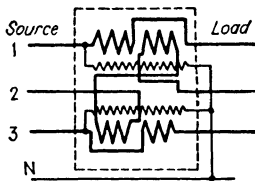

FIG. 64.

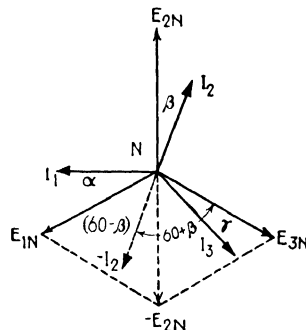

FIG. 65.

I_2 reacts with E_1 and E_3 to produce torque the same as it would produce with E_2 in the third element if present. Now if the transformer primaries are connected Δ , unbalance of secondary voltage due to unequal loading will react to distort the primary voltages but the resulting secondary voltages will still close the vector triangle. Therefore, no error in registration will result. For example, if phase 2 is heavily loaded, say with non-inductive load, the resulting voltage drop in wire 2 and the neutral wire will tend to shorten E_2 more than E_1 and E_3 and increase the angle between E_1 and E_3 . The current I_2 reacts with the resultant of E_1 and E_3 which is still equal to E_2 in magnitude.

Still another alternative involves the use of an ordinary two-element meter in conjunction with three current transformers in Δ -connection (Fig. 66). The current addition in this case is effected by the passage of the current from the odd wire through the current elements connected to the lines from which the potential taps are taken. Thus the path for the current originating in wire 2 is *jihgdcbk*, which indicates that it flows through

both elements in series in a direction opposite to that of the currents in each from the other current transformers.

To minimize the inherent voltage unbalance and the increasing effect of voltage transformer phase angles at low power factors, a third voltage transformer may be inserted (as suggested at the

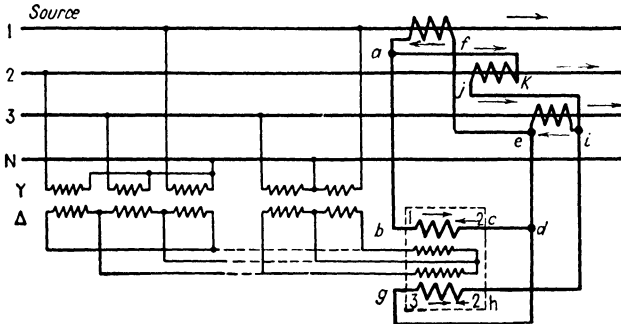

FIG. 66.

left of Fig. 66) the secondaries of the three being in closed Δ. This is seldom considered necessary.

5-10. Metering Combined Lighting and Power Loads. 1.

Any Relative Value of Lighting and Power Loads.—Delta-connected three-phase four-wire distribution may be obtained by tapping the center point of one phase as in Figs. 52 and 67. If

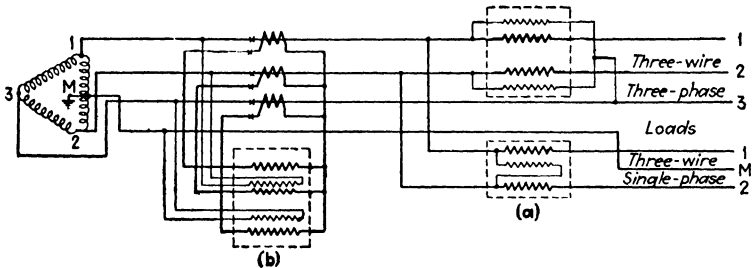

FIG. 67.

the single-phase (lighting) and three-phase (power) loads are supplied by independent circuits, each may be metered separately by the methods outlined in 5-2 and 5-6. The connections are those of Fig. 67. Any load connected between wires 3 and M will not be registered, but such a load is unlikely on account of the odd voltage between them (86.6 per cent of the three-phase line voltage).

This connection is especially appropriate where the lighting and power consumptions are sold on different rate bases.* It has, however, one defect; that arising out of the use of a three-wire single-phase meter when voltages and currents are unbalanced. If this error is to be avoided it will be desirable to replace the single-phase meter by a two-element polyphase meter. In either case, however, it will not be possible to ascertain from demand attachments on the two meters the combined value of the simultaneous demands on the lighting and power loads. But this will be desired only if power load and lighting load are on the same rate schedule. In that event the connections of Fig. 67b will be preferred.

2. *Small Power and Large Lighting Load.*—Another way of using a polyphase meter and a single-phase meter to register combined single-phase three-wire lighting and three-wire three-phase power is frequently used, especially where the power load is relatively small as it may be on store and office circuits. The lighting meter is chosen to be a two-element polyphase meter with elements connected ${}_1W_{1M}$ and ${}_2W_{2M}$; the second meter is a simple single-phase meter connected ${}_3W_{3M}$ and registers that part of the polyphase load not appearing in the other meter. That these two meters properly record all the energy can be seen by noting the conformity with Blondel's theorem. Each wire contains a current element and all these are associated with potentials from the respective wires to a common potential point (in this case M). The single-phase meter has only 190 volts in the case of a 220-volt service.

3. *Combined on One Meter for Demand Purposes.*—The scheme of Fig. 67b serves to register the two loads in one instrument. It is special in that it is a polyphase meter consisting of two single-phase elements, one a standard two-wire single-phase element and the other a three-wire single-phase element. The Δ -voltages may be unbalanced without interfering with the accuracy of registration of the polyphase load but, if the two portions of voltage of the tapped phase are unbalanced, more or less error will be encountered in the registration of the three-wire element as was analyzed in 5-2. A three-wire current transformer may be inserted in lines 1 and 2 and its secondary connected to the current coil of a standard two-wire single-phase element in the polyphase meter and accomplish the same result.

* See KING, H. W., *Elec. World*, Oct. 25, 1930.

The scheme of Fig. 67*b* will register a load connected between wires 3 and *M*.

4. *Combined Metering on Grounded Circuits.*—Both methods *a* and *b* of Fig. 67 are only in partial conformity with the requirements of the Blondel theorem which stipulates three current elements and three voltage elements. Such an installation is represented in Fig. 68 but it is evident that for precision the element connected to wire 3 should have a 190-volt voltage coil while the other two are 110 volt. Usually the performance of a 220-volt element will be satisfactory at 190 volts, especially

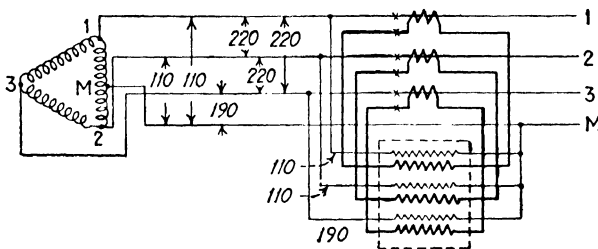

FIG. 68.

if it is calibrated at that voltage. It is imperative that the current coil associated with the odd voltage be inserted in the line wire which is opposite the middle of the tapped phase. This method is correct under all conditions and is, therefore, preferable from the accuracy standpoint to either of the methods of Fig. 67. It also is adapted to the customary safety practice of grounding such circuits at the point *M* at the transformers. Loads connected from any line wire to ground will be recorded by some element of the meter.

5. *Three-phase Lighting with Three-phase Power.*—If the lighting load justifies division of it among the phases of the polyphase system, either the five-wire scheme of Fig. 52 (with terminals 1, 2, 3 and, say, 3, 4, 5 used) or the six-wire scheme (with terminals 1, 2, 3 and 4, 5, 6 used) may be metered by using two separate polyphase meters, one connected in accordance with Fig. 60*a* for the 220-volt power load and the other similarly connected for the 110-volt lighting load.

5-11. *Combined Three-phase and Two-phase Loads.*—The three-phase and two-phase loads simultaneously derivable from the Scott-connected transformer system of Fig. 53 can be metered by either of the methods of Fig. 69. In *a* a standard

two-element polyphase meter is employed in conjunction with three current transformers, one of which is of special ratio. The two current coils of the meter are connected directly to the current transformers in wires 1 and 2; the common junction for the voltage leads is on 3. This much suffices to register the three-phase load and the portion of the two-phase load on phase 1, 2. The other phase (3, 4) of the two-phase load is registered by the same two elements by means of the current transformer in wire 4. But the vector sum of the (balanced) voltages 13

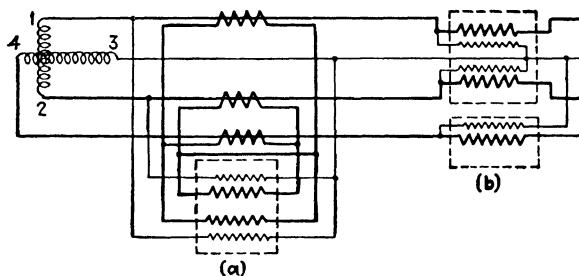

FIG. 69.

and 23 with which the current in 4 reacts to produce torque in the meter is equal to the $\sqrt{3}$ times the voltage 43 at which this phase load is delivered. This is compensated for in the ratio of the current transformer by making its secondary current $5/\sqrt{3}$ for the same primary current as produces 5 amp. in the other current transformers.

An alternative method *b* involves two meters without special features. A standard three-wire polyphase meter is connected in wires 1 and 2 with 3 as the common wire. The two-phase current in the 34 phase is registered by a separate single-phase meter. The scheme has practical value where transition from two-phase to three-phase distribution is in progress, because the polyphase meter may be left in place without change and the single-phase meter used elsewhere after the two-phase service has been abandoned.

5-12. Six-phase Power Measurement.—Loads on the six-phase systems of 4-10 (Fig. 54) may be metered as if three-phase using three Δ -connected current transformers in the manner of Fig. 66. Usually the six-phase load is a synchronous converter in which case the six-phase loads are balanced and the registration of its input may be effected with one single-phase

meter in the three-phase supply, its reading being multiplied by 3.

Problems

(It is intended that the analysis in practically all of these problems will be performed by drawing the vector diagrams corresponding to the load and connection situation stipulated.)

5-1. A lighting load of 10 amp. and a power load of 20 amp. at unity power factor are served by a three-wire $230/115$ -volt single-phase line through a 230-volt three-wire meter.

- a. What will be the error if the lighting load is all on one side of the line and the actual voltages are 112 volts on that side and 114 on the other side?
- b. What would it be if a 115-volt meter were being used with its potential on the same side as the lighting load?
- c. What if on the other side?

5-2. The potential leads from the two elements to the third (middle wire) in Fig. 60c accidentally become detached from that wire but remain tied together. What error in registration will result if the balanced-load power factor is 1.0? What if it is 0.50?

5-3. The current coil of a wattmeter is connected in series with one line wire *A* of a three-phase circuit. When the voltage coil is connected between line *A* and line *C* the meter reads 15 kw.; when it is connected between line *B* and line *C* the wattmeter reads 6.6 kw. The load is balanced and of lagging power factor. Determine the load and the power factor.

5-4. A single-phase motor load is added to the balanced load previously measured by a two-element polyphase meter. Does the meter register the new unbalanced load correctly, to whichever phase the single-phase motor is connected? Under such conditions of load, a meterman reports that, by opening the potential circuits of the two elements successively, the disk turns forward in one case and reverses in the other; is this consistent? Why?

5-5. Could you meter correctly the power taken by a three-phase motor by installing a single-phase wattmeter in wire 1 with voltage from 1 to 2 and multiply its registration by 2? If not, what fraction of the total power would be registered if the power factor is 1.0? What fraction if it is 0.80?

5-6. If the bill of one of your power customers should suddenly drop to two-thirds with no change in his manufacturing operations, what is the most likely defect you would expect to find in the metering installation?

5-7. A polyphase meter has voltage from lines 1 to 2 impressed on the voltage coil of the upper element and 3 to 2 on the lower voltage coil. Current from line 2 is passed through the two current coils in series. Show that the registration is correct for balanced loads of any power factor but badly in error for moderately unbalanced loads.

5-8. A balanced three-phase load is being measured by means of two wattmeters connected as in Fig. 60c. One reads 900 watts, the other 100 watts.

- a. Compare the values of power factor as computed from both the formulas of Par. 5-8.

- b. Recompute its value for the case in which the readings are 800 and -120.

5-9. On investigation a power company found that the polyphase meter through which an industrial plant was being served was incorrectly connected. The error resulted from incorrect polarity markings of one of the potential transformers. During two months the indicated demand had been 400 and 460 kw. and the watt-hour meter had registered 170,000 and 260,000 kw-hr. A careful test showed that the power factor was 72 per cent most of the time.

- a. By what factor should the demand-meter and watt-hour-meter readings be multiplied?
- b. The demand charge was \$1.50 per kilowatt per month and the energy charge 1.0 cent per kilowatt hour. How much revenue had the power company been losing because of the error?

5-10. Draw the vector diagram for the unbalanced-load condition on a four-wire three-phase system as discussed in Par. 5-9 in connection with Fig. 65.

5-11. A four-wire three-phase balanced load is metered by means of a split-current coil polyphase meter connected as in Fig. 64. The voltage leads instead of being taken from 1 to N and 3 to N are inadvertently taken from 1 to 2 and 3 to 2 as for a three-wire circuit. Show that the meter reads twice the true value at any power factor.

5-12. Show the proper connections to a watt-hour meter (two-element polyphase) for measuring the power delivered from a three-phase star- Δ connected bank of transformers, 4,000-volts four-wire primary to 220-volts three-wire secondary, using current transformers in the primary and meter potentials directly from the secondary lines. Draw the vector diagram.

- a. Can the correct registration be effected by use of two current transformers in the primary line and two of the secondary voltages?
- b. If not, should the correct phase relations between current and voltage for the two-wattmeters method be obtained by using three current transformers in the primary? How connected?
- c. When the connections are correct will the registration include some or all of the transformer loss? If not all, will it be the core loss or the copper loss?

5-13. Draw a vector diagram for assumed balanced three-phase and unbalanced single-phase loads and verify the accuracy of measurement claimed for Fig. 68.

5-14. Draw the connection diagram for metering:

- a. The five-wire,
- b. The six-wire system of Par. 4-10.

5-15. Two of the line wires and the neutral of a four-wire three-phase 110-volt secondary network are the source of supply to a three-wire residential service with balanced 110-volt resistance loads. Show vectorially the degree of metering accuracy obtained by using a regular three-wire $1\frac{1}{2}$ 20-volt single-phase meter with 110-volt potential. How will the load power factor affect the result? Will the accuracy be improved by reversing the connections of one of the current coils?

CHAPTER VI

EVOLUTION OF THE WATTHOUR METER

When electricity emerged from the physicist's laboratory into a role of usefulness in the everyday world, the inventor was faced with the problem of providing means for measuring it. As a salable commodity or service the magnitude to be measured involved the quantity (coulombs) of electricity delivered and the pressure (volts) at which it is delivered. The quantity in coulombs, in turn, involves the rate of flow (amperes) and the

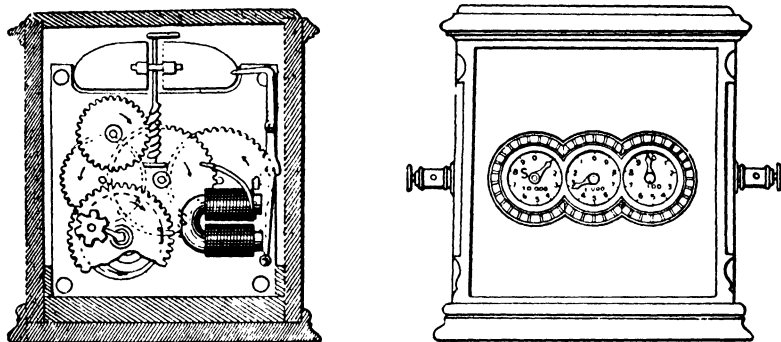

FIG. 70.

duration of flow (seconds). Energy, therefore, is the summation of the instantaneous products of volts and amperes and sufficiently short time intervals; $W = \int e i t$. In preparing to analyse the modern watthour meter in terms of its ability to perform this integration, it will be profitable to review the historical stages by which the component factors in energy measurement were successively introduced into the metering devices.

6-1. Clock-type Meters.—The need for some type of integrating meter arose with the introduction in America in the seventies of commercial arc lighting by the pioneers Wallace, Farmer, Brush, Thomson, and Houston. The first patent on a meter which would serve to measure the quantity of service rendered was issued to Samuel Gardiner in 1872. It consisted of a spring-driven clock mechanism (Fig. 70) held inactive

except when an electromagnet in series with the line became energized and released the detent. This meter merely registered the length of time during which there was current flow over the line; this was an adequate index of the consumption because the load and current were practically constant for the given series circuit.

A second meter of this type was patented in 1878 jointly by J. B. Fuller and W. E. Sawyer. This was an a-c. device consisting of a polarized electromagnet actuated by the line current or a shunted portion of it; the vibrations of the armature in synchronism with the pulsations of current actuated a train of registering wheels. Again the quantity registered was merely time in terms of the elapsed numbers of cycles of constant frequency.

In the next six or seven years, the introduction by Edison of the incandescent lamp and the multiple scheme of distribution accentuated the need for a meter and there was much inventive effort applied. Among the Americans who were active in trying to perfect the clockwork principle were Hudson Maxim, S. DeMott, Edward Weston, H. M. Byllesby, and R. P. Diehl; in England, C. V. Boys and S. Ferranti.

6-2. Edison Chemical Meters.—About the same time that Thomas A. Edison was launching the incandescent lamp, he devised an electrolytic meter which he called the “Weber” meter. Zinc plates were attached at the ends of a balance beam and suspended in an electrolyte of zinc sulphate. Passage of current from one plate through the electrolyte to the other would increase the weight of one and decrease that of the other. The consequent tipping of the beam actuated the registering mechanism and reversed the direction of the current through the cell so that the deposition of metal was made on the lighter plate. This device registered Q or It . (*i.e.*, ampere-hours).

The form in which this principle was placed in extensive commercial service by the Edison-Illuminating Companies (organized to exploit the Edison lamp and the multiple three-wire systems) omitted the beam and automatic registration.

It consisted of two electrolytic cells (Fig. 71) containing polished and amalgamated plates of copper immersed in a solution of copper sulphate. Two years (1883) after its introduction the active materials were changed to zinc and zinc sulphate. One ampere-hour resulted in a deposit of 1.224 g. of

zinc; to prevent too rapid accumulation and loss of weight the cells were shunted across German-silver shunts. Later refinement incorporated a shunt with a lower temperature coefficient. In cold weather a lighted lamp in the meter box prevented freezing of the electrolyte. The meterman once a month would remove one cell and replace it by a fresh one. The removed cell was carried to the office, the plates dried and weighed,

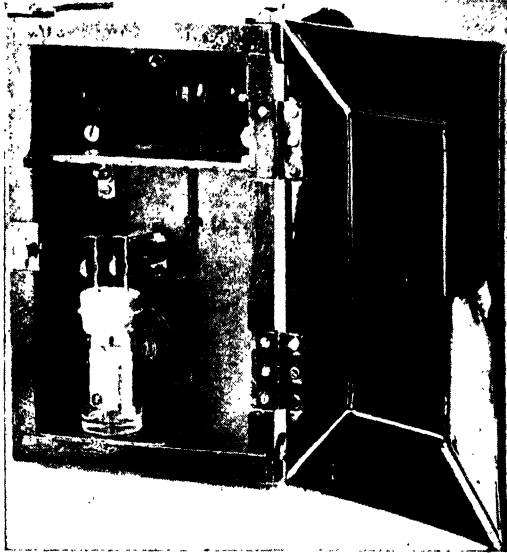

FIG. 71.

and the consumption calculated. One cell was left intact to give a quarterly check.

Others who devised meters on the electrochemical pattern were Green, Elihu Thomson, Johnston, Vanderpoel, and Ferranti (in England).

6-3. Pendulum-type Meters.—Professor Perry, who had been associated with Ayrton in the production of electrical apparatus, in 1882 brought out an accelerated pendulum meter in which the rate of oscillation was varied in proportion to the current passing.

Dr. H. Aron of Berlin in 1885 employed a similar design for a meter which was used extensively in Great Britain and on the continent until 1893. The 1887 form consisted in comparing the speeds of two pendulums (Fig. 72), one oscillating at a constant predetermined speed, the other having its period

modified by the load under measurement by means of an electromagnet in series with the line. In a still later form each pendulum carries a high-resistance coil (connected across the line) and swung inside or over a large coil carrying the load current.

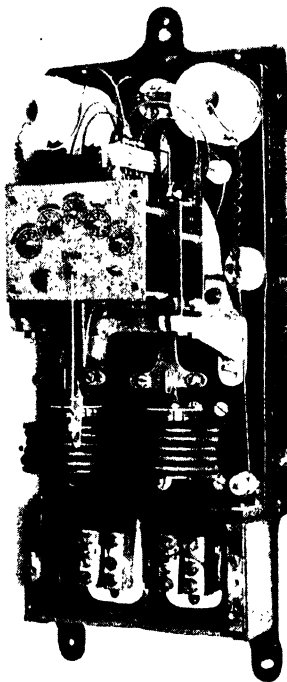

FIG. 72.

Their speeds are so affected by the electromagnetic retarding torque as to render the difference between them proportional to the watts. It is capable of high accuracy but is complicated and expensive in comparison with the modern watt-hour meter.

Maxim (1881) and DeMott (1885) employed similar principles. Pentz and Reckanzum omitted the clock mechanism and provided for driving the two pendulums electromagnetically. One had a constant period and the other had its period lengthened and oscillations decreased in number in proportion to the current.

6-4. Thermal Principle.—In 1882 Lucian Goulard and John D. Gibbs invented the transformer. William Stanley soon

developed the a-c. high-voltage multiple system and as a-c. systems made headway against the established d-c. systems there came a demand for a-c. meters. The early trend for a-c. indicating instruments had been toward the hot-wire principle. (The Cardew voltmeter was of this type.) It was natural that the first of the a-c. meters, devised by Prof. George Forbes (London) and exhibited to the American Institute of Electrical Engineers in 1887, should be of the thermal form (Fig. 73). A coil carrying the load current heated the air within the meter case and set up convection currents which impinged on mica fan blades. The mica fans were attached radially to a light paper cone resting on a jewel point. It was too delicate and

too sensitive to disturbing influences to give commercial promise.

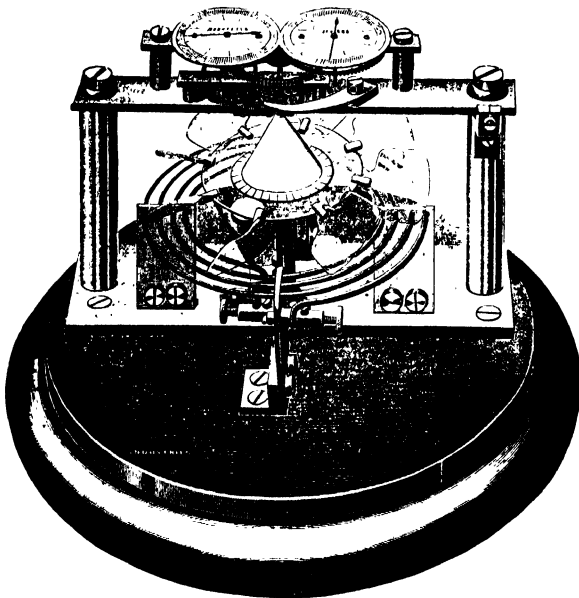

FIG. 73.

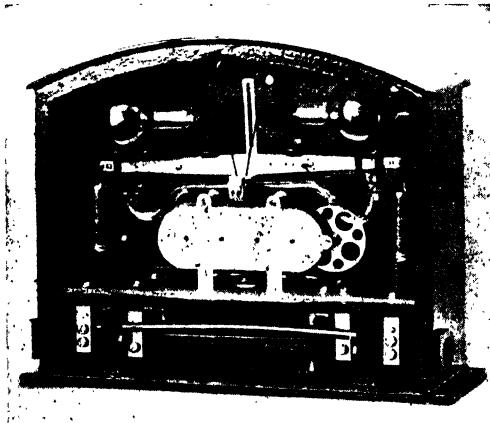

FIG. 74.

At about the same time Elihu Thomson introduced a vapor meter. It consisted of two evacuated glass bulbs connected by a capillary tube (Fig. 74). The bulbs were nearly filled with alcohol and each contained a small electric heating element.

The two bulbs were mounted on a beam, balance fashion, and the one in the depressed position dipped into a mercury well and connected its heater across a line shunt. The rise in temperature of the alcohol increased the vapor tension above the liquid and forced some of it through the capillary tube into the other bulb. The cycle was thereupon repeated, each oscillation of the beam registering a more or less definite consumption.

6-5. Shallenberger Ampere-hour Meters.—Edison as early as 1881 invented what was probably the first meter of the motor type. It consisted of a small bipolar motor (Fig. 75), the field

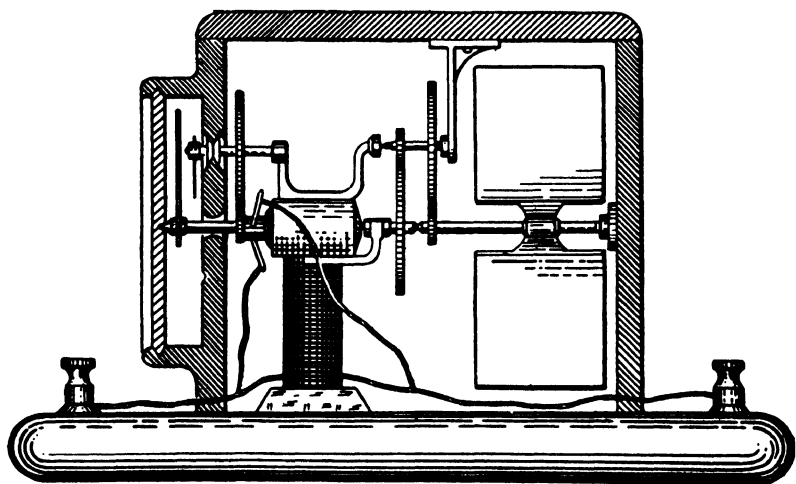

FIG. 75.

connected in series with the line and the armature shunted across the field. A fan controlled the speed proportional to the line current (as will be discussed in connection with the Shallenberger meter). It was not developed commercially because Edison was partial to the chemical meter.

The first really successful motor meter was devised by Oliver B. Shallenberger in 1888. In an experiment with a new form of arc lamp for alternating current, a small piece of spiral spring became detached from the mechanism and fell upon a flange of a magnet comprising a part of the lamp. It fell so as to be placed under the influence of the flux from the magnet and that from a core of soft-iron wires. Shallenberger noticed that the spring rotated slightly about its longitudinal axis. This was a new phenomenon and he saw in it at once the potentiality for

adaptation to a simple motor principle for meter purposes, the induction principle and rotating magnetic field. Within three weeks of his original observation he had employed the principle of two displaced magnetic fields with a time-phase difference of their fluxes to construct an induction ampere-hour meter.

The time and space displacement of the two magnetic fields was accomplished by placing the axis of a heavy short-circuited

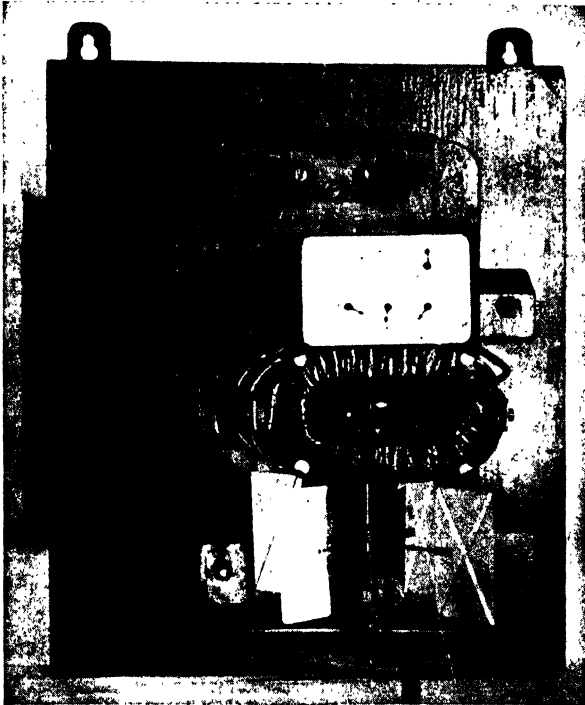

FIG. 76.

copper secondary at an angle with the axis of the parallel coils carrying the line current. Free to rotate within both coil systems was a light aluminum disk carrying a soft-iron ring. Control of the speed to some functional relation to the line current was accomplished (as in Edison's motor meter) by means of four light aluminum fans supported radially from the same shaft as the disk (Fig. 76). The driving torque was proportional to the flux and current in the main coils and also to the flux and current induced in the short-circuited coil. The latter was proportional to the former and, therefore, the driving torque was proportional to the square of the line current. The fan

developed a retarding torque proportional to the square of the speed at which it was rotated. With friction at the bearings and register neglected,

$$\begin{aligned}\text{Driving torque} &= K_1 I^2 \\ \text{Retarding torque} &= K_2 (\text{speed})^2\end{aligned}$$

Under conditions of steady load the speed will automatically assume a value at which

$$\text{Retarding torque} = \text{Driving torque}$$

or

$$K_2 (\text{speed})^2 = K_1 I^2$$

and

$$\text{Speed} = KI$$

The meter inherently had poor light-load characteristics because at 1/10 load the driving torque was only 1/100 of the full-load torque.

6-6. Thomson Recording Wattmeter (TRW).—A patent was obtained in 1889 by Elihu Thomson for a motor-type meter which was the first real watt-hour meter. The inventor's intention was to develop an a-c. meter. Actually its real field of usefulness has proved to be on d-c. systems because of the difficulty of lagging it for correct registration on inductive loads and because of the simplicity and lower cost of the induction meter. It consists of a small shunt motor (Fig. 77) with a cylindrical armature mounted on a vertical shaft and free to rotate in the fields of circular coils placed in series with the line. The armature is connected in series with a resistor across the line. The driving torque is, therefore, proportional to the current in the armature (and, therefore, to the line voltage) and also proportional to the line current in the series coils. The driving torque is, therefore, proportional to the product of E and I and, therefore, to watts. The armature shaft carries a copper disk which rotates between the poles of permanent magnets. The retarding torque of reaction between eddy currents induced in the disk and the magnet flux which induced them is proportional to the speed of the disk. In this instance the balance of the driving and retarding torques will result when the speed is proportional to the watts to which the driving element responds. The meter, therefore, performs the integration $\int EIdt$ and is a watt-hour meter.

6-7. D-c. Mercury-type Meter.—Barlow in 1823 discovered that magnetic flux threading through the plane of a disk would react with a radial current to produce torque which would make the disk rotate about its axis. Faraday made the same discovery. In 1888 and 1889 Ferraris and Hookham independently devised ampere-hour meters functioning on this principle. The brushes of Barlow and Faraday were supplanted by mercury contacts. In fact the disk was submerged in mercury contained

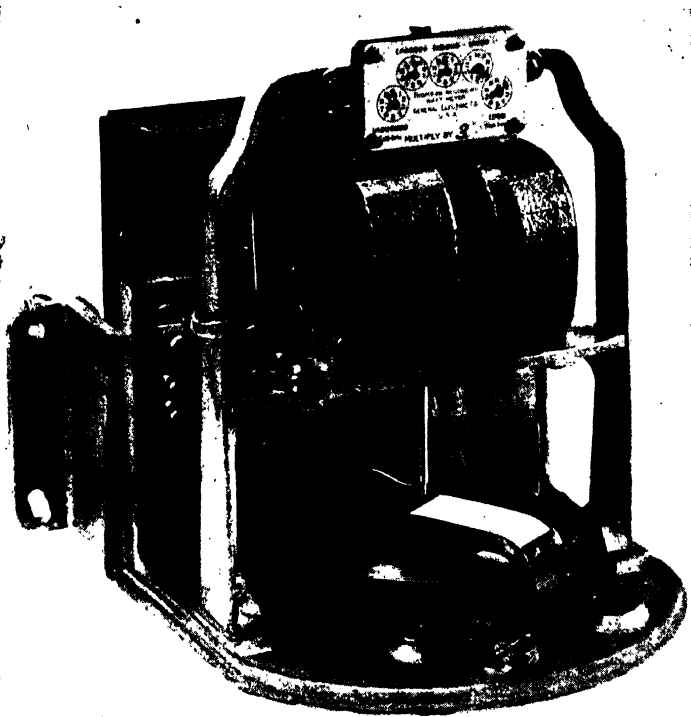

FIG. 77.

in a chamber of insulating material. The current passed across a diameter of the horizontal disk and encountered a vertical flux upward on one side of the shaft and downward on the other. The torque resulted in rotation. The Sangamo mercury ampere-hour and watt-hour meters are the direct American descendant.

6-8. Watthour Adaptation of the Induction Principle.—An induction meter in which a disk was subjected to two magnetic fields displaced in space and in time-phase was patented (United

States) in 1890 by Blathey. One coil was a shunt coil responsive to line voltages and the other a series coil energized by line current. Ferraris had discovered (1885) the rotating field produced by space-displaced polyphase windings. Blathey got the effect from a single-phase source; this meter was more than merely an ampere-hour meter like Shallenberger's but hardly a watt-hour meter because of the omission of phase control of the voltage flux. Gustav A. Scheefer in 1894 patented the scheme which introduced some correction of this sort; he sensed the necessity for maximum torque and speed under unity power-factor condition of the metered load. He also provided, for the first time, means for compensating for the friction of the moving parts; a short-circuited winding on the current coil functioned as a "shading coil."

It remained, however, for Shallenberger to make the last great stride in the evolution of the induction watt-hour meter. In 1895 he patented means for bringing the resultant flux from the voltage coil into time quadrature relation with the flux from the current coils. This assured not only maximum torque at unity power factor as Scheefer had approximately attained but also correct registration at any power factor. Subsequent development of the induction watt-hour meter has been in the direction of refinement and simplification of design with improvement in operating characteristics and, more recently, less variation of accuracy of registration with overloads and change in ambient temperature.

The Duncan, General Electric, Sangamo, and Westinghouse meters all function on the fundamental design established by Shallenberger and differ little from one another today in performance or manner of effecting adjustments or compensation.

6-9. Recapitulation.—The Gardiner and Fuller-Sawyer meters measured only the time of consumption. The Edison (chemical), Perry, Forbes, Thomson (vapor), and Shallenberger meters (1878–1888) measured current times the time or ampere-hours. The Thomson Commutator Meter measured d-c. watt-hours. In the a-c. field Blathey (1890) added volts to Shallenberger's ampere-hours; Scheefer (1894) added a function of the power-factor angle; and Shallenberger (1895) made that function the cosine and thus rendered the induction meter a true watt-hour meter for alternating current.

Bibliography

The following references to volumes of the *Electrician* (London) comprise reasonably complete treatment of the more significant developments and inventors in the field of electricity meters and watthour meters.

Aron's Coulomb Meter: vol. 14, p. 189, 1884; vol. 22, pp. 393, 395, 438, 1889; vol. 24, pp. 351, 379, 1890.

C. V. Boy's Meter: vol. 8, pp. 46, 190, 251, 1881; vol. 11, p. 110, 1883.

Blondlot's Meter: vol. 45, p. 121, 1900.

Duncan Ampere-hour Induction Meter: vol 33, p. 608, 1894.

Edison's Chemical Meter: vol 9, p. 65, 1882.

Edmondson-Oulton Pendulum Meter: vol. 24, p. 111, 1890; vol. 26, p. 332, 1891; vol. 31, p. 35, 1893.

Evershed's Frictionless (Magnetic-suspension) Motor Meter: vol. 45, pp. 283, 328, 513, 1900

Ferranti Meter: vol. 22, p. 71, 1889; vol. 26, p. 544, 1891; vol. 28, p. 537, 1842.

Forbes Current Meter: vol. 19, p. 422, 1887.

Fragar Motor: vol. 25, p. 254, 1890

Freres Meter: vol. 26, p. 612, 1891.

General Meter: vol. 31, p. 8, 1893.

Gerbox Meter: vol. 14, p. 213, 1884.

Hookham Meter: vol. 22, p. 394, 1888; vol. 23, p. 124, 1889; vol. 32, p. 220, 1893.

Marks' Meter: vol. 40, p. 201, 1898.

Pentz-Reckanzaum Meter: vol. 31, p. 8, 1893.

Perry's Meter: vol. 27, p. 190, 1891.

Shallenberger's Meter: vol. 21, p. 572, 1888; vol 22, p. 395, 1889.

Sprague's Meter: vol. 9, p. 67, 1882.

Siemen's Coulomb Meter: vol. 21, p. 183, 1888.

Slattery's Meter: vol. 23, p. 630, 1889.

Elihu Thomson Oscillating Meter: vol. 23, p. 60, 1889.

Thomson Recording Wattmeter: vol. 26, pp. 332, 532, 1891.

Wright Electrolytic Meter (Demand): vol. 47, p. 997, 1901.

Scheefer's Induction Meter: *Elec. World*, vol. 36, p. 340, 1900.

Stanley's Induction Meter: *Elec. World*, vol. 47, p. 1266, 1906.

CHAPTER VII

DIRECT-CURRENT WATTHOUR METER

In devising a d-c. watthour meter it would appear that the same principle of torque production could be employed as in the indicating wattmeter of the electrodynamic type. Continuous rotation at a speed proportional to the load would be desired in place of mere deflection to a new position of rest. The control spring would be removed and some other form of countertorque control substituted. Several additional coils would be added to the armature to permit development of adequate torque at all positions during rotation. A commutator would be needed. By this time the structure would begin to resemble the dynamo minus iron cores for field or armature. The commutator-type d-c. watthour meter of Thomson may be viewed in this way as an evolution from the electrodynamic wattmeter, with Edison's motor meter of 1881 as one of the way stations along the route.

7-1. Commutator-type Watthour Meter.—The structural design of a commercial commutator watthour meter (Fig. 78) consists of the following essential elements (1) the series field coils, (2) the armature, commutator, and brushes, (3) braking disk and magnets, (4) compensation for friction. In the evolution to this form two disturbing elements are encountered which were lesser obstacles to satisfactory performances in the case of the indicating wattmeter. One is the effect of the counter e.m.f. generated in the armature when it rotates and the other is the greater friction occasioned at the bearings by the necessarily heavier moving element.

If the meter is to register watthours correctly it must operate under all loads at speeds that are strictly proportional to the loads. This requirement is met by restricting the counter e.m.f. to low values by providing retarding torque of sufficient magnitude to keep the speed low. Thus if the meter is treated as a motor and the customary motor equations applied,

$$\begin{aligned}E_L &= E_a + i_a R_a \\E_a &= k_1 \phi_f S = k_2 I S\end{aligned}$$

$$T_d = k_3 \phi_f i_a = k_4 I i_a$$

in which E_L = line voltage.

I = line current through series coils to load.

E_a = counter e.m.f. in armature.

i_a = armature current.

R_a = total ohms of armature circuit.

T_d = driving torque.

In order that the driving torque may be proportional to the load, T_d will have to be proportional to $E_L I$ or $T_d = k_5 E_L I$.

But

$$T_d = k_4 I i_a = k_4 I \left(\frac{E_L - E_a}{R_a} \right)$$

and it is evident that E_a must be kept negligible with respect to E_L in order that the desired equality shall be attained. The

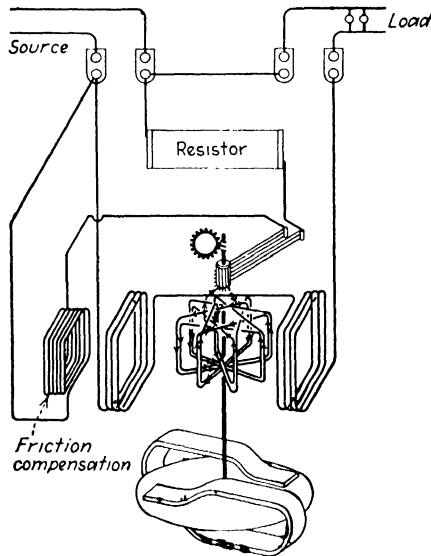

FIG. 78.

Bureau of Standards (1913) found the value of back e.m.f. for five representative 110-volt meters to range from 0.07 to 0.19 volt at full-load speed. This is accomplished by the employment of as much resistance (R_a) in the armature circuit as permits sufficient i_a to produce the requisite torque T_d . Furthermore, the braking torque must be created to equal T_d at that low value of speed.

With these prime considerations provided for in the design the more important of those remaining pertain to (1) obtaining maximum armature ampere-turns with minimum amperes and weight, (2) maximum field flux for permissible IR drop through series coils, (3) minimum bearing friction, (4) minimum weight of braking disk compatible with requisite braking torque, (5) minimum commutator diameter to minimize torque of brush friction.

7-2. Magnets and Braking Torque.—The voltage e induced in the disk of Fig. 78 when it is rotated between the poles of the drag magnet acts along the radius of the disk and establishes eddy currents across the path of the flux. In Fig. 79 these will flow in toward the shaft (for the downward flux direction and rotation toward the right). They in turn react with the same flux which induced them, to create a counter-torque toward the left, thus opposing the driving torque developed in the armature above; the driving torque was the cause of the motion of armature and braking disk toward the right.

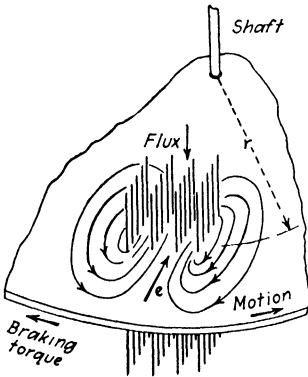

FIG. 79.

The voltage e will be proportional to the speed of rotation and the magnitude of the flux.

$$e = k_6 \phi_m S$$

The currents established by e will be inversely proportional to the effective resistance R of the distributed paths in the disk. The braking torque T_b at radius r will, therefore, be

$$T_b = k_7 \phi_m i_b r = k_7 \phi_m \frac{e}{R} r = k_7 \phi_m \left(\frac{k_6 \phi_m S}{R} \right) r = k \phi_m^2 \frac{S}{R} r$$

Several deductions may be drawn from this relation. (1) If T_b is equal to T_d at an appropriately low speed S , then R must be small and ϕ_m and r be large. (2) The magnet flux will be large when the magnets are powerful, of adequate polar area, and the air gap as small as mechanical clearance will permit. (3) The limit to the disk radius r will be the weight and size permissible. (4) The resistance R will be low if a low-resistance

material is employed along with as much thickness as weight permits. Aluminum best fits these over-all requirements for disk material. Copper of the same dimensions would have half the resistance, twice the eddy currents and braking torque, but three times the weight to be carried on the bearings.

Two other deductions should be noted in passing. (5) Any attempt to gain torque by increasing r (*i.e.*, moving magnets nearer the edge of the disk) may mean an increased resistance R of the disk paths due to their restriction at the edge. (6) A change in magnet strength (weakening with age, say) will result in twice as great a change in torque at a given speed. Since the speed will rise until T_b equals T_d , this means that a 1 per cent weakening of the magnets will result in a 2 per cent increase in speed for a given metered load.

When two magnets are employed, as in Fig. 81, placing the opposite poles adjacent accomplishes two purposes: (1) it tends to reduce the risk of demagnetization and (2) in spite of the flux lost in the series circuit through the magnets, that which passes through the disk establishes eddy currents in shorter paths than if the polarities adjacent were the same. This increases the braking torque.

7-3. Compensation for Friction.—The commutator meter presents four sources of friction: (1) upper and lower bearings, (2) gears and register, (3) brush contact, and (4) windage. All but air friction are sensibly constant and of them the brush friction represents 60 to 80 per cent of the total at rated full-load speed, the others dividing the rest practically equally. As a whole, friction for these meters lies between 0.6 and 1 per cent of the full-load driving torque. At 10 per cent of load the friction torque would be nearly 10 per cent of the driving torque and the meter would be seriously in error if no compensation were provided.

Commutator-type watthour meters are provided with a supplementary field coil the flux from which is added to that from the series coils energized by the load current under measurement. It is located parallel to the field coils and placed in series with the armature. In the modern lower voltage meters it also embraces most of the ohms required in the potential circuit to keep the armature current and voltage-circuit watts at the desired low values. With this compensation the average 5-amp. meter will start on currents as low as 0.04 amp.

The "light-load" coil will carry current to create torque by reaction of its flux with the same current in the armature coils when the voltage is on. Since it will carry current and produce torque proportional to the voltage, the friction-compensating torque will vary with the square of the voltage, whereas the friction will be independent of the voltage. A 110-volt meter which has been calibrated to be correct at 10 per cent load on 110 volts will be likely to "creep" (rotate on no load) if the voltage is raised to 130. Meters which have a tendency to creep under conditions of vibration are usually remedied by clipping a piece of iron wire over the edge of the disk where it will be subject to attraction by the corner of the drag magnets.

7-4. Characteristic Performance of Commutator Meter.—The friction compensation will not, however, guarantee the propor-

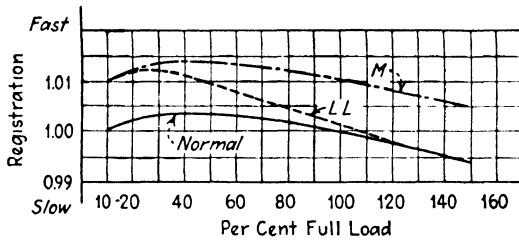

FIG. 80.

tionality of speed and driving torque because the friction is certain to vary somewhat with the speed, especially the air friction, whereas the compensating torque is sensibly constant. As a result of this and other minor factors (not, however, self-heating) the characteristic speed-load curve is of the form shown in Fig. 80. The curve marked "normal" shows the meter correct in speed and registration at both 10 and 100 per cent of its rated load. In general the heating of the series coil under sustained load will raise the hump and drop the overload tail of the curve.

A shift of the full-load (magnet) adjustment that increases the speed 1 per cent at full load will increase it by the same percentage at all loads (curve *M*, Fig. 80). If a meter is correct at 10 and 100 per cent load a shift of the light-load adjustment which increases the speed 1 per cent at 10 per cent load will have increased the speed 0.1 per cent (one-tenth as much) at full load (curve *LL*).

7-5. Calibration and Adjustments.—In order to permit correction for unavoidable differences between individual meters

in the manufacturing process and to correct for errors acquired while in service, the watthour meters are provided with two adjustments, full load and light load.

The full-load adjustment is accomplished by manipulation of the retarding torque introduced by the drag magnets,—changing either (1) the radius at which the magnets act or (2) the flux across the air gap and through the disk. The first requires moving the magnets; some makes offer a micrometer feature at this point. One obsolete type of (a-c.) meter employed a cylindrical braking structure and the full-load adjustment was effected by having the magnets moved parallel to the axis and thus

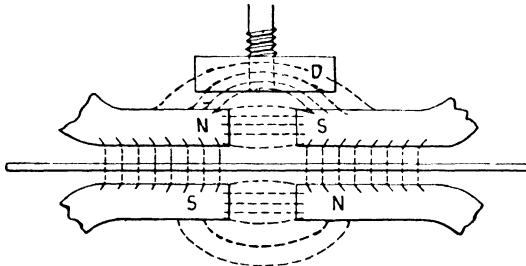

FIG. 81.

embracing more or less of the cylindrical area of the aluminum shell.

Changing the flux from fixed magnets is accomplished by shifting the position of a soft-iron disk *D* (Fig. 81) with respect to the magnet poles; moving it closer to them shunts some of the flux through the disk and reduces the flux threading through the disk; the meter speed rises because the retarding torque is reduced. Moving the iron disk away from the magnets and the aluminum braking disk decreases the meter speed.

Several schemes have been employed to vary the amount of friction compensation in calibrating these meters: (1) moving the light-load coil in a direction perpendicular to its plane and thus increasing or decreasing its contribution of flux at the armature location, (2) swinging the coil in its own plane and thus varying the amount of its flux intersecting the armature, (3) varying the number of turns of a fixed coil and thus varying its magnetomotive ampere-turns and the resulting flux. Method 1 was employed in the early Thomson meters but method 2 is now employed by all manufacturers.

7-6. Design Proportions of D-c. Watthour Meters.—Data for three representative makes of commutator-type watthour meter are offered in Table IV. There are also included for completeness and comparison the data for the mercury-type meter of the Sangamo Electric Company. It is not made in the 5-amp. size for which the other data are given and the data are given for its 10-amp. pattern.

The over-all resistances of the voltage circuit are practically identical and, therefore, so are the watts lost. The distribution of this resistance affects the distribution of the temperature rise from self-heating. Flux density has significance in connec-

TABLE IV.—ELECTRICAL AND MECHANICAL DESIGN DATA
Direct-current Watthour Meters 110 Volts, 5 Amp., Two Wire (except Sangamo data which are for 10-amp. Meter)

	Duncan E	General Electric C-6	Westing- house CW-6	Sangamo (mercury) D-5
Full load, r.p.m.....	36.66	45.83	46.66	25
Watthours per revolution.....	0.25	0.2	0.2	0.666
Ohms in voltage circuit:				
Armature.....	1,290	930	980	
Compensating coil.....	12	1,500	1,710	
Resistor.....	1,340			
Total.....	2,642	2,430	2,690	2,645
Watts loss in voltage circuit...	4.6	5	4.5	4.5
Current circuit resistance, ohms	0.23	0.22	0.21	0.003
Watts loss (full load).....	5.7	5.5	5.2	0.3
Flux density, gausses.....	85	75	70	
Moving element:				
Torque, centimeter-grams...	14.31	17.0	14.92	6.0
Weight, grams.....	156.2	91.0	96.1	3*
Ratio, torque/weight.....	0.092	0.187	0.155	2
Diameter of commutator, centimeters.....	0.465	0.240	0.240	
Commutator segments.....	8	8	8	
Thickness of disk, centimeters.	0.150	0.065	0.065	0.09
Diameter of disk, centimeters..	13.35	12.66	12.70	10.18
Magnets:				
Number used.....	2	4	4	2
Total flux, gausses.....	14,400	7,300	7,300	8,100
Retentivity index.....	247	304	302	88
Temperature coefficient (meter as a whole), degree centigrade	+0.10	+0.10	+0.07	+0.12

* Figure given is upward thrust on upper bearing.

tion with the judicious balance of ampere-turns in armature and series coils; it also has a bearing on the susceptibility to stray fields. Ratio of torque to weight is a commonly used index of the preponderance of driving torque over friction torque. Commutator diameter is a component of the friction torque contributed by the brushes riding against the commutator. The retentivity index for the magnets is the ratio of (1) the ratio of the magnet steel length to its cross section to (2) the ratio of the air-gap length to its cross section. The temperature coefficients of the aluminum-disk and voltage-circuit resistances are both positive and of the same order of magnitude, +0.40 per cent. The magnet air-gap flux weakens about 0.01 per cent per degree C.

The coefficient for the meter is sensibly the algebraic sum of the positive voltage-circuit coefficient, minus the positive disk coefficient (minus because increase in disk resistance means less eddy currents and less braking torque), and twice the negative magnet coefficient (twice because a change affects both the flux and the eddy currents which it induces).

7-7. Shunting and Astaticism.—Heavy-current-capacity d-c. meters present two problems: (1) the handling of the large current in the series coils or a shunted fraction of it, (2) the shielding against or neutralization of the stray fields from the heavy current buses in the immediate vicinity.

If the heavy currents are handled in their full value in the series coils, the conductors must be large to keep the drop and losses low and but few turns can be employed—often only one. If the series coils are shunted, the low permissible shunt drop indicates large coil conductors, few turns, and difficulty in developing the requisite flux and torque. The Columbia meter employs iron in the armature to enhance the flux and torque. The Duncan shunted meter employs an elongated armature and four series coils to enhance the torque. Mercury-type meters are readily shunted because of the inherently lower resistance of the series circuit through the mercury and disk (see Table IV).

Two schemes are employed to minimize the effect of stray fields. One astatic arrangement employs a four-pole wave-wound armature with two brushes and four series coils in quadrants about the armature. The other employs two separate armatures on the same shaft, their pairs of field coils giving

opposite flux directions so that a stray field will add as much to one as it subtracts from the other.

7-8. Mercury-type D-c. Watthour Meter.—The mercury-type watthour meter consists essentially of a copper disk floated in mercury and subjected to a magnetic field perpendicular to its plane—upward (in Fig. 82) on the right of the shaft and downward on the left. Current passing from left to right across the disk establishes clockwise rotating when viewed from above. The mercury serves the purpose of the brushes of the commutator meter and at the same time floats the entire moving system, a

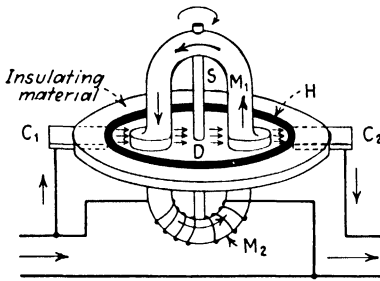

FIG. 82.

float aiding in the buoyancy. The copper disk and the attached float are completely immersed in the mercury. The buoyancy creates a slight upward thrust on the upper bearing. The disk constitutes a one-turn armature and the requisite torque is obtained by enhancing the flux from the voltage-circuit electromagnet

by means of an iron core. Slotting the disk radially gives an additional 50 per cent increase in torque.

Some of the features of the mercury meter are (1) minimized bearing friction and wear, (2) unaffected by vibration or stray fields, (3) high ratio of driving torque to friction torque, (4) low losses in the current circuit, (5) adaptability to shunted operation.

The same principle is adapted to ampere-hour measurements by substituting permanent magnets for the voltage-excited electromagnets of the watthour meter.

7-9. Friction Compensation of Mercury Meter.—In the commutator meter the torque to compensate for friction was produced by augmenting the field flux by means of a supplementary field coil energized by the line voltage. In the case of the mercury meter the torque to compensate for friction is obtained by augmenting the line current across the disk. In order to isolate the circuit by which this corrective current is passed through the disk from the variable-resistance load circuit, a thermocouple is employed. The heater coil *H* surrounding the thermocouple is placed in series with the voltage electromagnet coil *S.C.* The e.m.f. generated in the thermocouple circulates a corrective

current in a local circuit having its path in the disk in common with the load-current circuit. The polarity of the thermocouple e.m.f. is, of course, independent of the direction of current through the heater coil and, therefore, independent of the polarity of the line connections to the meter. The proper polarity of the thermocouple can be obtained by shifting its terminals from the upper and middle to the middle and lower blocks or *vice versa*. With the polarity correct an adjustment of the meter toward either fast or slow on light load is available because the thermo-

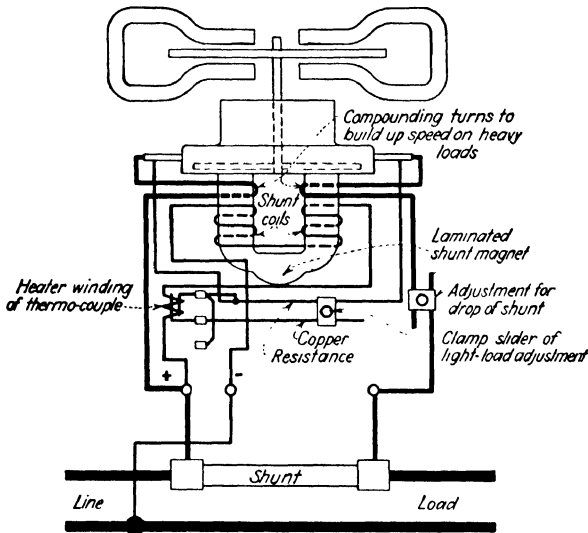

FIG. 83.

couple connection is not made at the end of the resistor rod. Thus moving *K* to the extreme left will reverse the thermocouple current through the disk and make the meter slower on light load. The magnitude of the corrective current is controlled by the length of resistor rod embraced between *K* and the thermocouple connection to the rod.

The compounding series turns *CT* around the voltage electro-magnet compensate for the increased torque of fluid friction at the higher speeds and, therefore, tend to prevent the "overload droop" of the load-registration curve.

7-10. Shunted Mercury Meter for Large Capacities.—All Sangamo meters above 10 amp. rating are used with shunts. Up to 75 amp. rating the shunt is connected across the meter

terminal posts within the case. From 100 amp. rating upward the shunts are external and the meter may readily be placed 25 ft. from the bus in which the shunt is inserted. When operated in conjunction with a shunt the relative resistance of the shunt and the parallel circuit through the meter, including leads and contact resistances, must be maintained at the proper proportions, more so than for millivoltmeters and shunts used as ammeters. A sliding-block adjustment *N* is furnished in the series circuit of shunted meters to bring the fraction of shunted current to its proper 10-amp. value when the line current is at the value for which the shunted meter is rated.

The voltage drop with 10 amp. through the 10-amp. unshunted meter is 30 mv. In the case of internally shunted meters (up to 75 amp.) or so-called "pocket-type" external shunts (up to 200 amp.) the voltage drop is 60 mv. With open-type (up to 1,000 amp.) or box-type shunts (up to 400 amp.) the voltage drop is 75 mv.

7-11. Watthour-meter Terms and Constants.—Since the watthour meter is designed to rotate at a speed proportional to the load watts, each revolution represents a definite number of watthours passed to the load during the time required for that one revolution. For an extended period of time the total revolutions made are to be a measure of the total watthours or kilowatt-hours consumed in the load. The revolutions made by the disk are communicated to a set of dials by means of a worm and set of gears.

The Code for Electricity Meters (approved as an American Standard and published in 1927 by the National Electric Light Association and Association of Edison Illuminating Companies) gives the following definitions covering the terms employed in connection with the dials, register, and meter constants.

Rotating Element.—That part of the motor element which rotates at a speed proportional to the power integrated by the meter.

Register.—That part of the meter which registers the revolutions of the rotating element in terms of units of electrical energy.

Dials.—The graduated circles over which the dial pointers move.

Dial Pointers.—Those parts of the register which move over the dials and point to the numbers on the divisions of the dials.

First Dial.—The graduated circle over which the most rapidly moving dial pointer moves.

Dial Train.—All the gear wheels and pinions used to interconnect the dial pointers.

Register Ratio (R_r).—The number of revolutions of the wheel meshing with the worm or pinion on the rotating element for one revolution of the first dial pointer.

Gear Ratio (R_g).—The number of revolutions of the rotating element for one revolution of the first dial pointer.

Register Reading.—The numerical value indicated on the dials by the dial pointers. Neither the register constant nor the test dial, if any, is considered.

Register Constant (K_r).—The factor used in conjunction with the register reading in order to ascertain the total amount of electrical energy that has passed through the meter. The register constant may be 1, 10, or any multiple of 10.

Percentage of Accuracy.—The percentage of accuracy of a meter is the ratio, expressed as a percentage of the registration in a given time to the true kilowatt-hours and is commonly referred to as the “accuracy” or “percentage accuracy” of the meter. (The term percentage registration means the same as percentage accuracy).

Watthour Constant (K_h).—The registration of one revolution of the rotating element expressed in watthours.

Watt-second Constant (K_s).—The registration of one revolution of the rotating element expressed in watt-seconds.

P = load watts.

R = number of revolutions of the disk.

S = time in seconds for R revolutions.

$$\begin{aligned} \text{Meter watthours} &= K_h R. \\ \text{Meter watt-seconds} &= K_h \times R \times 3,600 = K_s R \\ \text{Meter watts} &= \frac{K_h R \times 3,600}{S} = \frac{K_s R}{S} \quad [26] \\ \text{Per cent accuracy} &= \frac{\text{meter watts} \times 100}{\text{true watts}} \\ &= \frac{3,600 K_h R \times 100}{PS} = \frac{K_s R \times 100}{PS} \quad [27] \end{aligned}$$

Also, for single pitch worm and gear $R_g = R_r \times n$; n = number of worm wheel teeth; and, for double pitch worm and gear $R_g = R_r \times n/2$.

7-12. Testing Watthour Meters with Rotating Standards.—Portable watthour meters, called “rotating standards” or “test meters,” are provided with a plurality of current and voltage windings (one instrument thus serves to test service meters of a wide range of capacities) and with dials indicating revolutions and fractions of a revolution of the rotating element. They facilitate an accurate comparison between them and the meter under test. The two meters are subjected to the same load for the same length of time and the revolutions of each noted; an integral number of revolutions of the meter under test must be taken because fractions of its revolutions can only be estimated in the absence of graduations.

Let r = counted revolutions of meter under test.

R = counted revolutions of rotating standard.

k_h = watthour constant of meter under test.

K_h = watthour constant of rotating standard.

$$\text{Meter watthours} = rk_h.$$

$$\text{True watthours} = RK_h.$$

$$\begin{aligned} \text{Percentage accuracy} &= \frac{\text{meter watthours}}{\text{true watthours}} \times 100 \\ &= \frac{rk_h}{RK_h} \times 100 \end{aligned} \quad [28]$$

The revolutions (in a given time and with a given load) made by two accurate meters will be inversely proportional to their watthour constants. Since the watthour constants commonly employed bear simple ratios to one another, a pair of integral values of r and R can always be found which will consume an adequately but not inordinately long time. A comparison, then, of the revolutions R made by the rotating standard, while the meter makes r revolutions, with the revolutions R_0 , which would be made by the rotating standard if the meter were of 100 per cent accuracy, gives the percentage accuracy of the meter as $R_0/R \times 100$. Convenient tables can be constructed on this principle for the use of meter testers.

7-13. Register Constant.—Since watthour meters are seldom read oftener than once a month, it is essential that the pointer of the last dial shall not pass over its zero more than once during the month. This necessitates the use of the register constant which is merely a multiplying factor to increase the kilowatt-hour equivalent of the numerical value of the register reading. The

numerical value of one revolution of the first dial pointer of a standard register is 10; therefore, the register constant for kilowatt-hours is

$$K_r = \frac{K_h \times R_g}{10 \times 1,000} \quad [29]$$

Evidently the introduction of the register constant to prevent overrunning of the register is accomplished by increasing the gear ratio (and register ratio).

The interrelation of watthour constant, register ratio, register constant, and rated capacity of the meter can be seen from the following table pertaining to the General Electric Type C-6 d-c. watthour meter in selected ratings.

Rating, amperes	110 volts			220 volts			550 volts		
	K_h	K_r	R_r	K_h	K_r	R_r	K_h	K_r	R_r
5	0.2	1	500	0.4	1	250	1	1	100
10	0.4	1	250	0.75	1	133 $\frac{1}{3}$	2	1	50
50	2.0	1	50	4.0	1	25	10	1	10
100	4.0	1	25	7.5	1	13 $\frac{1}{3}$	20	10	50
600	25	10	40	50.0	10	20	125	100	80

Problems

7-1. The internal potential connections of an accurate meter are changed so that it runs backward. Will the difference of the dial readings be the true consumption? Why?

7-2. The "line" wires of a two-wire meter are interchanged with the "load" wires. Will the meter run forward or backward? If it runs forward, will it register the consumption correctly? Why?

7-3. A second meter (perhaps for check purposes) is connected on the load side of an existing meter of the same rating. What is the result on both meters? Would you expect them to register identically at all loads? Why?

7-4. A 100-volt 5-amp. two-wire meter having a watthour constant of $\frac{1}{3}$ is found to be creeping at the rate of 1 revolution in 2 min. By how much would the bill be too large at the end of a month? (The rate is 8 cents per kilowatt-hour.) Should the credit apply during periods of load on the meter?

7-5. A train of gears consists of wheels *A* and *B* on one shaft, *C* and *D* on another shaft, *E* and *F* on a third shaft. The wheels mesh as follows: *B* with *C*, *D* with *E*, *F* with *G*. Wheel *G* carries the first dial pointer. The numbers of teeth are as follows:

$$\begin{array}{llll} A = 100 & C = 50 & E = 80 & G = 80 \\ B = 10 & D = 10 & F = 80 & H = \text{pointer} \end{array}$$

- a. Compute the register ratio.
- b. What is the gear ratio if wheel *A* meshes with a single-pitch worm on the disk shaft?
- c. If the register constant is 1, what will have to be the watthour constant of the meter for which this register is appropriate?

7-6. What should be the register constant and register ratio of a 100-amp. 220-volt three-wire meter having a watthour constant of 12?

7-7. A Sangamo type D-5 75-amp. meter is discovered to have by mistake the register of a 25-amp. meter. The reading on March 10 was 3256; on April 10 it was 3593. What number of kilowatt-hours should be billed?

7-8. A 50-watt lamp burns $\frac{1}{2}$ hr. How many revolutions would be made by the disk of a meter having a watthour constant of 0.3? $\frac{1}{3}$? $\frac{1}{2}$? $\frac{1}{4}$?

7-9. A certain consumer's watthour meter tests as follows:

Load, per cent	Rotating standard		Consumer's meter	
	K_A	Revolutions	K_A	Revolutions
10	0.06	18.21	0.5	2
100	0.6	17.62	0.5	20

Calculate the percentage accuracy of the consumer's watthour meter at light load and full load.

7-10. For a meter under test $K_A = 1.25$; for the rotating standard $K_A = 0.5$. The meter under test makes 4 revolutions while the standard makes 10.15. What is the percentage accuracy?

7-11. A meter under test has a watthour constant of $\frac{2}{3}$; the rotating standard has two current windings, for 1 and 10 amp., with $K_A = 0.06$ and 0.6, respectively. If the meter is correct, how many revolutions should the standard make for 2 revolutions of the meter under test on light load and for 10 revolutions on full load?

7-12. Why does a d-c. commutator meter run faster with increase of metered load (which strengthens its field) whereas the shunt motor, which it resembles, runs slower if its field is strengthened?

7-13. The N.E.L.A. Meter Committee recommends that the register ratio shall be such that the register will not repeat in less than 25 days when operated at full load (rated amperes times 120 volts or multiples thereof) for 24 hr. a day. On this basis deduce from the table in Par. 7-13 the register constant, register ratio, and watthour constant of a 150-amp. 440-volt meter.

7-14. The Code for Electricity Meters stipulates that a d-c. watthour meter, cover on, shall not be affected more than 2.5 per cent at 20 per cent of rated current by an external magnetic field of 0.25 gauss applied in such a direction as to have its maximum effect. It suggests obtaining the 0.25-gauss field by passing 3.5 amp. in series through two four-turn coils wound on the edges of 100-cm. wooden disks and placed parallel 50 cm. apart. Verify the 0.25 gauss.

What is the relation in magnitude of this external field to the working flux of the meter?

What effect does the sheet-metal cover have?

CHAPTER VIII

PRINCIPLE OF INDUCTION WATTHOUR METER

The induction watthour meter is in many respects astonishingly simple in its structural assembly. And in spite of the complexity of the electrical and magnetic interactions which enter its operation, its accuracy under wide variations of load, power factor, voltage, frequency, and temperature will be found almost as striking. In fact there are relatively few devices surpassing its sustained accuracy among the many measuring instruments used in vending a measurable service or commodity to the public.

8-1. Induction Meter Comparable with Induction Motor.—The action of the induction watthour meter may be likened to that of the induction motor. In the polyphase induction motor the stator windings are displaced in their space relation the same number of electrical degrees as the corresponding applied voltages are displaced in time phase in the polyphase supply. The result is a stator flux which is uniform in magnitude and rotates about the rotor axis at uniform velocity; it induces in the short-circuited rotor e.m.f. which circulate currents in the closed rotor circuits. These currents react with the flux to create the driving torque of the motor.

The single-phase induction watthour meter uses an aluminum disk as the rotor and a *voltage electromagnet* and a *current electromagnet* so located as to apply their magnetic fluxes in a displaced space relationship. The requirement of time-phase displacement so readily met in the polyphase induction motor by the difference in time-phase of the polyphase voltages is met in the induction meter by making the voltage electromagnet as purely inductive as possible and the current electromagnet as purely non-inductive as possible. In the ideal meter the voltage-electromagnet flux will lag 90° behind the applied line voltage, and the current (or series) electromagnet flux will be in phase with the line or load current.

This quadrature relation between the two sources of flux resembles the quadrature relation of the two-phase induction

motor. In the motor the resultant flux rotates uniformly and acts upon the whole rotor. In the meter the resultant flux acts only on a portion of the disk and merely "shifts" or "glides" across that portion of the disk, always in the one direction—that in which rotation of the disk follows as a consequence.

8-2. "Shifting-field" Analysis of Action.—The particular arrangement of the voltage (or shunt) and the current (or series) electromagnets differs with the various manufacturers. In some cases they lie on opposite sides of the disk as in Fig. 84. In

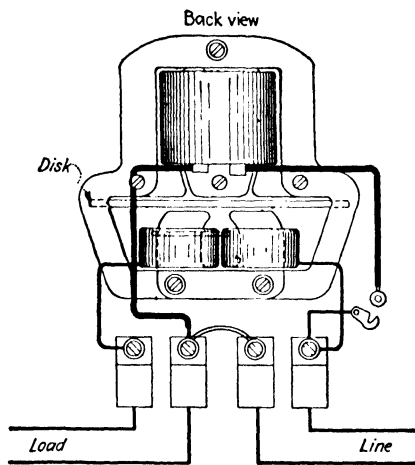

FIG. 84.

other cases they are placed on the same side of the disk. Some use two current coils in conjunction with one voltage coil and pole. Others use two voltage coils and poles with one current coil.

The disk is mounted on a vertical spindle and the rear portion of the disk passes through the air gap between the electromagnets. The front portion of the disk rotates between the poles of permanent magnets which serve, as in the case of the d-c. meters, to introduce the controlling torque which results in a disk speed proportional to the load in watts on the meter.

A typical form of driving element is that shown in Fig. 85 in which the voltage winding of several hundred turns is marked *V.C.* and the two current windings are at *S.C.*, of few turns and so wound and connected in series as to result in opposite magnetic polarities at the air gap. Flux configuration is shown at the right of Fig. 85 when it is at a maximum for the voltage

electromagnet and at the left for the time when the current electromagnet flux is at maximum value. Note that both fluxes divide in parallel paths.

At the time instant *a* (Fig. 86) the load current *I* through the series coils is a maximum and the flux is, say, upward at 1-2 and 2-3 and downward at 3-4 and 4-5; the current *I_E* in the potential coil is zero. At the instant *b*, *I* is zero and *I_E* is maximum, giving, say, flux upward at 2-3 and 3-4. At the instant *c*, *I_E* is zero again and *I* gives flux downward at 1-2 and 2-3 and upward at 3-4 and 4-5. The upward flux has, therefore, progressed from 1-2 and 2-3 to 2-3 and 3-4 and finally to 3-4

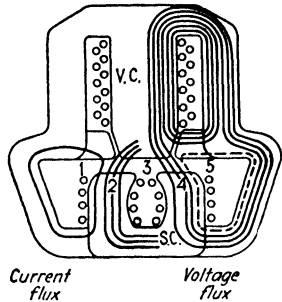
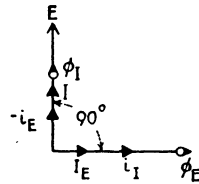
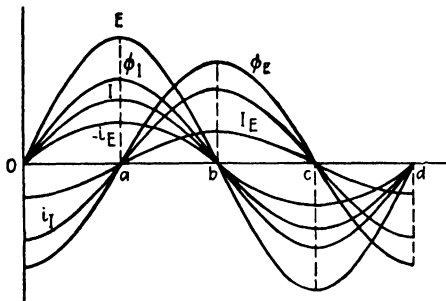

FIG. 85.



- E* = Voltage of circuit
- I_E* = Current in voltage electromagnet
- φ_E* = Flux of voltage electromagnet
- i_E* = Eddy currents induced in disk by *φ_E*
- I* = Current in series electromagnet
- φ_I* = Flux of current electromagnet
- i_I* = Currents induced in disk by *φ_I*

FIG. 86.

and 4-5 or has passed from left to right across the disk. The progress is summarized in the following tabulation.

Time Instant	Flux Paths				
	1-2	2-3	3-4	4-5	1-2
<i>a</i>	Up	Up	Down	Down	
<i>b</i>	0	Up	Up	0	
<i>c</i>	Down	Down	Up	Up	
<i>d</i>	0	Down	Down	0	Up

The result of such relative motion of flux and disk is, then, the induction of eddy currents in the disk similar to the rotor

currents of the induction motor and these currents react with the flux to create torque which drives the disk from left to right (or counterclockwise from above if the shaft is on the opposite side of the electromagnets from the reader).

While this account of the source of driving torque may give a helpful preliminary notion of the source of torque in the induction watt-hour meter, it does not lend itself readily to analysis of the effect upon the performance of the meter of such items as overloads, changes in voltage or frequency, change in temperature. The following treatment is, therefore, much more valuable.

8-3. Disk Eddy-current Analysis of Action.—The driving torque in induction watt-hour meters can be accounted for by the reaction in the disk of the alternating flux from one electromagnet with the eddy currents resulting from the alternation of flux from the second electromagnet and *vice versa*. The two fluxes must have a time-phase displacement (so that one will be at maximum while the other is at zero but changing most rapidly and thus inducing maximum eddy currents in the disk); they must also have a space displacement (so that part of the eddy-current paths for one pole will lie in the path of the flux from the other pole). This conception is preferable to that of the shifting field (just described in a qualitative manner) because it lends itself better to detailed analysis of effects of variation in voltage, frequency, wave form, load power factor, heavy overload, temperature, etc.

Consider again the ideal conditions existing in the electromagnet structure of Fig. 85 at the instant *a*. Current *I* in the series coils is at its maximum and likewise the flux ϕ_r established by it. In Fig. 87 this is upward at 1-2 and 2-3 and downward at 3-4 and 4-5 just as it was in Fig. 85 (left). If a load of unity power factor being metered is again assumed, then at *a* the voltage *E* is also a maximum but the voltage-electromagnet current I_E and flux ϕ_E are zero; however, the flux ϕ_E is changing at its greatest rate, inducing the maximum value of voltage in the disk (which constitutes a closed-circuit secondary) and, therefore, circulating at the moment the maximum value of disk eddy currents. These eddy currents circulate through the two regions where the flux ϕ_r exists and there they create the force reaction which is the basis of the driving torque, toward the right in both areas.

After the instant *a* the current I and flux ϕ_I begin to decrease and the change in the latter induces an e.m.f. and consequent eddy currents in the disk; these eddy currents pass through the region of the flux ϕ_E and the two react to create torque. When the instant *b* arrives, this torque reaction is at its maximum

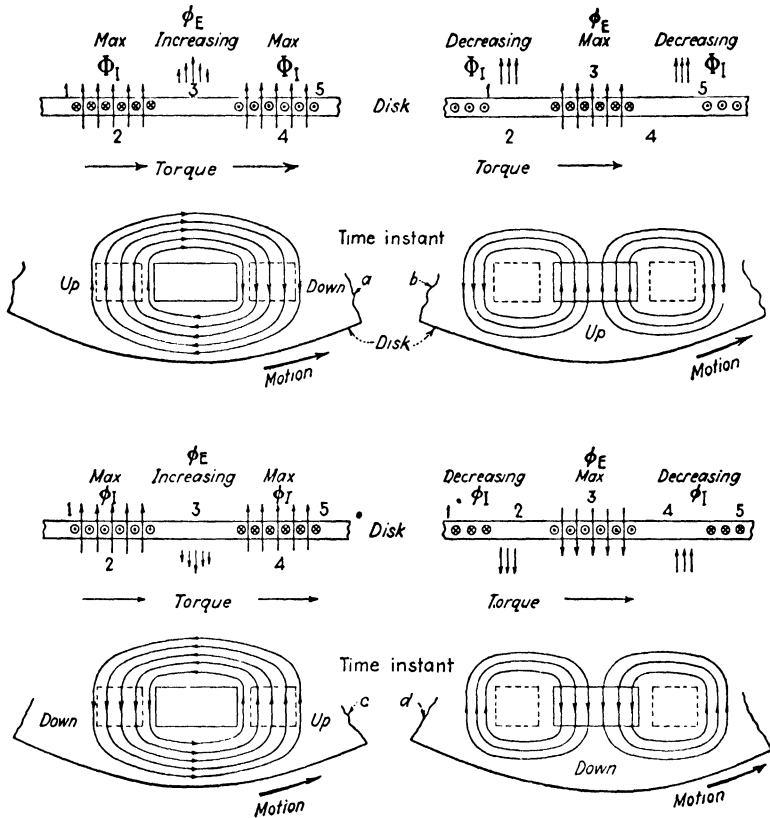

FIG. 87.

and that described in the last paragraph has declined to zero. If the time instants *c* and *d* are considered successively, the successive torque reactions (at unity power factor) of eddy currents from one set of poles with the flux from the other will be found to be all in one direction—that in which the disk rotates.

8-4. Factors Determining Torque.—In deducing an expression for the driving torque it will be desirable to keep the variables

as few as possible. Thus an indefinitely large disk will assure avoidance of restraint on the flow of the eddy currents. Also it will be assumed that the flux from the voltage electromagnet lags the voltage by 90° and that the current-coil flux is in phase with the current. Further it will be assumed that the load power factor is $\cos \theta$ corresponding to a phase angle θ between load voltage and current.

1. The instantaneous torques will be proportional to each alternating flux and also to the currents (induced by the changes of the other flux) which react with them. But at constant frequency the eddy currents will be proportional to the inducing flux. Therefore, the torque will be proportional to each of the fluxes and consequently to their product.
2. The torque will be proportional to the sine of the time-phase angle ψ between the fluxes. If the two fluxes are in phase, the sine and the torque will be zero. At zero power factor of load the torque should, of course, be zero. But a lag of 90° of current behind voltage, corresponding to zero power factor of load, brings the line current and current-coil flux into phase with the voltage-coil flux which already lagged the voltage by that same 90° in time angle. Therefore, the net torque is zero as is desired at zero power factor of load. Actually, there are equal positive and negative torques having zero resultant.
3. The torque will be proportional to the conductivity k and thickness t of the disk. A thicker disk would increase the eddy currents and torque. Lower resistance material would do likewise.
4. The torque will be proportional to the frequency f if the flux magnitudes are independent of the frequency. Each fixed flux will, with its higher rate of change at the higher frequency, induce proportionately greater currents in the disk and thereby increase the torque proportionately.
5. The torque will be directly proportional to the mean radius r to polar centers and inversely proportional to the distance d between centers. The greater the separation of poles, the greater the chance that the bulk of the eddy currents will pass between them and therefore produce no torque.

6. The torque will be proportional to a geometrical factor G dependent on the configuration of disk, voltage poles, and current poles.

With these factors assembled,

$$T_d \propto \frac{rkft}{d} \phi_E \phi_I G \sin \psi \quad [30]$$

8-5. Dependence of Torque on Geometrical Factors.—In commercial meters designed for economy of space and material the electromagnets are necessarily too close to the edge of the disk to permit symmetrical disposition and unrestrained magnitude of the eddy currents. Therefore, the torque realized is often only half that which would be obtained from the indefinitely large disk assumed in the preceding paragraph. The larger disk, if permissible, might provide more torque but it would introduce distinctly objectionable features of added weight and inertia offsetting the gains in torque. The maximum torque appears to be obtained* when (1) the flux circles overlap, the center to center distance being about $\sqrt{2}$ times their radii, (2) the perpendicular distance from the spindle to the locus of the flux centers is about 0.8 of the disk radius. The value of G is then $0.38R/a$, where R = radius of disk and a = radius of flux-circle areas.

8-6. Requisite Phase Relations.—Since the meter is to register watthours it must, for fixed values of E and I , develop torque proportional to the power factor; otherwise the speed will not be proportional to the watts load. At unity load power factor the torque must be a maximum and it must be zero when the load power factor is zero. These conditions will be established if the voltage-electromagnet flux lags 90° behind the line voltage E . In the actual meter the current flux will lag the current because of slight copper and core losses and the disk eddy currents will lag the voltage induced in the disk because of the inductance of their paths. Consequently it is more rigidly correct to say that the electromagnetic structure is to be so designed or compensated that, for load condition of unity power factor, the voltage flux shall be in phase with the eddy currents resulting in the disk from the flux established by load current through the series coils. When this condition has been

* JIMBO, S., Tokyo, 1927.

established the torque reaction of fluxes and eddy currents will be proportional to $\cos \theta$, the load power factor, which is then identical with the $\sin \psi$ of the torque expression.

8-7. Components of Driving Torque.—One component of driving torque is derived from the interaction of voltage coil flux ϕ_E with the eddy currents i_I induced in the disk by variation of the current-coil flux. The torque contributed by this component action, for a load power factor $\cos \theta$, is

$$T_1 = k_1 \phi_E i_I \cos \theta$$

where ϕ_E = voltage-electromagnet flux.

i_I = effective equivalent of eddy currents induced by the current electromagnets.

A second component of torque is produced through the interaction of series flux ϕ_I with eddy currents i_E induced in the disk by the voltage flux ϕ_E

$$T_2 = k_2 \phi_I i_E \cos \theta$$

The eddy currents from both sources are proportional:

Directly to the thickness of the disk.

Directly to its conductivity.

Directly to the frequency.

Directly to the flux magnitude.

Or

$$i_I \propto \phi I f \quad \text{and} \quad i_E \propto \phi_E f$$

The total driving torque is then

$$\begin{aligned} T_D &= T_1 + T_2 = (k_1 \phi_E i_I + k_2 \phi_I i_E) \cos \theta \\ &= (c_1 \phi_E \phi_I f + c_2 \phi_I \phi_E f) \cos \theta \\ &= c_3 \phi_E \phi_I f \cos \theta \end{aligned} \quad [31]$$

and $T_D \propto EI \cos \theta$ if the frequency is constant and the respective fluxes are always proportional to E and I . However, varying distribution of eddy currents and flux and the varying permeability of the iron will enter to impair this simple linear relation of driving torque to E , I , and θ . Further than this any variation in damping torque will combine with variations in driving torque to give a net torque that will in turn produce speeds not in strict proportionality to all load conditions. There is also to be considered (later) the contribution of torque T_f , from the device which compensates for friction.

8-8. Damping Torque of Permanent Magnets.—The only method now used in induction watthour meters for braking to bring the speed into proportionality with the load is the permanent magnet. It is usually placed singly or in pairs with the poles on opposite sides of the disk at points more or less diametrically opposite the driving electromagnet system. With the disk in motion, voltage and eddy currents are induced where the disk material passes through the flux of the permanent magnet; these eddy currents remain fixed in space relative to the magnet poles. They are proportional to the flux, the speed, and the conductivity of the disk. They react with the flux to create the magnet braking torque T_m .

$$T_m = c_4 \phi_m i_m$$

but

$$i_m = \frac{E_\phi}{Z} = c_5 \phi_m S$$

where ϕ_m = permanent-magnet flux.

E_ϕ = disk e.m.f. induced by ϕ_m at speed S .

Z = impedance of eddy-current paths in disk.

i_m = eddy currents induced by ϕ_m .

therefore

$$T_m = c_6 \phi_m^2 S \quad [32]$$

Thus if θ_m is constant the braking torque is proportional to the speed of rotation S , as is desired. Note that if the magnet should weaken, say, 1 per cent, the speed would rise 2 per cent before the braking torque would balance the existing driving torque.

8-9. Damping Torque of Electromagnet Flux.—From the standpoint of simplicity of design and of strict speed proportionality to load, the only desirable damping flux and braking torque would be that introduced by the braking magnets. This disk, however, in its rotation *moves through* the very same fluxes which, in their alternations, induce the eddy currents that provide the driving torque. The relative *motion* of the disk and the electromagnet fluxes results in the induction of e.m.f.s. and the circulation of eddy currents that react with the flux (that which caused them) to create a torque which *opposes the motion* and thus is a component of braking torque. In

each of these cases (the voltage flux and the current flux), as was the case with the permanent magnets, the torque is proportional to the square of the effective flux. It is also proportional to the speed.

$$T_E = c_7 \phi_E^2 S \quad [33]$$

$$T_I = c_8 \phi_I^2 S \quad [34]$$

8-10. Damping Torque of Friction.—Friction in the induction watt-hour meter arises at the jeweled bottom bearing, at the top-guide bearing, at the register mechanism, and from air friction at the disk surface. These amount to a reasonably constant total that must be small in torque value T_f as compared with the total driving torque T_D at full load; otherwise variations in the friction from the value for which the meter has been compensated will affect the accuracy at light loads when the driving torque is small. An important factor is, then, the ratio of full-load torque to friction torque; this varies from 1,500/1 to 200/1 in commercial meters. From the standpoint of light-load accuracy, high torque is a desirable attribute unless it is secured by means that cause undue friction. The method of compensating for friction torque will be described later.

8-11. Proportionality of Torques to Speed and Load.—The perfect meter would develop at all loads a driving torque that would counterbalance the braking and damping torques at speeds that would be proportional to the loads. The total driving torque is to be proportional to the load. $T_D = K_1 \times \text{load}$. The components of braking torque T_B are proportional to the speed.

$$T_B = T_m + T_E + T_I = K_2 \times \text{speed}$$

At any time when the driving torque exceeds the braking torque existing at the instant, the disk will accelerate until the speed builds the braking torque up to equality with the driving torque.

Then

$$T_D = K_1 \times \text{load}$$

and

$$T_B = K_2 \times \text{speed}$$

But

$$T_B = T_D$$

therefore

$$K_1 \times \text{load} = K_2 \times \text{speed}$$

and

Speed \propto Load.

This simple and ideal relation would render the speed-load curve for the meter a straight line. Unfortunately, however, we are dealing with a mechanical device which has a varying proportion of friction torque to other torques and also dealing with an electromagnetic device subject to the non-linear flux-current characteristics of iron. Thus when the torques—driving and braking—are assembled,

$$T_D + T_{fc} - (T_m + T_E + T_I + T_f) = 0 \quad [35]$$

With constant voltage assumed, T_E will be proportional to the speed but T_{fc} (obtained, as will be seen, through the medium of voltage flux) and T_f will be constant. The driving torque will vary with I , the load current, but T_I , the series damping torque, will vary with the speed and the square of the current; T_I and T_D will both be affected by the permeability. It is evident that friction and series damping T_I will have to be made as small as possible in comparison with T_D and T_m . The voltage-flux damping may be considered an adjunct of the permanent-magnet damping, if the voltage is assumed constant.

8-12. Characteristic Speed-load Curve.—The characteristic speed-load or registration curve of the induction watthour meter has been accounted for by F. C. Holtz in the following manner for a typical meter of 1924 or earlier. Different designs show slightly different shape of the curve. Improvements made in all meters since 1925 have resulted in much flatter curves and less overload droop.

In Fig. 88 the various components of driving and braking torque are represented in terms of the percentage which each constitutes of the theoretically correct torque at the respective values of load and speed.

1. *Driving Torque.*—Low permeability at low flux densities accompanying the smaller values of load current keeps the flux below proportionality to the current and thus reduces the torque below its desired value.

2. *Friction Torque.*—Assumed constant in magnitude, its percentage of the driving torque increases rapidly as the latter decreases with load.

3. *Damping Torque.*—The damping torque due to the permanent magnets and voltage electromagnet are assumed to attain

the correct value at each load and speed. That due to the series flux varies as the square of that flux and, therefore, increases rapidly beyond full load. It is the prime cause of the overload droop. Since it is also proportional to the speed, lower full-load speeds will help to prevent the overload droop. Lower speeds, however, demand stronger magnets.

4. *Increase in Series Flux.*—Lack of complete symmetry in the configuration of series and voltage flux may contribute

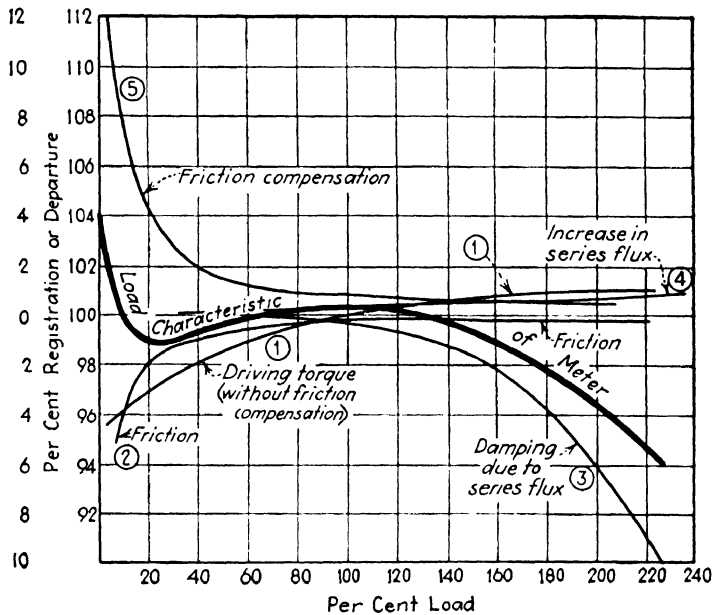

FIG. 88.

to the torque in much the same way that the friction compensation does. This may often cause rotation of the meter with either series or voltage excitation alone.

5. *Friction Compensation.*—Friction compensation introduces supplementary driving torque of fixed value (at a given voltage) and therefore reflects the same hyperbolic characteristic as friction does when considered in relation to the main driving torque.

The resultant of these torque components, each taken in its proper algebraic sense, constitutes the characteristic curve of the meter.

Problems

8-1. Show how to modify Fig. 84 to represent a three-wire $11\frac{1}{2}$ -volt meter.

8-2. A 50-watt lamp is on for 4 hr. How many revolutions would be made by the disk of a 5-amp., 115-volt Westinghouse OB watthour meter having a watthour constant of $\frac{1}{3}$? What would be its register ratio? Gear ratio? Full-load speed in revolutions per minute?

8-3. Examine the manufacturers' bulletins for the values of the various constants for the 60-cycle 115-volt two-wire single-phase meters in the following table:

Case	Type	Ampere rating	K_h	Worm ratio	R_r	R_v	K_r	Revolutions per minute (F.L.)
a	G.E. I-16	5						
b	Whse. OB	25						
c	Sang. HC	5						
d	Sang. HC	100						
e	Duncan MD	50						

8-4. How would you check the accuracy of a 230-volt three-wire single-phase meter by means of a 115-volt rotating standard?

8-5. The data shown at the top of page 134 are copied from data taken during the calibration in the laboratory of a Public Utilities Commission of the portable test meter of one of the utilities in the state.

- a. Determine the actual watthour constant (K_x) for each run on the portable test meter (Mowbray).
- b. Convert each result into percentage registration (% Reg.). The nominal values of K_x are (for 110 volts): 1.5 amp. = 0.1; 15 amp. = 1.0; 150 amp. = 10.0. (For 220 volts double these 110-volt values.)
- c. How much does the percentage registration for each 50 per cent lagging power factor run on the 15-amp. coil deviate from the percentage registration with the same current at 100 per cent power factor? (Record in column marked Dev.)
- d. What is the average of this deviation? (Record under Average dev.)
- e. Plot on coordinate paper the percentage registration of the 5-amp. coil (at 100 per cent power factor) for each speed (revolutions per minute) at which the meter is operated.
- f. How much does the percentage registration of each of the other coils differ from the percentage registration of the 5-amp. coil running at the same speed (same percentage load)? (Record in column marked Dev.)
- g. What is the average deviation for each coil?

X Illuminating Company's Portable }
 Test Meter 11 } vs. Pub. Util. Comm. Rot. Std. 27

Current coil		A	V	PF	Revolutions per minute		K _s	K _z	Per cent reg. _z	Dev.	Average dev.
Std.	X				Std.	X					

As found:

15	15	15	112	100	27.60	27.47	1.0025	1.007 +	99.3		
1.5				50	14.29	14.21	1.000	1.006 -	99.4	+0.1	
1.5		1.5		100	27.45	2.78	0.1005	1.018 -	99.2		

Made full-load and light-load adjustments:

1.5	15	1.5	112	100	27.91	2.80	0.1005				
5		3.8	112	100	23.42	7.79	0.3343				
			112	50	11.89	3.94	0.3333				
15		7.5	112	100	15.46	15.44	0.9995				
			112	50	8.16	8.14	0.998				
		15	112	100	28.18	28.23	1.0025				
			112	50	14.34	14.36	1.003				
50		20	112	100	10.87	36.18	3.337				
1.5	1.5	¼	112	100	5.31	5.31	0.1007				
		½	112		9.61	9.65	0.1001				
		¾	112		13.43	13.45	0.1003				
		1.5	112		23.79	23.89	0.10035				
50	150	37.5	112	100	20.99	6.96	3.331				
		75	112		14.21	14.18	9.98				
		150	112		26.42	26.39	10.00				
5	15	3.8	224	100	22.45	7.47	0.6686				
15		7.5	224		14.41	14.39	2.000				
		15			27.92	28.00	2.005				

h. Report the complete calibration of the meter in the following form to be used in conjunction with the characteristic curve plotted for the 110-volt 15-amp. coil combination.

For other coil combinations add the adjacent corrections to the percentage registration read from the curve for each given disk speed.

Volt rating	Power factor, per cent	Current coils		
		1.5	15	150
110	{ 100 50, lag			
220	{ 100 50, lag			

CHAPTER IX

INDUCTION WATTHOUR-METER PERFORMANCE

The requisites of an ideal watthour meter for energy measurement in average commercial service may be enumerated as follows:

1. Accurate registration under all reasonable load conditions.
2. Sustained accuracy for several years with minimum of attention and expense.
3. Low internal losses.
4. Independent of normal variations of:
 - a. Temperature.
 - b. Voltage.
 - c. Power factor.
 - d. Wave form.
 - e. Frequency.
5. Insensitive to external magnetic fields.
6. Insensitive to vibrations of support.
7. Ability to start on very light loads.
8. Capacity for and reasonable accuracy on overloads.
9. From a practical physical standpoint: be light in weight, compact in dimensions, rugged in construction, easy to install, easy to test, and easy to adjust.

This chapter will be devoted to a discussion of these requirements and the compensations which have been provided in modern designs to meet them more adequately. Of course, it should be recognized that voltage regulation, maintenance of the frequency, and approximation to sinusoidal wave form are steadily improving. The errors arising in watthour meters from variations and departures of these factors are now in general of less significance in commercial service than they have been in the past.

9-1. Vector Relations in Ideal Meter.—In the ideal induction watthour meter the voltage electromagnet would be devoid of copper and iron losses and the flux would lag the impressed voltage by 90° , in keeping with a purely inductive circuit. The current electromagnets, on the other hand, would be desired to have negligible inductance and the flux set up in phase with

the current. The voltage induced in the disk by the alternation of these two fluxes would in each case lag 90° behind the inducing flux. Finally the eddy currents resulting in the disk would be in phase with the local voltage establishing them, in the absence of appreciable inductance of the disk paths.

For loads of unity power factor, Fig. 89a shows the vector relations of these quantities. One component of the driving torque results from the interaction of i_I and ϕ_E , in phase with one another in this ideal meter and with load p.f. = 1. The other

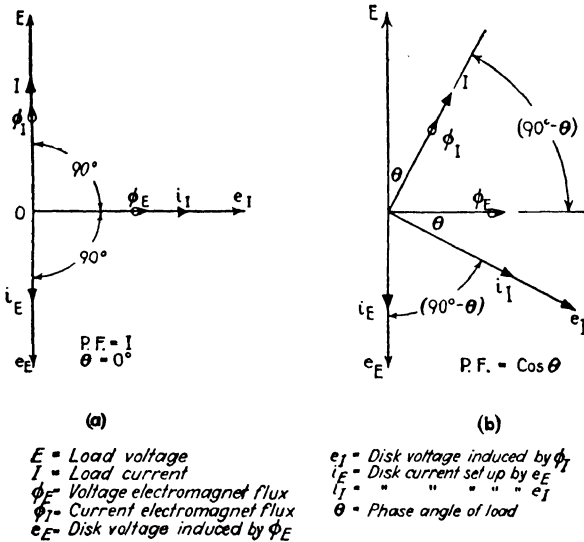

FIG. 89.

component of torque results from the interaction of i_E and ϕ_I , also in phase or in phase opposition. (The phase opposition does not necessarily signify negative torque because phase opposition merely means opposite polarity and this can be controlled by the design of the windings and polarity of the connections.) The two components of torque are at their maxima under these conditions of unity power-factor load.

When the load current I lags the voltage E by θ° , as in Fig. 89b, this phase angle appears between the eddy currents and the fluxes with which they react to produce the driving torque. The driving torque and speed are then proportional to $\cos \theta$ as well as to E and I .

9-2. Vector Relations in an Actual Unlagged Meter.—The practical meter will present two unavoidable departures from the ideal just established. They arise in two different elements of the meter.

a. Voltage Electromagnet.—This winding cannot be made ideally inductive but will have ohmic resistance. Also the laminated core will experience eddy-current and hysteresis losses. (Actually these are practically negligible.) The flux established in the core will not, therefore, be in exact quadrature

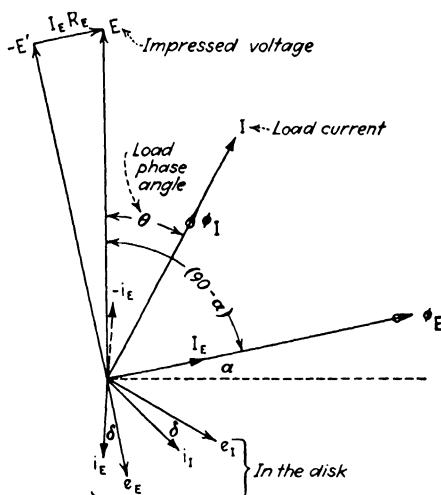

FIG. 90.

with the impressed line voltage but will lag it less than 90° , the departure being α .

b. Disk.—The eddy-current paths in the disk will not be wholly free of inductance in the close proximity of polar iron. Therefore, the disk eddy currents will lag the voltages which establish them by an angle δ . The disk eddy currents will not, therefore, at unity load power factor, be in quadrature with the fluxes with which they react to create the meter torque.

The current windings will also be slightly inductive and, therefore, create a third item of departure but this may also be ignored as negligible or else the resulting lag may be lumped with that arising in the disk.

The departures due to *a* and *b* incorporated in Fig. 89*b* give the phase relations of Fig. 90. The two components of total disk torque, corresponding to the ideal values of 8-7, are in this case

$$T_D = C_1 \phi_E i_l \cos(\theta + \alpha + \delta) + C_2 \phi_l i_E \cos(\theta + \alpha - \delta) \quad [36]$$

It is evident that this differs from the ideal relationship which requires that the torque be strictly proportional to $\cos \theta$, the cosine of the load phase angle. The meter without some corrective feature is, therefore, not accurate even at unity power factor and especially inaccurate at the lower values of load power factor. The compensation provided to effect the correction is called "lagging" because it counteracts the effect of α and "lags" the effective flux from the voltage coil to the desired quadrature value.

Before proceeding to analyze the lagging it will be well to note the magnitude of the errors in an uncompensated meter.

9-3. Error of an Unlagged Meter.—The statement that the errors of an unlagged meter are progressively greater as the load power factor decreases may be checked by assuming δ to be zero or negligible in Eq. [36]. In that event

$$T_D \propto \cos(\theta + \alpha)$$

instead of

$$T_D \propto \cos \theta$$

That the amount of error may be considerable at low power factors even when α is quite small may be seen from the departure between these two expressions as tabulated for various values of load power factor and various small values of α . It is apparent from the table that a phase angle for the voltage flux even as small as a 20 min. cannot be tolerated in meters from which accuracy is to be expected on low power-factor loads.

Lagging power factor, per cent	Load phase angle	Meter phase angle		
		2 min.	4 min.	20 min.
		Slow error of meter, per cent		
80	36° 53.4'	0.07	0.15	0.77
50	60°	0.10	0.20	1.00
20	78° 27.6'	0.30	0.58	2.87
10	84° 15.6'	0.60	1.20	5.80

The effect of δ , the lag angle of currents in the disk, can similarly be inferred by assuming α to be negligible or in some way compensated. Under such assumed conditions, since

$$i_E = K\phi_E \quad \text{and} \quad i_I = K\phi_I,$$

$$T \propto [\cos(\theta + \delta) + \cos(\theta - \delta)]$$

Expanding the cosine terms and adding:

$$T \propto \cos \theta \cos \delta$$

But δ is the result of the inductive reactance of the eddy-current paths in the disk and that reactance will be sensibly constant at a particular value of frequency. Therefore, $\cos \delta$ acts merely as a torque constant, has no variable effect (at fixed frequency), and consequently requires no direct compensation as is required for α .

9-4. Lagging the Induction Watthour Meter.—The defect of the uncompensated meter is that ϕ_E is not in quadrature with E in Fig. 90 but departs from quadrature by the angle α . The introduction in some way of an m.m.f. that would add a proper component of flux more or less in quadrature with ϕ_E would appear to solve the difficulty. Such a procedure cannot be accomplished, however, with the whole of the flux of the voltage electromagnet any more than with the mutual flux in a transformer. Actually, however, the result is attainable if the total flux is divided and only a portion is passed across the disk gap, where the quadrature relationship must be established. This is really the purpose of the division of the flux exhibited on the right half of Fig. 85. The manner in which it is accomplished may be inferred from consideration of an electric circuit (Fig. 91) comparable with the magnetic circuit of Fig. 85.

In Fig. 91 the reluctances of Fig. 85 have been exemplified by resistances. Inasmuch as the reluctances of the shunted path and the path across the disk both involve air gaps, the reluctance of all the iron portions of both paths may be ignored as inconsequentially small. Similarly resistance is attributed only to the two branch circuits in Fig. 91a. The currents in those branches will be in phase with one another and with the total current I_T . But the phase of the current I_2 in R_2 can be made to differ from that of I_1 (and I_T) by any desired amount by the insertion of an appropriate inductive reactance X and the vector relations then become those of Fig. 91c instead of Fig. 91b.

The watthour meter is designed so that the shunt reluctance is low relative to that of the disk-gap path and, therefore, a large portion of the total flux is shunted and a small portion

passes across the disk gap. This corresponds to a low value of R_1 and I_2 and a high value of R_2 and I_1 in Fig. 91a. Under such circumstances a small value of reactive voltage I_2X will effect a considerable shift in phase of I_2 without making I_T differ materially from I_1 in phase or magnitude.

Similarly in the magnetic circuit of the watthour meter a small m.m.f. introduced in the flux branch which passes across the disk will effect a shift in the phase of its flux (of course, to quadrature with the voltage on the meter) without necessitating the establishment of any appreciable increase in the magnitude

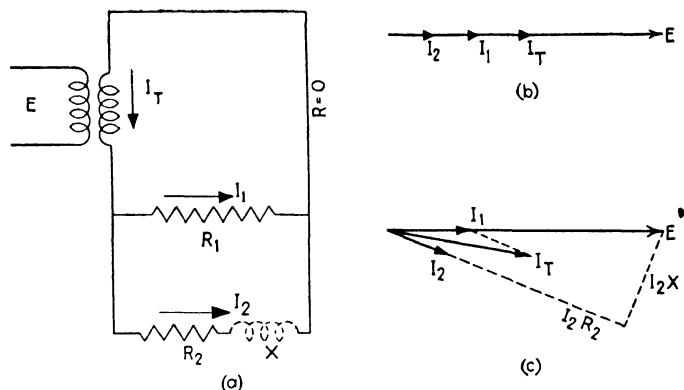

FIG. 91.

of the total flux or of the exciting current and, therefore, of the watts dissipated in the voltage coil and iron.

9-5. Action of the Lag Coil.—The requisite m.m.f. is obtained from a “lag coil” embracing the flux branch which passes across the disk and is therefore placed around the voltage electromagnet close to the disk. A few turns will induce a very small voltage e_L and this will circulate a lag-coil current i_L of similarly small magnitude in the lag-coil circuit if it is closed. This circuit will have some leakage reactance; its resistance will depend on the resistance of the winding and whatever supplementary resistance is inserted between its ends. Assume that the R and X of this circuit are such as to make i_L lag e_L by the angle β of Fig. 92. The m.m.f. M_L from the lag coil will be in phase with i_L and deduct vectorially from the total m.m.f. M_E (produced by the voltage-coil current I_E through its N_E turns) leaving $\phi_D \mathcal{R}_D$ as a “reluctance drop” to establish the disk flux ϕ_D through the reluctance \mathcal{R}_D of its branch path. The lag-coil m.m.f. has

two components, a demagnetizing component D and a quadrature component Q . Meanwhile ϕ_S is established by M_E in the shunting path. If then R_L and X_L of the lag-coil circuit are such as to give the lag-coil circuit a phase angle β and bring ϕ_D into quadrature with the voltage E impressed on the meter, the meter will register correctly at all load power factors.

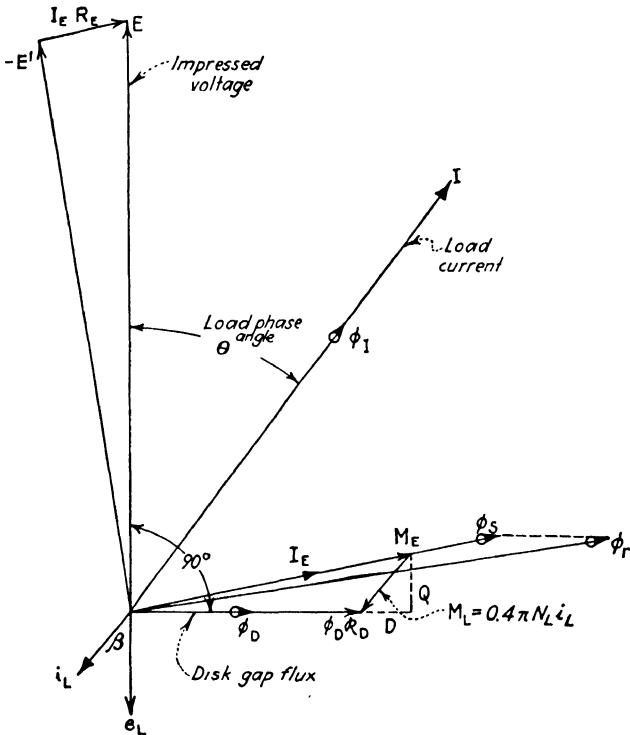

FIG. 92.

The method of "lagging" a meter is then, in one practice, to insert a lag coil with an adjustable resistance; the resistance is varied until the lag angle of its current behind its voltage introduces the m.m.f. necessary to shift the resultant m.m.f. and flux across the disk into quadrature with the meter voltage. If this resistance is too small (*i.e.*, too short), i_L and M_L will be too large, the meter is overlagged, and ϕ_D will lag E more than 90 deg.; the meter will, therefore, produce too much torque on low power factors and run fast. The rule is, then: **lengthen the lag resistor if the meter is fast on lagging power factor and con-**

versely shorten it if the meter is slow on lagging power factor. The converse results will obtain and the converse adjustments are to be made for leading power-factor conditions. When the adjustment is perfected the meter will be correct for both leading and lagging power factor. If it is left in error a small amount on lagging power factor, the error will be approximately twice as great on the same value of leading power factor, and conversely.

An alternative design involves a lagging circuit of one turn: a punched plate in which the material and cross section are chosen to give the value of impedance which will result in magnitude and phase angle of the lag plate current needed to establish the requisite m.m.f. M_L with that single turn. Adjustments subsequently are made by moving the plate either (1) *radially* with respect to the disk axis or (2) *parallel* to the axis of rotation. In either case the amount of flux embraced by, voltage induced in, and current established in the plate will change accordingly. Moving such a punching in a direction tangential to the rotation of the disk has a quite different effect and purpose as will be seen in the next paragraph.

9-6. Friction Compensation.—The torque to compensate for friction in the induction watt-hour meter is obtained by resort to the shaded-pole principle. Thus, in Fig. 93, if the light-load punching is placed with its vertical axis coincident with that of the voltage-electromagnet core, it will embrace all the voltage flux ϕ_E . If, however, it is shifted to an unsymmetrical position in the direction of the disk travel, it fails to embrace all the disk-gap flux of the voltage electromagnet. As much of the flux as does link with it, say during the increase in ϕ_E following the time instant a of Fig. 86, will induce in the punching a voltage which will circulate a current in it. This current will flow in such a direction (according to Lenz's law) as to have its m.m.f. oppose the increase in the inducing flux in the region n . No such counter m.m.f. will be experienced at m ; the flux density at m will, therefore, exceed that at n during this interval.

When the time instant b is reached, the flux ϕ_E is at maximum value and not changing; no voltage or current is induced in the punching and the flux equalizes over the voltage-electromagnet pole area. While ϕ_E decreases, the current in the punching flows in such direction as to oppose the decrease; the decrease takes place more rapidly at m than at n . A shift in flux has, therefore, taken place from left to right. If this is the direction

of motion of the disk under load, then the light-load punching is capable of contributing to the driving torque. The dimensions and resistance of the punching are so chosen as to contribute torque to the extent of the probable value of friction torque. The compensating torque developed increases with ϕ_E and with E ; therefore, abnormal rise in the line voltage may make the

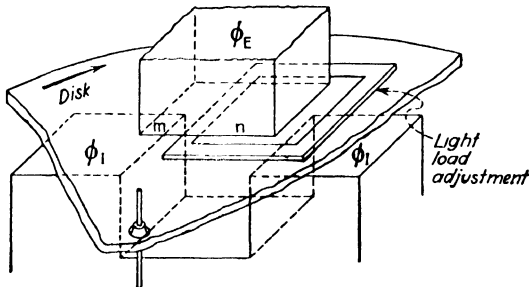

FIG. 93.

meter "creep" because the compensating torque may exceed the friction torque.

9-7. Effect of Departure in Voltage.—An increase in voltage increases the voltage-coil current and the voltage-coil flux values, including that contributed by the lag coil. For a change not exceeding 10 or 12 per cent there is little change in the phase relations of Fig. 90. The increase in the voltage-coil flux does, however, increase the damping and tends to make the meter run

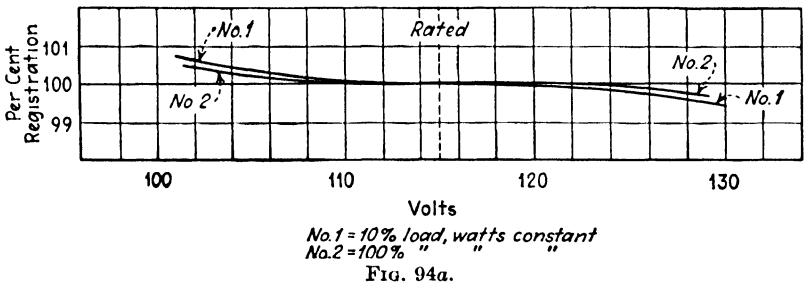

FIG. 94a.

slow (Fig. 94a) on the higher voltages. With decrease in voltage the damping is decreased and the meter runs fast on the lower voltages. Constant watts at rated value are implied in both statements.

With light load the loss in compensating friction torque from the decreased shaded-pole effect on the lower than normal

voltages will, in general, tend to make the meter run less fast than on full load. When the voltage is higher than normal it will be likely to run less slow than with full load.

If the power factor is lagging 50 per cent it may be expected that the registration curve with varying voltages will have the opposite slope from that shown in Fig. 94a for unity power-factor loads.

In general it may be said that modern induction watt-hour meters are affected not more than 0.3 per cent for 10 per cent departure in voltage.

9-8. Effect of Departure in Frequency.—Consider first the behavior of the meter under conditions of non-inductive load

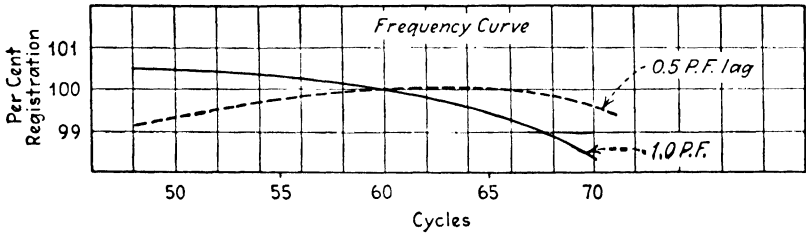

FIG. 94b.

(p.f. = 1.0) with current and voltage at rated values but the frequency varied. The flux established by the load current in the virtually non-inductive series coils will be independent of the frequency. The eddy currents induced in the disk by this alternating flux will, however, be proportional to the frequency. These eddy currents react with the voltage-coil flux. The highly inductive character of the voltage coil will tend to make its current and flux vary inversely as the frequency. (1) The driving torque contributed by the reaction of this flux ($\propto 1/f$) with the series-flux eddy current ($\propto f$) will be proportional to their product and therefore independent of the frequency. (2) The other contribution of driving torque comes from the interaction of series-coil flux with the eddy currents induced in the disk by the alternations of the voltage-coil flux. The former has been shown to be independent of the frequency; the latter is also independent of the frequency because, whereas the voltage-coil flux is inversely proportional to f , the eddy currents induced in the disk by it are directly proportional to f and consequently these two effects neutralize. Therefore, the combined torque from the two sources is practically independent of the frequency.

That the independence of frequency is, however, not perfect is seen from the typical performance shown in Fig. 94b. The decrease in registration with higher than normal frequency is principally attributable to two factors. (1) A large proportion of leakage flux of the voltage electromagnet is necessary to facilitate the phase-angle adjustment by means of the lag coil linking with the lesser portion of flux threading through it and the disk. With higher than normal frequency, volts the same, the flux decreases slightly faster than $1/f$ decreases. The torque and speed are, therefore, decreased. At the lower frequencies the relatively larger voltage-coil flux manifests itself in the damping and the curve flattens out; it may even be made to droop by control of the design. (2) The inductance of the eddy-current paths in the disk will tend to make the impedance increase with higher frequencies and, therefore, also make the eddy currents and torque decrease. The inductance of these eddy paths will be greater if the iron of the voltage and current cores is closer to the disk. This is one reason for a moderately large air gap in spite of the sacrifice in driving torque that it entails.

Further considerations affect the performance of the watthour meter on inductive load when the frequency departs from normal. The losses (copper and iron) in the voltage electromagnet are the cause of I_E failing to lag E by the desired 90° in Fig. 90. With higher than normal frequency, the iron losses in general increase more rapidly than the copper losses decrease. The total losses, therefore, increase and the 90° relation established by the lag coil at normal frequency then falls to less than 90° . Meanwhile, however, the current in the lag-coil circuit tends to lag its voltage more because of the greater inductive drop at the higher frequency. The net result is usually one of overcompensation at the higher frequencies, the meter then running fast on loads of lagging power factor; conversely it runs slow on lower than normal frequencies (Fig. 94b). This effect is one reason for keeping both the lag-coil ampere-turns and voltage-coil losses at low values.

9-9. Effect of Departure in Wave Form.—A non-sinusoidal wave can be decomposed by the Fourier analysis into a fundamental and its harmonics in specific proportions of amplitude and phase displacement from the fundamental. The effect of non-sinusoidal wave forms on the behavior of induction watt-hour meters is in the first instance a frequency effect. The

harmonic frequencies involved are the third order (180 cycles for a 60-cycle fundamental), fifth order (300 cycles), etc. The higher the frequency of the harmonic, the greater the reactance of the voltage coil and the less the magnitude of the current harmonic with respect to the magnitude of the harmonic component in the voltage wave. Further than this the higher harmonic current (and flux) component will, on account of the increased proportion of reactance, lag the voltage component more than in the case of the fundamental and lower harmonics. The current and flux wave forms are, therefore, quite different from the voltage wave form and in general nearer the sinusoidal. The reactance of the eddy-current paths in the disk creates a similar disparity between flux and eddy-current wave forms. The effect of the lag coil is enhanced at the higher frequencies.

A particular harmonic in the eddy current reacts to produce a torque component only with the harmonic of the same frequency in the flux wave. The reduction of the magnitude of the harmonic in either flux or disk eddy current reduces the torque contribution of that frequency. The over-all result of these various effects is that of overlagging; *i.e.*, the meter tends to run fast on low lagging power factors. There is, however, little occasion for concern about this characteristic with modern watthour meters operating on representative commercial power systems.

9-10. Improved Overload Characteristics.—The increase in use of electric appliances in the home has tended to increase the maximum load to be registered by the meter in residential service. The introduction of radio trickle chargers and motor-driven clocks has simultaneously emphasized the necessity for accuracy on sustained light loads in such a way as to preclude the adoption of meters of higher current rating to meet the increased values of maximum load. The urge has, therefore, been to retain the light-load accuracy of the 5-amp. meter for the great majority of residential services but to improve the overload characteristics.

The improvement has been accomplished principally by three means: (1) reportioning voltage and current fluxes, (2) slower speeds, (3) magnetic compensation. Increasing the magnitude of the voltage flux with respect to the current flux reduces, for a given desired value of driving torque, the damping effect of the series flux; this tends to alleviate the overload droop. Using

more powerful braking magnets decreases the speed of the meter at rated load and decreases the ratio of series flux to permanent-magnet flux; this also improves the overload registration. Magnetic compensation in one form employs a bridge or magnetic shunt which approaches saturation at about rated load and for overload values of current its reluctance increases and shunts an increased proportion of the increasing series flux through

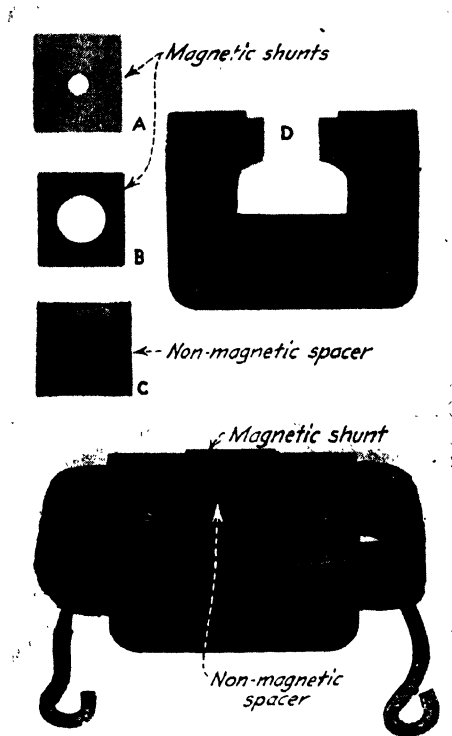

FIG. 95.

the disk; the driving torque is increased more rapidly than the load current and most of the overload droop is eliminated up to 300 per cent load (Fig. 95).

The progressive improvement in overload accuracy of all makes of watt-hour meters is typified by Fig. 96, which pertains to Westinghouse meters.

Of course, the increased current-carrying capacity of the coils has reduced the copper loss at rated value of current. Also the decrease in speed has had a favorable effect on the registration

with varying voltage; stronger braking flux from the permanent magnets tends to obscure the variations in damping effect accompanying the departures in voltage flux. Where needed, additional corrective effect can be accomplished by supplementing the leakage path (Fig. 85) of voltage flux by means of a saturable reactor; increasing voltage results in a greater proportion of the flux passing through the disk, enhancing the driving torque enough to offset the damping due to voltage flux.

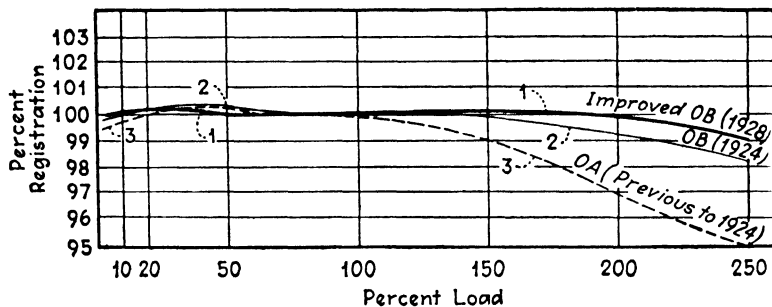

FIG. 96.

9-11. Effect of Departure in Temperature.—The induction watt-hour meter is composed essentially of copper, aluminum, steel lamination, and magnet steel. These materials have their inherent variation of conductivity, permeability, and hysteric properties with temperature. It might, therefore, be expected that the registration of watt-hour meters would vary with temperature, other factors constant. Characteristic performance of the older uncompensated meters is typified by Fig. 97; some meters reflected less slope for 50 per cent lagging power-factor loads with varying temperature but steeper slope for unity and leading power factors. Practically all commercial watt-hour meters not provided with modern compensating features, however, at low temperatures run faster as the power factor is shifted from leading to lagging; conversely they run slower at higher than normal temperatures as the power factor becomes more lagging.

It is evident that there are influences at work which make the speed vary with temperature when the load is non-inductive; the speed may vary because the driving torque or the braking torque or both are affected. It is also evident that the influences under unity power-factor conditions are supplemented by others which

make the speed departures greater or less when the power factor varies. Those factors which operate primarily to affect the performance at unity power factor are called "Class I errors"; those which primarily affect the phase relation of fluxes and therefore manifest themselves under conditions of reactive load are called "Class II errors."

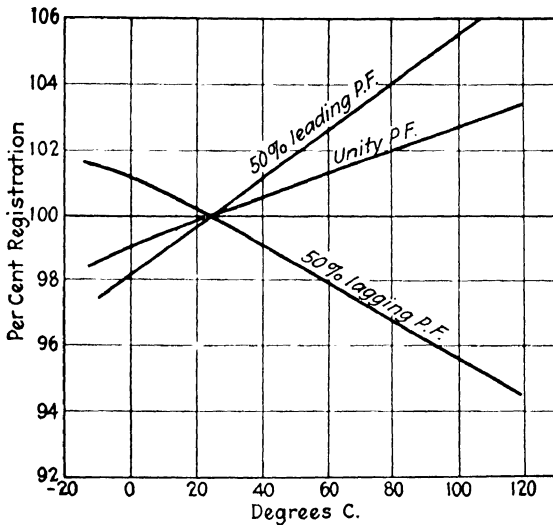

FIG. 97.

9-12. Sources of Class I and Class II Errors.—All the factors varying with temperature, except the changes in the braking magnets, can be associated with one or more of the vector components of Fig. 90. Inasmuch as rising or falling temperature and leading or lagging power factor will reflect opposite effects, it will be desirable to limit the discussion to one of the four possible combinations of load power factor and temperature change and infer the others from that one. The origin and consequences of temperature changes will be tabulated (Table V) for the condition of inductive load (lagging power factor) and rising temperature.

The two effects arising from the brake magnets may be viewed as the more important of the Class I errors; the others are divided in their effect on the registration, two resulting in increased speed and two in slower speed. In the case of the Class II errors, all here recognized have the effect of making the meter run slower on lagging power factor than at unity power

factor when the temperature is higher than normal. The sum total of these Class II errors may be treated therefore as if they were concentrated in the increased resistance of the voltage coil of the meter.

TABLE V.—CLASSIFICATION OF TEMPERATURE ERRORS

Member	Change	Result	Fig. 90	Class	Effect on registration	
					Unity p.f.	Lagging p.f.
Brake magnet...	Lower μ	Less ϕ_m	I	Fast	Same
Brake magnet...	Gap opens	Less ϕ_m	I	Fast	Same
Voltage coil.....	Incr. res.	Less flux	ϕ_{ED}	I	Slow	Same
Voltage coil.....	Incr. res.	Less lag of flux	ϕ_{ED}, δ	II	Slow	Slower
Voltage iron.....	Lower μ	Less flux	ϕ_{ED}	I	Slow	Same
Voltage iron.....	Lower μ	More E' and losses	I_E, E'	I	Fast	Same
Voltage iron.....	Lower μ	Less lag of flux	ϕ_{ED}, δ	II	Slow	Slower
Lag coil or plate.	Incr. res.	Less choking	ϕ_{ED}	I	Fast	Same
Lag coil or plate.	Incr. res.	Less lag of flux	ϕ_{ED}, δ	II	Slow	Slower
Disk.....	Incr. res.	Less lag of flux	ϕ_{ED}, δ	II	Slow	Slower

9-13. Compensation for Class I Errors.—Since the principal source of Class I errors resides in the brake magnets, it should be possible to compensate for all the Class I errors by compensating the magnets for their departures with temperature. The most logical means of compensation would naturally be (1) to use as a magnetic shunt some material which would decrease in permeability more rapidly than the magnets and thus shunt an increasing proportion of damping flux through the disk or (2) to use some temperature-sensitive material of which to construct the supports for the magnets so that their radial distance from the shaft would increase to compensate for their decreased flux with rising temperature and thus develop the same braking torque.

1. Temperature-sensitive magnetic materials to provide compensation by magnetic shunting have been found in copper-nickel alloys of the monel group. They consist of approximately 66 per cent nickel, 31.5 per cent copper, 1 per cent manganese, and 1.5 per cent iron. With most

advantageous proportioning, purification, and heat treatment they can be made to offer a temperature-permeability curve like that of Fig. 98 for H values (1.5 in this case) corresponding to the average m.m.fs. to which they are subjected as placed in conjunction with the magnets. The particular alloy shown is called Thermalloy *A* by Kinnard and Faus,* who studied its properties and perfected its application. The "release point" (at which the permeability drops with increasing temperature to that of air; *i.e.*, the material becomes non-magnetic) is controlled principally by the copper content, more copper lowering the release point. Since the rate of change of speed of the

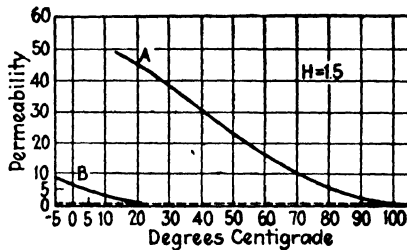

FIG. 98.

meters increases at the lower values of temperature whereas the rate of change of permeability of Thermalloy *A* falls off in this region, the meter would tend to be undercompensated with only *A* used to shunt the magnets; therefore, a second Thermalloy (*B*) having a lower release point (20°C.) and lower permeability but more rapid change in permeability at low temperatures is employed to correct the undercompensation.

The two blocks are inserted as shown in Fig. 99 from which it is evident that a more rapid decrease in permeability of blocks than of the magnets will shunt a greater portion of the flux through the disk as the temperature rises and thus compensate for Class I errors. It is also possible to incorporate the Class I temperature-compensating material with the full-load adjustment disk *D* of Fig. 81 as employed in some makes of induction meters.

* Temperature Errors in Induction Watthour Meters, *Trans. A. I. E. E.*, 1925.

2. Other methods tried have involved (a) the use of temperature-sensitive posts for supporting the magnets or (b) the use of bimetallic arms which expand with temperature at such a rate as to increase the radial location of the magnets when the temperature rises and weakens them, thus keeping the braking torque independent of temperature.

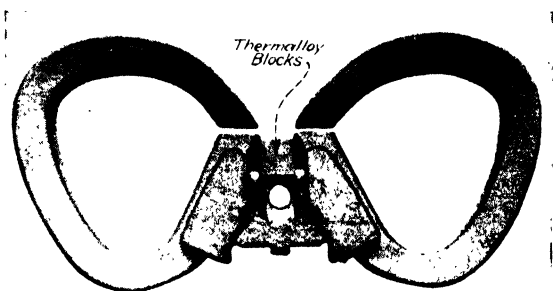

FIG. 99.

9-14. Compensation for Class II Errors.—The behavior of a meter compensated for Class I errors will be comparable to that of Fig. 100 which, for unity power factor, is a decided improvement over Fig. 97. The remaining departures due to Class II errors will be of the same order as in Fig. 97 with respect

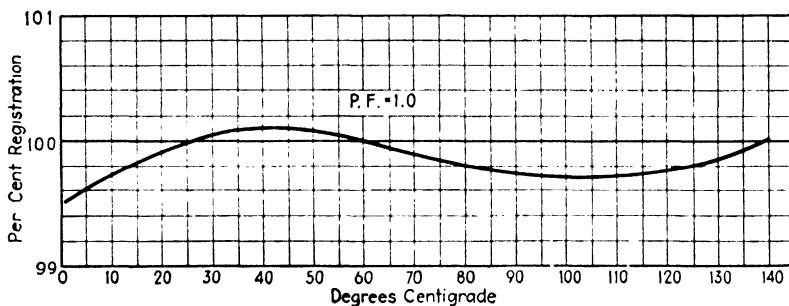

FIG. 100.

to the unity power-factor curves; but bringing the unity power-factor curve more nearly horizontal, as in Fig. 100, will tend to accentuate the slowness of the meter at higher than normal temperature when the load has a lagging power factor. Polyphase meters are usually subjected to reactive loads and, besides, one element of a two-element polyphase meter operates at a

lower power factor than that of the polyphase load. It becomes, therefore, imperative not only to provide accurate adjustment of the lagging of each single-phase element of polyphase meters but also to provide Class II temperature compensation for those meters which have been equipped with Class I compensation through the medium of the magnets as described in the preceding paragraph. Single-phase meters are not in general subjected to loads of such power factor as to make the Class II errors serious; nevertheless, it probably will be the practice ultimately to compensate the single-phase meters as well as the polyphase meters.

The predominant source of Class II errors is the resistance of the voltage coil; the lag plate or coil resistance also changes with temperature but the effect is smaller, and the change in disk resistance has a still smaller effect. Compensation for the residual change in registration with temperature and other than unity power factor of a meter compensated for Class I errors can, therefore, be effected by aiming the corrective effect at the resistance of the voltage winding. Inasmuch as the departure in registration is due to shift in phase of the flux at the disk with respect to the phase of the applied voltage, three methods can be cited as feasible for compensation of the Class II errors.

1. Minimize the resistance of the voltage winding and provide means of keeping its value constant when the temperature changes. One way, not wholly feasible from other considerations, is to place in series with the copper winding a filament of carbon the negative temperature coefficient of which will offset the positive temperature coefficient of the copper. A scheme preferred by the author for precision watthour meters employed in calibration of portable test meters involves the employment of an external resistor in series with the voltage coil of the precision meter. Adjustment of the value of the external resistance to the temperature of the meter will keep the registration the same for all power-factor conditions of the test load. Thus a change in resistance from 2.1 to 7.5 ohms will keep the meter of Fig. 101 at the same percentage registration for all load power factors within a range of 15 to 29°C. of room temperature. Incidentally the graph shows that the meter with all Class II compensation and lag adjustment omitted will run 2.6 per cent faster at 50 per cent lagging power factor than at power factor of unity when the temperature is 15°C., but only 0.8 per cent faster if the temperature is 29°C., showing the need of less compensation at the higher temperatures because the voltage-coil resistance has increased. More perfect Class I compensation of the magnets in this instance would have made the unity power-factor curves for the various temperatures coincide.

2. The usual resistor in the lag-coil circuit may be supplemented with a small reactor, the magnetic circuit of which is completed by a temperature-

sensitive alloy. As the meter warms up, the meter runs slower on loads of lagging power factor; *i.e.*, it is undercompensated and more current is required in the lag-coil circuit. The temperature-sensitive insert in the reactor core meanwhile loses permeability, there is less flux, less induced counter e.m.f., and more current circulates in the lag-coil circuit as is desired. A large permeability temperature coefficient is necessary for the alloy. This reactor as an independent unit may be dispensed with by employing an auxiliary lag plate, one leg of which is located in a slot provided for the purpose in the tip of the voltage pole. The slot is closed by means of a wedge of the alloy, its change in permeability with temperature changing

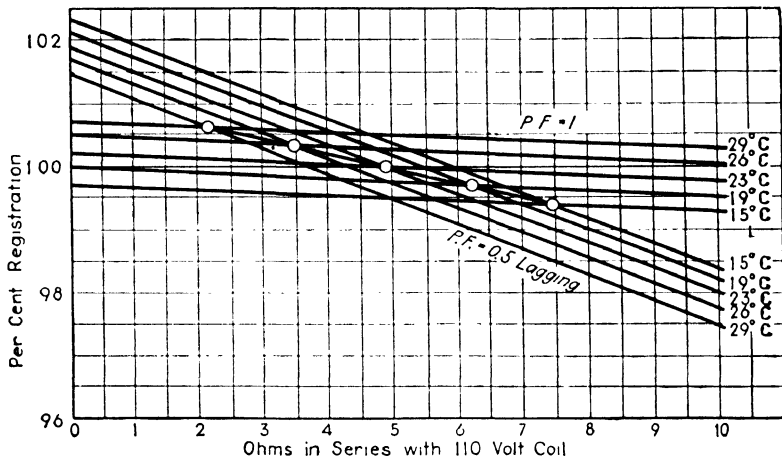

FIG. 101.

the distribution of voltage flux through the lag loop and thus changing the voltage induced in and current circulating in the lag loop.

3. The current-pole flux may be lagged as well at the voltage-pole flux and in such a way as to preserve quadrature relationship of the two fluxes at unity power factor regardless of the temperature. The meter will then have the same percentage registration at any temperature or any value of power factor that it has for unity power factor. A "figure-eight" loop of material having a high temperature coefficient of resistance (say copper) is placed around the two current poles and a loop of low-temperature-coefficient material, (say, phono-electric bronze) around the voltage pole. Some material having a negative coefficient would be preferable but all such materials have high specific resistance and would require inordinate cross section of the lag-coil conductor in order to provide sufficiently low resistance.

9-15. Characteristic Data of Watthour Meters.—Average values of electrical and mechanical quantities reflected by the representative makes of American watthour meters of recent design are given in Table VI:

TABLE VI.—DATA FOR MODERN WATTHOUR METERS
(5-amp. 115-volt 60-cycle two-wire meters)

	Westinghouse		General Electric I-16	Sangamo H.C.	Duncan MD
	OB	OC			
Revolutions per minute at 500 watts.....	25	25	16*	25	25
Approximate full-load torque, m.m.g.....	36	46	51.6	48	41.5
Approximate weight of moving element, grams.....	14	13	13.24	15½	15.2
Approximate ratio torque to weight of moving element	2.6	3	3.90	3	2.6
Approximate loss in voltage-coil circuit (watts at 115 volts).....	1.1	1.4	1.26	1.2	1.2
Approximate loss in current-coil circuit (watts at 5 amp.).....	0.30	0.15	0.158	0.19	0.20
Approximate total watts loss in meter.....	1.4	1.55	1.42	1.39	1.4
Approximate power factor of voltage-coil circuit....	0.13	0.16	0.13	0.31	0.18
Approximate diameter of disk, inches.....	3 ⁵ / ₁₆	3 ⁵ / ₈	3½	3½	3½
Approximate thickness of disk, inches.....	0.032	0.025	0.027	0.032	0.036
Approximate starting watts	1.5-2.0	1.5-2.0	1.7	1.5-2.0	2
Approximate resistance of potential-coil circuit, ohms	132	70	49.5	195	128
Approximate resistance of current-coil circuit, ohms	0.0092	0.006	0.00629†	0.008	0.0086

* At 550 watts.

† At 24°C.; at ultimate temperature, 0.00632.

CHAPTER X

TECHNIQUE OF METER TESTING

Testing of a service meter by comparison with a master meter was discussed briefly in 7-12. That process involves no exact determination of time since it consists only in comparing the number of revolutions of the two meters for identical duration of the same load. But the original verification of the master meter does involve accurate determination of the time during which a precise load is allowed to cause rotation of the meter. For many years the stopwatch was used for this purpose but its accuracy is considerably inferior to (1) clocks with contacts carried on the pendulum or (2) clocks with photocell beams intercepted by the pendulum or (3) tuning-fork-controlled clocks or (4) 100,000-cycle quartz crystal oscillators with 1,000-cycle accessories.

In general any timer functioning as a cycle counter is not to be relied upon for accuracy in intervals of the order of 1 min. because system frequencies, even where automatically regulated, are likely to waver from minute to minute. Their deviations are made to neutralize over the day, however, and thus be of acceptable accuracy for driving synchronous day clocks.

Checking of a-c. watt-hour meters also requires (1) means of establishing various values of load power factor, especially 50 per cent, (2) ways of shifting voltage phase to simulate desired power factors, (3) means of ascertaining the phase sequence so as to distinguish leading from lagging power factor, and as a matter of economy and convenience, (4) means of so-called "phantom loading."

10-1. Accurate Timing in Standardizing Watthour Meters.—Many ingenious schemes have been devised by which mechanical or magnetic attachments to the pendulum of a high-grade seconds-beating clock could open or close the circuits to relays which actuate the starting and stopping of a standard watt-hour meter during calibration. Interception by the pendulum of a beam of light as it falls on a photoelectric cell has proved superior

to most of these schemes because it eliminates the possibility of any retarding effect on the motion of the pendulum.

One scheme is that used by a metropolitan utility company as shown in Fig. 102. Each stroke of the pendulum reflects the beam of light to the photoelectric cell which actuates the grid of the amplifier tube whose plate current then energizes the main relay. This relay may close the circuit to a telegraph sounder and thus beat audible seconds for checking stopwatches for field use or it may close the circuit described in the following paragraph.

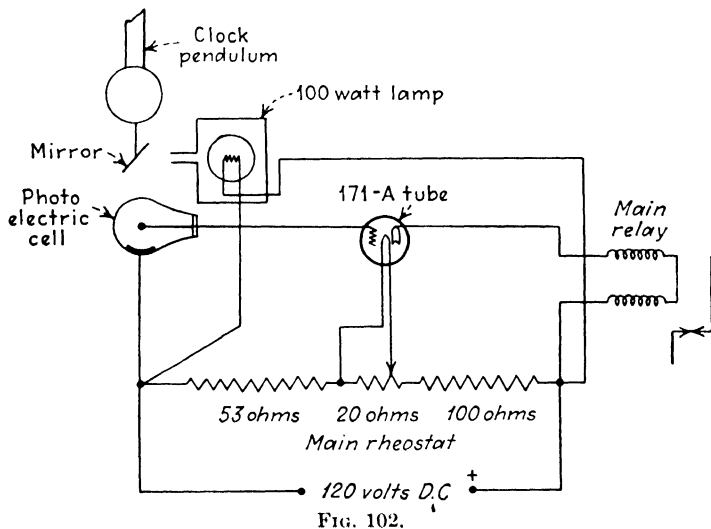

FIG. 102.

A mechanism for automatically energizing the voltage circuit of portable test meters for any predetermined length of time is shown in Fig. 103. The initiating relay *R* is to be energized every second, appropriately from the circuit of Fig. 102. When the load is adjusted to the desired value the push button *P* is depressed. Immediately thereafter contact *D* closes, making it unnecessary to hold *P* down. This follows the action of the pawl on the armature of magnet *M* pulled against spring *S*. A toothed wheel is advanced one tooth for each second's impulse. On the shaft of this toothed wheel is a series of staggered cams that are always reset to a fixed initial position after each run. Cam *A* on the first impulse closes contact *A* and energizes the voltage circuit of the meter through relay *O*. Switch *T* has meanwhile

been set to select the circuit opening cam, say *B*, which will trip after the desired number of seconds. This removes voltage from the meter, stops the run, and at the same time starts the reset motor so that the gang of cams will be restored to their original position. The reset motor is stopped by the opening of the d-c. supply at contact *C*.

This scheme is reported to be capable of a 0.02-sec. accuracy (about 1 cycle on 60 cycles) for any time duration.*

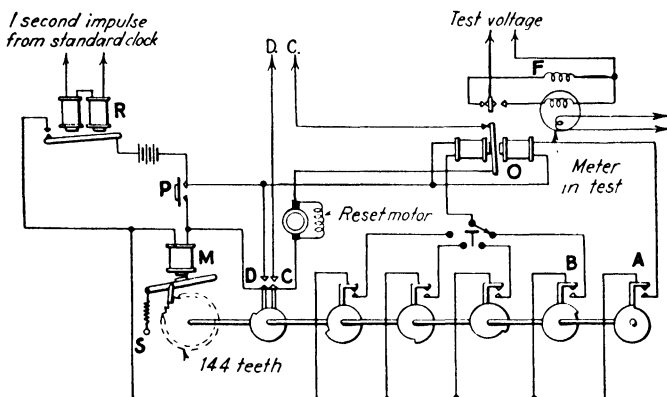

FIG. 103.

10-2. Stroboscopic Method of Meter Calibration.—The stroboscopic method of disclosing speed differences was one of the early ways of determining the slip of induction motors. A source of light made to flash in synchronism with the supply frequency is used to illuminate alternate black and white sectors on a disk mounted at the end of the induction-motor shaft. The disk appears to travel backward at a rate which indicates the degree of slip of the motor. The same principle has been adopted by H. P. Sparkes (A.I.E.E. paper, 1927) to the determination of the slow or fast difference between a watt-hour meter under test and the test meter.

A beam of light is directed perpendicularly at the edge of the disk of the test meter (Fig. 104). This edge has teeth which alternately intercept and pass the beam. When the beam is passing through a space between teeth, it activates the photoelectric cell whose output is amplified to flash a neon lamp placed near the disk of the meter under test. This disk is marked on

* See *Elec. World*, p. 1033, Nov. 23, 1929.

the edge with regularly spaced black spots. These spots will appear to stand still if the meter speeds are the same, as should be the case if both are accurate or have the same error and both have the same watt-hour constant.

Usually there are 400 marks on the periphery and therefore the apparent passage of one spot backward one space during one revolution represents 0.25 per cent difference in speeds of the two meters, the meter under test being the slower. At full load on a 25-r.p.m. meter displacement of one spot in 10 sec. would mean agreement of the two meters within 0.06 of 1 per cent.

The principal virtue of this scheme is that it (1) indicates the existence of error at once and (2) affords a means of adjusting

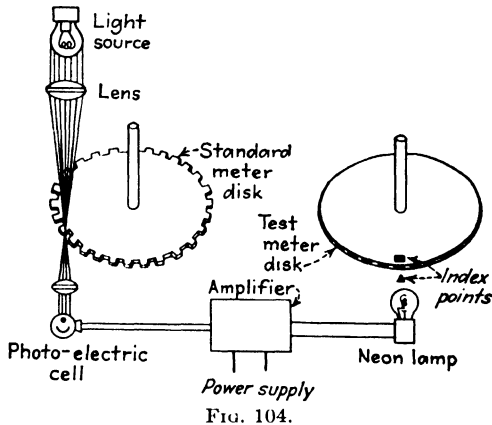

FIG. 104.

the meter intelligently during the run and thus substantially shortens the time required for testing. It also eliminates many opportunities for mistakes in calibration and in recording the sign of the error.

10-3. Phantom Loading.—The term “phantom loading” is used to designate the application to a meter of voltage and current which cause its rotation at desired speeds but do not involve the full expenditure of power represented by their product. The principal objects in resorting to phantom loading are to avoid waste of energy and to minimize the weight and cost of artificial load devices for meter testing. Design for minimum weight usually necessitates some sacrifice in close determination of the values of load current desired.

A phantom load (Figs. 105, 106) consists of a small constant-potential transformer with low voltage secondary (of the order

of 8.5 volts) and loading resistors of such value as to give desired values of current through the customary combinations of meter current elements encountered in testing procedure. The energy expended and the watt rating and weight of the resistor load are approximately $\frac{1}{13}$ what a 110-volt rheostat would involve. A considerably lower voltage might appear to effect more saving

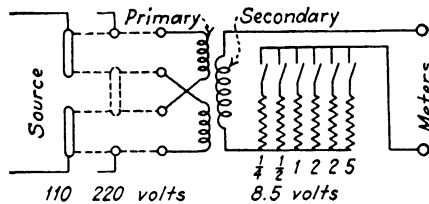

FIG. 105.

but it would not be justifiable because an adequate amount of resistance is needed in the secondary circuit to prevent the reactance of the meter coils from establishing an undesired shift in the phase of the current. With good design of the transformer and a limited volt-ampere burden of meter elements in series the phase shift can be kept small. The voltage phase shifter

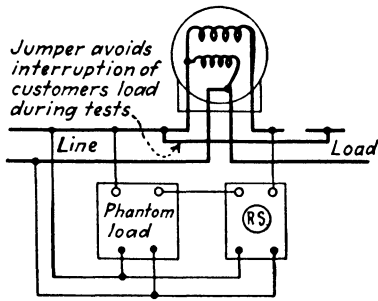

FIG. 106.

frequently used in conjunction with the phantom load can be resorted to in compensating for such phase shift of current as occurs in the phantom-load current circuit.

•10-4. Simulating Low Power Factor in Meter Testing.—

Inasmuch as watthour meters, especially polyphase meters, are likely to be subjected to reactive loads, provision must be made for testing such meters under load conditions of other than unity power factor. One way is, of course, to establish actual loads comprised of resistance and inductive reactance so proportioned as to give the desired power factor and watts. In general this is cumbersome and inflexible; adequately satisfactory results can be obtained by simulating these low power factors by phase-shifting methods. A lagging power-factor load can be imitated in its effect on the meters by advancing the phase of the voltage applied to the meter so that

it leads to current in its series coils, the current then lagging by the desired angle.

Several methods are available for phase shifting.

a. One, limited to obtaining only the approximate value of 50 per cent power factor, is based on taking, through resistance, current from one phase of a three-phase supply and taking for the voltage that other phase reversed which lags the first by 120° . The reversal (Fig. 107) results in a voltage leading by 60° . Of course, if a meter is lagged to be correct on inductive (lagging-current) loads it will also be correct on leading power factor. It is desirable, however, to know whether the voltage leads or lags in order to save time in making the lag adjustments,

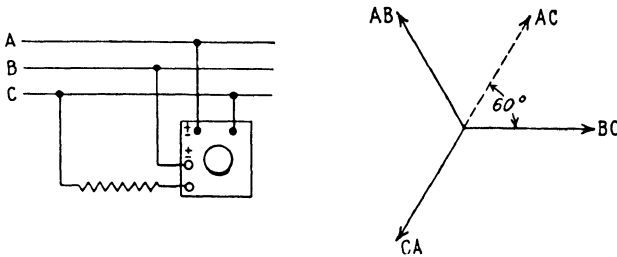

FIG. 107.

also to be able to attribute any uncorrected residual error to lag or lead as the case may be. The phase sequence can be determined by the methods of 10-6.

Other methods available are:

b. Two synchronously driven generators, one for source of voltage and the other of low voltage for current supply. One of the machines has its stator winding arranged to be shifted through any part of 180 electrical degrees. The current may, therefore, be made to lag and lead the voltage at the meter by any part of 90° . This method is usually employed only where precision testing demands sinusoidal supply of voltage and current. Sine-wave generators are made specially for such purposes.

c. Phase shifters. These are common in two forms, single-phase plug type and polyphase induction type.

10-5. Phase Shifters.—The induction-type phase shifter is based on the rotating-field principle of the induction motor and one may be adapted from the wound-rotor form of motor. The rotor is not permitted to revolve continuously but is rotated by hand to any appropriate position and locked there. When

the primary (stator) winding is excited from a polyphase source, the secondary (rotor) winding (Fig. 108) has polyphase voltages induced in it which will bear time-phase relations to the adjacent primary voltages that will depend on the angular shift of the rotor with respect to the stator. All values of angular displac-

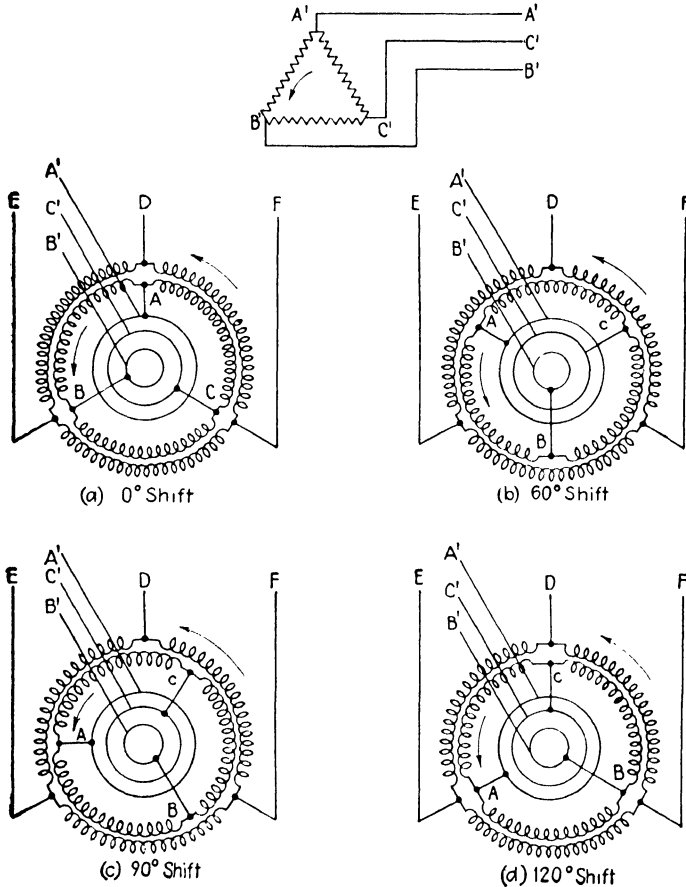

FIG. 108.

ment are available, lead or lag, the rotor position being established by means of a worm and gear. The ready availability of polyphase voltages makes this device useful where conditions may make polyphase test of polyphase meters preferable to the customary single-phase test with the current elements in series and voltage elements in parallel.

The plug type of phase shifter is based on the vector principle shown in Fig. 109. If the three voltages of a three-phase system are AB , BC , and CA , the subtraction of a portion of one, say CP , from another, say BC , results in the voltage BP making the angle θ with BC . The voltage BP will not, except when $CP = 0$ or $CP = CA$, have the same value as that of the three-phase system; but BE may be obtained equal to BC or even made a multiple of it by providing taps on the BPE coil at the points proportioned to the vector lengths in the figure.

In order to obtain phase displacements of more than 60° and also attain zero power factor it is necessary to extend the CA

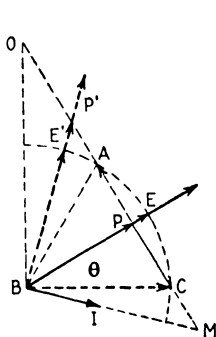

FIG. 109.

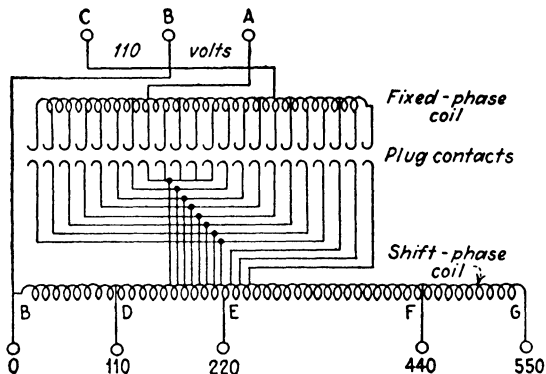

FIG. 110.

coil to O and establish OB in quadrature with BC . Also, because the inductance in the current coils of the meters and reactive drop in the phantom load, when one is used, may make the meter current I lag somewhat behind BC , it is desirable to extend the CA coil toward M . It is then possible to establish unity power factor by making BE lag BC as much as I does. The taps provided on the two coils may be spaced to give uniform shifts of, say, 5° in the angle, in which case the power factor in percentage will have more values near 100 per cent than near 0; or the taps may be made to give equal changes in the power-factor percentages.

The internal connections of the plug-type phase shifter are shown in Fig. 110 for the form supplied by the States Company. Typical connections for using the phase shifter in conjunction with a phantom load to check a service meter at low power factor against a rotating standard are shown in Fig. 111.

10-6. Determination of Phase Sequence.—If three similar lamps are connected in Y to the three-phase line *ABC* of Fig. 112, they will have equal voltages and currents and, therefore, burn with equal brightness. If, however, an iron-cored coil,

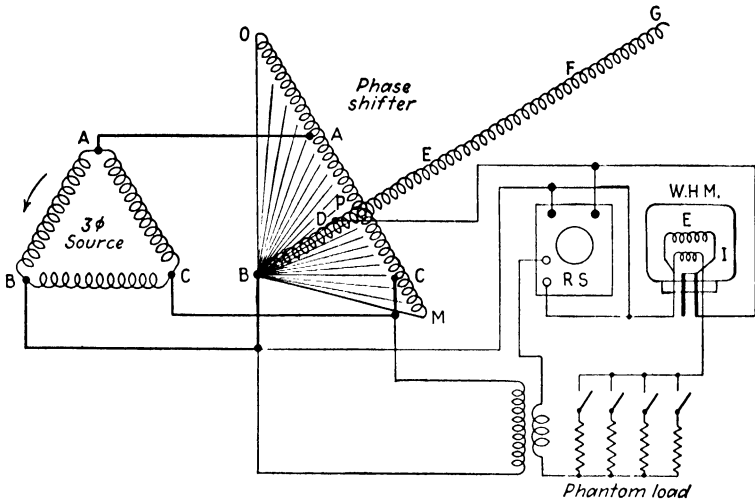

FIG. 111.

having small resistance but reactance ohms of the same order of magnitude as the lamp ohms, replaces the lamp *C*, the situation is changed. Its current lags its voltage by nearly 90° and the neutral point *O* must shift so that the three voltages will establish currents that have zero again for a vector sum. The vectors for this case are those of Fig. 113, the sequence being *AB-BC-CA*.

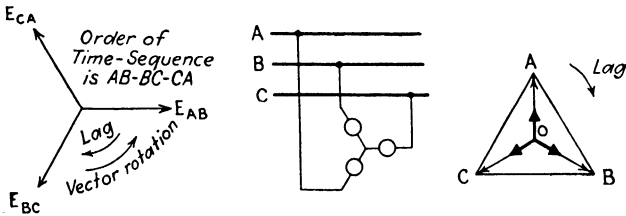

FIG. 112.

It should be noted that here the voltage *OB* is greater than *OA*; the lamp *B* is therefore brighter than *A*.

If, on the other hand, the time sequence of voltages is *AB-AC-BC*, then the neutral *O* must take the new position *O'*, which

is necessary to permit I_C , lagging $O'C$ by nearly 90° (Fig. 114), to balance I_A and I_B . Then E_{OA} is greater than E_{OB} and lamp A is brighter than B . The relative brilliancy of the two lamps is, therefore, an index of the time sequence of the three-phase voltages.

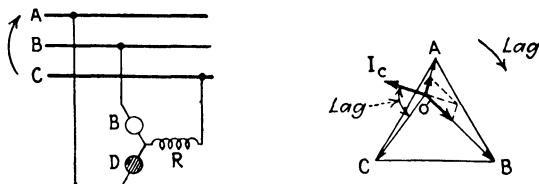

FIG. 113.

In either case the voltages follow one another in the same sequence as (1) the bright lamp, (2) reactance, (3) dim lamp. A very convenient reactance to use is the voltage coil of an induction watt-hour meter.

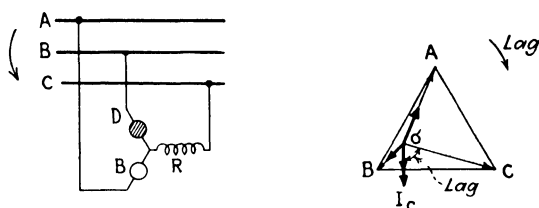

FIG. 114.

The speed of rotation of a watt-hour meter may also be used as an index of phase sequence. The current coil, with resistance in series to give, say, 5 amp., is connected across CB in Fig. 115.

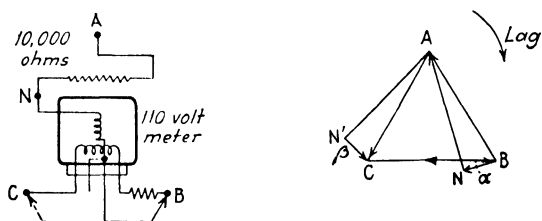

FIG. 115.

A 110-volt meter will have about 1,000 ohms of impedance in its voltage coil; a 10,000-ohm non-inductive resistance R is placed in series with the voltage coil. When the voltage coil and R are connected across AB and the phase sequence is $AB-BC-CA$, the speed of the meter will be higher than when

across AC because the angle α is less than β . If the sequence is the reverse, N and N' will interchange and the speed will be higher on AC .

A flux-addition method is the basis of the States phase-sequence indicator devised by H. J. Blakeslee. It consists of a polyphase-transformer core (Fig. 116) with three legs, two carrying primary windings to be connected to the line voltages, and the third a secondary winding with a lamp across its terminals. One of the primary windings is wound for low ratio, say 1:1, of reactance to resistance, the other for high ratio, say 10:1. The phase sequence determines the magnitude of the resultant flux in the middle leg, the voltage induced in its winding and the brightness of the lamp.

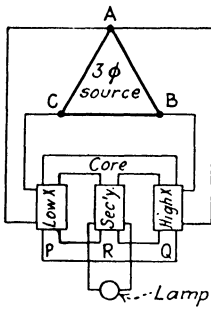

FIG. 116.

Thus, if the sequence is $AB-BC-CA$, the flux P will lag CA less than Q lags AB ; the resultant Q (Fig. 117), with the demagnetizing effect of lamp current in the secondary neglected, will be R , small in value. If the sequence is $AB-CA-BC$, the same fluxes will have a much larger resultant (Fig. 118) and the lamp will be brighter.

Of course, the direction of rotation of an induction motor depends on the sequence of voltages connected to its stator

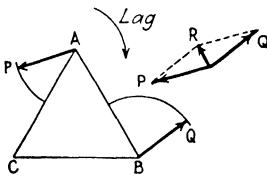

FIG. 117.

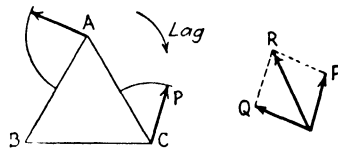

FIG. 118.

terminals. Once identified, the direction of rotation of a small portable motor, perhaps having a watthour meter disk for its rotor, will tell the phase sequence.

Problems

10-1. A meter tester was found using a distribution transformer (2,300/110 volts, 5 kva.) as a sort of phantom load. He had placed a large resistance (a few lamps in parallel) in series with the 2,300-volt winding and applied 110 volts. The secondary was connected directly to the current coils of his meters.

- a. How did he obtain desired values of meter currents in his tests?
- b. What determined the apparent power factor at the meter?

- c. How could he know what power factor he was using?
- d. What risks did he run from serious wave-form distortion?

10-2. Compute the number of turns to include between O and B and the tap points on each of the two coils of Figs. 110 and 111 in order to establish a phase difference of 40 deg. between BE and BC . Neglect impedance drops and assume two turns per volt with $BC = 110$ volts.

10-3. Take the two lamps of Figs. 113 and 114 as having 100 ohms and the coil as having 100 ohms of reactance and negligible resistance. Compute the voltage and current for each of the lamps and the coil. Employ complex algebra to express the components of each quantity on vertical and horizontal axes through O .

10-4. Show how a multiple secondary transformer could be used advantageously to test several meters at one time, current coils in series and each internally connected to one end of the voltage winding as in Fig. 111. (Potential current would flow cumulatively through the current coils if the voltage coils were all energized in parallel from a common source.)

CHAPTER XI

THE POLYPHASE METER

Loads on the various types of polyphase circuits may, of course, be metered by means of as many separate single-phase meters as are demanded by the Blondel theorem; the proper connection for each case has been discussed in Chap. V. The total load is the algebraic sum of the registrations of the two, three, or more meters; algebraic sum is stipulated because, for example, in the two-meter method for three-wire three-phase circuits, one meter will run backwards when the power factor is less than 50 per cent. This objection, plus that of maintenance of several meters instead of one, has led to the almost exclusive practice of using the polyphase meter which is composed of the two (or three) elements with disks on a single shaft and contained in one case. In the polyphase meter the algebraic addition of registrations is performed mechanically.

11-1. Features of Polyphase Meters.—In general the polyphase meters have parts identical with those of the corresponding single-phase meter, the principal difference being a larger case, two (or more) disks on one longer shaft, and variations of internal connections and terminal arrangement. Naturally, the moving element is nearly twice as heavy as for the single-phase meter and with the same bearing the friction torque is nearly double. This does not, however, make the polyphase meter particularly inferior to the single-phase meter since the driving torque and braking torque are correspondingly doubled.

Placing the two driving elements so close together resulted in a degree of electromagnetic interaction between them in some of the now obsolete models. Flux from one element found its way into the other element and created spurious torque and registration. Modern meters are designed to be free of this difficulty, a judicious arrangement of the parts and provision of magnetic shielding having minimized the effects of wandering fields.

11-2. Constants of Polyphase Meters.—In most instances the watt-hour constant for a given make and current rating of

polyphase meter will be twice that of the single-phase meter of the same rating. The register ratio will correspondingly be half the single-phase value. This would be the natural consequence of conforming to the same rated speed for full load in the two cases but having twice the input in the polyphase case. Expressed in other terms, the watthour constant of a 110-volt 5-amp. polyphase meter will be the same as that of a 220-volt 5-amp. single-phase meter of the same make and class.

When a meter is used with instrument transformers the over-all watthour constant is that of the meter multiplied by the ratios of current and voltage transformation. For example, a 115-volt 5-amp. polyphase meter, having a watthour constant of 0.6, is used with 2,300/115 voltage transformers and $2\frac{5}{5}$ current transformers on a 100-kw. load. The constant for meter and transformers is $0.6 \times 20 \times 5 = 60$.

In routine testing of the polyphase meter it is common practice to disconnect it from the current transformers (after short-circuiting them), place the current elements in series, and test by phantom load in comparison with a single-phase portable test meter. In this case the same fictitious energy is passing through both elements of the polyphase meter but it is registered only once by the single-phase test meter. Either the watthour constant of the polyphase meter should be halved or that of the single-phase meter doubled, preferably the former, in comparing the two registrations to ascertain the accuracy of the polyphase meter.

11-3. Adjustments in Polyphase Meters.—The full-load, light-load, and lag adjustments provided in a polyphase meter are no different in principle from those employed in single-phase meters.

A change in the full-load adjustment will affect both elements equally whether it be the upper or lower magnets that are adjusted. Likewise a light-load adjustment on one element will supply friction-compensation torque to modify the light-load speed even though the light load actually be a single-phase load passing only through the other element. Half the friction-compensation torque should be contributed by each element and the total contribution such as to give the desired light-load accuracy.

The separate elements of a polyphase meter may be subjected to widely varying torques if the system load is unbalanced. It is, therefore, important to have each element contribute its

true portion of the total registration. The speeds of the two elements cannot, however, be controlled separately by magnet adjustment because both magnet braking torques are applied through the disks to the one shaft and neither driving element knows which magnet torque it is overcoming. Any discrepancy in speed of the two elements must be removed by bringing them to equality for identical load conditions and then adjusting the magnets to give the correct speed for joint action of both elements. This equalizing adjustment is called "balancing." Balancing adjustments have taken the following forms: (1) taps on one of the voltage coils, less turns used resulting in more voltage-coil current and torque of the element; (2) changing the air gap between current and voltage electromagnets of one element, smaller air gap giving more torque; (3) mounting both current electromagnets on a plate, the shift of which vertically would decrease one air gap and increase the other.

The lag adjustment of the elements in a polyphase meter has already been shown to be important (see 5-7) because one element will usually be working at a lower power factor than the power factor of the polyphase load. Also it will be a leading power factor in one element if the load power factor is likely to have periods of better than 86.6 per cent value. Temperature compensation for Class II errors is more essential in a polyphase meter than in a single-phase meter (see 9-12), especially if the elements have been compensated for Class I errors.

11-4. Systematic Test and Adjustment.—There are two independent adjustments (light load and lag) for each element of a polyphase meter; there is also the magnet adjustment which affects the performance (full load) of both elements; and finally there is a balancing adjustment to bring the two elements to equality of registration. In approaching the correction of a meter of doubtful accuracy, much time will be wasted unless the tests and adjustments are made in a logical sequence. It appears to be most logical to balance the elements first, then lag each element separately, next adjust the full-load accuracy, and finally the light load. Single-phase source is recommended for comparison with a single-phase portable test meter.

1. *Balance.*—Apply normal voltage to the two voltage coils in parallel—full-load current at unity power factor through the two current coils in series but with one element reversed with respect to the other. Under these conditions the two

driving torques are opposed and there should be no rotation. If there is rotation the elements should be balanced by the means provided.

In this test the rotation will be very slow in any event. In an extreme case of light-load error of one of the elements, the rotation observed may be due to this cause. If this be the case, test 4 will disclose it and, after it is corrected, this balance test at full load should be made afresh.

2. *Lag Adjustment.*—Apply normal voltage to the two voltage coils in parallel—full-load current at zero lagging power factor to each element in succession. The test meter will cease to rotate when zero power factor is reached and the polyphase meter should also stop. If it rotates forward on the lagging current it is overlagged, if backward it is underlagged; the lag adjustment is made accordingly until both polyphase and test meter stand still. The second element is adjusted independently in the same manner. The first current element may then be reconnected in opposition and a balance test made, this time at 50 per cent lagging power factor as a check on the two adjustments. If correct, the meter should stand still.
3. *Full Load.*—Apply normal voltage to the two voltage coils in parallel and full-load current at unity power factor to the current coils in series, with forward rotation at or near rated speed. Adjust the position of the adjustable magnet until the registration is correct.
4. *Light Load.*—Apply normal voltage to the two voltage coils in parallel and light-load value of current at unity power factor to each element in succession. Make light-load adjustment on each so that both have equal registration but not necessarily correct registration. Then place the two current elements in series and make the remaining adjustment partly on each element until the registration is correct in light load. If the meter was considerably in error on light load, it will be well to repeat the full-load test and balance adjustment for the reason cited in test 1.

The question is frequently asked why the meter does not run at half speed when only one current coil is excited. The answer rests in the damping influence of the missing flux (see 8-9). It is for this reason that the voltage is applied to both elements in all the foregoing tests and further that the adjustments are not

predicated on precise half-speed operation with one element functioning. The full-load current speeds inherently will be a fraction of a per cent fast in either case because of the reduced damping effect. On the other hand, the speed will be less than half on light-load current because of the deficiency in friction compensation when only one potential coil is energized.

11-5. Adjustment of Registration for Polyphase-meter Error.

A meter adjusted in accordance with the procedure of 11-4 will perform correctly on a polyphase circuit under all conditions of load, balance, and power factor.

But suppose the meter during the test revealed appreciable errors under the various conditions of lag, balance, and light load. If these errors are to be recorded for the purpose of supplying a correction factor to faulty registration for the period preceding the test, it will be necessary to modify the procedure of 11-4 because that procedure was aimed at adjustment rather than at an "as found" record.

Even with the individual registration known for each element and for the combined elements, at both unity and, say, 50 per cent lagging power factor, there would still be much question as to the corrections to apply. The doubt arises from three sources: (1) the fluctuation of the load in kilowatts, (2) the balance or unbalance of the phase loads, (3) the fluctuation of the load power factor. Thus if the load power factor were exactly 50 per cent, one element should have zero torque; it might have extreme light-load and full-load errors without materially affecting the meter registration. In fact it might be wholly inoperative and still not prevent complete and correct registration by the other element. If the latter, however, were inoperative there would be no registration whatever. It is for this reason that the latest models of polyphase watt-hour meters are provided with open-potential indicators if desired.

If the load is known (or justifiably assumed) to be balanced and the power factor at all times lies within narrow limits, it is possible to compute the correction factor for the billing period with some degree of certainty. If the conditions are not so assumable, the case hinges largely on compromise. Nor does resort to single-phase meters remove all the uncertainty or risk.

11-6. Performance with Instrument Transformers.—The procedure of 11-4 would result in a registration curve as flat as the design of the meter permitted. This would be desirable

in the case of a self-contained meter connected directly into a low-voltage circuit of moderate current capacity.

But a large portion of the polyphase meters are used either (1) with current transformers because the load current exceeds the 100 or 150 amp. for which the meters can conveniently be built or (2) with both voltage and current transformers because the voltage exceeds the value of 600 volts safe for application direct to the meter. In these cases the instrument-transformer characteristics will be reflected in the registration by the meter.

Thus if two current transformers having the characteristics of Fig. 15 are used with a two-element polyphase meter adjusted to independent accuracy, the combination will be sufficiently accurate at 5-amp. secondary value of load current (unity power factor). But at 0.5-amp. value (light load) there will be an error of approximately 0.5 per cent, if curve 3 is assumed to apply to half the burden B as represented by one element of the polyphase meter. This error will be in the "slow" direction because, on the 100/5 ratio, 0.5 amp. in the secondary indicates a 10-amp. primary current whereas the actual primary current is 10.05 amp., *i.e.*, is 0.5 per cent higher. This effect may be overcome by adjusting the polyphase-meter elements to be 0.5 per cent fast on light load.

If in addition voltage transformers are used having the characteristics of Fig. 8, an independent shift in the polyphase-meter adjustment would be desirable for improved over-all accuracy. Thus, if each voltage coil is the sole burden on each transformer and constitutes 15 volt-amp. at 0.1 power factor, then the effect of the ratio factor (0.995) is to make the meter run 0.5 per cent fast. In this particular instance the voltage transformer just compensates the current transformer, the 0.5 per cent fast of one offsetting the 0.5 per cent slow of the other, and the polyphase meter should be set correct at light load.

Light load in these cases is usually taken at 0.5 amp.; the actual transformer ratios and necessary polyphase-meter offsetting are known from the curves for the known burdens. But in order to compensate for other loads some particular value of load must be assumed in order to correlate the meter adjustment with the ratio errors. Thus, with 3 amp. as the most likely load, the magnets should be set 0.4 per cent slow at that meter loading in order to offset the 0.5 per cent fast of the voltage transformers and 0.1 per cent slow of the current transformers.

Likewise the low power-factor performance of the metering installation will be affected by the phase angles of the instrument transformers. In Fig. 8 the voltage transformer secondary voltage leads the primary by 10 min. and (Fig. 15) the current transformer secondary current leads the primary by 10 min. In this instance the two compensate one another. When they do not, Eq. [12] will indicate the error due to phase angles and the lagging may be shifted accordingly if precision is required.

The flatter curves of recent current transformers and meters and the tendency of voltage transformer departures to counter-balance those of current transformers make these refinements of calibration progressively less essential in an increasing percentage of the installations.

11-7. Customary Connection on High-voltage Lines.—As was stated in Chap. V, the two-element meter with a current transformer and voltage transformer for each of its elements (Fig. 60*d*) is accurate for any degree of unbalance on three-phase three-wire circuits. When, however, the neutral is grounded (or connected by wire) at two or more points and the metering installation lies between these points, the system becomes in actuality or in effect a four-wire system and the two-element scheme is inaccurate whenever the loads are unbalanced. This method of metering is correct only for Δ -connected systems (which have no neutral to be grounded) or Y-connected systems with floating primary neutral.

If voltage transformers are Y-connected when used in a Δ -connected ungrounded system, the neutral point of the voltage transformer connection should not be grounded; the reason is that an accidental grounding of one of the line wires will impose an undue strain on the insulation of one of the voltage transformers. Further, the secondaries should in general be connected Δ to eliminate the effect of harmonics as well as to establish proper phase relation with the currents from the secondaries of the current transformers.

The three-element method of measurement (Fig. 119) is accurate for three-phase four-wire circuits under any conditions of balanced or unbalanced load, voltage, or power factor. It is, therefore, the advocated method of metering three-wire Y-connected systems when the neutral points are connected together either by wire or through multiple grounding, especially if the metering installation is placed between grounded points. The

three-element meter with three current transformers and three voltage transformers is somewhat more accurate than the schemes in which a two-element meter is made to approximate the three-element meter by split coils (Fig. 64) or Δ -connected current transformers (Fig. 66). The reason is that the third current is associated with the reversed vector sum of the other two voltages rather than its own phase voltage which, under unbalanced conditions, may differ from the vector sum of the other two voltages. Also each element has a power factor the same as the

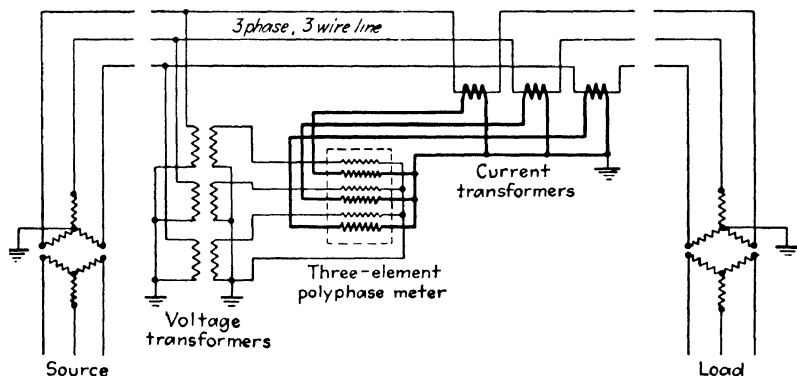

FIG. 119.

three-phase line power factor under balanced conditions and, under unbalanced conditions, approaches it more closely than the two-element meter does.

In the three-element method of metering on grounded-neutral systems the voltage transformers are connected Y-Y with neutrals of both their primaries and secondaries grounded. Voltage transformers should not be connected Y- Δ on three-phase four-wire circuits if the primary neutral of the voltage transformers is grounded; the reason is that the secondary Δ -connection would cause the voltage transformers to act as phase balancers and they are of insufficient volt-ampere capacity to accomplish such balancing without overheating.

11-8. Combined Current and Voltage Transformer Units.—High-voltage instrument transformers are relatively expensive. Some economy can be effected, especially in connection with the reduction in number of high-voltage bushings required, by consolidating a current and voltage transformer in one tank. In Fig. 120 with solid and low-resistance grounding of the voltage transformer neutral, six high-voltage bushings are required; if

resistors or reactors are inserted in the ground lead, nine high-voltage bushings would be required.

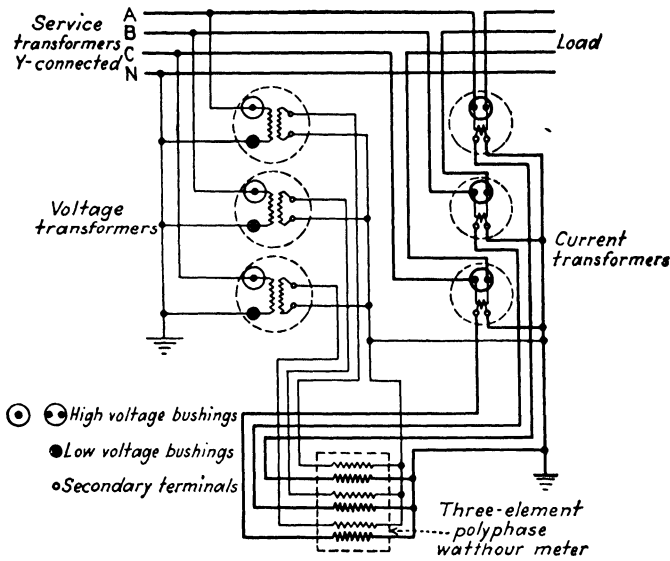

FIG. 120.

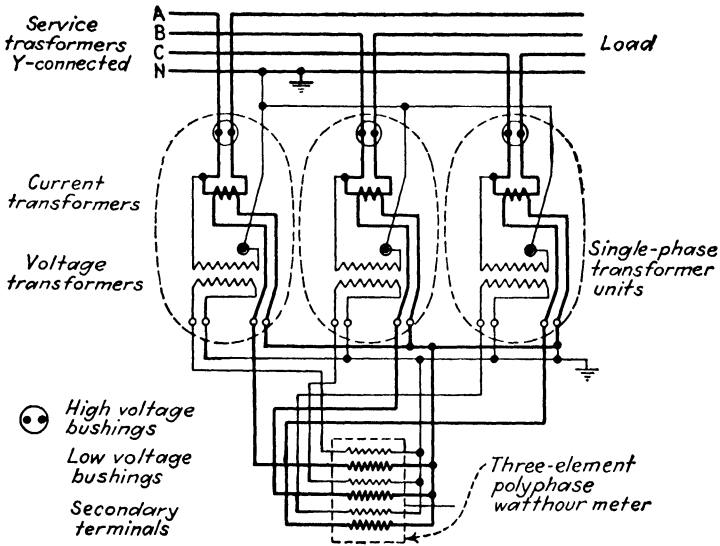

FIG. 121.

Single-phase combined units as in Fig. 121 would require only three high-voltage bushings if the neutral is solidly grounded.

but six if impedance is inserted in the neutral ground lead. Such single-phase combined units have been built for voltages up to and including 220 kv.

Three-phase units (three voltage transformers and three current transformers in one tank), requiring only three high-voltage bushings, have been constructed for use on normal system voltages up to 66 kv. (Fig. 122).

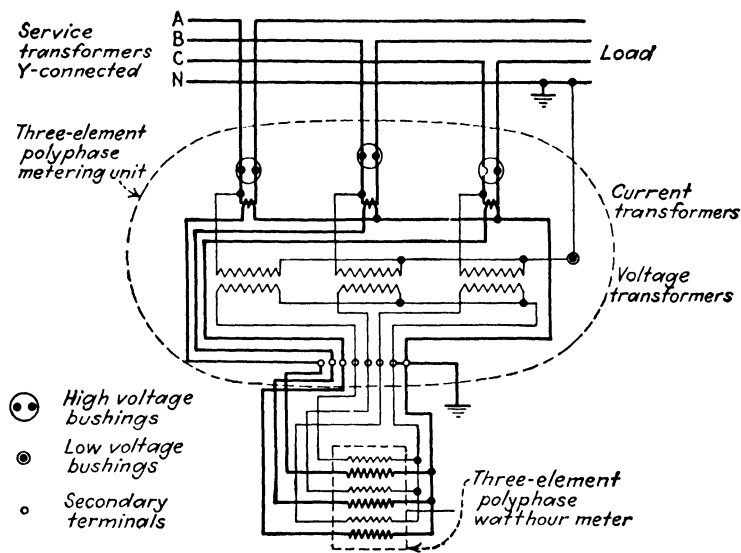

FIG. 122.

11-9. Selection of Instrument Transformers.—Many metering installations are made in contemplation of later increase in the load. Accurate metering, especially during extended light-load periods, makes it desirable to use current transformers of the lowest primary current rating compatible with the likely value of maximum load. For this reason current transformers with multiple ratios are sometimes used, a shift in connection to higher ratio being made when the load increase warrants it. Of course, some light-load accuracy will then be sacrificed unless the light load increases proportionately.

Operating conditions may dictate raising the line voltage after the transformers and meters have been installed. To avoid the necessity of replacing the instrument transformers, current transformers insulated for the expected voltage may be installed at the outset and the secondaries of the voltage transformers

may be provided with taps to give 115 volts with either voltage on the primary, which must, of course, be designed for the higher voltage.

Metering equipment is usually placed on the station side of line lightning arresters and during high-frequency disturbances (from lightning and surges arising out of faulty line conditions) the windings of the instrument transformers may be subjected to severe electrical stresses. For this reason current transformers are often protected by auxiliary spark gaps or low-voltage lightning arresters across their terminals. The principle of grading the line insulation to promote spillover away from expensive station equipment, including metering, may be applied by using one or two less insulator units in the strings supporting the line wires at the two or three transmission-line towers adjacent to the station and metering equipment. Likewise the primary windings of the instrument transformer should be designed for higher dielectric strength against impulse than the bushings through which the line wires or taps enter the transformer.

Faults on the lines may create line currents of very high value, dependent on the generating capacity connected to the system and the impedances to and through the fault. Current transformers must be given ample mechanical strength to withstand the magnetic stresses resulting from the short-circuit and fault currents; they should also have thermal capacity to avert damage or breakdown from excessive heating during the time required by the protective relay system to clear the fault.

11-10. Control of Instrument Transformer Burdens.—In general, indicating instruments, synchronizing devices, and relays, as well as watt-hour meters, will require instrument transformers. Economy may dictate the use of one set of instrument transformers for more than one or all these purposes; but such economy may be obtained at the expense of accuracy of registration of the watt-hour meters.

Current transformers give the best performance as to ratio and phase angle when their secondary burden is small (few meter and relay coils, *i.e.*, minimum series impedance). Bushing transformers are therefore often used for the relays and synchronizing equipment (their accuracy being adequate for these purposes) in order to relieve the burden on the wound type to which the energy meters are connected. In any event, the

highest accuracy will be obtained if the current transformers are designed for accurate performance within the desired limits of error in meter registration and compensated for the actual burden imposed on them; still higher accuracy will be obtained if the meter is compensated for the ratio and phase-angle departures of the instrument transformer (see 11-6).

The ratio and phase-angle departures of voltage transformers may be more nearly compensated by adjustment of the meter elements (full-load and lag calibration) when the burden is not subject to variation because of intermittent connection of voltmeters or other voltage devices. A volt-ampere rating of voltage transformers nearest to their expected burden will, of course, give the highest accuracy because the design for this rating gives them the best compensation for both ratio and phase angle.

Unbalanced burdens on the voltage transformers should be avoided as far as possible. Such unbalance of burden may arise from (1) the use of two autotransformers for reactive component measurement, (2) the use of open- Δ -connected loads on star-connected voltage transformer secondaries, or (3) the connection of voltage circuits of relays or instruments across the open end of open- Δ -connected secondaries. These connections may result in an effort of the transformers to correct the unbalance in their local circuit and by so doing shift the phase of their terminal voltages and result in metering inaccuracy. Reactive component autotransformers are most likely to cause such discrepancies; the insertion of dummy burdens will correct the unbalance of burden.

If the burden on a voltage transformer is of low power factor, improved accuracy may be obtained by using static condensers in parallel with the inductive burdens to improve the burden power factor (see Fig. 8). The volt-ampere burden is thereby reduced and so are the departures in ratio and phase angle. In general no wave-form distortion results from the interaction of condensers and inductive burdens.

11-11. Fusing Voltage Transformers.—Distribution transformers are commonly protected against overload by means of fuses in the primary leads. But for the much smaller currents involved in the primary leads of voltage transformers, the fuse wire has to be of such small diameter as to be very delicate if it is to blow with excessive burden or even in case of a short circuit on the secondary side. When primary fuses are used they may

be viewed therefore as protection of the line against failure of the voltage transformer itself. Some companies justify the omission of primary fuses on the basis of favorable experience in this respect. Others insert resistance in the primary leads to limit the current, in case of short circuit within the transformer, to 20 to 40 amp., a value which fuses of adequate ruggedness will interrupt. In normal operation the resistors carry only the very small primary current of the voltage transformer and the voltage drop through them does not affect appreciably the accuracy of metering.

Fuses in the secondary leads are more certain protection of the voltage transformer against short circuits or excessive burdens than are the primary fuses. They are, however, a possible source of metering inaccuracy because of (1) corrosion or loose contacts at the fuse clips, (2) undetected blown fuses, and (3) inadvertent removal. For these reasons often none is inserted (even if primary fuses are also omitted) and when used are installed close to the instrument terminals where they are more likely to be observed and maintained in good condition. If protection is desired while making meter or relay tests, fuses may be installed in the test leads.

11-12. Grounding of Instrument Transformer Secondaries.—

Safety to the meters, and to persons who have to come in contact with them, dictates the grounding of the secondary circuits of instrument transformers. In the absence of effective grounding, the leakage and capacitance effects may raise the potential of the secondary system to a value approaching that of one of the high-voltage line wires to ground. Grounding also protects against puncture of the primary windings or breakdown of the primary bushings as a result of lightning or other abnormal stress on these dielectrics.

Theoretically any point of the secondary may be grounded but it is preferable to ground a junction point of the secondaries of two transformers. The ground should be made as close to the instrument transformer terminals as possible. Best metering accuracy will be obtained if the grounding is made at only one point; grounding at two or more points on the same secondary system provides a possible path for ground currents from other sources than those involved in the secondary metering circuits and these may create phantom burdens which will distort the performance of the voltage or current transformers.

11-13. Precautions as to Secondary Leads.—High-voltage metering installations often necessitate placing the meters at a considerable distance from the instrument transformers and thus require long secondary leads. Such long leads should be of sufficient cross section to minimize the resistance burden which they add to the secondaries of current transformers. Otherwise ratio and phase-angle departures will be enlarged by the increased burden. When the distance is considerable this may necessitate a wire size much larger than required from the standpoint of current-carrying capacity.

Long secondary leads from voltage transformers to meters are less significant from the burden standpoint than in the case of current transformers. But in order that the drop in the leads shall not detract from the secondary voltage (and shift its phase) at the meter terminals, care should likewise be taken to keep their impedance to low values.

In general it is desirable to use common return wires for the secondary circuits from the terminals of instrument transformers to the meters, but independent return conductors should preferably be used for the current and voltage circuits. Both circuits should be grounded but as small as possible a portion of the common return current should flow in the common voltage conductor (for illustration see Figs. 121 and 122).

In all cases the secondary conductors, especially if they are long, should be arranged so that their inductive effect is minimized. This is facilitated by placing all within a single conduit or using a multiconductor cable; in either case the use of color-code wrappings on the conductors facilitates the verification of the connections.

Problems

11-1. Will the register and gear train of a 5-amp. 115-volt single-phase meter be equally appropriate for a 5-amp. 115-volt polyphase meter of the same make?

11-2. What size meter would you install to meter the consumption by a 15-hp. 230-volt three-phase motor which you know runs under full load whenever it is used? What size meter would you use if a test showed that the motor ran at full load only 1 hr. in every 4 hr. and at half load at other times?

11-3. A customer's load consists entirely of a 150-hp. 2,300-volt three-phase induction motor. What rating of meter would you install? Of voltage transformers? Of current transformers? What should be the register ratio for direct kilowatt-hour indications on the dials if the meter is

115-volt, 5-amp.? The register ratio should preferably be 20 or higher; what register constant and register ratio would be desirable in this case?

11-4. Show by vector analysis the reason for difference in accuracy of metering a three-phase four-wire load by (1) a two-element meter (see Figs. 64 and 65) and (2) a three-element meter (see Fig. 119) under the following load conditions:

- a. Voltages balanced, unity power factor, currents unbalanced.
- b. Unity power factor, unbalanced currents also unbalancing the voltages.
- c. Lagging power factor, with unbalanced currents and voltages.

11-5. In the case of long distance from current transformer to metering panel it appears that weight of secondary wire might be saved and burdens minimized by using a second step-down current transformer to reduce the standard 5-amp. secondary current to a few milliamperes and transmit the reduced current to the distant meters of low current rating. What are the advantages and disadvantages of this alternative? Would rectification of the small current (say by copper-oxide rectifiers) make the scheme more effective if at all feasible?

11-6. The speed of a single-phase watt-hour meter served from instrument transformers shows a secondary load of 175.7 watts when the secondary voltage is 115.23, the current 3.027 amp., with the current lagging the voltage by $59^{\circ} 45'$. Data on the instrument transformers are as follows:

Voltage transformer:

Nominal ratio.....	2300/115
Ratio correction factor.....	0.998
Phase angle, leading.....	15 min.

Current transformer:

Nominal ratio.....	500/5
Ratio correction factor.....	0.991
Phase angle, leading.....	30 min.

Show:

- a. Primary voltage is 2,300 volts.
- b. Primary current is 300 amp.
- c. Primary power factor is 50 per cent.
- d. Primary load is 345 kw.
- e. Error from ignoring the ratio and phase-angle departures of the transformers would be 6.4 kw. (*i.e.*, 1.9 per cent) high and to avoid the necessity of applying a correction factor the meter should be set 1.9 per cent slow at this loading.
- f. The registration would be 1.1 per cent high if the power factor were unity; therefore the magnets should be set to make the meter 1.1 per cent slow and the residue (0.8 per cent at 50 per cent power factor) should be compensated by lag adjustment.

11-7. Show that the voltage at the watt-hour meter would be only 0.3 volt less than at the secondary terminals of a 200-volt-amp. 115-volt voltage

transformer which is carrying half its rated burden, if the leads involve the use of 400 ft. of No. 9 wire.

11-8. Would the same length and size of leads as in Prob. 11-7 increase to an undue value the burden on the current transformer supplying 5 amp. to one element of a polyphase meter which in itself constitutes a burden of 0.7 watt and 0.98 reactive volt-amp.? What would be the volt-amperes, watts, and power factor of the burden of:

a. The meter element alone.

b. The meter element and the 400-ft. leads of No. 9 wire.

11-9. A watthour meter has registration characteristics and is used with a split-core type of current transformer having characteristics as follows:

Ampere load, per cent. . .	10	20	40	60	80	100
Watthour meter at 100 per cent power factor.	100.0	99.9	99.9	100.0	100.0	100.0
Watthour meter at 50 per cent power factor (lag).....	100.5	100.0	100.0	100.1	100.1	100.0
Current transformer ratio error, per cent. . .	+4.8	+2.4	0	-1.4	-2.2	-2.6
Current transformer phase angle.....	-1° 39'	-0° 18'	+1° 9'	+1° 18'	+1° 15'	+1° 12'

Show that by setting the meter itself 2.6 per cent fast at full load, 100 per cent power factor, 9 per cent slow at light load, and 5.6 per cent fast at rated current and 50 per cent power factor lagging, the meter combination will be within 1 per cent of accuracy for all loads of 20 per cent and upward of its rating.

CHAPTER XII

VERIFICATION OF POLYPHASE METERING CONNECTIONS

In 1933 the industrial and transportation customers of the electrical utility companies in the United States paid nearly \$520,000,000 for the 39 billion kilowatt-hours they consumed. The commercial light and power customers spent \$500,000,000 for their energy which totaled over 12 billion kilowatt-hours. In these two groups something in excess of 3,650,000 customers are involved. In addition, the revenue from power interchange between utilities represented \$140,000,000. All but a small portion of these various transactions, amounting in the aggregate to \$1,120,000,000, was measured by means of polyphase metering installations.

It is evident not only that a high degree of accuracy of the metering devices is justifiably demanded but also that they must be installed in such manner as to give both parties to the transactions the benefit of the accuracy of which the devices are capable. This means simply that care must be exercised in connecting meters to instrument transformers and to the power lines. There would be little occasion for discussing this subject if (1) there were not many opportunities for incorrect connections and improper operating conditions and (2) there were no technical difficulty in distinguishing the very few correct combinations from the multiplicity of possible incorrect connections which, nevertheless, result in meter performance and registration that often look plausibly good.

12-1. Possible Errors in Connection.—The two-element meter, with or without instrument transformers, has four terminals for the current windings (two for each element) and four terminals for the voltage windings. It is not likely that one of the current circuits will be open; this would mean either (1) single-phase functioning of the line or (2) the existence of a short-circuiting jumper around the meter or across one of the current transformers; therefore it is necessary to recognize only the

possibility of having either or both of the current connections reversed. This provides four situations: both correct, both reversed, one correct with the other reversed, and *vice versa*. Any one of these four situations (only one of which is systematically correct) may be associated with a multiplicity of situations arising in conjunction with the voltage connections.

The voltage connections may (1) be correct or (2) one of the voltage leads may be open-circuited or (3) the voltage coil in the meter open or (4) the voltage-transformer primary or secondary open or (5) two voltage leads from one element of

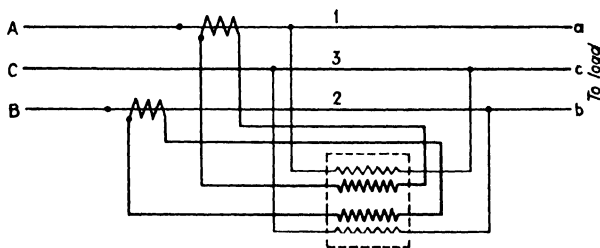

FIG. 123.

the meter (or from one voltage transformer) connected to the same line wire. These situations in conjunction with the four current possibilities enumerated give 16 possible combinations, only one of which, of course, will give the correct registration, *i.e.*, that in which the voltage and current connections are closed correctly. There are the further possibilities of having (6) one or both of the voltage elements reversed and, in addition, (7) a 120° shift in phase of all the voltage connections.

Dr. W. B. Kouwenhoven (in the *A.I.E.E. Transactions* of 1916) reported 30 equations for the registration resulting from all the possible combinations outlined. Many of them result in utterly fantastic results at certain power factors but quite plausible results at other power factors.

Charles H. Thayer has patented (No. 1,918,723) a circular calculating device which indicates the correction factor to be applied because of the incorrect correction of polyphase wattmeters or wathour meters.

12-2. Result with One Voltage Reversed.—Consider the simple case in which one voltage coil of the meter is supplied with a reversed voltage. Thus in Fig. 123 the lower element has the voltage E_{CB} instead of E_{BC} . The vector diagram for this

12-3. Result of Reversed Current Transformer and Interchanged Leads.—A second illustration of this method of analysis will be that in which one current transformer is reversed and in

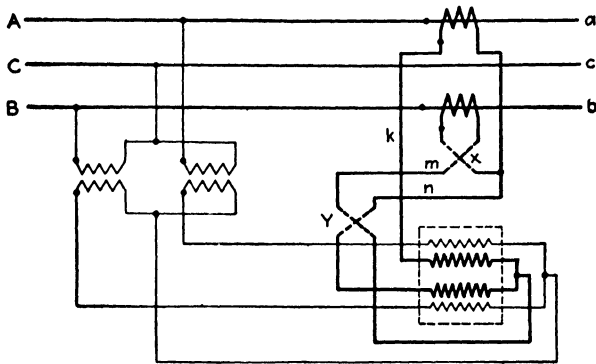

FIG. 125.

addition the lead from it to one element of the meter is interchanged with the common current return wire as at X and Y, respectively, in Fig. 125. The upper element functions with the proper voltage and current connections but the lower element is

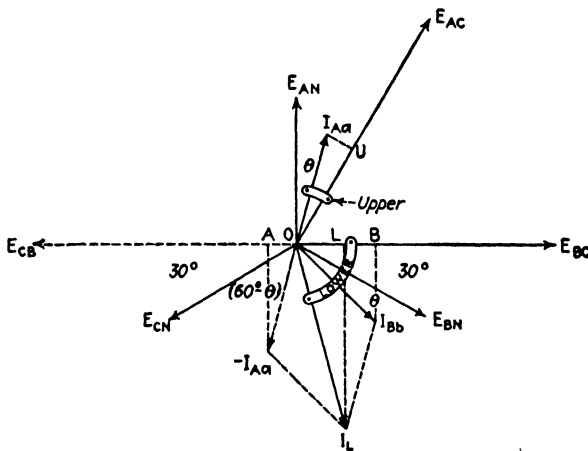

FIG. 126.

incorrect. The vector diagram is that of Fig. 126. The upper element registers at the rate

$$P_U = E_{AC} I_{Aa} \cos (30^\circ - \theta)$$

The lower element carries the current I_{Bb} in the proper direction as may be traced from the marked terminal of the B current

transformer by way of the common wire n through the lower current coil and back over wire m to the transformer. The lower element also carries I_{Aa} in the reversed sense; I_{Aa} passes through the lower element and returns to its transformer A in preference to the route from P over wire m which would entail the high impedance presented to its flow by transformer B . The lower element therefore registers at the rate

$$P_L = E_{Ac}I_{Bb} \cos(30^\circ + \theta) + E_{Bc}(-I_{Aa}) \cos(90^\circ + \theta)$$

This may be reduced to

$$P_L = EI[\cos(30^\circ + \theta) + \sin \theta]$$

The meter as a whole registers at the rate

$$\begin{aligned} P &= EI[\cos(30^\circ - \theta) + \cos(30^\circ + \theta) + \sin \theta] \\ &= EI(\sqrt{3} \cos \theta + \sin \theta) \end{aligned}$$

The total driving torque and speed of the meter will be proportional to the projections $OU + OB - OA = OU + OL$ of the currents in each element upon the vector of the voltage applied to that element.

It is evident that at unity power factor, θ and $\sin \theta$ will be zero, the registration will be correct, and the error might pass unnoticed. In this case L and B coincide and I_{Aa} produces no torque in reaction with E_{Bc} . For lagging power factors of less than 50 per cent the registration will be negative and for leading power factors the meter will overregister. (It will register double at 50 per cent leading power factor.)

This type of error occurs when the installer inadvertently reverses the current transformer and then interchanges those two leads which give plausible registration on loads near unity power factor. Or he may reverse the transformer to compensate for an inadvertent interchange of two of the three secondary leads. Incidentally, similar results will follow if the error is made in the voltage connections in conjunction with correct current connections.

12-4. Classification of Connections and Terminal Arrangements.—Before proceeding to discuss the basis, procedure, and limitations of these checks it is desirable to set up a classification of polyphase metering connections and terminal arrangements. Meters used on circuits of not over 600 volts and 100 or 150 amp. will in general be self-contained; *i.e.*, they will be rated at the

line voltage and the line wires will be connected to their current terminals. If the current exceeds 100 or 150 amp., current transformers will be used. If the voltage exceeds 600, both voltage and current transformers will be used, the latter necessary for insulation purposes even though the current rating may be between 5 and 100 amp. These practical and safety considerations in part establish the types of connections to be identified in a classification. Classes *A, B, C* in Figs. 127 to 129 apply to self-contained meters and involve eight, seven, and five external terminals, respectively. Classes *D, E, F* in Figs. 130 to 132 have either seven or eight external terminals and apply to installations with current transformers or current and voltage transformers.

Various checks will next be discussed in the light of their applicability to the foregoing meter classifications, their advantages, disadvantages, limitations, and general effectiveness in establishing the correctness or incorrectness of the connections under various load conditions.

12-5. Opening the Line Wires.—This check is applicable to all classes of meters, the degree of unbalance of load or its power factor need not be known and it is not necessary to trace the leads. It is founded on the principle that opening one of the three line wires will result in single-phase operation of the load and that the functioning element of the meter must rotate in the forward direction.

The procedure is: (1) see that the meter is rotating forward with both elements connected as found (or as revised to give this result); (2) open one of the line wires applying current to a current coil of the meter, at two points, one on the line side ahead of all taps to the meter and the other on the load side beyond all taps to the meter (as at *aa* in Fig. 127); (3) note the direction of rotation of the disk; (4) reclose the first line at both points; (5) repeat the operation with the other line wire (as at *bb* in Fig. 127) supplying current to the other current coil of the meter. If the meter rotation is backward in either case, the meter is incorrectly connected. The connection may be corrected by reversing either the voltage or the current connections to the element which gave backward rotation when it alone was energized.

This test is positive for all possible incorrect connections. It is, however, open to the objection that it is often impracticable to interfere with the customer's load to the extent of restricting to single-phase supply. Of course, the open line should not be

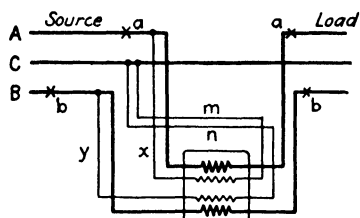

FIG. 127.—Class A.

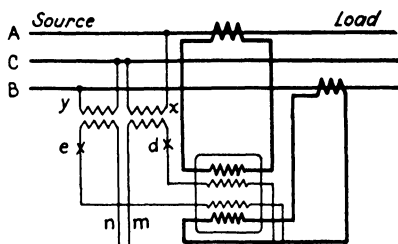

FIG. 130.—Class D.

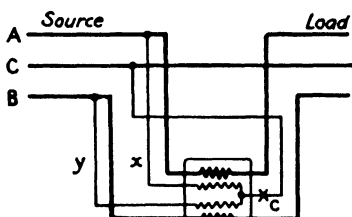

FIG. 128.—Class B.

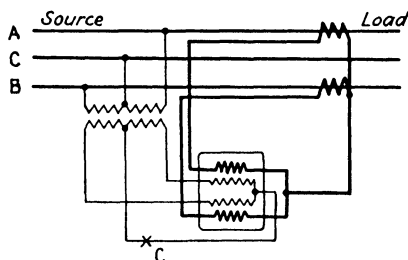

FIG. 131.—Class E.

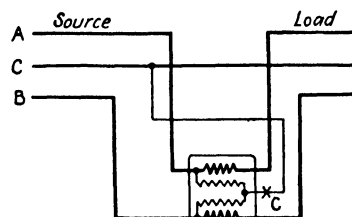

FIG. 129.—Class C.

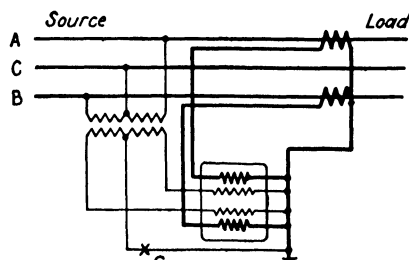

FIG. 132.—Class F.

bridged with a jumper. Even if this objection is absent, the wiring seldom provides a convenient physical means of opening a mainline conductor at *two* points close to the metering installation. The test may also introduce human hazards in the case of the higher voltage lines.

12-6. Opening the Voltage Leads.—This test is applicable to all but Class C meters. It is not necessary to know whether the load is balanced but it is essential to know whether the load power factor is more or less than 50 per cent.

Open the voltage lead to one element (as at *d* in Fig. 130) and note the direction of rotation. Close *d* and open the voltage lead to the other element (as at *e* in Fig. 130) and again note the direction of rotation. If the power factor is known to be less than 50 per cent, the meter must be incorrectly connected if its rotation is forward on both tests; under these circumstances one element should tend to run backward as explained in 5-7 and Fig. 62. If, on the other hand, the power factor is known to be higher than 50 per cent and the rotation is backward on either test, the meter must be incorrectly connected; unfortunately the converse is not true, *viz.*, that forward rotation on both tests verifies the connections, because there are several incorrect connections which will give forward rotation.

12-7. The Ackerman Check.—This check (described by P. Ackerman in *Electrical World*, January 17, 1914) is applicable to Classes B, E, and F and to loads which are not unbalanced to more than about 25 per cent of the least current. It subjects each of the voltage coils of the meter to one-half the voltage of the load phase embraced between the two current supplies to the current coils. This is accomplished by opening the common voltage lead (as at *C* in Figs. 128, 131, 132) but leaving the two voltage coils in series across the third phase voltage.

If the rotation is backward with the common voltage lead open, the meter is incorrectly connected. Of course, the series arrangement existing in the test might involve an interchange of the two voltage connections and still give the forward rotation indicative of a correct connection; therefore it is necessary as a preliminary (1) to make sure that the proper voltage and current are connected to the same meter element and (2) that the rotation is forward before the test is undertaken.

The advantage of this check is its simplicity and the fact that the load may be somewhat unbalanced and the power factor may

be any value. The disadvantage lies in its limited applicability, the fact that it involves tracing the leads, and that it is inconclusive for certain kinds of incorrect connections under particular load conditions (see 12-13).

12-8. Check for Class C Meters.—This check is an adaptation of the Ackerman check (see preceding paragraph) to the Class C meter which is self-contained and in which the voltage coils are connected to the line wires after they enter the meter at the current terminals. Under these circumstances the most likely

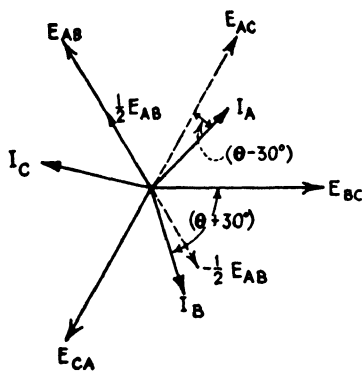

FIG. 133.

error is that the common voltage return wire will be connected to either of the line wires passing through the current coils instead of the line wire not passing through either current coil as it should be connected. Without tracing the leads this can be detected by first noting that the meter rotates forward with all leads connected or is connected so that it does rotate forward. The speed of the meter is determined by means of a stopwatch. The common voltage wire is then opened (as at *C* in Fig. 129) and the speed of the meter again determined. If the load has not changed in the meantime, the speed with the common voltage lead open should be one-half that with it closed; if it is not in the forward direction in both cases and one speed one-half the other, the meter is incorrectly connected.

The reason for the behavior and the conclusions may be seen from Fig. 133, the vector diagram corresponding to the connection of Fig. 129 with the phase sequence *A, B, C*. The registration speed of the meter with lagging-load phase angle θ when the common voltage lead is closed is

$$R = I_A E_{AC} \cos(\theta - 30^\circ) + I_B E_{BC} \cos(\theta + 30^\circ)$$

When the common voltage wire is open, the two voltage coils are in series across the voltage E_{AB} ; the current I_A reacts with $\frac{1}{2}E_{AB}$ and current I_B with $\frac{1}{2}E_{BA}$, reversed because it is applied to the voltage coil in opposite direction (entering at the right and leaving

at the left in Fig. 129). The registration speed when the common voltage wire is open will be

$$\begin{aligned} R' &= \frac{1}{2}I_B E_{AB} \cos(\theta - 30^\circ + 60^\circ) + \\ &\qquad\qquad\qquad \frac{1}{2}I_A E_{BA} \cos(\theta + 30^\circ - 60^\circ) \\ &= \frac{1}{2}I_B E_{AB} \cos(\theta + 30^\circ) + \frac{1}{2}I_A E_{AB} \cos(\theta - 30^\circ) \end{aligned}$$

It is seen that when the meter is properly connected $R' = \frac{1}{2}R$ if the currents and voltages are balanced. (It may also be shown to be so if they are not balanced.)

If, however, the common voltage lead is, say, connected to *A*, then the first term of the expression for R becomes zero. The first term of R' is then one-half R and the whole value of R' exceeds one-half R by the value of the second term of R' , which shows that the meter was incorrectly connected as found.

This check has the advantage that no knowledge of the load power factor or degree of balance is necessary; but the load must be constant during the two speed determinations.

12-9. The Kouwenhoven Check.—This check was described by Prof. W. B. Kouwenhoven in the *A.I.E.E. Transactions* for 1916, Part I (volume 35, page 183) and is applicable to all but Class C meters. It is applicable under any condition of power factor but the necessary modification becomes complicated if the load is not known to be approximately balanced. The leads must be traced to the extent of ascertaining the two voltage leads (as *x* and *y* in Figs. 127 and 130) which are connected to the line wires which supply current to the current coils, directly or through current transformers. It is also necessary, in all except Class A, to make sure that the common voltage leads (as at *m* and *n* in Figs. 127 and 130) are not connected to the same voltage coil; further, in the case of Classes B, E, and F, that these common voltage leads are not connected to a line wire which supplies current to one of the current coils.

With these points established the check amounts to interchanging the voltage leads *x* and *y*—at the meter in Class A or B, and on the primary side of the voltage transformers of Class D, E, or F. If the meter does anything but stop or at the most run at very slow speed in either direction, it is incorrectly connected. That this should be the result may be seen from Fig. 134 in which the registration speed with the voltage leads interchanged will be

$$\begin{aligned}
 R' &= I_B E_{AC} \cos (30^\circ + \theta + 60^\circ) + I_A E_{BC} \cos (30^\circ - \theta + 60^\circ) \\
 &= I_B E_{AC} \sin \theta - I_B E_{BC} \sin \theta
 \end{aligned}$$

which is zero under balanced load.

This check gives an indication of changes to be made in the connections to render them correct. If, after the voltage leads are interchanged, the meter runs forward at reduced speed, it signifies that one of the current connections is reversed but the voltage connections after the interchange are correct; the particular current coil to reverse is that one which results in

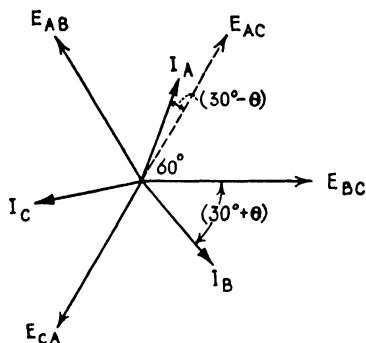

FIG. 134.

stopping the rotation when the voltage connections are momentarily restored to their original (incorrect) condition. If, however, after the voltage leads are interchanged, the meter runs forward at increased speed, it signifies that the original voltage connections were correct but that one of the current coils is reversed; reverse that current coil which will result in the meter stopping when the voltage

leads are again temporarily interchanged.

12-10. The Brown Check.—A check described by Raymond S. Brown in *Electrical World*, January 17, 1914, involves the use of a high non-inductive resistance (10,000 ohms or more) in series with the voltage coil of the meter. The test requires approximately balanced load and whether the power factor is lagging or leading must also be known or ascertained. Also the leads must be traced to the extent of determining that the corresponding current and voltage are applied to the same element of the meter.

The first step in the manipulative procedure is to determine which is the fast-moving element and which the slow-moving element; this is, of course, done by opening the voltage circuits of the two elements in turn. The voltage circuit of the fast-moving element is then left open (the element then contributing no torque) and the high resistance is inserted in series with the voltage coil of the slow-moving element. The direction of the rotation of the disk is then noted. If this rotation is forward and the power factor is lagging or if the rotation is backward and the power factor is leading, the meter is improperly connected.

There are several incorrect connections, however, which will not be disclosed by this test and consequently the converse of the conditions cited in the preceding sentence does not assure that the connections are positively correct.

The reason for the meter behavior on which this check bases its indications may be seen from Fig. 135. Inserting the resistance in series with the voltage coil of the slow-moving element absorbs the voltage E_R in the resistance and leaves E'_s applied to the voltage coil of the meter. If the power factor is lagging, I will fall in the region between $I_{100\%}$ and $I_{0\%}$ but anywhere within this range it will produce negative torque in reaction with E'_s , provided R is large enough to reduce E'_s to less than half E_s , which means that E'_s makes more than 60° with E_s . Positive torque and forward rotation of the slow-moving element

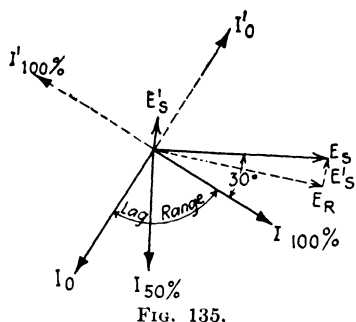

would require that I fall vectorially between $I'_{100\%}$ and I'_0 , which could follow only from leading current (contrary to the original assumption) or the reversal of current (or voltage) from its correct status.

12-11. The Woodson Check.—Most of the preceding checks (1) presuppose some knowledge of the load balance or power factor, (2) are limited in their applicability to certain of the classes of meters, (3) involve some tracing of leads, or (4) involve some temporary changes in the meter wiring which may result in continued error if the leads are not properly restored after the check. Also (5) most of the tests fail to give a positive indication for some particular power factor, lagging or leading.

W. C. Woodson of the New York Edison Company devised a test which avoids most of these shortcomings and gives inconclusive results only in certain cases where it is not possible to ascertain whether the load is of lagging or leading power factor. Such cases are limited in number, and, therefore, this test has much merit. Its principal weakness is that it involves more accessories than any of the others and the analysis of the record is practically a draughting-room job, which thus does not facilitate the immediate application of the results of the check to correct the connections in case they prove to be incorrect.

The check in principle amounts to obtaining data from which to plot vectorially the three currents and the three voltages of the metering circuit. It requires three wattmeters, an ammeter, a voltmeter, and a phase-sequence indicator in conjunction with switching devices to reverse the polarities of the meters, arrange them in Y or in series, etc. Each of the three meter-circuit currents is associated in the wattmeters with each of the three voltages. This makes it possible to establish the vector location of all these currents with respect to the three voltages whose

magnitude, phase displacement, and phase sequence are known or assumed.

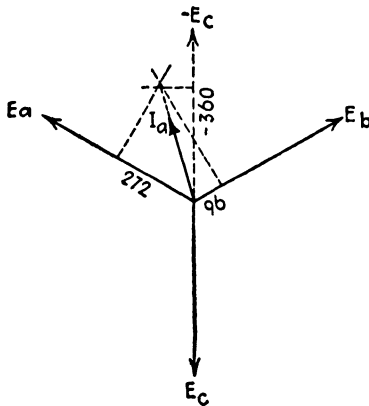

FIG. 136.

Thus in Fig. 136 the vector location of I_a is found as the intersection of perpendiculars drawn from points on the respective voltage vector laid off from the vector center at distances proportional to the wattmeter readings obtained when supplied by I_a and E_a , I_a and E_b , I_a and E_c . The other currents can be located by taking six additional readings, three with I_b and the

three voltages to neutral and three with I_c and those three voltages.

The decision as to correctness of the metering connection then rests on critical analysis of the plausibility of the vector diagram and its concordance with the known character of the customer's load. Incidentally if the tester makes a faulty connection in the test or records his data improperly, these errors will be disclosed by a badly distorted diagram.

12-12. Procedure in the Woodson Check.—The leads on the load side of the meter are connected to the wattmeter terminals so as to effect the Y-connection of Fig. 137. The readings are recorded with their proper algebraic sign. If any reading is negative it at once indicates that the wattmeter is incorrectly connected unless there is an extreme unbalance of load.

The wattmeters, retaining their respective Y-voltages of Fig. 137, are now inserted in series, first in line A as in Fig. 138, then in line B, and finally in line C. The nine readings are recorded.

This will be the appropriate opportunity to ascertain each line current by means of an ammeter inserted in series with the current coils of the wattmeters; the current can, however, be computed from the vector diagrams drawn from the data.

Finally ascertain the phase sequence and, if desired, the magnitude of the Y-voltages or line-to-line voltages at the watthour

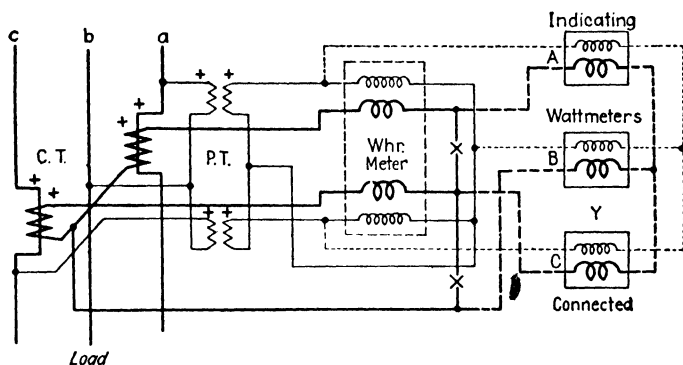

FIG. 137.

meter. Any ascertainable knowledge of load power factor and balance should also be noted in the report to aid in interpreting the meaning of the vector diagrams to be drawn.

The table on page 198 (from *N.E.L.A. Publication 278-31*) presents data typical of that obtained in a case in which it was found, on analysis of the subsequently drawn vector diagram, that the voltage connections had been interchanged and in

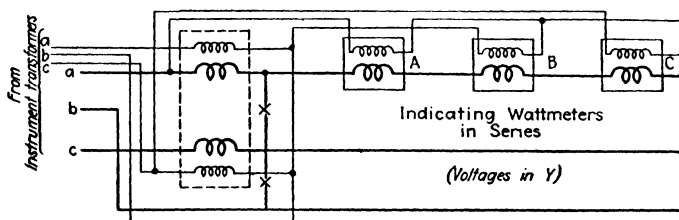

FIG. 138.

addition one of the current transformers was of reversed polarity.

It will be noted that the diagonal readings 272, 208, 68 are in accord with the Y-readings and would be identical with them if the load had not changed in the interim between readings. Also the algebraic sum should be close to zero in the vertical columns of the series readings.

Y-CONNECTION		VOLTAGES	
Wattmeter A.....	+270	AB	110
Wattmeter B.....	+209	BC	110.6
Wattmeter C.....	+ 68	AC	111.3

SERIES CONNECTION

	Line A	Line B	Line C
Amperes.....	5.7	3.4	3.2
Wattmeter A.....	+272	- 84	-192
Wattmeter B.....	-360	+208	+116
Wattmeter C.....	+ 96	-118	+ 68

Phase sequence ABC. Load—induction motors.

12-13. Plotting and Analyzing the Vector Diagram.—Following the principle enunciated in 12-11 and Fig. 136 the data of the series wattmeter test are transferred to the vectors of the three voltages to neutral arranged in their proper phase sequence.

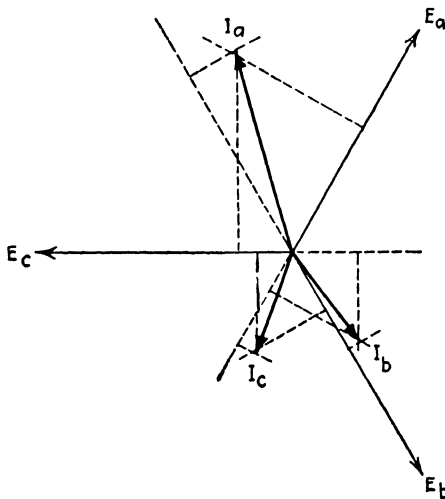

FIG. 139.

Thus in Fig. 139, the data of 12-12 establishes the three currents to fall in the phase positions I_a , I_b , I_c . Each of these currents is the only current which will result in the wattmeter readings obtained when that current is associated with each of the three voltages to neutral. The length of the current vector is laid off proportional to the respective ammeter readings or else computed from the voltage and wattmeter readings in conjunction with the

cosine of the angle between the current and voltage. This cosine is the ratio of the wattmeter reading to the length of the current radial to the intersection point of the perpendiculars, both measured to the same scale of volt-amperes and watts.

In this particular instance it is seen that the meter connection must be incorrect because the load is induction motors, an inherently balanced type of load. The currents are indicated



FIG. 140.

to be unequal whereas they should be equal. There is also an inconsistency indicated in the phase power factors; these should be identical for the balanced load of induction motors. Also the currents lead their respective phase voltages and this is not the case with induction motors.

In a compact form of the Woodson scheme, as made by the Weston Electrical Instrument Company, provision is also made for detecting short-circuited turns in current transformers (Fig. 140). An accessory reactor is inserted in series with the current coils of the wattmeters in the series test. The reactor materially increases the volt-ampere burden on the current transformer, the secondary voltage of which is thereby raised enough to reestablish any intermittent short circuit; the ratio of

TABLE VII.—CHECKS FOR POLYPHASE-METER CONNECTIONS

Name of check	Procedure	Meter is improperly connected if rotation with	
		Lagging power factor	Leading power factor
(1) Opening the lines.....	1. Open a "current" line wire. Close 2. Open the other "current" line wire	More than 50 per cent is	Less than 50 per cent is
(2) Opening the potentials.....	1. Open upper potential, close 2. Open lower potential	Backward on either test	Backward on either test
(3) Ackerman.....	Open common voltage return wire	Backward on either test	Backward on either test
(4) Class C.....	1. Ascertain speed (forward) 2. Get speed with common voltage return wire open	Backward	Backward
(5) Kouwenhoven.....	Interchange voltage leads	Backward	Backward
(6) Brown.....	1. Open voltage of "fast" element 2. Insert 10,000 ohms in voltage circuit of the "slow" element	Backward; or forward at other than half speed on test 2	Backward on test 2
(7) Woodson.....	Analysis of vector diagrams, plotted from readings of three ammeters and three Y-connected wattmeters indicating (a) watts of the three line currents with their voltages to neutral and (b) each line current with all three voltages to neutral	Either direction on balanced load	Backward on balanced load

TABLE VIII.—CONSEQUENCES AND DETECTION OF INCORRECT POLYPHASE-METER CONNECTIONS

Nature of error	Registration with balanced loads of power factor						Checks which are reliable at power factor						
	Lagging*			Leading*			Lagging			Leading			
	26 %	50 %	100 %	100 %	50 %	26 %	26 %	50 %	86 %	100 %	86 %	50 %	26 %
1 One E or I reversed.....							V A K W	V A K W	V A K W	V A K W	V A K W	V A K W	V A K W
2 E or I interchanged between element.....	0	0	0	0	0	0	V A K W	V A K W	V A K W	V A K W	V A K W	V A K W	V A K W
3 E or I interchanged and one instrument transformer reversed	Very fast	200 %	0	0	Bkwd.	Bkwd.	K	K	K	K	A	A	A
4 E or I all shifted 120 deg.	260 %	100 %	Bkwd.	Bkwd.	Bkwd.	Bkwd.	A	A	V A	V A	V A	V A	V
5 † E or I shifted 120 deg. with reversed E associated with common return I	Bkwd.	0	50 %	100 %	155 %	155 %	K W	W	V A K W	V A K W	V A K W	V A K W	A K W
6 E or I shifted 120 deg. and both E or both I reversed....	Bkwd.	Bkwd.	50 %	200 %	Very fast	Very fast			V	V	V A	V A	A
7 One E or I lead interchanged with common return wire	0	0	0	0	0	0	A K W	V A K W	V A K W	V A K W	V A K W	V A K W	V A K W
8 One E or one I reversed and its lead interchanged with common return wire	Bkwd.	0	100 %	200 %	Very fast	Very fast	K W	A K W	V A K W	V A K W	V A K W	V A K W	A K W
9 One pair E ₁ leads interchanged, same E ₂ reversed; outside I leads interchanged	Bkwd.	Bkwd.	Bkwd.	0	60 %	60 %	K W	K W	K W	K W	K W	K W	W
10 † One E ₂ or E ₁ interchanged with common return and I reversed in other element	Bkwd.	Bkwd.	Bkwd.	0	100 %	100 %	V A K W	V A K W	V A K W	V A K W	V A K W	V A K W	V A K W
11 † One E ₂ or E ₁ interchanged with common return wire and I reversed in same element	Very fast	200 %	100 %	0	Bkwd.	Bkwd.	V K W	K W	K W	K W	K W	K W	W

Cases omitted: (a) both potential coils connected to same phase; (b) open circuits. The existence of these errors can be detected by means of voltmeter or ammeter.
 * With opposite phase sequence the behaviors under leading and lagging loads will interchange.
 † The same results will follow if E is replaced by I, and vice versa, in the descriptions.
 ‡ The same results will follow if V = opening voltage leads; A = Ackerman; K = Kouwenhoven; W = Woodson.

the transformer is then decreased and the short circuit revealed by a sharp dip in the wattmeter reading. Current transformer errors from this cause which are too slight to be disclosed by the behavior of the watt-hour meter are thus exaggerated and revealed in conjunction with the verification of the meter connections.

12-14. Summary of Polyphase-meter Checks.—In order to summarize the features of the foregoing methods of checking polyphase-meter connections and to contrast their technique and range of applicability, two tables are presented (Tables VII and VIII). In the first table it should be remembered that minor preliminaries are omitted for the sake of simplicity in showing the essential elements of each check.

No claim is made that the second table is not susceptible to proof of inaccuracy in detail. Phase sequence, load balance, and the particular location of the point in the meter circuit where the errors in connection are made will change the load power factors at which the checks break down. The primary purpose of the table is to show the relative extent to which the checks approach universality of applicability. In general the Woodson test has the widest range, the Kouwenhoven check second, with the Ackerman and opening-the-voltage-leads checks sharing third place. The Brown check, not represented in the table, is about on a par with those assigned third place. Fortunately the various checks do not break down for the same errors and all the possible errors can be disclosed by applying two or more of the checks.

Incidentally Table VII gives vivid evidence in justification of the devotion of a chapter to this subject.

Problems

12-1. Show the proper connections to a two-element polyphase meter for measuring the consumption from a three-phase star- Δ -connected transformer bank, 4,000-volt four-wire primary to 220-volt three-wire secondary using current transformers on the primary side and applying voltages to the meter elements directly from the 220-volt secondary. Can the energy be measured correctly under all conditions of load in this manner?

12-2. Two polyphase meters were installed by the two companies involved to register the energy transfer over a three-phase 110,000-volt transmission line. Current transformers in line wires *A* and *C* supplied current to the corresponding elements of the two meters *M* and *N* in series.

Meter *M* was a two-element meter and its two voltage coils were connected across the respective secondary terminals *ab* and *cb* of Y-Y-connected voltage transformers *A_n*, *B_n*, *C_n* of 1,000/1 ratio.

Meter *N* was a $2\frac{1}{2}$ -element meter with the split coil connected (reversed) in the common current return lead to the junction of the two current transformers. Its voltage coils were connected to the Δ secondary voltages of Y- Δ -connected voltage transformers *AO*, *BO*, *CO*. The voltage coil for current element *A* had the 110-volt voltage of the secondary of *CO*. The voltage coil for current element *C* had the 110-volt voltage of the secondary of *AO*.

Meter *N* registered 50,000 kw-hr. more than meter *M* in the first 48 hr. in service.

Draw the connection diagrams and determine which meter was correct in its registration and what errors entered into the registration of the other meter.

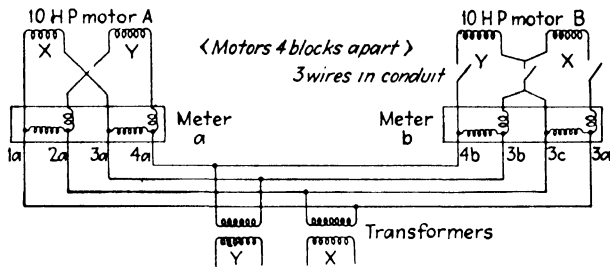

FIG. 141.

12-3. A four-wire two-phase system supplies two separate customers, *A* and *B*, through two-element polyphase meters *a* and *b*. The motor of customer *B* was connected three-wire and the polyphase meters were inadvertently connected as shown in Fig. 141. The error was discovered when meter *b* was found running at a time when motor *B* was idle.

Assume equal loads at 80 per cent lagging power factor on each of the two motors and determine the percentage error in metering for each of the three possible combinations of operating conditions, *i.e.*, both or either alone operating. Draw vector diagrams. Tabulate thus:

Case	Motor operating	Currents in elements				Torque in meter					
		X_a	Y_a	X_b	Y_b	X_a	Y_a	a	X_b	Y_b	b
1	<i>A</i>										
2	<i>B</i>										
3	Both										

12-4. A factory having an approximate demand of 180 kw. was purchasing two-phase power from the local electric public-service company. The energy was billed at a straight meter charge of 2 cents per kilowatt-hour. From April, 1928, to November 23, 1928, the consumption on the watthour meter (No. 701) was an average of 35,475 kw-hr. per month; but, with about

the same scale of operations at the factory, the monthly registration of meter 2845 (which replaced No. 701 on November 23, 1928) varied considerably as shown in the accompanying tabulation. These variations prompted investigations which, step by step, disclosed various faults in the metering installation and adjustment, as follows:

1. November 23, 1928, to November 1, 1929. Meter 2845 was installed with a register having a constant appropriate for a current transformer ratio of 60/1. On November 1, 1929, it was discovered that the meterman had inadvertently used current transformers of a 120/1 ratio. These 120/1 transformers were immediately replaced by others of 60/1 ratio.
2. November 1, 1929, to December 1, 1929. The low registration during November led to another inspection on December 1, 1929. It was found that the potential circuit of the lower element was open and it was closed at once. It is probable that this condition had existed from the time of the inspection on November 1, 1929.
3. November 23, 1928, to November 1, 1930. The factory executives on November 1, 1929, decided to install a check meter. It consistently registered much more consumption than the public-service company's meter 2845. A further inspection of the latter on November 1, 1930, revealed that it was connected reactively (potentials interchanged); it had probably been in that condition from the original date of installation. The connections were immediately corrected.
4. November 1, 1930, a test showed it to be running 15 per cent fast. This condition may also be assumed to have existed from the original date of installation and to have resulted from the magnet adjustment made by the installer in his efforts to make the (reactively connected) meter agree with the registration of his test meter. There is no evidence of any other meter adjustments made at the intervening inspections.

There was quite naturally a controversy over the proper adjustments of the payments made by the factory to the public-service company on the basis of the erroneous meter registration. The data herewith have been adapted from those compiled during the settlement of the controversy.

- a. For the purpose of a first estimate of the correct consumption during the (nearly) 2 years it was agreed that the average load was on the order of 150 kw. at 80 per cent power factor lagging for 285 full 9-hr. working days per year. During nights, Saturday afternoons, Sundays, and holidays (six in a year) the load was about 6 kw. at 50 per cent power factor lagging. Compute the 2-year bill on this approximate basis.
- b. By applying appropriate correction factors for the errors discovered, determine how much more the factory should pay than the \$11,192.90 which had been paid for the energy actually consumed during the period meter 2845 was in service.

Weigh the correction factor for the reactive connection in accordance with the amounts of registrations at each of the two power factors assumed in *a*.

Monthly consumption	Kilowatt-hours registered by meter	Registration of meter corrected for			
		(1) Current transformer ratio	(2) Potential	(3) Reactive	(4) Magnets
1928					
Nov. (23-30)	5,000				
Dec.	18,810				
1929					
Jan.	19,320				
Feb.	17,560				
Mar.	15,370				
Apr.	17,430				
May	17,570				
June	17,080				
July	12,320				
Aug.	17,440				
Sept.	17,590				
Oct.	18,300				
Nov.	14,800				
Dec.	17,105				
1930					
Jan.	20,050				
Feb.	28,100				
Mar.	36,110				
Apr.	19,330				
May	30,540				
June	31,510				
July	22,710				
Aug.	32,300				
Sept.	31,150				
Oct.	32,150				
Nov.	30,000	50,000	50,000	50,000	50,000
Dec. (18)	20,000				
Total kilowatt-hours billed on Meter 2845	559,645	Revised number of kilowatt-hours consumed			
Amount paid	\$11,192.90	Value at 2 cents per kilowatt-hour			
		Balance owed electric service company by factory			

Tabulate the results in columns adjacent to the recorded monthly consumptions.

- c. Compare the chances of correcting for these metering errors if the same mistakes had occurred on a three-phase installation.

12-5. On investigation a power company found that the three-phase three-wire polyphase meter through which an industrial plant was being served was incorrectly connected. The connections were apparently correct but the polarity of one of the voltage transformers was found to be incorrectly marked; this had the same effect as reversed secondary connection to the meter. During the three months preceding the investigation the indicated demand had ranged from 400 to 460 kw. and the watthour meter had registered from 170,000 to 250,000 kw-hr. per month. A careful test showed the power factor to be 72 per cent under average conditions.

- a. By what factor should the demand-meter and watthour-meter readings be multiplied?
- b. The demand charge was \$1.50 per kilowatt per month and the energy charge 1 cent per kilowatt-hour. Show that the power company had lost over \$8,000 in revenue because of the error.

CHAPTER XIII

REACTIVE METERING

Exciting currents of induction motors (also to a lesser extent of transformers and synchronous motors) and line drop in reactance of the feed circuits are the principal reasons why power systems operate at less than unity power factor. The lower the power factor, the more current or voltage must be supplied to deliver a given load in kilowatts. A consequence is the necessity of a larger wire size for lines and more copper and iron in transformers and in machines because more amperes and more volts demand these more generous designs. Ratings in kilovolt-amperes are thus necessarily increased and more money must be invested in the equipment and lines. Line losses are higher and voltage regulation is poorer with low power factor.

Power factor is therefore a matter of concern in connection with individual loads, with conditions at substations, on feeders, in generating and transforming apparatus. Corrective equipment such as synchronous condensers and static condensers may be used to improve the power factor and thus avoid greater outlay in providing increased kilovolt-ampere rating for continued operation at the low power factor. It is quite natural therefore that power factor should enter into rates and into metering. The user is expected to pay proportionately for the added system costs created by his contribution to low power factor as well as to pay for the energy consumed and for the demand.

13-1. Definition of Power-factor Terms.—In a single-phase circuit power factor is the ratio of the watts to the volt-amperes

$$\text{Power factor} = \frac{\text{watts}}{\text{volt-amperes}} = \frac{EI \cos \theta}{EI} = \cos \theta$$

Power factor is the cosine of the phase angle between current and voltage.

When it comes to polyphase circuits the situation is not so simple except in the case of balanced voltages applied to identical loads on each phase and therefore supplying balanced phase

currents displaced symmetrically, if at all, from the corresponding phase voltages. Under such circumstances the power factor of the polyphase line and load is the same as that of each of the phases.

If, however, the polyphase loads or voltages are unbalanced, then the currents in general will likewise not only be unequal but will make different phase angles with their respective phase voltages.

Each phase of the polyphase system will then have a power factor of its own. What shall be taken as the power factor of the polyphase system—the simple average of the individual phase power factors? An average somehow weighted to the unbalance? Or what?

This question has been answered in the Standardization Rules of the American Institute of Electrical Engineers as follows:

3243. *Power Factor in Polyphase Circuits.*—The power factor of a polyphase circuit, either balanced or unbalanced, is the ratio of the total active power in watts to the total vector volt-amperes.

The total vector volt-amperes is the square root of the sum of the squares of the total active power and the total reactive power.

The total reactive power is the algebraic sum of the reactive powers corresponding to the separate harmonic components of the system.

The last paragraph provides for the general case of non-sinusoidal wave forms of current and/or voltage. Non-sinusoidal current and voltage waves can be decomposed into sinusoidal components of harmonic frequencies, *i.e.*, multiples of the fundamental. The reactive volt-amperes are to be found separately for each of the components. Of course, ordinary power and energy measurements are usually made under conditions near enough to the ideal sinusoidal wave form to permit ignoring this refinement.

13-2. Polyphase Power Factor.—The A.I.E.E. Standards also provide the following definition:

3246. *Reactive Volt-amperes.*—The reactive volt-amperes in a circuit are the square root of the difference between the square of the apparent power (volt-amperes) and the square of the power (watts).

Consider an unbalanced three-wire three-phase load made up of an originally balanced inductive three-phase load, star-connected, and an added single-phase non-inductive load between

give instantaneous values but are also adaptable to recording meters giving a continuous chart of power factor. Other methods provide data for obtaining the average value of power factor over a period of time.

1. Simultaneous reading of ammeter, voltmeter, and wattmeter.
 - a. For single-phase circuits the power factor is the watts divided by the volt-amperes.
 - b. For balanced polyphase conditions the power factor is the total watts divided by the total volt-amperes, $\sqrt{3}EI$.
2. Direct indication of power-factor meter in portable or switchboard, indicating or recording type.
3. Relation of readings of single-phase elements of polyphase wattmeters or wathour meter.
4. Reactive component meters with modified voltage circuits.
5. Cross-phasing schemes for elements of polyphase wattmeters or watt-hour meters to convert them into reactive component meters.
6. Phasing transformers to apply quadrature voltage to the elements of the polyphase meter.
7. Kilovolt-ampere-hour meters in conjunction with wathour meters.

13-4. A Polyphase Power-factor Meter.—The question of power factor arises primarily with power circuits rather than

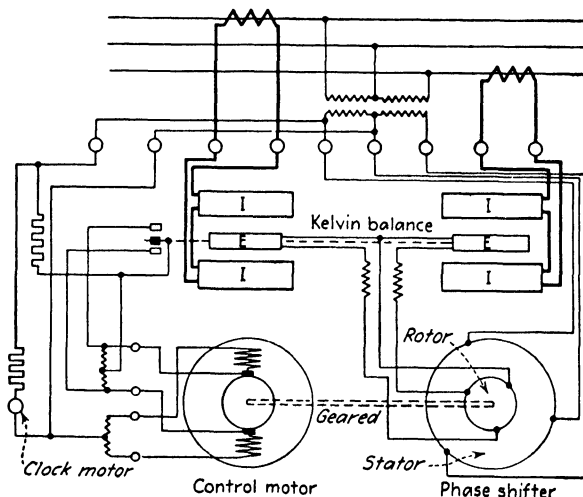

FIG. 145.

lighting circuits. Also power circuits are generally polyphase whereas lighting circuits are inherently single phase. Consequently there is much more interest in power factor of polyphase circuits than of single-phase circuits.

One form of power-factor meter which indicates in conformity with the A.I.E.E. definition of polyphase power factor employs a wattmeter of the Kelvin balance type in conjunction with a motor-operated phase shifter. The wattmeter has voltage coils in mechanical equilibrium at the ends of a beam pivoted at the middle. When there is current in the stationary current coils and voltage applied to the beam coils, the mutual attractions and

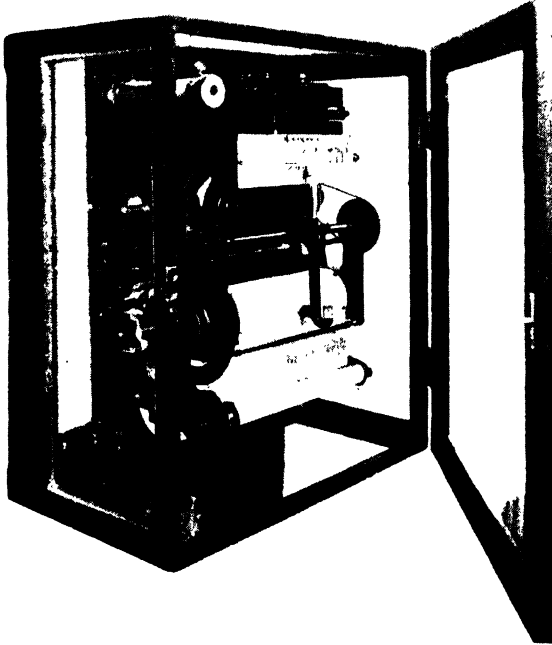

FIG. 146.

repulsions between coils produce torque proportional to the volts and amperes and to the cosine of the phase angle between them. The torque can be made zero under load only when the current and voltage are in quadrature. This is accomplished by placing at one end of the beam relay contacts which start a small motor in the appropriate direction of rotation. The motor shifts the position of a voltage phase shifter through which the line voltage is connected to the beam coils. This shift in phase continues until it has been changed enough to establish a quadrature relation between current and voltage. The Kelvin balance torque is then zero, the beam centers, and the motor stops.

Meanwhile the motor has also advanced the pen of the instrument to the corresponding position over the chart. The pen therefore draws a continuous graph of the instantaneous values of polyphase power factor (see Figs. 145, 146).

Since the motor always establishes zero torque between the Kelvin balance coils, the phase shifter must establish a 90° shift in voltage phase when the power factor is 1.0. The meter really responds to the reactive factor of the circuit but the chart scale is marked in corresponding values of power factor. Since all three line voltages are impressed on the stator of the phase shifter, the result is the ascertainment of the vectorial mean angle of lead or lag as indicated by θ in Fig. 144. The cosine of this angle is the polyphase power factor according to A.I.E.E. rules. The meter, made by the Westinghouse Electric and Manufacturing Company, is equally reliable under balanced or unbalanced load conditions.

13-5. Power Factor from Wattmeter Readings.—In 5-8 it was shown that the power factor of a balanced three-phase load could be expressed in terms of the readings of the two wattmeters (or of the two elements, separately, of a polyphase wattmeter).

$$\text{Power factor} = \cos \left[\tan^{-1} \sqrt{3} \frac{W_b - W_a}{W_b + W_a} \right] \quad [24]$$

This is, however, a bit cumbersome because it necessitates recourse to a trigonometric table. The foregoing expression can be converted through the medium of the relation, $\cos \theta = 1/\sqrt{1 + \tan^2 \theta}$, into

$$\begin{aligned} \text{Power factor} &= \frac{1}{\sqrt{1 + \left(\sqrt{3} \frac{W_b - W_a}{W_b + W_a} \right)^2}} \\ &= \frac{W_a + W_b}{\sqrt{(W_a + W_b)^2 + 3(W_b - W_a)^2}} \quad [25] \end{aligned}$$

It must be remembered that this applies only to balanced loads. Thus, even if the load were non-inductive and therefore of unity power factor, the power factor under unbalanced conditions would not be indicated as 1.0 by Eq. [25] because the wattmeter readings would in general not be equal. The relation gives unity only when the readings are equal. The relation has been put

POWER FACTOR OF BALANCED THREE PHASE SYSTEM

Determined by Single Phase Wattmeters

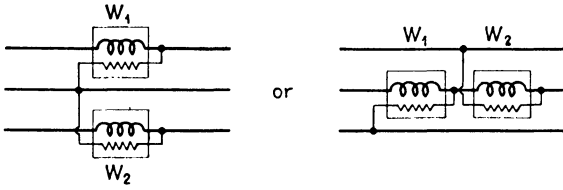

$$P.F. = \frac{W_2 + W_1}{\sqrt{(W_2 + W_1)^2 + 3(W_2 - W_1)^2}}$$

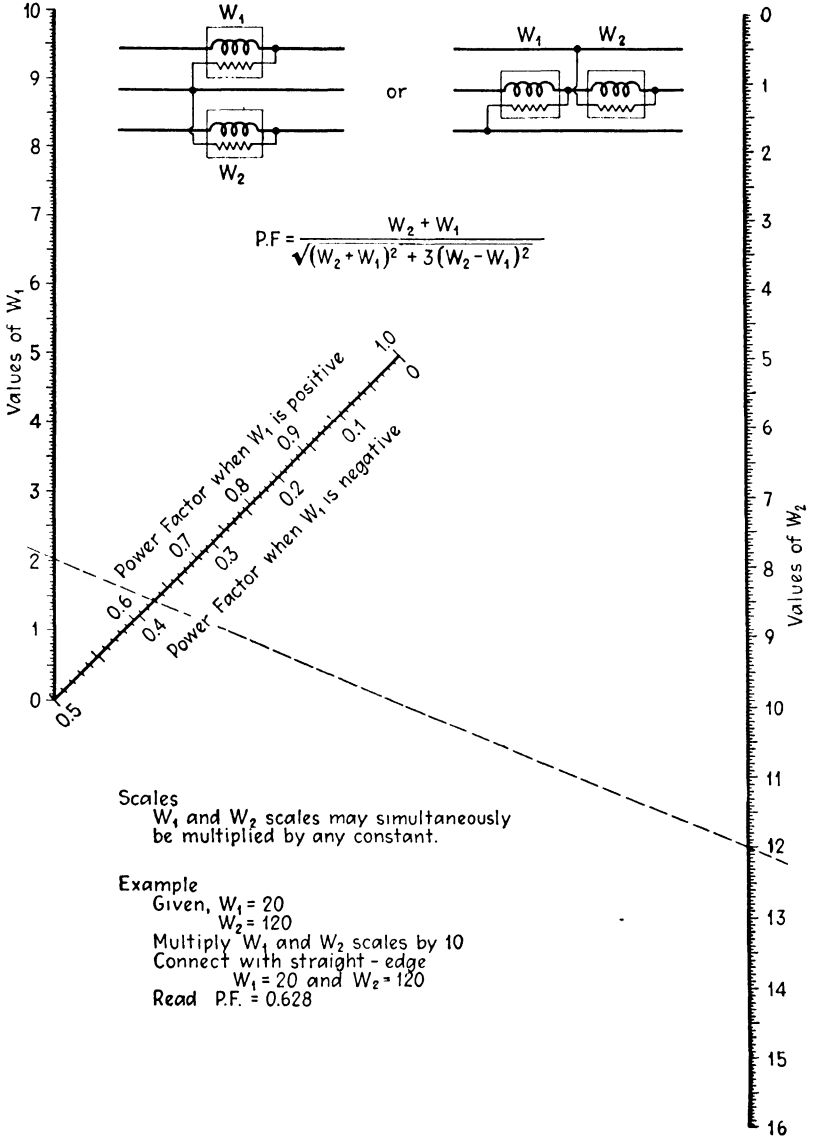

Scales
 W_1 and W_2 scales may simultaneously be multiplied by any constant.

Example
 Given, $W_1 = 20$
 $W_2 = 120$
 Multiply W_1 and W_2 scales by 10
 Connect with straight - edge
 $W_1 = 20$ and $W_2 = 120$
 Read P.F. = 0.628

FIG. 147.

into the convenient nomograph form of Fig. 147 by Prof. R. G. Warner of Yale University.

For unbalanced conditions a more reliable index of the power factor can be obtained only by taking cognizance of the unbalance. One method* is based on a cyclic shift of all three voltage connections from the two wattmeters (or two elements of a polyphase meter) to the line wires. Thus after I_1 is taken with E_{12} in one

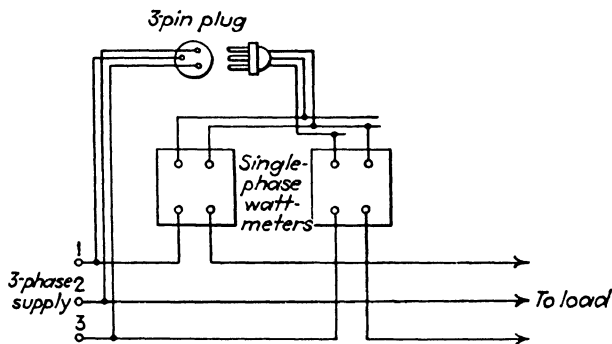

FIG. 148.

wattmeter and I_3 with E_{32} in the other to obtain the true watts W , the shifted connections then involve I_1 with E_{23} and I_3 with E_{13} , giving a new total wattmeter indication of Z . Either or both wattmeters may read negatively depending upon the power factor and unbalance as well as on the direction in which the connections are shifted. The sign of each reading is, of course, to be noted, and the sum taken algebraically.

If the total vector volt-amperes are called M and the equivalent polyphase power factor $\cos \theta$, the true watts W will be

$$W = M \cos \theta$$

The reading Z after the voltage connections have been shifted 120° will be

$$Z = M \cos (\theta - 120^\circ)$$

By expanding the second expression and solving for $\cos \theta$ it will be possible to express the power factor in terms of the ratio n of Z to W in the form

$$\cos \theta = \frac{\sqrt{3}}{2} \cdot \frac{1}{\sqrt{n^2 + n + 1}} \quad [36]$$

* See STUBBINGS, G. W., *Elec. World*, p. 823, May 7, 1932.

Figure 149 shows the relation between the power factor and values of n between 2 and 3. The power factor will be 1.0 only when Z is negative and half the magnitude of W .

If it is desired to know the order of magnitude of the unbalance, this may be inferred from the readings obtained when the current I_1 is associated in one wattmeter with E_{32} and I_3 in the other with E_{12} . It was shown in 12-9 that a watt-hour meter should stop if this is done under

balanced-load conditions. If it does not, then the speed (or, in the case of the polyphase wattmeter, the watts) in proportion to the value obtained under normal metering connections, is an index of the degree of unbalance. In a subsequent chapter it will be shown that

the interchanged connections associate the voltages with what is, relatively, the negative-sequence components of the current system. The larger the unbalance, the larger the negative-sequence components with respect to the positive-sequence components.

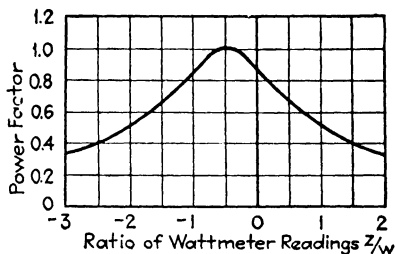

FIG. 149.

13-6. Reactive Meter with Modified Voltage Circuit.—Power measurement involves creating torque within the meter proportional to $EI \cos \theta$. Reactive volt-ampere measurement correspondingly calls for the production of meter torque proportional to $EI \sin \theta$. But $EI \sin \theta = EI \cos (90^\circ - \theta)$. Therefore taking the cosine component of current with respect to a voltage in quadrature with the circuit voltage results in an indication proportional to the sine of the circuit phase angle and consequently to the reactive component.

The quadrature voltage is obtainable in several ways:

1. By induction phase shifter.
2. By cross-phasing polyphase circuits.
3. By (a) inductance and capacitance in the voltage circuit of a wattmeter or (b) resistance and capacitance in the voltage circuit of a watt-hour meter.

Method 1 is principally a laboratory method, although applied without difficulty in recording instruments (see 13-4). Method 2 will be developed in several ways in succeeding paragraphs.

The third method works out simply in the case of the electrodynamic wattmeter, the potential circuit of which consists of a large resistance and negligible inductance. Thus, if, in Fig. 150a, it is desired to convert an electrodynamic wattmeter into a reactive volt-ampere indicator, an appropriate value of capacitance can be placed in parallel with its voltage coil and an inductance inserted in series with the combination. That this can produce a voltage across the meter in quadrature with the line voltage can be seen from Fig. 150b.

Let E' be the voltage across the meter. The current through the voltage circuit of the meter will be i_R in phase with E' and through the condenser i_C , leading E' by 90° . The current through

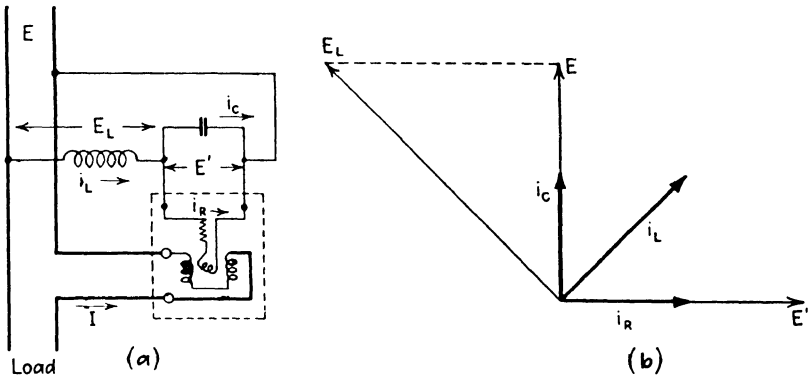

FIG. 150.

the inductance will be i_L and the voltage across the inductance E_L . The resultant of these voltages will be E , the line voltage. The voltage E' across the meter is seen to be in quadrature with the line voltage E provided i_C and i_R are equal. This will follow if the impedance of the condenser at the line frequency and of the inductance, likewise, are made equal to the ohms of meter resistance. For a 5,000-ohm meter, C is 0.53 mf. and L is 13.26 henries at 60 cycles.

A similar procedure could apparently be followed in the case of the watt-hour meter. Here, however, the voltage circuit is predominantly inductive and the resistance is not negligibly small. The requisite value of capacitance for a 110-volt 60-cycle meter would be about 3.5 mf. and the inductance about 27 henries. The objection to this scheme is that it is peculiarly sensitive to frequency changes. Departure from standard frequency is very slight in interconnected power systems of today, however.

Therefore the sensitiveness of frequency applies much more to the harmonic components of frequency which are present in wave forms not strictly sinusoidal.

13-7. Two-phase Reactive Metering.—Registration of either reactive volt-amperes or reactive volt-ampere-hours is readily accomplishable in two-phase circuits because each phase automatically provides a quadrature voltage necessary for measurement of the reactive component of the load on the other phase. Interchange of the voltage leads between outside wires and the

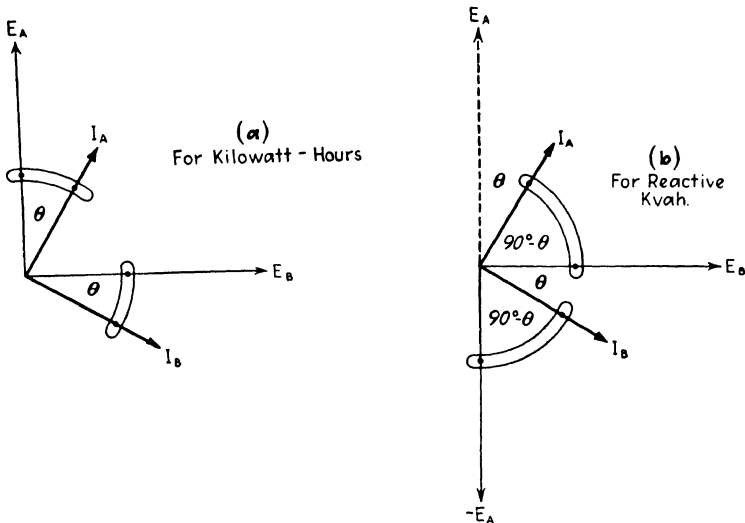

FIG. 151.

voltage coils of the watt-hour meter in Fig. 57 will shift the registration from energy to reactive component. It will, however, be necessary, in addition, to reverse the polarity for one of the elements, as can be seen from Fig. 151, in order that both elements shall contribute forward torque on the lagging power factor represented. If the power factor becomes leading rather than lagging, the polarities of both voltages will have to be reversed to insure forward registration. Without a ratchet a permanently connected meter would reverse direction of rotation whenever power factor changed from lagging to leading. The net registration under such reversals would have little meaning for billing purposes if this were allowed to happen. On tie lines where power factor may be either lagging or leading, two meters could be employed, one ratcheted against backward registration

under lagging conditions, the other against backward registration under leading conditions. The problem becomes intricate, however, if the flow of power also reverses direction. All this applies equally to three phase. The two-phase connections for

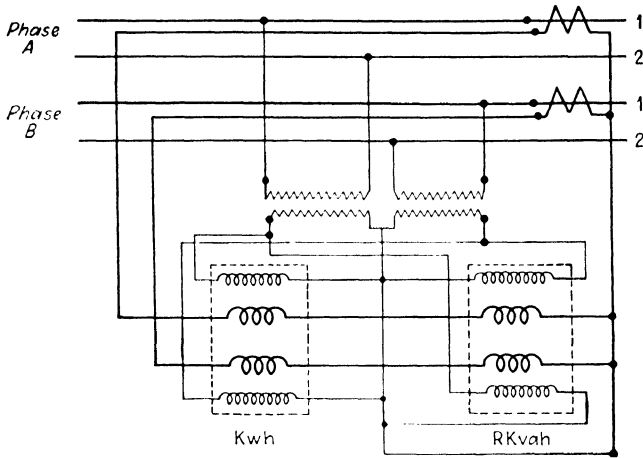

FIG. 152.

simultaneous registration of kilowatt-hours and reactive kilovolt-ampere-hours are as shown in Fig. 152.

13-8. Cross-phasing for Three-phase Reactive Metering.—

The same procedure in connection with Fig. 60 (three phase) as was applied in the preceding section to Fig. 56 (two phase) will convert the watt-hour meter into a reactive-component meter. Reversal of polarity of one voltage is again necessary. The con-

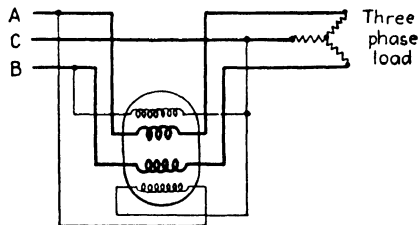

FIG. 153.

nections are as in Fig. 153, for a low-voltage circuit not requiring transformers. That this results in registration proportional to the reactive component may be demonstrated from Fig. 154, which assumes a lagging power factor of the order of 70 per cent. Three meter elements with the phase voltages and currents E_{AO}

and I_A , E_{BO} and I_B , E_{CO} and I_C applied to them would register the total energy. Any two such elements would register two-thirds the energy on balanced load. Any two such elements with voltages in quadrature with the proper phase voltage would register two-thirds the total reactive volt-ampere-hours. The line voltage E_{BC} is in quadrature with E_{AO} , also $-E_{AB}$ or E_{BA} is in quadrature with E_{CO} . These line voltages are, however, $\sqrt{3}$ times as great as the phase voltages and, therefore, give rkvah.

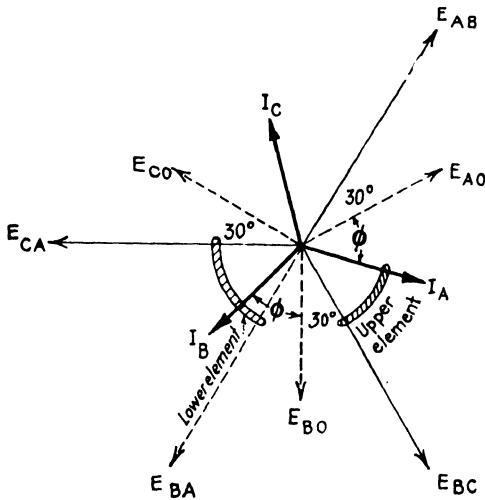

FIG. 154.

too great by the amount of this ratio. Since therefore the two meter elements give only two-thirds the registration from one standpoint but too great by $\sqrt{3}$ from another standpoint, the actual registration is $\frac{2}{3}\sqrt{3} = 1.155$. This is 15.5 per cent too great and requires the application of a correction factor of 0.866.

A more serious objection than the need of applying a correction factor of 0.866 is the fact that this connection leads to serious errors if the voltages and currents are not well balanced. This will be discussed in the next chapter.

Incidentally this connection amounts to one of the common incorrect connections for energy measurement in three-phase three-wire circuits as analyzed in the preceding chapter.

13-9. Phasing Transformers for Reactive Metering.—There are several feasible alternatives to the simple cross-phasing scheme of the preceding paragraph for reactive measurement in three-phase three-wire systems. Two involve two autotrans-

formers and one employs a reactor in Y with the two voltage elements of the polyphase reactive meter.

In one of the autotransformer methods two autotransformers are used in open Δ to perform a double function: shift the voltage 90° in phase position and restore the resultant voltage to the normal meter value of 110 or 115 volts as desired. The combination is called a "phasing transformer" or "reactive-component compensator." For the upper element of the rkvah.

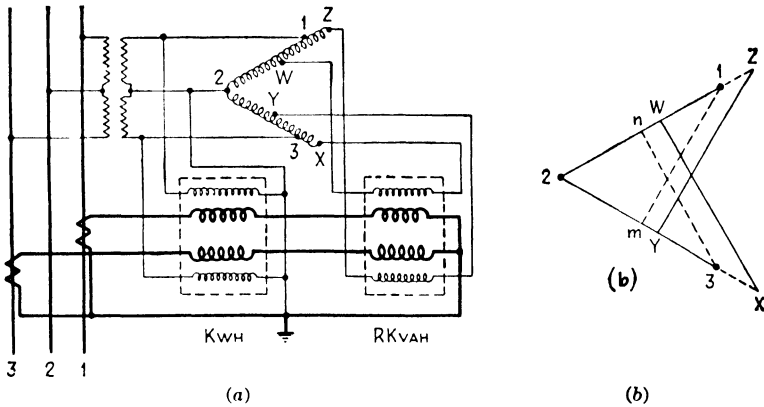

FIG. 155.

meter of Fig. 155a a voltage is desired in quadrature with that (E_{12}) employed with the corresponding element of the kwh. meter. This could be obtained by providing a middle tap n of the 1-2 coil in Fig. 155b and then taking for application to the reactive meter the voltage 3- n perpendicular to E_{12} . This would, however, have a magnitude of $0.866E_{12}$. The autotransformer makes it possible to raise E_{3n} to equality with E_{12} by extending the 2-3 winding 15.5 per cent to X and also increasing E_{2n} by the same amount so that W is a 57.7 per cent tap. The voltage WX is then

$$\sqrt{(1.155E_{12})^2 - (0.577E_{12})^2} = E_{12} = E_{32}$$

in magnitude and likewise YZ is made the normal meter voltage of 110 or 115. This scheme gives the quadrature shift and at the same time avoids the necessity otherwise of introducing the correction factor or register constant of 1.155.

The vector relations set up in Fig. 156 are for a power-factor angle θ so that the line currents are displaced $(30^\circ + \theta)$ from the line voltages. The upper element of the rkvah. meter registers at the rate

$$E_{12}I_1 \cos (\theta - 60^\circ)$$

$$= E_{12}I_1 \left(\frac{1}{2} \cos \theta + \frac{\sqrt{3}}{2} \sin \theta \right)$$

The lower element registers at the rate

$$E_{32}I_3 \cos (\theta - 120^\circ)$$

$$= E_{32}I_3 \left(-\frac{1}{2} \cos \theta + \frac{\sqrt{3}}{2} \sin \theta \right)$$

The two elements together (on the assumption that currents and voltages are balanced) register $\sqrt{3}EI \sin \theta$, which is the reactive component corresponding to a balanced power load of $\sqrt{3}EI \cos \theta$.

It should be noted that one of the voltages, in this case E_{ZY} , is reversed. That this is necessary can be seen from the figure by assuming zero power factor; under this condition the reactive meter should run at maximum speed forward for lagging current. Then I_1 will fall in phase with E_{23} and I_3 in phase with E_{12} and each will make a 30° angle with the voltage with which it is associated in the reactive-meter element. The reason for reversing one of the phasing transformer voltages is really the same as the reason for reversing one of the voltages for

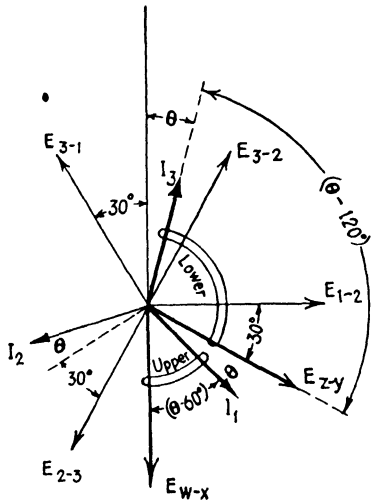

FIG. 156.

the watt-hour meter as was demonstrated to be necessary in 5-6.

A second phase-shifting scheme employs two autotransformers in T instead of open Δ . The mid-tap of one (the 1-2 coil in Fig. 157) is connected at O to an 86.6 per cent tap on the other (3-4). Point 4 is extended $0.5E$ from O and point 6 is extended to $0.866E$ from O ; point 5 is $0.5E$ distant from O . The voltage E_{4-5} is therefore equal to E and in quadrature with E_{1-2} . Consequently it is applied to the element which for watt-hour metering would have E_{1-2} applied to it. The voltage E_{6-5} to be applied to the other element is in quadrature with E_{3-2} which would be applied to it for the purpose of energy registration. The

scheme therefore registers $rkvah$, and without need for injecting a register constant.

13-10. Various Y-methods of Reactive Metering.—Each Y-voltage to the center of a balanced Δ is in quadrature with the

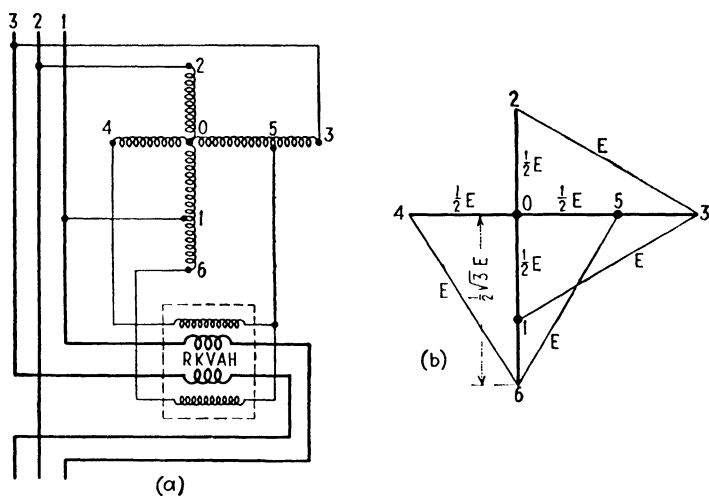

FIG. 157.

opposite side of the Δ . This suggests using an auxiliary reactor, identical in impedance and reactance with the two voltage elements of the reactive meter, and in Y with those elements to

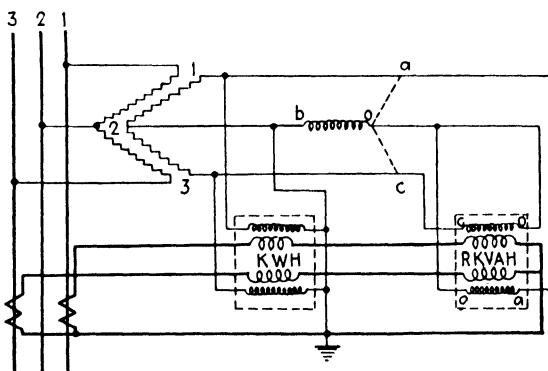

FIG. 158.

obtain the requisite quadrature voltage relation for reactive metering. The auxiliary reactor is most conveniently merely the voltage coil and laminations from a meter of the same type. The connections are as in Fig. 158, where it can be seen that the

two voltage coils have in effect the Y-arrangement shown in dotted lines ao and co . Inasmuch as the Y-voltage is only 57.7 per cent of the Δ voltage from the voltage transformers, it will be necessary to use a register constant of 1.73 (*i.e.*, $1/.577$) or else inject this ratio into the gear train in order to have correct rkvah. registered by the meter.

Of course, the register constant of 1.73 can be avoided by inserting a three-phase autotransformer which steps the voltages up in this ratio before applying them to the Y-connected reactor and voltage coils.

If the circuits provide a neutral wire, the voltage-coil terminals may be connected to it and the auxiliary reactor therefore dis-

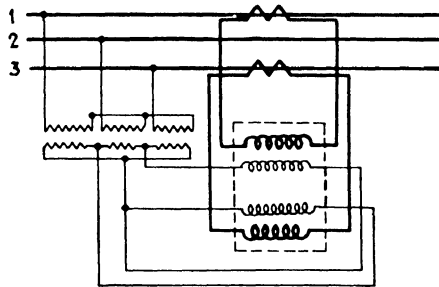

FIG. 159.

pensed with. This, however, constitutes a four-wire circuit and the reactive component of any single-phase load between wire 2 and the neutral would not be recorded by this connection of the two-element meter.

Still another method effects the establishment of the neutral by the inverse process of connecting the primaries of the voltage transformers in Y and their secondaries in Δ (see Fig. 159).

13-11. Four-wire Reactive Metering with Three-element Meter. *a. Cross-phasing to Line Wires (Fig. 160ab).*—In this case the current in each current element of the meter reacts with the voltage between the two line wires other than that from which the current was derived. At power factor 1.0 the angle between each current and the voltage with which it reacts is 90° , thus, as should be the case, creating no torque and no registration. Inasmuch as the true rkvah. result from the phase voltages in conjunction with the phase-current values, the registration under this connection, employing as it does the line-to-line voltages, is

too great in the ratio 1.73:1. The correction factor is thus 0.577.

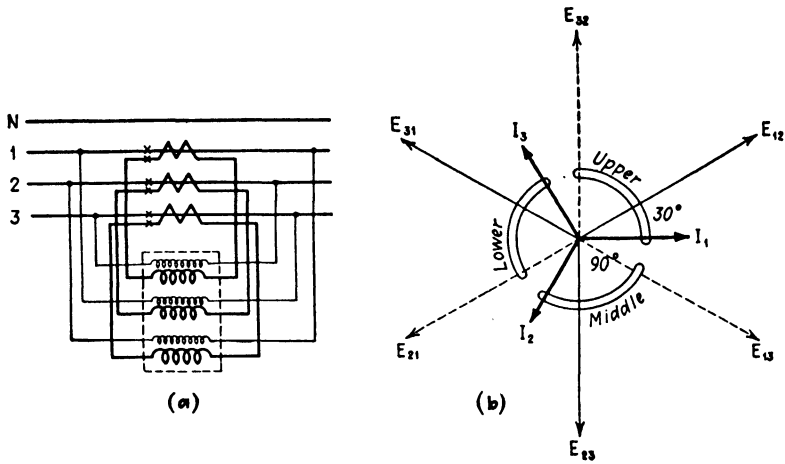

FIG. 160.

b. Voltage Transformers in Y-Y with Y Phasing Transformer (Fig. 161).—In every instance the aim in practical reactive metering is to derive from the system a voltage that will be in quadrature with that which would be applied for watt-hour measurement. In the case of the four-wire system this is easily effected by connecting three autotransformers in Y to the line or else to the

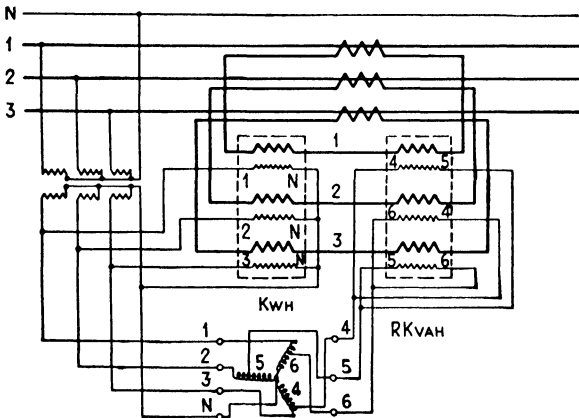

FIG. 161.

Y secondaries of voltage transformers whose primaries are connected in Y to the line. Taps at symmetrically chosen points

on two legs of the Y will provide a voltage in quadrature with that of the third leg. That quadrature voltage can be made equal to the leg voltage by taking taps at the 0.577 point from the neutral junction and thus avert the need for a correcting multiplier.

c. Open-Y Phasing Transformer (Fig. 162).—An arrangement of two autotransformers may be employed to obtain the requisite three quadrature voltages. They are connected V or open Y with the neutral wire of the four-wire system tied in at the junction of the transformers. The taps are so taken as to make the

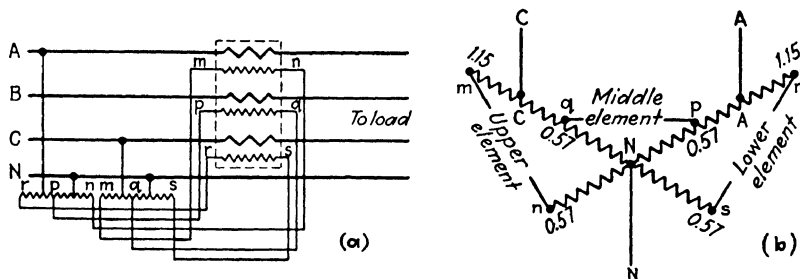

FIG. 162.

voltage applied to the voltage element of the reactive meter the same in magnitude as that applied to the associated watt-hour meter. Then no multiplier is required.

13-12. Four Wire (Reactive Metering with Two-element Meter. *a. Voltage Transformers in Y; Current Transformers in Δ (Fig. 163).*—The Δ -connection may be used as in Fig. 66 to circulate the three currents through the two elements of the meter in such a way as to have one of the currents appear in both elements. The third current in effect reacts with the resultant of the two voltages which are applied to the two voltage elements. That resultant, for balanced voltages, is the reverse of the third voltage. Thus in Fig. 163a current I_b circulates through both elements, positively in the upper and negatively in the lower. For energy metering, each of the three currents would have to react with its corresponding phase voltages, but for reactive metering a quadrature voltage is, of course, required in each case. These are obtained from the terminals of the Y-connected voltage transformer secondaries where E_{bc} is in quadrature with E_{an} , etc. Figure 163b is drawn for the condition of unity power factor for which the reactive-meter torque should be zero.

The upper element has current $-I_a$ reacting with E_{bc} . The lower element has current I_c reacting with E_{ba} . The upper element has current I_b reacting with E_{bc} ; the lower has current

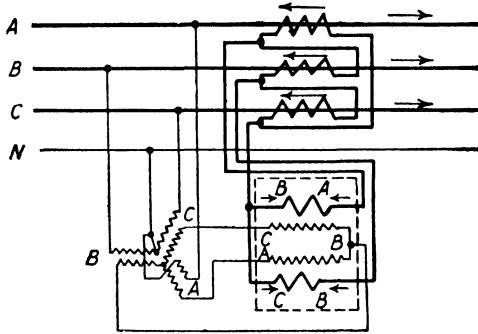

FIG. 163a.

$-I_b$ reacting with E_{ba} , which give the same effect as I_b reacting with $-E_{ba}$ or E_{ab} . The combined effect of I_b in the two elements is that of reaction with the resultant of E_{bc} and E_{ab} which is

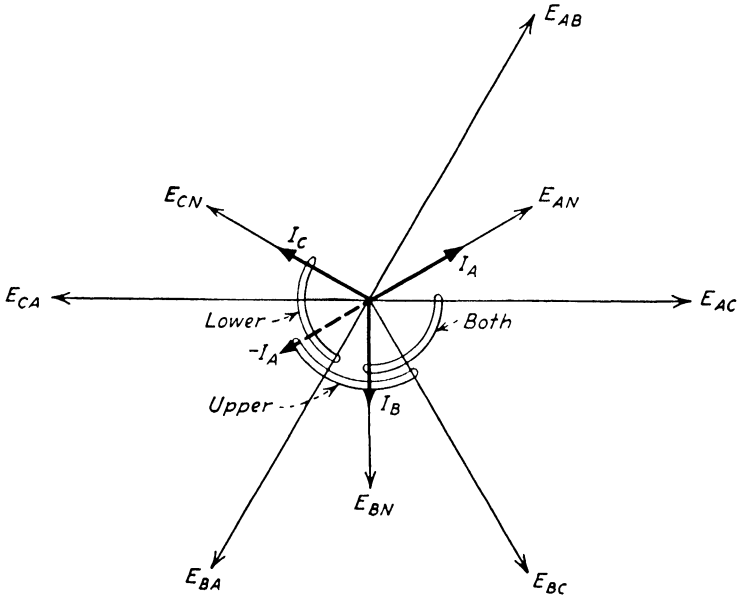

FIG. 163b.

E_{ac} . In each instance therefore the line current reacts with a voltage leading it and in quadrature with its phase voltage. Also each of the voltages is 1.73 times the phase voltage. The meter

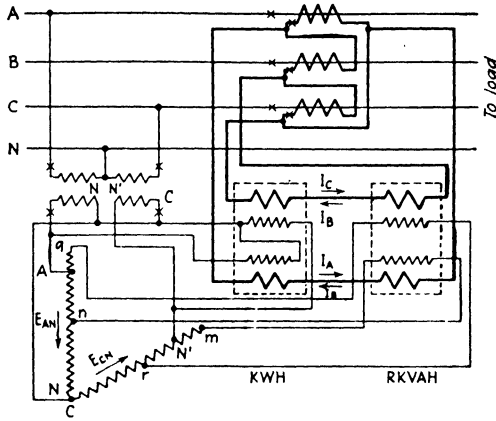
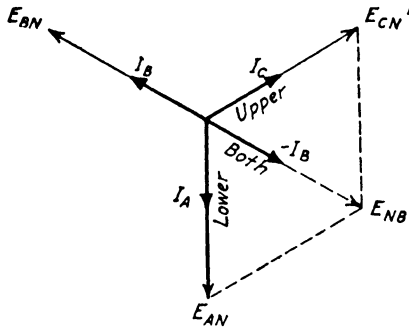
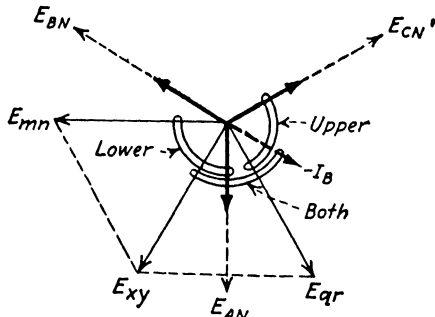

FIG. 164a.



Watt-hour Meter
FIG. 164b.



Reactive Meter
FIG. 164c.

therefore registers 1.73 times the sum of the reactive volt-amperes of all three phases and thus requires a correction factor of 0.577.

b. Voltage Transformers in V-V with Phasing Transformer; Current Transformers in Δ (Fig. 164).—Here again the Δ -connection of current transformers in conjunction with a two-element meter gives the effect of a three-element meter as in *a*. The use of the phasing transformer accomplishes three things: (1) it

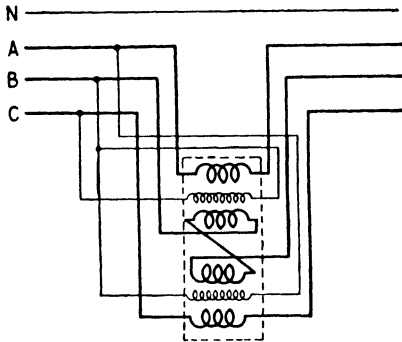

FIG. 165.

permits two voltage transformers to suffice whereas three were required in *a*; (2) it effects the quadrature shift of voltage phase; (3) it eliminates the correction factor required in *a*.

From Fig. 164*b*, drawn for unity power factor, it may be seen that, for the watt-hour meter, the current $-I_b$ reacts with the resultant E_{NB} of $E_{CN'}$ (upper) and E_{AN} (lower).

This is the same as I_b reacting with E_{BN} and the two elements thus record the total power of all three phases.

For the reactive meter the phasing transformer provides the quadrature voltages E_{qr} and E_{mn} to substitute for E_{CN} and E_{AN} , respectively. As in the watt-hour meter the current $-I_b$ reacts with the resultant of the two voltages, which in this case is E_{xy} . The reaction is the same as for E_{yz} with I_b and this constitutes the proper quadrature relation for the reactive measurement of the third phase. The reactive meter therefore registers the reactive volt-amperes of the three-phase four-wire load without need for a correction, provided the taps are taken as in Fig. 155.

13-13. Reactive Metering with $2\frac{1}{2}$ -element Meter.—For a low-voltage installation the voltage transformer would be omitted and the phasing transformers could likewise be omitted as in Fig. 165. The second set of current coils in each element of the $2\frac{1}{2}$ -element meter would introduce the torque item corresponding to the third line current. The voltages applied to the voltage element are respectively taken from the two line wires, from neither of which each of the currents for the principal current coils is taken. Thus I_A reacts with E_{CB} , I_C with E_{BA} , and I_B with the negative of the resultant of E_{CB} and E_{BA} , which is E_{CA} . Each

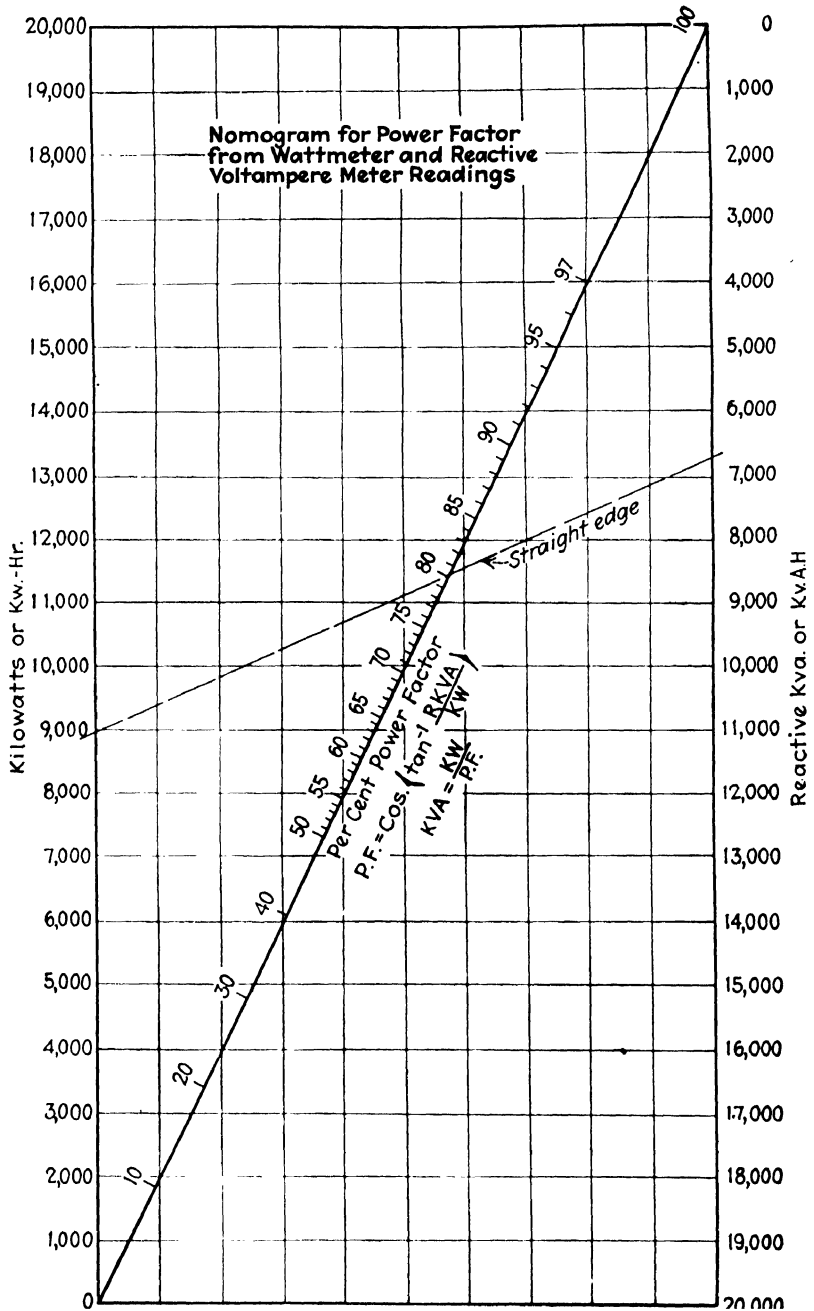

FIG. 166.

voltage leads by 90 deg. the phase voltage with which each current is associated. A correction factor of 0.577 is necessary. There is little difference between this case and that of 13-12*b*. The supplementary current coils of the meter accomplish the same effect of addition of currents as the Δ current transformers; the voltage E_{CB} applied to the (upper) element with current I_A in this instance is in the same phase position as the E_{mn} applied to the (lower) element of Fig. 164 which had current I_A .

13-14. Power Factor from Reactive and Watthour Readings.—The primary object of installing the reactive meter on the customer's service is to obtain an index of the power factor. Unless the power factor is constant, however, the most that a reactive metering installation can give is the average power factor for the period for which the readings have been taken. Strictly speaking, this is not a true average because the result will not necessarily agree with the average of the successive instantaneous values of the power factor. For billing purposes the average obtained through the medium of integrating meter readings is, however, considered an acceptable index.

For quick determination of the average power factor the nomograph of Fig. 166 is useful. Place a straight edge so that it intersects the kilowatt-hour and reactive kilovolt-ampere-hour scales at the observed values. The intersection with the oblique power-factor scale gives the percentage power factor. If this intersection is too acute for accuracy because the vertical scale values are quite small, better accuracy can be obtained by multiplying both the kwh. and the rkvah. by the same factor and thus bringing the straightedge position more nearly horizontal.

Problems

13-1. Properly connected for "two-wattmeter" method of measuring three-phase three-wire power, one single-phase wattmeter indicates 50 per cent more watts than the other. What is the power factor of the load if both indications are positive? What if the smaller is negative? Consider the load balanced.

13-2. When properly connected a polyphase wattmeter indicates 840 watts for a three-phase load not positively known to be balanced. When the voltage connections are all shifted 120 deg. in cyclic order, the meter indicates 672 watts. What is the power factor? Would degree of unbalance have affected the magnitude of the first reading provided the total load remained the same? What would the second indication have been if the load had been balanced at the outset?

13-3. Derive Eq. [36] in Par. 13-5.

13-4. Compute the requisite values of inductance and capacitance to use with the wattmeter of Par. 13-6 to register the reactive volt-amperes of a 25-cycle load as per Fig. 150. Assume p.f. of inductance coil equal to 0.2 and $I_C = I_R$.

13-5. Draw the vector diagrams for the connection diagrams of Figs. 158 and 159 and show that the two are equivalent in effect. What is the correction factor for Fig. 159, if a 20:1 ratio of the voltage transformers is assumed?

13-6. A certain three-phase three-wire transmission line operated at 66,000 volts serves as a tie to interchange power in either direction between two companies. One company measures its input to and draft from this line by means of a watthour meter and a reactive meter. Show why, under ordinary operation, either or both meters may reverse direction and, in fact, they may run in opposite directions at the same time.

13-7. In a certain plant "there is a three-phase system which is badly unbalanced. One phase carries about 3,000 amp., the second 1,200, and the third about 700. The load is mostly single-phase load (electric furnaces) and a reactive meter has been installed alongside the watthour meter. How near a correct power-factor determination can be expected?"* Comment on the plausibility of the data and its adequacy for answering the query.

13-8. Show that the taps indicated in Fig. 162 provide three voltages 120° apart and each equal in magnitude to and in quadrature with the phase to neutral voltages.

13-9. Show why a polyphase reactive meter will reverse direction if the phase sequence of the supply voltage is reversed. Would this occur however with the scheme of Fig. 150?

13-10. Show vectorially why it is necessary to reverse the secondary connections $C'N'$ of one of the voltage transformers in Fig. 164a. Why not reverse it at the meter terminals? Does this hinge on the use of the phasing transformer and its requirement of a 60-deg. angle?

13-11. Devise a way of avoiding the use of the phasing transformer of Fig. 164a by substituting a V-V connection of the voltage transformers. Manifestly the current transformer connections will have to be modified so that the reactive meter will be supplied with only two of the line currents, whereas the two current coils of the watthour meter can still, however, be supplied with all three load currents from the same set of current transformers. Show how this can be done. Which connection is the more accurate on unbalanced loads? †

* See *Elec. World*, vol. 82, pp. 1309-1314, 1923.

† See *Elec. Jour.*, vol. 25, p. 417 (1928).

CHAPTER XIV

ACCURACY OF REACTIVE METERING. SYMMETRICAL COMPONENTS

It is not unlikely that the preceding chapter gave the impression that, employing largely the same instruments as for power and energy metering, reactive metering should inherently be capable of an equal degree of accuracy. Unfortunately this is not the case, at least not under conditions of unbalanced voltages, currents, and loads. At some risk of repetition it will be emphasized again that the conventional methods of polyphase power and energy metering which adhere scrupulously to the Blondel theorem are precise for any power factor or condition of unbalance. But reactive-metering practice does not adhere rigidly to the dictates of that theorem and the departures account for the inaccuracies that enter when either the currents or voltage or both are not balanced, *i.e.*, are asymmetrical.

Briefly, analysis shows that all the reactive-metering schemes involving cross-phasing of voltages or the use of phasing transformers register in the wrong sense the volt-amperes associated with the negative phase-sequence components of voltage and current. As a consequence the error under unbalanced conditions is at least twice as great as the degree of unbalance. The aim of this chapter will be to develop the method of symmetrical components to the point where these errors can be determined for the various reactive-metering schemes discussed in the preceding chapter.

14-1. Reactive-metering Accuracy Affected by Unbalance.—There were described in Chap. V conventional methods of power and energy measurement which do not conform rigidly to the Blondel theorem. Thus it was found that the three-wire single-phase meter introduces inaccuracies under unbalanced conditions of voltage and load. Nor are the $2\frac{1}{2}$ -element polyphase watt-hour meters or the two-element meter in conjunction with Δ -connected current transformers on four-wire circuits free of error on unbalanced loads and unbalanced voltages.

The point in either instance is very simply that, in attempting to avoid one whole additional meter element (as required by the theorem), one of the currents is made to react with a substitute for its appropriate voltage. Under balanced conditions the substitute voltage would be identical with the proper voltage. But under unbalanced conditions this identity fails and metering error is introduced as a result.

The discrepancy in the case of reactive metering is due to a similar cause. In the effort to establish for the purposes of reactive measurement a voltage in quadrature with the one appropriate for energy or power metering, all the practical methods accomplish this by introducing all or part of the voltage of some other phase. Naturally then the resultant quadrature voltage under unbalanced conditions will not be equal numerically to or perhaps even in true quadrature with the voltage with which it is artificially set up in intended quadrature. Error results. No error would result, however, if the in-phase voltage itself could be rotated into a quadrature position without admixture of another voltage not always symmetrically equal to it.

Briefly, this is why reactive metering in practice is not on so high a plane of accuracy as power or energy metering. Even in the theoretical foundations of reactive metering there are also certain unsettled questions as to the physical nature and circuit behavior of what is rather glibly called reactive kilovolt-amperes or reactive kilovolt-ampere-hours. This lack of certainty about the interpretation of reactive component is a matter of international inquiry at the present time.

14-2. History of Symmetrical Components.—In analyzing the degrees of inaccuracy resulting in reactive metering under unbalanced conditions it would be a great simplification if any unbalanced system of voltages or currents could be converted into component systems which would each be symmetrical in themselves. In a similar way it is an immense help in dealing with distorted periodic wave forms to be able to resolve them entirely by Fourier analysis into a sinusoidal fundamental and its sinusoidal harmonics. Fortunately a not wholly dissimilar process has been discovered and perfected for handling unsymmetrical polyphase quantities in component form, each component in itself having symmetry.

The efforts of Ferraris, Lamme, and others as early as 1900 to explain the basis of functioning of the single-phase motor estab-

lished the germ of the idea of symmetrical components, sometimes called "symmetrical coordinates." They resolved the single-phase pulsating flux into two oppositely rotating fields of flux of constant value. E. F. W. Alexanderson's phase-balancer patent (1912) incorporated this concept, which had meanwhile been extended to unbalanced three-phase systems. L. G. Stokvis set up the mathematical analysis of three-phase generator voltage regulation* on the symmetrical-component concept.

To C. L. Fortescue, however, is due the credit for giving the concept a comprehensive generality of technique and application.† Especially did he show that in those parts of a system which are electrically symmetrical the currents and voltages of one symmetrical component have no influence upon the currents and voltages of a component having the opposite phase sequence. Each quantity can, therefore, be handled as if no quantity of one of the other component systems were present in the circuit. This property greatly simplifies the study of the unbalances that exist on transmission lines at times of faults due to short circuits or grounds. This field of application of symmetrical components has been treated comprehensively by R. D. Evans and C. F. Wagner in a series of articles running in *Electric Journal* from March, 1928, to November, 1931, and more recently published in book form.‡ V. Genkin, A. P. Mackerras, and W. A. Lewis among others have also contributed to the development and application of symmetrical components.

14-3. The Principle of Symmetrical Components.—In Figs. 48 and 49 (Chap. IV) it was shown that, if two symmetrical systems of vectors of the same phase sequence are combined, the resultant vector system is also symmetrical. But if the two component symmetrical systems are of opposite phase sequence, the resultant vector system is unsymmetrical. The technique of the symmetrical component analysis is based on the converse principle; *viz.*,

Any unsymmetrical system of three-phase vectors whose sum is zero can be resolved into two symmetrical systems: one, generally larger in magnitude, having the same (positive) phase sequence as the original unsymmetrical system and the other having the opposite (negative) phase sequence.

* *Comp. rend.*, pp. 46-49, 1914; *Elec. World*, pp. 1111-1115, May 1, 1915.

† His paper was presented at the A.I.E.E. convention of 1918.

‡ WAGNER and EVANS, "Symmetrical Components," *McGraw-Hill Book Company, Inc.*, 1933.

If the sum is not zero (as would be the case with four-wire three-phase system carrying current in the neutral wire or with ground current between two or more grounded points on a three-wire three-phase system), the unsymmetrical system can be resolved into symmetrical positive and negative phase sequence systems and a third component of zero phase sequence.

This enunciation for resolution of three-phase unsymmetrical vectors is merely a special case of the resolution of a generalized polyphase system of n phases. It is well to state the principle as generalized for any number of phases of the polyphase system because it clarifies the origin of the negative phase sequence components in the preceding three-phase statement.

Any unsymmetrical n -phase system can be resolved into n systems of vectors in which the phase angles between vectors taken in order are multiples of the phase angle for the fundamental component.

In the first of these systems the vectors, cyclically observed, are separated by $360^\circ/n$.

In the second, the angle by which the vectors in cyclic order are separated is $2(360^\circ)/n$.

And so on until the n th system the angle is

$$\frac{n(360^\circ)}{n} = 360^\circ,$$

which means that all the vectors are in phase; *i.e.*, there is zero phase sequence.

In the case of immediate practical interest, *viz.*, the three-phase system the respective phase angles for the three components are 120° , 240° , 360° . A glance at Fig. 167 shows how this leads to calling the second system a negative-sequence system. The vectors $I_{(n)1}$, $I_{(n)2}$, $I_{(n)3}$ are merely positive-sequence vectors with a 240° displacement. It is not at all a case of negative vector rotation. All the vector components rotate in one positive direction. The resultant unbalanced system I_1 , I_2 , I_3 manifestly does not sum to zero and there must, therefore, be a return current, in the ground or in a fourth wire, equal and opposite to $I_{(n)1} + I_{(n)2} + I_{(n)3}$. This ground current and the zero-sequence component in the three conductors constitute a single-phase system, asymmetrical in comparison with three-phase symmetry.

If the voltages or currents in a three-phase circuit are balanced as under normal balanced-load operation, the negative- and zero-sequence components are zero and only the positive-sequence components are present. The negative-sequence component is present during all periods of unbalance; the zero-sequence component is, however, present only when there is a load (or a

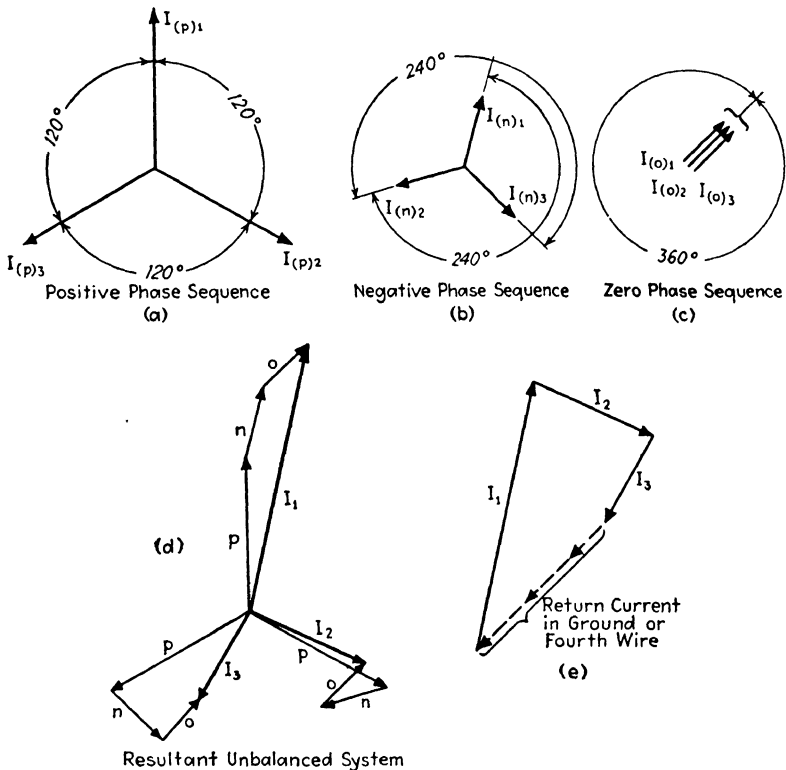

FIG. 167.

fault) between one of the three conductors and the neutral wire or ground. Symmetrical components are especially helpful to the relay engineer in analyzing the adequacy and performance of relays under short-circuit or fault conditions on transmission or distribution lines.

14-4. Three-phase Vector Operator.—Before proceeding to apply the symmetrical-component technique to reactive metering it will be necessary to set up certain fundamental relationships between the component vector systems.

In common rectangular coordinate notation a counterclockwise rotation of a vector through 90° is represented by a single application of the operator j . A second application of j produces 90° more of rotation and the vector is now 180° from its original position. It has merely changed sign and therefore

$$j \times j = -1 \quad \text{or} \quad j = \sqrt{-1} \quad \text{Also} \quad j = \epsilon^{j\frac{\pi}{2}} \quad [37]$$

In the three-phase system of symmetrical vectors the angle of rotation is $120^\circ = 2\pi/3$. Hence the vector operator is

$$\epsilon^{j\frac{2\pi}{3}} \text{ or } -\frac{1}{2} + j\frac{\sqrt{3}}{2}$$

This will be called a and consequently

$$\left. \begin{aligned} a &= \epsilon^{j\frac{2\pi}{3}} = -\frac{1}{2} + j\frac{\sqrt{3}}{2} \\ a^2 &= \epsilon^{-j\frac{2\pi}{3}} = -\frac{1}{2} - j\frac{\sqrt{3}}{2} \\ a^3 &= \epsilon^0 = 1 \end{aligned} \right\} \quad [38]$$

The various derivatives of the operator a for characteristic positions of three-phase vectors are indicated in Fig. 168. It is clear that 1 , a , and a^2 represent a balanced system of vectors with zero sum.

Therefore

$$\left. \begin{aligned} \text{whence} \quad & 1 + a + a^2 = 0 \\ & 1 + a^2 = -a \\ \text{and} \quad & 1 + a = -a^2 \end{aligned} \right\} \quad [39]$$

Other relations can be obtained by algebraic manipulation or else derived from Fig. 168 by inspection.

Table IX summarizes the more commonly used relationships of the functions of the operator a .

14-5. Interrelations of the Components.—There are various useful relations between the vectors of each of the symmetrical-component systems in conjunction with these of the unsymmetrical system of which they are the components.

The positive-sequence components of currents for phases 1, 2, and 3 are $I_{(p)1}$, $I_{(p)2}$, $I_{(p)3}$. They follow the sequence

1, 2, 3 and are 120° apart. Since they are identical in magnitude, differing only in vector position, each may be expressed in terms of the others by applying a or a^2 as operators:

$$\left. \begin{aligned} I_{(p)1} &= aI_{(p)2} = a^2I_{(p)3} \\ I_{(p)2} &= aI_{(p)3} = a^2I_{(p)1} \\ I_{(p)3} &= aI_{(p)1} = a^2I_{(p)2} \end{aligned} \right\} \quad [40]$$

Since the system is balanced, $I_{(p)1} + I_{(p)2} + I_{(p)3} = 0$, and no component of a neutral or ground current can arise out of the positive-sequence system.

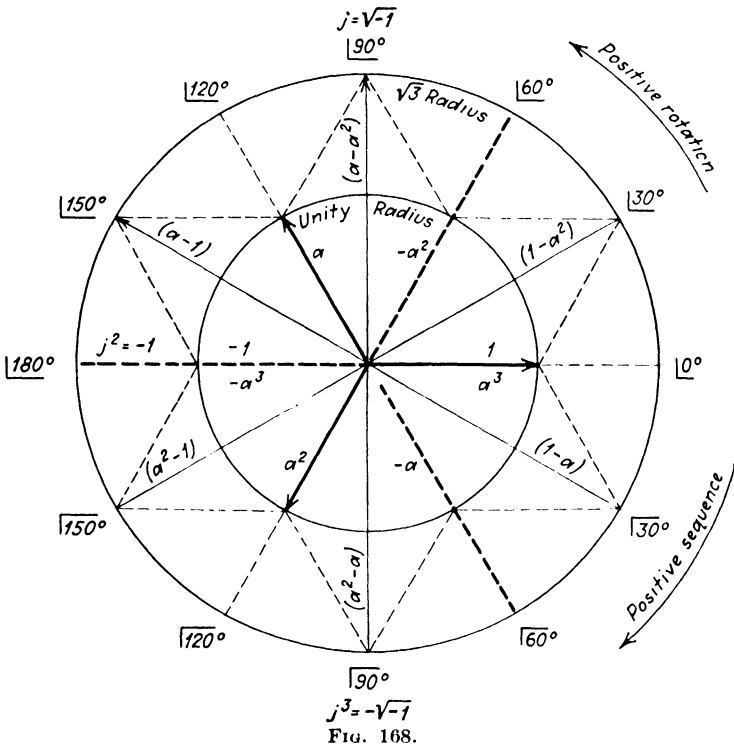

FIG. 168.

The negative-sequence system has similar interrelations but they differ because the phase sequence is 1, 3, 2

$$\left. \begin{aligned} I_{(n)1} &= aI_{(n)3} = a^2I_{(n)2} \\ I_{(n)2} &= aI_{(n)1} = a^2I_{(n)3} \\ I_{(n)3} &= aI_{(n)2} = a^2I_{(n)1} \end{aligned} \right\} \quad [41]$$

TABLE IX.—SOME FUNCTIONS OF THREE-PHASE OPERATOR

Number	Function of operator	Three-phase equivalent	Equivalent in other operators		
			Algebraic	Exponential	Trigonometric
1	a	a	$-\frac{1}{2} + j\frac{\sqrt{3}}{2}$	$e^{j\frac{2\pi}{3}}$	$ \underline{120^\circ}$
2	a^2	a^2	$-\frac{1}{2} - j\frac{\sqrt{3}}{2}$	$e^{-j\frac{2\pi}{3}}$	$ \underline{120^\circ}$
3	a^3	1	1	e^0	$ \underline{0^\circ}$
4	$\frac{1}{a}$	a^2	$-\frac{1}{2} - j\frac{\sqrt{3}}{2}$	$e^{-j\frac{\pi}{3}}$	$ \underline{120^\circ}$
5	$1 + a$	$-a^2$	$\frac{1}{2} + j\frac{\sqrt{3}}{2}$	$e^{j\frac{\pi}{3}}$	$ \underline{60^\circ}$
6	$1 + a^2$	$-a$	$\frac{1}{2} - j\frac{\sqrt{3}}{2}$	$e^{-j\frac{\pi}{3}}$	$ \underline{60^\circ}$
7	$a^{1/2}$	$-a^2$	$\frac{1}{2} + j\frac{\sqrt{3}}{2}$	$e^{j\frac{\pi}{3}}$	$ \underline{60^\circ}$
8	$a^{-1/2}$	$-a$	$\frac{1}{2} - j\frac{\sqrt{3}}{2}$	$e^{-j\frac{\pi}{3}}$	$ \underline{60^\circ}$
9	$a^{1/4}$	$\frac{1}{\sqrt{3}}(1 - a^2)$	$\frac{1}{2} + j\frac{\sqrt{3}}{2}$	$\sqrt{3}e^{j\frac{\pi}{6}}$	$\sqrt{3} \underline{30^\circ}$
10	$a^{-1/4}$	$\frac{1}{\sqrt{3}}(1 - a)$	$\frac{1}{2} - j\frac{\sqrt{3}}{2}$	$\sqrt{3}e^{-j\frac{\pi}{6}}$	$\sqrt{3} \underline{30^\circ}$
11	$1 - a$	$\sqrt{3}a^{-1/4}$	$\frac{1}{2} - j\frac{\sqrt{3}}{2}$	$\sqrt{3}e^{-j\frac{\pi}{6}}$	$\sqrt{3} \underline{30^\circ}$
12	$1 - a^2$	$\sqrt{3}a^{1/4}$	$\frac{1}{2} + j\frac{\sqrt{3}}{2}$	$\sqrt{3}e^{j\frac{\pi}{6}}$	$\sqrt{3} \underline{30^\circ}$
13	$a - a^2$	$\sqrt{3}a^{3/4}$	$j\sqrt{3}$	$e^{j\frac{\pi}{2}}$	$\sqrt{3} \underline{90^\circ}$
14	$a^2 - a$	$-\sqrt{3}a^{1/4}$	$-j\sqrt{3}$	$e^{-j\frac{\pi}{2}}$	$\sqrt{3} \underline{90^\circ}$
15	$a^2 + a$	-1	-1	$e^{j\pi}$	$ \underline{180^\circ}$
16	$a - 1$	$-\sqrt{3}a^{-1/4}$	$-\frac{1}{2} + j\frac{\sqrt{3}}{2}$	$\sqrt{3}e^{j\frac{5\pi}{6}}$	$\sqrt{3} \underline{150^\circ}$
17	$a^2 - 1$	$-\sqrt{3}a^{1/4}$	$-\frac{1}{2} - j\frac{\sqrt{3}}{2}$	$\sqrt{3}e^{-j\frac{5\pi}{6}}$	$\sqrt{3} \underline{150^\circ}$
18	$\frac{1}{a - a^2}$	$\frac{1}{\sqrt{3}}a^{3/4}$	$\frac{1}{j\sqrt{3}}$	$\frac{1}{\sqrt{3}}e^{-j\frac{\pi}{2}}$	$\frac{1}{\sqrt{3}} \underline{90^\circ}$
19	$\frac{1}{a + a^2}$	-1	-1	$-e^{j\pi}$	$ \underline{180^\circ}$

Again, the negative system is balanced and therefore has zero sum $I_{(n)1} + I_{(n)2} + I_{(n)3} = 0$, and consequently no component of neutral or ground current can arise out of the negative-sequence system.

The zero-sequence components $I_{(o)1}$, $I_{(o)2}$, $I_{(o)3}$ are unidirectional. In other words they are of equal magnitude but in phase with each other and consequently asymmetrical in comparison with the three-phase system in which they exist. Since no part of the neutral current can arise out of the positive- and negative-sequence systems, the zero sequence constitutes the whole of the neutral current, $I_{(N)}$,

$$I_N = I_{(o)1} + I_{(o)2} + I_{(o)3} \quad [42]$$

Also since the vector sums of both positive- and negative-sequence components are zero, the vector sum of any set of three-phase unsymmetrical currents must equal the sum of the zero-sequence components, *i.e.*, the neutral current,

$$I_N = I_1 + I_2 + I_3$$

Still another principle is that the neutral conductor (or ground) current divides equally between the three-phase conductors:

$$\frac{1}{3}I_N = I_{(o)1} = I_{(o)2} = I_{(o)3} \quad [43]$$

14-6. Relations of Vectors to Their Symmetrical Components.

There are also relations between the vectors of the unsymmetrical system and the vectors of its symmetrical components. Thus

$$\left. \begin{aligned} I_1 &= I_{(p)1} + I_{(n)1} + I_{(o)1} \\ I_2 &= I_{(p)2} + I_{(n)2} + I_{(o)2} \\ I_3 &= I_{(p)3} + I_{(n)3} + I_{(o)3} \end{aligned} \right\} \quad [44]$$

But a more useful set of relations, however, is the following, based throughout on the symmetrical components of phase 1 in terms of which the other phase components can be expressed. After this is done, the subscripts may be dropped from the symmetrical components:

$$\left. \begin{aligned} I_1 &= I_p + I_n + I_o \\ I_2 &= a^2 I_p + a I_n + I_o \\ I_3 &= a I_p + a^2 I_n + I_o \end{aligned} \right\} \quad [45]$$

By multiplying the second by a and the third by $1/a$ there results

$$\left. \begin{aligned} I_1 &= I_p + I_n + I_o \\ aI_2 &= a^3I_p + a^2I_n + aI_o \\ \frac{1}{a}I_3 &= I_p + aI_n + \frac{1}{a}I_o \end{aligned} \right\} \quad [46]$$

But $a^3 = 1$, $1/a = a^2$ and $1 + a + a^2 = 0$. Thus in taking the sum of the three equations, I_n and I_o vanish so that

$$\left. \begin{aligned} 3I_p &= I_1 + aI_2 + a^2I_3 \\ 3I_n &= I_1 + a^2I_2 + aI_3 \\ 3I_o &= I_1 + I_2 + I_3 = I_N \end{aligned} \right\} \quad [47]$$

Similarly,
and

These relations will be found to provide the basis for geometrical methods of resolving an unsymmetrical system into its symmetrical components. These will be described later.

14-7. Power and Energy of Symmetrical Components.—In addition to the relations of the two preceding sections there are aspects of the power and reactive flow associated with the symmetrical-component systems of current and voltage which will facilitate the analysis of the accuracy of metering unbalanced circuits.

The total power of the three-phase circuit may be expressed in three ways:

$$1. \quad P = \underline{E}_1 \underline{I}_1 \cos \theta_1 + \underline{E}_2 \underline{I}_2 \cos \theta_2 + \underline{E}_3 \underline{I}_3 \cos \theta_3 \quad [48]$$

This implies phase voltages and not line-to-line voltages and also that the underscoring signifies that the E 's and I 's are taken only in their scalar magnitudes.

2. Another way of expressing this is to abbreviate each term by letting a dot between the letters indicate that E is multiplied by the component of I (*i.e.*, $I \cos$) in phase with it, *i.e.*, a scalar product.

$$P = E_1 \cdot I_1 + E_2 \cdot I_2 + E_3 \cdot I_3 \quad [48a]$$

3. Still another way of expressing the total power in a general three-phase system is to sum the power in each of the component systems: positive-sequence voltage and current, negative-sequence voltage and current, zero-sequence

voltage and current. This can be written by inspection, if it is remembered that there can be no power interaction of the current of one component system with the voltage of another component. Since symmetry is the characteristic of all components, all three phases of each component will have identical phase angles between E and I and will therefore make identical contributions of power. (See Fig. 169.)

$$P = 3E_p I_p \cos \alpha + 3E_n I_n \cos \beta + 3E_o I_o \cos \gamma \quad [49]$$

where α is the phase angle between E and I of the positive-sequence system, β for the negative-sequence, and γ for the

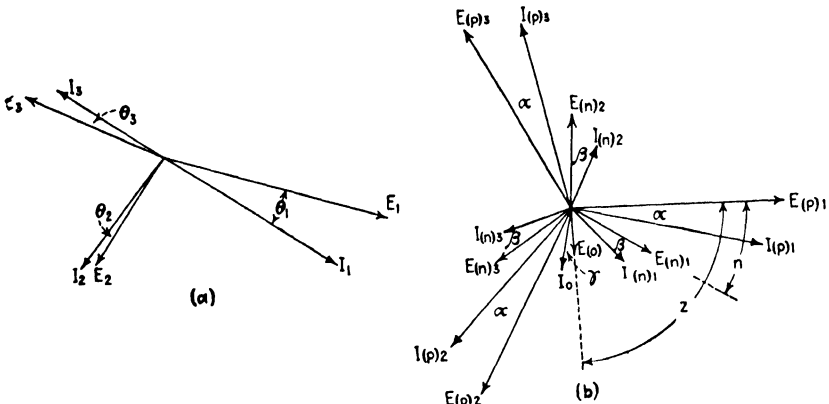

FIG. 169.

zero-sequence system. Equation [49] is for a four-wire or multigrounded three-wire circuit. For an ungrounded three-wire circuit there can be no neutral or zero phase-sequence current and the expression reduces to

$$P = 3E_p I_p \cos \alpha + 3E_n I_n \cos \beta \quad [49a]$$

For the reactive component of the total volt-amperes, similar reasoning results in the expression

$$Q = 3E_p I_p \sin \alpha + 3E_n I_n \sin \beta + 3E_o I_o \sin \gamma \quad [50]$$

for a four-wire or grounded three-phase circuit, and

$$Q = 3E_p I_p \sin \alpha + 3E_n I_n \sin \beta \quad [50a]$$

for an ungrounded three-wire circuit.

14-8. Unbalance Errors in Power Metering.—Analysis of the power- and energy-metering methods of Chap. V will show that those which are in strict conformity with the Blondel theorem involve no inherent error under unbalanced conditions. Any subterfuge like the $2\frac{1}{2}$ -element meter or Δ -connected current transformers to avoid a full third-meter element in connection with four-wire systems will result in the introduction of error under unbalanced conditions. This results because each current is not made to react exclusively with the voltage with which most intimately related in the system.

For example, consider the accuracy with which the four-wire three-phase $2\frac{1}{2}$ -element meter of Fig. 64 will measure energy under unbalanced conditions of voltage and/or current. The registration of the upper element will be

$$R_U = E_1 \cdot (I_1 - I_2) = (E_{(p)1} + E_{(n)1}) \cdot [I_{(p)1} + I_{(n)1} + I_{(\omega)1} - (I_{(p)2} + I_{(n)2} + I_{(\omega)2})]$$

For the lower element the registration will be

$$R_L = E_3 \cdot (I_3 - I_2) = (E_{(p)3} + E_{(n)3} + E_{(\omega)3}) \cdot [I_{(p)3} + I_{(n)3} + I_{(\omega)3} - (I_{(p)2} + I_{(n)2} + I_{(\omega)2})]$$

Expanding the former expression:

$$\begin{aligned} R_U = & E_{(p)1} \cdot I_{(p)1} + E_{(p)1} \cdot I_{(n)1} + E_{(p)1} \cdot I_{(\omega)1} + E_{(n)1} \cdot I_{(p)1} + \\ & E_{(n)1} \cdot I_{(n)1} + E_{(n)1} \cdot I_{(\omega)1} + E_{(\omega)1} \cdot I_{(p)1} + E_{(\omega)1} \cdot I_{(n)1} + \\ & E_{(\omega)1} \cdot I_{(\omega)1} - E_{(p)1} \cdot I_{(p)2} - E_{(p)1} \cdot I_{(n)2} - E_{(p)1} \cdot I_{(\omega)2} - \\ & E_{(n)1} \cdot I_{(p)2} - E_{(n)1} \cdot I_{(n)2} - E_{(n)1} \cdot I_{(\omega)2} - E_{(\omega)1} \cdot I_{(p)2} - \\ & E_{(\omega)1} \cdot I_{(n)2} - E_{(\omega)1} \cdot I_{(\omega)2} \end{aligned}$$

There will be a similar expression for the registration of the lower element.

Each term can next be converted from vector to numerical magnitudes of E and I along with the angles between the factors in each term. It will be found desirable to introduce the angle n between the voltages of the positive- and negative-sequence systems and also the angle c between the voltages of the positive- and zero-sequence systems. To carry this out in detail for the 18 terms of the expressions for R_U and R_L is too cumbersome to incorporate here, so only the result of substitution and simplification will be indicated.*

* Some of the omitted steps will be found in a paper by Prof. R. E. Johnson in the 1931 report of the Great Lakes Division of the National Electric Light Association.

$$R_U + R_L = 3E_p I_p \cos \alpha + 3E_n I_n \cos \beta + 3E_o I_p \cos (60^\circ + z - \alpha) + 3E_o I_n \cos \{60^\circ - [z - (n + \beta)]\} \quad [51]$$

Comparison of this result with Eq. [49] discloses the failure of this particular metering scheme to register any part of the power (or energy) associated with the zero-sequence quantities. On the other hand, it does register as power (or energy), when it should not do so, interaction of the zero-sequence voltage with the positive- and negative-sequence currents. It should be especially noticed, however, that the scheme registers the negative-sequence component of power (or energy) in the correct amount and with the correct (positive) algebraic sign. This will be found generally not to be the case with reactive metering.

The error with this scheme, by subtracting Eq. [51] from Eq. [49] is

$$\text{Error} = 3E_o I_o \cos \gamma - 3E_o I_p \cos (60^\circ + z - \alpha) - 3E_o I_n \cos \{60^\circ - [z - (n + \beta)]\} \quad [52]$$

There is, therefore, no error in this scheme unless the zero-sequence component of voltage is not zero.

This error can be wholly avoided by employing the three-element meter as shown in Fig. 63.

14-9. Error of Cross-phasing Three-wire Reactive Meters.—

In 13-8 it was mentioned that an objection to mere cross-phasing of the ordinary two-element meter for reactive measurement on three-wire circuits was its tendency to introduce more or less serious error under unbalanced conditions. That this error can be prohibitive under extreme conditions of load unbalance was shown by the author in an article in the December 29, 1923, issue of *Electrical World*. Computations of the meter registrations for various combinations of non-inductive and inductive load and with only one or only two phases loaded showed errors as high as +50 per cent in reactive registration with a corresponding error of +39 per cent in apparent total kilovolt-ampere and of -38 per cent in derived power factor. These particular errors occurred with assumed single-phase load of 50 per cent power factor between the conductors carrying a meter current coil and the one that does not. For a 50 per cent power-factor load between that conductor and the other current-coil conductor the errors are -50 per cent in reactive component, -34 per cent in total kilovolt-ampere, and +51 per cent in

power factor. For a load across the third phase there is no error.

In general the error with this scheme is less with non-inductive load and with less load unbalance, as might be expected. But on the whole the scheme, while simple and therefore attractive, is so prone to inaccuracy under unbalanced conditions that its application should be materially restricted.

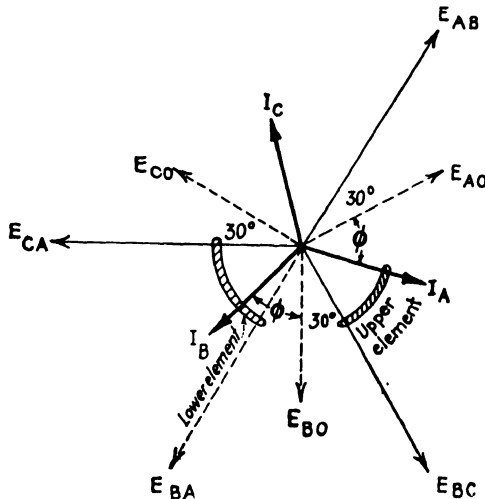

FIG. 154.

The source of this error can be ascertained by the method of the preceding paragraph as applied to Fig. 154. For the upper element

$$R_U = E_{32} \cdot I_1 = (E_2 - E_3) \cdot I_1$$

For the lower element

$$R_L = E_{21} \cdot I_3 = (E_1 - E_2) \cdot I_3$$

By substituting the positive- and negative-sequence components of the E 's and I 's and proceeding generally with the transformations and substitutions of the preceding paragraph in conjunction with the vectors and angles of Fig. 168, there is the following result for the registration of the meter:

$$R_U + R_L = 2\sqrt{3}E_p I_p \sin \alpha - 2\sqrt{3}E_n I_n \sin \beta - \sqrt{3}E_p I_n \sin [60^\circ - (n + \beta)] - \sqrt{3}E_n I_p \sin [60^\circ - (n - \alpha)] \quad [53]$$

To be correct this should be

$$Q = 3E_p I_p \sin \alpha + 3E_n I_n \sin \beta \quad [50a]$$

Several discrepancies are noted between the registration and the true value. In the first place it is evident that the meter reading must be multiplied by $\frac{1}{2}\sqrt{3}$ in order even to approximate the true result; this was noted in 13-8.

By applying this multiplier and subtracting Eq. [50a] from Eq. [53],

$$\text{Error} = 6E_n I_n \sin \alpha + \frac{3}{2}E_p I_n \sin [60^\circ - (n + \beta)] + \frac{3}{2}E_n I_p \sin [60^\circ - (n - \alpha)] \quad [54]$$

The principal term in the error is due to the fact that the torque represented by the negative-sequence components is registered subtractively as shown by Eq. [53] whereas it should, of course, be registered additively as per Eq. [50a]. This is, however, a characteristic error of all metering schemes involving any degree of cross-phasing (see author's article, *Electrical World*, December 29, 1923, for full vector analysis of this characteristic). In this instance there are additional errors arising within the meter from torque interaction of the negative-sequence current with the positive-sequence voltage and *vice versa*.

This connection therefore introduces more error than most of the other reactive-metering schemes. Consequently it should be avoided unless the voltage and current are pretty certain to be balanced.

The magnitude of error can be reduced to that of the superior reactive-metering schemes for three-wire circuits by substituting a $2\frac{1}{2}$ -element meter with the current circuit common to both elements inserted in the *C* lead of Fig. 153.

14-10. Reactive Metering with Phasing Transformers.—

a. Open- Δ Type.—If the effect of ratios of voltage and current transformers is ignored, the registration of the upper element in Fig. 155 is

$$R_U = E_{wx} \cdot I_1 = \frac{1}{\sqrt{3}}(2E_{23} + E_{12}) \cdot I_1$$

and for the lower element

$$R_L = E_{xy} \cdot I_3 = \frac{1}{\sqrt{3}}(2E_{12} + E_{23}) \cdot I_3$$

Substituting scalar magnitudes and angles from Fig. 168 and simplifying as before:

$$R_U + R_L = 3E_p I_p \sin \alpha - 3E_n I_n \sin \beta \quad [55]$$

If this is compared with the true value as in Eq. [50a], there is the

$$\text{Error} = 6E_n I_n \sin \beta \quad [56]$$

The scheme therefore has only the one inescapable error of all the cross-phasing schemes, *viz.*, that the negative-sequence

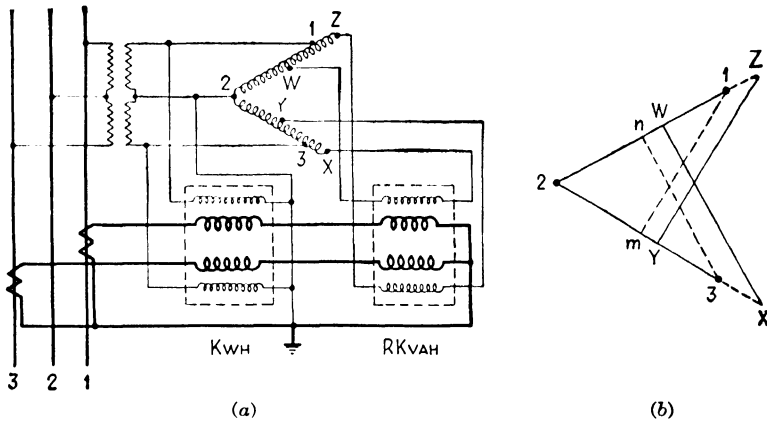

FIG. 155.

reactive volt-amperes are registered in the wrong algebraic sense.

b. Scott-connected Type.—Registration of the upper element as deduced from Fig. 157 is

$$R_U = E_{45} \cdot I_1 = \frac{2\sqrt{3}}{3} \left(E_{32} + \frac{1}{2} E_{21} \right) \cdot I_1$$

and for the lower

$$R_L = E_{65} \cdot I_3 = \frac{1}{2} (E_{54} + \sqrt{3} E_{21}) \cdot I_3$$

The successive steps in determining the error in registration here are, in order,

1. Replace the line voltages by the phase voltages; *e.g.*,
 $E_{23} = E_2 - E_3$.

2. Substitute the components for all current and voltage vectors.
3. Replace each vector product by the scalar magnitudes and the sines of the angles between each E and I .

4. Combine the terms; many will drop out.

The result will be found to be

$$R_U + R_L = 3E_p I_p \sin \alpha - 3E_n I_n \sin \beta \quad [57]$$

There is then the

$$\text{Error} = 6E_n I_n \sin \beta \quad [58]$$

Once more the error amounts to twice the unbalancing quantity associated with the negative-sequence components of voltage and current. If either of these is zero, there is no error in the reactive registration.

14-11. Three-element Four-wire Meter with Cross-phased Potentials.—This is the four-

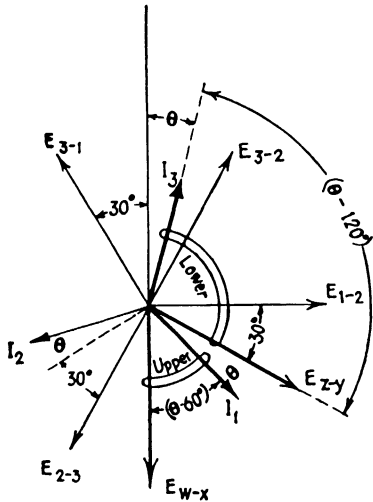

FIG. 156.

14-11. Three-element Four-wire Meter with Cross-phased Potentials.

—This is the four-

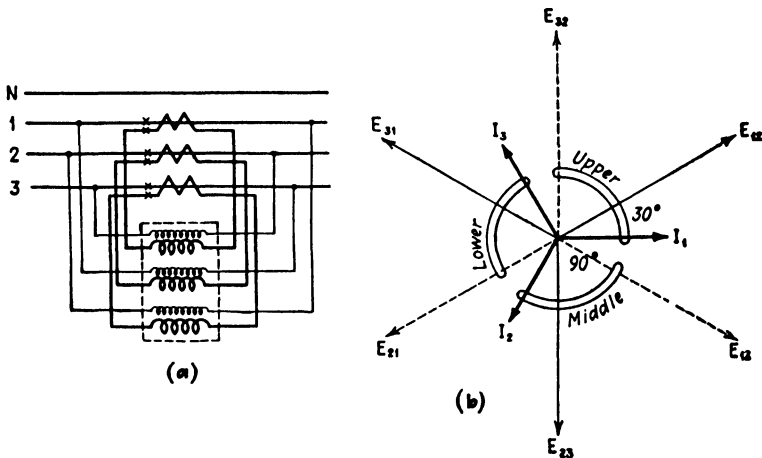

FIG. 160.

wire equivalent of the three-wire cross-phased meter of 14-9 and is shown in Fig. 160.

$$R_U = E_{32} \cdot I_1$$

$$R_M = E_{13} \cdot I_2$$

$$R_L = E_{21} \cdot I_3$$

are the registrations of upper, middle, and lower elements, respectively. By proceeding as in the preceding instances and

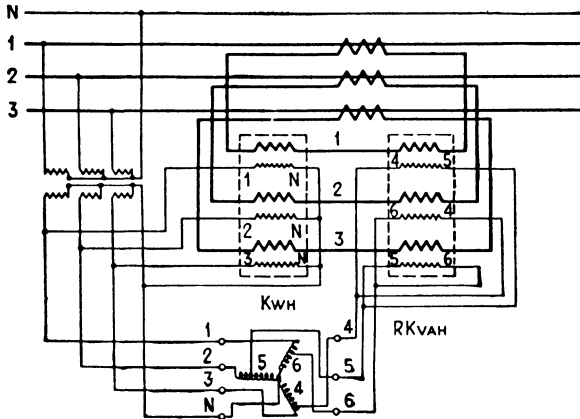

FIG. 161.

finally correcting the registration by applying the proper multiplier 0.577, there will result for the total registration

$$R_U + R_M + R_L = 3E_p I_p \sin \alpha - 3E_n I_n \sin \beta \quad [59]$$

With the possibility of the existence of zero-sequence components in a four-wire system the true registration should be as in Eq. [52].

$$Q = 3E_p I_p \sin \alpha + 3E_n I_n \sin \beta + 3E_o I_o \sin \gamma \quad [60]$$

This scheme has the common defect of registering the negative-sequence component in the wrong direction and does not register any part of such zero-sequence components of reactive volt-amperes as may be present.

14-12. Three-element Meter with Y Phasing Transformer.—With reference to Fig. 161 the registration of the respective meter elements (the ratios of the instrument transformers again ignored) will be

$$R_U = E_{45} \cdot I_1 = \frac{1}{3} \sqrt{3} (E_{30} - E_{20}) \cdot I_1$$

$$R_M = E_{64} \cdot I_2 = \frac{1}{3} \sqrt{3} (E_{10} - E_{30}) \cdot I_2$$

$$R_L = E_{56} \cdot I_3 = \frac{1}{3} \sqrt{3} (E_{20} - E_{10}) \cdot I_3$$

Applying the steps of the preceding sections:

$$R_U + R_M + R_L = 3E_p I_p \sin \alpha - 3E_n I_n \sin \beta \quad [61]$$

There is as in the immediately preceding instance the

$$\text{Error} = 6E_n I_n \sin \beta + 3E_o I_o \sin \gamma \quad [62]$$

14-13. Open-Y Phasing Transformer.—With reference to Fig. 162 the registration of the three elements will be

$$\begin{aligned} R_U &= E_{mn} \cdot I_A = (\frac{2}{3}\sqrt{3}E_{CN} - \frac{1}{3}\sqrt{3}E_{AN}) \cdot I_A \\ &= \frac{1}{3}\sqrt{3}(-E_{NA} - 2E_{NC}) \cdot I_A \\ R_M &= E_{pq} \cdot I_B = \frac{1}{3}\sqrt{3}(-E_{NA} + E_{NC}) \cdot I_B \\ R_L &= E_{rs} \cdot I_C = \frac{1}{3}\sqrt{3}(-2E_{NA} - E_{NC}) \cdot I_C \end{aligned}$$

Substituting components and simplifying:

$$\begin{aligned} R_U + R_M + R_L &= 3E_p I_p \sin \alpha - 3E_n I_n \sin \beta - \\ &3E_o I_p \sin (60^\circ + z - \alpha) - 3E_o I_n \sin \{60^\circ - [z - (n + \beta)]\} \quad [63] \end{aligned}$$

The error is, as before, found by subtracting from this total registration the sum of the reactive component values associated

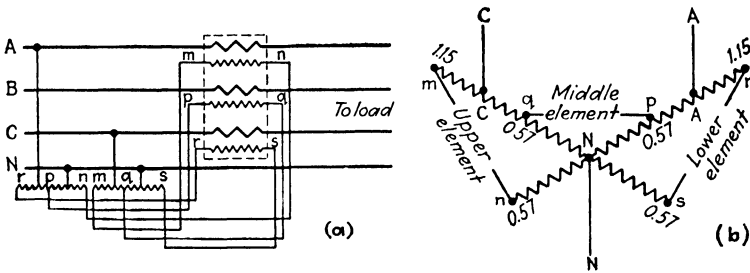

FIG. 162.

with the positive-, negative-, and zero-sequence systems, *i.e.*, Eq. [63] minus Eq. [50].

$$\begin{aligned} \text{Error} &= 6E_n I_n \sin \beta + 3E_o I_o \sin \gamma + \\ &3E_o I_p \sin (60^\circ + z - \alpha) + 3E_o I_n \sin \{60^\circ - [z - (n + \beta)]\} \quad [64] \end{aligned}$$

14-14. Two-element Meter on Four-wire; Phasing Transformer in Y, Current Transformer in Δ .—This was the case of Fig. 163a, treated in 13-12a. Here the registration of the upper element (with the effect of instrument transformer ratios omitted) is

$$R_U = E_{BC} \cdot (I_B - I_A)$$

and the lower element

$$R_L = E_{BA} \cdot (I_c - I_b)$$

The total reactive registration, after the symmetrical components of voltage and current are substituted, is

$$R_U + R_L = 3\sqrt{3}E_p I_p \sin \alpha - 3\sqrt{3}E_n I_n \sin \beta \quad [65]$$

This is a case in which the registration is to be corrected by applying the multiplier $\frac{1}{3}\sqrt{3}$ to correct for the departure in

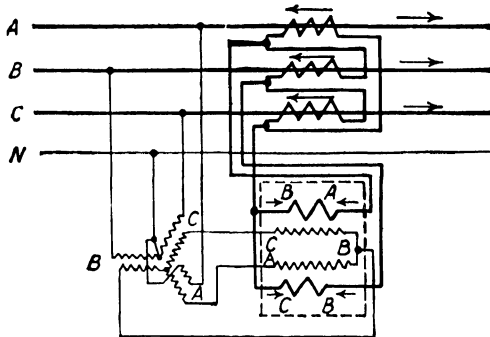

FIG. 163a.

value of voltage applied to the meter. After this correction is made, the error, by comparison with Eq. [50], is found to be

$$\text{Error} = 6E_n I_n \sin \beta + 3E_o I_o \sin \gamma \quad [66]$$

The same error would result from using a $2\frac{1}{2}$ -element meter (as in Fig. 165) in place of the two-element meter in conjunction with Δ -connected current transformers (Fig. 163a).

14-15. Voltage Transformers in V-V; Open- Δ Phasing Transformer; Current Transformers in Δ .—This is the case of Fig. 164a. Once more with the ratio of the current and voltage transformers ignored for the sake of simplicity, the registrations of the upper and lower elements are

$$R_U = E_{qr} \cdot (I_C - I_B)$$

$$R_L = E_{mn} \cdot (I_A - I_B)$$

Replacing the phasing transformer voltages by their equivalents in line-voltage values:

$$R_U = \frac{1}{3}\sqrt{3}(2E_{AN} + E_{CN}) \cdot (I_C - I_B)$$

$$R_L = \frac{1}{3}\sqrt{3}(-2E_{CN} - E_{AN}) \cdot (I_A - I_B)$$

Substituting the symmetrical components and simplifying:

$$R_U + R_L = 3E_p I_p \sin \alpha - E_n I_n \sin \beta - 3E_o I_p \sin (60^\circ + z - \alpha) - 3E_o I_n \sin \{60^\circ - [z - (n + \beta)]\} \quad [67]$$

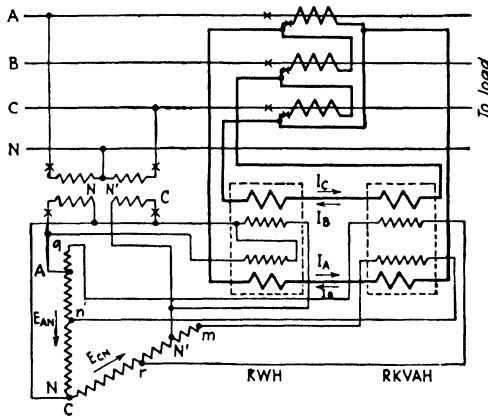
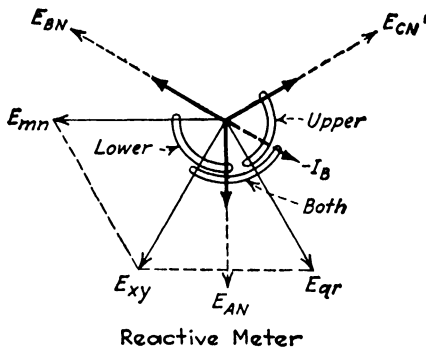

FIG. 164a.



Reactive Meter
FIG. 164c.

This is similar to the case of the open-Y phasing transformer and the error, therefore similar, is

$$\text{Error} = 6E_n I_n \sin \beta + 3E_o I_o \sin \gamma + 3E_o I_p \sin (60^\circ + z - \alpha) + 3E_o I_n \sin \{60^\circ - [z - (n + \beta)]\} \quad [68]$$

The error would be the same if a 2½-element meter were used instead of the two-element meter and Δ-connected current transformers.

14-16. Cross-phased 2½-element Meter.—This was the case of 13-13 and Fig. 165. In this instance the registrations of the two elements are proportional to

$$R_U = E_{cb} \cdot (I_a - I_b)$$

$$R_L = E_{ba} \cdot (I_c - I_b)$$

to be corrected by a multiplier of $\frac{1}{3}\sqrt{3}$.

Substituting the symmetrical components of current and voltage and simplifying:

$$R_U + R_L = 3E_p I_p \sin \alpha - 3E_n I_n \sin \beta \quad [69]$$

The error by comparison with the proper value as given by [50] is

$$\text{Error} = 6E_n I_n \sin \beta + 3E_o I_o \sin \gamma \quad [70]$$

14-17. Summary of Reactive Errors under Unbalanced Conditions.—Certain general

conclusions can be drawn from a summary of the errors of the various reactive metering schemes as presented in Table X.

1. If the voltages (or currents) are balanced, there is no error no matter how much the currents (or voltages) are unbalanced.
2. Every one of the schemes registers the negative-sequence components of reactive volt-amperes in the wrong sense and therefore introduces an error at least twice as great as the percentage of unbalance.
3. All the four-wire schemes fail to register any part of the zero-sequence components of reactive volt-amperes.
4. Cross-phasing a two-element meter (without phasing transformer) introduces a component of torque arising out of the interaction of negative-sequence components of current with positive-sequence components of voltage and *vice versa*; these products represent no power and no true reactive volt-amperes.
5. All types of phasing transformers on three-wire circuits introduce merely the error of registering the negative-sequence components in the wrong sense.

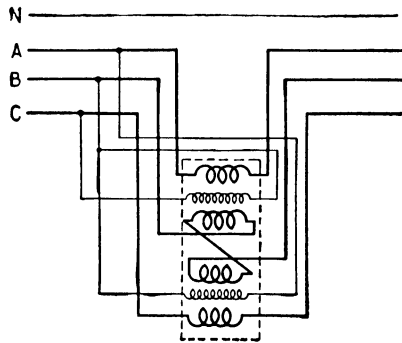

FIG. 165.

6. All types of phasing transformers on four-wire circuits introduce error through creating torque reaction between the zero-sequence component of voltage with the positive- and negative-sequence components of current; in general, however, this zero-sequence component of voltage will be small inasmuch as it is likely to arise principally out of drop in the neutral wire.
7. The $2\frac{1}{2}$ -element meter, or the two-element meter served from Δ -connected current transformers, used with a phasing transformer, has the simple error of the three-element meter.

TABLE X.—SUMMARY OF ERRORS IN REACTIVE METERING DUE TO UNBALANCE

Case	Section	Circuit wires	Number of meter elements	Type of phasing transformer	Instrument-transformer connection		Correction factor	Nature of error
					Voltage	Current		
1	14-9	3	2	None	None	None	$\frac{1}{2}\sqrt{3}$	$6(N) + \frac{3}{2}(NP)$
2	14-10 _a	3	2	Open Δ	Open Δ	Direct	1	$6(N)$
3	14-10 _b	3	2	Scott	None	None	1	$6(N)$
4	14-11	4	3	None	None	Direct	$\frac{1}{3}\sqrt{3}$	$6(N) + 3(O)$
5	14-12	4	3	Y	Y-Y or none	Direct	1	$6(N) + 3(O)$
6	14-13	4	3	Open Y	None or Y-Y	None or direct	1	$6(N) + 3(O) + 3(OP) + 3(ON)$
7	14-14	4	2	None	Y	Δ	$\frac{1}{3}\sqrt{3}$	$6(N) + 3(O)$
8	14-15	4	2	Open Δ	V-V	Δ	1	$6(N) + 3(O) + 3(OP) + 3(ON)$
9	14-16	4	$2\frac{1}{2}$	None	None	None	$\frac{1}{3}\sqrt{3}$	$6(N) + 3(O)$

(N) means negative-sequence rva.

(O) means zero-sequence rva.

(OP) means zero-sequence voltages interacting with positive-sequence currents.

(ON) means zero-sequence voltages interacting with negative-sequence currents.

(NP) means negative-sequence voltages interacting with positive-sequence currents and vice versa.

On the whole the tendency toward error on unbalance, the necessity for using a correction factor to compensate for odd voltage values, or the necessity for using special potential coils or registers to overcome the effects of odd voltages or multipliers should influence the choice of connections for general practice. On this basis only cases 2 and 3 of the table can be recommended for use on 3-wire circuits and cases 6 and 8 for 4-wire circuits. In the last case elimination of the multiplier by means of the phasing transformer is of more moment than elimination of errors

introduced by the phasing transformer through torque interaction of the symmetrical components.

These recommendations are further justified because they involve the use of the same type and rating of meter for rkvah. measurement as for the watt-hour meter on the given load.

14-18. Graphical Resolution of Symmetrical Components.—It was mentioned in 14-6 that the relations in Eq. [47] provide the basis for resolving an unbalanced system into its symmetrical components.

The first relation of Eq. [47] may be interpreted as indicating that three times the positive-sequence component is equal to the vector sum of vector 1 plus vector 2 rotated 120° plus vector 3 rotated 240° (or -120°). Also in the second relation three times the negative-sequence component is equal to the vector sum of the first plus the second rotated 240° and the third rotated 120° . By the third relation of Eq. [47] the zero-sequence component is merely one-third the vector sum, without rotation of any vector, or is equal to one-third the neutral current.

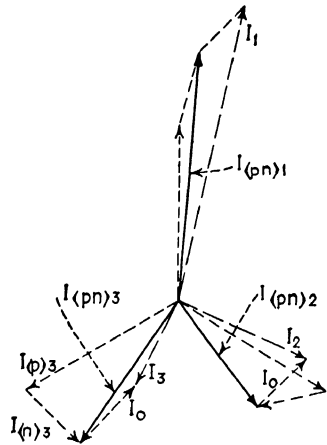

FIG. 170.

This last principle reduces all three-phase resolutions to a determination only of the positive- and negative-sequence components. Thus in Fig. 167 the zero-sequence component I_0 is one-third the closing side of the open figure. If this component is deducted from each of the vectors as in Fig. 170, the residual set of vectors embraces only the positive- and negative-sequence components.

First Method.—Arranging the three vectors in a triangle, the second and third are rotated 120° and -120° , respectively, about the extremities of the first. One-third the sum of the three in the new positions is the positive-sequence component as in Fig. 171a. The opposite direction of rotation of the second and third vectors produces three times the negative-sequence component as called for by the second relation of Eq. [47]. The result is seen to check with the components as assumed in Fig. 166abc.

Second Method.—Another method develops the positive- and negative-sequence components in a vector position which shows

directly how they combine to result in one of the unbalanced vectors. In Fig. 171b the middle point of M is taken on one of the vectors, say I_1 , and a right triangle AMP constructed with a 30° angle at A . Then BP is the negative-sequence component of I_1 and PA its positive-sequence component. The angle between the components is n .

This is based upon relationships which may be derived from Eq. [47] and certain j equivalents of a as shown in Table IX at items 1

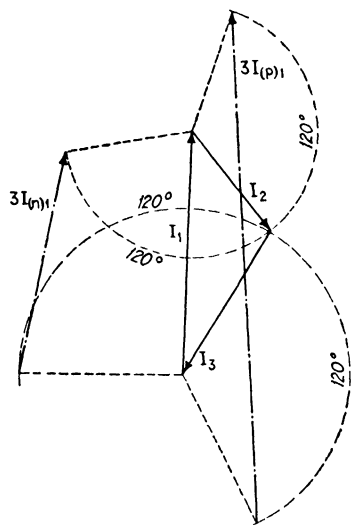

FIG. 171a.

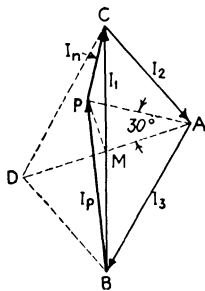

FIG. 171b.

and 2. By substituting these values for a in Eq. [47] and simplifying, there is for the positive-sequence component

$$I_{(p)1} = \frac{1}{2}I_1 + j\frac{1}{2\sqrt{3}}(I_3 - I_2)$$

and for the negative

$$I_{(n)1} = \frac{1}{2}I_1 - j\frac{1}{2\sqrt{3}}(I_3 - I_2)$$

The midpoint M establishes $\frac{1}{2}I_1$ in each of these expressions. Also AM is half the diagonal of the parallelogram $ABCD$ and therefore, vectorially,

$$AM = \frac{1}{2}(I_3 - I_2)$$

With angle MAP made equal to 30°

$$MP = AM \tan 30^\circ = \frac{1}{\sqrt{3}}AM = \frac{1}{2\sqrt{3}}(I_3 - I_2)$$

in magnitude and in addition is rotated 90° from *AM*. Therefore

$$MP = j \frac{1}{2\sqrt{3}}(I_3 - I_2)$$

The construction made $I_p = CM + MP$ and $I_n = BM + MP$ and these vector sums are in keeping with the requirements of Eq. [47].

Third Method.—Still another method develops the components in the form of equilateral triangles (Fig. 172). Construction lines are drawn from each vertex of the original vector triangle making 30° angles inside and outside with the sides of the original triangle. The six intersection points establish the vertices of the equilateral triangles, outside for the positive-sequence components and inside for the negative-sequence components.

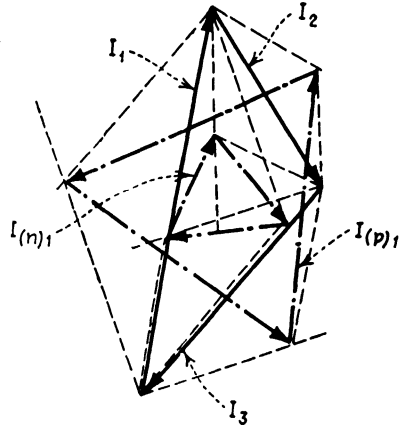

FIG. 172.

14-19. Metering Positive-sequence Voltages.—Symmetrical components may be measured by conventional forms of voltmeters, ammeters, wattmeters, and watt-hour meters in conjunction with specially designed external networks. In some instances the design of the meter may be modified by insertion

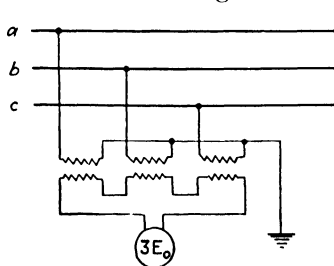

FIG. 173.

of special windings that dispense with the networks. The devising of these networks is principally due to R. D. Evans.

Zero-sequence voltage is easily measured as one-third the vector sum of the three line-to-neutral voltages as in Eq. [43]. This is simply obtained by inserting a voltmeter between the series terminals

of the three secondaries of voltage transformers, the primaries of which are subjected to the three neutral voltages. If calibrated to register one-third the voltage on it, the meter in Fig. 173 will indicate the zero-sequence component of voltages.

The positive- and negative-sequence voltages are related to the line-to-neutral voltages by Eq. [47]. As in the graphical construction (Fig. 170) the voltages are to be rotated 120° or 240°; but in case of the symmetrical-component meter the desired result can be affected by shifting the current through the meter

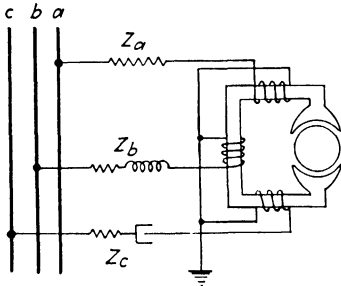

FIG. 174.

coil by an equivalent angle as long as the magnitude is kept proportional to the respective voltages. The phase shift of 120° and 240° by mere impedance would require negative resistances; but the negative effect can easily be attained by reversing the voltage and thus letting a 60° shift by an impedance element suffice. Thus in Fig. 174 the reversal of voltages E_b and E_c in conjunction with proportions of R and X in impedances Z_b and Z_c which will give a lagging current of 60° in Z_b and a leading current of 60° in Z_c will cause the meter to indicate three times the positive-sequence component of voltage.

Interchange of Z_b and Z_c will cause the meter to register the negative-sequence component as in Eq. [47].

14-20. Networks for Voltage Components.—If the zero-sequence components are excluded from the measurement network, the necessity for a special meter with three coils as in Fig. 174 can be avoided by means of an impedance network devised by C. T. Alleutt. Thus in Fig. 175, by Kirchoff's principle,

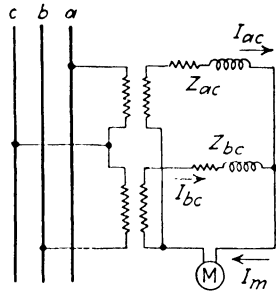

FIG. 175.

$$I_M = I_{ac} + I_{bc}$$

$$(E_{aN} - E_{cN}) = I_{ac}Z_{ac} + (I_{ac} + I_{bc})Z_M \quad [71a]$$

$$(E_{cN} - E_{bN}) = I_{bc}Z_{bc} + (I_{ac} + I_{bc})Z_M \quad [71b]$$

To solve for I_M multiply Eq. [71a] by Z_{bc} and Eq. [71b] by Z_{ac} and add the results.

$$I_M = \frac{Z_{bc}(E_{aN} - E_{cN}) + Z_{ac}(E_{cN} - E_{aN})}{Z_{bc}Z_{ac} + Z_M Z_{bc} + Z_M Z_{ac}}$$

Substituting for each of the voltages its positive- and negative-sequence components and simplifying:

$$I_M = \frac{(1 - a)(Z_{bc} + aZ_{ac})}{Z_{bc}Z_{ac} + Z_M(Z_{bc} + Z_{ac})} E_p + \frac{(1 - a^2)Z_{bc} + (a^2 - a)Z_{ac}}{Z_{bc}Z_{ac} + Z_M(Z_{bc} + Z_{ac})} E_n \quad [72]$$

This indicates that the meter may be made to register either the positive-sequence component E_p or the negative-sequence component E_n by so adjusting the impedances that the numerator of the coefficient of the other becomes zero.

Thus if

$$(1 - a^2)Z_{bc} = -(a^2 - a)Z_{ac}$$

since

$$(a^2 - a) = a^2(1 - a^2)$$

$$Z_{bc} = -a^2Z_{ac} = (\frac{1}{2} + j\frac{1}{2}\sqrt{3})Z_{ac}$$

and the meter will register only in proportion to the positive-sequence component.

Likewise if

$$Z_{bc} = -aZ_{ac} = (\frac{1}{2} - j\frac{1}{2}\sqrt{3})Z_{ac},$$

the meter will register only in proportion to the negative-sequence component.

Interchange of these 60° impedances or of two of the leads between the line wires and the network will change the meter from positive- to negative-sequence registration or *vice versa*.

Similar results can be attained by omitting the reversal of one voltage as in Fig. 175 and substituting a 60° condensive impedance for the resistance branch.

14-21. Network for Symmetrical Component of Current.—For the case where zero-sequence current is not present or cannot be (as in the three-phase three-wire ungrounded circuit), a network like Fig. 176 will accomplish the same results for current as did Fig. 175 for the voltages. Here the shunt impedance Z_c is to have a 60° phase angle so that for phase rota-

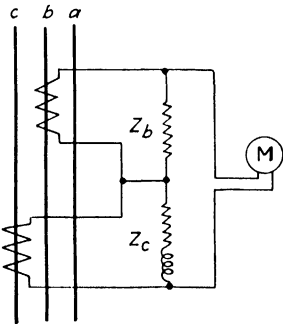

FIG. 176.

tion *abc* the meter will register the positive-sequence component of current.

Interchange of the current transformer connections or of the impedances will convert the meter to a negative-sequence indicator.

Wattmeters and watthour meters can be employed to indicate or register sequence components of power and energy flow by connecting their voltage and current windings to proper combinations of the segregating networks shown in Figs. 173 to 176.

14-22. Unbalance Factor.—The unbalance factor is the ratio of the negative- to positive-sequence magnitudes. It may apply to voltage, current, or even power and energy as measured by the sequence-metering schemes of the preceding sections.

European practice tends to emphasize the economic bearing of unbalanced loads upon the cost of rendering service. Unbalance of current prevents full economic use of investment in conductors and in apparatus capacities. It also tends to unbalance the voltages and thus necessitate added capital outlay for facilities to restore the voltage balance and maintain regulation. In this country there is less disposition at present to rank unbalance factor with power factor and load factor as an element to be metered in conjunction with billing for electric service.

Problems

14-1. A single-phase load of 60 kw. at 70 per cent lagging power factor is added to an existing balanced three-phase load of 100 kw. at 80 per cent lagging power factor. The voltage between line wires is 440.

- a. What are the three new line currents?
- b. What are the positive and negative sequence components of current?
- c. What is the current unbalance factor?

14-2. A three-phase four-wire system serves an industrial load which is mostly single-phase arc furnaces. Under certain conditions of factory operation the currents in the phase wires were found to be 3,000, 1,200, and 700 amp., respectively.

- a. Assume the voltages negligibly unbalanced and the same lagging phase angle in each phase and find I_p , I_n , and I_o by the method of Figs. 167 and 171b.
- b. Which method of metering the reactive component would you advocate in order to get the most reliable index of "average monthly power factor" of such a load?

14-3. Under short-circuit conditions out on the line between phases 1 and 2 the line currents at a substation are $I_1 = 1,200$ amp., $I_2 = 1,200$ amp.,

and $I_3 = 200$ amp. At the same time the Y-voltages are $E_{1N} = 42$ kv., $E_{2N} = 62$ kv., and $E_{3N} = 100$ kv.

- a. Show by the graphical method of Fig. 172 that $I_p = 793$ amp. and $I_n = 593$ amp.
- b. Check these results by applying Eq. [47].
- c. Show by the graphical method of Fig. 171b that $E_p = 71.7$ kv. and $E_n = 28.6$ kv.
- d. Check the results in c by Eq. [47] with voltages substituted for currents.

14-4. A 5-hp. wound-rotor induction motor took 1,730 watts of input under the following conditions of voltage unbalance:

$$\begin{array}{lll} E_{21} = 108.9, & E_{13} = 106.3, & E_{32} = 100.9 \\ I_1 = 24.0, & I_2 = 18.8, & I_3 = 14.6. \end{array}$$

- a. Show that $E_p = 60.9$, $E_n = 2.7$, $I_p = 18.7$, $I_n = 5.5$.
- b. What is the percentage voltage unbalance?

A reactive meter connected as in **14-10a** indicated 2,913.5 volt-amp.

- c. What should it have indicated if capable of such accuracy, assuming $\sin \alpha = 0.866$ and $\sin \beta = 0.820$?
- d. What was the percentage error in reactive-component measurement? Compare with the percentage voltage unbalance.

14-5. Use the method of **14-8** to show that four-wire three-phase meter with three elements is capable of registering loads of unbalanced nature without error.

14-6. Why does the geometrical construction of Fig. 172 as outlined in **14-18** result in the positive- and negative-sequence components?

CHAPTER XV

KILOVOLT-AMPERE METERING

The objective of reactive metering is to obtain an index of ruling power factor. Another frequent objective is an ascertainment of kilovolt-ampere demand at the time of maximum kilowatt demand. But as will be shown the assimilation of watthour meter readings with reactive kilovolt-ampere meter readings on loads that have variable characteristics does not give an index of power factor over the metering period that meets rigid requirements of rate economics. Where the loads and the revenues involved are of such magnitude as to justify the generally greater expense, the kilovolt-ampere meter is available in several forms. From it, used in conjunction with the watthour meter, there can be obtained indications that reconcile power metering more closely with the requirements of an equitable rate than is obtainable through the medium of conventional reactive metering.

Reactive metering artificially separates components which are continuously blended in the circuit in varying proportions. Kilovolt-ampere metering deals with them directly in their blended state. The latter comes nearer therefore to registering the circuit quantities in keeping with the manner in which they predetermine the necessary provision of capacity in power plants, substations, and lines. In the final analysis the aim of kva. as well as reactive metering is to promote load conditions which will keep power factor high and kva. capacity of lines and apparatus from unnecessary excess over kilowatt demand.

15-1. Kvah. Preferable to Rkvah.—That ordinary reactive metering may give dubious results can be seen from Fig. 177 which, while exaggerating ordinary conditions, is, nevertheless, not an impossible situation. The diagram represents a constant load of 340 kw. with 60 kva. of reactive component for one hour followed by 60 kw. and 340 kva. of reactive for the second hour. The corresponding power factors are 0.984 and 0.173. These are the values that would be obtained from meter readings taken at

the end of each of the hours. The kva.-hours computed would be 341.6 for the first hour and 341.6 for the second hour or 683.2 for the two hours with a resultant power factor of 0.494.

Actually, however, the watthour and reactive meters would not in general be read at hourly intervals, ordinarily not oftener than monthly. Two hourly periods so different in character would, if combined, more nearly represent the extremes likely to be embraced in a month's registration. The results for the 2-hr. interval are 565.6 kvah. and a power factor of 0.707. A kvah. meter, on the other hand, would circumvent such erroneous inferences by integrating the kvah. in purely additive manner rather than the vectorial summation which results from, say, monthly registration of watthour and reactive meter. That the error in kvah. by the latter procedure is considerable (17.3 per cent in this instance) can be inferred from Table XI. The kva. meter always gives a larger value than is obtained by taking the square root of the sum of the squares of kw-hr. and rkvah. for an extended period.

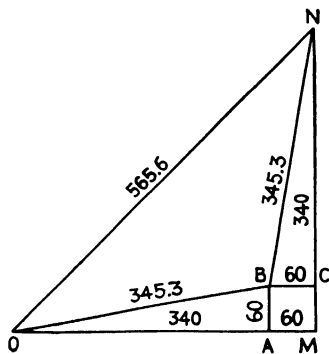

FIG. 177.

TABLE XI

Quantity	First hour	Second hour	Two hours	
			By kw-h. and rkvah.	By kw-h. and kvah.
Kwh.	340 (OA)	60 (BC)	400 (OM)	400 (OM)
Rkvah.	60 (AB)	340 (CN)	400 (MN)	
Kvah.	345.3 (OB)	345.3 (BN)	565.6 (ON)	683.2 (OBN)
Power factor.	0.984	0.173	0.707	0.494

These discrepancies become even greater if the indications of an unratcheted reactive meter on a load that may have either lagging or leading power factor are compared with those of a kva. meter.

15-2. Classification of Kva. Meters.—Two general types of kva. meters exist. One type embraces several forms of meters

that have in common the employment of the obvious principle that a wattmeter can be converted to a volt-ampere meter if the phase angle between current and voltage is eliminated or compensation introduced to neutralize its effect. With the phase angle made equivalent to zero degrees, $\cos \theta$ becomes 1. $EI \cos \theta$ becomes EI and the wattmeter is converted to a volt-ampere meter. Meters which fall under this classification are the Angus, Aron, Lincoln VAD, General Electric with over-running register, and schemes involving rectification of the alternating quantities.

The second type functions on the principle of vector addition. Two watt-hour-meter elements, one for watt-hours and the other for reactive volt-ampere-hours, are coupled through the medium of some mechanism which sums their revolutions or speeds vectorially. They derive the kva. in the form $\sqrt{(\text{k.w.})^2 + (\text{rkva.})^2}$. Meters which fall under this vector-addition classification are the Landis & Gyr, Sangamo, and Westinghouse (two forms).

15-3. Angus Volt-ampere Meter.—The induction watt-hour meter becomes a volt-ampere-hour meter if the potential applied to it is equal to the circuit voltage but shifted in phase from it so that, regardless of the load power factor, it is in phase at the meter with the load current. This is, however, difficult of accomplishment, apparently requiring a power-factor meter responding to the circuit power factor and actuating a potential phase shifter to which it would be mechanically coupled. By proper linkage and proper taps on the phase shifter, the desired result might be obtained, but from the design standpoint this is an impracticable scheme.

An equivalent result is obtained in the Angus meter. Instead of shifting the voltage phase, the flux which the voltage produces in the meter is shifted by a corresponding amount so as always to be in time quadrature with the current flux. This establishes the condition for maximum torque with given current and voltage.

In the Angus meter the phase shifter responding to load power factor is an inbuilt feature. The flux from the current coils C and C' (in Fig. 178) follows a divided path; part of the flux goes across the air gap at the disk and part across the rotor. The rotor has a polyphase winding, which is connected through slip rings and brushes to the three potential leads from the

metered polyphase circuit. This winding creates a rotating magnetic field which reacts with the current flux and causes the rotor to turn to such a position that, when the current flux is a maximum, the rotating field at that instant will be aligned with the current flux. The rotor thus serves as power-factor meter and phase shifter. After the shift of the rotor the potential flux across the air gap *KN* and disk is always in quadrature with current flux across *MP*, regardless of the power factor.

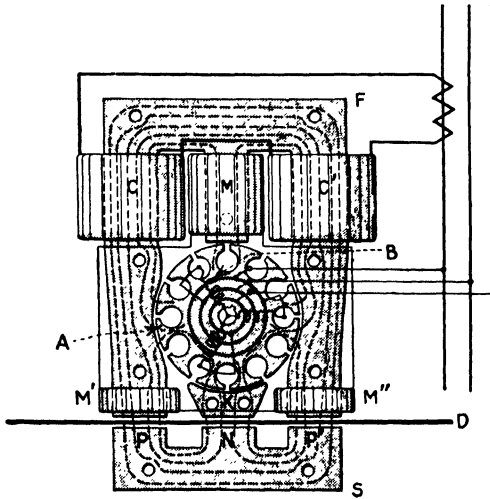

FIG. 178.

This is inherently a single-phase element. If a three-phase load is balanced, three times its indications on one phase will, of course, represent the kva. of the three-phase circuit. For the case where unbalance may occur on a three- or four-wire circuit, three such elements would be needed for accuracy.

15-4. Lincoln Volt-ampere Demand (VAD) Meter.—Although this is ordinarily employed in the form of a demand meter (see Chap. XVI), it is included here because of its kva. aspects. A phase-shifting autotransformer so modifies the response of the meter as to indicate volt-amperes with acceptable accuracy over a limited range of power factor. The accuracy depends on the amount of departure in actual power factor of the load from the average value estimated in advance. The phase-shifter taps are so taken as to compensate for the estimated value of power factor. Thus if the estimated average power factor is 80 per cent lagging, the phase angle is $36^{\circ}52'$. If the phase of

the voltage applied to the demand meter is then lagged $36^{\circ}52'$ by means of the phase shifter, the voltage will be in phase with the current (or in the case of the two-element three-phase meter 30° from it). The meter therefore gives a volt-ampere response.

But the indications will be true volt-amperes only at the assumed power factor—in this case 80 per cent. The errors will not exceed 1 per cent, however, as long as the phase angle between E and I at the VAD meter is not over $8^{\circ}7.5'$, lead or lag. This means that the actual load phase angle can be between $28^{\circ}44.5'$ and 45° without exceeding a 1 per cent error resulting from the arbitrary assumption of 80 per cent average power factor of the load. This means further that the power factor may range from 87.6 to 70.7 per cent without incurring more than the 1 per cent error. The phase-shifting autotransformer may be provided with taps to permit setting at other values of power factor. The customary power-factor ranges for the two sets of taps are 90 to 65 per cent and 75 to 45 per cent, allowing a 2 per cent tolerance in extreme error.

A ready way of ascertaining the power factor prevailing at the time of maximum demand of a given load is to connect a demand meter to each of the two sets of taps. The meter giving the larger indication at the end of a reading period reveals the power-factor range as that for which its taps have been taken. If the power factor varies widely, both meters may be left permanently installed, the larger indication of the two always being recorded as the maximum volt-ampere demand.

15-5. Overrunning-register Type.—Somewhat the same principle as in the Lincoln meter was developed by the General Electric Company. It is a single-phase meter consisting of three distinct induction watt-hour-meter elements. Each of these elements is adjusted by means of "lagging" (see 9-4) the potential element so that it will give maximum torque under different load power factors. Instead of shifting the voltage phase as in the Lincoln meter, however, it rests on shifting the time phase of the air-gap flux produced by the voltage element. The lag angles are customarily chosen at 11° , 33° , and 55° corresponding to 98, 84, and 60 per cent power factor. The meter elements are all connected to a single register through the medium of ratchets so that the element with the highest torque (and speed) actuates the register.

Under the conditions cited the registration is proportional to the volt-amperes with an error not exceeding 1 per cent for any phase angle less than 66° or power factor better than 40 per cent. The error is kept within these limits by adjusting each element to be 1 per cent fast at the compensated power-factor angle. Each would then be 1 per cent slow at the intermediate phase angles of 22° and 44° , each displaced 11° from the setting points of 11° , 33° , and 55° . Three such three-element meters are required to measure the volt-amperes of an unbalanced three-phase load.

15-6. Aron Ampere-hour Meter.—On the assumption that voltage is practically constant on commercial systems an ampere-hour meter should suffice for determination of kilovolt-ampere-hours. The Aron meter is of this type, being compensated for a limited range of voltage variation. It consists of an induction element functioning on the shaded-pole principle and actuated by the load current. The rotation of the disk of the meter is controlled, in part, by the damping action of permanent magnets and, in part, by the self-damping effect of the current flux (see 8-9). At rated load the damping from these two sources is made practically the same. If i is the load current, S the meter speed, and I the current equivalent of the permanent-magnet damping, the driving torque is ai^2 and the braking torque is $bS(I^2 + i^2)$ where a and b are design constants. At balance of driving and braking torque

$$S = \frac{a}{b} \left(\frac{I^2}{I^2 + i^2} \right) = k \left(\frac{I^2}{I^2 + i^2} \right)$$

Thus the relation of speed to torque is not strictly linear but can be made practically so except for the low percentages of load current.

Voltage variation is compensated for by means of a load-voltage-excited solenoid which moves a "shading coil" with respect to the main driving element. The shading coil contributes an amount of driving torque which corrects the torque and speed so as to keep the registration sensibly proportional to volt-amperes.

15-7. Volt-amperes by Rectification.—The advent of copper oxide and electron-tube rectification has afforded a ready means of converting alternating volts and amperes to equivalent d-c. values. The effect of phase angle can thus be eliminated

and the meter subjected to the rectified values then indicates or registers a result proportional to the a-c. volt-amperes. For integration only the commutator- or mercury-type meters may be used although the thermal type could presumably be adapted to demand indications.

Mere rectification does not suffice, however, in eliminating the effect of phase displacement between the a-c. quantities. The pulsations of the rectified half waves retain a phase displacement which will affect meter torque as can be seen from Fig. 179. Filters are needed in either or both the current and

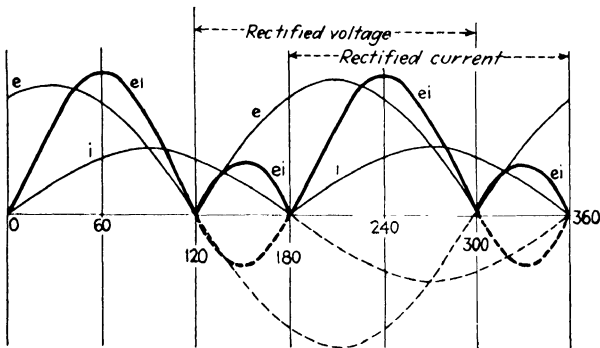

FIG. 179.

voltage circuits to smooth the waves sufficiently to minimize the phase displacement between the rectified half waves. A filter in the voltage circuit is the more feasible from the standpoint of rating and size of the filter elements. With the voltage wave converted to a reasonably smooth line it is practically immaterial where the current half waves fall in time phase.

Experimentation at Yale University in 1928-1930 by the author in conjunction with T. A. Abbott demonstrated a degree of feasibility of a single-phase meter based on this principle. Full-wave rectification of both voltage and current by means of copper oxide disk units in conjunction with the filter circuit indicated in Fig. 180 gave on a slightly modified electrodynamic wattmeter the results indicated in Fig. 181. The independence of power-factor values obtained by means of a phase shifter was practically perfect. The characteristics of the rectifier did not, however, permit deflection in close accordance with a linear law; there was also a time lag in response due to the thermal characteristics of the rectifiers. Effort to integrate kilovolt-ampere-hours

by means of a mercury-type d-c. watt-hour meter with demand register did not prove particularly successful because the 2½-

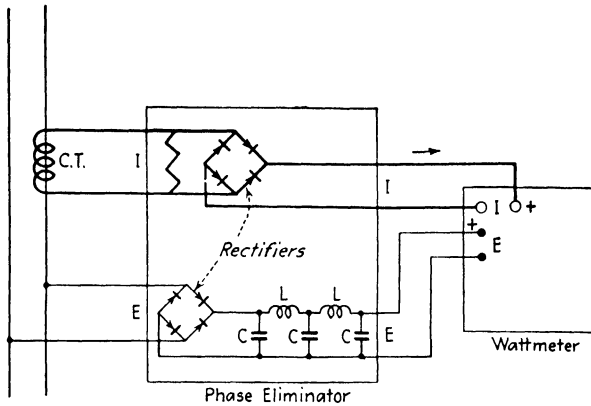

FIG. 180.

amp. rating dictated as an upper limit by filter considerations conflicted with the higher current rating dictated by the limitations of the mercury meter.

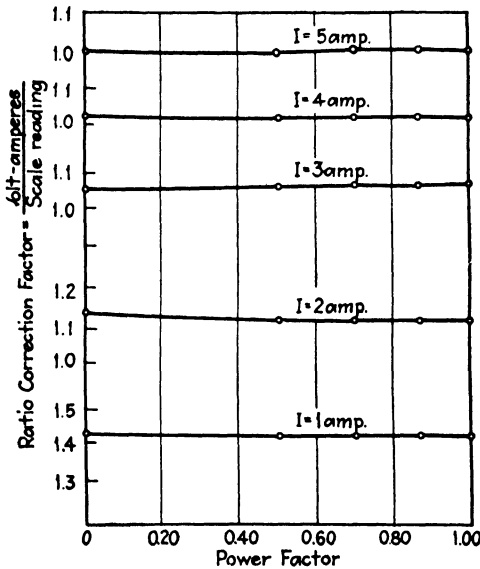

FIG. 181.

15-8. Phase-elimination Meters in Unbalanced Polyphase Circuits.—Inasmuch as the two-element wattmeter or watt-hour

TABLE XII.—VOLT-AMPERE METERING INACCURATE ON UNBALANCED LOADS

Case	Phase 1-2		Phase 2-3		Phase 3-1		Meter A		Meter B		Total volt-amperes		Actual volt-amperes
	I	p.f.	I	p.f.	I	p.f.	Connection		Reading		Uncorrected	Corrected*	
							$E_{12}I_1$	$E_{31}I_3$	$E_{12}I_1$	$E_{31}I_3$			
a.....	10	0.50	10	0.50	10	0.50	$E_{12}I_1$	$E_{31}I_3$	1,732	1,732	3,464	3,000	
b.....	10	1.00	10	0.50	10	0.50	$E_{12}I_1$	$E_{32}I_3$	1,000	1,732	2,732	3,000	
c.....	10	1.00	10	0.50	10	0.50	$E_{31}I_2$	$E_{21}I_3$	2,000	1,732	3,732	3,000	

* Correction factor 0.866.

meter will inherently register the power or energy correctly in three-wire three-phase lines regardless of load balance or power factor, it would appear that any of the preceding phase-elimination schemes would also register the volt-ampere quantities with equal inherent accuracy on a two-element basis. Actually accuracy is attainable only under balanced conditions and with identical power factor on all phases; even then a correction factor of $\frac{3}{2\sqrt{3}}$ or 0.866 must be applied for the same reasons as for the reactive meter discussed in 13-8. For unbalanced conditions of load and of individual phase power factors there will be errors incurred just as for the reactive meter.

To disclose the magnitude of error possible in two-element volt-ampere metering on unbalanced and mixed loads, consider the three simple cases of Δ -loading on a three-wire three-phase circuit presented in Table XII. Case *a* is a balanced load. Case *b* is balanced as to phase current but unbalanced as to watts, power factor, and line currents. For the metering, line 2 is taken as the common potential wire. Case *c* is identical with *b* except that line 1 is taken as the common potential wire for the metering.

For the balanced case there is no error. But for the unbalanced case there is error that is in itself dependent on the particular wires chosen

desired vector result is obtained graphically on a chart. The pen is moved horizontally in proportion to the kilowatts during the 15- or 30-min. demand interval (Fig. 182) while the chart is driven vertically at a speed proportional to the reactive volt-amperes by coupling the chart drive to the shaft of the reactive meter; the pen as a result draws the vector triangle, the hypotenuse of which is kva. demand during the interval. Vertical rulings on the chart constitute the kw.-demand scale and the same scale can be applied to the vertical side of the triangle to determine the kilovar magnitude. To facilitate deriving the kva. demand and power factor a polar chart is printed at intervals on the chart paper. By drawing OC parallel and equal to BT the intercept on the kva. circles will disclose the kva. demand to the same scale as the kw. Power factor can also be determined directly from the radial scale for power-factor angles.

If the load varies in magnitude and in power factor, the vector kva. and "average" power factor can be determined by joining the extremities of the record; the arithmetical sum of kva., if desired, can be determined by adding the component lengths of the record line.

Since the chart moves at a speed proportional to the reactive kva. and not uniformly (in proportion to time as in ordinary graphic or recording meters), some supplementary time scale must be provided if the time of occurrence of the maximum demand, poorest power factor, etc., are to be ascertained. A synchronous motor advances a second stylus slowly to the right from midnight to noon across the twelve hour-lines and back to the left during the period from noon to midnight. The time of day of the record can thus be read from the chart.

15-11. Vector Addition by Pantograph (Westinghouse RS).—The Westinghouse RS meter employs a pantograph to derive the vector sum of kwh. and rkva. demand from demand mechanisms superimposed on commercial polyphase meters, one for power and the other for the reactive component. The demand pointers of the kwh. and rkva. elements are arranged to swing over two opposed quadrants so placed that links connected to these pointers will move a pen (attached at the junction E of the links) over a kva. scale consisting of circular arcs. With power factor 1.0 the arm C (Fig. 183) will swing about N , the zero of the rkva. scale, as D is advanced along PS by the rotation of A proportional to the kw. demand. The PS scale

is therefore the kw.-demand scale. Conversely, PQ is the rkva.-demand scale because at zero power factor the arm D will pivot about M , the zero of the kw.-demand scale. For intermediate power factors the junction will assume a position E' fixed by the components PR and RE' , each of which is sensibly a straight line, whence PE' is the kva. demand, the resultant of the kw. demand PR and the rkva. demand RE' .

The location of E gives the demand during the prevailing demand interval. In order to leave a permanent record of

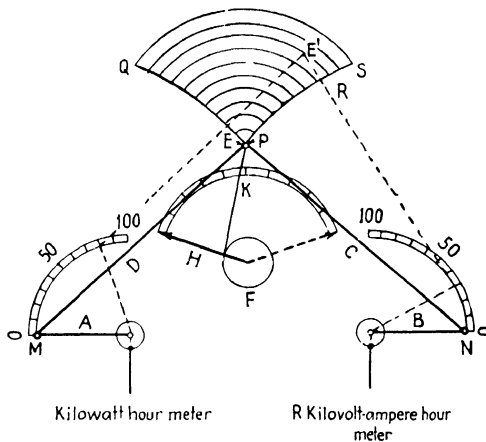

FIG. 183.

the maximum kva. demand, a third demand pointer and scale are provided below the sector PSQ . This pointer is advanced by means of a cord wrapped about a drum on its shaft and passing through a pulley at P to the link junction E . When a length of cord PE (proportional to kva.) is unwound from the drum by the motion of E , the kva.-demand pointer is advanced a corresponding amount over its scale and held there by friction until the last value of kva. is exceeded in some subsequent demand interval.

15-12. Vector Addition by Rolling Sphere (Westinghouse RI).

A valuable geometrical property of the sphere constitutes the principle of action of the Westinghouse RI kva.-demand meter. A light aluminum ball rests at three points on a free wheel W and two other wheels (Fig. 184) driven at speeds proportional respectively to kw. and rkva. The sphere rotates about an axis XY , the position of which depends on the ratios of the speeds of the two wheels d_1 and d_2 . If these speeds are

equal and the same in direction (as they will be at 70.7 per cent lagging power factor), the axis of rotation of the sphere will be horizontal and parallel to the axis of the two wheels. The radii of rotation a and b are then equal. Since the two wheel contacts

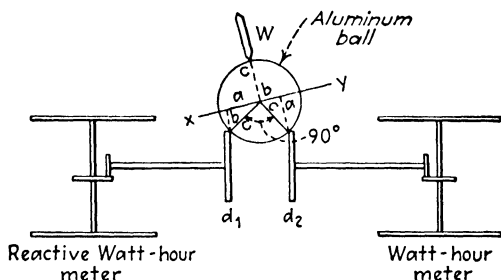

FIG. 184.

are separated by 90° of great circle arc, the speed of rotation of the third wheel W is proportional to C . Since $C = \sqrt{a^2 + b^2}$ the wheel W rotates at a speed proportional to the kva. The wheel W at all times follows the equatorial great circle, the one whose plane is perpendicular to the axis of rotation of the sphere. The tangential component of friction causes it to do so and thus swing to appropriate angular positions.

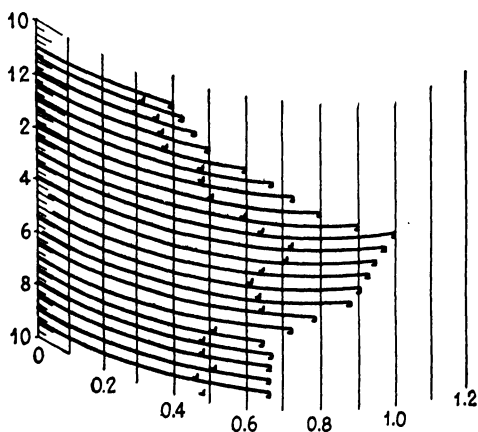

FIG. 185.

For power factor 1.0 the sphere will pivot about the stationary (reactive) wheel d_1 and the wheel W will ride in the middle of the upper left quadrant. For lagging power factor it will swing toward the right reaching the 45° position in the upper right

quadrant at zero power factor. For leading power factors it will move below its unity power-factor position because the reactive kva. wheel d_1 will then be rotating in a direction opposite to the kw. wheel d_2 and the sphere will be rotating about a vertical axis.

The revolutions of W during any demand interval are integrated by gearing and communicated to a pen which draws a proportionately long kva. record line on the chart (Fig. 185). Power factor is indicated by having a pen actuated by the kw.-demand element make a small mark alongside of the kva. line

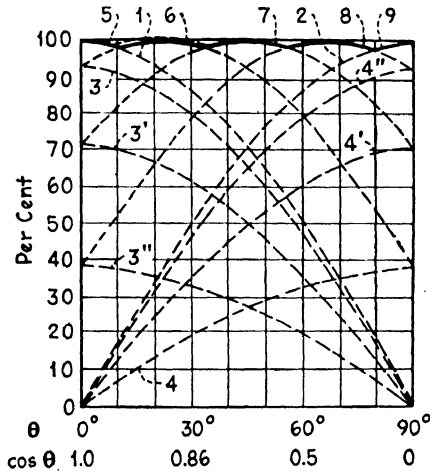

FIG. 186.

just at the end of the demand period, power factor being the ratio of the scale reading of the kw. mark and the length of the kva. record line.

15-13. Landis and Gyr "Trivector" Volt-ampere-hour Meter. The ingenious scheme of the Landis and Gyr "Trivector" meter employs a watt-hour meter and rva.h. meter as the actuating means for driving a volt-ampere-hour register in addition to the conventional kwh. and rkva.h. registers. The registration of total kilovolt-ampere-hours is brought within 1 per cent of accuracy for all values of power factor by resort to ratchet drive and a special assembly of planetary and spur gearing. Three intermediate systems of gearing effect additions of particular fractions of the speeds of each of the driving elements so that the combined speed at the kva.h. register is sensibly the same for any power factor as it is for 100 per cent power factor.

In Fig. 186 it can be seen that curve 1 represents the speed of the watthour element as power factor changes from zero to 1. Curve 2 is the speed curve for the reactive meter. Without any supplementary mechanism a volt-ampere registration with constant volt-amperes of load at decreasing power factors would drop along curve 1, instead of remaining constant. With ratchet or overrun mechanism provided, the reactive meter would take up the drive of the volt-ampere register as soon as

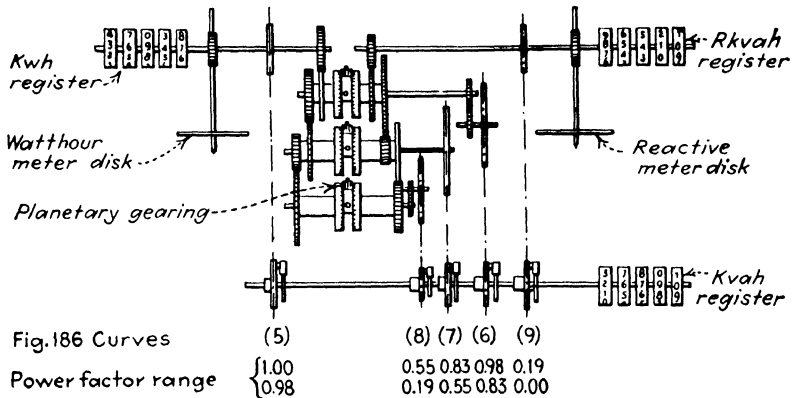

FIG. 187.

the power factor dropped to 0.707 and again increase the speed toward its proper value as the power factor approached zero. Throughout the 0 to 1 range of power factor the meter would average only 85 per cent of the kvah. and at 70.7 per cent power factor it would register only 70.7 per cent of the kvah.

The curves 1 and 2 are sine curves. Two sine curves when added result in a sine curve regardless of the phase displacement between them. The Trivector meter employs this principle by mechanical means rather than the electrical means of phase shifting as employed in the Lincoln VAD and General Electric overrunning register meters. The spur-gear sets in the central portion of Fig. 187 establish appropriate fractions of the speeds of the kwh. and rkvah. shafts that conform to the curves 3, 3', 3'', 4'', 4', 4. The planetary-gear sets then effect the addition of these in pairs: 3 and 4 to establish 6; 3' and 4' to establish 7; 3'' and 4'' to establish 8. The ratchets on the shaft of the volt-ampere register provide for its rotation at the maximum speed imparted to it from any of the five sources—watthour

meter or reactive meter alone, or any of the three intermediate combinations.

For fixed volt-ampere load at any power factor the meter will operate at the practically constant speed represented by the heavy-line segments of curves 5, 6, 7, 8, 9. The cusps are at 98.5 per cent so that a 1 per cent fast adjustment of kwh. and rkvah. elements will reduce the maximum error of kvah. registration to less than 1 per cent.

For leading power factors a relay (responsive to reversal of torque when power factor passes through unity) reverses the polarity of the potential on the reactive meter and thus drives it forward whether the power factor be lagging or leading.

15-14. Miscellaneous Kilovolt-ampere Meters.—Many other schemes for obtaining the product of volts and amperes independently of whatever phase angle may exist between them have been proposed. Even though the principal ones actually applied in practice have been described in this chapter, the opportunity for ingenuity in circumventing the phase-angle difficulty is large and interest in the subject is sustained. There is always the urge to meet the economic criterion that kva. demand is a truer index of readiness-to-serve cost than a kw. demand which ignores power factor and therefore the requisite capacity of apparatus and lines.

As showing principles differing from those already described there may be mentioned two United States patents by W. F. Sutherland (1,646,034 and 1,651,482). In one the (single-phase) meter is designed to sum the two torques obtained from two elements, one of which develops the torque $E \cos \theta \times I \cos \theta$ or $EI \cos^2 \theta$, the other $EI \sin^2 \theta$; the sum is $EI (\cos^2 \theta + \sin^2 \theta)$ or EI as desired. In the other (polyphase) meter one element develops torque proportional to $(E \pm I)^2 = E^2 \pm 2EI + I^2$ by means of combining the rotating fields established by E and I excitation of a polyphase structure similar to the induction-motor rotor and stator. The undesired terms E^2 and I^2 are neutralized in the torque result by setting up countertorques proportional to E^2 and I^2 (see 8-9). The remaining torque is proportional to EI as desired.

As a complete substitute for reactive and kva. metering Prof. V. Karapetoff has patented and the author has discussed (see *Electrical World*, January 28, 1933) a metering scheme which registers only the negative loop of the power wave. This is

the real quantity which oscillates or reciprocates between generator and load and it can therefore serve as an index of the excess apparatus and line capacity necessitated by low power factor. The meter involves half-wave rectification and allows only negative current to react with positive voltage in producing the meter torque.

Problems

15-1. Substitute for the data on which Fig. 177 was constructed the following load conditions:

First hour, 80 kw. at constant p.f. 0.707 lagging

Second hour, 80 kw. at constant p.f. 0.832 leading

Construct the kvah. diagram for three ways of metering the variable power-factor load:

- a. Kwh. and rkvah. meters, the latter without ratchet.
- b. Kwh. and rkvah. meters, the latter with ratchet.
- c. Westinghouse RI kvah. meter.

Tabulate the result for each hour and for the 2-hr. period as in **15-1** and Table XI. (The three "2-hr." power factors are 0.97, 0.89, 0.81, respectively.)

15-2. Determine the amount of phase shift to be introduced in conjunction with the Lincoln VAD meter of Par. **15-4** in order to keep within 2 per cent error in volt-ampere measurement for power-factor range of:

- a. 90 to 65 per cent.
- b. 75 to 45 per cent.

After the taps appropriate to either one of these ranges have been chosen, how much error in volt-ampere registration will result if the power factor happens to go to the extreme value of the other range, all power factors lagging?

15-3. A constant 110-volt Δ -connected load has equal impedances of 11 ohms in each leg but the proportions of reactance and resistance are such as to make the respective power factors 1, 0.866, and 0.50. The volt-ampere-hours of the load are to be determined by two "overrunning-register" meters (single phase, see Par. **15-5**); each meter consists of three single-phase elements for which the voltage phase is shifted 11° , 33° , and 55° , respectively.

- a. What are the total volt-amperes of this load?
- b. How many volt-amperes does each meter indicate?
- c. Shift one of the meters to the third wire and again determine the two indications.

15-4. Plot a curve showing the error in approximate volt-ampere registration of a watthour meter which has its potential shifted 30° lagging for all values of power factor, leading and lagging.

- a. How can the error be minimized over a 10 per cent power factor range either side of 86.6 per cent?
- b. What will a two-element watthour meter so adjusted read on the load of Prob. 15-3 if placed in the same wires as chosen for the meter in Prob. 15-3b?

15-5. Recompute Table XII for the three cases given but with the meter elements so inserted that wire 3 is used as the common potential wire instead of wire 2 as in the table, which applies to the group of "phase-elimination" meters.

15-6. Determine the registration of a polyphase Trivector meter inserted in the same two line wires of the load in Prob. 15-3 as were chosen in solving Prob. 15-3b.

15-7. If the curves 6 and 8 of Fig. 186 were eliminated by the omission of the corresponding planetary gearing and ratchet wheels of Fig. 187, what maximum error would result in volt-ampere registration of such an incomplete Trivector meter?

How much could this error be reduced by adjustment of the meter speeds as in **15-13**, next to the last paragraph?

CHAPTER XVI

DEMAND METERING

It takes funds, fuel, and folks to run an electric utility system and the charges for what it has for sale are to be designed somehow to recover the costs associated with such application of men, money, and materials to public service. The watthour meter of itself, in conjunction with a simple block-meter rate for energy, might suffice if all customers were quite similar as to time, extent, and regularity of their usage. Under such ideal circumstances the requisite capacity in plants and lines could be calculated and provided to a nicety. The annual carrying and operating charges associated with keeping the capacity-to-serve continually available could without great difficulty be apportioned equitably among all users. These charges could easily be a component of the meter rate over and above the assessment for production costs of energy actually consumed and for a fair share of the general operating administration of the company.

But this ideal loading is hardly if ever realized. Residential, commercial, and industrial consumer groups have their characteristic hours and peaks of usage. Within these groups there is even more diversity between individual loads as to time and magnitude of maximum and normal use. A user who creates a large demand for short periods is, of course, a less desirable customer than one who draws a steady load over long periods.

For the mass of small users the items of "demand" or maximum sustained use and "general" cost can be covered by a monthly charge of so much per room per month or so much per 100 sq. ft. or otherwise. But for the larger commercial and industrial users equity in allocation of the demand charge requires the installation of demand measurement either as an integral part of the watthour meter or in the form of a separate meter. The demand meter may be viewed not so much as a means of penalizing a customer for high peaks in conjunction with low kilowatt-hour consumption but more as a means of inducing higher load factor, longer "burning hours." In this

respect it can be likened to reactive metering, the prime objective of which is to encourage better power factor.

16-1. Definitions of Demand Characteristics.—The official definitions employed in the technique and practice of demand measurement are those of the "Code for Electricity Meters," an American Standards Association standard published by the National Electric Light Association (since superseded by Edison Electric Institute). The following are the definitions of the most significant terms:

1. *Load Factor.*—The load factor of a machine, plant, or system is the ratio of the average power to the maximum power during a certain period of time. The average power is taken over a certain period of time, such as a day, a month, or a year, and the maximum is taken as the average over a short interval of the maximum load within that period.
2. *Demand.*—The demand, for an installation or system, is the load which is drawn from the source of supply at the receiving terminals, averaged over a suitable and specified interval of time. Demand is expressed in kilowatts, kilovolt-amperes, amperes, or other suitable units.
3. *Maximum Demand.*—The maximum demand of an installation or system is the greatest of all demands which have occurred during the period. It is determined by measurement, according to specifications, over a prescribed time interval. In accordance with specifications, a demand may be measured by an instrument with a time lag or an instrument integrating the load over the prescribed time interval, or the load may be determined from a sufficient number of readings of an indicating instrument, taken over the time interval.
4. *Demand Interval.*—The length of the interval of time over which the demand is measured. For example, in a 15-min. demand, the demand interval is 15 min.

Temperature is the principal factor which limits the amount of load which can be imposed on electrical equipment. Considering the mass of its parts and its capacity for heat storage and heat dissipation, the limiting temperature of the insulating material is reached only after an appreciable time duration of the load. Any instantaneous demand is a less fair and less significant index of the tax upon apparatus-heating limitations than a

demand averaged in some manner over a period. The most common period is 15 min. with 30- and 60-min. intervals next in order of prevalence. A survey by the N.E.L.A. Rate Research Committee in 1931 showed the 15-, and 30-, and 60-min. intervals to be in vogue in the ratio 40:8:1, respectively.

5. *Diversity Factor*.—The ratio of the sum of the maximum power demands of the subdivisions of any system, or parts of a system to the maximum demand of the whole system, or of the part of the system under consideration, measured at the point of supply.
6. *Averaged Maximum Demand*.—The highest average or arithmetical mean of several similar demands. It may be computed from several demands on a definite number of days, either consecutive or within certain limits of time, such as a month or a year.
7. *Demand Meter*.—A demand meter is a device which indicates or records the demand or maximum demand.
8. *Integrated-demand Meter*.—An integrated-demand meter is one which indicates or records the maximum demand obtained through integration.
9. *Lagged-demand Meter*.—A lagged-demand meter is one in which the indication of the maximum demand is subject to a characteristic time lag.

16-2. Classification of Demand Meters.—There are three principal types of demand meters: (I) recording (formerly called “graphic” or “curve-drawing”) meters, (II) integrated-demand meters, (III) lagged-demand meters.

In addition there are current limiters or demand limiters which are not meters but devices which restrict the customer's maximum use to predetermined limits and consequently act like demand meters in promoting improved load factors or preventing the penalty of higher demand charges than are necessary. There are also multi-rate and excess meters which record separately usage during on-peak hours or in excess of a predetermined value.

Class I. Recording Meters.—A recording wattmeter in which a pen draws on a moving chart the load-time curve can, of course, be used to ascertain maximum demand. In general the instantaneous demand is not to be taken but rather the average demand over the stipulated demand interval. With a fluctuating load this involves the use of a planimeter to measure the area under

the load curve during the various demand intervals. Division of the area by the time base gives as the demand the average height of the curve. This is usually a tedious process and not conducive to simplicity in billing. A circular chart makes for much more difficulty than the strip type.

Either of the following types is generally preferable.

Class II. Integrated-demand Meters.—Some device may be used in conjunction with the watthour meter so that a periodic record is made of the kilowatt-hours consumed during the demand interval. Such an integrated-demand meter is available in two forms, both involving the principle of arithmetical averaging. The effect is equivalent to that of a meter reader reading the watthour meter every 15 or 30 min.

Form A.—This type shows the energy consumption during intervals which begin and end at specific and arbitrarily established times. If the record is on a tape or chart which carries a time scale, the magnitude of demand and the day and time of day of that demand can all be ascertained from the record. If the record is the position of a pointer on a demand scale, only the magnitude of the demand since the last reset of the pointer is ascertainable.

Form B.—This type makes a record on a tape or chart each time the consumption of a predetermined block of kilowatt-hours has occurred. The higher the load, the more frequently a record is made. The maximum demand is ascertained by scrutinizing the tape or chart to find the demand interval during which the largest number of equal blocks of kilowatt-hours were consumed. This type differs from Form A in that the time of beginning and ending the time interval is not arbitrarily fixed but is selectable by the computer.

Class III. Lagged-demand Meters.—The lagged-demand meters function on the basis of requiring a certain time interval for the indication to reach a point corresponding to the value of the load. The scheme is thus an effort to make the indication lag behind the actual value of the load in much the same way that the rising temperature of the supply apparatus lags behind the load imposed on it. The indication therefore can appropriately have a logarithmic or exponential time characteristic.

Class III demand meters differ from Class II in that the record begins when the load begins and not at some fixed clock time as for Class II. Two forms exist.

Form A.—In this type the rate at which the pointer moves over the scale is proportional to the load at each instant. It therefore moves upscale at constant speed under constant load. The lagging is mechanical.

Form B.—In this type the speed of motion of the pointer diminishes, even with constant load, toward the end of the deflection integral. Theoretically, it would take an infinite time to reach the ultimate deflection. Practically this

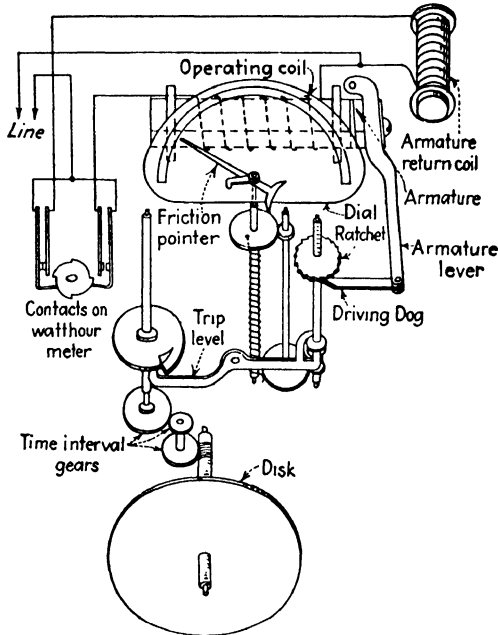

FIG. 188.

characteristic is overcome by defining the time interval as that required for the instrument to indicate 90 per cent of the full value of a steady load thrown on the system suddenly without previous loading. The lagging is thermal (or a mechanical equivalent).

16-3. Integrated-demand Meter, Form A.—(1) The General Electric Type M meter will be described as typical of the demand meter embracing in its structure no electrical element producing torque proportional to the load. Contacts opened and closed at the associated watt-hour meter (at a rate proportional to the speed of that meter's disk) actuate solenoids (Fig. 188) in the demand meter which advance and return its pointer over a

scale. A constant-speed induction motor of the disk type provides the timing for the 15-, 30-, or 60-min. reset function.

The higher the load, the more rapidly the watthour meter is rotating and the more frequently the contacts are made and broken. In turn the actuation of the two solenoids (operating and armature return) is more frequent and the driving dog therefore advances the demand pointer more rapidly over the scale. The rate is proportional to the load. When the clock

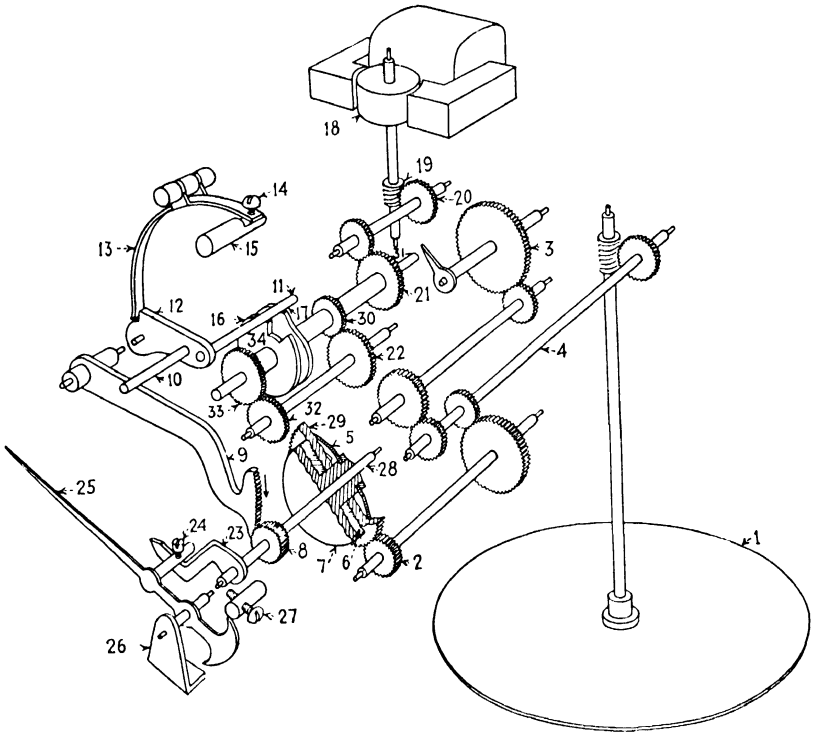

FIG. 189.

motor has reached the end of the predetermined demand interval, the trip lever disengages the driving gear and a spring returns to the zero position the pusher arm which advanced the pointer. The indicating pointer itself is retained by friction at the maximum demand position until some subsequent demand advances it further or until it is reset to zero by the meter reader.

16-4. Integrated-demand Meter, Form A.—(2) Another variety of Form A integrated-demand meter consolidates the demand indicator with the watthour meter so that the kilowatt-

hours consumed and the maximum demand in kilowatts are shown on a single dial. The timing is generally provided by means of a small synchronous motor. The Sangamo Type HB Maximum Demand meter as shown schematically in Fig. 189 is characteristic of several makes of demand meters. The watt-hour-meter disk 1 drives the kilowatt-hour register gearing 3 in the usual way but shaft 4 also drives the shaft 28 which carries the pusher arm 23 which advances the indicating sweep hand 25 at a rate proportional to the load. A friction clutch 7 couples gear 6 to shaft 28. The reset mechanism which acts in accordance with the predetermined time interval is driven by the synchronous motor 18. Cam 16, by means of a double gear reduction (30/22, 32/33), is operated at slower speed than cam 17, usually one-sixteenth as fast as cam 17. Whenever the small radius of cam 17 coincides with the notch 34 in cam 16, pin 11 drops into notch 34 and, through the medium of toothed sector 9, returns the pusher arm 23 to zero as fixed by set screws 27. This reset function is performed at 15-, 30-, or 60-min. intervals as desired by proper choice of the gear reduction between the synchronous motor and the cams 16 and 17.

The demand registers attachable to Duncan, Westinghouse OB, and General Electric I-16 watt-hour meters involve the same general principle as the Sangamo demand register just described, although there are differences of detail in the cam and gearing arrangements.

16-5. Integrated-demand Meter, Form A.—(3) The Westinghouse RA Polyphase Recording Demand meter provides a graphic record in place of the dial indication of the preceding designs of integrated-demand meters. The pen *P* (Fig. 190) is positively advanced by the rotation of the watt-hour-meter shaft *D* which at the same time is advancing the kilowatt-hour register. At the end of the demand interval the tripping rod pushes against *F* and takes gear *G* out of mesh with worm 1. The pen is then swung back to zero by the counterweight *C*. When pressure on *F* is released, spring *E* replaces *G* in mesh with worm 1 for a new cycle.

The time interval is controlled by the spring-driven clock *I* the rate of which is regulated by the escapement mechanism *J* and a differential spring governor. At the predetermined time intervals the trip on shaft *M* allows shaft *K* to rotate at a speed which is controlled by the fan governor *L*. The reset wheel *Y* is

given a quarter turn and causes the bell-crank *H* to trip the pen *P* through the medium of *F* as previously described. Just before the pen is returned to zero by this means, the large gear on the

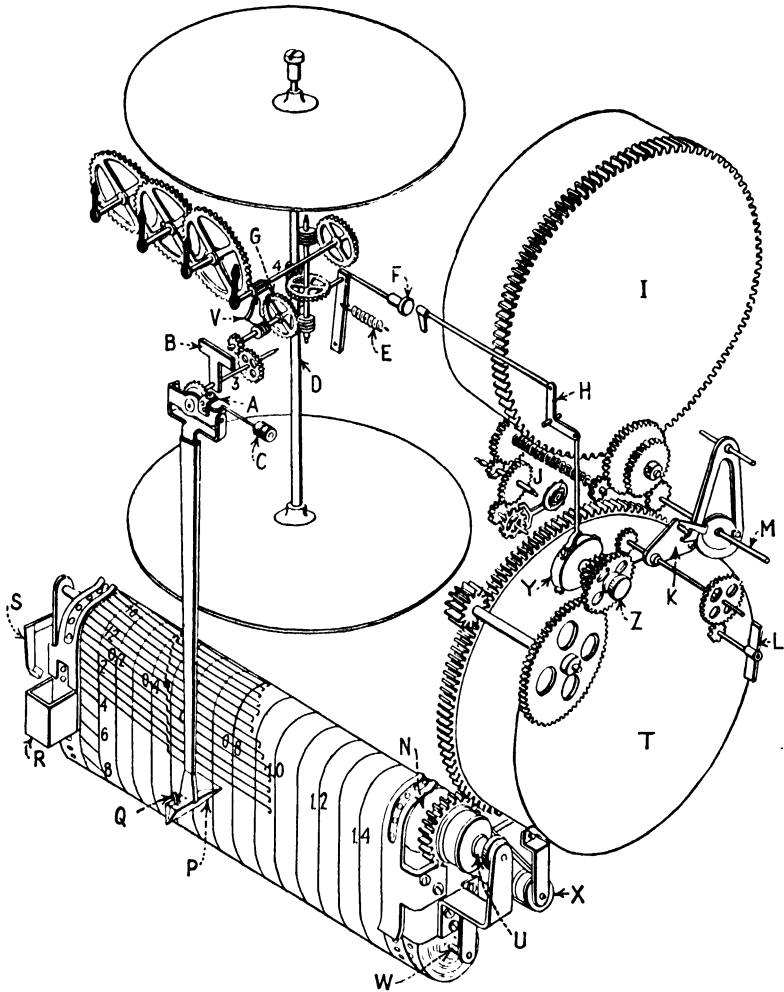

FIG. 190.

spring-driven drum *T* is allowed to advance the chart a small amount, proportional to the time scale printed on the chart. The object in starting the motion of the proper chart before the pen is returned to zero is to make a small "hook" at the end of each indication so that there will be no doubt just how far the pen

had been advanced in making the demand indication on the chart.

As shown, the record on the chart has a "jog" near the middle of the trace. This is the 15-min. interval, the paper being advanced slightly at this time without returning the pen to zero, thus making the meter simultaneously a 15-min. and 30-min. demand device.

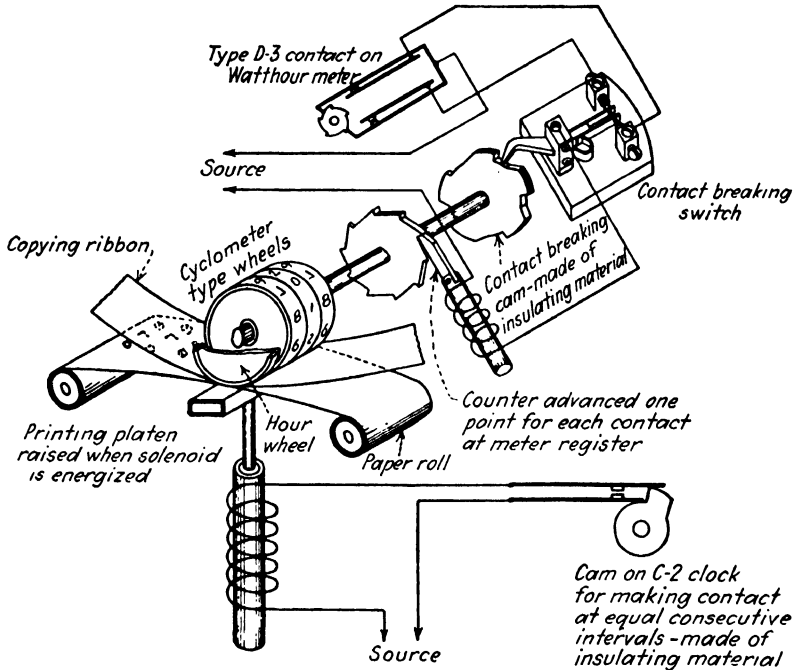

FIG. 191a.

16-6. Integrated-demand Meter, Form B.—Formerly the General Electric Company made a meter, known as the Printometer, which can be placed in this classification. Other than recording meters it offered the principal example of Form B (see 16-2) in that, when set for a shorter time interval than the billing demand interval, it afforded a means whereby the computer of the bill could choose the time of beginning and end of the demand interval in a way not provided in Form A which establishes these times arbitrarily by the clock action.

The Printometer was actuated by the associated watthour meter. A separate contact-making clock provided the timing element. As shown in Fig. 191a the cyclometer counter of the

demand meter reproduces the registration of the watthour meter and this is printed on the tape by the following means: The *D-3* contact wheel attached to the register of the watthour meter (see 16-3) advances the counter one unit for each unit of advance of the watthour-meter register. At the predetermined time intervals the clock contacts close and a solenoid is energized to raise the printing platen and make a record of the time and the kilowatt-hours on the tape as shown in Fig. 191b.

Assume the demand-interval is 1 hr. The maximum consumption during any hour is from 8:30 to 9:30, *i.e.*, 227-141 or 86 kw-hr. With a Form A meter beginning the hourly demand intervals "on the hour," the maximum demand would have determined as 85 from the difference 268-183 from 9:00 to 10:00. The maximum half-hour consumption is 44 kw-hr. between 9:00 and 9:30 giving a 30-min. demand of 88 kw. To the extent that the Printometer may be set to print the record at shorter intervals than the demand interval, it therefore enables the computer to choose the beginning and end of the time interval.

This meter has been superseded by Type PD which prints the actual consumption during each interval (the cyclometer dial being reset to zero after each record, thereby making subtraction by the computer unnecessary).

6	079	0	}	6
6	079	6		
7	085	6	}	12
7	091	14		
8	105	36	}	50
8	141	42		
9	183	42	}	86
9	227	44		
10	268	41	}	84
10	311	43		
11	347	36	}	68
11	379	32		
12	409	30	}	62
12	433	24		

FIG. 191b.

An earlier form, even more closely in conformity with the definition of Form B, printed the time and the kilowatt-hours each time a given number of kilowatt-hours was consumed. During the high loads the records become more frequent and the computer looked for the particular time interval in which the largest consumption took place.

16-7. Lagged-demand Meter, Form A.—This type is exemplified by the former RO meter of the Westinghouse Electric and Manufacturing Company. Mechanical and electrical means were employed to prevent the demand being registered as the instantaneous value of the load; *i.e.*, the lagging was electro-mechanical. It really consisted of a watthour meter and a

wattmeter built into a single electrical structure. An auxiliary disk is inserted in the air gap of the driving element (Fig. 192) above the regular watt-hour-meter disk. The auxiliary disk is restrained against rotation by a spiral spring. Without any other restraint it would deflect instantly to an amount proportional to the torque imposed upon it; this torque is proportional to the load. The same torque rotates the watt-hour-meter disk continuously at a speed proportional to the load. The demand

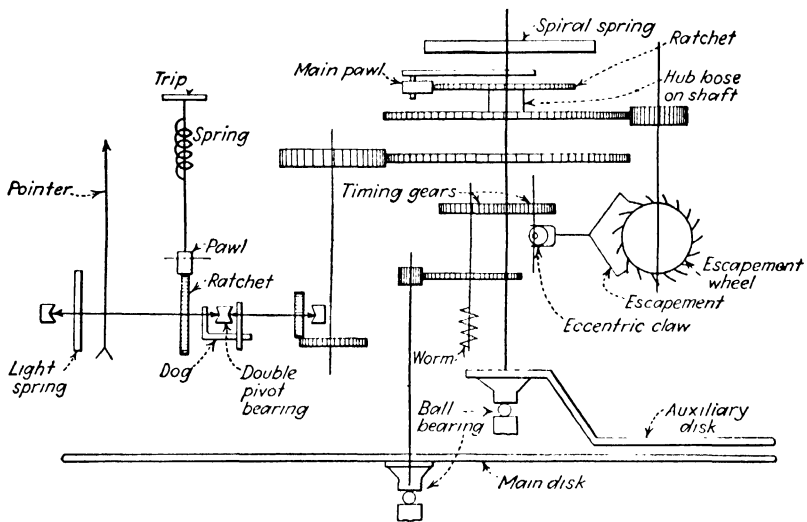

FIG. 192.

disk is further restrained by an escapement actuated by the watt-hour mechanism. The action is as follows:

At any load the rate at which the escapement wheel is released by the escapement claw, which is oscillated by an eccentric geared to the shaft of the watt-hour disk, is proportional to the speed of the watt-hour meter. The higher the load, the more rapid the escapement action and the faster the demand disk is allowed to deflect and carry the demand pointer to its corresponding deflection. But the higher the load, the greater the ultimate deflection of the auxiliary disk and of the demand pointer. The rate at which the demand pointer is advanced is therefore proportional to the load. In other words, the time required for registration of the demand of all constant loads is the same and by proper gearing this time can be made 15, 30, or 60 min. to fit the demand interval desired.

Thus in R_1 the heating effect at power factor $\cos \theta$ is

$$I_1^2 R_1 = \left[i_e^2 + 2 \frac{I_L}{2} i_e \cos \theta + \left(\frac{I_L}{2} \right)^2 \right] R_1$$

and in R_2

$$\begin{aligned} I_2^2 R_2 &= \left[i_e^2 + 2 \frac{I_L}{2} i_e \cos (180^\circ - \theta) + \left(\frac{I_L}{2} \right)^2 \right] R_2 \\ &= \left[i_e^2 - 2 \frac{I_L}{2} i_e \cos \theta + \left(\frac{I_L}{2} \right)^2 \right] R_2 \end{aligned}$$

If R_1 and R_2 are made equal, since the two springs heated by these thermal units are opposed, the deflection D is proportional to the difference in heating developed in the two resistors.

$$\begin{aligned} D &= KR(I_1^2 - I_2^2) \\ &= KR \left(4 \frac{I_L}{2} i_e \cos \theta \right) \\ &= K(2)(i_e R) I_L \cos \theta \\ &= K' E I_L \cos \theta \end{aligned}$$

The deflection, without heat storage, is thus proportional to the load in watts.

Lagging, or delay of deflection, is accomplished by enclosing the bimetallic springs in boxes of such mass and specific heat as to absorb and store the heat to a degree that establishes the desired demand interval.

16-9. Demand Interval for Thermal Meters.—When heat is developed by the load in a thermally lagged demand meter and imparted to the heat-storage boxes, the temperature of those boxes and of the bimetallic springs follows an exponential or logarithmic law. The mathematical statement of this law is

$$\theta = T_1(1 - e^{-kt}) \quad [73]$$

in which

θ = the rise in temperature at any time above the initial temperature.

T_1 = the final temperature rise when equilibrium is reached, *i.e.*, the ultimate temperature rise corresponding to a constant and sustained load.

e = 2.7183, the base of Napierian logarithms.

k = a calibrating constant.

t = elapsed time from the beginning of heat application.

The temperature rise is not proportional to the instantaneous watts but depends on the history of the load up to the time in question. The meaning of the expression of Eq. [73] can readily be grasped by assuming constant load and letting t successively have values which are multiples of some short time interval, say 5 min., and letting $e^k = 2$. Then $T_1 - \theta = T_1/2^t$ as t is made 1, 2, 3, etc. for consecutive 5-min. intervals. The intervening temperature rise in each interval is such as to halve the amount of rise still to take place in reaching T_1 . This characteristic is shown in Fig. 194. One-half the ultimate rise in temperature

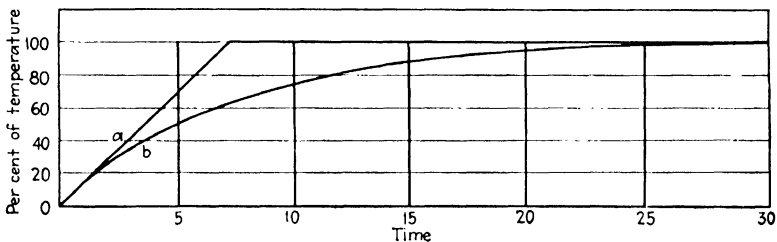

FIG. 194.

takes place in the first 5 min., three-fourths is attained in the second 5 min., seven-eighths in 15 min., etc. Theoretically the ultimate temperature will never be reached but practically it is reached within the customary demand intervals.

The demand interval for a thermal meter depends, therefore, on arbitrary definition. If deflection reaches 90 per cent of the ultimate value in 10 min., it will be at 99 per cent of full reading in 20 min. and 99.9 per cent in 30 min. It is a matter of choice whether the demand interval be called 10, 20, or 30 min. Likewise a meter which gives a 90 per cent deflection in 15 min. would give 99 per cent in 30 min. and might be described as having a 15-min. or 30-min. demand interval depending upon the definition incorporated in the power contract.

16-10. Mechanical Equivalent of Thermal Demand Meter.—The Westinghouse RL Demand Meter, described by B. H. Smith in a 1934 A.I.E.E. paper, involves a mechanism which simulates the functioning of the thermal demand meter of 16-8. Its response is similarly logarithmic in character. The pusher arm is not tripped as in definite time-interval meters but moves always up or down scale as the load varies, thus giving a continuous indication of the existing demand.

The essence of the mechanism consists of a disk, ball, cylinder, and an involute cam attached to the planetary gear of a differential gear assembly (Fig. 195). The two sides *A* and *B* of the differential are driven respectively by the watt-hour-meter shaft and by a synchronous motor through the medium of the disk *E*, ball and cylinder *F*, which is tilted slightly so that the ball always rests against the involute cam *C*. If the cam is not in such

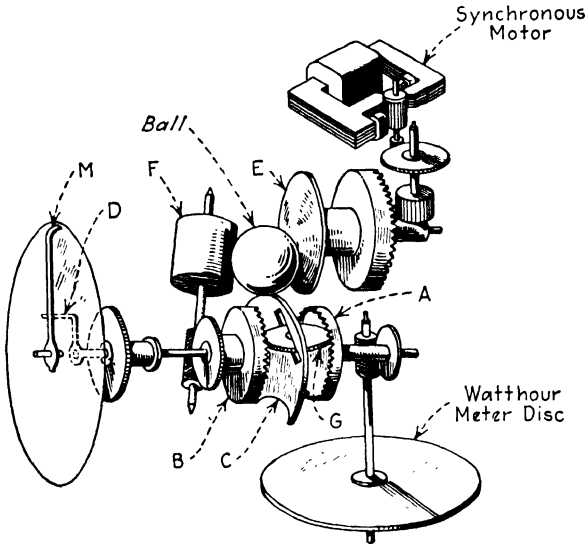

FIG. 195.

angular position as to place the ball at the center of the disk *E*, the constant rotation of *E* by the synchronous motor will spin the ball about an axis parallel to the shaft of *F*, and *F* in turn will be propelled at a speed proportional to the speed of *E* and to the radius of the ball's contact circle on *E*. Gear *B* will then be driven by cylinder *F* and in turn the planetary gear mounted on the involute cam *C* will be turned at a speed which will be the difference of the speeds of *A* and *B*.

If there is no load on the watt-hour meter, *A* will be stationary and the cam *C* will turn until the ball is pushed to the center of the disk where it will then remain because it, *B*, and the planetary gear and cam will no longer be rotated by the disk. The pusher arm *D*, attached to the shaft of the cam, will meanwhile have gone to its zero position corresponding to zero load and demand. Likewise for any constant load the then constant speeds of both

A and *B* will keep the planetary gear, cam, and ball in fixed locations corresponding to that value of load.

For any constant load abruptly applied to the meter, the motion of the ball, planetary gear, cam, and pusher arm will at first be rapid and then decrease as the position of equilibrium corresponding to that load is reached. This is also the characteristic of the thermal meter as analyzed in 16-9. The time to reach the 90 per cent point is

$$t = T \log \frac{1}{1 - 0.9}$$

$$= 2.302T$$

where *T* is the time for the watthour meter to bring the ball and cam from the zero position to that corresponding to the load with the synchronous motor not running, *i.e.*, gear *B* stationary. Thus if the gear ratios between the motor and *B* and between the meter and *A* are so chosen as to bring the pointer to full scale for full load on the meter in 30/2.302 or 13.02 min., the time interval may be called 30 min. In other words, with the motor running the demand pointer will attain 90 per cent of true value in 30 min. In another 30 min. the indication will be brought to 99 per cent. For a 15-min. interval the gear ratios would be so chosen as to attain the 90 per cent value in 6.51 min. with the synchronous motor not running.

16-11. Other Thermal Demand Meters.—The Westinghouse RH Thermal Demand Meter operates on the same principle as the Lincoln meter. The General Electric H-2 meter registers maximum current demand. In this instance only one heater is necessary in the case of a two-wire meter, the second bimetallic spring responding only to changes in ambient temperature and thus rendering the meter practically independent of the temperature of the surroundings. (The two opposed springs in the Lincoln and Westinghouse meters also compensate for ambient temperature.) The scale is an ampere-squared scale and therefore not linear as in the Lincoln thermal watt-demand meter.

The Wright Demand Indicator is also a maximum-ampere-demand meter. It consists of two glass bulbs filled with air and connected by a U-tube filled with concentrated sulphuric acid. An index tube is tapped off at the top of one branch of the U-tube. Around the bulb at the top of the other branch of the U-tube is a heater unit which carries the load current. Load

results in the heating of the air in the bulb, the acid is pushed upward in the other arm of the U and runs over into the index column. The amount which accumulates there is a measure of the maximum value of amperes. The meter is reset to zero, after reading, by tilting the meter so as to drain the acid from the index tube back into the U-tube. Lagging is obtained by capillary constrictions in the tube.

The Wright and General Electric H-2 meters may be used on either alternating or direct current.

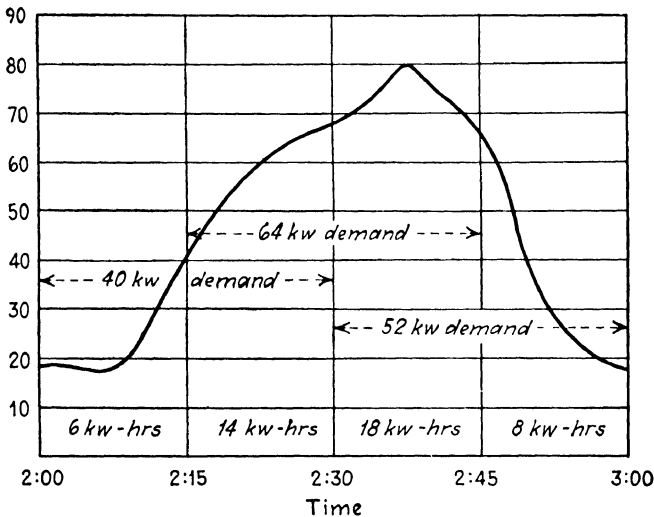

FIG. 196.

16-12. Concordance of Demand Meters.—In spite of the radical differences between the integrated-demand and lagged-demand meters they can be and are designed to indicate the same value of maximum demand for the same steady load sustained over several demand intervals. But on loads that fluctuate or are intermittent, considerable difference in demand indication may result because of the difference in principle of action. Also the tendency for integrated-demand meters, especially Form A, to “split the peak” is a factor accounting for difference in indications on varying loads. The definite-time integrated-demand meter (Form A) will on this account give a different result from the Form B meter if the period of maximum demand so occurs as to overlap two of its definite-time-demand intervals. The Form B record made by the early Printometers could

be so interpreted as to identify the actual maximum load more accurately.

The consequences of splitting the peak can be seen from a study of the following data derived from a watthour- and demand-meter installation (see Fig. 196):

Time	Kilowatt-hours during each interval	Average load, kilowatts	Recorded demand	
			Half hourly	Hourly
2:00 to 2:15	6	24	40	46
2:15 to 2:30	14	56		
	32			
2:30 to 2:45	18	72	64	
2:45 to 3:00	8	32	52	

If it is assumed that the demand meter had a 30-min. interval which started at 2:00 P.M., it registered a 40-kw. demand during the first half-hour interval and a maximum demand of 52 kw. during the second. If, however, the interval had started at 2:15, the recorded demand between 2:15 and 2:45, the only full interval within the given time, would have been 64 kw. It is evident that "splitting of the peak" works to the advantage of the customer, in this case to the extent of 12 kw. But if such fluctuation occurs frequently during a billing period, the meter will ultimately catch one of the peak intervals at its beginning and thus record the true 30-min. demand.

Incidentally in this case a 15-min. demand meter happening to start its interval at 2:30 would have recorded a 72-kw. demand as the maximum. A 60-min. demand meter would have recorded 46 kw. at the maximum. The instantaneous demand is 80 kw.

The indication of a thermally lagged meter (Form B) will be different under the same value of constant load from that made by an integrated-demand meter, especially during the first few minutes. At the end of the demand interval both will, of course, indicate the appropriate value. Thus Fig. 197 is drawn for constant loads of 100 kw. and 80 kw., both types of meters having the same 15-min. demand interval. For the thermally lagged

meter the indication will be 90 kw. after 15 min. (and 99 kw. in 30 min.). On the ideal exponential curve 60 per cent of the demand, or 60 kw., will have been indicated in the first 6 min. (40 per cent of the 15-min. interval). On the Lincoln meter this value will be approximately 57 kw. owing to a time delay in getting the heat from the heater to the actuating parts of the meter. On the other hand, the integrated-demand meter shows 100 kw. at the end of the 15-min. interval and the 60 kw., or 60 per cent of the demand, will not be indicated until 60 per cent, or 9 min., of the time has elapsed.

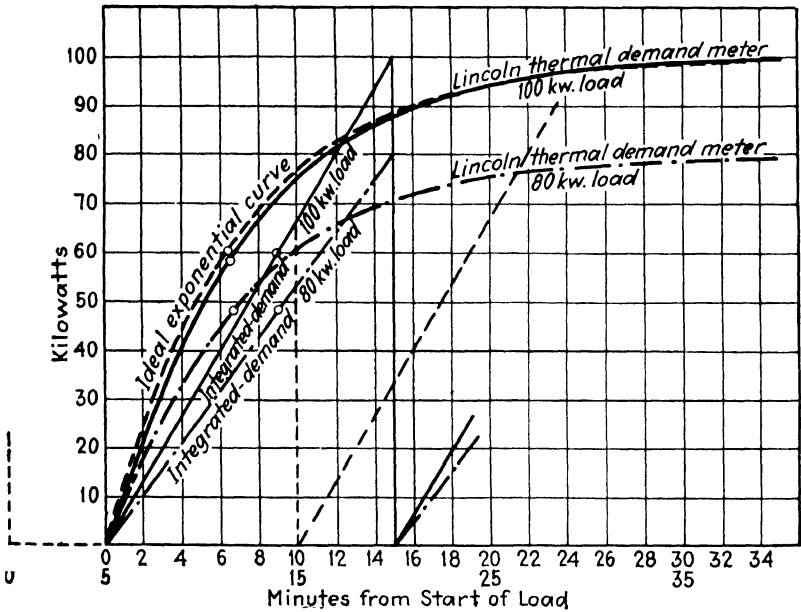

FIG. 197.

If the load, however, is 80 kw. instead of 100 kw., the thermal meter will again show 90 per cent, or 72 kw., at 15 min. and will have reached 48 kw., or 60 per cent of the ultimate value, in about 6½ min. The integrated-demand meter will still show 60 per cent of the load, or 48 kw., in 60 per cent of the time, or 9 min. It is evident that the thermally lagged meter indicates the demand at a rate decreasing with duration of load whereas the integrated-demand meter shows increments proportional to the time duration. The significance of this characteristic of the thermal meter is that its indications depend not only

upon the particular sequence of the values of a varying load but upon the values of load preceding any interval in question. The power-supply apparatus supplying this demand, in approaching its limiting temperature, is affected by the same sequences and history.

One further point may be illustrated by Fig. 197, *viz.*, the effect of "splitting the peak." If the constant load was thrown on at time zero, the thermal meter began at once to indicate it, doing so at the outset somewhat more rapidly than the integrated-demand meter. If the integrated-demand meter had started its interval 5 min. before the load came on, it would reset after indicating only two-thirds of the demand during the 10 active minutes of the interval. Unless the load thereafter continued through the succeeding 15-min. interval it would thus fail to indicate the true demand.

On the whole the thermal meter tends to read relatively high on short abrupt peaks because of the initial rapid response. This is true despite its tendency to be delayed in full registration of constant loads. On the other hand, the integrated-demand meter of the definite-time-interval type tends to read low owing to splitting of the peaks between successive time intervals and there is no assurance that two such demand meters will indicate the same when connected to the same load unless their demand intervals are in synchronism. The tendency of the thermal meter to over-register on short high load peaks may be overcome entirely by the use of a structure which reaches something less than 90 per cent of its final value in the specified time—in other words, by a change in definitions.

CHAPTER XVII

LOAD TOTALIZING. TELEMETERING

Much of man's inventive ingenuity has been devoted to extending the scope of his faculties and senses to larger and smaller magnitudes than those for which nature endowed him. The lever and block and tackle multiply the muscular forces he can apply; automobiles, railroads, and airplanes increase his speed and distance of locomotion enormously; telescopes and microscopes lengthen the distance and depth of his vision; telephones and microphones increase the range of his voice and hearing, etc. In the same way there is the urge to bring before the electrical operator's vision the indications of electrical and other meters scattered widely over the electrical system. *Telemetering* is the new art which performs that function.

Coordinated operation of larger power systems has necessitated concentration of the supervision at one point—or at the most a few points. Economical generation of steam power in conjunction with available hydro is one reason for such centralization. Another is the virtue of concentrating broad authority in case of power interruptions, accidents, and other emergencies. A third factor is the reduction of labor of attendance at substations. These are the influences which have instigated the development of telemetering along with the perfection of supervisory or remote control systems.

Summation of loads existing at such outlying points is also an important element in the economical and safe handling of the system. Summation of the output of several generators connected to a duplicated or sectionalized bus is likewise a desirable possibility. *Totalizing* electrical quantities for several circuits, especially kilowatt-hours of output or consumption and kilowatts of demand, involves principles that transcend those which suffice for the design and functioning of the simple meters which are adequate for individual circuits.

These two new tools of the metering art, devised primarily for electric-power systems, are now equally available to a wide range

of industrial uses. For example, the over-all demand of a large industrial plant served with power at several independent points can be totalized and the result transmitted by telemetering to, say, the industrial plant supervisor to guide him in controlling peaks of demand and in the most economical use of energy.

TOTALIZING

17-1. Totalizing by Multicurrent-coil Watthour Meters.—

Where two or more circuits have voltages that are sensibly equal and in phase, it is feasible to extend the principle of the three-wire single-phase meter (see 5-2) to the multicircuit polyphase situation. A single voltage coil on the driving electromagnet of the watthour-meter element serves to represent the voltage component of all the circuits. Up to four current coils can readily be provided and thus effect totalization for four circuits. In order to keep to standard dimensions for 5-amp. elements, the rating of each of the four current coils is preferably set at $2\frac{1}{2}$ amp. and the current transformer ratios chosen accordingly. The advent of meter designs having accuracy extended to loads of 250 and 300 per cent of normal (see 9-8) facilitates the satisfactory functioning of such a multicurrent-coil watthour meter, especially where wide diversity in loading is likely to exist on the several circuits to be totalized.

Of course, it is necessary that the circuit from which the voltage is taken be energized at all times when there is load on any of the circuits; otherwise the registration will be interrupted and incomplete. This difficulty can be avoided if the voltage for the meter can be taken from a bus serving all the circuits. It is evident that the opportunity for errors in connections, especially with multielement meters such as three-element four-wire meters, is great and therefore unusual care must be taken in tracing and verifying the connections to the respective current coils.

The totalized demand of the various circuits is readily obtained by attaching to the register of the totalizing meter the demand attachments or contact-making mechanisms described in Chap. XVI.

17-2. Totalizing by Paralleled Current Transformers.—

Instead of adding the currents by means of their fluxes as in 17-1, the loads may be totalized by combining the respective load currents and applying the resultant current to a single

current coil in each element of the meter. The current summation can be effected by paralleling the secondaries of current transformers whose primaries are inserted in the respective circuits (see Fig. 198).

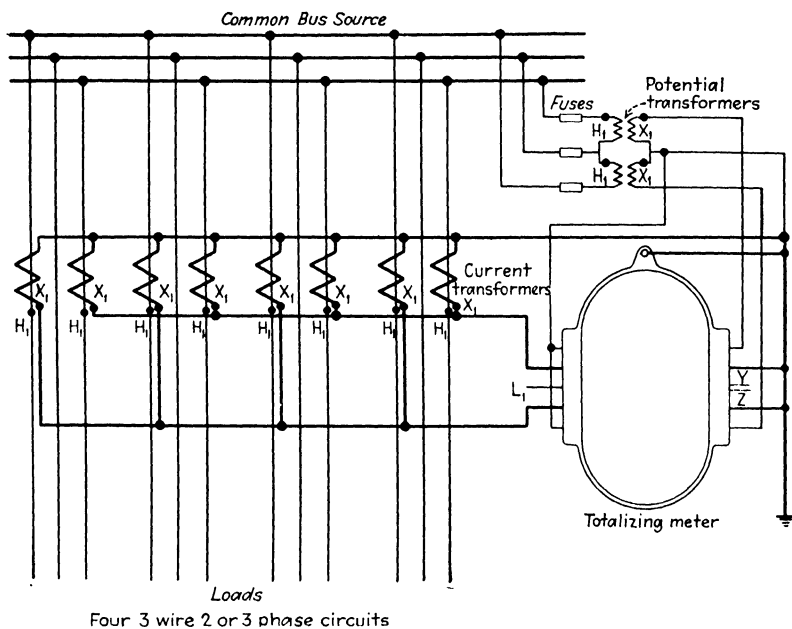

FIG. 198.

This method has certain limitations:

1. All current transformers must have the same ratio. It is not sufficient that all have the same nominal secondary rating. If the primary ratings and ratios are not the same, the totalized reading would have significance only for some one particular proportioning of the respective load currents.
2. The current transformers must have practically identical characteristics; *i.e.*, their phase-angle errors and ratio errors must be substantially the same.
3. As in the multicurrent-coil meter the voltages of the respective circuits must be equal in magnitude, synchronized, and in phase with one another.
4. Metering accuracy is sacrificed to a degree because under paralleled conditions the burdens on the current transformers are greater and more variable with variable loading

of the circuits; as a consequence the phase-angle and ratio errors are likely to be greater.

5. Metering accuracy is also sacrificed to the extent that the combined load has wider range of variation than the individual circuits. The meter element thereby has to operate over a wider range of torque and speed, incurring the risk of extremes of light and full load. The 300 per cent meter contributes to making totalization a feasibility.
6. Unless the common voltage is taken from a common bus, provision must be made for transferring connections from an unenergized to an energized circuit and thus insuring voltage on the meter at all times.

Absence of load on one of the circuits will, of course, afford an opportunity for part of the totalized current from the secondaries of the other current transformers to be diverted through the idle secondary instead of through the meter coil. The open-circuit impedance of current transformers is, however, so high that the error from this cause is generally small enough to be ignored in practice. A measure of the same sort of error is present whenever the loadings on the different circuits are unequal. It is even smaller in magnitude than in the case of no load on one or more of the circuits. Any tendency for current to flow from another source through the secondary of a current transformer is equivalent to an increase in the burden on that transformer and its flux and secondary voltage rise accordingly to offset the flow, or, conversely, its own voltage rises to maintain its own secondary current output at the value corresponding to its primary (load) current.

17-3. Totalizing by Multielement Meter.—Certain of the preceding limitations, notably those numbered 1, 3, 5, and 6, can be overcome by providing two (or three) watt-hour elements for each circuit embraced in the totalization (two for three-wire two-phase or three-phase and three for four-wire three-phase). Such meters have been developed with as many as 24 watt-hour elements, thus capable of totalizing directly 12 three-wire three-phase circuits. It is no longer necessary for the circuits to be synchronized or even of the same voltage; it is necessary, however, that the product of the ratios of current and voltage transformers be the same for all elements.

In a multielement with eight or more elements it is customary to use at least two shafts and to add their revolutions at the

register through the medium of differential gearing, similar in principle to the "differential" of the automobile. Even then the moving elements are much heavier than those of the simple polyphase meters. This accentuates the light-load errors, *i.e.*, when the combined load on a shaft is small relative to the combined capacity of the elements on that shaft. This error

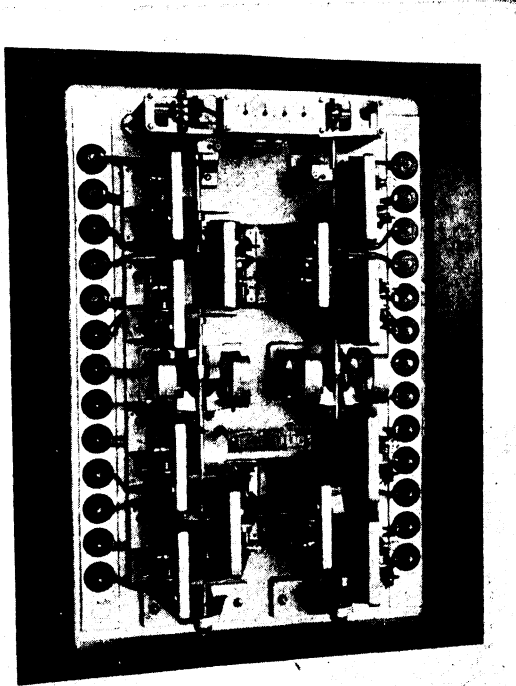

FIG. 199.

is not of especial significance in connection with demand readings but it should be considered if the registration of the meter in kilowatt-hours is to be used for billing or for interconnection credit-charge purposes. In general the readings of watt-hour meters on the separate circuits when totaled numerically will have higher accuracy than the multi-element meter. A multi-element meter consisting of two two-element or two three-element meters is called a "duplex totalizing meter."

One or more of the circuits may be deenergized and the multi-element meter may therefore be subjected to a variable amount of

damping from the voltage-electromagnet sources (see 8-9). The error is not, however, great in comparison with others of a torque and friction nature arising from the multiplicity of

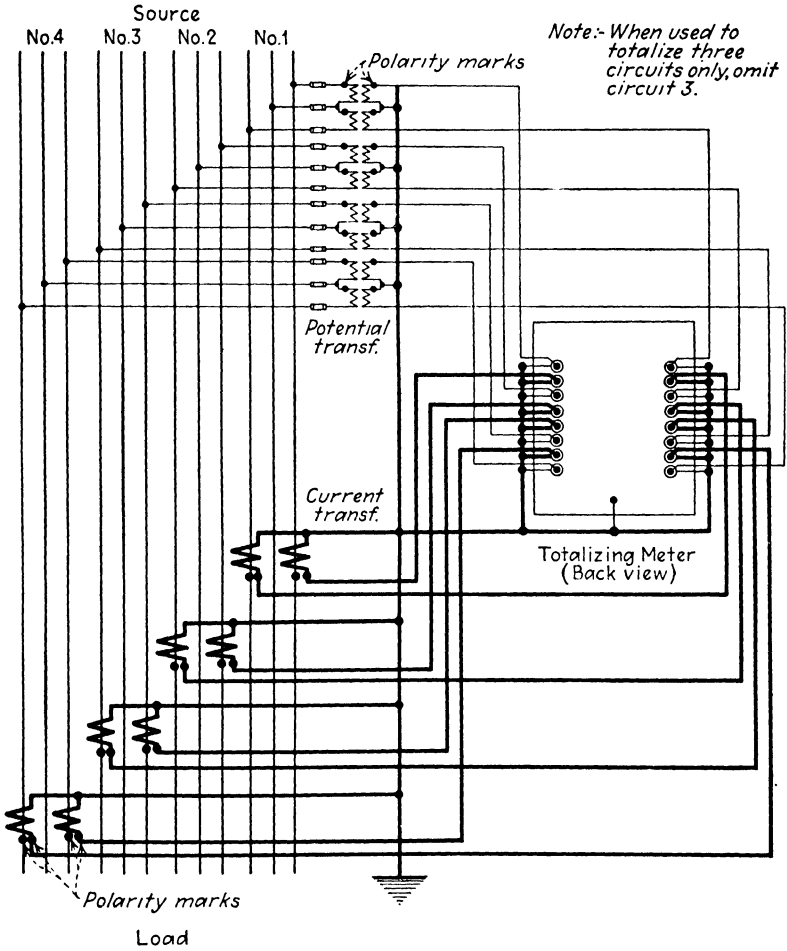

FIG. 200.

elements. Torques per moving element are designed to be relatively high.

Because of the probable diversity of the individual circuits, overloads do not in general arise for the multielement meter. In any event the overload characteristics of the meter can be made practically as good as those of the individual elements (see 9-8).

A six-circuit meter, is shown in Fig. 199. The connections for a four-circuit meter are shown in Fig. 200 where ingoing and return leads to each coil are connected to a double terminal post.

17-4. Totalizing by Relays and Impulses.—Summation may be effected by employing the impulse principle in conjunction with contacts installed on the rotating shaft or register of each meter. Impulses are thus transmitted to a receiver or totalizing

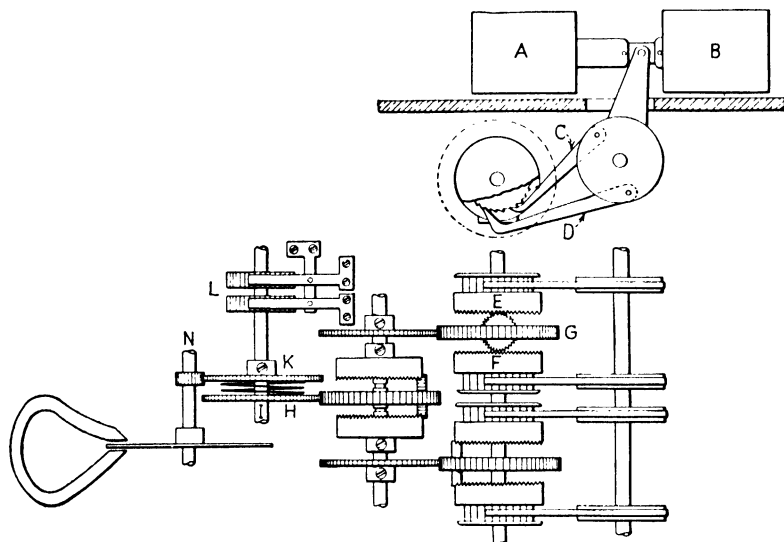

FIG. 201.

relay at a rate proportional to the speed and load on each meter. The total number of impulses received will then be proportional to the combined load, provided the mechanism is so devised as not to "lose" impulses received simultaneously from different sources. Much ingenuity has been resorted to in order to obviate such error. With this accomplished there is practically no limit to the number of circuits that can be totalized, their relative ratings, or the distance of the metering points from the totalizing installation.

The General Electric Type DT-2 Relay (Fig. 201) is one illustration of mechanism which totalizes by impulses in such a way as to prevent loss of simultaneous impulses. In the four-circuit relay shown each meter is connected by a five-wire circuit of its pair of solenoids, *A* and *B*. Alternate contacts at

the circuit meter actuate *A*, then *B*, which in turn actuate pawls which advance the crown gear wheel *E*. Each impulse at *E* advances the planetary gear *G*, independently of impulses reaching *F* from the second meter. Wheel *G* therefore rotates at a rate proportional to the sum of the loads on these first two meters. A final stage of addition for the two pairs of meters is transmitted to a third planetary which drives the gear *H*. Gear *H* winds a spring whose tension drives *K*, which is mounted on the contact shaft which carries the cam contacts *L* that

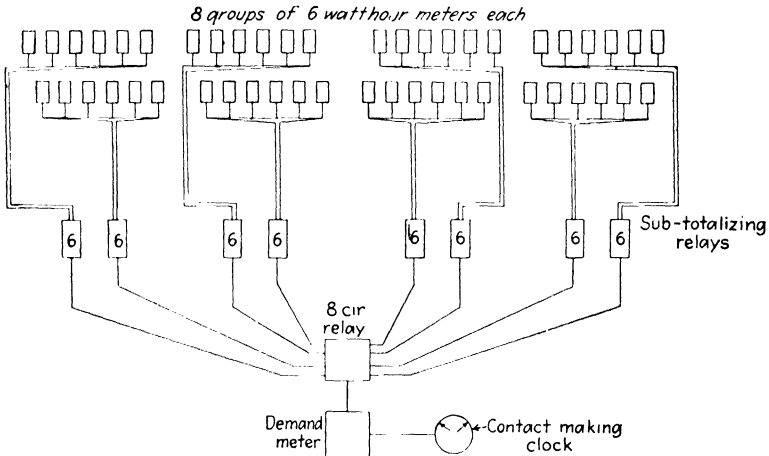

FIG. 202.

energize the totalizing demand meter over a three-wire circuit. To make these impulses fall at fairly uniform rates regardless of the "bunching" of impulses received from the four meters, a drag magnet acting on a disk geared to *K* creates a back torque on the spring between *K* and *H*.

Eight six-circuit totalizing relays of this type were installed by the Union Electric Light and Power Company (St. Louis) to sum up the simultaneous demands of 48 individual cable circuits across the Mississippi River from the Cahokia generating station* (see Fig. 202).

17-5. Special Features of Impulse Totalizers.—The Westinghouse Company in its Type RA Impulse Totalizer adds a torque motor to convert the totalizing shaft from a driven to a driving shaft, thus relieving the initial solenoids and their

* See STOKES and NELSON, Demand Metering Equipment, *A. I. E. E. Regional Paper* 28-31, 1928.

supply circuits from supplying energy to serve the pawl and planetary mechanism. The object is to relieve the duty on the individual watthour-meter contacts and reduce the mechanical wear on the totalizing mechanism.

The Landis and Gyr Summation Meter also employs the impulse principle but uses an alternative to the preceding scheme to prevent loss of simultaneous impulses from separate sources. There is in the summation meter a relay for each meter (up to

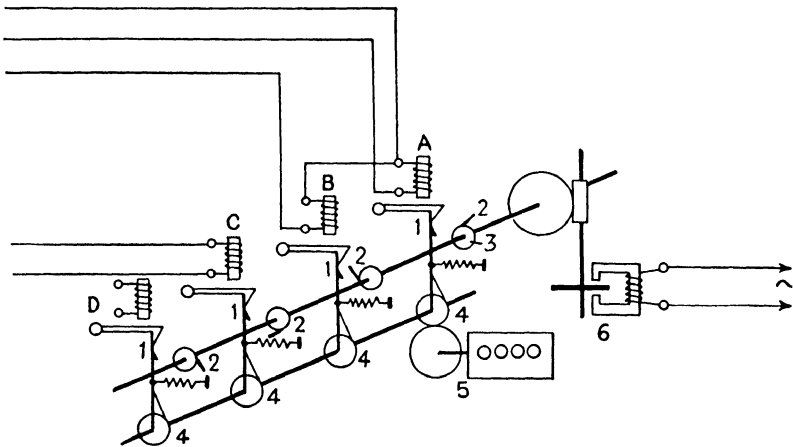

FIG. 203.

eight), the reading or registration of which is to be included in the totalization. Every time a given number of watthours has passed through a meter (this number must be the same for all the meters) a contact is made and an impulse sent to the corresponding relay in the summation meter. To insure that all these impulses register toward the advance of the dial of the summation meter, the following mechanism is employed (see Fig. 203):

When one of the relays is energized by an impulse its armature releases a lever 1 which is moved by a spring toward a cam on a shaft bearing all the cams and driven by an induction disk motor 6; as it moves, a pawl slides over the teeth of a gear wheel 4 on the totalizing shaft. The cam projection 2 subsequently pushes the lever back to relatch it and as the lever moves back the pawl advances the gear 4 by an amount corresponding to the number of watthours represented by one impulse. This component of the total load or demand is thus registered on the totalizing dial 5. Loss of simultaneous impulses is prevented

by staggering the cams 2 radially so that the levers are returned successively to the latch position. Thus, even if two impulses are received simultaneously, they are registered in the summation consecutively, the effect being that of storing the impulses.

As shown, relay *A* might respond to the impulses from a polyphase meter and *B* to those from a single-phase meter on the same circuit. If meters *A* and *B* are close together a three-wire impulse circuit would suffice, a common return being feasible. Relay *C* might be connected to a d-c. meter. Relay *D* in this illustration is a spare.

17-6. Totalizing by Thermal Converter.—Still another method of load totalizing is one employing the thermal converter principle embodied in the Lincoln Thermal Storage Demand Meter (see **16-7**). The difference in temperature of the two resistor heaters of Fig. 193 is proportional to the watts load. If this temperature differential is applied to a thermocouple the resulting small e.m.f. is likewise proportional to the watts. By arranging such thermocouple e.m.f.s. in series the resultant e.m.f. is a measure of the summation of the loads. These loads may be widely scattered since the current to be transmitted is very small, especially if a potentiometer is employed to measure the total e.m.f. at the point where totalization is desired. The equipment is described in detail in **17-17**.

This scheme has the advantage that it is inherently reversible; *i.e.*, if one of the loads is negative, its thermocouple e.m.f. is reversed with respect to the others and the resultant series e.m.f. is reduced by an amount proportional to the negative load. In his A.I.E.E. paper* on this subject Professor Lincoln cited Canadian installations involving as high as 166,000 kw. totalized by 18 polyphase converters now working over circuits 30 conductor miles in length and involving as high as 1,500 ohms of totalizing circuit resistance.

TELEMETERING

17-7. Functions and Scope of Telemetering.—Telemetering is the indicating, recording, or integrating of a quantity at a distance by electrical translating means (A.I.E.E. definition). Much of the present development of this art has occurred in conjunction with the extensive adoption of automatic stations and the supervisory equipment which gives the centrally situated

* Totalizing of Electric System Loads, January, 1929.

system operator a visual indication of apparatus positions (switches open or closed, turbine gate openings, etc.) and also affords him the means of manipulating such apparatus at the unattended remote substation. To obtain safe, economical, and expeditious operation of his system the operator must also be able to "read" voltage, watts, power factor, etc., at outlying points. Television would in some respects be an ideal solution but this being economically if not technically unfeasible, telemetering in some form is the practical alternative. Telemetering is adaptable to integrating and recording functions as well as indicating.

Extension of the metered circuit itself, even by the use of long voltmeter leads, long leads from shunts or from instrument transformers, while often practicable for distances of several hundred feet or even up to a mile or two, is not truly telemetering.

The discussion which follows will treat telemetering as distinct from the supervisory-control equipment with which it is frequently associated. It will also be confined to the telemetering of electrical indications and thus omit reference to telemetering of temperature, wind velocities, tank levels, gas pressures, etc. Further it will not attempt to enumerate all the schemes which have been devised, many of them ingenious but not, however, extensively used.

One factor always to be considered in telemetering is that of channels available for transmitting the readings to the distant point. Multiconductor cables or open-wire pilot circuits, telephone lines and wired-wireless or carrier-current coupling to power-transmission circuits are the channels commonly employed, the former for short and the latter generally only for long distances. Telephone circuits are being used simultaneously for speech transmission and for telemetering and supervisory control signals. To assure freedom from interference with speech there are definite limits to voltage, current, and frequency values impressed for telemetering purposes.

For the sake of economy it will be desirable to have as many indications as possible transmitted through a given channel. Telemetering schemes requiring complicated and expensive apparatus at the terminals will be feasible only for the longer distances.

Accuracy and reliability of telemetered indications will depend to a different extent for the different systems upon the

loop resistance and the insulation leakage resistance of the transmitting circuit.

17-8. Classification of Telemeters.—The electrical indications, the transmission of which to some distant point is most likely to be desired, are, in the order of prominence and prevalence,

Amperes.	Reactive kilovolt-amperes.
Kilowatts.	Kilovolt-amperes.
Volts.	Frequency.
Kilowatt-hours.	Power factor.

To transmit and indicate or record these quantities there have been devised a multiplicity of schemes which are reducible in principle to the following types, based upon the translating means employed:

- Current.
- Duplicated position.
- Impulse.
- Voltage (including potentiometer and thermal converter).
- Frequency.

Further classifications may be based upon the relationship of the measured quantity and the translating means. Thus, if the translating means is frequency and this frequency varies directly with the magnitude of the measured watts, this would be called "direct-relation telemetering." It would be called "inverse-relation telemetering" if the translating means, say current, decreased with increase in the measured quantity.

In *step-by-step* systems no change is registered until there is a predetermined increase or decrease from the last recorded value. *Continuous* indication is afforded when the receiving meter tends to follow every decrease or increase in the metered quantity at the transmitting end.

17-9. Factors Which Limit Telemetering.—Since the objective of telemetering is to transmit indications at a distance, the factor of distance enters the choice of a system. Those schemes which require a continuous metallic circuit encounter two limiting factors, line resistance and line-leakage conductance, which affect different schemes to different degrees. In general those schemes which employ voltage as the translating means can function satisfactorily with line resistance of 50,000 to 120,000 ohms. The "position" schemes necessitate the lowest line resistance and consequently are limited to the shortest distances.

On the other hand, the voltage schemes in general require higher values of line insulation (2.5 to 5 megohms), while impulse systems can perform satisfactorily with megohms in the range from 0.1 to 1. Insulation resistances are much lower for open wires than for cable circuits. Leakage of open wires is, however, negligible in dry weather as compared with wet weather when the shunt-path resistances are multiplied in number and decreased in individual values.

Other factors to be considered are (1) whether indicated, recorded, or integrated values are to be telemetered, (2) whether a multiplicity of conductors is required for the transmitting circuit, (3) whether telephone circuits are available or special circuits must be run, (4) whether the telemetering is combined with or independent of supervisory control, (5) whether the transmitting principles and translating means will permit the intrusion of insulating transformers, repeaters, duplexing, quadruplexing, etc., into the circuit, and (6) whether load totalization is required in conjunction with telemetering.

“Current” and “voltage” (including potentiometer and thermal converter) telemetering employ direct current as the translating means and therefore cannot function through insulating transformers or vacuum-tube repeaters unless the latter are shunted by “retardation coils.” Current-balance telemetering is used in conjunction with load dispatching for moderate distances. Impulse telemetering is employed for greater distances, for customer billing and intercorporate energy accounting, and where leased telephone lines must be thoroughly insulated from the power circuits and supervisory control circuits.

17-10. Current-balance Telemetering Principle.—In current-balance (also called “torque-balance”) telemetering a direct current (usually between 0.0002 and 0.02 amp.) is established proportional to the quantity to be telemetered and this d-c. value is transmitted over the line. At the receiver various schemes are employed to translate these milliamperes into the desired volts, power factor, frequency, kilowatts, etc. Several makes use a milliammeter with correspondingly graduated scale. The Leeds and Northrup system in some cases uses a self-balancing potentiometer to measure the voltage drop occasioned by this current flowing through a resistor incorporated in the receiver.

At the sending end several schemes are employed to establish proportionality of the transmitted current and the quantity to be telemetered. The objective is accomplished by any means that will be a practical substitute for the simple but impracticable scheme of Fig. 204. There the operating element, say a wattmeter, has its restraining spring removed and, on the shaft, in place of it, is the d-c. restraining element, a permanent-magnet moving-coil milliammeter, standard except for the omission of its restraining spring and pointer. On the same shaft of this ideal

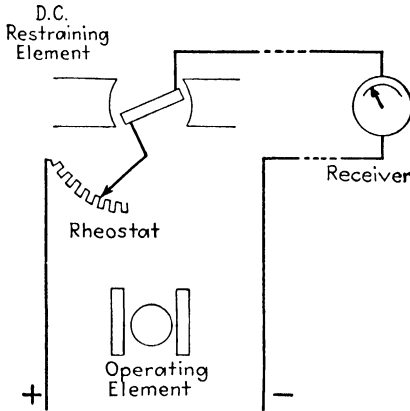

FIG. 204.

telemeter is an arm which makes frictionless contact with a finely graduated rheostat which has a range from 0 to ∞ ohms compressed within a small angular range (say 2° or 3°) of the shaft rotation. Any deflection of the wattmeter will shift the moving system to the position where the resistance introduced into the transmitting circuit will permit just enough current to flow through the line, the receiver, and the restraining element at the transmitter to balance the torque of the wattmeter. In principle this scheme automatically compensates for variations in the impressed d-c. voltage or in the resistance of the line wires. The scheme is impracticable because no such rheostat can have frictionless contact or infinite and finely divisible resistance compressed into such small angular range.

17-11. Forms of Current-balance Telemetering.—In the Westinghouse Current Balance Telemeter (Fig. 205) the pivoted member of a Kelvin balance had attached to it a contact arm and the moving element of the d-c. restraining member. Change

in the quantity to be telemetered unbalanced the Kelvin meter and a contact was made in the control motor circuit which started the motor. The motor rotated the rheostat arm to the point where the current through the restraining element restored the Kelvin balance to its neutral position, opened the motor circuit, and stopped the motor. Meanwhile the current in the line had indicated or recorded the telemetered value on the millimeter scale of the distant receiver. Use of the motor overcame the frictional and range limitations of the idealistic scheme previously

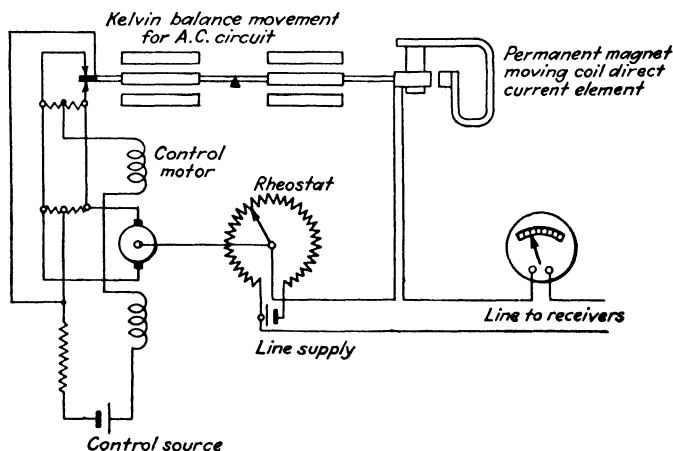

FIG. 205.

outlined. Undoubtedly the inherently favorable characteristics of thermionic tubes will be employed in place of the Kelvin balance and motor-operated rheostat of the former equipment.

The Midworth Distant Repeater is similar in general details to the Westinghouse scheme. The Leeds and Northrup Current-Balance Telemeter comprises a self-balancing relay mechanism, which continuously adjusts current through a shunt so that the voltage drop across it equals that derived from the telemetered quantity through the medium of a thermal converter, thermocouple, another d-c. shunt, or the like. The balancing current is transmitted to the receiver.

The Esterline-Angus Long Distance Recorder and the General Electric Torque-balance Telemeter employ grid-controlled vacuum tubes to supply the requisite value of resistance to establish the balancing value of direct circuit. In the latter (Fig. 206) a photoelectric tube and optical system are employed

in addition to the (piotron) vacuum tube. Any failure of the direct current in the restraining element to balance the torque of the telemetered quantity in the operating element will cause the mirror on its shaft to reflect the beam of light into one of the two photoelectric tubes. If it falls on one it will bias the piotron grid voltage to cut-off, *i.e.*, infinite resistance, and then no plate current will flow through the restraining element and line. If it falls on the other the plate resistance of the piotron

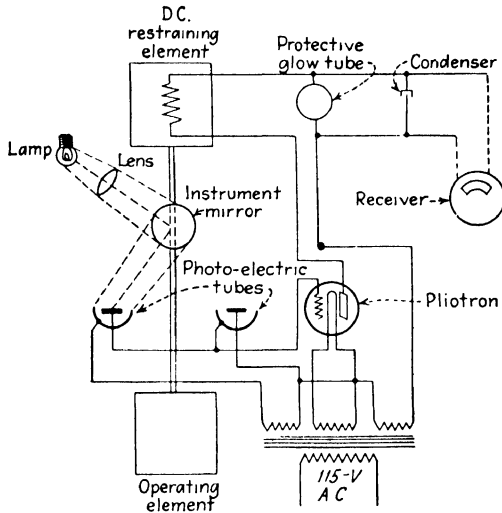

FIG. 206.

is reduced to about 10,000 ohms and thus allows maximum current to flow through the restraining element and telemeter circuit. Balance is obtained when the beam is so divided between the two photoelectric tubes as to establish the requisite value of grid bias, plate resistance, and plate-to-line current. The optical system constitutes a frictionless rheostat and the piotron readily affords the "infinite" range of resistance.

17-12. The Selsyn or Synchro-tie Motor.—Perfect mechanical coupling between a transmitter and a receiver would, if it were possible, duplicate the desired indications at the remote point. A practical electrical means of coupling is afforded by a pair of small induction-motor units which have a self-synchronous characteristic. They are designated as Selsyn or Synchro-tie motors. The transmitter unit has a single-phase rotor which is coupled or geared to the meter whose indications are to be telemetered (Fig. 207). The single-phase rotor of the transmitter

and receiver units is connected to sources of voltage which shall not be out of phase. The polyphase stators of transmitter and receiver are connected together by three conductors which constitute the telemeter line.

For any position of the rotor there are voltages induced in the three stator windings which depend for their respective magnitudes on the particular position of the rotor. If the rotor of the receiver is in the same relative angular position, corresponding voltages will be induced in the receiver stator, there will be no circulating currents in the line between the two stator windings, and no torque exerted on the receiver. If, now, the transmitter rotor be displaced by its meter element, the voltage balance of the stators is disturbed and circulating currents flow, tending to turn the receiver rotor until the induced stator

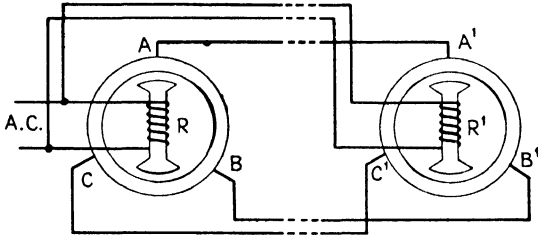

FIG. 207.

voltages again balance. The rotor of the receiver, and with it the moving element of the receiver meter, will thus follow the successive positions of transmitter rotor and the instrument which moves it.

17-13. Telemetering by Duplicated Position.—A telemeter system employing Selsyn or Synchro-tie motors is unaffected by moderate variations in voltage or frequency but five wires are, however, required between transmitter and receiver unless the same single-phase a-c. supply is available at both locations with no phase displacement between the applied rotor voltages. Any such phase displacement arising out of power line and transformer impedance drops or from phase shifts due to differences in transformer bank connections will introduce more or less serious errors in the telemetered indications. Also, if the scheme involves more than a complete revolution of the rotors, the telemetered indications may get out of step in case the power circuit or the telemeter circuit is subject to interruptions. For these reasons the duplicated-position scheme of telemetering is

limited to relatively short distances. The limiting value of telemeter circuit resistance is about 200 ohms per conductor. Two miles is a fair limit of distance.

Inasmuch as considerable torque is required to turn the transmitter rotor, this scheme of telemetering is more feasible for transmitting the position of mechanisms endowed with more torque than electrical instruments produce; it is, however, possible to use power-amplifying relays or relay-actuated motors to supplement the weak torque of electrical instruments. In that event several receiver rotors can be actuated by one transmitter and the distance may be increased to 12 or even 20 miles.

17-14. Characteristics of Impulse Telemetering.—A system feasible for long distances (distances of upward of 200 miles have been reported) involves the transmission of impulses originated by means similar to those employed in demand metering as described in 16-3 and in totalizing as described in 17-4. It is especially feasible therefore for watt-hour meters, their speed of rotation readily providing a means for originating impulses at a rate proportional to the load. At the receiving end impulse counters in the form of polarized relays (or the equivalent) actuate an escapement which by gearing to a dial indicates the registration or indication of the transmitter.

The impulse method is susceptible of good accuracy, the action being positive and relatively independent of line conditions. Induction from the often parallel power line or leaky telemeter-line insulation (*e.g.*, alkali-dust deposit in wet weather) may interfere seriously with the current-balance scheme but will hardly impair the functioning of the impulse scheme. Furthermore, the impulses may be transmitted through coupling or "insulating" transformers usually required by a communication company which leases one of its telephone circuits for telemetering purposes. The receiver is, however, relatively intricate and sensitive to static disturbances on the telemeter line.

Impulse systems are classified in two ways: (*a*) high or low rate, (*b*) step-by-step or continuous indications. The high-rate systems are generally of the continuous type and the low rate are step by step (see 17-8).

17-15. Low-rate Impulse Superior for Totalizing Telemetering. High-rate impulse systems employ 200 to 400 impulses per minute for full-scale reading of the receiving telemeter. Low-rate systems employ 20 to 50 impulses per minute. High-rate

systems are most frequently applied for transmission of indicated quantities (watts, volts, power factor, etc.) in conjunction with load dispatching and its associated supervisory control.

The low-rate system is peculiarly adapted to totalizing and telemetering simultaneous demands on a multiplicity of circuits serving a common load. In fact the totalizing application was evolved from low-rate impulse telemetering because of its appropriateness for telemetering. This appropriateness rests on the fact that, if the duration of each impulse is shortened, the probability of superposition of impulses from different transmitters is minimized and accuracy of totalization and consequently of the telemetered total is thereby enhanced. High speed of action of the contacts which "chop off" the impulses is thus desirable.

In the Westinghouse scheme, for example, this problem has been met by opening the telemeter circuit momentarily to transmit what is really then more an interruption than a current impulse. Inasmuch as an a-c. circuit is inherently "interrupted" twice every cycle when the current goes through zero, it would be necessary to employ long contact-opening periods in order to distinguish between the 120 "interruptions" per second of a 60-cycle current and the interruptions due to contact opening. For this reason the alternating current is rectified (copper oxide rectifier) for the telemeter transmission. Filtering or the meter-coil inductance sufficiently deprives the rectified current of ripples to avoid frequency effects on the impulse counters in the telemeter receiver.

The time of contact opening at the transmitter attached to the watt-hour-demand meter may be of the order of 0.01 to 0.025 sec. The probability of error E in the telemetered total at any load for any impulse-duration value is

$$E = \frac{t(N_1 + N_2 + N_3 \dots)^2 - N_1^2 - N_2^2 \dots}{T(N_1 + N_2 + N_3 \dots)}$$

where $N_1, N_2, N_3 \dots$ = impulses per demand interval at respective telemetering transmitters.

t = duration of each impulse (or interruption).

T = length of demand interval.

If all the sending meters were in contact synchronism and therefore had identical loads, the transmitted result would be

that for only one of the meters and the error would be the maximum possible. This contingency is wholly improbable.

For $t = 0.02$ sec., $T = 900$ sec. (15-min. demand interval), and $N = 600$, the probable error with even 12 meters (50 contacts per demand interval) can be shown to be only 1.2 per cent at full load and proportionately less for lesser loads. It is also obvious that low-rate telemetering affords longer life of the contacts and the mechanisms.

17-16. Telemetering with Voltage Dividers.—In the voltage systems the meter measuring the telemetered quantity actuates a voltage divider or its equivalent in such manner as to apply to the telemeter line a voltage proportional to the quantity to be telemetered. This voltage is measured by a self-adjusting potentiometer which constitutes the receiver. The normal line current with these systems is only that needed during the balancing process at the receiver potentiometer. Inasmuch, therefore, as the telemeter quantity is a voltage rather than any sustained value of current, variation in telemeter loop resistance due to temperature or other causes affects only the sensitivity and not the inherent accuracy. Since, however, direct current is employed in the telemeter line, a continuous metallic circuit is required, *i.e.*, free of insulating transformers and vacuum-tube repeaters (unless the latter are shunted by “retardation coils”).

The telemetering systems of the Leeds and Northrup Company are the principal voltage systems in the field of telemetered quantities. In the (1) potentiometer transmitter and (2) voltage-multiplier forms, both of which can function satisfactorily on loop resistances up to 50,000 ohms, the maximum open-circuit d-c. voltage on the telemeter line is 24 volts; usually the impressed value is 1 volt or less per 2,000 ohms of loop resistance. In the (3) thermal converter scheme it is always less than 1 volt.

In the potentiometer-transmitter telemeter (Fig. 208), the self-adjusting motor-driven potentiometer at the receiver shifts its slide-wire contact until balance is obtained, the indication then being a duplicate of the reading of the transmitter instrument. A rotary switch and auxiliary battery (at the receiver) in conjunction with a polarized relay (at the transmitter) serves to compare the transmitted and received voltages for calibration purposes. The rotary switch, when not establishing the normal telemeter line connections, in its first position connects

a relatively high-voltage battery across the telemeter line. The polarized relay (not sensitive enough to be actuated by normal telemetering line current) is actuated and moves switch S to its alternate position S' . The next position of the rotary switch connects the telemeter line to the extremities of the receiver slide wire. If the receiver galvanometer does not indicate balance, the resistor in series with the recorder slide

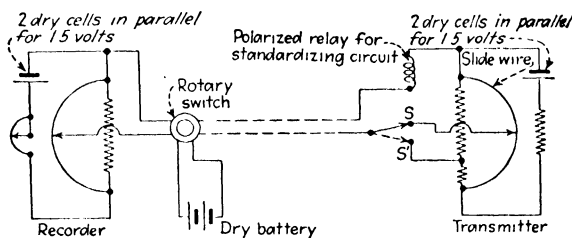

FIG. 208.

wire and two-cell recorder battery is adjusted to give balance. The next position of the rotary switch resets the polarized relay at the transmitter by applying reversed battery potential on the line. The final position reverts the connection to normal telemetering functioning.

In the voltage-multiplier telemeter (Fig. 209) a self-balancing mechanism adjusts the battery B_1 voltage across R_1 and R_2

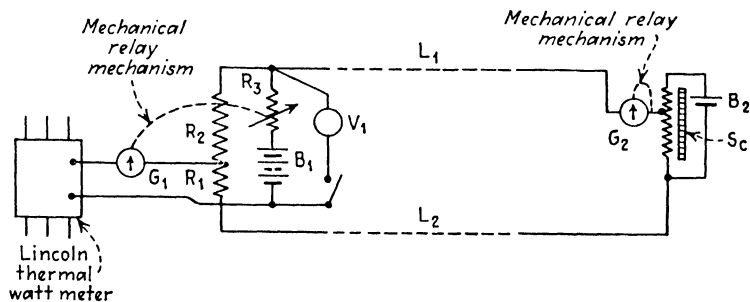

FIG. 209.

so that the voltage across R_1 equals that established proportional to the telemetered quantity by means of a thermal converter, thermocouple, d-c. shunt, etc. The galvanometer G_2 at the receiver, through the medium of the mechanical relay mechanism, moves a contact along a variable resistance fed by a battery B . The reading of the potentiometer recorder is then obtained from the scale S_c .

17-17. Thermal Recorder (Voltage) Telemeter.—The principle of the Lincoln Thermal Demand Meter (see 16-8) affords a means of developing a voltage proportional to load by substituting a thermocouple for the opposed springs of the demand meter. This constitutes a unique form of telemeter transmitter in that it has no moving parts.

In the polyphase thermal converter of Fig. 210 the thermocouples are plainly marked; the heater resistors are indicated by

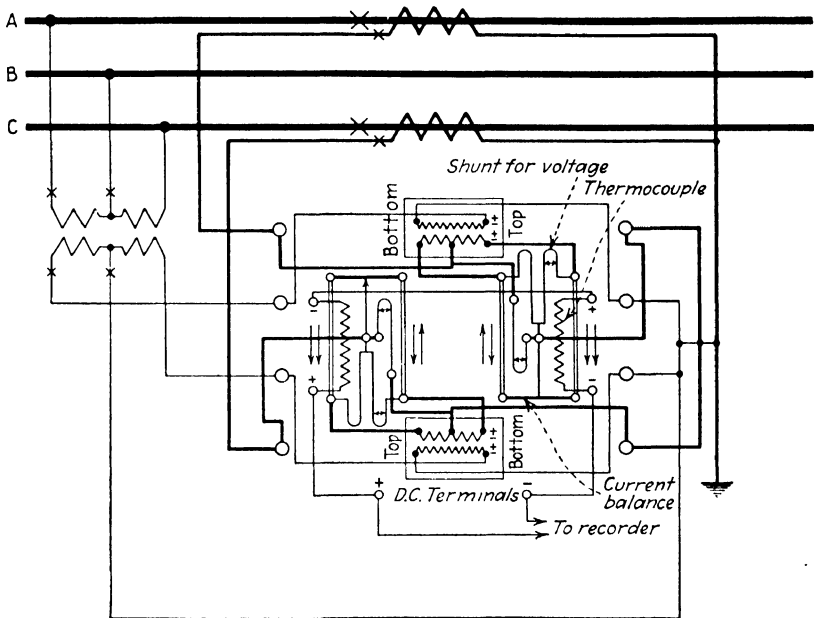

FIG. 210.

double lines. Voltage and current balancing are made during calibration by adjustment of the respective shunts, until zero e.m.f. is obtained at the thermocouple terminals when either voltage or current alone is applied to the recorder. A series calibrating resistance brings thermocouple e.m.f. to rated value at rated load. The converter attains 90 per cent of full response in 8 sec. and 99 per cent in another 8 sec. A recording potentiometer is usually the receiver.

It is a simple matter to totalize the loads at many scattered points by merely arranging the telemeter circuit so that the d-c. thermocouple voltages are in series with their sum then representing the total load.

The order of magnitude of thermocouple voltage at rated load for a polyphase meter is 40 mv. Even for the totalization of 20 stations the voltage transmitted by the telemeter line to the recorder is thus only 0.8 volt. It is evident that telemeter line-loop resistance can be larger and the line longer the greater the number of thermal converters there are in series and the greater therefore the number of loads permissibly totalized and telemetered. For any load that is to be subtracted rather than added the thermocouple terminals can be reversed with respect

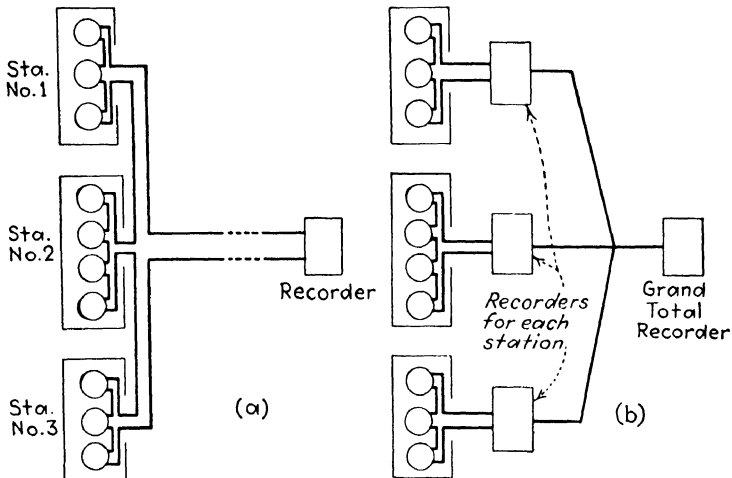

FIG. 211.

to the others and thus subtract its voltage from the series total.

Totalization for the generators at all stations may be effected by the single recorder at a distant point as in Fig. 211a. Totalization may also be effected separately for each station as in Fig. 211b. In the latter case the greater distance likely to be involved in transmitting to the grand-total receiver the partial totals for portions of the system warrants a modification of the elementary scheme. Two modifications are commonly applied.

One is essentially a current-balance scheme in which current from a dry cell, battery, or a copper oxide rectifier is regulated to create in a resistor a voltage drop equal and opposite to that of the totalizing thermal recorder at the station. The resulting current over the telemeter line is similarly measured as a resist-

ance drop (proportional to the load at the transmitter station) by the potentiometer grand totalizing receiver or recorder.

The other modification is essentially a voltage-balance scheme. A motor-driven retransmitting potentiometer places on the telemeter line a voltage proportional to the sum of the thermal converter e.m.fs. but much greater than that sum in magnitude. These voltages are transmitted and interpreted by the receiving potentiometer in terms of the grand-total loading at the several thermal converter installations.

17-18. Frequency as Translating Means in Telemetering.—

As a translating means, frequency appears to offer certain inherent advantages not afforded by current, voltage, or position telemetering. These last translating means will inevitably be affected to some degree by such line conditions as variable impedance, variable leakage conductance, and inductive interference. On the other hand, a frequency of some particular value will perforce appear at the receiving end as an identical frequency, if at all. By sending and measuring a frequency which has been established proportional to the quantity to be telemetered, still another form of telemetering is thus possible.

A small condenser (about 0.005 mf.) is attached to the moving element of the meter whose reading is to be telemetered. This condenser is connected to an oscillator so that the frequency of the oscillator circuit varies in accordance with the meter deflection. But the high frequency which such a small capacitance could control would be up in the radio-frequency range and much too high for wire transmission. Therefore, a second oscillator of constant frequency is used to create a low-value beat frequency which can be made proportional to the actuating meter's reading. This beat frequency is detected and its current value amplified by thermionic-tube circuits and then transmitted over the telemeter line. The receiver is a direct-reading frequency meter with a scale corresponding to that of the transmitting instrument.

This system is readily adaptable to the carrier principle. Coupling capacitors superpose (through modulators) the telemeter frequency of some hundreds of cycles per second upon the 60 cycles of the power-transmission line. Coupling capacitors at the receiving end in conjunction with a demodulator restore the original frequency and it is registered on a simple frequency meter just as in pilot-wire or telephone-line telemetering.

Several readings may be transmitted simultaneously by using different frequency bands (say 300 to 600, 800 to 1,600, and 2,000 to 4,000 cycles per second) for each different telemetered quantity. Band-pass filters at the receiving end will unscramble the several frequencies and deliver them to their respective instruments.

APPENDIX

INSTRUMENT CHARACTERISTICS AND PERFORMANCE

A-1. Definitions.—Among the definitions in the A.I.E.E. Standards 33 (Electrical Indicating Instruments) are the following as they appear in the fifth draft of revision (January, 1933) authorization pending:

“An indicating instrument is an instrument in which the present value of the quantity under observation is indicated by the position of a pointer relative to a scale. The term ‘instrument’ is used in two different senses:

- a. Instrument proper as described below, and
- b. To include not only the instrument proper but, in addition, any necessary auxiliary devices, such as shunts, shunt leads, resistors, reactors, capacitors, or instrument transformers.

“The instrument proper consists of the actuating mechanism together with those auxiliary devices (scale, resistors, shunts, etc.) which are built into the case or made a corporate part thereof.

“The mechanism of an indicating instrument is the arrangement of parts for producing and controlling the motion of the pointer.

“The moving element of an instrument comprises those parts which move as a direct result of a variation in the electrical quantity which the instrument is measuring.

“The torque of an instrument is the turning moment produced by the electrical quantity to be measured acting through the mechanism. This is also termed the “deflecting torque” and in instruments having controlled systems is opposed by the controlling torque, which is the turning moment produced by the mechanism of the instrument tending to return it to the fixed position. Torque is expressed in millimeter-grams.”

It will be noted that the word “meter” is not used in the foregoing excerpts. Nevertheless, where rigidity of expression is not imperative it is often convenient to use “meter” as synonymous with “electrical indicating instrument.”

A-2. Classification of Indicating Instruments.—Electrical indicating instruments may be classified as follows:

- A. As to use.
 1. Portable.
 2. Switchboard (back connected).
 3. Wall type (front connected).
 4. Laboratory standard.
- B. As to principle of operation.
 1. Electrodynamic.
 2. Permanent-magnet moving coil.
 3. Moving iron.
 - a. Plunger.
 - b. Vane.

- c. Repulsion.
- d. Attraction.
- 4. Induction.
- 5. Electrothermic.
 - a. Hot wire.
 - b. Thermocouple.
- 6. Electrostatic.
- 7. Thermionic.
- 8. Rectifier.

A-3. Requirements of Electrical Indicating Instruments.—The adequacy and refinement of an electrical indicating instrument may be ascertained from an analysis of the following principal aspects of its design and performance:

1. Expenditure of energy in the instrument.
2. Sensitivity.
3. Accuracy.
4. Promptness of response. (That is, is it appropriately damped?)
5. Simplicity of scale law. (That is, is the deflection of the moving element simply related to the quantity being measured?)

The designer of the instrument is confronted at the outset with the first two items as his principal limiting factors. Minimum expenditure of energy in the instrument demands that the resistance be high for a voltmeter and low for a millivoltmeter and shunt used as an ammeter combination. Maximum feasible voltmeter resistance results in minimized current available for torque production in the moving element. This in turn requires maximum feasible magnetic flux from the permanent magnet. These limitations react upon one another so as to fix the turns required in the moving coil to develop adequate deflecting torque for the moving element. These coil turns, along with the bobbin, shaft, pointer (and half the controlling springs), fix the weight to be carried on the pivot and jewel bearing. The bearing involves limiting values of pressure and friction. The friction in turn determines the requisite value of deflecting torque and thus the magnet strength, coil current, coil turns, deflecting torque, and spring controlling torque.

A-4. Supports for Moving Elements.—Several types of supports are available for the moving elements of indicating instruments:

- a. Pivot bearing.
- b. Knife edge.
- c. Filar or thread suspension.
- d. Magnetic suspension.
- e. Flotation.

The knife-edge type has commonly been employed in current-balance and electrostatic instruments. The filar or thread suspension is used in galvanometers. The magnetic suspension was for a time employed by Stanley in watt-hour meters.

A-5. Pivot and Jewel Bearings.—The common form of bearing consists of a hardened-steel pivot riding on a sapphire or diamond jewel. The pivot is ground to a rounded end with a very small radius (actually often sharper than a needle point). The jewel may be flat or ground to a concave radius

considerably greater than that of the end of the pivot. The resulting area of contact may be very small, of the order of 10^{-5} mm.² As a result even with the lightest of moving elements, the unit pressures are very great.

Thus with an element weighing 2 g. (approximately the weight of the moving element of a Model 45 Weston d-c. voltmeter) and a contact area of 0.000002 mm.², the unit pressure assumes the value of 100 kg. per square millimeter or over 60 tons per square inch.

The limiting value or crushing load of steel on agate or sapphire is of the order of 200 kg. per square millimeter and a safe working value would certainly not exceed 150 kg. per square millimeter. By recognizing the tendency for impact loads to rise to twice the static value it is seen that the pressures employed in practical design make careful handling imperative if mushrooming of the steel pivot or crushing of the jewel is not to be the result of rough handling.

These high unit pressures are dictated by considerations of low friction and high sensitivity of the instrument. The relative importance of unit pressure and area of contact in determining the friction torque to be overcome when the moving element is deflected and the pivot turns on the jewel may be seen from the following analysis of a flat-end pivot on a flat jewel (Fig. 212).

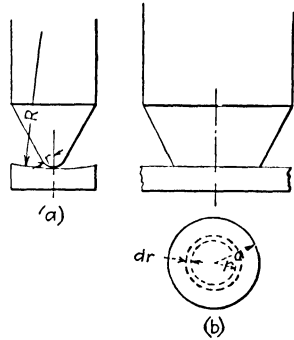

FIG. 212.

Let W = the weight of the moving element in grams.

a = radius of the area of contact circle in millimeters.

μ = coefficient of friction.

T_f = torque of friction in millimeter-grams.

The unit pressure is $p = \frac{W}{\pi a^2}$ g. per square millimeter.

The total force on an elementary area dA is $p dA$.

The force of friction for dA is $\mu p dA$.

The element of torque at any radius r is $dT_f = \mu p r dA$.

But $dA = 2\pi r dr$ for the annular elementary zone. The total torque of friction is then

$$T_f = \int_0^a \mu p r dA = 2\pi \mu p \int_0^a r^2 dr = \frac{2}{3} \mu p a^3 = \frac{2}{3} \mu W a$$

The torque is, therefore, directly proportional to the cube of the radius of contact area but only to the first power of the unit pressure. For minimum-friction torque the radius of contact area must therefore be reduced to the point where further decrease would result in unsafe unit pressures.

The same result would obtain for a pivot with rounded point resting in a jewel of much larger radius, with uniform pressure distribution assumed over a contact area sufficiently large to avoid any, even elastic, deformation. For the case of some deformation, but nevertheless elastic, the foregoing expression becomes*

* See Goss, *Gen. Elec. Rev.*, April, 1933.

$$T = \frac{2}{3} \mu \pi a^2 K W^{3/2}$$

where K is a constant depending on the materials and dimensions of the pivot. If the load causes permanent deformation of the pivot point, then

$$T_f = \frac{2}{3} \mu \sqrt{\frac{1}{\pi \rho}} W^{3/2}$$

The permissible minimum radius of contact circle for a given safe value of unit pressure p_s may be found thus:

$$W = \pi a^2 p_s \text{ or } a = \sqrt{\frac{W}{\pi p_s}} \quad [74]$$

The resulting friction torque for a weight of moving element W g. borne on a pivot of contact area large enough to limit the crushing stress to the value p_s is

$$T_f = \frac{2}{3} \mu W^{3/2} \sqrt{\frac{1}{\pi p_s}} \quad [75]$$

The friction torque is, under these limitations, proportional to the $3/2$ power of the weight of the moving element and the importance of minimum weight is even more evident.

Quality of design for pivot instruments is frequently expressed in terms of the ratio of torque of the instrument to the weight of the moving system. This "mechanical factor of merit" should, however, in the light of the foregoing discussion, be expressed as the ratio of the torque at full scale to the $3/2$ or $3/2$ power of the weight of the moving element in order to indicate more truly the smallness of the friction torque relative to the developed torque of the instrument. The $3/2$ value is advocated.

The order of magnitude of the friction torque of the bearing from Eq. [75] can be sensed by taking p_s as 150 kg. per square millimeter, μ as 0.2, and W as 2 g. These values give a friction torque of about 1/250,000,000 lb.-ft. Unless the additional deflecting torque created by increased current through the moving element of the instrument exceeds this value, the pointer will not shift position. If a sensitivity of one-fourth of a scale division is demanded, then the full-scale deflection (say 150 divisions) will require a torque development of about 1/400,000 lb.-ft.

A-6. Control of Deflection: Restoring Forces.—Early attempts at electrical instrument design employed gravity as the restoring force. All modern instruments employ springs to provide the force against which deflection takes place. The degree of proportionality of the quantity under measurement to the deflecting torque which it develops and also the degree of proportionality of the deflection to the restoring force developed by the spring will jointly determine the scale law for the instrument. In permanent-magnet moving-coil instruments the deflecting force can be made practically linearly proportional to the quantity under measurement by proper shaping of the magnet pole faces and proper proportioning of flux density to coil ampere-turns. The scale will then be a uniform scale if the springs which control the deflection develop restoring torque proportional to their deflection. In electrodynamic instruments (voltmeters and

ammeters) the torque developed for deflection will be inherently proportional to the square of the quantity under measurement and a linear spring will give a "squared-law" scale. The resulting "compression" of the scale near the zero end can be obviated somewhat by judicious proportioning of the relative dimensions and locations of the fixed and moving coils.

The helical spring inherently surpasses the flat spiralled spring in linearity of its torque-deflection relation but its use would inordinately increase the depth of the instrument case. The flat spiralled spring is invariably used. Its behavior during deflection conforms to that of a beam fixed at one end and loaded at the free end.

For the cylindrical helical spring the torsion constant is

$$K = \frac{T}{\beta} = \frac{EI}{L} = \frac{bx^3E}{12L} \quad [76]$$

where K = dyne-centimeters per radian of twist.

β = total angular deflection in radians.

E = coefficient of elasticity.

L = Length of spring in centimeters.

I = moment of cross-sectional area.

= $\frac{bx^3}{12}$ for rectangular cross section.

in which b = depth of spring parallel to axis of helix in centimeters.

x = radial thickness of spring in centimeters.

In the case of the flat spiral spring the continuous variation in radius and curvature modifies the above result to

$$K = \frac{2EI}{(a_i + a_o)\gamma} \quad [77]$$

where a_i = inner radius of spiral in centimeters.

a_o = outer radius of spiral in centimeters.

γ = total angular length of spring in radians.

The action when the deflection of the moving system coils or uncoils the spring is really one of bending and if no permanent set is to be imparted the bending stress must be limited. This is accomplished by making its length several hundred times the radial thickness. For purposes of adequate conductivity and mechanical stability the depth parallel to the axis must usually be some twenty times the radial thickness.

A-7. Control of Response.—Thus far there have been mentioned four factors associated with the behavior of the moving element when an electrical quantity is being measured by the instrument: (1) the deflecting torque, (2) the restoring or controlling torque, (3) mass and inertia of the moving element, (4) friction. Under the influence of these alone the moving element would at first overshoot its final position of rest, then, owing to the excess restoring torque, swing far below that position, and subsequently repeat oscillations many times before coming to rest when the friction had decreased the amplitude of the oscillations to zero. It is evident that a meter so designed would require an inordinate time to come to rest. It would be especially useless for measuring a constantly varying quantity, however accurate it might be in indicating the value of a steady quantity.

For satisfactory promptness of registration one additional design factor must be taken into account, *viz.*, (5) adequate damping of the amplitude of oscillations so as to reduce to a minimum the time for the moving element to come to rest. The consequent equation of the torques and displacements involved in a deflection of the instrument is

$$T_d = I\alpha + K\theta + D\omega + T_f$$

where T_d = deflecting torque in dyne-centimeters.

I = moment of inertia of moving system in gram-square centimeter.

α = angular acceleration in radians per second per second.

K = spring restoring torque in dyne-centimeters per radian.

θ = angular displacement in radians.

D = damping torque in dyne-centimeters per radian per second.

ω = angular velocity in radians per second.

T_f = friction torque of bearings in dyne-centimeters.

If for the moment all but the first term are ignored, it is to be inferred that promptness of response will be facilitated by a large initial value of α , the angular acceleration. This will result if I is small with respect to T_d or if the moving element is as light in weight as is practicable and the weight is also distributed in such manner as to provide a radius of gyration as small as torque considerations will justify. The light element likewise promotes low value of friction and high sensitivity. The desideratum is a high ratio of torque to weight and not necessarily high absolute value of torque.

Now taking the spring controlling or restoring force also into consideration, we have

$$T_d = I\alpha + K\theta$$

A sudden application of the deflecting torque will set the moving element in motion, the spring reaction being zero at the outset and increasingly opposing the deflecting torque as the deflection progresses. When $K\theta = T_d$, the angular acceleration α will be reduced to zero. Call the deflection at this point θ_1 , and then $T_d = K\theta_1$. Then

$$\begin{aligned} K\theta_1 &= I\alpha + K\theta \\ I\alpha + K(\theta - \theta_1) &= I\alpha + K\theta' = 0 \end{aligned}$$

in which $\theta' = \theta - \theta_1$ is the instantaneous deflection either side of the mean deflection, *i.e.*, the point of rest if the oscillation were damped. The motion is simple harmonic with a periodic time

$$t = 2\pi\sqrt{\frac{I}{K}}$$

As a matter of fact the motion would be the same with respect to the zero point of a center-zero scale if the deflecting force were applied and then removed. In this case the equation would be

$$I\alpha + K\theta = 0$$

in which θ is the angular value of the initial displacement. The behavior in either case is represented graphically in Fig. 213.

A constant amount of friction at the bearings would reduce the amplitude of consecutive swings by a *fixed amount*. The number of swings made before

coming to rest would be inordinately great for an instrument designed to have an acceptably high sensitivity and, therefore, low value of friction. The effect of friction, exaggerated greatly, is represented in Fig. 213.

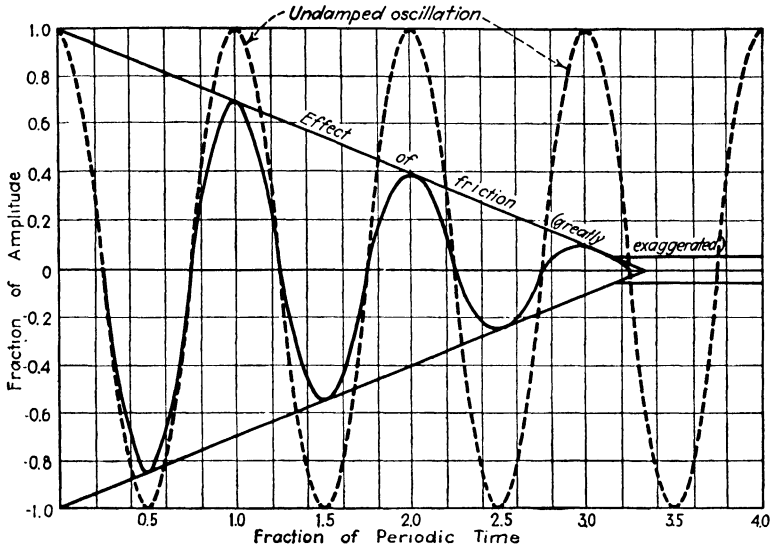

FIG. 213.

A-8. Damping.—It is evident that the slight damping effect of friction will have to be supplemented in order to render the instrument commercially

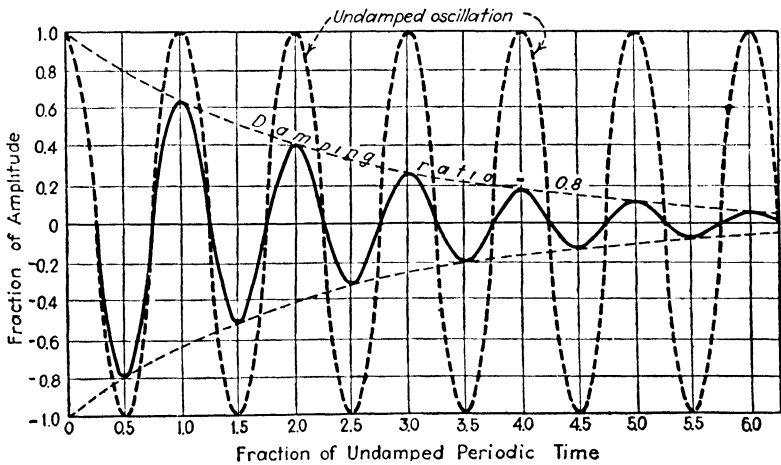

FIG. 214.

serviceable. This damping is in practice obtained in two ways: (1) fluid friction, which is independent of the load but is proportional to the speed at the low velocities encountered in electrical instruments, (2) electromagnetic

or eddy-current damping, in which the torque is also proportional to the speed as long as the temperature (and resistance) of the eddy-current disk and the strength of the magnetic field are kept constant.

Examples of fluid friction damping are (a) a vane moving in free air, (b) a vane or piston moving in a box or chamber, (c) a vane moving in a liquid more or less viscous. The last is employed in graphic meters having relatively heavy moving elements. An example of electromagnetic or eddy-current damping is a metallic (usually aluminum) disk or frame moving

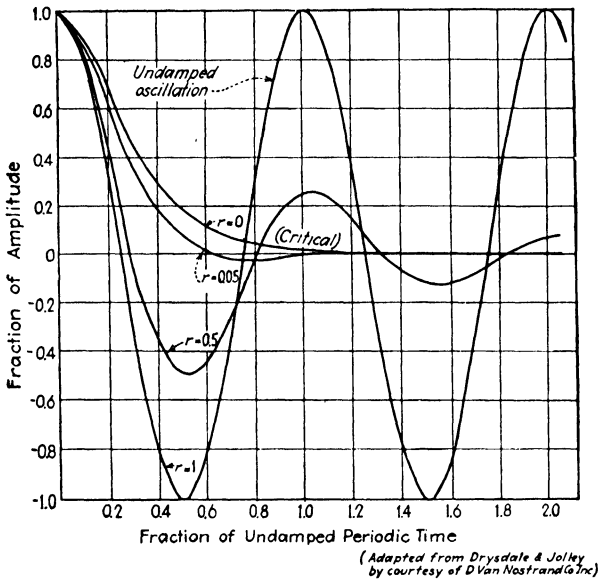

FIG. 215.

between the poles of a permanent magnet. In d-c. voltmeters and ammeters the frame on which the moving coil is moved provides the closed circuit in which the damping eddy currents flow. In a-c. instruments the damping may be obtained by an accessory magnet and disk or by means of the vane in a practically closed chamber. Small clearance between the vane and the walls of the chamber promotes the reduction to a minimum of the size and weight of the damping vane which, of course, adds to the weight and inertia of the moving element.

The effect of air damping on the oscillations of the moving system is to decrease by a *constant fraction* the amplitude of successive swings. The decay is logarithmic as is shown in Fig. 214, the equation for which is a composite of that for undamped simple harmonic motion.

$$\theta = \theta_{\max} \sin \left(\sqrt{\frac{K}{I}} t - \beta \right)$$

and that for a damped inertialess system $\theta = \theta_{\max} e^{-\frac{K}{D}t}$ and can be shown to be

$$\theta = Ce^{-\frac{D}{2I}t} t \sin \sqrt{\frac{K}{I} - \frac{D^2}{4I^2}}$$

in which the periodic time is*

$$\tau = \frac{2\pi\sqrt{\frac{I}{K}}}{\sqrt{1 - \frac{D^2}{4IK}}}$$

From this it is seen that the period of the damped oscillation is greater than when the damping is removed and is lengthened as the damping torque D is increased. When $D^2 = 4IK$, the periodic time is infinite and the moving element glides to its point of rest without overshooting. This condition is called "critical damping." It is indicated in Fig. 215.

Consecutive swings of the damped oscillation are reduced in the ratio r , called the "damping ratio," which is related to the mechanical constants of the moving system thus:

$$r = e^{-\frac{\pi}{\sqrt{\frac{4IK}{D^2} - 1}}}$$

Instruments in which the damping ratio is less than 0.5 may be classed as well damped because each consecutive oscillation in the same direction will be reduced to less than one-quarter (*i.e.*, 0.5^2) and the pointer comes to rest fairly rapidly. Zero value of r corresponds to "dead-beat" behavior of the pointer or "critical damping."

* For a derivation of these two expressions and a much more comprehensive treatment of the whole problem of damping, see Drysdale and Jolley, "Electrical Measuring Instruments" vol. I, D. Van Nostrand Company, 1924.

INDEX

A

- Abbott, T. A., 268
- Ackerman, P., polyphase check, 191
- Adjustment, bill, for polyphase errors, 172
 - of polyphase meter with transformers, 173
- Agnew, P. G., 56
- Alexanderson, E. F. W., 234
- American Institute of Electrical Engineers, 208
- Ammeter, characteristics, 10
 - with current transformer, 13
- Angus kva. meter, 264
- Aron, H., 97
 - ampere-hour meter, 267
- Association of Edison Illuminating Companies, 35, 116

B

- Balancing polyphase meter, 170
- Bearing pressure, jewel, 327
- Blakeslee, H. J., 166
- Blathey, G., 104
- Blondel theorem, 77, 81
- Boys, C. V., 96
- Brooks, H. B., 35, 40
- Brown, R. S., polyphase meter check, 194
- Burden, instrument transformers, 21-23
- Byllesby, H. M., 96

C

- Checking connections, polyphase meters, 189-202
- Code for Electricity Meters, 35, 116

- Constants, register, 117, 118
 - watthour, 117
 - watt-second, 117
- Current transformer, with ammeter, 31
 - burden, 27, 29, 30, 178
 - data, 10, 46
 - bushing type, 44, 178
 - calibration, absolute, 52
 - interchanged watthour meters, 55
 - mutual inductance, 53
 - relative, 55
 - resistance, 54
 - combined with voltage transformer, 175
 - compared with power transformer, 27
 - compensated, 35, 42
 - connection errors, 187
 - correction chart, 45
 - errors at low range, 31
 - hinged or split-core, 44
 - hole type, 43
 - ideal, 26
 - inverted, 44
 - load increase allowance, 177
 - magnetization, 28, 29
 - open-circuiting, hazard, 31
 - paralleled for totalizing, 301
 - phase angle, 28-31
 - protecting, by sphere gap, 178
 - ratio, 27, 28
 - in reactive metering, 224-228
 - ring type, 43
 - secondary leads, 181
 - Silsbee, test set, 59-62
 - stress under fault conditions, 178
 - three-wire type, 43
 - through type, 43

Current transformer, two-stage
(Brooks), 40-42
with wattmeter, 32

D

Damping, critical, 12, 332
of instruments, 10, 326, 329-333
Demand, definition, 281
maximum, significance, 280
Wright, indicator, 295
Demand interval, 281, 292
Demand meters, classified, 282
concordance, 296
splitting peak, 298
integrated-, 282-289
lagged-, 282, 289-292
thermal, 291
Westinghouse ball type, 293
De Mott, S., 96, 98
Diehl, R. P., 96
Disk, dimensions, 112, 115
eddy-path inductance, 137
effect of frequency, 144
shifting field, analysis, 123
Diversity factor, defined, 282
in totalizing, 305

E

Edison, Thomas A., 96
chemical meter, 96
Energy, defined, 1
Esterline-Angus telemeter, 314
Evans, R. D., 234

F

Ferranti, S., 96, 97
Forbes, George, 98
Fortescue, C. L., 53, 73, 234
Frequency, effect, on induction
meter, 144
on torque, 126
Friction, compensation, 109, 132
of induction meter, 142
of mercury meter, 114
Full-load adjustment, 107, 111
mercury meter, 115
polyphase meter, 171

Fuller, J. B., 96
Fusing voltage transformers, 179

G

Gardiner, Samuel, 95
Grounding, instrument transform-
ers, 174, 179

H

Holtz, F. C., 40, 131

I

Impulse, totalizing by, 306
Instruments, accuracy, 326
bearings of, 326
characteristics of, 10, 325
damping, 9
deflection, 328
design proportions, 9
effect of stray fields, 15
indicating, classified, 325
inertia, 9, 329
losses in, 326
precautions in use, 13
prompt response, 326, 329
sensitivity, 326
springs, 329
weights of moving elements, 9

J

Jewel bearing pressure, 327

K

Karapetoff, V., 277
Kilovolt-ampere-hours compared
with reactive kilovolt-ampere-
hours, 262
Kilovolt-ampere metering, by recti-
fication, 267
unbalance errors, 270
by vector addition, 271
Kilovolt-ampere meters, Angus
type, 264
Aron type, 267

- Kilovolt-ampere meters, classified, 263
 Landis and Gyr, 275
 Lincoln demand type, 265
 overrunning register, 266
 Sangamo recording demand, 271
 unbalance errors, 270
 Westinghouse, ball type, 273
 pantograph, 272
- Kinnard, I. F., 151
- Kouwenhoven, W. B., 185
 polyphase meter check, 193
- L
- Lag coil, 141
 Lag plate, 142
 Lagging, errors averted, 138
 methods of, 141
 necessity for, 138
 of polyphase meter, 169, 171
 principle of action, 139
- Landis and Gyr, kvah. meter, 275
 summation meter, 308
- Leeds and Northrup telemeter, 312, 319
- Light-load, adjustment, 110, 111
 errors in totalizing, 304
 induction meter, 142
 mercury meter, 114
 polyphase meter, 171
 with transformers, 173
- Lincoln, P. M., 309
 thermal demand meter, 291, 309
 thermal recorder telemeter, 321
 volt-ampere demand meter, 265
- Load factor, defined, 281
- Losses, in commutator meters, 112
 in indicating instruments, 326
 in induction meters, 155
- M
- Maxim, Hudson, 96, 98
- Mercury-type watthour meter, 104, 114
 friction compensation, 114
 shunted, large capacity, 115
- Meters, ampere-hour, 100
 clock type, 95
 Edison, chemical, 96
 motor, 100
 electricity, early, 95
 pendulum, Aron, 97
 thermal, Forbes, 98
 vapor, Thomson, 99
- N
- National Electric Light Association, 35, 116
- P
- Phantom loading, 159
- Phase angle, current transformer, 28-31
 elimination of, in kva. meter, 267
 with polyphase meters, 173
 of voltage transformers, 20, 23
 of wattmeter, 7
- Phase sequence, determination of, 164
 indicator, 166
- Phase shifter, 161-163
 in kva. meter, 264
 in power-factor meter, 210
- Phasing transformer, for reactive metering, 219, 246
 in Y with three-element meter, 249, 250
- Photocell in timing, 157
- Polyphase systems, Blondel theorem, 77
 Δ -connection, 69, 83
 evolution of three-phase, 66
 four-wire circuits, 87
 high-voltage, 174-178
 metering combined loads, 89-92
 superiority of, 65
 unbalanced, 71
 various types, 73-75
 Y-connection, 68, 82
- Polyphase watthour meter, Ackerman check, 191
 adjustments, 169
 balance, 170

- Polyphase watt-hour meter, Brown
 check, 194
 connections, classified, 188
 errors, 184-188
 constants, 168
 on high-voltage link, 174
 with instrument transformers, 172
 opening-the-lines check, 189
 terminal arrangements, 188
 test, systematic, 170
 Woodson check, 194-200
- Power, by ammeter and voltmeter, 2
 errors of connections, 2
 defined, 1
 by wattmeter, 3
- Power factor, definitions, 207
 from kva. meter, 272
 low, for testing, 160
 measurement, polyphase, 209
 meter, polyphase, 210
 of polyphase circuits, 208
 in polyphase registration, 172
 from reactive readings, 230
 from two-wattmeter readings, 85,
 86
 of watt-hour meters, 155
 wattmeter for low, 6
 from wattmeter readings, 87, 212
- Printometer, General Electric, 288
- Rotating standard (*see* Test meter,
 portable)

S

- Sangamo volt-ampere demand
 meter, 271
- Sawyer, W. E., 96
- Scheefer, G. A., 104
- Selsyn telemeter, 315-317
- Shallenberger, Oliver B., 100, 104
- Silsbee, F. B., 49, 52, 59
- Smith, B. H., 293
- Sparkes, H. P., 158
- Speed-load relation, 130-132
 improved characteristics, 146
- Splitting the peak, demand meters,
 298
- Stokvis, L. G., 234
- Stroboscopic calibration, 158
- Sutherland, W. F., 277
- Symmetrical components, graphical
 resolution, 255
 history, 233
 metering, of currents, 259, 260
 of voltages, 257-259
 power and energy by, 241
 principle, 235
- Synchro-tie telemeter, 315-317

R

- Reactive compensator, 219
- Reactive meter, 215
- Reactive metering, accuracy, 232
 compared with kva., 262
 four-wire, 223
 phasing transformer, 219
 three-phase, cross-phasing, 218
 two-phase, 217
 two-and-one-half-element meter,
 228
 unbalance errors, 244-255
 Y-methods, 222
- Reactive volt-amperes, 208
- Recording meters, 282
- Register, 116
 constant, 117, 118
 ratio, 117

T

- Telemeter, current type, 311, 312
 current-balance type, 311, 312
 frequency type, 323
 impulse type, 311, 312, 317-319
 limiting factors, 311
 position type, 315
 Selsyn, 315-317
 Synchro-tie, 315-317
 systems classified, 311
 thermal recorder, 321
 torque-balance type, 302, 314
 with voltage dividers, 319
 voltage type, 311, 312
- Temperature, effect on induction
 meter, 148
 errors, Class I, 149, 150
 Class II, 149, 151

- Test meter, portable, 118**
 timing in calibration, 156
- Thermal converter totalizing, 309**
- Thermal demand meter, 291-293, 309**
- Thermalloy, 151**
- Thomson, Elihu, 95, 97, 99**
 recording wattmeter, 102
 vapor meter, 99
- Timing in meter calibration, 156**
- Torque, ampere-hour meter, 102**
 braking, magnet, 108, 129
 series flux, 129-132
 voltage flux, 129-132
 commutator meter, 107
 developed in disk, 124
 driving, 125-128
 equilibrium, 330
 factors affecting, 126
 friction, 109, 130, 131, 327
 of indicating instruments, 10, 12, 327
 ratio to weight, 12, 113, 155, 328
 in totalizing meter, 305
- Totalizing, multicoiled meter, 301**
 multielement meter, 303
 paralleled current transformers, 301
 relays and impulses, 306
 thermal converter, 309, 322
- Transformer, instrument, calibration, 48**
 characteristics, ideal, 18
 combined current and voltage, 175-177
 correction factors, 36-39
 current (*see* Current transformer)
 for high voltage, 174
 with polyphase meter, 172
 potential (*see* Voltage transformer)
 in reactive metering, 251-253
 "Trivector" kvah. meter, 275
- U
- Unbalance errors, in kva. metering, 270**
- Unbalance errors, in power metering, 243**
 in reactive metering, 244-255
- Unbalance factor defined, 260**
- V
- Vectors, current transformer, 27, 32, 33, 41**
 Δ -connection, 69, 70
 Silsbee test set, 61
 single-phase, 64
 three-phase system, 67-74
 two-phase system, 80
 two-wattmeter method, 85
 voltage transformer, 19, 24, 25
 watthour meter, 136
 wattmeter, 7
- Voltage transformer, burden, 10, 21, 179**
 calibration, absolute, 49
 relative, 51
 combined with current transformer, 175-177
 compared with power transformer, 20
 fusing practice, 179
 ideal, 18
 phase angle, 20, 23, 129
 ratio, 18, 22, 179
 in reactive metering, 224-228
 regulation, 20, 22
 secondary leads, 181
 selection, 177
 with voltmeter, 24
 with wattmeter, 25, 32
- Voltage variation, effect on induction meter, 143**
- Voltmeter, characteristics of, 10**
 in power measurement, 2
- W
- Wagner, C. F., 234**
- Warner, R. G., 214**
- Watthour meter, astatic, 113**
 braking torque, 129, 130
 calibration, stroboscopic, 158
 of transformer by, 56-58

- Watt-hour meter, characteristics,**
135-137, 155
commutator type, 106, 110
constants, 117
design data, d.-c., 112
disk eddy currents, 124
driving torque, 107, 125-128
evolution, steps in, 104
frequency variation, effect of, 144
lagging, 139-142
magnet braking torque, 108
mercury type, d.-c., 103, 114
overload compensation, 146
phase relations, 127
shifting field of, 122, 123
shunted d.-c., 113
speed-load relation, 130-132
stroboscopic calibration, 158
temperature, coefficients, 112, 113
 compensation, 150-154
- Watt-hour meter, temperature**
variation, effect of, 148
tests, 156-163, 170-173
Thomson, d.-c., 102
three-wire, errors, 78-80
vector relations, 136-138
voltage variation, effect, 143
wave-form, effect, 145
- Wattmeter, accuracy of, 5**
characteristics of, 10
compensated low power-factor, f
effect of inductance, 6
errors of connections, 5
power by, 3
- Westinghouse kva. meter, ball type,**
273
 pantograph type, 272
- Weston, Edward, 96
Wilson, M. S., 42
Woodson, W. C., 195
Wright demand indicator, 295

